

Reference pressure sensor Models CPT6200 and CPT6210

WIKA data sheet CT 11.03



Applications

- Calibration service companies and service industry
- Measurement and control laboratories
- Pressure tests

Special features

- Measuring ranges from 0 ... 100 mbar to 0 ... 1,000 bar [0 ... 5 psi to 0 ... 14,500 psi]
- Pressure type: positive and negative pressure, absolute pressure and differential pressure
- Accuracy: 0.2 % or 0.1 % (incl. calibration certificate)
- Fast connection to digital display instrument (plug-and-play)



Reference pressure sensor model CPT62x0

Configurator



Description

Extensive application possibilities

For the hand-held pressure indicators model CPH6200 and CPH6300, external reference pressure sensors of model CPT6200 with measuring ranges of up to 1,000 bar [14,500 psi] are available. The CPT6210 reference pressure sensor is available for intrinsically safe use with the model CPH6210 hand-held pressure indicator.

Functionality

The sensors have been designed for measuring gauge and absolute pressure. Differential pressure measurement is possible with a 2-channel version CPH62x0-S2, and two connected model CPT62x0 reference pressure sensors.

Certified accuracy

For each reference pressure sensor, the accuracy for the complete measuring chain is certified by a factory calibration certificate. On request, a DAkkS calibration certificate will be provided for the reference pressure sensor.

Specifications

Basic information		
Case		
Material	Stainless steel	
Dimensions	→ See technical drawing	
Weight	Approx. 220 g [0.49 lb]	
Electrical connection	Bayonet connector, 7-pin	
Sensor compatibility per plug-and-play		
CPT6200	<ul style="list-style-type: none"> ■ To CPH6200 ■ To CPH6300 	<ul style="list-style-type: none"> ■ Via 1.1 m [3.3 ft] sensor connection cable ■ Extension cable for connection of sensors Length: approx. 3.8 m [12.5 ft] to approx. 5 m [16.4 ft]
CPT6210	To CPH6210	<ul style="list-style-type: none"> ■ Via 1.1 m [3.3 ft] sensor connection cable ■ Extension cable for connection of sensors Length: approx. 3.8 m [12.5 ft] to approx. 5 m [16.4 ft]
Ingress protection	<ul style="list-style-type: none"> ■ IP65 ■ IP67 when connected Both ingress protection types are met	

Accuracy specifications	
Accuracy ¹⁾	<ul style="list-style-type: none"> ■ ≤ 0.2 % of span at reference conditions ■ 0.1 % recommended, only in combination with a calibration of sensor and hand-held
Reference conditions	
Ambient temperature	15 ... 25 °C [59 ... 77 °F]
Mounting position	Vertical mounting position, process connection facing downwards
Compensated range	0 ... 80 °C [0 ... 176 °F]
Mean temperature coefficient	≤ 0.2 % of span/10 K (outside the reference conditions)

1) It is defined by the total measurement uncertainty, which is expressed with the coverage factor (k = 2) and includes the following factors: the intrinsic performance of the instrument, the measurement uncertainty of the reference instrument, long-term stability, influence of ambient conditions, drift and temperature effects over the compensated range during a periodic zero point adjustment.

Pressure ranges, gauge pressure

mbar	
0 ... 100	0 ... 400
0 ... 160	0 ... 600
0 ... 250	-

bar	
0 ... 1	0 ... 60
0 ... 1.6	0 ... 70
0 ... 2.5	0 ... 100
0 ... 4	0 ... 160
0 ... 6	0 ... 250
0 ... 10	0 ... 400
0 ... 16	0 ... 600
0 ... 25	0 ... 1,000
0 ... 40	-

psi	
0 ... 5	0 ... 300
0 ... 10	0 ... 500
0 ... 15	0 ... 1,000
0 ... 20	0 ... 1,500
0 ... 30	0 ... 2,000
0 ... 50	0 ... 3,000
0 ... 100	0 ... 6,000
0 ... 150	0 ... 8,000
0 ... 200	0 ... 14,500

Pressure ranges, absolute pressure

bar abs.	
0 ... 0.25	0 ... 4
0 ... 0.4	0 ... 6
0 ... 0.6	0 ... 10
0 ... 1	0 ... 16
0 ... 1.2	0 ... 25
0 ... 1.6	0.8 ... 1.2
0 ... 2.5	-

psi abs.	
0 ... 5	0 ... 50
0 ... 10	0 ... 100
0 ... 15	0 ... 150
0 ... 20	0 ... 200
0 ... 30	-

Pressure ranges, vacuum and +/- measuring range

mbar	
-600 ... +600	-19.99 ... +40
-400 ... +400	-19.99 ... +60
-250 ... +250	-600 ... 0
-100 ... +100	-400 ... 0
-19.99 ... +25	-250 ... 0

psi	
-3 ... +3	-8 ... 0
-5 ... +5	-15 ... 0
-8 ... +8	-15 ... +40
-15 ... +15	-15 ... +70
-3 ... 0	-15 ... +130
-5 ... 0	-

bar	
-1 ... 0	-1 ... 9
-1 ... 1.5	-1 ... 15
-1 ... 3	-1 ... 24
-1 ... 5	-1 ... 39

→ Other measuring ranges on request.

Further details on: measuring range

Overpressure limit		
3 times	< 25 bar	< 360 psi
2 times	> 25 ... ≤ 600 bar	> 360 ... ≤ 8,700 psi
1.5 times	> 600 ... ≤ 1,000 bar	> 8,700 ... ≤ 14,500 psi

Process connection

Standard	Thread sizes	Possible measuring ranges
EN 837	<ul style="list-style-type: none"> ■ G ½ B ■ G ¼ B 	≤ 1,000 bar [≤ 14,500 psi]
	<ul style="list-style-type: none"> ■ G ½ B flush with O-ring (NBR) ■ G ½ B flush with O-ring (EPDM) 	1.6 ... 1,000 bar or bar abs. [20 ... 14,500 psi or psi abs.]
	<ul style="list-style-type: none"> ■ G 1 B flush with O-ring (NBR) ■ G 1 B flush with O-ring (EPDM) 	> 0.1 ... ≤ 1.6 bar or bar abs. [> 5 ... ≤ 20 psi or psi abs.]
	<ul style="list-style-type: none"> ■ ½ NPT ■ ¼ NPT 	≤ 1,000 bar [≤ 14,500 psi]
ANSI/ASME B1.20.1	<ul style="list-style-type: none"> ■ ½ NPT ■ ¼ NPT 	≤ 1,000 bar [≤ 14,500 psi]

Further details on: process connection		
Process connection adapter 1)	<ul style="list-style-type: none"> ■ Without ■ G ½ to ¼ NPT ■ G ½ to ½ NPT 	
Seal	<ul style="list-style-type: none"> ■ NBR ■ EPDM ■ FKM/FPM 	
Other versions	Oil- and grease-free	Per G93:2019 level D (< 220 mg/m ²)
	Thread (only for CTP6210)	M4 in pressure port, 5 mm deep
	→ Others on request	
Material		
Wetted parts	-1 ... 1,000 bar [-14.5 ... 14,500 psi]	<ul style="list-style-type: none"> ■ Stainless steel 1.4404 (316L) ■ Elgiloy® 2.4711
	> 40 bar ... ≤ 1,000 bar [> 500 ... ≤ 15,000 psi]	<ul style="list-style-type: none"> ■ Process connection: stainless steel 1.4404 (316L) ■ Sensor: Elgiloy® 2.4711
	-1 ... 10,000 bar [-14.5 ... 150,000 psi]	<ul style="list-style-type: none"> ■ Stainless steel 1.4435 (316L) ■ Hastelloy® 2.4819 (HC276) ■ Gold-plated
	> 25 bar [360 psi]	<ul style="list-style-type: none"> ■ Stainless steel with O-ring from NBR ■ Elgiloy® with O-ring from NBR
Flush design	<ul style="list-style-type: none"> ■ Stainless steel with O-ring from NBR ■ Stainless steel with O-ring from FKM/FPM ■ Stainless steel with O-ring from EPDM ■ Hastelloy C4 with O-ring from NBR ■ Hastelloy C4 with O-ring from FKM/FPM ■ Hastelloy C4 with O-ring from EPDM 	
Internal pressure transmission medium	Synthetic oil	<ul style="list-style-type: none"> ■ For measuring ranges to ≤ 16 bar [≤ 300 psi] ■ Flush diaphragm ■ Listed by FDA for food industry



1) Only possible for thread size G ½ B.

Operating conditions	
Medium temperature range	
CPT6200	-30 ... +100 °C [-22 ... +212 °F]
CPT6210	-20 ... +50 °C [-4 ... +122 °F]
Operating temperature	
CPT6200	-20 ... +80 °C [-4 ... +176 °F]
CPT6210	-20 ... +50 °C [-4 ... +122 °F]
Storage temperature range	
CPT6200	-40 ... +100 °C [-40 ... +212 °F]
CPT6210	-40 ... +80 °C [-40 ... +176 °F]
Relative humidity, condensation	0 ... 95 % relative humidity (non-condensing)
Ingress protection	<ul style="list-style-type: none"> ■ IP65 ■ IP67 when connected Both ingress protection types are met
Permissible pollution degree	3 per EN 61010-1
EMC (HF field)	EN 61326 emission (group 1, class B) and immunity (portable equipment)

Safety-related characteristic values for reference pressure sensor CPT6210

Parameters	Power supply circuit CPT6210
Max. input voltage	$U_i = \text{DC } 10.4 \text{ V}$
Max. input current	$I_i = 100 \text{ mA}$
Max. input power	$P_i = 500 \text{ mW}$
Max. internal capacitance	$C_i = 600 \text{ nF}$
Max. internal inductance	L_i negligible

Approvals

Logo	Description	Region
	EU declaration of conformity for CPT6200	European Union
	EMC directive EN 61326 emission (group 1, class B) and immunity (portable equipment)	
	Pressure Equipment Directive PS > 200 bar; module A, pressure accessory	
	RoHS directive	
	EU declaration of conformity for CPT6210	European Union
	EMC directive EN 61326 emission (group 1, class B) and immunity (portable equipment)	
	Pressure Equipment Directive PS > 200 bar; module A, pressure accessory	
	RoHS directive	
	ATEX directive Hazardous areas - Ex i Zone 1 gas II 2G Ex ib IIC T4 Gb II 2G Ex ib IIC T4	

Certificates



Description	
Calibration	<ul style="list-style-type: none"> ■ 3.1 inspection certificate per EN 10204 ■ DAkkS calibration certificate (traceable and accredited in accordance with ISO/IEC 17025)
Recommended calibration interval	1 year (dependent on conditions of use)

→ For approvals and certificates, see website

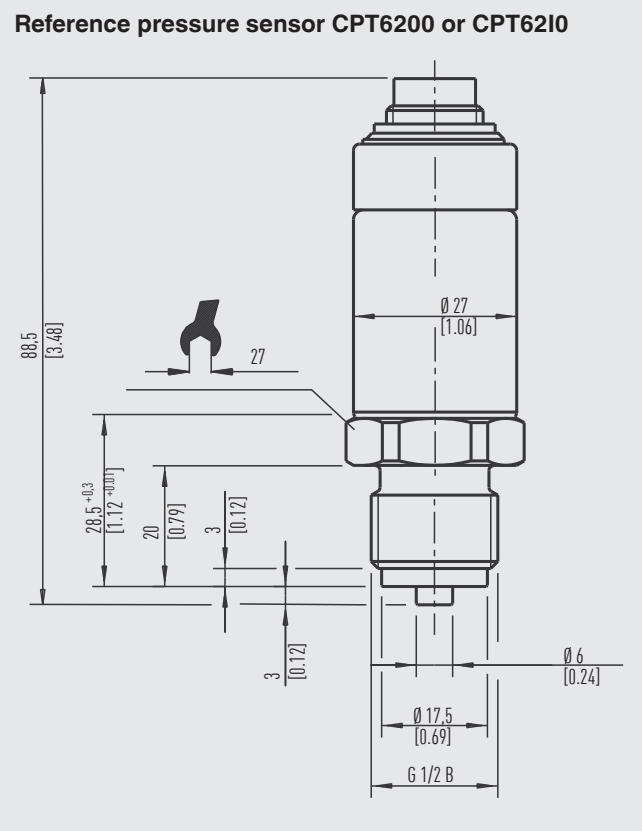

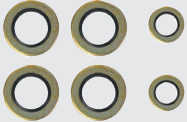

Dimensions in mm [in]

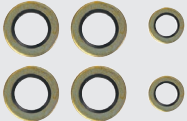

Accessories and spare parts

For model CPT6200 to CPH6200 or CPH6300		Order code
Description ¹⁾		CPH-A-62- CPH-A-63-
	Seal set Consisting of: <ul style="list-style-type: none"> ■ 4 x G 1/2 USIT seals ■ 2 x G 1/4 USIT seals ■ Plastic box 	-D-
	Cable Sensor connection cable Length: approx. 1.1 m [3.3 ft]	-S-
	Extension cable for connection of sensors Length: approx. 3.8 m [12.5 ft] to approx. 5 m [16.4 ft]	-V-
Ordering information for your enquiry:		
1. Order code: CPH-A-62- 2. Option:		↓ []

1) The figures are an example and may change depending on the state of the art in design, material composition and representation.

For model CPT6210 to CPH6210		Order code
Description ¹⁾		CPH-A-6I-
	Seal set Consisting of: <ul style="list-style-type: none"> ■ 4 x G 1/2 USIT seals ■ 2 x G 1/4 USIT seals ■ Plastic box 	-D-
	Cable Sensor connection cable Length: approx. 1.1 m [3.3 ft] <p> Ex version! Marked with blue ring.</p>	-S-
	Extension cable for connection of sensors Length: approx. 3.8 m [12.5 ft] to approx. 5 m [16.4 ft] <p> Ex version! Marked with blue ring.</p>	-V-
Ordering information for your enquiry:		
1. Order code: CPH-A-6I- 2. Option:		↓ []

1) The figures are an example and may change depending on the state of the art in design, material composition and representation.

Scope of delivery

- Reference pressure sensor model CPT6200 or model CPT6210
- Operating instructions
- Calibration certificate

Ordering information

Model / Unit / Measuring range / Accuracy / Process connection / Wetted parts / Special design features / Type of certificate / Pressure adapter / Further approvals / Additional ordering information

Configurator



© 01/2025 WIKA Alexander Wiegand SE & Co. KG, all rights reserved.
The specifications given in this document represent the state of engineering at the time of publishing.
We reserve the right to make modifications to the specifications and materials.

