**Instruction
Manual**

**Model UT750
Digital Indicating Controller
User's Manual for
Dual-loop Control**



IM 05D01B02-51E

Blank Page

Introduction

Thank you for purchasing the UT750 digital indicating controller.

■ How to Use the Manuals

| Purpose | Title | Description |
|---|--------------------------------------|--|
| Setup | 1. Installation | Describes the tasks (installation, wiring, and others) required to make the controller ready for operations. |
| Basic operation | 2. Initial Settings | Describes examples of setting PV input types, control output types, and alarm types. Making settings described herein allows you to carry out basic control. |
| Operating procedures and troubleshooting | 3. Operations 4.1 Troubleshooting | Describes key operation sequences. For operation control through external contact inputs, see "1.5 Terminal Wiring Diagrams." |
| Brief operation | 5.1 Parameter Map | Contains the parameter map used as a guideline for setting parameters. |
| Function description and setpoint recording | 5.2 Lists of Parameters | Briefly describes the functions of parameters. In addition, each parameter table has a User Setting column, where you can record your setpoints when setting them in the controller. |

■ Controllers Applicable to Dual-loop Control

The specification codes of the UT750 applicable to dual-loop control are given in the table below.

| | |
|----------|----------|
| UT750-50 | UT750-51 |
|----------|----------|

■ Regarding This User's Manual

- (1) This manual should be provided to the end user. Keep an extra copy or copies of the manual in a safe place.
- (2) Read this manual carefully to gain a thorough understanding of how to operate this product before starting operation.
- (3) This manual describes the functions of this product. Yokogawa M&C Corporation (hereinafter simply referred to as Yokogawa) does not guarantee the application of these functions for any particular purpose.
- (4) Under absolutely no circumstances may the contents of this manual, in part or in whole, be transcribed or copied without permission.
- (5) The contents of this manual are subject to change without prior notice.
- (6) Every effort has been made to ensure that the details of this manual are accurate. However, should any errors be found or important information be omitted, please contact your nearest Yokogawa representative or our sales office.

■ Safety Precautions

The following symbol is indicated on the controller to ensure safe use.



This symbol on the controller indicates that the operator must refer to an explanation in the user's manual in order to avoid the risk of injury or death of personnel or damage to the instrument. The manual describes how the operator should exercise special care to avoid electric shock or other dangers that may result in injury or loss of life.

The following symbols are used in the hardcopy user's manuals and in the user's manual supplied on the CD-ROM.



Indicates that operating the hardware or software in a particular manner may damage it or result in a system failure.



Draws attention to information that is essential for understanding the operation and/or features of the controller.

■ Regarding Force Majeure

Yokogawa M&C Corporation assumes no liability for any loss or damage, direct or indirect, caused by the use of or unpredictable defects of the product.

Model UT750 Digital Indicating Controller User's Manual for Dual-loop Control

IM 05D01B02-51E 1st Edition

CONTENTS

| | | |
|-----------|--|------------|
| 1. | Installation | 1-1 |
| 1.1 | Model and Suffix Codes | 1-1 |
| 1.2 | How to Install | 1-2 |
| 1.3 | How to Connect Wires | 1-5 |
| 1.4 | Hardware Specifications | 1-7 |
| 1.5 | Terminal Wiring Diagrams | 1-13 |
| 2. | Initial Settings | 2-1 |
| 2.1 | Names and Functions of Front Panel Parts | 2-2 |
| 2.2 | Setting UT Mode (Setting First at Power-on) | 2-3 |
| 2.3 | Changing UT Mode | 2-4 |
| 2.4 | Setting PV Input Types of Loop1 and Loop2 | 2-6 |
| 2.5 | Setting Control Output Types of Loop1 and Loop2 | 2-10 |
| 2.6 | Initializing Parameters | 2-13 |
| 2.7 | Changing Alarm Type of Loop1 | 2-14 |
| 2.8 | Changing Alarm Type of Loop2 | 2-16 |
| 2.9 | Description of Multiple Setpoints and PID | 2-19 |
| 3. | Operations | 3-1 |
| 3.1 | Monitoring-purpose Operating Displays Available during Operation | 3-1 |
| 3.2 | Setting Target Setpoint (SP) of Loop1 | 3-5 |
| 3.3 | Setting Target Setpoint (SP) of Loop2 | 3-6 |
| 3.4 | Performing/Canceling Auto-tuning of Loop1 | 3-7 |
| 3.5 | Performing/Canceling Auto-tuning of Loop2 | 3-9 |
| 3.6 | Setting PID of Loop1 Manually | 3-11 |
| 3.7 | Setting PID of Loop2 Manually | 3-13 |
| 3.8 | Setting Alarm Setpoints of Loop1 | 3-14 |
| 3.9 | Setting Alarm Setpoints of Loop2 | 3-16 |
| 3.10 | Selecting Target Setpoint Numbers (SPNO) | 3-17 |
| 3.11 | Switching between Run and Stop | 3-18 |
| 3.12 | Switching between AUTO and MAN of Loop1 | 3-19 |
| 3.13 | Switching between AUTO and MAN of Loop2 | 3-20 |
| 3.14 | Manipulating Control Output during Manual Operation of Loop1 | 3-21 |
| 3.15 | Manipulating Control Output during Manual Operation of Loop2 | 3-24 |
| 3.16 | Switching between Remote (REM) and Local (LCL) of Loop1 | 3-26 |
| 3.17 | Switching between Remote (REM) and Local (LCL) of Loop2 | 3-28 |

| | | |
|------------|--|------------|
| 4. | Troubleshooting and Maintenance | 4-1 |
| 4.1 | Troubleshooting | 4-1 |
| 4.2 | Maintenance | 4-5 |
| 4.2.1 | Cleaning | 4-5 |
| 4.2.2 | Replacing Brackets | 4-5 |
| 4.2.3 | Attaching Terminal Cover | 4-5 |
| 4.2.4 | Replacing Parts with a Limited Service Life | 4-7 |
| 4.2.5 | Replacing Control Output Relays | 4-8 |
| 5. | Parameters | 5-1 |
| 5.1 | Parameter Map | 5-1 |
| 5.2 | Lists of Parameters | 5-6 |
| 6. | Function Block Diagram and Descriptions | 6-1 |

1. Installation

This chapter describes installation, wiring, and other tasks required to make the controller ready for operation.

1.1 Model and Suffix Codes

Before using the controller, check that the model and suffix codes match your order.

| Model | Suffix Code | Description |
|--------------------|-------------|--|
| UT750 | | Digital indicating controller (provided with Custom Computing Function*) |
| Type | -0 | Single-loop type |
| | -1 | Position proportional type |
| | -5 | Dual-loop type |
| Optional functions | 0 | None |
| | 1 | With communication, remote input |

Check that the following items are provided:

- Digital indicating controller (of ordered model) 1
- Brackets (mounting hardware) 1 pair
- Unit label 1
- User's Manuals for Single-loop Control 5 (A2 size)
- User's Manual (Reference) (CD-ROM version) 1

* Using an optional custom computation building tool (Model LL200-E10) that runs on a personal computer, you can build a variety of computations (e.g., four arithmetic operations, logical operations, ten-segment linearizer computations, temperature correction factor computations, and pressure correction factor computations) to be applied to the controller's I/O signals.

1.2 How to Install

NOTE

To install the controller, select a location where:

1. no one may accidentally touch the terminals,
2. mechanical vibrations are minimal,
3. corrosive gas is minimal,
4. temperature can be maintained at about 23°C and the fluctuation is minimal,
5. no direct radiant heat is present,
6. no magnetic disturbances are caused,
7. no wind blows against the terminal board (reference junction compensation element),
8. no water is splashed,
9. no flammable materials are around,

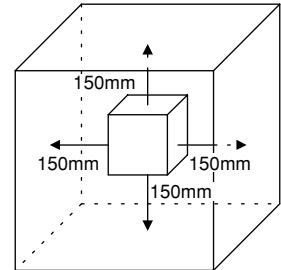

Never place the controller directly on flammable items or equipment.

If the controller has to be installed close to flammable items or equipment, be sure to provide shielding panels all around the controller, at least 150 mm away from every side; the panels should be made of either 1.43 mm-thick metal-plated steel plates or 1.6 mm-thick uncoated steel plates.

● Installation Position

Install the controller at an angle within 30° from horizontal with the front panel facing upward. Do not install it facing downward. The position of right and left sides should be horizontal.

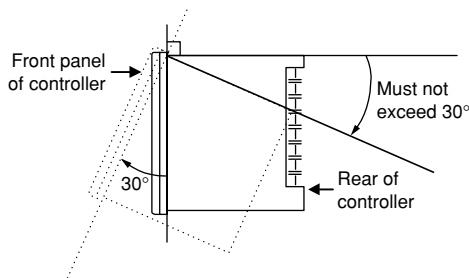

External Dimensions and Panel Cutout Dimensions

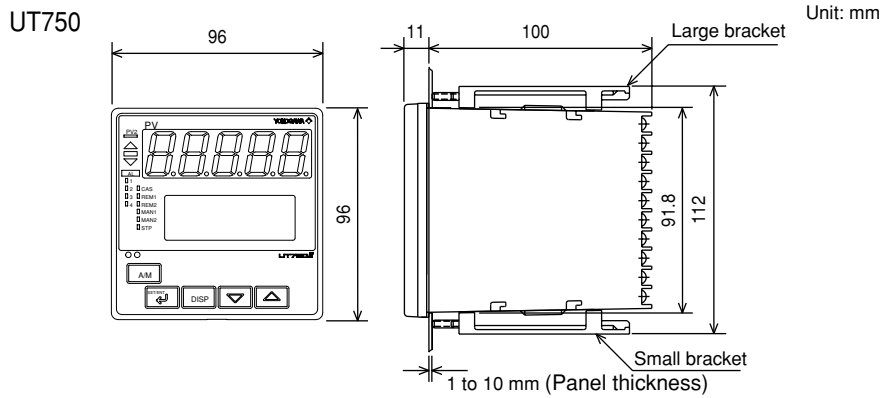

General installation

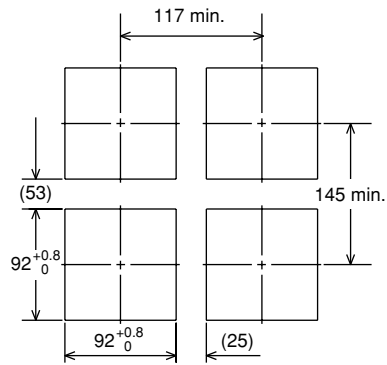

Side-by-side close installation

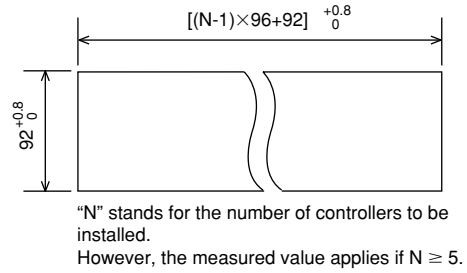

■ How to Install



CAUTION

Turn off the power to the controller before installing it on the panel because there is a possibility of electric shock.

After opening the mounting hole on the panel, follow the procedures below to install the controller:

1. Insert the controller into the opening from the front of the panel so that the terminal board on the rear is at the far side.
2. Set the brackets in place on the top and bottom of the controller as shown in the figure below, then tighten the screws of the brackets. Take care not to overtighten them.

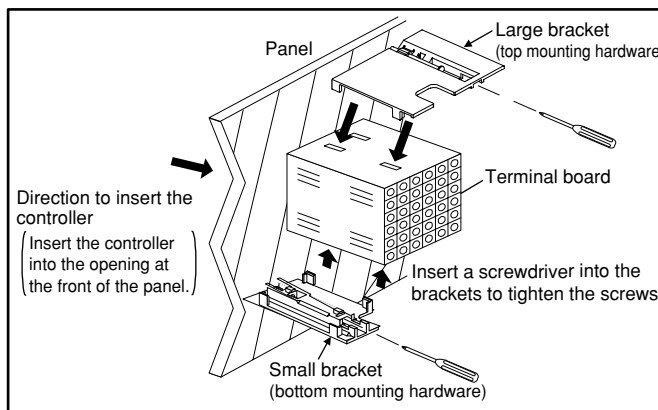

1.3 How to Connect Wires



- 1) Before carrying out wiring, turn off the power to the controller and check that the cables to be connected are not alive with a tester or the like because there is a possibility of electric shock.
- 2) Wiring must be carried out by personnel who have basic electrical knowledge and practical experience.

NOTE

- 1) Provide power from a single-phase instrument power supply. If there is a lot of noise in the power line, insert an insulating transformer into the primary side of the line and use a line filter (recommended part: ZAC2205-00U from TDK) on the secondary side. As a countermeasures against noise, do not place the primary and secondary power cables close to each other.
- 2) For thermocouple input, use shielded compensating lead wires for wiring. For RTD input, use shielded wires that have low conductor resistance and cause no significant differences in resistance between the three wires. The cables to be used for wiring, terminal specifications, and recommended parts are as shown below.
- 3) Control output relays may be replaced. However, because they have a life of 100,000 times that of the resistance load, use auxiliary relays to turn on/off a load.
- 4) The use of inductance (L) loads such as auxiliary relays, motors and solenoid valves causes malfunction or relay failure; always insert a CR filter for use with alternating current or a diode for use with direct current, as a spark-removal surge suppression circuit, into the line in parallel with the load.

■ For DC Relay Wiring

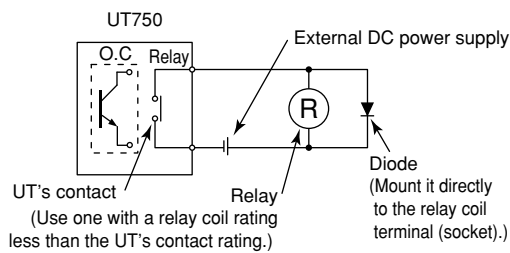

■ For AC Relay Wiring

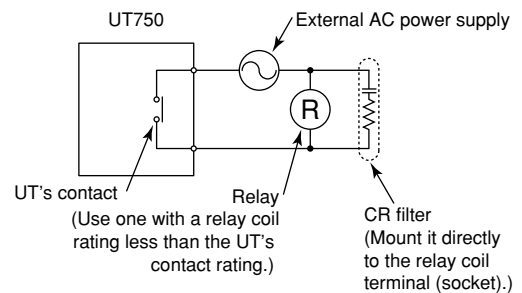

● Cable Specifications and Recommended Cables

| Purpose | Name and Manufacturer |
|--|---|
| Power supply, grounding, relay contact outputs | 600 V PVC insulated wires, JIS C 3307, 0.9 to 2.0 mm ² |
| Thermocouple | Shielded compensating lead wires, JIS C 1610, □X-□-□-□ (See Yokogawa Electric's GS 6B1U1-E.) |
| RTD | Shielded wires (three conductors), UL2482 (Hitachi Cable) |
| Other signals | Shielded wires |

● Recommended Terminal Lugs

| Applicable wire size | Tightening torque |
|-----------------------------|-------------------|
| 0.3 to 1.65 mm ² | 0.8 N·m or less |

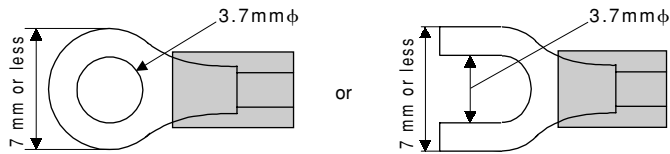

● Terminal Covers

| Target Model | Part Number | Sales Unit |
|--------------|-------------|------------|
| For UT750 | T9115YD | 1 |

1.4 Hardware Specifications

PV Input Signals

- Number of inputs: 2 (terminals for Loop1: ⑪-⑫-⑬, terminals for Loop2: ④①-④②-④③)
- Input type: Universal input system. The input type can be selected with the software.
- Sampling period: 50, 100, 200 and 500 ms (The sampling period can be selected with the software.)
Initial value; 200 ms
- Burnout detection: Functions at TC, RTD, standard signal (0.4 to 2 V or 1 to 5 V)
Upscale, downscale, and off can be specified.
For standard signal, burnout is determined to have occurred if it is 0.1 V or less.
- Input bias current: 0.05 μA (for TC or RTD b-terminal)
- Measurement current (RTD): About 0.13 mA
- Input resistance: 1 M Ω or more for thermocouple or mV input
About 1 M Ω for DC voltage input
Loop2 PV input of 0.00 to 1.25 V range is about 8 M Ω
- Allowable signal source resistance: 250 Ω or less for thermocouple or mV input
Effects of signal source resistance: 0.1 $\mu\text{V}/\Omega$ or less
2 k Ω or less for DC voltage input
Effects of signal source resistance: About 0.01%/100 Ω
- Allowable wiring resistance: for RTD input
Maximum 150 Ω /wire: Conductor resistance between three wires should be equal
However, 10 Ω /wire for a maximum range of -150.0 to 150.0 $^{\circ}\text{C}$.
Wire resistance effect: $\pm 0.1^{\circ}\text{C}/10 \Omega$
- Allowable input voltage: ± 10 V DC for thermocouple, mV, or RTD input
 ± 20 V DC for DC voltage input
- Noise rejection ratio: 40 dB (50/60 Hz) or more in normal mode
120 dB (50/60 Hz) or more in common mode
- Reference junction compensation error: $\pm 1.0^{\circ}\text{C}$ (15 to 35 $^{\circ}\text{C}$)
 $\pm 1.5^{\circ}\text{C}$ (0 to 15 $^{\circ}\text{C}$, 35 to 50 $^{\circ}\text{C}$)
- Applicable standards: JIS, IEC, DIN (ITS-90) for thermocouples and RTD

Remote Input Signals (For both Loop1 and Loop2)

Available only for controllers with remote input terminals.

- Number of inputs: 1 (terminals ⑳-㉑)
- Input type: Settable in a range of 0-2, 0-10, 0.4-2.0, or 1-5 V DC
- Sampling period: 100, 200 and 500 ms
The sampling period of a remote input signal is associated with the PV input's sampling period. If the PV input's sampling period is 50 ms, however, the sampling period of a remote input signal lengthens to 100 ms.
- Input resistance: About 1 M Ω
- Input accuracy: $\pm 0.3\% \pm 1$ digit of input span for 0 to 2 V DC
 $\pm 0.2\% \pm 1$ digit of input span for 0 to 10 V DC
 $\pm 0.375\% \pm 1$ digit of input span for 0.4 to 2.0 V DC
 $\pm 0.3\% \pm 1$ digit of input span for 1 to 5 V DC
Under standard operating conditions (23 $\pm 2^{\circ}\text{C}$, 55 $\pm 10\%$ RH, power frequency of 50/60 Hz)

Loop Power Supply

Power is supplied to a two-wire transmitter.

(15 V DC: terminals ⑭-⑮)

A resistor (10 to 250 Ω) connected between the controller and transmitter converts a current signal into a voltage signal, which is then read via the PV input terminal.

Supply voltage: 14.5 to 18.0 V DC, max. 21 mA (provided with a protection circuit against a field short-circuit)

Retransmission Output

Either PV, target setpoint, or control output is output.

Either the retransmission output or the loop power supply can be used with terminals ⑭-⑮.

- Number of outputs: 1 or 2 (terminals ⑭-⑮, terminals ⑯-⑰)
- Output signal: 4-20, 0-20, 20-4, or 20-0 mA DC (where, outputting signal levels of less than 0 mA is not feasible)
- Load resistance: 600 Ω or less
- Output accuracy: ±0.1% of span (±5% of span for 1 mA or less.)
Under standard operating conditions (23±2°C, 55±10% RH, power frequency of 50/60 Hz)

Control Output

Universal output system, The output type can be selected with the software.

- Current output
(Loop1: terminals ⑯-⑰; heating-side output: terminals ⑯-⑰, cooling-side output: terminals ⑭-⑮)
(Loop2: terminals ④⑥-④⑦; heating-side output: terminals ④⑥-④⑦, cooling-side output: Not selected)

| | |
|-------------------|--|
| Number of outputs | 2 or 3 (two for heating/cooling control), switched between a voltage pulse output and current output. |
| Output signal | 4-20, 0-20, 20-4, or 20-0 mA DC |
| Load resistance | 600 Ω or less |
| Output accuracy | ±0.1% of span (±5% of span for 1 mA or less) Under standard operating conditions (23±2°C, 55±10% RH, power frequency of 50/60 Hz) |

- Voltage pulse output
(Loop1: terminals ⑯-⑰; heating-side output: terminals ⑯-⑰, cooling-side output: Not selected)
(Loop2: terminals ④⑥-④⑦; heating-side output: terminals ④⑥-④⑦, cooling-side output: Not selected)

| | |
|-------------------|--|
| Number of outputs | 2 switched between a voltage pulse output and current output. |
| Output signal | On-voltage = 12 V or more (load resistance: 600 Ω or more) Off-voltage = 0.1 V DC or less |
| Resolution | 10 ms or 0.1% of output, whichever is larger |

- Relay contact output
(Loop1: terminals ①-②-③, heating-side output: terminals ①-②-③, cooling-side output: terminals ④-⑦)
(Loop2: terminals ④⑧-④⑨-⑤⑩; heating-side output: terminals ④⑧-④⑨-⑤⑩, cooling-side output: terminals ⑤-⑦)

| | |
|-------------------|--|
| Number of outputs | 2 or 4 (two for heating/cooling control) |
| Output signal | Three terminals (NC, NO, and common) |
| Contact rating | 250 V AC or 30 V DC, 3 A (resistance load) |
| Resolution | 10 ms or 0.1% of output, whichever is larger |

Contact Inputs

- Purpose: Target setpoint selection, remote/local mode switching, and run/stop switching
- Number of inputs: 7
- Input type: Non-voltage contact or transistor open collector input
- Input contact rating: 12 V DC, 10 mA or more
- On/off determination: For non-voltage contact input, contact resistance of 1 k Ω or less is determined as "on" and contact resistance of 20 k Ω or more as "off." For transistor open collector input, input voltage of 2 V or less is determined as "on" and leakage current must not exceed 100 μ A when "off."
- Minimum status detection hold time: PV input's sampling period \times 3

Contact Outputs

- Purpose: Alarm output, FAIL output, and others
- Number of outputs: 7 (relay: 3, transistor: 4)
- Relay contact rating: 240 V AC, 1 A, or 30 V DC, 1 A (COM terminal is common)
- Transistor contact rating: 24 V DC, 50 mA (COM terminal is common)

Display Specifications

- PV display: 5-digit, 7-segment, red LEDs, character height of 20 mm for UT750
- Setpoint display: 32 \times 128 dot LCD display with back-light
- Status indicating lamps: LEDs

Safety and EMC Standards

- Safety: Compliant with IEC1010-1: 1990 and EN61010-1: 1992
Approved by CSA1010
CSA1010 installation category (overvoltage category): CATII (IEC1010-1)
Approved by UL508
- EMC standards: This instrument complies with the following EMC standards (the instrument continues to operate at a measuring accuracy of within \pm 20% of the range during tests):
 - EMI (emission), EN55011: Class A Group 1
 - EMS (immunity), EN50082-2: 1995

Construction, Installation, and Wiring

- Construction: Only the front panel is dust-proof and drip-proof (protection class IP55) For side-by-side close installation the controller loses its dust-proof and drip-proof protection.
- Material: ABS resin and polycarbonate
- Case color: Black
- Weight: About 1 kg or less
- Dimensions: 96 (W) × 96 (H) × 100 (depth from panel face) mm
- Installation: Panel-mounting type. With top and bottom mounting hardware (1 each)
- Panel cutout dimensions: $92_0^{+0.8}$ (W) × $92_0^{+0.8}$ (H) mm
- Installation position: Up to 30° upward facing (not designed for facing downward)
- Wiring: M3.5 screw terminals (for signal wiring and power/ground wiring as well)

Power Supply Specifications

- Power supply: Rated voltage of 100 to 240 V AC ($\pm 10\%$), 50/60 Hz
 - Power consumption: Max. 20 VA (8.0 W max.)
 - Data backup: Lithium cell with life expectancy of 10 years.
 - Withstanding voltage
 - Between primary terminals* and secondary terminals**:
At least 1500 V AC for 1 minute (Note)
 - Between primary terminals* and grounding terminal:
At least 1500 V AC for 1 minute (Note)
 - Between grounding terminal and secondary terminals**:
At least 1500 V AC for 1 minute
 - Between secondary terminals**:
At least 500 V AC for 1 minute
 - * Primary terminals indicate power terminals and relay output terminals
 - ** Secondary terminals indicate analog I/O signal, voltage pulse output, and contact input terminals
- Note: The withstanding voltage is specified as 2300 V AC per minute to provide a margin of safety.
- Insulation resistance: 20 M Ω or more at 500 V DC between power terminals and grounding terminal
 - Grounding: Class 3 grounding (grounding resistance of 100 Ω or less)

Signal Isolations

- PV input terminals for Loop1: Isolated from PV input terminals for Loop2 and other input/output terminals. Not isolated from the internal circuit.
- PV input terminals for Loop2: Isolated from PV input terminals for Loop1 and other input/output terminals and internal circuit.
- Remote input terminals: Isolated from other input/output terminals and the internal circuit.
- 15 V DC loop power supply terminals: Not isolated from analog current output and voltage pulse control output. Isolated from other input/output terminals and internal circuit.
- Analog output terminals (for control output and retransmission): Not isolated between analog outputs and from 15 V DC loop power supply and voltage pulse control output. Isolated from other input/output terminals and internal circuit.
- Voltage pulse control output terminals: Not isolated from analog outputs and 15 V DC loop power supply. Isolated from other input/output terminals and internal circuit.
- Relay contact control output terminals: Isolated between contact output terminals and from other input/output terminals and internal circuit.
- Contact input terminals: Not isolated between contact input terminals and from communication terminals. Isolated from other input/output terminals and internal circuit.
- Relay contact output terminals: Not isolated between relay contact outputs. Isolated from other input/output terminals and internal circuit.
- Transistor contact output terminals: Not isolated between transistor contact outputs. Isolated from other input/output terminals and internal circuit.
- RS-485 communication terminals: Not isolated from contact input terminals. Isolated from other input/output terminals and internal circuit.
- Power terminals: Isolated from other input/output terminals and internal circuit.
- Grounding terminals: Isolated from other input/output terminals and internal circuit.

Environmental Conditions

- Normal operating conditions:
 - Ambient temperature: 0 to 50°C (40°C or less for side-by-side close installation)
 - Temperature change rate: 10°C/h or less
 - Ambient humidity: 20 to 90% RH (no condensation allowed)
 - Magnetic field: 400 A/m or less
 - Continuous vibration at 5 to 14 Hz: Full amplitude of 1.2 mm or less
 - Continuous vibration at 14 to 150 Hz: 4.9 m/s² or less
 - Short-period vibration: 14.7 m/s², 15 seconds or less
 - Shock: 14.7 m/s² or less, 11 ms
 - Installation height: Height above sea level of 2000 m or less
 - Warm-up time: 30 minutes or more after power on
- Transportation and storage conditions:
 - Temperature: -25 to 70°C
 - Temperature change rate: 20°C/h or less
 - Humidity: 5 to 95% RH (no condensation allowed)
- Effects of changes in operating conditions
 - Effects from changes in ambient temperature:
 - On voltage or thermocouple input, $\pm 1 \mu\text{V}/^\circ\text{C}$ or $\pm 0.01\%$ of F.S./°C, whichever is larger
 - On remote input, $\pm 0.02\%$ of F.S./°C
 - On RTD input, $\pm 0.05^\circ\text{C}/^\circ\text{C}$ (ambient temperature) or less
 - On analog output, $\pm 0.05\%$ of F.S./°C or less
 - Effects from power supply fluctuation (within rated voltage range)
 - On remote input, $\pm 1 \mu\text{V}/10 \text{ V}$ or $\pm 0.01\%$ of F.S./10 V, whichever is larger
 - On analog output, $\pm 0.05\%$ of F.S./10 V or less

1.5 Terminal Wiring Diagrams



NOTE

Do not use unassigned terminals as relay terminals.

Terminal wiring diagrams are shown on and after the next page.

UT750 Dual-loop Control (Model UT750-5□)

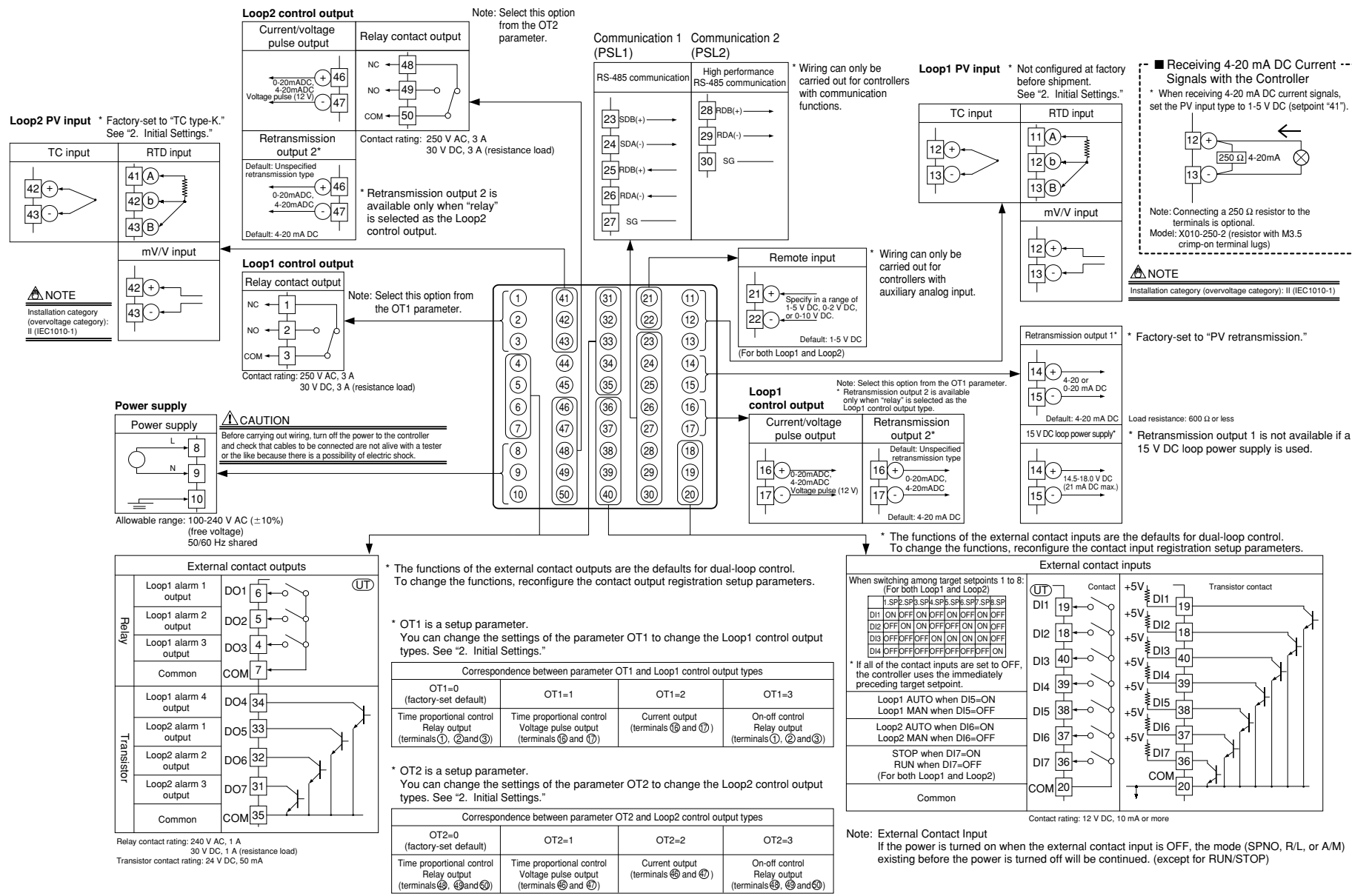

UT750 Dual-loop Heating/Cooling Control (Model UT750-5)

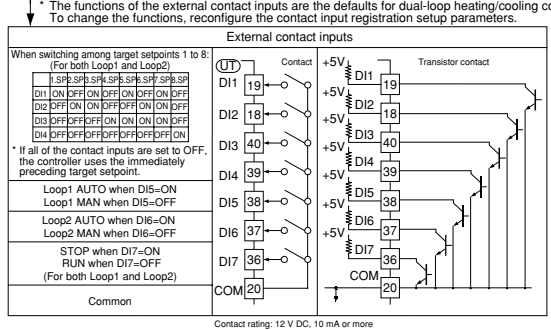
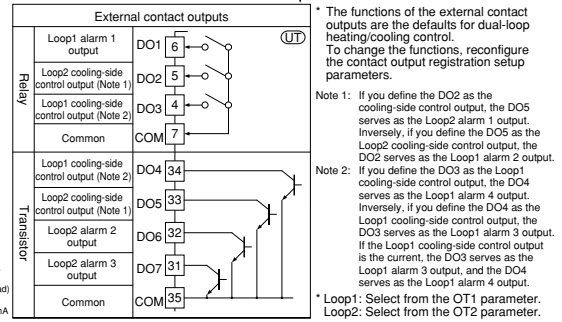
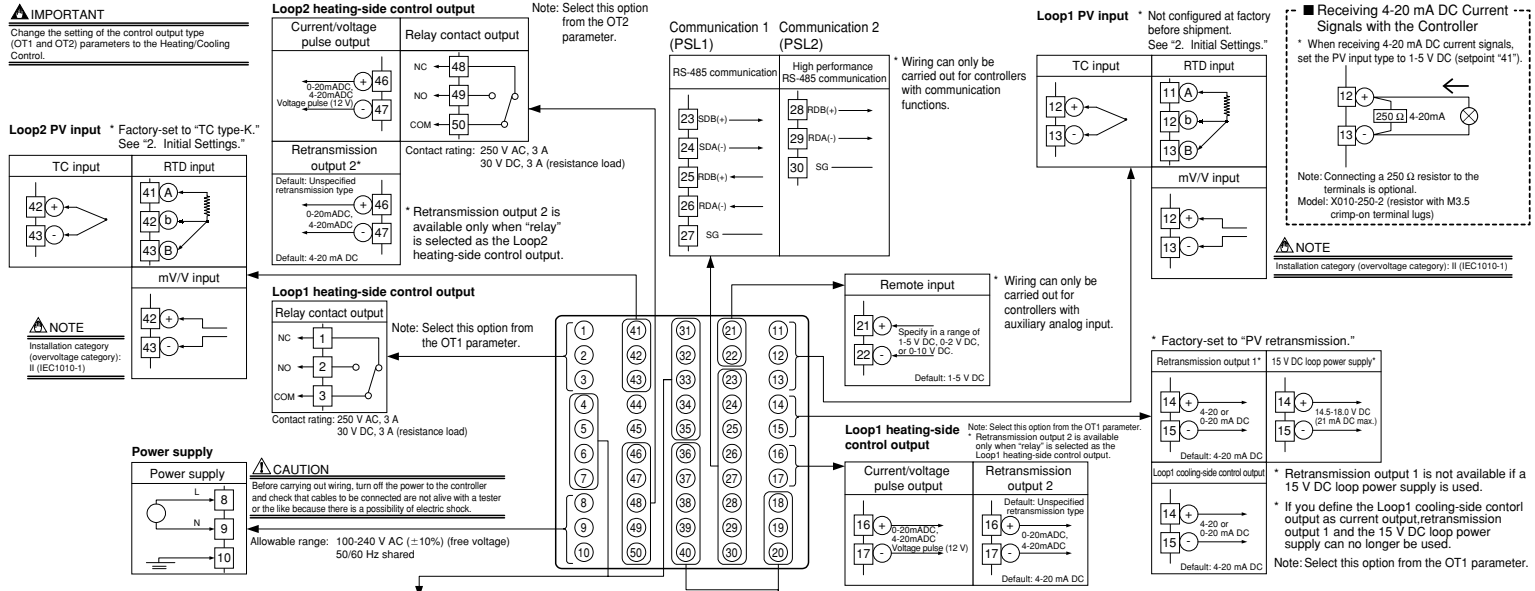

* OT1 is a setup parameter. You can change the settings of the parameter OT1 to change the Loop1 control output types. See "2. Initial Settings."

| Correspondence between parameter OT1 and heating-side output types/cooling-side output types of Loop1 | | | | | | | | |
|---|--|--|--|---|--|---|--|--|
| OT1=4 | OT1=5 | OT1=6 | OT1=7 | OT1=8 | OT1=9 | OT1=10 | OT1=11 | OT1=12 |
| Heating side: Relay output (terminals ①, ② and ③) Cooling side: Relay output (terminals ④ and ⑤) | Heating side: Voltage pulse output (terminals ⑥ and ⑦) Cooling side: Relay output (terminals ⑧ and ⑨) | Heating side: Current output (terminals ⑩ and ⑪) Cooling side: Relay output (terminals ⑫ and ⑬) | Heating side: Relay output (terminals ⑭, ⑮ and ⑯) Cooling side: Transistor output (terminals ⑰ and ⑱) | Heating side: Voltage pulse output (terminals ⑲ and ⑳) Cooling side: Transistor output (terminals ㉑ and ㉒) | Heating side: Current output (terminals ㉓ and ㉔) Cooling side: Current output (terminals ㉕ and ㉖) | Heating side: Relay output (terminals ㉗, ㉘ and ㉙) Cooling side: Current output (terminals ㉚ and ㉛) | Heating side: Voltage pulse output (terminals ㉜ and ㉝) Cooling side: Current output (terminals ㉞ and ㉟) | Heating side: Current output (terminals ㊱ and ㊲) Cooling side: Current output (terminals ㊳ and ㊴) |

* OT2 is a setup parameter. You can change the settings of the parameter OT2 to change the Loop2 control output types. See "2. Initial Settings."

| Correspondence between parameter OT2 and heating-side output types/cooling-side output types of Loop2 | | | | | |
|---|--|--|--|---|---|
| OT2=4 | OT2=5 | OT2=6 | OT2=7 | OT2=8 | OT2=9 |
| Heating side: Relay output (terminals ①, ② and ③) Cooling side: Relay output (terminals ④ and ⑤) | Heating side: Voltage pulse output (terminals ⑥ and ⑦) Cooling side: Relay output (terminals ⑧ and ⑨) | Heating side: Current output (terminals ⑩ and ⑪) Cooling side: Relay output (terminals ⑫ and ⑬) | Heating side: Relay output (terminals ⑭, ⑮ and ⑯) Cooling side: Transistor output (terminals ⑰ and ⑱) | Heating side: Voltage pulse output (terminals ⑲ and ⑳) Cooling side: Transistor output (terminals ㉑ and ㉒) | Heating side: Current output (terminals ㉓ and ㉔) Cooling side: Transistor output (terminals ㉕ and ㉖) |

Blank Page



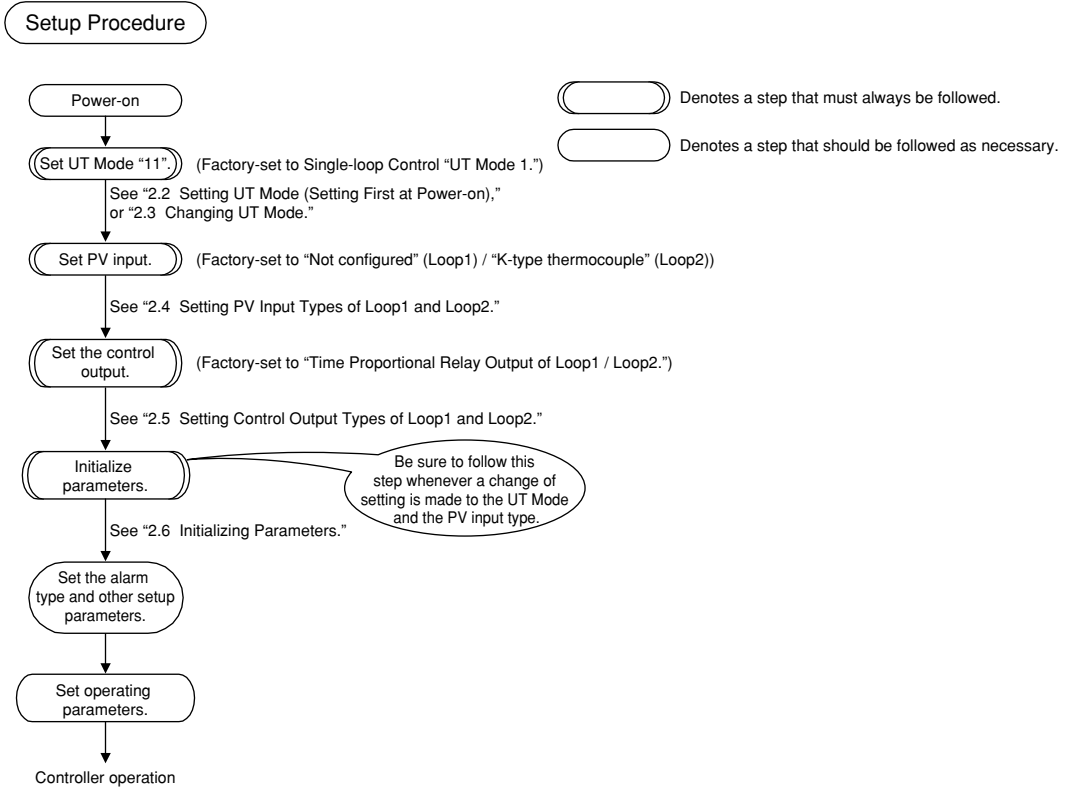

2. Initial Settings

This chapter describes examples of setting PV input types, control output types, and alarm types. Carrying out settings described herein allows you to perform basic control. Refer to examples of various settings to understand how to set parameters required. Refer to “5.1 Parameter Map” for an easy to understand explanation of setting various parameters. If you cannot remember how to carry out an operation during setting, press the **DISP** key no more than four times. This brings you to the display (operating display) that appears at power-on.

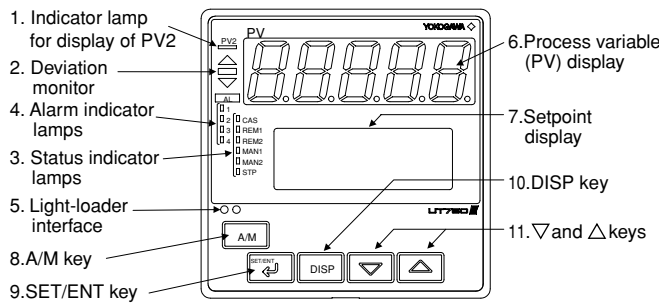

2.1 Names and Functions of Front Panel Parts



| Name of Part | Function |
|--------------------------------------|--|
| 1. Indicator lamp for display of PV2 | Is lit when Loop2 PV is displayed on PV display. |
| 2. Deviation monitor | When lit, indicates the status of a deviation (PV - SP). △: Is lit (in orange) if a deviation exceeds the deviation display range. □: Is lit (in green) when a deviation is within the deviation display range. ▽: Is lit (in orange) if a deviation falls below the deviation display range. The deviation monitor goes off if any display other than the operating display or SELECT display is shown. |
| 3. Status indicator lamps | Is lit (in green) to indicate the status of operation or control. CAS: Not used in dual-loop control. REM1: Is lit when in remote mode of Loop1. REM2: Is lit when in remote mode of Loop2. MAN1: Is lit when in manual mode of Loop1. MAN2: Is lit when in remote mode of Loop2. STP: Is lit when operation stopped. Is unlit when a setup parameter setting display is shown. |
| 4. Alarm indicator lamps | If any of alarms 1 to 4 of Loop1 occurs, the respective alarm indicator lamp (AL1 to AL4) is lit (in orange). |
| 5. Light-loader interface | Interface for an adapter cable used when setting and storing parameters from a PC. This requires an optional parameter setting tool. |
| 6. Process variable (PV) display | Displays PV of Loop1 or Loop2. Displays an error code (in red) if an error occurs. |
| 7. Setpoint display | Displays the name and value of a target setpoint (SP), output (OUT), deviation (DV), deviation trend, or a parameter. Displays an error code if the controller fails. |
| 8. A/M key |  Used to switch between the AUTO and MAN modes of Loop1. Each time you press the key, it switches to the AUTO or MAN mode alternately. (AUTO and MAN of Loop2 mode switch is made by parameter.) |
| 9. SET/ENT key |  Used to switch or register a parameter. Pressing the key for more than 3 second allows you to switch between the operating display and the main menu for operating parameter setting display alternately. |
| 10. DISP key |  Used to switch between displays. Pressing this key while any operating display is shown lets you switch to another prearranged operating display. Pressing this key while any display other than an operating display is shown lets you go back one display. (One to four presses (maximum) of this key lets you return to the current operating display, though the number of presses depends on the operating status.) |
| 11. ▽ and △ keys |   Used to change numerical values. On setting displays for various parameters, you can change target setpoints, parameters, and output values (in manual operation). Pressing the ▽ key decreases a numerical value, while pressing the △ key causes it to increase. You can hold down a key to gradually increase the speed of change. These keys also switch between menu displays when a main menu or submenu of parameter setting display is shown. |

2.2 Setting UT Mode (Setting First at Power-on)

NOTE

- The controller displays an operating display when the power is turned on. The submenu "IN" appears at this point if the type of PV input has not been defined yet. In this case, first set a UT mode to "Dual-loop Control," following the operating procedure described below. Then PV input type, control output type and others.
- The controller is configured to the default of each parameter at the factory before shipment. First check these defaults listed in "5.2 Lists of Parameters" and change their values if necessary.

The following operation describes a procedure of setting a UT mode to "Dual-loop Control." (set "11")

1. Display view at power-on

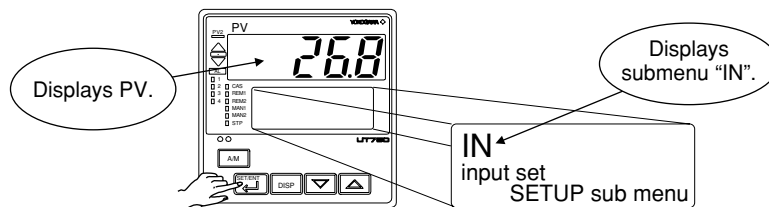

In steps 2 and later, illustrations of the LCD are cited to explain the procedure.

2. Press the key once to display the submenu "MD".

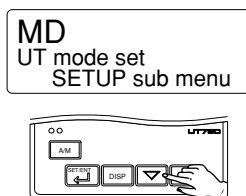

3. Press the key once to display the parameter "UTM" (controller mode).

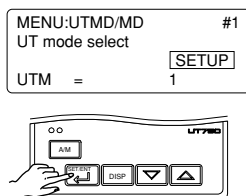

4. Press the or key to display the setpoint "11".

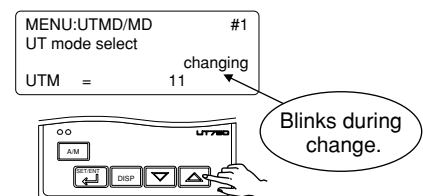

- 5. Press the  key once to register the setpoint.

MENU:UTMD/MD #1
 UT mode select 
 UTM = 11

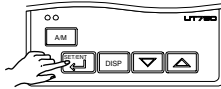

- 6. The controller re-starts (which is normal). Then set PV input type. See “2.4 Setting PV Input Types of Loop1 and Loop2.”

IN
 input set
 SETUP sub menu

2.3 Changing UT Mode

The following operation describes the procedure of changing a UT mode to “Dual-loop Control.” (set “11”)

- 1. Bring the operating display into view (display appears at power-on).

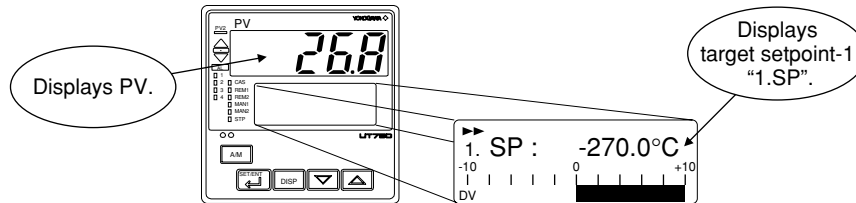

In steps 2 and later, illustrations of the LCD are cited to explain the procedure.

- 2. Press the  key for more than 3 seconds to call up the main menu “MODE”.

MODE
 mode parameter
 main menu

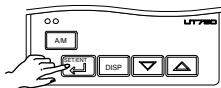

- 4. Press the  key once to display the main menu “LOOP1”.

LOOP1
 loop 1 setup para
 SETUP main menu

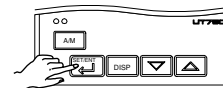

- 3. Press the  key once to display the main menu “STUP”.

STUP
 password input
 main menu

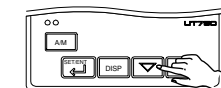

- 5. Press the  key once to display the main menu “UTMD”.

UTMD
 UT750 configuration
 SETUP main menu

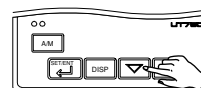

- 6. Press the  key once to display the submenu "MD".

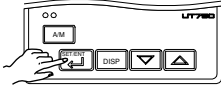

MD
UT mode set
SETUP main menu

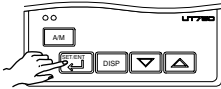

- 7. Press the  key once to display the Parameter "UTM".

MENU:UTMD/MD #1
UT mode select
UTM = 1



- 8. Press the  or  key to display the setpoint "11".

MENU:UTMD/MD #1
UT mode select
UTM = 11

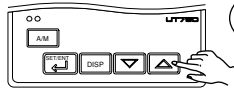

Blinks during change.

- 9. Press the  key once to register the setpoint.

MENU:UTMD/MD #1
UT mode select
UTM = 11

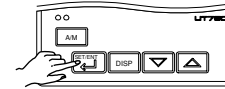

- 10. The controller re-starts (which is normal). Then set PV input type. See "2.4 Setting PV Input Types of Loop1 and Loop2."

IN
input set
SETUP sub menu

2.4 Setting PV Input Types of Loop1 and Loop2

The following operating procedure describes an example of setting the PV input type of Loop1 to K-type thermocouple (-200.0 to 500.0°C) and measurement range of 0.0 to 200.0°C.

You can take the same steps for the PV input type (IN2) and ranges (RH2, RL2) or scales(SH2, SL2) of Loop2 that are displayed after the Loop1 related parameters.

PV input of Loop1 (Factory-set to “Not configured”)

| | |
|------------------------------|-------|
| PV input terminal | |
| Thermocouple/mV/V input..... | ⑫-⑬ |
| RTD input | ⑪-⑫-⑬ |

PV input of Loop2 (Factory-set to “K-type thermocouple”)

| | |
|------------------------------|-------|
| PV input terminal | |
| Thermocouple/mV/V input..... | ⑫-⑬ |
| RTD input | ④-⑫-⑬ |

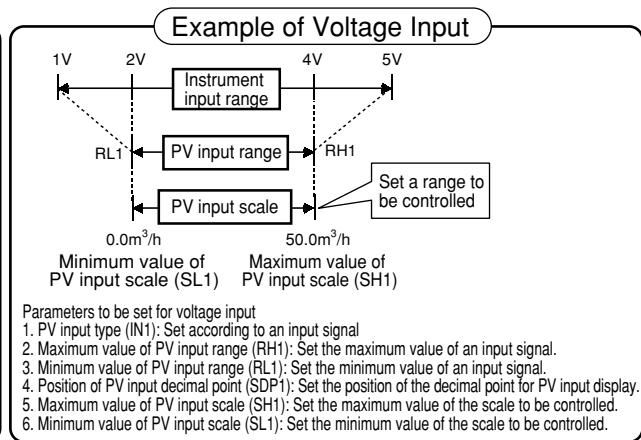
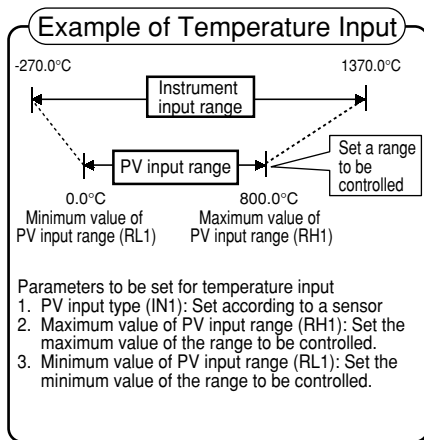

NOTE

The controller may automatically initialize the registered operating parameter setpoints if any change is made to the data item PV Input Type (IN1, IN2), Maximum Value of PV Input Range (RH1, RH2), Minimum Value of PV Input Range (RL1, RL2), PV Input Decimal Point Position (SDP1, SDP2), Maximum Value of PV Input Scale (SH1, SH2) or Minimum Value of PV Input Scale (SL1, SL2). After a change has been made to any of these data items, be sure to verify the registered operating parameter setpoints to ensure that they are correct. If any data item has been changed to its default, set it to a required value.

1. Bring the operating display into view (display appears at power-on).
The PV display in the figure below shows the error code for input burnout (*b.oUt*) if PV input wiring is not yet complete. The error code disappears when you wire the PV input terminals correctly.

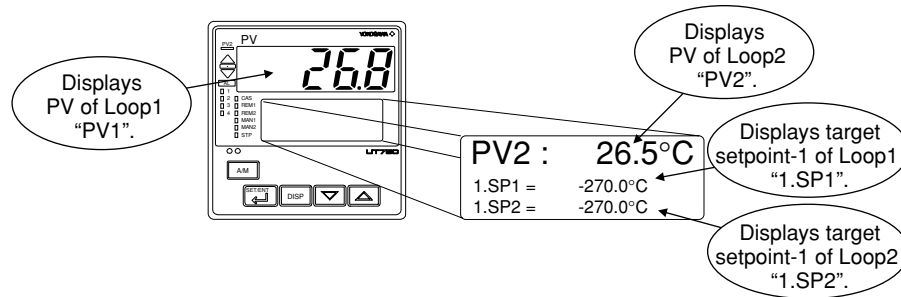

In steps 2 and later, illustrations of the LCD are cited to explain the procedure.

2. Press the  key for more than 3 seconds to call up the main menu "MODE".

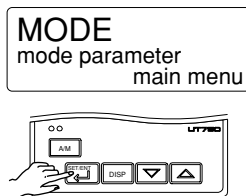

6. Press the  key once to display the submenu "MD".

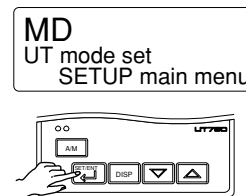

3. Press the  key once to display the main menu "STUP".

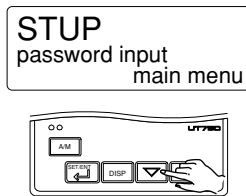

7. Press the  key once to display the submenu "IN".

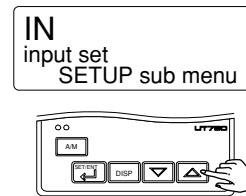

4. Press the  key once to display the main menu "LOOP1".

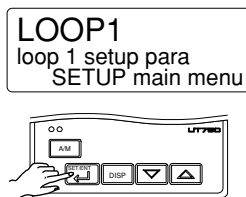

8. Press the  key once to display the parameter "IN1" (PV input type of Loop1).

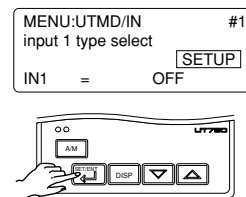

5. Press the  key once to display the main menu "UTMD".

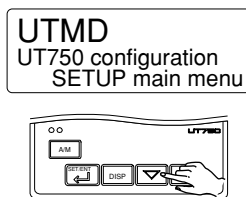

- 9. Press the or key to display the required setpoint. The figure below shows an example of setting the PV input type to K-type thermocouple (-200.0°C to 500.0°C).

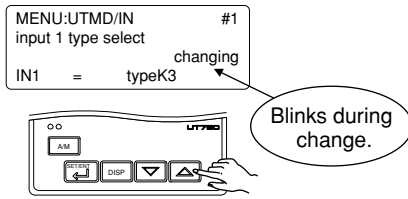

- 10. Press the key once to register the setpoint.

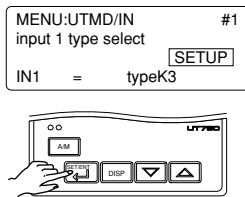

- 11. Press the key once to display the parameter "UNI1" (PV input unit of Loop1).

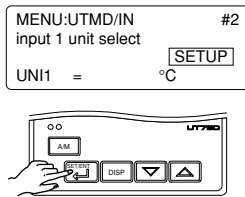

- 12. Press the key once to display the parameter "RH1" (maximum value of PV input range of Loop1).

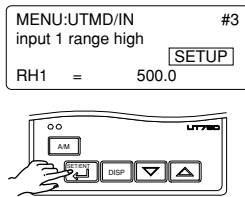

- 13. Press the or key to display the required setpoint. The figure below shows an example of setting the maximum value of the PV input range to 200.0°C.

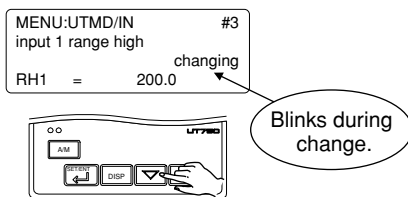

- 14. Press the key once to register the setpoint.

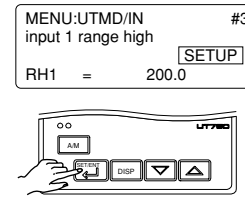

- 15. Press the key once to display the parameter "RL1" (minimum value of PV input range of Loop1).

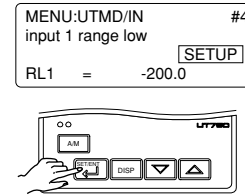

- 16. Press the or key to display the required setpoint. The figure below shows an example of setting the minimum value of the PV input range to 0.0°C.

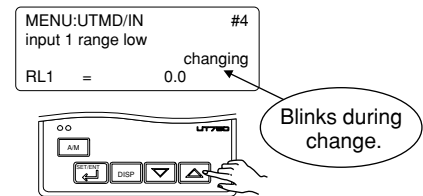

- 17. Press the key once to register the setpoint.

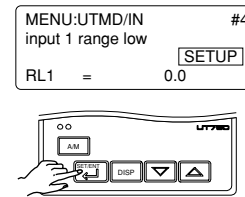

If the type of input is voltage, also configure the PV Input Decimal Point Position (SDP1), Maximum Value of PV Input Scale (SH1) and Minimum Value of PV Input Scale (SL1) parameters that follow this step.

- 18. Press the key for more than 3 seconds. This returns you to the display shown at power-on (figure below).

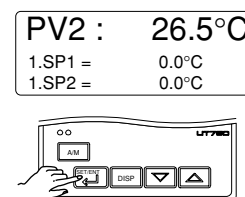

Instrument Input Range Codes

| Input | Type | Instrument Input Range Code | Instrument Input Range | Measurement Accuracy | |
|-----------------|-------------------------|--------------------------------|---|---|--|
| Unspecified | | OFF (0) | Set the data item PV Input Type "IN1" to the OFF option to leave the PV input type undefined. | | |
| Thermocouple | K | typeK1 (1) | -270.0 to 1370.0°C -450.0 to 2500.0°F | ±0.1% of instrument range ±1 digit at 0°C or more ±0.2% ±1 digit for temperatures below 0°C, where the accuracy is: ±2% of instrument range ±1 digit for temperatures below -200.0°C for a type-K thermocouple, or ±1% of instrument range ±1 digit for temperatures below -200.0°C for a type-T thermocouple. | |
| | | typeK2 (2) | -270.0 to 1000.0°C -450.0 to 2300.0°F | | |
| | | typeK3 (3) | -200.0 to 500.0°C -200.0 to 1000.0°F | | |
| | J | typeJ (4) | -200.0 to 1200.0°C -300.0 to 2300.0°F | | |
| | T | typeT1 (5) | -270.0 to 400.0°C -450.0 to 750.0°F | | |
| | | typeT2 (6) | 0.0 to 400.0°C -200.0 to 750.0°F | | |
| | B | typeB (7) | 0.0 to 1800.0°C 32 to 3300°F | | ±0.15% of instrument range ±1 digit at 400°C or more ±5% of instrument range ±1 digit at less than 400°C |
| | S | typeS (8) | 0.0 to 1700.0°C 32 to 3100°F | | ±0.15% of instrument range ±1 digit |
| | R | typeR (9) | 0.0 to 1700.0°C 32 to 3100°F | | |
| | N | typeN (10) | -200.0 to 1300.0°C -300.0 to 2400.0°F | | ±0.1% of instrument range ±1 digit ±0.25% of instrument range ±1 digit for temperatures below 0°C |
| | E | typeE (11) | -270.0 to 1000.0°C -450.0 to 1800.0°F | | ±0.1% of instrument range ±1 digit at 0°C or more ±0.2% ±1 digit for temperatures below 0°C, where the accuracy is: ±1.5% of instrument range ±1 digit for temperatures below -200.0°C for a type-E thermocouple. |
| | L(DIN) | typeL (12) | -200.0 to 900.0°C -300.0 to 1600.0°F | | |
| | U(DIN) | typeU1 (13) | -200.0 to 400.0°C -300.0 to 750.0°F | | |
| | | typeU2 (14) | 0.0 to 400.0°C -200.0 to 1000.0°F | | |
| | W | typeW (15) | 0.0 to 2300.0°C 32 to 4200°F | | ±0.2% of instrument range ±1 digit |
| | Platinel 2 | Plati2 (16) | 0.0 to 1390.0°C 32 to 2500.0°F | | ±0.1% of instrument range ±1 digit |
| | PR20-40 | PR2040 (17) | 0.0 to 1900.0°C 32 to 3400°F | | ±0.5% of instrument range ±1 digit at 800°C or more No accuracy is guaranteed at less than 800°C |
| | W97Re3-W75Re25 | W97Re3 (18) | 0.0 to 2000.0°C 32 to 3600°F | | ±0.2% of instrument range ±1 digit |
| RTD | JPt100 | JPt1 (30) | -200.0 to 500.0°C -300.0 to 1000.0°F | ±0.1% of instrument range ±1 digit (Note 1) (Note 2) | |
| | | JPt2 (31) | -150.00 to 150.00°C -200.0 to 300.0°F | ±0.2% of instrument range ±1 digit (Note 1) | |
| | Pt100 | Pt1 (35) | -200.0 to 850.0°C -300.0 to 1560.0°F | ±0.1% of instrument range ±1 digit (Note 1) (Note 2) | |
| | | Pt2 (36) | -200.0 to 500.0°C -300.0 to 1000.0°F | | |
| | | Pt3 (37) | -150.00 to 150.00°C -200.0 to 300.0°F | | ±0.2% of instrument range ±1 digit (Note 1) |
| Standard signal | 0.4 to 2 V 1 to 5 V | 0.4 to 2V (40) 1 to 5V (41) | 0.400 to 2.000 V 1.000 to 5.000 V | ±0.1% of instrument range ±1 digit Display range is scalable in a range of -19999 to 30000. Display span is 30000 or less. | |
| DC voltage | 0 to 2 V 0 to 10 V | 0 to 2V (50) 0 to 10V (51) | 0.000 to 2.000 V 0.00 to 10.00 V | | |
| | 0.00 to 1.25 V (Note 3) | 0.00 to 1.25 V (52) | 0.000 to 1.200 V | | |
| | -10 to 20 mV | mV1 (55) | -10.00 to 20.00 mV | | |
| | 0 to 100 mV | mV2 (56) | 0.0 to 100.0 mV | | |

* Performance in the standard operating conditions (at 23±2°C, 55±10%RH, and 50/60 Hz power frequency)

Note 1: The accuracy is ±0.3°C of instrument range ±1 digit for a temperature range from 0°C to 100°C.

Note 2: The accuracy is ±0.5°C of instrument range ±1 digit for a temperature range from -100°C to 200°C.

Note 3: Only used for PV input of Loop2 (IN2).

* To receive a 4-20 mA DC signal, select a standard signal of 1 to 5 V DC and connect it to a 250 Ω resistor. This resistor is optional.

Model: X010-250-2 (resistor with M3.5 crimp-on terminal lugs)

2.5 Setting Control Output Types of Loop1 and Loop2

The following operating procedure describes an example of changing the control output type of Loop1 from time proportional PID relay output (0: factory-set default) to current output (2).

You can take the same steps for the control output type of Loop2 (OT2) that is displayed after the control output type of Loop1.

Control output of Loop1

| | |
|---|-------------------------------------|
| Control output terminal | Values in parentheses are setpoints |
| Time proportional PID relay (0)/on-off(3) output..... | ①-②-③ |
| Current (2)/time proportional PID voltage pulse (1) output..... | ⑫-⑬ |

For details on the output terminals for heating/cooling control, see "1.5 Terminal Wiring Diagrams."

Control output of Loop2

| | |
|---|-------------------------------------|
| Control output terminal | Values in parentheses are setpoints |
| Time proportional PID relay (0)/on-off(3) output..... | ④⑧-④⑨-⑤① |
| Current (2)/time proportional PID voltage pulse (1) output..... | ④⑥-④⑷ |

For details on the output terminals for heating/cooling control, see "1.5 Terminal Wiring Diagrams."

1. Bring the operating display into view (display appears at power-on).

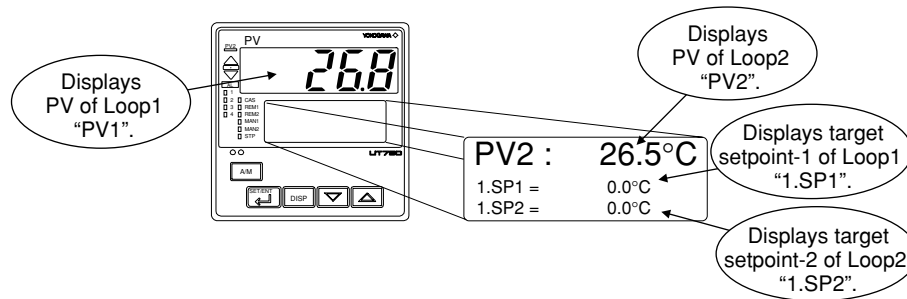

In steps 2 and later, illustrations of the LCD are cited to explain the procedure.

2. Press the key for more than 3 seconds to call up the main menu "MODE".

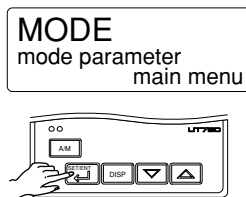

4. Press the key once to display the main menu "LOOP1".

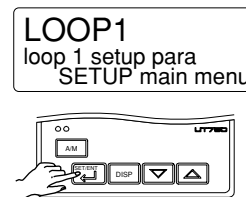

3. Press the key once to display the main menu "STUP".

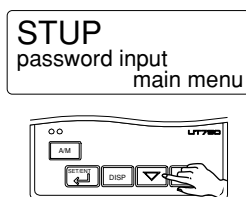

5. Press the key once to display the main menu "UTMD".

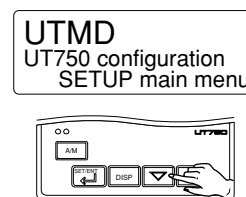

- 6. Press the  key once to display the submenu "MD".

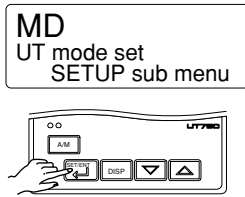

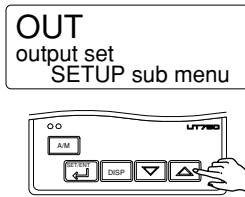

- 7. Press the  key twice to display the submenu "OUT".

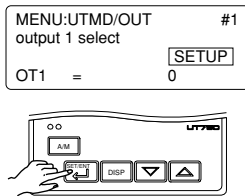

- 8. Press the  key once to display the parameter "OT1" (control output type of Loop1).



- 9. Press the  or  key to display the required setpoint. The figure below shows an example of setting to current output (4 to 20 mA DC).

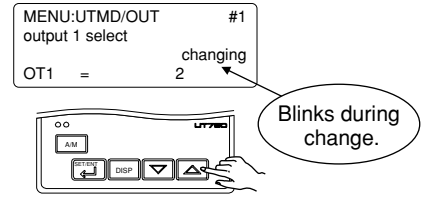

- 10. Press the  key once to register the setpoint.

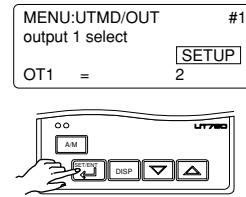

You can take the same steps for the control output type of Loop2 (OT2) that is displayed after the control output type of Loop1.

- 11. Press the  key **more than 3 seconds**. This returns you to the display shown at power-on (figure below).

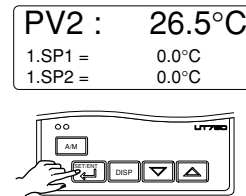

● List of Control Output Types of Loop1

| Parameter Symbol | Name of Parameter | Setpoint | Control Output Types |
|------------------|------------------------------|----------|---|
| OT1 | Loop1 Control output type | 0 | Time proportional PID relay contact output (terminals ① - ② - ③) |
| | | 1 | Time proportional PID voltage pulse output (terminals ⑯ - ⑰) |
| | | 2 | Current output (terminals ⑯ - ⑰) |
| | | 3 | On/off control relay contact output (terminals ① - ② - ③) |
| | | 4 | Heating-side relay output (terminals ① - ② - ③), cooling-side relay output (terminals ④ - ⑦) |
| | | 5 | Heating-side pulse output (terminals ⑯ - ⑰), cooling-side relay output (terminals ④ - ⑦) |
| | | 6 | Heating-side current output (terminals ⑯ - ⑰), cooling-side relay output (terminals ④ - ⑦) |
| | | 7 | Heating-side relay output (terminals ① - ② - ③), cooling-side transistor output (terminals ⑳ - ㉑) |
| | | 8 | Heating-side pulse output (terminals ⑯ - ⑰), cooling-side transistor output (terminals ⑳ - ㉑) |
| | | 9 | Heating-side current output (terminals ⑯ - ⑰), cooling-side transistor output (terminals ⑳ - ㉑) |
| | | 10 | Heating-side relay output (terminals ① - ② - ③), cooling-side current output (terminals ⑭ - ⑮) |
| | | 11 | Heating-side pulse output (terminals ⑯ - ⑰), cooling-side current output (terminals ⑭ - ⑮) |
| | | 12 | Heating-side current output (terminals ⑯ - ⑰), cooling-side current output (terminals ⑭ - ⑮) |

● List of Control Output Types of Loop2

| Parameter Symbol | Name of Parameter | Setpoint | Control Output Types |
|------------------|------------------------------|----------|---|
| OT2 | Loop2 Control output type | 0 | Time proportional PID relay contact output (terminals ⑳ - ㉑ - ㉒) |
| | | 1 | Time proportional PID voltage pulse output (terminals ㉓ - ㉔) |
| | | 2 | Current output (terminals ㉓ - ㉔) |
| | | 3 | On/off control relay contact output (terminals ⑳ - ㉑ - ㉒) |
| | | 4 | Heating-side relay output (terminals ⑳ - ㉑ - ㉒), cooling-side relay output (terminals ⑤ - ⑦) |
| | | 5 | Heating-side pulse output (terminals ㉓ - ㉔), cooling-side relay output (terminals ⑤ - ⑦) |
| | | 6 | Heating-side current output (terminals ㉓ - ㉔), cooling-side relay output (terminals ⑤ - ⑦) |
| | | 7 | Heating-side relay output (terminals ⑳ - ㉑ - ㉒), cooling-side transistor output (terminals ㉑ - ㉒) |
| | | 8 | Heating-side pulse output (terminals ㉓ - ㉔), cooling-side transistor output (terminals ㉑ - ㉒) |
| | | 9 | Heating-side current output (terminals ㉓ - ㉔), cooling-side transistor output (terminals ㉑ - ㉒) |

2.6 Initializing Parameters

Be sure to follow the steps below after a change of setting has been made to the data item PV Input Type, PV Input Range or PV Input Scale.

1. Bring the operating display into view (display appears at power-on).

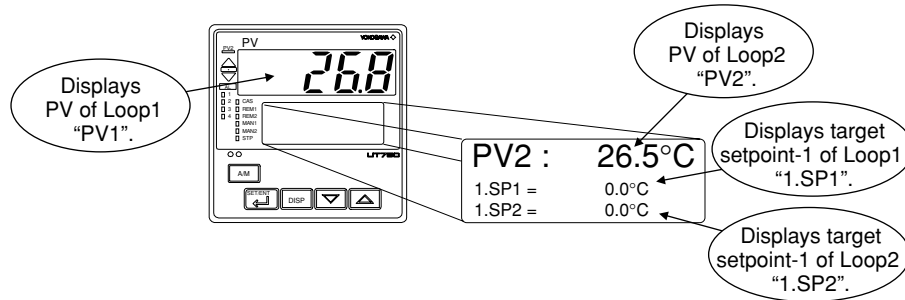

In steps 2 and later, illustrations of the LCD are cited to explain the procedure.

2. Press the key for more than 3 seconds to call up the main menu "MODE".

MODE
mode parameter
main menu

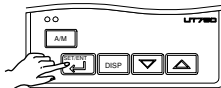

3. Press the key once to display the main menu "STUP".

STUP
password input
main menu

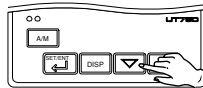

4. Press the key once to display the main menu "LOOP1".

LOOP1
loop 1 setup para
SETUP main menu

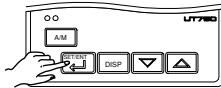

5. Press the key once to display the main menu "UTMD".

UTMD
UT750 configuration
SETUP main menu

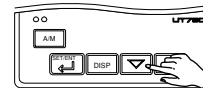

6. Press the key once to display the submenu "MD".

MD
UT mode set
SETUP sub menu

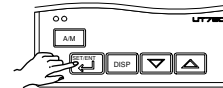

7. Press the key twice to display the submenu "INIT".

INIT
parameter initialize
SETUP sub menu

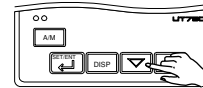

- 8. Press the  key once to display the parameter "INI".

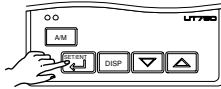
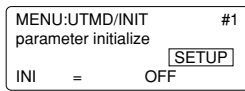

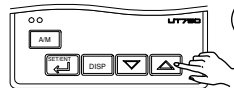
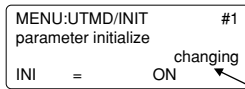

- 9. Press the  key to display "ON".

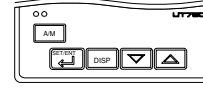
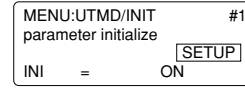

Blinks during change.

- 10. Press the  key once. The display momentarily becomes blank (which is normal), indicating the parameters have been initialized.



- 11. Press the  key for **more than 3 seconds**. This returns you to the display shown at power-on (figure below).

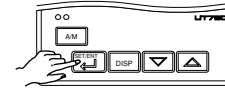
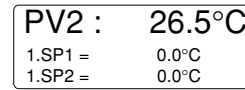

2.7 Changing Alarm Type of Loop1

The following operating procedure describes an example of changing alarm1 of Loop1 (factory-set to the PV high limit alarm) to the PV low limit alarm.

When you have changed alarm type, the alarm setpoint will be initialized; set the alarm setpoint again.

| Alarm output terminals | Factory-set defaults |
|--------------------------------|--------------------------|
| Alarm-1 (terminal numbers ⑥-⑦) |PV high limit alarm |
| Alarm-2 (terminal numbers ⑥-⑦) |PV low limit alarm |
| Alarm-3 (terminal numbers ④-⑦) |PV high limit alarm |
| Alarm-4 (terminal numbers ④-⑤) |PV low limit alarm |

- 1. Bring the operating display into view (display appears at power-on).

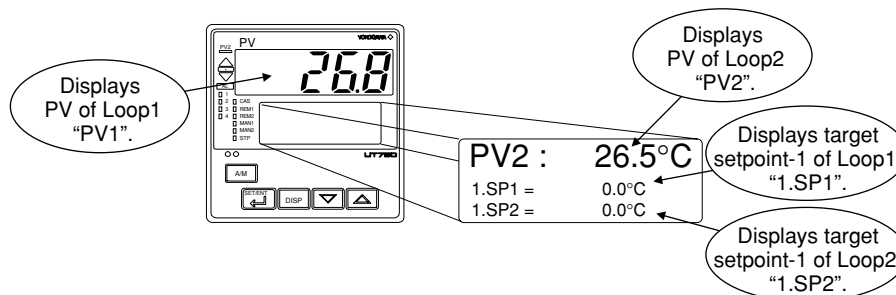

In steps 2 and later, illustrations of the LCD are cited to explain the procedure.

- 2. Press the  key for more than 3 seconds to call up the main menu "MODE".

MODE
mode parameter
main menu

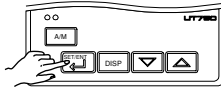

- 3. Press the  key once to display the main menu "STUP".

STUP
password input
main menu

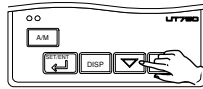

- 4. Press the  key once to display the main menu "LOOP1".

LOOP1
loop 1 setup para
SETUP main menu

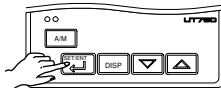

- 5. Press the  key once to display the submenu "SP".

SP
SP control
SETUP sub menu

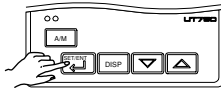

- 6. Press the  key once to display the submenu "ALM".

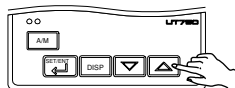

ALM
alarm control
SETUP sub menu

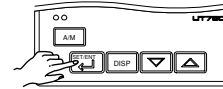

- 7. Press the  key once to display the parameter "AL1" (alarm-1 type).

MENU:LOOP1/ALM #1
alarm 1 type select
AL1 = 1



- 8. Press the  or  key to display the required setpoint. The figure below shows an example of setting the PV low limit alarm.

MENU:LOOP1/ALM #1
alarm 1 type select
AL1 = 2

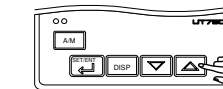

Blinks during change.

- 9. Press the  key once to register the setpoint.

MENU:LOOP1/ALM #1
alarm 1 type select
AL1 = 2

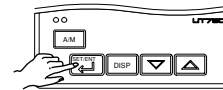

You can take the same steps for alarm-2 type (AL2), alarm-3 type (AL3), and alarm-4 type (AL4) that are displayed after this.

- 10. Press the  key for more than 3 seconds. This returns you to the display shown at power-on (figure below).

PV2 : 26.5°C
1.SP1 = 0.0°C
1.SP2 = 0.0°C

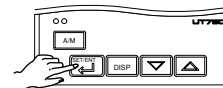

- 11. When setting alarm setpoints, see "3.8 Setting Alarm Setpoints of Loop1."

2.8 Changing Alarm Type of Loop2

The following operating procedure describes an example of changing alarm 1 of Loop2 (factory-set to the PV high limit alarm) to the PV low limit alarm.

When you have changed alarm type, the alarm setpoint will be initialized; set the alarm setpoint again.

| Alarm output terminals | Factory-set defaults |
|--------------------------------|----------------------|
| Alarm-1 (terminal numbers ③-⑤) | PV high limit alarm |
| Alarm-2 (terminal numbers ⑥-⑧) | PV low limit alarm |
| Alarm-3 (terminal numbers ⑨-⑪) | PV high limit alarm |

1. Bring the operating display into view (display appears at power-on).

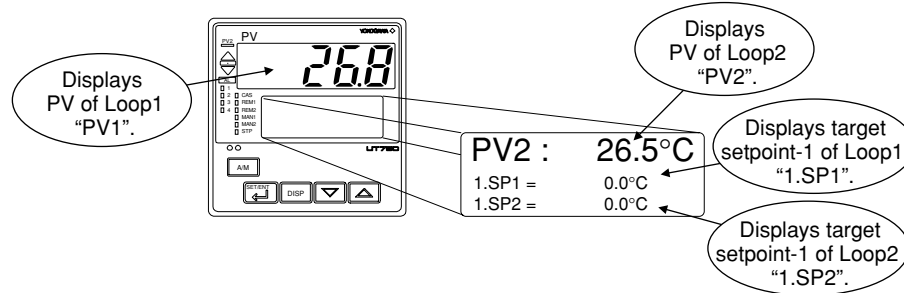

In steps 2 and later, illustrations of the LCD are cited to explain the procedure.

2. Press the key for more than 3 seconds to call up the main menu "MODE".

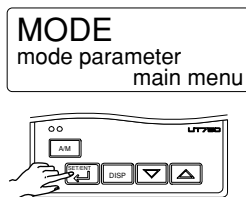

4. Press the key once to display the main menu "LOOP1".

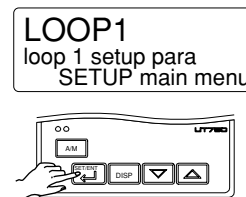

3. Press the key once to display the main menu "STUP".

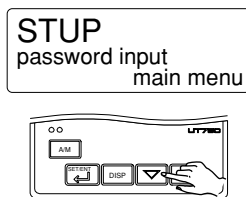

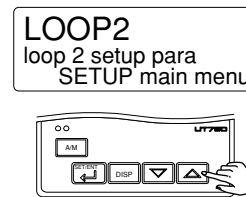

5. Press the key once to display the main menu "LOOP2".

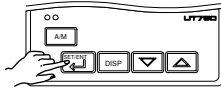

- 6. Press the  key once to display the submenu "SP".

SP
SP control
SETUP sub menu



- 7. Press the  key once to display the submenu "ALM".

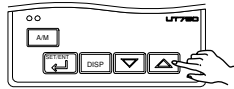

ALM
alarm control
SETUP sub menu

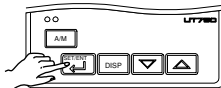

- 8. Press the  key once to display the parameter "AL1" (alarm-1 type).

MENU:LOOP2/ALM #1
alarm 1 type select
AL1 = 1



- 9. Press the  or  key to display the required setpoint. The figure below shows an example of setting the PV low limit alarm.

MENU:LOOP2/ALM #1
alarm 1 type select
AL1 = changing 2

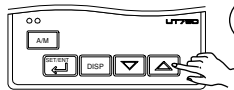

Blinks during change.

- 10. Press the  key once to register the setpoint.

MENU:LOOP2/ALM #1
alarm 1 type select
AL1 = 2

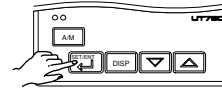

You can take the same steps for alarm-2 type (AL2), alarm-3 type (AL3), and alarm-4 type (AL4) that are displayed after this.

- 11. Press the  key for more than 3 seconds. This returns you to the display shown at power-on (figure below).

PV2 : 26.5°C
1.SP1 = 0.0°C
1.SP2 = 0.0°C

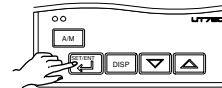

- 12. When setting alarm setpoints, see "3.9 Setting Alarm Setpoints of Loop2."

■ List of Alarm Types (both for Loop1 and Loop2)

The table below shows the alarm types and alarm actions.

In the table, codes 1 to 10 are not provided with stand-by actions, while codes 11 to 20 are provided with stand-by actions.

| Alarm type | Alarm action "Open/close" shows status of relay contact, and "lit" and "unlit" shows status of lamp | Alarm type code | | Alarm type | Alarm action "Open/close" shows status of relay contact, and "lit" and "unlit" shows status of lamp | Alarm type code | |
|--|---|--------------------------------|-------------------------------|---|---|--------------------------------|-------------------------------|
| | | Contact closes if alarm occurs | Contact opens if alarm occurs | | | Contact closes if alarm occurs | Contact opens if alarm occurs |
| No alarm | | OFF | | | | | |
| PV high limit | | 1 | / | De-energized on deviation low limit alarm | | / | 6 16 |
| | | 11 | | | | | |
| PV low limit | | 2 | / | Deviation high and low limits | | / | 7 17 |
| | | 12 | | | | | |
| Deviation high limit | | 3 | / | Deviation within high and low limits | | / | 8 18 |
| | | 13 | | | | | |
| Deviation low limit | | 4 | / | De-energized on PV high limit | | / | 9 19 |
| | | 14 | | | | | |
| De-energized on deviation high limit alarm | | 5 | / | De-energized on PV low limit | | / | 10 20 |
| | | 15 | | | | | |
| Timer function (Alarm-1 only) | Upward (hour/minute) | 21 | / | Sensor grounding alarm | Sensor grounding alarm | / | 25 |
| | Downward (hour/minute) | 22 | | Fault diagnosis output (Note1) | Fault diagnosis output | | 26 |
| | Upward (minute/second) | 23 | | FAIL output (Note2) | The controller stops when in a FAIL state. The control output is set to "OFF" or "0%" and the alarm output is set to "OFF". | | 27 |
| | Downward (minute/second) | 24 | | | | | |
| SP high limit | | 28 | / | Output high limit | | / | 30 |
| SP low limit | | 29 | | Output low limit | | | |

Note 1: The fault diagnosis output turns on in case of input burnout, A/D converter failure, or reference junction compensation (RJC) failure.

For input burnout or A/D converter failure, the control output is set to the setpoint of the Preset Output Value operating parameter (PO).

Note 2: The FAIL output is on during normal operation and turns off case failure.

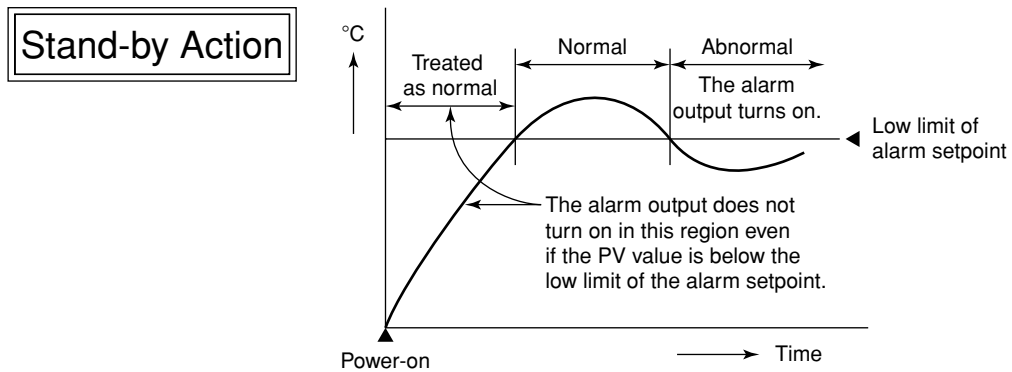

2.9 Description of Multiple Setpoints and PID

The UT750 has a maximum of eight target setpoints for Loop1 and Loop2, and has PID for each of these setpoints. The following shows the correspondence between the target setpoint numbers (SPNO), target setpoints (SP), and PID parameters.

For example, if you have set “2” to the target setpoint number (SPNO), the control parameters available are target setpoint (2.SP), proportional band (heating-side proportional band) (2.P), integral time (heating-side integral time) (2.I), derivative time (heating-side derivative time) (2.D), cooling-side proportional band (2.Pc), cooling-side integral time (2.Ic), and cooling-side derivative time (2.Dc).

To use multiple target setpoints, see the table below to check the corresponding parameters.

● Target Setpoint (SP) and PID Parameter of Loop1

| Target setpoint number (SPNO) | Target setpoint (SP) | PID parameter | | | | | |
|-------------------------------|----------------------|--|--|--|--------------------------------|----------------------------|------------------------------|
| | | Proportional band (heating-side proportional band) | Integral time (heating-side integral time) | Derivative time (heating-side derivative time) | Cooling-side proportional band | Cooling-side integral time | Cooling-side derivative time |
| SPNO=1 | 1.SP | 1.P | 1.I | 1.D | 1.Pc | 1.Ic | 1.Dc |
| SPNO=2 | 2.SP | 2.P | 2.I | 2.D | 2.Pc | 2.Ic | 2.Dc |
| SPNO=3 | 3.SP | 3.P | 3.I | 3.D | 3.Pc | 3.Ic | 3.Dc |
| SPNO=4 | 4.SP | 4.P | 4.I | 4.D | 4.Pc | 4.Ic | 4.Dc |
| SPNO=5 | 5.SP | 5.P | 5.I | 5.D | 5.Pc | 5.Ic | 5.Dc |
| SPNO=6 | 6.SP | 6.P | 6.I | 6.D | 6.Pc | 6.Ic | 6.Dc |
| SPNO=7 | 7.SP | 7.P | 7.I | 7.D | 7.Pc | 7.Ic | 7.Dc |
| SPNO=8 | 8.SP | 8.P | 8.I | 8.D | 8.Pc | 8.Ic | 8.Dc |

● Target Setpoint (SP) and PID Parameter of Loop2

| Target setpoint number (SPNO) | Target setpoint (SP) | PID parameter | | | | | |
|-------------------------------|----------------------|--|--|--|--------------------------------|----------------------------|------------------------------|
| | | Proportional band (heating-side proportional band) | Integral time (heating-side integral time) | Derivative time (heating-side derivative time) | Cooling-side proportional band | Cooling-side integral time | Cooling-side derivative time |
| SPNO=1 | 1.SP | 1.P | 1.I | 1.D | 1.Pc | 1.Ic | 1.Dc |
| SPNO=2 | 2.SP | 2.P | 2.I | 2.D | 2.Pc | 2.Ic | 2.Dc |
| SPNO=3 | 3.SP | 3.P | 3.I | 3.D | 3.Pc | 3.Ic | 3.Dc |
| SPNO=4 | 4.SP | 4.P | 4.I | 4.D | 4.Pc | 4.Ic | 4.Dc |
| SPNO=5 | 5.SP | 5.P | 5.I | 5.D | 5.Pc | 5.Ic | 5.Dc |
| SPNO=6 | 6.SP | 6.P | 6.I | 6.D | 6.Pc | 6.Ic | 6.Dc |
| SPNO=7 | 7.SP | 7.P | 7.I | 7.D | 7.Pc | 7.Ic | 7.Dc |
| SPNO=8 | 8.SP | 8.P | 8.I | 8.D | 8.Pc | 8.Ic | 8.Dc |

* The target setpoint numbers (SPNO) of Loop1 and Loop2 are the same.

Blank Page

3. Operations

This chapter describes key entries for operating the controller. For operations using external contact inputs, see “1.5 Terminal Wiring Diagrams.” If you cannot remember how to carry out an operation during setting, press the **DISP** key no more than four times. This brings you to the display (operating display) that appears at power-on.

3.1 Monitoring-purpose Operating Displays Available during Operation

The monitoring-purpose operating displays available during operation include those for dual-loop and those for dual-loop heating/cooling control.

■ Operating Displays for Dual-loop Control

● PV2 Display

The PV input value of Loop1 appears on the PV display.

The PV input value of Loop2 (PV2), the target setpoint of Loop1 (1.SP1) and target setpoint of Loop2 (1.SP2) appears on the Setpoint display (LCD).

● OUT Display (Loop1)

The PV input value of Loop1 appears on the PV display.

The target setpoint of Loop1 (1.SP1), PID number, and control output value, along with the control output bar appears on the Setpoint display (LCD).

● OUT Display (Loop2)

The PV input value of Loop2 appears on the PV display.

The target setpoint of Loop2 (1.SP2), PID number, and control output value, along with the control output bar appears on the Setpoint display (LCD).

● Deviation Trend Display (Loop1)

The PV input value of Loop1 appears on the PV display.

The deviation trend of Loop1 appears on the Setpoint display (LCD).

● Deviation Trend Display (Loop2)

The PV input value of Loop2 appears on the PV display.

The deviation trend of Loop2 appears on the Setpoint display (LCD).

● Data List Display (Loop1)

The PV input value of Loop1 appears on the PV display.

The target setpoint of Loop1, control output value, deviation, and PID number appears on the Setpoint display (LCD).

● Data List Display (Loop2)

The PV input value of Loop2 appears on the PV display.

The target setpoint of Loop2, control output value, deviation, and PID number appears on the Setpoint display (LCD).

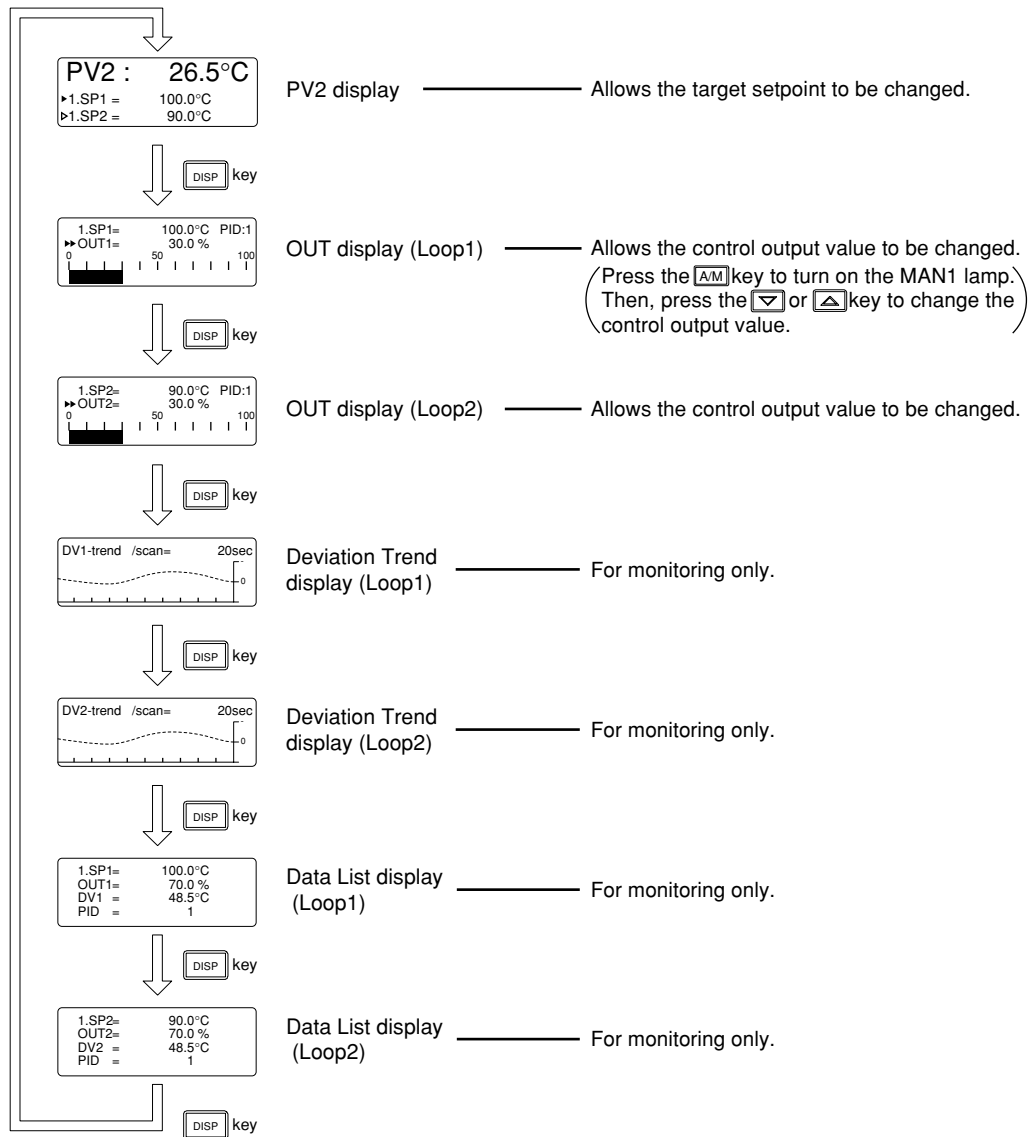

■ Operating Displays for Dual-loop Heating/Cooling Control

● PV2 Display

The PV input value of Loop1 appears on the PV display.

The PV input value of Loop2 (PV2), the target setpoint of Loop1 (1.SP1) and the target setpoint of Loop2 (1.SP2) appears on the Setpoint display (LCD).

● Heating/Cooling OUT Display (Loop1)

The PV input value of Loop1 appears on the PV display.

The target setpoint (1.SP1), PID number, and heating-side (H1) and cooling-side (C1) control output values of Loop1 appears on the Setpoint display (LCD).

● Heating/Cooling OUT Display (Loop2)

The PV input value of Loop2 appears on the PV display.

The target setpoint (1.SP2), PID number, and heating-side (H2) and cooling-side (C2) control output values of Loop2 appears on the Setpoint display (LCD).

● Deviation Trend Display (Loop1)

The PV input value of Loop1 appears on the PV display.

The deviation trend of Loop1 appears on the Setpoint display (LCD).

● Deviation Trend Display (Loop2)

The PV input value of Loop2 appears on the PV display.

The deviation trend of Loop2 appears on the Setpoint display (LCD).

● Heating/Cooling Data List Display (Loop1)

The PV input value of Loop1 appears on the PV display.

The target setpoint, heating-side (H1) and cooling-side (C1) control output values, deviation, and PID number of Loop1 appears on the Setpoint display (LCD).

● Heating/Cooling Data List Display (Loop2)

The PV input value of Loop2 appears on the PV display.

The target setpoint, heating-side (H2) and cooling-side (C2) control output values, deviation, and PID number of Loop2 appears on the Setpoint display (LCD).

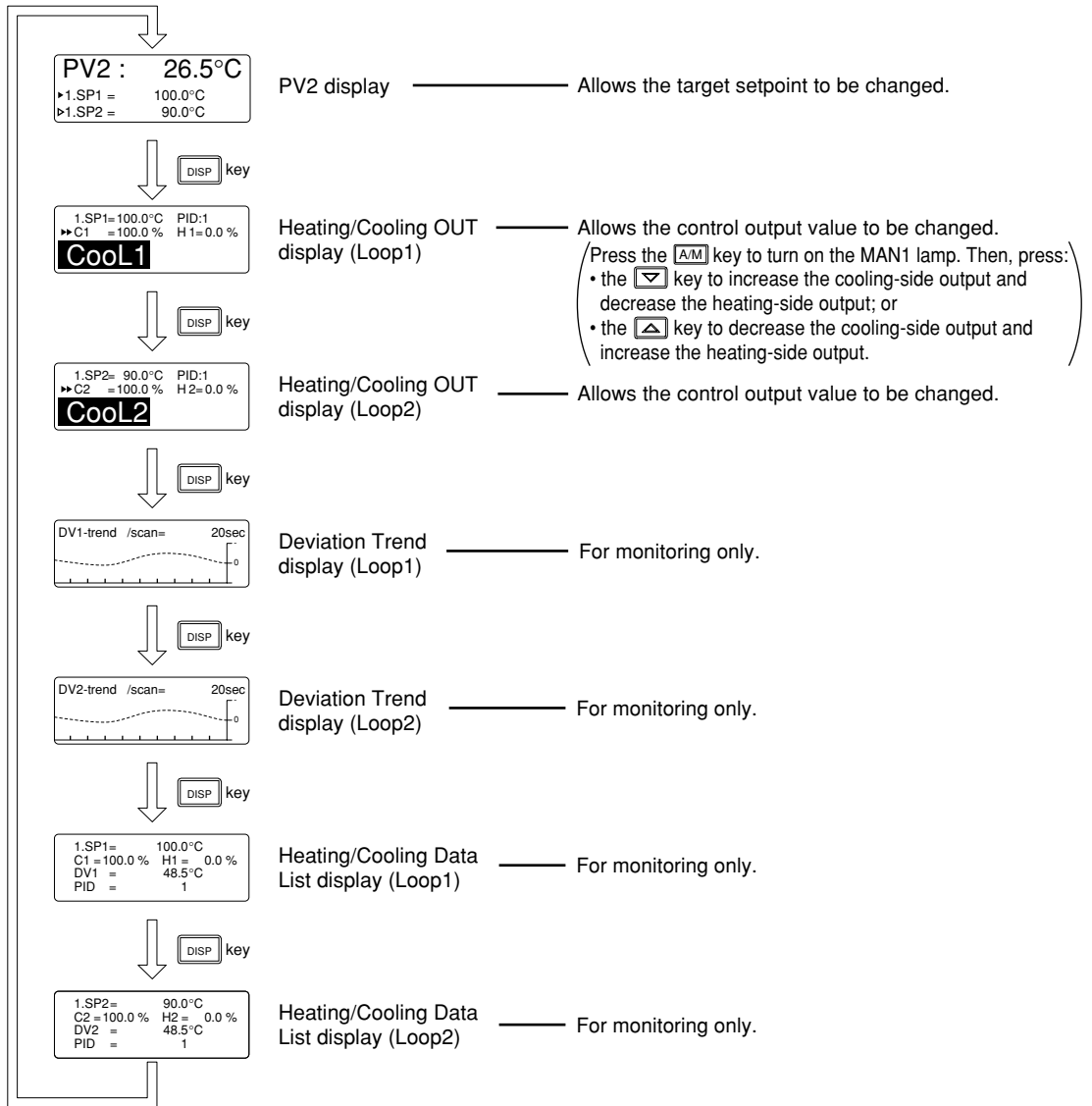

3.2 Setting Target Setpoint (SP) of Loop1

The following operating procedure describes an example of setting 150.0 to a target setpoint of Loop1. In automatic operation, the controller starts control using set target setpoints.

1. Bring the operating display into view (display appears at power on).

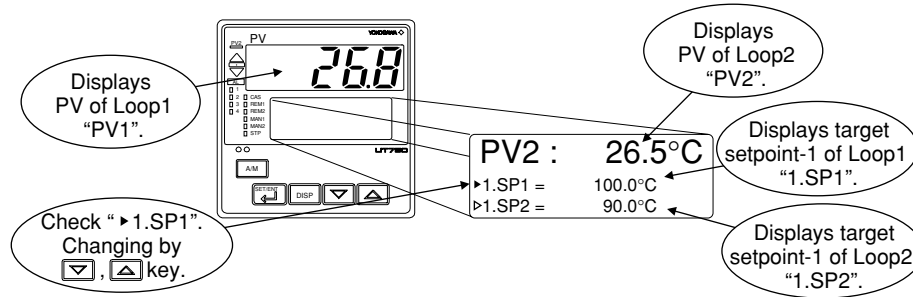

In steps 2 and later, illustrations of the LCD are cited to explain the procedure.

2. Press the key once to display "▶ 1.SP1".

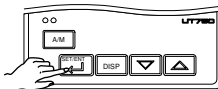
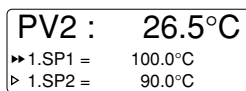

4. Press the key once to register the setpoint.

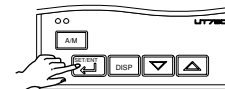
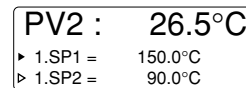

3. Press the or key to display the required setpoint.

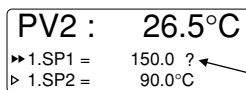

Blinks during change.

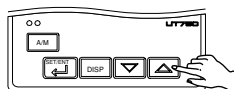

3.3 Setting Target Setpoint (SP) of Loop2

The following operating procedure describes an example of setting 150.0 to a target setpoint of Loop2. In automatic operation, the controller starts control using set target setpoints.

1. Bring the operating display into view (display appears at power on).

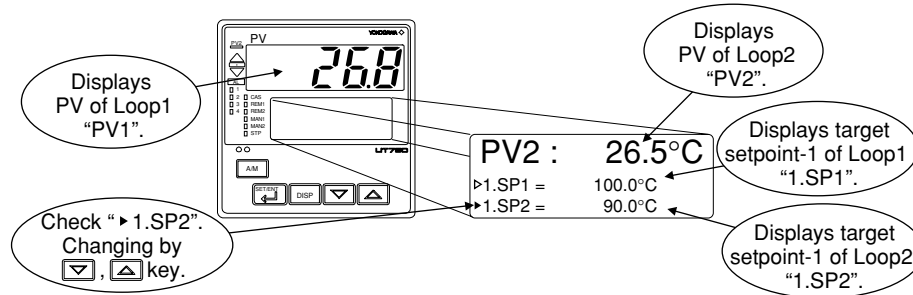

In steps 2 and later, illustrations of the LCD are cited to explain the procedure.

2. Press the [RETURN] key once to display ">>1.SP2".

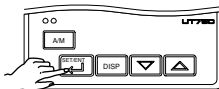
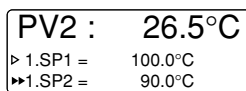

4. Press the [RETURN] key once to register the setpoint.

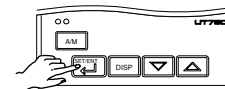
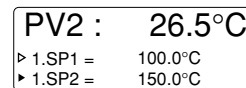

3. Press the [UP] or [DOWN] key to display the required setpoint.

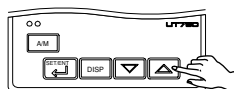
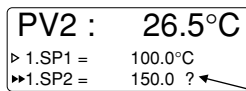

Blinks during change.

3.4 Performing/Canceling Auto-tuning of Loop1

Auto-tuning should be carried out after setting a target setpoint of Loop1 (SP). Make sure the controller is in automatic operation mode (AUTO) and in running state (RUN) before carrying out auto-tuning. See "3.12 Switching between AUTO and MAN of Loop1," to change to AUTO and "3.11 Switching between Run and Stop," to change to Run.

NOTE

When on-off control is being used, auto-tuning cannot be carried out. Moreover, do not perform auto-tuning when controlling any of the following processes.

- Control processes with quick response such as flow control or pressure control
- Processes where even temporary output on/off results in inconvenience
- Processes where a large output change at control element results in inconvenience
- Processes where variations in PV may exceed an allowable range, adversely affecting product quality

1. Bring the operating display into view (display appears at power on).

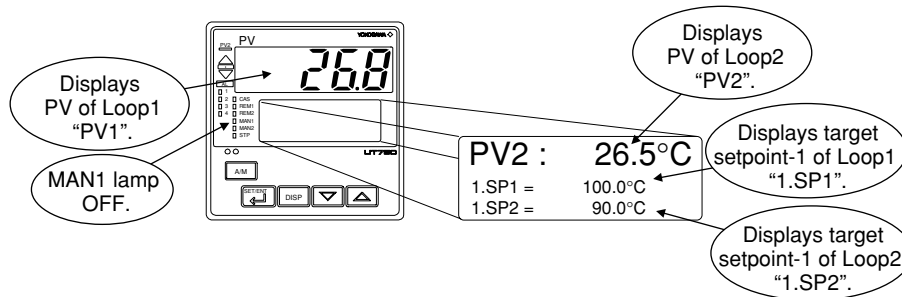

In steps 2 and later, illustrations of the LCD are cited to explain the procedure.

2. Press the key for more than 3 seconds to call up the main menu "MODE".

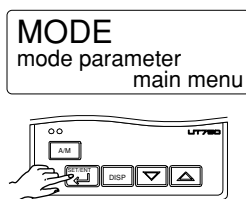

4. Press the key once to display the submenu "PAR".

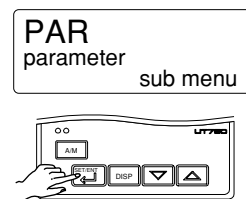

3. Press the key once to display the main menu "LP1".

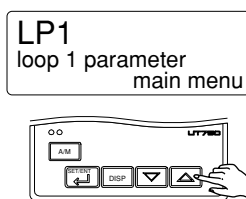

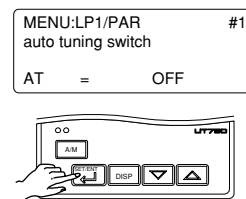

5. Press the key once again to display the parameter "AT".

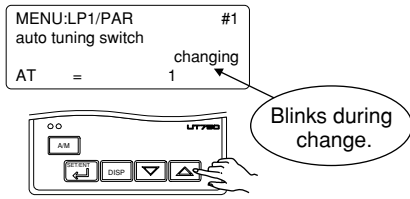

6. Press the  or  key to display the required setpoint. Tuning for 1.SP is AT = 1. To cancel auto-tuning, set AT = OFF.



7. Press the  key once to register the setpoint. (This starts auto-tuning.) If the  key is pressed when AT = OFF, auto-tuning will be cancelled. In this case, PID contains the value existing before auto-tuning.

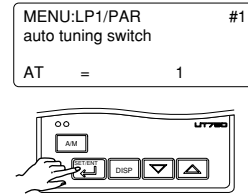

8. During auto-tuning, the panel indications become as shown below.

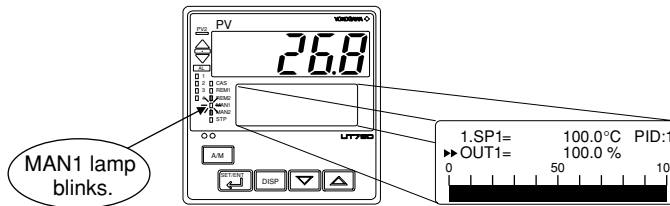

Auto-tuning is complete when the MAN1 lamp goes off.

3.5 Performing/Canceling Auto-tuning of Loop2

Auto-tuning should be carried out after setting a target setpoint of Loop2 (SP). Make sure the controller is in automatic operation mode (AUTO) and in running state (RUN) before carrying out auto-tuning. See "3.13 Switching between AUTO and MAN of Loop2," to change to AUTO and "3.11 Switching between Run and Stop," to change to Run.

NOTE

When on-off control is being used, auto-tuning cannot be carried out. Moreover, do not perform auto-tuning when controlling any of the following processes.

- Control processes with quick response such as flow control or pressure control
- Processes where even temporary output on/off results in inconvenience
- Processes where a large output change at control element results in inconvenience
- Processes where variations in PV may exceed an allowable range, adversely affecting product quality

1. Bring the operating display into view (display appears at power on).

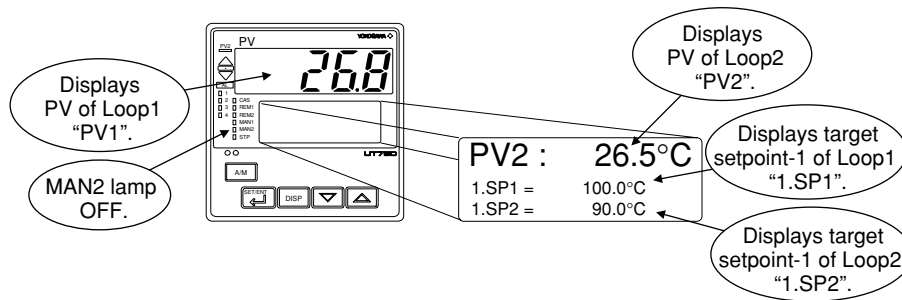

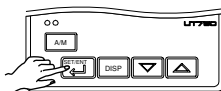

In steps 2 and later, illustrations of the LCD are cited to explain the procedure.

2. Press the  key for more than 3 seconds to call up the main menu "MODE".

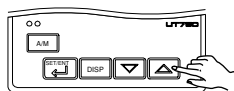
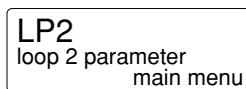

3. Press the  key twice to display the main menu "LP2".



4. Press the  key once to display the submenu "PAR".

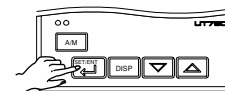
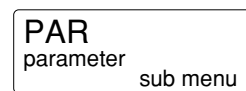

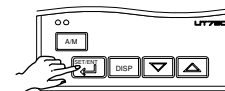
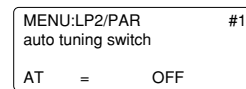

5. Press the  key once again to display the parameter "AT".

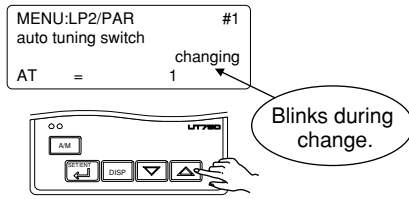

6. Press the  or  key to display the required setpoint. Tuning for 1.SP is AT = 1. To cancel auto-tuning, set AT = OFF.



7. Press the  key once to register the setpoint. (This starts auto-tuning.) If the  key is pressed when AT = OFF, auto-tuning will be cancelled. In this case, PID contains the value existing before auto-tuning.

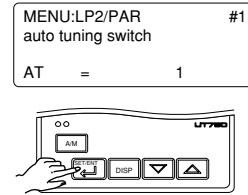

8. During auto-tuning, the panel indications become as shown below.

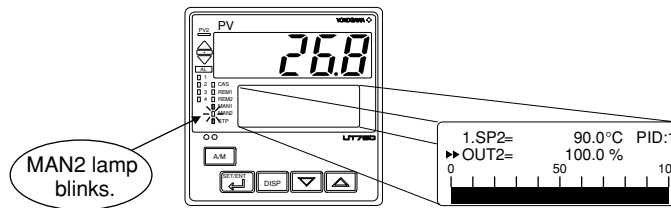

Auto-tuning is complete when the MAN2 lamp goes off.

3.6 Setting PID of Loop1 Manually

If you know the values to be set or if suitable PID constants cannot be obtained by auto-tuning, follow the procedure below to set values.

1. Bring the operating display into view (display appears at power on).

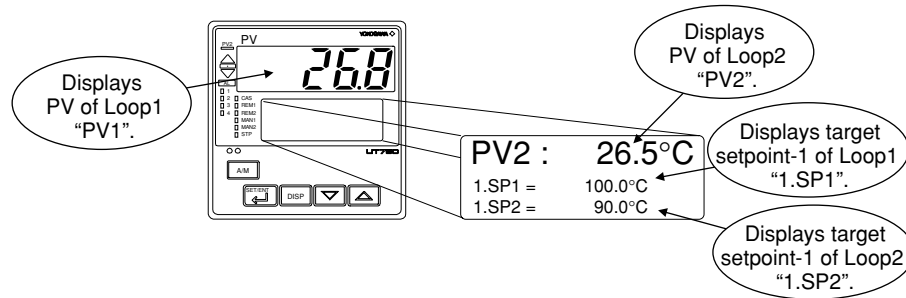

In steps 2 and later, illustrations of the LCD are cited to explain the procedure.

2. Press the key for more than 3 seconds to call up the main menu "MODE".

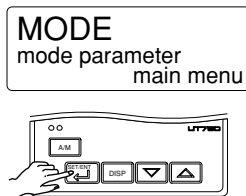

3. Press the key once to display the main menu "LP1".

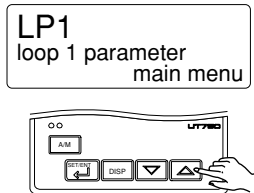

4. Press the key once to display the submenu "PAR".

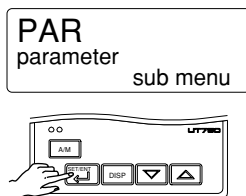

5. Press the key once to display the submenu "1.PID".

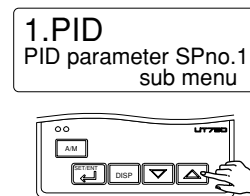

6. Press the key six times to display the parameter "1.P" (proportional band for 1.SP).

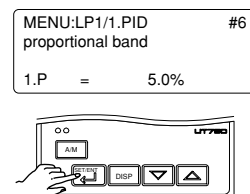

7. Press the or key to display the required setpoint.

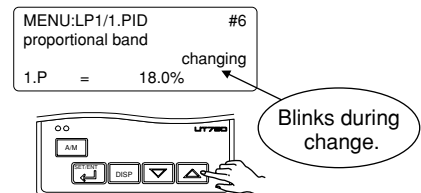

8. Press the  key once to register the setpoint.

MENU:LP1/1.PID #6
proportional band
1.P = 18.0%

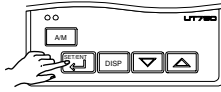

The same steps can be used for integral time (1.I) and derivative time (1.D) that are displayed after this.

[TIP]
For the PID parameter number you set in step 5, select:
the submenu "1.PID" if the PID constants are for 1.SP;
the submenu "2.PID" if the PID constants are for 2.SP;
the submenu "3.PID" if the PID constants are for 3.SP; and
the submenu "4.PID" if the PID constants are for 4.SP.

9. Press the  key for more than 3 seconds. This returns you to the display shown at power-on (figure below).

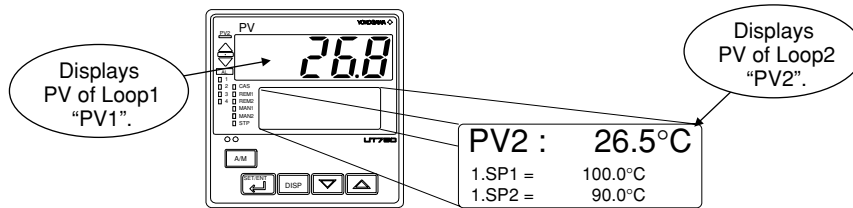

3.7 Setting PID of Loop2 Manually

If you know the values to be set or if suitable PID constants cannot be obtained by auto-tuning, follow the procedure below to set values.

1. Bring the operating display into view (display appears at power on).

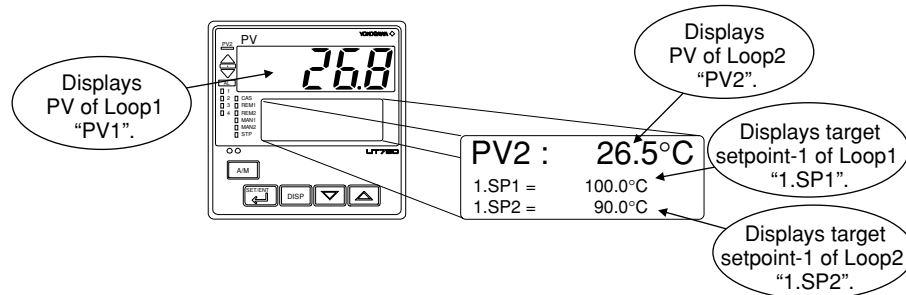

In steps 2 and later, illustrations of the LCD are cited to explain the procedure.

2. Press the key for **more than 3 seconds** to call up the main menu "MODE".

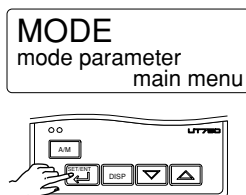

5. Press the key once to display the submenu "1.PID".

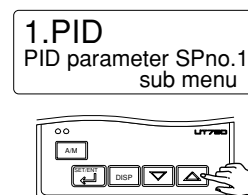

3. Press the key twice to display the main menu "LP2".

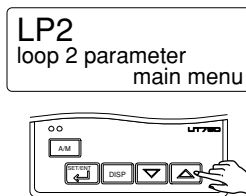

6. Press the key six times to display the parameter "1.P" (proportional band for 1.SP).

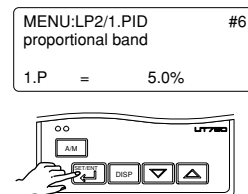

4. Press the key once to display the submenu "PAR".

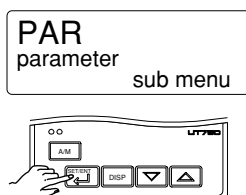

7. Press the or key to display the required setpoint.

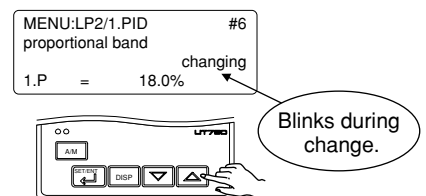

- 8. Press the  key once to register the setpoint.

MENU:LP2/1.PID #6
proportional band
1.P = 18.0%

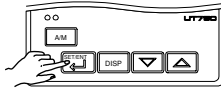

The same steps can be used for integral time (1.I) and derivative time (1.D) that are displayed after this.

[TIP]
For the PID parameter number you set in step 5, select:
the submenu "1.PID" if the PID constants are for 1.SP;
the submenu "2.PID" if the PID constants are for 2.SP;
the submenu "3.PID" if the PID constants are for 3.SP; and
the submenu "4.PID" if the PID constants are for 4.SP.

- 9. Press the  key for more than 3 seconds. This returns you to the display shown at power-on (figure below).

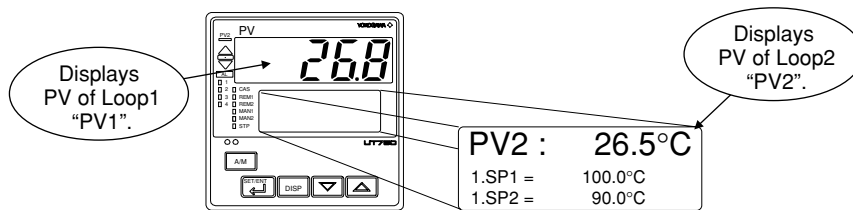

3.8 Setting Alarm Setpoints of Loop1

The following operating procedure describes an example of setting 160.0 to alarm-1 setpoint of Loop1. Check alarm type before setting the alarm setpoint.

When changing the alarm type, see "2.7 Changing Alarm Type of Loop1."

| Alarm output terminals | Factory-set defaults |
|--------------------------------|--------------------------|
| Alarm-1 (terminal numbers ⑥-⑦) |PV high limit alarm |
| Alarm-2 (terminal numbers ⑤-⑦) |PV low limit alarm |
| Alarm-3 (terminal numbers ④-⑦) |PV high limit alarm |
| Alarm-4 (terminal numbers ③-⑤) |PV low limit alarm |

- 1. Bring the operating display into view (display appears at power on).

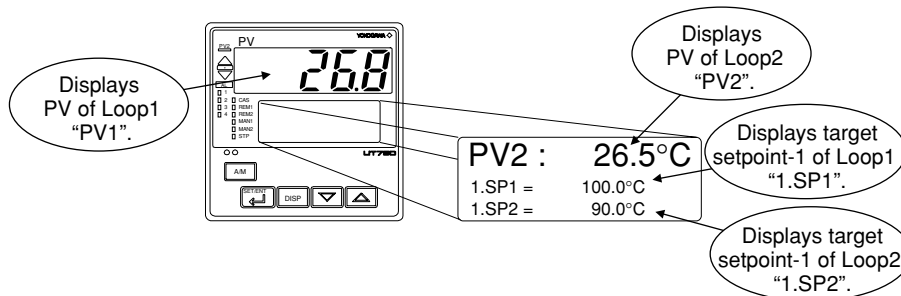

In steps 2 and later, illustrations of the LCD are cited to explain the procedure.

- 2. Press the  key for more than 3 seconds to call up the main menu "MODE".

MODE
mode parameter
main menu

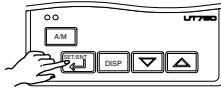

- 3. Press the  key once to display the main menu "LP1".

LP1
loop 1 parameter
main menu

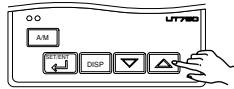

- 4. Press the  key once to display the submenu "PAR".

PAR
parameter
sub menu

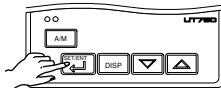

- 5. Press the  key once to display the submenu "1.PID".

1.PID
PID parameter SPno.1
sub menu

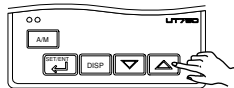

- 6. Press the  key twice to display the parameter "1.A1".

MENU:LP1/1.PID #2
alarm-1 set point
1.A1 = 200.0°C

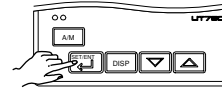

- 7. Press the  or  key to display the required setpoint.

MENU:LP1/1.PID #2
alarm-1 set point
1.A1 = 160.0°C

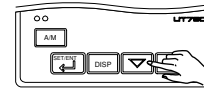

Blinks during change.

- 8. Press the  key once to register the setpoint.

MENU:LP1/1.PID #2
alarm-1 set point
1.A1 = 160.0°C

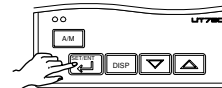

You can take the same steps for alarm-2 setpoint (1.A2), alarm-3 setpoint (1.A3), alarm-4 setpoint (1.A4) that are displayed after this.

- 9. Press the  key for more than 3 seconds. This returns you to the display shown at power-on (figure below).

PV2 : 26.5°C
1.SP1 = 100.0°C
1.SP2 = 90.0°C

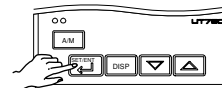

3.9 Setting Alarm Setpoints of Loop2

The following operating procedure describes an example of setting 160.0 to alarm-1 setpoint of Loop2. Check alarm type before setting the alarm setpoint.

When changing the alarm type, see “2.8 Changing Alarm Type of Loop2.”

| Alarm output terminals | Factory-set defaults |
|--------------------------------|--------------------------|
| Alarm-1 (terminal numbers ③-⑤) |PV high limit alarm |
| Alarm-2 (terminal numbers ②-④) |PV low limit alarm |
| Alarm-3 (terminal numbers ①-⑤) |PV high limit alarm |

1. Bring the operating display into view (display appears at power on).

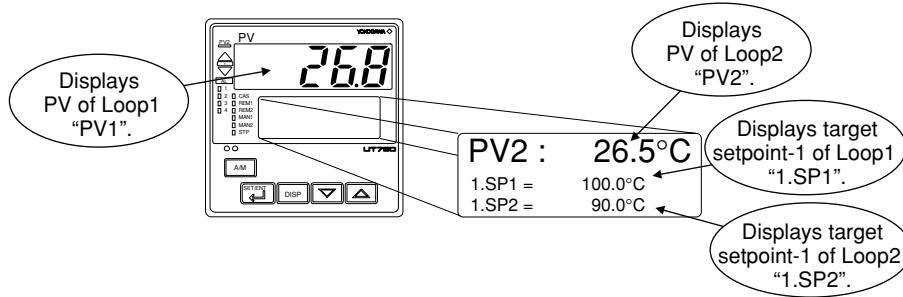

In steps 2 and later, illustrations of the LCD are cited to explain the procedure.

2. Press the key for more than 3 seconds to call up the main menu "MODE".

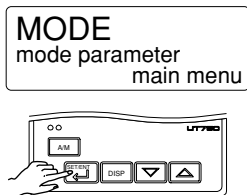

3. Press the key twice to display the main menu "LP2".

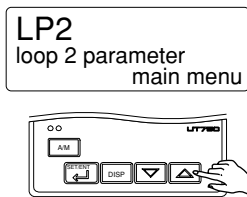

4. Press the key once to display the submenu "PAR".

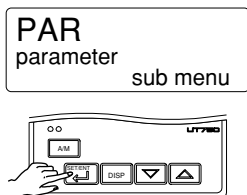

5. Press the key once to display the submenu "1.PID".

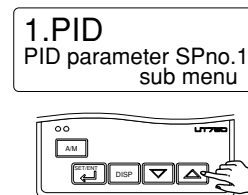

6. Press the key twice to display the parameter "1.A1".

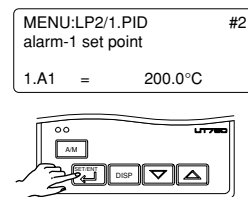

7. Press the or key to display the required setpoint.

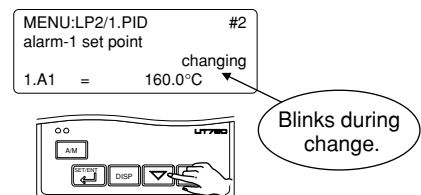

8. Press the  key once to register the setpoint.

| | |
|-------------------|---------|
| MENU:LP2/1.PID | #2 |
| alarm-1 set point | |
| 1.A1 = | 160.0°C |

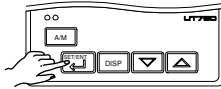

You can take the same steps for alarm-2 setpoint (1.A2), alarm-3 setpoint (1.A3), alarm-4 setpoint (1.A4) that are displayed after this.

9. Press the  key for **more than 3 seconds**. This returns you to the display shown at power-on (figure below).

| | |
|---------|---------|
| PV2 : | 26.5°C |
| 1.SP1 = | 100.0°C |
| 1.SP2 = | 90.0°C |

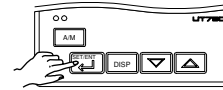

3.10 Selecting Target Setpoint Numbers (SPNO)

The following operating procedure describes an example of changing a target setpoint number (SPNO) from 1 to 2.



NOTE

- If a target setpoint number has been switched using contact input, when the contact input is on, that number cannot be selected by keystroke.
- The target setpoint numbers (SPNO) of Loop1 and Loop2 are the same.

1. Bring the operating display into view (display appears at power on).

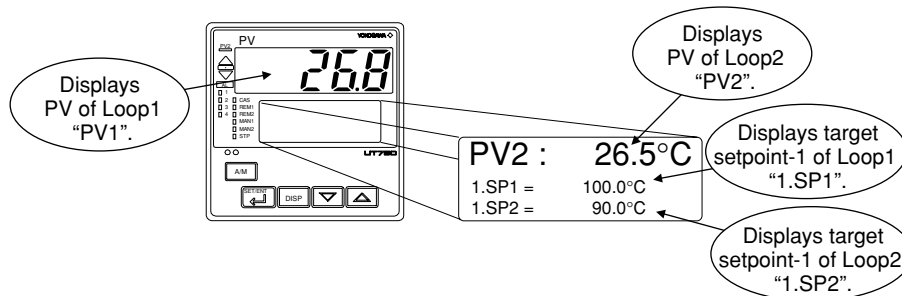

In steps 2 and later, illustrations of the LCD are cited to explain the procedure.

- 2. Press the  key for **more than 3 seconds** to call up the main menu “MODE”.

MODE
mode parameter
main menu

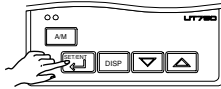

- 3. Press the  key several times to display the parameter “SPNO”.

MENU:MODE #6
SPno. select
SPNO = 1

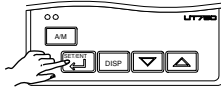

- 4. Press the  or  key to display the required setpoint.

MENU:MODE #6
SPno. select
SPNO = changing
2

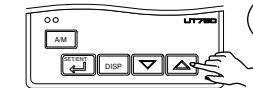

Blinks during change.

- 5. Press the  key once to register the setpoint.

MENU:MODE #6
SPno. select
SPNO = 2

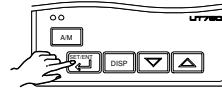

- 6. Press the  key for **more than 3 seconds**. This returns you to the display shown at power-on (figure below).

Displays target setpoint-2 “2.SP1, 2.SP2”.

PV2 : 26.5°C
2.SP1 = 140.0°C
2.SP2 = 120.0°C

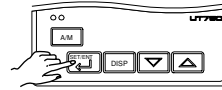

3.11 Switching between Run and Stop

Selection between the Run state (RUN) and Stop state (STOP) can be made with contact input 7 (DI7). (Simultaneously for Loop1 and Loop2)

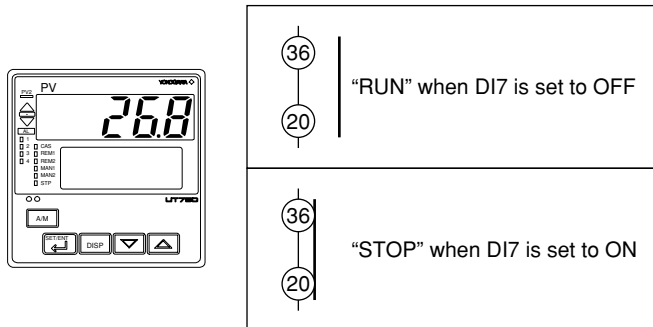

When at a stop, the controller behaves as described below:

| | |
|----------------|---|
| PV input | Displays the PV value. |
| Control output | Provides the preset output value (factory-set to 0%). |
| Alarm output | Turns the output on in case of an alarm. |

3.12 Switching between AUTO and MAN of Loop1

NOTE

If AUTO and MAN of Loop1 have been switched using contact input, when the contact input is ON, switching between AUTO and MAN cannot be achieved by keystroke.

1. Bring the operating display into view (display appears at power on).

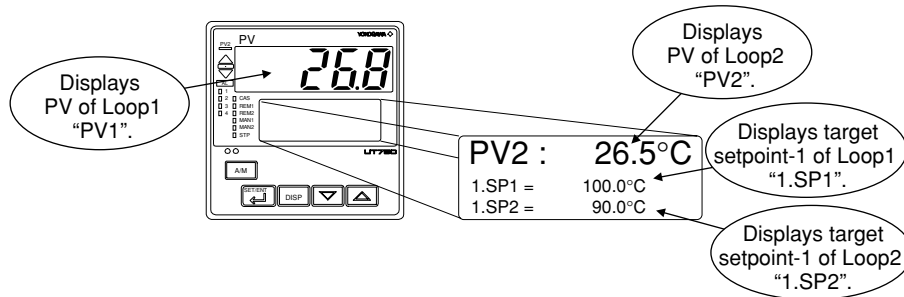

2. Each time you press the **AM** key on the front panel of the instrument, AUTO and MAN is switched alternately.

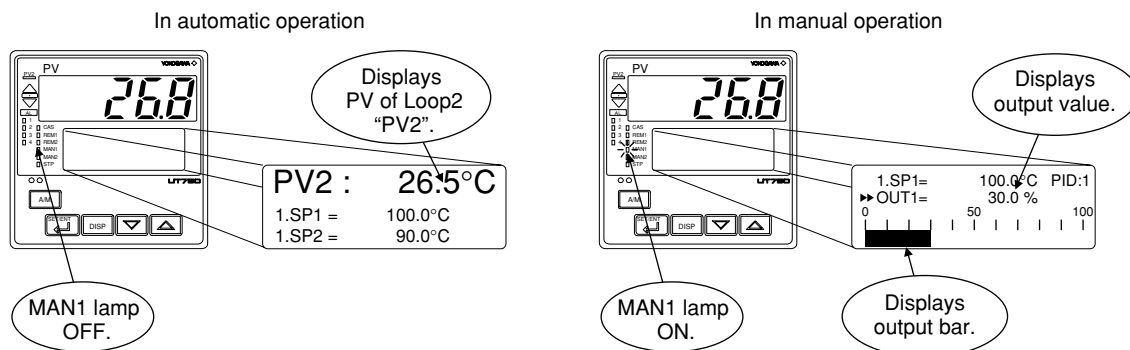

3.13 Switching between AUTO and MAN of Loop2

NOTE

If AUTO and MAN of Loop2 have been switched using contact input, when the contact input is ON, switching between AUTO and MAN cannot be achieved by keystroke.

- 1. Bring the operating display into view (display appears at power on).

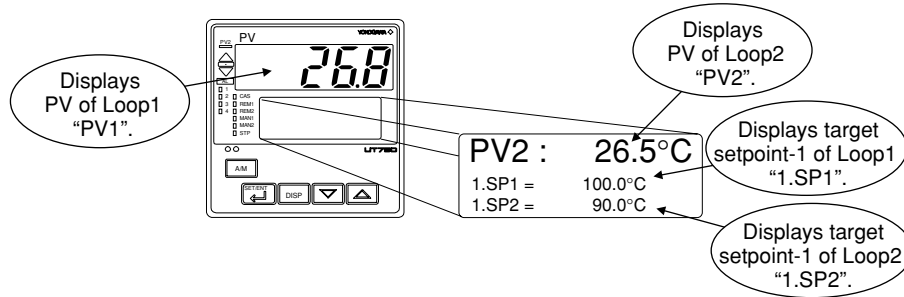

In step 2 and later, illustrations of the LCD are cited to explain the procedure.

- 2. Press the  key for more than 3 seconds to call up the main menu "MODE".

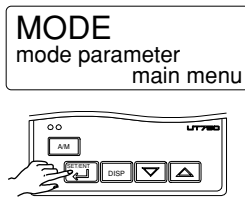

- 3. Press the  key once to display the parameter "MODE".

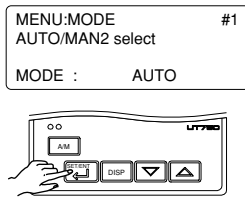

- 4. Press the  or  key to display the required setpoint.

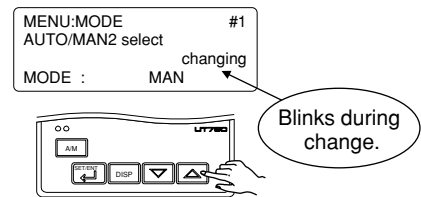

- 5. Press the  key once to register the setpoint.

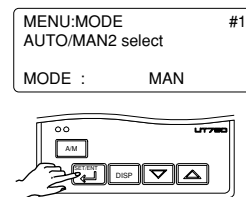

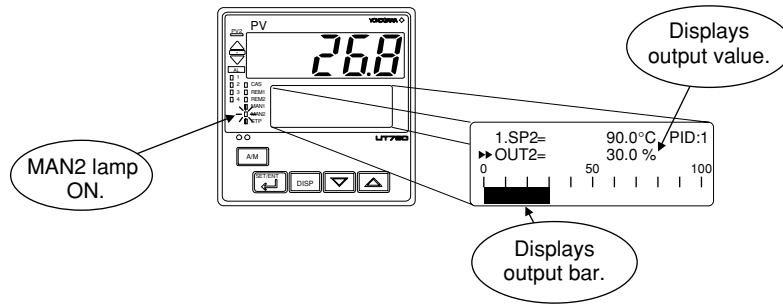

- 6. Automatically return to the operating display (figure below).



3.14 Manipulating Control Output during Manual Operation of Loop1

 **NOTE**

Control output cannot be changed if the controller is stopped. In this case, the preset output value (operating parameter PO) will be output.

A control output value is linked with a display value changed using the  or  key. Note that the control output changes as displayed without requiring the  key.

- 1. Bring manual operating display into view. For switching to manual operation, see “3.12 Switching between AUTO and MAN of Loop1”.

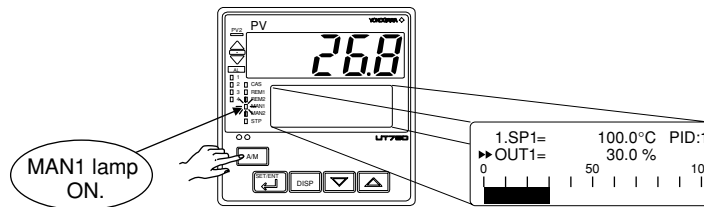

- 2. Press the  or  key to change a control output value. You don't need to press the  key.

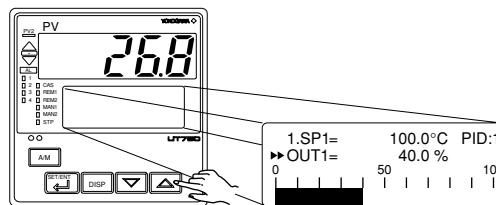

■ Manipulating the Control Output during Heating/Cooling Control

Showing the Heating/Cooling OUT display.

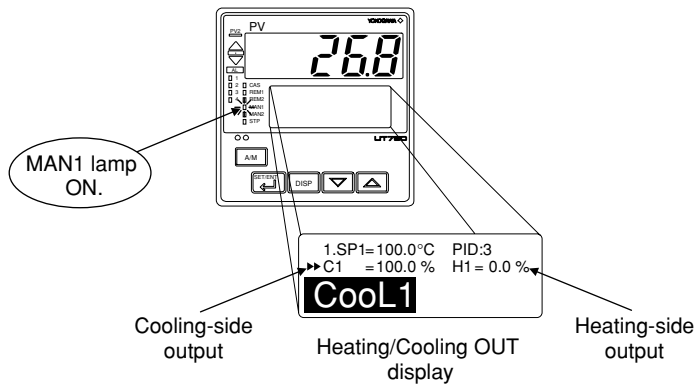

● Controller Behavior and Control Output Manipulation when the Dead Band is Positive

The following is an example when the DB parameter is set at 12.4%.

If you hold down the key with the heating-side output under manipulation (i.e., cooling-side output C1 = 0.0%), the heating-side output (H1 =) decreases. Consequently, both the heating-side and cooling-side outputs change to 0.0%. If you keep the key held down longer, you enter the state of manipulating the cooling-side output, and its value begins to increase.

Inversely, if you hold down the key with the cooling-side output under manipulation (i.e., heating-side output H1 = 0.0%), the cooling-side output (C1 =) decreases. Consequently, both the heating-side and cooling-side outputs go to 0.0%. If you keep the key held down longer, you enter the state of manipulating the heating-side output, and its value begins to increase.

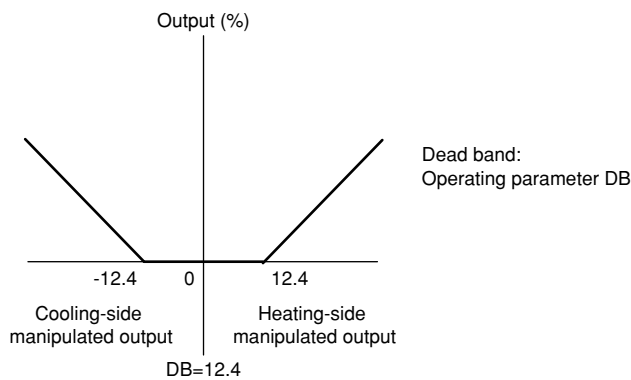

Change in manipulated output when the dead band is positive

● **Controller Behavior and Control Output Manipulation when the Dead Band is Negative**

The following is an example when the DB parameter is set at -12.4%.

If you hold down the key with the heating-side output under manipulation (i.e., cooling-side output C1 = 0.0%), the heating-side output (H1 =) decreases. If the output H1 falls below 24.8%, the cooling-side output C1 begins to increase from 0.0%. If you keep the key held down longer and the output C1 rises above 24.8%, the output H1 goes to 0.0% and you enter the state of manipulating the cooling-side output.

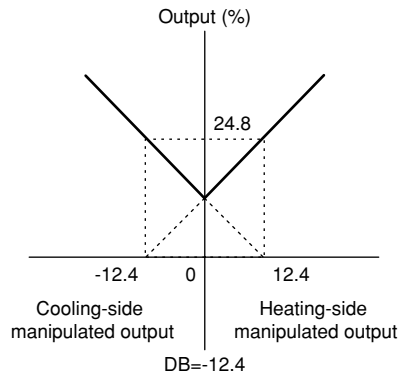



Change in manipulated output when the dead band is negative

3.15 Manipulating Control Output during Manual Operation of Loop2

NOTE

Control output cannot be changed if the controller is stopped. In this case, the preset output value (operating parameter PO) will be output.

A control output value is linked with a display value changed using the  or  key. Note that the control output changes as displayed without requiring the  key.

- 1. Bring manual operating display into view. For switching to manual operation, see “3.13 Switching between AUTO and MAN of Loop2”.

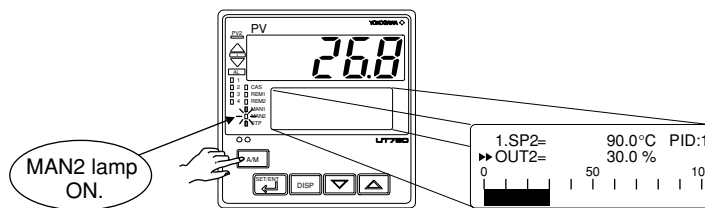

- 2. Press the  or  key to change a control output value. You don't need to press the  key.

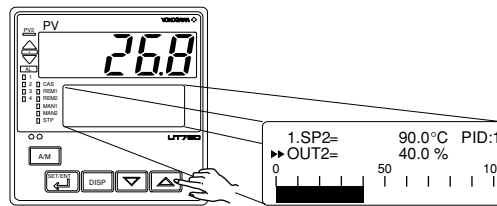



■ Manipulating the Control Output during Heating/Cooling Control

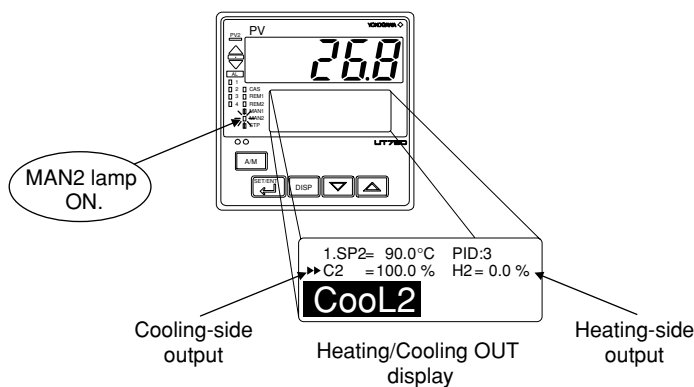

Showing the Heating/Cooling OUT display.



● Controller Behavior and Control Output Manipulation when the Dead Band is Positive

The following is an example when the DB parameter is set at 12.4%.

If you hold down the  key with the heating-side output under manipulation (i.e., cooling-side output C2 = 0.0%), the heating-side output (H2 =) decreases. Consequently, both the heating-side and cooling-side outputs change to 0.0%. If you keep the  key held down longer, you enter the state of manipulating the cooling-side output, and its value begins to increase.

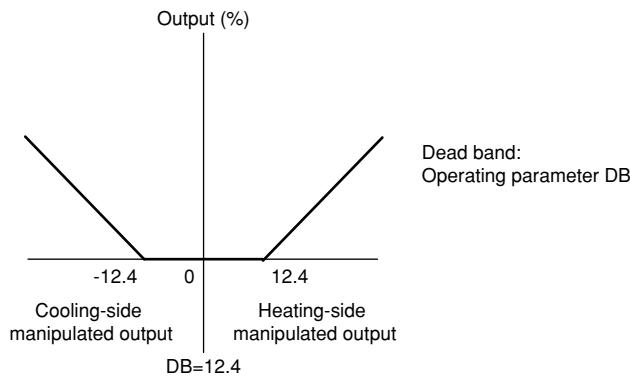

Inversely, if you hold down the  key with the cooling-side output under manipulation (i.e., heating-side output H2 = 0.0%), the cooling-side output (C2 =) decreases. Consequently, both the heating-side and cooling-side outputs go to 0.0%. If you keep the  key held down longer, you enter the state of manipulating the heating-side output, and its value begins to increase.



Change in manipulated output when the dead band is positive

● Controller Behavior and Control Output Manipulation when the Dead Band is Negative

The following is an example when the DB parameter is set at -12.4%.

If you hold down the  key with the heating-side output under manipulation (i.e., cooling-side output C2 = 0.0%), the heating-side output (H2 =) decreases. If the output H2 falls below 24.8%, the cooling-side output C2 begins to increase from 0.0%. If you keep the  key held down longer and the output C2 rises above 24.8%, the output H2 goes to 0.0% and you enter the state of manipulating the cooling-side output.

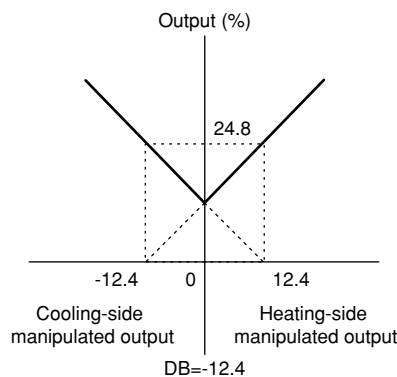

Change in manipulated output when the dead band is negative

3.16 Switching between Remote (REM) and Local (LCL) of Loop1

The following operating procedure describes an example of switching from Local (LCL) to remote (REM) of Loop1.

Switching between REM and LCL is possible for only controllers with remote input feature.

● **Local:**

Performs control using target setpoints set in the controller.

● **Remote:**

Performs control using external analog signals as target setpoints.

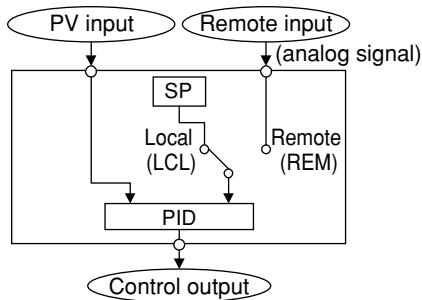

Note: The PID group number when the controller is in remote-mode operation is the same as the number set in the Target Setpoint Number (SPNO) parameter.

NOTE

If remote status is achieved by external contact input (contact input is ON), switching between REM and LCL cannot be achieved by keystroke.

1. Bring the operating display into view (display appears at power on).

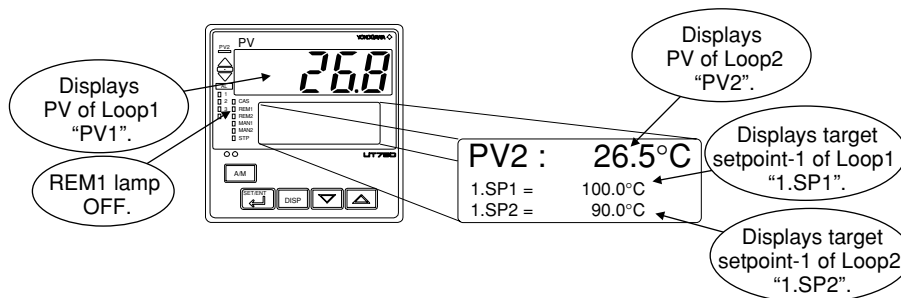

In steps 2 and later, illustrations of the LCD are cited to explain the procedure.

- 2. Press the  key for more than 3 seconds to call up the main menu "MODE".

MODE
mode parameter
main menu

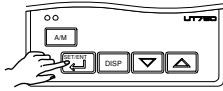

- 3. Press the  key several times to display the parameter "MODE:LOCAL".

MENU:MODE #3
REM/LOC1 select
MODE : LOCAL

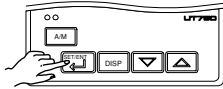

- 4. Press the  or  key to display "RE-MOTE".

MENU:MODE #3
REM/LOC1 select
MODE : REMOTE

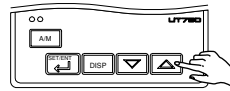

Blinks during change.

- 5. Press the  key once to register the setpoint.

MENU:MODE #3
REM/LOC1 select
MODE : REMOTE

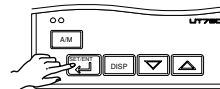

Automatically return to the operating display (figure below).

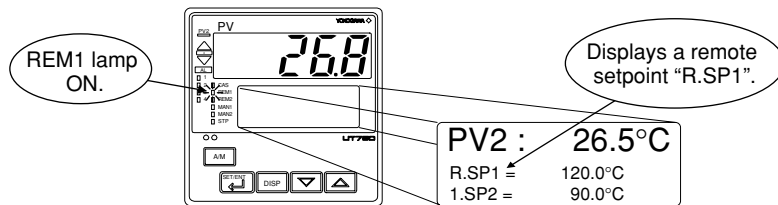

3.17 Switching between Remote (REM) and Local (LCL) of Loop2

The following operating procedure describes an example of switching from Local (LCL) to remote (REM) of Loop2.

Switching between REM and LCL is possible for only controllers with remote input feature.

● **Local:**

Performs control using target setpoints set in the controller.

● **Remote:**

Performs control using external analog signals as target setpoints.

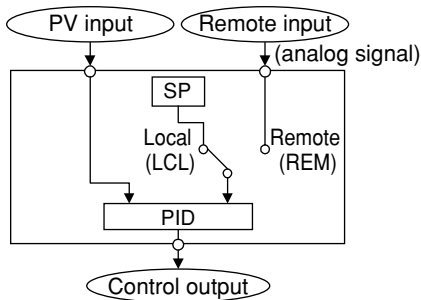

Note: The PID group number when the controller is in remote-mode operation is the same as the number set in the Target Setpoint Number (SPNO) parameter.

 **NOTE**

If remote status is achieved by external contact input (contact input is ON), switching between REM and LCL cannot be achieved by keystroke.

1. Bring the operating display into view (display appears at power on).

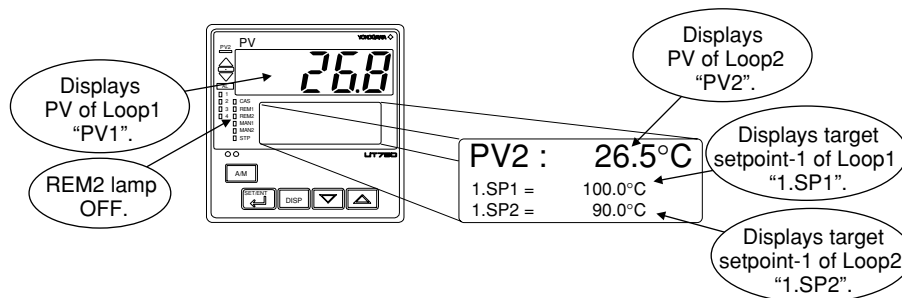

In steps 2 and later, illustrations of the LCD are cited to explain the procedure.

- 2. Press the  key for more than 3 seconds to call up the main menu "MODE".

MODE
mode parameter
main menu

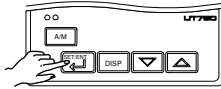

- 3. Press the  key several times to display the parameter "MODE:LOCAL".

MENU:MODE #4
REM/LOC2 select
MODE : LOCAL

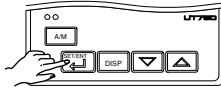

- 4. Press the  or  key to display "RE-MOTE".

MENU:MODE #4
REM/LOC2 select
MODE : REMOTE

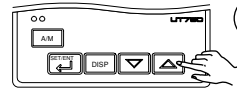

Blinks during change.

- 5. Press the  key once to register the setpoint.

MENU:MODE #4
REM/LOC2 select
MODE : REMOTE

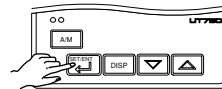

Automatically return to the operating display (figure below).

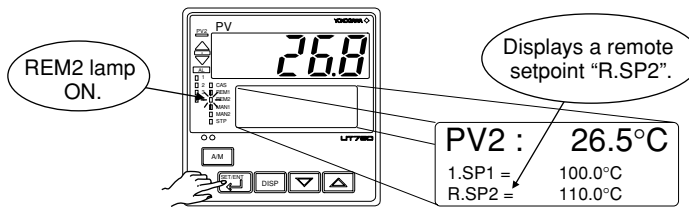

Blank Page

4. Troubleshooting and Maintenance

4.1 Troubleshooting

■ Troubleshooting Flow

If the operating display does not appear after turning on the controller's power, follow the measures in the procedure below.

If a problem appears complicated, contact our sales representative.

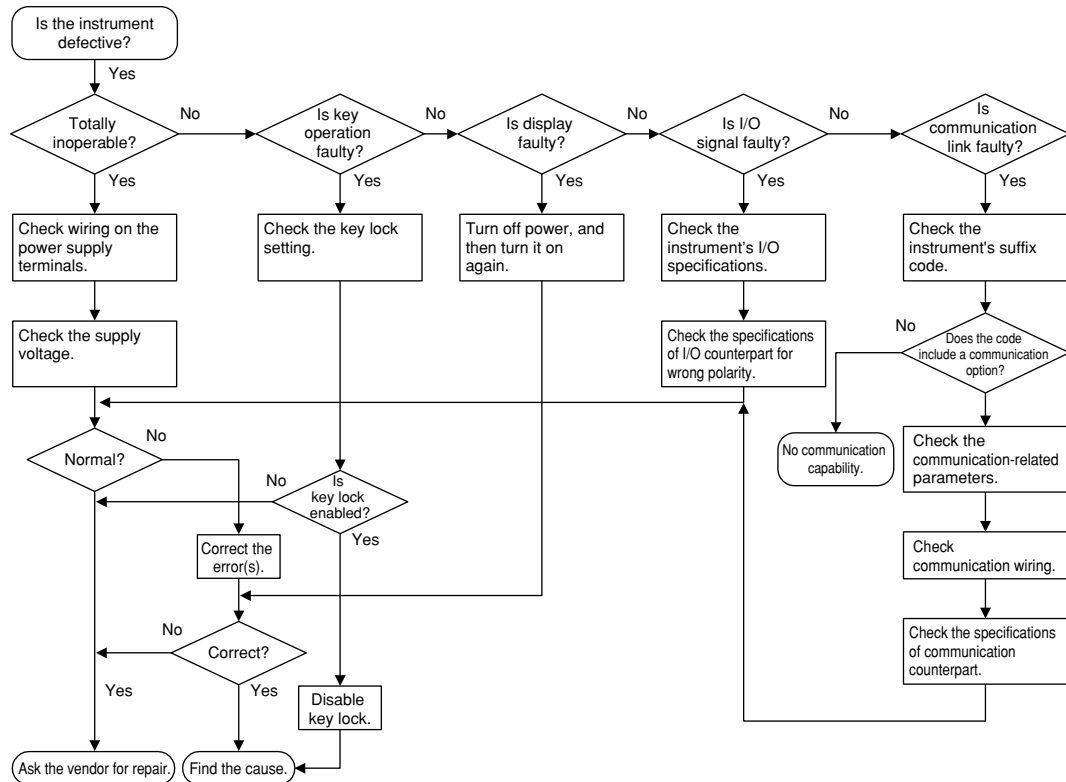

IMPORTANT

Take note of the parameter settings when asking the vendor for repair.

■ Errors at Power on

The following table shows errors that may be detected by the fault diagnosis function when the power is turned on.

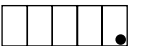
| Display position | Error indication | Description of error | PV | Control output | Alarm output | Retransmission output | Communication | Remedy |
|-------------------|---|--------------------------|---------------------------------|---------------------------------|---------------|-----------------------|---------------------------------|----------------------------------|
| PV-indicating LED | E000 | Faulty RAM | None | 0% or less or OFF | OFF | 0% or less | Stopped | Faulty Contact us for repair. |
| | E001 | Faulty ROM | | | Undefined | Undefined | | |
| | E002 | System data error | Normal action (out of accuracy) | Normal action (out of accuracy) | | | Normal action (out of accuracy) | |
| | PV decimal point blinks.  | Faulty calibration value | | | Normal action | Normal action | | |
| LCD | Error code (See description below.) | Parameter error | Normal action | 0% or less or OFF | | | Normal action | Normal action |

An error code is displayed in the event of an error, according to its type.

An error code is a two-digit figure in which a combination of 6 bits of on and off is converted into a decimal number.

The following shows the relationship between each bit and parameter to be checked for abnormality.

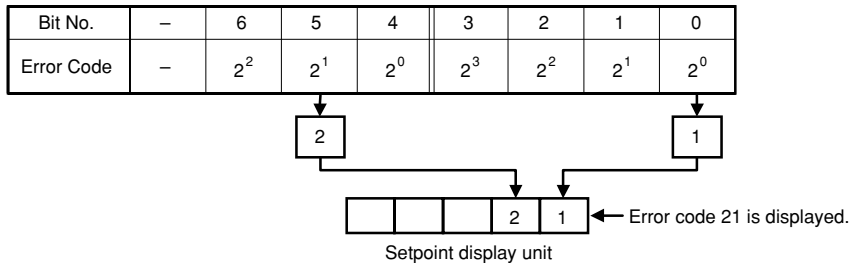

| Bit No. | 6 | 5 | 4 | 3 | 2 | 1 | 0 |
|-------------------------|-----------------------|----------------------|------------------|------------|---------|-----------------------|------------------|
| Parameter to be checked | Operation mode/output | Operating parameters | Setup parameters | Range data | UT mode | Custom computing data | Calibration data |

For example, if an error occurs with the operating parameter and calibration data, the error code will be as follows:

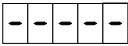

■ Possible Errors during Operation

The following shows possible errors occurring during operations.

| Display position (Note) | Error indication | Description of error | PV | Control output | Alarm output | Retransmission output | Communication | Remedy |
|-------------------------|---|---|---|---|---------------|-----------------------|---------------|--|
| 3 | Displays "RJC" and PV alternately | RJC error | Measured with RJC=0 | Normal action | Normal action | Normal action | Normal action | Faulty Contact us for repair. |
| | E300 | ADC error | 105% | In AUTO: Preset value output In MAN: Normal action | | | | Check wires and sensor. |
| | B.OUT | PV burnout error | Dependent on the BSL parameter Up-scale: 105% Down-scale: -5% | Normal action | | | | Check process. |
| | OVER or -OVER | Excessive PV Out of -5 to 105% | -5% or 105% | Normal action | | | | Check process. Press any key to erase error indication. |
| | E200 | Auto-tuning failure (Time-out) | | Action with PID existing before auto-tuning | | | | Check process. Press any key to erase error indication. |
| 2 | Setpoint display  | Feedback resistor breakdown | Normal action | Stopped | Stopped | Stopped | Normal action | Check the feedback resistor. |
| | Left end of SP display unit blinks. | Faulty communication line | | Normal action | | | | Check wires and communication parameters, and make resetting. Recovery at normal receipt |
| 1 | Decimal point at right end lights.  | Runaway (due to defective power or noise) | Undefined | 0% or less or OFF | OFF | 0% or less | Stopped | Faulty if power off/on does not reset start the unit. Contact us for repair. |
| - | All indications off | Power off | None | | | | | Check for abnormal power. |

Note 1: PV-indicating LED display
 2: LCD
 3: Display showing the PV of the loop in which the error has been caused

■ Remedies if Power Failure Occurs during Operations

The operation status and remedies after a power failure differ with the length of power failure time:

● Instantaneous Power Failure of 20 ms or less

A power failure is not detected. Normal operation continues.

● Power Failure of about 2 seconds or less

The following show effects caused in "settings" and "operation status."

| | |
|-------------------|---|
| Alarm action | Continues. Alarm with standby function will enter standby status. |
| Setting parameter | Set contents of each parameter are retained. |
| Auto-tuning | Cancelled. |
| Control action | Action before power failure continues. |

● **Power Failure of more than about 2 seconds**

The following show effects caused in “settings” and “operation status.”

| | | |
|--|---|---|
| Alarm action | Continues. Alarm with standby function will enter standby status. | |
| Setting parameter | Set contents of each parameter are retained. | |
| Auto-tuning | Cancelled. | |
| Control action | Differs with setting of setup parameter “R.MD”(restart mode). | |
| | R.MD setting | Control action after recovery from power failure |
| | CONT | Action before power failure continues. (factory-shipped setting) |
| | MAN | Outputs preset output value (PO) (NOTE) as control output and continues action set before power failure in MAN mode. |
| | AUTO | Outputs preset output value (PO) (NOTE) as control output and continues action set before power failure in AUTO mode. |
| (NOTE) For heating/cooling control, preset output value is 50% of PID computation. | | |

■ **Troubleshooting when the Controller Fails to Operate Correctly**

If your control tasks are not successful, check the preset parameters and controller wiring before concluding the controller to be defective. The following show some examples of troubleshooting you should refer to in order to avoid the possibility of other problems.

● **The Controller does not Show the Correct Process Variable (PV).**

- The UT750 controllers have a universal input.
The type of PV input can be set/changed using the parameter “IN1”, “IN2”. At this point, the controller must be wired correctly according to the selected type of PV input. Check the wiring first if the controller fails to show the correct PV value. To do this, refer to “2. Initial Settings.”
With the parameters “RH1”, “RL1”, “SDP1”, “SH1” and “SL1”, it is possible to scale the input signal and change its number of decimal places. Also check that these parameters are configured correctly.

● **The Controller does not Provide any Control Output or the Control Output does not Change at all.**

- The UT750 controllers have a universal output.
The type of control output can be set/changed using the parameter “OT1”, “OT2”. At this point, the controller must be wired correctly according to the selected type of control output. Check the wiring first if the controller provides no control output. To do this, refer to “1.5 Terminal Wiring Diagrams.”
With the parameters “OH” and “OL”, it is possible to set/change the high and low limits of control output. The control output may not change at all, however, because of restrictions on these parameters. Also check the restrictions on these parameters.
- The control output can only be changed when the controller is in the MAN mode.
If the MAN lamp is off (i.e., the controller is in the AUTO mode), you cannot change the control output using key operation.

● **The Control Output does not Change soon after the Target Setpoint SP has been Changed.**

- If this happens, check the setpoint of the parameter “MOD”. In cases where fixed-point control is selected as the PID control mode (MOD = 1), tracking based on the I-term works to prevent the control output from changing suddenly even if the target setpoint SP is varied.
The control output therefore may appear to be working incorrectly at first; however it gradually adapts itself to the new target setpoint. Be especially careful when the controller is in the fixed-point control mode; the control output may fail to change and therefore result in a loss of control if you change the target setpoint SP too frequently.

4.2 Maintenance

This section describes the cleaning and maintenance of the UT750.

4.2.1 Cleaning

The front panel and operation keys should be gently wiped with a dry cloth.



NOTE

Do not use alcohol, benzine, or any other solvents.

4.2.2 Replacing Brackets

When the brackets are broken or lost, purchase the following brackets for replacement.

| Target Model | Part No. | Sales Unit |
|--------------|----------|---|
| UT750 | T9115NL | A large bracket and small bracket in pair |

SEE ALSO

“1.2 How to Install,” for how to replace brackets.

4.2.3 Attaching Terminal Cover

When a terminal cover is necessary, purchase the following part.

| Target Model | Part No. | Sales Unit |
|--------------|----------|------------|
| UT750 | T9115YD | 1 |

■ Attaching Terminal Cover

The procedure for attaching the terminal cover is as follows.



Do not touch the terminals on the rear panel when power is being supplied to the controller. Doing so may result in electric shock.

Before attaching the terminal cover, turn off the source circuit breaker and use a tester to check that the power cable is not conducting any electricity.

1. Before attaching the terminal cover, fold it once or twice so that the side which has the “Handle With Care” symbol () is on the outside.

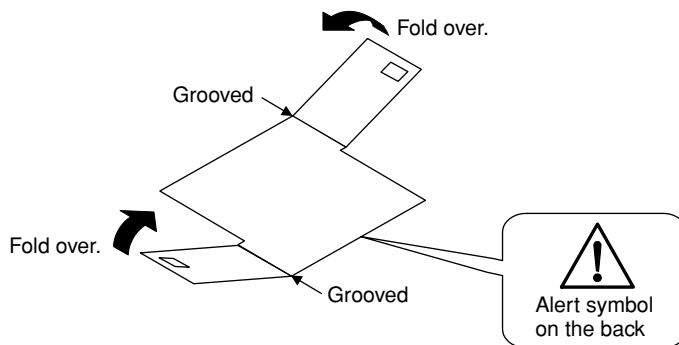

Folding Direction of Terminal Cover



Do not fold the terminal cover the wrong way, doing so not only reduces the cover's strength but may also cause the hinge to crack, thereby disabling attachment.

2. With the cover properly folded, fit its top and bottom holes to the protrusions of the mounting brackets.

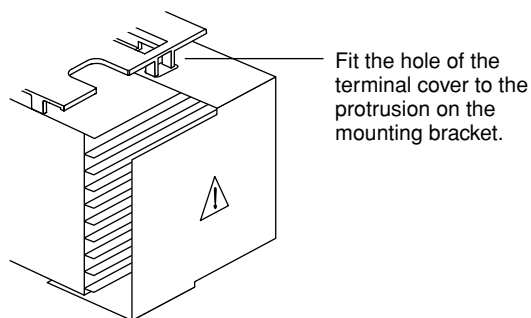

Attaching Terminal Cover

4.2.4 Replacing Parts with a Limited Service Life

The following UT750 parts have a limited service life.

The service life given in the table assume that the controller is used under normal operating conditions.

| Part | Service life |
|---------------------------------|--|
| Aluminum electrolytic condenser | About 10 years (rated) |
| Batteries for backup | About 10 years (rated) |
| Alarm output relays | About 100,000 more ON-OFF operations or with resistance load |
| Control output relays | About 100,000 more ON-OFF operations or with resistance load |

If any of these parts, except control output relays, cause a controller failure due to deterioration, contact your dealer for replacement at your cost.

Control output relays can be replaced by yourself.

SEE ALSO

“4.2.5 Replacing Control Output Relays,” for how to replace the control output relays.

4.2.5 Replacing Control Output Relays

This subsection describes how to replace the control output relays.

The replacement must be performed by an engineer qualified for the work.



Always turn off the power before starting the work in order to avoid electric shock.

Do not pull out the internal unit for any other purpose other than to replace the control output relays.

1. Insert a flat-blade screwdriver (tip width of 6 mm is recommended) into the opening with the tip in parallel with the front panel, and then turn the screwdriver gently. Take this procedure to four openings 1, 2, 3 and 4 (see the figure below) on the upper and lower parts of the bezel, in order. The bezel slightly moves forward from the housing.

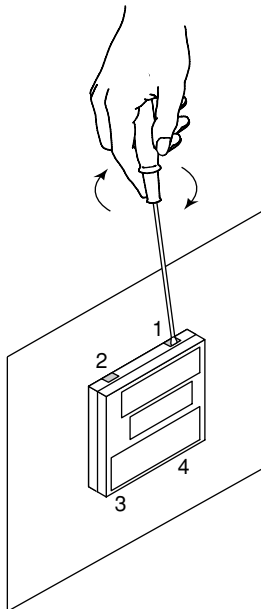

2. Push up the center of the bottom gasket of bezel by a finger to release the latch.

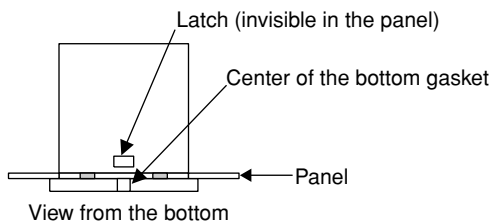

3. Insert the screwdriver into the four openings and flip the tip forward to move the bezel more forward.
4. Hold the bezel and pull it along with the internal unit out of the housing. (Note) Be careful not to damage the RJC sensor.

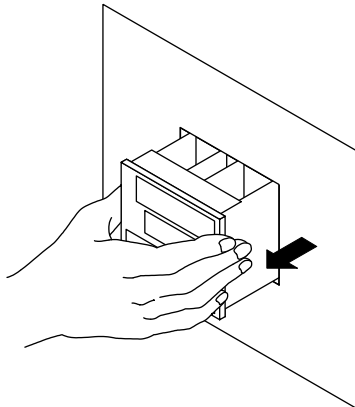

5. The location and number of the relays differ depending on the model code of the UT750. Confirm the location of the control output relay to be replaced before pulling out the relay.

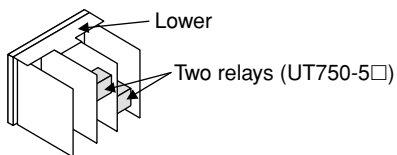

6. Pull out the relay to be replaced. The control output relays are easy to remove and mount, since they are connected via a socket onto the print boards.

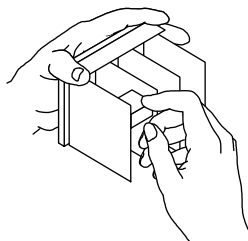

Insert the new relay in the socket. Use the following relay.

| | |
|--------------|---------------------|
| Manufacturer | OMRON |
| Model | G6B-2114P-FD-US-P6B |
| Power supply | 12 V DC |

7. **Insert the internal unit into the housing.**
Apply power to the controller and confirm that the initial operating display is shown. If the operating display is not shown properly, turn off the controller and pull out the internal unit. Then, insert it into the housing again.

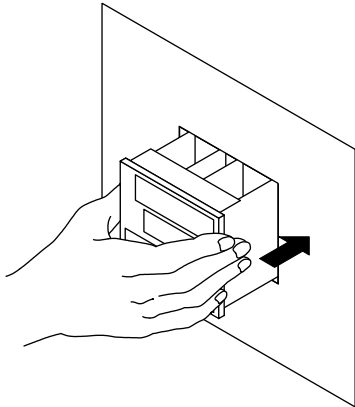

This completes replacement of the control output relay.

5. Parameters

5.1 Parameter Map

This section contains “Operating Parameter Map” and “Setup Parameter Map” for UT750 as a guideline for setting parameters.





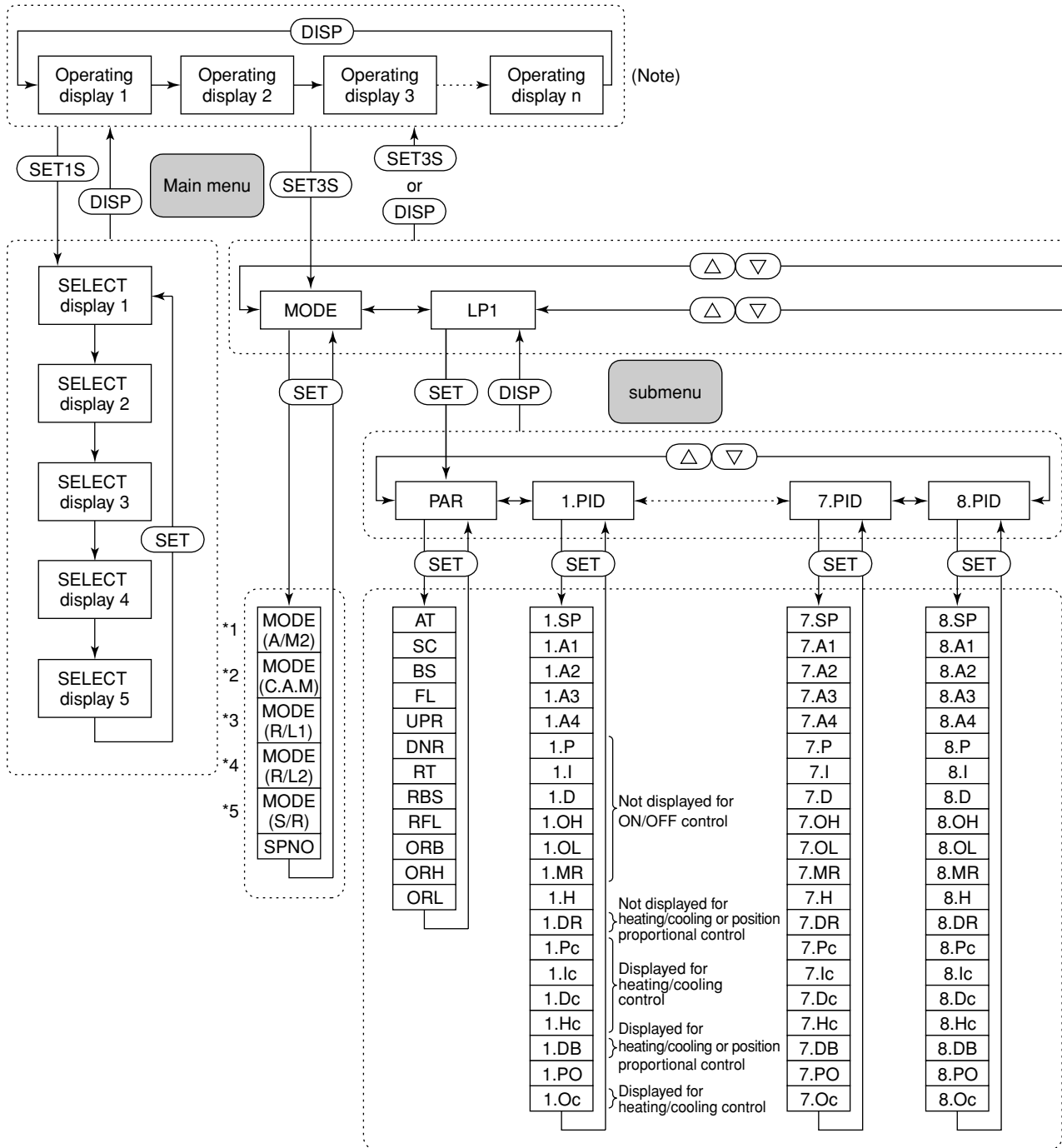

These maps are helpful in finding the positions of the displays when setting the parameters, and should be used as a quick reference for the entire range of parameter displays.

UT750 Operating Parameter Map

Operating Display



- *1 Parameter MODE (A/M2) is displayed when UT mode is "Dual-loop control" or "Temperature and humidity control."
- *2 Parameter MODE (C.A.M) is displayed when UT mode is "Cascade secondary-loop control" or "Cascade control."
- *3 Parameter MODE (R/L1) is displayed only for the controller with auxiliary analog (remote) input.
- *4 Parameter MODE (R/L2) is displayed only for the dual-loop type controller with auxiliary analog (remote) input.
- *5 Parameter MODE (S/R) is displayed when the contact input registration parameter S/R (setup parameter) is set to "0."
- *6 Main menu LP2 is displayed when UT mode is "Cascade control," "Dual-loop control," "Temperature and humidity control" or "Cascade control with two universal inputs."

- SET** : Press the  key once.
- DISP** : Press the  key once.
- SET1S** : Press the  key for 1 second.
- SET3S** : Press the  key for 3 seconds.
- △** **▽** : Press the  or  key once.

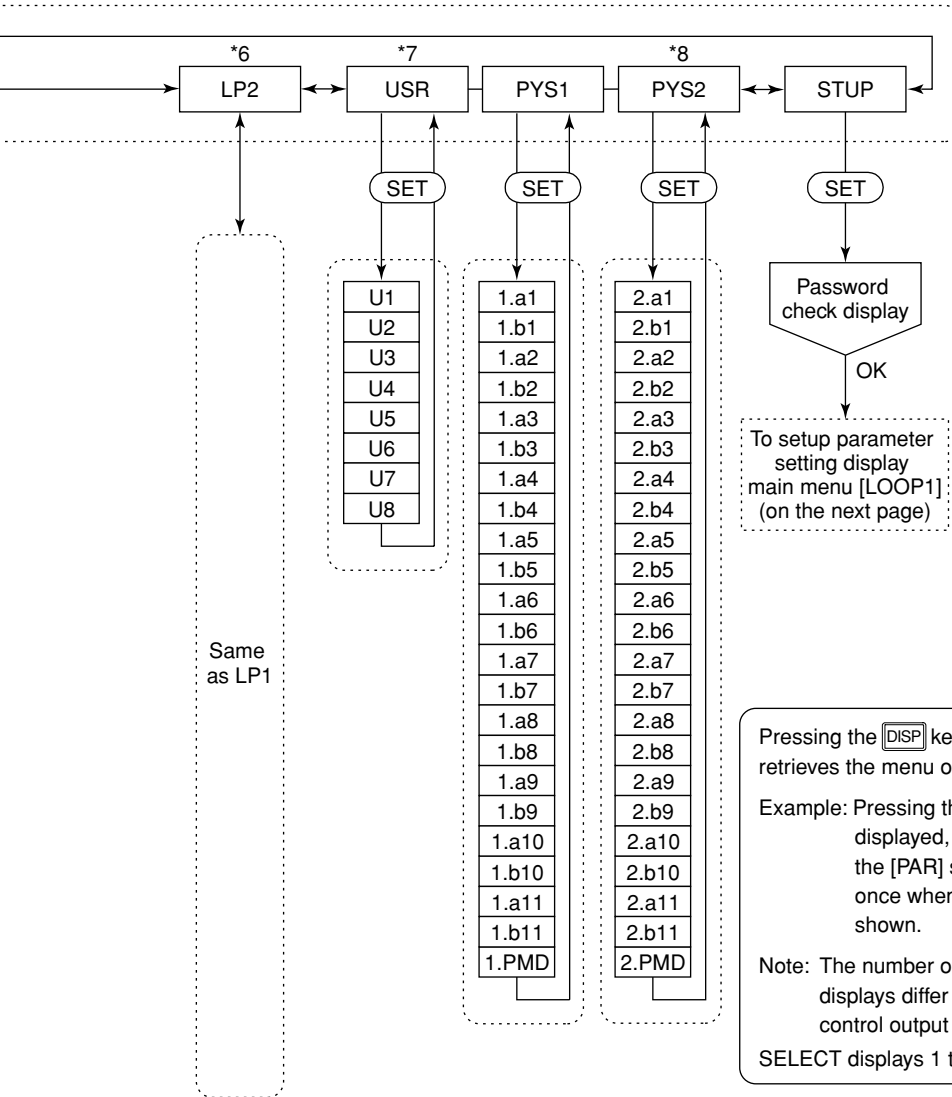

Pressing the **DISP** key once when a parameter setting display is shown retrieves the menu of that parameter setting display.

Example: Pressing the **DISP** key once when the [PAR] submenu is displayed, will display the [LP1] main menu. Conversely, the [PAR] submenu will reappear by pressing the **DISP** key once when the [PAR] submenu's "FL" parameter display is shown.

Note: The number of operating displays and the contents of such displays differ according to the UT750 models, UT modes and control output types.

SELECT displays 1 to 5 are shown only when they are registered.

*7 Main menu USR is displayed when UT mode is "Loop control with PV switching," "Loop control with PV auto-selector," "Loop control with PV switching and two universal inputs," or "Loop control with PV auto-selector and two universal inputs."

*8 Main menu PYS2 is displayed when UT mode is "Cascade control," "Loop control with PV switching," "Dual-loop control," "Temperature and humidity control," "Cascade control with two universal inputs" or "Loop control with PV switching and two universal inputs."



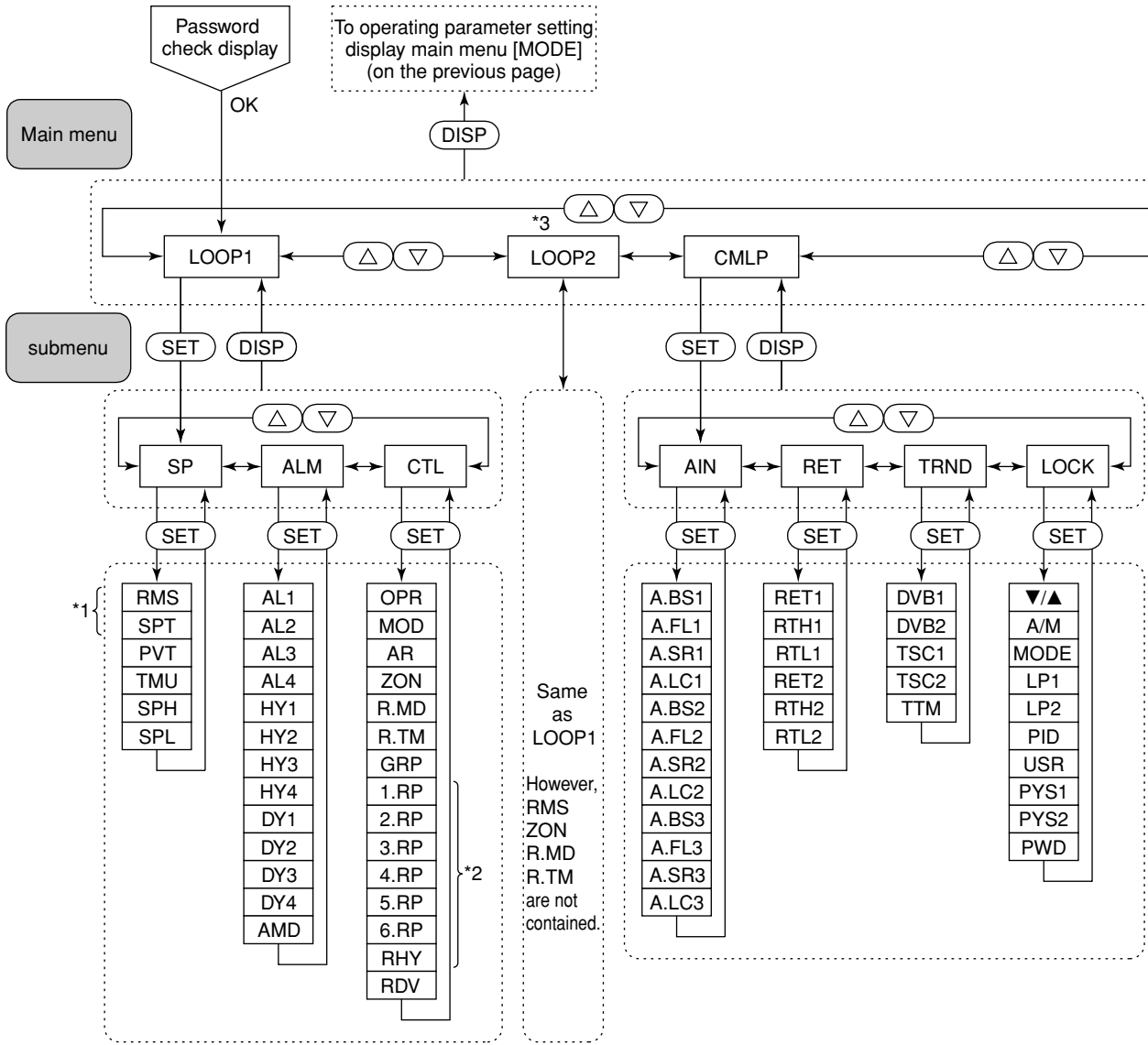

UT750 Setup Parameter Map



*1 Parameters RMS and SPT are displayed only for the controller with auxiliary analog (remote) input.

*2 Displayed when parameter ZON is "1."

*3 Main menu LOOP2 is displayed when UT mode is "Cascade control," "Dual-loop control," "Temperature and humidity control," or "Cascade control with two universal inputs."

SET : Press the  key once.
DISP : Press the  key once.
△ ▽ : Press the  or  key once.

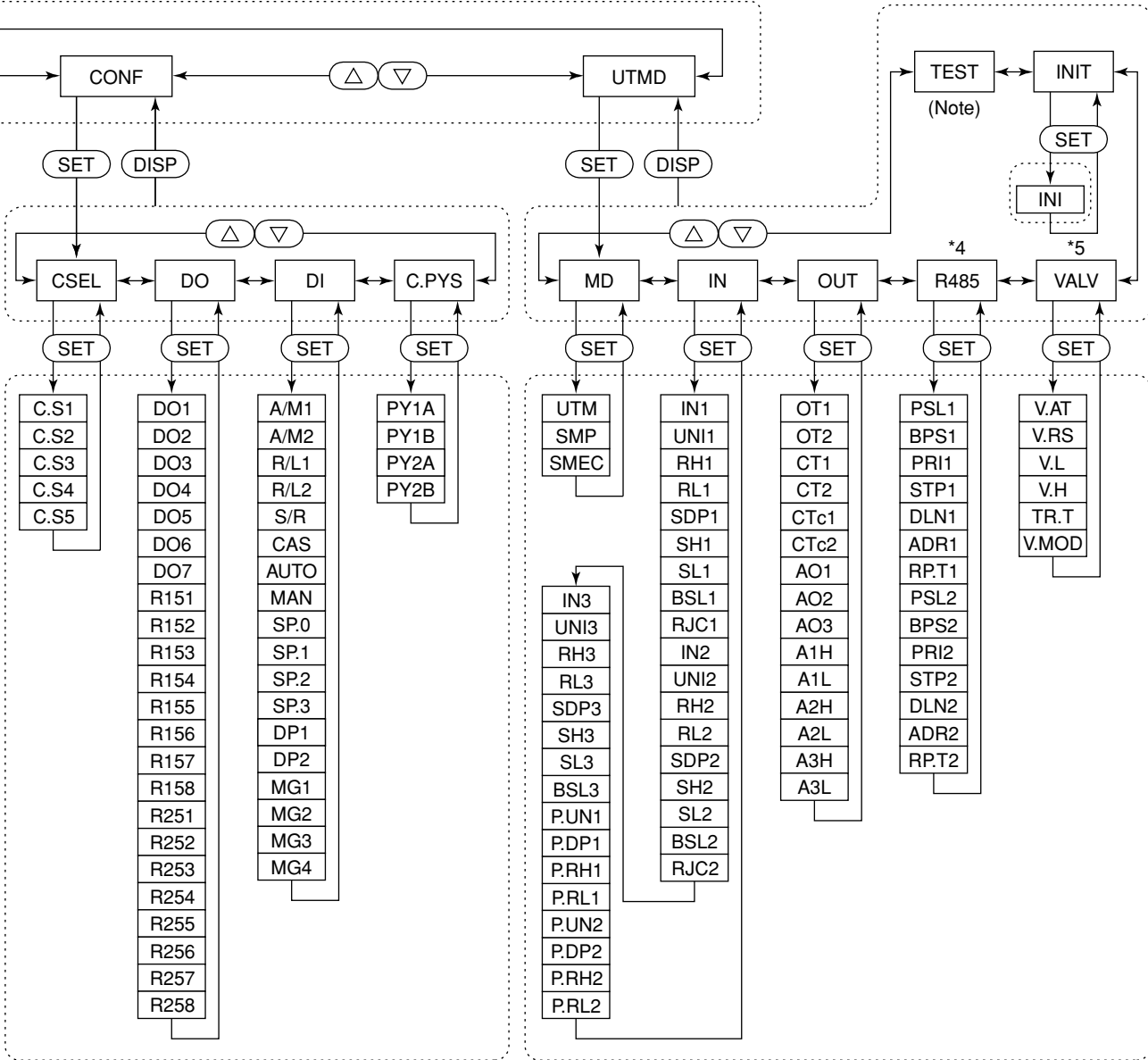

Note: The parameter items shown on the [TEST] submenu of the setup parameter setting display are to be used by Yokogawa service personnel to check the controller functions. User cannot set or change these parameters.

- *4 Submenu R485 is displayed only for the controller with communication function.
- *5 Submenu VALV is displayed only for the position proportional controller.

5.2 Lists of Parameters

This section describes the functions of parameters briefly. In addition, each parameter table has a “User Setting” column, where you can record your setpoints when setting them in the controller.

- * Parameters relating to PV or setpoints should all be set in real numbers. For example, use temperature values to define target setpoints and alarm setpoints for temperature input.
- * The “User Setting” column in the table is provided for the customer to record setpoints.
- * Numbers in () are the parameter setpoints that apply when the communication function is used. ex. REMOTE (1), LOCAL (0)

■ Operating Parameters

● Operation Mode Parameters

Located in: Main menu = **MODE**

| Parameter Symbol | Name of Parameter | Setting Range and Description | Initial Value | User Setting |
|--------------------|----------------------------------|--|---------------|--------------|
| MODE (A/M2) | Loop2 AUTO/MAN switching | AUTO (0) MAN (1) | MAN (1) | |
| MODE (R/L1) | Loop1 Remote/Local switching | Set to “Local” when carrying out control using the target setpoints of the controller or to “Remote” when using target setpoints acquired via a remote input signal or communication. Use the setup parameter RMS, “Remote Input Selection,” to determine whether the target setpoints should be acquired via the remote input signal or communication. REMOTE (1): Remote mode LOCAL (0): Local mode | LOCAL (0) | |
| MODE (R/L2) | Loop2 Remote/Local switching | REMOTE (1): Remote mode LOCAL (0): Local mode | LOCAL (0) | |
| MODE (S/R) | Run/Stop switching | Outputs the predetermined (preset) fixed value when the controller stops. A preset output value can be defined for each target setpoint using the operating parameter “PO”. (Both Loop1 and Loop2) STOP (1): Stops operation. RUN (0): Starts operation. | RUN (0) | |
| SPNO | Target setpoint number selection | 1: Selects target setpoint-1 (1.SP). (Both Loop1 and Loop2) 2: Selects target setpoint-2 (2.SP). 3: Selects target setpoint-3 (3.SP). 4: Selects target setpoint-4 (4.SP). Likewise, options 5 to 8 select target setpoints 5 (5.SP) to 8 (8.SP). | 1 | |

The following parameters are for Loop1.

● **Operation-related Parameters**

Located in: Main menu = **LP1** ; Submenu = **PAR**

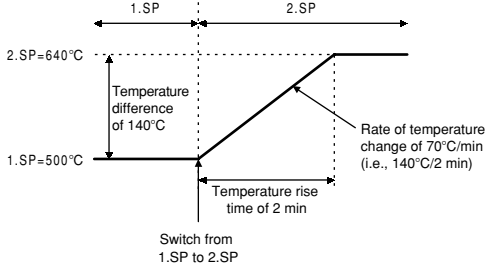
| Parameter Symbol | Name of Parameter | Setting Range and Description | Initial Value | User Setting |
|------------------|----------------------------|---|-----------------------------------|--------------|
| AT | Auto-tuning | OFF (0): No auto-tuning 1: Auto-tuning for 1.SP 2: Auto-tuning for 2.SP 3: Auto-tuning for 3.SP 4: Auto-tuning for 4.SP 5 to 8: Perform auto-tuning on a group basis in the same way as 1 to 4 9: Performs auto-tuning to all groups 1 to 8. | OFF (0) | |
| SC | "SUPER" function | OFF (0): Disable 1: Overshoot suppressing function Suppresses overshoots generated by abrupt changes in the target setpoint or by disturbances. 2: Hunting suppressing function (Stable mode) Suitable to stabilize the state of control when the load varies greatly, or the target setpoint is changed. Enables to answer the wider characteristic changes compared with Response mode. 3: Hunting suppressing function (Response mode) Enables quick follow-up and short converging time of PV for the changed target setpoint. Note: Use "SUPER" function (SC) 2 or 3 in PID control or PI control. "SUPER" function 2 or 3 is not available in the following controls: 1) ON/OFF control 2) P control (control for proportional band only) 3) PD control (control for proportional band and derivative item only) 4) Heating/cooling control Can not be used for the control processes with quick response such as flow control or pressure control. | OFF (0) | |
| BS | PV input bias | -100.0% to 100.0% of Loop1 PV input range span Used to correct the PV input value. | 0.0% of Loop1 PV input range span | |
| FL | PV input filter | OFF (0), 1 to 120 sec. Used when the PV input value fluctuates. | OFF (0) | |
| UPR | Setpoint ramp-up-rate | OFF (0) 0.0% + 1 digit of Loop1 PV input range span to 100.0% of Loop1 PV input range span | OFF (0) | |
| DNR | Setpoint ramp-down-rate | Set ramp-up-rate or ramp-down-rate per hour or minute. Sets unit in ramp-rate time unit (TMU). Used to prevent the target setpoint from changing suddenly. The ramp setting function works when: 1. the target setpoint is changed (e.g., "1.SP" is changed from 100°C to 150°C); 2. the target setpoint number (SPNO) is changed (e.g., the parameter is changed from 1.SP to 2.SP); 3. the power is turned on or has recovered from a failure; or 4. the operating mode is changed from Manual to Auto.  | OFF (0) | |
| RT | Ratio setting | 0.001 to 9.999 Target setpoint = Remote input × Ratio setpoint + Remote bias | 1.000 | |
| RBS | Remote input bias | -100.0 to 100.0% of Loop1 PV input range span Used to correct the remote input value. | 0.0% of Loop1 PV input range span | |
| RFL | Remote input filter | OFF (0), 1 to 120 sec. Used when the remote input value fluctuates. | OFF (0) | |
| ORB | ON/OFF rate detection band | 0.0 to 100.0% of Loop1 PV input range span | 1.0% of Loop1 PV input range span | |
| ORH | ON/OFF rate high limit | ORL + 1 digit to 105.0% | 100.0% | |
| ORL | ON/OFF rate low limit | -5.0% to ORH - 1 digit | 0.0% | |

The following parameters are for Loop1.

● **Setpoint-, Alarm- and PID-related Parameters**

Located in: Main menu = **LP1** ; Submenu = **1.PID**

The table below lists the Target Setpoint-1 (1.SP) operating parameter and parameters that apply to the 1.SP parameter.

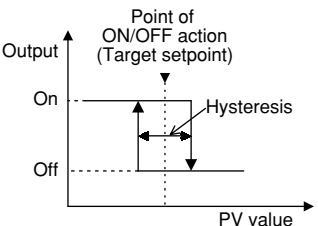
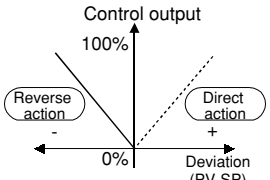
| Parameter Symbol | Name of Parameter | Setting Range and Description | Initial Value | User Setting |
|------------------|--|---|---|--------------|
| 1.SP | Target setpoint-1 | 0.0 to 100.0% of Loop1 PV input range However, between target setpoint limiter lower limit (SPL) and upper limit (SPH) | 0.0% of Loop1 PV input range | |
| 1.A1 | Alarm-1 setpoint | PV alarm / SP alarm: -100.0 to 100.0% of Loop1 PV input range Deviation alarm: -100.0 to 100.0% of Loop1 PV input range span | PV high limit/SP high limit alarm: 100.0% of Loop1 PV input range Deviation alarm: 0.0% of Loop1 PV input range span Other PV/SP low limit alarm: 0.0% of Loop1 PV input range Output high limit alarm: 100.0% Output low limit alarm: 0.0% | |
| 1.A2 | Alarm-2 setpoint | Output alarm: -5.0 to 105.0% Timer alarm (for alarm-1 only): 0.00 to 99.99 (hour, min.) or (min., sec.) | | |
| 1.A3 | Alarm-3 setpoint | Allows alarms 1 to 4 (1.A1 to 1.A4) to be set for target setpoint 1 (1.SP). Four alarms can also be set for target setpoints 2 to 8. | | |
| 1.A4 | Alarm-4 setpoint | | | |
| 1.P | Proportional band/Heating-side proportional band (in heating/cooling control) | 0.1 to 999.9% of Loop1 PV input range In heating/cooling control: 0.0 to 999.9% (heating-side on/off control applies when 0.0) | 5.0% | |
| 1.I | Integral time Heating-side integral time (in heating/cooling control) | OFF (0), 1 to 6000 sec. | 240 sec. | |
| 1.D | Derivative time Heating-side derivative time (in heating/cooling control) | OFF (0), 1 to 6000 sec. | 60 sec. | |
| 1.OH | Output high limit Heating-side output high limit (in heating/cooling control) | -5.0 to 105.0% Heating-side limiter in heating/cooling control: 0.0 to 105.0% (1.OL < 1.OH) | 100% Heating/cooling control: 100.0% | |
| 1.OL | Output low limit Cooling-side output high limit (in heating/cooling control) | -5.0 to 105.0% Cooling-side limiter in heating/cooling control: 0.0 to 105.0% (1.OL < 1.OH) SD (shutdown): Set in manual operation in 4-20 mA control output. Output is 0 mA. | 0.0% Heating/cooling control: 100.0% | |
| 1.MR | Manual reset | -5.0 to 105.0% (enabled when integral time "1.I" is OFF) The manual reset value equals the output value when PV = SP is true. For example, if the manual reset value is 50%, the output value is 50% when PV = SP becomes true. | 50.0% | |
| 1.H | ON/OFF control hysteresis Heating-side ON/OFF control hysteresis (in heating/cooling control) | In ON/OFF control: 0.0 to 100.0% of Loop1 PV input range span Heating/cooling control: 0.0 to 100.0% Hysteresis can be set in the target setpoint when the controller is performing ON/OFF control.  | ON/OFF control: 0.5% of Loop1 PV input range span Heating/cooling control: 0.5% | |
| 1.DR | Direct/reverse action switching | REVERSE (0): reverse action, DIRECT (1): direct action  | REVERSE (0) | |

| Parameter Symbol | Name of Parameter | Setting Range and Description | Initial Value | User Setting |
|------------------|---|--|---------------|--------------|
| 1.Pc | Cooling-side proportional band | 0.0 to 999.9% of Loop1 PV input range (Cooling-side ON/OFF control applies when 0.0) | 5.0% | |
| 1.Ic | Cooling-side integral time | OFF (0), 1 to 6000 sec. | 240 sec. | |
| 1.Dc | Cooling-side derivative time | OFF (0), 1 to 6000 sec. | 60 sec. | |
| 1.Hc | Cooling-side ON/OFF control hysteresis | 0.0 to 100.0% | 0.5% | |
| 1.DB | Dead band | In heating/cooling control: -100.0 to 50.0% When performing heating/cooling control: setting any positive value prohibits both the heating and cooling outputs from turning on; setting any negative value allows both the heating and cooling outputs to turn on; and setting a value of zero either the heating or cooling output to turn on. | 3.0% | |
| 1.PO | Preset output/Heating-side preset output (in heating/cooling control) | -5.0 to 105.0% In heating/cooling control: Heating side 0.0 to 105.0% In Stop mode, fixed control output can be generated. | 0.0% | |
| 1.Oc | Cooling-side preset output | 0.0 to 105.0% In Stop mode, cooling-side fixed control output can be generated. | 0.0% | |

If you are using two or more groups of setpoint, alarm and PID parameters, use the following table to record their values.

| Parameter | n=2 | n=3 | n=4 | n=5 | n=6 | n=7 | n=8 |
|-----------|-----|-----|-----|-----|-----|-----|-----|
| n.SP | | | | | | | |
| n.A1 | | | | | | | |
| n.A2 | | | | | | | |
| n.A3 | | | | | | | |
| n.A4 | | | | | | | |
| n.P | | | | | | | |
| n.I | | | | | | | |
| n.D | | | | | | | |
| n.OH | | | | | | | |
| n.OL | | | | | | | |
| n.MR | | | | | | | |
| n.H | | | | | | | |
| n.DR | | | | | | | |
| n.Pc | | | | | | | |
| n.Ic | | | | | | | |
| n.Dc | | | | | | | |
| n.Hc | | | | | | | |
| n.DB | | | | | | | |
| n.PO | | | | | | | |
| n.Oc | | | | | | | |

The following parameters are for Loop1.

● **Ten-segment Linearizer 1 Parameters**

Located in: Main menu = **PYS1**

- Ten-segment linearizer biasing (factory-set default)

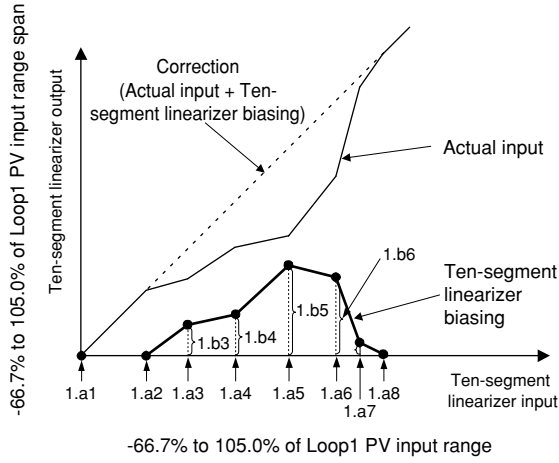

- Ten-segment linearizer approximation

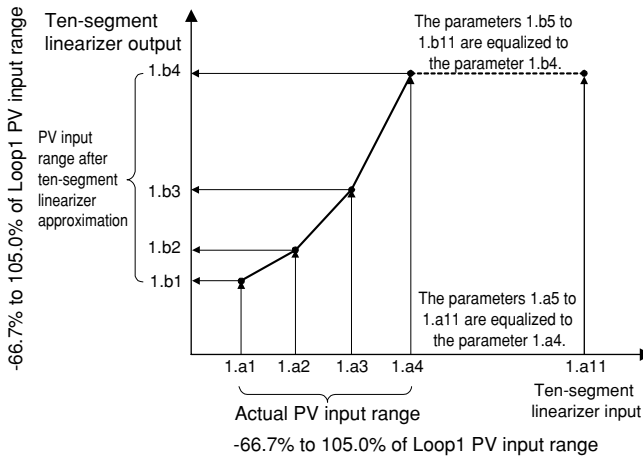

The following parameters are for Loop2.

● **Operation-related Parameters**

Located in: Main menu = **LP2** ; Submenu = **PAR**

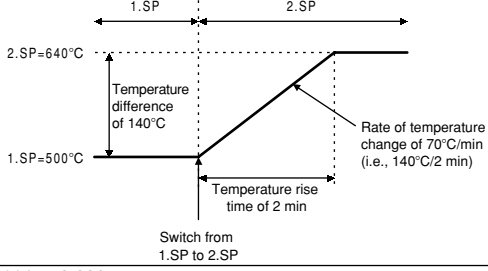
| Parameter Symbol | Name of Parameter | Setting Range and Description | Initial Value | User Setting |
|------------------|----------------------------|---|-----------------------------------|--------------|
| AT | Auto-tuning | OFF (0): No auto-tuning 1: Auto-tuning for 1.SP 2: Auto-tuning for 2.SP 3: Auto-tuning for 3.SP 4: Auto-tuning for 4.SP 5 to 8: Perform auto-tuning on a group basis in the same way as 1 to 4 9: Performs auto-tuning to all groups 1 to 8. | OFF (0) | |
| SC | "SUPER" function | OFF (0): Disable 1: Overshoot suppressing function Suppresses overshoots generated by abrupt changes in the target setpoint or by disturbances. 2: Hunting suppressing function (Stable mode) Suitable to stabilize the state of control when the load varies greatly, or the target setpoint is changed. Enables to answer the wider characteristic changes compared with Response mode. 3: Hunting suppressing function (Response mode) Enables quick follow-up and short converging time of PV for the changed target setpoint. Note: Use "SUPER" function (SC) 2 or 3 in PID control or PI control. "SUPER" function 2 or 3 is not available in the following controls: 1) ON/OFF control 2) P control (control for proportional band only) 3) PD control (control for proportional band and derivative item only) 4) Heating/cooling control Can not be used for the control processes with quick response such as flow control or pressure control. | OFF (0) | |
| BS | PV input bias | -100.0% to 100.0% of Loop2 PV input range span Used to correct the PV input value. | 0.0% of Loop2 PV input range span | |
| FL | PV input filter | OFF (0), 1 to 120 sec. Used when the PV input value fluctuates. | OFF (0) | |
| UPR | Setpoint ramp-up-rate | OFF (0) 0.0% + 1 digit of Loop2 PV input range span to 100.0% of Loop2 PV input range span | OFF (0) | |
| DNR | Setpoint ramp-down-rate | Set ramp-up-rate or ramp-down-rate per hour or minute. Sets unit in ramp-rate time unit (TMU). Used to prevent the target setpoint from changing suddenly. The ramp setting function works when: 1. the target setpoint is changed (e.g., "1.SP" is changed from 100°C to 150°C); 2. the target setpoint number (SPNO) is changed (e.g., the parameter is changed from 1.SP to 2.SP); 3. the power is turned on or has recovered from a failure; or 4. the operating mode is changed from Manual to Auto.  | OFF (0) | |
| RT | Ratio setting | 0.001 to 9.999 Target setpoint = Remote input × Ratio setpoint + Remote bias | 1.000 | |
| RBS | Remote input bias | -100.0 to 100.0% of Loop2 PV input range span Used to correct the remote input value. | 0.0% of Loop2 PV input range span | |
| RFL | Remote input filter | OFF (0), 1 to 120 sec. Used when the remote input value fluctuates. | OFF (0) | |
| ORB | ON/OFF rate detection band | 0.0 to 100.0% of Loop2 PV input range span | 1.0% of Loop2 PV input range span | |
| ORH | ON/OFF rate high limit | ORL + 1 digit to 105.0% | 100.0% | |
| ORL | ON/OFF rate low limit | -5.0% to ORH - 1 digit | 0.0% | |

The following parameters are for Loop2.

● **Setpoint-, Alarm- and PID-related Parameters**

Located in: Main menu = **LP2** ; Submenu = **1.PID**

The table below lists the Target Setpoint-1 (1.SP) operating parameter and parameters that apply to the 1.SP parameter.

| Parameter Symbol | Name of Parameter | Setting Range and Description | Initial Value | User Setting |
|------------------|--|--|---|--------------|
| 1.SP | Target setpoint-1 | 0.0 to 100.0% of Loop2 PV input range However, between target setpoint limiter lower limit (SPL) and upper limit (SPH) | 0.0% of Loop2 PV input range | |
| 1.A1 | Alarm-1 setpoint | PV alarm / SP alarm: -100.0 to 100.0% of Loop2 PV input range Deviation alarm: -100.0 to 100.0% of Loop2 PV input range span Output alarm: -5.0 to 105.0% Timer alarm (for alarm-1 only): 0.00 to 99.99 (hour, min.) or (min., sec.) Allows alarms 1 to 4 (1.A1 to 1.A4) to be set for target setpoint 1 (1.SP). Four alarms can also be set for target setpoints 2 to 8. | PV high limit/SP high limit alarm: 100.0% of Loop2 PV input range Deviation alarm: 0.0% of Loop2 PV input range span Other PV/SP low limit alarm: 0.0% of Loop2 PV input range Output high limit alarm: 100.0% Output low limit alarm: 0.0% | |
| 1.A2 | Alarm-2 setpoint | | | |
| 1.A3 | Alarm-3 setpoint | | | |
| 1.A4 | Alarm-4 setpoint | | | |
| 1.P | Proportional band/Heating-side proportional band (in heating/cooling control) | 0.1 to 999.9% of Loop2 PV input range In heating/cooling control: 0.0 to 999.9% (heating-side on/off control applies when 0.0) | 5.0% | |
| 1.I | Integral time Heating-side integral time (in heating/cooling control) | OFF (0), 1 to 6000 sec. | 240 sec. | |
| 1.D | Derivative time Heating-side derivative time (in heating/cooling control) | OFF (0), 1 to 6000 sec. | 60 sec. | |
| 1.OH | Output high limit Heating-side output high limit (in heating/cooling control) | -5.0 to 105.0% Heating-side limiter in heating/cooling control: 0.0 to 105.0% (1.OL < 1.OH) | 100% Heating/cooling control: 100.0% | |
| 1.OL | Output low limit Cooling-side output high limit (in heating/cooling control) | -5.0 to 105.0% Cooling-side limiter in heating/cooling control: 0.0 to 105.0% (1.OL < 1.OH) SD (shutdown): Set in manual operation in 4-20 mA control output. Output is 0 mA. | 0.0% Heating/cooling control: 100.0% | |
| 1.MR | Manual reset | -5.0 to 105.0% (enabled when integral time "1.I" is OFF) The manual reset value equals the output value when PV = SP is true. For example, if the manual reset value is 50%, the output value is 50% when PV = SP becomes true. | 50.0% | |
| 1.H | ON/OFF control hysteresis Heating-side ON/OFF control hysteresis (in heating/cooling control) | In ON/OFF control: 0.0 to 100.0% of Loop2 PV input range span Heating/cooling control: 0.0 to 100.0% Hysteresis can be set in the target setpoint when the controller is performing ON/OFF control. | ON/OFF control: 0.5% of Loop2 PV input range span Heating/cooling control: 0.5% | |
| | | | | |
| 1.DR | Direct/reverse action switching | REVERSE (0): reverse action, DIRECT (1): direct action | REVERSE (0) | |
| | | | | |

| Parameter Symbol | Name of Parameter | Setting Range and Description | Initial Value | User Setting |
|------------------|---|--|---------------|--------------|
| 1.Pc | Cooling-side proportional band | 0.0 to 999.9% of Loop2 PV input range (Cooling-side ON/OFF control applies when 0.0) | 5.0% | |
| 1.Ic | Cooling-side integral time | OFF (0), 1 to 6000 sec. | 240 sec. | |
| 1.Dc | Cooling-side derivative time | OFF (0), 1 to 6000 sec. | 60 sec. | |
| 1.Hc | Cooling-side ON/OFF control hysteresis | 0.0 to 100.0% | 0.5% | |
| 1.DB | Dead band | In heating/cooling control: -100.0 to 50.0% When performing heating/cooling control: setting any positive value prohibits both the heating and cooling outputs from turning on; setting any negative value allows both the heating and cooling outputs to turn on; and setting a value of zero either the heating or cooling output to turn on. | 3.0% | |
| 1.PO | Preset output/Heating-side preset output (in heating/cooling control) | -5.0 to 105.0% In heating/cooling control: Heating side 0.0 to 105.0% In Stop mode, fixed control output can be generated. | 0.0% | |
| 1.Oc | Cooling-side preset output | 0.0 to 105.0% In Stop mode, cooling-side fixed control output can be generated. | 0.0% | |

If you are using two or more groups of setpoint, alarm and PID parameters, use the following table to record their values.

| Parameter | n=2 | n=3 | n=4 | n=5 | n=6 | n=7 | n=8 |
|-----------|-----|-----|-----|-----|-----|-----|-----|
| n.SP | | | | | | | |
| n.A1 | | | | | | | |
| n.A2 | | | | | | | |
| n.A3 | | | | | | | |
| n.A4 | | | | | | | |
| n.P | | | | | | | |
| n.I | | | | | | | |
| n.D | | | | | | | |
| n.OH | | | | | | | |
| n.OL | | | | | | | |
| n.MR | | | | | | | |
| n.H | | | | | | | |
| n.DR | | | | | | | |
| n.Pc | | | | | | | |
| n.Ic | | | | | | | |
| n.Dc | | | | | | | |
| n.Hc | | | | | | | |
| n.DB | | | | | | | |
| n.PO | | | | | | | |
| n.Oc | | | | | | | |

The following parameters are for Loop2.

● Ten-segment Linearizer 2 Parameters

Located in: Main menu = PYS2

- Ten-segment linearizer biasing (factory-set default)

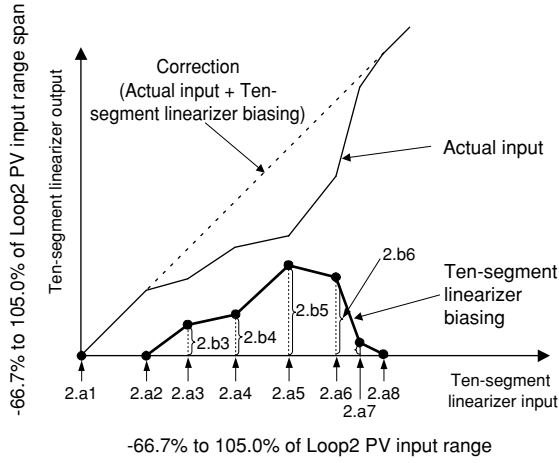

- Ten-segment linearizer approximation

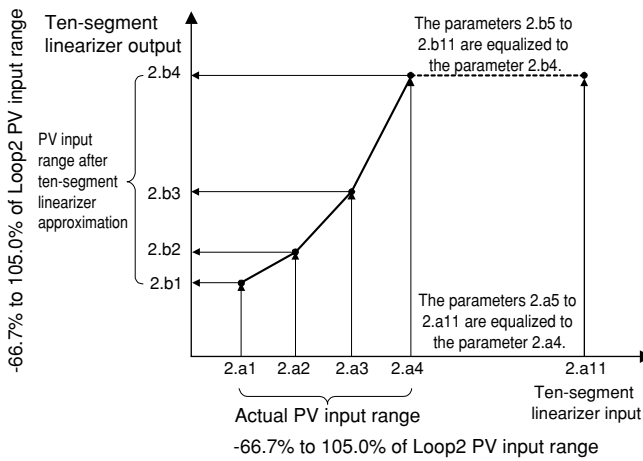

■ Setup Parameters

The following parameters are for Loop1.

● Target Setpoint-related Parameters

Located in: Main menu = **LOOP1** ; Submenu = **SP**

| Parameter Symbol | Name of Parameter | Setting Range and Description | Initial Value | User Setting |
|------------------|-------------------------------------|--|--------------------------------|--------------|
| RMS | Remote input selection | RSP (0): Uses the value set remotely via remote input (terminals). COM (1): Uses the value set remotely via communication. (For both Loop1 and Loop2) | RSP (0) | |
| SPT | SP tracking selection | OFF (0), ON (1) Tracking is performed when the mode changes from Remote to Local (The local setpoint keeps track of the remote setpoint.) | ON (1) | |
| PVT | PV tracking selection | Causes the setpoint to keep track of the PV value so the setpoint automatically reverts to its original value at a preset rate of change. The Setpoint Ramp-up (UPR) and Setpoint Ramp-down (DNR) parameters are used in combination. - Operating conditions - 1: Manual operation → Automatic operation; 2: Stop → Start of automatic operation; 3: Power-on; 4: Change SP number OFF (0): Disable ON (1): Enable | OFF (0) | |
| TMU | Ramp-rate time unit setting | Time unit of setpoint ramp-up (UPR) and setpoint ramp-down (DNR) HOUR (0): Denotes "per hour." MIN (1): Denotes "per minute." | HOUR (0) | |
| SPH | Target setpoint limiter upper limit | 0.0% to 100.0% of Loop1 PV input range. Note that SPL < SPH | 100.0% of Loop1 PV input range | |
| SPL | Target setpoint limiter lower limit | Places limits on the ranges within which the target setpoints (1.SP to 8.SP) are changed. | 0.0% of Loop1 PV input range | |

The following parameters are for Loop1.

● Alarm-related Parameters

Located in: Main menu = **LOOP1** ; Submenu = **ALM**

| Parameter Symbol | Name of Parameter | Setting Range and Description | Initial Value | User Setting |
|------------------|---------------------|--|---|--------------|
| AL1 | Alarm-1 type | OFF (0), 1 to 31 (same as below) Common to all target setpoints. | 1 | |
| AL2 | Alarm-2 type | OFF (0), 1 to 20, 25 to 31 1: PV high limit (energized, no stand-by action) 2: PV low limit (energized, no stand-by action) | 2 | |
| AL3 | Alarm-3 type | 3: Deviation high limit (energized, no stand-by action) 4: Deviation low limit (energized, no stand-by action) | 1 | |
| AL4 | Alarm-4 type | 5: Deviation high limit (de-energized, no stand-by action) 6: Deviation low limit (de-energized, no stand-by action) For other alarm types, see "2.7 Changing Alarm Type of Loop1." Common to all target setpoints. | 2 | |
| HY1 | Alarm-1 hysteresis | 0.0 to 100.0% of Loop1 PV input range span Output alarm: 0.0 to 100.0% | 0.5% of Loop1 PV input range span Output alarm: 0.5% | |
| HY2 | Alarm-2 hysteresis | Allows margins to be set for an alarm setpoint. With the hysteresis settings, it is possible to prevent relays from chattering. | | |
| HY3 | Alarm-3 hysteresis | | | |
| HY4 | Alarm-4 hysteresis | | | |
| DY1 | Alarm-1 delay timer | 0.00 to 99.59 (min., sec.) (enabled when alarm-1 type "AL1" is 1 to 20 or 28 to 31) An alarm is output when the delay timer expires after the alarm setpoint is reached. | 0.00 | |
| | | | | |
| DY2 | Alarm-2 delay timer | 0.00 to 99.59 (min., sec.) (enabled when alarm-2 type "AL2" is 1 to 20 or 28 to 31) | | |
| DY3 | Alarm-3 delay timer | 0.00 to 99.59 (min., sec.) (enabled when alarm-3 type "AL3" is 1 to 20 or 28 to 31) | | |
| DY4 | Alarm-4 delay timer | 0.00 to 99.59 (min., sec.) (enabled when alarm-4 type "AL4" is 1 to 20 or 28 to 31) | | |
| AMD | Alarm mode | Allows the alarm function to be enabled or disabled according to the operating condition. 0: Always active 1: Not active when in Stop mode 2: Not active when in Stop mode or manual operation | 0 | |

The following parameters are for Loop1.

● **Control Action-related Parameters**

Located in: Main menu = **LOOP1** ; Submenu = **CTL**

| Parameter Symbol | Name of Parameter | Setting Range and Description | Initial Value | User Setting |
|------------------|---|--|--------------------------------|--------------|
| OPR | Output velocity limiter | OFF (0) 0.1 to 100.0%/sec. can limit control output velocity | OFF (0) | |
| MOD | PID control mode | 0: Standard PID control (with output bump at SP change) 1: Fixed Point control (without output bump at SP change) Choose "Fixed Point Control" when controlling pressure or flow rate. | 0 | |
| AR | Anti-reset windup (Excess integration prevention) | AUTO (0), 50.0 to 200.0% The larger Setting, the sooner PID computation (integral computation) stops. Used when the control output travels up to 100% or down to 0% and stays at this point. | AUTO (0) | |
| ZON | Zone PID selection | 0: SP selection 1: Zone PID If set to "SP selection," allows PID constants to be selected for each target setpoint. If set to "Zone PID," automatically selects PID constants according to the temperature range set in the given Reference Point parameter. (For both Loop1 and Loop2) | 0 | |
| R.MD | Restart mode | CONT (0): Continues action set before power failure. MAN (1): Starts from manual operation status AUTO (2): Continues action set before power failure in automatic operation. (For both Loop1 and Loop2) Allows you to determine how the controller should recover from a power failure of longer than 2 sec. | CONT (0) | |
| R.TM | Restart timer | 0 to 10 sec. (For both Loop1 and Loop2) Sets time between power on and the instant where controller starts computation. | 0 sec. | |
| GRP | PID group number | Allows you to determine how many groups of setpoint, alarm and PID parameters the controller should show. 1: Show one set. 2: Show two sets. 3: Show three sets. 4: Show four sets. 5 to 8: Show as many groups of parameters as have been set. | 8 | |
| 1.RP | Zone PID reference point-1 | 0.0 to 100.0% of Loop1 PV input range. Note that 1.RP ≤ 2.RP ≤ 3.RP ≤ 4.RP ≤ 5.RP ≤ 6.RP. Sets reference points at which switching is carried out between groups of PID constants according to the given temperature zone. You can set a maximum of six reference points and therefore a maximum of seven temperature zones. To enable this parameter, set the Zone PID Selection (ZON) parameter to "1". The example below sets reference points 1 and 2 to provide 3 zones to switch PID constants automatically. A maximum of seven zones can be set. | 100.0% of Loop1 PV input range | |
| 2.RP | Zone PID reference point-2 | | | |
| 3.RP | Zone PID reference point-3 | | | |
| 4.RP | Zone PID reference point-4 | | | |
| 5.RP | Zone PID reference point-5 | | | |
| 6.RP | Zone PID reference point-6 | | | |
| | | | | |

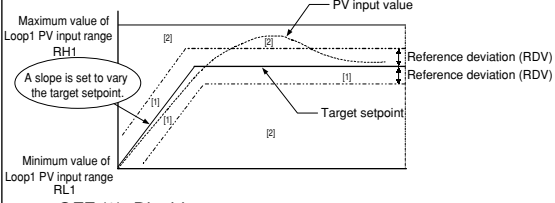
| Parameter Symbol | Name of Parameter | Setting Range and Description | Initial Value | User Setting |
|------------------|---------------------------|---|-----------------------------------|--------------|
| RHY | Zone switching hysteresis | 0.0 to 10.0% of Loop1 PV input range span Allows hysteresis to be set for switching at a reference point. | 0.5% of Loop1 PV input range span | |
| RDV | Reference deviation | <p>Used to select a group of PID parameters according to a deviation from the given target setpoint. The controller uses the PID parameters of the number selected in PID group number (GRP) if the PV input falls outside the given deviation range.</p> <p>The following example shows a case when only the reference deviation is set without setting any reference point. The selected group of PID parameters is as follows.</p> <p>Since region 1 is within the deviation range, the controller uses the 1st group of PID parameters.</p> <p>Since region 2 is outside the deviation range, the controller uses the PID parameters of the number selected in PID group number (GRP).</p>  <p>OFF (0): Disable 0.0% to 100.0% of Loop1 PV input range span</p> | OFF (0) | |

The following parameters are for Loop2.

● **Target Setpoint-related Parameters**

Located in: Main menu = LOOP2 ; Submenu = SP

| Parameter Symbol | Name of Parameter | Setting Range and Description | Initial Value | User Setting |
|------------------|-------------------------------------|--|--------------------------------|--------------|
| SPT | SP tracking selection | OFF (0), ON (1) Tracking is performed when the mode changes from Remote to Local (The local setpoint keeps track of the remote setpoint.) | ON (1) | |
| PVT | PV tracking selection | Causes the setpoint to keep track of the PV value so the setpoint automatically reverts to its original value at a preset rate of change. The Setpoint Ramp-up (UPR) and Setpoint Ramp-down (DNR) parameters are used in combination. - Operating conditions - 1: Manual operation → Automatic operation; 2: Stop → Start of automatic operation; 3: Power-on; 4: Change SP number OFF (0): Disable ON (1): Enable | OFF (0) | |
| TMU | Ramp-rate time unit setting | Time unit of setpoint ramp-up (UPR) and setpoint ramp-down (DNR) HOUR (0): Denotes "per hour." MIN (1): Denotes "per minute." | HOUR (0) | |
| SPH | Target setpoint limiter upper limit | 0.0% to 100.0% of Loop2 PV input range. Note that SPL < SPH | 100.0% of Loop2 PV input range | |
| SPL | Target setpoint limiter lower limit | Places limits on the ranges within which the target setpoints (1.SP to 8.SP) are changed. | 0.0% of Loop2 PV input range | |

The following parameters are for Loop2.

● Alarm-related Parameters

Located in: Main menu = **LOOP2** ; Submenu = **ALM**

| Parameter Symbol | Name of Parameter | Setting Range and Description | Initial Value | User Setting |
|------------------|---------------------|--|---|--------------|
| AL1 | Alarm-1 type | OFF (0), 1 to 31 (same as below) Common to all target setpoints. | 1 | |
| AL2 | Alarm-2 type | OFF (0), 1 to 20, 25 to 31 1: PV high limit (energized, no stand-by action) 2: PV low limit (energized, no stand-by action) | 2 | |
| AL3 | Alarm-3 type | 3: Deviation high limit (energized, no stand-by action) 4: Deviation low limit (energized, no stand-by action) | 1 | |
| AL4 | Alarm-4 type | 5: Deviation high limit (de-energized, no stand-by action) 6: Deviation low limit (de-energized, no stand-by action) For other alarm types, see "2.8 Changing Alarm Type of Loop2." Common to all target setpoints. | 2 | |
| HY1 | Alarm-1 hysteresis | 0.0 to 100.0% of Loop2 PV input range span Output alarm: 0.0 to 100.0% Allows margins to be set for an alarm setpoint. With the hysteresis settings, it is possible to prevent relays from chattering. | 0.5% of Loop2 PV input range span Output alarm: 0.5% | |
| HY2 | Alarm-2 hysteresis | <p>Hysteresis for PV high limit alarm</p> | | |
| HY3 | Alarm-3 hysteresis | | | |
| HY4 | Alarm-4 hysteresis | | | |
| DY1 | Alarm-1 delay timer | | 0.00 to 99.59 (min., sec.) (enabled when alarm-1 type "AL1" is 1 to 20 or 28 to 31) An alarm is output when the delay timer expires after the alarm setpoint is reached. | 0.00 |
| | | | | |
| DY2 | Alarm-2 delay timer | 0.00 to 99.59 (min., sec.) (enabled when alarm-2 type "AL2" is 1 to 20 or 28 to 31) | | |
| DY3 | Alarm-3 delay timer | 0.00 to 99.59 (min., sec.) (enabled when alarm-3 type "AL3" is 1 to 20 or 28 to 31) | | |
| DY4 | Alarm-4 delay timer | 0.00 to 99.59 (min., sec.) (enabled when alarm-4 type "AL4" is 1 to 20 or 28 to 31) | | |
| AMD | Alarm mode | Allows the alarm function to be enabled or disabled according to the operating condition. 0: Always active 1: Not active when in Stop mode 2: Not active when in Stop mode or manual operation | 0 | |

The following parameters are for Loop2.

● **Control Action-related Parameters**

Located in: Main menu = **LOOP2** ; Submenu = **CTL**

| Parameter Symbol | Name of Parameter | Setting Range and Description | Initial Value | User Setting |
|------------------|---|---|-----------------------------------|--------------|
| OPR | Output velocity limiter | OFF (0) 0.1 to 100.0%/sec. can limit control output velocity | OFF (0) | |
| MOD | PID control mode | 0: Standard PID control (with output bump at SP change) 1: Fixed Point control (without output bump at SP change) Choose "Fixed Point Control" when controlling pressure or flow rate. | 0 | |
| AR | Anti-reset windup (Excess integration prevention) | AUTO (0), 50.0 to 200.0% The larger Setting, the sooner PID computation (integral computation) stops. Used when the control output travels up to 100% or down to 0% and stays at this point. | AUTO (0) | |
| GRP | PID group number | Allows you to determine how many groups of setpoint, alarm and PID parameters the controller should show. 1: Show one set. 2: Show two sets. 3: Show three sets. 4: Show four sets. 5 to 8: Show as many groups of parameters as have been set. | 8 | |
| 1.RP | Zone PID reference point-1 | 0.0 to 100.0% of Loop2 PV input range. Note that 1.RP ≤ 2.RP ≤ 3.RP ≤ 4.RP ≤ 5.RP ≤ 6.RP. Sets reference points at which switching is carried out between groups of PID constants according to the given temperature zone. You can set a maximum of six reference points and therefore a maximum of seven temperature zones. To enable this parameter, set the Zone PID Selection (ZON) parameter to "1". The example below sets reference points 1 and 2 to provide 3 zones to switch PID constants automatically. A maximum of seven zones can be set. | 100.0% of Loop2 PV input range | |
| 2.RP | Zone PID reference point-2 | | | |
| 3.RP | Zone PID reference point-3 | | | |
| 4.RP | Zone PID reference point-4 | | | |
| 5.RP | Zone PID reference point-5 | | | |
| 6.RP | Zone PID reference point-6 | | | |
| RHY | Zone switching hysteresis | 0.0 to 10.0% of Loop2 PV input range span Allows hysteresis to be set for switching at a reference point. | 0.5% of Loop2 PV input range span | |
| RDV | Reference deviation | Used to select a group of PID parameters according to a deviation from the given target setpoint. The controller uses the PID parameters of the number selected in PID group number (GRP) if the PV input falls outside the given deviation range. The following example shows a case when only the reference deviation is set without setting any reference point. The selected set of PID parameters is as follows. Since region 1 is within the deviation range, the controller uses the 1st group of PID parameters. Since region 2 is outside the deviation range, the controller uses the PID parameters of the number selected in PID group number (GRP). | OFF (0) | |

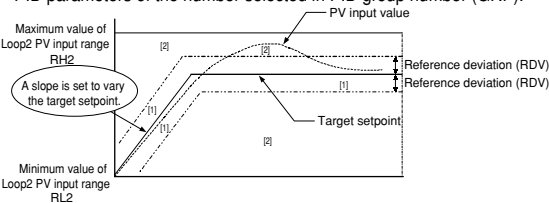
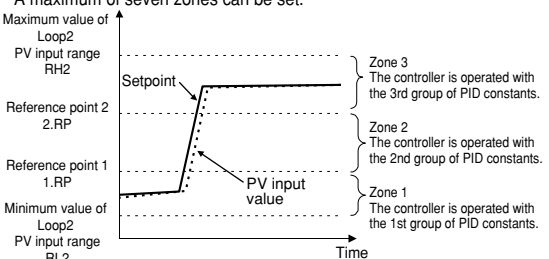

● Analog Input Computation Parameters

Located in: Main menu = **CMLP** ; Submenu = **AIN**

| Parameter Symbol | Name of Parameter | Setting Range and Description | Initial Value | User Setting |
|------------------|--|---|-----------------------------------|--------------|
| A.BS1 | Analog input-1 bias | Used to correct the PV input value of Loop1 beforehand. When in normal operation, use the PV Input Bias (BS) operation mode parameter. -100.0% to 100.0% of PV input range span of Loop1. | 0.0% of Loop1 PV input range span | |
| A.FL1 | Analog input-1 filter | OFF (0): Disable 1 to 120 sec. | OFF (0) | |
| A.SR1 | Analog input-1 square-root computation | Performs square-root computation for the PV input value of Loop1. OFF (0): Do not compute the square root. ON (1): Compute the square root. | OFF (0) | |
| A.LC1 | Analog input-1 low signal cutoff | 0.0% to 5.0% The slope equals "1" at levels below the low-signal cutoff point. | 1.0% | |
| A.BS2 | Analog input-2 bias | Used to correct the PV input value of Loop2 beforehand. When in normal operation, use the PV input Bias (BS) operation mode parameter. -100.0% to 100.0% of PV input range span of Loop2. | 0.0% of Loop2 PV input range span | |
| A.FL2 | Analog input-2 filter | OFF (0): Disable 1 to 120 sec. | OFF (0) | |
| A.SR2 | Analog input-2 square-root computation | Performs square-root computation for the PV input value of Loop2. OFF (0): Do not compute the square root. ON (1): Compute the square root. | OFF (0) | |
| A.LC2 | Analog input-2 low signal cutoff | 0.0% to 5.0% The slope equals "1" at levels below the low-signal cutoff point. | 1.0% | |
| A.BS3 | Analog input-3 bias | Used to correct the remote input value. -100.0% to 100.0% of PV input range span of Loop1 | 0.0% of Loop1 PV input range span | |
| A.FL3 | Analog input-3 filter | OFF (0): Disable 1 to 120 sec. | OFF (0) | |
| A.SR3 | Analog input-3 square-root computation | Performs square-root computation for the remote input value. OFF (0): Do not compute the square root ON (1): Compute the square root | OFF (0) | |
| A.LC3 | Analog input-3 low signal cutoff | 0.0% to 5.0% The slope equals "1" at levels below the low-signal cutoff point. | 1.0% | |

● Retransmission Output Parameters

Located in: Main menu = **CMLP** ; Submenu = **RET**

| Parameter Symbol | Name of Parameter | Setting Range and Description | Initial Value | User Setting |
|------------------|--|--|--------------------------|--------------|
| RET1 | Retransmission output-1 type | <p>OFF (0): Disable 1: PV1, 2: SP1, 3: OUT1, 4: LPS loop power supply (15 V), 5: PV2, 6: SP2, 7: OUT2 Retransmission output 1 is always provided via terminals 14 and 15.</p> <p>In heating/cooling control, an output value before allocation to heating/cooling control (0% to 100%) is transmitted if setpoint "3" or "7" is selected. (0% to 50%: Cooling-side output; 50% to 100%: Heating-side output)</p> | 1 | |
| RTH1 | Maximum value of retransmission output-1 scale | RET1=1, 2: RTL1 + 1 digit to 100.0% of PV input range RET1=3: RTL1 + 1 digit to 100.0% | 100.0% of PV input range | |
| RTL1 | Minimum value of retransmission output-1 scale | RET1=1, 2: 0.0% of PV input range to RTH1 - 1 digit RET1=3: 0.0% to RTH1 - 1 digit | 0.0% of PV input range | |
| RET2 | Retransmission output-2 type | <p>Retransmission output-2 is available when the type of control output is not "current" or "voltage pulse." The output is provided via terminals 16 and 17.</p> <p>OFF (0): Disable 1: PV1, 2: SP1, 3: OUT1, 4: LPS loop power supply (15 V), 5: PV2, 6: SP2, 7: OUT2</p> <p>In heating/cooling control, an output value before allocation to heating/cooling control (0% to 100%) is transmitted if setpoint "3" or "7" is selected. (0% to 50%: Cooling-side output; 50% to 100%: Heating-side output)</p> | OFF (0) | |
| RTH2 | Maximum value of retransmission output-2 scale | RET2=1, 2: RTL2 + 1 digit to 100.0% of PV input range RET2=3: RTL2 + 1 digit to 100.0% | 100.0% of PV input range | |
| RTL2 | Minimum value of retransmission output-2 scale | RET2=1, 2: 0.0% of PV input range to RTH2 - 1 digit RET2=3: 0.0% to RTH2 - 1 digit | 0.0% of PV input range | |

● Deviation Trend Parameters

Located in: Main menu = **CMLP** ; Submenu = **TRND**

| Parameter Symbol | Name of Parameter | Setting Range and Description | Initial Value | User Setting |
|------------------|---------------------------------|---|-----------------------------------|--------------|
| DVB1 | Deviation display band of Loop1 | 0.0 to 100.0% of Loop1 PV input range span Permits a change in the span of deviation shown on the front-panel deviation monitor. | 1.0% of Loop1 PV input range span | |
| DVB2 | Deviation display band of Loop2 | 0.0 to 100.0% of Loop2 PV input range span Permits a change in the span of deviation shown on the front-panel deviation monitor. | 1.0% of Loop2 PV input range span | |
| TSC1 | Deviation trend scale of Loop1 | 0.1 to 100.0% of Loop1 PV input range span Allows the deviation axis on the Deviation Trend operating display to be re-scaled. | 5.0% of Loop1 PV input range span | |
| TSC2 | Deviation trend scale of Loop2 | 0.1 to 100.0% of Loop2 PV input range span Allows the deviation axis on the Deviation Trend operating display to be re-scaled. | 5.0% of Loop2 PV input range span | |
| TTM | Deviation trend scan time | 0 to 600 sec. Allows the time axis on the Deviation Trend operating display to be re-scaled. | 5 sec. | |

● Security-related Parameters

Located in: Main menu = **CMLP** ; Submenu = **LOCK**

| Parameter Symbol | Name of Parameter | Setting Range and Description | Initial Value | User Setting |
|------------------|---|-----------------------------------|---------------|--------------|
| ▼/▲ | Front panel data setting (△,▽) key lock | OFF (0): Unlock ON (1): Lock | OFF (0) | |
| A/M | Front panel A/M key lock | OFF (0): Unlock ON (1): Lock | OFF (0) | |
| MODE | Operating parameter main menu [MODE] lock | OFF (0): Unlock ON (1): Lock | OFF (0) | |
| LP1 | Operating parameter main menu [LP1] lock | OFF (0): Unlock ON (1): Lock | OFF (0) | |
| LP2 | Operating parameter main menu [LP2] lock | OFF (0): Unlock ON (1): Lock | OFF (0) | |
| PID | Operating parameter main menu [PID] lock | OFF (0): Unlock ON (1): Lock | OFF (0) | |
| USR | Although not used in Dual-loop Control, it is shown on the display. | | | |
| PYS1 | Operating parameter main menu [PYS1] lock | OFF (0): Unlock ON (1): Lock | OFF (0) | |
| PYS2 | Operating parameter main menu [PYS2] lock | OFF (0): Unlock ON (1): Lock | OFF (0) | |
| PWD | Password setting | 0: Password not set 1 to 30000 | 0 | |

● **SELECT Display Parameters**

Located in: Main menu = **CONF** ; Submenu = **CSEL**

| Parameter Symbol | Name of Parameter | Setting Range and Description | Initial Value | User Setting |
|------------------|-------------------------------|--|---------------|--------------|
| C.S1 | SELECT display-1 registration | OFF (0), 201 to 1023 Select the desired parameter from among the operating and setup parameters, then register the number (D register No.) accompanying that parameter. For example, registering "302" for C.S1 allows you to change alarm-1 setpoint in operating display. Numbers for registering alarm SP parameter for operating display: Loop1 alarm-1 setpoint: 302 Loop1 alarm-2 setpoint: 303 Loop1 alarm-3 setpoint: 304 Loop1 alarm-4 setpoint: 305 Above numbers are alarm setpoint parameters for target setpoint-1 (1.SP). Set the registration number of the alarm setpoint parameter for target setpoint 2 (2.SP), to a value obtained by adding 25 to the registration number of the alarm setpoint parameter for the parameter 1.SP. Likewise, set the registration number of the alarm setpoint parameter for target setpoint 3 (3.SP), to a value obtained by adding 25 to the registration number of the alarm setpoint parameter for the parameter 2.SP. Likewise, the registration numbers for 4.SP to 8.SP can be obtained. | OFF (0) | |
| C.S2 | SELECT display-2 registration | | | |
| C.S3 | SELECT display-3 registration | | | |
| C.S4 | SELECT display-4 registration | | | |
| C.S5 | SELECT display-5 registration | | | |

● **Contact Output Registration Parameters**

Located in: Main menu = **CONF** ; Submenu = **DO**

| Parameter Symbol | Name of Parameter | Setting Range and Description | Initial Value | User Setting |
|------------------|--|--|---------------|--------------|
| DO1 | Relay output flag registration for DO1 | The following setpoints are registration numbers for Dual-loop Control only. 5689: Alarm-1 output 0: No function 5690: Alarm-2 output 5691: Alarm-3 output 5693: Alarm-4 output The following setpoints are only available for heating/cooling control. 1607: Cooling-side output (Loop1) 1609: Cooling-side output (Loop1) 1615: Cooling-side output (Loop2) 1617: Cooling-side output (Loop2) Both the setpoints 1607 and 1609 or 1615 and 1617 provide the same cooling-side output value. | 5689 | |
| DO2 | Relay output flag registration for DO2 | | 1615 | |
| DO3 | Relay output flag registration for DO3 | | 1607 | |
| DO4 | Open-collector transistor output flag registration for DO4 | | 1609 | |
| DO5 | Open-collector transistor output flag registration for DO5 | | 1617 | |
| DO6 | Open-collector transistor output flag registration for DO6 | | 5698 | |
| DO7 | Open-collector transistor output flag registration for DO7 | | 5699 | |

Parameters R151 to R258 are shown only for a controller with communication function. See the CD-ROM edition of the user's manual for details on how to use these parameters.

● **Contact Input Registration Parameters**

Located in: Main menu = **CONF** ; Submenu = **DI**

| Parameter Symbol | Name of Parameter | Setting Range and Description | Initial Value | User Setting | | | | | | | | | | | | | | | | | | | | | | | | | | | | | | | | | | | | | | | | | | | | | |
|------------------|--|--|---------------|--------------|------|------|------|------|------|------|------|-----|----|-----|----|-----|----|-----|----|-----|-----|-----|----|----|-----|-----|----|----|-----|-----|-----|-----|-----|----|----|----|----|-----|-----|-----|-----|-----|-----|-----|-----|-----|----|------|--|
| A/M1 | Loop1 Auto/Manual switching | These parameters determine which contact input to use to make selections/switches listed on the left. No function: 0 DI1: 5161 DI2: 5162 DI3: 5163 DI4: 5164 DI5: 5165 DI6: 5166 DI7: 5167 The contact inputs are factory-set as shown below. Contact inputs 1 to 4 (DI1 to DI4): SP selection (see table below) Contact input 5 (DI5): Loop1 Auto (ON)/Manual (OFF) switching Contact input 6 (DI6): Loop2 Auto (ON)/Manual (OFF) switching Contact input 7 (DI7): Run (ON)/Stop (OFF) switching SP Selection: <table border="1" style="margin-left: 20px;"> <thead> <tr> <th></th> <th>1.SP</th> <th>2.SP</th> <th>3.SP</th> <th>4.SP</th> <th>5.SP</th> <th>6.SP</th> <th>7.SP</th> <th>8.SP</th> </tr> </thead> <tbody> <tr> <td>DI1</td> <td>ON</td> <td>OFF</td> <td>ON</td> <td>OFF</td> <td>ON</td> <td>OFF</td> <td>ON</td> <td>OFF</td> </tr> <tr> <td>DI2</td> <td>OFF</td> <td>ON</td> <td>ON</td> <td>OFF</td> <td>OFF</td> <td>ON</td> <td>ON</td> <td>OFF</td> </tr> <tr> <td>DI3</td> <td>OFF</td> <td>OFF</td> <td>OFF</td> <td>ON</td> <td>ON</td> <td>ON</td> <td>ON</td> <td>OFF</td> </tr> <tr> <td>DI4</td> <td>OFF</td> <td>OFF</td> <td>OFF</td> <td>OFF</td> <td>OFF</td> <td>OFF</td> <td>OFF</td> <td>ON</td> </tr> </tbody> </table> If all of the SP parameters of a contact input are set to "OFF", the controller uses the immediately preceding SP. | | 1.SP | 2.SP | 3.SP | 4.SP | 5.SP | 6.SP | 7.SP | 8.SP | DI1 | ON | OFF | ON | OFF | ON | OFF | ON | OFF | DI2 | OFF | ON | ON | OFF | OFF | ON | ON | OFF | DI3 | OFF | OFF | OFF | ON | ON | ON | ON | OFF | DI4 | OFF | OFF | OFF | OFF | OFF | OFF | OFF | ON | 5165 | |
| | 1.SP | | 2.SP | 3.SP | 4.SP | 5.SP | 6.SP | 7.SP | 8.SP | | | | | | | | | | | | | | | | | | | | | | | | | | | | | | | | | | | | | | | | |
| DI1 | ON | | OFF | ON | OFF | ON | OFF | ON | OFF | | | | | | | | | | | | | | | | | | | | | | | | | | | | | | | | | | | | | | | | |
| DI2 | OFF | | ON | ON | OFF | OFF | ON | ON | OFF | | | | | | | | | | | | | | | | | | | | | | | | | | | | | | | | | | | | | | | | |
| DI3 | OFF | | OFF | OFF | ON | ON | ON | ON | OFF | | | | | | | | | | | | | | | | | | | | | | | | | | | | | | | | | | | | | | | | |
| DI4 | OFF | | OFF | OFF | OFF | OFF | OFF | OFF | ON | | | | | | | | | | | | | | | | | | | | | | | | | | | | | | | | | | | | | | | | |
| A/M2 | Loop2 Auto/Manual switching | | 5166 | | | | | | | | | | | | | | | | | | | | | | | | | | | | | | | | | | | | | | | | | | | | | | |
| R/L1 | Loop1 Remote/Local switching | | 0 | | | | | | | | | | | | | | | | | | | | | | | | | | | | | | | | | | | | | | | | | | | | | | |
| R/L2 | Loop2 Remote/Local switching | | 0 | | | | | | | | | | | | | | | | | | | | | | | | | | | | | | | | | | | | | | | | | | | | | | |
| S/R | Run/Stop switching | | 5167 | | | | | | | | | | | | | | | | | | | | | | | | | | | | | | | | | | | | | | | | | | | | | | |
| CAS | Switch to Cascade mode (when in cascade control) | | 0 | | | | | | | | | | | | | | | | | | | | | | | | | | | | | | | | | | | | | | | | | | | | | | |
| AUTO | Switch to Auto mode (when in cascade control) | | 0 | | | | | | | | | | | | | | | | | | | | | | | | | | | | | | | | | | | | | | | | | | | | | | |
| MAN | Switch to Manual mode (when in cascade control) | | 0 | | | | | | | | | | | | | | | | | | | | | | | | | | | | | | | | | | | | | | | | | | | | | | |
| SP.0 | Bit-0 of SP number setting | | 5161 | | | | | | | | | | | | | | | | | | | | | | | | | | | | | | | | | | | | | | | | | | | | | | |
| SP.1 | Bit-1 of SP number setting | 5162 | | | | | | | | | | | | | | | | | | | | | | | | | | | | | | | | | | | | | | | | | | | | | | | |
| SP.2 | Bit-2 of SP number setting | 5163 | | | | | | | | | | | | | | | | | | | | | | | | | | | | | | | | | | | | | | | | | | | | | | | |
| SP.3 | Bit-3 of SP number setting | 5164 | | | | | | | | | | | | | | | | | | | | | | | | | | | | | | | | | | | | | | | | | | | | | | | |
| DP1 | Operating display interruption-1 | 0 | | | | | | | | | | | | | | | | | | | | | | | | | | | | | | | | | | | | | | | | | | | | | | | |
| DP2 | Operating display interruption-2 | 0 | | | | | | | | | | | | | | | | | | | | | | | | | | | | | | | | | | | | | | | | | | | | | | | |
| MG1 | Message display interruption-1 | 0 | | | | | | | | | | | | | | | | | | | | | | | | | | | | | | | | | | | | | | | | | | | | | | | |
| MG2 | Message display interruption-2 | 0 | | | | | | | | | | | | | | | | | | | | | | | | | | | | | | | | | | | | | | | | | | | | | | | |
| MG3 | Message display interruption-3 | 0 | | | | | | | | | | | | | | | | | | | | | | | | | | | | | | | | | | | | | | | | | | | | | | | |
| MG4 | Message display interruption-4 | 0 | | | | | | | | | | | | | | | | | | | | | | | | | | | | | | | | | | | | | | | | | | | | | | | |

● **UT Mode Parameters**

Located in: Main menu = **UTMD** ; Submenu = **MD**

| Parameter Symbol | Name of Parameter | Setting Range and Description | Initial Value | User Setting |
|------------------|--|--|----------------------|--------------|
| UTM | Controller mode (UT mode) | 11: Dual-loop control For another controller mode, see the User's Manual (Reference) (CD-ROM version). | 1 | |
| SMP | PV sampling period setting | 50, 100, 200 and 500 ms The controller restarts if any change is made to the PV sampling period; this does not affect other parameter settings at all, however. | 200 ms | |
| SMEC | Sampling period error counter (reading only) | 0 to 30000 | Shows 0 at power-on. | |

● Input-related Parameters

Located in: Main menu = **UTMD** ; Submenu = **IN**

| Parameter Symbol | Name of Parameter | Setting Range and Description | Initial Value | User Setting |
|------------------|---|---|--------------------------------------|--------------|
| IN1 | PV input type of Loop1 (INPUT 1 terminals) Terminals ①, ② and ③ | Specify the type of PV input type of Loop1 as a range code. See "Instrument Input Range Codes" in the "2. Initial Settings." | OFF (0) | |
| UNI1 | PV input unit of Loop1 | Select the PV input unit of Loop1. % (0): Percent °F (5): Fahrenheit °C (1): Degree Celsius - (2): No unit | Depend on the PV input type of Loop1 | |
| RH1 | Max. value of PV input range of Loop1 | Set the instrument input range (RL1 < RH1). | Depend on the PV input type of Loop1 | |
| RL1 | Min. value of PV input range of Loop1 | - For temperature input - Set the range of temperature that is actually controlled. - For voltage input - Set the range of a voltage signal that is applied. The scale across which the voltage signal is actually controlled should be set using the parameters Maximum Value of PV Input Scale of Loop1 (SH1) and Minimum Value of PV Input Scale of Loop1 (SL1). | Depend on the PV input type of Loop1 | |
| SDP1 | PV input decimal point position of Loop1 (shown when in voltage-input mode) | Set the position of the decimal point of voltage-mode PV input of Loop1. 0 to 4 0: No decimal place, 1: One decimal place, 2, 3, 4: Two, three, four decimal places | Depend on the PV input type of Loop1 | |
| SH1 | Max. value of PV input scale of Loop1 (shown when in voltage-input mode) | Set the read-out scale of voltage-mode PV input of Loop1. -19999 to 30000, where SL1 < SH1 | Depend on the PV input type of Loop1 | |
| SL1 | Min. value of PV input scale of Loop1 (shown when in voltage-input mode) | | Depend on the PV input type of Loop1 | |
| BSL1 | Selection of PV input burnout action of Loop1 | Allows the PV input value of Loop1 to be determined as shown below in case of PV input of Loop1 burnout. • 105% of PV input range of Loop1 if set to "Upscale" • -5.0% of PV input range of Loop1 if set to "Downscale" OFF (0): Disable UP (1): Upscale DOWN (2): Downscale | Depend on the PV input type of Loop1 | |
| RJC1 | Presence/absence of PV input reference junction compensation of Loop1 | Allows input compensation to be applied to thermocouple input. OFF (0): Absent ON (1): Present | ON (1) | |
| IN2 | PV input type of Loop2 (INPUT 2 terminals) Terminals ④, ⑤ and ⑥ | Specify the type of PV input type of Loop2 as a range code. See "Instrument Input Range Codes" in the "2. Initial Settings." | typeK1 (1) | |
| UNI2 | PV input unit of Loop2 | Select the PV input unit of Loop2. % (0): Percent °F (5): Fahrenheit °C (1): Degree Celsius - (2): No unit | °C (1) | |
| RH2 | Max. value of PV input range of Loop2 | Set the instrument input range (RL2 < RH2). | 1370.0 | |
| RL2 | Min. value of PV input range of Loop2 | - For temperature input - Set the range of temperature that is actually controlled. - For voltage input - Set the range of a voltage signal that is applied. The scale across which the voltage signal is actually controlled should be set using the parameters Maximum Value of PV Input Scale of Loop2 (SH2) and Minimum Value of PV Input Scale of Loop2 (SL2). | -270.0 | |
| SDP2 | PV input decimal point position of Loop2 (shown when in voltage-input mode) | Set the position of the decimal point of voltage-mode PV input of Loop2. 0 to 4 0: No decimal place, 1: One decimal place, 2, 3, 4: Two, three, four decimal places | 2 | |

| Parameter Symbol | Name of Parameter | Setting Range and Description | Initial Value | User Setting |
|------------------|--|---|--|--------------|
| SH2 | Max. value of PV input scale of Loop2 (shown when in voltage-input mode) | Set the read-out scale of voltage-mode PV input of Loop2. -19999 to 30000, where SL2 < SH2 | 100.00 | |
| SL2 | Min. value of PV input scale of Loop2 (shown when in voltage-input mode) | | 0.00 | |
| BSL2 | Selection of PV input burnout action of Loop2 | Allows the PV input value of Loop2 to be determined as shown below in case of PV input of Loop2 burnout. <ul style="list-style-type: none"> • 105% of PV input range of Loop2 if set to "Upscale" • -5.0% of PV input range of Loop2 if set to "Downscale" OFF (0): Disable UP (1): Upscale DOWN (2): Downscale | OFF (0) | |
| RJC2 | Presence/absence of PV input reference junction compensation of Loop2 | Allows input compensation to be applied to thermocouple input. OFF (0): Absent ON (1): Present | ON (1) | |
| IN3 | Remote input type (INPUT 3 terminals) Terminals ② and ③ | Specify the type of remote input as a range code. See "Instrument Input Range Codes" in the "2. Initial Settings." | 1 to 5 V (41) | |
| UNI3 | Remote input unit | Select the unit of remote input. % (0): Percent °F (5): Fahrenheit °C (1): Degree Celsius - (2): No unit | % (0) | |
| RH3 | Maximum value of remote input range | Set the range of a voltage signal. (RL3 < RH3) | 5.000 | |
| RL3 | Minimum value of remote input range | | 1.000 | |
| SDP3 | Remote input decimal point position | Set the position of the decimal point for remote input. 0 to 4 0: No decimal place, 1: One decimal place, 2, 3, 4: Two, three, four decimal places | Same as the PV input decimal point position of Loop1 | |
| SH3 | Max. value of remote input scale | Set the remote input read-out scale. -19999 to 30000, where SL3 < SH3 | Maximum value of PV input scale of Loop1 | |
| SL3 | Min. value of remote input scale | | Minimum value of PV input scale of Loop1 | |
| BSL3 | Remote input burnout action selection | Allows the remote input value to be determined as shown below in case of remote input burnout. <ul style="list-style-type: none"> • 105% of remote input range if set to "Upscale" • -5.0% of remote input range if set to "Downscale" OFF (0): Disable UP (1): Upscale DOWN (2): Downscale | OFF (0) | |
| P.UN1 | PV1 unit (Loop1) | Set the unit of PV1. % (0): Percent °F (5): Fahrenheit °C (1): Degree Celsius - (2): No unit | Same as the PV input unit of Loop1 | |
| P.DP1 | PV1 decimal point position (Loop1) | Under normal operation, set the same value as in the PV Input Decimal Point Position of Loop1 (SDP1) parameter. To shift the decimal point for temperature input, use this parameter. For example, set as "P.DP1 = 0" to change a temperature reading of one decimal place to that of no decimal place. This involves reconfiguring the P.RH1 and P.RL1 parameters. 0 to 4 | - | |
| P.RH1 | Maximum value of PV1 range (Loop1) | Under normal operation, keep the values of these parameters between the maximum and minimum values of the PV input range of Loop1. -19999 to 30000 P.RL1 < P.RH1, where P.RH1 - P.RL1 ≤ 30000 | Maximum value of PV input range or scale of Loop1 | |
| P.RL1 | Minimum value of PV1 range (Loop1) | | Minimum value of PV input range or scale of Loop1 | |

| Parameter Symbol | Name of Parameter | Setting Range and Description | Initial Value | User Setting |
|------------------|------------------------------------|---|---|--------------|
| P.UN2 | PV2 unit (Loop2) | Set the unit of PV2. % (0): Percent °F (5): Fahrenheit °C (1): Degree Celsius - (2): No unit | Same as the unit of PV input of Loop2 | |
| P.DP2 | PV2 decimal point position (Loop2) | Under normal operation, set the same value as in the PV Input Decimal Point Position of Loop2 (SDP2) parameter. To shift the decimal point for temperature input, use this parameter. For example, set as "P.DP2 = 0" to change a temperature reading of one decimal place to that of no decimal place. This involves reconfiguring the P.RH2 and P.RL2 parameters. 0 to 4 | - | |
| P.RH2 | Maximum value of PV2 range (Loop2) | Under normal operation, keep the values of these parameters between the maximum and minimum values of the PV input range of Loop2. -19999 to 30000 P.RL2 < P.RH2, where P.RH2 - P.RL2 ≤ 30000 | Maximum value of PV input range or scale of Loop2 | |
| P.RL2 | Minimum value of PV2 range (Loop2) | | Minimum value of PV input range or scale of Loop2 | |

● Output-related Parameters

Located in: Main menu = **UTMD** ; Submenu = **OUT**

| Parameter Symbol | Name of Parameter | Setting Range and Description | Initial Value | User Setting |
|------------------|---------------------------|--|---------------|--------------|
| OT1 | Loop1 control output type | 0 Time proportional PID relay contact output (terminals ① - ② - ③) | 0 | |
| | | 1 Time proportional PID voltage pulse output (terminals ⑩ - ⑪) | | |
| | | 2 Current output (terminals ⑩ - ⑪) | | |
| | | 3 ON/OFF control relay contact output (terminals ① - ② - ③) | | |
| | | 4 Heating-side relay output (terminals ① - ② - ③), cooling-side relay output (terminals ④ - ⑦) | | |
| | | 5 Heating-side pulse output (terminals ⑩ - ⑪), cooling-side relay output (terminals ④ - ⑦) | | |
| | | 6 Heating-side current output (terminals ⑩ - ⑪), cooling-side relay output (terminals ④ - ⑦) | | |
| | | 7 Heating-side relay output (terminals ① - ② - ③), cooling-side transistor output (terminals ⑳ - ㉓) | | |
| | | 8 Heating-side pulse output (terminals ⑩ - ⑪), cooling-side transistor output (terminals ㉑ - ㉓) | | |
| | | 9 Heating-side current output (terminals ⑩ - ⑪), cooling-side transistor output (terminals ㉑ - ㉓) | | |
| | | 10 Heating-side relay output (terminals ① - ② - ③), cooling-side current output (terminals ⑭ - ⑮) | | |
| | | 11 Heating-side pulse output (terminals ⑩ - ⑪), cooling-side current output (terminals ⑭ - ⑮) | | |
| | | 12 Heating-side current output (terminals ⑩ - ⑪), cooling-side current output (terminals ⑭ - ⑮) | | |
| OT2 | Loop2 control output type | 0 Time proportional PID relay contact output (terminals ④⑧ - ④⑨ - ⑤⑩) | 0 | |
| | | 1 Time proportional PID voltage pulse output (terminals ④⑩ - ④⑪) | | |
| | | 2 Current output (terminals ④⑩ - ④⑪) | | |
| | | 3 ON/OFF control relay contact output (terminals ④⑧ - ④⑨ - ⑤⑩) | | |
| | | 4 Heating-side relay output (terminals ④⑧ - ④⑨ - ⑤⑩), cooling-side relay output (terminals ⑤ - ⑦) | | |
| | | 5 Heating-side pulse output (terminals ④⑩ - ④⑪), cooling-side relay output (terminals ⑤ - ⑦) | | |
| | | 6 Heating-side current output (terminals ④⑩ - ④⑪), cooling-side relay output (terminals ⑤ - ⑦) | | |
| | | 7 Heating-side relay output (terminals ④⑧ - ④⑨ - ⑤⑩), cooling-side transistor output (terminals ③③ - ③⑤) | | |
| | | 8 Heating-side pulse output (terminals ④⑩ - ④⑪), cooling-side transistor output (terminals ③③ - ③⑤) | | |
| | | 9 Heating-side current output (terminals ④⑩ - ④⑪), cooling-side transistor output (terminals ③③ - ③⑤) | | |

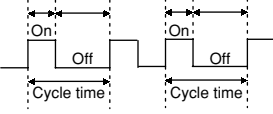
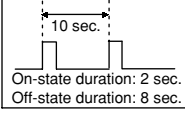
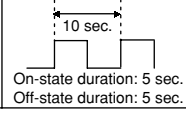
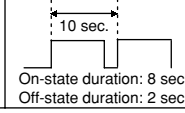
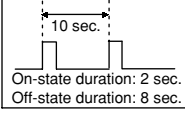
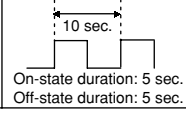
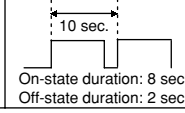
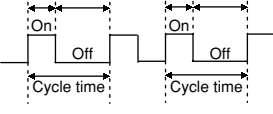
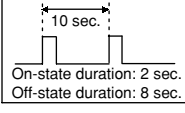
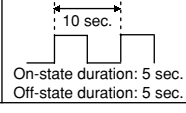
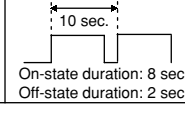
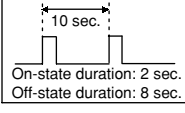
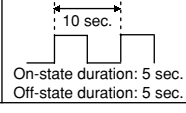
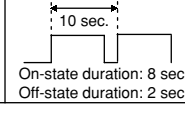
| Parameter Symbol | Name of Parameter | Setting Range and Description | Initial Value | User Setting | | |
|---|--|---|---------------|--------------|---------------------------|---------------------------|
| CT1 | Loop1 control output cycle time Heating-side control output cycle time (in heating/cooling control) | 1 to 1000 sec.  | 30 sec. | | | |
| | | Relay's Behavior when Cycle Time = 10 sec. <table border="1" data-bbox="657 421 1228 555"> <thead> <tr> <th>For 20% of Control Output</th> <th>For 50% of Control Output</th> <th>For 80% of Control Output</th> </tr> </thead> <tbody> <tr> <td></td> <td></td> <td></td> </tr> </tbody> </table> | | | For 20% of Control Output | For 50% of Control Output |
| For 20% of Control Output | For 50% of Control Output | For 80% of Control Output | | | | |
|  |  |  | | | | |
| CT2 | Loop2 control output cycle time Heating-side control output cycle time (in heating/cooling control) | 1 to 1000 sec.  | 30 sec. | | | |
| | | Relay's Behavior when Cycle Time = 10 sec. <table border="1" data-bbox="657 768 1228 902"> <thead> <tr> <th>For 20% of Control Output</th> <th>For 50% of Control Output</th> <th>For 80% of Control Output</th> </tr> </thead> <tbody> <tr> <td></td> <td></td> <td></td> </tr> </tbody> </table> | | | For 20% of Control Output | For 50% of Control Output |
| For 20% of Control Output | For 50% of Control Output | For 80% of Control Output | | | | |
|  |  |  | | | | |
| CTc1 | Loop1 Cooling-side control output cycle time | 1 to 1000 sec. | 30 sec. | | | |
| CTc2 | Loop2 Cooling-side control output cycle time | 1 to 1000 sec. | 30 sec. | | | |
| A01 | Analog output-1 type (OUTPUT 1: Terminals ⑥ and ⑦) | Allows control output or retransmission output to be presented as one of the following current signals. 0: 4 to 20 mA 1: 0 to 20 mA 2: 20 to 4 mA 3: 20 to 0 mA | 0 | | | |
| A02 | Analog output-2 type (OUTPUT 2: Terminals ④ and ⑤) | | 0 | | | |
| A03 | Analog output-3 type (OUTPUT 3: Terminals ④ and ⑤) | | 0 | | | |
| A1H | Analog output-1 100% segmental point | Set the values of segmental points for the 0% and 100% output levels at which the values are presented via OUTPUT-1 (terminals ⑥ and ⑦). See "■ Performing Split Computations" below. | 100.0% | | | |
| A1L | Analog output-1 0% segmental point | | 0.0% | | | |
| A2H | Analog output-2 100% segmental point | Set the values of segmental points for the 0% and 100% output levels at which the values are presented via OUTPUT-2 (terminals ④ and ⑤). See "■ Performing Split Computations" below. | 100.0% | | | |
| A2L | Analog output-2 0% segmental point | | 0.0% | | | |
| A3H | Analog output-3 100% segmental point | Set the values of segmental points for the 0% and 100% output levels at which the values are presented via OUTPUT-3 (terminals ④ and ⑤). See "■ Performing Split Computations" below. | 100.0% | | | |
| A3L | Analog output-3 0% segmental point | | 0.0% | | | |

■ Performing Split Computations

[V-mode Output]

The following explains an example of letting “Analog OUTPUT-1 (terminals ⑯ and ⑰)” and “Analog OUTPUT-3 (terminals ⑭ and ⑮)” present the V-mode characteristics of split computations.

- [1] Set the Control Output Type (OT1) parameter to “2”.
This sets the control output to “current output.”
- [2] Set the Retransmission Output 1 (RET1) parameter to “3”.
This sets the retransmission output to “control output retransmission.”
- [3] Set the Analog Output-1 100% Segmental Point (A1H) parameter to “100%”.
- [4] Set the Analog Output-1 0% Segmental Point (A1L) parameter to “25%”.
- [5] Set the Analog Output-3 100% Segmental Point (A3H) parameter to “0%”.
- [6] Set the Analog Output-3 0% Segmental Point (A3L) parameter to “75%”.

The figure below shows an example where both analog outputs-1 and 3 are set to the current signal of 4 to 20 mA DC. The type of output signal can be determined separately for each of the analog outputs listed above, using the following three parameters.

Analog output-1: Analog output-1 type (AO1)

Analog output-2: Analog output-2 type (AO2)

Analog output-3: Analog output-3 type (AO3)

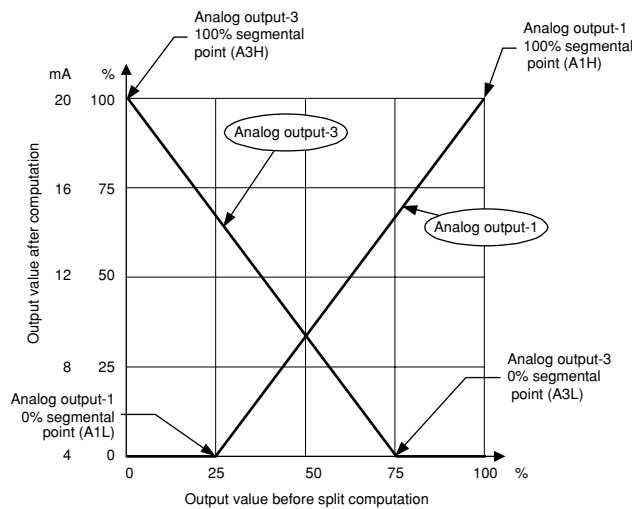

[Parallel-mode Output]

The following explains an example of letting “Analog OUTPUT-1 (terminals ⑬ and ⑭)” and “Analog OUTPUT-3 (terminals ⑮ and ⑯)” present the parallel-mode characteristics of split computations.

- [1] Set the Control Output Type (OT1) parameter to “2”.
This sets the control output to “current output.”
- [2] Set the Retransmission Output 1 (RET1) parameter to “3”.
This sets the retransmission output to “control output retransmission.”
- [3] Set the Analog Output-1 100% Segmental Point (A1H) parameter to “100%”.
- [4] Set the Analog Output-1 0% Segmental Point (A1L) parameter to “25%”.
- [5] Set the Analog Output-3 100% Segmental Point (A3H) parameter to “75%”.
- [6] Set the Analog Output-3 0% Segmental Point (A3L) parameter to “0%”.

The figure below shows an example where both analog outputs-1 and 3 are set to the current signal of 20 to 0 mA DC. The type of output signal can be determined separately for each of the analog outputs listed above, using the following three parameters.

- Analog output-1: Analog output-1 type (AO1)
- Analog output-2: Analog output-2 type (AO2)
- Analog output-3: Analog output-3 type (AO3)

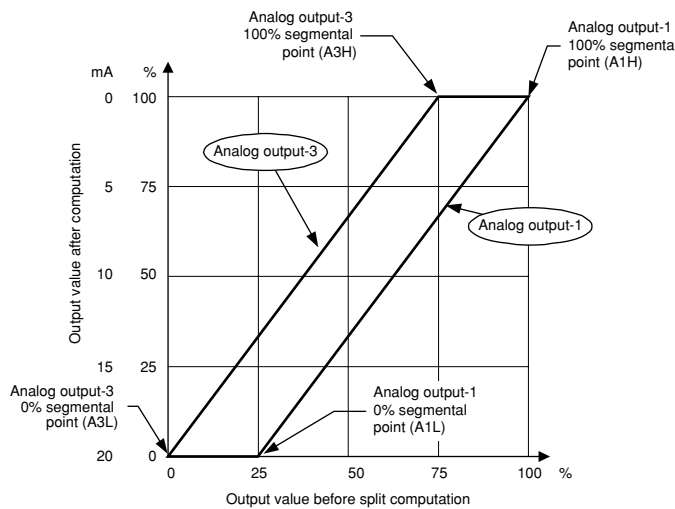

● Communication Parameters

Located in: Main menu = **UTMD** ; Submenu = **R485**

| Parameter Symbol | Name of Parameter | Setting Range and Description | Initial Value | User Setting |
|------------------|-------------------------|---|---------------|--------------|
| PSL1 | Protocol selection-1 | 0: PC link communication 1: PC link communication (with sum check) 2: Ladder communication 3: Coordinated master station 4: Coordinated slave station 7: MODBUS (ASCII) 8: MODBUS (RTU) 9: Coordinated master station (2 loop mode) 10: Coordinated slave station (loop-1 mode) 11: Coordinated slave station (loop-2 mode) Terminal numbers: ⑳, ㉑, ㉒, ㉓ and ㉔ (terminals for 4-wire connection) | 0 | |
| BPS1 | Baud rate-1 | 600 (0), 1200 (1), 2400 (2), 4800 (3), 9600 (4) (bps) | 9600 (4) | |
| PRI1 | Parity-1 | NONE (0): None EVEN (1): Even ODD (2): Odd | EVEN (1) | |
| STP1 | Stop bit-1 | 1, 2 | 1 | |
| DLN1 | Data length-1 | 7, 8; 7 is fixed for MODBUS (ASCII) 8 is fixed for MODBUS (RTU), Ladder | 8 | |
| ADR1 | Address-1 | 1 to 99 However, the maximum number of stations connectable is 31. | 1 | |
| RP.T1 | Minimum response time-1 | 0 to 10 (× 10 ms) | 0 | |
| PSL2 | Protocol selection-2 | 0: PC link communication 1: PC link communication (with sum check) 2: Ladder communication 3: Coordinated master station 4: Coordinated slave station 5: I/O expansion (for single-controller applications) 6: I/O expansion (for dual-controller applications) 9: Coordinated master station (2 loop mode) 10: Coordinated slave station (loop-1 mode) 11: Coordinated slave station (loop-2 mode) Terminal numbers: ㉕, ㉖ and ㉗ (terminals for 2-wire connection) | 0 | |
| BPS2 | Baud rate-2 | 600 (0), 1200 (1), 2400 (2), 4800 (3), 9600 (4), 19200 (5), 38400 (6) (bps) | 9600 (4) | |
| PRI2 | Parity-2 | NONE (0): None EVEN (1): Even ODD (2): Odd | EVEN (1) | |
| STP2 | Stop bit-2 | 1, 2 | 1 | |
| DLN2 | Data length-2 | 7, 8 8 is fixed for Ladder | 8 | |
| ADR2 | Address-2 | 1 to 99 However, the maximum number of stations connectable is 31. | 1 | |
| RP.T2 | Minimum response time-2 | 0 to 10 (× 10 ms) | 0 | |

● Parameter-initializing Parameters

Located in: Main menu = **UTMD** ; Submenu = **INIT**

| Parameter Symbol | Name of Parameter | Setting Range and Description | Initial Value | User Setting |
|------------------|--------------------------|--|---------------|--------------|
| INI | Parameter initialization | Be sure to carry out parameter initialization when any change is made to the PV input type, PV input scale or decimal point position. OFF (0): - ON (1): Initialize parameters | OFF (0) | |

■ Tips about Heating/Cooling Control

In heating/cooling control, the controller outputs the result of computation after splitting it into heating-purpose and cooling-purpose signals. In addition, the controller can perform PID control or ON/OFF control on the heating and cooling sides separately. When performing ON/OFF control, set the proportional band to “0”.

The controller splits the result of computation (0 to 100%) into heating-side and cooling-side signals, as described below.

- 0% to 50% of the computation result is presented as a 0% to 100% cooling-side output.
- 50% to 100% of the computation result is presented as a 0% to 100% heating-side output.

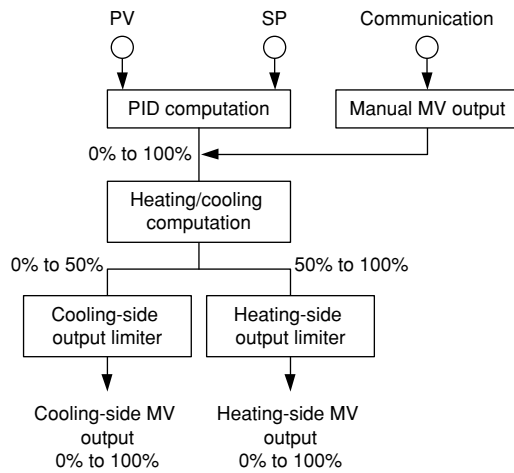

Heating/cooling control provides two methods in which either none of the heating- and cooling-side outputs are presented or both of the heating- and cooling-side outputs are presented, as shown in the following figures.

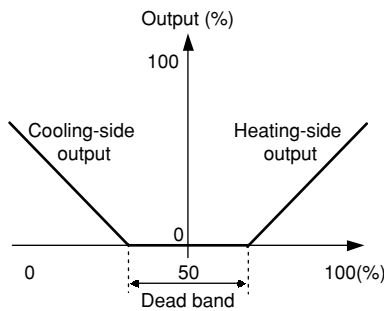

Value of control output before split into heating- and cooling-side outputs

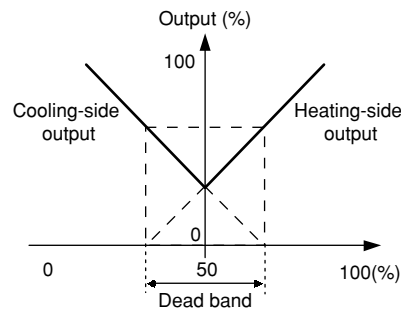

Value of control output before split into heating- and cooling-side outputs

Precautions in Heating/Cooling Control

- Keep the ratio of the heating-side proportional band (P) to the cooling-side proportional band (Pc) equal to or below 5.
- If neither the heating-side nor the cooling-side is performing ON/OFF control, setting the integral time (I or Ic) of one side to “0” results in the Integral Time parameters of both sides being set to “OFF”, irrespective of the integral time setting of the other side.

6. Function Block Diagram and Descriptions

This chapter contains the function block diagrams for “Dual-loop Control,” “Dual-loop Heating/Cooling Control.” For details on these function block diagrams, refer to the descriptions mentioned later.

■ Function Block Diagram for Dual-loop Control

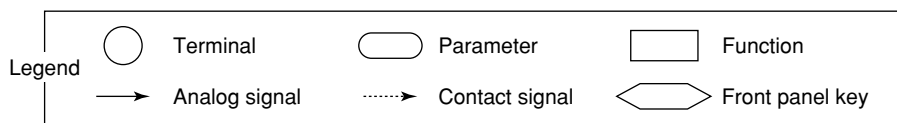
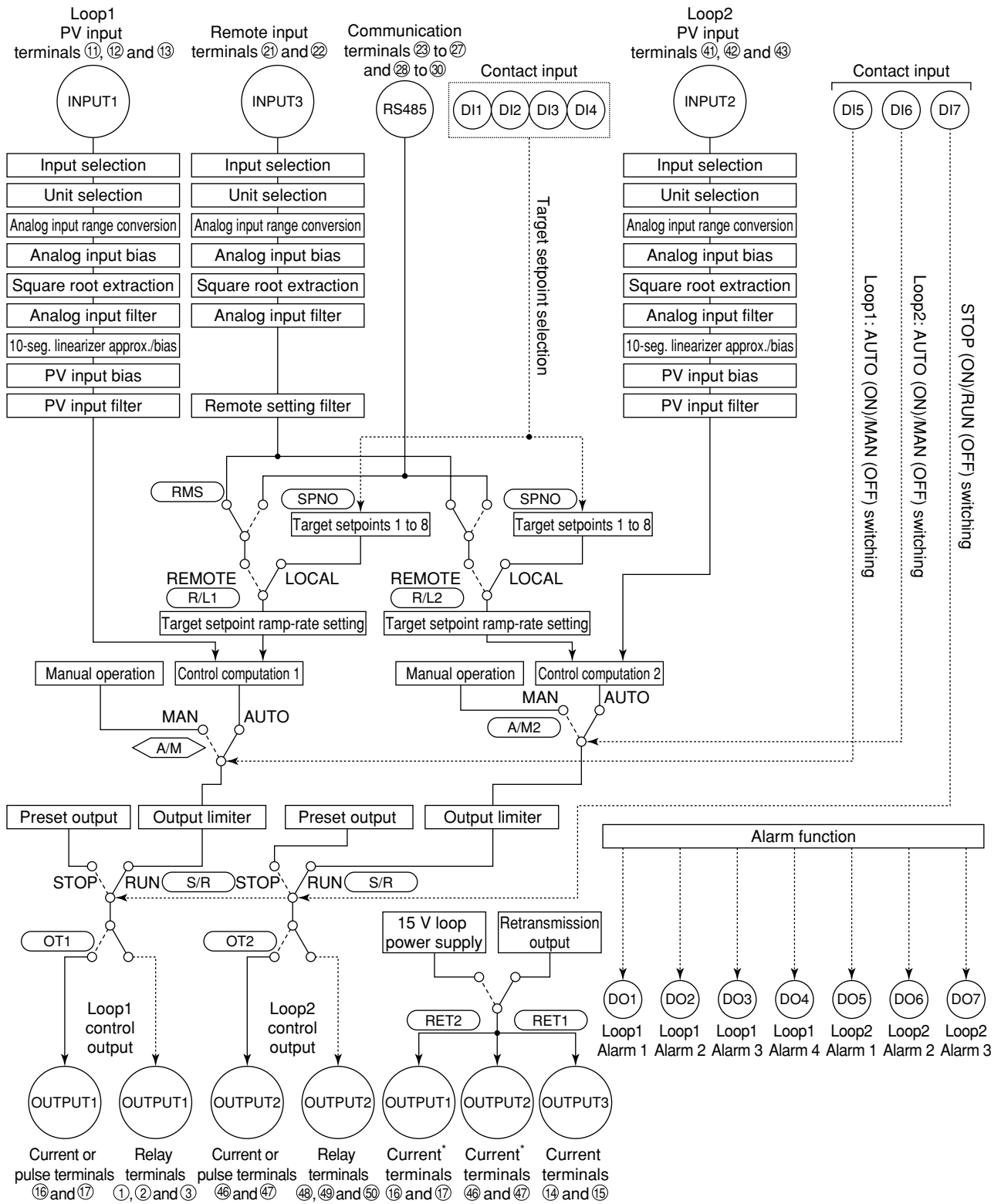

Function Block Diagram for Dual-loop Heating/Cooling Control

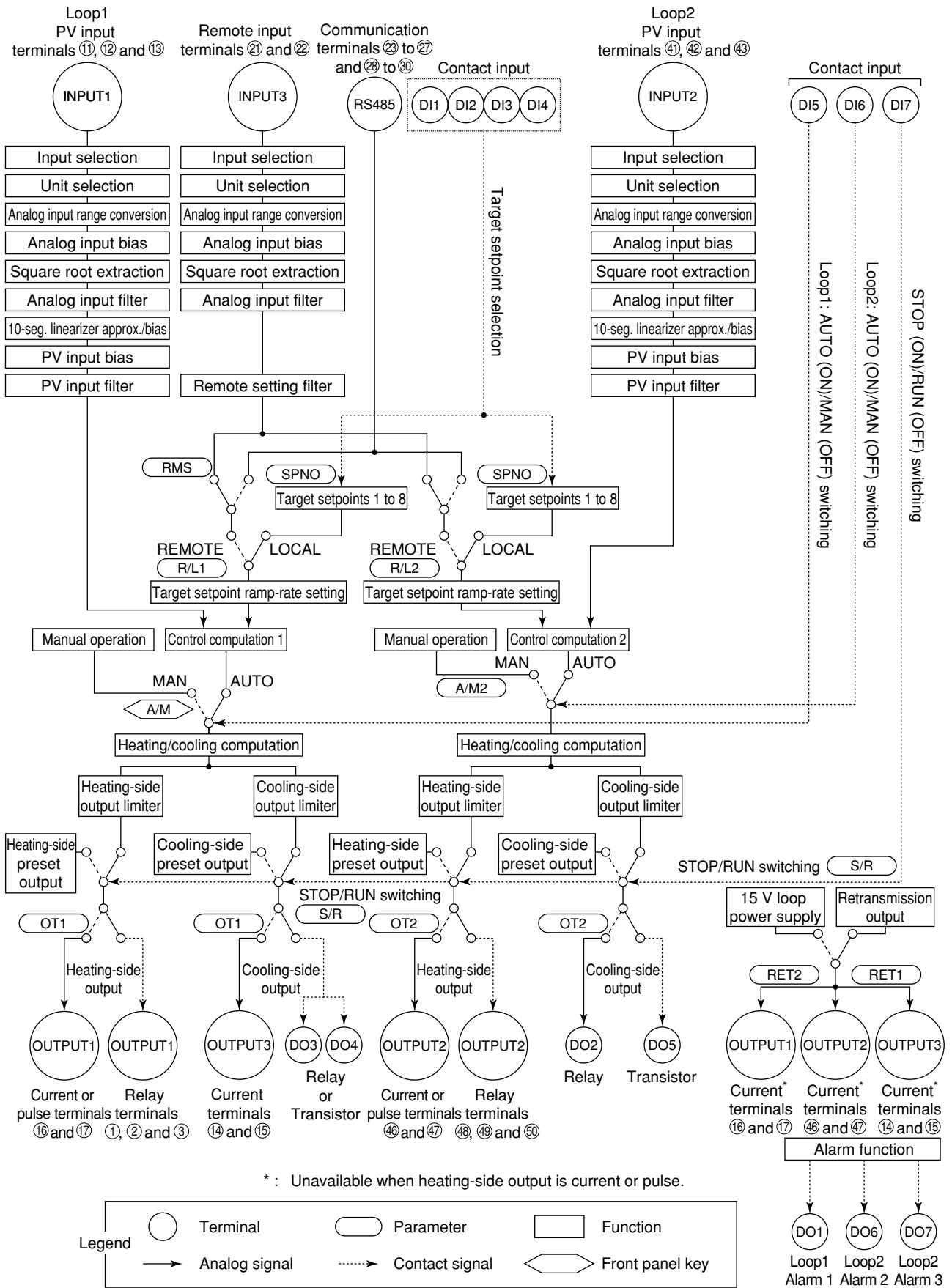

Functions and Parameters for “Dual-loop Control” in Initial State

Functions and parameters in initial state are given in the tables below. For details on each parameter, refer to “5.2 Lists of Parameters.”

■ PV Input of Loop1

PV input of Loop1 (INPUT1) is a universal input, which can receive signals from thermocouple, RTD, or DC voltage signals. The controller is capable of biasing, square root extraction, first-order lag computation (filtering) ten-segment linearizer approximation, and ten-segment linearizer biasing on input signals.

Each function can be set by the following parameters.

Setup Parameters

| Function | Parameter | Main menu | Submenu |
|-------------------------------|---------------------------|-----------|---------|
| Input selection | IN1 | UTMD | IN |
| Unit selection | UNI1 | UTMD | IN |
| Analog input range conversion | RH1, RL1 (SDP1, SH1, SL1) | UTMD | IN |
| Analog input bias | A.BS1 | CMLP | AIN |
| Square root extraction | A.SR1, A.LC1 | CMLP | AIN |
| Analog input filter | A.FL1 | CMLP | AIN |

Operating Parameters

| Function | Parameter | Main menu | Submenu |
|--|------------------------------|-----------|---------|
| Ten-segment linearizer mode | 1.PMD | PYS1 | None |
| Ten-segment linearizer approximation/biasing | 1.a1 to 1.a11, 1.b1 to 1.b11 | PYS1 | None |
| PV input bias | BS | LP1 | PAR |
| PV input filter | FL | LP1 | PAR |

Note: PV input bias (BS) and PV input filter (FL) among the operating parameters are used as bias and filter when normal operation. Analog input bias (A.BS1) and analog input filter (A.FL1) among the setup parameters are used when PV correction value is decided in advance.

■ PV Input of Loop2

PV input of Loop2 (INPUT2) is a universal input, which can receive signals from thermocouple, RTD, or DC voltage signals. The controller is capable of biasing, square root extraction, first-order lag computation (filtering) ten-segment linearizer approximation, and ten-segment linearizer biasing on input signals.

Each function can be set by the following parameters.

Setup Parameters

| Function | Parameter | Main menu | Submenu |
|-------------------------------|---------------------------|-----------|---------|
| Input selection | IN2 | UTMD | IN |
| Unit selection | UNI2 | UTMD | IN |
| Analog input range conversion | RH2, RL2 (SDP2, SH2, SL2) | UTMD | IN |
| Analog input bias | A.BS2 | CMLP | AIN |
| Square root extraction | A.SR2, A.LC2 | CMLP | AIN |
| Analog input filter | A.FL2 | CMLP | AIN |

Operating Parameters

| Function | Parameter | Main menu | Submenu |
|--|------------------------------|-----------|---------|
| Ten-segment linearizer mode | 2.PMD | PYS2 | None |
| Ten-segment linearizer approximation/biasing | 2.a1 to 2.a11, 2.b1 to 2.b11 | PYS2 | None |
| PV input bias | BS | LP2 | PAR |
| PV input filter | FL | LP2 | PAR |

Note: PV input bias (BS) and PV input filter (FL) among the operating parameters are used as bias and filter when normal operation. Analog input bias (A.BS2) and analog input filter (A.FL2) among the setup parameters are used when PV correction value is decided in advance.

■ Remote Input

Remote input (INPUT3) can receive DC voltage signals. The controller is capable of biasing, square root extraction, first-order lag computation (filtering), and ratio biasing on remote input signals.

Each function can be set by the following parameters.

Setup Parameters

| Function | Parameter | Main menu | Submenu |
|-------------------------------|---------------------------|-----------|---------|
| Input selection | IN3 | UTMD | IN |
| Unit selection | UNI3 | UTMD | IN |
| Analog input range conversion | RH3, RL3 (SDP3, SH3, SL3) | UTMD | IN |
| Analog input bias | A.BS3 | CMLP | AIN |
| Square root extraction | A.SR3, A.LC3 | CMLP | AIN |
| Analog input filter | A.FL3 | CMLP | AIN |
| Remote input selection | RMS | LOOP1 | SP |

Note: Remote input signal can be received via communication. For details, refer to "GREEN Series Communication Functions" (IM 05G01B02-01E).

Operating Parameters



| Function | Parameter | Main menu | Submenu |
|---------------------------------|-----------------|-----------|---------|
| Remote setting filter | RFL | LP1 | PAR |
| Ratio bias calculation | RT, RBS | LP1 | PAR |
| Remote/Local switching of Loop1 | MODE (REM/LOC1) | MODE | None |
| Remote/Local switching of Loop2 | MODE (REM/LOC2) | MODE | None |



■ Contact Input

It is possible to select one out of eight setpoints by turning the four contact input signals ON or OFF. This function is assigned to DI1 (contact input 1) to DI4 (contact input 4). (For both Loop1 and Loop2)

| Contact input | Target setpoint number to be selected (SPNO) | | | | | | | | If all contact inputs are set to "OFF", the controller uses the immediately preceding target setpoint. |
|---------------|--|-----|-----|-----|-----|-----|-----|-----|--|
| | 1 | 2 | 3 | 4 | 5 | 6 | 7 | 8 | |
| DI1 | ON | OFF | ON | OFF | ON | OFF | ON | OFF | |
| DI2 | OFF | ON | ON | OFF | OFF | ON | ON | OFF | |
| DI3 | OFF | OFF | OFF | ON | ON | ON | ON | OFF | |
| DI4 | OFF | OFF | OFF | OFF | OFF | OFF | OFF | ON | |

For example, set contact input 2 (DI2) only to "ON" to change target setpoint 1 to 2. Set contact inputs 1 (DI1) and 2 (DI2) to "ON" to select target setpoint 3.

Automatic (ON)/Manual (OFF) switching function of Loop1 is assigned to DI5 (contact input 5). Manipulated output can be changed using the  and  keys in manual mode.

Automatic (ON)/Manual (OFF) switching function of Loop2 is assigned to DI6 (contact input 6). Manipulated output can be changed using the  and  keys in manual mode.

Run (OFF)/Stop (ON) switching function is assigned to DI7 (contact input 7). Preset output value is output when the operation is stopped. PV input and alarm remain functioning as normal. This function is common to Loop1 and Loop2.

■ Target Setpoint and PID (Loop1)

It is possible to use a maximum of eight groups of target setpoints and PID parameters. The target setpoint can be selected by key operation or contact input. For selection by contact input, refer to "Contact Input." Target setpoint number (SPNO) is common to Loop1 and Loop2.

Operating Parameters

| Function | Parameter | Main menu | Submenu |
|-------------------------------------|-----------|-----------|---------|
| Target setpoint number selection | SPNO | MODE | None |
| Target setpoints 1 to 8 | n.SP | LP1 | n.PID |
| Proportional band (P) | n.P | LP1 | n.PID |
| Integral time (I) | n.I | LP1 | n.PID |
| Derivative time (D) | n.D | LP1 | n.PID |
| Cooling-side proportional band (Pc) | n.Pc | LP1 | n.PID |
| Cooling-side integral time (Ic) | n.Ic | LP1 | n.PID |
| Cooling-side derivative time (Dc) | n.Dc | LP1 | n.PID |

Note: Parameters n.SP, n.P, n.I, n.D, n.Pc, n.Ic, n.Dc (n=1 to 8) and submenu n.PID (n=1 to 8) correspond to the target setpoint number selected in the target setpoint number selection (SPNO).

The target setpoint ramp rate setting function prevents the target setpoint from changing suddenly. It is possible to set the upward and downward changing rate (i.e., ramp rate) independently in the parameters UPR and DNR. The unit of the ramp rate (hour, or minute) is specified in TMU.

Setup Parameters

| Function | Parameter | Main menu | Submenu |
|-----------------------------|-----------|-----------|---------|
| Ramp-rate time unit setting | TMU | LOOP1 | SP |

Operating Parameters

| Function | Parameter | Main menu | Submenu |
|-----------------------------------|-----------|-----------|---------|
| Target setpoint ramp-rate setting | UPR, DNR | LP1 | PAR |

■ Target Setpoint and PID (Loop2)

It is possible to use a maximum of eight groups of target setpoints and PID parameters. The target setpoint can be selected by key operation or contact input. For selection by contact input, refer to "Contact Input." Target setpoint number (SPNO) is common to Loop1 and Loop2.

Operating Parameters

| Function | Parameter | Main menu | Submenu |
|-------------------------------------|-----------|-----------|---------|
| Target setpoint number selection | SPNO | MODE | None |
| Target setpoints 1 to 8 | n.SP | LP2 | n.PID |
| Proportional band (P) | n.P | LP2 | n.PID |
| Integral time (I) | n.I | LP2 | n.PID |
| Derivative time (D) | n.D | LP2 | n.PID |
| Cooling-side proportional band (Pc) | n.Pc | LP2 | n.PID |
| Cooling-side integral time (Ic) | n.Ic | LP2 | n.PID |
| Cooling-side derivative time (Dc) | n.Dc | LP2 | n.PID |

Note: Parameters n.SP, n.P, n.I, n.D, n.Pc, n.Ic, n.Dc (n=1 to 8) and submenu n.PID (n=1 to 8) correspond to the target setpoint number selected in the target setpoint number selection (SPNO).

The target setpoint ramp rate setting function prevents the target setpoint from changing suddenly. It is possible to set the upward and downward changing rate (i.e., ramp rate) independently in the parameters UPR and DNR. The unit of the ramp rate (hour, or minute) is specified in TMU.

Setup Parameters

| Function | Parameter | Main menu | Submenu |
|-----------------------------|-----------|-----------|---------|
| Ramp-rate time unit setting | TMU | LOOP2 | SP |

Operating Parameters

| Function | Parameter | Main menu | Submenu |
|-----------------------------------|-----------|-----------|---------|
| Target setpoint ramp-rate setting | UPR, DNR | LP2 | PAR |

■ Control Output of Loop1

Control output of Loop1 (OUTPUT1) selects the output type among the current output, voltage pulse output, and relay contact output signal.

Preset output value is output when the operation is stopped by key operation or contact input, which takes priority over the manual operation.

Each function can be set by the following parameters.

Setup Parameters

| Function | Parameter | Main menu | Submenu |
|--|-----------|-----------|---------|
| Control output type selection | OT1 | UTMD | OUT |
| Control output cycle time | CT1 | UTMD | OUT |
| Cooling-side control output cycle time | CTc1 | UTMD | OUT |
| Analog output 1 type | AO1 | UTMD | OUT |

Operating Parameters

| Function | Parameter | Main menu | Submenu |
|----------------------------|------------|-----------|---------|
| Preset output | n.PO | LP1 | n.PID |
| Cooling-side preset output | n.POc | LP1 | n.PID |
| Output limiter | n.OL, n.OH | LP1 | n.PID |

Note: Parameters n.PO, n.POc, n.OL, n.OH (n=1 to 8) and submenu n.PID (n=1 to 8) correspond to the target setpoint number selected in the target setpoint number selection (SPNO).

■ Control Output of Loop2

Control output of Loop2 (OUTPUT2) selects the output type among the current output, voltage pulse output, and relay contact output signal.

Preset output value is output when the operation is stopped by key operation or contact input, which takes priority over the manual operation.

Each function can be set by the following parameters.

Setup Parameters

| Function | Parameter | Main menu | Submenu |
|--|-----------|-----------|---------|
| Control output type selection | OT2 | UTMD | OUT |
| Control output cycle time | CT2 | UTMD | OUT |
| Cooling-side control output cycle time | CTc2 | UTMD | OUT |
| Analog output 1 type | AO2 | UTMD | OUT |

Operating Parameters

| Function | Parameter | Main menu | Submenu |
|----------------------------|------------|-----------|---------|
| Preset output | n.PO | LP2 | n.PID |
| Cooling-side preset output | n.POc | LP2 | n.PID |
| Output limiter | n.OL, n.OH | LP2 | n.PID |

Note: Parameters n.PO, n.POc, n.OL, n.OH (n=1 to 8) and submenu n.PID (n=1 to 8) correspond to the target setpoint number selected in the target setpoint number selection (SPNO).

■ Contact Output

Alarm 1 of Loop1 is output via DO1 (contact output 1).

Alarm 2 of Loop1 is output via DO2 (contact output 2). When cooling-side output is set for relay output in heating/cooling control of Loop2, cooling-side output is output via DO2. Alarm 2 of Loop1 is output via DO5.

Alarm 3 of Loop1 is output via DO3 (contact output 3). When cooling-side output is set for relay output in heating/cooling control of Loop1, cooling-side output is output via DO3. Alarm 3 of Loop1 is output via DO4.

Alarm 4 of Loop1 is output via DO4 (contact output 4). When cooling-side output is set for transistor output in heating/cooling control of Loop1, cooling-side output is output via DO4. Alarm 4 of Loop1 is output via DO3.

Alarm 1 of Loop2 is output via DO5 (contact output 5). When cooling-side output is set for transistor output in heating/cooling control of Loop2, cooling-side output is output via DO5. Alarm 1 of Loop2 is output via DO3.

Alarm 2 of Loop2 is output via DO6 (contact output 6).

Alarm 3 of Loop2 is output via DO7 (contact output 7).

Setup Parameters

| Function | Parameter | Main menu | Submenu |
|-----------------------|-----------|-----------|---------|
| Alarm 1 type of Loop1 | AL1 | LOOP1 | ALM |
| Alarm 2 type of Loop1 | AL2 | LOOP1 | ALM |
| Alarm 3 type of Loop1 | AL3 | LOOP1 | ALM |
| Alarm 4 type of Loop1 | AL4 | LOOP1 | ALM |
| Alarm 1 type of Loop2 | AL1 | LOOP2 | ALM |
| Alarm 2 type of Loop2 | AL2 | LOOP2 | ALM |
| Alarm 3 type of Loop2 | AL3 | LOOP2 | ALM |
| Alarm 4 type of Loop2 | AL4 | LOOP2 | ALM |

Operating Parameters

| Function | Parameter | Main menu | Submenu |
|---------------------------|-----------|-----------|---------|
| Alarm 1 setpoint of Loop1 | n.A1 | LP1 | n.PID |
| Alarm 2 setpoint of Loop1 | n.A2 | LP1 | n.PID |
| Alarm 3 setpoint of Loop1 | n.A3 | LP1 | n.PID |
| Alarm 4 setpoint of Loop1 | n.A4 | LP1 | n.PID |
| Alarm 1 setpoint of Loop2 | n.A1 | LP2 | n.PID |
| Alarm 2 setpoint of Loop2 | n.A2 | LP2 | n.PID |
| Alarm 3 setpoint of Loop2 | n.A3 | LP2 | n.PID |
| Alarm 4 setpoint of Loop2 | n.A4 | LP2 | n.PID |

Note: Submenu n.PID (n=1 to 8) corresponds to the target setpoint number selected in target setpoint number selection (SPNO).

■ Retransmission Output

PV, target setpoint, or control output can be output to retransmission output 1 (OUTPUT3).

It cannot be used when cooling-side output of Loop1 is current or voltage pulse.

Retransmission output 2 (OUTPUT1) can be used when the heating-side output of Loop2 is relay.

Each function can be set by the following parameters.

Setup Parameters

| Function | Parameter | Main menu | Submenu |
|-------------------------------|------------|-----------|---------|
| Retransmission output 1 type | RET1 | CMLP | RET |
| Retransmission output 1 scale | RTH1, RTL1 | CMLP | RET |
| Retransmission output 2 type | RET2 | CMLP | RET |
| Retransmission output 2 scale | RTH2, RTL2 | CMLP | RET |

■ 15 V DC Loop Power Supply

The 15 V DC loop power supply (OUTPUT3) uses the same terminal as retransmission output 1 or 2. The 15 V DC loop power supply can not be used when retransmission output 1 or 2 is used. To use the 15 V DC loop power supply, set "4" in retransmission output 1 type (RET1) or retransmission output 2 type (RET2).

Each function can be set by the following parameters.

Setup Parameters

| Function | Parameter | Main menu | Submenu |
|------------------------------|-----------|-----------|---------|
| Retransmission output 1 type | RET1 | CMLP | RET |
| Retransmission output 2 type | RET2 | CMLP | RET |

Blank Page

Revision Information

- Title : Model UT750 Digital Indicating Controller User's Manual for Dual-loop Control
- Manual No. : IM 05D01B02-51E

May 2000/1st Edition
Newly published

Written by Products Documents
Controllers & Conditioners Division
Yokogawa M&C Corporation
Published by Yokogawa M&C Corporation
1-19-18 Nakacho, Musashino-shi, Tokyo 180-0006, JAPAN

Blank Page