

UltraFlo® 4000 SERIES

Ultrasonic Flow Meter

Operating Manual



Table of Contents

| | |
|----------------------------------------------------------|----|
| Safety Information | 03 |
| Technological Progress | 03 |
| Product Description | 03 |
| Features | 04 |
| Measuring Principle | 04 |
| Operational Safety | 04 |
| Technical Specifications | 05 |
| Installation Instructions | 06 |
| Assembly of the Flowmeter | 07 |
| Electrical Wiring | 09 |
| Commissioning | 11 |
| Display and User Menu | 12 |
| Menu Organization for 5-Pin Version | 13 |
| Menu Organization for 8-Pin Version | 14 |
| Functionalities of flow meter and default settings | 15 |
| Exchange of Measuring Device | 21 |
| Behavior of the Temperature Sensor | 22 |
| Possible Error Text | 23 |
| Dimensions and Weight | 23 |
| Warranty, Returns and Limitations | 24 |



Corrosion-Free
Instrumentation Equipment

Safety Information

Please always observe the following safety instructions!

Please pay attention to the safety instructions with the following pictograms and signal words in these operating instructions :



Warning | Caution | Danger

indicates general hazardous situations or cases which, if not avoided, could result in serious injury or death.



IMPORTANT!

indicates situations or cases which, if not avoided, could result in damage or failure of the **UltraFlo®** equipment.

Notice : Is used to lead users to helpful information not related to personal injury.

Intended Use

- ❑ The flow meter **UltraFlo®** should only be used for measuring the flow of pure, homogeneous liquids.
- ❑ The **UltraFlo®** is not intended for use in medical applications.
- ❑ The volume flow meter **UltraFlo®** is built in accordance with industry standard EN 61010 regulations (corresponds to VDE 0411 "Safety specifications for electrical measurement, control and laboratory devices").
- ❑ The manufacturer is not liable for any injury, damage or harm due to inappropriate or unintended use or modifications of the flow meter. Conversions and/or changes to the flow meter may only be made, if they are expressly performed in accordance with the operating instructions in this operating manual.

Personnel for Installation, Commissioning and Operation



- ❑ Assembly, electrical installation, commissioning and maintenance of the flow meter must be carried out by qualified, trained personnel. The qualified personnel must have read and understood the operating instructions in this operating manual and must follow the operating instructions in this manual.
- ❑ The installer has to ensure that the flow meter is correctly connected according to the electrical connection diagrams in this operating manual.
- ❑ Serious injury or death from electric shock may occur if wiring, installation, disassembly or removal of wires is performed while electrical power is energized

Technological Progress

The manufacturer reserves the right to revise, alter, or modify the flow meter to the most current technology without special prior notice. Further information about the latest updates and potential additions to these operating instructions are available from www.iconprocon.com

Product Description

The **UltraFlo® 4000** Flow Meter utilizes ultrasonic technology to measure both conductive and non conductive liquids, and is an excellent choice for very corrosive liquids such as strong acids and alkalies.

The **UltraFlo® 4000** has no moving parts and can measure pulsating, dosing and metering flow applications. All parts that contact the liquid are made of corrosion resistant Polysulfone.

The **UltraFlo® 4000** is characterized by its high measurement accuracy, repeatability and guaranteed long-life performance.

Features

- ❑ All Plastic Polysulfone Wetted Materials
- ❑ High Accuracy: ± 1.0%
- ❑ M12 Quick Disconnect
- ❑ Superior Corrosion Resistance
- ❑ 4-20mA + Pulse Relay Output | RS-485
- ❑ Negligible Pressure Drop
- ❑ Empty Pipe Alarm
- ❑ Air Bubble Detection



Measuring Principle

The ultrasonic flow measurement is based on the phase-difference approach:
 Two ultrasonic-sensors located opposite from each other alternatively transmitting and receiving ultrasonic signals. If there is no liquid flow both sensors receive the transmitted ultrasonic signals in the same phase, i.e. without phase difference. If liquid is flowing there is a phase shift. It differs when measured in direction of the flow than when measured against the direction of the flow. This phase difference is directly proportional to the flow rate.

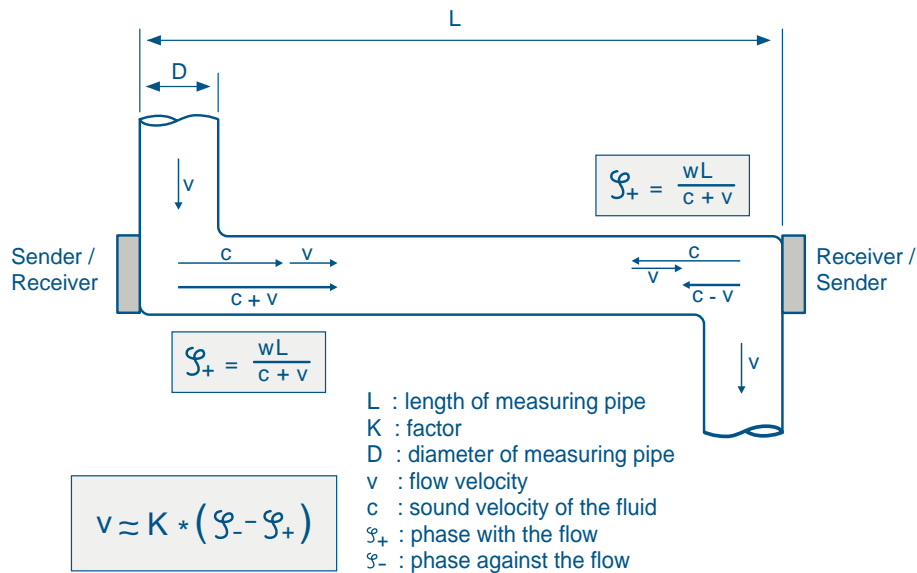

Fig. 1: Presentation of the principle of ultrasonic flow measuring

Operational Safety

- ❑ Comprehensive self-tests ensure highest possible safety.
- ❑ Faults (process or system errors) are output on a digital output or displayed on the display menu.
- ❑ The protection class is IP 67.
- ❑ Flowmeter meets the general EMC immunity requirements according to CE, EN 61000-6-3, EN 61000-4-2, EN 61000-4-3, EN 61000-4-4, EN 61000-4-5, EN 61000-4-6.
- ❑ Flowmeter meets the safety requirements concerning the Protective Extra Low Voltage directive according to EN 50178, SELV, PELV.

Technical Specifications

| General | | | | |
|--------------------------------|------------------------------------------------------------------------------------------------------------------------------------------------------------------------------------|-----------------------|-----------------------|----------------------|
| Material | Polysulfone | | | |
| Protection Class | IP67 NEMA 4X | | | |
| Medium Temperature | 14 -176°F -10°- 80°C | | | |
| Measuring Range GPM LPM | 0.08 – 5.5 0.3 - 21 | 0.02 – 9.5 0.9 - 36 | 0.9 – 15.8 3.5 - 60 | 1.3 – 63.4 5 - 240 |
| Max. Pressure Non-Shock | 145 psi 10 bar | 145 psi 10 bar | 145 psi 10 bar | 145 psi 10 bar |
| Process Connection | | | | |
| Outside Thread | ½" | ¾" | 1" | 1¼" |
| Weight lbs | 1.0 | 1.0 | 1.3 | 1.3 |
| Electrical | | | | |
| Power Input | 24VDC 3.6W | | | |
| Power Supply | 18-30VDC | | | |
| Connection | plug 5 pins, plug 8 pins, 10-wire Teflon cable (5m) | | | |
| Output | | | | |
| Output | 4-20mA + Pulse Relay RS-485 | | | |
| Ambient Temperature | -20....+60°C | | | |
| Storage Temperature | -20....+70°C | | | |
| Current output QA | 0/4...20 mA Lower- and upper limit adjustable, Ground connected to supply ground Error Signal according to NAMUR NE43 | | | |
| Digital output Q1/2 | via transistor npn- and pnp-logic max. 30V/100mA output voltage according to DIN 19240: ≤ 5V means LOW ≥ 12V means HIGH Short cut resistant Frequency 0....10kHz | | | |
| Data Interface | Data Interface for Parameterize | | | |
| Measuring Deviation | ± 2% of reading ± 3 mm/s Option: ± 1% of reading ± 3 mm/s Reference conditions (VDE/VDI 2642) | | | |
| Repeatability | 0.5% | | | |
| Display | | | | |
| LCD Display | Simultaneous Display of volume Flow, Quantity, bar graph, lighted | | | |
| Standards and Approvals | | | | |
| CE FCC RoHS Compliant | | | | |

Installation Instructions

Note : The housing of UltraFlo is labeled with an arrow symbolizing the direction of the flow measurement. The flow meter has to be installed in a way so that the flowthrough is in the same direction as the arrow symbol.

The housing of Flowmeter is labeled with an arrow symbolizing the direction of the flow. The flowmeter must be installed in direction of the flow.

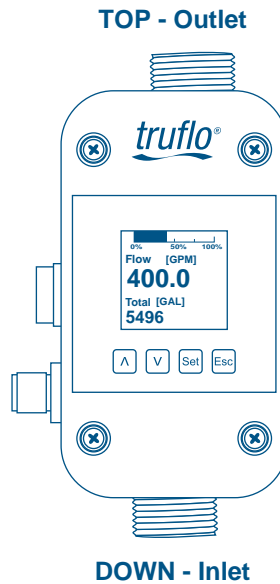

Fig. 2: Installation position of Flowmeter

Note : For fastest possible bubble detection it is important to keep the pipe distance to UltraFlo as short as possible. Accurate measurement can only be assured, if the pipe is completely filled and the liquid does not outgas. Notwithstanding it may be advantageous for dosing applications to install. The UltraFlo as close as possible to the dosing equipment. Particles present in the flow stream may result in measuring errors.

When using pumps, UltraFlo must be installed in flow direction on the pressure side, on order to ensure sufficient pressure.

! Do not exceed the maximum pressure allowance for of the Flowmeter (see Technical specifications - Page-5). Exceed the maximum pressure can lead to destruction of the Flowmeter.

For correct volume flow measurements straight and unobstructed inflow and outflow distances have to be observed. Starting from the connection thread these have to be at least:

| Nominal Diameter | DN7 3/8" | DN10 1/2" | DN15 3/4" | DN20 1" |
|------------------|-----------|-----------|-------------|-------------|
| Inflow Distance | 5 cm 2.0" | 5 cm 2.0" | 40 cm 15.8" | 60 cm 23.6" |
| Outflow Distance | 0 cm 0.0" | 0 cm 0.0" | 20 cm 7.9" | 20 cm 7.9" |

i Always make sure that the maximum torque of the nuts for the hydraulic connections is not exceeded. Use the delivered seals and the maximum torque depending on the diameter:

| Nominal Diameter | DN7 3/8" | DN10 1/2" | DN15 3/4" | DN20 1" |
|------------------|----------------|----------------|----------------|----------------|
| Inflow Distance | 2Nm 1.5 ft-lbs | 3Nm 2.2 ft-lbs | 4Nm 3.0 ft-lbs | 6Nm 4.4 ft-lbs |

i Due to the material characteristics of PSU UltraFlo has a limited resistance against UV rays.

Assembly of the Flowmeter

Note : The flow meter is mounted into a pipe system by using the mechanical connection. UltraFlo should be mounted vertically into the pipe for the best measuring performance. Do not install the flow meter after a dosing valve where the flow meter can run empty. Placing the flow meter after a dosing valve and allowing it to run empty will cause a measuring deviation at the next measurement. To avoid bubbles in the liquid, UltraFlo should be installed on the pressure side of the pump.

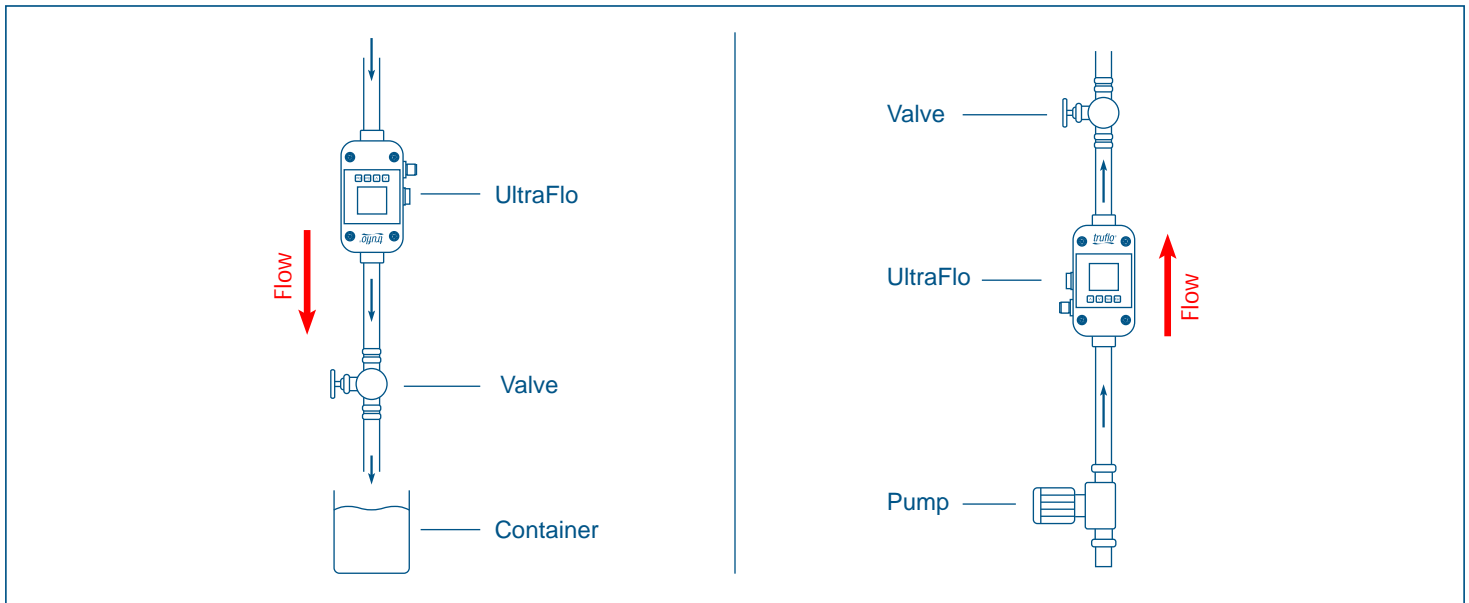

Fig. 3: Mounting examples for UltraFlo

If it is not possible to mount the flow meter vertically, then mount the instrument in a location where the pipe will be filled at all times. The best measuring result is achieved if bubbles do not pass through UltraFlo® 4000 Series.

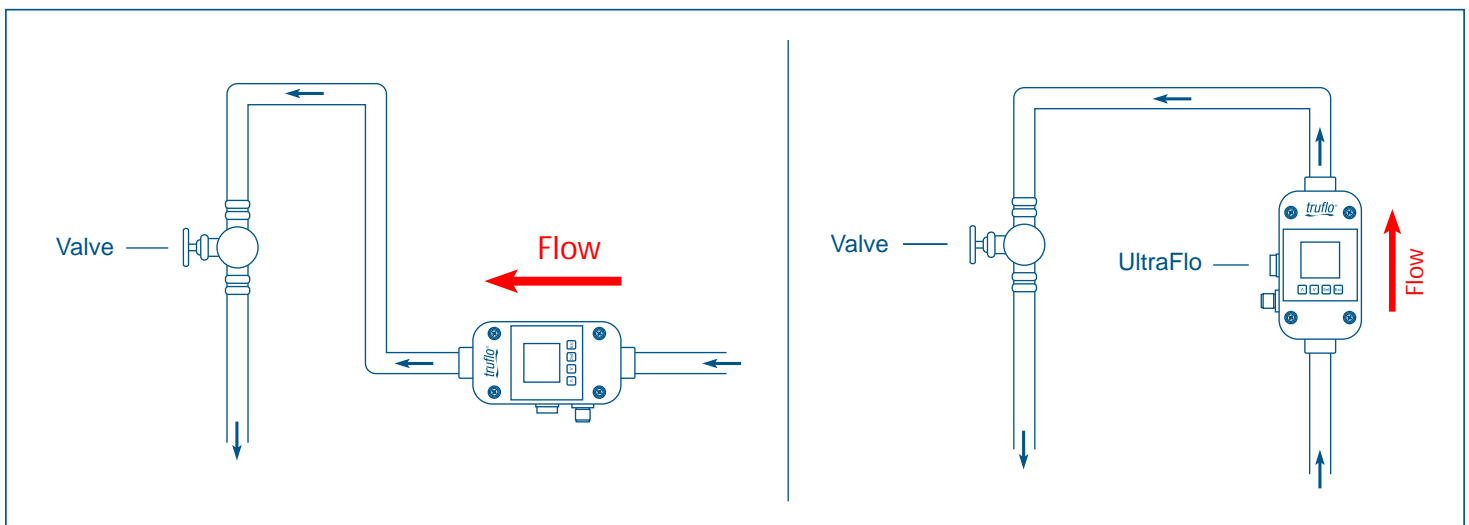

Fig. 4: Mounting possibilities

For applications with a “clean design” for which it is necessary to completely drain the pipe system, we recommend mounting the flow meter in the vertical position. Residual liquid may remain inside the device if flow meter is mounted horizontally.

Vibrations or mechanical forces may decrease measuring accuracy. Mounting the flow meter using two clamps will reduce vibrations or movements. Use the clamps as seen in the figure below at the inlet and outlet connections of UltraFlo® 4000 Series.

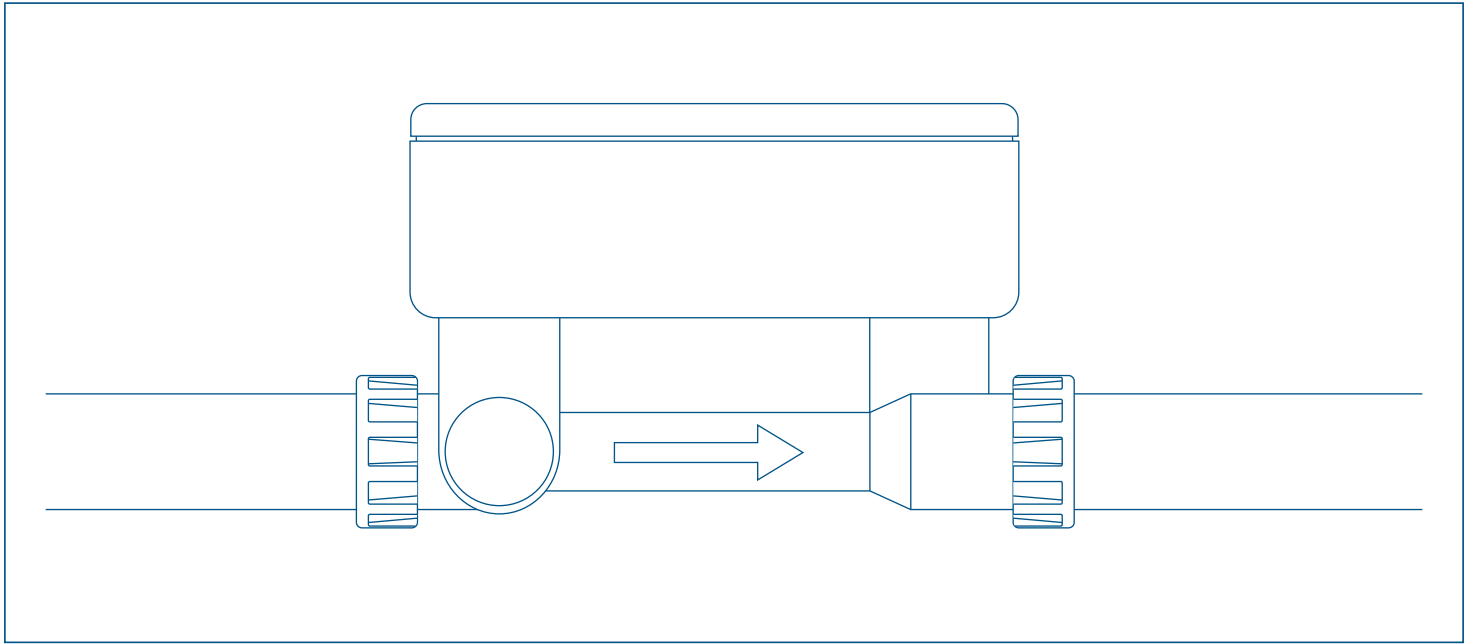

Fig. 5: Mounting the UltraFlo

UltraFlo must be installed without mechanical tensions on the existing pipe system. The flow meter may be damaged if there is tension on the existing pipe system. Set the axial channel offset to 5mm when mounting the flow meter (For details see section 5.1 Dimensions and weight on page 22 / latter F).



Non-compliance of the installation instructions may result in tearing of the housing, liquid may leak out.

Applications with Hot Liquids



If UltraFlo is used in applications with liquid temperatures hotter than 60°C and mounted horizontally then the flow meter should be mounted with the electronic housing on the underside to reduce exposure to rising heat. If UltraFlo is mounted vertically, heat damage is not an issue.

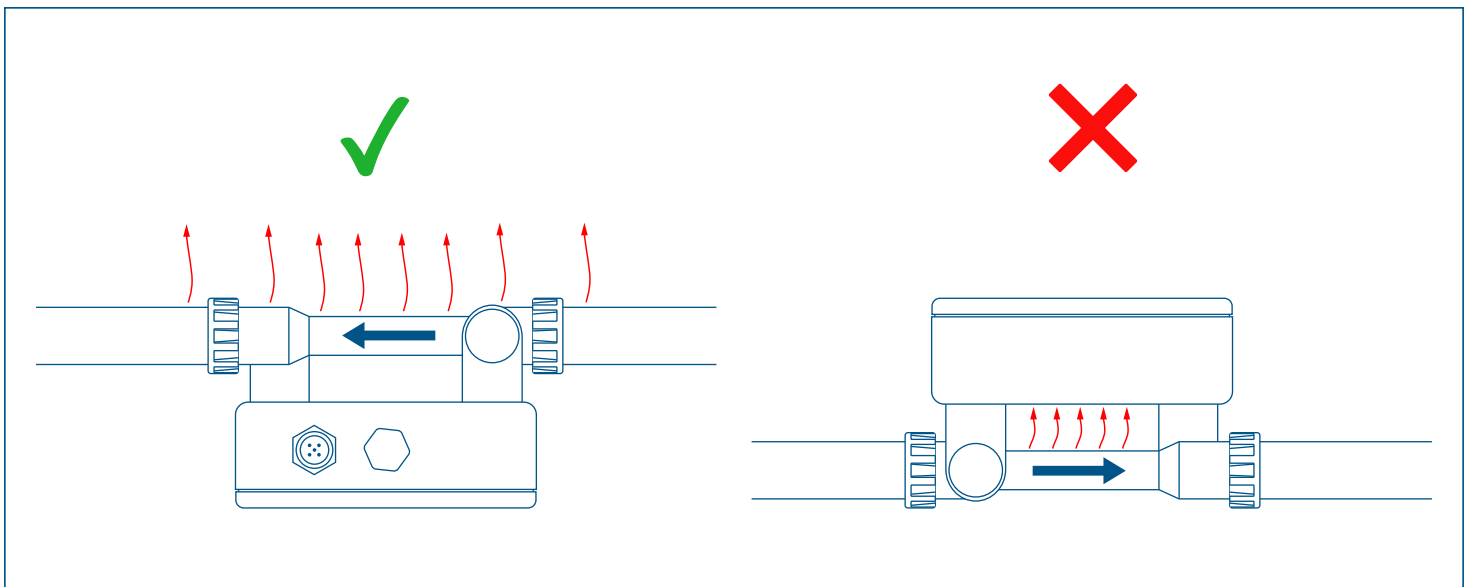

Fig. 6: UltraFlo with Hot Liquids

Electrical Wiring

Serious injury or death from electric shock may occur if wiring, installation, disassembly or remove of wires is performed while electrical power is energized.

 Always shut off or disconnect electrical power at service panel and lock switch or breaker and tag to prevent energizing electrical power during work or while Flowmeter is not assembled and installed.

Wiring installation, disassembly and removal must be performed by qualified persons experienced and knowledgeable about electrical work.

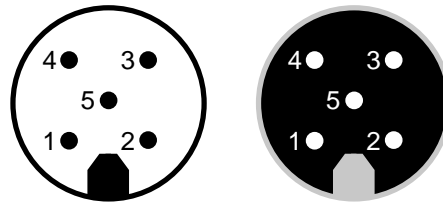



Fig. 7: Pin code: Connection plug / Socket for 5-pin version

Connector cable pin configuration defined by manufacturer The outlets may be re-programmed for specific applications

| Pin | Function | Description |
|-----|--------------------------------|-----------------------------------------------------------------------------------------------------------------------------------------------------------------------------------------|
| 1 | L+ | Power supply : 18...30 VDC |
| 2 | Pulse output O1 alternative: | Digital Output Q1 Freely adjustable ranging from 0.1 to 3000 ml/pulse in 0.1 ml/pulse steps, npn-Transistor, max. load 30V/100mA. Max. Voltage must be less than the supply voltage. |
| | 1. Empty pipe output | Configurable output of 0V or 24V when pipe is empty. |
| | 2. Dosing output | Configurable output of 0V or 24V |
| | 3. Upper or Lower Limit output | Configurable output of 0V or 24V when reaching upper or lower limit |
| | 4. Negative flow | Configurable output of 0V or 24V when liquid flows in negative direction |
| 3 | GND | Ground : 0 V |
| 4 | Communication | Communication interface |
| 5 | Analog output QA | 4-20mA ; 0-20mA Example: 0L/min => 4mA 60L/min => 20mA Empty pipe Alert => 3.5mA (4-20mA depending on the configured limits) |

 **Attention :** Only operate the flowmeter within the operating limits stipulated on the product label and the operating manual / data sheet. Use outside these conditions lead to overloads which cause permanent damage.

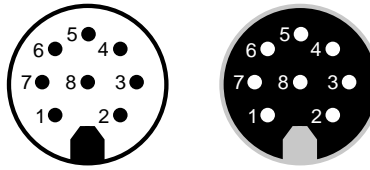

Fig. 8: Pin code: Connection plug / socket for 8-pin version

Connector cable pin configuration defined by manufacturer
The outlets may be re-programmed for specific applications.

| Pin | Function | Description |
|-----|--------------------------------|-----------------------------------------------------------------------------------------------------------------------------------------------------------------------------------------|
| 1 | L+ | Power supply : 18...30 VDC |
| 2 | Pulse output O1 alternative: | Digital Output Q1 Freely adjustable ranging from 0.1 to 3000 ml/pulse in 0.1 ml/pulse steps, npn-Transistor, max. load 30V/100mA. Max. Voltage must be less than the supply voltage. |
| | 1. Empty pipe output | Configurable output of 0V or 24V when pipe is empty. |
| | 2. Dosing output | Configurable output of 0V or 24V |
| | 3. Upper or Lower Limit output | Freely adjustable ranging from 0.1 to 3000 ml/pulse in 0.1 ml/pulse steps. |
| | 4. Negative flow | Configurable output of 0V or 24V when flow reaches upper or lower limit. |
| 3 | GND | Ground : 0 V |
| 4 | Digital output Q2 Functions: | Digital output Q2 Configurable npn- or pnp-Transistor, max. Load 30V/ 100mA. Max. Voltage must be less than the supply voltage. |
| | 1. Empty pipe output | Configurable output of 0V or 24V when pipe is empty. |
| | 2. Dosing output | Configurable output of 0V or 24V |
| | 3. Pulse output | Freely adjustable ranging from 0.1 to 3000 ml/pulse in 0.1 ml/pulse steps. |
| | 4. Upper or Lower Limit output | Configurable output of 0V or 24V when flow reaches upper or lower limit. |
| | 5. Negative flow | Configurable output of 0V or 24V when liquid flows in negative direction. |
| 5 | Analog output QA | 4-20mA ; 0-20mA Example: 0L/min => 4mA 60L/min => 20mA Empty pipe Alert => 3.5mA (4-20mA depending on the configured limits) |
| 6 | Communication | Communication Interface |
| 7 | Digital input I1 | Digital input I1 |
| | 1. Dosing output | Starts the dosage by a rising edge of 24V. |
| | 2. Set offset | The Offset is set by a rising edge of 24V. |
| | 3. Reset counter | Reset of the counter by a rising edge of 24V. |
| | 4. Creeping flow off | Creeping suppression is deactivated as long as there are 24V at the input. |
| 8 | Shielding | EMC safety |

i Attention : Only operate the flowmeter within the operating limits stipulated on the product label and the operating manual / data sheet. Use outside these conditions lead to overloads which cause permanent damage.

Commissioning

NOTE : If Flowmeter is used for a fluid other than water the "basic trim" has to be carried out during commissioning. Therefore the device has absolutely be filled with medium.

The basic trim can be done on the device display (alternatively Programmtool). During the adjustment the medium may not flow as it affects the function

Operation

If Flowmeter is used as volume flowmeter for water or water-like liquids, it will not require on-site calibration. Parameters for water are calibrated at the factory. Notwithstanding the Flowmeter may also be supplied with customized settings. The coordination must be done at time of purchase order.

NOTE : If necessary, e.g. if viscosity and/or speed of sound deviate significantly from water, the pre-set parameters can be adjusted via Programmtool. It is always necessary to adjust the manufacturer pre-set parameters when using the Flowmeter as a dosing device according to section 3.2 (Dosing 1. Flowmeter as a dosing device). Adjusting the manufacturer pre-set parameters requires Programmtool.

The following parameters may be changed to settings suitable for the individual conditions: for 5-pin version

- ❑ Digital output Q1, function and behavior
- ❑ Analog output QA, function and behavior
- ❑ Flow range, for which shall apply 4...20 mA
- ❑ Pulse value
- ❑ Creeping suppression
- ❑ Optimization of measurement curve with up to 8 interpolation values (medium matrix)

The following parameters may be changed to settings suitable for the individual conditions: for 8-pin version

- ❑ Digital output Q1, function and behavior
- ❑ Digital output Q2, function and behavior
- ❑ Digital input I1, function and behavior
- ❑ Analog output QA, function and behavior
- ❑ Flow range, for which shall apply 4...20 mA
- ❑ Pulse value
- ❑ Creeping suppression
- ❑ Optimization of measurement curve with up to 8 interpolation values (medium matrix)

Also reference the UltraFlo® operating instructions

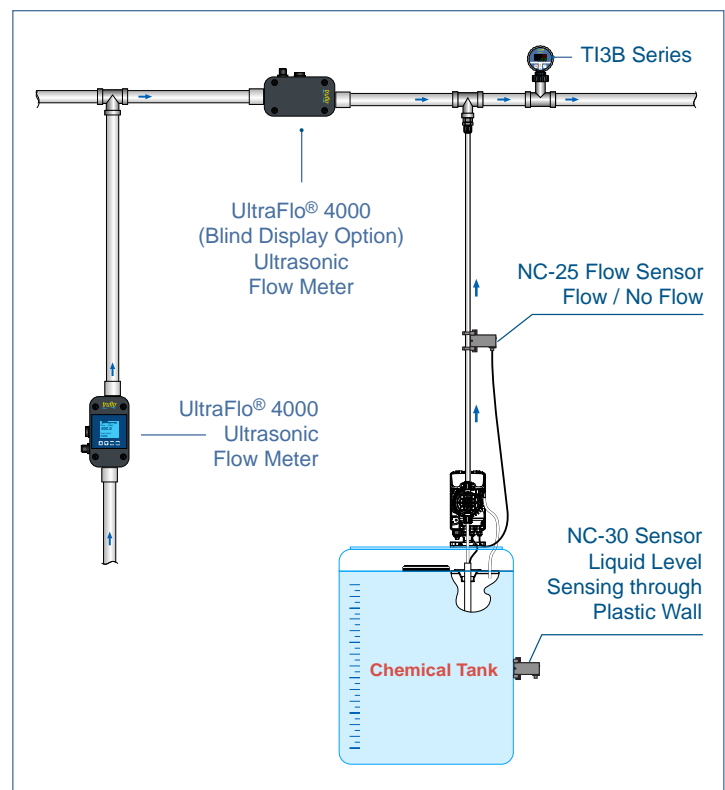

Display and User Menu

Flowmeter is equipped with a display to visualize actual measurement values and to change parameters of the flow meter. Menu navigation and parameter changes are controlled by the four keys on the keypad.

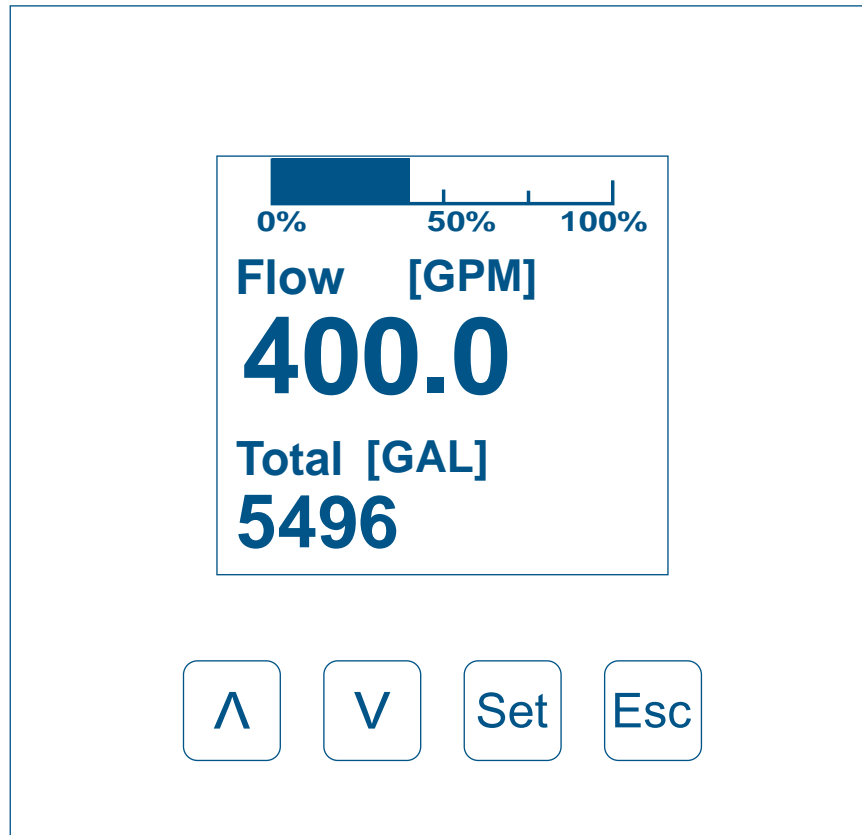







Fig. 9: Operating with the key pad

Press the **[Set]**  key to display the main menu. Different menu options can be selected by using the two arrow keys.

To enter e.g. analog limits "Analog output - Upper limit" use the arrow  or  keys to change values and press **[Set]**  key to confirm. To switch back to the last menu level press the **[Esc]**  key. As soon as the operator tries to change values the user will be prompted to enter a password. Password protection is used to ensure changes to values or configurations are done by authorized personnel.

The default password for Flowmeter is **41414**. The password can be changed with Programmtool. The user level will remain active for 5 minutes after the last press on any button.

 **The Password should only be shared with personnel authorized to make changes to setting.**

NOTE : Always the first parameter of the menu appears in the display. This need not be the adjusted enabled parameter. The enabled parameter appears inverted and possibly visible by scrolling.

NOTE : Functions marked with asterisk (*) are only available for the Flowmeter 8-pin version. Flowmeter without user display supports the same functions as the display-version. The display and programming unit Programmtool is needed to change configurations of Flowmeter without user display.

Menu Organization for 5-Pin Version

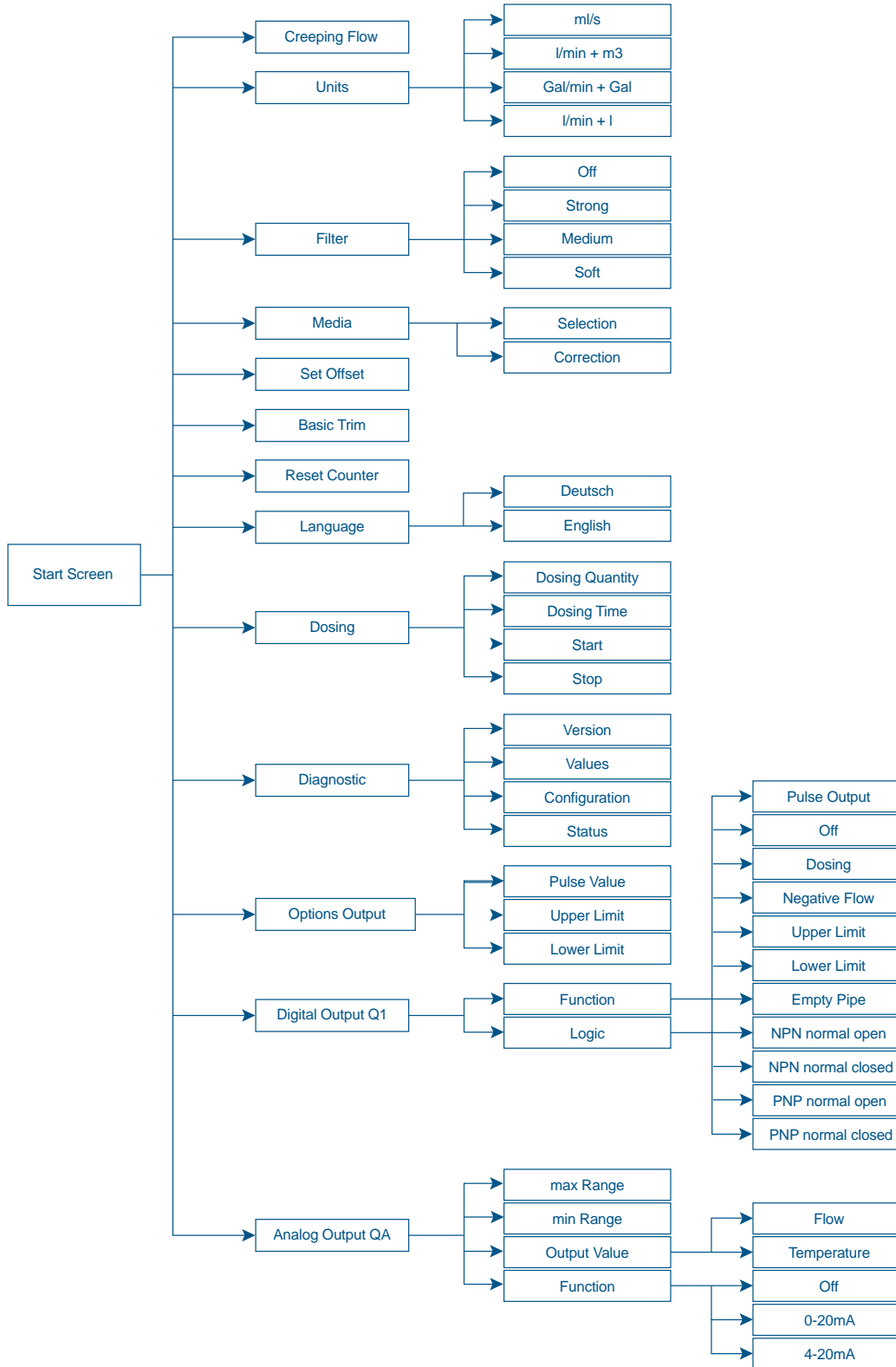

Menu Organization for 8-Pin Version

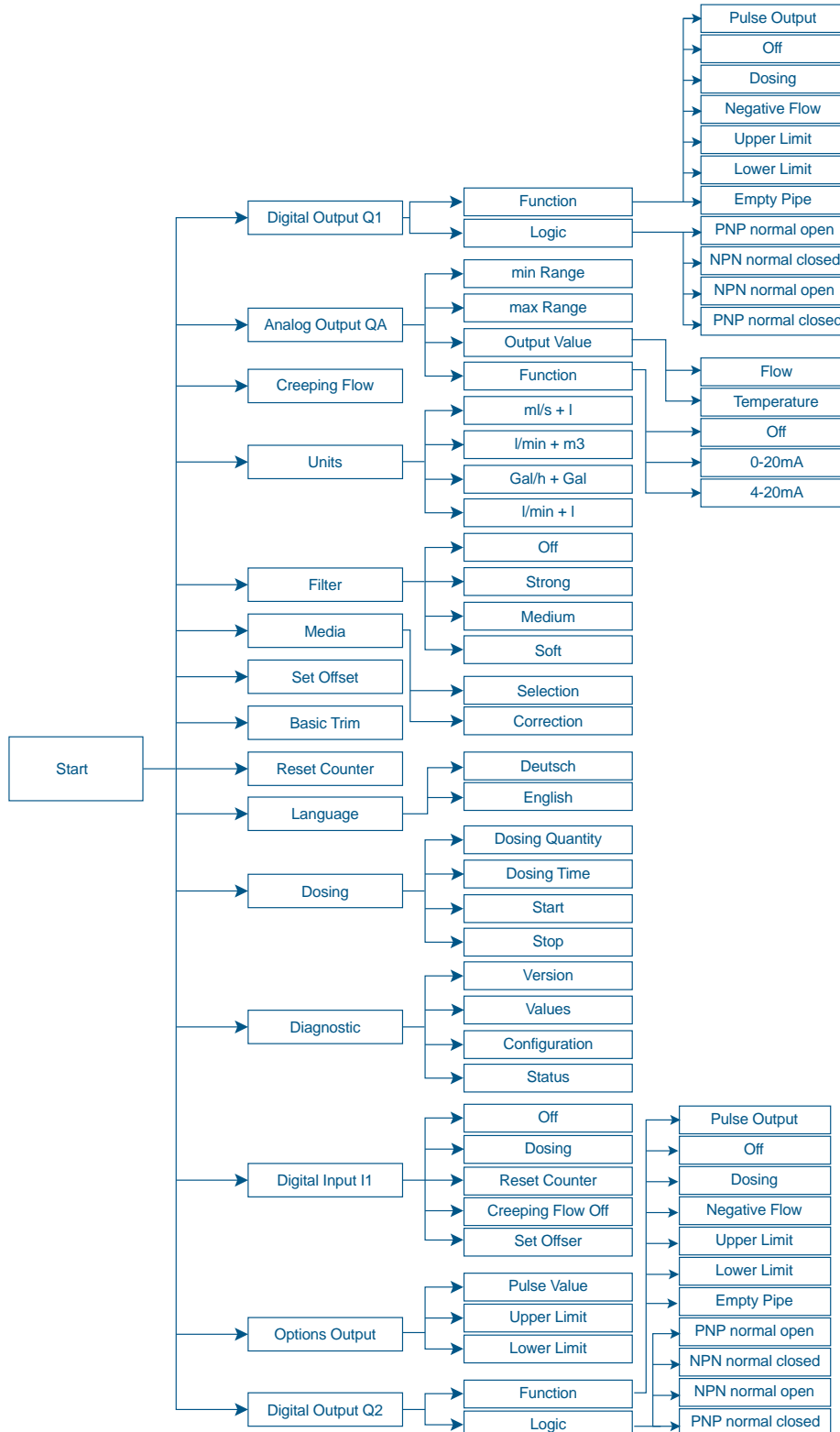

Functionalities of flow meter and default settings

Set Offset

In the sub menu “Set Offset” it is possible to set the actual offset of the flow meter. Use this function only when UltraFlo is completely filled with liquid, and there is no flow. If the offset is set while flow is present or when the pipe is empty it will cause an offset drift what results in a faulty measurement.

A small offset change, e.g. caused by variable temperatures, is automatically done by the flow meter. It is also possible to set the offset via the configurable digital inputs.

Language

The language of the display can be changed. Available languages are English and German.

Filter

The function “Filter” averages the analog output signal. Possible settings: Soft, Medium, Strong, Off. The analog output signal reacts faster to signal changes when average determination is set to “soft”. Whereas the analog output signal reacts slower when average determination is set to “strong”.

Units

UltraFlo is able to show actual flow or the volume in different units. Following units can be selected: ml/s + l , Gal/min +Gal , l/min + l , l/min + m³.

The first letters correspond to the unit of the flow value. The letters after the + correspond to the unit of the volume value.

Reset Counter

The volume counter of UltraFlo can be reset.

 **Important!** : Once reset, counter values cannot be restored. After a reset the counter works normally.

Basic Trim

NOTE : The “Basic Trim” function insures that the flow meter is conforming to the media specific characteristics. To execute this function, UltraFlo runs a selfdiagnostic function which optimizes all important parameters. This process lasts approximately 1 minute.

 **Important!** : To make sure the basic trim is correctly done, the flow meter has to be filled with liquid without a flow.
When there is an error detected while performing the basic trim function, the display shows “Error”. After successfully finishing the basic trim function, the display will show “Done”.

Digital Outputs

All outputs switch over to high resistance when the supply is smaller than 18V. When overload or short circuit is detected the digital outputs are switched off after 100µs for a period of 2s. When time is up the outputs get applied again.

| Empty Pipe Output | | |
|-------------------|----------------|-----------------|
| | Empty Pipe | Filled, No Flow |
| 0V Normal Closed | High resistant | 0V |
| 0V Normal Open | 0V | High resistant |
| 24V Normal Closed | High resistant | 24V |
| 24V Normal Open | 24V | High resistant |

| Pulse Output | | | |
|--------------------|-------------------|--------------------|---------------------|
| | Empty Pipe | Filled, No Flow | Filled, Flow |
| 0V Normal Closed | 0V | 0V | 0V Pulses |
| 0V Normal Open | 0V | 0V | 0V Pulses |
| 24V Normal Closed | High Resistance | High Resistance | 24V Pulses |
| 24V Normal Open | High Resistance | High Resistance | 24V Pulses |
| Upper Limit Output | | | |
| | Below Lower Limit | Between the Limits | Above Upper Limit |
| 0V Normal Closed | High resistance | High resistance | 0V |
| 0V Normal Open | 0V | 0V | High resistance |
| 24V Normal Closed | High Resistance | High Resistance | 24V |
| 24V Normal Open | 24V | 0V | High resistance |
| Lower Limit Output | | | |
| | Below Lower Limit | Between the Limits | Above Upper Limit |
| 0V Normal Closed | 0V | High Resistance | High Resistance |
| 0V Normal Open | High Resistance | 0V | 0V |
| 24V Normal Closed | 24V | High Resistance | High Resistance |
| 24V Normal Open | High Resistance | 24V | 24V |
| Dosing Output | | | |
| | Startup of Device | While Dosing | Before/After Dosing |
| 0V Normal Closed | High Resistance | High Resistance | 0V |
| 0V Normal Open | High Resistance | 0V | High Resistance |
| 24V Normal Closed | High Resistance | High Resistance | 24V |
| 24V Normal Open | High Resistance | 24V | High Resistance |



Important! When using the dosing function the output should not be configured as normal closed!
If the dosing output is configured as normal closed the valve will stay open after the

□ Digital output Q1

Digital output Q1 may be used as pulse output, empty pipe detection, for switching dosing valve or limit control. By using Programtool the user can switch between npn and pnp-transistor logic. In case of inductive load a diode has to be connected parallel to the coil.

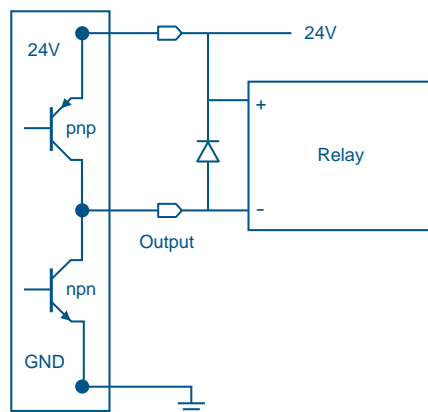

Fig. 5: Connecting Output Q1 to Relay

Setting area : off, pulse output, empty pipe, dosing output, lower limit, upper limit, negative flow

❑ Digital output Q2*

Digital outputs 2 may be used as pulse output, empty pipe detection, for switching dosing valve, limit control or flow direction control. See Page- 7 **Electrical Wiring** table connection

The **npn** or **pnp** logic can be selected. When the output is connected to an inductive consumer a diode has to be installed parallel to the load.

Flowmeter via pnp, external counter e.g. PLC

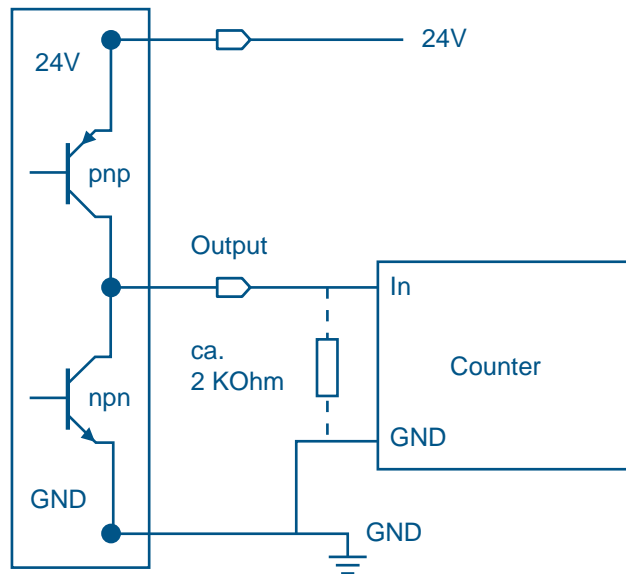

Fig. 6: Connecting Output Q2 to counter

Setting area : off, pulse output, empty pipe, dosing output, lower limit, upper limit, negative flow

i Important! Inductive load on the digital outputs without an installed diode may cause damage on the Flowmeter electronics. dosing batch.

Dosing Function

Dosing can be determined in different ways :

1. Flowmeter as dosing device (dosing control via Flowmeter)

Flowmeter controls the complete dosing function. The dosing quantity (e.g. 400 ml) is pre-set in the Flowmeter via Programmtool. Dosing starts, as soon as line start of dosing is wired to 24 V, e.g. via a pushbutton. Flowmeter will now open the dosing valve via the output configured for it. When the pre-set dosing quantity is reached, the dosing valve is closed via the above output. The second output can be used independently for signalling empty pipe, limit control, pulse output or signalling negative flow.

2. Flowmeter as flowmeter (dosing control via dosing equipment)

The dosing equipment controls the entire dosing function. The dosing quantity is fixed in the dosing equipment control during commissioning by pre-selecting the meter pulses. Dosing starts, when the relevant pushbutton of the dosing equipment is pushed. The control will now open the dosing valve. From now on Flowmeter will send a voltage pulse to the control for each volume unit that has flown through (e.g. per 1ml). When the pre-selected pulse quantity is reached, the control closes the dosing valve. In this case, output 1 is used to send out pulses, output 2 is independently usable for empty pipe detection, limit control or signalling negative flow.

⚠ The customer has to provide an emergency stop and an overfilling stop to prevent hazardous situations. Both functions must perform safety shut down of pumps and WARNING! closing of valves.

❑ Pulse value

This section determines the output settings for pulsed outputs.

Choose configuration such as to neither exceed the maximum output frequency of the Flowmeter (10kHz) nor the maximum input frequency of the control. If the maximum frequency is exceeded the Flowmeter will not output pulses correctly.

| | |
|------------------------|----------------------------------------------|
| Example | 2.0 ml/Pulse |
| This Means | a pulse is emitted every 2.0 ml. |
| Setting Range | 0.1...3000.0 ml/Pulse, in 0.1 ml/Pulse steps |
| Default Setting | 1.0 ml/Pulse |

| Flow | Pulse value | Frequency | Period | Duration of the Pulse | |
|------|-------------|-----------|--------|-----------------------|------|
| ml/s | ml/Pulse | Hz | s | s | ms |
| 1 | 1 | 1 | 1 | 0.5 | 500 |
| 100 | 1 | 100 | 0.01 | 0.005 | 5 |
| 1000 | 0.1 | 10000 | 0.0001 | 0.00005 | 0.05 |
| 100 | 10 | 10 | 0.1 | 0.05 | 50 |
| 0.5 | 10 | 0.05 | 20 | 1 | 50 |

In the last case every 20 seconds, a pulse of 1 second duration is put out.

Dosing

The Flowmeter can be configured for manually dosing by choosing the dosing function via the user display. The Volume "Dosing Batch" and the "Dosing Time" are freely adjustable. When the "Dosing Time" is set to zero, the timer control is inactive. A dosage can be started and stopped with the menu function keys "Start" and "Stop".

| | |
|---------------------------------------|------------------|
| Setting Range "Dosing Batch" | 0 - 3500 Liters |
| Setting Range "Dosing Time" | 0 -30000 Seconds |
| Default Setting "Dosing Batch" | 0 Liters |
| Default Setting "Dosing Time" | 3 Seconds |

 **Important!** If Dosing Time = 0 the time switch-off is inactive.

❑ Analog output QA

The analog output is available as current output 4-20mA or 0-20mA. This is selected with the purchase order. As standard it comes with current output 4-20mA. It can also be switched off by using Programmtool.

The current output ranges from 0 to 22.6mA measuring the flow rate or the condition of the flow measurement.

The values here signify for 4-20mA configuration

- ❑ 20 mA the upper limit of the relevant measurement
- ❑ 4 mA the lower limit of the relevant measurement
- ❑ 3.5 mA empty pipe

Upper and lower limit parameters can be set within the type-specific measurement of the device. By default zero flow is set at 4 mA and the maximum flow is set at 20 mA

| | |
|----------------------|---------------------|
| Setting range | 0-20mA, 4-20mA, off |
| Output value | Flow, Temperature |

 **Important!** When current output is used, the load must not be higher than 500 Ohm. A higher load prevents the device from providing the maximum current of 22.6mA

Characteristic Curves Analog Output

0 - 20mA

For the following graphic "min Range" is used for 0% and "max Range" is used for 100%.

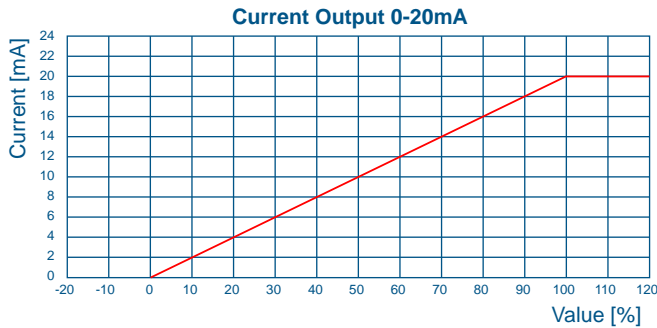

| Value | Current [mA] |
|---------------------|--------------------------------------|
| Smaller 0% | 0 |
| 0% (min Range) | 0 |
| Between 0% and 100% | Linear interpolation from 0 to 20 mA |
| 100% (max Range) | 20 |
| Bigger 100% | 20 |

4 - 20mA

For the following graphic "min Range" is used for 0% and "max Range" is used for 100%.

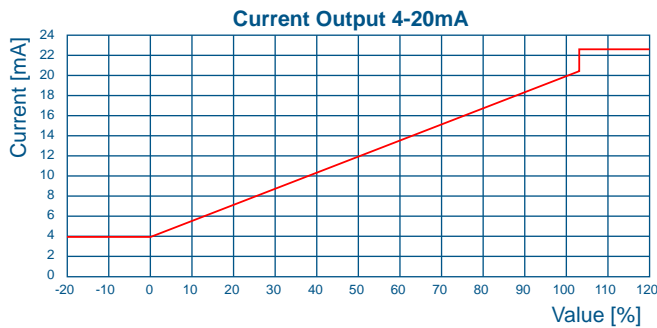

| Value | Current [mA] |
|-----------------------|----------------------------------------|
| Empty pipe | 3.5 |
| Smaller -1.2% | 3.8 |
| Between -1.2% and 0% | Linear interpolation from 3.8 to 4mA |
| 0% (min Range) | 4 |
| Between 0% and 100% | Linear interpolation from 4 to 20mA |
| 100% (max Range) | 20 |
| Between 100% and 103% | Linear interpolation from 20 to 20.5mA |
| Bigger 103% | 22.6 |

Filter options for Analog Output

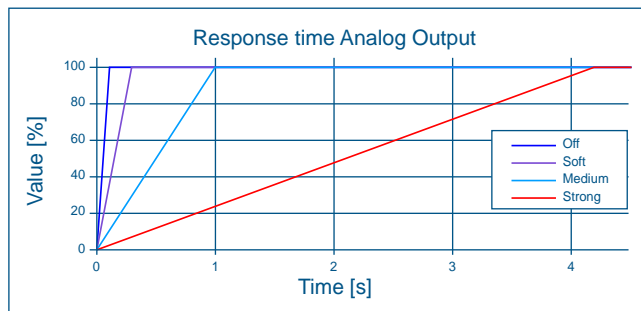

| | |
|--------|------|
| Filter | 100% |
| off | 16ms |
| soft | 0.3s |
| medium | 1s |
| strong | 4.2s |

Creeping Suppression

The creeping suppression excludes flow measurements that result from convection in a narrow band around zero, even with a closed valve. At the factory, the creeping suppression is set at a standard value in relation to the cross-section of the flowmeter.

There are higher tolerances below the Standard Default Settings.

- Setting range : 0.0...20 l/min, in 0.006 l/min steps
- Default settings : 0.09 l/min for DN7 / 3/8", LowFlow option 0.03l/min
- 0.3 l/min for DN10 / 1/2"
- 0.9 l/min for DN15 / 3/4"
- 1.2 l/min for DN20 / 1"

The Creeping Suppression Works with a Hysteresis of -25%.

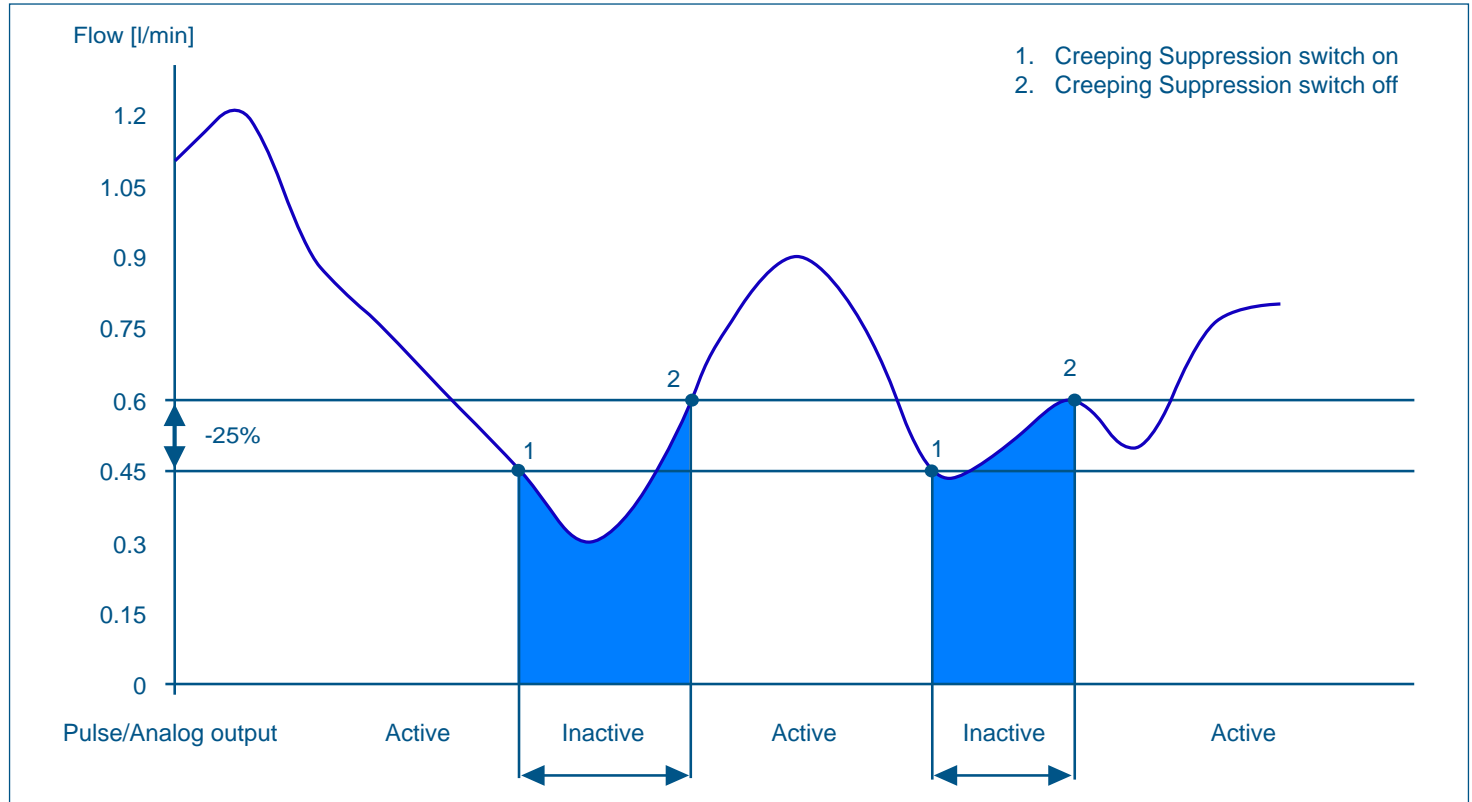

Fig. 7: Function of the creeping suppression illustrated with 0.6 l/min

Example : Creeping suppression = 0.6 l/min

If the flow rate is lower than 0.45 l/min the pulse output/analog output becomes inactive.

If the flow rate exceeds 0.6 l/min a pulse is output again and added to the totalizer.

Similarly, a value is transmitted to the analog output again.

Digital input

Flowmeter has a digital input that is programmable to following functions: dosing input, set offset, creeping suppression inactive and reset counter. In order to start a dosing process, 24V DC power is required. The status of the dosing parameters is modified with the Programmtool.

NOTE : The dosing input is locked so that a re-start is not possible during a running dosing process. After changing configurations via Programmtool a restart of the device is necessary to activate the doing input function.

Available Input Functions

| | Set offset | Creeping flow off | Dosing | Reset Counter | off |
|-------------------------------|--------------------------------------|------------------------------------------|----------------------------------------|--------------------------------------------|-----|
| 0V | - | - | - | - | - |
| 24V | Rising edge: 0->24V Set offset | State : deactivating creeping flow | Rising edge: 0->24V start dosing | Rising edge: 0->24 Vcounter is reset | - |
| Run only in stationary medium | | | | | |

The input function "Set Offset" may only be used when there is no flow through the meter. If an offset trim is done while liquid flow is present an offset drift will cause measurement deviations. If the Flowmeter shows an offset drift caused by a wrong offset setting, run the function "Set Offset" or "Basic Trim" again with filled flow meter and no present flow.

Overview of Default Settings

| Function | Default Settings |
|----------------------|--------------------------------------------------------------------------------------------------------|
| Digital output Q1 | Pulse output as 24V normal open |
| Digital output Q2* | Empty pipe detection as 24V normal open |
| Digital input | No function assigned |
| Analog output QA | Current output |
| Current output | 4-20mA |
| Measuring range | 20mA -> 6 l/min for 3/8" 24 l/min for 1/2" 60 l/min for 3/4" 120 l/min for 1" |
| Pulse value | 1 ml/pulse |
| Creeping suppression | 0.09 l/min for 3/8", 0.03l/min LowFlow 0.3 l/min for 1/2" 0.9 l/min for 3/4" 1.2 l/min for 1" |

General Information

Please check the following before powering the flowmeter for the first time:

- Check the electrical connections and cable allocations
- Check the installation position of the flowmeter. Are the direction of the arrow on the name plate and the actual flow direction in the pipe congruent?
- Is the measurement pipe completely filled with fluid?

When everything has been checked, switch on power. After 30 minutes with power running the measuring device reaches the maximum accuracy.

Now, Flowmeter is operational!

Exchange of Measuring Device

- Switch off power before disconnecting the electrical connections!
- Wiring installation, disassembly and removal must be performed by qualified persons experienced and knowledgeable about electrical work.
- Serious injury or death from electric shock may occur if wiring, installation, disassembly or remove of wires is performed while electrical power is energized
- Please note that after replacing the flowmeter



- a) the programming of the previous flowmeter should be saved and copied on the new flowmeter
- b) when using the dosing function, set a quantity

If the device requires a configuration change, the display and programming unit Programmtool is required.

Repair, Hazardous Substances

Before sending the flowmeter for repair, the following precautions must be taken:

⚠️ Clean all process chemicals from the device. Fully rinse the flow path. Please pay close attention to the process fittings. All media must be removed before returning. This is particularly important, if the medium to be measured is health hazardous.

Devices judged to be insufficiently cleaned will be returned to sender. No inspection of device will be done until proper cleaning is completed by user.

Costs due to inadequate cleaning of the instrument for possible disposal or injury (burns, etc.) will be charged to the sender of the meter into account.

⚠️ With the flowmeter send a detailed report describing the failure, the application and the physical-chemical properties of the medium parameters. (e.g. a decontamination declaration).

In order to be able to process your repair order quickly and smoothly it is important that you provide a technical contact person including phone and fax number as well as e-mail address.

Behavior of the Temperature Sensor

The integrated temperature sensor has no direct contact to the liquid and is used to calculate the expansion of the housing. The environment temperature greatly influences the actual temperature of the temperature sensor. The response time of temperature changes relates to the mounting position of the temperature sensor inside the housing.

Step-Response Time

Step-response time after a significant temperature change. (Filter "Off")

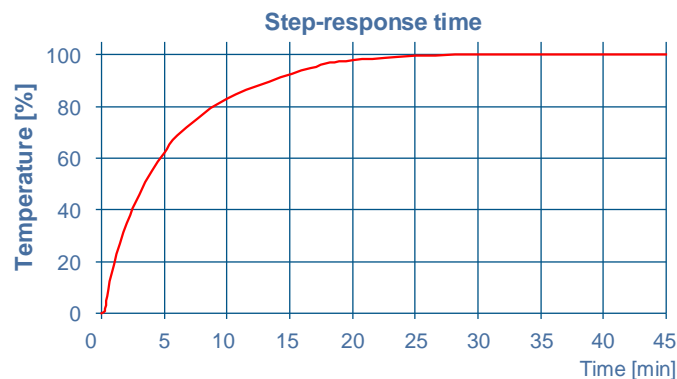

Filter Configurations for Temperature Sensor

| | |
|--------|------|
| Filter | 100% |
| Off | 1s |
| Soft | 16s |
| Medium | 1min |
| Strong | 4min |

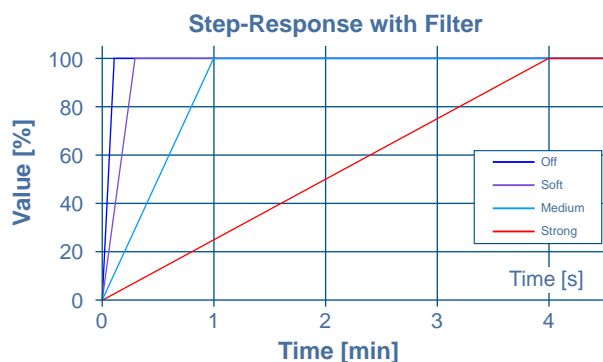

Influence of the environment temperature

In the table below some examples of the temperature influence are shown.

| Liquid Temp | X | 0.7 | + | Environment temp. | X | 0.3 | = | Measured Temp. |
|-------------|---|-----|---|-------------------|---|-----|---|----------------|
| 40 | X | 0.7 | + | 20°C | X | 0.3 | = | 34°C |
| 40 | X | 0.7 | + | 20°C | X | 0.3 | = | 37°C |
| 40 | X | 0.7 | + | 20°C | X | 0.3 | = | 40°C |
| 60 | X | 0.7 | + | 20°C | X | 0.3 | = | 48°C |

Possible Error Text

| Display text | Pulse value | Behavior |
|---------------|------------------------------------------------------------------------------------------------|-------------------------|
| Empty Pipe | When "Empty Pipe" is detected, no flow measurement | Display flashing + text |
| Low Voltage | When power supply is less than 18V the outputs are inactive. | Display flashing + text |
| Short Circuit | When over load of the digital outputs is detected (>100mA), outputs are inactive. | Only text |
| Lower Limit | When the flow is less than an adjustable limit and the output is configured for limit control. | Only text |
| Upper limit | When the flow is more than an adjustable limit and the output is configured for limit control. | Only text |
| Sonic Speed | Actual sonic speed out of specified value. Run basic trim! | Only text |

Dimensions & Weight

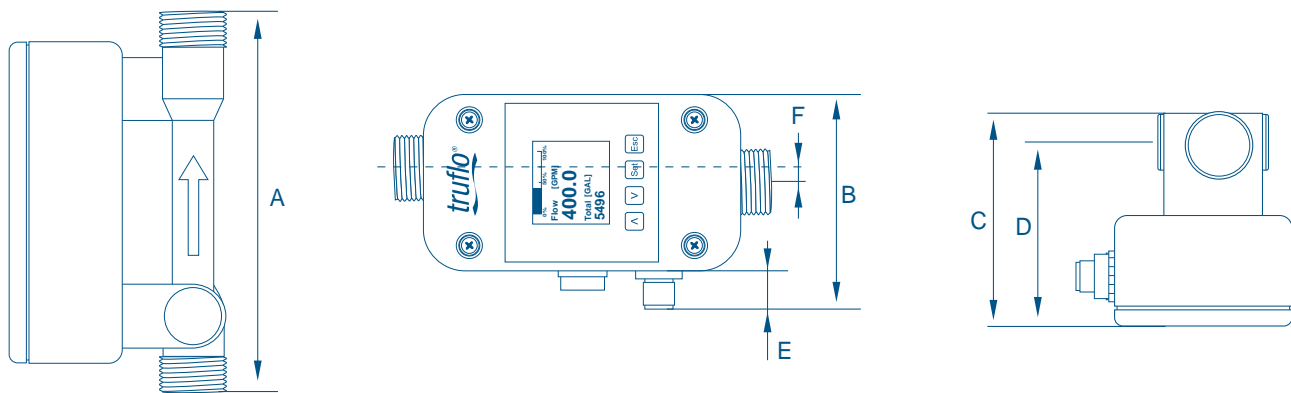

| Nominal Diameter | Connection | Lengths A [mm] | Widths B [mm] | Height C [mm] | Height axis D [mm] | Plug E [mm] | Parting line F [mm] | Weight [g] |
|------------------|--------------|----------------|---------------|---------------|--------------------|-------------|---------------------|------------|
| DN10 3/8" | 1/2" G,NPT | 147.0 | 84.0 | 83.0 | 70.5 | 15.0 | 5.0 | 332 |
| DN15 1/2" | 3/4" G,NPT | 147.0 | 84.0 | 84.5 | 71.1 | 15.0 | 5.0 | 344 |
| DN20 3/4" | 1" G,NPT | 160.0 | 84.0 | 94.2 | 77.6 | 15.0 | 5.0 | 414 |
| DN25 1" | 1 1/4" G,NPT | 160.0 | 84.0 | 98.5 | 77.6 | 15.0 | 5.0 | 332 |

Warranty, Returns and Limitations

Warranty

Icon Process Controls Ltd warrants to the original purchaser of its products that such products will be free from defects in material and workmanship under normal use and service in accordance with instructions furnished by Icon Process Controls Ltd for a period of one year from the date of sale of such products. **Icon Process Controls Ltd** obligation under this warranty is solely and exclusively limited to the repair or replacement, at **Icon Process Controls Ltd** option, of the products or components, which **Icon Process Controls Ltd** examination determines to its satisfaction to be defective in material or workmanship within the warranty period. Icon Process Controls Ltd must be notified pursuant to the instructions below of any claim under this warranty within thirty (30) days of any claimed lack of conformity of the product. Any product repaired under this warranty will be warranted only for the remainder of the original warranty period. Any product provided as a replacement under this warranty will be warranted for the one year from the date of replacement.

Returns

Products cannot be returned to **Icon Process Controls Ltd** without prior authorization. To return a product that is thought to be defective, go to www.iconprocon.com, and submit a customer return (MRA) request form and follow the instructions therein. All warranty and non-warranty product returns to **Icon Process Controls Ltd** must be shipped prepaid and insured. **Icon Process Controls Ltd** will not be responsible for any products lost or damaged in shipment.

Limitations

This warranty does not apply to products which: 1) are beyond the warranty period or are products for which the original purchaser does not follow the warranty procedures outlined above; 2) have been subjected to electrical, mechanical or chemical damage due to improper, accidental or negligent use; 3) have been modified or altered; 4) anyone other than service personnel authorized by Icon Process Controls Ltd have attempted to repair; 5) have been involved in accidents or natural disasters; or 6) are damaged during return shipment to **Icon Process Controls Ltd** reserves the right to unilaterally waive this warranty and dispose of any product returned to **Icon Process Controls Ltd** where: 1) there is evidence of a potentially hazardous material present with the product; or 2) the product has remained unclaimed at Icon Process Controls Ltd for more than 30 days after Icon Process Controls Ltd has dutifully requested disposition. This warranty contains the sole express warranty made by **Icon Process Controls Ltd** in connection with its products. **ALL IMPLIED WARRANTIES, INCLUDING WITHOUT LIMITATION, THE WARRANTIES OF MERCHANTABILITY AND FITNESS FOR A PARTICULAR PURPOSE, ARE EXPRESSLY DISCLAIMED.** The remedies of repair or replacement as stated above are the exclusive remedies for the breach of this warranty. **IN NO EVENT SHALL Icon Process Controls Ltd BE LIABLE FOR ANY INCIDENTAL OR CONSEQUENTIAL DAMAGES OF ANY KIND INCLUDING PERSONAL OR REAL PROPERTY OR FOR INJURY TO ANY PERSON. THIS WARRANTY CONSTITUTES THE FINAL, COMPLETE AND EXCLUSIVE STATEMENT OF WARRANTY TERMS AND NO PERSON IS AUTHORIZED TO MAKE ANY OTHER WARRANTIES OR REPRESENTATIONS ON BEHALF OF Icon Process Controls Ltd.** This warranty will be interpreted pursuant to the laws of the province of Ontario, Canada.

If any portion of this warranty is held to be invalid or unenforceable for any reason, such finding will not invalidate any other provision of this warranty

For additional product documentation and technical support visit www.iconprocon.com | e-mail: sales@iconprocon.com support@iconprocon.com | Ph: 905.469.9283



Corrosion-Free
Instrumentation Equipment

CORROSION

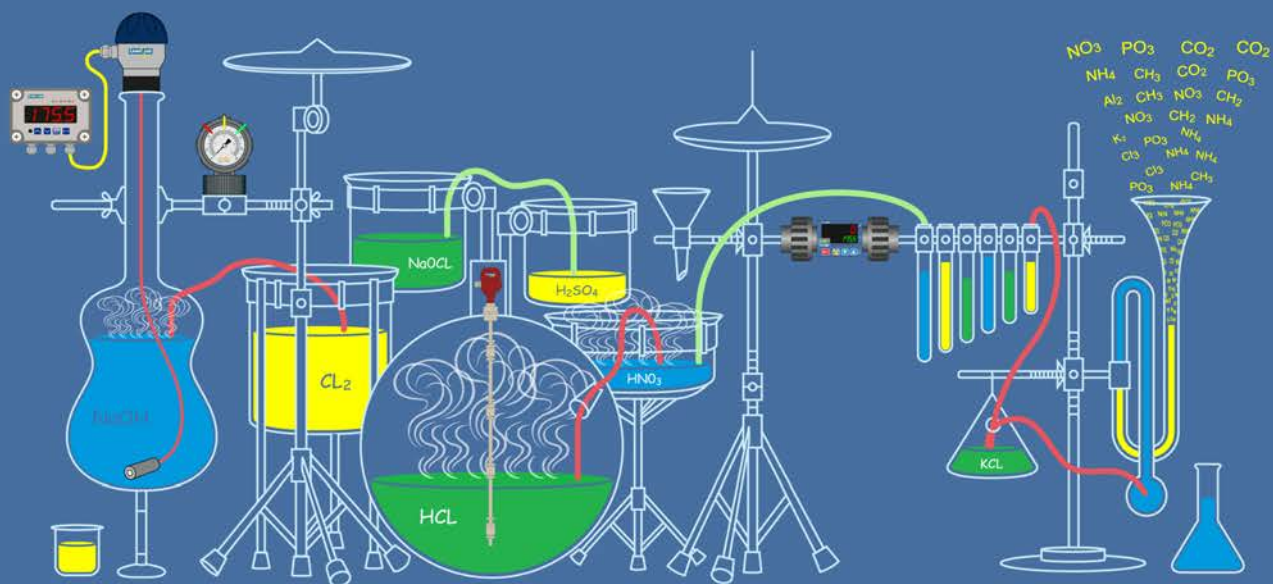

We Measure & Control
All Kinds of Corrosive Liquid S#*o%

'Industry's Most Extensive Line of
Corrosion-Free Instrumentation' Equipment'



Corrosion-Free
Instrumentation Equipment