

# Reference manual

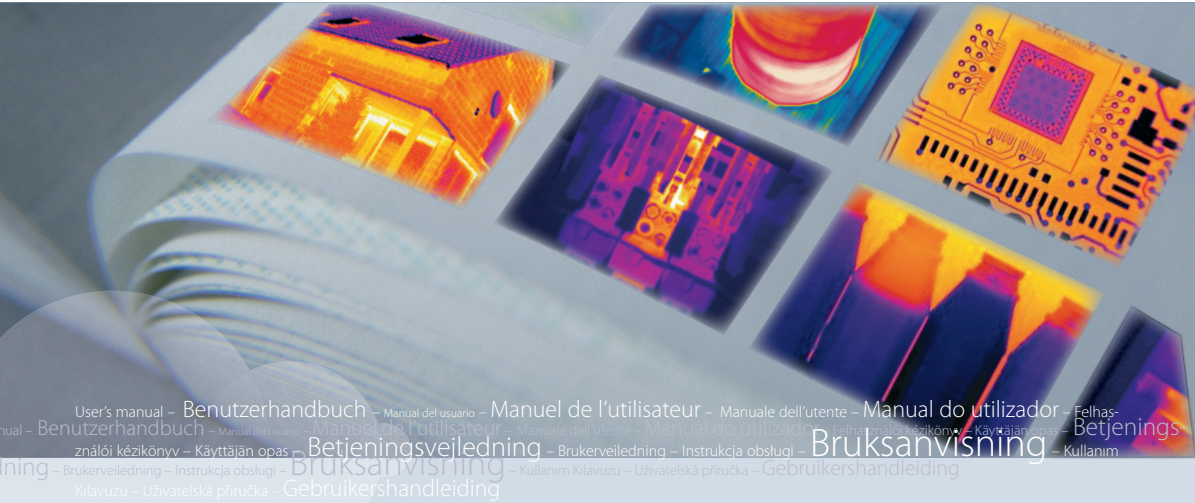

User's manual – Benutzerhandbuch – Manual del usuario – Manuel de l'utilisateur – Manuale dell'utente – Manual do utilizador – Felhasználói kézikönyv – Käyttöäjan opas – Betjeningsvejledning – Brukerveiledning – Instrukcja obsługi – Bruksanvisning – Kullanim Kilavuzu – Uživatelská příručka – Gebruikershandleiding

ThermaCAM™ B360  
ThermaCAM™ B400  
ThermaCAM™ T360  
ThermaCAM™ T400

Publ. No.	1558792
Revision	a239
Language	English (EN)
Issue date	August 2, 2007



<b>Warnings &amp; Cautions</b>	<b>1</b>
<b>Notice to user</b>	<b>2</b>
<b>Important note about this manual</b>	<b>3</b>
<b>Quick Start Guide</b>	<b>4</b>
<b>List of accessories</b>	<b>5</b>
<b>A note about ergonomics</b>	<b>6</b>
<b>Camera parts</b>	<b>7</b>
<b>Toolbars and work areas</b>	<b>8</b>
<b>Navigating the menu system</b>	<b>9</b>
<b>External devices and storage media</b>	<b>10</b>
<b>Handling the camera</b>	<b>11</b>
<b>Working with images</b>	<b>12</b>
<b>Working with measurement tools and isotherms</b>	<b>13</b>
<b>Annotating images</b>	<b>14</b>
<b>Changing settings</b>	<b>15</b>



<b>Cleaning the camera</b>	<b>16</b>
<b>Technical data</b>	<b>17</b>
<b>Dimensions</b>	<b>18</b>
<b>Application examples</b>	<b>19</b>
<b>Introduction to building thermography</b>	<b>20</b>
<b>Introduction to thermographic inspections of electrical installations</b>	<b>21</b>
<b>About FLIR Systems</b>	<b>22</b>
<b>Glossary</b>	<b>23</b>
<b>Thermographic measurement techniques</b>	<b>24</b>
<b>History of infrared technology</b>	<b>25</b>
<b>Theory of thermography</b>	<b>26</b>
<b>The measurement formula</b>	<b>27</b>
<b>Emissivity tables</b>	<b>28</b>
<b>Index</b>	<b>29</b>



---

# *Reference manual*



---

### Legal disclaimer

All products manufactured by FLIR Systems are warranted against defective materials and workmanship for a period of one (1) year from the delivery date of the original purchase, provided such products have been under normal storage, use and service, and in accordance with FLIR Systems instruction.

All products not manufactured by FLIR Systems included in systems delivered by FLIR Systems to the original purchaser carry the warranty, if any, of the particular supplier only and FLIR Systems has no responsibility whatsoever for such products.

The warranty extends only to the original purchaser and is not transferable. It is not applicable to any product which has been subjected to misuse, neglect, accident or abnormal conditions of operation. Expendable parts are excluded from the warranty.

In the case of a defect in a product covered by this warranty the product must not be further used in order to prevent additional damage. The purchaser shall promptly report any defect to FLIR Systems or this warranty will not apply.

FLIR Systems will, at its option, repair or replace any such defective product free of charge if, upon inspection, it proves to be defective in material or workmanship and provided that it is returned to FLIR Systems within the said one-year period.

FLIR Systems has no other obligation or liability for defects than those set forth above.

No other warranty is expressed or implied. FLIR Systems specifically disclaims the implied warranties of merchantability and fitness for a particular purpose.

FLIR Systems shall not be liable for any direct, indirect, special, incidental or consequential loss or damage, whether based on contract, tort or any other legal theory.

### Copyright

© FLIR Systems, 2007. All rights reserved worldwide. No parts of the software including source code may be reproduced, transmitted, transcribed or translated into any language or computer language in any form or by any means, electronic, magnetic, optical, manual or otherwise, without the prior written permission of FLIR Systems.

This manual must not, in whole or part, be copied, photocopied, reproduced, translated or transmitted to any electronic medium or machine readable form without prior consent, in writing, from FLIR Systems.

Names and marks appearing on the products herein are either registered trademarks or trademarks of FLIR Systems and/or its subsidiaries. All other trademarks, trade names or company names referenced herein are used for identification only and are the property of their respective owners.

### Quality assurance

The Quality Management System under which these products are developed and manufactured has been certified in accordance with the ISO 9001 standard.

FLIR Systems is committed to a policy of continuous development; therefore we reserve the right to make changes and improvements on any of the products described in this manual without prior notice.

### Patents

This product is protected by patents, design patents, patents pending, or design patents pending.

One or several of the following patents, design patents, patents pending, or design patents pending apply to the products and/or features described in this manual:

Designation	Status	Reg. No.
China	Application	00809178.1
China	Application	01823221.3
China	Application	01823226.4
China	Design Patent	235308
China	Design Patent	ZL02331553.9
China	Design Patent	ZL02331554.7
China	Pending	200530018812.0
EPC	Patent	1188086
EPO	Application	01930377.5
EPO	Application	01934715.2
EPO	Application	27282912
EU	Design Patent	000279476-0001
France	Patent	1188086



<b>Designation</b>	<b>Status</b>	<b>Reg. No.</b>
Germany	Patent	60004227.8
Great Britain	Design Patent	106017
Great Britain	Design Patent	3006596
Great Britain	Design Patent	3006597
Great Britain	Patent	1188086
International	Design Patent	DM/057692
International	Design Patent	DM/061609
Japan	Application	2000-620406
Japan	Application	2002-588123
Japan	Application	2002-588070
Japan	Design Patent	1144833
Japan	Design Patent	1182246
Japan	Design Patent	1182620
Japan	Pending	2005-020460
PCT	Application	PCT/SE01/00983
PCT	Application	PCT/SE01/00984
PCT	Application	PCT/SE02/00857
PCT	Application	PCT/SE03/00307
PCT	Application	PCT/SE/00/00739
Sweden	Application	0302837-0
Sweden	Design Patent	68657
Sweden	Design Patent	75530
Sweden	Patent	518836
Sweden	Patent	522971
Sweden	Patent	524024
U.S.	Application	09/576266
U.S.	Application	10/476,760
U.S.	Design Patent	466540
U.S.	Design Patent	483782
U.S.	Design Patent	484155
U.S.	Patent	5,386,117
U.S.	Patent	5,637,871
U.S.	Patent	5,756,999
U.S.	Patent	6,028,309
U.S.	Patent	6,707,044
U.S.	Patent	6,812,465
U.S.	Patent	7,034,300

Designation	Status	Reg. No.
U.S.	Pending	29/233,400

#### EULA Terms

- You have acquired a device ("INFRARED CAMERA") that includes software licensed by FLIR Systems AB from Microsoft Licensing, GP or its affiliates ("MS"). Those installed software products of MS origin, as well as associated media, printed materials, and "online" or electronic documentation ("SOFTWARE") are protected by international intellectual property laws and treaties. The SOFTWARE is licensed, not sold. All rights reserved.
- IF YOU DO NOT AGREE TO THIS END USER LICENSE AGREEMENT ("EULA"), DO NOT USE THE DEVICE OR COPY THE SOFTWARE. INSTEAD, PROMPTLY CONTACT FLIR Systems AB FOR INSTRUCTIONS ON RETURN OF THE UNUSED DEVICE(S) FOR A REFUND. **ANY USE OF THE SOFTWARE, INCLUDING BUT NOT LIMITED TO USE ON THE DEVICE, WILL CONSTITUTE YOUR AGREEMENT TO THIS EULA (OR RATIFICATION OF ANY PREVIOUS CONSENT).**
- **GRANT OF SOFTWARE LICENSE.** This EULA grants you the following license:
  - You may use the SOFTWARE only on the DEVICE.
  - **NOT FAULT TOLERANT.** THE SOFTWARE IS NOT FAULT TOLERANT. FLIR Systems AB HAS INDEPENDENTLY DETERMINED HOW TO USE THE SOFTWARE IN THE DEVICE, AND FLIR Systems AB HAS RELIED UPON FLIR Systems AB TO CONDUCT SUFFICIENT TESTING TO DETERMINE THAT THE SOFTWARE IS SUITABLE FOR SUCH USE.
  - **NO WARRANTIES FOR THE SOFTWARE.** THE SOFTWARE is provided "AS IS" and with all faults. THE ENTIRE RISK AS TO SATISFACTORY QUALITY, PERFORMANCE, ACCURACY, AND EFFORT (INCLUDING LACK OF NEGLIGENCE) IS WITH YOU. ALSO, THERE IS NO WARRANTY AGAINST INTERFERENCE WITH YOUR ENJOYMENT OF THE SOFTWARE OR AGAINST INFRINGEMENT. **IF YOU HAVE RECEIVED ANY WARRANTIES REGARDING THE DEVICE OR THE SOFTWARE, THOSE WARRANTIES DO NOT ORIGINATE FROM, AND ARE NOT BINDING ON, FLIR Systems AB.**
  - No Liability for Certain Damages. **EXCEPT AS PROHIBITED BY LAW, FLIR Systems AB SHALL HAVE NO LIABILITY FOR ANY INDIRECT, SPECIAL, CONSEQUENTIAL OR INCIDENTAL DAMAGES ARISING FROM OR IN CONNECTION WITH THE USE OR PERFORMANCE OF THE SOFTWARE. THIS LIMITATION SHALL APPLY EVEN IF ANY REMEDY FAILS OF ITS ESSENTIAL PURPOSE. IN NO EVENT SHALL FLIR Systems AB BE LIABLE FOR ANY AMOUNT IN EXCESS OF U.S. TWO HUNDRED FIFTY DOLLARS (U.S.\$250.00).**
  - **Limitations on Reverse Engineering, Decompilation, and Disassembly.** You may not reverse engineer, decompile, or disassemble the SOFTWARE, except and only to the extent that such activity is expressly permitted by applicable law notwithstanding this limitation.
  - **SOFTWARE TRANSFER ALLOWED BUT WITH RESTRICTIONS.** You may permanently transfer rights under this EULA only as part of a permanent sale or transfer of the Device, and only if the recipient agrees to this EULA. If the SOFTWARE is an upgrade, any transfer must also include all prior versions of the SOFTWARE.
  - **EXPORT RESTRICTIONS.** You acknowledge that SOFTWARE is subject to U.S. export jurisdiction. You agree to comply with all applicable international and national laws that apply to the SOFTWARE, including the U.S. Export Administration Regulations, as well as end-user, end-use and destination restrictions issued by U.S. and other governments. For additional information see <http://www.microsoft.com/exporting/>.

---

# Table of contents

<b>1</b>	<b>Warnings &amp; Cautions</b> .....	<b>1</b>
<b>2</b>	<b>Notice to user</b> .....	<b>4</b>
<b>3</b>	<b>Important note about this manual</b> .....	<b>7</b>
<b>4</b>	<b>Quick Start Guide</b> .....	<b>9</b>
<b>5</b>	<b>List of accessories</b> .....	<b>11</b>
<b>6</b>	<b>A note about ergonomics</b> .....	<b>14</b>
<b>7</b>	<b>Camera parts</b> .....	<b>16</b>
7.1	View of the rear .....	16
7.2	View of the front .....	20
7.3	View of the bottom side .....	22
7.4	Battery condition indicator .....	23
7.5	Laser pointer .....	24
<b>8</b>	<b>Toolbars and work areas</b> .....	<b>26</b>
8.1	Toolbars .....	26
8.1.1	Measurement toolbar .....	26
8.1.2	Documentation toolbar .....	27
8.1.3	Image marker toolbar .....	28
8.1.4	Voice annotation toolbar .....	29
8.2	Work areas .....	30
8.2.1	Main work area .....	30
8.2.2	Sketch work area .....	32
8.2.3	Text annotation and image description work area .....	34
8.2.4	Operation mode area .....	37
<b>9</b>	<b>Navigating the menu system</b> .....	<b>39</b>
<b>10</b>	<b>External devices and storage media</b> .....	<b>41</b>
10.1	Connecting external devices .....	42
10.2	Inserting SD Memory Cards .....	43
<b>11</b>	<b>Handling the camera</b> .....	<b>44</b>
11.1	Charging the battery .....	44
11.1.1	Using the combined power supply and battery charger to charge the battery when it is inside the camera .....	45
11.1.2	Using the combined power supply and battery charger to charge the battery when it is outside the camera .....	46
11.1.3	Using the stand-alone battery charger to charge the battery .....	47
11.2	Inserting the battery .....	48
11.3	Removing the battery .....	50
11.4	Turning on the camera .....	52
11.5	Turning off the camera .....	52
11.6	Adjusting the angle of lens .....	53
11.7	Mounting an additional infrared lens .....	54
11.8	Removing an additional infrared lens .....	56

11.9	Attaching the sunshield .....	58
11.10	Using the laser pointer .....	60
<b>12</b>	<b>Working with images</b> .....	<b>61</b>
12.1	Adjusting the infrared camera focus .....	61
12.2	Previewing an image .....	62
12.3	Saving an image .....	63
12.4	Opening an image .....	64
12.5	Adjusting an image manually .....	65
12.6	Hiding overlay graphics .....	68
12.7	Deleting an image .....	69
12.8	Deleting all images .....	70
<b>13</b>	<b>Working with measurement tools and isotherms</b> .....	<b>72</b>
13.1	Setting up measurement tools .....	72
13.2	Setting up measurement tools (advanced mode) .....	73
13.3	Setting up isotherms .....	74
13.4	Removing measurement tools .....	76
13.5	Moving measurement tools .....	77
13.6	Resizing areas .....	78
13.7	Changing object parameters .....	79
<b>14</b>	<b>Annotating images</b> .....	<b>81</b>
14.1	Adding a digital photo .....	82
14.2	Adding a voice annotation .....	83
14.3	Adding a text annotation .....	84
14.4	Adding an image description .....	87
14.5	Adding a sketch .....	88
14.6	Adding an image marker .....	89
<b>15</b>	<b>Changing settings</b> .....	<b>91</b>
15.1	Changing image settings .....	91
15.2	Changing regional settings .....	92
15.3	Changing camera settings .....	93
<b>16</b>	<b>Cleaning the camera</b> .....	<b>95</b>
16.1	Camera housing, cables, and other items .....	95
16.2	Infrared lens .....	96
<b>17</b>	<b>Technical data</b> .....	<b>97</b>
<b>18</b>	<b>Dimensions</b> .....	<b>111</b>
18.1	Camera .....	111
18.1.1	Camera dimensions .....	111
18.1.2	Camera dimensions, continued .....	112
18.1.3	Camera dimensions, continued .....	113
18.1.4	Camera dimensions, continued (with 30 mm/15° lens) .....	114
18.1.5	Camera dimensions, continued (with 10 mm/45° lens) .....	115
18.2	Battery .....	116
18.3	Stand-alone battery charger .....	117
18.4	Stand-alone battery charger with the battery .....	118
18.5	Infrared lens (30 mm/15°) .....	119
18.6	Infrared lens (10 mm/45°) .....	120
<b>19</b>	<b>Application examples</b> .....	<b>121</b>

19.1	Moisture & water damage .....	121
19.2	Faulty contact in socket .....	122
19.3	Oxidized socket .....	123
19.4	Insulation deficiencies .....	124
19.5	Draft .....	125
<b>20</b>	<b>Introduction to building thermography .....</b>	<b>127</b>
20.1	Important note .....	127
20.2	Typical field investigations .....	127
20.2.1	Guidelines .....	127
20.2.1.1	General guidelines .....	127
20.2.1.2	Guidelines for moisture detection, mold detection & detection of water damages .....	128
20.2.1.3	Guidelines for detection of air infiltration & insulation deficiencies ...	128
20.2.2	About moisture detection .....	129
20.2.3	Moisture detection (1): Low-slope commercial roofs .....	129
20.2.3.1	General information .....	129
20.2.3.2	Safety precautions .....	130
20.2.3.3	Commented building structures .....	131
20.2.3.4	Commented infrared images .....	132
20.2.4	Moisture detection (2): Commercial & residential façades .....	134
20.2.4.1	General information .....	134
20.2.4.2	Commented building structures .....	134
20.2.4.3	Commented infrared images .....	136
20.2.5	Moisture detection (3): Decks & balconies .....	136
20.2.5.1	General information .....	136
20.2.5.2	Commented building structures .....	137
20.2.5.3	Commented infrared images .....	139
20.2.6	Moisture detection (4): Plumbing breaks & leaks .....	139
20.2.6.1	General information .....	139
20.2.6.2	Commented infrared images .....	140
20.2.7	Air infiltration .....	142
20.2.7.1	General information .....	142
20.2.7.2	Commented building structures .....	142
20.2.7.3	Commented infrared images .....	144
20.2.8	Insulation deficiencies .....	145
20.2.8.1	General information .....	145
20.2.8.2	Commented building structures .....	145
20.2.8.3	Commented infrared images .....	147
20.3	Theory of building science .....	149
20.3.1	General information .....	149
20.3.2	The effects of testing and checking .....	150
20.3.3	Sources of disruption in thermography .....	151
20.3.4	Surface temperature and air leaks .....	153
20.3.4.1	Pressure conditions in a building .....	153
20.3.5	Measuring conditions & measuring season .....	159
20.3.6	Interpretation of infrared images .....	159
20.3.7	Humidity & dew point .....	161
20.3.7.1	Relative & absolute humidity .....	161
20.3.7.2	Definition of dew point .....	162
20.3.8	Excerpt from Technical Note 'Assessing thermal bridging and insulation continuity' (UK example) .....	162
20.3.8.1	Credits .....	162

	20.3.8.2	Introduction .....	163
	20.3.8.3	Background information .....	163
	20.3.8.4	Quantitative appraisal of thermal anomalies .....	164
	20.3.8.5	Conditions and equipment .....	167
	20.3.8.6	Survey and analysis .....	168
	20.3.8.7	Reporting .....	169
20.4	Disclaimer .....		171
	20.4.1	Copyright notice .....	171
	20.4.2	Training & certification .....	171
	20.4.3	National or regional building codes .....	171
<b>21</b>	<b>Introduction to thermographic inspections of electrical installations .....</b>		<b>173</b>
21.1	Important note .....		173
21.2	General information .....		173
	21.2.1	Introduction .....	173
	21.2.2	General equipment data .....	174
	21.2.3	Inspection .....	175
	21.2.4	Classification & reporting .....	175
	21.2.5	Priority .....	176
	21.2.6	Repair .....	176
	21.2.7	Control .....	177
21.3	Measurement technique for thermographic inspection of electrical installations .....		178
	21.3.1	How to correctly set the equipment .....	178
	21.3.2	Temperature measurement .....	178
	21.3.3	Comparative measurement .....	180
	21.3.4	Normal operating temperature .....	181
	21.3.5	Classification of faults .....	182
21.4	Reporting .....		184
21.5	Different types of hot spots in electrical installations .....		186
	21.5.1	Reflections .....	186
	21.5.2	Solar heating .....	186
	21.5.3	Inductive heating .....	187
	21.5.4	Load variations .....	187
	21.5.5	Varying cooling conditions .....	188
	21.5.6	Resistance variations .....	189
	21.5.7	Overheating in one part as a result of a fault in another .....	189
21.6	Disturbance factors at thermographic inspection of electrical installations .....		191
	21.6.1	Wind .....	191
	21.6.2	Rain and snow .....	191
	21.6.3	Distance to object .....	192
	21.6.4	Object size .....	193
21.7	Practical advice for the thermographer .....		195
	21.7.1	From cold to hot .....	195
	21.7.2	Rain showers .....	195
	21.7.3	Emissivity .....	195
	21.7.4	Reflected apparent temperature .....	196
	21.7.5	Object too far away .....	196
<b>22</b>	<b>About FLIR Systems .....</b>		<b>197</b>
22.1	More than just an infrared camera .....		198
22.2	Sharing our knowledge .....		198
22.3	Supporting our customers .....		198
22.4	A few images from our facilities .....		199

---

<b>23</b>	<b>Glossary</b> .....	201
<b>24</b>	<b>Thermographic measurement techniques</b> .....	205
24.1	Introduction .....	205
24.2	Emissivity .....	205
24.2.1	Finding the emissivity of a sample .....	206
24.2.1.1	Step 1: Determining reflected apparent temperature .....	206
24.2.1.2	Step 2: Determining the emissivity .....	208
24.3	Reflected apparent temperature .....	209
24.4	Distance .....	209
24.5	Relative humidity .....	209
24.6	Other parameters .....	209
<b>25</b>	<b>History of infrared technology</b> .....	211
<b>26</b>	<b>Theory of thermography</b> .....	215
26.1	Introduction .....	215
26.2	The electromagnetic spectrum .....	215
26.3	Blackbody radiation .....	216
26.3.1	Planck's law .....	217
26.3.2	Wien's displacement law .....	218
26.3.3	Stefan-Boltzmann's law .....	220
26.3.4	Non-blackbody emitters .....	221
26.4	Infrared semi-transparent materials .....	223
<b>27</b>	<b>The measurement formula</b> .....	225
<b>28</b>	<b>Emissivity tables</b> .....	231
28.1	References .....	231
28.2	Important note about the emissivity tables .....	231
28.3	Tables .....	231
	<b>Index</b> .....	247





**WARNING**

- This equipment generates, uses, and can radiate radio frequency energy and if not installed and used in accordance with the instruction manual, may cause interference to radio communications. It has been tested and found to comply with the limits for a Class A computing device pursuant to Subpart J of Part 15 of FCC Rules, which are designed to provide reasonable protection against such interference when operated in a commercial environment. Operation of this equipment in a residential area is likely to cause interference in which case the user at his own expense will be required to take whatever measures may be required to correct the interference.
- (Applies only to cameras with laser pointer:) Do not look directly into the laser beam. The laser beam can cause eye irritation.
- Do not disassemble or do a modification to the battery. The battery contains safety and protection devices which, if they become damaged, can cause the battery to become hot, or cause an explosion or an ignition.
- If there is a leak from the battery and the fluid gets into your eyes, do not rub your eyes. Flush well with water and immediately get medical care. The battery fluid can cause injury to your eyes if you do not do this.
- Do not continue to charge the battery if it does not become charged in the specified charging time. If you continue to charge the battery, it can become hot and cause an explosion or ignition.
- Only use the correct equipment to discharge the battery. If you do not use the correct equipment, you can decrease the performance or the life cycle of the battery. If you do not use the correct equipment, an incorrect flow of current to the battery can occur. This can cause the battery to become hot, or cause an explosion and injury to persons.
- Make sure that you read all applicable MSDS (Material Safety Data Sheets) and warning labels on containers before you use a liquid: the liquids can be dangerous.

**CAUTION**

- Do not point the infrared camera (with or without the lens cover) at intensive energy sources, for example devices that emit laser radiation, or the sun for a long period of time. This can have an unwanted effect on the accuracy of the camera. It can also cause damage to the detector in the camera.
- Do not use the camera in a temperature higher than +50°C (+122°F), unless specified otherwise in the technical data section. High temperatures can cause damage to the camera.
- (Applies only to cameras with laser pointer:) Protect the laser pointer with the protective cap when you do not operate the laser pointer.
- Do not attach the batteries directly to a car's cigarette lighter socket.
- Do not connect the positive terminal and the negative terminal of the battery to each other with a metal object (such as wire).
- Do not get water or salt water on the battery, or permit the battery to get wet.
- Do not make holes in the battery with objects. Do not hit the battery with a hammer. Do not step on the battery, or apply strong impacts or shocks to it.
- Do not put the batteries in or near a fire, or into direct sunlight. When the battery becomes hot, the built-in safety equipment becomes energized and can stop the battery charging process. If the battery becomes hot, damage can occur to the safety equipment and this can cause more heat, damage or ignition of the battery.

- Do not put the battery on a fire or increase the temperature of the battery with heat.
  - Do not put the battery on or near fires, stoves, or other high-temperature locations.
  - Do not solder directly onto the battery.
  - Do not use the battery if, when you use, charge, or store the battery, there is an unusual smell from the battery, the battery feels hot, changes color, changes shape, or is in an unusual condition. Contact your sales office if one or more of these problems occurs.
  - Only use a specified battery charger when you charge the battery.
  - The temperature range through which you can charge the battery is  $\pm 0^{\circ}\text{C}$  to  $+45^{\circ}\text{C}$  ( $+32^{\circ}\text{F}$  to  $+113^{\circ}\text{F}$ ). If you charge the battery at temperatures out of this range, it can cause the battery to become hot or to break. It can also decrease the performance or the life cycle of the battery.
  - The temperature range through which you can discharge the battery is  $-15^{\circ}\text{C}$  to  $+50^{\circ}\text{C}$  ( $+5^{\circ}\text{F}$  to  $+122^{\circ}\text{F}$ ). Use of the battery out of this temperature range can decrease the performance or the life cycle of the battery.
  - When the battery is worn, apply insulation to the terminals with adhesive tape or similar materials before you discard it.
  - Do not apply solvents or similar liquids to the camera, the cables, or other items. This can cause damage.
  - Be careful when you clean the infrared lens. The lens has a delicate anti-reflective coating.
  - Do not clean the infrared lens too vigorously. This can damage the anti-reflective coating.
-

INTENTIONALLY LEFT BLANK

---

## 2 Notice to user

2

### Typographical conventions

---

This manual uses the following typographical conventions:

- **Semibold** is used for menu names, menu commands and labels, and buttons in dialog boxes.
- *Italic* is used for important information.
- **Monospace** is used for code samples.
- **UPPER CASE** is used for names on keys and buttons.

### Comments and questions

---

Make a report of errors that you find, as well as your suggestions for new revisions. Send an e-mail to:

[documentation@flir.se](mailto:documentation@flir.se)

### Technical support

---

For technical support, visit:

<http://flir.custhelp.com>

To submit a question to the technical support team, you must be a registered user. It only takes a few minutes to register online. If you only want to search the knowledgebase for existing questions and answers, you do not need to be a registered user.

When you want to submit a question, make sure that you have the following information to hand:

- The camera model
- The camera serial number
- The communication protocol, or method, between the camera and your PC (for example, Ethernet, USB, or FireWire)
- Operating system on your PC
- Microsoft® Office version
- Full name, publication number, and revision number of the manual

### User-to-user forums

---

Exchange ideas, problems, and infrared solutions with fellow thermographers around the world in our user-to-user forums. To go to the forums, visit:

<http://www.infraredtraining.com/community/boards/>

### Software updates

---

FLIR Systems regularly issues software upgrades and service releases on the support pages of the company website:

<http://www.flirthermography.com>

To find the latest upgrades and service releases, make that sure you select **USA** in the **Select country** box in the top right corner of the page.

### Calibration

---

(This notice only applies to cameras with measurement capabilities.)

We recommend that you send in the camera for calibration once a year. Contact your local sales office for instructions on where to send the camera.

### Accuracy

---

(This notice only applies to cameras with measurement capabilities.)

---

For very accurate results, we recommend that you wait 5 minutes after you have started the camera before measuring a temperature.

---

**Disposal of  
electronic waste**



As with most electronic products, this equipment must be disposed of in an environmentally friendly way, and in accordance with existing regulations for electronic waste. Please contact your FLIR Systems representative for more details.

---

**Training**

To read about infrared training, visit:  
<http://www.infraredtraining.com>

---

INTENTIONALLY LEFT BLANK

---

# 3 Important note about this manual

## General

---

FLIR Systems issues generic manuals that cover several cameras within a model line.

This means that this manual may contain descriptions and explanations that do not apply to your particular camera model.

---

## NOTE

FLIR Systems reserves the right to discontinue models, parts or accessories, and other items, or to change specifications at any time without prior notice.

---

3

INTENTIONALLY LEFT BLANK



---

# 4

# Quick Start Guide

## Procedure

Follow this procedure to get started right away:

1	Charge the battery for four hours.
2	Insert the battery into the camera.
3	Insert an SD Memory Card into the card slot at the top of the camera.
4	Push the On/Off button to turn on the camera.
5	Set the correct object temperature range.
6	Aim the camera toward your target of interest.
7	Use the Focus button to focus the camera.
8	Push the Preview/Save button to save the image.
9	To move the image to a computer, do one of the following: <ul style="list-style-type: none"><li>■ Remove the SD Memory Card and insert it into a card reader connected to a computer.</li><li>■ Connect a computer to the camera using a USB Mini-B cable.</li></ul>
10	Move the image from the card or camera using a drag-and-drop operation.

## SEE

- Section 11.1 – Charging the battery on page 44
- Section 11.2 – Inserting the battery on page 48
- Section 10.2 – Inserting SD Memory Cards on page 43
- Section 11.4 – Turning on the camera on page 52
- Section 15.1 – Changing image settings on page 91
- Section 13 – Working with measurement tools and isotherms on page 72
- Section 10.1 – Connecting external devices on page 42

INTENTIONALLY LEFT BLANK

# 5 List of accessories

## General

This section contains a list of accessories that you can purchase for your camera. The accessories included in the transport case depends on the camera model and customer configuration.

## Contents

Item	Part number
12 VDC power cable with cigarette lighter adapter	1910490
Additional infrared lens (10 mm/45°)	1196725
Additional infrared lens (30 mm/15°)	1196724
Battery	1196398
Battery charger	1196474
Camera pouch	1124545
Documentation CD-ROM (including reference manuals in multiple languages, application guides, etc.)	1124640
Lens cap for infrared camera	1196818
Microphone headset	1910489
Neck strap	1124544
Power cord	One of the following: <ul style="list-style-type: none"><li>■ EU: 1910400</li><li>■ USA: 1910401</li><li>■ Great Britain: 1910402</li><li>■ Australia: 1910464</li></ul>
Power supply	1910399
SD Memory Card, 256 MB	1910473
Stylus pen	1196795
Sunshield	1123970
USB cable	1910423
User manual	1558790
Video cable	1910582

**NOTE**

FLIR Systems reserves the right to discontinue models, parts or accessories, and other items, or to change specifications at any time without prior notice.

---

INTENTIONALLY LEFT BLANK

---

# 6 A note about ergonomics

## General

---

To prevent strain injuries, it is important that you hold the camera ergonomically correct. This section gives advice and examples on how to hold the camera.

---

## NOTE

Please note the following:

- Always adjust the angle of the lens to suit your work position.
  - When you hold the camera, make sure that you support the camera housing with your left hand too. This decreases the strain on your right hand.
- 

## Figure

10758503.a1

10758603.a1

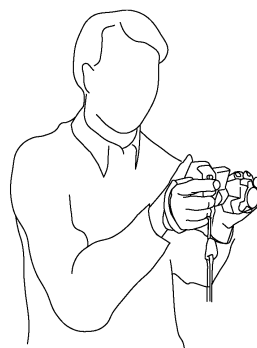
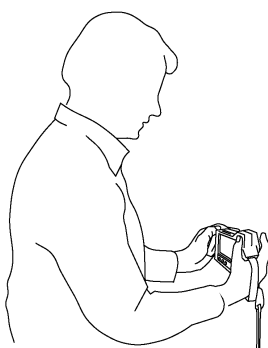

10758803.a1

10758703.a1

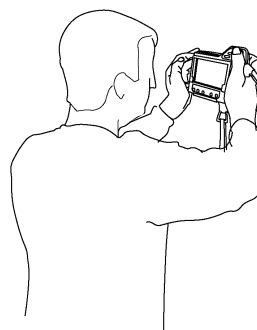

---

## SEE ALSO

- Section 11.6 – Adjusting the angle of lens on page 53
-

INTENTIONALLY LEFT BLANK

# 7 Camera parts

## 7.1 View of the rear

Figure

10758903.a1

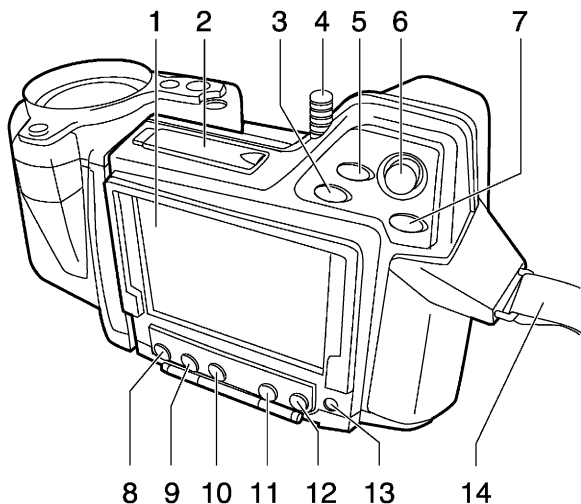

7

### Explanation

This table explains the figure above:

1	Touch screen LCD
2	Cover for SD Memory Card slot



3	<p><b>Zoom button</b></p> <ul style="list-style-type: none"> <li>■ The zoom button has the following functions on live images: <ul style="list-style-type: none"> <li>■ Push to enter the zoom state.</li> <li>■ Use the joystick to zoom into or out of an image.</li> <li>■ Push the zoom button once again to reset to 1 × zoom factor.</li> <li>■ Push the A/M button, the joystick, or the Preview/Save button to confirm the zoom factor and leave the zoom state.</li> </ul> </li> <li>■ The zoom button has the following functions on still images: <ul style="list-style-type: none"> <li>■ Zooming: <ul style="list-style-type: none"> <li>■ Push to enter the zoom state.</li> <li>■ Use the joystick to zoom into or out of an image.</li> <li>■ Push the zoom button once again to reset to 1 × zoom factor.</li> <li>■ Push the A/M button or the Preview/Save button to confirm the zoom factor and leave the zoom state.</li> </ul> </li> <li>■ Panning: <ul style="list-style-type: none"> <li>■ Push to enter the zoom state.</li> <li>■ Push the joystick to enter the pan state.</li> <li>■ Use the joystick to pan over an image.</li> <li>■ Push the joystick to confirm the pan position and leave the pan state.</li> </ul> </li> </ul> </li> </ul>
4	<p><b>Stylus pen</b></p> <p><b>Note:</b> Push the stylus pen firmly into its holder when not in use.</p>
5	<p><b>Camera button</b></p> <p>The camera button has the following functions:</p> <ul style="list-style-type: none"> <li>■ On live images: Switch between the infrared camera and the digital camera.</li> <li>■ On live fusion images: Switch between fusion and infrared imagery. Switching between fusion and infrared imagery enables you to accurately focus the infrared image.</li> </ul>
6	<p><b>Joystick</b></p> <p>The joystick has the following functions:</p> <ul style="list-style-type: none"> <li>■ In live infrared manual mode, and in still infrared mode: <ul style="list-style-type: none"> <li>■ Push up/down to adjust the level.</li> <li>■ Push left/right to adjust the span.</li> </ul> </li> <li>■ In menus, in dialog boxes, and in the image archive: <ul style="list-style-type: none"> <li>■ Push up/down or left/right to navigate.</li> <li>■ Push to confirm choices.</li> </ul> </li> </ul>

7	<p>A/M button</p> <p>The A/M button has the following functions:</p> <ul style="list-style-type: none"> <li>■ Push to switch between automatic and manual adjustment modes.</li> <li>■ Push and hold down for more than one second to perform a non-uniformity correction.</li> <li>■ In still infrared mode: Switch user focus between the documentation toolbar and the temperature scale.</li> </ul>
8	<p>Measure button</p> <p>The Measure button has the following functions:</p> <ul style="list-style-type: none"> <li>■ In live infrared mode: Push to display/hide the measurement menu.</li> <li>■ In still infrared mode: Push to display/hide the measurement toolbar.</li> </ul>
9	<p>Info button</p> <p>The function of the Info button is to display different levels of information on the screen.</p>
10	<p>Setup button</p> <p>The function of the Setup button is to display/hide the setup mode. In the setup mode you can change image settings, camera settings, and regional settings.</p>
11	<p>Archive button</p> <p>The Archive button has the following functions:</p> <ul style="list-style-type: none"> <li>■ Push to open the image archive.</li> <li>■ Push to close the image archive.</li> </ul>
12	<p>Mode button</p> <p>The function of the mode button is to display/hide the mode selector.</p>
13	<p>On/Off button.</p> <p>The On/Off button has the following functions:</p> <ul style="list-style-type: none"> <li>■ To turn on the camera, push the On/Off button.</li> <li>■ To turn off the camera, push and hold down the On/Off button for more than 0.2 second.</li> </ul> <p>The On/Off button is also a power indicator that shows when the camera is on.</p>
14	<p>Hand strap</p>

INTENTIONALLY LEFT BLANK

## 7.2

## View of the front

Figure

10759003.a1

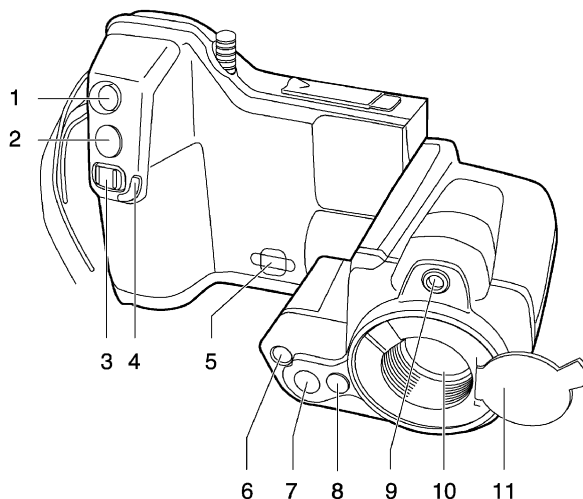

7

## Explanation

This table explains the figure above:

<b>1</b>	<p>Laser pointer button</p> <p>The laser pointer button has the following functions:</p> <ul style="list-style-type: none"> <li>■ Push the laser pointer button to turn on the laser pointer.</li> <li>■ Release the laser pointer button to turn off the laser pointer.</li> </ul>
<b>2</b>	<p>Preview/Save button</p> <p>The save button has the following functions:</p> <ul style="list-style-type: none"> <li>■ Push and hold down the Preview/Save button for more than one second to preview an image. At this point you can annotate the image with a digital photo, a text annotation, a voice annotation, image markers, etc.</li> <li>■ Briefly push the Preview/Save button to save an infrared image in the infrared camera mode (without previewing).</li> <li>■ Briefly push the Preview/Save button to save a digital photo in the digital camera mode (without previewing).</li> </ul>
<b>3</b>	<p>Focus button</p> <p>The focus button has the following functions:</p> <ul style="list-style-type: none"> <li>■ Move the Focus button left for far focus.</li> <li>■ Move the Focus button right for close focus.</li> <li>■ Briefly push the Focus button to autofocus.</li> </ul> <p><b>Note:</b> It is important that you hold the camera steady while autofocusing.</p>

---

4	Protective edge for the focus button
5	Attachment point for the neck strap
6	Video lamp
7	Digital camera lens
8	Release button for additional infrared lenses
9	Laser pointer
10	Infrared lens
11	Lens cap for the infrared lens

---

**NOTE**

The laser pointer may not be enabled in all markets.

---

### 7.3 View of the bottom side

Figure

10759103.a1

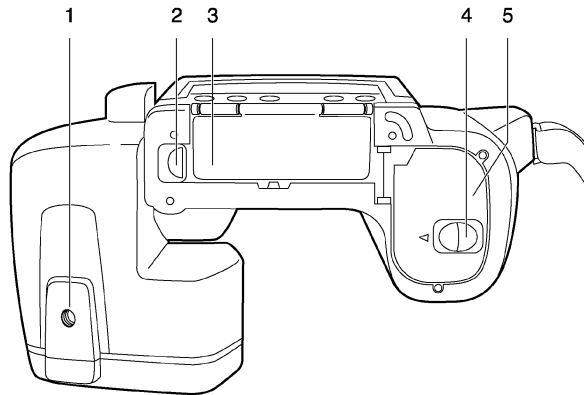

7

Explanation

This table explains the figure above:

1	Tripod mount 1/4"-20
2	Release button for the cover to the connector bay
3	Cover for the connector bay
4	Release button for the battery compartment cover
5	Cover for the battery compartment

## 7.4 *Battery condition indicator*

**General** The battery has a battery condition indicator.

**Figure**

10715703.a3

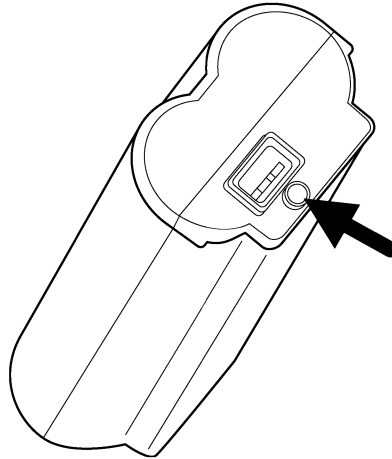

7

**Explanation**

This table explains the battery condition indicator:

Type of signal	Explanation
The green light flashes.	The power supply or the stand-alone battery charger is charging the battery.
The green light is continuous.	The battery is fully charged.
The green light is off.	The camera is using the battery (instead of the power supply).

## 7.5 *Laser pointer*

---

**General**

The camera has a laser pointer. When the laser pointer is on, you can see a laser dot approximately 40 mm (1.57 in.) above the target.

---

**Figure**

This figure shows the difference in position between the laser pointer and the optical center of the infrared lens:

10759203.a1

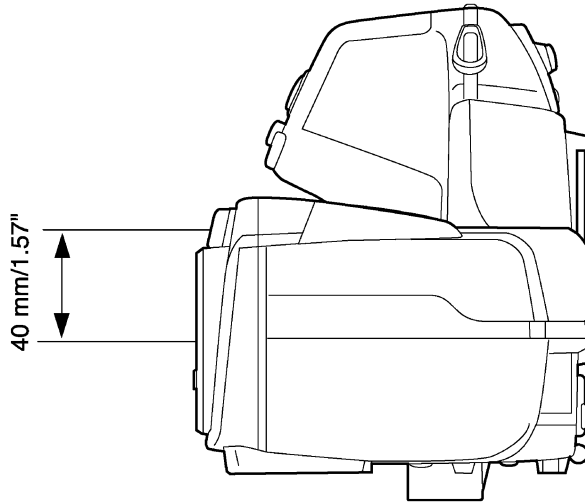



- 
- WARNING** Do not look directly into the laser beam. The laser beam can cause eye irritation.
- 
- CAUTION** Protect the laser pointer with the protective cap when you are not using the laser pointer.
- 
- NOTE**
- A laser warning symbol is displayed on the screen when the laser pointer is on.
  - The laser pointer may not be enabled in all markets.
- 

**Laser warning label** A laser warning label with the following information is attached to the camera:

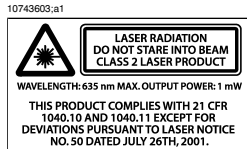

**Laser rules and regulations**

Wavelength: 635 nm. Max. output power: 1 mW.

This product complies with 21 CFR 1040.10 and 1040.11 except for deviations pursuant to Laser Notice No. 50, dated July 26th, 2001.

---

# 8 Toolbars and work areas

## 8.1 Toolbars

### 8.1.1 Measurement toolbar

#### NOTE

- The measurement toolbar becomes visible when you push the Measure button and select **Advanced**.
- You use the measurement toolbar to set up measurement tools in the advanced mode, or when editing a saved image in the archive mode.
- To navigate on the toolbar, use either the joystick or the stylus pen.

Figure

10760803.a1

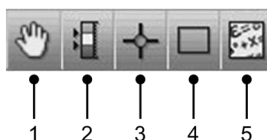

#### Explanation

This table explains the figure above:

1	You select this toolbar button to do one or more of the following: <ul style="list-style-type: none"><li>■ Move measurement tools</li><li>■ Remove measurement tools</li><li>■ Turn on and turn off alarms (only for spotmeters and areas).</li><li>■ Set alarm levels (only for spotmeters and areas).</li></ul>
2	Isotherm toolbar button You select this toolbar button to set up different types of isotherms. The isotherm command colors all pixels with a temperature above, below, or between one or more preset temperature levels.
3	Spotmeter toolbar button You select this toolbar button to create a spotmeter.
4	Area toolbar button You select this toolbar button to create a measurement area.
5	Object parameters toolbar button You select this toolbar button to change object parameters. Setting the correct object parameters is important if precise measurement results are required.

## 8.1.2 Documentation toolbar

### NOTE

- The documentation toolbar becomes visible when you preview an image, or when you edit an image from the image archive.
- To preview an image, push and hold down the Save button for more than one second.
- To navigate on the toolbar, use either the joystick or the stylus pen.

### Figure

10760903.a1

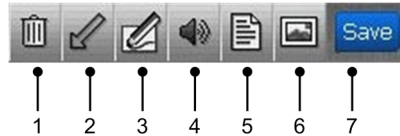

### Explanation

This table explains the figure above:

<b>1</b>	<p>Delete image toolbar button</p> <p>You select this toolbar button to discard the image that you are previewing.</p>
<b>2</b>	<p>Add markers toolbar button</p> <p>You select this tool to add arrow markers to points of interest in an infrared image. The arrow marker will be saved in the infrared image.</p>
<b>3</b>	<p>Add sketch toolbar button</p> <p>You select this toolbar button to add a freehand sketch to an infrared image. The sketch will be linked to the infrared image.</p>
<b>4</b>	<p>Add voice annotation toolbar button</p> <p>You select this toolbar button to add a voice annotation to an infrared image. The voice annotation will be saved in the infrared image.</p>
<b>5</b>	<p>Add text annotation toolbar button</p> <p>You select this toolbar button to add text annotations and/or image descriptions to an infrared image. Text annotations and image descriptions will be saved in the infrared image.</p>
<b>6</b>	<p>Add digital photo toolbar button</p> <p>You select this toolbar button to add a digital photo to the infrared image. The digital photo will be linked to the infrared image.</p>
<b>7</b>	<p><b>Save toolbar button</b></p> <p>You select this toolbar button to save the infrared image after you have added any of the previous five annotations. If you have opened an image from the image archive, this toolbar button says <b>Close</b> instead of <b>Save</b>.</p>

### 8.1.3 Image marker toolbar

**NOTE**

- The image marker toolbar becomes visible when you add an image marker. You do this from the documentation toolbar.
- To navigate on the toolbar, use either the joystick or the stylus pen.

**Figure**

10762303.a2

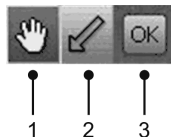

**Explanation**

This table explains the figure above:

1	You select this toolbar button to move and remove any markers you have previously added to the image.
2	Marker toolbar button You select this toolbar button to create a marker. Tap gently on the toolbar button using the stylus pen, and then draw a line on the image.
3	OK toolbar button You select this toolbar button to confirm any markers you have added to the image before leaving this work mode.

## 8.1.4 Voice annotation toolbar

### NOTE

- The voice annotation toolbar becomes visible when you record or listen to a voice comment. You do this from the documentation toolbar.
- To navigate on the toolbar, use either the joystick or the stylus pen.
- Some buttons have more than one function, and the symbols on the buttons will change depending on the context.

### Figure

10763803.a2

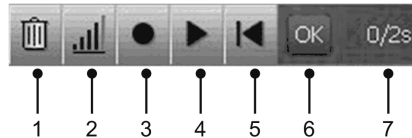

### Explanation

This table explains the figure above:

1	Discard recording toolbar button You select this toolbar button to delete a voice comment that you have made.
2	Adjust volume toolbar button You select this toolbar button and move the joystick up/down to adjust the volume when you play back voice comments.
3	Start/stop recording toolbar button You select this toolbar button to start and stop the recording of a voice comment.
4	Start/stop playback toolbar button You select this toolbar button to start and stop the playback of a previously recorded voice comment.
5	Go to beginning toolbar button You select this toolbar button to go back to the beginning of the recording.
6	OK toolbar button You select this toolbar button to confirm and save the previously recorded voice comment.
7	Time indicator (X/Y seconds, where X = elapsed recording time and Y = total recording time)

## 8.2 Work areas

### 8.2.1 Main work area

Figure

10760703.a1

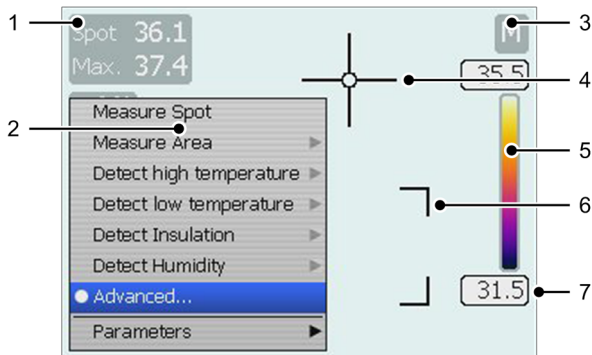

#### Explanation

This table explains the figure above:

1	Measurement results table (in °C or °F, depending on the settings)
2	Measurement menu. To open and close this menu, push the Measure button.
3	Indicator for the automatic adjustment mode or the manual adjustment mode (A/M)
4	Spotmeter
5	Temperature scale
6	Measurement area
7	Limit indicator for the temperature scale

INTENTIONALLY LEFT BLANK

8

### 8.2.2 Sketch work area

**NOTE**

- The sketch work area becomes visible when you add a sketch to an infrared image. You do this from the documentation toolbar.
- To navigate in the area, use either the joystick or the stylus pen.
- To draw the sketch, use the stylus pen.

Figure

10762203.a1

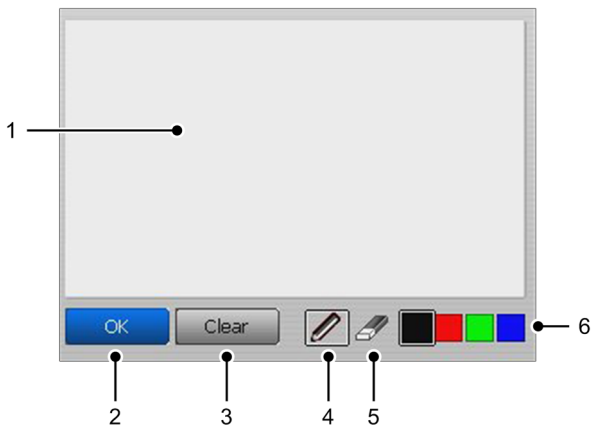

8

**Explanation**

This table explains the figure above:

<b>1</b>	Canvas You draw your sketch in this area, using the stylus pen.
<b>2</b>	OK button You select this button to confirm the sketch and leave the sketch mode.
<b>3</b>	Clear button You select this button to clear the whole canvas.
<b>4</b>	Pen button You select this button to enable the pen.
<b>5</b>	Eraser button You select this button to enable the eraser.
<b>6</b>	Color palette You select this color swatch to switch between colors.



**SEE ALSO**

For information about adding a sketch to an infrared image, see section 14.5 – Adding a sketch on page 88.

---

### 8.2.3 Text annotation and image description work area

**NOTE**

- The text annotation and image description work area becomes visible when you add a text annotation or an image description to an infrared image. You do this from the documentation toolbar.
- To navigate in the area, use either the joystick or the stylus pen.

**Figure**

This figure shows the text annotation work area:

10765603.a2

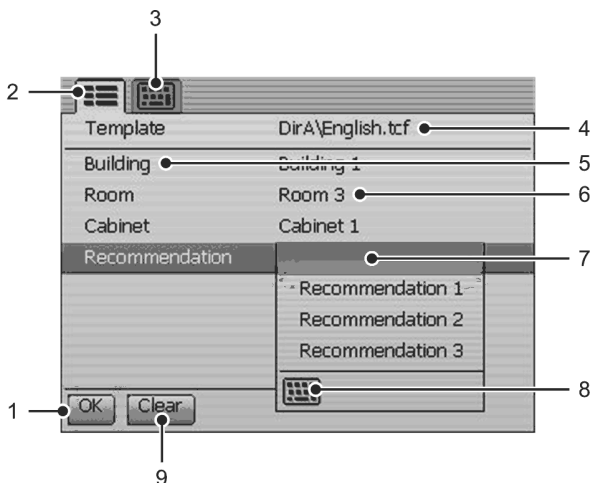

8

**Explanation**

This table explains the figure above:

<b>1</b>	OK button You select this button to confirm and save the text annotation.
<b>2</b>	Tab for the text annotation work area (to select from pre-defined strings)
<b>3</b>	Tab for the image description work area (to enter the freetext mode, using the stylus pen)
<b>4</b>	Filename indicator for the text annotation file
<b>5</b>	Text annotation label
<b>6</b>	Text annotation value
<b>7</b>	Submenu displaying additional text annotation values
<b>8</b>	Keyboard button You select this button to go to the keyboard and enter text using the stylus pen.

---

9	<b>Clear button</b> You select this button to clear the selected tab from all input data.
---	--

**SEE ALSO**

For information about adding a text annotation to an infrared image, see section 14.3 – Adding a text annotation on page 84.

---

Figure

This figure shows the image description work area:

10765703.a.1

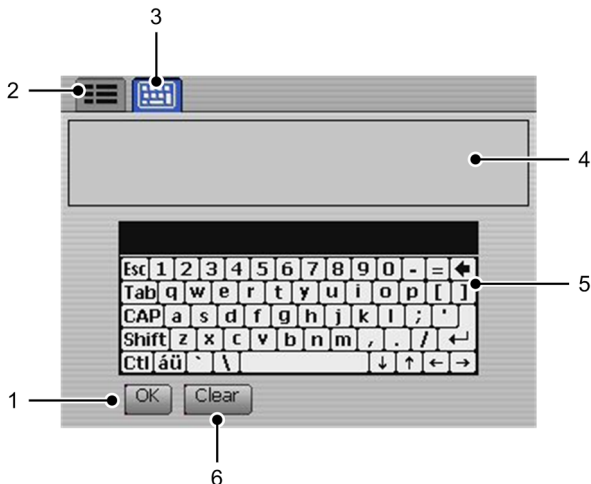

8

Explanation

This table explains the figure above:

1	OK button You select this button to confirm and save the text annotation.
2	Tab for the text annotation work area (to select from pre-defined strings)
3	Tab for the image description work area (to enter the free text mode, using the stylus pen)
4	Preview window for the image description
5	Keyboard
6	Clear button You select this button to clear the selected tab from all input data.

SEE ALSO

For information about adding an image description to an infrared image, see section 14.4 – Adding an image description on page 87.

## 8.2.4 Operation mode area

### NOTE

- The operation mode area becomes visible when you push the Mode button.
- To navigate in the area, use either the joystick or the stylus pen.

### Figure

10765803.a1

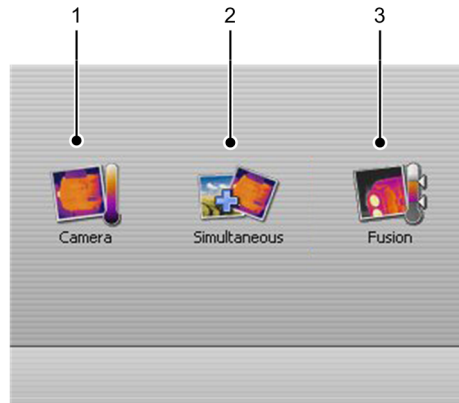

### Explanation

This table explains the figure above:

<b>1</b>	<p><b>Camera mode</b></p> <p>This is the most commonly used operation mode of the camera.</p> <p>If you select this mode, and briefly push the Preview/Save button, an infrared image of your target of interest is saved to the SD Memory Card.</p> <p>If you push and hold down the Preview/Save button for more than one second, the documentation toolbar will be displayed.</p>
<b>2</b>	<p><b>Simultaneous snapshot mode</b></p> <p>If you select this mode, and briefly push the Preview/Save button, the camera will automatically save a digital photo at the same time as it saves the infrared image.</p>
<b>3</b>	<p><b>Fusion mode</b></p> <p>If you select this mode, and briefly push the Preview/Save button, the camera will merge the live infrared image with a live digital photo. This can make it easier to analyze the image and locate faults and anomalies in the target.</p> <p>At this stage you can use the joystick to adjust the temperature levels for the fusion image. For example, you can set the temperature levels so that one temperature span is displayed for the infrared image and one for the digital photo.</p>

INTENTIONALLY LEFT BLANK

---

# 9 Navigating the menu system

Figure

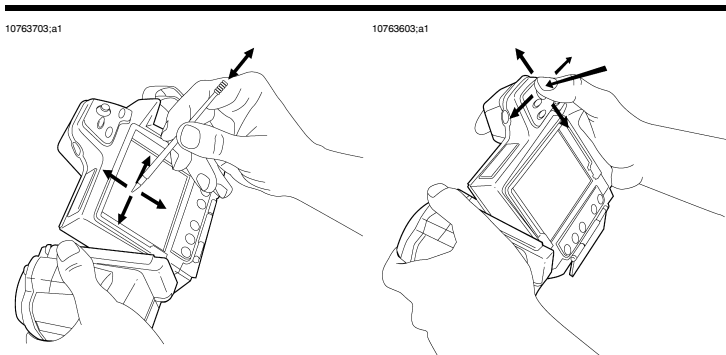

---

Explanation

The figure above shows the two ways to navigate the menu system in the camera:

- Using the stylus pen to navigate the menu system (left).
- Using the joystick to navigate the menu system (right).

You can also use a combination of the two.

In this manual it is assumed that the joystick is used, but most tasks can also be carried out using the stylus pen.

---

INTENTIONALLY LEFT BLANK



---

# 10 External devices and storage media

---

## General

You can connect the following external devices and storage media to the camera:

- A power supply.
  - A video monitor.
  - A computer to move images and other files to and from the camera.
  - An external USB device, such as a USB keyboard or USB memory stick.
  - A headset to record and listen to voice comments.
  - One SD Memory Card.
-

## 10.1 Connecting external devices

Figure

10759303.a2

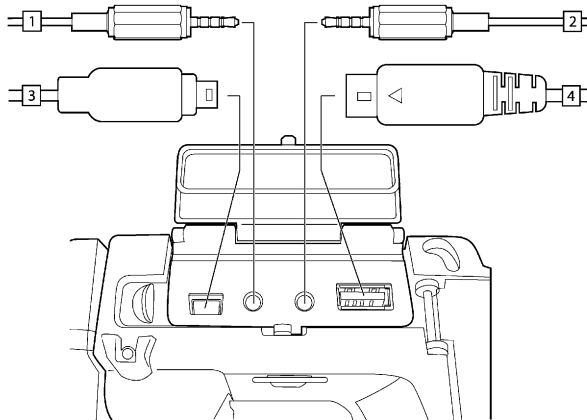

### Explanation

This table explains the figure above:

1	To connect a headset to the camera to record and listen to voice comment, use a headset cable and this socket.
2	To connect a video monitor to the camera, use a CVBS cable (a composite video cable) and this socket.
3	To connect a computer to the camera to move images and files to and from the camera, use a USB Mini-B cable and this socket.
4	To connect an external USB device to the camera, use a USB-A cable and this socket.

## 10.2

**Inserting SD Memory Cards**

Figure

10759503.a1

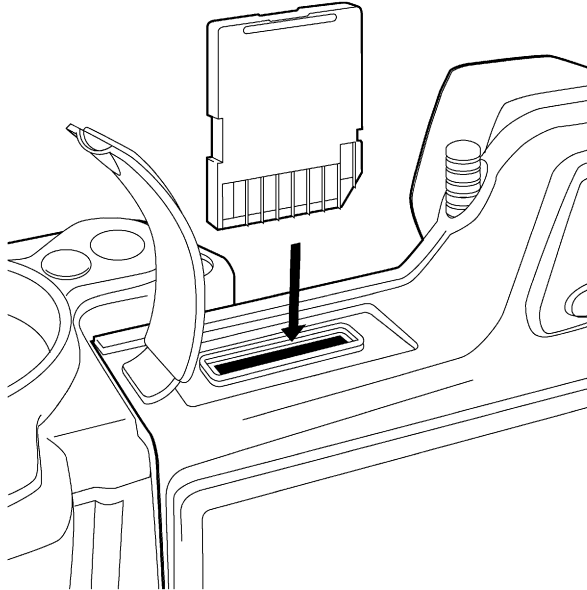

## Procedure

Follow this procedure to insert an SD Memory Card:

1	Open the rubber cover that protects the card slot.
2	Push the SD Memory Card firmly into the card slot, until a clicking sound is heard.

---

# 11 Handling the camera

## 11.1 *Charging the battery*

---

**NOTE** You must charge the battery for four hours before you start using the camera for the first time.

---

**General** You must charge the battery when a low battery voltage warning is displayed on the screen.

Follow one of these procedures to charge the battery:

- Use the combined power supply and battery charger to charge the battery when it is inside the camera.
  - Use the combined power supply and battery charger to charge the battery when it is outside the camera.
  - Use the stand-alone battery charger to charge the battery
- 

**SEE** For information on how to charge the battery, see the following sections:

- Section 11.1.1 – Using the combined power supply and battery charger to charge the battery when it is inside the camera on page 45
  - Section 11.1.2 – Using the combined power supply and battery charger to charge the battery when it is outside the camera on page 46
  - Section 11.1.3 – Using the stand-alone battery charger to charge the battery on page 47
-

---

### 11.1.1 Using the combined power supply and battery charger to charge the battery when it is inside the camera

---

**NOTE** For brevity, the ‘combined power supply and battery charger’ is called the ‘power supply’ below.

---

**Procedure** Follow this procedure to use the power supply to charge the battery when it is inside the camera:

<b>1</b>	Open the battery compartment lid.
<b>2</b>	Connect the power supply cable plug to the connector on the battery.
<b>3</b>	Connect the power supply mains-electricity plug to a mains socket.
<b>4</b>	Disconnect the power supply cable plug when the green light of the battery condition indicator is continuous.

---

**SEE ALSO** For information about the battery condition indicator, see section 7.4 – Battery condition indicator on page 23.

---

### 11.1.2 Using the combined power supply and battery charger to charge the battery when it is outside the camera

---

**NOTE** For brevity, the ‘combined power supply and battery charger’ is called the ‘power supply’ below.

---

**Procedure** Follow this procedure to use the power supply to charge the battery when it is outside the camera:

<b>1</b>	Put the battery on a flat surface.
<b>2</b>	Connect the power supply cable plug to the connector on the battery.
<b>3</b>	Connect the power supply mains-electricity plug to a mains socket.
<b>4</b>	Disconnect the power supply cable plug when the green light of the battery condition indicator is continuous.

---

**SEE ALSO** For information about the battery condition indicator, see section 7.4 – Battery condition indicator on page 23.

---

---

### 11.1.3 Using the stand-alone battery charger to charge the battery

---

**Procedure**

Follow this procedure to use the stand-alone battery charger to charge the battery:

<b>1</b>	Put the battery in the stand-alone battery charger.
<b>2</b>	Connect the power supply cable plug to the connector on the stand-alone battery charger.
<b>3</b>	Connect the power supply mains-electricity plug to a mains socket.
<b>4</b>	Disconnect the power supply cable plug when the green light of the battery condition indicator is continuous.

---

**SEE ALSO**

For information about the battery condition indicator, see section 7.4 – Battery condition indicator on page 23.

---

## 11.2 Inserting the battery

**NOTE** Use a clean, dry cloth to remove any water or moisture on the battery before you insert it.

**Procedure** Follow this procedure to insert the battery:

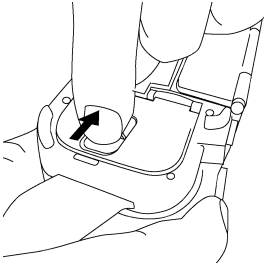
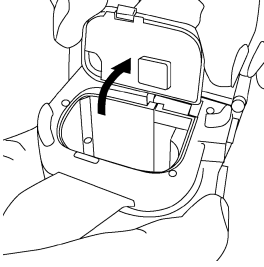
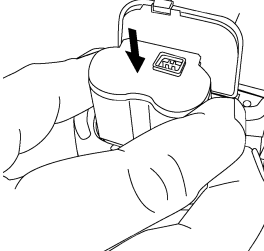
<p><b>1</b></p> <p>10759603.a1</p>	<p>Push the release button on the battery compartment cover to unlock it.</p> 
<p><b>2</b></p> <p>10759703.a1</p>	<p>Open the cover to the battery compartment.</p> 
<p><b>3</b></p> <p>10759803.a1</p>	<p>Push the battery into the battery compartment until the battery locking mechanism engages.</p> 



**4** Close the cover to the battery compartment.



10759903.a1



## 11.3 Removing the battery

Procedure

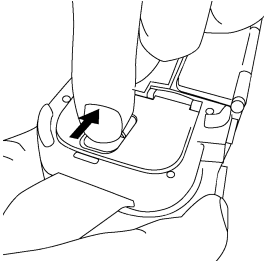
Follow this procedure to remove the battery:

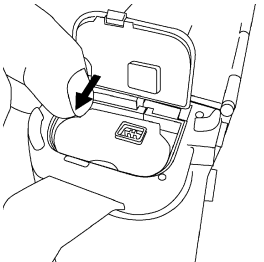
<p><b>1</b></p>	<p>Push the release button on the battery compartment cover to unlock it.</p> <p>10759603.a1</p> 
<p><b>2</b></p>	<p>Open the cover to the battery compartment.</p> <p>10763903.a1</p> 
<p><b>3</b></p>	<p>Push the red release button in the direction of the arrow to unlock the battery.</p> <p>10760003.a2</p> 

- 4** Pull out the battery from the battery compartment.

10760103,a1

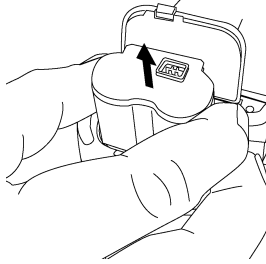

## 11.4 *Turning on the camera*

---

Procedure To turn on the camera, push and release the On/Off button.

---

## 11.5 *Turning off the camera*

---

Procedure To turn off the camera, push and hold down the On/Off button for more than 0.2 second.

---

## 11.6 *Adjusting the angle of lens*

### General

To make your working position as comfortable as possible, you can adjust the angle of the lens.

### Figure

10760203.a1

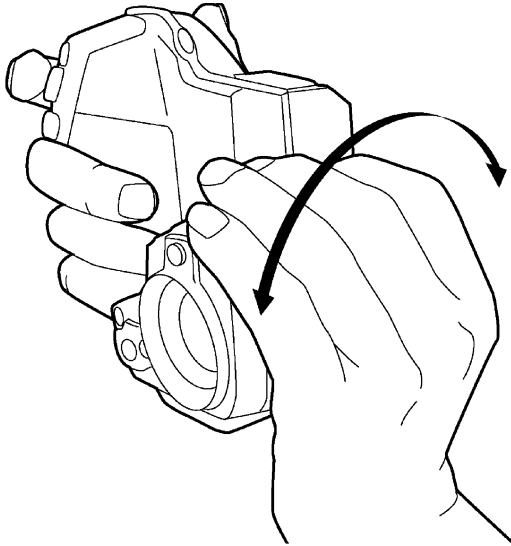

### Procedure

To adjust the angle, tilt the lens up or down.

## 11.7 Mounting an additional infrared lens



### NOTE

Do not touch the lens surface when you mount an infrared lens. If this happens, clean the lens according to the instructions in section 16.2 – Infrared lens on page 96.

### Procedure

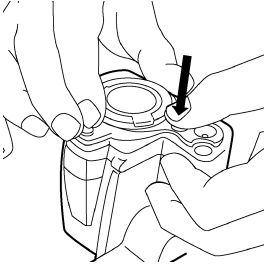
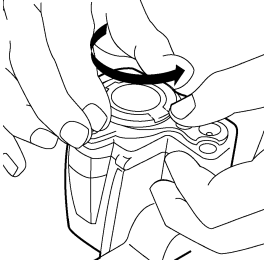
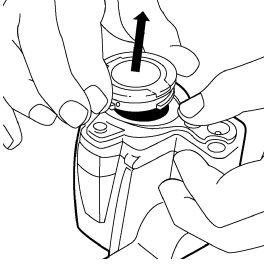
Follow this procedure to mount an additional infrared lens:

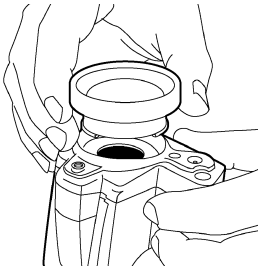
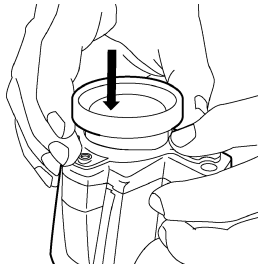
<p><b>1</b></p> <p>10764003.a1</p>	<p>Push the lens release button to unlock the lens cap.</p> 
<p><b>2</b></p> <p>10764103.a1</p>	<p>Rotate the lens cap 30° counter-clockwise (looking at the front of the lens).</p> 
<p><b>3</b></p> <p>10764203.a1</p>	<p>Carefully pull out the lens cap from the bayonet ring.</p> 

<p><b>4</b></p>	<p>Correctly position the lens in front of the bayonet ring.</p> <p>10764303.a1</p> 
<p><b>5</b></p>	<p>Carefully push the lens into position.</p> <p>10764403.a1</p> 
<p><b>6</b></p>	<p>Rotate the lens 30° clockwise (looking at the front of the lens).</p> <p>10764503.a1</p> 



## 11.8 Removing an additional infrared lens

### NOTE

- Do not touch the lens surface when you remove an infrared lens. If this happens, clean the lens according to the instructions in section 16.2 – Infrared lens on page 96.
- When you have removed the lens, put the lens caps on the lens immediately, to protect it from dust and fingerprints.

### Procedure

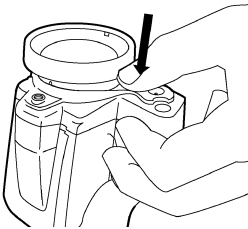
Follow this procedure to remove an additional infrared lens:

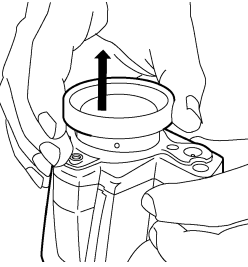
<p>1</p>	<p>Push the lens release button lens to unlock the lens.</p> <p>10764603.a1</p> 
<p>2</p>	<p>Rotate the lens counter-clockwise 30° (looking at the front of the lens).</p> <p>10764703.a1</p> 
<p>3</p>	<p>Carefully pull out the lens from the bayonet ring.</p> <p>10764803.a1</p> 

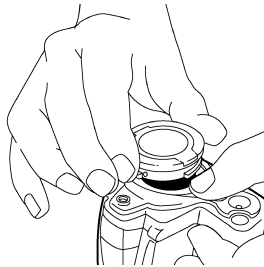
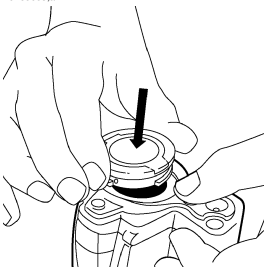
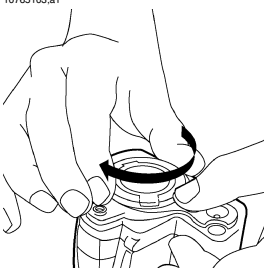

<p><b>4</b></p>	<p>Correctly position the lens cap in front of the bayonet ring.</p> <p>10764903.a1</p> 
<p><b>5</b></p>	<p>Carefully push the lens cap into position.</p> <p>10765003.a1</p> 
<p><b>6</b></p>	<p>Rotate the lens 30° clockwise (looking at the front of the lens).</p> <p>10765103.a1</p> 

## 11.9 Attaching the sunshield

### General

You can attach a sunshield to the camera to make the LCD screen easier to see in sunlight.

### Procedure

Follow this procedure to attach the sunshield to the camera:

- 1 Align the two front tabs of the sunshield with the corresponding two notches at the top of the screen.

10765203.a1

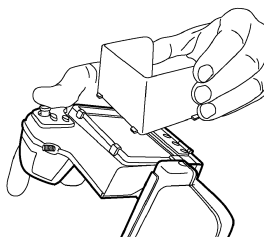

- 2 Push the front part of the sunshield into position. Make sure that the two tabs mate with the corresponding notches.

10765303.a1

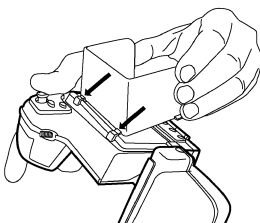

- 3 Carefully hold together the two rear wings of the sunshield.

10765403.a1

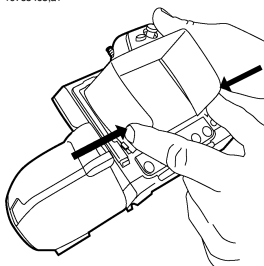

- 4** Push the rear part of the sunshield toward the screen, and then release your grip. Make sure that the two tabs mate with the corresponding notches.

10765503.a1

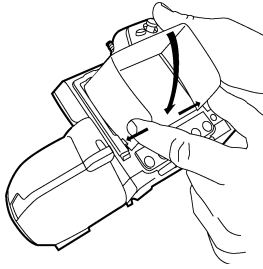

## 11.10 Using the laser pointer

Figure

10760303.a1

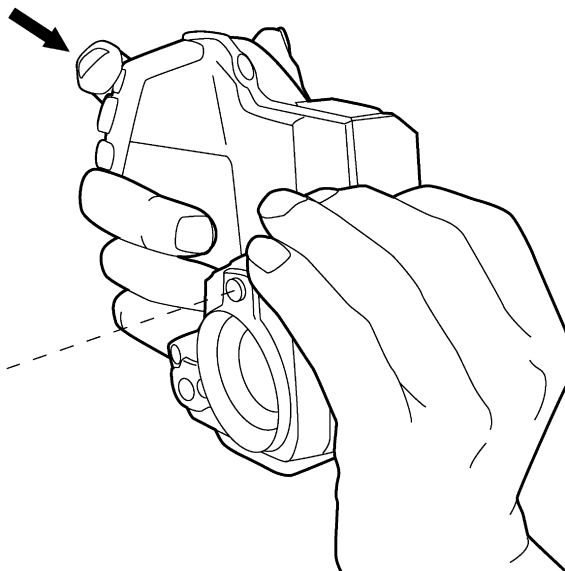

**Procedure**

Follow this procedure to use the laser pointer:

1	To turn on the laser pointer, push and hold the laser pointer button.
2	To turn off the laser pointer, release the laser pointer button.

**NOTE**

The laser pointer may not be enabled in all markets.

---

# 12 Working with images

## 12.1 *Adjusting the infrared camera focus*

### Procedure

---

To adjust the infrared camera focus, do one of the following:

- Push the focus button left for far focus.
- Push the focus button right for near focus.
- Briefly push the focus button toward the camera button to autofocus.

### NOTE

---

It is important that you hold the camera steady while autofocusing.

---

## 12.2 *Previewing an image*

---

### General

In preview mode, you can add various types of annotations to the image before you save it. You do this by using the documentation toolbar that is automatically displayed when you preview an image.

In preview mode you can also check that the image contains the required information before you save it to the SD Memory Card.

---

### Procedure

To preview an image, push and hold down the Preview/Save button for more than one second.

---

### SEE ALSO

- For more information about the documentation toolbar, see section 8.1.2 – Documentation toolbar on page 27.
  - For more information about adding annotations, see section 14 – Annotating images on page 81.
-

## 12.3 Saving an image

### General

You can save one or more images to the SD Memory Card.

### Image capacity

This table gives information on the *approximate* number of images that can be saved on SD Memory Cards:

Card size	No voice annotation	Incl. 30 seconds voice annotation
256 MB	500	250
512 MB	1000	500
1 GB	2000	1000

### Procedure

To save an image without previewing, briefly push the Preview/Save button.

## 12.4 *Opening an image*

---

**General**

When you save an image, it is stored on the SD Memory Card. To display the image again, you can recall it from the SD Memory Card.

---

**Procedure**

Follow this procedure to open an image:

<b>1</b>	Push the Archive button to open the most recently saved image.
<b>2</b>	If you want to open another image, do one of the following: <ul style="list-style-type: none"><li>▪ <b>1</b> Move the joystick upwards. This will display the images as thumbnails.</li><li>▪ <b>2</b> Select the image you want to open by using the joystick.</li><li>▪ <b>3</b> Push the Select button to open this image.</li><li>▪ Move the joystick left/right. This will display the next/previous image in the full image mode.</li></ul>

---

**NOTE**

To leave archive mode, push the Archive button.

---



## 12.5 Adjusting an image manually

### General

An image can be adjusted *automatically* or *manually*.

These two modes are indicated in the top right corner of the screen by the letters A and M. You use the A/M button to switch between these two modes

### Example 1

This figure shows two infrared images of cable connection points. In the left image a correct analysis of the circled cable is difficult if you only auto-adjust the image. You can analyze this cable in more detail if you

- change the temperature scale level
- change the temperature scale span.

In the left image, the image is auto-adjusted. In the right image the maximum and minimum temperature levels have been changed to temperature levels near the object. On the temperature scale to the right of each image you can see how the temperature levels were changed.

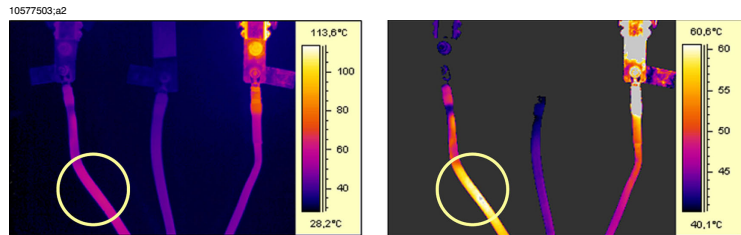

A (automatic)

M (manual)

**Example 2**

This figure shows two infrared images of an isolator in a power line.

In the left image, the cold sky and the power line structure are recorded at a minimum temperature of  $-26.0^{\circ}\text{C}$  ( $-14.8^{\circ}\text{F}$ ). In the right image the maximum and minimum temperature levels have been changed to temperature levels near the isolator. This makes it easier to analyze the temperature variations in the isolator.

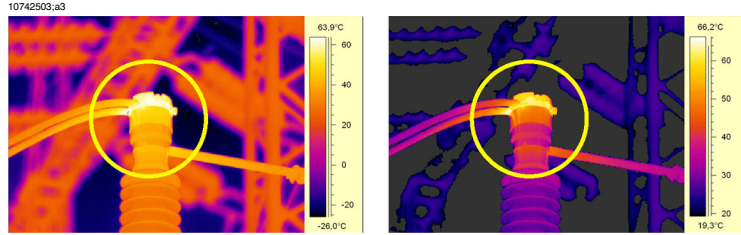

A (automatic)

M (manual)

**Changing  
temperature the  
scale level**

Follow this procedure to change the temperature scale level:

<b>1</b>	Make sure that the camera displays a live infrared image. To do this, select Camera mode using the Mode button and the joystick.
<b>2</b>	Make sure that the camera is in the manual adjustment mode. This is indicated by the letter M in the top right corner of the screen. If not, push the A/M button once.
<b>3</b>	To change the temperature scale level, move the joystick up/down. Note that this changes both the minimum and maximum scale level temperature by the same amount.

**Changing  
temperature the  
scale span**

Follow this procedure to change the temperature scale span:

<b>1</b>	Make sure that the camera displays a live infrared image.
<b>2</b>	Make sure that the camera is in the manual adjustment mode. This is indicated by the letter M in the top right corner of the screen. If not, push the A/M button once.
<b>3</b>	To change the temperature scale span, move the joystick left/right.

## 12.6 *Hiding overlay graphics*

---

**General** Overlay graphics provide information about an image. You can choose to hide overlay graphics incrementally in steps.

---

**Procedure** To hide overlay graphics in steps, push the Info button.

---

## 12.7 *Deleting an image*

### General

You can delete one or more images from the SD Memory Card.

### Procedure

Follow this procedure to delete an image:

<b>1</b>	Push the Archive button.
<b>2</b>	Do one of the following: <ul style="list-style-type: none"> <li>■ Move the joystick left/right to select the image you want to delete, then go to Step 5 below.</li> <li>■ Move the joystick upwards to display the images as thumbnails, then go to Step 3 below.</li> </ul>
<b>3</b>	Select the image you want to delete by using the joystick.
<b>4</b>	Push the joystick to open the image.
<b>5</b>	Push the joystick to display a menu.
<b>6</b>	On the menu, select <b>Delete image</b> by using the joystick.
<b>7</b>	Push the joystick to confirm.

## 12.8 *Deleting all images*

---

**General**

You can delete all images from the SD Memory Card.

---

**Procedure**

Follow this procedure to delete all images:

1	Push the Archive button.
2	Push the joystick to display a menu.
3	On the menu, select <b>Delete all</b> by using the joystick.
4	Push the joystick to confirm.

---

INTENTIONALLY LEFT BLANK

---

# 13

## Working with measurement tools and isotherms

### 13.1 *Setting up measurement tools*

---

**General**

To measure the temperature, you use one measurement tools or several. This section describes how you set up a spotmeter or an area.

---

**Procedure**

Follow this procedure to set up a spotmeter, or use an area:

1	Push the Measure button.
2	On the menu, select one of the following commands, using the joystick: <ul style="list-style-type: none"><li>■ Measure spot</li><li>■ Measure area.</li></ul>
3	Push the joystick to confirm the choice. For the area tool, you must also set if the maximum or minimum temperature should be displayed.
4	Push the Measure button to leave the menu. The temperature of the measurement tool is displayed in the top left corner of the screen.

---

**NOTE**

The area inside the center of the spotmeter must be covered by the object of interest, to display a correct temperature.

For accurate measurements, you must set the object parameters. See section 13.7 – Changing object parameters on page 79.

---

**SEE ALSO**

You can also set up measurement tools using the advanced mode, allowing more complex setups. For more information, see section 13.2 – Setting up measurement tools (advanced mode) on page 73.

---





## 13.2 Setting up measurement tools (advanced mode)

### General

You can use the advanced mode to set up measurement tools. This mode allows you to combine several tools, and to place them arbitrarily on the screen.

### Procedure

Follow this procedure to set up a measurement tool using the advanced mode:

<b>1</b>	Push the Measure button.
<b>2</b>	On the menu, select <b>Advanced</b> .
<b>3</b>	Push the joystick. This will display a measurement toolbar at the bottom of the screen.
<b>4</b>	<p>Do one or more of the following:</p> <ul style="list-style-type: none"> <li>▪ To create an isotherm, select the  toolbar button. This will display a menu on which you can select the type of isotherm you want to use.</li> <li>▪ To create a spotmeter, select the  toolbar button and push the joystick.</li> <li>▪ To create an area, select the  toolbar button and push the joystick.</li> </ul>

### SEE ALSO

- For more information on isotherms, see section 13.3 – Setting up isotherms on page 74.
- For more information on the measurement toolbar, see section 8.1.1 – Measurement toolbar on page 26.

## 13.3 Setting up isotherms

### General

You can make the camera display an isotherm color when certain measurement conditions are met. The following isotherms can be set up:

- An isotherm color that is displayed when a temperature rises above a preset value.
- An isotherm color that is displayed when a temperature falls below a preset value.
- An isotherm color that is displayed when the camera detects an area where there may be a risk of humidity in a building structure.
- An isotherm color that is displayed when the camera detects what may be an insulation deficiency in a wall.

### Setting up a high-temperature isotherm

Follow this procedure to set up an isotherm color that is displayed when a temperature rises above a preset value:

<b>1</b>	Push the Measure button.
<b>2</b>	On the menu, select <b>Detect high temperature</b> .
<b>3</b>	Push the joystick three times.
<b>4</b>	Move the joystick up/down to set the temperature at which you want the isotherm color to be displayed.
<b>5</b>	Push the joystick to confirm.
<b>6</b>	Push the Measure button to leave the main menu. The screen will now display the isotherm color when the temperature exceeds the set temperature level.

### Setting up a low-temperature isotherm

Follow this procedure to set up an isotherm color that is displayed when a temperature falls below a preset value:

<b>1</b>	Push the Measure button.
<b>2</b>	On the menu, select <b>Detect low temperature</b> .
<b>3</b>	Push the joystick three times.
<b>4</b>	Move the joystick up/down to set the temperature at which you want the isotherm color to be displayed.
<b>5</b>	Push the joystick to confirm.
<b>6</b>	Push the Measure button to leave the main menu. The screen will now display an isotherm color when the temperature falls below the set level.

**Setting up a humidity isotherm**

Follow this procedure to set up an isotherm color that is displayed when the camera detects an area where there may be a risk of humidity in a building structure:

<b>1</b>	Push the Measure button.
<b>2</b>	On the menu, select <b>Detect humidity</b> .
<b>3</b>	Push the joystick twice.
<b>4</b>	Use the joystick to set the following parameters: <ul style="list-style-type: none"> <li>■ <b>Rel. humidity limit:</b> The critical limit of relative humidity that you want to detect in a building structure. For example, mold will grow in areas where the relative humidity is less than 100%, and you may want to find such areas.</li> <li>■ <b>Rel. hum. limit:</b> The current relative humidity at the inspection site.</li> <li>■ <b>Atm. temp.:</b> The current atmospheric temperature at the inspection site.</li> </ul>
<b>5</b>	Push the joystick to confirm each choice.
<b>6</b>	Push the Measure button to leave the main menu. The screen will now display an isotherm color when the relative humidity exceeds the set level.

**Setting up an insulation isotherm**

Follow this procedure to set up an isotherm color that is displayed when the camera detects what may be an insulation deficiency in a wall:

<b>1</b>	Push the Measure button.
<b>2</b>	On the menu, select <b>Detect insulation</b> .
<b>3</b>	Push the joystick twice.
<b>4</b>	Use the joystick to set the following parameters: <ul style="list-style-type: none"> <li>■ <b>Inside temp.:</b> The temperature inside the building you are inspecting.</li> <li>■ <b>Outside temp.:</b> The temperature outside the building you are inspecting.</li> <li>■ <b>Thermal index:</b> The accepted energy loss through the wall. Different building codes recommend different values, but typical values are 60–80 for new buildings. Refer to your national building code for recommendations.</li> </ul>
<b>5</b>	Push the joystick to confirm each choice.
<b>6</b>	Push the Measure button to leave the main menu. The screen will now display an isotherm color when the the camera detects an area with an energy loss higher than the set value.

## 13.4 Removing measurement tools

### NOTE

The easiest way to remove a measurement tool is to select another menu command on the measurement menu. However, if you wish to remove all measurement tools you must follow the procedures in this section.

### Removing spotmeters and areas

Follow this procedure to remove a spotmeter or an area:

1	Push the Measure button.
2	On the menu, select <b>Advanced</b> . This will display the measurement menu.
3	Select the  toolbar button. This will display a menu listing all currently active measurement tools.
4	On the menu, select the measurement tool that you wish to remove. This will display a submenu.
5	On the submenu, select <b>Remove</b> and push the joystick.

### Removing isotherms

Follow this procedure to remove an isotherm:

1	Push the Measure button.
2	On the menu, select <b>Advanced</b> . This will display the measurement menu.
3	Select the  toolbar button. This will display a menu listing all currently active isotherms.
4	On the submenu, select <b>Off</b> and push the joystick.

## 13.5 Moving measurement tools

### Procedure

Follow this procedure to move a measurement tool:

1	Push the Measure button.
2	On the menu, select <b>Advanced</b> . This will display the measurement menu.
3	Select the  toolbar button. This will display a menu listing all currently active measurement tools.
4	On the menu, select the measurement tool that you wish to move. This will display a submenu.
5	On the submenu, select <b>Move</b> and push the joystick. This will make the measurement tool turn blue. You can now move the measurement tool using the joystick.

## 13.6 Resizing areas

### Procedure

Follow this procedure to resize an area:

1	Push the Measure button.
2	On the menu, select <b>Advanced</b> . This will display the measurement menu.
3	Select the  toolbar button. This will display a menu listing all currently active measurement tools.
4	On the menu, select the area. This will display a submenu.
5	On the submenu, select <b>Resize</b> and push the joystick. This will create resizing handles for the area. You can now resize the area using the joystick.

## 13.7 Changing object parameters

### General

For accurate measurements, you must set the object parameters. This procedure describes how to change the parameters.

### Types of parameters

The camera can use these object parameters:

- **Emissivity**, which determines how much of the radiation originates from the object as opposed to being reflected by it.
- **Reflected apparent temperature**, which is used when compensating for the radiation from the surroundings reflected by the object into the camera. This property of the object is called reflectivity.
- **Object distance**, i.e. the distance between the camera and the object of interest.
- **Atmospheric temperature**, i.e. the temperature of the air between the camera and the object of interest.
- **Relative humidity**, i.e. the relative humidity of the air between the camera and the object of interest.

### Recommended values

If you are unsure about the values, the following are recommended:

Atmospheric temperature	+20°C (+69°F)
Emissivity	0.95
Object distance	1.0 m (3.3 ft.)
Reflected apparent temperature	+20°C (+69°F)
Relative humidity	50%

**Procedure**

Follow this procedure to change the object parameters globally:

<b>1</b>	Push the Measure button.
<b>2</b>	On the menu, select <b>Parameters</b> .
<b>3</b>	Push the joystick.
<b>4</b>	Go to the parameter that you want to change, using the joystick.
<b>5</b>	Push the joystick.
<b>6</b>	Move the joystick up/down to change the value.
<b>7</b>	Push the joystick to confirm.
<b>8</b>	Push the Measure button to leave the menu.

**NOTE**

- Of the five parameters above, *emissivity* and *reflected apparent temperature* are the two most important to set correctly in the camera.
- You can also change object parameters from the Measure menu.

**SEE ALSO**

For more information about parameters, and how to correctly set emissivity and reflected apparent temperature, see section 24 – Thermographic measurement techniques on page 205.

---



---

# 14 Annotating images

---

## General

This section describes how to save additional information to an infrared image by using annotations.

The reason for using annotations is to make reporting and post-processing more efficient by providing essential information about the image, such as conditions, photos, sketches, where it was taken, and so on.

## SEE

- Section 14.1 – Adding a digital photo on page 82
  - Section 14.2 – Adding a voice annotation on page 83
  - Section 14.4 – Adding an image description on page 87
  - Section 14.3 – Adding a text annotation on page 84
  - Section 14.5 – Adding a sketch on page 88
  - Section 14.6 – Adding an image marker on page 89
-

## 14.1 Adding a digital photo

### General

When you save an infrared image you can also add a digital photo of the object of interest. This digital photo will automatically be associated with the infrared image, which will simplify post-processing and reporting in, for example, ThermoCAM™ Reporter.

### Procedure

Follow this procedure to take a digital photo:

1	To preview an image, push and hold down the Preview/Save button for more than one second. This will display the documentation toolbar.
2	On the documentation toolbar, select the  toolbar button and push the joystick.
3	Do one of the following: <ul style="list-style-type: none"><li>▪ To take the digital photo, push the Preview/Save button.</li><li>▪ To go back to infrared mode, push the joystick</li></ul>

## 14.2 Adding a voice annotation

### General

A voice annotation is an audio recording that is saved in an infrared image.

The voice annotation is recorded using a microphone headset connected to the camera. The recording can be played back in the camera, and in image analysis and reporting software from FLIR Systems.

### Procedure

Follow this procedure to add a voice annotation:

1	To preview an image, push and hold down the Preview/Save button for more than one second. This will display the documentation toolbar.
2	On the documentation toolbar, select the voice annotation  toolbar button, using the joystick.
3	Push the joystick. This will display the voice annotation toolbar.
4	Record the voice annotation. Make sure the microphone headset is connected to the camera.  For information about the toolbar buttons on the voice annotation toolbar, see section 8.1.4 – Voice annotation toolbar on page 29.
5	To save the voice annotation and close the voice annotation toolbar, select OK and push the joystick.
6	On the documentation toolbar, select Save and push the joystick.

## 14.3 Adding a text annotation

### General

A text annotation can be saved in an infrared image. Using this feature, you can annotate images using a file with predefined text strings.

This feature is a very efficient way of recording information when you are inspecting a large number of similar objects. The idea behind using text annotations is to avoid filling out forms or inspection protocols manually.

### Definition of label and value

The concept of *text annotation* is based on two important definitions – *label* and *value*. The following examples explain the difference between the two definitions.

Label (examples)	Value (examples)
Company	Company A Company B Company C
Building	Workshop 1 Workshop 2 Workshop 3
Section	Room 1 Room 2 Room 3
Equipment	Tool 1 Tool 1 Tool 3
Recommendation	Recommendation 1 Recommendation 2 Recommendation 3

### Differences between a text annotation and an image description

Text annotations and image descriptions differ in several ways:

- A *text annotation* is a proprietary annotation format from FLIR Systems, and the information cannot be retrieved by other vendors' software. An *image description* uses a standard tag in the JPG file format and can be retrieved by other software.
- The structure of a *text annotation* relies on *information pairs* (label and value), while an *image description* does not. An image description file can have virtually any information structure.

<b>Valid file format</b>	<p>The valid file format for a text annotation is *.tcf. A *.tcf file is a text file with one of the following two encodings:</p> <ul style="list-style-type: none"> <li>■ ANSI encoding (supported in ThermaCAM™ Reporter)</li> <li>■ UTF-8 encoding (not supported in ThermaCAM™ Reporter). This encoding must be used for all languages outside the ISO 8859-1 (Latin-1) encoding, e.g. Japanese or Cyrillic.</li> </ul> <p>To create a *.tcf file, write your text using a text editor (e.g. Notepad on PCs), save the file with ANSI or UTF-8 encoding. The file must have the suffix *.tcf: add or edit the filename as appropriate. You can also use the text annotation editor in ThermaCAM™ Reporter to create text annotations.</p>
<b>Maximum number of characters</b>	<p>The maximum number of characters in a *.tcf file is 512 characters per label and value, respectively.</p>
<b>Example markup structure</b>	<p>This is an example markup structure of a *.tcf file. The words between angled brackets are labels, and the words without angled brackets are values.</p> <pre> &lt;Company&gt; Company A Company B Company C &lt;Building&gt; Workshop 1 Workshop 2 Workshop 3 &lt;Section&gt; Room 1 Room 2 Room 3 &lt;Equipment&gt; Tool 1 Tool 2 Tool 3 &lt;Recommendation&gt; Recommendation 1 Recommendation 2 Recommendation 3 </pre>

## Procedure

Follow this procedure to add a text annotation:

<b>1</b>	To preview an image, push and hold down the Preview/Save button for more than one second. This will display the documentation toolbar.
<b>2</b>	Move the joystick left to select the text annotation  toolbar button.
<b>3</b>	Push the joystick to display the text annotation and image description work area. If the SD Memory Card contains a valid *.tcf file, the text annotation labels will be displayed as a list.  For information about the work area, see section 8.2.3 – Text annotation and image description work area on page 34.
<b>4</b>	Move the joystick up/down to select a text annotation label.
<b>5</b>	Push the joystick. This will display a submenu listing all available text annotation values for that label.
<b>6</b>	On the submenu, move the joystick up/down to select the value you want to use. You can also select the keyboard button at the bottom of the submenu if you want to create a value from scratch.
<b>7</b>	Push the joystick. This will close the submenu, and the value you selected will now be displayed to the right of the text annotation label.
<b>8</b>	Repeat Steps 4 to 7 for any other text annotation labels that you want to include in your text annotation.
<b>9</b>	Select the OK button at the bottom of the screen and push the joystick.
<b>10</b>	On the documentation toolbar, select Save and push the joystick. The text annotation is now saved in the image file.

## 14.4 Adding an image description

### General

An image description is a brief textual description that is saved in an infrared image. The image description can be retrieved from the image file using software from other companies.

### Differences between a text annotation and an image description

Image descriptions and text annotations differ in several ways:

- A *text annotation* is a proprietary annotation format from FLIR Systems, and the information cannot be retrieved by other vendors' software. An *image description* uses a standard tag in the JPG file format and can be retrieved by other software.
- The structure of a *text annotation* relies on *information pairs* (label and value), while an *image description* does not. An image description file can have virtually any information structure.

### Procedure

Follow this procedure to add an image description:

1	To preview an image, push and hold down the Preview/Save button for more than one second. This will display the documentation toolbar.
2	Move the joystick left to select the text annotation  toolbar button.
3	Push the joystick to display the text annotation and image description work area.  For information about the work area, see section 8.2.3 – Text annotation and image description work area on page 34.
4	Select the image description tab, using the joystick. This will display a keyboard on the screen.
5	Type your image description by tapping the keyboard buttons using the stylus pen.
6	Select the OK button at the bottom of the screen and push the joystick. The image description is now saved in the image file.
7	On the documentation toolbar, select Save and push the joystick.

## 14.5 Adding a sketch

### General

A sketch is freehand drawing that you create in a sketch work area separate from the infrared image using the stylus pen. You can use the sketch feature to mark areas of interest, write down comments and dimensions, etc.

### Procedure

Follow this procedure to add a sketch:

1	To preview an infrared image, push and hold down the Preview/Save button for more than one second.
2	On the documentation toolbar, select the  toolbar button, using the stylus pen. This will display the sketch work area. For information about the work area, see section 8.2.2 – Sketch work area on page 32.
3	In the sketch work area, draw your sketch using the stylus pen. You can change pen color, and erase your sketch using the eraser.
4	To confirm your sketch and leave the sketch work area, select <b>OK</b> .
5	On the documentation toolbar, select <b>Save</b> and push the joystick.





## 14.6 Adding an image marker

### General

An image marker is a line with an arrowhead, pointing to an area of interest in an infrared image.

### Procedure

Follow this procedure to add an image marker:

1	To preview an infrared image, push and hold down the Preview/Save button for more than one second.
2	On the documentation toolbar, select the  toolbar button, using the stylus pen.
3	On the image marker toolbar, select the  toolbar button, using the stylus pen. For information about the image marker toolbar, see section 8.1.3 – Image marker toolbar on page 28.
4	To create an image marker, draw a line in the image. The arrowhead will be created at the end of the line that you draw.
5	To save your image marker, select OK.
6	On the documentation toolbar, select Save and push the joystick.

INTENTIONALLY LEFT BLANK

---

# 15 Changing settings

## 15.1 *Changing image settings*

### General

---

On this tab you can change the following image settings:

- Color palette, i.e. how the infrared image is colored. A different palette can make it easier to analyze an image.
- Object temperature range, i.e. the temperature range used for measuring objects. You must change the temperature range according to the expected temperature of the object you are inspecting.

### Procedure

---

Follow this procedure to change one or more of the aforementioned settings:

1	Push the Setup button.
2	Go to the <b>Image</b> tab.
3	Select the setting that you want to change.
4	Push the joystick.
5	Move the joystick up/down to select a new value.
6	Push the Setup button to confirm the change and leave the setup mode.

---

## 15.2 Changing regional settings

---

### General

On this tab you can change the following image settings:

- Language
  - Date format (YY-MM-DD, MM/DD/YY, DD/MM/YY)
  - Time format (24 h or AM/PM)
  - Set date and time
  - Distance unit (meters or feet)
  - Temperature unit (°C or °F)
  - Video format (PAL or NTSC).
- 

### Procedure

Follow this procedure to change one or more of the aforementioned settings:

1	Push the Setup button.
2	Go to the <b>Regional</b> tab.
3	Select the setting that you want to change.
4	Push the joystick.
5	Move the joystick up/down to select a new value.
6	Push the Setup button to confirm the change and leave the setup mode.

---

## 15.3 Changing camera settings

### General

On this tab you can change the following settings:

- Camera lamp (On/Off)
- Display intensity (High, Medium, Low)
- Click sound (On/Off)
- Alarm sound (On/Off)
- Auto power off (Off/3 min/5 min/10 min/20 min)
- USB mode (Network disk/Mass Storage Device)
- Remember camera mode (Yes/No)
- Calibrate touch pad
- Reset to default settings.

### Procedure

Follow this procedure to change one or more of the aforementioned settings:

<b>1</b>	Push the Setup button.
<b>2</b>	Go to the Camera tab.
<b>3</b>	Select the setting that you want to change.
<b>4</b>	Push the joystick.
<b>5</b>	Move the joystick up/down to select a new value.
<b>6</b>	Push the Setup button to confirm the change and leave the setup mode.

INTENTIONALLY LEFT BLANK

---

# 16 Cleaning the camera

## 16.1 *Camera housing, cables, and other items*

---

### Liquids

Use one of these liquids:

- Warm water
  - A weak detergent solution
- 

### Equipment

A soft cloth

---

### Procedure

Follow this procedure to clean the camera housing, cables, and other items:

1	Soak the cloth in the liquid.
2	Twist the cloth to remove excess liquid.
3	Clean the part with the cloth.

---

### CAUTION

Do not apply solvents or similar liquids to the camera, the cables, or other items. This can cause damage.

---

## 16.2 *Infrared lens*

---

**Liquids**

Use one of these liquids:

- 96% isopropyl alcohol
  - A commercial lens cleaning liquid with more than 30% isopropyl alcohol
- 

**Equipment**

Cotton wool

---

**Procedure**

Follow this procedure to use a liquid to clean the infrared lens:

<b>1</b>	Soak the cotton wool in the liquid.
<b>2</b>	Twist the cotton wool to remove excess liquid.
<b>3</b>	Clean the lens one time only and discard the cotton wool.

---

**WARNING**

Make sure that you read all applicable MSDS (Material Safety Data Sheets) and warning labels on containers before you use a liquid: the liquids can be dangerous.

---

**CAUTION**

- Be careful when you clean the infrared lens. The lens has a delicate anti-reflective coating.
  - Do not clean the infrared lens too vigorously. This can damage the anti-reflective coating.
-



## Disclaimer

FLIR Systems reserves the right to discontinue models, parts or accessories, and other items, or to change specifications at any time without prior notice.

## Imaging and optical data

Field of view (FOV)	25° × 18.75°
Close focus limit	0.4 m (1.31 ft.)
Focal length	18.04 mm (0.710 in.)
Spatial resolution (IFOV)	1.36 mrad
Lens identification	Automatic
F-number	1.3
Thermal sensitivity/NETD	< 0.08°C (< 0.14°F) @ +30°C (+86°F)
Image frequency	Subject to geographical region: <ul style="list-style-type: none"> <li>■ 9 Hz</li> <li>■ 30 Hz</li> </ul>
Focus	Automatic or manual
Electronic zoom	Subject to camera model: <ul style="list-style-type: none"> <li>■ 1–8× Continuous, interpolating zooming on images</li> <li>■ 1–2× Continuous, interpolating zooming on images</li> </ul>
Panning	Panning over zoomed-in images

## Detector data

Detector type	Focal plane array (FPA), uncooled microbolometer
Spectral range	7.5–13 μm
Resolution	320 × 240 pixels

## Image presentation

Display	Built-in display, 3.5 in. (320 × 240 pixels)
Display type	Touch screen LCD
Color depth	16 k colors
Display, aspect ratio	3:2

## Measurement

Object temperature range	Subject to camera model
Accuracy	±2°C (±3.6°F) or ±2% of reading

## Digital camera

Digital camera, resolution	1.3 Mpixels (1280 × 1024 pixels), built-in
Digital camera, focus	Fixed focus
Digital camera, aspect ratio	5:4
Digital camera, image frequency	10 Hz
Digital camera, color depth	24 bits on a GretagMacBeth ColorCheckerChart with an illumination of 10 lux
Video lamp	1000 cd

## Laser pointer

Classification	Class 2
Laser type	Semiconductor AlGaInP diode laser
Laser power	1 mW
Laser wavelength	635 nm (red)
Note	The laser pointer may not be enabled in all markets.

**Data  
communication  
interfaces**

USB, purpose	<ul style="list-style-type: none"> <li>■ USB-A: External USB devices</li> <li>■ USB Mini-B: Data transfer to and from PC</li> </ul>
USB, standard	USB 2.0 full speed (12 Mbps)
USB, connector type	<ul style="list-style-type: none"> <li>■ USB-A connector</li> <li>■ USB Mini-B connector</li> </ul>
Audio, purpose	Microphone headset connection for voice annotation of images
Audio, connector type	4-pole 3.5 mm jack
Video, purpose	Composite video output
Video, standard	CVBS (ITU-R-BT.470 PAL/SMPTE 170M NTSC)
Video, connector type	4-pole 3.5 mm jack
Storage media	SD Memory Card

**Pin configuration  
for USB Mini-B  
connector**

10763203.a1

17

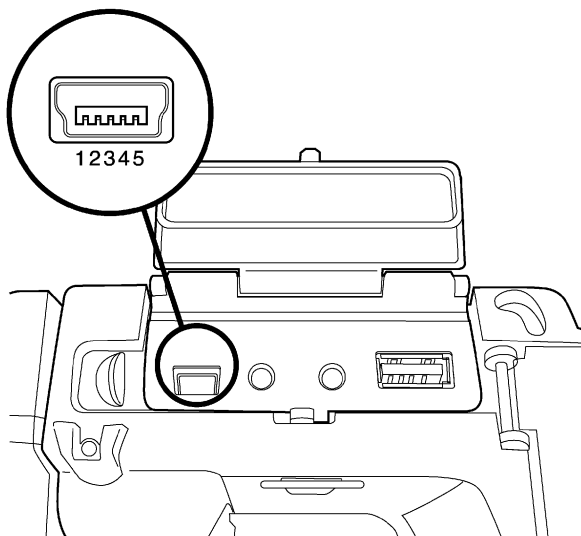

Pin	Configuration
1	+5 V (out)
2	USB -
3	USB +
4	N/C
5	Ground

**Pin configuration  
for microphone  
headset connector**

10763503.a1

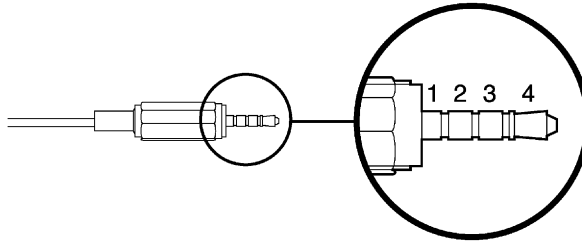

Pin	Configuration
1	Mic return
2	Headphone +
3	Mic in
4	Headphone -

**Pin configuration  
for video  
connector**

10763503.a1

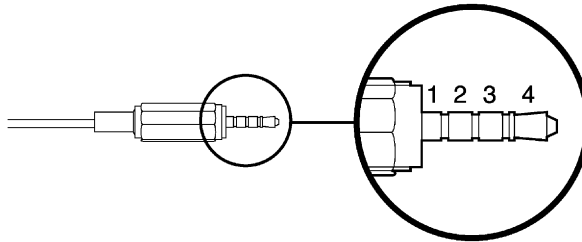

Pin	Configuration
1	Audio right
2	Ground
3	Video out
4	Audio left

**Pin configuration  
for USB-A  
connector**

10763303.a1

17

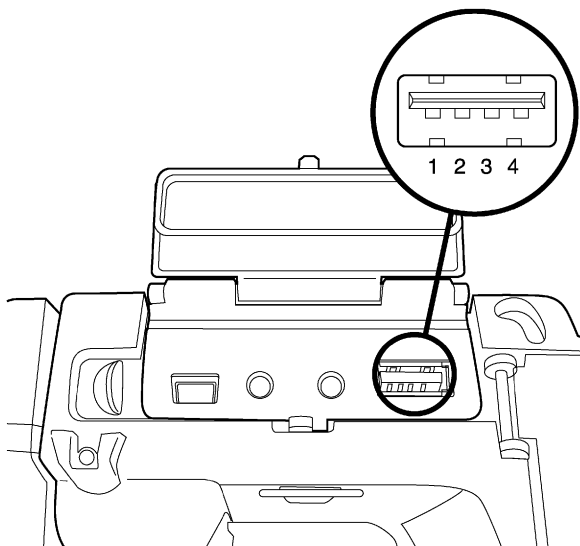

Pin	Configuration
1	+5 V (in)
2	USB -
3	USB +
4	Ground

## Power system

Battery type	Rechargeable Li Ion battery
Battery voltage	7.2 V
Battery capacity	2200 mAh, at +20°C to +25°C (+68°F to +77°F)
Battery operating time	Approximately 4 hours at +25°C (+77°F) ambient temperature and typical use
Charging system	<ul style="list-style-type: none"> <li>■ Use the combined power supply &amp; battery charger to charge the battery when it is inside or outside the camera.</li> <li>■ Use the stand-alone battery charger to charge the battery.</li> </ul>
Power management	Automatic shut down and sleep mode after a time period that the user can set
AC operation	AC adapter, 90–260 VAC input. 12 V output to camera
Voltage	11–16 VDC
Start-up time from sleep mode	Instant on

Pin configuration  
for power  
connector

10763403.a1

17

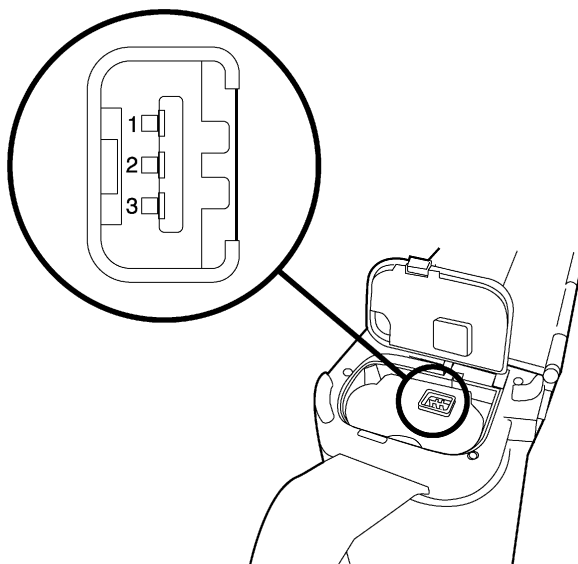

Pin	Configuration
1	+12 V
2	GND
3	GND



## Environmental data

Operating temperature range	–15°C to +50°C (+5°F to +122°F)
Storage temperature range	–40°C to +70°C (–40°F to +158°F)
Humidity (operating and storage)	IEC 68-2-30/24 h 95% relative humidity +25°C to +40°C (+77°F to +104°F)
EMC	<ul style="list-style-type: none"> <li>■ EN 61000-6-2:2001 (Immunity)</li> <li>■ EN 61000-6-3:2001 (Emission)</li> <li>■ FCC 47 CFR Part 15 Class B (Emission)</li> </ul>
Magnetic fields	EN 61 000-4-8, Test level 5 for continuous field (Severe industrial environment)
Encapsulation	<ul style="list-style-type: none"> <li>■ Camera housing and lens: IP 54 (IEC 60529)</li> <li>■ Transport case: IP 65 (IEC 60529)</li> </ul>
Bump	25 g (IEC 60068-2-29)
Vibration	2 g (IEC 60068-2-6)
Safety	Power supply and parts containing radio transmitters: EN/UL/CSA 60950-1

## Physical data

Camera weight, incl. battery	0.88 kg (1.94 lb.)
Battery weight	0.12 kg (0.26 lb.)
Camera size (L × W × H)	106.0 × 201.0 × 125.0 mm (4.17 × 7.91 × 4.92 in.), with built-in lens pointing forward
Battery size (L × W × H)	91.8 × 41.3 × 26.2 mm (3.61 × 1.63 × 1.03 in.)
Battery charger size (L × W × H)	80.2 × 97.8 × 46.5 mm (3.16 × 3.85 × 1.83 in.), without battery
Tripod mounting	UNC 1/4"-20
Material	<ul style="list-style-type: none"> <li>■ Polycarbonate + acrylonitrile butadiene styrene (PC-ABS)</li> <li>■ Thixomold magnesium</li> <li>■ Thermoplastic elastomer (TPE)</li> </ul>

IR lenses  
(optional)

17

30 mm/15° lens, Field of view (FOV)	15° x 11.3°
30 mm/15° lens, Close focus limit	1.2 m (3.93 ft.)
30 mm/15° lens, Focal length	30.38 mm (1.196 in.)
30 mm/15° lens, Spatial resolution (IFOV)	0.82 mrad
30 mm/15° lens, F-number	1.3
30 mm/15° lens, Size (Length × Diameter)	24.3 × 58 mm (0.96 × 2.28 in.)
30 mm/15° lens, Camera size (L × W × H)	121.1 × 201.0 × 125.0 mm (4.76 × 7.91 × 4.92 in.), with 15° lens pointing forward
30 mm/15° lens, Weight	0.092 kg (0.203 lb.), incl. two lens caps
10 mm/45° lens, Field of view (FOV)	44.9° x 33.7°
10 mm/45° lens, Close focus limit	0.2 m (0.66 ft.)
10 mm/45° lens, Focal length	9.66 mm (0.380 in.)
10 mm/45° lens, Spatial resolution (IFOV)	2.45 mrad
10 mm/45° lens, F-number	1.3
10 mm/45° lens, Size (Length × Diameter)	38.4 × 47 mm (1.51 × 1.85 in.)
10 mm/45° lens, Camera size (L × W × H)	135.2 × 201.0 × 125.0 mm (5.32 × 7.91 × 4.92 in.), with 45° lens pointing forward
10 mm/45° lens, Weight	0.105 kg (0.231 lb.), incl. two lens caps

**Field of view and distance,  
30 mm/15° lens**

10763103.a1

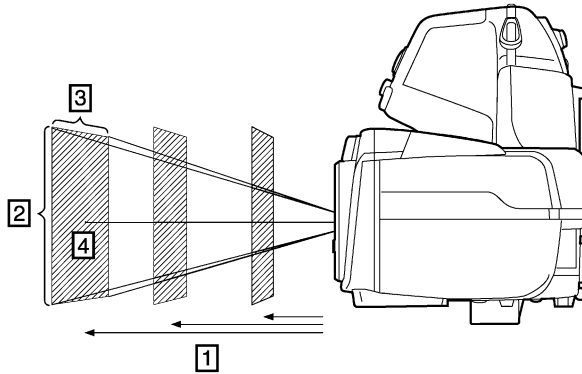

**Figure 17.1** Relationship between the field of view and distance. **1:** Distance to target; **2:** VFOV = vertical field of view; **3:** HFOV = horizontal field of view; **4:** IFOV = instantaneous field of view (size of one detector element).

This table gives examples of the field of view of a 30 mm/15° lens for different target distances:

10762803.a1

Focal length: 30.36 mm									
Resolution: 320 x 240 pixels									
Field of view in degrees: 15.0									
<b>D ---&gt;</b>			<b>2.00</b>	<b>5.00</b>	<b>10.00</b>	<b>25.00</b>	<b>50.00</b>	<b>100.00</b>	<b>m</b>
HFOV			0.53	1.32	2.63	6.58	13.17	26.33	<b>m</b>
VFOV			0.39	0.99	1.97	4.94	9.87	19.75	<b>m</b>
IFOV			1.65	4.11	8.23	20.57	41.15	82.29	<b>mm</b>
<b>D ---&gt;</b>			<b>6.56</b>	<b>16.39</b>	<b>32.79</b>	<b>81.97</b>	<b>163.93</b>	<b>327.87</b>	<b>ft.</b>
HFOV			1.73	4.32	8.63	21.58	43.17	86.34	<b>ft.</b>
VFOV			1.30	3.24	6.48	16.19	32.38	64.75	<b>ft.</b>
IFOV			0.06	0.16	0.32	0.81	1.62	3.24	<b>in.</b>
<b>Legend:</b>									
D = Distance to target in meters & feet									
HFOV = Horizontal field of view in meters & feet									
VFOV = Vertical field of view in meters & feet									
IFOV = Instantaneous field of view (size of one detector element) in millimeters & inches									

Field of view and distance,  
18 mm/25° lens  
lens (built-in)

10763103.a1

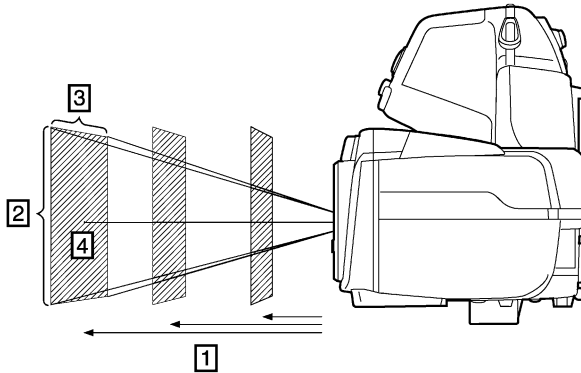

**Figure 17.2** Relationship between the field of view and distance. **1:** Distance to target; **2:** VFOV = vertical field of view; **3:** HFOV = horizontal field of view, **4:** IFOV = instantaneous field of view (size of one detector element).

This table gives examples of the field of view of a 18 mm/25° lens for different target distances:

10762903.a1

Focal length: 18.04 mm									
Resolution: 320 x 240 pixels									
Field of view in degrees: 25.0									
D --->	0.50	1.00	2.00	5.00	10.00	25.00	50.00	100.00	m
HFOV	0.22	0.44	0.89	2.22	4.43	11.09	22.17	44.35	m
VFOV	0.17	0.33	0.67	1.66	3.33	8.31	16.63	33.26	m
IFOV	0.69	1.39	2.77	6.93	13.86	34.65	69.29	138.58	mm
D --->	1.64	3.28	6.56	16.39	32.79	81.97	163.93	327.87	ft.
HFOV	0.73	1.45	2.91	7.27	14.54	36.35	72.70	145.40	ft.
VFOV	0.55	1.09	2.18	5.45	10.90	27.26	54.52	109.05	ft.
IFOV	0.03	0.05	0.11	0.27	0.55	1.36	2.73	5.46	in.
<b>Legend:</b>									
D = Distance to target in meters & feet									
HFOV = Horizontal field of view in meters & feet									
VFOV = Vertical field of view in meters & feet									
IFOV = Instantaneous field of view (size of one detector element) in millimeters & inches									

**Field of view & distance,  
10 mm/45° lens**

10763103.a1

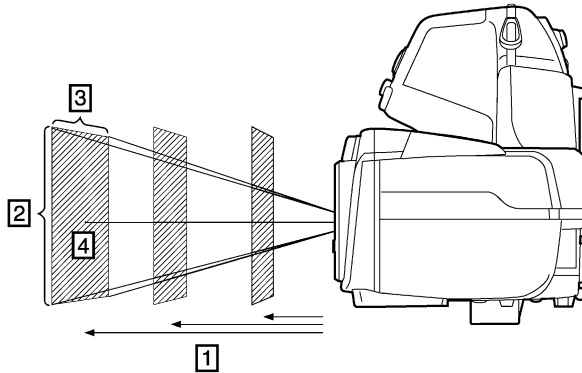

**Figure 17.3** Relationship between the field of view and distance. **1:** Distance to target; **2:** VFOV = vertical field of view; **3:** HFOV = horizontal field of view, **4:** IFOV = instantaneous field of view (size of one detector element).

This table gives examples of the field of view of a 10 mm/45° lens for different target distances:

10763003.a1

Focal length: 9.66 mm									
Resolution: 320 x 240 pixels									
Field of view in degrees: 44.9									
D --->	0.50	1.00	2.00	5.00	10.00	25.00	50.00	100.00	m
HFOV	0.41	0.83	1.66	4.14	8.28	20.70	41.41	82.82	m
VFOV	0.31	0.62	1.24	3.11	6.21	15.53	31.06	62.11	m
IFOV	1.29	2.59	5.18	12.94	25.88	64.70	129.40	258.80	mm
D --->	1.64	3.28	6.56	16.39	32.79	81.97	163.93	327.87	ft.
HFOV	1.36	2.72	5.43	13.58	27.15	67.88	135.76	271.53	ft.
VFOV	1.02	2.04	4.07	10.18	20.36	50.91	101.82	203.65	ft.
IFOV	0.05	0.10	0.20	0.51	1.02	2.55	5.09	10.19	in.
<b>Legend:</b>									
D = Distance to target in meters & feet									
HFOV = Horizontal field of view in meters & feet									
VFOV = Vertical field of view in meters & feet									
IFOV = Instantaneous field of view (size of one detector element) in millimeters & inches									

INTENTIONALLY LEFT BLANK

---

# 18 Dimensions

## 18.1 Camera

### 18.1.1 Camera dimensions

---

Figure

10760403.a1

18

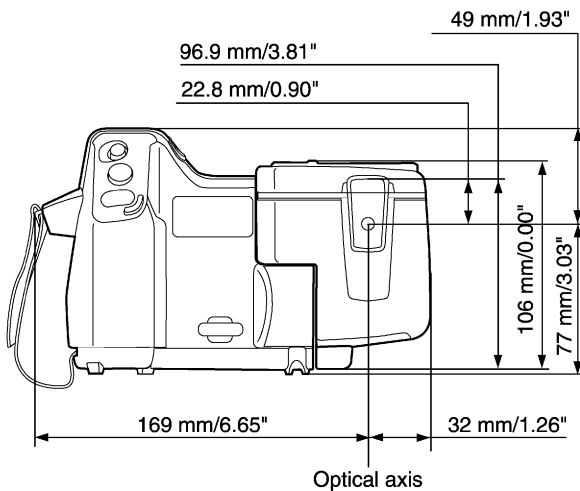

18.1.2 Camera dimensions, continued

Figure

10760503.a1

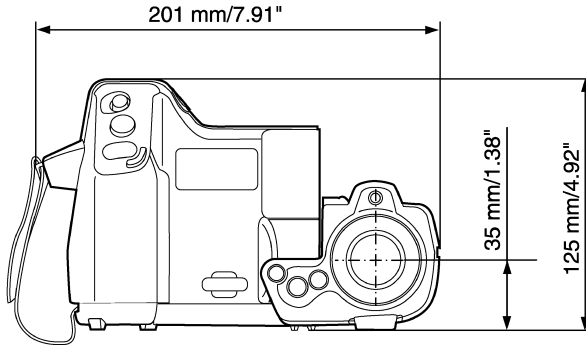



### 18.1.3 Camera dimensions, continued

Figure

10760603.a1

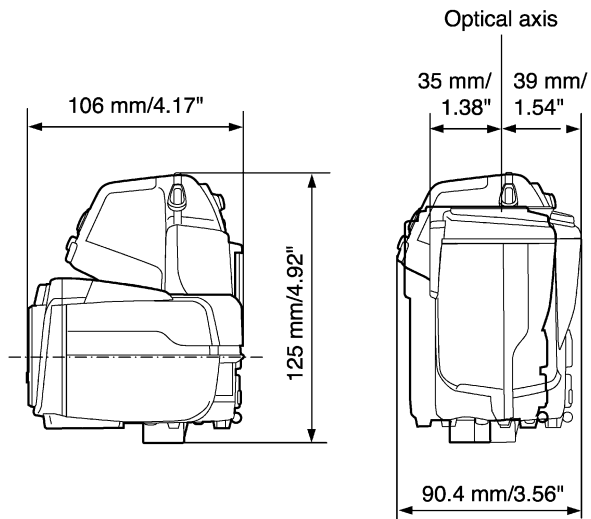

18.1.4 Camera dimensions, continued (with 30 mm/15° lens)

Figure

10762703.a1

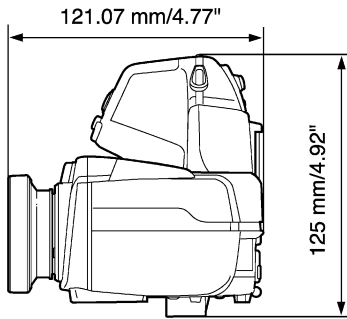

18.1.5 Camera dimensions, continued (with 10 mm/45° lens)

Figure

10762603.a1

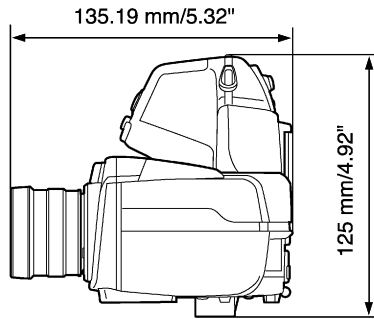

## 18.2 Battery

Figure

10602103.a2

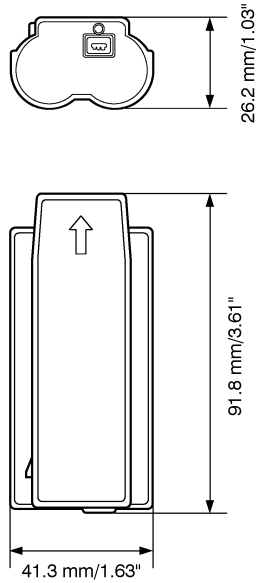

18

**NOTE**

Use a clean, dry cloth to remove any water or moisture on the battery before you install it.

## 18.3 Stand-alone battery charger

Figure

10602203.a3

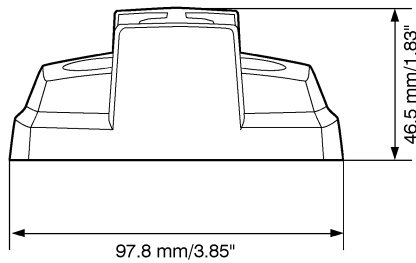
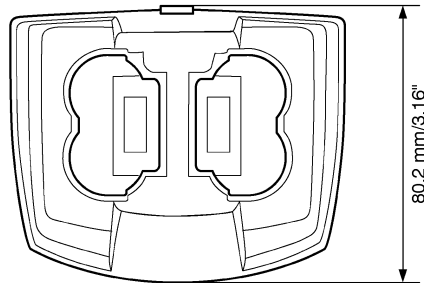
**NOTE**

Use a clean, dry cloth to remove any water or moisture on the battery before you install it.

## 18.4 Stand-alone battery charger with the battery

Figure

10602303.a3

18

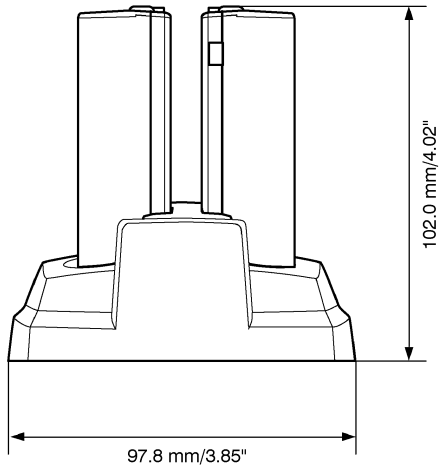

**NOTE**

Use a clean, dry cloth to remove any water or moisture on the battery before you install it.

## 18.5 Infrared lens (30 mm/15°)

Figure

10762503.a1

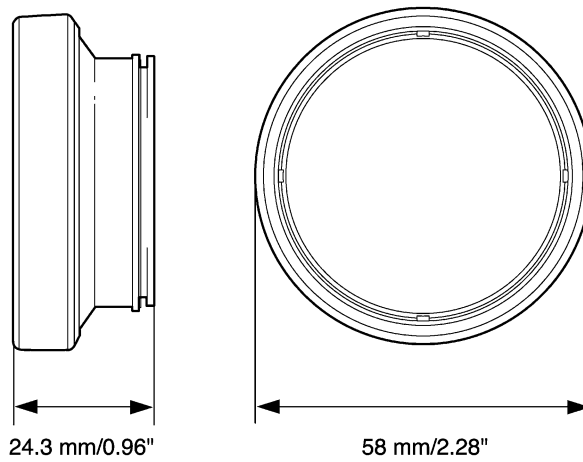

18

18.6 *Infrared lens (10 mm/45°)*

Figure

10762403.a1

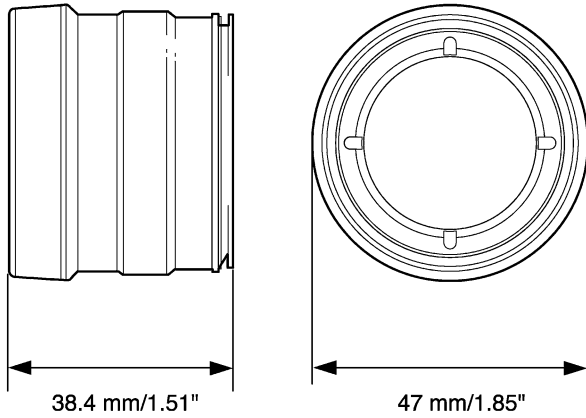



---

# 19 Application examples

## 19.1 *Moisture & water damage*

### General

---

It is often possible to detect moisture and water damage in a house by using an infrared camera. This is partly because the damaged area has a different heat conduction property and partly because it has a different thermal capacity to store heat than the surrounding material.

---

### NOTE

Many factors can come into play as to how moisture or water damage will appear in an infrared image.

For example, heating and cooling of these parts takes place at different rates depending on the material and the time of day. For this reason, it is important that other methods are used as well to check for moisture or water damage.

---

### Figure

The image below shows extensive water damage on an external wall where the water has penetrated the outer facing because of an incorrectly installed window ledge.

10739503.a1

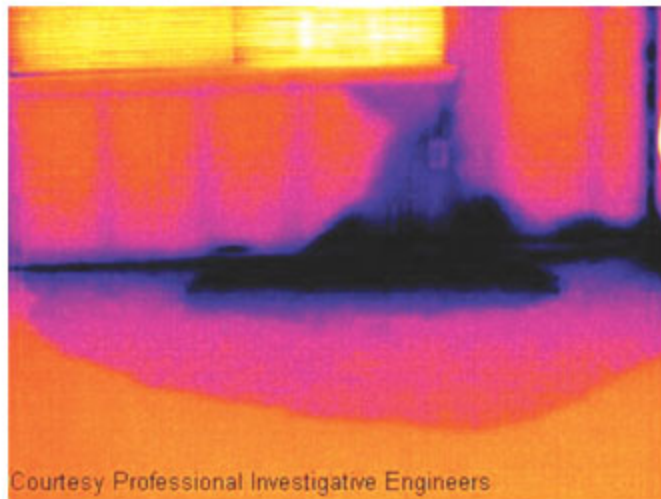

## 19.2 *Faulty contact in socket*

---

### General

Depending on the type of connection a socket has, an improperly connected wire can result in local temperature increase. This temperature increase is caused by the reduced contact area between the connection point of the incoming wire and the socket, and can result in an electrical fire.

---

### NOTE

A socket's construction may differ dramatically from one manufacturer to another. For this reason, different faults in a socket can lead to the same typical appearance in an infrared image.

Local temperature increase can also result from improper contact between wire and socket, or from difference in load.

---

### Figure

The image below shows a connection of a cable to a socket where improper contact in the connection has resulted in local temperature increase.

10739603\_a1

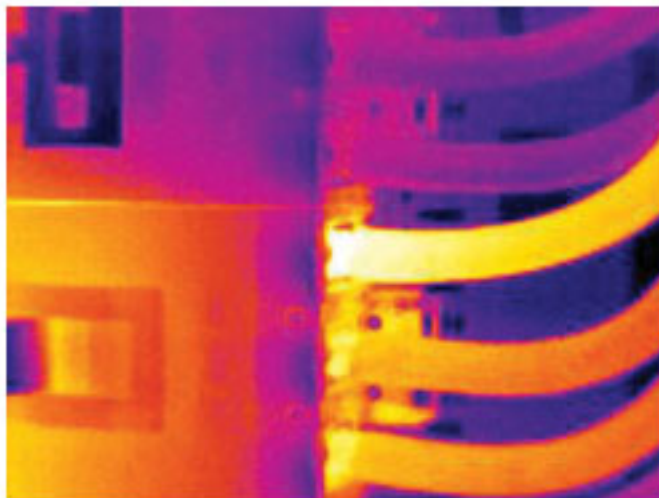

## 19.3 Oxidized socket

### General

Depending on the type of socket and the environment in which the socket is installed, oxides may occur on the socket's contact surfaces. These oxides can lead to locally increased resistance when the socket is loaded, which can be seen in an infrared image as local temperature increase.

### NOTE

A socket's construction may differ dramatically from one manufacturer to another. For this reason, different faults in a socket can lead to the same typical appearance in an infrared image.

Local temperature increase can also result from improper contact between a wire and socket, or from difference in load.

### Figure

The image below shows a series of fuses where one fuse has a raised temperature on the contact surfaces against the fuse holder. Because of the fuse holder's blank metal, the temperature increase is not visible there, while it is visible on the fuse's ceramic material.

10739703.a1

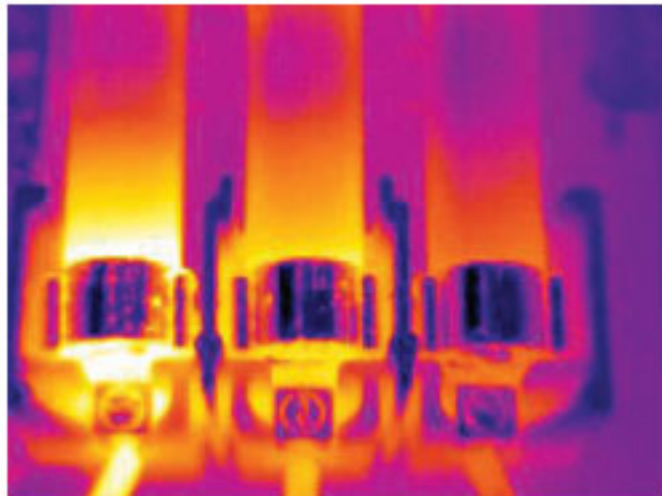

## 19.4 *Insulation deficiencies*

---

### General

Insulation deficiencies may result from insulation losing volume over the course of time and thereby not entirely filling the cavity in a frame wall.

An infrared camera allows you to see these insulation deficiencies because they either have a different heat conduction property than sections with correctly installed insulation, and/or show the area where air is penetrating the frame of the building.

---

### NOTE

When you are inspecting a building, the temperature difference between the inside and outside should be at least 10°C (18°F). Studs, water pipes, concrete columns, and similar components may resemble an insulation deficiency in an infrared image. Minor differences may also occur naturally.

---

### Figure

In the image below, insulation in the roof framing is lacking.. Due to the absence of insulation, air has forced its way into the roof structure, which thus takes on a different characteristic appearance in the infrared image.

10739803.a1

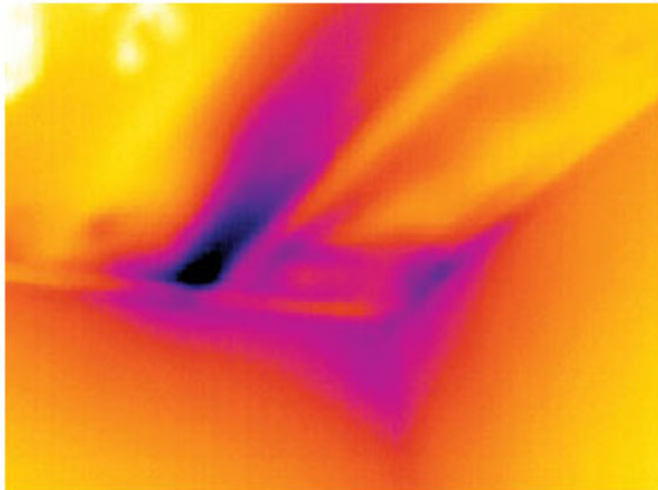

## 19.5 Draft

### General

Draft can be found under baseboards, around door and window casings, and above ceiling trim. This type of draft is often possible to see with an infrared camera, as a cooler airstream cools down the surrounding surface.

### NOTE

When you are investigating draft in a house, there should be sub-atmospheric pressure in the house. Close all doors, windows, and ventilation ducts, and allow the kitchen fan to run for a while before you take the infrared images.

An infrared image of draft often shows a typical stream pattern. You can see this stream pattern clearly in the picture below.

Also keep in mind that drafts can be concealed by heat from floor heating circuits.

### Figure

The image below shows a ceiling hatch where faulty installation has resulted in a strong draft.

10739903.a1

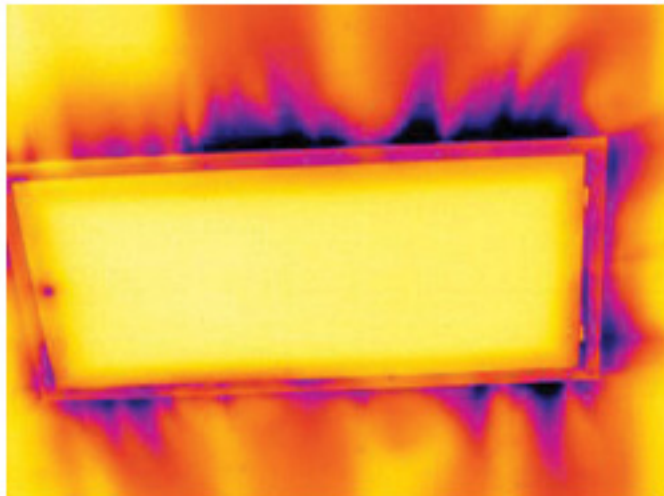

INTENTIONALLY LEFT BLANK

---

# 20 Introduction to building thermography

## 20.1 *Important note*

All camera functions and features that are described in this section may not be supported by your particular camera configuration.

## 20.2 *Typical field investigations*

### 20.2.1 Guidelines

As will be noted in subsequent sections there are a number of general guidelines the user should take heed of when carrying out building thermography inspection. This section gives a summary of these guidelines.

#### 20.2.1.1 *General guidelines*

- The emissivity of the majority of building materials fall between 0.85 and 0.95. Setting the emissivity value in the camera to 0.90 can be regarded as a good starting point.
- An infrared inspection alone should never be used as a decision point for further actions. Always verify suspicions and findings using other methods, such as construction drawings, moisture meters, humidity & temperature datalogging, tracer gas testing etc.
- Change level and span to thermally tune the infrared image and reveal more details. The figure below shows the difference between a thermally untuned and a thermally tuned infrared image.

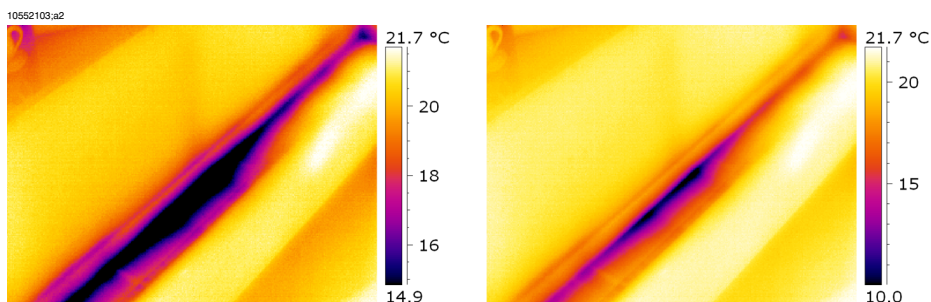

**Figure 20.1 LEFT:** A thermally untuned infrared image; **RIGHT:** A thermally tuned infrared image, after having changed level and span.

### 20.2.1.2 Guidelines for moisture detection, mold detection & detection of water damages

- Building defects related to moisture and water damages may only show up when heat has been applied to the surface, e.g. from the sun.
- The presence of water changes the thermal conductivity and the thermal mass of the building material. It may also change the surface temperature of building material due to evaporative cooling. Thermal conductivity is a material's ability to conduct heat, while thermal mass is its ability to store heat.
- Infrared inspection does not directly detect the presence of mold, rather it may be used to find moisture where mold may develop or has already developed. Mold requires temperatures between +4°C to +38°C (+40°F to +100°F), nutrients and moisture to grow. Humidity levels above 50% can provide sufficient moisture to enable mold to grow.

20

10556003.a1

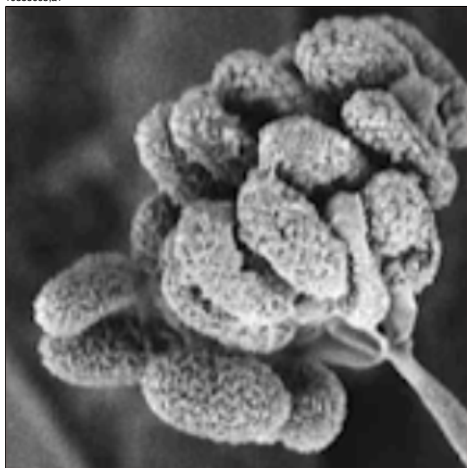

**Figure 20.2** Microscopic view of mold spore

### 20.2.1.3 Guidelines for detection of air infiltration & insulation deficiencies

- For very accurate camera measurements, take measurements of the temperature and enter this value in the camera.
- It is recommended that there is a difference in pressure between the outside and the inside of the building structure. This facilitates the analysis of the infrared images and reveals deficiencies that would not be visible otherwise. Although a negative pressure of between 10 and 50 Pa is recommended, carrying out the inspection at a lower negative pressure may be acceptable. To do this, close all windows, doors and ventilation ducts and then run the kitchen exhaust fan for some time to reach a negative pressure of 5–10 Pa (applies to residential houses only).



- A difference in temperature between the inside and the outside of 10–15°C (18–27°F) is recommended. Inspections can be carried out at a lower temperature difference, but will make the analysis of the infrared images somewhat more difficult.
- Avoid direct sunlight on a part of a building structure—e.g. a façade—that is to be inspected from the inside. The sunlight will heat the façade which will equalize the temperature differences on the inside and mask deficiencies in the building structure. Spring seasons with low nighttime temperatures ( $\pm 0^{\circ}\text{C}$  ( $+32^{\circ}\text{F}$ )) and high daytime temperatures ( $+14^{\circ}\text{C}$  ( $+57^{\circ}\text{F}$ )) are especially risky.

### 20.2.2 About moisture detection

Moisture in a building structure can originate from several different sources, e.g.:

- External leaks, such as floods, leaking fire hydrants etc.
- Internal leaks, such as freshwater piping, waste water piping etc.
- Condensation, which is humidity in the air falling out as liquid water due to condensation on cold surfaces.
- Building moisture, which is any moisture in the building material prior to erecting the building structure.
- Water remaining from firefighting.

As a non-destructive detection method, using an infrared camera has a number of advantages over other methods, and a few disadvantages:

Advantage	Disadvantage
<ul style="list-style-type: none"> <li>■ The method is quick.</li> <li>■ The method is a non-intrusive means of investigation.</li> <li>■ The method does not require relocation of the occupants.</li> <li>■ The method features an illustrative visual presentation of findings.</li> <li>■ The method confirms failure points and moisture migration paths.</li> </ul>	<ul style="list-style-type: none"> <li>■ The method only detects surface temperature differentials and can not see through walls.</li> <li>■ The method can not detect subsurface damage, i.e. mold or structural damage.</li> </ul>

### 20.2.3 Moisture detection (1): Low-slope commercial roofs

#### 20.2.3.1 General information

Low-slope commercial roofing is one of the most common roof types for industrial building, such as warehouses, industrial plants, machinery shops etc. Its major advantages over a pitched roof is the lower cost in material and building. However, due to its design where snow and ice will not fall off by itself—as is the case for the majority of pitched roofs—it must be strongly built to support the accumulated weight of both roof structure and any snow, ice and rain.

Although a basic understanding of the construction of low-slope commercial roofs is desirable when carrying out a roof thermography inspection, expert knowledge is not necessary. There is a large number of different design principles for low-slope commercial roofs—both when it comes to material and design—and it would be impossible for the infrared inspection person to know them all. If additional information about a certain roof is needed, the architect or contractor of the building can usually supply the relevant information.

Common causes of roof failure are outlined in the table below (from SPIE Thermosense Proceedings Vol. 371 (1982), p. 177).

Cause	%
Poor workmanship	47.6
Roof traffic	2.6
Poor design	16.7
Trapped moisture	7.8
Materials	8.0
Age & weathering	8.4

Potential leak locations include the following:

- Flashing
- Drains
- Penetrations
- Seams
- Blisters

#### 20.2.3.2 Safety precautions

- Recommend a minimum of two people on a roof, preferably three or more.
- Inspect the underside of the roof for structural integrity prior to walking on it.
- Avoid stepping on blisters that are common on built up bitumen and gravel roofs.
- Have a cell phone or radio available in case of emergency.
- Inform local police and plant security prior to doing nighttime roof survey.

**20.2.3.3 Commented building structures**

This section includes a few typical examples of moisture problems on low-slope commercial roofs.

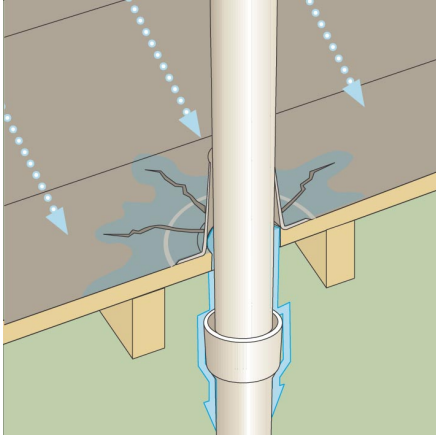
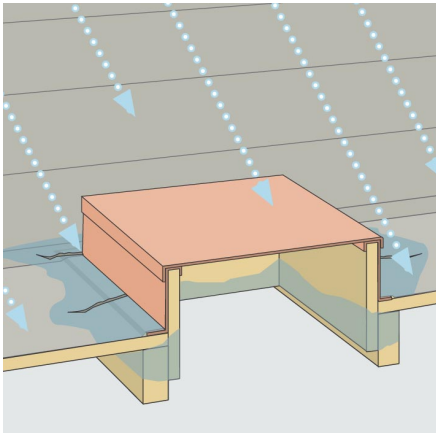
Structural drawing	Comment
<p>10553603,a2</p> 	<p>Inadequate sealing of roof membrane around conduit and ventilation ducts leading to local leakage around the conduit or duct.</p>
<p>10553703,a2</p> 	<p>Roof membrane inadequately sealed around roof access hatch.</p>

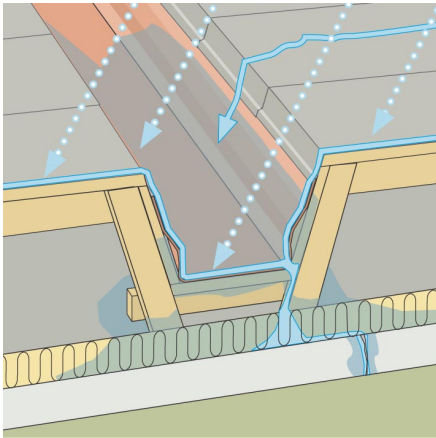
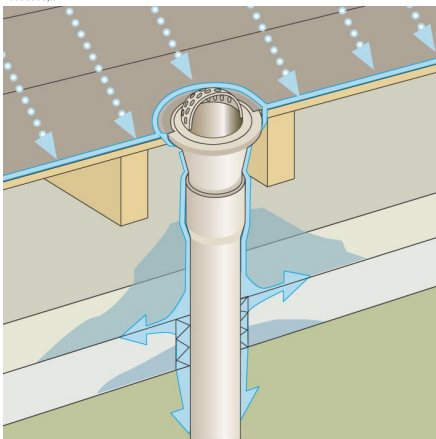
Structural drawing	Comment
<p>10553803.a2</p>  <p>The diagram shows a cross-section of a roof with a drainage channel. Blue arrows indicate water flow towards the channel. The channel is positioned high on the roof slope, and the roof surface has a very shallow angle. Dotted blue lines represent water that has pooled in the channel and is leaking through the roof structure into the insulation below.</p>	<p>Drainage channels located too high and with too low an inclination. Some water will remain in the drainage channel after rain, which may lead to local leakage around the channel.</p>
<p>10553803.a2</p>  <p>The diagram shows a cross-section of a roof with a vertical outlet pipe. Blue arrows show water flowing down the pipe. At the junction where the pipe meets the roof membrane, there is a visible gap. Dotted blue lines indicate water leaking through this gap into the insulation below the roof surface.</p>	<p>Inadequate sealing between roof membrane and roof outlet leading to local leakage around the roof outlet.</p>

**20.2.3.4**      **Commented infrared images**

How do you find wet insulation below the surface of the roof? When the surface itself is dry, including any gravel or ballast, a sunny day will warm the entire roof. Early in the evening, if the sky is clear, the roof will begin to cool down by radiation. Because of its higher thermal capacity the wet insulation will stay warmer longer than the dry and will be visible in the infrared imager (see photos below). The technique is particularly effective on roofs having absorbent insulation—such as wood fiber, fiberglass, and perlite—where thermal patterns correlate almost perfectly with moisture.

Infrared inspections of roofs with nonabsorbent insulations, common in many single-ply systems, are more difficult to diagnose because patterns are more diffuse.

This section includes a few typical infrared images of moisture problems on low-slope commercial roofs:

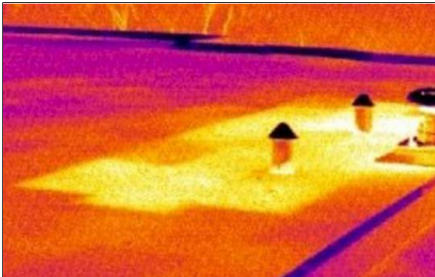
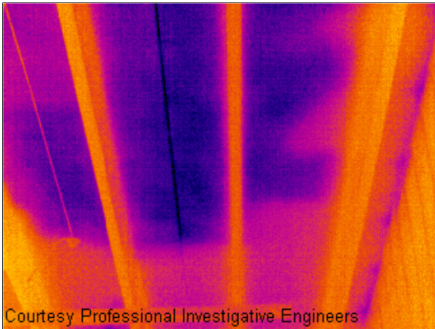
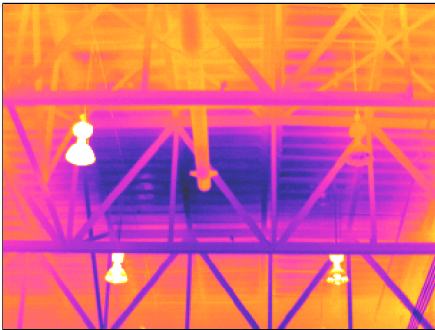
Infrared image	Comment
<p>10554003.a1</p> 	<p>Moisture detection on a roof, recorded during the evening.</p> <p>Since the building material affected by moisture has a higher thermal mass, its temperature decreases slower than surrounding areas.</p>
<p>10554103.a1</p>  <p>Courtesy Professional Investigative Engineers</p>	<p>Water-damaged roofing components and insulation identified from infrared scan from the underside of the built-up roof on a structural concrete tee deck.</p> <p>Affected areas are cooler than the surrounding sound areas, due to conductive and/or thermal capacitive effect.</p>
<p>10554203.a1</p> 	<p>Daytime survey of built-up low-slope commercial roof.</p> <p>Affected areas are cooler than the surrounding dry areas, due to conductive and/or thermal capacitive effect.</p>

## 20.2.4 Moisture detection (2): Commercial & residential façades

### 20.2.4.1 General information

Thermography has proven to be invaluable in the assessment of moisture infiltration into commercial and residential façades. Being able to provide a physical illustration of the moisture migration paths is more conclusive than extrapolating moisture meter probe locations and more cost-effective than large intrusive test cuts.

### 20.2.4.2 Commented building structures

This section includes a few typical examples of moisture problems on commercial and residential façades.

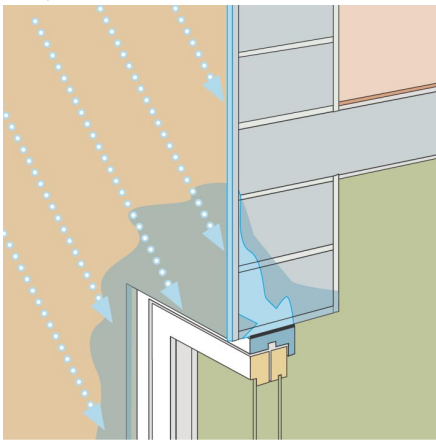
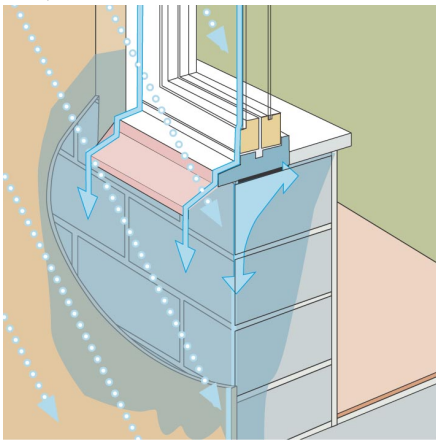
Structural drawing	Comment
<p>10554303.a2</p> 	<p>Pelting rain penetrates the façade due to badly executed bed joints. Moisture builds up in the masonry above the window.</p>
<p>10554403.a2</p> 	<p>Pelting rain hits the window at an angle. Most of the rain runs off the window edge flashing but some finds its way into the masonry where the plaster meets the underside of the flashing.</p>

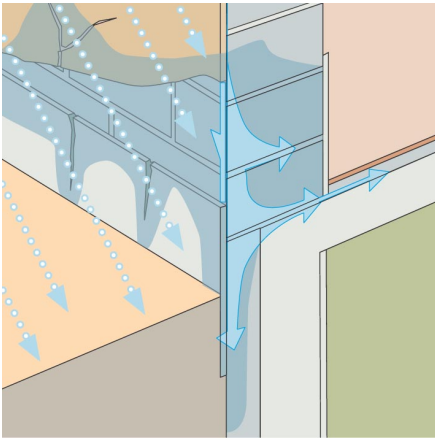
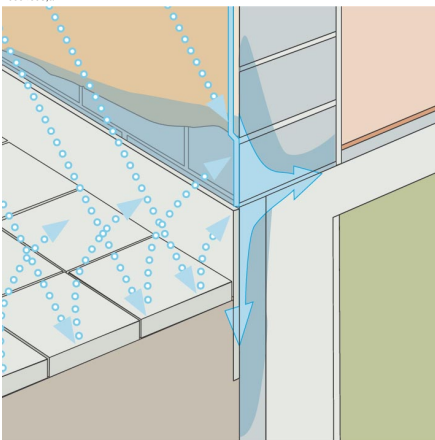
Structural drawing	Comment
<p>10554503,a2</p> 	<p>Rain hits the façade at an angle and penetrates the plaster through cracks. The water then follows the inside of the plaster and leads to frost erosion.</p>
<p>10554603,a2</p> 	<p>Rain splashes on the façade and penetrates the plaster and masonry by absorption, which eventually leads to frost erosion.</p>

**20.2.4.3**      **Commented infrared images**

This section includes a few typical infrared images of moisture problems on commercial & residential façades.

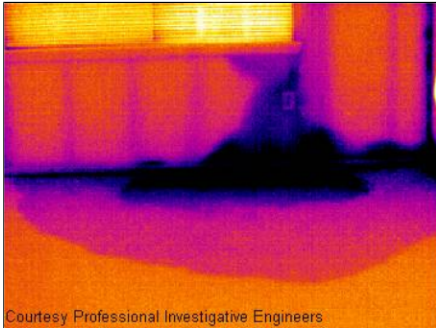
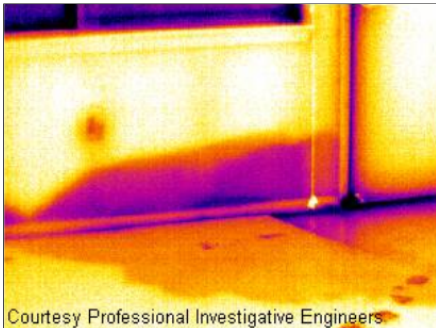
Infrared image	Comment
<p>10554703.a1</p>  <p>Courtesy Professional Investigative Engineers</p>	<p>Improperly terminated and sealed stone veneer to window frame and missing flashings has resulted in moisture infiltration into the wall cavity and interior living space.</p>
<p>10554803.a1</p>  <p>Courtesy Professional Investigative Engineers</p>	<p>Moisture migration into drywall from capillary drive and interior finish components from inadequate clearance and slope of grade from vinyl siding façade on an apartment complex.</p>

**20.2.5**      **Moisture detection (3): Decks & balconies**

**20.2.5.1**      **General information**

Although there are differences in design, materials and construction, decks—plaza decks, courtyard decks etc—suffer from the same moisture and leaking problems as low-slope commercial roofs. Improper flashing, inadequately sealed membranes, and insufficient drainage may lead to substantial damage in the building structures below.

Balconies, although smaller in size, require the same care in design, choice of material, and workmanship as any other building structure. Since balconies are usually supported on one side only, moisture leading to corrosion of struts and concrete reinforcement can cause problems and lead to hazardous situations.



**20.2.5.2 Commented building structures**

This section includes a few typical examples of moisture problems on decks and balconies.

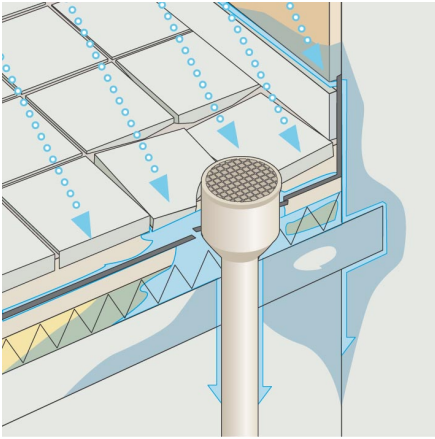
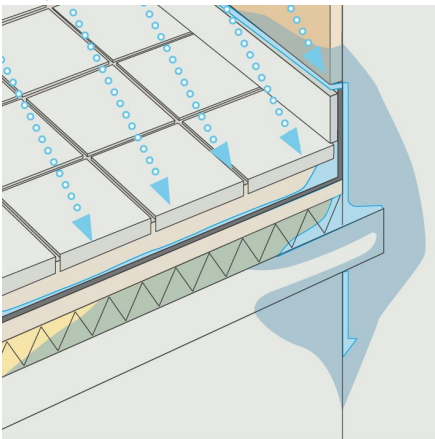
Structural drawing	Comment
<p>10555203.a2</p>  <p>This diagram shows a cross-section of a roof edge with a circular drainage outlet. Blue arrows indicate rainwater flowing from the paving stones towards the outlet. However, the waterproofing membrane is not properly sealed around the base of the outlet pipe, allowing water to seep through the joint and into the structure below.</p>	<p>Improper sealing of paving and membrane to roof outlet, leading to leakage during rain.</p>
<p>10555103.a2</p>  <p>This diagram shows a cross-section of a deck edge where it meets a vertical wall. Blue arrows indicate rainwater running down the face of the deck. At the junction with the wall, there is no flashing or proper waterproofing, which allows water to penetrate through the concrete and insulation layers into the interior of the building.</p>	<p>No flashing at deck-to-wall connection, leading to rain penetrating the concrete and insulation.</p>

20

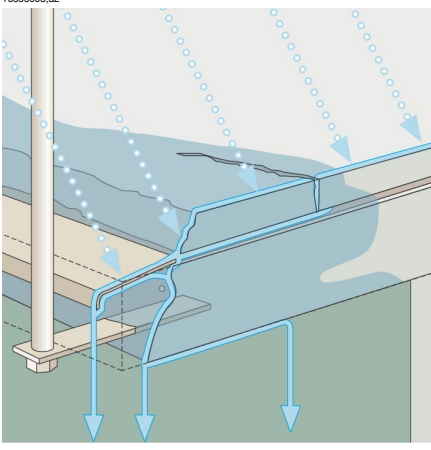
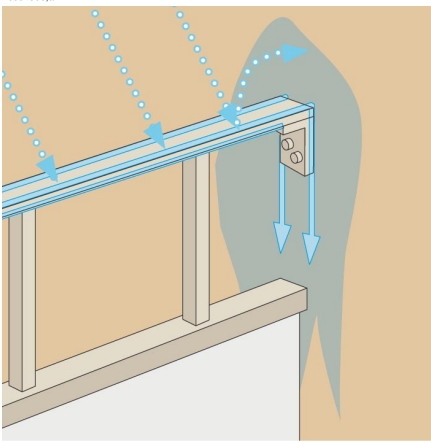
Structural drawing	Comment
<p>10555003.a2</p> 	<p>Water has penetrated the concrete due to inadequately sized drop apron and has led to concrete disintegration and corrosion of reinforcement.</p> <p><b>SECURITY RISK!</b></p>
<p>10554903.a2</p> 	<p>Water has penetrated the plaster and underlying masonry at the point where the handrail is fastened to the wall.</p> <p><b>SECURITY RISK!</b></p>

### 20.2.5.3 Commented infrared images

This section includes a few typical infrared images of moisture problems on decks and balconies.

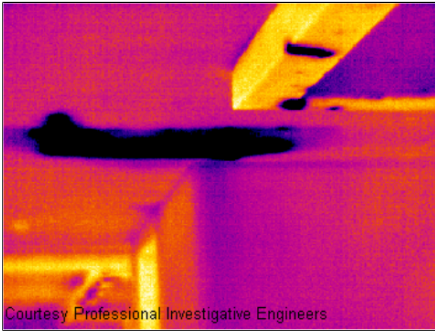
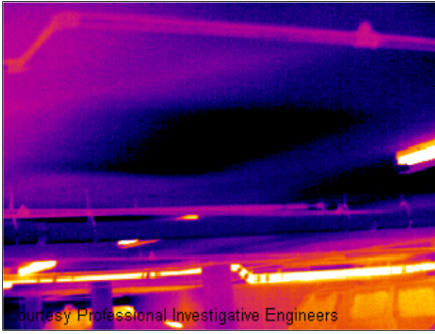
Infrared image	Comment
<p>1055303.a1</p>  <p>Courtesy Professional Investigative Engineers</p>	<p>Improper flashing at balcony-to-wall connections and missing perimeter drainage system resulted in moisture intrusion into the wood framing support structure of the exterior walkway balcony of a loft complex.</p>
<p>1055403.a1</p>  <p>Courtesy Professional Investigative Engineers</p>	<p>A missing composite drainage plane or medium on a below-grade parking garage plaza deck structure resulted in standing water between the structural concrete deck and the plaza wearing surface.</p>

## 20.2.6 Moisture detection (4): Plumbing breaks & leaks

### 20.2.6.1 General information

Water from plumbing leaks can often lead to severe damage on a building structure. Small leaks may be difficult to detect, but can—over the years—penetrate structural walls and foundations to a degree where the building structure is beyond repair.

Using building thermography at an early stage when plumbing breaks and leaks are suspected can lead to substantial savings on material and labor.

20.2.6.2 **Commented infrared images**

This section includes a few typical infrared images of plumbing breaks & leaks.

20

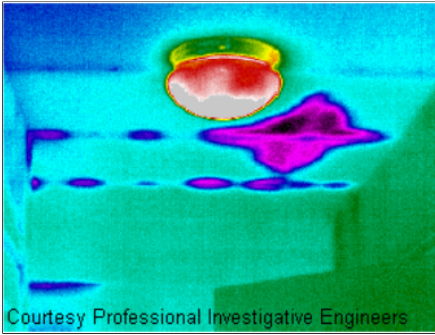
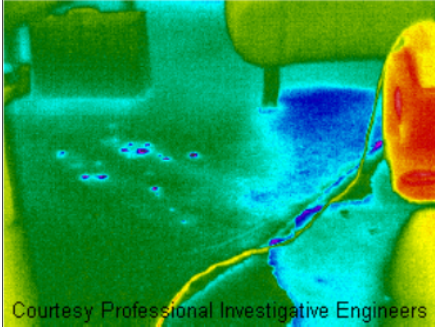
Infrared image	Comment
<p>10555503.a1</p>  <p>Courtesy Professional Investigative Engineers</p>	<p>Moisture migration tracking along steel joist channels inside ceiling of a single family home where a plumbing line had ruptured.</p>
<p>10555603.a1</p>  <p>Courtesy Professional Investigative Engineers</p>	<p>Water from plumbing leak was found to have migrated farther than originally anticipated by the contractor during remediation techniques of cutting back carpet and installing dehumidifiers.</p>

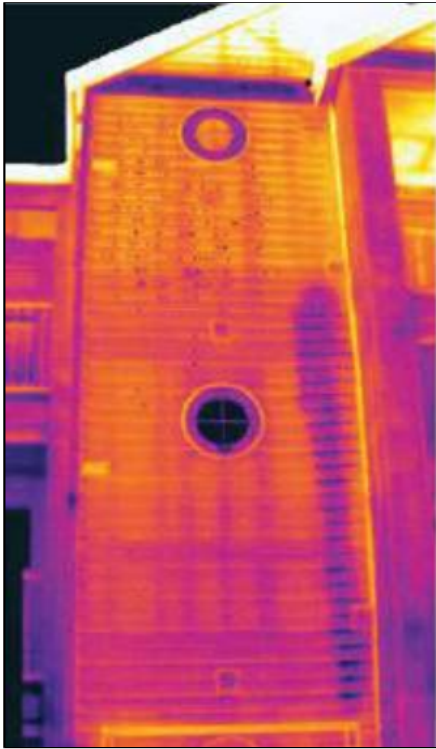
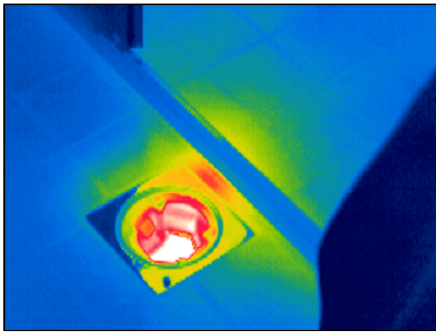
Infrared image	Comment
<p data-bbox="149 199 209 211">10555703.a1</p> 	<p data-bbox="611 199 1052 303">The infrared image of this vinyl-sided 3-floor apartment house clearly shows the path of a serious leak from a washing machine on the third floor, which is completely hidden within the wall.</p>
<p data-bbox="149 982 209 994">10555803.a1</p> 	<p data-bbox="611 982 1052 1034">Water leak due to improper sealing between floor drain and tiles.</p>

## 20.2.7 Air infiltration

### 20.2.7.1 General information

Due to the wind pressure on a building, temperature differences between the inside and the outside of the building, and the fact that most buildings use exhaust air terminal devices to extract used air from the building, a negative pressure of 2–5 Pa can be expected. When this negative pressure leads to cold air entering the building structure due to deficiencies in building insulation and/or building sealing, we have what is called *air infiltration*. Air infiltration can be expected at joints and seams in the building structure.

Due to the fact that air infiltration creates an air flow of cool air into e.g. a room, it can lead to substantial deterioration of the indoor climate. Air flows as small as 0.15 m/s (0.49 ft./s) are usually noticed by inhabitants, although these air flows may be difficult to detect using ordinary measurement devices.

On an infrared image air infiltration can be identified by its typical ray pattern, which emanates from the point of exit in the building structure—e.g. from behind a skirting strip. Furthermore, areas of air infiltration typically have a lower detected temperature than areas where there is only an insulation deficiency. This is due to the chill factor of the air flow.

### 20.2.7.2 Commented building structures

This section includes a few typical examples of details of building structures where air infiltration may occur.

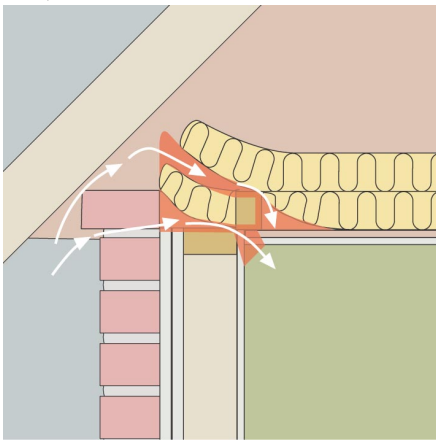
Structural drawing	Comment
 <p>10552503.a2</p>	<p>Insulation deficiencies at the eaves of a brickwall house due to improperly installed fiberglass insulation batts.</p> <p>The air infiltration enters the room from behind the cornice.</p>

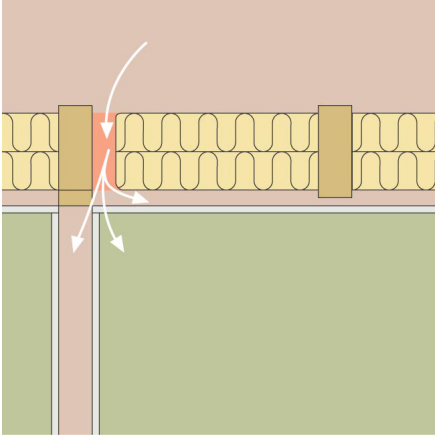
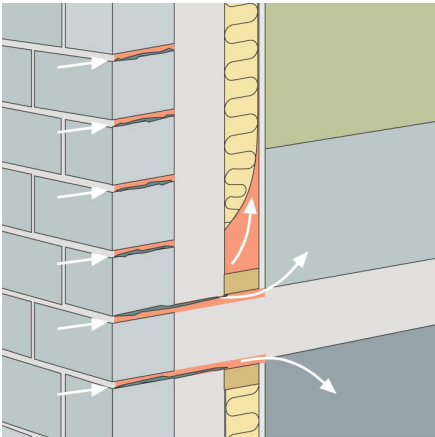
Structural drawing	Comment
<p>10552303.a2</p> 	<p>Insulation deficiencies in an intermediate flow due to improperly installed fiberglass insulation batts.</p> <p>The air infiltration enters the room from behind the cornice.</p>
<p>10552603.a2</p> 	<p>Air infiltration in a concrete floor-over-crawl-space due to cracks in the brick wall façade.</p> <p>The air infiltration enters the room beneath the skirting strip.</p>

**20.2.7.3 Commented infrared images**

This section includes a few typical infrared images of details of building structures where air infiltration has occurred.

20

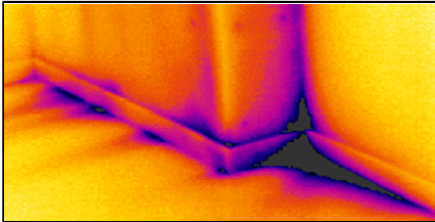
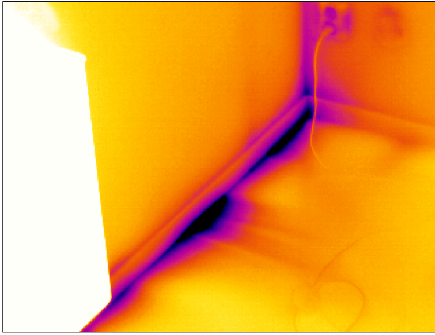
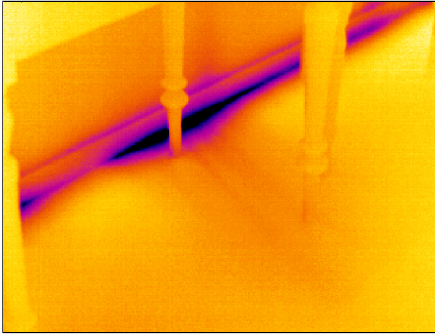
Infrared image	Comment
<p>10552703.a1</p> 	<p>Air infiltration from behind a skirting strip. Note the typical ray pattern.</p>
<p>10552803.a1</p> 	<p>Air infiltration from behind a skirting strip. Note the typical ray pattern. The white area to the left is a radiator.</p>
<p>10552803.a1</p> 	<p>Air infiltration from behind a skirting strip. Note the typical ray pattern.</p>



## 20.2.8 Insulation deficiencies

### 20.2.8.1 General information

Insulation deficiencies do not necessarily lead to air infiltration. If fiberglass insulation batts are improperly installed air pockets will form in the building structure. Since these air pockets have a different thermal conductivity than areas where the insulation batts are properly installed, the air pockets can be detected during a building thermography inspection.

As a rule of thumb, areas with insulation deficiencies typically have higher temperatures than where there is only an air infiltration.

When carrying out building thermography inspections aimed at detecting insulation deficiencies, be aware of the following parts in a building structure, which may look like insulation deficiencies on the infrared image:

- Wooden joists, studs, rafter, beams
- Steel girders and steel beams
- Water piping inside walls, ceilings, floors
- Electrical installations inside walls, ceilings, floors—such as trunking, piping etc.
- Concrete columns inside timber framed walls
- Ventilation ducts & air ducts

### 20.2.8.2 Commented building structures

This section includes a few typical examples of details of building structures with insulation deficiencies:

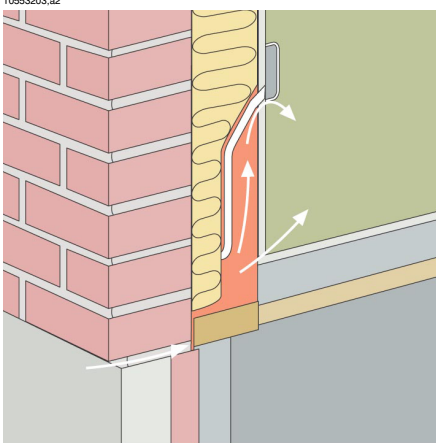
Structural drawing	Comment
	<p>Insulation deficiencies (and air infiltration) due to improper installation of insulation batts around an electrical mains supply.</p> <p>This kind of insulation deficiency will show up as dark areas on an infrared image.</p>

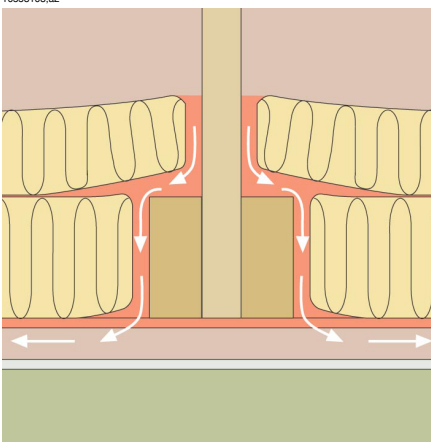
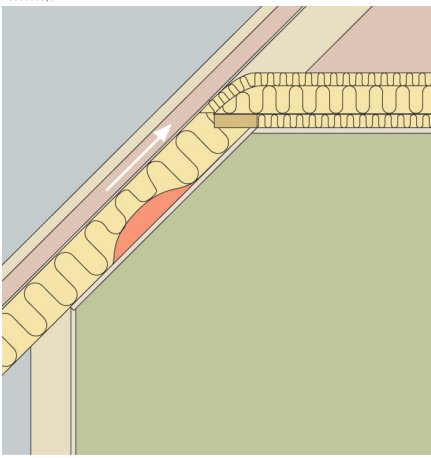
Structural drawing	Comment
<p>10553103;a2</p> 	<p>Insulation deficiencies due to improper installation of insulation batts around an attic floor beam. Cool air infiltrates the structure and cools down the inside of the ceiling.</p> <p>This kind of insulation deficiency will show up as dark areas on an infrared image.</p>
<p>10553003;a2</p> 	<p>Insulation deficiencies due to improper installation of insulation batts creating an air pocket on the outside of an inclined ceiling.</p> <p>This kind of insulation deficiency will show up as dark areas on an infrared image.</p>

### 20.2.8.3 Commented infrared images

This section includes a few typical infrared images of insulation deficiencies.

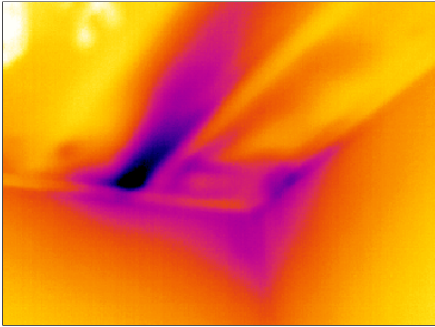
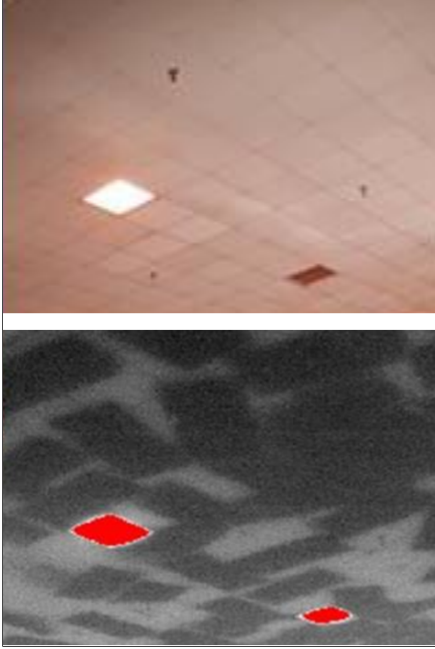
Infrared image	Comment
<p>10553303.a1</p> 	<p>Insulation deficiencies in an intermediate floor structure. The deficiency may be due to either missing insulation batts or improperly installed insulations batts (air pockets).</p>
<p>10553403.a1</p> 	<p>Improperly installed fiberglass batts in a suspended ceiling.</p>

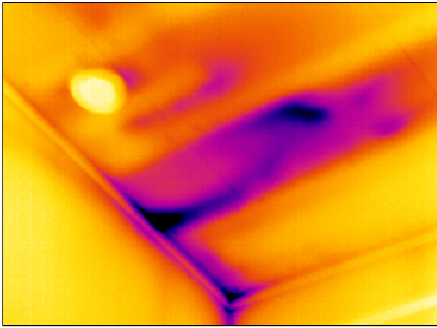
Infrared image	Comment
<p data-bbox="150 199 210 211">10553503.a1</p>  An infrared thermography image showing a floor structure. The image is color-coded by temperature, with yellow and orange representing warmer areas and purple and blue representing cooler areas. A prominent dark purple/blue area in the center indicates a significant temperature drop, likely due to insulation deficiencies. The surrounding areas are warmer, shown in yellow and orange. The image is labeled '10553503.a1' in the top left corner.	<p data-bbox="611 199 1053 305">Insulation deficiencies in an intermediate floor structure. The deficiency may be due to either missing insulation batts or improperly installed insulations batts (air pockets).</p>

## 20.3 *Theory of building science*

### 20.3.1 General information

The demand for energy-efficient constructions has increased significantly in recent times. Developments in the field of energy, together with the demand for pleasant indoor environments, have resulted in ever-greater significance having to be attached to both the function of a building's thermal insulation and airtightness and the efficiency of its heating and ventilation systems.

Defective insulation and tightness in highly insulated and airtight structures can have a great impact on energy losses. Defects in a building's thermal insulation and airtightness do not merely entail risk of excessive heating and maintenance costs, they also create the conditions for a poor indoor climate.

A building's degree of insulation is often stated in the form of a thermal resistance or a coefficient of thermal transmittance (U value) for the various parts of the building. However, the stated thermal resistance values rarely provide a measure of the actual energy losses in a building. Air leakage from joints and connections that are not airtight and insufficiently filled with insulation often gives rise to considerable deviations from the designed and expected values.

Verification that individual materials and building elements have the promised properties is provided by means of laboratory tests. Completed buildings have to be checked and inspected in order to ensure that their intended insulation and airtightness functions are actually achieved.

In its structural engineering application, thermography is used to study temperature variations over the surfaces of a structure. Variations in the structure's thermal resistance can, under certain conditions, produce temperature variations on its surfaces. Leakage of cold (or warm) air through the structure also affects the variation in surface temperature. This means that insulation defects, thermal bridges and air leaks in a building's enclosing structural components can be located and surveyed.

Thermography itself does not directly show the structure's thermal resistance or airtightness. Where quantification of thermal resistance or airtightness is required, additional measurements have also to be taken. Thermographic analysis of buildings relies on certain prerequisites in terms of temperature and pressure conditions across the structure.

Details, shapes and contrasts in the thermal image can vary quite clearly with changes in any of these parameters. The in-depth analysis and interpretation of thermal images therefore requires thorough knowledge of such aspects as material and structural properties, the effects of climate and the latest measuring techniques. For assessing

the results of measurements, there are special requirements in terms of the skills and experience of those taking the measurements, e.g. by means of authorization by a national or regional standardization body.

### 20.3.2 The effects of testing and checking

It can be difficult to anticipate how well the thermal insulation and airtightness of a completed building will work. There are certain factors involved in assembling the various components and building elements that can have a considerable impact on the final result. The effects of transport, handling and storage at the site and the way the work is done cannot be calculated in advance. To ensure that the intended function is actually achieved, verification by testing and checking the completed building is required.

Modern insulation technology has reduced the theoretical heat requirement. This does mean, however, that defects that are relatively minor, but at important locations, e.g. leaking joints or incorrectly installed insulation, can have considerable consequences in terms both of heat and comfort. Verification tests, e.g. by means of thermography, have proved their value, from the point of view both of the designer and the contractor and of the developer, the property manager and the user.

- For the designer, the important thing is to find out about the function of various types of structures, so that they can be designed to take into account both working methods and functional requirements. The designer must also know how different materials and combinations of materials function in practice. Effective testing and checking, as well as experiential feedback, can be used to achieve the required development in this area.
- The contractor is keen on more testing and inspection in order to ensure that the structures keep to an expected function that corresponds to established requirements in the regulations issued by authorities and in contractual documents. The contractor wants to know at an early stage of construction about any changes that may be necessary so that systematic defects can be prevented. During construction, a check should therefore be carried out on the first apartments completed in a mass production project. Similar checking then follows as production continues. In this way systematic defects can be prevented and unnecessary costs and future problems can be avoided. This check is of benefit both to manufacturers and to users.
- For the developer and the property manager it is essential that buildings are checked with reference to heat economy, maintenance (damage from moisture or moisture infiltration) and comfort for the occupants (e.g. cooled surfaces and air movements in occupied zones).

- For the user the important thing is that the finished product fulfills the promised requirements in terms of the building's thermal insulation and airtightness. For the individual, buying a house involves a considerable financial commitment, and the purchaser therefore wants to know that any defects in the construction will not involve serious financial consequences or hygiene problems.

The effects of testing and checking a building's insulation and airtightness are partly physiological and partly financial.

The physiological experience of an indoor climatic environment is very subjective, varying according to the particular human body's heat balance and the way the individual experiences temperature. The experience of climate depends on both the indoor air temperature and that of the surrounding surfaces. The speed of movement and moisture content of indoor air are also of some significance. Physiologically, a draft produces the sensation of local cooling of the body's surface caused by

- excessive air movements in the occupied zone with normal air temperature;
- normal air movements in the occupied zone but a room temperature that is too low;
- substantial radiated heat exchange with a cold surface.

It is difficult to assess the quantitative effects of testing and checking a building's thermal insulation.

Investigations have shown that defects found in the thermal insulation and airtightness of buildings cause heat losses that are about 20–30% more than was expected. Monitoring energy consumption before and after remedial measures in relatively large complexes of small houses and in multi-dwelling blocks has also demonstrated this. The figures quoted are probably not representative of buildings in general, since the investigation data cannot be said to be significant for the entire building stock. A cautious assessment however would be that effectively testing and checking a building's thermal insulation and airtightness can result in a reduction in energy consumption of about 10%.

Research has also shown that increased energy consumption associated with defects is often caused by occupants increasing the indoor temperature by one or a few degrees above normal to compensate for the effect of annoying thermal radiation towards cooled surfaces or a sensation of disturbing air movements in a room.

### 20.3.3 Sources of disruption in thermography

During thermography, the risk of confusing temperature variations caused by insulation defects with those associated with the natural variation in U values along warm surfaces of a structure is considered slight under normal conditions.

The temperature changes associated with variations in the U value are generally gradual and symmetrically distributed across the surface. Variations of this kind do of course occur at the angles formed by roofs and floors and at the corners of walls.

Temperature changes associated with air leaks or insulation defects are in most cases more evident with characteristically shaped sharp contours. The temperature pattern is usually asymmetrical.

During thermography and when interpreting an infrared image, comparison infrared images can provide valuable information for assessment.

The sources of disruption in thermography that occur most commonly in practice are

- the effect of the sun on the surface being thermographed (sunlight shining in through a window);
- hot radiators with pipes;
- lights directed at, or placed near, the surface being measured;
- air flows (e.g. from air intakes) directed at the surface;
- the effect of moisture deposits on the surface.

Surfaces on which the sun is shining should not be subjected to thermography. If there is a risk of an effect by sunlight, windows should be covered up (closing Venetian blinds). However, be aware that there are building defects or problems (typically moisture problems) that only show up when heat has been applied to the surface, e.g. from the sun.

For more information about moisture detection, see section 20.2.2 – About moisture detection on page 129.

A hot radiator appears as a bright light surface in an infrared U image. The surface temperature of a wall next to a radiator is raised, which may conceal any defects present.

For maximum prevention of disruptive effects from hot radiators, these may be shut off a short while before the measurement is taken. However, depending on the construction of the building (low or high mass), these may need to be shut off several hours before a thermographic survey. The room air temperature must not fall so much as to affect the surface temperature distribution on the structure's surfaces. There is little timelag with electric radiators, so they cool down relatively quickly once they have been switched off (20–30 minutes).

Lights placed against walls should be switched off when the infrared image is taken.

During thermography there should not be any disruptive air flows (e.g. open windows, open valves, fans directed at the surface being measured) that could affect the surfaces being thermographed.



Any wet surfaces, e.g. as a result of surface condensation, have a definite effect on heat transfer at the surface and the surface temperature. Where there is moisture on a surface, there is usually some evaporation which draws off heat, thus lowering the temperature of the surface by several degrees. There is risk of surface condensation at major thermal bridges and insulation defects.

Significant disruptions of the kind described here can normally be detected and eliminated before measuring.

If during thermography it is not possible to shield surfaces being measured from disruptive factors, these must be taken into account when interpreting and evaluating the results. The conditions in which the thermography was carried out should be recorded in detail when each measurement is taken.

### 20.3.4 Surface temperature and air leaks

Defects in building airtightness due to small gaps in the structure can be detected by measuring the surface temperature. If there is a negative pressure in the building under investigation, air flows into the space through leaks in the building. Cold air flowing in through small gaps in a wall usually lowers the temperature in adjacent areas of the wall. The result is that a cooled surface area with a characteristic shape develops on the inside surface of the wall. Thermography can be used to detect cooled surface areas. Air movements at the wall surface can be measured using an air velocity indicator. If there is a positive pressure inside the building being investigated, warm room air will leak out through gaps in the wall, resulting in locally warm surface areas around the locations of the leaks.

The amount of leakage depends partly on gaps and partly on the differential pressure across the structure.

#### 20.3.4.1 Pressure conditions in a building

The most important causes of differential pressure across a structural element in a building are

- wind conditions around the building;
- the effects of the ventilation system;
- temperature differences between air inside and outside (thermal differential pressure).

The actual pressure conditions inside a building are usually caused by a combination of these factors.

The resultant pressure gradient across the various structural elements can be illustrated by the figure on page 155. The irregular effects of wind on a building means that in practice the pressure conditions may be relatively variable and complicated.

In a steady wind flow, Bernoulli's Law applies:

$$\frac{\rho v^2}{2} + p = \text{constant}$$

where:

$\rho$	Air density in kg/m <sup>3</sup>
$v$	Wind velocity in m/s
$p$	Static pressure in Pa

and where:

$$\frac{\rho v^2}{2} + p$$

denotes the dynamic pressure and  $p$  the static pressure. The total of these pressures gives the total pressure.

Wind load against a surface makes the dynamic pressure become a static pressure against the surface. The magnitude of this static pressure is determined by, amongst other things, the shape of the surface and its angle to the wind direction.

The portion of the dynamic pressure that becomes a static pressure on the surface ( $p_{stat}$ ) is determined by what is known as a stress concentration factor:

$$C = \frac{p_{stat}}{\frac{\rho v^2}{2}}$$

If  $\rho$  is 1.23 kg/m<sup>3</sup> (density of air at +15°C (+59°F)), this gives the following local pressures in the wind flow:

$$p_{stat} = C \times \frac{\rho v^2}{2} = C \times \frac{v^2}{1.63} \text{ Pa}$$

10551803.a1

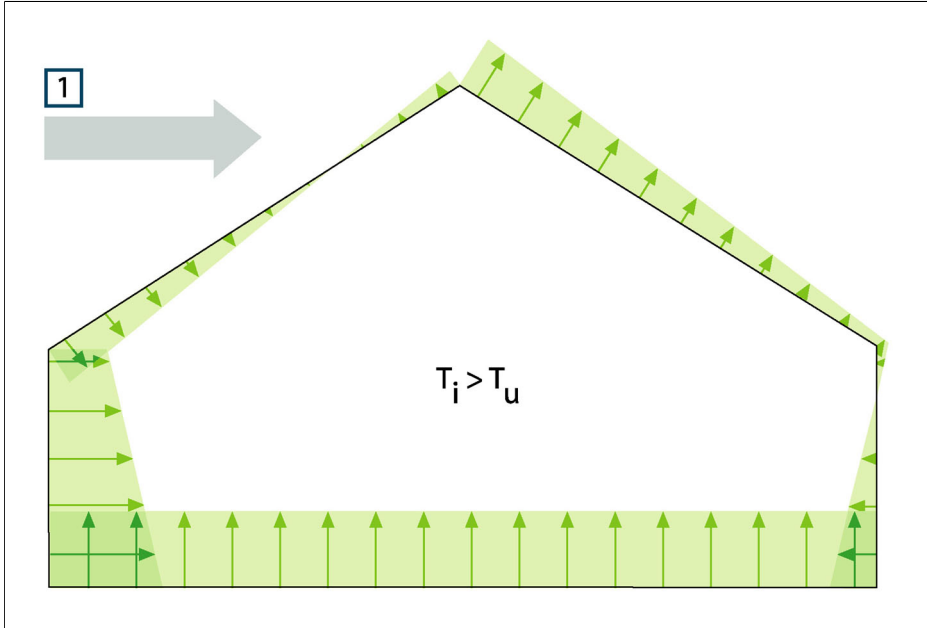

20

**Figure 20.3** Distribution of resultant pressures on a building's enclosing surfaces depending on wind effects, ventilation and internal/external temperature difference. 1: Wind direction;  $T_u$ : Thermodynamic air temperature outdoors in K;  $T_i$ : Thermodynamic air temperature indoors in K.

If the whole of the dynamic pressure becomes static pressure, then  $C = 1$ . Examples of stress concentration factor distributions for a building with various wind directions are shown in the figure on page 156.

The wind therefore causes an internal negative pressure on the windward side and an internal positive pressure on the leeward side. The air pressure indoors depends on the wind conditions, leaks in the building and how these are distributed in relation to the wind direction. If the leaks in the building are evenly distributed, the internal pressure may vary by  $\pm 0.2 p_{\text{stat}}$ . If most of the leaks are on the windward side, the internal pressure increases somewhat. In the opposite case, with most of the leaks on the leeward side, the internal pressure falls.

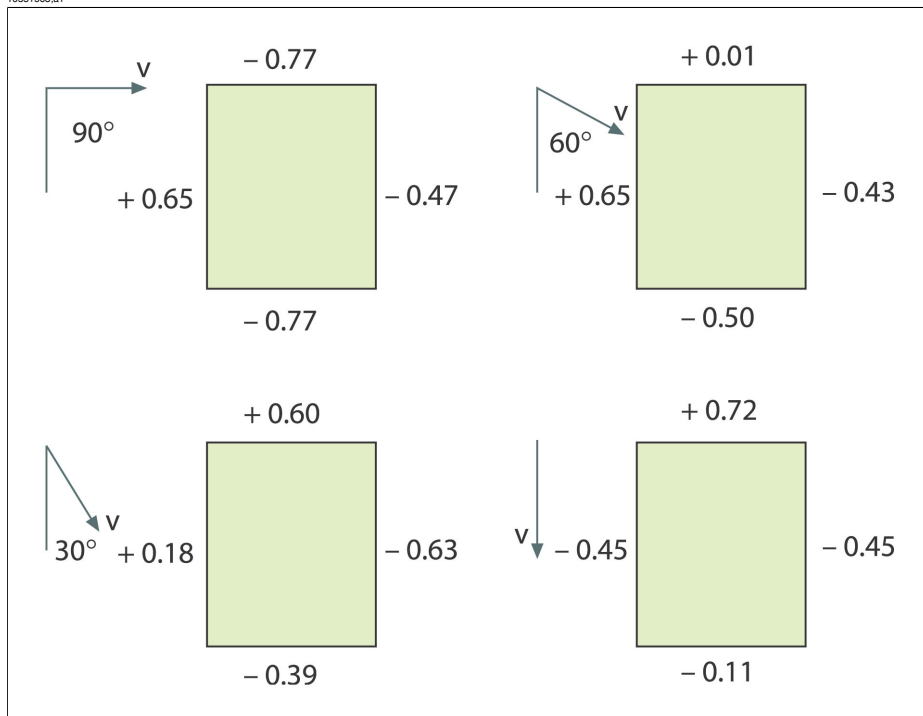

**Figure 20.4** Stress concentration factor (C) distributions for various wind directions and wind velocities (v) relative to a building.

Wind conditions can vary substantially over time and between relatively closely situated locations. In thermography, such variations can have a clear effect on the measurement results.

It has been demonstrated experimentally that the differential pressure on a façade exposed to an average wind force of about 5 m/s (16.3 ft/s) will be about 10 Pa.

Mechanical ventilation results in a constant internal negative or positive pressure (depending on the direction of the ventilation). Research has showed that the negative pressure caused by mechanical extraction (kitchen fans) in small houses is usually between 5 and 10 Pa. Where there is mechanical extraction of ventilation air, e.g. in multi-dwelling blocks, the negative pressure is somewhat greater, 10–50 Pa. Where there is so-called balanced ventilation (mechanically controlled supply and extract air), this is normally adjusted to produce a slight negative pressure inside (3–5 Pa).

The differential pressure caused by temperature differences, the so-called chimney effect (airtightness differences of air at different temperatures) means that there is a negative pressure in the building's lower part and a positive pressure in the upper

part. At a certain height there is a neutral zone where the pressures on the inside and outside are the same, see the figure on page 158. This differential pressure may be described by the relationship:

$$\Delta p = g \times \rho_u \times h \left( 1 - \frac{T_u}{T_i} \right) \text{ Pa}$$

$\Delta p$	Air pressure differential within the structure in Pa
$g$	9.81 m/s <sup>2</sup>
$\rho_u$	Air density in kg/m <sup>3</sup>
$T_u$	Thermodynamic air temperature outdoors in K
$T_i$	Thermodynamic air temperature indoors in K
$h$	Distance from the neutral zone in meters

20

If  $\rho_u = 1.29 \text{ kg/m}^3$  (density of air at a temperature of 273 K and  $\approx 100 \text{ kPa}$ ), this produces:

$$\Delta p \approx 13 \times h \left( 1 - \frac{T_u}{T_i} \right)$$

With a difference of  $+25^\circ\text{C}$  ( $+77^\circ\text{F}$ ) between the ambient internal and external temperatures, the result is a differential pressure difference within the structure of about 1 Pa/m difference in height (= 3.28 Pa/ft.).

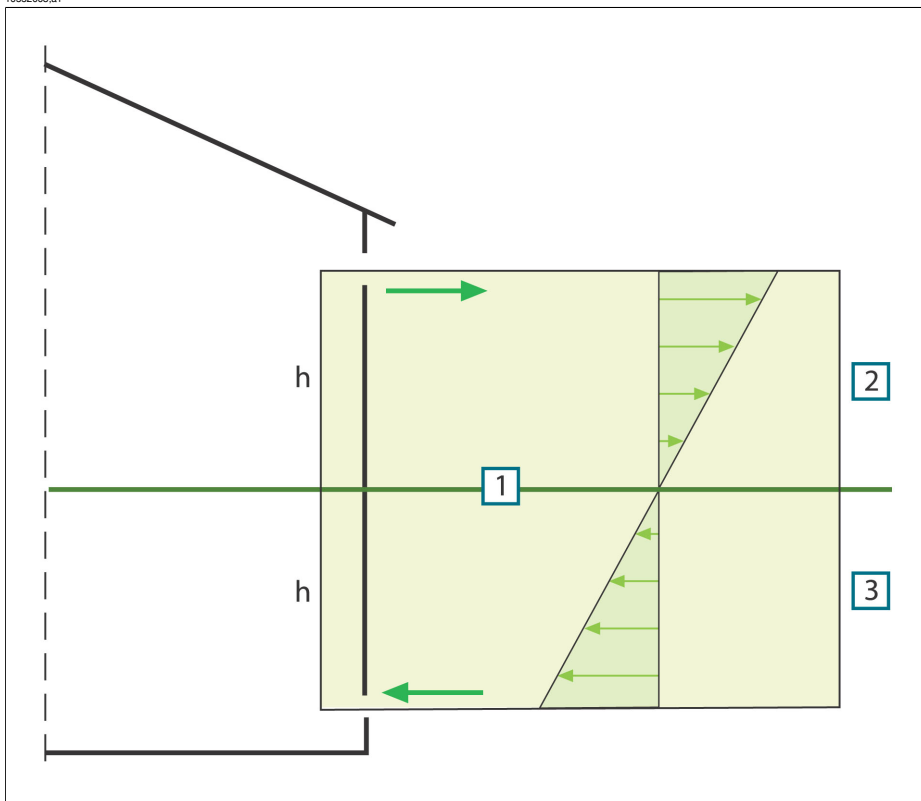

**Figure 20.5** Distribution of pressures on a building with two openings and where the external temperature is lower than the internal temperature. 1: Neutral zone; 2: Positive pressure; 3: Negative pressure; **h**: Distance from the neutral zone in meters.

The position of the neutral zone may vary, depending on any leaks in the building. If the leaks are evenly distributed vertically, this zone will be about halfway up the building. If more of the leaks are in the lower part of the building, the neutral zone will move downwards. If more of the leaks are in the upper part, it will move upwards. Where a chimney opens above the roof, this has a considerable effect on the position of the neutral zone, and the result may be a negative pressure throughout the building. This situation most commonly occurs in small buildings.

In a larger building, such as a tall industrial building, with leaks at doors and any windows in the lower part of the building, the neutral zone is about one-third of the way up the building.

### 20.3.5 Measuring conditions & measuring season

The foregoing may be summarized as follows as to the requirements with regard to measuring conditions when carrying out thermographic imaging of buildings.

Thermographic imaging is done in such a way that the disruptive influence from external climatic factors is as slight as possible. The imaging process is therefore carried out indoors, i.e. where a building is heated, the structure's warm surfaces are examined.

Outdoor thermography is only used to obtain reference measurements of larger façade surfaces. In certain cases, e.g. where the thermal insulation is very bad or where there is an internal positive pressure, outdoor measurements may be useful. Even when investigating the effects of installations located within the building's climatic envelope, there may be justification for thermographic imaging from outside the building.

The following conditions are recommended:

- The air temperature difference within the relevant part of the building must be at least  $+10^{\circ}\text{C}$  ( $+18^{\circ}\text{F}$ ) for a number of hours before thermographic imaging and for as long as the procedure takes. For the same period, the ambient temperature difference must not vary by more than  $\pm 30\%$  of the difference when the thermographic imaging starts. During the thermographic imaging, the indoor ambient temperature should not change by more than  $\pm 2^{\circ}\text{C}$  ( $\pm 3.6^{\circ}\text{F}$ ).
- For a number of hours prior before thermographic imaging and as long as it continues, no influencing sunlight may fall upon the relevant part of the building.
- Negative pressure within the structure  $\approx 10\text{--}50$  Pa.
- When conducting thermographic imaging in order to locate only air leaks in the building's enclosing sections, the requirements in terms of measuring conditions may be lower. A difference of  $5^{\circ}\text{C}$  ( $9^{\circ}\text{F}$ ) between the inside and outside ambient temperatures ought to be sufficient for detecting such defects. To be able to detect air leaks, certain requirements must however be made with regard to the differential pressure; about 10 Pa should be sufficient.

### 20.3.6 Interpretation of infrared images

The main purpose of thermography is to locate faults and defects in thermal insulation in exterior walls and floor structures and to determine their nature and extent. The measuring task can also be formulated in such a way that the aim of the thermography is to confirm whether or not the wall examined has the promised insulation and airtightness characteristics. The 'promised thermal insulation characteristics' for the wall according to the design can be converted into an expected surface temperature distribution for the surface under investigation if the measuring conditions at the time when the measurements are taken are known.

In practice the method involves the following:

Laboratory or field tests are used to produce an expected temperature distribution in the form of typical or comparative infrared images for common wall structures, comprising both defect-free structures and structures with in-built defects.

Examples of typical infrared images are shown in section 20.2 – Typical field investigations on page 127.

If infrared images of structural sections taken during field measurements are intended for use as comparison infrared images, then the structure's composition, the way it was built, and the measurement conditions at the time the infrared image was taken must be known in detail and documented.

20

In order, during thermography, to be able to comment on the causes of deviations from the expected results, the physical, metrological and structural engineering prerequisites must be known.

The interpretation of infrared images taken during field measurements may be described in brief as follows:

A comparison infrared image for a defect-free structure is selected on the basis of the wall structure under investigation and the conditions under which the field measurement was taken. An infrared image of the building element under investigation is then compared with the selected infrared image. Any deviation that cannot be explained by the design of the structure or the measurement conditions is noted as a suspected insulation defect. The nature and extent of the defect is normally determined using comparison infrared images showing various defects.

If no suitable comparison infrared image is available, evaluation and assessment are done on the basis of experience. This requires more precise reasoning during the analysis.

When assessing an infrared image, the following should be looked at:

- Uniformity of brightness in infrared images of surface areas where there are no thermal bridges
- Regularity and occurrence of cooled surface areas, e.g. at studding and corners
- Contours and characteristic shapes in the cooled surface area
- Measured temperature differences between the structure's normal surface temperature and the selected cooled surface area
- Continuity and uniformity of the isotherm curve on the surface of the structure. In the camera software the isotherm function is called **Isotherm** or **Color alarm**, depending on camera model.



Deviations and irregularities in the appearance of the infrared image often indicate insulation defects. There may obviously be considerable variations in the appearance of infrared images of structures with insulation defects. Certain types of insulation defects have a characteristic shape on the infrared image.

Section 20.2 – Typical field investigations on page 127 shows examples of interpretations of infrared images.

When taking infrared images of the same building, the infrared images from different areas should be taken with the same settings on the infrared camera, as this makes comparison of the various surface areas easier.

### 20.3.7 Humidity & dew point

#### 20.3.7.1 *Relative & absolute humidity*

Humidity can be expressed in two different ways—either as *relative humidity* or as *absolute humidity*. Relative humidity is expressed in percent of how much water a certain volume of air can hold at a certain temperature, while absolute humidity is expressed in percent water by weight of material. The latter way to express humidity is common when measuring humidity in wood and other building materials.

The higher the temperature of air, the larger the amount of water this certain volume of air can hold. The following table specifies the maximum amounts of water in air at different temperatures.

**Figure 20.6 A:** Temperature in degrees Celsius; **B:** Maximum amount of water expressed in g/m<sup>3</sup> (at sea level)

A	B	A	B	A	B	A	B
30.0	30.44	20.0	17.33	10.0	9.42	0.0	4.86
29.0	28.83	19.0	16.34	9.0	8.84	-1.0	4.49
28.0	27.29	18.0	15.40	8.0	8.29	-2.0	4.15
27.0	25.83	17.0	14.51	7.0	7.77	-3.0	3.83
26.0	24.43	16.0	13.66	6.0	7.28	-4.0	3.53
25.0	23.10	15.0	12.86	5.0	6.81	-5.0	3.26
24.0	21.83	14.0	12.09	4.0	6.38	-6.0	3.00
23.0	20.62	13.0	11.37	3.0	5.96	-7.0	2.76
22.0	19.47	12.0	10.69	2.0	5.57	-8.0	2.54
21.0	18.38	11.0	10.04	1.0	5.21	-9.0	2.34

**Figure 20.7 A:** Temperature in degrees Fahrenheit; **B:** Maximum amount of water in gr/ft<sup>3</sup> (at sea level)

A	B	A	B	A	B	A	B
86.0	13.30	68.0	7.58	50.0	4.12	32.0	2.12
84.2	12.60	66.2	7.14	48.2	3.86	30.2	1.96
82.4	11.93	64.4	6.73	46.4	3.62	28.4	1.81
80.6	11.29	62.6	6.34	44.6	3.40	26.6	1.67
78.8	10.68	60.8	5.97	42.8	3.18	24.8	1.54
77.0	10.10	59.0	5.62	41.0	2.98	23.0	1.42
75.2	9.54	57.2	5.29	39.2	2.79	21.2	1.31
73.4	9.01	55.4	4.97	37.4	2.61	19.4	1.21
71.6	8.51	53.6	4.67	35.6	2.44	17.6	1.11
69.8	8.03	51.8	4.39	33.8	2.28	15.8	1.02

*Example:*

The relative humidity of a certain volume of air at a temperature of +30°C (+86°F) is 40 % RH. Amount of water in 1 m<sup>3</sup> (35.31 ft<sup>3</sup>) of air at +30°C = 30.44 × Rel Humidity = 30.44 × 0.40 = 12.18 g (187.96 gr).

### 20.3.7.2 Definition of dew point

Dew point is the temperature at which the humidity in a certain volume of air will condense as liquid water.

*Example:*

The relative humidity of a certain volume of air at a temperature of +30°C (+86°F) is 40 % RH. Amount of water in 1 m<sup>3</sup> (35.31 ft<sup>3</sup>) of air at +30°C = 30.44 × Rel Humidity = 30.44 × 0.40 = 12.18 g (187.96 gr). In the table above, look up the temperature for which the amount of water in air is closest to 12.18 g. This would be +14.0°C (+57.2°F), which is the approximate dew point.

### 20.3.8 Excerpt from Technical Note ‘Assessing thermal bridging and insulation continuity’ (UK example)

#### 20.3.8.1 Credits

This Technical Note was produced by a working group including expert thermographers, and research consultants. Additional consultation with other persons and organisations results in this document being widely accepted by all sides of industries.

The contents of this Technical Note is reproduced with kind permission from, and fully copyrighted to, United Kingdom Thermography Association (UKTA).

UK Thermography Association  
c/o British Institute of Nondestructive Testing  
1 Spencer Parade  
Northampton NN1 5AA  
United Kingdom

Tel: +44 (0)1604 630124

Fax: +44 (0)1604 231489

### **20.3.8.2**            *Introduction*

Over the last few years the equipment, applications, software, and understanding connected with thermography have all developed at an astonishing rate. As the technology has gradually become integrated into mainstream practises, a corresponding demand for application guides, standards and thermography training has arisen.

The UKTA is publishing this technical note in order to establish a consistent approach to quantifying the results for a 'Continuity of Thermal Insulation' examination. It is intended that specifiers should refer to this document as a guide to satisfying the requirement in the Building Regulations, therefore enabling the qualified thermographer to issue a pass or fail report.

### **20.3.8.3**            *Background information*

Thermography can detect surface temperature variations as small as 0.1 K and graphic images can be produced that visibly illustrate the distribution of temperature on building surfaces.

Variations in the thermal properties of building structures, such as poorly fitted or missing sections of insulation, cause variations in surface temperature on both sides of the structure. They are therefore visible to the thermographer. However, many other factors such as local heat sources, reflections and air leakage can also cause surface temperature variations.

The professional judgement of the thermographer is usually required to differentiate between real faults and other sources of temperature variation. Increasingly, thermographers are asked to justify their assessment of building structures and, in the absence of adequate guidance, it can be difficult to set definite levels for acceptable or unacceptable variation in temperature.

The current Standard for thermal imaging of building fabric in the UK is BS EN 13187:1999 (BS EN 13187:1999, Thermal Performance of Buildings—Qualitative detection of thermal properties in building envelopes—Infrared method (ISO 6781:1983 modified). However, this leaves interpretation of the thermal image to the professional expertise of the thermographer and provides little guidance on the demarcation between acceptable and unacceptable variations. Guidance on the appearance of a

range of thermal anomalies can be found in BINDT Guides to thermal imaging (Infrared Thermography Handbook; Volume 1, Principles and Practise, Norman Walker, ISBN 0903132338, Volume 2, Applications, A. N. Nowicki, ISBN 090313232X, BINDT, 2005).

#### 20.3.8.3.1 Requirements

A thermographic survey to demonstrate continuity of insulation, areas of thermal bridging and compliance with Building Regulations should include the following:

- Thermal anomalies.
- Differentiate between real thermal anomalies, where temperature differences are caused by deficiencies in thermal insulation, and those that occur through confounding factors such as localised differences in air movement, reflection and emissivity.
- Quantify affected areas in relation to the total insulated areas.
- State whether the anomalies and the building thermal insulation as a whole are acceptable.

#### 20.3.8.4 Quantitative appraisal of thermal anomalies

A thermographic survey will show differences in apparent temperature of areas within the field of view. To be useful, however, it must systematically detect all the apparent defects; assess them against a predetermined set of criteria; reliably discount those anomalies that are not real defects; evaluate those that are real defects, and report the results to the client.

##### 20.3.8.4.1 Selection of critical temperature parameter

The BRE information Paper IP17/01 (Information Paper IP17/01, Assessing the Effects of Thermal Bridging at Junctions and Around Openings. Tim Ward, BRE, 2001) provides useful guidance on minimum acceptable internal surface temperatures and appropriate values of Critical Surface Temperature Factor,  $f_{CRsi}$ . The use of a surface temperature factor allows surveys under any thermal conditions to show areas that are at risk of condensation or mould growth under design conditions.

The actual surface temperature will depend greatly on the temperatures inside and outside at the time of the survey, but a 'Surface Temperature Factor' ( $f_{Rsi}$ ) has been devised that is independent of the absolute conditions. It is a ratio of temperature drop across the building fabric to the total temperature drop between inside and outside air.

For internal surveys:  $f_{Rsi} = (T_{si} - T_e)/(T_i - T_e)$

$T_{si}$  = internal surface temperature

$T_i$  = internal air temperature

$T_e$  = external air temperature

A value for  $f_{CRsi}$  of 0.75 is considered appropriate across new building as the upper end usage is not a factor considered in testing for ‘Continuity of Insulation’, or ‘Thermal Bridging’. However, when considering refurbished or extended buildings, for example swimming pools, internal surveys may need to account for unusual circumstances.

#### 20.3.8.4.2 *Alternative method using only surface temperatures*

There are strong arguments for basing thermographic surveys on surface temperatures alone, with no need to measure air temperature.

- Stratification inside the building makes reference to air internal temperatures very difficult. Is it mean air temperature, low level, high level or temperature at the level of the anomaly and how far from the wall should it be measured?
- Radiation effects, such as radiation to the night sky, make use of external air temperature difficult. It is not unusual for the outside surface of building fabric to be below air temperature because of radiation to the sky which may be as low as  $-50^{\circ}\text{C}$  ( $-58^{\circ}\text{F}$ ). This can be seen with the naked eye by the fact that dew and frost often appear on building surfaces even when the air temperature does not drop below the dewpoint.
- It should be noted that the concept of U values is based on ‘environmental temperatures’ on each side of the structure. This is neglected by many inexperienced analysts.
- The two temperatures that are firmly related to the transfer of heat through building fabric (and any solid) are the surface temperatures on each side.
- Therefore, by referring to surface temperatures the survey is more repeatable.
- The surface temperatures used are the averages of surface temperatures on the same material in an area near the anomaly on the inside and the outside of the fabric. Together with the temperature of the anomaly, a threshold level can be set dependent on these temperatures using the critical surface temperature factor.
- These arguments do not obviate the need for the thermographer to beware of reflections of objects at unusual temperatures in the background facing the building fabric surfaces.
- The thermographer should also use a comparison between external faces facing different directions to determine whether there is residual heat from solar gain affecting the external surfaces.
- External surveys should not be conducted on a surface where  $T_{si} - T_{so}$  on the face is more than 10% greater than  $T_{si} - T_{so}$  on the north or nearest to north face.
- For a defect that causes a failure under the 0.75 condition of IP17/01 the critical surface factors are 0.78 on the inside surface and 0.93 on the outside surface.

The table below shows the internal and external surface temperatures at an anomaly which would lead to failure under IP17/01. It also shows the deterioration in thermal insulation that is necessary to cause this.

Example for lightweight built-up cladding with defective insulation	Good area	Failing area
Outside temperature in °C	0	0
Inside surface temperature in °C	19.1	15.0
Outside surface temperature in °C	0.3	1.5
Surface factor from IP17/01	0.95	0.75
Critical external surface temperature factor, after IP17/01		0.92
Insulation thickness to give this level of performance, mm	80	5.1
Local U value W/m <sup>2</sup> K	0.35	1.92
UKTA TN1 surface factor		0.78
UKTA TN1 surface factor outside		0.93

### Notes to the table

1 Values of surface resistances taken from ADL2 2001, are:

- Inside surface 0.13 m<sup>2</sup>K/W
- Outside surface 0.04 m<sup>2</sup>K/W

These originate from BS EN ISO 6946 (BN EN ISO 6946:1997 Building components and building elements - Thermal resistance and thermal transmittance - Calculation method).

2 Thermal insulation used here is assumed to have a conductivity of 0.03 W/m K.

3 The difference in temperature between an anomaly and the good areas is 1.2 degrees on the outside and 4.1 degrees on the inside.

4 The UKTA TN1 surface temperature factor for internal surveys is:

$$F_{si} = (T_{sia} - T_{so}) / (T_{si} - T_{so})$$

where:

$T_{sia}$  = internal surface temperature at anomaly

$T_{so}$  = external surface temperature (good area)

$T_{si}$  = internal surface temperature (good area)

5 The UKTA TN1 surface temperature factor for external surveys is:

$$F_{so} = (T_{soa} - T_{si}) / (T_{so} - T_{si})$$

where  $T_{soa}$  = external surface temperature at anomaly

#### 20.3.8.4.3 Selecting maximum acceptable defect area

The allowable area of defect is a quality control issue. It can be argued that there should be no area on which condensation, mould growth or defective insulation will occur and any such anomalies should be included in the report. However, a commonly

used value of 0.1% of the building exposed surface area is generally accepted as the maximum combined defect area allowable to comply with the Building Regulations. This represents one square metre in every thousand.

#### **20.3.8.4.4      *Measuring surface temperature***

Measurement of surface temperature is the function of the infrared imaging system. The trained thermographer will recognise, account for and report on the variation of emissivity and reflectivity of the surfaces under consideration.

#### **20.3.8.4.5      *Measuring area of the defects***

Measurement of defect area can be performed by pixel counting in the thermal analysis software or most spreadsheet packages provided that:

- the distance from camera to object is accurately measured probably using a laser measurement system,
- the target distance should take into account the IFOV of the imaging system,
- any angular change between the camera and the object surface from the perpendicular is accounted for.

Buildings consist of numerous construction features that are not conducive to quantitative surveys including windows, roof lights, luminaries, heat emitters, cooling equipment, service pipes and electrical conductors. However, the joints and connections between these objects and the building envelope should be considered as part of the survey.

#### **20.3.8.5      *Conditions and equipment***

To achieve best results from a thermal insulation survey it is important to consider the environmental conditions and to use the most appropriate thermographic technique for the task.

Thermal anomalies will only present themselves to the thermographer where temperature differences exist and environmental phenomena are accounted for. As a minimum, the following conditions should be complied with:

- Temperature differences across the building fabric to be greater than 10°C (18°F).
- Internal air to ambient air temperature difference to be greater than 5°C (9°F) for the last twentyfour hours before survey.
- External air temperature to be within  $\pm 3^{\circ}\text{C}$  ( $\pm 5.4^{\circ}\text{F}$ ) for duration of survey and for the previous hour.
- External air temperature to be within  $\pm 10^{\circ}\text{C}$  ( $\pm 18^{\circ}\text{F}$ ) for the preceding twentyfour hours.

In addition, external surveys should also comply with the following:

- Necessary surfaces free from direct solar radiation and the residual effects of past solar radiation. This can be checked by comparing the surface temperatures of opposite sides of the building.
- No precipitation either just prior to or during the survey.
- Ensure all building surfaces to be inspected are dry.
- Wind speed to be less than 10 metres / second (19.5 kn.).

As well as temperature, there are other environmental conditions that should also be taken into account when planning a thermographic building survey. External inspections, for example, may be influenced by radiation emissions and reflections from adjacent buildings or a cold clear sky, and even more significantly the heating effect that the sun may have on surface.

20

Additionally, where background temperatures differ from air temperatures either internally or externally by more than 5 K, then background temperatures should be measured on all effected surfaces to allow surface temperature to be measured with sufficient accuracy.

#### 20.3.8.6 Survey and analysis

**The following provides some operational guidance to the thermographic operator.**

The survey must collect sufficient thermographic information to demonstrate that all surfaces have been inspected in order that all thermal anomalies are reported and evaluated.

Initially, environmental data must be collected, as with any thermographic survey including:

- Internal temperature in the region of the anomaly.
- External temperature in the region of the anomaly.
- Emissivity of the surface.
- Background temperature.
- Distance from the surface.

By interpolation, determine the threshold temperature to be used.

- For internal surveys the threshold surface temperature ( $T_{sia}$ ) is  $T_{sia} = f_{si}(T_{si} - T_{so}) + T_{so}$ . The thermographer will be looking for evidence of surface temperature below this threshold.
- For external surveys the threshold temperature ( $T_{soa}$ ) is  $T_{soa} = f_{so}(T_{so} - T_{si}) + T_{si}$ . The thermographer will be looking for evidence of surface temperature above this threshold.

Images of anomalies must be captured in such a way that they are suitable for analysis:

- The image is square to any features of the wall or roof.



- The viewing angle is nearly perpendicular to the surface being imaged. Interfering sources of infrared radiation such as lights, heat emitters, electric conductors, reflective elements are minimised.

The method of analysis will depend somewhat on analysis software used, but the key stages are as follows:

Produce an image of each anomaly or cluster of anomalies.

- Use a software analysis tool to enclose the anomalous area within the image, taking care not to include construction details that are to be excluded.
- Calculate the area below the threshold temperature for internal surveys or above the threshold temperature for external surveys. This is the defect area. Some anomalies that appeared to be defects at the time of the survey may not show defect areas at this stage.
- Add the defect areas from all the images  $\sum A_d$ .
- Calculate the total area of exposed building fabric. This is the surface area of all the walls and roof. It is conventional to use the external surface area. For a simple shape building this is calculated from overall width, length and height.  

$$A_t = (2h(L + w)) + (Lw)$$
- Identify the critical defect area  $A_c$ . Provisionally this is set at one thousandth or 0.1% of the total surface area.  

$$A_c = A_t/1000$$
- If  $\sum A_d < A_c$  the building as a whole can be considered to have 'reasonably continuous' insulation.

### 20.3.8.7 Reporting

Reports should certificate a pass/fail result, comply with customers requirements and as a minimum include the information required by BSEN 13187. The following data is normally required so that survey can be repeated following remedial action.

- Background to the objective and principles of the test.
- Location, orientation, date and time of survey.
- A unique identifying reference.
- Thermographer's name and qualifications.
- Type of construction.
- Weather conditions, wind speed and direction, last precipitation, sunshine, degree of cloud cover.
- Ambient temperatures inside and outside before, at the beginning of survey and the time of each image. Air temperature and radiant temperature should be recorded.
- Statement of any deviation from relevant test requirements.
- Equipment used, last calibration date, any known defects.
- Name, affiliation and qualifications of tester.

- Type, extent and position of each observed defect.
- Results of any supplementary measurements and investigations.
- Reports should be indexed and archived by thermographers.

#### 20.3.8.7.1 *Considerations and limitations*

The choice between internal and external surveys will depend on:

- Access to the surface. Buildings where both the internal and the external surfaces are obscured, e.g., by false ceilings racking or materials stacked against walls may not be amenable to this type of survey.
- Location of the thermal insulation. Surveys are usually more effective from the side nearest to the thermal insulation.
- Location of heavyweight materials. Surveys are usually less effective from the side nearest to the heavyweight material.
- The purpose of the survey. If the survey aims to show risk of condensation and mould growth it should be internal.
- Location of glass, bare metal or other materials that may be highly reflective. Surveys are usually less effective on highly reflective surfaces.
- A defect will usually produce a smaller temperature difference on the outside of a wall exposed to external air movement. However, missing or defective insulation near the external surface can often be more readily identified externally.

## 20.4 *Disclaimer*

### 20.4.1 Copyright notice

Some sections and/or images appearing in this chapter are copyrighted to the following organizations and companies:

- FORMAS—The Swedish Research Council for Environment, Agricultural Sciences and Spatial Planning, Stockholm, Sweden
- ITC—Infrared Training Center, Boston, MA, United States
- Stockton Infrared Thermographic Services, Inc., Randleman, NC, United States
- Professional Investigative Engineers, Westminster, CO, United States
- United Kingdom Thermography Association (UKTA)

### 20.4.2 Training & certification

**Carrying out building thermography inspections requires substantial training and experience, and may require certification from a national or regional standardization body. This section is provided only as an introduction to building thermography. The user is strongly recommended to attend relevant training courses.**

**For more information about infrared training, visit the following website:**

**<http://www.infraredtraining.com>**

### 20.4.3 National or regional building codes

The commented building structures in this chapter may differ in construction from country to country. For more information about construction details and standards of procedure, always consult national or regional building codes.

INTENTIONALLY LEFT BLANK

---

# 21 Introduction to thermographic inspections of electrical installations

## 21.1 *Important note*

All camera functions and features that are described in this section may not be supported by your particular camera configuration.

Electrical regulations differ from country to country. For that reason, the electrical procedures described in this section may not be the standard of procedure in your particular country. Also, in many countries carrying out electrical inspections requires formal qualification. Always consult national or regional electrical regulations.

## 21.2 *General information*

### 21.2.1 Introduction

Today, thermography is a well-established technique for the inspection of electrical installations. This was the first and still is the largest. the largest application of thermography. The infrared camera itself has gone through an explosive development and we can say that today, the 8th generation of thermographic systems is available. It all began in 1964, more than 40 years ago. The technique is now established throughout the whole world. Industrialized countries as well as developing countries have adopted this technique.

Thermography, in conjunction with vibration analysis, has over the latest decades been the main method for fault diagnostics in the industry as a part of the preventive maintenance program. The great advantage with these methods is that it is not only possible to carry out the inspection on installations in operation; normal working condition is in fact a prerequisite for a correct measurement result, so the ongoing production process is not disturbed. Thermographic inspection of electrical installations are used in three main areas:

- Power generation
- Power transmission
- Power distribution, that is, industrial use of electrical energy.

The fact that these controls are carried out under normal operation conditions has created a natural division between these groups. The power generation companies measure during the periods of high load. These periods vary from country to country

and for the climatic zones. The measurement periods may also differ depending on the type of plant to be inspected, whether they are hydroelectric, nuclear, coal-based or oil-based plants.

In the industry the inspections are—at least in Nordic countries with clear seasonal differences—carried out during spring or autumn or before longer stops in the operation. Thus, repairs are made when the operation is stopped anyway. However, this seems to be the rule less and less, which has led to inspections of the plants under varying load and operating conditions.

### 21.2.2 General equipment data

The equipment to be inspected has a certain temperature behavior that should be known to the thermographer before the inspection takes place. In the case of electrical equipment, the physical principle of why faults show a different temperature pattern because of increased resistance or increased electrical current is well known.

21

However, it is useful to remember that, in some cases, for example solenoids, ‘overheating’ is natural and does not correspond to a developing defect. In other cases, like the connections in electrical motors, the overheating might depend on the fact that the healthy part is taking the entire load and therefore becomes overheated.

A similar example is shown in section 21.5.7 – Overheating in one part as a result of a fault in another on page 189.

Defective parts of electrical equipment can therefore both indicate overheating and be cooler than the normal ‘healthy’ components. It is necessary to be aware of what to expect by getting as much information as possible about the equipment before it is inspected.

The general rule is, however, that a hot spot is caused by a probable defect. The temperature and the load of that specific component at the moment of inspection will give an indication of how serious the fault is and can become in other conditions.

Correct assessment in each specific case demands detailed information about the thermal behavior of the components, that is, we need to know the maximum allowed temperature of the materials involved and the role the component plays in the system.

Cable insulations, for example, lose their insulation properties above a certain temperature, which increases the risk of fire.

In the case of breakers, where the temperature is too high, parts can melt and make it impossible to open the breaker, thereby destroying its functionality.

The more the IR camera operator knows about the equipment that he or she is about to inspect, the higher the quality of the inspection. But it is virtually impossible for an IR thermographer to have detailed knowledge about all the different types of equipment that can be controlled. It is therefore common practice that a person responsible for the equipment is present during the inspection.

### 21.2.3 Inspection

The preparation of the inspection should include the choice of the right type of report. It is often necessary to use complementary equipment such as ampere meters in order to measure the current in the circuits where defects were found. An anemometer is necessary if you want to measure the wind speed at inspection of outdoor equipment.

Automatic functions help the IR operator to visualize an IR image of the components with the right contrast to allow easy identification of a fault or a hot spot. It is almost impossible to miss a hot spot on a scanned component. A measurement function will also automatically display the hottest spot within an area in the image or the difference between the maximum temperature in the chosen area and a reference, which can be chosen by the operator, for example the ambient temperature.



**Figure 21.1** An infrared and a visual image of a power line isolator

When the fault is clearly identified and the IR thermographer has made sure that it is not a reflection or a naturally occurring hot spot, the collection of the data starts, which will allow the correct reporting of the fault. The emissivity, the identification of the component, and the actual working conditions, together with the measured temperature, will be used in the report. In order to make it easy to identify the component a visual photo of the defect is often taken.

### 21.2.4 Classification & reporting

Reporting has traditionally been the most time-consuming part of the IR survey. A one-day inspection could result in one or two days' work to report and classify the found defects. This is still the case for many thermographers, who have chosen not to use the advantages that computers and modern reporting software have brought to IR condition monitoring.

The classification of the defects gives a more detailed meaning that not only takes into account the situation at the time of inspection (which is certainly of great importance), but also the possibility to normalize the over-temperature to standard load and ambient temperature conditions.

An over-temperature of +30°C (+86°F) is certainly a significant fault. But if that over-temperature is valid for one component working at 100% load and for another at 50% load, it is obvious that the latter will reach a much higher temperature should its load increase from 50% to 100%. Such a standard can be chosen by the plant's circumstances. Very often, however, temperatures are predicted for 100% load. A standard makes it easier to compare the faults over time and thus to make a more complete classification.

#### 21.2.5 Priority

Based on the classification of the defects, the maintenance manager gives the defects a repair priority. Very often, the information gathered during the infrared survey is put together with complementary information on the equipment collected by other means such as vibration monitoring, ultrasound or the preventive maintenance scheduled.

Even if the IR inspection is quickly becoming the most used method of collecting information about electrical components safely with the equipment under normal operating conditions, there are many other sources of information the maintenance or the production manager has to consider.

The priority of repair should therefore not be a task for the IR camera operator in the normal case. If a critical situation is detected during the inspection or during the classification of the defects, the attention of the maintenance manager should of course be drawn to it, but the responsibility for determining the urgency of the repair should be his.

#### 21.2.6 Repair

To repair the known defects is the most important function of preventive maintenance. However, to assure production at the right time or at the right cost can also be important goals for a maintenance group. The information provided by the infrared survey can be used to improve the repair efficiency as well as to reach the other goals with a calculated risk.

To monitor the temperature of a known defect that can not be repaired immediately for instance because spare parts are not available, can often pay for the cost of inspection a thousandfold and sometimes even for the IR camera. To decide not to repair known defects to save on maintenance costs and avoid unnecessary downtime is also another way of using the information from the IR survey in a productive way.



However, the most common result of the identification and classification of the detected faults is a recommendation to repair immediately or as soon as it is practically possible. It is important that the repair crew is aware of the physical principles for the identification of defects. If a defect shows a high temperature and is in a critical situation, it is very common that the repair personnel expect to find a highly corroded component. It should also come as no surprise to the repair crew that a connection, which is usually healthy, can give the same high temperatures as a corroded one if it has come loose. These misinterpretations are quite common and risk putting in doubt the reliability of the infrared survey.

### 21.2.7 Control

A repaired component should be controlled as soon as possible after the repair. It is not efficient to wait for the next scheduled IR survey in order to combine a new inspection with the control of the repaired defects. The statistics on the effect of the repair show that up to a third of the repaired defects still show overheating. That is the same as saying that those defects present a potential risk of failure.

To wait until the next scheduled IR survey represents an unnecessary risk for the plant.

Besides increasing the efficiency of the maintenance cycle (measured in terms of lower risk for the plant) the immediate control of the repair work brings other advantages to the performance of the repair crew itself.

When a defect still shows overheating after the repair, the determination of the cause of overheating improves the repair procedure, helps choose the best component suppliers and detect design shortcomings on the electrical installation. The crew rapidly sees the effect of the work and can learn quickly both from successful repairs and from mistakes.

Another reason to provide the repair crew with an IR instrument is that many of the defects detected during the IR survey are of low gravity. Instead of repairing them, which consumes maintenance and production time, it can be decided to keep these defects under control. Therefore the maintenance personnel should have access to their own IR equipment.

It is common to note on the report form the type of fault observed during the repair as well as the action taken. These observations make an important source of experience that can be used to reduce stock, choose the best suppliers or to train new maintenance personnel.

## 21.3 Measurement technique for thermographic inspection of electrical installations

### 21.3.1 How to correctly set the equipment

A thermal image may show high temperature variations:

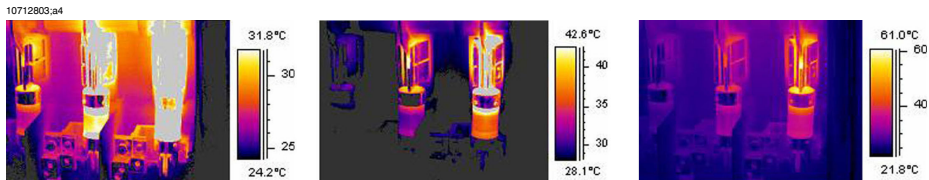
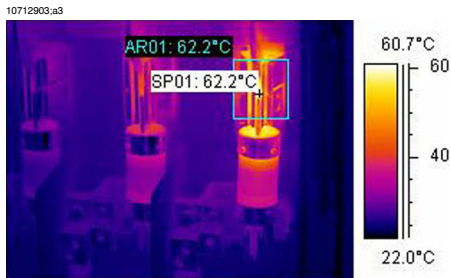

**Figure 21.2** Temperature variations in a fusebox

In the images above, the fuse to the right has a maximum temperature of +61°C (+142°F), whereas the one to the left is maximum +32°C (+90°F) and the one in the middle somewhere in between. The three images are different inasmuch as the temperature scale enhances only one fuse in each image. However, it is the same image and all the information about all three fuses is there. It is only a matter of setting the temperature scale values.

### 21.3.2 Temperature measurement

Some cameras today can automatically find the highest temperature in the image. The image below shows how it looks to the operator.

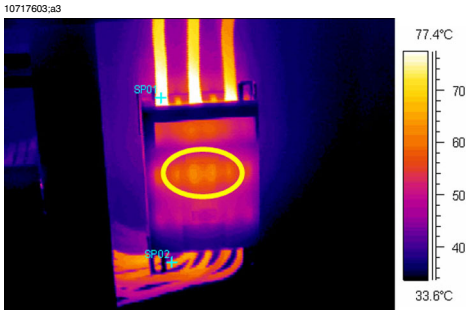

**Figure 21.3** An infrared image of a fusebox where the maximum temperature is displayed

The maximum temperature in the area is +62.2°C (+144.0°F). The spot meter shows the exact location of the hot spot. The image can easily be stored in the camera memory.

The correct temperature measurement depends, however, not only on the function of the evaluation software or the camera. It may happen that the actual fault is, for example, a connection, which is hidden from the camera in the position it happens

to be in for the moment. It might be so that you measure heat, which has been conducted over some distance, whereas the ‘real’ hot spot is hidden from you. An example is shown in the image below.



**Figure 21.4** A hidden hot spot inside a box

Try to choose different angles and make sure that the hot area is seen in its full size, that is, that it is not disappearing behind something that might hide the hottest spot. In this image, the hottest spot of what the camera can ‘see’, is +83°C (+181°F), where the operating temperature on the cables below the box is +60°C (+140°F). However, the real hot spot is most probably hidden inside the box, see the in yellow encircled area. This fault is reported as a +23.0°C (+41.4°F) excess temperature, but the real problem is probably essentially hotter.

Another reason for underestimating the temperature of an object is bad focusing. It is very important that the hot spot found is in focus. See the example below.

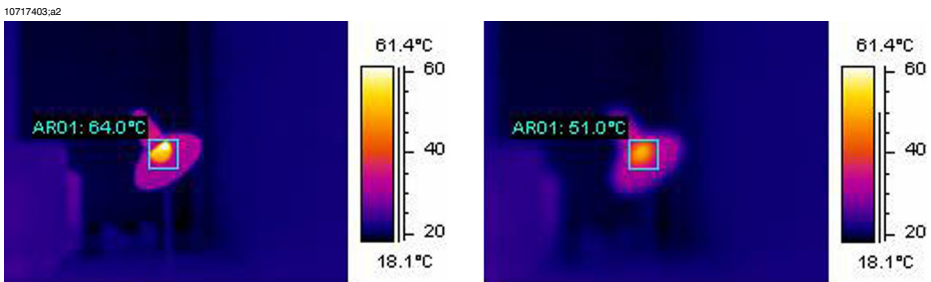

**Figure 21.5** LEFT: A hot spot in focus; RIGHT: A hot spot out of focus

In the left image, the lamp is in focus. Its average temperature is +64°C (+147°F). In the right image, the lamp is out of focus, which will result in only +51°C (+124°F) as the maximum temperature.

### 21.3.3 Comparative measurement

For thermographic inspections of electrical installations a special method is used, which is based on comparison of different objects, so-called *measurement with a reference*. This simply means that you compare the three phases with each other. This method needs systematic scanning of the three phases in parallel in order to assess whether a point differs from the normal temperature pattern.

A normal temperature pattern means that current carrying components have a given operation temperature shown in a certain color (or gray tone) on the display, which is usually identical for all three phases under symmetrical load. Minor differences in the color might occur in the current path, for example, at the junction of two different materials, at increasing or decreasing conductor areas or on circuit breakers where the current path is encapsulated.

The image below shows three fuses, the temperatures of which are very close to each other. The inserted isotherm actually shows less than +2°C (+3.6°F) temperature difference between the phases.

Different colors are usually the result if the phases are carrying an unsymmetrical load. This difference in colors does not represent any overheating since this does not occur locally but is spread along the whole phase.

10713203.a3

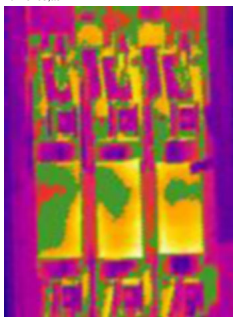

**Figure 21.6** An isotherm in an infrared image of a fusebox

A 'real' hot spot, on the other hand, shows a rising temperature as you look closer to the source of the heat. See the image below, where the profile (line) shows a steadily increasing temperature up to about +93°C (+199°F) at the hot spot.

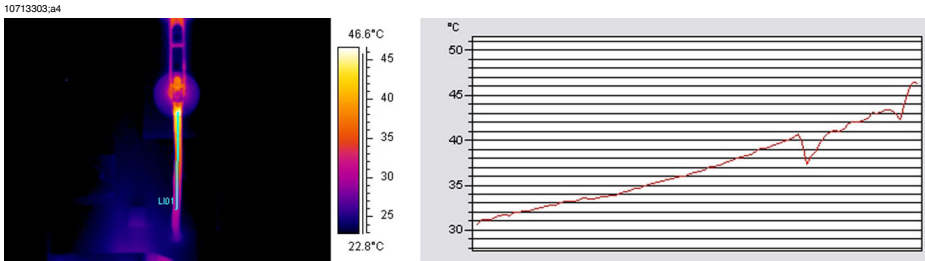

**Figure 21.7** A profile (line) in an infrared image and a graph displaying the increasing temperature

### 21.3.4 Normal operating temperature

Temperature measurement with thermography usually gives the absolute temperature of the object. In order to correctly assess whether the component is too hot, it is necessary to know its operating temperature, that is, its normal temperature if we consider the load and the temperature of its environment.

As the direct measurement will give the absolute temperature—which must be considered as well (as most components have an upper limit to their absolute temperatures)—it is necessary to calculate the expected operating temperature given the load and the ambient temperature. Consider the following definitions:

- **Operating temperature:** the absolute temperature of the component. It depends on the current load and the ambient temperature. It is always higher than the ambient temperature.
- **Excess temperature (overheating):** the temperature difference between a properly working component and a faulty one.

The excess temperature is found as the difference between the temperature of a 'normal' component and the temperature of its neighbor. It is important to compare the same points on the different phases with each other.

As an example, see the following images taken from indoor equipment:



**Figure 21.8** An infrared image of indoor electrical equipment (1)



**Figure 21.9** An infrared image of indoor electrical equipment (2)

The two left phases are considered as normal, whereas the right phase shows a very clear excess temperature. Actually, the operating temperature of the left phase is +68°C (+154°F), that is, quite a substantial temperature, whereas the faulty phase to the right shows a temperature of +86°C (+187°F). This means an excess temperature of +18°C (+33°F), that is, a fault that has to be attended to quickly.

For practical reasons, the (normal, expected) operating temperature of a component is taken as the temperature of the components in at least two out of three phases, provided that you consider them to be working normally.. The ‘most normal’ case is of course that all three phases have the same or at least almost the same temperature. The operating temperature of outdoor components in substations or power lines is usually only 1°C or 2°C above the air temperature (1.8°F or 3.6°F). In indoor substations, the operating temperatures vary a lot more.

This fact is clearly shown by the bottom image as well. Here the left phase is the one, which shows an excess temperature. The operating temperature, taken from the two ‘cold’ phases, is +66°C (+151°F). The faulty phase shows a temperature of +127°C (+261°F), which has to be attended to without delay.

### 21.3.5 Classification of faults

Once a faulty connection is detected, corrective measures may be necessary—or may not be necessary for the time being. In order to recommend the most appropriate action the following criteria should be evaluated:

- Load during the measurement
- Even or varying load
- Position of the faulty part in the electrical installation
- Expected future load situation
- Is the excess temperature measured directly on the faulty spot or indirectly through conducted heat caused by some fault inside the apparatus?

Excess temperatures measured directly on the faulty part are usually divided into three categories relating to 100% of the maximum load.

I	< 5°C (9°F)	The start of the overheat condition. This must be carefully monitored.
II	5–30°C (9–54°F)	Developed overheating. It must be repaired as soon as possible (but think about the load situation before a decision is made).
III	>30°C (54°F)	Acute overheating. Must be repaired immediately (but think about the load situation before a decision is made).

## 21.4 Reporting

Nowadays, thermographic inspections of electrical installations are probably, without exception, documented and reported by the use of a report program. These programs, which differ from one manufacturer to another, are usually directly adapted to the cameras and will thus make reporting very quick and easy.

The program, which has been used for creating the report page shown below, is called ThermaCAM™ Reporter. It is adapted to several types of infrared cameras from FLIR Systems.

A professional report is often divided into two sections:

- Front pages, with facts about the inspection, such as:
  - Who the client is, for example, customer's company name and contact person
  - Location of the inspection: site address, city, and so on
  - Date of inspection
  - Date of report
  - Name of thermographer
  - Signature of thermographer
  - Summary or table of contents
- Inspection pages containing IR images to document and analyze thermal properties or anomalies.
  - Identification of the inspected object:
    - What is the object: designation, name, number, and so on
    - Photo
  - IR image. When collecting IR images there are some details to consider:
    - Optical focus
    - Thermal adjustment of the scene or the problem (level & span)
    - Composition: proper observation distance and viewing angle.
  - Comment
    - Is there an anomaly or not?
    - Is there a reflection or not?
    - Use a measurement tool—spot, area or isotherm—to quantify the problem. Use the simplest tool possible; a profile graph is almost never needed in electrical reports.

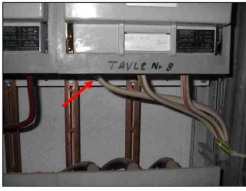
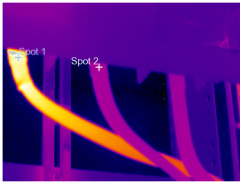

10713603.a3

	<b>THERMOGRAPHY INSPECTION</b> for <b>FLIR Systems AB</b>		Date: 2005-10-10 Sign: _____ Contract. : 1708																													
	<b>Photograph</b>																															
		<table border="1" style="width: 100%; border-collapse: collapse;"> <tr> <td>Place</td> <td colspan="3">Building 1</td> </tr> <tr> <td>Localization</td> <td colspan="3">Right panel, group 2</td> </tr> <tr> <td>Equipment</td> <td colspan="3">Fuse</td> </tr> <tr> <td>Model / type</td> <td colspan="3">BBC LHBN 250</td> </tr> <tr> <td>Phase / ID</td> <td colspan="3">Supply for Panel 8</td> </tr> <tr> <td>Room temperature °C</td> <td colspan="3">15</td> </tr> <tr> <td colspan="2"><b>Status</b></td> <td colspan="2"><b>Over heated</b></td> </tr> </table>			Place	Building 1			Localization	Right panel, group 2			Equipment	Fuse			Model / type	BBC LHBN 250			Phase / ID	Supply for Panel 8			Room temperature °C	15			<b>Status</b>		<b>Over heated</b>	
		Place	Building 1																													
Localization	Right panel, group 2																															
Equipment	Fuse																															
Model / type	BBC LHBN 250																															
Phase / ID	Supply for Panel 8																															
Room temperature °C	15																															
<b>Status</b>		<b>Over heated</b>																														
<b>Thermogram</b>																																
		<table border="1" style="width: 100%; border-collapse: collapse;"> <tr> <td>Temp. Spot 1</td> <td colspan="3">34 °C</td> </tr> <tr> <td>Temp. Spot 2</td> <td colspan="3">17 °C</td> </tr> <tr> <td colspan="2"><b>TEMPERATURE DIFF</b></td> <td colspan="2"><b>17 °C</b></td> </tr> <tr> <td>Phase</td> <td>L1</td> <td>L2</td> <td>L3</td> </tr> <tr> <td>Load ( A )</td> <td>45</td> <td>47</td> <td>47</td> </tr> <tr> <td>Rated load</td> <td colspan="3">250</td> </tr> <tr> <td><b>Fault class</b></td> <td colspan="3"><b>2</b></td> </tr> </table>			Temp. Spot 1	34 °C			Temp. Spot 2	17 °C			<b>TEMPERATURE DIFF</b>		<b>17 °C</b>		Phase	L1	L2	L3	Load ( A )	45	47	47	Rated load	250			<b>Fault class</b>	<b>2</b>		
		Temp. Spot 1	34 °C																													
Temp. Spot 2	17 °C																															
<b>TEMPERATURE DIFF</b>		<b>17 °C</b>																														
Phase	L1	L2	L3																													
Load ( A )	45	47	47																													
Rated load	250																															
<b>Fault class</b>	<b>2</b>																															
<b>Comment</b>																																
Disconnect cable, clean contact surfaces. Check for connectivity between cable shoe and lead. Replace any defective component. Assemble according to directions with correct torque.  Note that load is only 18%. Calculated temperature rise at 50% load would be approximately 104°C. $[T50=(T1-T2)*(1.25/45)^{1.6}+T2]$																																
<b>Corrected</b>																																
Measure taken: _____		Date: _____																														
Sign: _____		Sign.: _____																														
Side 1																																

21

**Figure 21.10** A report example

## 21.5 Different types of hot spots in electrical installations

### 21.5.1 Reflections

The thermographic camera sees any radiation that enters the lens, not only originating from the object that you are looking at, but also radiation that comes from other sources and has been reflected by the target. Most of the time, electrical components are like mirrors to the infrared radiation, even if it is not obvious to the eye. Bare metal parts are particularly shiny, whereas painted, plastic or rubber insulated parts are mostly not. In the image below, you can clearly see a reflection from the thermographer. This is of course not a hot spot on the object. A good way to find out if what you see is a reflection or not, is for you to move. Look at the target from a different angle and watch the 'hot spot.' If it moves when you do, it is a reflection.

Measuring temperature of mirror like details is not possible. The object in the images below has painted areas which are well suited for temperature measurement. The material is copper, which is a very good heat conductor. This means that temperature variation over the surface is small.

21

10717503.a2

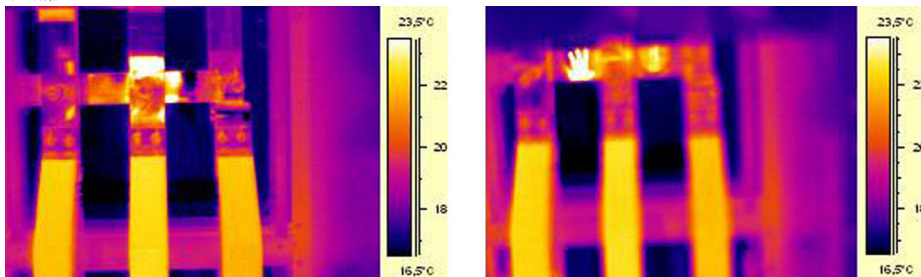

**Figure 21.11** Reflections in an object

### 21.5.2 Solar heating

The surface of a component with a high emissivity, for example, a breaker, can on a hot summer day be heated up to quite considerable temperatures by irradiation from the sun. The image shows a circuit breaker, which has been heated by the sun.

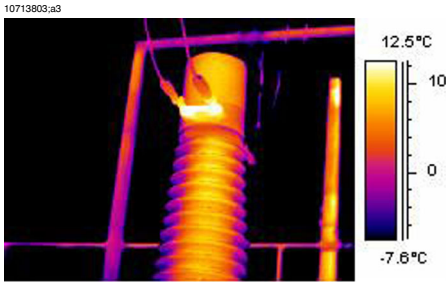

**Figure 21.12** An infrared image of a circuit breaker

### 21.5.3 Inductive heating

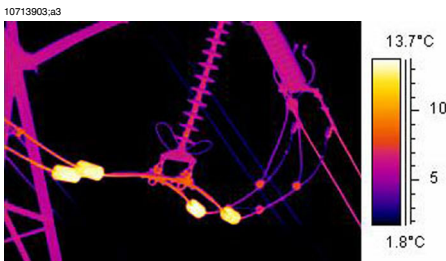
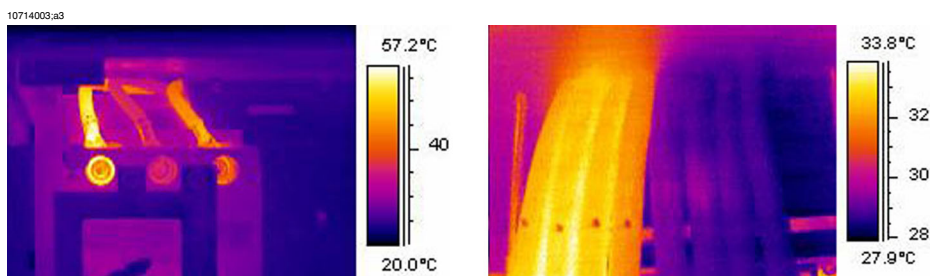

**Figure 21.13** An infrared image of hot stabilizing weights

Eddy currents can cause a hot spot in the current path. In cases of very high currents and close proximity of other metals, this has in some cases caused serious fires. This type of heating occurs in magnetic material around the current path, such as metallic bottom plates for bushing insulators. In the image above, there are stabilizing weights, through which a high current is running. These metal weights, which are made of a slightly magnetic material, will not conduct any current but are exposed to the alternating magnetic fields, which will eventually heat up the weight. The overheating in the image is less than +5°C (+9°F). This, however, need not necessarily always be the case.

### 21.5.4 Load variations

3-phase systems are the norm in electric utilities. When looking for overheated places, it is easy to compare the three phases directly with each other, for example, cables, breakers, insulators. An even load per phase should result in a uniform temperature pattern for all three phases. A fault may be suspected in cases where the temperature of one phase differs considerably from the remaining two. However, you should always make sure that the load is indeed evenly distributed. Looking at fixed ampere meters or using a clip-on ampere meter (up to 600 A) will tell you.

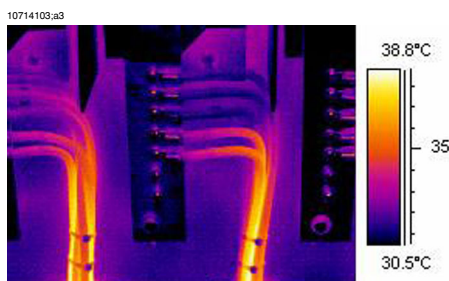

**Figure 21.14** Examples of infrared images of load variations

The image to the left shows three cables next to each other. They are so far apart that they can be regarded as thermally insulated from each other. The one in the middle is colder than the others. Unless two phases are faulty and overheated, this is a typical example of a very unsymmetrical load. The temperature spreads evenly along the cables, which indicates a load-dependent temperature increase rather than a faulty connection.

The image to the right shows two bundles with very different loads. In fact, the bundle to the right carries next to no load. Those which carry a considerable current load, are about 5°C (9°F) hotter than those which do not. No fault to be reported in these examples.

### 21.5.5 Varying cooling conditions



**Figure 21.15** An infrared image of bundled cables

When, for example, a number of cables are bundled together it can happen that the resulting poor cooling of the cables in the middle can lead to them reaching very high temperatures. See the image above.

The cables to the right in the image do not show any overheating close to the bolts. In the vertical part of the bundle, however, the cables are held together very tightly, the cooling of the cables is poor, the convection can not take the heat away, and the cables are notably hotter, actually about 5°C (9°F) above the temperature of the better cooled part of the cables.

### 21.5.6 Resistance variations

Overheating can have many origins. Some common reasons are described below.

Low contact pressure can occur when mounting a joint, or through wear of the material, for example, decreasing spring tension, worn threads in nuts and bolts, even too much force applied at mounting. With increasing loads and temperatures, the yield point of the material is exceeded and the tension weakens.

The image to the left below shows a bad contact due to a loose bolt. Since the bad contact is of very limited dimensions, it causes overheating only in a very small spot from which the heat is spread evenly along the connecting cable. Note the lower emissivity of the screw itself, which makes it look slightly colder than the insulated—and thereby it has a high emissivity—cable insulation.

The image to the right shows another overheating situation, this time again due to a loose connection. It is an outdoor connection, hence it is exposed to the cooling effect of the wind and it is likely that the overheating would have shown a higher temperature, if mounted indoors.

10714203.a3

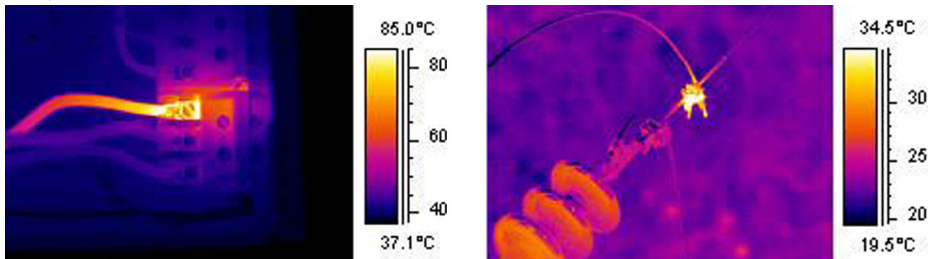
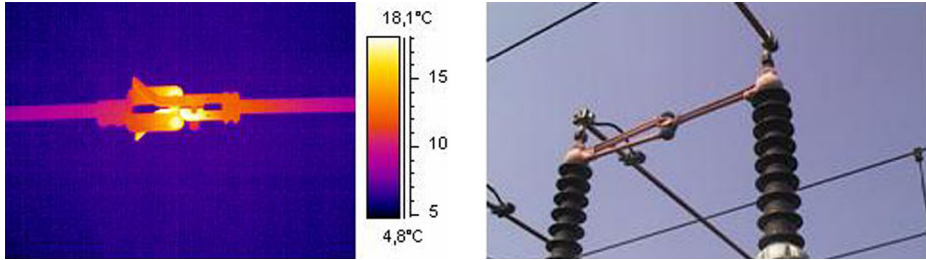

**Figure 21.16** LEFT: An infrared image showing bad contact due to a loose bolt; RIGHT: A loose outdoor connection, exposed to the wind cooling effect.

### 21.5.7 Overheating in one part as a result of a fault in another

Sometimes, overheating can appear in a component although that component is OK. The reason is that two conductors share the load. One of the conductors has an increased resistance, but the other is OK. Thus, the faulty component carries a lower load, whereas the fresh one has to take a higher load, which may be too high and which causes the increased temperature. See the image.

10714303.a3



**Figure 21.17** Overheating in a circuit breaker

The overheating of this circuit breaker is most probably caused by bad contact in the near finger of the contactor. Thus, the far finger carries more current and gets hotter. The component in the infrared image and in the photo is not the same, however, it is similar).

## 21.6 *Disturbance factors at thermographic inspection of electrical installations*

During thermographic inspections of different types of electrical installations, disturbance factors such as wind, distance to object, rain or snow often influence the measurement result.

### 21.6.1 **Wind**

During outdoor inspection, the cooling effect of the wind should be taken into account. An overheating measured at a wind velocity of 5 m/s (10 knots) will be approximately twice as high at 1 m/s (2 knots). An excess temperature measured at 8 m/s (16 knots) will be 2.5 times as high at 1 m/s (2 knots). This correction factor, which is based on empirical measurements, is usually applicable up to 8 m/s (16 knots).

There are, however, cases when you have to inspect even if the wind is stronger than 8 m/s (16 knots). There are many windy places in the world, islands, mountains, and so on but it is important to know that overheated components found would have shown a considerably higher temperature at a lower wind speed. The empirical correction factor can be listed.

Wind speed (m/s)	Wind speed (knots)	Correction factor
1	2	1
2	4	1.36
3	6	1.64
4	8	1.86
5	10	2.06
6	12	2.23
7	14	2.40
8	16	2.54

The measured overheating multiplied by the correction factor gives the excess temperature with no wind, that is, at 1 m/s (2 knots).

### 21.6.2 **Rain and snow**

Rain and snow also have a cooling effect on electrical equipment. Thermographic measurement can still be conducted with satisfactory results during light snowfall with dry snow and light drizzle, respectively. The image quality will deteriorate in heavy

snow or rain and reliable measurement is no longer possible. This is mainly because a heavy snowfall as well as heavy rain is impenetrable to infrared radiation and it is rather the temperature of the snowflakes or raindrops that will be measured.

### 21.6.3 Distance to object

This image is taken from a helicopter 20 meters (66 ft.) away from this faulty connection. The distance was incorrectly set to 1 meter (3 ft.) and the temperature was measured to +37.9°C (+100.2°F). The measurement value after changing the distance to 20 meters (66 ft.), which was done afterwards, is shown in the image to the right, where the corrected temperature is +38.8°C (+101.8°F). The difference is not too crucial, but may take the fault into a higher class of seriousness. So the distance setting must definitely not be neglected.

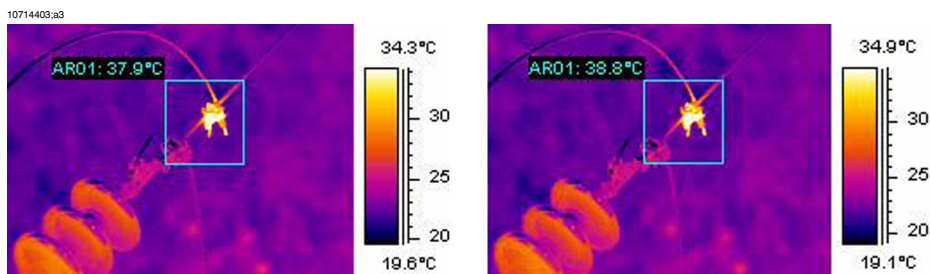

**Figure 21.18** LEFT: Incorrect distance setting; RIGHT: Correct distance setting

The images below show the temperature readings from a blackbody at +85°C (+185°F) at increasing distances.

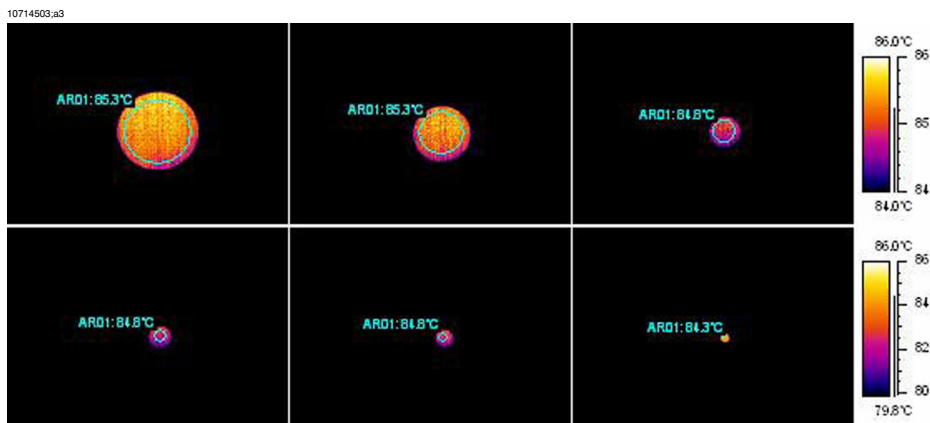

**Figure 21.19** Temperature readings from a blackbody at +85°C (+185°F) at increasing distances



The measured average temperatures are, from left to right, +85.3°C (+185.5°F), +85.3°C (+185.5°F), +84.8°C (+184.6°F), +84.8°C (+184.6°F), +84.8°C (+184.6°F) and +84.3°C (+183.7°F) from a blackbody at +85°C (+185°F). The thermograms are taken with a 12° lens. The distances are 1, 2, 3, 4, 5 and 10 meters (3, 7, 10, 13, 16 and 33 ft.). The correction for the distance has been meticulously set and works, because the object is big enough for correct measurement.

#### 21.6.4 Object size

The second series of images below shows the same but with the normal 24° lens. Here, the measured average temperatures of the blackbody at +85°C (+185°F) are: +84.2°C (+183.6°F), +83.7°C (+182.7°F), +83.3°C (+181.9°F), +83.3°C (+181.9°F), +83.4°C (+181.1°F) and +78.4°C (+173.1°F).

The last value, (+78.4°C (+173.1°F)), is the maximum temperature as it was not possible to place a circle inside the now very small blackbody image. Obviously, it is not possible to measure correct values if the object is too small. Distance was properly set to 10 meters (33 ft.).



**Figure 21.20** Temperature readings from a blackbody at +85°C (+185°F) at increasing distances (24° lens)

The reason for this effect is that there is a smallest object size, which gives correct temperature measurement. This smallest size is indicated to the user in all FLIR Systems cameras. The image below shows what you see in the viewfinder of camera model 695. The spot meter has an opening in its middle, more easily seen in the detail to the right. The size of the object has to be bigger than that opening or some radiation from its closest neighbors, which are much colder, will come into the measurement

as well, strongly lowering the reading. In the above case, where we have a point-shaped object, which is much hotter than the surroundings, the temperature reading will be too low.

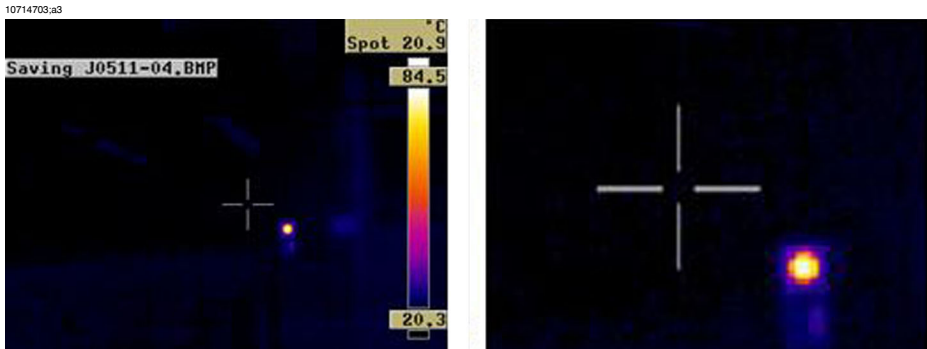

21

**Figure 21.21** Image from the viewfinder of a ThermoCAM 695

This effect is due to imperfections in the optics and to the size of the detector elements. It is typical for all infrared cameras and can not be avoided.

## 21.7 *Practical advice for the thermographer*

Working in a practical way with a camera, you will discover small things that make your job easier. Here are ten of them to start with.

### 21.7.1 From cold to hot

You have been out with the camera at +5°C (+41°F). To continue your work, you now have to perform the inspection indoors. If you wear glasses, you are used to having to wipe off condensed water, or you will not be able to see anything. The same thing happens with the camera. To measure correctly, you should wait until the camera has become warm enough for the condensation to evaporate. This will also allow for the internal temperature compensation system to adjust to the changed condition.

### 21.7.2 Rain showers

If it starts raining you should not perform the inspection because the water will drastically change the surface temperature of the object that you are measuring. Nevertheless, sometimes you need to use the camera even under rain showers or splashes. Protect your camera with a simple transparent polyethylene plastic bag. Correction for the attenuation which is caused by the plastic bag can be made by adjusting the object distance until the temperature reading is the same as without the plastic cover. Some camera models have a separate **External optics transmission** entry.

### 21.7.3 Emissivity

You have to determine the emissivity for the material, which you are measuring. Mostly, you will not find the value in tables. Use optical black paint, that is, Nextel Black Velvet. Paint a small piece of the material you are working with. The emissivity of the optical paint is normally 0.94. Remember that the object has to have a temperature, which is different—usually higher—than the ambient temperature. The larger the difference the better the accuracy in the emissivity calculation. The difference should be at least 20°C (36°F). Remember that there are other paints that support very high temperatures up to +800°C (+1472°F). The emissivity may, however, be lower than that of optical black.

Sometimes you can not paint the object that you are measuring. In this case you can use a tape. A thin tape for which you have previously determined the emissivity will work in most cases and you can remove it afterwards without damaging the object of your study. Pay attention to the fact that some tapes are semi-transparent and thus are not very good for this purpose. One of the best tapes for this purpose is Scotch electrical tape for outdoor and sub-zero conditions.

#### 21.7.4 Reflected apparent temperature

You are in a measurement situation where there are several hot sources that influence your measurement. You need to have the right value for the reflected apparent temperature to input into the camera and thus get the best possible correction. Do it in this way: set the emissivity to 1.0. Adjust the camera lens to near focus and, looking in the opposite direction away from the object, save one image. With the area or the isotherm, determine the most probable value of the average of the image and use that value for your input of reflected apparent temperature.

#### 21.7.5 Object too far away

Are you in doubt that the camera you have is measuring correctly at the actual distance? A rule of thumb for your lens is to multiply the IFOV by 3. (IFOV is the detail of the object seen by one single element of the detector). Example: 25 degrees correspond to about 437 mrad. If your camera has a  $120 \times 120$  pixel image, IFOV becomes  $437/120 = 3.6$  mrad (3.6 mm/m) and your spot size ratio is about  $1000/(3 \times 3.6) = 92:1$ . This means that at a distance of 9.2 meters (30.2 ft.), your target has to be at least about 0.1 meter or 100 mm wide (3.9"). Try to work on the safe side by coming closer than 9 meters (30 ft.). At 7–8 meters (23–26 ft.), your measurement should be correct.

## 22 About FLIR Systems

FLIR Systems was established in 1978 to pioneer the development of high-performance infrared imaging systems, and is the world leader in the design, manufacture, and marketing of thermal imaging systems for a wide variety of commercial, industrial, and government applications. Today, FLIR Systems embraces four major companies with outstanding achievements in infrared technology since 1965—the Swedish AGEMA Infrared Systems (formerly AGA Infrared Systems), and the three United States companies Indigo Systems, FSI, and Inframetrics.

10722703.a1



**Figure 22.1** LEFT: Thermovision® Model 661 from 1969. The camera weighed approximately 25 kg (55 lb.), the oscilloscope 20 kg (44 lb.), and the tripod 15 kg (33 lb.). The operator also needed a 220 VAC generator set, and a 10 L (2.6 US gallon) jar with liquid nitrogen. To the left of the oscilloscope the Polaroid attachment (6 kg/13 lb.) can be seen. RIGHT: InfraCAM from 2006. Weight: 0.55 kg (1.21 lb.), including the battery

The company has sold more than 40,000 infrared cameras worldwide for applications such as predictive maintenance, R & D, non-destructive testing, process control and automation, and machine vision, among many others.

FLIR Systems has three manufacturing plants in the United States (Portland, OR, Boston, MA, Santa Barbara, CA) and one in Sweden (Stockholm). Direct sales offices in Belgium, Brazil, China, France, Germany, Great Britain, Hong Kong, Italy, Japan, Sweden, and the USA—together with a worldwide network of agents and distributors—support our international customer base.

FLIR Systems is at the forefront of innovation in the infrared camera industry. We anticipate market demand by constantly improving our existing cameras and developing new ones. The company has set milestones in product design and development such as the introduction of the first battery-operated portable camera for industrial inspections, and the first uncooled infrared camera, to mention just two innovations.

FLIR Systems manufactures all vital mechanical and electronic components of the camera systems itself. From detector design and manufacturing, to lenses and system electronics, to final testing and calibration, all production steps are carried out and supervised by our own engineers. The in-depth expertise of these infrared specialists ensures the accuracy and reliability of all vital components that are assembled into your infrared camera.

### **22.1** *More than just an infrared camera*

At FLIR Systems we recognize that our job is to go beyond just producing the best infrared camera systems. We are committed to enabling all users of our infrared camera systems to work more productively by providing them with the most powerful camera–software combination. Especially tailored software for predictive maintenance, R & D, and process monitoring is developed in-house. Most software is available in a wide variety of languages.

We support all our infrared cameras with a wide variety of accessories to adapt your equipment to the most demanding infrared applications.

### **22.2** *Sharing our knowledge*

Although our cameras are designed to be very user-friendly, there is a lot more to thermography than just knowing how to handle a camera. Therefore, FLIR Systems has founded the Infrared Training Center (ITC), a separate business unit, that provides certified training courses. Attending one of the ITC courses will give you a truly hands-on learning experience.

The staff of the ITC are also there to provide you with any application support you may need in putting infrared theory into practice.

### **22.3** *Supporting our customers*

FLIR Systems operates a worldwide service network to keep your camera running at all times. If you discover a problem with your camera, local service centers have all the equipment and expertise to solve it within the shortest possible time. Therefore, there is no need to send your camera to the other side of the world or to talk to someone who does not speak your language.

## 22.4 A few images from our facilities

10401303.a1

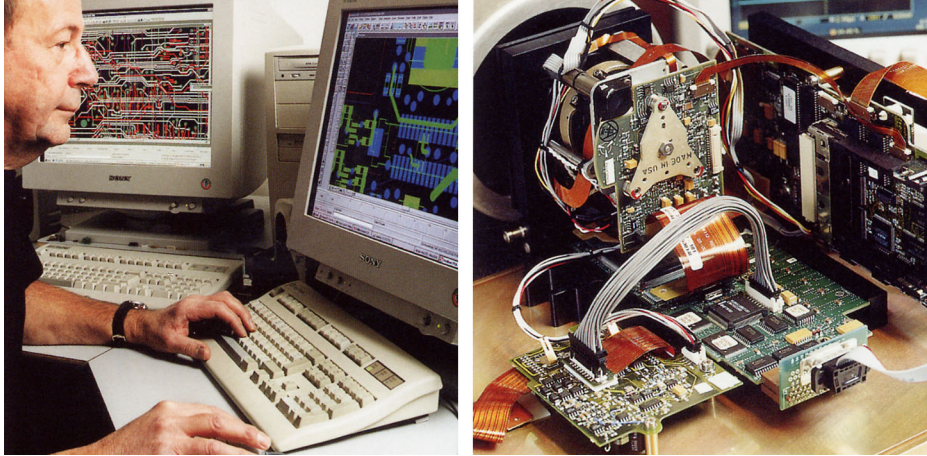

**Figure 22.2** LEFT: Development of system electronics; RIGHT: Testing of an FPA detector

10401403.a1

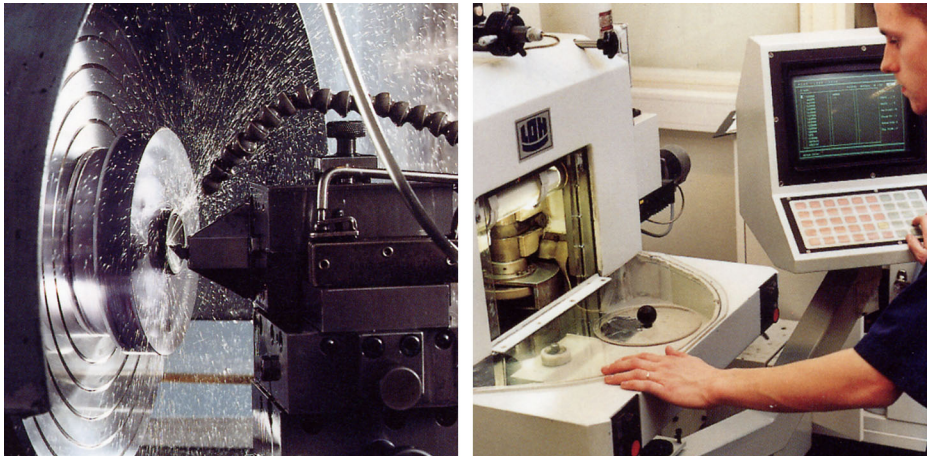

**Figure 22.3** LEFT: Diamond turning machine; RIGHT: Lens polishing

10401503.a1

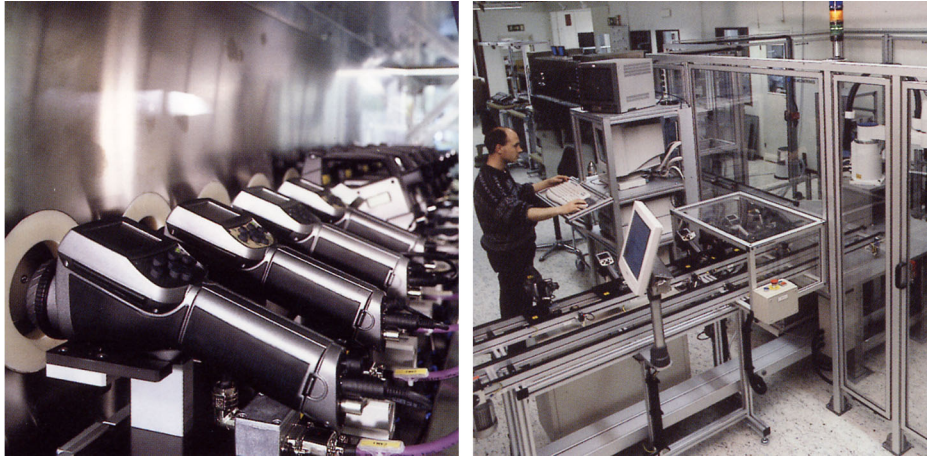

**Figure 22.4** LEFT: Testing of infrared cameras in the climatic chamber; RIGHT: Robot used for camera testing and calibration



# 23 Glossary

Term or expression	Explanation
absorption (absorption factor)	The amount of radiation absorbed by an object relative to the received radiation. A number between 0 and 1.
ambient	Objects and gases that emit radiation towards the object being measured.
atmosphere	The gases between the object being measured and the camera, normally air.
autoadjust	A function making a camera perform an internal image correction.
autopalette	The IR image is shown with an uneven spread of colors, displaying cold objects as well as hot ones at the same time.
blackbody	Totally non-reflective object. All its radiation is due to its own temperature.
blackbody radiator	An IR radiating equipment with blackbody properties used to calibrate IR cameras.
calculated atmospheric transmission	A transmission value computed from the temperature, the relative humidity of air and the distance to the object.
cavity radiator	A bottle shaped radiator with an absorbing inside, viewed through the bottleneck.
color temperature	The temperature for which the color of a blackbody matches a specific color.
conduction	The process that makes heat spread into a material.
continuous adjust	A function that adjusts the image. The function works all the time, continuously adjusting brightness and contrast according to the image content.
convection	The process that makes hot air or liquid rise.
difference temperature	A value which is the result of a subtraction between two temperature values.
dual isotherm	An isotherm with two color bands, instead of one.
emissivity (emissivity factor)	The amount of radiation coming from an object, compared to that of a blackbody. A number between 0 and 1.
emittance	Amount of energy emitted from an object per unit of time and area ( $W/m^2$ )

<b>Term or expression</b>	<b>Explanation</b>
estimated atmospheric transmission	A transmission value, supplied by a user, replacing a calculated one
external optics	Extra lenses, filters, heat shields etc. that can be put between the camera and the object being measured.
filter	A material transparent only to some of the infrared wavelengths.
FOV	Field of view: The horizontal angle that can be viewed through an IR lens.
FPA	Focal plane array: A type of IR detector.
graybody	An object that emits a fixed fraction of the amount of energy of a blackbody for each wavelength.
IFOV	Instantaneous field of view: A measure of the geometrical resolution of an IR camera.
image correction (internal or external)	A way of compensating for sensitivity differences in various parts of live images and also of stabilizing the camera.
infrared	Non-visible radiation, having a wavelength from about 2–13 $\mu\text{m}$ .
IR	infrared
isotherm	A function highlighting those parts of an image that fall above, below or between one or more temperature intervals.
isothermal cavity	A bottle-shaped radiator with a uniform temperature viewed through the bottleneck.
Laser LocatIR	An electrically powered light source on the camera that emits laser radiation in a thin, concentrated beam to point at certain parts of the object in front of the camera.
laser pointer	An electrically powered light source on the camera that emits laser radiation in a thin, concentrated beam to point at certain parts of the object in front of the camera.
level	The center value of the temperature scale, usually expressed as a signal value.
manual adjust	A way to adjust the image by manually changing certain parameters.
NETD	Noise equivalent temperature difference. A measure of the image noise level of an IR camera.
noise	Undesired small disturbance in the infrared image
object parameters	A set of values describing the circumstances under which the measurement of an object was made, and the object itself (such as emissivity, ambient temperature, distance etc.)

Term or expression	Explanation
object signal	A non-calibrated value related to the amount of radiation received by the camera from the object.
palette	The set of colors used to display an IR image.
pixel	Stands for <i>picture element</i> . One single spot in an image.
radiance	Amount of energy emitted from an object per unit of time, area and angle ( $W/m^2/sr$ )
radiant power	Amount of energy emitted from an object per unit of time (W)
radiation	The process by which electromagnetic energy, is emitted by an object or a gas.
radiator	A piece of IR radiating equipment.
range	The current overall temperature measurement limitation of an IR camera. Cameras can have several ranges. Expressed as two blackbody temperatures that limit the current calibration.
reference temperature	A temperature which the ordinary measured values can be compared with.
reflection	The amount of radiation reflected by an object relative to the received radiation. A number between 0 and 1.
relative humidity	Percentage of water in the air, relative to what is physically possible. Air temperature dependent.
saturation color	<p>The areas that contain temperatures outside the present level/span settings are colored with the saturation colors. The saturation colors contain an 'overflow' color and an 'underflow' color.</p> <p>There is also a third red saturation color that marks everything saturated by the detector indicating that the range should probably be changed.</p>
span	The interval of the temperature scale, usually expressed as a signal value.
spectral (radiant) emittance	Amount of energy emitted from an object per unit of time, area and wavelength ( $W/m^2/\mu m$ )
temperature range	The current overall temperature measurement limitation of an IR camera. Cameras can have several ranges. Expressed as two blackbody temperatures that limit the current calibration.
temperature scale	The way in which an IR image currently is displayed. Expressed as two temperature values limiting the colors.
thermogram	infrared image

<b>Term or expression</b>	<b>Explanation</b>
transmission (or transmittance) factor	Gases and materials can be more or less transparent. Transmission is the amount of IR radiation passing through them. A number between 0 and 1.
transparent isotherm	An isotherm showing a linear spread of colors, instead of covering the highlighted parts of the image.
visual	Refers to the video mode of a IR camera, as opposed to the normal, thermographic mode. When a camera is in video mode it captures ordinary video images, while thermographic images are captured when the camera is in IR mode.

---

# 24 Thermographic measurement techniques

## 24.1 *Introduction*

An infrared camera measures and images the emitted infrared radiation from an object. The fact that radiation is a function of object surface temperature makes it possible for the camera to calculate and display this temperature.

However, the radiation measured by the camera does not only depend on the temperature of the object but is also a function of the emissivity. Radiation also originates from the surroundings and is reflected in the object. The radiation from the object and the reflected radiation will also be influenced by the absorption of the atmosphere.

To measure temperature accurately, it is therefore necessary to compensate for the effects of a number of different radiation sources. This is done on-line automatically by the camera. The following object parameters must, however, be supplied for the camera:

- The emissivity of the object
- The reflected apparent temperature
- The distance between the object and the camera
- The relative humidity
- Temperature of the atmosphere

## 24.2 *Emissivity*

The most important object parameter to set correctly is the emissivity which, in short, is a measure of how much radiation is emitted from the object, compared to that from a perfect blackbody of the same temperature.

Normally, object materials and surface treatments exhibit emissivity ranging from approximately 0.1 to 0.95. A highly polished (mirror) surface falls below 0.1, while an oxidized or painted surface has a higher emissivity. Oil-based paint, regardless of color in the visible spectrum, has an emissivity over 0.9 in the infrared. Human skin exhibits an emissivity 0.97 to 0.98.

Non-oxidized metals represent an extreme case of perfect opacity and high reflexivity, which does not vary greatly with wavelength. Consequently, the emissivity of metals is low – only increasing with temperature. For non-metals, emissivity tends to be high, and decreases with temperature.

**24.2.1 Finding the emissivity of a sample**

**24.2.1.1 Step 1: Determining reflected apparent temperature**

Use one of the following two methods to determine reflected apparent temperature:

**24.2.1.1.1 Method 1: Direct method**

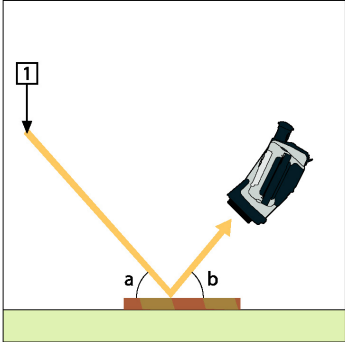
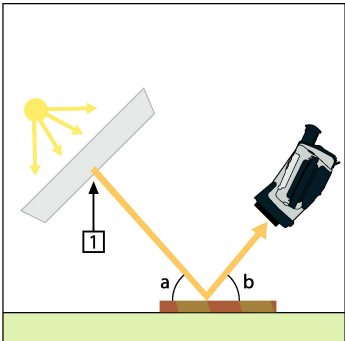
Step	Action
1	<p>Look for possible reflection sources, considering that the incident angle = reflection angle (<math>a = b</math>).</p> <p>10588903.a1</p>  <p><b>Figure 24.1</b> 1 = Reflection source</p>
2	<p>If the reflection source is a spot source, modify the source by obstructing it using a piece of cardboard.</p> <p>10589103.a2</p>  <p><b>Figure 24.2</b> 1 = Reflection source</p>

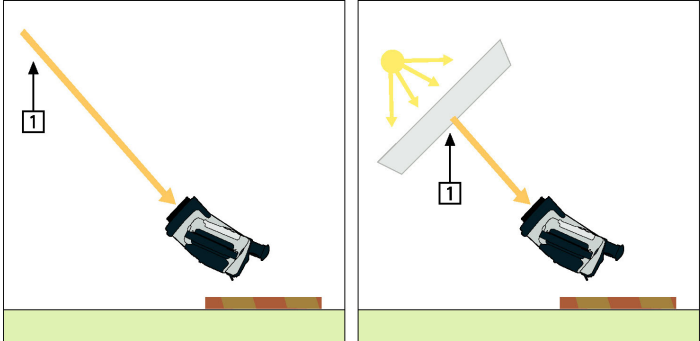
Step	Action
3	<p>Measure the radiation intensity (= apparent temperature) from the reflecting source using the following settings:</p> <ul style="list-style-type: none"> <li>▪ Emissivity: 1.0</li> <li>▪ <math>D_{obj}</math>: 0</li> </ul> <p>You can measure the radiation intensity using one of the following two methods:</p> <p>10589003.a2</p>  <p><b>Figure 24.3</b> 1 = Reflection source</p>

☞ Please note the following:

Using a thermocouple to measure reflecting temperature is not recommended for two important reasons:

- A thermocouple does not measure radiation intensity
- A thermocouple requires a very good thermal contact to the surface, usually by gluing and covering the sensor by a thermal isolator.

#### 24.2.1.1.2 Method 2: Reflector method

Step	Action
1	Crumble up a large piece of aluminum foil.
2	Uncrumble the aluminum foil and attach it to a piece of cardboard of the same size.
3	Put the piece of cardboard in front of the object you want to measure. Make sure that the side with aluminum foil points to the camera.
4	Set the emissivity to 1.0.

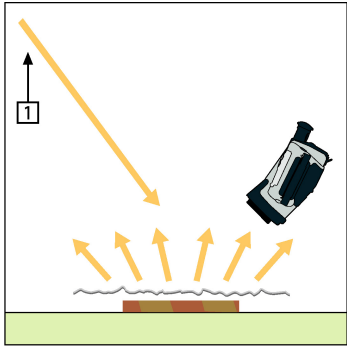
Step	Action
5	<p>Measure the apparent temperature of the aluminum foil and write it down.</p>  <p>Figure 24.4 Measuring the apparent temperature of the aluminum foil</p>

#### 24.2.1.2 Step 2: Determining the emissivity

Step	Action
1	Select a place to put the sample.
2	Determine and set reflected apparent temperature according to the previous procedure.
3	Put a piece of electrical tape with known high emissivity on the sample.
4	Heat the sample at least 20 K above room temperature. Heating must be reasonably even.
5	Focus and auto-adjust the camera, and freeze the image.
6	Adjust <b>Level</b> and <b>Span</b> for best image brightness and contrast.
7	Set emissivity to that of the tape (usually 0.97).
8	<p>Measure the temperature of the tape using one of the following measurement functions:</p> <ul style="list-style-type: none"> <li>▪ <b>Isotherm</b> (helps you to determine both the temperature and how evenly you have heated the sample)</li> <li>▪ <b>Spot</b> (simpler)</li> <li>▪ <b>Box Avg</b> (good for surfaces with varying emissivity).</li> </ul>
9	Write down the temperature.
10	Move your measurement function to the sample surface.
11	Change the emissivity setting until you read the same temperature as your previous measurement.



Step	Action
12	Write down the emissivity.

☞ Please note the following:

- Avoid forced convection
- Look for a thermally stable surrounding that will not generate spot reflections
- Use high quality tape that you know is not transparent, and has a high emissivity you are certain of
- This method assumes that the temperature of your tape and the sample surface are the same. If they are not, your emissivity measurement will be wrong.

### 24.3 *Reflected apparent temperature*

This parameter is used to compensate for the radiation reflected in the object. If the emissivity is low and the object temperature relatively far from that of the reflected it will be important to set and compensate for the reflected apparent temperature correctly.

### 24.4 *Distance*

The distance is the distance between the object and the front lens of the camera. This parameter is used to compensate for the following two facts:

- That radiation from the target is absorbed by the atmosphere between the object and the camera.
- That radiation from the atmosphere itself is detected by the camera.

### 24.5 *Relative humidity*

The camera can also compensate for the fact that the transmittance is also dependent on the relative humidity of the atmosphere. To do this set the relative humidity to the correct value. For short distances and normal humidity the relative humidity can normally be left at a default value of 50 %.

### 24.6 *Other parameters*

In addition, some cameras and analysis programs from FLIR Systems allow you to compensate for the following parameters:

- Atmospheric temperature – *i.e.* the temperature of the atmosphere between the camera and the target
- External optics temperature – *i.e.* the temperature of any external lenses or windows used in front of the camera
- External optics transmission – *i.e.* the transmission of any external lenses or windows used in front of the camera

INTENTIONALLY LEFT BLANK

---

## 25 History of infrared technology

Less than 200 years ago the existence of the infrared portion of the electromagnetic spectrum wasn't even suspected. The original significance of the infrared spectrum, or simply 'the infrared' as it is often called, as a form of heat radiation is perhaps less obvious today than it was at the time of its discovery by Herschel in 1800.

10388703.a1

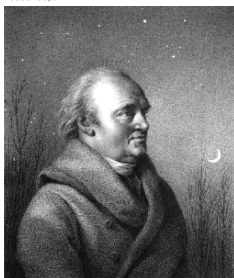

**Figure 25.1** Sir William Herschel (1738–1822)

The discovery was made accidentally during the search for a new optical material. Sir William Herschel—Royal Astronomer to King George III of England, and already famous for his discovery of the planet Uranus—was searching for an optical filter material to reduce the brightness of the sun's image in telescopes during solar observations. While testing different samples of colored glass that gave similar reductions in brightness, he was intrigued to find that some of the samples passed very little of the sun's heat, while others passed so much heat that he risked eye damage after only a few seconds' observation.

Herschel was soon convinced of the necessity of setting up a systematic experiment, with the objective of finding a single material that would give the desired reduction in brightness as well as the maximum reduction in heat. He began the experiment by repeating Newton's prism experiment, but looking for the heating effect rather than the visual distribution of intensity in the spectrum. He first blackened the bulb of a sensitive mercury-in-glass thermometer with ink, and with this as his radiation detector he proceeded to test the heating effect of the various colors of the spectrum formed on the top of a table by passing sunlight through a glass prism. Other thermometers, placed outside the sun's rays, served as controls.

As the blackened thermometer was moved slowly along the colors of the spectrum, the temperature readings showed a steady increase from the violet end to the red end. This was not entirely unexpected, since the Italian researcher Landriani, in a similar experiment in 1777, had observed much the same effect. It was Herschel,

however, who was the first to recognize that there must be a point where the heating effect reaches a maximum, and that measurements confined to the visible portion of the spectrum failed to locate this point.

10388903.a1



**Figure 25.2** Marsilio Landriani (1746–1815)

Moving the thermometer into the dark region beyond the red end of the spectrum, Herschel confirmed that the heating effect continued to increase. The maximum point, when he found it, lay well beyond the red end—in what is known today as the ‘infrared wavelengths.’

When Herschel revealed his discovery, he referred to this new portion of the electromagnetic spectrum as the ‘thermometrical spectrum.’ The radiation itself he sometimes referred to as ‘dark heat,’ or simply ‘the invisible rays.’ Ironically, and contrary to popular opinion, it wasn’t Herschel who originated the term ‘infrared.’ The word only began to appear in print around 75 years later, and it is still unclear who should receive credit as the originator.

25

Herschel’s use of glass in the prism of his original experiment led to some early controversies with his contemporaries about the actual existence of the infrared wavelengths. Different investigators, in attempting to confirm his work, used various types of glass indiscriminately, having different transparencies in the infrared. Through his later experiments, Herschel was aware of the limited transparency of glass to the newly discovered thermal radiation, and he was forced to conclude that optics for the infrared would probably be restricted to the use of reflective elements exclusively (i.e., plane and curved mirrors). Fortunately, this proved to be true only until 1830, when the Italian investigator Melloni made his great discovery that naturally occurring rock salt (NaCl)—which was available in large enough crystals to be made into lenses and prisms—is remarkably transparent to the infrared. The result was that rock salt became the principal infrared optical material, and remained so for the next century, until the art of synthetic crystal growing was mastered in the 1930s.

10399103.a1



**Figure 25.3** Macedonio Melloni (1798–1854)

Thermometers, as radiation detectors, remained unchallenged until 1829, the year Nobili invented the thermocouple. (Herschel's own thermometer could be read to  $0.2^{\circ}\text{C}$  ( $0.036^{\circ}\text{F}$ ), and later models were able to be read to  $0.05^{\circ}\text{C}$  ( $0.09^{\circ}\text{F}$ .) Then a breakthrough occurred: Melloni connected a number of thermocouples in series to form the first thermopile. The new device was at least 40 times as sensitive as the best thermometer of the day for detecting heat radiation—capable of detecting the heat from a person standing 3 meters (10 ft.) away.

The first so-called 'heat-picture' became possible in 1840, the result of work by Sir John Herschel, son of the discoverer of the infrared and a famous astronomer in his own right. Based upon the differential evaporation of a thin film of oil when exposed to a heat pattern focused upon it, the thermal image could be seen by reflected light where the interference effects of the oil film made the image visible to the eye. John Herschel also managed to obtain a primitive record of the thermal image on paper, which he called a 'thermograph.'

10399003.a2



**Figure 25.4** Samuel P. Langley (1834–1906)

The improvement of infrared-detector sensitivity progressed slowly. Another major breakthrough, made by Langley in 1880, was the invention of the bolometer. This consisted of a thin blackened strip of platinum connected in one arm of a Wheatstone bridge circuit upon which the infrared radiation was focused and to which a sensitive galvanometer responded. This instrument is said to have been able to detect the heat from a cow at a distance of 400 meters (1311 ft.).

An English scientist, Sir James Dewar, first introduced the use of liquefied gases as cooling agents (such as liquid nitrogen with a temperature of  $-196^{\circ}\text{C}$  ( $-320.8^{\circ}\text{F}$ )) in low-temperature research. In 1892 he invented a unique vacuum insulating container in which it was possible to store liquefied gases for entire days. The common ‘thermos flask’, used for storing hot and cold drinks, is based upon his invention.

Between the years 1900 and 1920, the inventors of the world ‘discovered’ the infrared. Many patents were issued for devices to detect personnel, artillery, aircraft, ships—and even icebergs. The first operating systems, in the modern sense, began to be developed during the 1914–18 war, when both sides had research programs devoted to the military exploitation of the infrared. These programs included experimental systems for enemy intrusion/detection, remote temperature sensing, secure communications, and ‘flying torpedo’ guidance. An infrared search system tested during this period was able to detect an approaching airplane at a distance of 1.5 km (0.94 miles), or a person more than 300 meters (984 ft.) away.

The most sensitive systems up to this time were all based upon variations of the bolometer idea, but the period between the two world wars saw the development of two revolutionary new infrared detectors: the image converter and the photon detector. At first, the image converter received the greatest attention by the military, because it enabled an observer for the first time in history to literally ‘see in the dark.’ However, the sensitivity of the image converter was limited to the near-infrared wavelengths, and the most interesting military targets (i.e. enemy soldiers) had to be illuminated by infrared search beams. Since this involved the risk of giving away the observer’s position to a similarly equipped enemy observer, it is understandable that military interest in the image converter eventually faded.

The tactical military disadvantages of so-called ‘active’ (i.e. search beam-equipped) thermal-imaging systems provided impetus following the 1939–45 war for extensive secret military infrared-research programs into the possibilities of developing ‘passive’ (no search beam) systems based around the extremely sensitive photon detector. During this period, military secrecy prevented disclosure of the status of infrared-imaging technology. This secrecy only began to be lifted in the middle of the 1950s, and viable thermal-imaging devices finally began to be available to civilian science and industry.

# 26 Theory of thermography

## 26.1 Introduction

The subjects of infrared radiation and the related technique of thermography are still new to many who will use an infrared camera. In this section the theory behind thermography will be given.

## 26.2 The electromagnetic spectrum

The electromagnetic spectrum is divided arbitrarily into a number of wavelength regions, called *bands*, distinguished by the methods used to produce and detect the radiation. There is no fundamental difference between radiation in the different bands of the electromagnetic spectrum. They are all governed by the same laws and the only differences are those due to differences in wavelength.

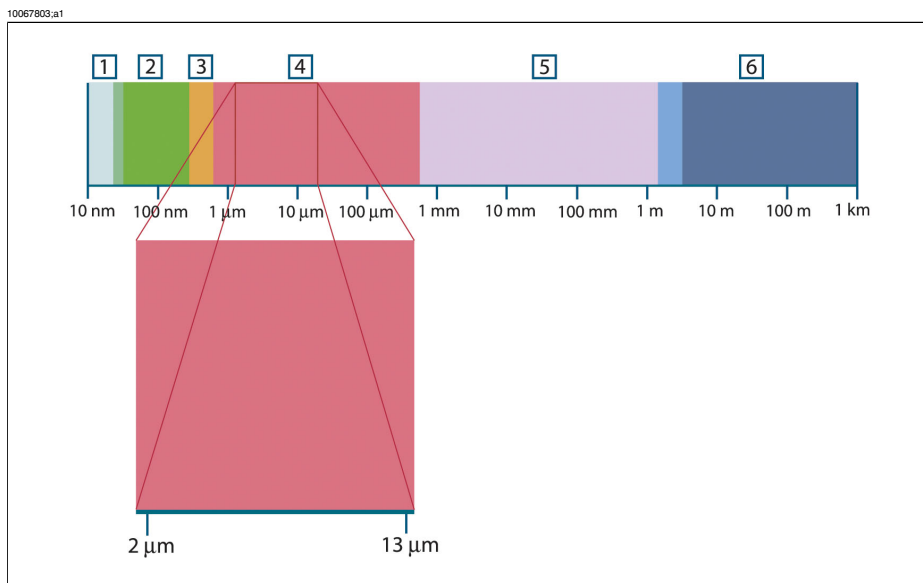

**Figure 26.1** The electromagnetic spectrum. 1: X-ray; 2: UV; 3: Visible; 4: IR; 5: Microwaves; 6: Radiowaves.

Thermography makes use of the infrared spectral band. At the short-wavelength end the boundary lies at the limit of visual perception, in the deep red. At the long-wavelength end it merges with the microwave radio wavelengths, in the millimeter range.

The infrared band is often further subdivided into four smaller bands, the boundaries of which are also arbitrarily chosen. They include: the *near infrared* (0.75–3 μm), the *middle infrared* (3–6 μm), the *far infrared* (6–15 μm) and the *extreme infrared* (15–100

$\mu\text{m}$ ). Although the wavelengths are given in  $\mu\text{m}$  (micrometers), other units are often still used to measure wavelength in this spectral region, e.g. nanometer (nm) and Ångström (Å).

The relationships between the different wavelength measurements is:

$$10\,000\ \text{Å} = 1\,000\ \text{nm} = 1\ \mu = 1\ \mu\text{m}$$

### 26.3 Blackbody radiation

A blackbody is defined as an object which absorbs all radiation that impinges on it at any wavelength. The apparent misnomer *black* relating to an object emitting radiation is explained by Kirchhoff's Law (after *Gustav Robert Kirchhoff*, 1824–1887), which states that a body capable of absorbing all radiation at any wavelength is equally capable in the emission of radiation.

10388803.a1

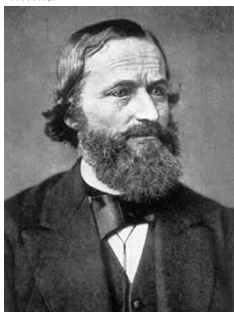

**Figure 26.2** Gustav Robert Kirchhoff (1824–1887)

The construction of a blackbody source is, in principle, very simple. The radiation characteristics of an aperture in an isotherm cavity made of an opaque absorbing material represents almost exactly the properties of a blackbody. A practical application of the principle to the construction of a perfect absorber of radiation consists of a box that is light tight except for an aperture in one of the sides. Any radiation which then enters the hole is scattered and absorbed by repeated reflections so only an infinitesimal fraction can possibly escape. The blackness which is obtained at the aperture is nearly equal to a blackbody and almost perfect for all wavelengths.

By providing such an isothermal cavity with a suitable heater it becomes what is termed a *cavity radiator*. An isothermal cavity heated to a uniform temperature generates blackbody radiation, the characteristics of which are determined solely by the temperature of the cavity. Such cavity radiators are commonly used as sources of radiation in temperature reference standards in the laboratory for calibrating thermographic instruments, such as a FLIR Systems camera for example.



If the temperature of blackbody radiation increases to more than 525 °C (977 °F), the source begins to be visible so that it appears to the eye no longer black. This is the incipient red heat temperature of the radiator, which then becomes orange or yellow as the temperature increases further. In fact, the definition of the so-called *color temperature* of an object is the temperature to which a blackbody would have to be heated to have the same appearance.

Now consider three expressions that describe the radiation emitted from a blackbody.

### 26.3.1 Planck's law

10389203,a1



**Figure 26.3** Max Planck (1858–1947)

Max Planck (1858–1947) was able to describe the spectral distribution of the radiation from a blackbody by means of the following formula:

$$W_{\lambda b} = \frac{2\pi hc^2}{\lambda^5 \left( e^{\frac{hc}{\lambda kT}} - 1 \right)} \times 10^{-6} [\text{Watt} / \text{m}^2, \mu\text{m}]$$

where:

$W_{\lambda b}$	Blackbody spectral radiant emittance at wavelength $\lambda$ .
$c$	Velocity of light = $3 \times 10^8$ m/s
$h$	Planck's constant = $6.6 \times 10^{-34}$ Joule sec.
$k$	Boltzmann's constant = $1.4 \times 10^{-23}$ Joule/K.
$T$	Absolute temperature (K) of a blackbody.
$\lambda$	Wavelength ( $\mu\text{m}$ ).

☛ The factor  $10^{-6}$  is used since spectral emittance in the curves is expressed in  $\text{Watt}/\text{m}^2, \mu\text{m}$ .

Planck's formula, when plotted graphically for various temperatures, produces a family of curves. Following any particular Planck curve, the spectral emittance is zero at  $\lambda = 0$ , then increases rapidly to a maximum at a wavelength  $\lambda_{\text{max}}$  and after passing it approaches zero again at very long wavelengths. The higher the temperature, the shorter the wavelength at which maximum occurs.

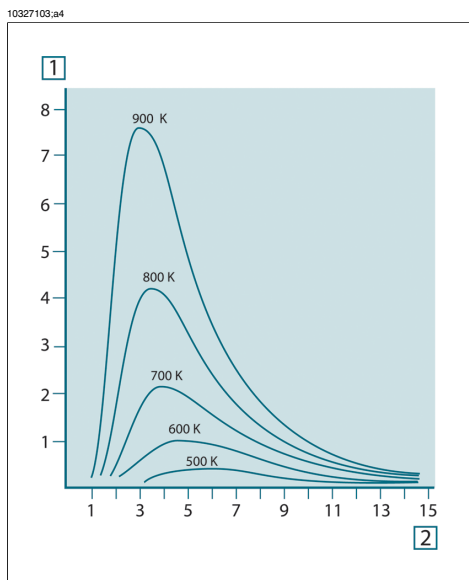

**Figure 26.4** Blackbody spectral radiant emittance according to Planck's law, plotted for various absolute temperatures. **1:** Spectral radiant emittance ( $\text{W}/\text{cm}^2 \times 10^3(\mu\text{m})$ ); **2:** Wavelength ( $\mu\text{m}$ )

### 26.3.2 Wien's displacement law

26

By differentiating Planck's formula with respect to  $\lambda$ , and finding the maximum, we have:

$$\lambda_{\text{max}} = \frac{2898}{T} [\mu\text{m}]$$

This is Wien's formula (after *Wilhelm Wien*, 1864–1928), which expresses mathematically the common observation that colors vary from red to orange or yellow as the temperature of a thermal radiator increases. The wavelength of the color is the same as the wavelength calculated for  $\lambda_{\text{max}}$ . A good approximation of the value of  $\lambda_{\text{max}}$  for a given blackbody temperature is obtained by applying the rule-of-thumb  $3\,000/T$

$\mu\text{m}$ . Thus, a very hot star such as Sirius (11 000 K), emitting bluish-white light, radiates with the peak of spectral radiant emittance occurring within the invisible ultraviolet spectrum, at wavelength  $0.27 \mu\text{m}$ .

10389403.a1

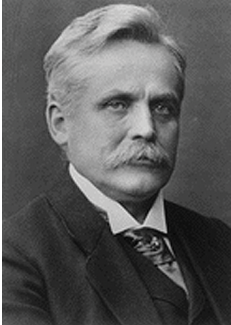

**Figure 26.5** Wilhelm Wien (1864–1928)

The sun (approx. 6 000 K) emits yellow light, peaking at about  $0.5 \mu\text{m}$  in the middle of the visible light spectrum.

At room temperature (300 K) the peak of radiant emittance lies at  $9.7 \mu\text{m}$ , in the far infrared, while at the temperature of liquid nitrogen (77 K) the maximum of the almost insignificant amount of radiant emittance occurs at  $38 \mu\text{m}$ , in the extreme infrared wavelengths.

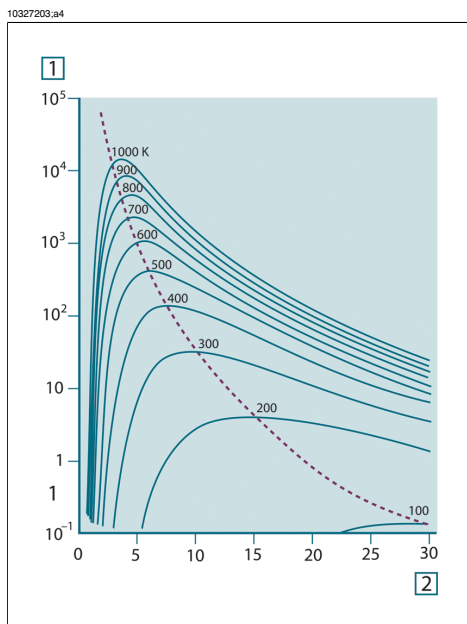

**Figure 26.6** Planckian curves plotted on semi-log scales from 100 K to 1000 K. The dotted line represents the locus of maximum radiant emittance at each temperature as described by Wien's displacement law. 1: Spectral radiant emittance ( $\text{W}/\text{cm}^2 (\mu\text{m})$ ); 2: Wavelength ( $\mu\text{m}$ ).

### 26.3.3 Stefan-Boltzmann's law

By integrating Planck's formula from  $\lambda = 0$  to  $\lambda = \infty$ , we obtain the total radiant emittance ( $W_b$ ) of a blackbody:

$$W_b = \sigma T^4 \quad [\text{Watt}/\text{m}^2]$$

This is the Stefan-Boltzmann formula (after *Josef Stefan*, 1835–1893, and *Ludwig Boltzmann*, 1844–1906), which states that the total emissive power of a blackbody is proportional to the fourth power of its absolute temperature. Graphically,  $W_b$  represents the area below the Planck curve for a particular temperature. It can be shown that the radiant emittance in the interval  $\lambda = 0$  to  $\lambda_{\text{max}}$  is only 25 % of the total, which represents about the amount of the sun's radiation which lies inside the visible light spectrum.

10399303.a1



**Figure 26.7** Josef Stefan (1835–1893), and Ludwig Boltzmann (1844–1906)

Using the Stefan-Boltzmann formula to calculate the power radiated by the human body, at a temperature of 300 K and an external surface area of approx. 2 m<sup>2</sup>, we obtain 1 kW. This power loss could not be sustained if it were not for the compensating absorption of radiation from surrounding surfaces, at room temperatures which do not vary too drastically from the temperature of the body – or, of course, the addition of clothing.

#### 26.3.4 Non-blackbody emitters

So far, only blackbody radiators and blackbody radiation have been discussed. However, real objects almost never comply with these laws over an extended wavelength region – although they may approach the blackbody behavior in certain spectral intervals. For example, a certain type of white paint may appear perfectly *white* in the visible light spectrum, but becomes distinctly *gray* at about 2 μm, and beyond 3 μm it is almost *black*.

There are three processes which can occur that prevent a real object from acting like a blackbody: a fraction of the incident radiation  $\alpha$  may be absorbed, a fraction  $\rho$  may be reflected, and a fraction  $\tau$  may be transmitted. Since all of these factors are more or less wavelength dependent, the subscript  $\lambda$  is used to imply the spectral dependence of their definitions. Thus:

- The spectral absorptance  $\alpha_\lambda$  = the ratio of the spectral radiant power absorbed by an object to that incident upon it.
- The spectral reflectance  $\rho_\lambda$  = the ratio of the spectral radiant power reflected by an object to that incident upon it.
- The spectral transmittance  $\tau_\lambda$  = the ratio of the spectral radiant power transmitted through an object to that incident upon it.

The sum of these three factors must always add up to the whole at any wavelength, so we have the relation:

$$\alpha_\lambda + \rho_\lambda + \tau_\lambda = 1$$

For opaque materials  $\tau_\lambda = 0$  and the relation simplifies to:

$$\alpha_\lambda + \rho_\lambda = 1$$

Another factor, called the emissivity, is required to describe the fraction  $\varepsilon$  of the radiant emittance of a blackbody produced by an object at a specific temperature. Thus, we have the definition:

The spectral emissivity  $\varepsilon_\lambda$  = the ratio of the spectral radiant power from an object to that from a blackbody at the same temperature and wavelength.

Expressed mathematically, this can be written as the ratio of the spectral emittance of the object to that of a blackbody as follows:

$$\varepsilon_\lambda = \frac{W_{\lambda o}}{W_{\lambda b}}$$

Generally speaking, there are three types of radiation source, distinguished by the ways in which the spectral emittance of each varies with wavelength.

- A blackbody, for which  $\varepsilon_\lambda = \varepsilon = 1$
- A graybody, for which  $\varepsilon_\lambda = \varepsilon = \text{constant less than 1}$
- A selective radiator, for which  $\varepsilon$  varies with wavelength

According to Kirchhoff's law, for any material the spectral emissivity and spectral absorptance of a body are equal at any specified temperature and wavelength. That is:

$$\varepsilon_\lambda = \alpha_\lambda$$

From this we obtain, for an opaque material (since  $\alpha_\lambda + \rho_\lambda = 1$ ):

$$\varepsilon_\lambda + \rho_\lambda = 1$$

For highly polished materials  $\varepsilon_\lambda$  approaches zero, so that for a perfectly reflecting material (*i.e.* a perfect mirror) we have:

$$\rho_\lambda = 1$$

For a graybody radiator, the Stefan-Boltzmann formula becomes:

$$W = \varepsilon \sigma T^4 \text{ [Watt/m}^2\text{]}$$

This states that the total emissive power of a graybody is the same as a blackbody at the same temperature reduced in proportion to the value of  $\varepsilon$  from the graybody.

10401203.a2

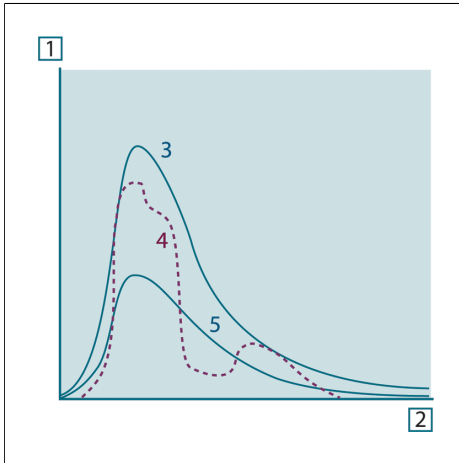

**Figure 26.8** Spectral radiant emittance of three types of radiators. 1: Spectral radiant emittance; 2: Wavelength; 3: Blackbody; 4: Selective radiator; 5: Graybody.

10327303.a4

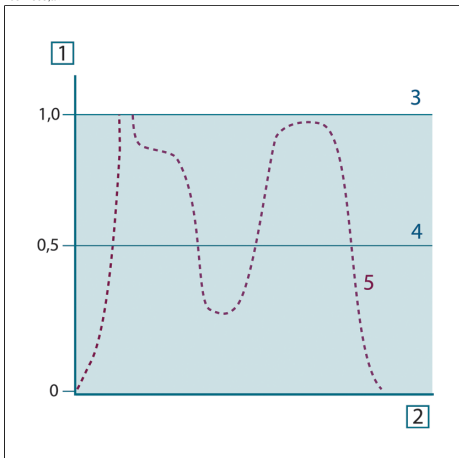

**Figure 26.9** Spectral emissivity of three types of radiators. 1: Spectral emissivity; 2: Wavelength; 3: Blackbody; 4: Graybody; 5: Selective radiator.

## 26.4 Infrared semi-transparent materials

Consider now a non-metallic, semi-transparent body – let us say, in the form of a thick flat plate of plastic material. When the plate is heated, radiation generated within its volume must work its way toward the surfaces through the material in which it is partially absorbed. Moreover, when it arrives at the surface, some of it is reflected back into the interior. The back-reflected radiation is again partially absorbed, but

some of it arrives at the other surface, through which most of it escapes; part of it is reflected back again. Although the progressive reflections become weaker and weaker they must all be added up when the total emittance of the plate is sought. When the resulting geometrical series is summed, the effective emissivity of a semi-transparent plate is obtained as:

$$\varepsilon_{\lambda} = \frac{(1 - \rho_{\lambda})(1 - \tau_{\lambda})}{1 - \rho_{\lambda}\tau_{\lambda}}$$

When the plate becomes opaque this formula is reduced to the single formula:

$$\varepsilon_{\lambda} = 1 - \rho_{\lambda}$$

This last relation is a particularly convenient one, because it is often easier to measure reflectance than to measure emissivity directly.



## 27 The measurement formula

As already mentioned, when viewing an object, the camera receives radiation not only from the object itself. It also collects radiation from the surroundings reflected via the object surface. Both these radiation contributions become attenuated to some extent by the atmosphere in the measurement path. To this comes a third radiation contribution from the atmosphere itself.

This description of the measurement situation, as illustrated in the figure below, is so far a fairly true description of the real conditions. What has been neglected could for instance be sun light scattering in the atmosphere or stray radiation from intense radiation sources outside the field of view. Such disturbances are difficult to quantify, however, in most cases they are fortunately small enough to be neglected. In case they are not negligible, the measurement configuration is likely to be such that the risk for disturbance is obvious, at least to a trained operator. It is then his responsibility to modify the measurement situation to avoid the disturbance e.g. by changing the viewing direction, shielding off intense radiation sources etc.

Accepting the description above, we can use the figure below to derive a formula for the calculation of the object temperature from the calibrated camera output.

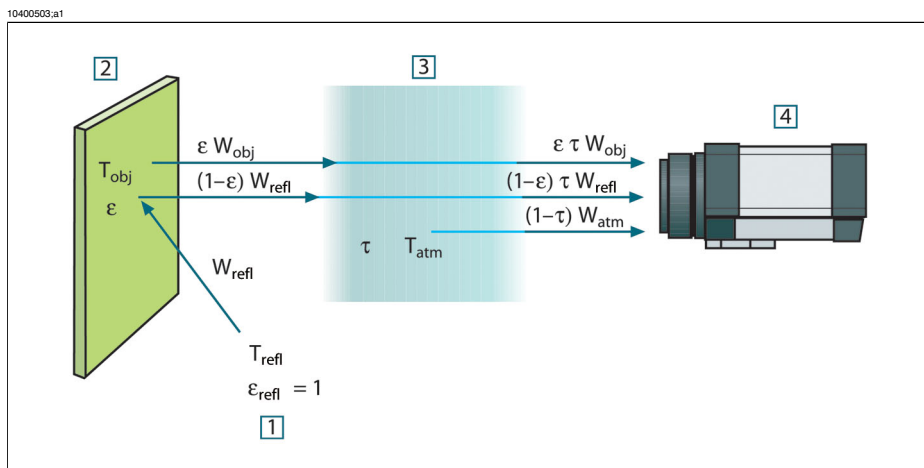

**Figure 27.1** A schematic representation of the general thermographic measurement situation. 1: Surroundings; 2: Object; 3: Atmosphere; 4: Camera

Assume that the received radiation power  $W$  from a blackbody source of temperature  $T_{\text{source}}$  on short distance generates a camera output signal  $U_{\text{source}}$  that is proportional to the power input (power linear camera). We can then write (Equation 1):

$$U_{source} = CW(T_{source})$$

or, with simplified notation:

$$U_{source} = CW_{source}$$

where C is a constant.

Should the source be a graybody with emittance  $\varepsilon$ , the received radiation would consequently be  $\varepsilon W_{source}$ .

We are now ready to write the three collected radiation power terms:

1 – *Emission from the object* =  $\varepsilon\tau W_{obj}$ , where  $\varepsilon$  is the emittance of the object and  $\tau$  is the transmittance of the atmosphere. The object temperature is  $T_{obj}$ .

2 – *Reflected emission from ambient sources* =  $(1 - \varepsilon)\tau W_{refl}$ , where  $(1 - \varepsilon)$  is the reflectance of the object. The ambient sources have the temperature  $T_{refl}$ .

It has here been assumed that the temperature  $T_{refl}$  is the same for all emitting surfaces within the halfsphere seen from a point on the object surface. This is of course sometimes a simplification of the true situation. It is, however, a necessary simplification in order to derive a workable formula, and  $T_{refl}$  can – at least theoretically – be given a value that represents an efficient temperature of a complex surrounding.

Note also that we have assumed that the emittance for the surroundings = 1. This is correct in accordance with Kirchhoff's law: All radiation impinging on the surrounding surfaces will eventually be absorbed by the same surfaces. Thus the emittance = 1. (Note though that the latest discussion requires the complete sphere around the object to be considered.)

3 – *Emission from the atmosphere* =  $(1 - \tau)\tau W_{atm}$ , where  $(1 - \tau)$  is the emittance of the atmosphere. The temperature of the atmosphere is  $T_{atm}$ .

The total received radiation power can now be written (Equation 2):

$$W_{tot} = \varepsilon\tau W_{obj} + (1 - \varepsilon)\tau W_{refl} + (1 - \tau)W_{atm}$$

We multiply each term by the constant C of Equation 1 and replace the CW products by the corresponding U according to the same equation, and get (Equation 3):

$$U_{tot} = \varepsilon\tau U_{obj} + (1 - \varepsilon)\tau U_{refl} + (1 - \tau)U_{atm}$$

Solve Equation 3 for  $U_{obj}$  (Equation 4):

$$U_{obj} = \frac{1}{\varepsilon\tau} U_{tot} - \frac{1-\varepsilon}{\varepsilon} U_{refl} - \frac{1-\tau}{\varepsilon\tau} U_{atm}$$

This is the general measurement formula used in all the FLIR Systems thermographic equipment. The voltages of the formula are:

**Figure 27.2** Voltages

$U_{obj}$	Calculated camera output voltage for a blackbody of temperature $T_{obj}$ i.e. a voltage that can be directly converted into true requested object temperature.
$U_{tot}$	Measured camera output voltage for the actual case.
$U_{refl}$	Theoretical camera output voltage for a blackbody of temperature $T_{refl}$ according to the calibration.
$U_{atm}$	Theoretical camera output voltage for a blackbody of temperature $T_{atm}$ according to the calibration.

The operator has to supply a number of parameter values for the calculation:

- the object emittance  $\varepsilon$ ,
- the relative humidity,
- $T_{atm}$
- object distance ( $D_{obj}$ )
- the (effective) temperature of the object surroundings, or the reflected ambient temperature  $T_{refl}$ , and
- the temperature of the atmosphere  $T_{atm}$

This task could sometimes be a heavy burden for the operator since there are normally no easy ways to find accurate values of emittance and atmospheric transmittance for the actual case. The two temperatures are normally less of a problem provided the surroundings do not contain large and intense radiation sources.

A natural question in this connection is: How important is it to know the right values of these parameters? It could though be of interest to get a feeling for this problem already here by looking into some different measurement cases and compare the relative magnitudes of the three radiation terms. This will give indications about when it is important to use correct values of which parameters.

The figures below illustrates the relative magnitudes of the three radiation contributions for three different object temperatures, two emittances, and two spectral ranges: SW and LW. Remaining parameters have the following fixed values:

- $\tau = 0.88$
- $T_{refl} = +20\text{ °C} (+68\text{ °F})$
- $T_{atm} = +20\text{ °C} (+68\text{ °F})$

It is obvious that measurement of low object temperatures are more critical than measuring high temperatures since the 'disturbing' radiation sources are relatively much stronger in the first case. Should also the object emittance be low, the situation would be still more difficult.

We have finally to answer a question about the importance of being allowed to use the calibration curve above the highest calibration point, what we call extrapolation. Imagine that we in a certain case measure  $U_{\text{tot}} = 4.5$  volts. The highest calibration point for the camera was in the order of 4.1 volts, a value unknown to the operator. Thus, even if the object happened to be a blackbody, i.e.  $U_{\text{obj}} = U_{\text{tot}}$ , we are actually performing extrapolation of the calibration curve when converting 4.5 volts into temperature.

Let us now assume that the object is not black, it has an emittance of 0.75, and the transmittance is 0.92. We also assume that the two second terms of Equation 4 amount to 0.5 volts together. Computation of  $U_{\text{obj}}$  by means of Equation 4 then results in  $U_{\text{obj}} = 4.5 / 0.75 / 0.92 - 0.5 = 6.0$ . This is a rather extreme extrapolation, particularly when considering that the video amplifier might limit the output to 5 volts! Note, though, that the application of the calibration curve is a theoretical procedure where no electronic or other limitations exist. We trust that if there had been no signal limitations in the camera, and if it had been calibrated far beyond 5 volts, the resulting curve would have been very much the same as our real curve extrapolated beyond 4.1 volts, provided the calibration algorithm is based on radiation physics, like the FLIR Systems algorithm. Of course there must be a limit to such extrapolations.

10400603.a2

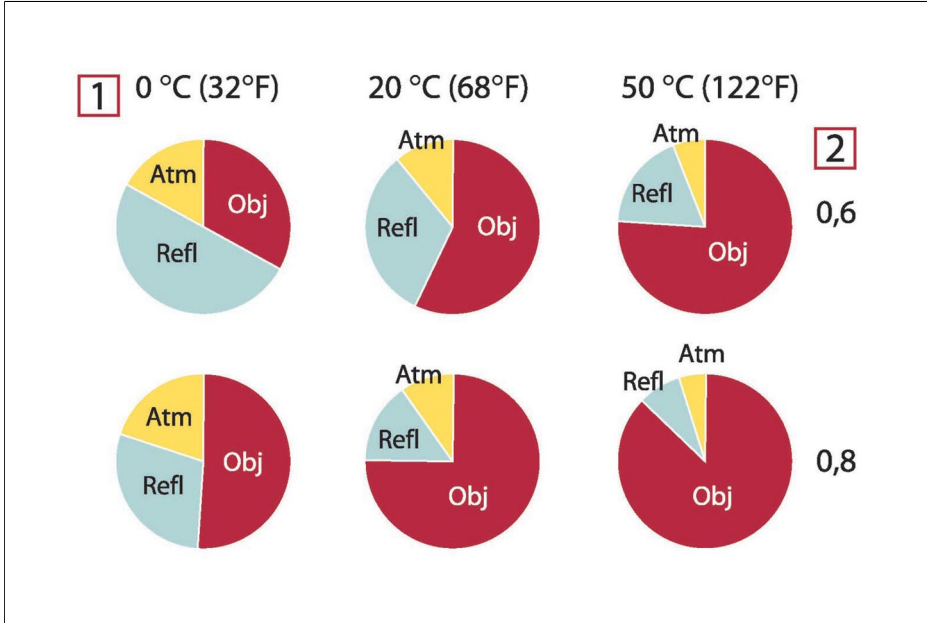

**Figure 27.3** Relative magnitudes of radiation sources under varying measurement conditions (SW camera). **1:** Object temperature; **2:** Emittance; **Obj:** Object radiation; **Refl:** Reflected radiation; **Atm:** atmosphere radiation. Fixed parameters:  $\tau = 0.88$ ;  $T_{\text{refl}} = 20\text{ °C}$  (+68 °F);  $T_{\text{atm}} = 20\text{ °C}$  (+68 °F).

10400703.a2

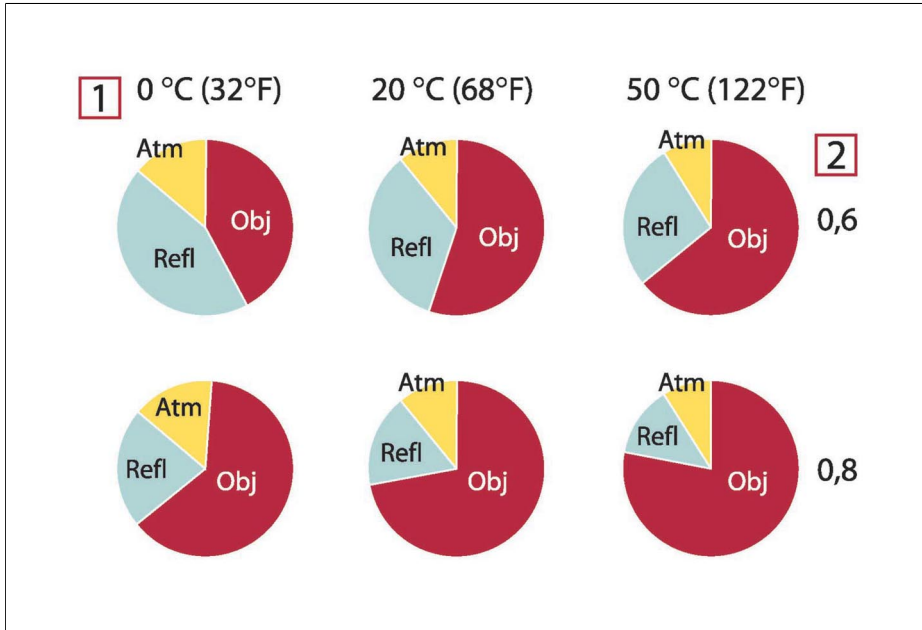

**Figure 27.4** Relative magnitudes of radiation sources under varying measurement conditions (LW camera). **1**: Object temperature; **2**: Emittance; **Obj**: Object radiation; **Refl**: Reflected radiation; **Atm**: atmosphere radiation. Fixed parameters:  $\tau = 0.88$ ;  $T_{\text{refl}} = 20 \text{ }^\circ\text{C}$  (+68 °F);  $T_{\text{atm}} = 20 \text{ }^\circ\text{C}$  (+68 °F).

# 28 Emissivity tables

This section presents a compilation of emissivity data from the infrared literature and measurements made by FLIR Systems.

## 28.1 References

1	Mikaél A. Bramson: <i>Infrared Radiation, A Handbook for Applications</i> , Plenum press, N.Y.
2	William L. Wolfe, George J. Zissis: <i>The Infrared Handbook</i> , Office of Naval Research, Department of Navy, Washington, D.C.
3	Madding, R. P.: <i>Thermographic Instruments and systems</i> . Madison, Wisconsin: University of Wisconsin – Extension, Department of Engineering and Applied Science.
4	William L. Wolfe: <i>Handbook of Military Infrared Technology</i> , Office of Naval Research, Department of Navy, Washington, D.C.
5	Jones, Smith, Probert: <i>External thermography of buildings...</i> , Proc. of the Society of Photo-Optical Instrumentation Engineers, vol.110, Industrial and Civil Applications of Infrared Technology, June 1977 London.
6	Paljak, Pettersson: <i>Thermography of Buildings</i> , Swedish Building Research Institute, Stockholm 1972.
7	Vlcek, J.: <i>Determination of emissivity with imaging radiometers and some emissivities at <math>\lambda = 5 \mu\text{m}</math></i> . Photogrammetric Engineering and Remote Sensing.
8	Kern: <i>Evaluation of infrared emission of clouds and ground as measured by weather satellites</i> , Defence Documentation Center, AD 617 417.
9	Öhman, Claes: <i>Emittansmätningar med AGEMA E-Box</i> . Teknisk rapport, AGEMA 1999. (Emittance measurements using AGEMA E-Box. Technical report, AGEMA 1999.)

## 28.2 Important note about the emissivity tables

The emissivity values in the table below are recorded using a shortwave (SW) camera. The values should be regarded as recommendations only and used by caution.

## 28.3 Tables

**Figure 28.1 T:** Total spectrum; **SW:** 2–5  $\mu\text{m}$ ; **LW:** 8–14  $\mu\text{m}$ , **LLW:** 6.5–20  $\mu\text{m}$ ; **1:** Material; **2:** Specification; **3:** Temperature in °C; **4:** Spectrum; **5:** Emissivity; **6:** Reference

1	2	3	4	5	6
Aluminum	anodized, black, dull	70	LW	0.95	9
Aluminum	anodized, black, dull	70	SW	0.67	9

1	2	3	4	5	6
Aluminum	anodized, light gray, dull	70	LW	0.97	9
Aluminum	anodized, light gray, dull	70	SW	0.61	9
Aluminum	anodized sheet	100	T	0.55	2
Aluminum	as received, plate	100	T	0.09	4
Aluminum	as received, sheet	100	T	0.09	2
Aluminum	cast, blast cleaned	70	LW	0.46	9
Aluminum	cast, blast cleaned	70	SW	0.47	9
Aluminum	dipped in HNO <sub>3</sub> , plate	100	T	0.05	4
Aluminum	foil	27	3 μm	0.09	3
Aluminum	foil	27	10 μm	0.04	3
Aluminum	oxidized, strongly	50–500	T	0.2–0.3	1
Aluminum	polished	50–100	T	0.04–0.06	1
Aluminum	polished, sheet	100	T	0.05	2
Aluminum	polished plate	100	T	0.05	4
Aluminum	roughened	27	3 μm	0.28	3
Aluminum	roughened	27	10 μm	0.18	3
Aluminum	rough surface	20–50	T	0.06–0.07	1
Aluminum	sheet, 4 samples differently scratched	70	LW	0.03–0.06	9
Aluminum	sheet, 4 samples differently scratched	70	SW	0.05–0.08	9
Aluminum	vacuum deposited	20	T	0.04	2
Aluminum	weathered, heavily	17	SW	0.83–0.94	5
Aluminum bronze		20	T	0.60	1
Aluminum hydroxide	powder		T	0.28	1
Aluminum oxide	activated, powder		T	0.46	1



1	2	3	4	5	6
Aluminum oxide	pure, powder (alumina)		T	0.16	1
Asbestos	board	20	T	0.96	1
Asbestos	fabric		T	0.78	1
Asbestos	floor tile	35	SW	0.94	7
Asbestos	paper	40–400	T	0.93–0.95	1
Asbestos	powder		T	0.40–0.60	1
Asbestos	slate	20	T	0.96	1
Asphalt paving		4	LLW	0.967	8
Brass	dull, tarnished	20–350	T	0.22	1
Brass	oxidized	70	SW	0.04–0.09	9
Brass	oxidized	70	LW	0.03–0.07	9
Brass	oxidized	100	T	0.61	2
Brass	oxidized at 600 °C	200–600	T	0.59–0.61	1
Brass	polished	200	T	0.03	1
Brass	polished, highly	100	T	0.03	2
Brass	rubbed with 80-grit emery	20	T	0.20	2
Brass	sheet, rolled	20	T	0.06	1
Brass	sheet, worked with emery	20	T	0.2	1
Brick	alumina	17	SW	0.68	5
Brick	common	17	SW	0.86–0.81	5
Brick	Dinas silica, glazed, rough	1100	T	0.85	1
Brick	Dinas silica, refractory	1000	T	0.66	1
Brick	Dinas silica, unglazed, rough	1000	T	0.80	1
Brick	firebrick	17	SW	0.68	5
Brick	fireclay	20	T	0.85	1

1	2	3	4	5	6
Brick	fireclay	1000	T	0.75	1
Brick	fireclay	1200	T	0.59	1
Brick	masonry	35	SW	0.94	7
Brick	masonry, plastered	20	T	0.94	1
Brick	red, common	20	T	0.93	2
Brick	red, rough	20	T	0.88–0.93	1
Brick	refractory, corundum	1000	T	0.46	1
Brick	refractory, magnetite	1000–1300	T	0.38	1
Brick	refractory, strongly radiating	500–1000	T	0.8–0.9	1
Brick	refractory, weakly radiating	500–1000	T	0.65–0.75	1
Brick	silica, 95 % SiO <sub>2</sub>	1230	T	0.66	1
Brick	sillimanite, 33 % SiO <sub>2</sub> , 64 % Al <sub>2</sub> O <sub>3</sub>	1500	T	0.29	1
Brick	waterproof	17	SW	0.87	5
Bronze	phosphor bronze	70	LW	0.06	9
Bronze	phosphor bronze	70	SW	0.08	9
Bronze	polished	50	T	0.1	1
Bronze	porous, rough	50–150	T	0.55	1
Bronze	powder		T	0.76–0.80	1
Carbon	candle soot	20	T	0.95	2
Carbon	charcoal powder		T	0.96	1
Carbon	graphite, filed surface	20	T	0.98	2
Carbon	graphite powder		T	0.97	1
Carbon	lampblack	20–400	T	0.95–0.97	1
Chipboard	untreated	20	SW	0.90	6

1	2	3	4	5	6
Chromium	polished	50	T	0.10	1
Chromium	polished	500–1000	T	0.28–0.38	1
Clay	fired	70	T	0.91	1
Cloth	black	20	T	0.98	1
Concrete		20	T	0.92	2
Concrete	dry	36	SW	0.95	7
Concrete	rough	17	SW	0.97	5
Concrete	walkway	5	LLW	0.974	8
Copper	commercial, bur-nished	20	T	0.07	1
Copper	electrolytic, careful-ly polished	80	T	0.018	1
Copper	electrolytic, pol-ished	–34	T	0.006	4
Copper	molten	1100–1300	T	0.13–0.15	1
Copper	oxidized	50	T	0.6–0.7	1
Copper	oxidized, black	27	T	0.78	4
Copper	oxidized, heavily	20	T	0.78	2
Copper	oxidized to black-ness		T	0.88	1
Copper	polished	50–100	T	0.02	1
Copper	polished	100	T	0.03	2
Copper	polished, commer-cial	27	T	0.03	4
Copper	polished, mechan-ical	22	T	0.015	4
Copper	pure, carefully prepared surface	22	T	0.008	4
Copper	scraped	27	T	0.07	4
Copper dioxide	powder		T	0.84	1
Copper oxide	red, powder		T	0.70	1

1	2	3	4	5	6
Ebonite			T	0.89	1
Emery	coarse	80	T	0.85	1
Enamel		20	T	0.9	1
Enamel	lacquer	20	T	0.85–0.95	1
Fiber board	hard, untreated	20	SW	0.85	6
Fiber board	masonite	70	LW	0.88	9
Fiber board	masonite	70	SW	0.75	9
Fiber board	particle board	70	LW	0.89	9
Fiber board	particle board	70	SW	0.77	9
Fiber board	porous, untreated	20	SW	0.85	6
Gold	polished	130	T	0.018	1
Gold	polished, carefully	200–600	T	0.02–0.03	1
Gold	polished, highly	100	T	0.02	2
Granite	polished	20	LLW	0.849	8
Granite	rough	21	LLW	0.879	8
Granite	rough, 4 different samples	70	LW	0.77–0.87	9
Granite	rough, 4 different samples	70	SW	0.95–0.97	9
Gypsum		20	T	0.8–0.9	1
Ice: See Water					
Iron, cast	casting	50	T	0.81	1
Iron, cast	ingots	1000	T	0.95	1
Iron, cast	liquid	1300	T	0.28	1
Iron, cast	machined	800–1000	T	0.60–0.70	1
Iron, cast	oxidized	38	T	0.63	4
Iron, cast	oxidized	100	T	0.64	2
Iron, cast	oxidized	260	T	0.66	4
Iron, cast	oxidized	538	T	0.76	4

1	2	3	4	5	6
Iron, cast	oxidized at 600 °C	200–600	T	0.64–0.78	1
Iron, cast	polished	38	T	0.21	4
Iron, cast	polished	40	T	0.21	2
Iron, cast	polished	200	T	0.21	1
Iron, cast	unworked	900–1100	T	0.87–0.95	1
Iron and steel	cold rolled	70	LW	0.09	9
Iron and steel	cold rolled	70	SW	0.20	9
Iron and steel	covered with red rust	20	T	0.61–0.85	1
Iron and steel	electrolytic	22	T	0.05	4
Iron and steel	electrolytic	100	T	0.05	4
Iron and steel	electrolytic	260	T	0.07	4
Iron and steel	electrolytic, carefully polished	175–225	T	0.05–0.06	1
Iron and steel	freshly worked with emery	20	T	0.24	1
Iron and steel	ground sheet	950–1100	T	0.55–0.61	1
Iron and steel	heavily rusted sheet	20	T	0.69	2
Iron and steel	hot rolled	20	T	0.77	1
Iron and steel	hot rolled	130	T	0.60	1
Iron and steel	oxidized	100	T	0.74	1
Iron and steel	oxidized	100	T	0.74	4
Iron and steel	oxidized	125–525	T	0.78–0.82	1
Iron and steel	oxidized	200	T	0.79	2
Iron and steel	oxidized	1227	T	0.89	4
Iron and steel	oxidized	200–600	T	0.80	1
Iron and steel	oxidized strongly	50	T	0.88	1
Iron and steel	oxidized strongly	500	T	0.98	1
Iron and steel	polished	100	T	0.07	2

1	2	3	4	5	6
Iron and steel	polished	400–1000	T	0.14–0.38	1
Iron and steel	polished sheet	750–1050	T	0.52–0.56	1
Iron and steel	rolled, freshly	20	T	0.24	1
Iron and steel	rolled sheet	50	T	0.56	1
Iron and steel	rough, plane surface	50	T	0.95–0.98	1
Iron and steel	rusted, heavily	17	SW	0.96	5
Iron and steel	rusted red, sheet	22	T	0.69	4
Iron and steel	rusty, red	20	T	0.69	1
Iron and steel	shiny, etched	150	T	0.16	1
Iron and steel	shiny oxide layer, sheet,	20	T	0.82	1
Iron and steel	wrought, carefully polished	40–250	T	0.28	1
Iron galvanized	heavily oxidized	70	LW	0.85	9
Iron galvanized	heavily oxidized	70	SW	0.64	9
Iron galvanized	sheet	92	T	0.07	4
Iron galvanized	sheet, burnished	30	T	0.23	1
Iron galvanized	sheet, oxidized	20	T	0.28	1
Iron tinned	sheet	24	T	0.064	4
Lacquer	3 colors sprayed on Aluminum	70	LW	0.92–0.94	9
Lacquer	3 colors sprayed on Aluminum	70	SW	0.50–0.53	9
Lacquer	Aluminum on rough surface	20	T	0.4	1
Lacquer	bakelite	80	T	0.83	1
Lacquer	black, dull	40–100	T	0.96–0.98	1
Lacquer	black, matte	100	T	0.97	2
Lacquer	black, shiny, sprayed on iron	20	T	0.87	1

1	2	3	4	5	6
Lacquer	heat-resistant	100	T	0.92	1
Lacquer	white	40–100	T	0.8–0.95	1
Lacquer	white	100	T	0.92	2
Lead	oxidized, gray	20	T	0.28	1
Lead	oxidized, gray	22	T	0.28	4
Lead	oxidized at 200 °C	200	T	0.63	1
Lead	shiny	250	T	0.08	1
Lead	unoxidized, polished	100	T	0.05	4
Lead red		100	T	0.93	4
Lead red, powder		100	T	0.93	1
Leather	tanned		T	0.75–0.80	1
Lime			T	0.3–0.4	1
Magnesium		22	T	0.07	4
Magnesium		260	T	0.13	4
Magnesium		538	T	0.18	4
Magnesium	polished	20	T	0.07	2
Magnesium powder			T	0.86	1
Molybdenum		600–1000	T	0.08–0.13	1
Molybdenum		1500–2200	T	0.19–0.26	1
Molybdenum	filament	700–2500	T	0.1–0.3	1
Mortar		17	SW	0.87	5
Mortar	dry	36	SW	0.94	7
Nichrome	rolled	700	T	0.25	1
Nichrome	sandblasted	700	T	0.70	1
Nichrome	wire, clean	50	T	0.65	1
Nichrome	wire, clean	500–1000	T	0.71–0.79	1
Nichrome	wire, oxidized	50–500	T	0.95–0.98	1

1	2	3	4	5	6
Nickel	bright matte	122	T	0.041	4
Nickel	commercially pure, polished	100	T	0.045	1
Nickel	commercially pure, polished	200–400	T	0.07–0.09	1
Nickel	electrolytic	22	T	0.04	4
Nickel	electrolytic	38	T	0.06	4
Nickel	electrolytic	260	T	0.07	4
Nickel	electrolytic	538	T	0.10	4
Nickel	electroplated, polished	20	T	0.05	2
Nickel	electroplated on iron, polished	22	T	0.045	4
Nickel	electroplated on iron, unpolished	20	T	0.11–0.40	1
Nickel	electroplated on iron, unpolished	22	T	0.11	4
Nickel	oxidized	200	T	0.37	2
Nickel	oxidized	227	T	0.37	4
Nickel	oxidized	1227	T	0.85	4
Nickel	oxidized at 600 °C	200–600	T	0.37–0.48	1
Nickel	polished	122	T	0.045	4
Nickel	wire	200–1000	T	0.1–0.2	1
Nickel oxide		500–650	T	0.52–0.59	1
Nickel oxide		1000–1250	T	0.75–0.86	1
Oil, lubricating	0.025 mm film	20	T	0.27	2
Oil, lubricating	0.050 mm film	20	T	0.46	2
Oil, lubricating	0.125 mm film	20	T	0.72	2
Oil, lubricating	film on Ni base: Ni base only	20	T	0.05	2
Oil, lubricating	thick coating	20	T	0.82	2



1	2	3	4	5	6
Paint	8 different colors and qualities	70	LW	0.92–0.94	9
Paint	8 different colors and qualities	70	SW	0.88–0.96	9
Paint	Aluminum, various ages	50–100	T	0.27–0.67	1
Paint	cadmium yellow		T	0.28–0.33	1
Paint	chrome green		T	0.65–0.70	1
Paint	cobalt blue		T	0.7–0.8	1
Paint	oil	17	SW	0.87	5
Paint	oil, black flat	20	SW	0.94	6
Paint	oil, black gloss	20	SW	0.92	6
Paint	oil, gray flat	20	SW	0.97	6
Paint	oil, gray gloss	20	SW	0.96	6
Paint	oil, various colors	100	T	0.92–0.96	1
Paint	oil based, average of 16 colors	100	T	0.94	2
Paint	plastic, black	20	SW	0.95	6
Paint	plastic, white	20	SW	0.84	6
Paper	4 different colors	70	LW	0.92–0.94	9
Paper	4 different colors	70	SW	0.68–0.74	9
Paper	black		T	0.90	1
Paper	black, dull		T	0.94	1
Paper	black, dull	70	LW	0.89	9
Paper	black, dull	70	SW	0.86	9
Paper	blue, dark		T	0.84	1
Paper	coated with black lacquer		T	0.93	1
Paper	green		T	0.85	1
Paper	red		T	0.76	1
Paper	white	20	T	0.7–0.9	1

1	2	3	4	5	6
Paper	white, 3 different glosses	70	LW	0.88–0.90	9
Paper	white, 3 different glosses	70	SW	0.76–0.78	9
Paper	white bond	20	T	0.93	2
Paper	yellow		T	0.72	1
Plaster		17	SW	0.86	5
Plaster	plasterboard, untreated	20	SW	0.90	6
Plaster	rough coat	20	T	0.91	2
Plastic	glass fibre laminate (printed circ. board)	70	LW	0.91	9
Plastic	glass fibre laminate (printed circ. board)	70	SW	0.94	9
Plastic	polyurethane isolation board	70	LW	0.55	9
Plastic	polyurethane isolation board	70	SW	0.29	9
Plastic	PVC, plastic floor, dull, structured	70	LW	0.93	9
Plastic	PVC, plastic floor, dull, structured	70	SW	0.94	9
Platinum		17	T	0.016	4
Platinum		22	T	0.03	4
Platinum		100	T	0.05	4
Platinum		260	T	0.06	4
Platinum		538	T	0.10	4
Platinum		1000–1500	T	0.14–0.18	1
Platinum		1094	T	0.18	4
Platinum	pure, polished	200–600	T	0.05–0.10	1
Platinum	ribbon	900–1100	T	0.12–0.17	1

1	2	3	4	5	6
Platinum	wire	50–200	T	0.06–0.07	1
Platinum	wire	500–1000	T	0.10–0.16	1
Platinum	wire	1400	T	0.18	1
Porcelain	glazed	20	T	0.92	1
Porcelain	white, shiny		T	0.70–0.75	1
Rubber	hard	20	T	0.95	1
Rubber	soft, gray, rough	20	T	0.95	1
Sand			T	0.60	1
Sand		20	T	0.90	2
Sandstone	polished	19	LLW	0.909	8
Sandstone	rough	19	LLW	0.935	8
Silver	polished	100	T	0.03	2
Silver	pure, polished	200–600	T	0.02–0.03	1
Skin	human	32	T	0.98	2
Slag	boiler	0–100	T	0.97–0.93	1
Slag	boiler	200–500	T	0.89–0.78	1
Slag	boiler	600–1200	T	0.76–0.70	1
Slag	boiler	1400–1800	T	0.69–0.67	1
Snow: See Water					
Soil	dry	20	T	0.92	2
Soil	saturated with water	20	T	0.95	2
Stainless steel	alloy, 8 % Ni, 18 % Cr	500	T	0.35	1
Stainless steel	rolled	700	T	0.45	1
Stainless steel	sandblasted	700	T	0.70	1
Stainless steel	sheet, polished	70	LW	0.14	9
Stainless steel	sheet, polished	70	SW	0.18	9

1	2	3	4	5	6
Stainless steel	sheet, untreated, somewhat scratched	70	LW	0.28	9
Stainless steel	sheet, untreated, somewhat scratched	70	SW	0.30	9
Stainless steel	type 18-8, buffed	20	T	0.16	2
Stainless steel	type 18-8, oxidized at 800 °C	60	T	0.85	2
Stucco	rough, lime	10–90	T	0.91	1
Styrofoam	insulation	37	SW	0.60	7
Tar			T	0.79–0.84	1
Tar	paper	20	T	0.91–0.93	1
Tile	glazed	17	SW	0.94	5
Tin	burnished	20–50	T	0.04–0.06	1
Tin	tin-plated sheet iron	100	T	0.07	2
Titanium	oxidized at 540 °C	200	T	0.40	1
Titanium	oxidized at 540 °C	500	T	0.50	1
Titanium	oxidized at 540 °C	1000	T	0.60	1
Titanium	polished	200	T	0.15	1
Titanium	polished	500	T	0.20	1
Titanium	polished	1000	T	0.36	1
Tungsten		200	T	0.05	1
Tungsten		600–1000	T	0.1–0.16	1
Tungsten		1500–2200	T	0.24–0.31	1
Tungsten	filament	3300	T	0.39	1
Varnish	flat	20	SW	0.93	6
Varnish	on oak parquet floor	70	LW	0.90–0.93	9
Varnish	on oak parquet floor	70	SW	0.90	9

1	2	3	4	5	6
Wallpaper	slight pattern, light gray	20	SW	0.85	6
Wallpaper	slight pattern, red	20	SW	0.90	6
Water	distilled	20	T	0.96	2
Water	frost crystals	-10	T	0.98	2
Water	ice, covered with heavy frost	0	T	0.98	1
Water	ice, smooth	-10	T	0.96	2
Water	ice, smooth	0	T	0.97	1
Water	layer >0.1 mm thick	0-100	T	0.95-0.98	1
Water	snow		T	0.8	1
Water	snow	-10	T	0.85	2
Wood		17	SW	0.98	5
Wood		19	LLW	0.962	8
Wood	ground		T	0.5-0.7	1
Wood	pine, 4 different samples	70	LW	0.81-0.89	9
Wood	pine, 4 different samples	70	SW	0.67-0.75	9
Wood	planed	20	T	0.8-0.9	1
Wood	planed oak	20	T	0.90	2
Wood	planed oak	70	LW	0.88	9
Wood	planed oak	70	SW	0.77	9
Wood	plywood, smooth, dry	36	SW	0.82	7
Wood	plywood, untreated	20	SW	0.83	6
Wood	white, damp	20	T	0.7-0.8	1
Zinc	oxidized at 400 °C	400	T	0.11	1
Zinc	oxidized surface	1000-1200	T	0.50-0.60	1

28 – Emissivity tables

1	2	3	4	5	6
Zinc	polished	200–300	T	0.04–0.05	1
Zinc	sheet	50	T	0.20	1

# Index

## A

about FLIR Systems: 197  
 absolute humidity: 161  
 accuracy: 5  
 adding image description: 87  
 address: viii  
 air infiltration: 142  
 air movement: 151  
 airtightness: 151  
 assessment, correct: 174

## B

balconies: 136  
 bands  
   extreme infrared: 215  
   far infrared: 215  
   middle infrared: 215  
   near infrared: 215  
 battery  
   charging: 44  
 battery charger: 45, 46, 47  
 battery condition indicator: 23  
 behavior, temperature: 174  
 blackbody  
   construction: 216  
   explanation: 216  
   practical application: 216  
 breakers: 174  
 breaks, plumbing: 139  
 building codes  
   national: 171  
   regional: 171  
 building science: 149  
 building structures, commented: 131, 134, 137, 142, 145

## C

cable insulation: 174  
 cables  
   cleaning: 95  
 calibration: 4  
 camera  
   cleaning: 95  
   turning off: 52  
   turning on: 52  
 camera parts  
   battery condition indicator: 23  
 case, transport: 11

cavity radiator  
   applications: 216  
   explanation: 216  
 certification: 171  
 charger, battery: 45, 46, 47  
 charging battery: 44  
 checking, effects of: 150  
 classification: 175, 177, 182  
 cleaning  
   camera: 95  
   lens: 96  
 commented building structures: 131, 134, 137, 142, 145  
 commented infrared images: 132, 136, 139, 140, 144, 147  
 comments: 4  
 commercial façades: 134  
 commercial roofs, low-slope: 129  
 conditions  
   cooling: 188  
   measuring: 159  
   pressure: 153  
   wind: 156  
 connectors  
   power: 104  
 control: 177  
 conventions  
   typographical  
     *italic*: 4  
     monospace: 4  
     **semibold**: 4  
     UPPERCASE: 4  
 cooling conditions: 188  
 copyright: viii  
 correct assessment: 174  
 courses: 5, 171  
 creating  
   image description: 87  
   text annotation: 84  
 customer support: 4

## D

data  
   technical: 97  
 decks: 136  
 defect, probable: 174  
 defective parts: 174  
 defects, classification of: 176  
 deficiencies, insulation : 145, 150

definition of dew point: 162  
 detection, moisture: 129  
 deviations: 161  
 Dewar, James: 214  
 dew point, definition of: 162  
 digital photo, taking: 82  
 disruption, sources of: 151  
 distance: 107, 108, 109, 192  
     explanation: 209  
 disturbance factors  
     distance: 192  
     object size: 193  
     rain: 192  
     snow: 192  
     wind: 191  
 draft: 125

## E

education: 5, 171  
 effects of  
     checking: 150  
     testing: 150  
 electromagnetic spectrum: 215  
 electronic waste: 5  
 emissivity: 195  
     data: 231  
     explanation: 205  
     tables: 231  
 equipment data, general: 174  
 excess temperature: 181  
 external leaks: 129  
 extreme infrared band: 215

## F

façades, commercial & residential : 134  
 factors, disturbance  
     distance: 192  
     object size: 193  
     rain: 192  
     snow: 192  
     wind: 191  
 far infrared band: 215  
 faults, classification: 182  
 faulty contact in socket: 122  
 field of view: 107, 108, 109  
 FLIR Systems  
     copyright: viii  
     history: 197  
     ISO 9001: viii  
     legal disclaimer: viii  
     patents: viii  
     patents pending: viii  
     postal address: viii

(continued)  
     product warranty: viii  
     quality assurance: viii  
     quality management system: viii  
     request for enhancement: 4  
     RFE: 4  
     trademarks: viii  
     warranty: viii  
 formulas  
     Planck's law: 217  
     Stefan Boltzmann's formula: 220  
     Wien's displacement law: 218  
 forums: 4  
 FOV: 107, 108, 109

## G

general equipment data: 174  
 glossary: 204  
 graybody: 222  
 guidelines  
     air infiltration: 128  
     general: 127  
     insulation deficiencies: 128  
     moisture detection: 128  
     mold detection: 128  
     water damage: 128  
 Gustav Robert Kirchhoff: 216

## H

heating  
     inductive: 187  
     solar: 186  
 heat picture: 213  
 Herschel, William: 211  
 history  
     FLIR Systems: 197  
     infrared technology: 211  
 humidity  
     absolute: 161  
     relative: 161

## I

identification: 177  
 image  
     opening: 64  
 image description, adding: 87  
 indicators  
     battery condition: 23  
     inductive heating: 187  
     infiltration, air: 142  
 infrared images  
     commented: 132, 136, 139, 140, 144, 147



infrared images (*continued*)  
 interpretation of: 159  
 infrared semi-transparent body: 223  
 infrared technology  
 history: 211  
 inspection: 175  
 insulation, cable: 174  
 insulation deficiencies: 124, 145, 150  
 internal leaks: 129  
 interpretation of infrared images: 159  
 irregularities: 161  
 ISO 9001: viii  
*italic*: 4

**J**

James Dewar: 214  
 Josef Stefan: 220

**K**

Kirchhoff, Gustav Robert: 216

**L**

Landriani, Marsilio: 211  
 Langley, Samuel P.: 214  
 laws  
 Planck's law: 217  
 Stefan-Boltzmann's formula: 220  
 Wien's displacement law: 218  
 leaks: 139  
 external: 129  
 internal: 129  
 legal disclaimer: viii  
 lens  
 cleaning: 96  
 Leopoldo Nobili: 213  
 list, packing: 11  
 load variations: 187  
 low-slope commercial roofs: 129  
 Ludwig Boltzmann: 220

**M**

Macedonio Melloni: 212  
 Marsilio Landriani: 211  
 Max Planck: 217  
 measurement  
 comparative: 180  
 temperature: 178  
 measurement formula: 225  
 measurement situation  
 general thermographic: 225  
 measuring conditions: 159  
 measuring season: 159

mechanical ventilation: 156  
 Melloni, Macedonio: 212  
 middle infrared band: 215  
 moisture & water damage: 121  
 moisture detection: 129  
 commercial & residential façades: 134  
 decks & balconies: 136  
 low-slope commercial roofs: 129  
 plumbing breaks & leaks: 139  
 mold: 128  
 monospace: 4  
 movement, air: 151

**N**

near infrared band: 215  
 Nobili, Leopoldo : 213  
 non-blackbody emitters: 221  
 normal operating temperature: 181

**O**

object size: 193  
 opening  
 image: 64  
 operating temperature, normal: 181  
 overheating: 189  
 oxidized socket: 123

**P**

packing list: 11  
 parts, camera  
 battery condition indicator: 23  
 parts, defective: 174  
 patents: viii  
 patents pending: viii  
 photo, taking: 82  
 Planck, Max: 217  
 plumbing breaks: 139  
 postal address: viii  
 power connector: 104  
 pin configuration: 104  
 preparation: 175  
 pressure  
 dynamic: 154  
 static: 154  
 total: 154  
 pressure conditions: 153  
 priority, repair: 176  
 probable defect: 174  
 product warranty: viii

**Q**  
 quality assurance: viii

quality management system: viii

## R

radiation power terms

- emission from atmosphere: 226
- emission from object: 226
- reflected emission from ambient source: 226

radiation sources

- relative magnitudes: 229, 230

radiators

- cavity radiator: 216
- graybody radiators: 222
- selective radiators: 222

rain: 192, 195

reflected apparent temperature: 196

- explanation: 209

reflections: 186

relative humidity: 161

- explanation: 209

relative magnitudes

- radiation sources: 229, 230

releases, service: 4

repair priority: 176

report: 175

reporting: 175, 184

request for enhancement: 4

residential façades: 134

resistance variations: 189

RFE: 4

roofs, low-slope commercial: 129

## S

safety precautions: 130

Samuel P. Langley: 214

science, building: 149

season, measuring: 159

**semibold**: 4

semi-transparent body: 223

service releases: 4

shutting down

- camera: 52

Sir James Dewar: 214

Sir William Herschel: 211

snow: 192

software updates: 4

solar heating: 186

solenoids: 174

sources of disruption: 151

spectrum

- thermometrical: 212

speed, wind: 175

stand-alone battery charger: 47

starting

- camera: 52

Stefan, Josef: 220

stopping

- camera: 52

support, technical: 4

surface temperature: 153

switching off

- camera: 52

switching on

- camera: 52

## T

taking digital photo: 82

technical data: 97

technical support: 4

temperature

- excess: 181

- normal operating: 181

- reflected apparent: 196, 209

temperature, surface: 153

temperature behavior: 174

temperature measurement: 178

temperature variations: 151

testing, effects of: 150

text annotation, creating: 84

theory of thermography: 215

thermograph: 213

thermographic measurement techniques

- introduction: 205

thermographic theory: 215

thermometrical spectrum: 212

thermos flask: 214

trademarks: viii

training: 5, 171

transport case: 11

turning off

- camera: 52

turning on

- camera: 52

typographical conventions

- italic*: 4

- monospace: 4

- semibold**: 4

- UPPERCASE: 4

## U

updates

- software: 4

UPPERCASE: 4

user-to-user forums: 4

**V**

variations

load: 187

resistance: 189

ventilation, mechanical: 156

**W**

WARNING: 1

warranty: viii

waste: 5

Wien, Wilhelm: 218

Wilhelm Wien: 218

William Herschel: 211

wind: 191

wind conditions: 156

wind speed: 175

---

**A note on the technical production of this manual**

This manual was produced using XML – eXtensible Markup Language. For more information about XML, visit the following site:

- <http://www.w3.org/XML/>

Readers interested in the history & theory of markup languages may also want to visit the following sites:

- <http://www.gla.ac.uk/staff/strategy/information/socarcpj/>
- <http://www.renater.fr/Video/2002ATHENS/P/DC/History/plan.htm>

**A note on the typeface used in this manual**

This manual was typeset using Swiss 721, which is Bitstream's pan-European version of Max Miedinger's Helvetica™ typeface. Max Miedinger was born December 24th, 1910 in Zürich, Switzerland and died March 8th, 1980.

For more information about Max Miedinger's Helvetica™ typeface, see Lars Muller's book *Helvetica: Homage to a Typeface*, and the following sites:

- <http://www.ms-studio.com/articles.html>
- <http://www.helveticafilm.com/>

**The following file identities and file versions were used in the formatting stream output for this manual:**

20235103.xml a20  
20235203.xml a20  
20235303.xml a15  
20236703.xml a34  
20237103.xml a8  
20238703.xml b7  
20250403.xml a16  
20254903.xml a41  
20257003.xml a26  
20257103.xml a14  
20257303.xml a20  
20273203.xml a11  
20273903.xml a4  
20275203.xml a10  
20278303.xml a7  
20279803.xml a4  
20281003.xml a1  
20283703.xml a3  
20283803.xml a3  
20283903.xml a3  
20284003.xml a4  
20284103.xml a4  
20284203.xml a4  
20284303.xml a3  
20284403.xml a3  
20284503.xml a3  
20284703.xml a3  
20284803.xml a3  
20284903.xml a5  
20285003.xml a2  
20285103.xml a3  
20285203.xml a3  
R110.rcp a3  
config.xml a5



**■ BELGIUM**

FLIR Systems  
Uitbreidingstraat 60-62  
B-2600 Berchem  
BELGIUM  
Phone: +32 (0)3 287 87 11  
Fax: +32 (0)3 287 87 29  
E-mail: [info@flir.be](mailto:info@flir.be)  
Web: [www.flirthermography.com](http://www.flirthermography.com)

**■ BRAZIL**

FLIR Systems  
Av. Antonio Bardella, 320  
CEP: 18085-852 Sorocaba  
São Paulo  
BRAZIL  
Phone: +55 15 3238 8070  
Fax: +55 15 3238 8071  
E-mail: [paul.verminnen@flir.com.br](mailto:paul.verminnen@flir.com.br)  
E-mail: [flir@flir.com.br](mailto:flir@flir.com.br)  
Web: [www.flirthermography.com](http://www.flirthermography.com)

**■ CANADA**

FLIR Systems  
5230 South Service Road, Suite #125  
Burlington, ON. L7L 5K2  
CANADA  
Phone: 1 800 613 0507 ext. 30  
Fax: 905 639 5488  
E-mail: [IRCanada@flir.com](mailto:IRCanada@flir.com)  
Web: [www.flirthermography.com](http://www.flirthermography.com)

**■ CHINA**

FLIR Systems  
Beijing Representative Office  
Rm 203A, Dongwai Diplomatic Office  
Building  
23 Dongzhimenwai Dajie  
Beijing 100600  
P.R.C.  
Phone: +86 10 8532 2304  
Fax: +86 10 8532 2460  
E-mail: [beijing@flir.com.cn](mailto:beijing@flir.com.cn)  
Web: [www.flirthermography.com](http://www.flirthermography.com)

**■ CHINA**

FLIR Systems  
Shanghai Representative Office  
Room 6311, West Building  
Jin Jiang Hotel  
59 Maoming Road (South)  
Shanghai 200020  
P.R.C.  
Phone: +86 21 5466 0286  
Fax: +86 21 5466 0289  
E-mail: [shanghai@flir.com.cn](mailto:shanghai@flir.com.cn)  
Web: [www.flirthermography.com](http://www.flirthermography.com)

**■ CHINA**

FLIR Systems  
Guangzhou Representative Office  
1105 Main Tower, Guang Dong  
International Hotel  
339 Huanshi Dong Road  
Guangzhou 510098  
P.R.C.  
Phone: +86 20 8333 7492  
Fax: +86 20 8331 0976  
E-mail: [guangzhou@flir.com.cn](mailto:guangzhou@flir.com.cn)  
Web: [www.flirthermography.com](http://www.flirthermography.com)

**■ FRANCE**

FLIR Systems  
10 rue Guynemer  
92130 Issy les Moulineaux  
Cedex  
FRANCE  
Phone: +33 (0)1 41 33 97 97  
Fax: +33 (0)1 47 36 18 32  
E-mail: [info@flir.fr](mailto:info@flir.fr)  
Web: [www.flirthermography.com](http://www.flirthermography.com)

**■ GERMANY**

FLIR Systems  
Bernier Strasse 81  
D-60437 Frankfurt am Main  
GERMANY  
Phone: +49 (0)69 95 00 900  
Fax: +49 (0)69 95 00 9040  
E-mail: [info@flir.de](mailto:info@flir.de)  
Web: [www.flirthermography.com](http://www.flirthermography.com)

**■ GREAT BRITAIN**

FLIR Systems  
2 Kings Hill Avenue - Kings Hill  
West Malling  
Kent, ME19 4AQ  
UNITED KINGDOM  
Phone: +44 (0)1732 220 011  
Fax: +44 (0)1732 843 707  
E-mail: [sales@flir.uk.com](mailto:sales@flir.uk.com)  
Web: [www.flirthermography.com](http://www.flirthermography.com)

**■ HONG KONG**

FLIR Systems  
Room 1613-15, Tower 2  
Grand Central Plaza  
138 Shatin Rural Committee Rd  
Shatin, N.T.  
HONG KONG  
Phone: +852 27 92 89 55  
Fax: +852 27 92 89 52  
E-mail: [flir@flir.com.hk](mailto:flir@flir.com.hk)  
Web: [www.flirthermography.com](http://www.flirthermography.com)

**■ ITALY**

FLIR Systems  
Via L. Manara, 2  
20051 Limbiate (MI)  
ITALY  
Phone: +39 02 99 45 10 1  
Fax: +39 02 99 69 24 08  
E-mail: [info@flir.it](mailto:info@flir.it)  
Web: [www.flirthermography.com](http://www.flirthermography.com)

**■ JAPAN**

FLIR SYSTEMS Japan KK  
Nishi-Gotanda Access 8F  
3-6-20 Nishi-Gotanda  
Shinagawa-Ku  
Tokyo 141-0031  
JAPAN  
Phone: +81 3 6277 5681  
Fax: +81 3 6277 5682  
E-mail: [info@flir.jp](mailto:info@flir.jp)  
Web: [www.flirthermography.com](http://www.flirthermography.com)

**■ SWEDEN**

FLIR Systems  
Worldwide Thermography Center  
P.O. Box 3  
SE-182 11 Danderyd  
SWEDEN  
Phone: +46 (0)8 753 25 00  
Fax: +46 (0)8 753 23 64  
E-mail: [sales@flir.se](mailto:sales@flir.se)  
Web: [www.flirthermography.com](http://www.flirthermography.com)

**■ USA**

FLIR Systems  
Corporate headquarters  
27700A SW Parkway Avenue  
Wilsonville, OR 97070  
USA  
Phone: +1 503 498 3547  
Web: [www.flirthermography.com](http://www.flirthermography.com)

**■ USA (Primary sales & service contact in USA)**

FLIR Systems  
USA Thermography Center  
16 Esquire Road  
North Billerica, MA. 01862  
USA  
Phone: +1 978 901 8000  
Fax: +1 978 901 8887  
E-mail: [marketing@flir.com](mailto:marketing@flir.com)  
Web: [www.flirthermography.com](http://www.flirthermography.com)

**■ USA**

FLIR Systems  
Indigo Operations  
70 Castilian Dr.  
Goleta, CA 93117-3027  
USA  
Phone: +1 805 964 9797  
Fax: +1 805 685 2711  
E-mail: [sales@indigosystems.com](mailto:sales@indigosystems.com)  
Web: [www.corebyindigo.com](http://www.corebyindigo.com)

**■ USA**

FLIR Systems  
Indigo Operations  
IAS Facility  
701 John Sims Parkway East  
Suite 2B  
Niceville, FL 32578  
USA  
Phone: +1 850 678 4503  
Fax: +1 850 678 4992  
E-mail: [sales@indigosystems.com](mailto:sales@indigosystems.com)  
Web: [www.corebyindigo.com](http://www.corebyindigo.com)