

# Rosemount™ 2501 Solids Level Switch

## Rotating Paddle



CE

**Contents**

Introduction..... 3

Mechanical installation..... 11

Electrical installation..... 20

Configuration..... 25

Operation..... 28

Maintenance..... 31

Product certifications..... 33

# 1 Introduction

The level switch detects the presence and absence of a process media at its installation point, and reports it as a switched electrical output.

---

**Note**

Other language versions of this Quick Start Guide can be found at [Emerson.com/Rosemount](http://Emerson.com/Rosemount).

---

## 1.1 Safety messages

### NOTICE

Read this manual before working with the product. For personal and system safety, and for optimum product performance, ensure you thoroughly understand the contents before installing, using, or maintaining this product.

For technical assistance, contacts are listed below:

---

#### Customer Central

Technical support, quoting, and order-related questions.

- United States - 1-800-999-9307 (7:00 am to 7:00 pm CST)
- Asia Pacific- 65 777 8211

#### North American Response Center

Equipment service needs.

- 1-800-654-7768 (24 hours a day — includes Canada)
- Outside of these areas, contact your local Emerson representative.

### ⚠ WARNING

#### Physical access

Unauthorized personnel may potentially cause significant damage to and/or misconfiguration of end users' equipment. This could be intentional or unintentional and needs to be protected against.

Physical security is an important part of any security program and fundamental to protecting your system. Restrict physical access by unauthorized personnel to protect end users' assets. This is true for all systems used within the facility.

---

**⚠ WARNING**

**Failure to follow safe installation and servicing guidelines could result in death or serious injury.**

- Ensure the level switch is installed by qualified personnel and in accordance with applicable code of practice.
- Use the level switch only as specified in this manual. Failure to do so may impair the protection provided by the level switch.

**Explosions could result in death or serious injury.**

- The level switch must only be installed and operated in non-hazardous (ordinary) locations.

**Electrical shock could cause death or serious injury.**

- Avoid contact with the leads and terminals. High voltage that may be present on leads can cause electrical shock.
- Ensure the power to the level switch is off, and the lines to any other external power source are disconnected or not powered while wiring the level switch.
- Ensure the wiring is suitable for the electrical current and the insulation is suitable for the voltage, temperature, and environment.

**Process leaks could result in death or serious injury.**

- Ensure the level switch is handled carefully. If the process seal is damaged, gas or dust might escape from the silo (or other vessel)

**Any substitution of non-recognized parts may jeopardize safety. Repair, e.g. substitution of components, etc. may also jeopardize safety and is under no circumstances allowed.**

- Unauthorized changes to the product are strictly prohibited as they may unintentionally and unpredictably alter performance and jeopardize safety. Unauthorized changes that interfere with the integrity of the welds or flanges, such as making additional perforations, compromise product integrity and safety. Equipment ratings and certifications are no longer valid on any products that have been damaged or modified without the prior written permission of Emerson. Any continued use of product that has been damaged or modified without the written authorization is at the customer's sole risk and expense.
-

**⚠ CAUTION**

The products described in this document are NOT designed for nuclear-qualified applications.

- Using non-nuclear qualified products in applications that require nuclear-qualified hardware or products may cause inaccurate readings.
- For information on Rosemount nuclear-qualified products, contact your local Emerson Sales Representative.

Individuals who handle products exposed to a hazardous substance can avoid injury if they are informed of and understand the hazard.

- If the product being returned was exposed to a hazardous substance as defined by Occupational Safety and Health Administration (OSHA), a copy of the required Safety Data Sheet (SDS) for each hazardous substance identified must be included with the returned level switch.

## 1.2 Applications

A Rosemount™ 2501 Solids Level Switch is used for monitoring the level of bulk materials in all types of containers and silos.

The level switch can be equipped for process overpressure <sup>(1)</sup> and low pressure, and also for very high or low process temperatures.

The level switch can be used with different paddle shapes and sizes to monitor fine and medium solids in bulk materials. See [Table 4-1](#) for a guide to the minimum density requirements.

Typical applications are:

- Building materials
  - Lime, extruded polystyrene foam (XPS), molding sand, etc.
- Food and beverage
  - Milk powder, flour, salt, etc.
- Plastics
  - Plastic granulates, etc.
- Timber
- Chemicals

The level switch has a threaded, flanged, or Tri Clamp process connection for mounting it onto a silo (or other vessel). You can mount it on a side wall of the silo, so that it is level with the filling limit to be monitored. Alternatively,

---

(1) *Overpressure (or blast overpressure) is the pressure caused by a shock wave over and above normal atmospheric pressure.*

if it has an extended length, mount it vertically on top of a silo to monitor the maximum filling limit.

The length of the paddle can be up to 158 in. (4 m) with an extension tube or up to 394 in. (10 m) with an extension rope.

The use of a sliding sleeve is recommended so that the switching point can be changed easily during the live operation of the level switch.

**Figure 1-1: Typical Installation Examples**

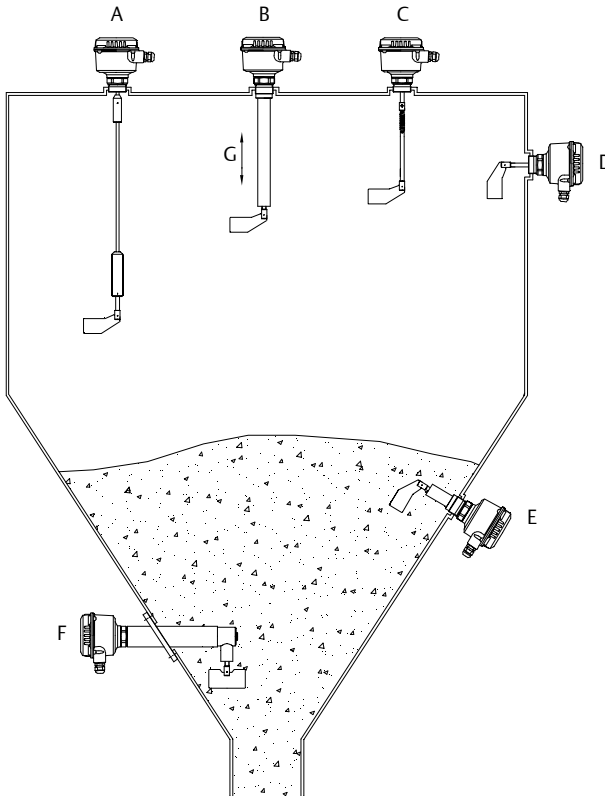

- A. Rosemount 2501R or 2501S with the rope-extended fork length
- B. Rosemount 2501M with the tube extension and optional sliding sleeve
- C. Rosemount 2501L with the pendulum shaft
- D. Rosemount 2501L with the boot-shaped vane paddle
- E. Rosemount 2501J
- F. Rosemount 2501K
- G. Optional sliding sleeve

### 1.3 Measurement principles

Using a synchronous motor, the paddle (measuring vane) is driven to rotate 360 degrees.

When the vane of the paddle is not covered by a solids medium, a spring pulls the motor and it switches a lug to the left position (Figure 1-2, top illustration). The signal output indicates an 'uncovered' state and the motor rotates the paddle.

When a solids medium covers the vane of the paddle, and causes the rotation to stop, the lug is switched to the right position (Figure 1-2, bottom illustration). The signal output indicates a 'covered' state due to a rising level of material, and the motor is stopped until the vane becomes uncovered.

**Figure 1-2: Switching Lug Function**

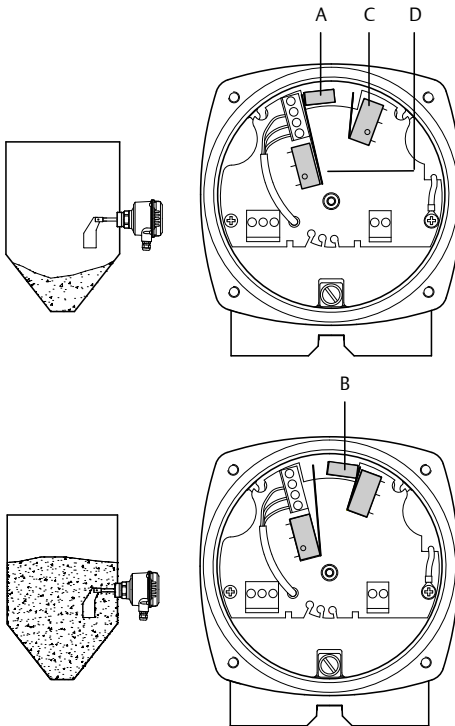

- A. Switching lug in left position ('uncovered' state)
- B. Switching lug in right position ('covered' state)
- C. Switch for stopping the motor
- D. Switch for signal output

The electrical outputs vary depending on the power supply selected when the Rosemount 2501 was ordered. See the Rosemount 2501 [Product Data Sheet](#) for the Power Supply option codes, and [Electronics](#) for an overview of the outputs.

## 1.4 Functions

### 1.4.1 Selection guide

**Table 1-1: Rosemount 2501 Selection Guide**

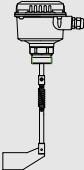
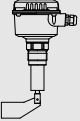
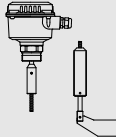
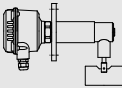
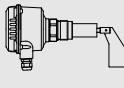
Type of installation	Model option codes					
	2501L	2501M	2501R	2501S	2501K	2501J
						
Full silo detection	*	*(1)	*	*	*	*
On-demand detection	*			*(1)	*	*
Empty silo detection	*			*(1)	*	*
Vertical mounting	*	*	*	*(1)		*
Angled mounting (top)	*		*(2)			*
Horizontal mounting	*				*	*
Angled mounting (bottom)	*					*

(1) Consider the maximum permitted mechanical traction force.

(2) Available only with the "bearing at tube end" option.



### 1.4.2 Shaft sealing and metal material

**Table 1-2: Shaft Sealing and Metal Material**

Application	Sealing material <sup>(1)</sup>			Metal		Bearing
	NBR	FPM	PTFE	ALU <sup>(2)</sup>	SST 304 (1.4301) <sup>(3)</sup>	SST
Animal feed press			*		*	*
Synthetic granules, powders	*			*		
Salt			*		*	*
Dust filter (for up to 392 °F)			*		*	
Dust filter (for up to 302 °F)		*			*	
Bitumen			*		*	
Cement	*			*		
Wood chip dryer			*		*	
Pressure conveying vessel, 8 bar			*		*	
Sugar	*			*		
Flour	*			*		
Carbon black	*			*		

(1) Selection varies, depending on process temperature and pressure:

NBR: Maximums are 80 °C and 0.8 bar.

FPM: Maximums are 150 °C and 0.8 bar.

PTFE: Maximums are 250 °C and 0.8 bar, 80/150/250 °C and 5/10 bar.

(2) Aluminum.

(3) 316L (1.4404) stainless steel is recommended in particular cases.

### 1.4.3 Electronics

**Table 1-3: Electronics**

Power supply	SPDT <sup>(1)</sup>	DPDT <sup>(2)</sup>	FSH/ FSL <sup>(3)</sup>	Output delay <sup>(4)</sup>	Fail safe alarm
Ac version 24 or 48 Vac or 115 or 230 Vac	*	-	-	-	-
Dc version 24 Vdc	*	-	-	-	-
Universal voltage 24 Vdc / 22 .. 230 Vac	-	*	*	*	option

(1) *Single-Pole-Double-Throw contacts.*

(2) *Double-Pole-Double-Throw contacts.*

(3) *Selectable Fail Safe High or Fail Safe Low alarm output. See [Wiring the universal voltage version](#) and [Jumper Settings for Fail Safe High or Low](#).*

(4) *Adjustable time delay for the switched outputs.*

#### Switched signal output

The ac-voltage or dc-voltage versions of the level switch output a 'covered paddle' or 'uncovered paddle' status signal through SPDT relay contacts.

See [Wiring the ac and dc voltage versions](#) for details.

The universal-voltage version of the level switch outputs a 'covered paddle' or 'uncovered paddle' status signal through DPDT relay contacts.

See [Wiring the universal voltage version](#) for details.

When using the universal-voltage version of the level switch, there is an adjustable delay for the switched signal output. Setting a delay helps to prevent false switching of the output when there is movement of the bulk material in a silo (or other vessel). See [Figure 4-1](#) for details.

#### Fail safe alarm

The fail-safe alarm option makes it possible for the level switch to indicate a fault using the alarm relay.

The following faults are indicated:

- Motor failure
- Gear failure
- Electronics failure (for motor power supply)
- Supply voltage failure
- Terminal wiring defect

## 2 Mechanical installation

### 2.1 Mounting considerations

Before mounting the level switch on a silo (or other vessel), review the safety and pre-mounting sections.

#### 2.1.1 Safety

##### General safety

1. Installation of this equipment shall be carried out by suitably trained personnel, in accordance with the applicable code of practice.
2. If equipment is likely to come into contact with aggressive substances, it is the user's responsibility to take suitable precautions that prevent it from being adversely affected, thus ensuring the type of protection is not compromised.
  - a. Aggressive substances: e.g. acidic liquids or gases that may attack metals or solvents that may affect polymeric materials.
  - b. Suitable precautions: e.g. regular checks as part of routine inspections or establishing from a material's data sheet that it is resistant to specific chemicals.
3. It is the responsibility of the installer to:
  - a. Ensure the mechanical force exerted on the paddle by the bulk solids does not exceed the maximum permitted for that paddle. Refer to the technical specifications in the Rosemount 2501 [Product Data Sheet](#) for further information.
  - b. Take protective measures, such as fitting an angled shield (reverse V shape) to the silo or selecting an extension tube option, when there are high mechanical forces.
  - c. Ensure that the process connection is tightened by the correct amount of torque and sealed to prevent process leaks.
4. Technical data
  - a. The Rosemount 2501 [Product Data Sheet](#) has all the technical specifications. See [Emerson.com/Rosemount](#) for other language versions.

### 2.1.2 Mechanical load

See [Figure 2-1](#) for the maximum loads supported by the level switch.

**Figure 2-1: Maximum Permitted Mechanical Load**

#### Rosemount 2501L

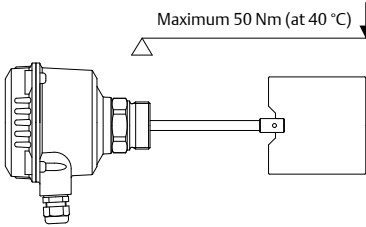

#### Rosemount 2501M and 2501J

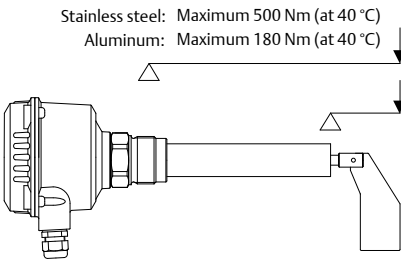

#### Rosemount 2501M and 2501K

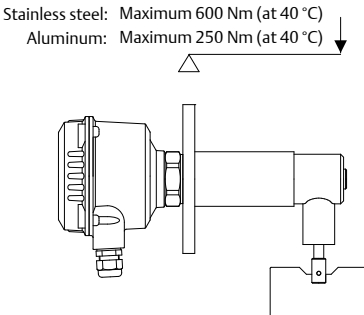

#### Rosemount 2501S

Contact Emerson for the maximum load of a Rosemount 2501S.

**Note**

Take protective measures, such as fitting an angled shield (reverse-V shape) to the silo or selecting an extension tube option, when there are high mechanical forces.

**2.1.3 Mounting location**

Take time to assess a suitable mounting location. Avoid mounting the level switch near the filling point, internal structures, and walls of a silo (or other vessel). When mounting the extended length versions of the level switch, it is especially important to consider internal structures. Forcing the level switch into a small or congested space risks damage to the sensor and could impair the protection it provides.

**2.1.4 Sliding sleeve**

Tighten both M8 screws with a torque of 20 Nm to establish a seal and maintain the process pressure. See [Figure 2-2](#).

**Figure 2-2: Sliding Sleeve, M8 Screws**

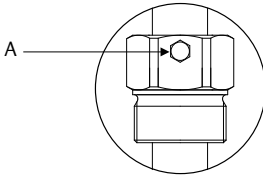

*A. Two off M8 screws*

**2.1.5 Flange mounting**

A suitable gasket must be fitted to provide a seal when the flanges are tightened.

**2.1.6 Hygienic applications**

The food-grade materials are suitable for use under normal and predictable hygienic applications (according to directive 1935/2004 Art.3). There are currently no hygienic certifications for the Rosemount 2501.

**2.1.7 Rotatable housing**

The housing of the level switch can be rotated against the threaded connection after mounting.

---

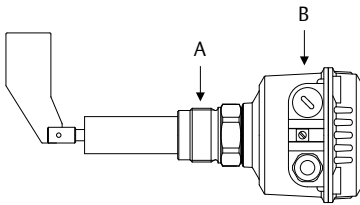
**Figure 2-3: Housing Rotation**

A. Threaded process connection

B. Rotatable housing

---

### 2.1.8 Orientation of cable glands

When the level switch is mounted horizontally, ensure the cable glands are pointed downwards to avoid water getting inside the housing. Unused conduit entries must be completely sealed with a suitably rated stopping (blanking) plug.

### 2.1.9 Seals

Apply PTFE tape to the threaded process connection or use a flat gasket. This is required for a silo (or other vessel) to maintain the process pressure.

### 2.1.10 Future maintenance

It is advisable to:

- Grease the screws of the housing cover (lid) when a corrosive atmosphere is present.
- Use PTFE tape to avoid seizing of aluminum process connection thread with the socket.

This will help prevent difficulties when the cover needs to be removed during future maintenance tasks.

## 2.2 Mounting the level switch

Figure 2-4 shows how the level switch should be mounted.

**Figure 2-4: Rosemount 2501L Mounting Examples**

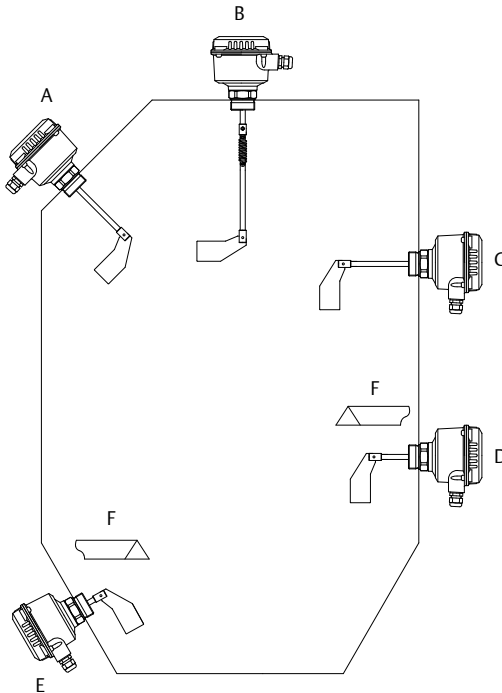

- A. Angled-mounting, at top of silo, for full-silo (overflow) detection. Maximum  $L=23.62$  in. (600 mm)
- B. Vertical-mounting for full-silo (overflow) detection, with pendulum shaft or rope-extension. Check the maximum load of the level switch
- C. Horizontal-mounting, near top of silo, for full-silo (overflow) detection. Maximum  $L=11.8$  in. (300 mm)
- D. Horizontal-mounting, near bottom of silo, for control (on demand) detection. Maximum  $L=5.9$  in. (150 mm)
- E. Angled-mounting, at bottom of silo, for empty-silo (filling demand) detection. Maximum  $L=11.8$  in. (300 mm)
- F. A protective shield is recommended depending on the load

The boot-shaped vane (paddle) is recommended for horizontal mountings because it aligns to the movement of the solids material. See [Mechanical load](#) and [Sensitivity](#) to check that the paddle meets the application limits.

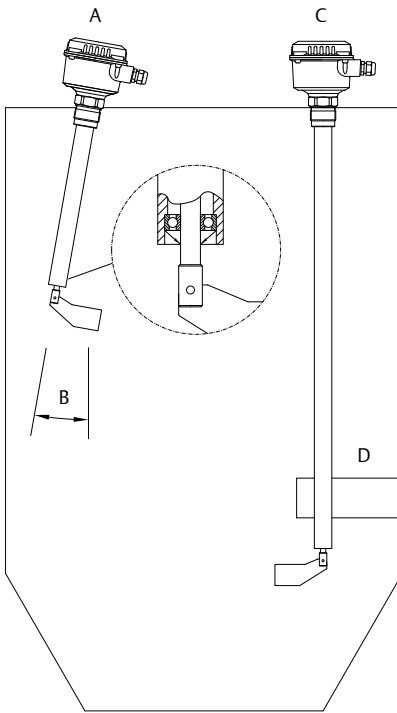
**Figure 2-5: Rosemount 2501M Mounting Examples**

- A. Vertical-mounting for full-silo (overflow) detection with optional sliding sleeve. Maximum L=118 in. (3000 mm)
- B. The maximum angle of deviation from the normal vertical position is 10° when using the "bearing at tube end" option
- C. Vertical-mounting for full-silo (overflow) detection, with optional sliding sleeve. Maximum L=158 in. (4000 mm)
- D. Supports from the side of the silo are recommended



**Figure 2-6: Rosemount 2501R and 2501S Mounting Examples**

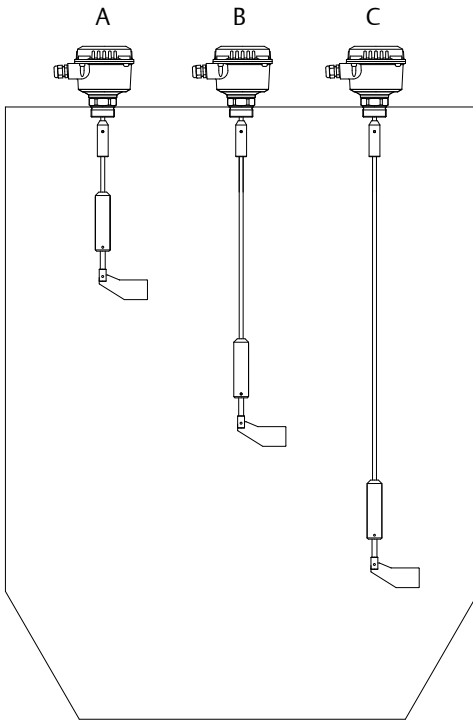

- A. Full-silo (overflow) detection, with a rope extension
- B. Demand detection, with a rope extension
- C. Empty-silo (filling demand), detection with a rope extension

Maximum L=394 in. (10000 mm). See [Mechanical load](#) and [Sensitivity](#) to check the limits of the rope-extended vane (paddle).

**Figure 2-7: Rosemount 2501K Mounting Examples**

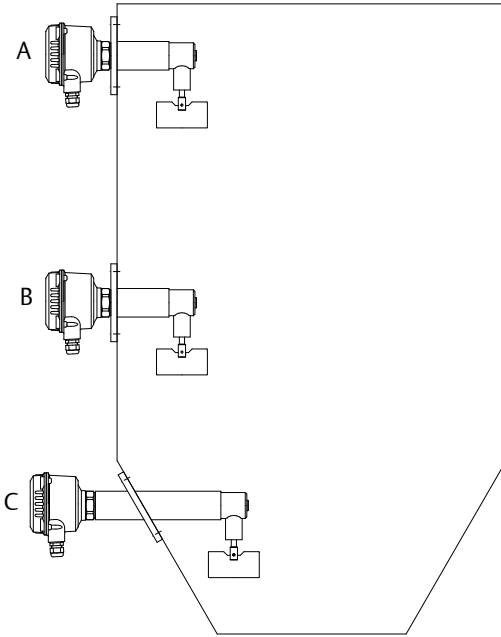

- A. *Horizontal mounting for full-silo (overflow) detection*
- B. *Horizontal mounting for demand detection*
- C. *Horizontal mounting for empty-silo detection*

A protective angle is recommended depending on the load.

---

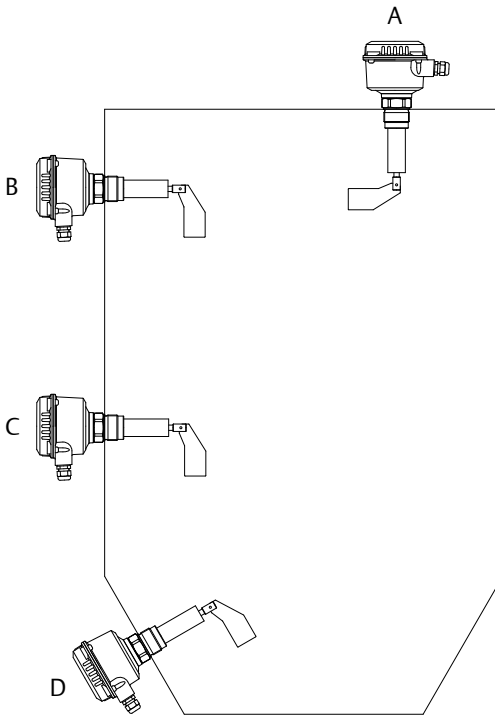
**Figure 2-8: Rosemount 2501J Mounting Examples**

- A. Vertical or angled mounting, at the top of silo, for full-silo (overflow) detection
- B. Horizontal mounting, at the top of silo, for full-silo (overflow) detection
- C. Horizontal mounting for demand detection
- D. Angled mounting, at the bottom of silo, for empty-silo detection
- E. A protective angle is recommended depending on the load

The boot-shaped vane (paddle) is recommended for horizontal mountings because it aligns to the movement of the solids material. See [Mechanical load](#) and [Sensitivity](#) to check that the paddle meets the application limits.

---

## 3 Electrical installation

### 3.1 Safety messages

#### **⚠ WARNING**

**Failure to follow safe installation and servicing guidelines could result in death or serious injury.**

- Ensure the level switch is installed by qualified personnel and in accordance with applicable code of practice.
- Use the level switch only as specified in this manual. Failure to do so may impair the protection provided by the level switch.

**Explosions could result in death or serious injury.**

- The level switch must only be installed and operated in non-hazardous (ordinary) locations.

**Electrical shock could cause death or serious injury.**

- Avoid contact with the leads and terminals. High voltage that may be present on leads can cause electrical shock.
- Ensure the power to the level switch is off, and the lines to any other external power source are disconnected or not powered while wiring the level switch.
- Ensure the wiring is suitable for the electrical current and the insulation is suitable for the voltage, temperature, and environment.

---

### 3.2 Wiring considerations

#### 3.2.1 Handling

In cases of improper handling or handling malpractice, the electrical safety of the device cannot be guaranteed.

#### 3.2.2 Installation regulations

Local regulations or VDE 0100 (Regulations of German Electrotechnical Engineers) must be observed.

When using 24 V supply voltage, an approved power supply with reinforced insulation to mains is required.

#### 3.2.3 Fuse

Use a fuse as stated in the connection diagrams.

For details, see [Wiring the level switch](#).

### 3.2.4 Residual Current Circuit Breaker (RCCB) protection

In case of a defect, the distribution voltage must automatically be cut-off by an RCCB protection switch to protect against indirect contact with dangerous voltages.

### 3.2.5 Power supply

#### **Power supply switch**

A voltage disconnection switch must be provided near the device.

#### **Supply voltage**

Compare the supply voltage applied with the specifications given on the electronic module and nameplate before switching on the device.

### 3.2.6 Wiring

#### **Field wiring cables**

The diameter has to match the clamping range of the used cable gland.

The cross-section has to match the clamping range of the connection terminals and the maximum current must be considered.

All field wiring must have insulation suitable for at least 250 Vac.

The temperature rating must be at least 194 °F (90 °C).

Use a shielded cable when there are electrical interferences present that are higher than stated in the EMC standards. Otherwise, an unshielded instrumentation cable can be used.

#### **Wiring diagram**

The electrical connections are made in accordance with the wiring diagram.

#### **Guiding the cables in the terminal box**

The field wiring cables must be cut to a length to be able to properly fit them into the terminal box.

### 3.2.7 Cable glands

The screwed cable gland and stopping plug must have the following specifications:

- Ingress protection IP66
- Temperature range from -40 °C to +70 °C
- Pull relief

Ensure the screwed cable gland safely seals the cable and is tight enough to prevent water ingress. Unused conduit or cable entries must be sealed with a stopping (blanking) plug.

A strain relief must be provided for the field wiring cables when the device is installed with the factory-provided cable glands.

### 3.2.8 Conduit system

When a threaded conduit system is used instead of a cable gland, the regulations of the country must be observed. The conduit must have a ½-in. NPT tapered thread to match a NPT threaded conduit entry of the level switch and comply with ANSI B 1.20.1. Unused conduit entries must be closed tightly with a metal stopping (blanking) plug.

### 3.2.9 Micro-switch protection

Provide protection for micro-switch contacts to protect the device against inductive load surges.

### 3.2.10 Static charging

The Rosemount 2501 must be grounded to avoid a static electrical build-up. This is particularly important for applications with pneumatic conveying and non-metallic containers.

### 3.2.11 Commissioning

Commissioning must be performed with closed lid.

## 3.3 Wiring the level switch

Wiring connections are done directly on the PCB.

**Figure 3-1: PCB Connections**

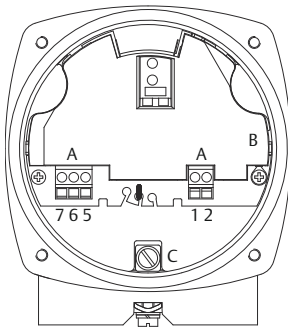

- A. Connection terminals for power supply and signal outputs
- B. The motor is internally connected to the housing (grounded)
- C. Protective Earth (PE) terminal

**Wiring the ac and dc voltage versions**

Power supply (ac version):

- 24, 48, 115 , or 230 Vac (50/60 Hz), maximum of 4 VA
- External fuse: maximum 10 A, fast or slow, HBC, 250 Vac

**Note**

The supply voltage is selected when ordering the level switch.  
All voltages are  $\pm 10\%$  (EN 61010).

Power supply (dc version):

- 24 Vdc  $\pm 15\%$ , maximum of 2.5 W
- External fuse: not required

**Note**

The supply voltage is selected when ordering the level switch.  
The voltage variance of  $\pm 15\%$  includes the  $\pm 10\%$  of EN 61010.

Signal output (ac and dc versions):

- Micro-switched, SPDT relay contacts
- Maximum 250 Vac, 5 A, non-inductive
- Maximum 30 Vdc, 4 A, non-inductive

**Figure 3-2: Terminal Connections (Ac and Dc Voltage Versions)**

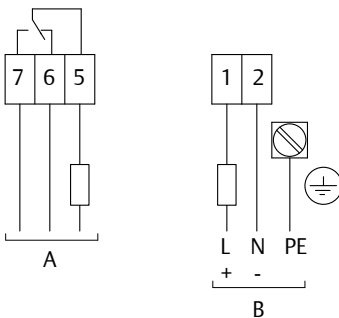

- A. Signal output connections
- B. Power supply connections

Maximum wire size is 4 mm<sup>2</sup> (AWG12).

### Wiring the universal voltage version

Power supply (universal voltage version):

- 24 Vdc  $\pm 15\%$ , maximum 4 W
- 22 to 230 Vac (50/60 Hz)  $\pm 10\%$ , maximum 10 VA

**Note**

The voltage variances of  $\pm 10\%$  and  $\pm 15\%$  include the  $\pm 10\%$  of EN 61010.

Signal and alarm outputs (universal voltage version):

- DPDT relay contacts
- Maximum 250 Vac, 5 A, non-inductive
- Maximum 30 Vdc, 4 A, non-inductive
- External fuse: maximum 10 A, fast or slow, HBC, 250 V

**Figure 3-3: Wiring Connections (Universal Voltage Version)**

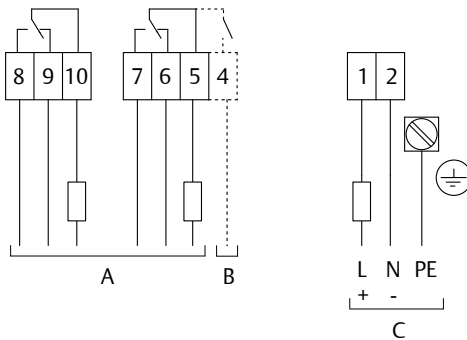

- A. Signal output connections
- B. Alarm output connections<sup>(2)</sup>
- C. Power supply connections

Maximum wire size is 4 mm<sup>2</sup> (AWG12).

### Grounding

The PE terminal of the level switch must be connected to an earth (grounding point) to avoid static electrical discharges. This is particularly important for applications with pneumatic conveyors.

<sup>(2)</sup> Available only when the Fail Safe Alarm (rotation control) option is selected at the time of ordering.

The relay contact is open when de-energized.



## 4 Configuration

### 4.1 Signal output delay

**Figure 4-1: Delay Timers for Signal Output Change**

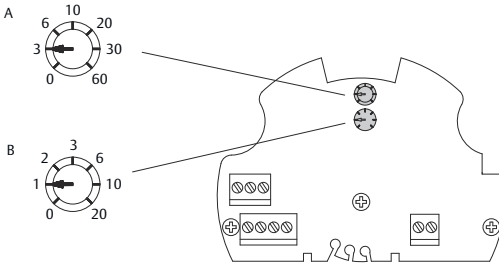

- A. Delay timer in seconds - for the switchover from a covered-to-uncovered paddle state. Factory default is 3 seconds.
- B. Delay timer in seconds - for the switchover from an uncovered-to-covered paddle state. Factory default is 1 second.

### 4.2 Jumper Settings for Fail Safe High or Low

Use the FSH setting when the level switch is to be applied as a full-silo detector. A power failure or line break is regarded as a full-silo signal (as protection against overfilling).

Use the FSL setting when the level switch is to be applied as an empty-silo detector. A power failure or line break is regarded as empty-silo signal (as protection against running dry).

**Figure 4-2: Jumper Settings for FSH or FSL**

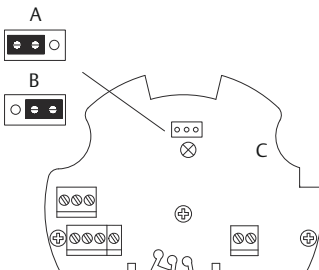

- A. Jumper setting for enabling FSL (factory default)
- B. Jumper setting for enabling FSH

### 4.3 Adjustment of the spring

The spring is adjustable in three positions. It should be changed only if necessary.

- **Fine** for light material
- **Medium** for nearly every material (factory setting)
- **Coarse** for very sticky material

The spring can be changed using small pliers.

**Figure 4-3: Adjustment of the Spring**

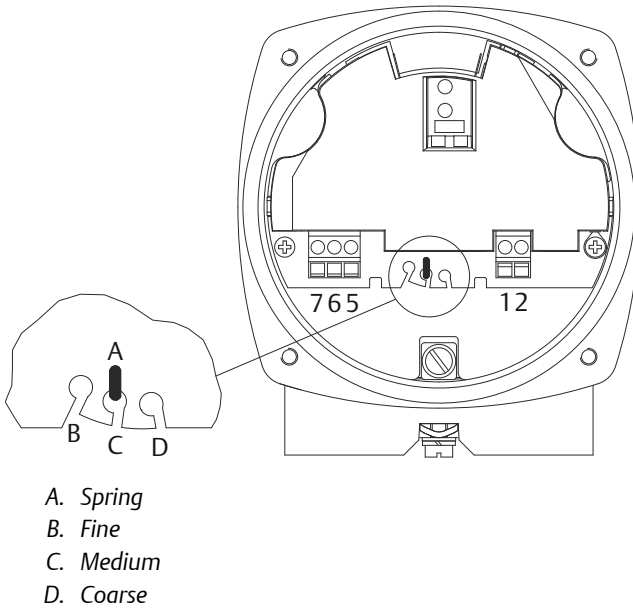

## 4.4 Sensitivity

Table 4-1 shows approximate values for the minimum densities, at which a normal function should be possible. It is a guideline only for loose, non-compacted material. During a filling operation, the density of bulk material can change (e.g. for fluidized material).

**Table 4-1: Minimum Density Requirements and Sensitivity Settings**

Paddle	Minimum density in g/l = kg/m <sup>3</sup> (lb/ft <sup>3</sup> ) <sup>(1)</sup> (without guarantee)			
	Bulk material completely covering the vane		Bulk material covering the vane up to 3.93 in. (100 mm)	
	Spring adjustment		Spring adjustment	
	Fine	Medium (factory setting)	Fine	Medium (factory setting)
Boot-shaped vane 40 x 98	200 (12)	300 (18)	100 (60)	150 (9)
Boot-shaped vane 35 x 106	200 (12)	300 (18)	100 (60)	150 (9)
Boot-shaped vane 28 x 98	300 (18)	500 (30)	150 (9)	200 (12)
Boot-shaped 26 x 77	350 (21)	560 (33)	200 (12)	250 (15)
Vane 50 x 98	300 (18)	500 (30)	150 (9)	250 (15)
Vane 50 x 150	80 (4.8)	120 (7.2)	40 (2.4)	60 (3.6)
Vane 50 x 250	30 (1.8)	50 (3)	15 (0.9)	25 (1.5)
Vane 98 x 98	100 (60)	150 (9)	50 (3)	75 (4.5)
Vane 98 x 150	30 (1.8)	50 (3)	15 (0.9)	25 (15)
Vane 98 x 250	20 (1.2)	30 (1.8)	15 (0.9)	15 (0.9)
Hinged vane 98 x 200 b=37 double-sided	70 (4.2)	100 (60)	35 (2.16)	50 (3)
Hinged vane 98 x 200 b=28 double-sided	100 (60)	150 (9)	50 (3)	75 (4.5)
Hinged vane 98 x 100 b=37 single-sided	200 (12)	300 (18)	100 (60)	150 (9)
Hinged vane 98 x 100 b=28 single-sided	300 (18)	500 (30)	150 (9)	250 (15)

(1) For versions with the **Heating of housing** option, the above-mentioned data must be multiplied by 1.5.

## 5 Operation

### 5.1 Overview of the outputs

For an overview of signal and alarm output for the different electronic versions, see [Electronics](#).

### 5.2 Signal outputs

**Figure 5-1: Switching Logic (Ac and Dc Versions)**

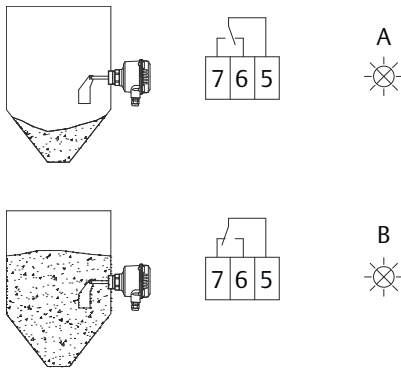

A. *Green*

B. *Red*

- The dc-voltage version has a LED that changes color to indicate if the paddle is covered or uncovered by solids material.
- The ac-voltage version does not have a LED.

**Figure 5-2: Switching Logic (Universal Voltage Version)**

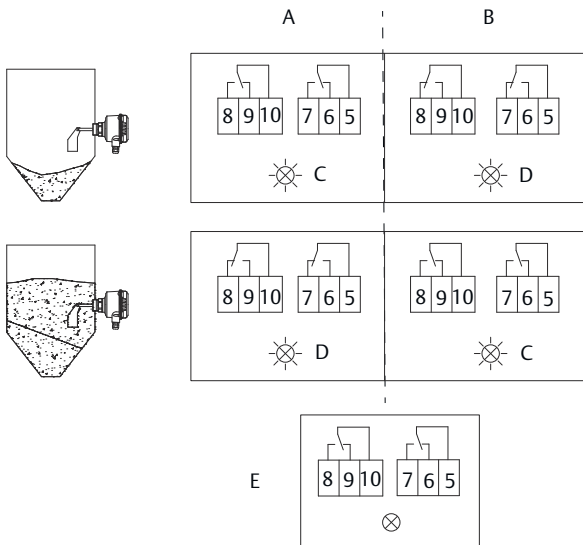

- A. FSL (Fail Safe Low)
- B. FSH (Fail Safe High)
- C. Yellow
- D. Green
- E. Power failure

**Note**

See [Jumper Settings for Fail Safe High or Low](#) for details on how to select an FSH or FSL alarm output.

### 5.3 Alarm output (Fail Safe High or Low)

If the paddle of the level switch is not covered, the rotating paddle shaft triggers pulses at 20-second intervals. In the event of a fault, the pulses are stopped and the alarm relay de-energizes after 30 seconds.

**Figure 5-3: Switching Logic (Universal Voltage Version)**

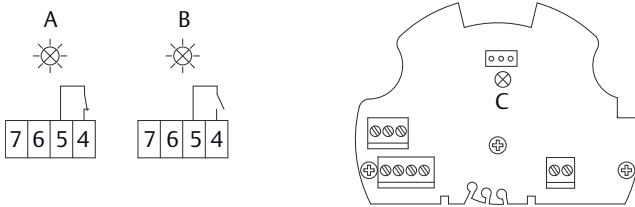

- A. Yellow or green, i.e. no fault. See [Figure 5-2](#).
- B. Red, i.e. fault
- C. LED location on PCB

**Figure 5-4: Connection Example**

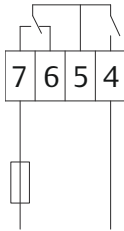

When a Rosemount 2501 is used in a full-silo detection application with maximum safety, the output signal can indicate:

- Full-silo signal
- Failure of supply voltage
- Incorrect wiring
- The level switch has developed a fault

## 6 Maintenance

### 6.1 Opening the lid (cover)

Before opening the lid for maintenance reasons, consider the following:

- Do not remove the lid while circuits are live.
- Ensure that no dust deposits or airborne dusts are present.
- Ensure that rain does not enter the housing.

### 6.2 Regular checks for safety

To ensure robust safety in hazardous locations and with electrical safety, the following items must be regularly checked depending on the application:

- Mechanical damage or corrosion of the field wiring cables or any other components (housing side and sensor side).
- Tight sealing of the process connection, cable glands, and enclosure lid.
- Properly connected external PE cable (if present).

### 6.3 Cleaning

If cleaning is required by the application, following must be observed:

- Cleaning agent must comply with the materials of the unit (chemical resistance). Mainly the shaft sealing, lid sealing, cable gland and the surface of the unit must be considered.

The cleaning process must be done in a way, that:

- The cleaning agent cannot enter into the unit through the shaft sealing, lid sealing or cable gland.
- No mechanical damage of the shaft sealing, lid sealing, cable gland or other parts can happen.

### 6.4 Function test

A frequent function test may be required depending on the application.

Observe all relevant safety precautions related to work safety (e.g. electrical safety, process pressure, etc).

This test does not prove if the level switch is sensitive enough to measure the material of the application.

Function tests are done by stopping the rotating paddle with appropriate means and monitoring if a correct change of the signal output from uncovered to covered happens.

## 6.5 Production date

The production year is shown on the nameplate.

## 6.6 Spare parts

Refer to the Rosemount 2501 [Product Data Sheet](#) for all spare parts.



# 7 Product certifications

## 7.1 EU Declaration of Conformity

Figure 7-1: EU Declaration of Conformity (Page 1)





	<h3>EU Declaration of Conformity</h3> <p>No: RMD 1151 Rev. A</p>	
<p>We,</p> <p style="margin-left: 40px;"><b>Rosemount Measurement Limited</b> 158 Edinburgh Avenue Slough, Berkshire, SL1 4UE United Kingdom</p> <p>declare under our sole responsibility that the product,</p> <p style="text-align: center;"><b>Rosemount™ 2501 Solids Level Switch – Paddle</b></p> <p>manufactured by,</p> <p style="margin-left: 40px;"><b>Rosemount Measurement Limited</b> 158 Edinburgh Avenue Slough, Berkshire, SL1 4UE United Kingdom</p> <p>to which this declaration relates, is in conformity with the provisions of the European Union Directives, including the latest amendments, as shown in the attached schedule.</p> <p>Assumption of conformity is based on the application of the harmonized standards and, when applicable or required, a European Union notified body certification, as shown in the attached schedule.</p>		
 <hr style="border: 0; border-top: 1px solid black;"/> <p>(signature)</p>	<hr style="border: 0; border-top: 1px solid black;"/> <p>Technical Directory (function)</p>	
<p>Timothy Hill (name)</p>	<hr style="border: 0; border-top: 1px solid black;"/> <p>25-Oct-19 Slough, GB (date of issue &amp; place)</p>	
<p>Page 1 of 2 <span style="float: right;">en</span></p>		

Figure 7-2: EU Declaration of Conformity (Page 2)

	<b>EU Declaration of Conformity</b> No: RMD 1151 Rev. A	
<b>EMC Directive (2014/30/EU)</b>		
All Models Harmonized Standards: EN 61326-1:2013		
<b>LV Directive (2014/35/EU)</b>		
All Models Harmonized Standards: EN 61010-1:2010		
<b>RoHS Directive (2011/65/EU)</b>		
All Models Harmonized Standard: EN 50581:2012		
The Model 2501 is in conformity with Directive 2011/65/EU of the European Parliament and of the Council on the restriction of the use of certain hazardous substances in electrical and electronic equipment.		
<p>(Minor variations in design to suit the application and/or mounting requirements are identified by alpha/numeric characters where indicated * above)</p> <p>Page 2 of 2 <span style="float: right;">en</span></p>		

## 7.2 European Union directive information

The most recent revision of the EU Declaration of Conformity can be found at [Emerson.com/Rosemount](http://Emerson.com/Rosemount).

## 7.3 China RoHS

含有China RoHS 管控物质超过最大浓度限值的部件型号列表 Rosemount 2501  
List of Rosemount 2501 Parts with China RoHS Concentration above MCVs

部件名称 Part Name	有害物质 / Hazardous Substances					
	铅 Lead (Pb)	汞 Mercury (Hg)	镉 Cadmium (Cd)	六价铬 Hexavalent Chromium (Cr +6)	多溴联苯 Polybrominated biphenyls (PBB)	多溴联苯醚 Polybrominated diphenyl ethers (PBDE)
电子组件 Electronics Assembly	X	O	X	O	O	O
壳体组件 Housing Assembly	X	O	O	O	O	O
过程连接/扩展部件 Process Connection / Extension	X	O	O	O	O	O
测量叶片 Measuring Vane	O	O	O	O	O	O

本表格系依据 SJ/T11364 的规定而制作。  
This table is proposed in accordance with the provision of SJ/T11364.

- O: 意为该部件的所有均质材料中该有害物质的含量均低于GB/T 26572所规定的限量要求。  
O: Indicate that said hazardous substance in all of the homogeneous materials for this part is below the limit requirement of GB/T 26572.
- X: 意为在该部件所使用的的所有均质材料里，至少有一类均质材料中该有害物质的含量高于GB/T 26572所规定的限量要求。  
X: Indicate that said hazardous substance contained in at least one of the homogeneous materials used for this part is above the limit requirement of GB/T 26572.



### **Global Headquarters**

Emerson Automation Solutions  
6021 Innovation Blvd.  
Shakopee, MN 55379, USA

- +1 800 999 9307 or +1 952 906 8888
- +1 952 204 8889
- RFQ.RMD-RCC@Emerson.com

### **North America Regional Office**

Emerson Automation Solutions  
8200 Market Blvd.  
Chanhassen, MN 55317, USA

- +1 800 999 9307 or +1 952 906 8888
- +1 952 204 8889
- RMT-NA.RCCRFQ@Emerson.com

### **Latin America Regional Office**

Emerson Automation Solutions  
1300 Concord Terrace, Suite 400  
Sunrise, FL 33323, USA

- +1 954 846 5030
- +1 954 846 5121
- RFQ.RMD-RCC@Emerson.com

### **Europe Regional Office**

Emerson Automation Solutions Europe  
GmbH  
Neuhofstrasse 19a P.O. Box 1046  
CH 6340 Baar  
Switzerland

- +41 (0) 41 768 6111
- +41 (0) 41 768 6300
- RFQ.RMD-RCC@Emerson.com

### **Asia Pacific Regional Office**

Emerson Automation Solutions  
1 Pandan Crescent  
Singapore 128461

- +65 6777 8211
- +65 6777 0947
- Enquiries@AP.Emerson.com

### **Middle East and Africa Regional Office**

Emerson Automation Solutions  
Emerson FZE P.O. Box 17033  
Jebel Ali Free Zone - South 2  
Dubai, United Arab Emirates

- +971 4 8118100
- +971 4 8865465
- RFQ.RMTMEA@Emerson.com

 [Linkedin.com/company/Emerson-Automation-Solutions](https://www.linkedin.com/company/Emerson-Automation-Solutions)

 [Twitter.com/Rosemount\\_News](https://twitter.com/Rosemount_News)

 [Facebook.com/Rosemount](https://www.facebook.com/Rosemount)

 [Youtube.com/user/RosemountMeasurement](https://www.youtube.com/user/RosemountMeasurement)

©2019 Emerson. All rights reserved.

Emerson Terms and Conditions of Sale are available upon request. The Emerson logo is a trademark and service mark of Emerson Electric Co. Rosemount is a mark of one of the Emerson family of companies. All other marks are the property of their respective owners.