

Portable Gas Leak Detector

SP-220 Series

TYPE M

TYPE L

Operating Manual

Part Number: 71-0407

Revision: A

Released: 4/9/19

Contents

1. Outline of the Product.....	3
Preface.....	3
Purpose of use.....	3
Definition of DANGER, WARNING, CAUTION and NOTE.....	3
How to check the standards and explosion-proof specifications	4
2. Important Notices on Safety.....	5
2-1. Danger cases	5
2-2. Warning cases	6
2-3. Precautions.....	7
2-4. Safety information.....	9
3. Product Components.....	10
3-1. Names and functions for each part	10
4. How to Use	13
4-1. Before using the detector	13
4-2. Preparation for start-up	13
4-3. How to replace the batteries	13
4-4. How to start the detector	15
4-5. Basic operating procedures.....	17
4-6. How to detect.....	18
4-7. Changing the alarm setpoint	19
4-8. Performing an air calibration	20
4-9. Snap logger	21
4-10. Peak hold function.....	22
4-11. Change of the alarm and operation sounds	22
4-12. How to turn on the illumination lamp.....	23
4-13. Power-off	23
5. Display Mode.....	24
5-1. Entering the display mode.....	24
5-2. Measured gas switching setting.....	26
5-3. Log data display	27
6. User Mode	28
6-1. Entering the user mode	28
6-2. Date/time setting.....	30
6-3. Clock function ON/OFF setting	31
7. Alarm Function.....	32
7-1. Gas alarm activation.....	32
7-2. Fault alarm activation	32
8. Maintenance	33
8-1. Maintenance intervals and items.....	33
8-2. How to clean.....	35
8-3. Parts replacement	35
9. Calibration Mode	38
9-1. Fresh Air Adjustment	38
9-2. Preparing for a Span Adjustment (Gas Bag).....	40
9-3. Preparing for a Span Adjustment (Demand Flow Regulator).....	41
9-4. Automatic Span Adjustment.....	41
9-5. Manual Span Adjustment.....	44
9-6. Password.....	46
9. Storage and Disposal	49
10-1. Procedures to store the detector or leave it for a long time.....	49
10-2. Procedures to use the detector again	49
10-3. Disposal of products.....	50
10. Troubleshooting.....	51
10. Spare Parts List	53
11. Product Specifications	54
12. Appendix.....	55
12-1. Definition of terms	55

1.

Outline of the Product

Preface

Thank you for choosing our portable gas leak detector SP-220 series (hereinafter referred to as the detector). Please check that the model number of the product you purchased is included in the specifications on this manual.

This manual explains how to use the detector and its specifications. It contains information required for using the detector properly. First-time users and users who have already used the product must read and understand the operating manual to enhance their knowledge and experience before using the detector.

Note that the contents of this manual are subject to change without notice for product improvement. It is also prohibited to copy or reproduce this manual, in whole or in part, without permission.



Regardless of warranty period, we shall not make any indemnification for accidents and damage caused by using the detector.
Make sure to read the warranty policy specified on the warranty.

Purpose of use

This detector is used to detect a single channel, such as city gas, LP gas, etc., in air. It has 2 different specifications: TYPE M used to detect leakage of city gases, such as methane. TYPE L used to detect leakage of LP gases, such as a liquefied petroleum gas. Detection results are not intended to guarantee life or safety in any way.

Definition of DANGER, WARNING, CAUTION and NOTE

Throughout this manual, the following indications are used to ensure safe and effective work.

 DANGER	This message indicates that improper handling may cause serious damage on life, health or assets.
 WARNING	This message indicates that improper handling may cause serious damage on health or assets.
 CAUTION	This message indicates that improper handling may cause minor damage on health or assets.
NOTE	This message indicates advice on handling.

How to check the standards and explosion-proof specifications

The detector has different specifications depending on the standards or explosion-proof certification type. Check the specifications of the product you have before use. See the Declaration of Conformity at the end of this operating manual for CE marking specifications. For the product specifications, check the nameplate attached to the product shown in the following figure.

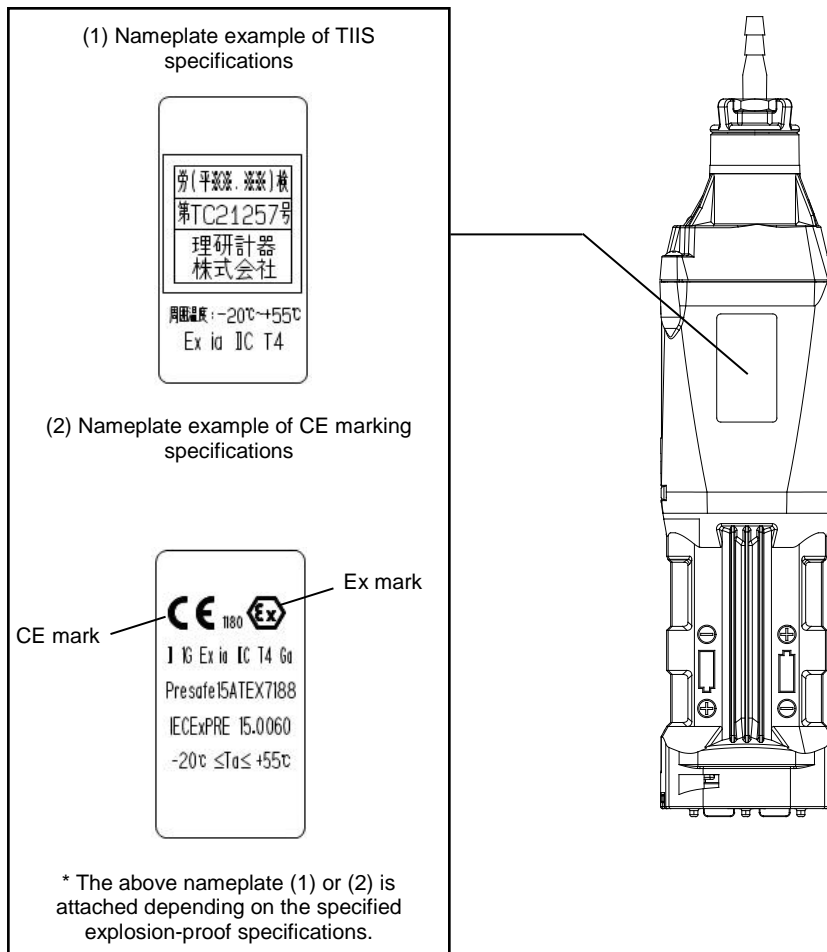

2. Important Notices on Safety

To maintain the performance and use the detector safely, observe the following instructions of DANGER, WARNING, and CAUTION.

2-1. Danger cases



DANGER

About use

- While conducting measurement in a manhole or confined space, do not lean over or look into the manhole or closed space. It may lead to dangers because oxygen-deficient air or other gases may blow out.
- Oxygen-deficient air or other gases may be discharged from the gas exhausting outlet of the detector. Never inhale the air or gases.
- High-concentration (100% LEL or higher) gases may be discharged from the gas exhausting outlet of the detector. Never use fire near it.

2-2. Warning cases



WARNING

Sampling point pressure

- The concentration meter is designed to draw gases under the atmospheric pressure. If excessive pressure is applied to the gas inlet and outlet of the detector, measured gases may leak out from its inside and may cause dangerous conditions. Be sure that excessive pressure is not applied to the detector's gas inlet or outlet during use.

Air calibration in atmosphere

- Perform an air calibration in a fresh air environment. If interference gases or other gases exist, the adjustment cannot be performed properly, thus leading to dangers when gas is present.

Response to gas alarm

- A gas alarm is triggered by changes in temperature and humidity. In such a case, check the atmosphere for freshness and perform air calibration again in the measured atmosphere. Example) If the detector is turned on in a room with a temperature of 20°C and a humidity of 40% RH and taken outside (a temperature of 30°C and a humidity of 60% RH), an alarm is triggered by humidity changes. In such a case, perform air calibration outside and measure. The detector performs air calibration automatically when it is turned on. Even in such a case, check the atmosphere for freshness and perform air calibration again in the measured atmosphere.



WARNING

Battery level check

- Before use, check that there remains sufficient battery power. When the detector is not used for a long period, the batteries may be exhausted. Never fail to replace them with new ones before use.
- If a low battery voltage alarm is triggered, gas detection cannot be conducted. If the alarm is triggered during use, turn off the power and promptly replace the batteries in a safe area.

Others

- Do not throw the detector into fire.
- Do not wash the detector in a washing machine or ultrasonic cleaner, etc.
- Do not block the buzzer sound opening. No alarm sound can be heard.
- Do not remove the battery while the power is on.

2-3. Precautions



CAUTION

Do not expose the detector to oil, chemicals, etc. Do not submerge the detector under water.

- Do not use in a place where the detector is exposed to liquids such as oil and chemicals.
- The detector is not water-pressure-resistant. Do not use the detector where a high water pressure is applied to it (under a faucet, shower, etc.) or submerge it under water for a long time. The detector is water-proof only in fresh water and running water, and not in hot water, salt water, detergent, chemicals, human sweat, etc.
- The gas inlet and outlet are not water-proof. Be careful not to let water such as rainwater, etc. get into these parts. Because this may cause trouble and gas cannot be detected.
- Do not place the detector where water or dirt gets accumulated. The detector placed at such a location may cause malfunction due to water or dirt that gets into the buzzer opening, etc.
- Note that drawing in dirty water, dust, metallic powder, etc. will significantly deteriorate the sensor sensitivities. Be careful when the detector is used in an environment where these elements exist.

Do not use the detector in a place where the temperature drops below -20°C or rises over 55°C.

- The operating temperature of the detector is -20 to +55°C. Do not use the detector at higher temperatures, humidities and pressures or at lower temperatures than the operating range.
- Avoid long-term use of the detector in a place where it is exposed to direct sunlight.
- Do not store the detector in a sun-heated car.
- Avoid a sudden humidity or temperature change.
- Do not leave the detector in a place with high temperature and humidity for a long time. The performance of the unit may deteriorate.

Observe the operating restrictions to prevent condensation inside the concentration meter or gas sampling hose.

- Condensation formed on the detector or taper nozzle causes clogging, gas adsorption, etc., which may disturb accurate gas detection. Thus, condensation must be avoided. In addition to the installation environment, carefully monitor the temperature/humidity of the sampling point to prevent condensation, etc. on the detector or taper nozzle. Please observe the operating restrictions.

Do not use a transceiver near the detector.

- Radio wave from a transceiver or other device near the detector may disturb readings. If a transceiver or other radio wave transmitting device is used, it must be used in a place where it disturbs nothing.
- Do not use the detector near a device that emits strong electromagnetic waves (high-frequency or high-voltage devices).

Verify that the flow check display is rotating before using the detector.

- If the flow check display is not rotating, the detector is not operating properly. Check whether the flow rate is lost.

Never fail to perform regular maintenance.

- Since this is a precision device, regular maintenance must be performed. Continuing to use the detector without performing maintenance will compromise the sensitivity of the sensor, thus resulting in inaccurate gas detection.



CAUTION

Others

- After a gas continuously comes into contact or a highly-concentrated gas comes into contact, the detector may stay in alarm. In such a case, draw fresh air for more than five minutes (recommended) and perform air calibration again.
- Pressing buttons unnecessarily may change the settings, preventing alarms from activating correctly. Operate the detector using only the procedures described in this operating manual.
- Do not drop or give shock to the detector. The accuracy of the detector may be deteriorated.
- Do not jab the buzzer opening with a sharp-pointed item. Doing so may cause a failure or damage.
- Do not remove the panel sheet on the display. The water-proof and dust-proof performances will be deteriorated.
- Do not affix a label or the like on the infrared port. Infrared communications can no longer be conducted.
- The operating environment may include gases that have harmful effects on the sensor of the detector. The detector cannot be used in the presence of the following gases:
(1) High-concentration sulfides (such as H₂S, SO₂, etc.)
(2) Halogen gases (such as chloride compounds, etc.)
(3) Silicone (Si compounds)
(4) High-concentration solvent gases. Do not use the detector in the presence of the above (1), (2), and (3) gases (such as high-concentration sulfides, halogen gases, silicone, etc.), which may shorten the sensor life significantly or cause malfunctions such as inaccurate readings.

In case the detector is used for detection in the presence of silicone, etc., be sure to check the gas sensitivities before using it again.

If the above (4) gas (high-concentration solvent gas) is exposed, a crack may occur in the unit. Thus, do not use high-concentration solvent gases.

About battery replacement

- Never fail to turn off the power of the detector before replacing the batteries.
- Replace both of the two batteries with new ones at one time.
- Pay attention to the polarities of the batteries.

Usage

- In a low-temperature environment, the operating time is shortened due to the battery performance property.
- At low temperatures, the responses of the LCD display may slow down.
- Perform air calibration under pressure and temperature/humidity conditions close to those in the operating environment and in fresh air.
- Perform air calibration after the reading is stabilized.
- If there is a sudden temperature change of 15°C or more between the storage and operational locations, turn on the power of the detector, let it stand for more than 5 minutes in a similar environment to the operational location, and perform air calibration in fresh air before using it.
- When cleaning the detector, do not splash water over it or use organic solvents such as alcohol and benzene on it. The surface of the detector may be discolored or damaged.
- If the detector is not used for a long time, turn on the power at least once every six months and check that the pump draws in air (about three minutes). The detector, when not activated for a long time, may cease to work because of hardening of the grease in the pump motor.
- If the detector is not used for a long time, store it after removing the batteries. Battery leaks may result in fire, injury, etc.
- When the detector is used again after a long-period storage, never fail to perform air calibration. For information on readjustment including air calibration, please contact RKI.

2-4. Safety information

Portable gas leak detector SP-220 is a gas detector to continuously detect combustible gases. The detector draws gases with the internal micro pump. Use only two TOSHIBA AA alkaline batteries (LR6T) connected in series for power supply. Do not replace the dry batteries in a hazardous location.

Explosion-proof specifications

- Ex ia IIC T4 Ga
-  II 1 G Ex ia IIC T4 Ga
- Operating temperature range: -20 to +55°C

Electrical specifications

- Only TOSHIBA AA alkaline batteries (LR6T) can be used.

Certificate Number

- IECEX: IECEX PRE 15.0060
- ATEX: Presafe15 ATEX7188

Applied standards

- | | |
|---------------------|-------------------|
| · IEC 60079-0:2011 | · EN60079-0:2012 |
| · IEC 60079-11:2011 | · EN60079-11:2012 |

Precautions

- Do not replace the battery unit in a hazardous location.
- Do not replace the dry batteries in a hazardous location.
- Do not disassemble/modify the unit.
- Use only TOSHIBA AA alkaline batteries (LR6T) for the dry battery unit.

INST. No. 0 0 0 0 0 0 0 0 0 0

A B C D E

- A: Manufacturing year (0-9)
- B: Manufacturing month (1-9, XYZ for Oct.-Dec.)
- C: Manufacturing lot
- D: Serial number
- E: Factory code

Manufacturer

RIKEN KEIKI CO., LTD.
2-7-6 Azusawa, Itabashi-ku, Tokyo, 174-8744 Japan
Web site: <http://www.rikenkeiki.co.jp/>

NOTE

TOSHIBA AA alkaline batteries (LR6) can be used for TIIS specifications.

3. Product Components

3-1. Names and functions for each part

This section describes names and functions of the main unit, the battery unit parts, and the LCD display.

Main unit

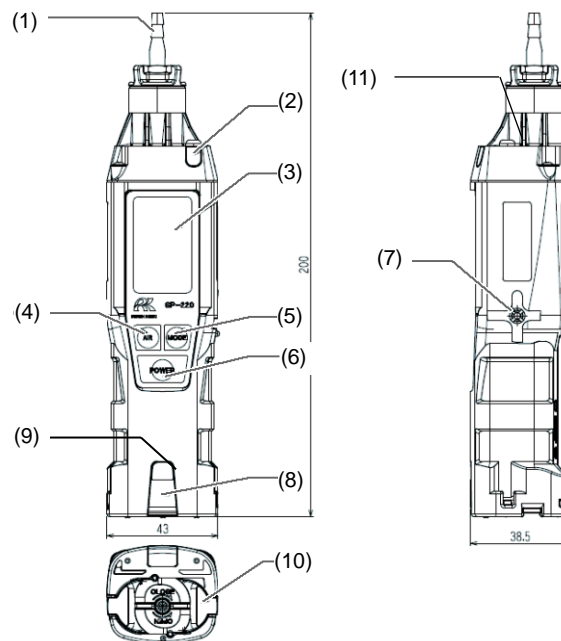



No.	Name	Function
(1)	Gas inlet	Collects gases.
(2)	Alarm LED array	Blinks or lights up in response to an alarm.
(3)	LCD display	Displays gas concentrations, measured gas name, alarms, etc.
(4)	AIR button	Keep this switch pressed to perform air calibration. Used to change the screen and decrease numerical values in the setting mode.
(5)	MODE button	Press this switch to change between display modes. Used to change the screen and increase numerical values in the setting mode.
(6)	POWER button	Turns the power ON or OFF. Used to change the screen and confirm values in the setting mode.
(7)	Gas outlet	Exhausts the gas drawn into the detector. (Do not block it.)
(8)	Alarm LED array	Blinks or lights up in response to an alarm.
(9)	Infrared port	Used during infrared communications.
(10)	Battery cover	Protects the battery. Remove it to replace the batteries.
(11)	LED light	Provides you light for work.

Standard accessories

Unpack and check the main unit and accessories.

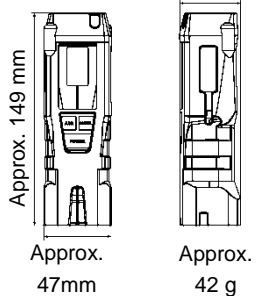
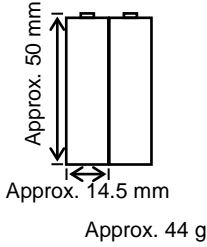
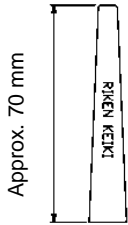
- AA alkaline battery (2 pcs) (installed)
- Taper nozzle (1 pc)
- Rubber protection cover (1 pc) (Protect the detector from shocks by being hit, etc.)
- Hand strap (1 pc)
- Replacement hydrophobic filters (5 pcs)
- Product warranty (1 pc)
- Operating manual (1 pc)

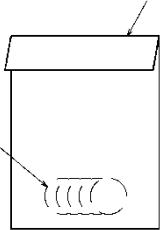
Name	Appearance/ weight	Quantity	Name	Appearance/ weight	Quantity
Rubber protection cover	<p>Approx. 42.5 mm</p>  <p>Approx. 149 mm</p> <p>Approx. 47 mm</p> <p>Approx. 42 mm</p> <p>Approx. 42 g</p>	1 pc (attached)	AA alkaline battery	 <p>Approx. 50 mm</p> <p>Approx. 14.5 mm</p> <p>Approx. 44 g</p>	2 pcs (installed)
Taper nozzle	 <p>Approx. 70 mm</p> <p>Approx. 9 g</p>	1 pc	Hand strap	 <p>Approx. 150 mm</p> <p>Approx. 2 g</p>	1 pc
Replacement hydrophobic filters	<p>Plastic bag</p>  <p>Approx. φ16 mm</p> <p>Approx. 1g</p>	1 bag (5 pcs included)	Operating manual	—	1 pc
			Product warranty	—	1 pc

If there is anything missing, contact RKI.



CAUTION

- Do not remove the panel sheet on the display. The water-proof and dust-proof performances will be deteriorated.
- Do not affix a label or the like on the infrared port. Infrared communications can no longer be conducted.

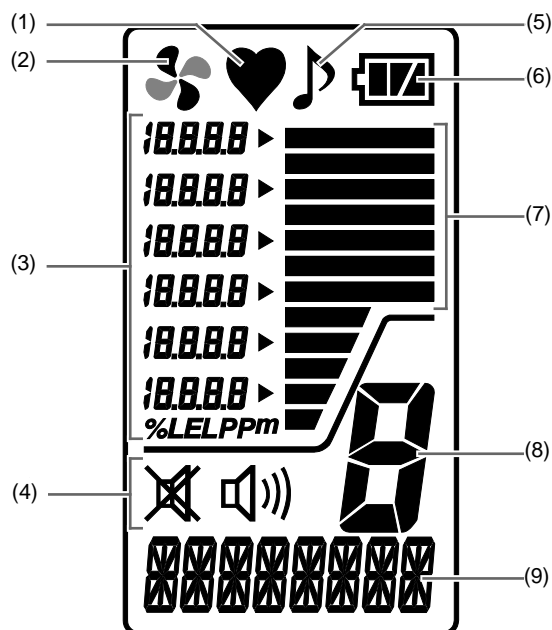

LCD display



No.	Name	Function
(1)	Operating state display	Displays the operating status in the detection mode. Normal: Blinking
(2)	Flow check display	Displays the flow rate status. Normal: Rotating
(3)	Gas concentration display	Displays gas concentration and units (ppm).
(4)	Alarm sound display	Displays the setting status of the alarm sound.
(5)	Operation sound display	Displays the setting status of the operation sound.
(6)	Battery level icon	Displays the battery level.
(7)	Bar meter display	Displays the level of gas concentration in the form of a bar meter.
(8)	Mode display	Displays the measuring mode status.
(9)	Gas name and message display	Displays the gas name and a message according to the function.

NOTE

- The meanings of battery level icons are as follows:

 : Sufficient/
  : Low/
  : Needs replacement

If the battery level further drops, the inside of the battery icon starts to blink ().

4. How to Use

4-1. Before using the detector

First-time users and users who have already used the detector must follow the operating precautions. Ignoring the precautions may damage the unit, resulting in inaccurate gas measurement.

4-2. Preparation for start-up

Before use, read and understand the following precautions. Ignoring these may cause inaccurate gas detection.

- The batteries are installed (with sufficient battery level).
- Check that the taper nozzle and filter are not contaminated.
- Check that the taper nozzle is not bent or has no hole.
- Check that the nipple to which the taper nozzle is attached is not loose.

4-3. How to replace the batteries

When the detector is used for the first time, or when the battery level is low, install two new AA alkaline batteries according to the following procedures.

- 1 Check that the power of the detector is turned off.
Turn off the power if it is turned on.
- 2 Turn the lock plate counterclockwise and open the battery cover.
- 3 Remove old batteries and then install new batteries while observing the correct polarity.
- 4 Close the battery cover and turn the lock plate clockwise to lock.

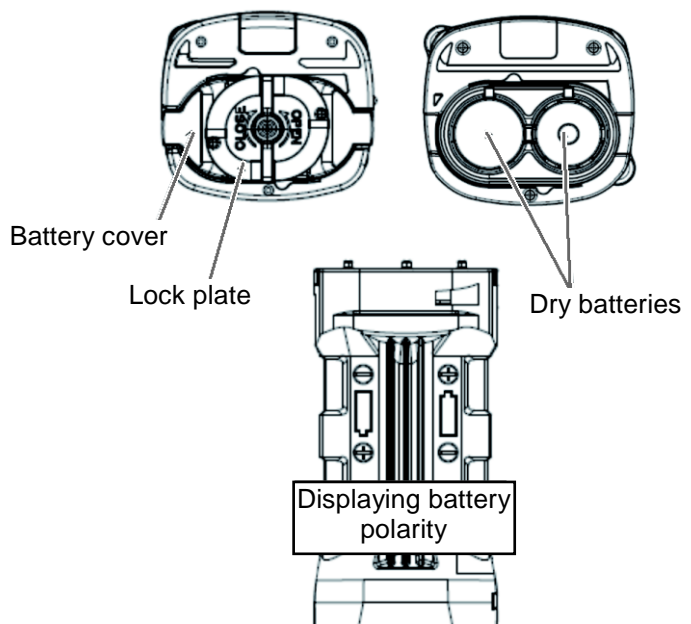



CAUTION

- Never fail to turn off the power of the detector before replacing the batteries.
- Replace the batteries in a safe place.
- Replace both of the two batteries with new ones at one time.
- Pay attention to the polarities during replacement. Replace while checking the battery polarities stamped on the body.
- If the battery cover is not completely locked, the dry batteries may become dislodged or water may get in through the clearance. Water may also get in if a minute foreign substance is caught between the detector and battery cover.

4-4. How to start the detector

When the power is turned on, a self-diagnostic starts, and then the detector enters the detection mode.

Power-on

Press and hold the **POWER** button until the buzzer blips (one second or longer) to turn on the power. When the power is turned on, the LCD display changes automatically as shown below, and the detector enters the detection mode.

(Display example: For city gases)

- 1 Press and hold the **POWER** button for one second or longer. Hold it down until all the LCDs and alarm lamp light up and the buzzer blips.

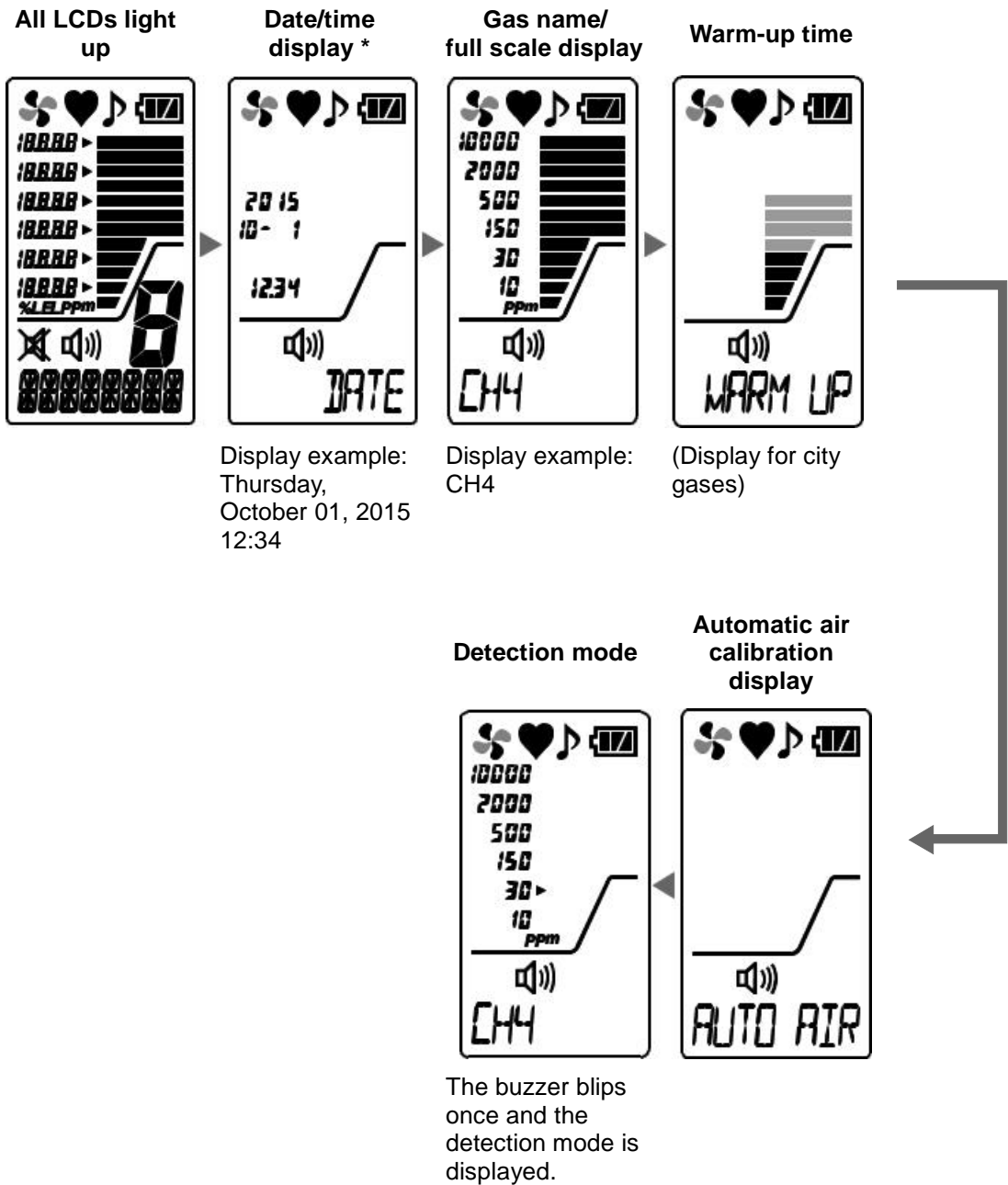

* The date/time display is displayed only when the clock function is enabled. It is not normally displayed because the clock function is disabled by default.
To enable the clock function, see "6-3. Clock function ON/OFF setting" on page 31.

NOTE

- When powering on after leaving the detector for more than five minutes with the batteries removed, such as when powering on for the first time, replacing the batteries, etc., or powering on with the batteries inserted with incorrect polarities, a clock abnormality (FAIL CLOCK) may be triggered. When it is reset using the MODE button, the detector moves to the date/time setting screen. See "6-2. Date/time setting" on page 30 and set the date/time.
- Warm-up time (WARM UP) is different depending on the stability status of the sensor.
- If the detector is not used for a long period, warm-up time may be longer or a sensor abnormality (FAIL SENSOR) may be displayed. In such a case, restart the detector.
- The detector performs an air calibration automatically during start-up. If an environment where the detector is turned on is different from the atmosphere being measured, perform an air calibration again in the atmosphere being measured.

About LCD backlight

- Pressing the **AIR**, **MODE** or **POWER** button turns on the LCD backlight. The LCD backlight goes off after 30 seconds of no operation.
When an alarm is triggered, the LCD backlight lights up automatically.
-

4-5. Basic operating procedures

The detection mode is entered after power-on. Gas is detected in the ppm range.
 (Display example: For city gases)

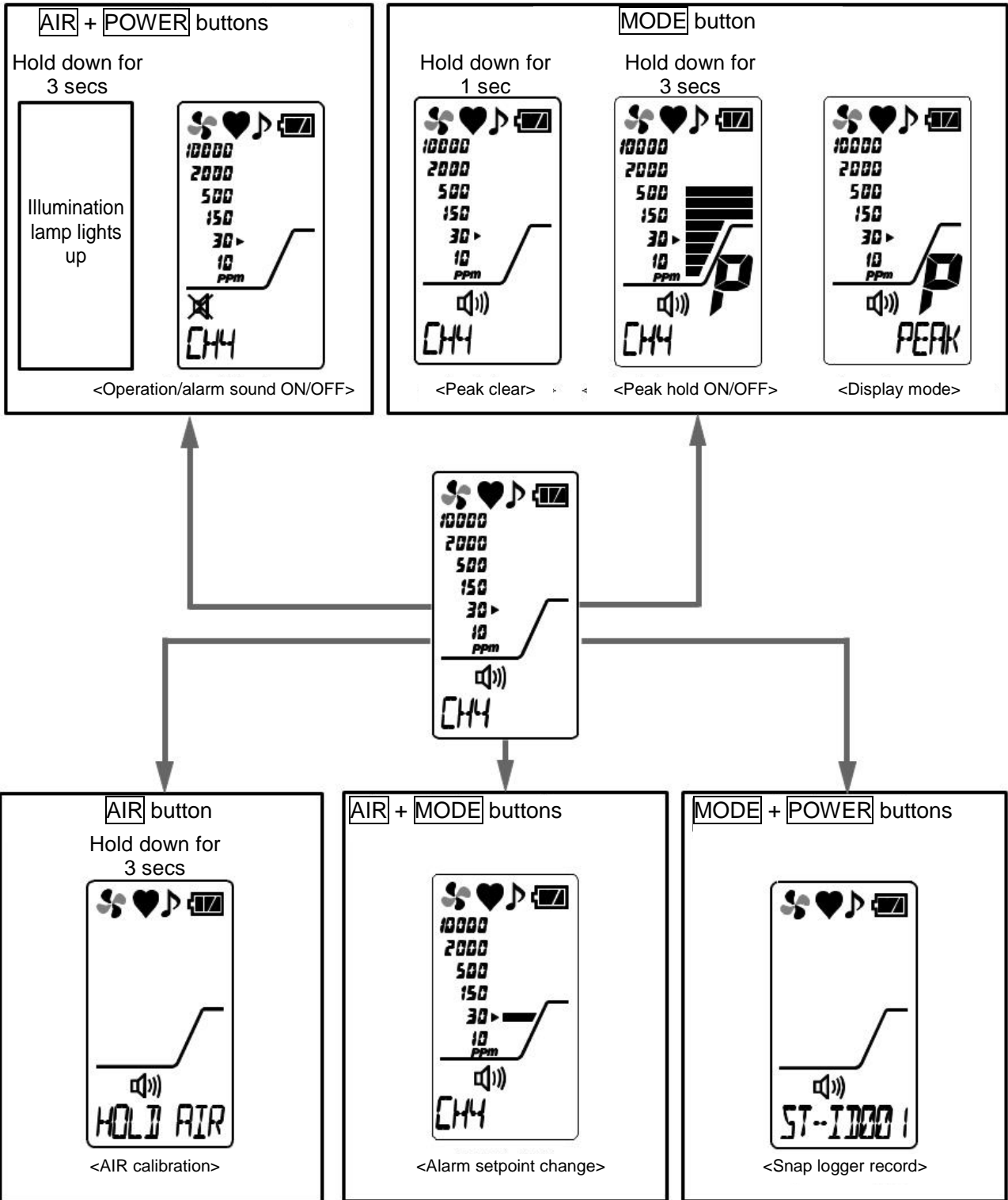

* Displayed only when the clock function is enabled. See "6-3. Clock function ON/OFF setting" on page 31.

4-6. How to detect

While the detector is operating in detection mode, put the tip of the taper nozzle close to the detection area and draw sample.

The detector measures gas in the ppm range. If a gas is drawn, the detected gas concentration is displayed with the bar meter on the LCD display.



DANGER

- While conducting measurement in a manhole or confined space, do not lean over or look into the manhole or closed space. It may lead to dangers because oxygen-deficient air or other gases may blow out.
- Oxygen-deficient air or other gases may be discharged from the gas exhausting outlet of the detector. Never inhale the air or gases.
- High-concentration (100% LEL or higher) combustible gases may be discharged from the gas exhausting outlet of the detector. Never use fire near it.



WARNING

- The detector is designed to draw gases around it under the atmospheric pressure. If excessive pressure is applied to the gas inlet and outlet of the detector, detected gases may leak out from its inside and may cause dangerous conditions. Be sure that excessive pressure is not applied to the detector while used.
- When performing an air calibration, verify that you are in a fresh air environment before starting. If interference gases or other gases exist, the adjustment cannot be performed properly, thus leading to dangers when the gas leaks.
- Issuance of a gas alarm indicates that there are extreme dangers. Take proper actions based on your judgment.
- Before use, check that there remains sufficient battery power. When the detector is not used for a long period, the batteries may be exhausted. Never fail to replace them with new ones before use.
- If a low battery alarm is triggered, gas detection cannot be conducted. If the alarm is triggered during use, turn off the power and promptly replace the batteries in a safe area.
- Do not block the buzzer sound opening. No alarm sound can be heard.
- If the main unit is dropped or given a shock, the reading may rise and it may remain so. In such a case, perform air calibration in a place where the surrounding air is fresh.



CAUTION

- Before performing gas detection, attach the taper nozzle provided with the detector to prevent disturbances by air dust.

4-7. Changing the alarm setpoint

The detector has 5 preset alarm setpoints that the user can cycle through (10 ppm, 30 ppm, 150 ppm, 500 ppm, and 2000 ppm). The alarm setpoint of city gas (CH₄) and LP gas (LPG) is factory set to 30 ppm.

How to change the alarm setpoint

- 1 In the detection mode, press the **AIR** and **MODE** buttons at the same time. The alarm setpoint is changed to the next pre-defined setpoint every time the **AIR** and **MODE** buttons are pressed. There are 5 setpoints total, all in the ppm range.

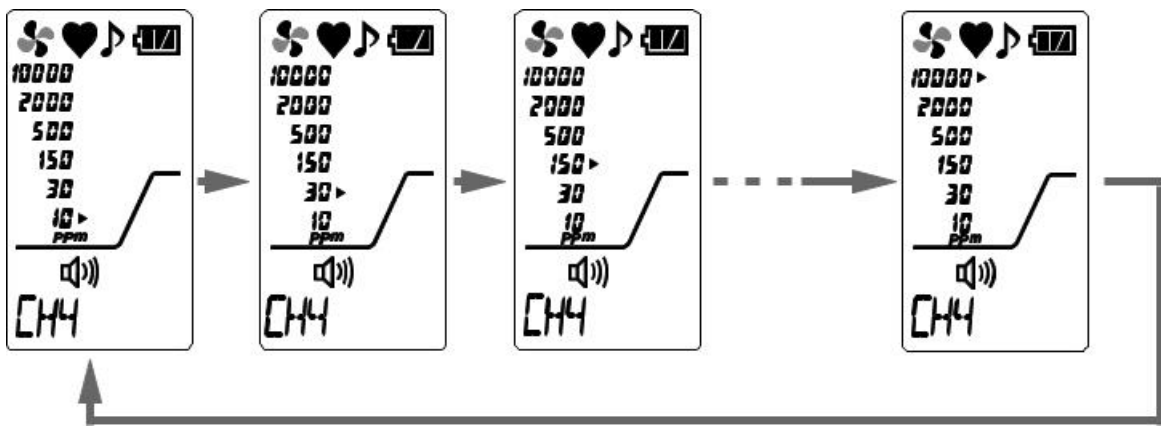

NOTE

- The alarm setpoint cannot be set to 10000 ppm.

4-8. Performing an air calibration

After a high-concentration gas is detected or an alarm is triggered by temperature/humidity changes, perform an air calibration in the measured atmosphere.

* Before performing an air calibration, verify a fresh air environment.

- 1 In the detection mode, hold down the AIR button.

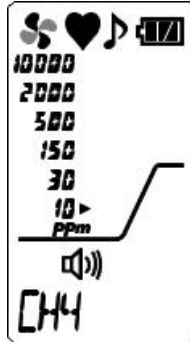

(Display for city gases)

- 2 Release the **AIR** button when the display changes from "HOLD AIR" to "RELEASE".

(Buzzer sound: Three times <blip, blip, blip>)

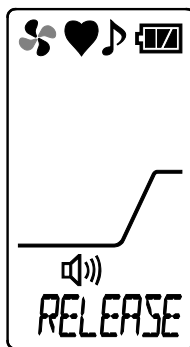
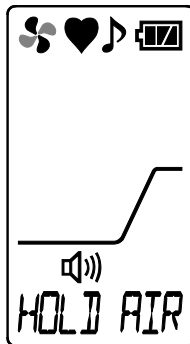

The air calibration is done and the detector returns to detection mode.
(Buzzer sound: Once <blip>)

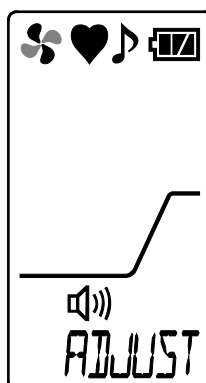

If the air calibration fails, "FAIL AIR CAL" is displayed. Perform an air calibration again in fresh surrounding air.

NOTE

- Perform an air calibration under pressure and temperature/humidity conditions close to those in the operating environment and in fresh air.
- Perform an air calibration after the reading is stabilized.
- If there is a sudden temperature change between the storage and operational locations, turn on the power of the detector, let it stand for five minutes or more in a similar environment to the operational location, and perform an air calibration in fresh air before using it.

4-9. Snap logger

Any peak value during measurement can be recorded.

Up to 256 points of data can be recorded. When the number of recorded data points reaches the maximum, recorded data will be overwritten, starting from the oldest data.

This function is enabled when the clock function is enabled. Since the clock function is disabled by default, enable it before using the snap logger function (See "6-3. Clock function ON/OFF setting" on page 31).

- 1 In the detection mode, press the **MODE** and **POWER** buttons at the same time. The detector enters the station ID selection screen.

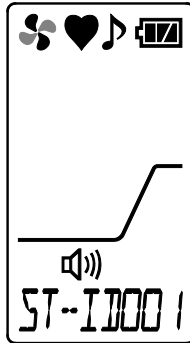

- 2 Use the **MODE** or **AIR** button to select the station ID and press the **POWER** button. The peak value is displayed.

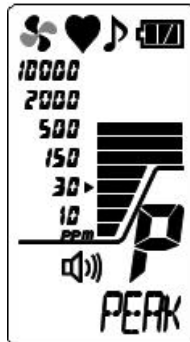

To stop recording, press the **AIR** and **MODE** buttons at the same time. The detector returns to the detection mode.

- 3 Press the **POWER** button. The date/time and peak value are recorded.

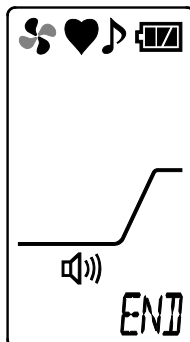

To continue recording the log, repeat steps 2 to 3. To stop recording the log, press the **AIR** and **MODE** buttons at the same time. The detector returns to the detection mode.

NOTE

- The recorded data can be read out by the "Data Logger Management Program" (optional). See the operating manual of "Data Logger Management Program" for more information.

4-10. Peak hold function

When the peak hold function is enabled, the latest peak value is always displayed with the bar meter. (Display example: For city gases)

- In the detection mode, hold down the **MODE** button (for three seconds or longer). The peak hold function is enabled. While the peak hold function is enabled, "P" is displayed on the LCD display.

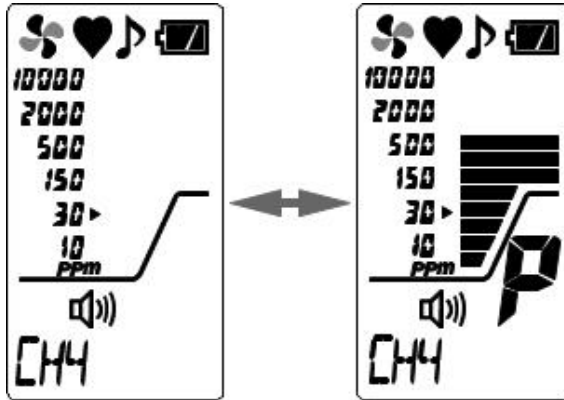

To disable the peak hold function, hold down the **MODE** button for three seconds or longer.

NOTE

- To clear a saved peak value, hold down the **MODE** button (for one second) in the detection mode.

4-11. Change of the alarm and operation sounds

Turn the alarm and operation sounds ON or OFF. (Display example: For city gases)

- In the detection mode, press the **AIR** and **POWER** buttons at the same time. The settings for the alarm and operation sounds are switched every time the **AIR** and **POWER** buttons are pressed.

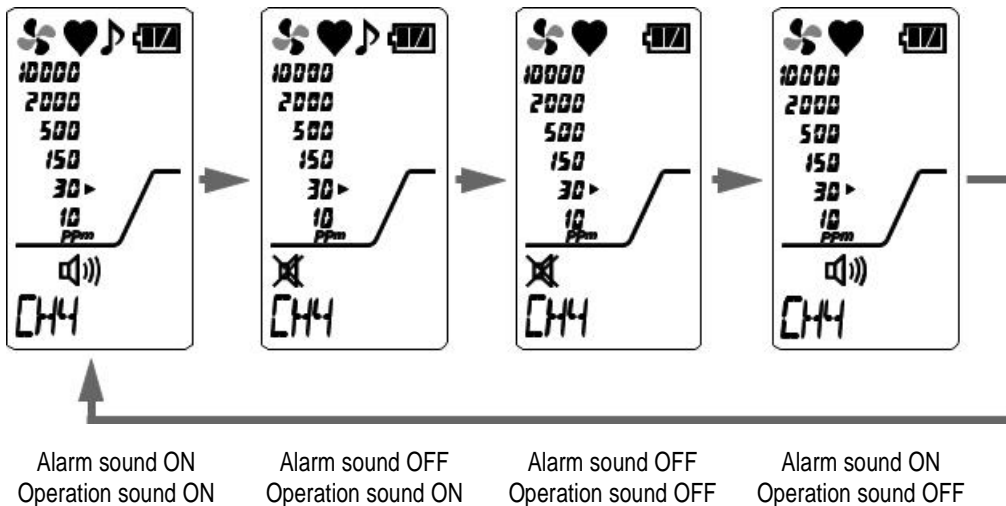

4-12. How to turn on the illumination lamp

The illumination lamp can be turned on, if necessary.

- 1 Hold down the **AIR** and **POWER** buttons at the same time (for three seconds or longer).

The illumination lamp lights up. The illumination lamp will automatically go off two minutes after it lights up.

To turn off the illumination lamp, hold down the **AIR** and **POWER** buttons at the same time (for three seconds or longer).

4-13. Power-off

Press and hold the **POWER** button (at least three seconds) until the buzzer blips three times ("TURN OFF" disappears) to turn off the power.



CAUTION

- If a gas remains in the detector, it enters the automatic exhaust mode (for a maximum of 30 seconds). The detector will be turned off after the automatic exhaust mode is complete. The mode counts down from automatic exhaust start (PURGE 30). The detector switches to the "TURN OFF" display when the gas exhaust is completed and is turned off.

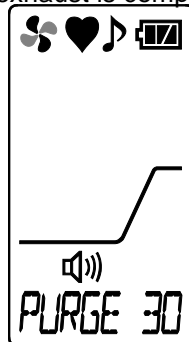

Automatic exhaust start (PURGE 30)

5. Display Mode

5-1. Entering the display mode

This mode allows users to view and change various display settings and perform other operation.
(Display example: For city gases)

- 1 In the detection mode, press the **MODE** button.
The detector enters the peak value display in the display mode.

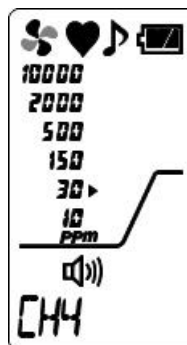

- 2 Next, press the **MODE** button to display the appropriate menu.
The setting screen for the display mode is switched every time the button is pressed. Holding down the button also switches the setting screen. When the detector returns to the detection mode, the setting screen stops being switched.

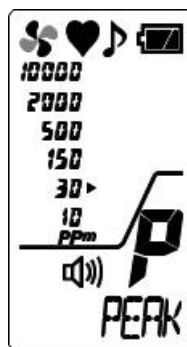

- 3 Select the setting item and press the **POWER** button.
For setting items, see "Display mode overview" on page 25.

NOTE

- The detector automatically returns to the detection mode in about 20 seconds if the detector is left unoperated.
 - Gas detection is continued in the display mode and an alarm can be activated.
-

Display mode overview

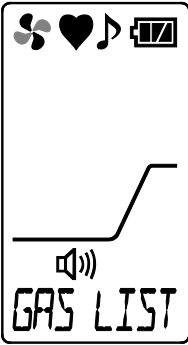
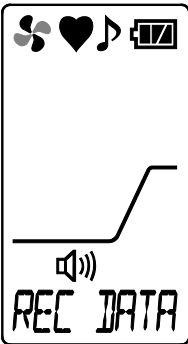
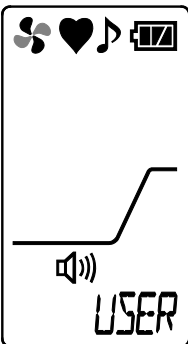
Item	LCD display	Details
Peak display		<p>Displays the maximum concentration detected during the period from power-on to the point of checking.</p> <p>* To clear the peak display, hold down the AIR button until "PEAK CLR" is displayed.</p>
Measured gas switching setting		<p>By changing the setting to the pre-registered gas in the detector, the converted concentration from the detection target gas will be displayed. (P. 26)</p>
Log data display		<p>Displays the data recorded by the snap logger. (P. 27)</p> <p>* Displayed only when the clock function is enabled See "6-3. Clock function ON/OFF setting" on page 31.</p>
Entering user mode		<p>Enters the user mode. (P. 28)</p>

5-2. Measured gas switching setting

Normally, the concentration display of the detector is "CH4 or LPG" by default depending on the specifications; however, the display can be switched between LPG and CH4 according to the specifications to detect its concentration.

(Display example: For city gases)

- 1 On the "GAS LIST" screen in the display mode, press the **POWER** button.
The detector enters the gas reading setting.

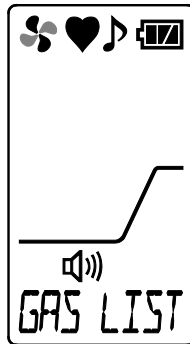

The currently set gas name is displayed.

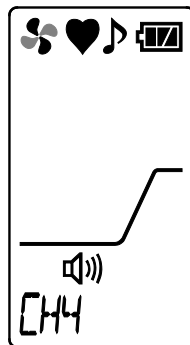

- 2 Press the **MODE** or **AIR** button to select a gas name to be read instead.
The gas name switches to another every time the button is pressed.

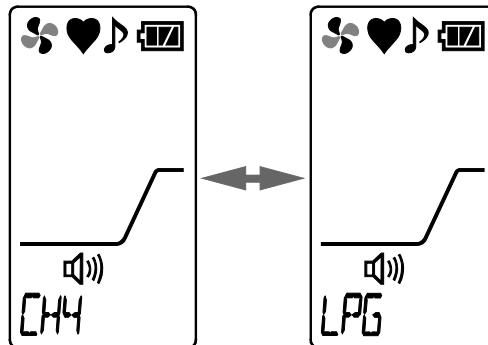

- 3 When the target gas name is displayed, press the **POWER** button.
"END" is displayed, returning to the display mode.

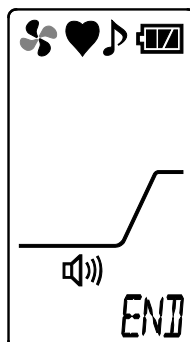

5-3. Log data display

The data recorded by the snap logger can be viewed.

The "REC DATA" screen is displayed only when the clock function is enabled (See "6-3. Clock function ON/OFF setting" on page 31).

(Display example: For city gases)

- On the "REC DATA" screen in the display mode, press the **POWER** button.
The detector enters the log data display.
The recorded date/time is displayed and the station ID and memory number are displayed alternately. If there is no recorded data, "NO DATA" is displayed.

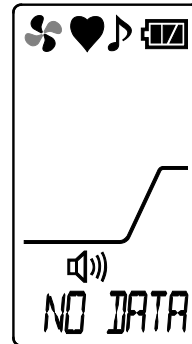
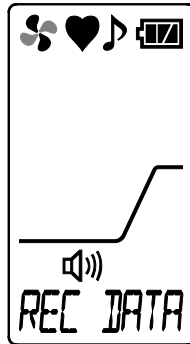

* When there is no recorded data

- Press the **MODE** or **AIR** button to select log data to be displayed.
The recorded content switches to the other every time the button is pressed.

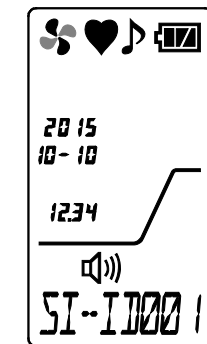

<Station ID>

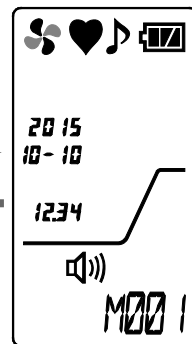

<Memory number>

- When the target log data is displayed, press the **POWER** button.

The gas name and peak value of the selected memory are displayed alternately.

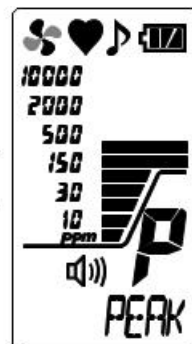
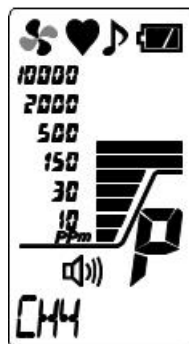

- To exit the display, press the **MODE** and **AIR** buttons at the same time.
The detector returns to the display mode.

6. User Mode

6-1. Entering the user mode

The maintenance including internal clock correction, etc. can be performed.
(Display example: For city gases)

- 1 In the detection mode, press the **MODE** button a few times to display "USER" and then press the **POWER** button.
The detector enters the date/time setting in the user mode.

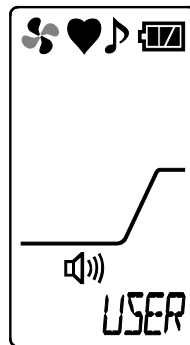

- 2 Next, press the **MODE** or **AIR** button to display the appropriate menu.
The setting screen for the user mode switches to another every time the button is pressed.

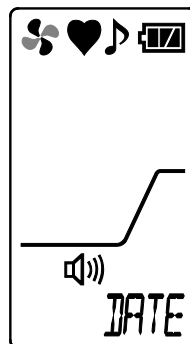

- 3 Select the setting item and press the **POWER** button.
For setting items, see "User mode overview" on page 29.



CAUTION

- Return to the detection mode after use.

User mode overview

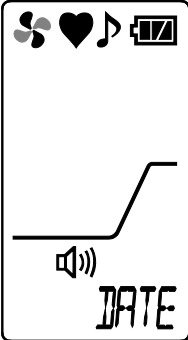
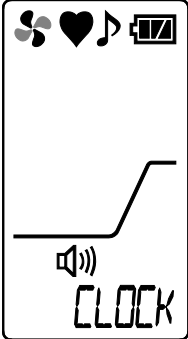
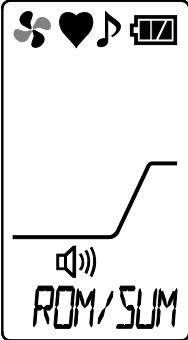
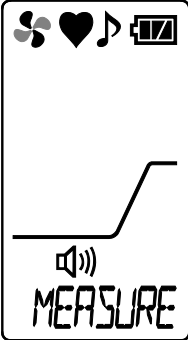
Item	LCD display	Details
Date/time setting		<p>Set the date/time of the internal clock. (P. 30)</p> <p>* When the clock function is disabled, the date/time setting screen is not displayed.</p>
Clock function ON/OFF setting		<p>Enable or disable the clock function.</p>
ROM/SUM display		<p>Displays the program number and SUM value of the detector.</p> <p>* This is not typically used by the user.</p>
Entering detection mode		<p>To exit the user mode, press the POWER button to enter the detection mode.</p>

6-2. Date/time setting

Set the date/time of the internal clock.

The date/time setting screen is displayed only when the clock function is enabled. Enable the clock function in "6-3. Clock function ON/OFF setting" on page 31 before setting the date/time.

- 1 On the "DATE" screen in the user mode, press the **POWER** button.
The detector enters the date/time setting.

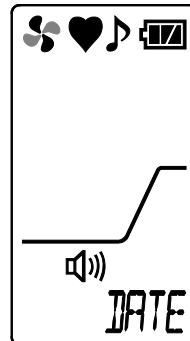

- 2 Use the **MODE** or **AIR** buttons to change the date/time and press the **POWER** button to confirm each change.

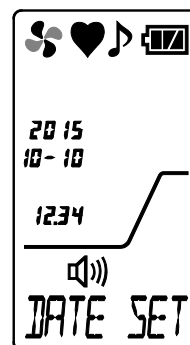

- 3 Set year -> month -> day -> hour -> minute in this order.

When the "minute" value is confirmed, "END" is displayed and then the detector returns to the user mode menu.

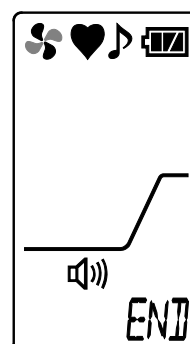

6-3. Clock function ON/OFF setting

Enable or disable the clock function.

The clock function is disabled by default. If the date/time needs to be displayed on start-up or the snap logger function is used, enable the clock function.

- 1 On the "CLOCK" screen in the user mode, press the **POWER** button.

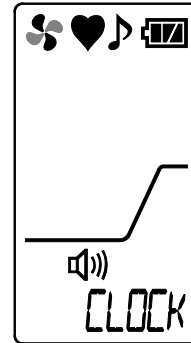

- 2 Use the **MODE** or **AIR** button to display the desired setting (ON/OFF) and press the **POWER** button to confirm it.

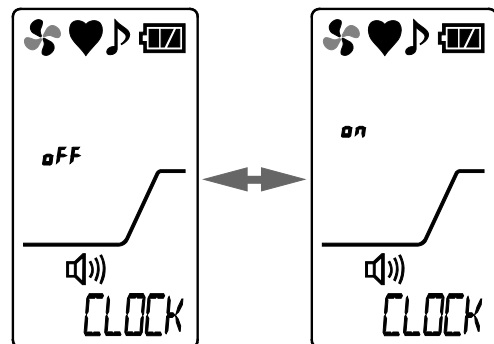

- 3 Setting completed

After the clock function ON/OFF setting is completed, "END" is displayed and then the detector returns to the user mode menu.

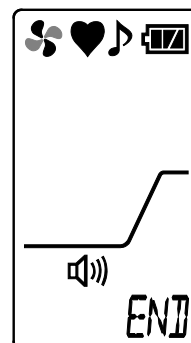

NOTE

- When the clock function is changed from OFF to ON, a clock abnormality (FAIL CLOCK) may be triggered if the date/time is inaccurate. When the failure condition is reset using the MODE button, the detector moves to the date/time setting screen. Set the date/time in accordance with "6-2. Date/time setting" on page 30.
- When the clock function is changed from OFF to ON for the first time, is powered on after leaving the detector for more than five minutes with the batteries removed, or is powered on with the batteries inserted with incorrect polarities, a clock abnormality (FAIL CLOCK) may be triggered.

7. Alarm Function

7-1. Gas alarm activation

When the concentration of detected gas reaches or exceeds the alarm setpoint values, a "gas alarm" is triggered in the detector. The alarm lamp blinks, the buzzer sounds, and the bar meter display indicates an alarm condition. (Auto-reset operation)

The blinking alarm lamp and buzzer sound operation for gas alarms have different intervals depending on the detected concentration.

7-2. Fault alarm activation

"Fault alarm" is triggered using a buzzer sound and blinking alarm lamp when an abnormality is detected in the detector. (Self-latching)

When an alarm is triggered, one of the following fault details is displayed on the LCD.

- | | | | |
|-----------------------------|-----------------|-----------------------|----------------|
| - System abnormalities | : FAIL SYSTEM | - Battery voltage low | : FAIL BATTERY |
| - Calibration abnormalities | : FAIL AIR CAL | - Clock abnormalities | : FAIL CLOCK |
| - Low flow rate | : FAIL LOW FLOW | - Pump abnormalities | : FAIL PUMP |
| - Sensor abnormalities | : FAIL SENSOR | | |

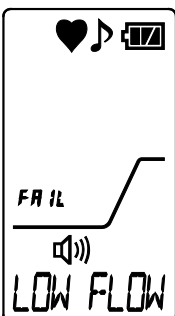
Alarm lamp	Repeatedly blinks at about one-second intervals.
Buzzer	Repeatedly sounds intermittent beeps at about one-second intervals. Blip-blip, blip-blip
LCD display	Display example of low flow rate (LOW FLOW) 

If a fault alarm is triggered, determine the cause and take appropriate action.

If the unit has problems and is repeatedly malfunctioning, contact RKI immediately.

- The recorded data can be read out by the "Data Logger Management Program" (optional). See the operating manual of "Data Logger Management Program" for more information.

8. Maintenance

The detector is a precision device.

To maintain the performance of the detector and improve the reliability of detecting leaks, perform regular maintenance.

8-1. Maintenance intervals and items

Perform the following maintenance regularly before use.

- Daily maintenance: Perform maintenance before each day's use.
- Monthly maintenance: Perform alarm test once a month.
- Regular maintenance: Perform maintenance once or more during a one year period to maintain the unit's performance.

Maintenance item	Maintenance content	Daily maintenance	Monthly maintenance	Regular maintenance
Battery level check	Check that the battery level is sufficient.	○	○	○
Concentration display check	Allow the detector to draw in fresh air and verify that the concentration display value is zero. If the reading is incorrect, perform a zero adjustment by air calibration after ensuring that no other gases exist.	○	○	○
Flow rate check	Check the flow check display to find abnormalities.	○	○	○
Filter check	Check the dust filter for dust or clogging.	○	○	○
Span adjustment	Check the gas alarm using a calibration gas.	-	-	○

About maintenance services

We provide services on regular maintenance including span adjustment, other adjustments and maintenance.

To make the calibration gas, dedicated tools, such as a gas cylinder of the specified concentration, gas sampling bag, etc., must be used.

Our qualified service engineers have expertise, knowledge and other information on the dedicated tools used for services, along with other products. To maintain the safety operation of the unit, please use our maintenance service.

The followings are typical maintenance services. For details, contact RKI.

<Main Services>

Item	Services
Battery level check	Checks the battery level.
Concentration display check	Verifies that the concentration display value is zero by using the zero gas. Performs the air calibration if the reading is incorrect.
Flow rate check	Checks the flow rate indicator to find abnormalities. Checks the flow rate by using an external flow meter to verify the accuracy of the flow rate indicator on the detector. If the flow rate is incorrect, adjusts the flow rate.
Filter check	Checks the dust filter for dust or clogging. Replaces a dirty or clogged dust filter.
Span adjustment	Performs span adjustment using a calibration gas.
Cleaning and repair of the unit (visual diagnosis)	Checks dust or damage on the surface of the unit, cleans and repairs such parts. Replaces parts which are cracked or damaged.
Unit operation check	Operates the buttons to check the operation of functions and parameters, etc.
Replacement of consumable parts	Replaces consumable parts, such as a sensor, filter, pump, etc.

8-2. How to clean

Clean the detector if it becomes extremely dirty. The detector must be turned off while cleaning it. Use a wash cloth or the like to remove dust. Do not use water or organic solvent for cleaning because they may cause malfunctions.

Because an extremely contaminated inside of the taper nozzle may disturb the gas detection, it must be cleaned with dry air, etc.



CAUTION

- When cleaning the detector, do not splash water over it or use organic solvents such as alcohol, benzene, etc. on it. Doing so may cause discoloration or damage to the surface of the detector or a sensor failure.

NOTE

- When the detector gets wet, water may remain in the buzzer sound opening or grooves. Drain water as follows:
 - (1) Wipe away moisture on the detector thoroughly using a dry towel, cloth, etc.
 - (2) While holding the detector firmly, shake it about ten times with the buzzer sound opening facing downward.
 - (3) Wipe away moisture coming out from the inside thoroughly using a towel, cloth, etc.
 - (4) Place the detector on a dry towel, cloth, etc. and let it stand at normal temperatures.

8-3. Parts replacement

Hydrophobic filter replacement procedure

Continuing to use the detector may cause the hydrophobic filter to be contaminated or clogged. Replace the hydrophobic filter if it becomes extremely dirty.

Also, replace the hydrophobic filter when it has absorbed water or if a low flow rate is noticed.

- 1 Turn the cap counterclockwise and remove it.



- 2 Remove the rubber seal from the cap. The hydrophobic filter is installed in the rubber seal.



- 3 Replace the hydrophobic filter with a new one. Make sure it's seated in the rubber seal correctly.



- 4 Attach the rubber seal, with the hydrophobic filter installed, to the cap. Make sure the rubber seal's rib has been firmly inserted into the cap's groove.

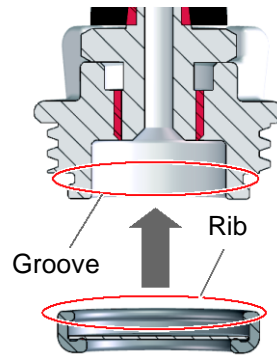

- 5 Attach the cap, with the rubber seal attached, to the main unit.

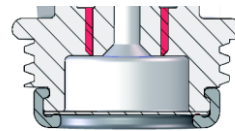

Interference gas removal filter (CF-8392) replacement procedure

The interference gas removal filter (CF-8392) is installed to the detector to remove interference gases that damage sensors such as silicone, sulfides, etc.

Continuing to use the detector may cause the filter to be contaminated or clogged. Replace the filter when it has absorbed water or oil, etc. or if a low flow rate is noticed, or when the sensor sensitivity deteriorates significantly.

Install the filter by sliding the grooves on its sides to the guide of the case.

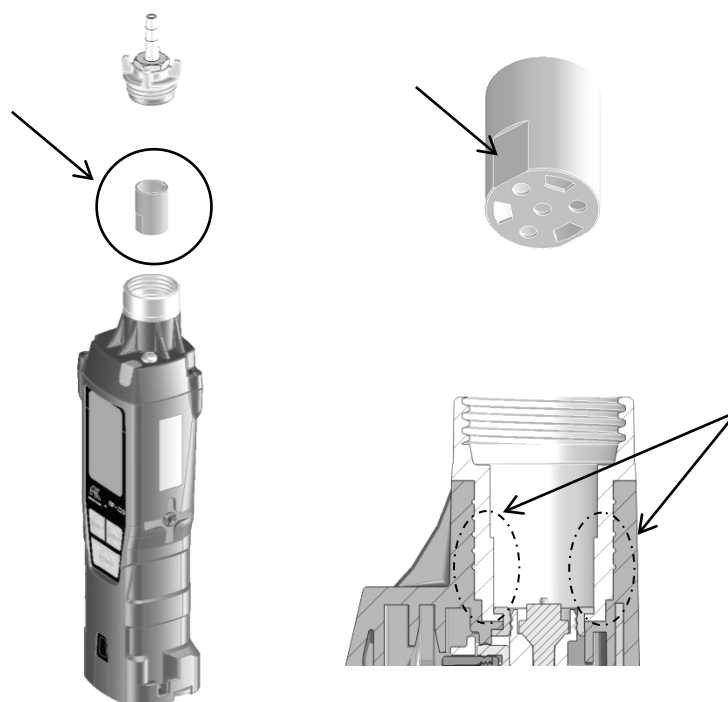

Sensor replacement

The sensor comes with a 1-year warranty. It has a typical life of 2-3 years, depending on the operating environment. The sensor life has expired if, for example, the reading fluctuates or does not come back after a response test. Contact RKI for sensor replacement.

Battery replacement

For battery replacement, see "How to replace the batteries" on page 13.

9. Calibration Mode

This section describes how to perform a fresh air adjustment, an automatic span adjustment, and a manual span adjustment on the SP-220. It also describes how to turn on the Calibration Mode password function.

9-1. Fresh Air Adjustment

RKI Instruments, Inc. recommends that the fresh air adjustment be performed in a fresh air area (area known to be free of toxic and combustible gases and of normal oxygen content, 20.9%). If a fresh air environment is not available, a cylinder of zero air can be used as long as the gas is applied through a humidifier tube. Calibration kits for the SP-220 do not normally include zero air or a humidifier tube.

- 1 Be sure the SP-220 has been running in Detection Mode for at least 10 minutes before continuing.
- 2 With the instrument running in Detection Mode, press and hold the **AIR** and **MODE** buttons for 3 seconds.
- 3 If the Calibration Mode password parameter has been set to on (factory setting is off), you will be prompted for a password.

Use the **AIR** and **MODE** buttons to adjust each character and press the **POWER** button to move to the next character.

- 4 The AIR CAL menu item will be displayed.



- 5 Press and release the **POWER** button.

- 6 Make sure you are in a fresh air area (area known to be free of toxic and combustible gases and of normal oxygen content, 20.9%).

- 7 Press and hold the **AIR** button. Release the **AIR** button when the screen says "RELEASE".

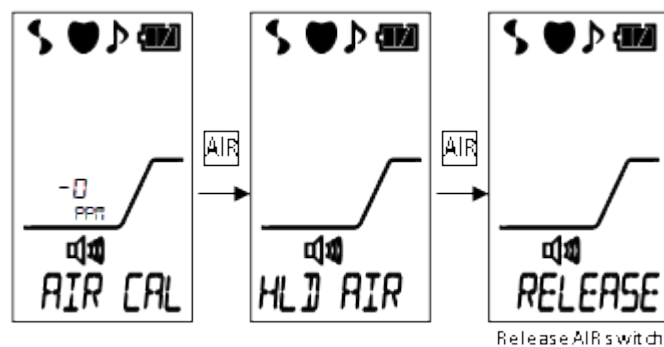

- 8 The instrument will perform a fresh air adjustment and will return to the AIR CAL menu item.

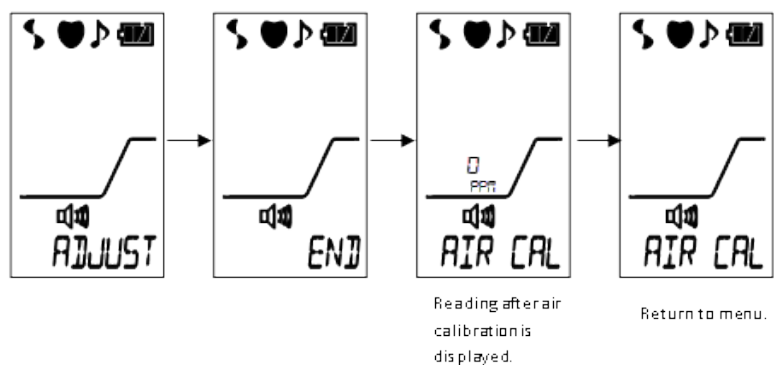

- 9 See the following sections for span adjustment descriptions.

To return to Detection Mode without performing a span adjustment, scroll to the MEASURE menu item and press and release the **POWER** button.

To turn the instrument off, press and hold the **POWER**.

9-2. Preparing for a Span Adjustment (Gas Bag)

This section describes how to prepare for calibration if you are using a calibration kit that includes:

- Gas bag with a tubing clamp
 - Fixed flow regulator
 - Calibration cylinder (methane for Type M, propane for Type L)
1. Empty the gas bag.
 2. Connect the bag's tubing to the fixed flow regulator's hose barb fitting.
 3. Screw the fixed flow regulator onto the calibration cylinder.
 4. If your regulator has a knob, turn the knob counterclockwise to start the flow of gas into the gas bag.
 5. Allow the gas to dispense until the gas bag is a little over half full.
 6. If your regulator has a knob, turn the knob clockwise to stop the flow of gas.
 7. Clamp the gas bag tubing shut.
 8. Remove the tubing from the fixed flow regulator's hose barb fitting.
 9. Remove the fixed flow regulator from the calibration cylinder.

9-3. Preparing for a Span Adjustment (Demand Flow Regulator)

This section describes how to prepare for calibration if you are using a calibration kit that includes:

- Demand flow regulator
 - Calibration tubing
 - Calibration cylinder (methane for Type M, propane for Type L)
1. Screw the demand flow regulator onto the calibration cylinder.
 2. Connect the tubing to the demand flow regulator's hose barb fitting.

9-4. Automatic Span Adjustment

These instructions describe an automatic calibration of the SP-220. Be sure you have performed a fresh air adjustment and prepared for calibration as described in the previous sections before continuing. The screens in this section show a Type M instrument. If you have a Type L, your screens will appear slightly different.

- 1 If you have just performed a fresh air adjustment and the instrument is still running in Calibration Mode, continue to step 5.

If your instrument is not currently running in Calibration Mode, continue to step 2.

- 2 With the instrument running in Detection Mode, press and hold the **AIR** and **MODE** buttons for 3 seconds.
- 3 If the Calibration Mode password parameter has been set to on (factory setting is off), you will be prompted for a password.

Use the **AIR** and **MODE** buttons to adjust each character and press the **POWER** button to move to the next character.

- 4 The AIR CAL menu item will be displayed.



- 5 Use the **AIR** or **MODE** button to scroll to the AUTO CAL menu item.



- 6 Press and release the **POWER** button. The auto cal value will be displayed.

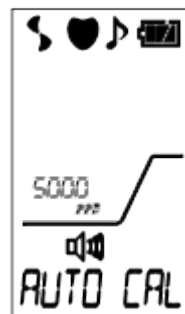

- 7 To adjust the auto cal value:
 - a. Press and hold the **MODE** button then press and hold the **POWER** button. The auto cal value will begin to flash.
 - b. Use the **AIR** and **MODE** buttons to adjust the value.
 - c. Press the **POWER** button to confirm the change.

- 8 Press and release the **POWER** button. The gas reading will begin to flash.
- 9 Apply calibration gas for 1 minute.
Depending on your calibration kit, you will need to either:
 - a. Connect the gas bag tubing to the instrument's inlet or
 - b. Connect the tubing from the demand flow regulator to the instrument's inlet.

- 10 Press and release the **POWER** button. The instrument will perform a gas adjustment and will return to the AUTO CAL menu item.

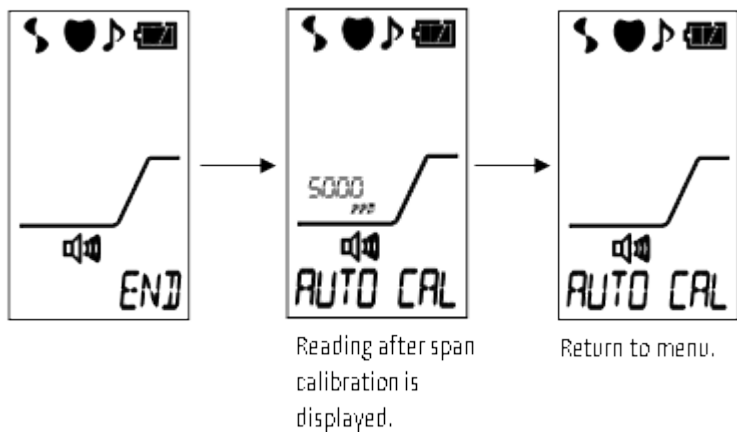

- 11 Disconnect the calibration gas source from the instrument's inlet fitting.
- 12 To enter Detection Mode, scroll to the MEASURE menu item and press and release the **POWER** button.

To turn off the instrument, press and hold the **POWER** button.

9-5. Manual Span Adjustment

These instructions describe a manual calibration of the SP-220. Be sure you have performed a fresh air adjustment and prepared for calibration as described in the previous sections before continuing.

- 1 If you have just performed a fresh air adjustment and the instrument is still running in Calibration Mode, continue to step 5.

If your instrument is not currently running in Calibration Mode, continue to step 2.

- 2 With the instrument running in Detection Mode, press and hold the **AIR** and **MODE** buttons for 3 seconds.

- 3 If the Calibration Mode password parameter has been set to on (factory setting is off), you will be prompted for a password.

Use the **AIR** and **MODE** buttons to adjust each character and press the **POWER** button to move to the next character.

- 4 The AIR CAL menu item will be displayed.



- 5 Use the **AIR** or **MODE** button to scroll to the MANU_CAL menu item.



- 6 Press and release the **POWER** button. The gas reading will begin to flash.



- 7 Apply calibration gas for 1 minute.
Depending on your calibration kit, you will need to either:
- a. Connect the gas bag tubing to the instrument's inlet or
 - b. Connect the tubing from the demand flow regulator to the instrument's inlet.

- 8 Use the **AIR** and **MODE** buttons to adjust the gas reading to match the value listed on the calibration cylinder.

- 9 Press and release the **POWER** button. The instrument will perform a gas adjustment and will return to the MANU_CAL menu item.

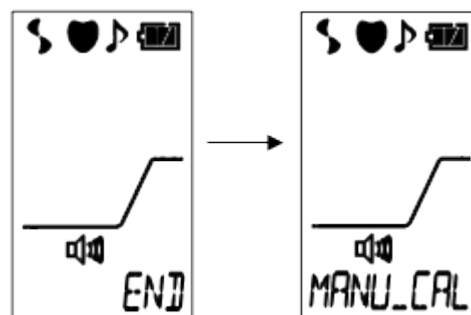

- 10 Disconnect the calibration gas source from the instrument's inlet fitting.

- 11 To enter Detection Mode, scroll to the MEASURE menu item and press and release the **POWER** button.

To turn off the instrument, press and hold the **POWER** button.

9-6. Password

These instructions describe how to turn the Calibration Mode password on or off and how to set the password.

- 1 If your instrument is still running in Calibration Mode, continue to step 4.

If your instrument is not currently running in Calibration Mode, continue to step 2.

- 2 With the instrument running in Detection Mode, press and hold the **AIR** and **MODE** buttons for 3 seconds.

- 3 The AIR CAL menu item will be displayed.



- 4 Use the **AIR** or **MODE** button to scroll to the **PASSWORD** menu item.
- 5 Press and release the **POWER** button. The current setting will be displayed.
- 6 Use the **AIR** or **MODE** button to adjust the on/off setting. If the password is set to on, a user-defined password will be required to enter Calibration Mode.
- 7 Press and release the **POWER** button.

If you set the password function to off, continue to step 9.

If you set the password function to on, continue to step 8.

- 8 Use the **AIR** or **MODE** button to adjust the first number in the desired password.

Press and release the **POWER** button to move on to the next character and then save the password.

- 9 To enter Detection Mode, scroll to the MEASURE menu item and press and release the **POWER** button.

To turn off the instrument, press and hold the **POWER** button.

10. Storage and Disposal

10-1. Procedures to store the detector or leave it for a long time

The detector must be stored under the following environmental conditions.

- In a dark place under the normal temperature and humidity away from direct sunlight
- In a place where gases, solvents, vapors, etc. are not present

Store the detector in a shipping carton, if any, in which the product was delivered.
Store the detector away from dust, etc. if the shipping carton is not available.



CAUTION

- If the detector is not used for a long time, store it after removing the batteries. Leaks from dry batteries may result in fire or injury.
- The detector, when not used for a long time, may cease to work because of hardening of the grease in the pump motor.

10-2. Procedures to use the detector again



CAUTION

- When the detector is used again after a long-period storage, perform a calibration.
- Contact RKI for information on readjustment including calibration.

10-3. Disposal of products

When the detector is disposed of, it must be treated properly as an industrial waste in accordance with the local regulations, etc.



WARNING

- Dispose of dry batteries in accordance with procedure specified by the local authority.

<Disposal in EU Member States>

When disposing of the detector in EU member states, sort the batteries as specified. Handle the removed batteries according to the classified refuse collection system and recycling system based on the regulations of EU member states.

Removing batteries

For battery removal, see "4-3. How to replace the batteries" on page 13.

NOTE

Crossed-out recycle dustbin mark

This symbol mark is indicated on the products which contain the batteries which fall under EU Battery Directive 2006/66/EC. Such batteries need to be disposed of as specified by the latest Directive. This symbol mark indicates that the batteries need to be separated from the ordinary waste and disposed of appropriately.



11.

Troubleshooting

This Troubleshooting section does not explain the causes of all the malfunctions which occur on the detector. This simply helps to find the causes of malfunctions which may frequently occur. If the detector shows a symptom which is not explained in this manual, or still has malfunctions even though remedial actions are taken, please contact RKI.

<Abnormalities on Unit>

Symptoms	Causes	Actions
The power cannot be turned on.	The battery level is too low.	Replace both of the two batteries with new ones.
	The POWER button was released quickly.	For power-on, keep the POWER button pressed until a blip is heard.
	Dry batteries are not installed properly.	Check that the batteries are properly installed to the main unit.
Abnormal operations	Disturbances by sudden static electricity noise, etc.	Turn off the power once and then turn it on again (restart).
Cannot operate the detector.	Disturbances by sudden static electricity noise, etc.	Remove the batteries in a safe place. Then reinstall them and turn on the power to perform operations.
System abnormalities FAIL SYSTEM	A circuit abnormality occurred.	Contact RKI for repair.
Sensor abnormalities FAIL SENSOR	A sensor has failed.	Remove the batteries in fresh air. Then reinstall them and turn on the power to perform operations. Restart the detector a few times. If the problem still persists, contact RKI to replace the sensor.
A low battery voltage alarm is displayed. FAIL BATTERY	The battery level is low.	Turn off the power and replace the dry batteries with new ones in a safe area.
A low flow rate alarm is displayed. FAIL LOW FLOW	Water, oil or the like is drawn.	Check the taper nozzle for any damage or mark of drawn water, oil, etc.
	The taper nozzle is clogged.	Check the taper nozzle for connection condition, clogging, torsion, etc.
	The detector was powered on at a low temperature or has not been used for a long time.	Cycle the power a few times. The pump may start operating. If the problem still persists, contact RKI to replace the pump.
	The pump has deteriorated.	Contact RKI to replace the pump.
Air calibration	Fresh air is not supplied	Supply fresh air and then perform air

Symptoms	Causes	Actions
impossible FAIL AIR CAL	around the detector.	calibration in the measured atmosphere.
Clock abnormalities FAIL CLOCK	Abnormalities of the internal clock	Set the date/time. If such a symptom is observed repeatedly, the built-in clock is seemingly malfunctioning. Thus, it must be replaced. Contact RKI for repair.
Pump abnormalities FAIL PUMP	Abnormalities of the pump	Contact RKI for repair.

12. Spare Parts List

Part Number	Description
06-1248RK-03	Calibration tubing, 3 feet
81-0003RK-01	Calibration cylinder, 5250 ppm propane in air, 34 liter steel (for Type L units)
81-0010RK-01	Calibration cylinder, 5000 ppm methane in air, 34 liter steel (for Type M units)
81-1001RK	Dispensing valve, without knob, for 17 liter and 34 liter steel cylinders (cylinders with external threads)
81-1054RK	Regulator, demand flow, 0.5 LPM with gauge and knob, for 34 liter aluminum, 58 liter, and 103 liter cylinders (cylinders with internal threads)
81-1055RK	Regulator, demand flow, 0.5 LPM with gauge and knob, for 17 liter and 34 liter steel cylinders (cylinders with external threads)
81-1126RK	Gas bag with tubing and clamp
81-SP220L-DLV	Calibration kit: 34 liter steel cylinder of 5250 ppm propane in air, demand flow regulator, calibration tubing (for Type L units)
81-SP220L-LV	Calibration kit: 34 liter steel cylinder of 5250 ppm propane in air, dispensing valve, gas bag (for Type L units)
81-SP220M-DLV	Calibration kit: 34 liter steel cylinder of 5000 ppm methane in air, demand flow regulator, calibration tubing (for Type M units)
81-SP220M-LV	Calibration kit: 34 liter steel cylinder of 5000 ppm methane in air, dispensing valve, gas bag (for Type M units)

13. Product Specifications

Model	SP-220 (TYPE M)	SP-220 (TYPE L)
Detection principle	Hot-wire semiconductor	
Gas to be detected	Methane (Switchable to LPG)	LPG (Switchable to methane)
Calibration gas	Methane (CH ₄) calibration	Propane (C ₃ H ₈) calibration
Concentration display	LCD bar meter + grid	
Detection range	10 - 10000 ppm	
Detection method	Pump suction type	
Alarm setpoint value	Default: 30 ppm (set one of five levels: 10, 30, 150, 500 and 2000 ppm)	
Displays	Operating state display, flow check display, alarm sound display, operation sound display, battery level display, bar meter display, mode display, gas name and message display	
Response time (under the same conditions)	3 seconds or less	
Gas alarm type	One-step alarm	
Gas alarm display	Lamp blinking/buzzer sounding	
Gas alarm pattern	Non latching (auto-reset)	
Fault alarm	Sensor abnormality/low flow rate/battery voltage low/system abnormality/calibration abnormality/clock abnormality/pump abnormality	
Fault alarm display	Lamp blinking/buzzer sounding/fault detail display	
Fault alarm pattern	Self-latching	
Power supply	AA alkaline battery x 2	
Continuous operating time	Approx. 13 hours (alkaline batteries, at 20°C, without alarms or lighting)	
Operating temperature range	-20 - +55°C	
Operating humidity range	95% RH or less (Non-condensing)	
Explosion-proof structure	Intrinsically safe explosion-proof structure	
Explosion-proof class	ExiaIICT4(TIIS)/II1GExiaIICT4Ga(Presafe/ATEX)(IECEX)	
Protection class	Equivalent to IP-55	
External dimensions	Approx. 43 (W) x 200 (H) x 39 (D) mm (projection portions excluded)	
Weight	Approx. 215 g (without batteries)	

* The gas concentration is only approximate because the detector is designed to be used to detect a small amount of gas leakage.

14. Appendix

14-1. Definition of terms

vol%	Gas concentration indicated in the unit of one-hundredth of the volume
ppm	Gas concentration indicated in the unit of one-millionth of the volume
LEL	The acronym of Lower Explosive Limit. Lower explosive limit (LEL) refers to the lowest concentration of a combustible gas in air capable of causing explosion when ignited.

Declaration of Conformity

We, **RIKEN KEIKI CO., LTD.**

**2-7-6, Azusawa, Itabashi-ku,
Tokyo 174-8744 Japan**

declare in our sole responsibility that the following product conforms to all the relevant provisions.

Product Name: Portable Toxic Gas Monitor
Model Name: SP-220
Council Directives: EMC: 2004/108/EC(Until 19 April 2016)
2014/30/EU(From 20 April 2016)
ATEX : 94/9/EC(Until 19 April 2016)
2014/34/EU(From 20 April 2016)
RoHS : 2011/65/EU
Applicable Standards: EMC : EN 50270(2015)
ATEX : EN 60079-0(2012):A11(2013)
EN 60079-11(2012)
EN 60079-26(2007)

RoHS : EN 50581(2012)

Name and address of the ATEX Notified Body : DNV Nemko Presafe AS
Gaustadalleen 30,0373 Oslo,Norway

Number of the EC type examination certificate : Presafe 15 ATEX 7188
Oct 26, 2015

Name and address of the ATEX Auditing Organization : Baseefa Ltd.
Rockhead Business
Park, staden Lane,
Buxton, Derbyshire, SK17 9RZ

The Marking of the equipment or protective system shall include the following : II 1G Ex ia II C T4 Ga

Year to begin affixing CE Marking: 2016

Place: Tokyo, Japan

Signature: 
Full Name: Tetsuya Kawabe

Date: Mar 31, 2016

Title: Director, Quality control center