

# ProCon® — R7 Series with NEXUS® ORP Sensor Transmitter Operating Manual

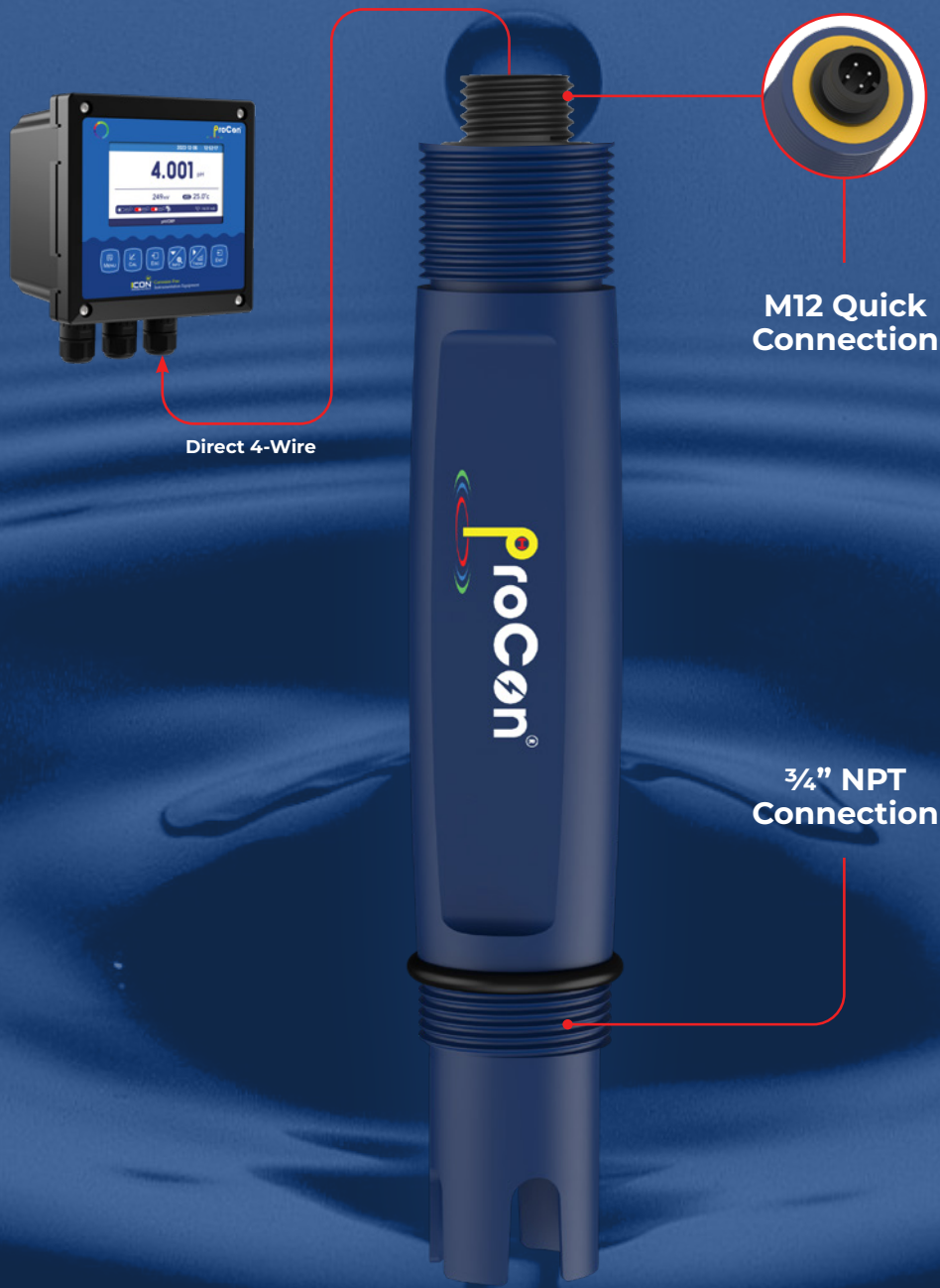

Direct 4-Wire

M12 Quick  
Connection

3/4" NPT  
Connection



**R7C**  
Gold Electrode



**R7G**  
Platinum Electrode



Industrial  
Analytical  
Equipment



### Preface

Please read this manual carefully before use.

Only properly skilled authorized personnel should carry out installation, setup and operation. Ensure that the power cable is physically separated from the power supply during the initial wiring connection or repair.

For example,

1. Apparent damage to the sensor
2. The sensor does not work properly or provides specified measurements
3. The sensor has been stored for a long time in an environment where the temperature exceeds 70°C

### Safety Information



- De-pressurize and vent system prior to installation or removal
- Confirm chemical compatibility before use
- **DO NOT** exceed maximum temperature or pressure specifications
- **DO NOT** alter product construction
- **ALWAYS** wear safety goggles or face-shield during installation and/or service

### Preparation before measurement



Important

**Be sure to calibrate your sensor prior to use.**

**Please refer to the operating instructions of your ProCon® Controller for calibration details.**

Connect the wires from the sensor to the appropriate ProCon® controller. All ProCon® pH sensors come with an internal PT1000 temperature electrode. Refer to sensor wiring diagram of controller.

Prepare electrode maintenance before measurement. When using the electrode, the protective bottle at the top shall be screwed off and placed at a place where it is not easy to touch. Then, the protective bottle cap shall be removed and the electrode bulb and liquid interface shall be immersed in the measured liquid.

### ORP Sensor Calibration SimpCal®

1. Use a standard buffer reference solution with known ORP value. (always use a fresh buffer solution)
2. Unscrew the sensor protection cap and wash the sensing electrode with distilled water. Carefully wipe any excess water with a soft paper towel and gently wipe the gold/platinum sheet to keep it clean.
3. Select the calibration mode in the controller (See manual for ProCon® SimpCal® for step by step simple instruction)
4. Insert the sensor into the first reference solution ensure the sensor tip is covered.
5. Stir
6. Wait for the reading to stabilize (60 seconds)
7. Press the Enter button on the ProCon® Controller
8. Wait until the DONE is display on screen
9. Once the sensor has been calibrated rinse with distilled water. Carefully wipe any excess water with a soft paper towel and gently wipe the gold/platinum sheet to keep it clean.

In order to ensure a fast response time, the electrode glass should always be kept wet. After the calibration is completed and the electrode is properly cleaned, store the sensor in a 3mol KCl Potassium Chloride solution.

**NOTE:** After use it is important to inspect the sensor to ensure there are no deposits and the gold/platinum is clean. If needed the sensor can be washed with a dilute HCL acid wash.

It is not recommended to store the sensor in distilled , or deionized water.



#### Warning | Caution | Danger

Indicates a potential hazard. Failure to follow all warnings may lead to equipment damage, injury, or death.



#### Note | Technical Notes

Highlights additional information or detailed procedure.



#### Hand Tighten Only

Over tightening may permanently damage product threads and lead to failure of the retaining nut.



#### Do Not Use Tools

Use of tool(s) may damage produced beyond repair and potentially void product warranty.



#### Personal Protective Equipment (PPE)

Always utilize the most appropriate PPE during installation and service of Truflo products.



## High performance industrial pH sensor for harsh applications

The ProCon® P14 series offers the ultimate combination of durability, functionality and long-term performance; exactly what is required for industry's most complex applications. The Nexus® reference eliminates reference poisoning. The sensors are available in flat planar or bulb style design.

All measurement functions are combined in one compact body — measuring electrode, temperature sensor and an inner reference chamber. The 2-wire 4-20mA, 4-wire or 4-20mA + RS485 output options simplify calibration and communication with remote displays and controllers..

- ✓ M12 Quick Connection
- ✓ 4-20mA Output
- ✓ Temperature Compensated
- ✓ Nexus® Solid KCl Reference
- ✓ PP or PPS Body Materials
- ✓ RS 485 Modbus Communication
- ✓ No Preamp Required
- ✓ 3/4" NPT Connection

**NO PREEMPT THE PREAMP NO**

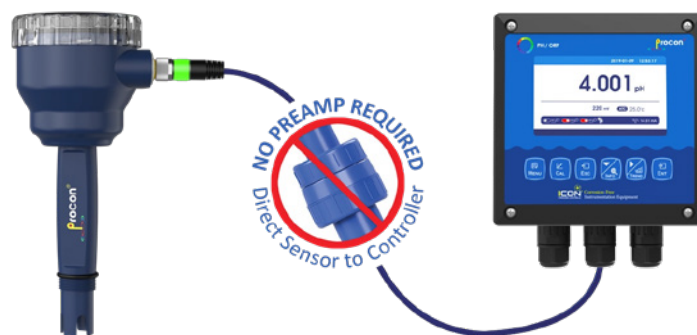

Enhanced chip technology allows for remote calibration as well as diagnostic data

Digital output — longer distances without compromising accuracy.

### Nexus® technology

- Solid KCl infused reference junction
- Eliminates reference poisoning/leaching
- Extended life expectancy

**Integral Preamp**  
2-wire 4-20mA, RS485  
direct sensor to controller  
connection (no preamp)

**NEXUS®**

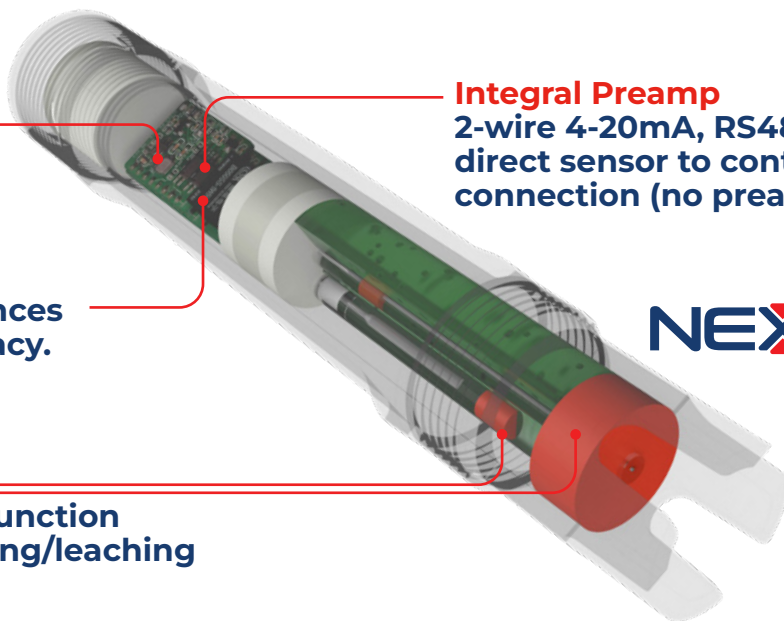

## 2 Durable Sensors Designed for the Toughest ORP Environments



**R7C**  
Gold Electrode



**R7G**  
Platinum Electrode



### Smart Sensor Technology

Advanced electronic circuitry stores ORP data for automatic sensor recognition and trouble-free calibration when connected to the ProCon® Controller.

### Outputs

1. 4-20mA 2-Wire
2. 4-20mA + RS485

Both the measuring and reference electrodes are encapsulated within the non-porous advanced KCL infused polymer known as Nexus®.

### Less Calibration and Maintenance

Most sensors require on-going recalibration and are prone to premature failure due to what is known as gradient drift, or sensor drift.

The Nexus® series is a solid reference material. Poisoning or leaching of the reference electrolyte that occurs in standard sensor is greatly reduced.

The Nexus reference helps to eliminate the need for ongoing maintenance or cleaning requirement due to fouling or film build up removal which occurs with many process applications with traditional pH sensors.

### Faster Response-Longer Lasting

The solid Nexus® reference provides for faster response time to changing ORP values since there is no requirement for a junction.

- ✓ Double junction reference extends sensor life and protects against poisoning ions
- ✓ Durable gold/platinum electrode enhances performance and increased reliability
- ✓ Operates in sub-zero temperatures down to 14°F (-10°C)
- ✓ Advanced electronic diagnostics provides excellent repeatability and reliability

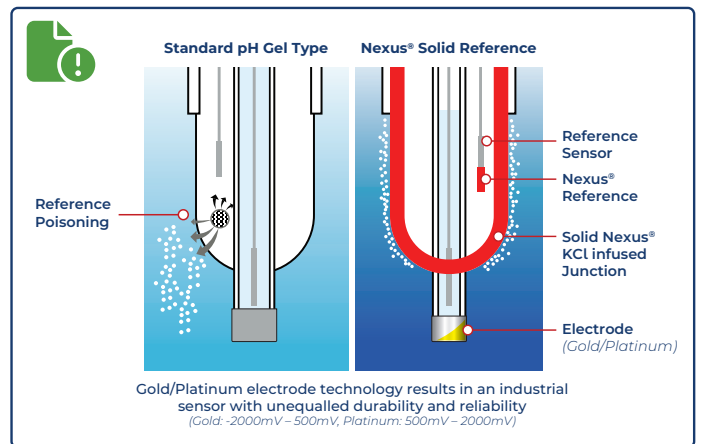

Direct D500 Controller with SimpliCal® Auto Calibration



Direct 4-Wire

### Typical Uses

#### R7C (Gold)

- Highly Acidic
- Reducing Environments (Cyanide)
- Below 500mV

#### R7G (Platinum)

- High Oxidation
- Chlorinated (Pools, Spas)
- Potable Water
- Above 500mV





### Specifications

Measurement Range	
ORP	-1000mV – 1000mV
Output Signal — No Preamp Required	
2 Wire Loop Powered   4-20mA + RS 485 Direct Sensor Output	
Accuracy	
± 1mV	
Operating Temperature	
14 to 176°F   -10 to 80°C   Automatic Temperature Compensation	
Maximum Pressure	
145 Psi   10 bar	
Design	
Sensor body	PP Polypropylene (std)   Ryton®   PPS
Reference System	3.3 Mol Ag / AgCl / KCl Double Junction
pH electrode	Gold (R7C)   Platinum (R7G)
Reference	Solid Nexus®
Connection	3/4" NPT
Measuring Electrode Resistance	< 500 MΩ
Impedance Range	102 – 675 MΩ
Temperature Compensation/Output- 4-20 + RS485 Model	
Pt-1000 (Std)	
Pt-100	

### Dimensions

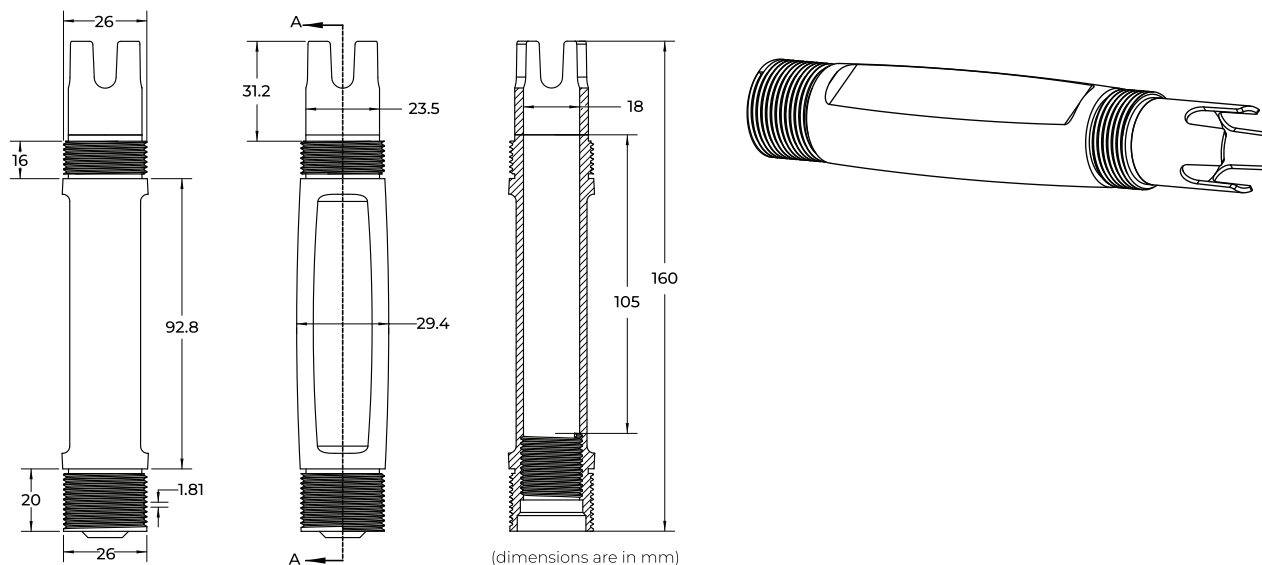



### Temperature Control

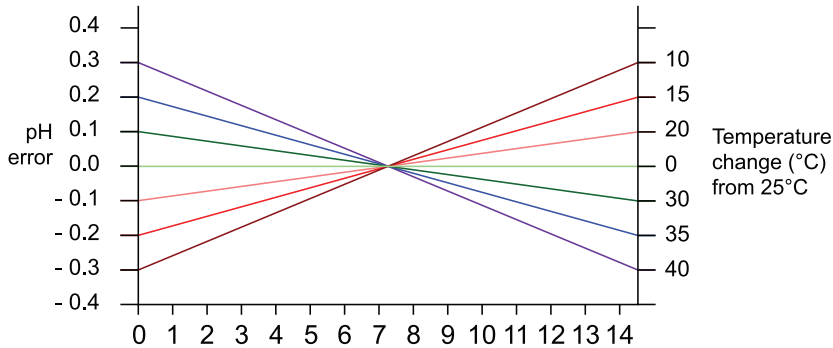

### Temperature vs. Pressure

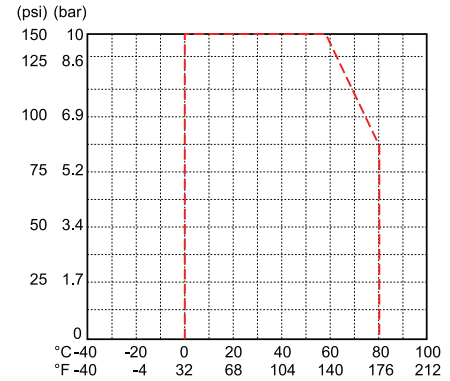

### In-line Mounting



1. Avoid vertical installation. (air may be present)
2. Optimum installation 15° above horizontal.
3. Process liquid should flow upward. (for downward flow ensure backpressure is present in order to avoid air within pipe)

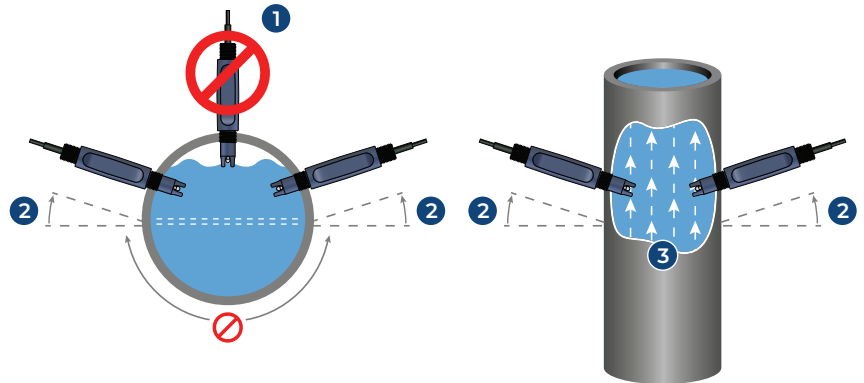

### Typical Application

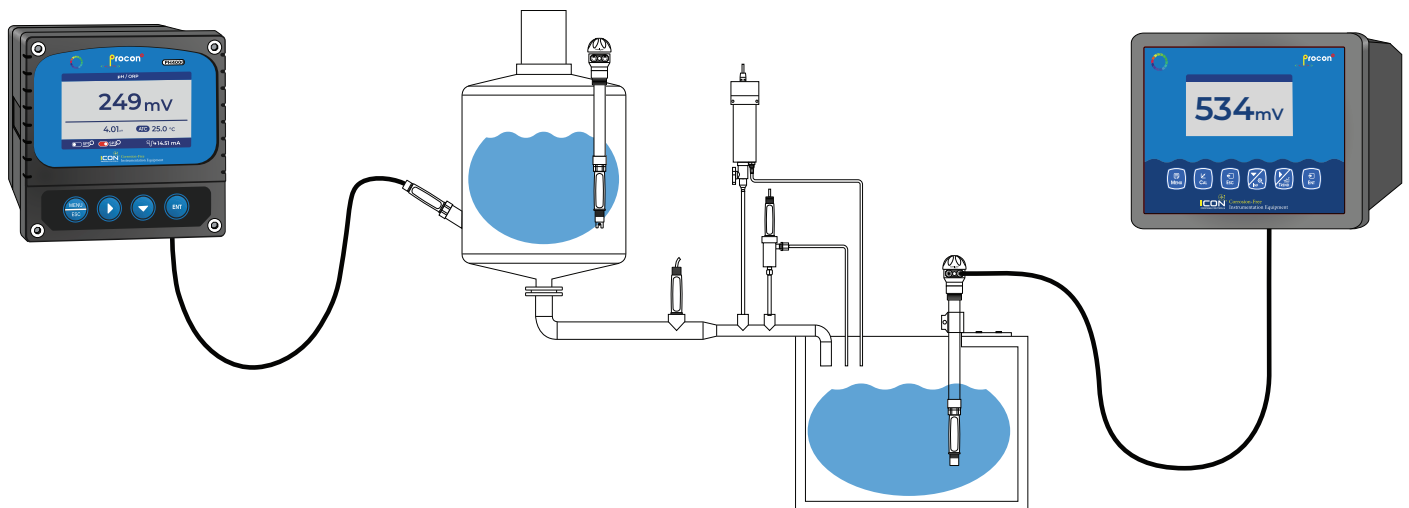



### Wiring — Flying Lead

#### 4-20mA 2-wire

- 1 Blue: mA-
- 2 Brown: mA+



#### 4-20mA 4-wire

- 1 Transparent: 4-20mA
- 2 Black (thick): Ref
- 3 White: Temperature
- 4 Green: Temperature

Connects directly to ProCon® controller



#### 4-20mA + RS485 Output

- 1 Red: 9-24VDC +
- 2 Black: 9-24VDC -
- 3 Transparent: 4-20mA
- 4 Black (thick): Ref
- 5 Green: RS 485 A
- 6 White: RS 485 B

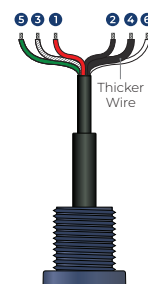

### Wiring — M12

#### 4 Pin M12 Connection



#### 4-20mA | 4 Pin

Color	Description
Blue	4-20mA -
Brown	4-20mA +

#### 4-20mA + Controller | 4 Pin

Color	Description
White	Temperature
Green	Temperature
Black (Thick)	Reference
Transparent	4-20mA

#### 8 Pin M12 Connection



#### 4-20mA + RS485 | 8 Pin

Color	Description
Red	9-24 VDC +
Black	9-24 VDC -
Transparent	4-20mA
Black (Thick)	Reference
Green	RS485 A
White	RS485 B

#### 4 Pin IO - Link Connection



#### I-O Link | 4 Pin

Pin	Description
Pin 1	24 VDC +
Pin 2	
Pin 3	GND
Pin 4	4-20mA

### Model Selection

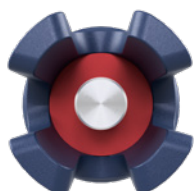

#### R7G — General Purpose ORP Sensor

Part Number	Material	Output	Type	Connection
R7G-P-D-1-F-M	PP	4-wire (for ProCon® display)	Flat	M12
R7G-P-M-1-F-M	PP	4-20mA (2-wire, std)	Flat	M12
R7G-P-S-1-F-M	PP	RS485 + 4-20mA	Flat	M12

Last digit:  
 "M" for M12 Connection (std)  
 "B" Blind (J-Box)  
 "D" Display (J-Box)  
 "F" Flying Lead

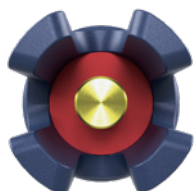

#### R7C — Complex Environment ORP Sensor

Part Number	Material	Output	Type	Connection
R7C-P-D-1-F-M	PP	4-wire (for ProCon® display)	Flat	M12
R7C-P-M-1-F-M	PP	4-20mA (2-wire, std)	Flat	M12
R7C-P-S-1-F-M	PP	RS485 + 4-20mA	Flat	M12

Last digit:  
 "M" for M12 Connection (std)  
 "B" Blind (J-Box)  
 "F" Flying Lead



### Fittings

#### Easy Install Clamp On Pipe Saddles

Part Number	Material	Size	Seal	Thread	Connection
PSA-2	PVC	2"	FPM	¾" NPT	PVC
PSA-3	PVC	3"	FPM	¾" NPT	PVC
PSA-4	PVC	4"	FPM	¾" NPT	PVC
PSA-6	PVC	6"	FPM	¾" NPT	PVC
PSA-8	PVC	8"	FPM	¾" NPT	PVC

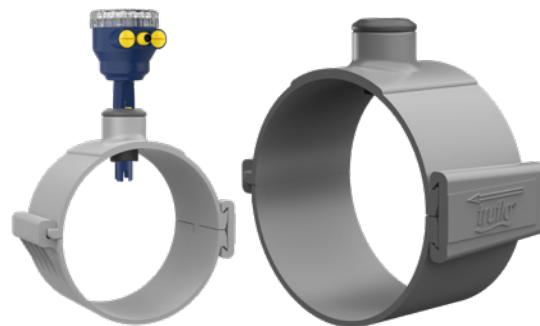

#### True Union Tee Fitting

Part Number	Material	Size	Seal	Thread	Connection
TUPA-PV-5	PVC	1/2"	FPM (std)   EPDM	¾" NPT	Socket   NPT
TUPA-PP-5	PP	1/2"	FPM (std)   EPDM	¾" NPT	Butt   NPT
TUPA-PF-5	PVDF	1/2"	FPM (std)   EPDM	¾" NPT	Butt   NPT
TUPA-PV-7	PVC	3/4"	FPM (std)   EPDM	¾" NPT	Socket   NPT
TUPA-PP-7	PP	3/4"	FPM (std)   EPDM	¾" NPT	Butt   NPT
TUPA-PF-7	PVDF	3/4"	FPM (std)   EPDM	¾" NPT	Butt   NPT
TUPA-PV-1	PVC	1"	FPM (std)   EPDM	¾" NPT	Socket   NPT
TUPA-PP-1	PP	1"	FPM (std)   EPDM	¾" NPT	Butt   NPT
TUPA-PF-1	PVDF	1"	FPM (std)   EPDM	¾" NPT	Butt   NPT
TUPA-PV-15	PVC	1 1/2"	FPM (std)   EPDM	¾" NPT	Socket   NPT
TUPA-PP-15	PP	1 1/2"	FPM (std)   EPDM	¾" NPT	Butt   NPT
TUPA-PF-15	PVDF	1 1/2"	FPM (std)   EPDM	¾" NPT	Butt   NPT
TUPA-PV-2	PVC	2"	FPM (std)   EPDM	¾" NPT	Socket   NPT
TUPA-PP-2	PP	2"	FPM (std)   EPDM	¾" NPT	Butt   NPT
TUPA-PF-2	PVDF	2"	FPM (std)   EPDM	¾" NPT	Butt   NPT



#### Cast Iron Saddle Fitting

Part Number	Material	Size	Seal
CISSP020	Cast Iron / SS / PVC	2"	FKM O-Rings
CISSP030	Cast Iron / SS / PVC	3"	FKM O-Rings
CISSP040	Cast Iron / SS / PVC	4"	FKM O-Rings
CISSP060	Cast Iron / SS / PVC	6"	FKM O-Rings
CISSP080	Cast Iron / SS / PVC	8"	FKM O-Rings
CISSP100	Cast Iron / SS / PVC	10"	FKM O-Rings
CISSP120	Cast Iron / SS / PVC	12"	FKM O-Rings
CISSP140	Cast Iron / SS / PVC	14"	FKM O-Rings
CISSP160	Cast Iron / SS / PVC	16"	FKM O-Rings
CISSF020	Cast Iron / SS / PVDF	2"	FKM O-Rings
CISSF030	Cast Iron / SS / PVDF	3"	FKM O-Rings
CISSF040	Cast Iron / SS / PVDF	4"	FKM O-Rings
CISSF060	Cast Iron / SS / PVDF	6"	FKM O-Rings
CISSF080	Cast Iron / SS / PVDF	8"	FKM O-Rings
CISSF100	Cast Iron / SS / PVDF	10"	FKM O-Rings
CISSF120	Cast Iron / SS / PVDF	12"	FKM O-Rings
CISSF140	Cast Iron / SS / PVDF	14"	FKM O-Rings
CISSF160	Cast Iron / SS / PVDF	16"	FKM O-Rings



#### Weldolet® Pipe Adaptor

Part Number	Material	Size	Connection
WAS-2	PVC	2"-4"	¾" NPT
WAS-6	PVC	6"-24"	¾" NPT
WPF-SS-2	SS	2"-4"	¾" NPT
WPF-SS-6	SS	6"-24"	¾" NPT

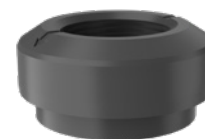



## Electrode preservation:



1. Clean the electrode correctly after use
2. Place the electrode in the electrode storage bottle for storage
3. The solution in the protective bottle is 3 mol/L KCl solution

## Warranty

**Icon Process Controls** warrants this product to be free from significant deviations in material and workmanship for a period of one year from the date of purchase. If repair is necessary and has not been the result of abuse or misuse within the warranty period, please return to **Icon Process Controls** and amendment will be made without any charge. **Icon Process Controls** Customer Service Center will determine if product problem is due to deviations or customer abuse. Out of warranty products will be repaired on a charge basis.

Authorization must be obtained from **Icon Process Controls** Customer Service Center to issue a RIR number before returning items for any reason. When applying for authorization, please include the date and the reason of return. Instruments must be carefully packed to prevent damage in shipment and insured against possible damage or loss. **Icon Process Controls** will not be responsible for any damage resulting from careless or insufficient packing.

**Warning:** Damage as a result of inadequate packaging is the user / distributor's responsibility.



**Phone:** 905.469.9283 · **Sales:** sales@iconprocon.com · **Support:** support@iconprocon.com



Use with any of the following controllers — **NO PREAMP REQUIRED**



**SINGLE INPUT**



**DUAL INPUT**



**FIVE INPUT**



[iconprocon.com](http://iconprocon.com)