

# C300 Series Controller

Conductivity | TDS | Resistivity | Salinity

Operating Manual



Industrial  
Analytical  
Equipment



Corrosion-Free  
Instrumentation Equipment

**Contents**

Preface ..... 3

Features..... 3

Technical Specifications..... 4

Typical Application..... 4

Instrument Connection..... 5

Dimension..... 5

Instrument Installation..... 6

Keypad Descriptions..... 7

Display Descriptions..... 8

Menu Structure..... 9

Measurement Settings (Quick Start)..... 12

Calibration Settings (Quick Start)..... 13

Alarm Settings (Quick Start)..... 14

Current Settings (Quick Start)..... 15

Communication Settings (Quick Start)..... 16

System Settings (Quick Start)..... 17

Maintenance Settings (Quick Start)..... 18

Measurement Setup..... 19

pH Buffer Reading vs Temperature..... 20

Calibration Setup..... 20

Alarm Setup..... 24

Current Setup..... 24

System Setup..... 26

Maintenance..... 26

Troubleshooting..... 27

Warranty..... 27

## Preface

Please read this manual carefully before use.

When receiving the instrument, please open the package carefully, check whether the instrument and accessories are damaged by transportation and whether the accessories are complete. If any abnormalities are found, please contact our after-sales service department or regional customer service center, and keep the package for return processing.

This instrument is an analytical measurement and control instrument with highly precision. Only skilled, trained or authorized person should carry out installation, setup and operation of the instrument. Ensure that the power cable is physically separated from the power supply when connection or repair. Once the safety problem occurs, make sure that the power to the instrument is off and disconnected.

### For example,

1. Apparent damage to the analyzer
2. The analyzer does not work properly or provides specified measurements
3. The analyzer has been stored for a long time in an environment where the temperature exceeds 70°C

The analyzer must be installed by licensed professionals in accordance with relevant local specifications, and instructions are included in the operation manual. Comply with the technical specifications and input requirements of the controller.

## Features

The instrument is equipped with different types of pH or ORP sensors. Widely used in power plants, petrochemical industry, metallurgical electronics, mining, paper industry, biological fermentation engineering, medicine, food and beverage, environmental protection water treatment, aquaculture, modern agricultural planting and other industries. The pH (acidity and alkalinity) value, ORP (redox potential) value and temperature value of water solution were continuously monitored and controlled.

- ❑ Large LCD display
- ❑ Intelligent menu operation
- ❑ SimpliCal<sup>®</sup> automatic calibration
- ❑ Manual + automatic temperature compensation
- ❑ Two (2) relay control switches
- ❑ 4-20mA & RS485 multiple output modes
- ❑ Multi-parameter display simultaneously shows conductivity and temp
- ❑ Password protection



## Technical Specifications

Measuring Range	0 – 500mS/cm
Resolution	0.1 $\mu$ S/cm   0.01mS/cm
Intrinsic Error	$\pm$ 0.5% F.S
Resistivity	0 – 18.25M $\Omega$ /cm
Resolution	0.01K $\Omega$ /cm   0.01M $\Omega$ /cm
TDS	0 – 250g/L
Resolution	0.01mg/L   0.01g/L
Salinity	0 – 700ppt
Resolution	0.01ppm   0.01ppt
Working Temperature	32 – 302°F   0 – 150°C
Temperature Compensation	Automatic or Manual
Outputs	Two (2) 4–20mA   20–4mA   0–20mA
Communication	RS485 MODBUS RTU
Relay Control Contact	5A 240VAC   5A – 28VDC
Power Supply	9 – 36VDC (std)   85 – 265VAC   Power Consumption 3W
Environmental Temperature	14 – 140°F   -10 – 60°C
Relative Humidity	$\leq$ 90%
Enclosure Rating	IP65
Weight	0.5kg
Dimensions	98 × 98 × 130mm
Installation Opening Size	93 X 93mm
Installation methods	Panel   Pipe   Wall

## Typical Application

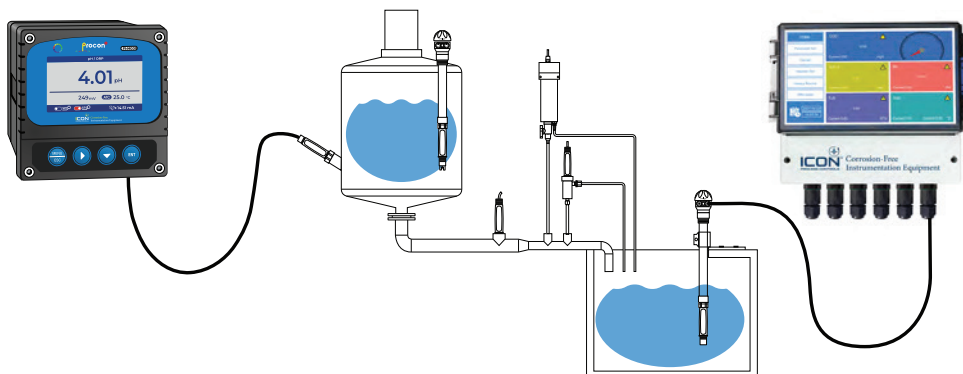

## Instrument Connection

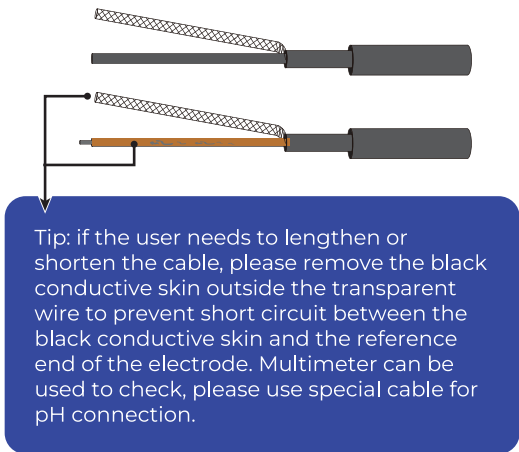
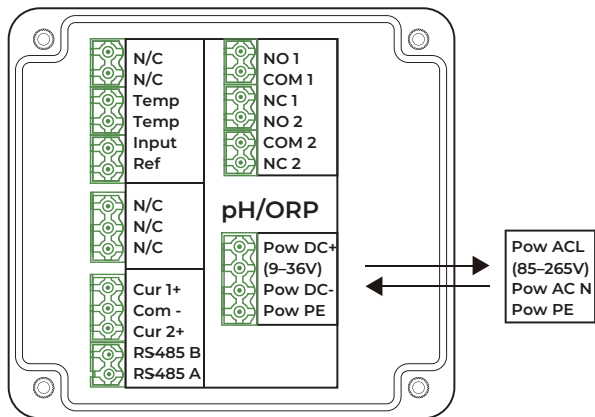

Tip: if the user needs to lengthen or shorten the cable, please remove the black conductive skin outside the transparent wire to prevent short circuit between the black conductive skin and the reference end of the electrode. Multimeter can be used to check, please use special cable for pH connection.

Terminal	Function
N/C	No Connection
N/C	No Connection
Temp	Temperature Sensor
Temp	Temperature Sensor
Input	Measurement
Ref	Reference
N/C	No Connection
N/C	No Connection
N/C	No Connection
Cur 1 +	Current output 1+
Com -	Current output common
Cur 2 +	Current output 2+
RS485 B	Communication Terminal
RS485 A	Communication Terminal

Terminal	Function
NO 1	High set relay working position
COM 1	Alarm relay common
NC 1	High set relay resting position
NO 2	Low set relay working position
COM 2	Alarm relay common
NC 2	Low set relay resting position
Pow DC + (9 – 36V)	DC power + (9 – 36V)
Pow DC -	DC power -
Pow PE	Earth wire
Pow ACL (85 – 265V)	Live wire
Pow AC N	Neutral wire
Pow PE	Earth wire

## Dimension

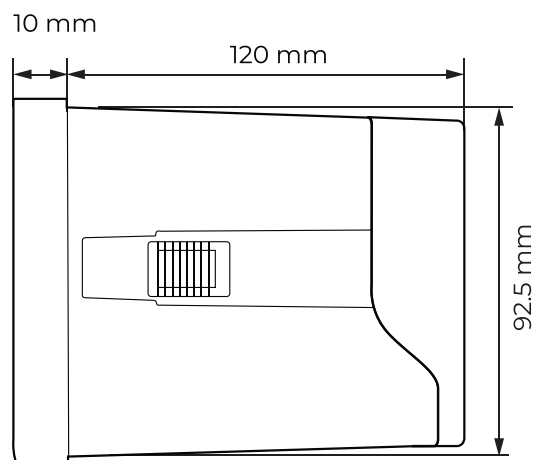
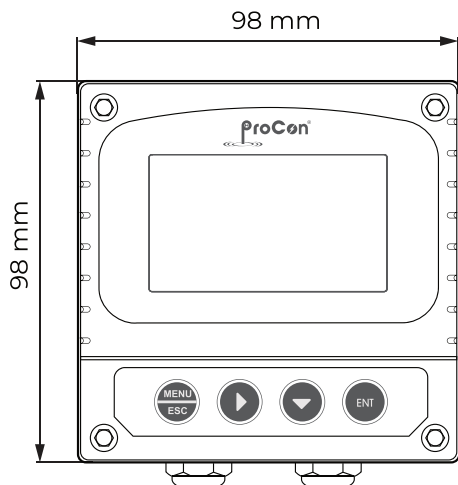

# Instrument Installation

## Control Panel Installation

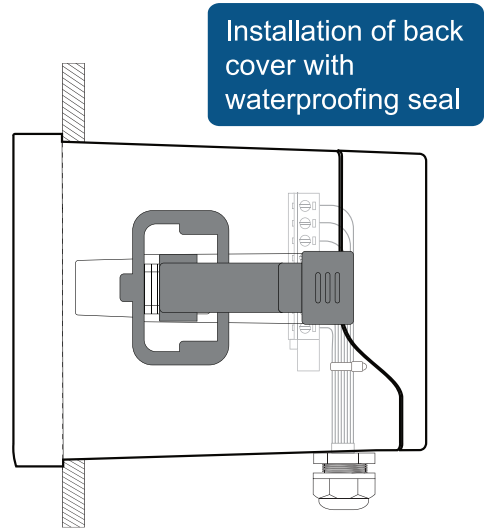
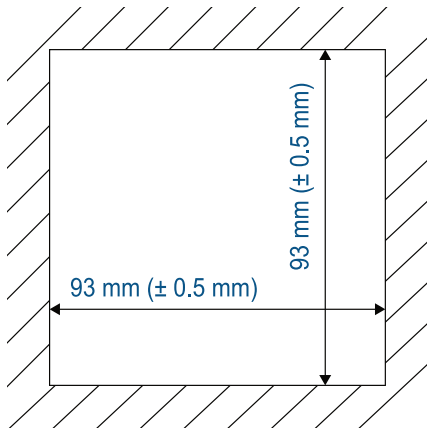

## Wall Mounting

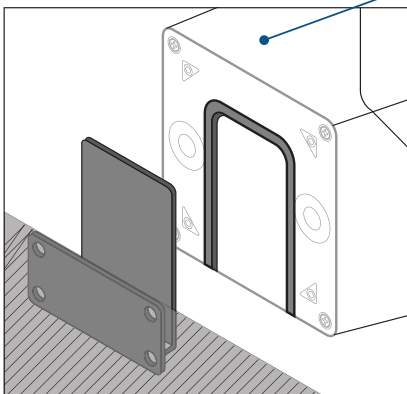
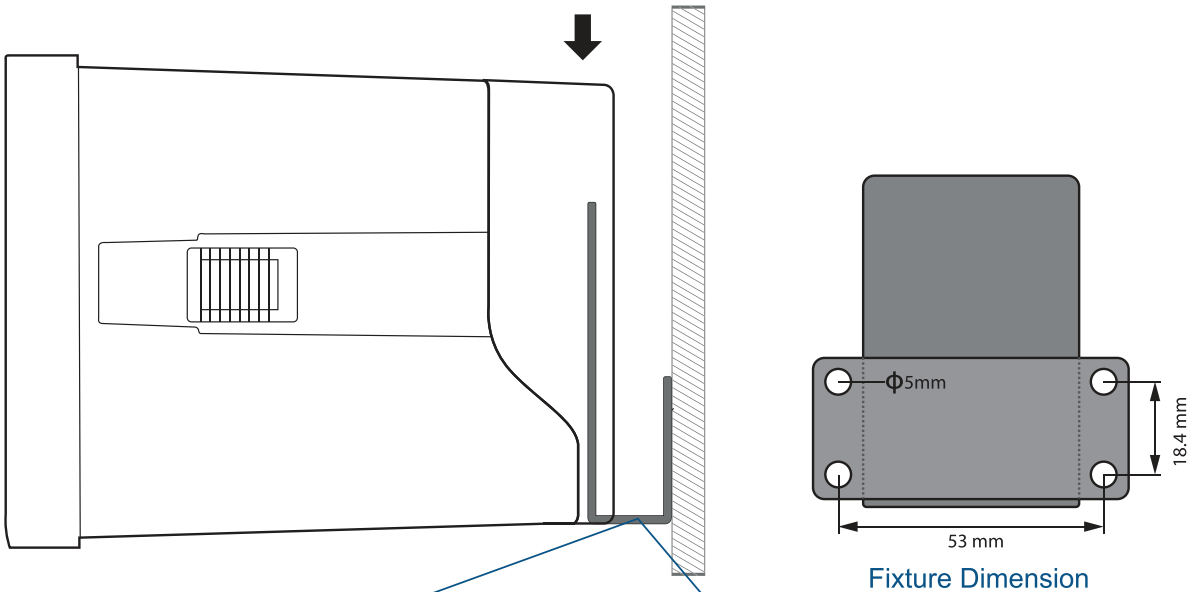

Fixed bracket (M4 screw) is installed on the wall first.

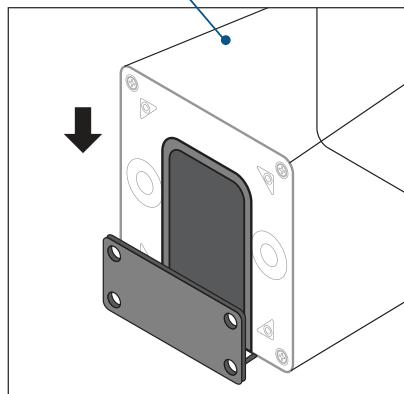

Insert the instrument into the fixture along the chute

## Keypad Descriptions

Press to move menu left

Confirm Options

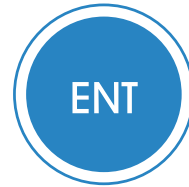
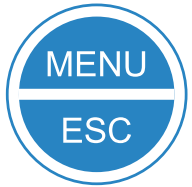

Enter menu programming menu  
Return to previous menu  
Long press to return the measurements screen

Menu setting mode: press this key to loop down the menu options  
Value input mode: current mA / loop  
In measurement mode, long press to set parameters for browsing

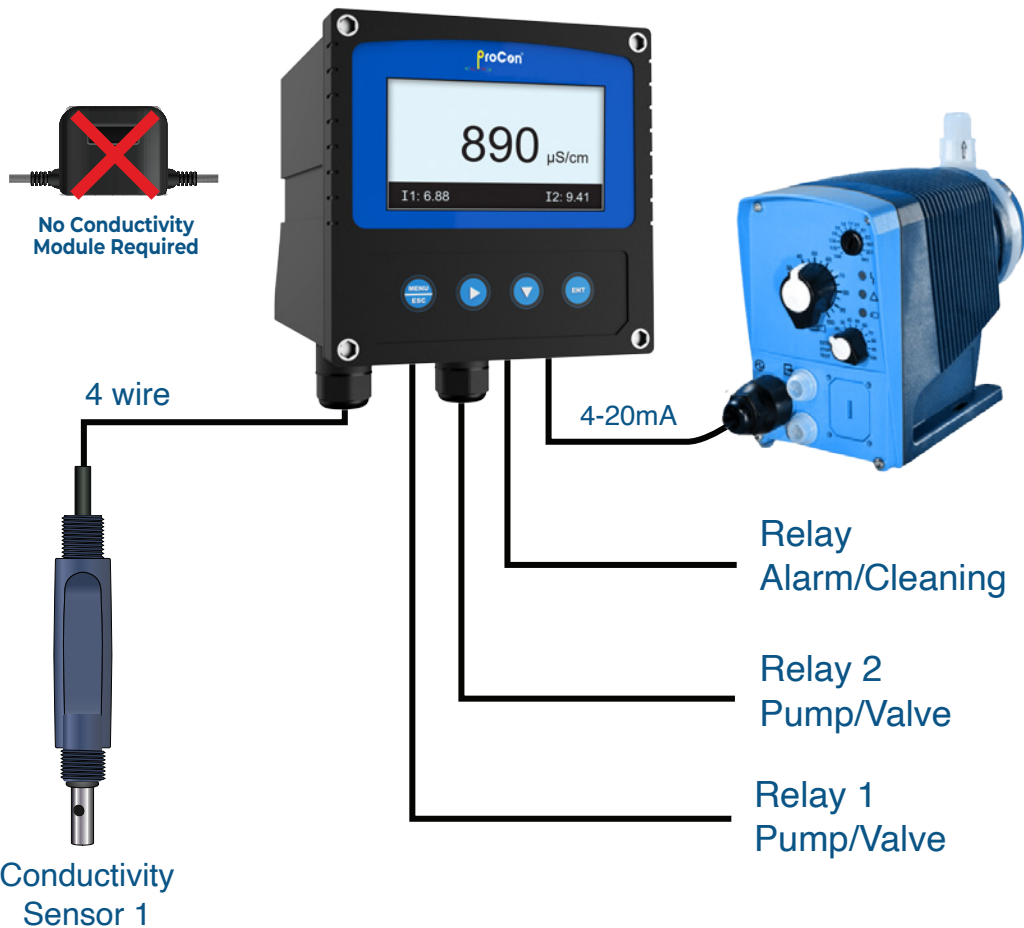

## Display Descriptions

Check all electrical connections before use. The instrument will display as shown in the figure below after the power is turned on.

### Main Display

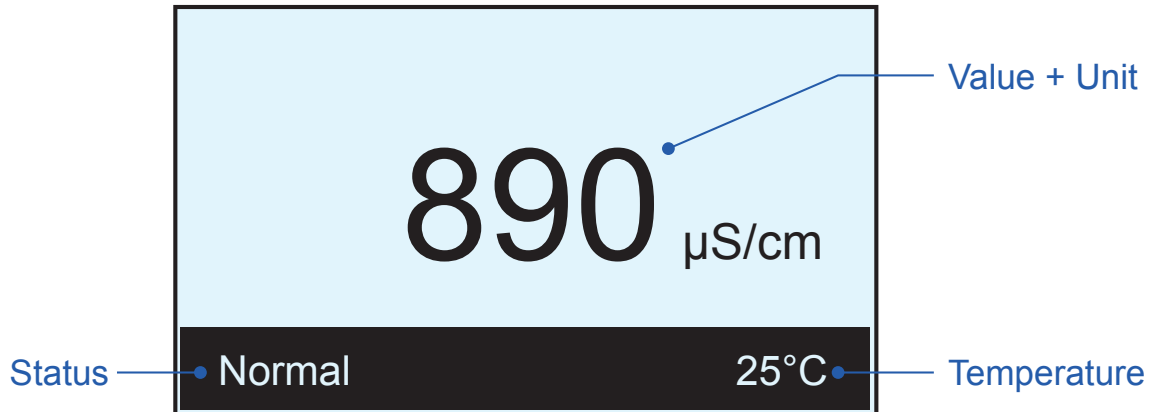

### Conductivity Mode

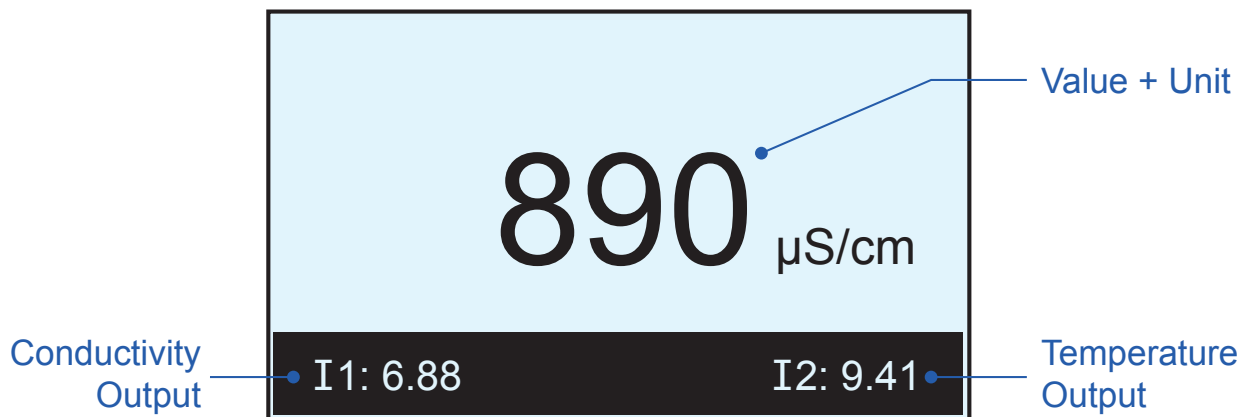



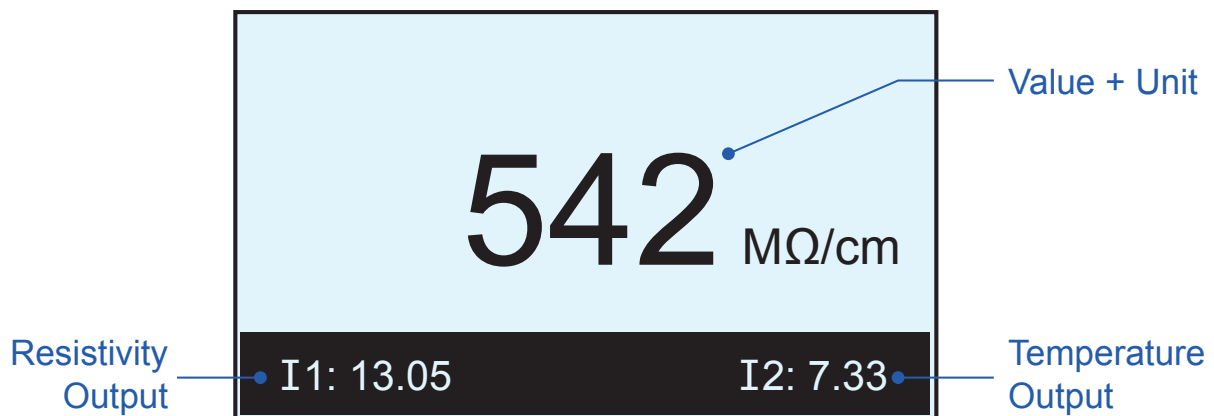

### Resistivity Mode





## Menu Structure

Press  [MENU] key to enter programming mode:

If the monitor prompts you to enter the calibration security password, press the  or  key to set the calibration security password, and then press the  [ENT] key to confirm the calibration security password. No initial password here, please enter directly by pressing the  [ENT] key.

Item	Display	Selection	Sub Menu	
Measurement	Electrode	pH		
		ORP		
	Temperature	Type		NTC2.252 kΩ
				NTC10 kΩ
				Pt100
				Pt1000 (Default)
		Offset	0.00 (Default)	
		Input		Automatic (Default)
			Manual	
	Unit		N/A	
		°C (Default)		
°F				
Calibration	S-S-C (Standard solution calibration pH)	pH	pH 2 points 4/6/9	
			pH 3 points 4/6/9	
			pH 2 points 4/7/10	
			pH 3 points 4/7/10	
	S-S-C query (Standard solution calibration query pH)	Offset 1		
		Slope 1		
		Offset 2		
		Slope 2		
	On-site calibration	Offset Adjustment 1		
	On-site query	Linear		
		Offset		
	S-S-C (Standard solution calibration ORP)	ORP S-P (single point)		
	S-S-C (Standard solution calibration ORP)	ORP slope		
On-site calibration				
On-site query	Offset			
	Linear			

Item	Display	Selection	Sub Menu
Alarm	Relay 1 (pH)	Channel	pH
		Alarm Mode	Low Alarm
			High Alarm
		Limit	
	Hysteresis	0.00 (Default)	
	Relay 2 (pH)	Channel	pH
		Alarm Mode	Low Alarm
			High Alarm
		Limit	
	Hysteresis	0.00 (Default)	
	Relay 1 (ORP)	Channel	ORP
		Alarm Mode	Low Alarm
			High Alarm
		Limit	
	Hysteresis	100 (Default)	
	Relay 2 (ORP)	Channel	ORP
Alarm Mode		Low Alarm	
		High Alarm	
Limit			
Hysteresis	100 (Default)		
Current setting	Current 1	Channel	Major measured value (Default)
			Temperature
		Output Type	4-20mA   20-4mA   0-20mA
		Upper Limit	14.00 (Default for pH)
	2000 (Default for ORP)		
	Lower Limit	0.00 (Default for pH)	
		-2000 (default for ORP)	
	Current 2	Channel	Major measured value (Default)
			Temperature
		Output Type	4-20mA   20-4mA   0-20mA
Upper Limit		100 (Default)	
Lower Limit	0.0 (Default)		
Communication	Baud Rate	4800 Bps	
		9600 Bps (Default)	
		19200 Bps	
	Parity bit	No Parity (Default)	
		Even Parity	
		Odd Parity	
	Stop bit	1 bit (Default)	
		2 bits	
Address	1 (default)	1 – 247	

Item	Display	Selection	Sub Menu
System	Language	English	
	Display	Speed	Low
			Standard
			Medium
			High
		Backlight	30 sec
			1 min
			5 min (Default)
			15 min
	30 min		
	Always on		
Password	No password (Default)		
Series No	XXXXXXXXXX		
Version	VER6.1.00		
Restore	Calibration		
	Parameter		
Maintenance Current2 4mA	Current	Current1 4mA	
		Current2 20mA	
		Current2 4mA	
		Current2 20mA	
	Relay Test	Relay 1: off	
		Relay 1: off	

## Measurement Settings (Quick Start)

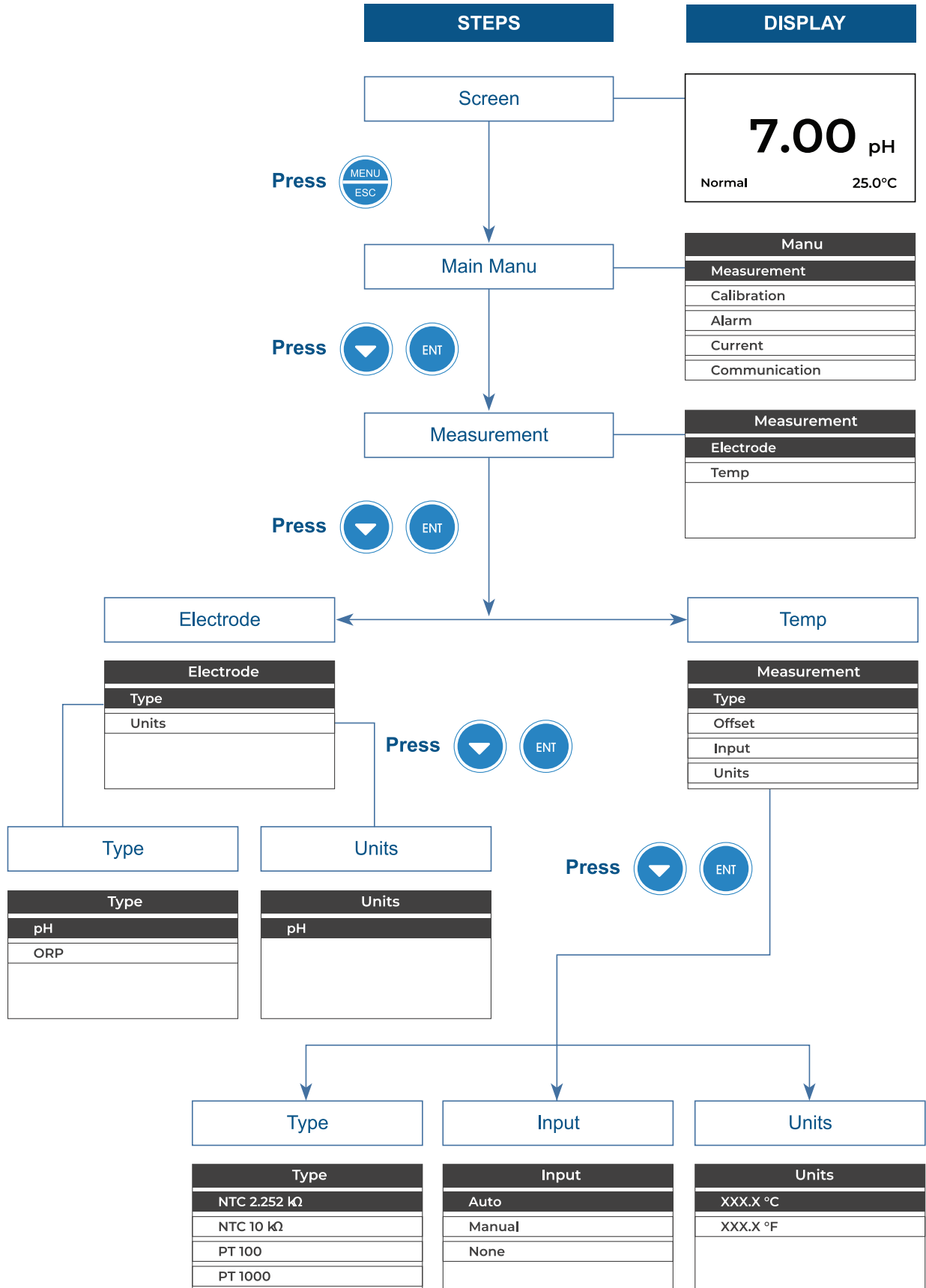

## Calibration Settings (Quick Start)

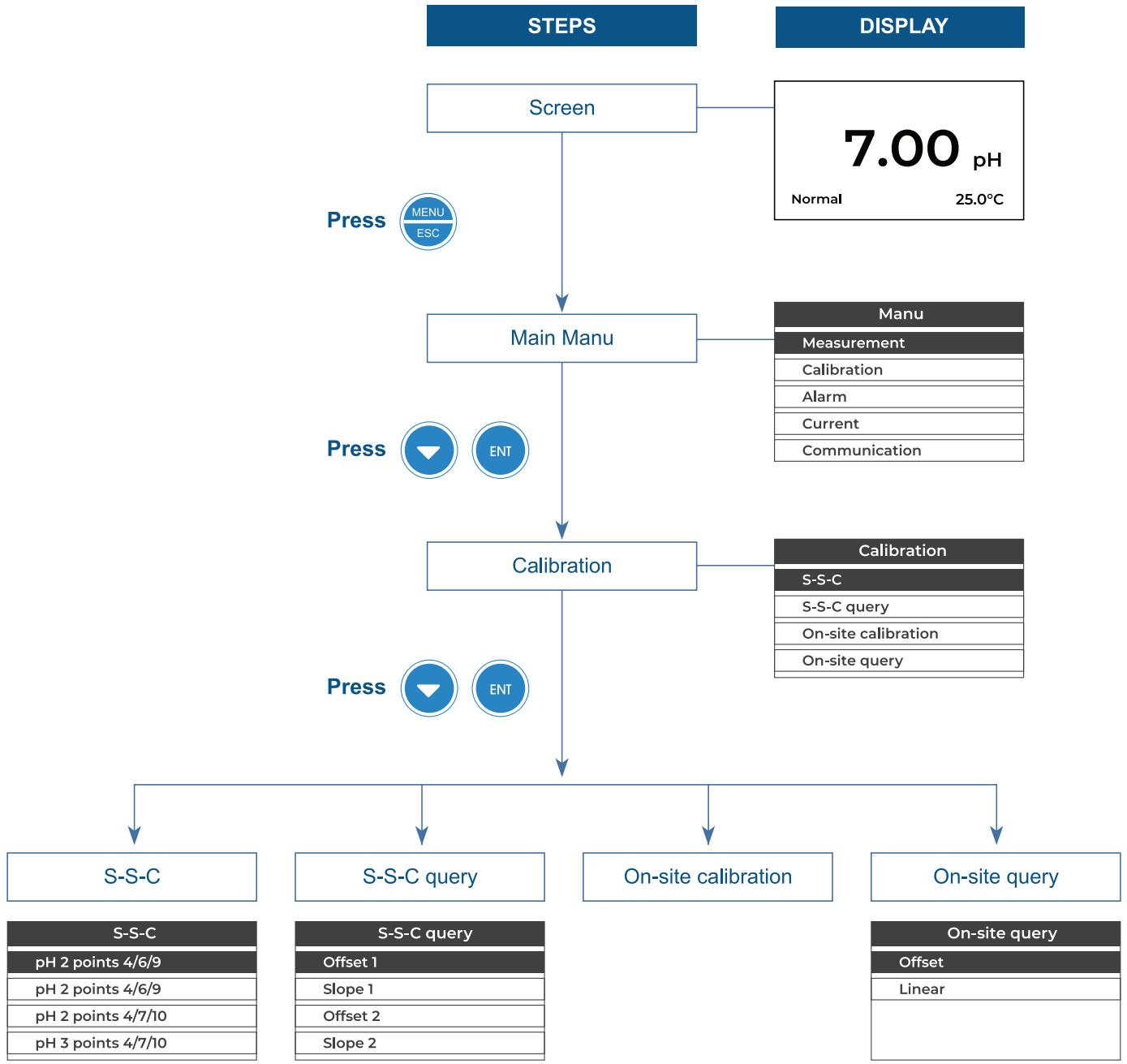

## Alarm Settings (Quick Start)

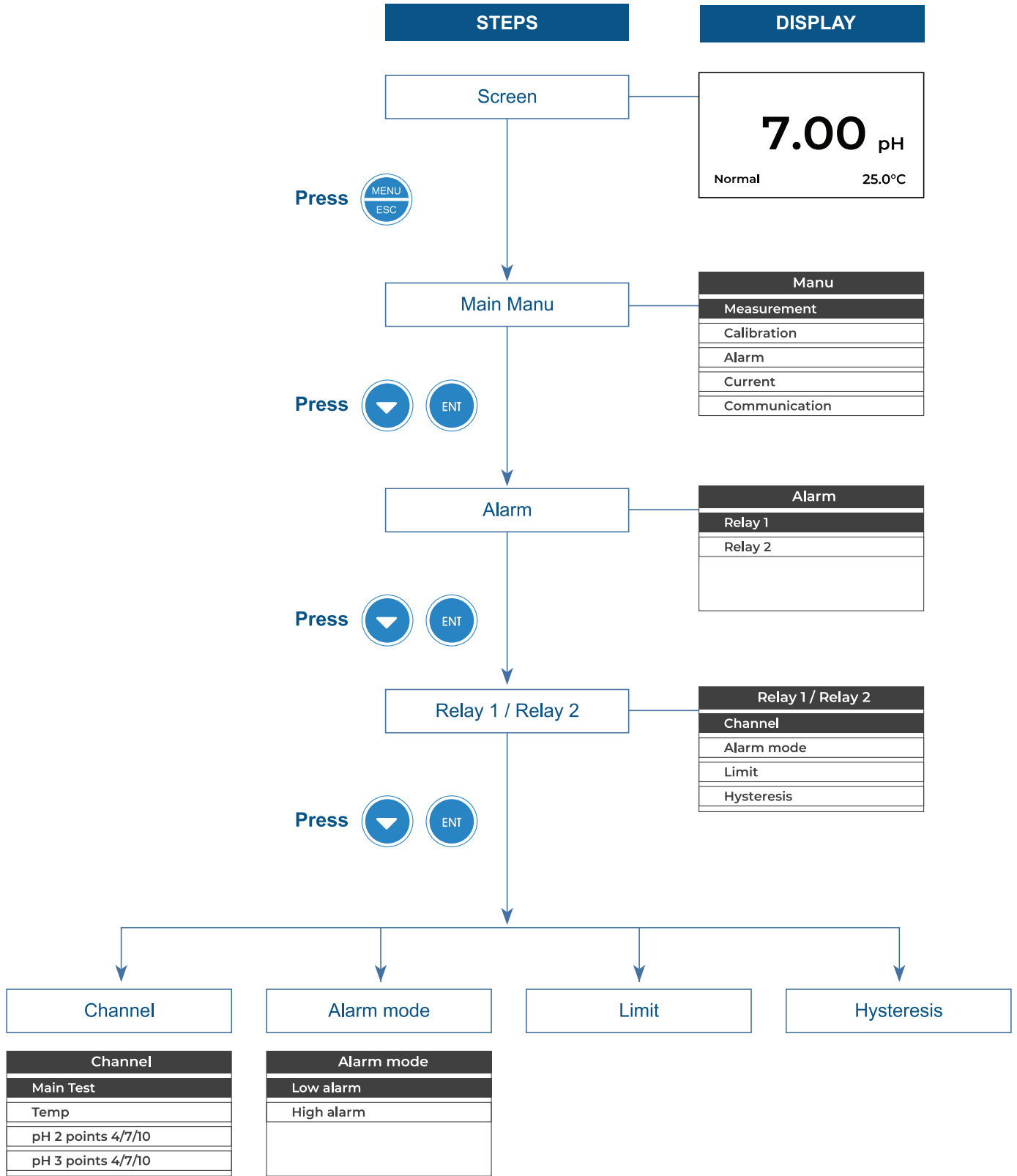

## Current Settings (Quick Start)

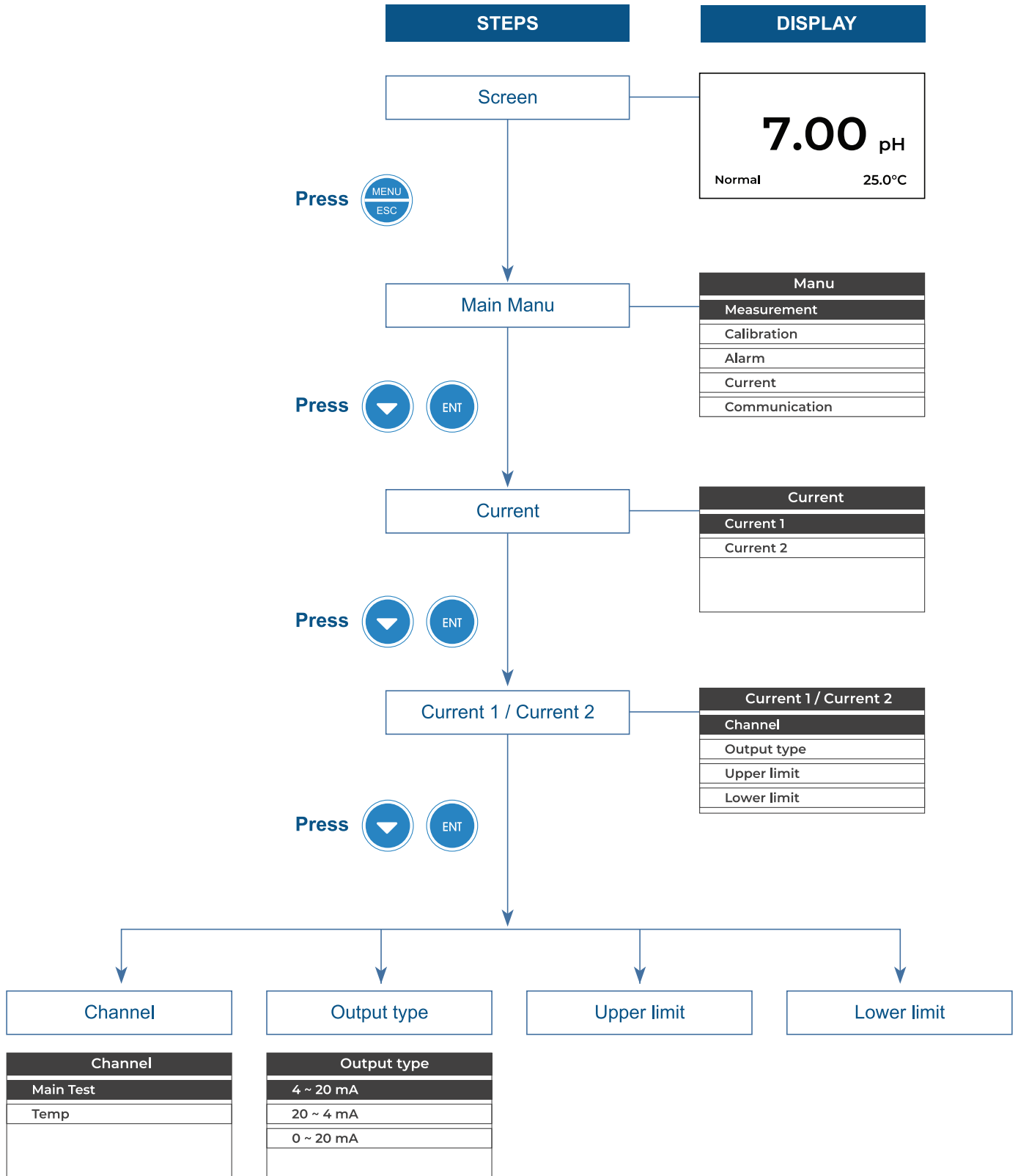

## Communication Settings (Quick Start)

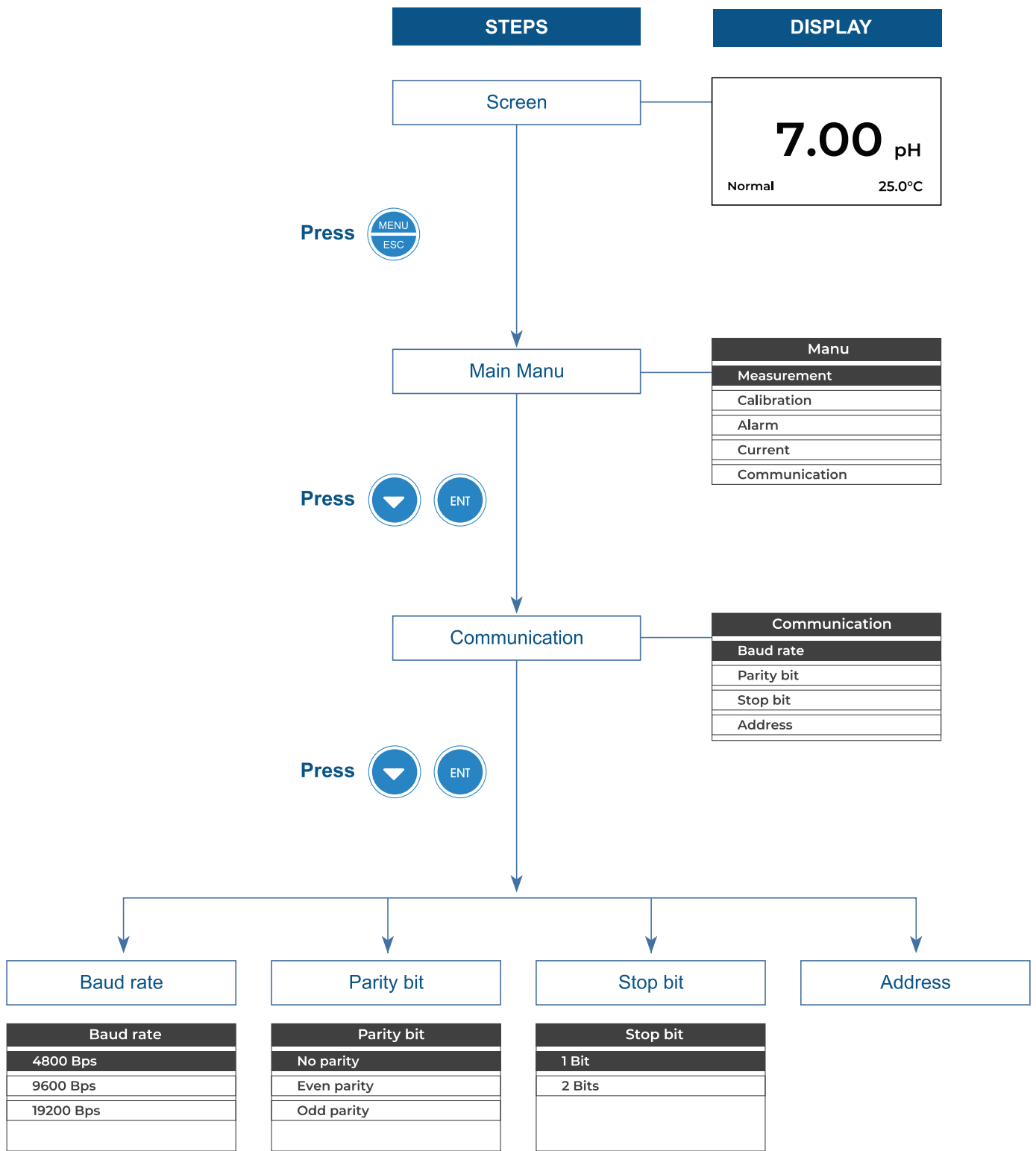



## System Settings (Quick Start)

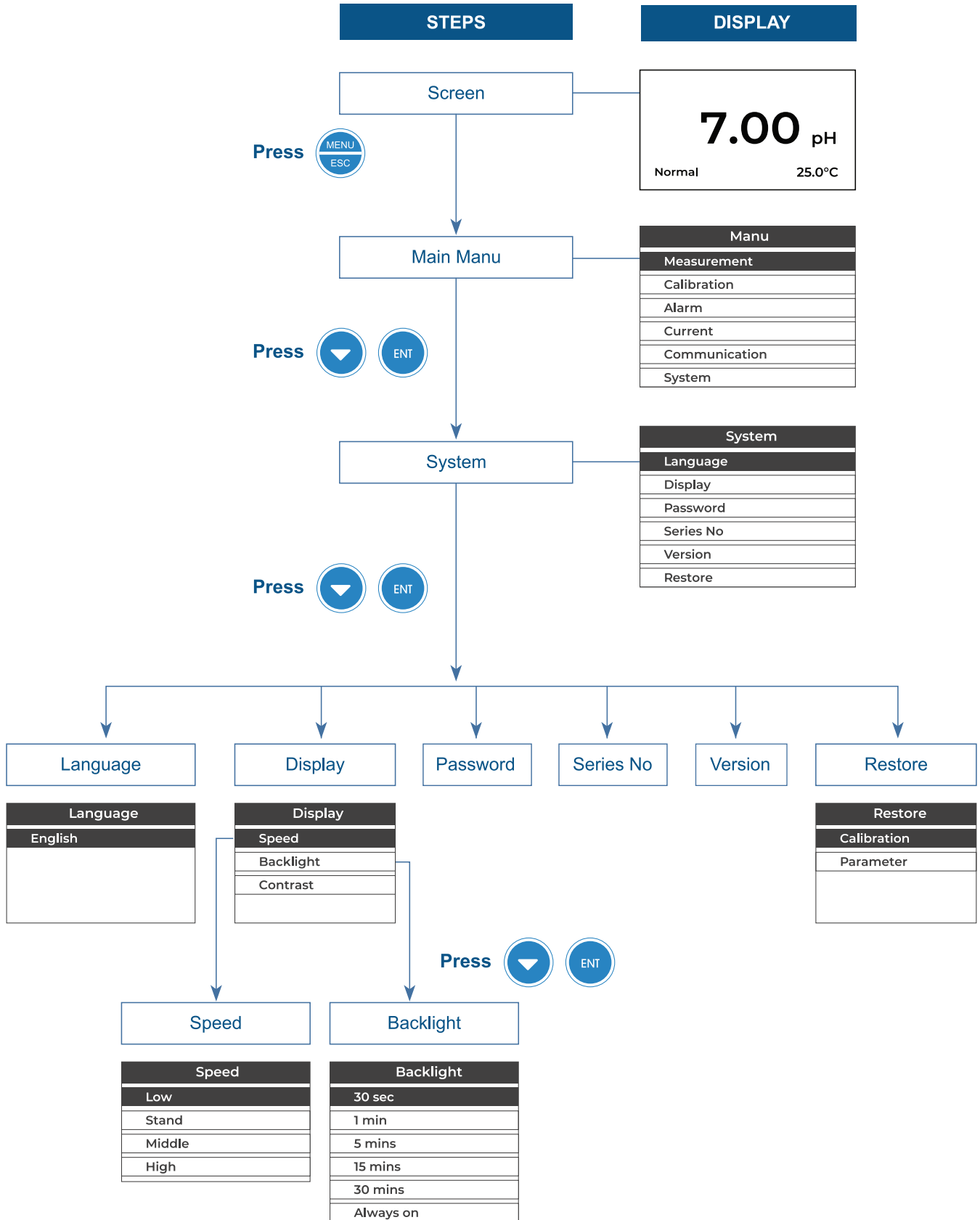

## Maintenance Settings (Quick Start)

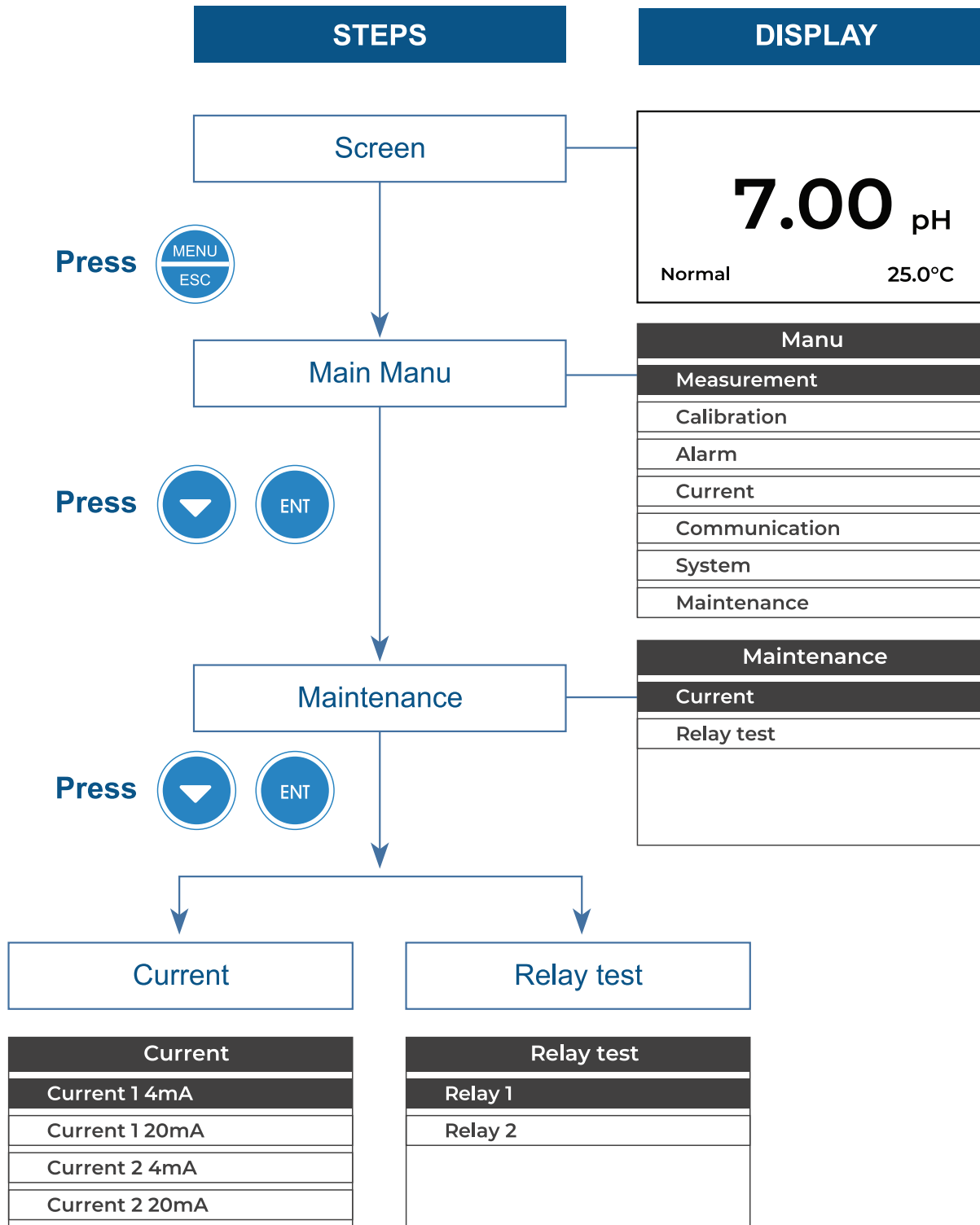

# Measurement Setup

## Electrode Setup

When the pH electrode connected to this instrument, you need to select the electrode type as "PH" in this item. It's the same when the electrode becomes OPR.

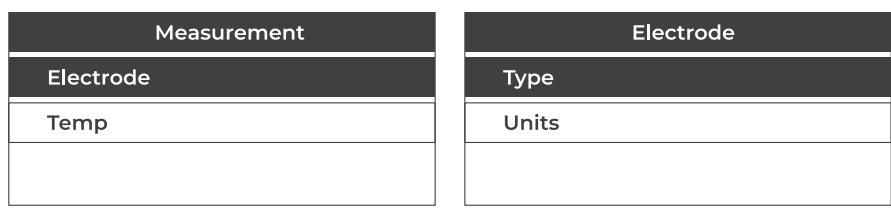

## Temperature Setup

There are four kinds of temperature types: NTC2.252K , NTC10K , PT100 and PT1000, user needs to choose the right temp comp for the electrode to display the right temperature. "Err" means no temp comp.

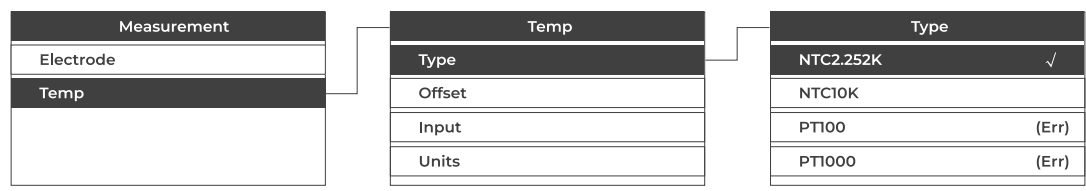

The user can compare the temperature measured by other standard instruments with the temperature measured by the D300. If there is an error, you can use the "temperature offset" to modify it, assuming that the temperature measured by D300 is 25°C, and the temperature measured by other standard instruments is 24.8°C. Then enter "-0.2°C" here, then press "Esc", and then select "Save".

You can choose Auto, Manual and None in `Temperature input`. Choosing `Auto` the temperature is from electrode. Choosing "Manual", user is able to input the temperature. Choosing "None" there will be no display of temperature, the default temperature of the system is 25°C as comp.

User can choose (°C) and (°F)

## Temperature Offset Setting

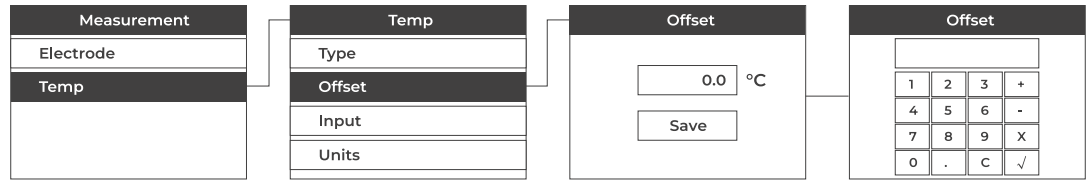

## Temperature Input Setting

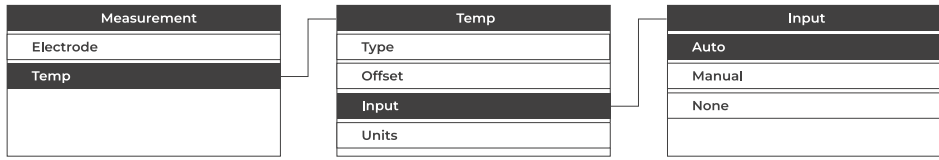

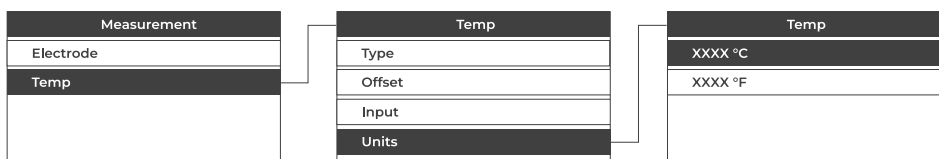

## Temperature Units Setting



## pH Buffer Reading vs Temperature

Temp(°C)	pH 4.01	pH 6.86	pH 9.18	pH 4.00	pH 7.00	pH 10.01
0	4.01	6.98	9.47	4.01	7.12	10.32
5	4.01	6.95	9.38	4.00	7.09	10.25
10	4.00	6.92	9.32	4.00	7.06	10.18
15	4.00	6.90	9.27	4.00	7.04	10.12
20	4.00	6.88	9.22	4.00	7.02	10.06
25	4.01	6.86	9.18	4.00	7.00	10.01
30	4.01	6.85	9.14	4.01	6.99	9.97
35	4.02	6.84	9.10	4.02	6.98	9.93
40	4.03	6.84	9.07	4.03	6.97	9.89
45	4.04	6.83	9.04	4.04	6.97	9.86
50	4.06	6.83	9.01	4.06	6.97	9.83
55	4.08	6.83	8.99	4.07	6.97	9.91
60	4.10	6.84	8.96	4.09	6.98	9.97
70	4.12	6.85	8.92	4.12	6.99	9.76
80	4.16	6.86	8.89	4.16	7.00	9.74
90	4.20	6.88	8.85	4.20	7.02	9.73

## Calibration Setup

Press  [ESC] and  [ENT] "Calibration Setup" If you are prompted to enter the password, you need to enter the password set in advance. If the password is not set, you can directly select "OK" and press the  [ENT] key to enter:

Standard liquid calibration	pH 2 points calibration	NIST: 4.00, 6.86, 9.18	Calibrate middle point first
		USA: 4.01, 7.01, 10.01	Calibrate middle point first
	pH 3 points calibration	NIST: 4.00, 6.86, 9.18	Calibrate in order
		USA: 4.01, 7.01, 10.01	Calibrate in order
	ORP 1 Point		Input ORP standard liquid value
Onsite calibration			Input the onsite value

### Calibration with Standard Liquid (pH, 2 points)

There are two groups of 2-point standard liquid USA: 4.01, 7.01, 10.01 and NIST:

4.00, 6.86, 9.18, The following example uses the NIST standard solution set:

Choose pH standard liquid, press  [ENT] to enter the mode

PH S-S-C
pH (2 points) 4/6/9
pH (3 points) 4/6/9
pH (2 points) 4/7/10
pH (3 points) 4/7/10

Choose 'pH (2 points) 4/6/9' (Before each operation, the electrode can be placed in the standard solution for about 60s)

Clean sensor and place it into 6.86 standard liquid to calibrate...

Esc
Enter

point 1: pH 6.86
Vol: 8.0 mv
Temp: 25.0 °C
Enter when stable 60 S

After calibration of 1st point, follow with the 2nd point:

Clean sensor and place it into 4.00/9.18 standard liquid to calibrate...

Esc
Enter

point 2 pH 4.00/9.18
Vol: 170.0 mv
Temp: 25.0 °C
Enter when stable 60 S

After above calibration, there will be the results:

Calibration 6.86 and 4.00 will be saved in offset 1 and slope 1; calibration 6.86 and 9.18 will be saved in offset 2 and slope 2.

pH calibration query
Offset 1
Slope 1
Offset 2
Slope 2

Save the results and it can be queried next time.

The pH value of the buffer is measured at 25 °C, please select the correct buffer (please refer to P30 "Buffer Table").

Before calibration, the electrode can be activated by soaking in the solution to ensure the stability and accuracy of the calibration value and the detection value.

### Calibration with Standard Liquid (pH, 3 points)

There are two groups of 3-point standard liquid USA: 4.01, 7.01, 10.01 and NIST:

4.00, 6.86, 9.18, The following example uses the NIST standard solution set:

Choose pH standard liquid, press [ENT] to enter the mode

PH S-S-C
pH (2 points) 4/6/9
pH (3 points) 4/6/9
pH (2 points) 4/7/10
pH (3 points) 4/7/10

Choose 'pH (2 points) 4/6/9' (Before each operation, the electrode can be placed in the standard solution for about 60s)

Clean sensor and put into pH 9.18 standard liquid to calibrate...	
<b>Esc</b>	<b>Enter</b>

point 1: pH 9.18
Vol: -120.0 mv
Temp: 25.0 °C
Enter when stable 60 S

After calibration of 1st point, follow with the 2nd point:

Clean sensor and place it into 6.86 standard liquid to calibrate...	
<b>Esc</b>	<b>Enter</b>

point 2: pH 6.86
Vol: 8.0 mv
Temp: 25.0 °C
Enter when stable 60 S

After calibration of 2nd point, follow with the 3rd point:

Clean sensor and put into pH 4.00 standard liquid to calibrate...	
<b>Esc</b>	<b>Enter</b>

point 3: pH 4.00
Vol: 170.0 mv
Temp: 25.0 °C
Enter when stable 60 S

After above calibration, there will be the results:

pH calibration query
Offset 1
Slope 1
Offset 2
Slope 2

Save the results and it can be queried next time.

The pH value of the buffer is measured at 25 ° C, please select the correct buffer (please refer to P30 "Buffer Table"). Before calibration, the electrode can be activated by soaking in the solution to ensure the stability and accuracy of the calibration value and the detection value.

### Onsite Calibration

If you choose pH onsite calibration, install the pH electrode in the actual water sample, and use standard portable instruments or standard laboratory test equipment data for comparison and calibration:

Place electrode in water sample to calibrate...	
<b>Start</b>	<b>Cancel</b>

pH: 4.00 pH
Vol: 170.0 mv
Temp 25.0 °C
Enter when stable 60 S

Please enter the pH value obtained from the standard portable instrument or standard laboratory test equipment data. After pressing 'Enter', the instrument will display the calibration result, press the "Save" button to exit:

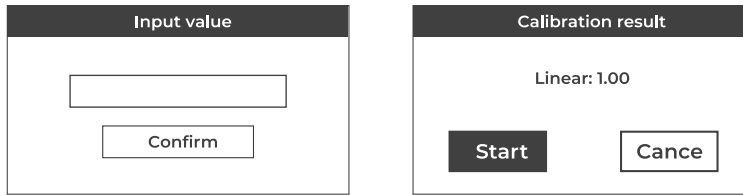

Save the results and it can be queried next time 2.4 ORP Standard solution calibration (S-S-C) Choose ORP single point calibration, and put the sensor into standard liquid, follow the instruction to operate:

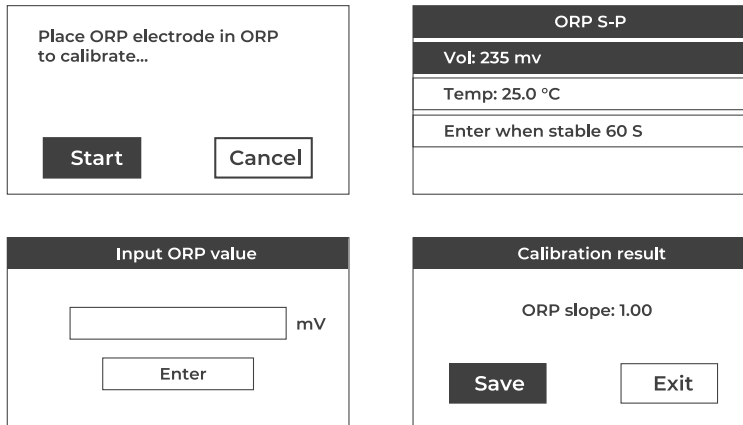

Save the results and it can be queried next time 2.5 ORP onsite calibration Choose onsite ORP and put sensor into water sample, follow the instruction to operate;

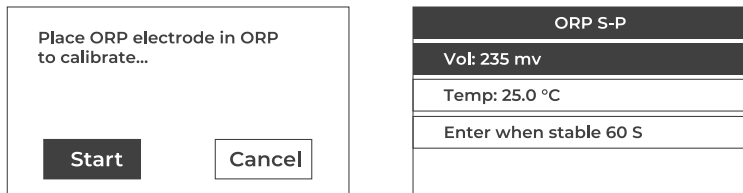

Input the ORP value obtained from the standard portable instrument or standard laboratory laboratory equipment data. After pressing [ENT] the instrument will display the calibration result, press the "Save" button to exit;

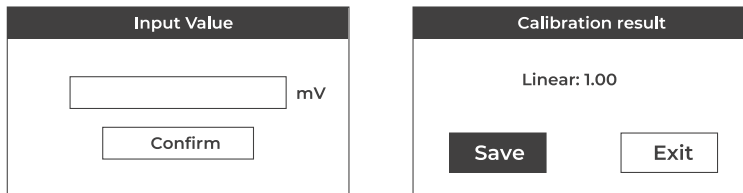

Save the results and it can be queried next time.

## Alarm Setup

User can choose setting of relays here;

Alarm	Relay 1
Relay 1	Channel
Relay 2	Alarm mode
	Limit
	Hysteresis

The user can set the relay 'High alarm' or 'Low alarm' through the 'Alarm mode' of the relay. The default of relay 1 is 'High alarm', and the default of relay 2 is 'Low alarm' When value is beyond the high/low limit, a ticking sound will be emitted.

Eg.: When the PH value exceeds 10.00, an alarm is required. Enter 10.00 in the limit value setting. After the setting is completed, the instrument will make a ticking sound after the PH value exceeds 10.00, At this time, in the measurement mode, 'High Alarm' will be displayed in the lower left corner. At this time, the normally open end of the relay is closed, and the normally closed end is disconnected, and the relay starts to work.;

Limit	Hysteresis value
<input type="text"/> pH	<input type="text"/> pH
<input type="button" value="Save"/>	<input type="button" value="Save"/>

## Current Setup

The user can set the output current here;

Current	Current 1
Current 1	Channel selection
Current 2	Output type
	Upper limit
	Lower limit

Channel Selection	Output type
Main test	4 – 20 mA
Temp	20 – 4 mA
	0 – 20 mA

Can choose 'Main test' or 'Temp'

There are three types of 'output type' to choose from, namely '4~20mA', '20~4mA' and '0~20mA', which correspond to the upper and lower limits of the measured value respectively;

Take pH as example, Choose 'Main value' , '4-20m' as output, upper limit (PH) is 14, lower limit(PH) is 0, then 4mA means that PH is 0.00, 20mA means that PH is 14.00.



“Current Setting” can assist users to connect to equipment such as central control computer and data acquisition instrument.

<p style="text-align: center;"><b>Upper Limit</b></p> <p style="text-align: center;"><input type="text" value="12.00"/> pH</p> <p style="text-align: center;"><input type="button" value="Save"/></p>	<p style="text-align: center;"><b>Lower Limit</b></p> <p style="text-align: center;"><input type="text" value="0.00"/> pH</p> <p style="text-align: center;"><input type="button" value="Save"/></p>
<p style="text-align: center;"><b>Verify old password</b></p> <p style="text-align: center;"><input type="text"/></p> <p style="text-align: center;"><input type="button" value="Confirm"/></p>	<p style="text-align: center;"><b>Series No</b></p> <p style="text-align: center;">SN:99999999999999</p>

In the 'Password', you first need to enter the old password. If you haven't set a password, select 'Confirm' to enter and you can jump to the 'Enter New Password' interface.

<p style="text-align: center;"><b>Version</b></p> <p style="text-align: center;">Version: 6.1.00</p>	<p style="text-align: center;"><b>Restore</b></p> <table border="1" style="width: 100%;"> <tr> <td style="text-align: center;">Calibration</td> </tr> <tr> <td style="text-align: center;">Parameter</td> </tr> </table>	Calibration	Parameter
Calibration			
Parameter			

User can find 'Password', 'Version' and 'Restore' Version info and SN can assist remote help.

If you need to cancel the password, please enter the old password according to the prompts in the 'Password Settings'. When prompted to 'Enter the new password', just select 'Save'. There is no password by default when the product leaves the factory. In the 'restore factory settings', there is 'calibration recovery' and 'parameter recovery'. 'Calibration restore' will restore the internal data and need recalibration 'Parameter restore' will restore all the data exception calibration data Password is need to enter 'Restore factory settings', when there is no password, press  [ENT] to enter the interface.

<p style="text-align: center;"><b>Address</b></p> <p style="text-align: center;"><input type="text" value="1"/></p> <p style="text-align: center;"><input type="button" value="Save"/></p>
--

When data from multiple instruments need to be uploaded on site, the network node setting can help users quickly and effectively distinguish the data source when uploading data, and up to 247 groups can be set.

Set “system text”, “version information” and “modify password” and other related settings in the system settings.

## System Setup

System
Language
Display
Password
Series No
Version
Restore

Language
English

Display
Speed
Backlight
Contrast

Speed
Low
Standard
Middle
High

'Speed' can adjust the speed of the screen display data, the system is divided into four categories 'low, standard, medium and high'. When leaving the factory, the system default display rate is 'standard'.

Backlight
30 sec
1 min
5 min
15 min
Always on

Display
Speed
Backlight
Contrast

## Maintenance

Maintenance
Current
Relay test
Contrast

Current	
Current 1	4mA
Current 1	20mA
Current 2	4mA
Current 2	20mA

Password is needed to enter 'Current calibration', if there is no password, press 'Enter' directly.

To calibrate current:

eg: to calibrate current1 4mA;

After the user connects the multimeter to the internal 'Cur 1+' (output current one/positive) and 'Com-' (output current negative), if the multimeter displays a mA value of 3.98mA, press direction key to modify until the current value displayed on the multimeter is the corresponding milliamp value (4mA), the calibration is completed.

When testing the current1, the test leads of the multimeter should be connected to 'Cur 1+' & 'Com-', and when testing the current, it should be connected to 'Cur 2+' & 'Com-', where 'Cur 1+' and 'Cur 2' '+' is the positive pole, and 'Com-' is the negative pole, which is also the output current common terminal.

Relay test
Relay 1: On
Relay 2: On

After selecting the corresponding relay, press  [ENT] to hear a clicking sound, then the relay is judged to be normal.

## Troubleshooting

### 1. LCD display is not bright

Possible Causes: Instrument or LCD Screen power supply failure.

Solutions: Check whether the power supply is connected or not, and check whether the power supply wire of the sensor is connected in the wrong direction.

### 2. No current output

Possible Causes: It could be a fault in the current module or a wiring fault.

Solutions: Please check that the current output wiring is correct. Please refer to the wiring terminal diagram in the instructions.

### 3. The output current of the transmitter does not match the display current.

Possible Causes: Current output may not be correctly calibrated.

Solutions: Please re-calibrate the 20mA output.

### 4. There is a on the screen.

Possible causes: The transmitter does not communicate properly with the sensor. Solutions: Check whether the signal line of the sensor is correct. Please refer to the wiring diagram in the instruction.

### 5. Measurements display results fluctuate greatly.

Possible causes: Sensor wiring error or low display rate setting.

Solutions: Check wiring or increase display rate appropriately.

## Warranty

**Icon Process Controls** warrants this product to be free from significant deviations in material and workmanship for a period of one year from the date of purchase. If repair is necessary and has not been the result of abuse or misuse within the warranty period, please return to **Icon Process Controls** and amendment will be made without any charge. We Instruments Customer Service Center will determine if product problem is due to deviations or customer abuse. Out of warranty products will be repaired on a charge basis.

Authorization must be obtained from **Icon Process Controls** Customer Service Center to issue a RIR number before returning items for any reason. When applying for authorization, please include date requiring the reason of return. Instruments must be carefully packed to prevent damage in shipment and insured against possible damage or loss. **Icon Process Controls** will not be responsible for any damage resulting from careless or insufficient packing.

**Warning:** Damage as a result of inadequate packaging is the User / distributor's responsibility. Please follow the guidelines below before transporting.

Use the original packaging material if possible, when transporting back the unit for repair. Otherwise wrap it with bubble pack and use a corrugated box for better protection. Include a brief description of any faults suspected for the convenience of Customer Service Center, if possible. If there are any questions, feel free to contact our Customer Service Center or distributors.



by



# Need a great sensor?

Pair your D300 Series controller with the industry's most innovative and reliable sensing technology

[iconprocon.com](http://iconprocon.com)



Industrial Analytical Equipment



Corrosion-Free Instrumentation Equipment