

Model PM880 AC

Portable Hygrometer
User's Manual



Flow



Model PM880 AC

Portable Hygrometer

User's Manual

910-268 Rev. B
August 2021

panametrics.com

Copyright 2021 Baker Hughes company.

This material contains one or more registered trademarks of Baker Hughes Company and its subsidiaries in one or more countries. All third-party product and company names are trademarks of their respective holders.

[no content intended for this page]

Information Paragraphs

- **Note** paragraphs provide information that provides a deeper understanding of the situation, but is not essential to the proper completion of the instructions.
- **Important** paragraphs provide information that emphasizes instructions that are essential to proper setup of the equipment. Failure to follow these instructions carefully may cause unreliable performance.
- **Caution!** paragraphs provide information that alerts the operator to a hazardous situation that can cause damage to property or equipment.
- **Warning!** paragraphs provide information that alerts the operator to a hazardous situation that can cause injury to personnel. Cautionary information is also included, when applicable.

Safety Issues

WARNING! It is the responsibility of the user to make sure all local, county, state and national codes, regulations, rules and laws related to safety and safe operating conditions are met for each installation.

Auxiliary Equipment

Local Safety Standards

The user must make sure that he operates all auxiliary equipment in accordance with local codes, standards, regulations, or laws applicable to safety.

Working Area

WARNING! Auxiliary equipment may have both manual and automatic modes of operation. As equipment can move suddenly and without warning, do not enter the work cell of this equipment during automatic operation, and do not enter the work envelope of this equipment during manual operation. If you do, serious injury can result.

WARNING! Make sure that power to the auxiliary equipment is turned OFF and locked out before you perform maintenance procedures on the equipment.

Qualification of Personnel

Make sure that all personnel have manufacturer-approved training applicable to the auxiliary equipment.

Personal Safety Equipment

Make sure that operators and maintenance personnel have all safety equipment applicable to the auxiliary equipment. Examples include safety glasses, protective headgear, safety shoes, etc.

Unauthorized Operation

Make sure that unauthorized personnel cannot gain access to the operation of the equipment.

Environmental Compliance

Waste Electrical and Electronic Equipment (WEEE) Directive

Panametrics Measurement & Control Solutions is an active participant in Europe's *Waste Electrical and Electronic Equipment* (WEEE) take-back initiative, directive 2002/96/EC.



The equipment that you bought has required the extraction and use of natural resources for its production. It may contain hazardous substances that could impact health and the environment.

In order to avoid the dissemination of those substances in our environment and to diminish the pressure on the natural resources, we encourage you to use the appropriate take-back systems. Those systems will reuse or recycle most of the materials of your end life equipment in a sound way.

The crossed-out wheeled bin symbol invites you to use those systems.

If you need more information on the collection, reuse and recycling systems, please contact your local or regional waste administration.

Visit www.bakerhughesds.com/health-safetyand-environment-hse for take-back instructions and more information about this initiative.

Chapter 1. Getting Started

1.1 Powering On and Off1
 1.1.1 Powering On1
 1.1.2 Powering Off2
 1.2 Entering Data Using the Keypad2
 1.3 Entering Setup Data2
 1.3.1 Selecting Probe Type2
 1.3.2 Entering Calibration Data3
 1.4 Displaying Measurements7
 1.4.1 Selecting the Number of Measurements7
 1.4.2 Selecting the Types of Measurements7
 1.5 Saving Data in a Site File8
 1.5.1 Accessing the Site Manager8
 1.5.2 Entering a Site Name8

Chapter 2. Taking Measurements

2.1 Installing the Probe in a Sample System11
 2.1.1 Installing a Moisture Probe11
 2.2 Connecting the Sample System to the Process12
 2.3 Making Probe Connections12
 2.4 Recalling a Site File13
 2.4.1 Accessing the Site Manager13
 2.4.2 Retrieving the Site File13
 2.5 Operating the Sample System13
 2.6 Conducting a Leak Test14
 2.7 Shutting Down the Sample System14

Chapter 3. Using the PM880 AC Screen

3.1 Screen Components16
 3.2 Setting Up the Screen to Display Measurements17
 3.2.1 Selecting the Number of Views (Measurements)17
 3.2.2 Selecting the Types of Measurements17
 3.2.3 Selecting Numeric, Line or Bar Graph Format18
 3.2.4 Setting Up the Numeric Format18
 3.2.5 Adjusting the Line/Bar Graph Scale19
 3.3 Creating Function Key Shortcuts19
 3.3.1 Assigning/Re-assigning a Function Key19
 3.3.2 Clearing a Function Key20
 3.4 Using the Backlight20
 3.4.1 Turning the Backlight On and Off Manually20
 3.4.2 Setting the Backlight Timer20
 3.5 Adjusting the Contrast21
 3.6 Taking a Bitmap Screen Capture – Snapshot21

Chapter 4. Using Special Features

4.1 Selecting English or Metric Units24
 4.2 Entering Date and Time24
 4.3 Changing Date and Time Appearance24
 4.3.1 Accessing the Locale Tab24
 4.3.2 Selecting the Separator25
 4.3.3 Selecting the Date/Time Format25
 4.4 Adding a Message to a Site File25
 4.4.1 Accessing the Site Manager25
 4.4.2 Selecting a Site File25
 4.4.3 Entering a Site Message25
 4.5 Setting a Probe Calibration Reminder25
 4.5.1 Accessing the Probe ID Tab25
 4.5.2 Entering Probe Information26

4.6	Using Automatic Calibration (AutoCal)	26
4.7	Entering Constants and User Functions	27
4.8	Entering a User Constant	28
4.8.1	Entering a Saturation Constant	28
4.8.2	Entering User Functions	30
4.8.3	Setting Up User Tables	32
4.9	Using Computer Enhanced Response	33
4.9.1	Response Time Procedure	34
4.10	Entering Reference Data	35
4.11	Using Sleep Mode	35
4.11.1	Placing the PM880 AC in Sleep Mode	35
4.11.2	Resuming Operation	36
4.12	Displaying Meter Information	37
4.13	Changing the Display Language	38
4.14	Using On-Line Help	38
Chapter 5. Logging Data		
5.1	Setting Up a New Log	39
5.1.1	Creating a New Log	39
5.1.2	Entering a Log Name	40
5.1.3	Selecting General Log Settings	40
5.1.4	Selecting a Measurement to Log	41
5.2	Pausing a Log	41
5.3	Starting or Restarting a Log	42
5.4	Ending a Log	42
5.5	Viewing All Logs	43
5.6	Viewing Log Setup Details	43
5.7	Displaying Logged Data	44
5.7.1	Using the Graph Format	44
5.7.2	Using the Spreadsheet Format	46
Chapter 6. Managing Files		
6.1	Saving a New Site File	49
6.2	Recalling a Site File	50
6.3	Saving a Site File	50
6.4	Renaming a Site or Log File	50
6.4.1	Renaming a Site File	51
6.4.2	Renaming a Log File	51
6.5	Copying a Log	52
6.6	Deleting All Types of Files	54
6.7	Sorting Files in the Site/Drive/Log Manager	54
Chapter 7. Using the PM880 AC with a PC and Printer		
7.1	Setting Up PM880 AC IR Communications	56
7.1.1	Using the Add Hardware Wizard	56
7.1.2	Using Panaview	62
7.2	Transferring and Printing Files Key	64
7.3	Printing a Site or Log File	64
7.3.1	Printing a Site File	64
7.3.2	Printing a Log File	65
7.4	Printing Reports	66
7.5	Transferring a File To a PC	66
7.6	Transferring a File from a PC	68
7.6.1	Using Windows Explorer in Windows 95/98/2000	68
7.6.2	Using Windows NT 4.0	68
7.6.3	Using Windows 95/98	68
7.6.4	Using Windows 2000	68

Chapter 8. Maintenance and Troubleshooting

8.1 Checking the PM880 AC Memory Status 72

8.2 Testing the Screen 72

8.3 Testing the Keypad 73

8.4 Testing the Watchdog Timer Circuit 73

8.5 Resetting to Factory Default Settings 74

8.6 Viewing or Changing Security Settings 75

 8.6.1 Setting the Security Passcodes 75

 8.6.2 Setting Remote Access Security 76

8.7 Updating PM880 AC Software 77

 8.7.1 Upgrading Requirements 77

 8.7.2 Updating Software Using IrOBEX 78

 8.7.3 Updating Software Using IrCOMM 78

8.8 Error and Screen Messages 80

8.9 Common Problems 82

8.10 Replacing and Recalibrating the Moisture Probes 85

8.11 Recalibrating the Pressure Sensors 85

Chapter 9. Features and Specifications

9.1 The PM880 AC Hygrometer 87

9.2 Probes 87

 9.2.1 M Series and TF Series Moisture Probes 88

 9.2.2 Moisture Image Series Probe 88

9.3 Cabling 90

9.4 Overall 90

9.5 Operational 91

9.6 Electronics 91

9.7 Moisture Measurement 92

9.8 Dew/frost Point Temperature 92

9.9 Temperature Measurement 92

9.10 Pressure Measurement 92

9.11 Sample System 93

9.12 Optional Accessories 93

Chapter A. Measurement Considerations

A.1 Choosing a Measurement Site 95

A.2 Moisture/Temperature Probe Considerations 95

A.3 Sample System Guidelines 97

Chapter B. Menu Maps

Chapter 1. Getting Started

The Panametrics PM880 AC is a versatile, portable hygrometer that is designed for spot sampling moisture measurements. Although the PM880 AC offers many options, it requires only minimal setup to begin taking measurements.

This chapter is designed to provide a step-by-step guide to getting the meter up and running as quickly as possible. Additional programming options are discussed in later chapters.

Follow the sections in this chapter to setup your meter. This chapter includes the following information:

- Powering On and Off
- Entering Data Using the Keypad
- Entering Setup Data
- Displaying Measurements
- Saving Data in Site Files

1.1 Powering On and Off

1.1.1 Powering On

To turn the PM880 AC on, press the red button in the upper-right-hand corner of the keypad. Immediately upon powerup the PM880 AC displays a series of messages and performs various checks. The screen then appears similar to the one shown in Figure 1.

Note: If the meter displays a Probe Reminder message, press [ENTER].

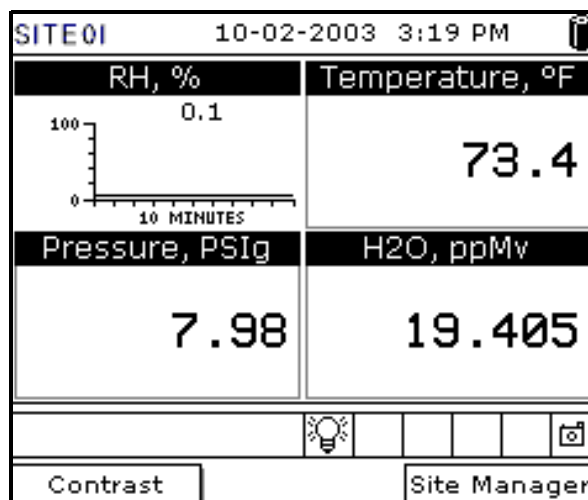

Figure 1: Screen After Powering On

Note: If the meter fails any of these tests, contact the factory.

1.1.2 Powering Off

1. To turn the PM880 AC off, press the red key for 3 seconds. The screen now appears similar to Figure 2. Press **[F1]** to shut down the PM880 AC.

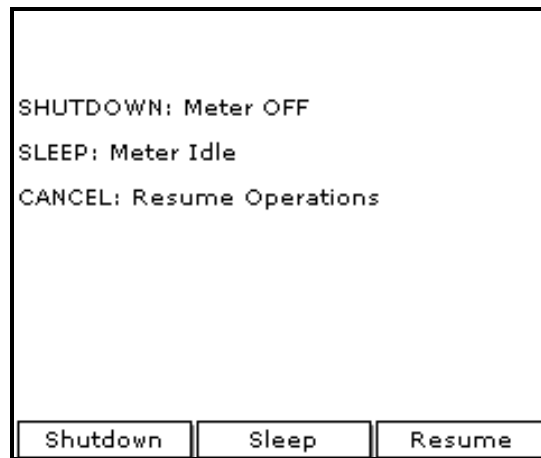

Figure 2: Shutdown Menu

1.2 Entering Data Using the Keypad

Use the information below to familiarize yourself with how to enter data using the PM880 AC keypad.

Use the arrow keys to scroll to a menu topic and then press **[ENTER]** to open the menu.

When entering data into a menu window, press:

- The **[▼]** key to scroll forward through the menu options.
- The **[▲]** key to scroll back through menu options.
- The **[F2]** key (Cancel) or the **[ESC]** key to exit a menu at any time and return to Operate Mode without changing data.

Note: If you enter an incorrect numeric value, press the **[◀]** key to erase the last digit entered.

1.3 Entering Setup Data

For immediate operation, the PM880 AC requires only a moisture probe and its corresponding calibration data. You should enter data for each site where you plan to make a measurement. Once entered, you can save it into a file that can be recalled at the measurement site. Use the sections that follow to program your meter.

Note: The PM880 AC has additional menus that enable you to tailor measurements as specifically as possible to your particular application. For more information on menu options refer to Chapter 4, Using Special Features.

1.3.1 Selecting Probe Type

Use the steps below to select the probe type for the measurement site. Refer to Figure 9 on page 17 for a menu map.

Note: You may also enter a constant value (rather than a live input) for moisture, temperature or pressure measurement. For more information refer to Entering Constants and User Functions on page 27.

1. If the menu is not active, press **[MENU]**.
2. Use the arrow key to scroll to Program and press **[ENTER]**.

- Use the arrow key to scroll to Probe and press [ENTER]. The screen appears similar to Figure 3.

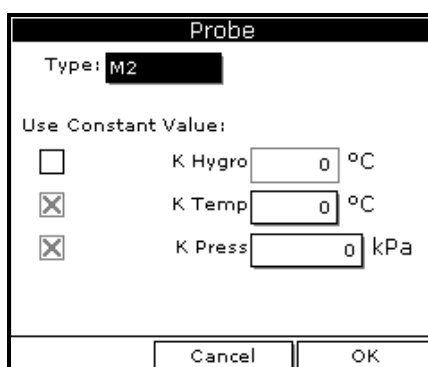

Figure 3: Probe Window

- At Type, press [ENTER] to open the drop-down list of probe types.
Note: If you do not know the probe type, refer to the Calibration Data Sheet.
- Use the arrow keys to scroll to the desired selection and press [ENTER].
- Press [F3] (OK) to exit.

Next, do one of the following:

- If you are using an M or TF Series probe, proceed to *Entering Calibration Data* on the next page.
- If you are using an MIS or an MISP2 Probe, proceed to *Displaying Measurements* on page 7.

Note: If you have an MIS probe that was sent back to the factory for calibration **without** the electronics module, you need to enter calibration data as described in *Entering Calibration Data* on page 3.

1.3.2 Entering Calibration Data

The PM880 AC needs moisture and/or pressure calibration data for probes. You must enter this data when setting up:

- a new unit
- a probe(s) sent back to the factory for calibration

Be sure you have the **Calibration Data Sheets** that are supplied with each Panametrics probe. Each Calibration Data Sheet consists of a list of data points that you will need to enter or verify, and lists its corresponding probe serial number. Calibration Data Sheets are usually packed inside the probe cases.

Since the PM880 AC enables you to use more than one probe, the meter provides a place to enter the probe serial number to help you match the probes to the corresponding site files. The probe serial number is stored as part of the site file.

Use the sections which follow to enter the serial number, and the moisture and pressure calibration data for the probes.

1.3.2.1 Entering Probe ID

- If the menu is not active, press [MENU].
- Use the arrow key to scroll to Program and press [ENTER].
- Use the arrow key to scroll to Calibrate and press [ENTER].

- Use the arrow keys to scroll to the Probe ID tab and press **[ENTER]**. A screen similar to Figure 4 appears.

The screenshot shows a window titled "Calibration - [0123456]". At the top, there are four tabs: "Hygro", "Pressure", "Saturation", and "Probe ID", with "Probe ID" being the active tab. Below the tabs, there are four input fields: "S/N:" with the value "123456" and a "PR" dropdown menu; "Calibrated On:" with the date "01-01-2003"; and "Cal Reminder:" with the value "12 Months". At the bottom of the window, there are two buttons: "Cancel" and "OK".

Figure 4: Probe ID Window

- Use the arrow keys to scroll to S/N and press **[ENTER]**.
- Use the numeric keys to enter the serial number from the Calibration Data Sheet and press **[ENTER]**. The serial number also appears on the hex nut of the moisture probe.
- Use the arrow keys to scroll to the suffix box and press **[ENTER]** to open the drop-down list.
- Use the arrow keys to scroll to the desired suffix and press **[ENTER]**.
- Press **[F3]** (OK) to exit.

1.3.2.2 Entering Moisture Calibration Data

You need to enter calibration data for M and TF Series probes only. The Moisture Image[®] Series (MIS) probes store all calibration data in their electronics module, and upload it into the PM880 AC memory when needed.

Note: *It is not necessary to enter calibration data for the Moisture Image Series (MIS) probe unless you send it back to the factory for calibration **without** its electronics module. If this is the case, you must manually enter the calibration data as described below.*

Note: *It is not necessary to enter calibration data for the MISP2 probe.*

Enter moisture calibration data (MH or FH) and dewpoint readings (up to 20 data points) for the moisture probe as described below. Refer to Figure 9 on page 17 for a menu map.

Note: *If you are using an MIS probe and do not need to enter data, proceed to Displaying Measurements on page 7.*

- If the menu is not active, press **[MENU]**.
- Use the arrow key to scroll to Program and press **[ENTER]**.
- Use the arrow key to scroll to Calibrate and press **[ENTER]**.
- If necessary, use the arrow key to scroll to Hygro and press **[ENTER]**. A screen appears similar to Figure 5 on page 5.
- Press **[▼]** to move the pointer to the 00/MH box in the calibration table.
- Press **[ENTER]** to change the value. Use the numeric keys to enter the desired MH or FH value, and press **[ENTER]**.

Calibration - [0301728]			
Hygro	Pressure	Saturation	Probe ID
##	MH	Dew Point C	
00	0.2709	-110.0	
01	0.2813	-100.0	
02	0.2921	-90.0	
03	0.3033	-80.0	
04	0.3150	-70.0	

Cancel OK

Figure 5: Hygro Window in Calibration

7. Press [▶] to move to the next text box, and press [ENTER]. Use the numeric keys to enter the corresponding dewpoint reading and press [ENTER].
8. Use the arrow keys to scroll to additional data points and repeat steps 5, 6 and 7 until you have entered the values for each data point.

Note: To insert an additional data point, press [F1] (Insert).
To delete a data point, press [F2] (Delete).

9. When you have completed entering values, press [F3] (EXIT).

Next, do one of the following:

- If the probe has a pressure transducer, proceed to step 3 in *Entering Pressure Calibration Data* on page 5.
- If the probe does not have a pressure transducer, press [F3] (OK). Proceed to *Displaying Measurements* on page 7.

1.3.2.3 Entering Pressure Calibration Data

To enter calibration data for the pressure transducer, you must list the zero and span range in mV (or FP) and psig. Refer to Figure 9 on page 17 for a menu map.

1. If the menu is not active, press [MENU].
2. Use the arrow key to scroll to Program and press [ENTER].
3. Use the arrow key to scroll to Calibrate and press [ENTER].
4. Use the arrow key to scroll to Pressure and press [ENTER]. The screen appears similar to Figure 6.

Note: The corresponding mV value can be in psig (English) or kPa (metric). The supplied Calibration Data Sheets list these values in psig. If you want to change the system units, refer to Selecting English or Metric Units on page 24.

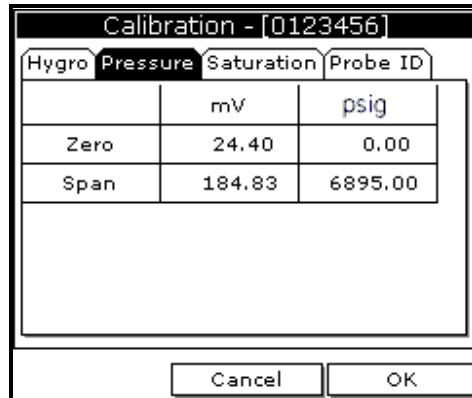

Calibration - [0123456]			
Hygro	Pressure	Saturation	Probe ID
	mV	psig	
Zero	24.40	0.00	
Span	184.83	6895.00	

Cancel OK

Figure 6: Calibration Pressure Window

5. Press [▼] to move the pointer to the Zero/mV (Zero/FP) box in the table.
6. Press [ENTER] to change the value. Use the numeric keys to enter the desired value and press [ENTER].
7. The corresponding pressure value box is highlighted. Use the numeric keys to enter the corresponding pressure value and press [ENTER].
8. The span mV box is highlighted. Repeat steps 5, 6 and 7 to enter the Span values.
9. When you have completed entering values, press [F3] (Exit).
10. Press [F3] (OK) and proceed to *Displaying Measurements*.

1.4 Displaying Measurements

The PM880 AC can display one to four measurement parameters simultaneously. There are two parts for displaying measurements: selecting the number of measurements and then selecting the type of measurements. See Figure 9 on page 17 for a menu map.

1.4.1 Selecting the Number of Measurements

1. If the menu is not active, press **[MENU]**.
2. Use the arrow keys to scroll to Site and press **[ENTER]**.
3. Use the arrow keys to move to the desired number of views or measurement windows (1 View, 2 Views, etc.).
4. Press **[ENTER]** at your selection. The screen displays the designated number of views (measurement windows).

1.4.2 Selecting the Types of Measurements

1. Press **[SEL]** or arrow keys to move the pointer to the window you want to change and press **[ENTER]**.
2. Use the arrow keys to scroll to Measurement and press **[ENTER]**. The screen appears similar to Figure 7. The left column displays the five measurement types and the right column displays the measurement units.

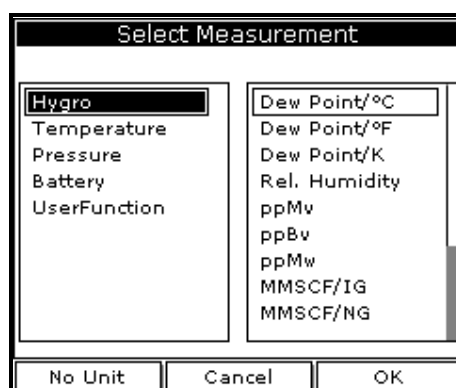

Figure 7: Select Measurement Window

3. Use the arrow keys to scroll to the desired measurement type and press **[SEL]**.
4. Use the arrow keys to select the desired measurement unit (or diagnostic parameter).

Note: Press **[F3]** (No Unit) to display a measurement with no units.

5. Press **[F3]** (OK).
6. Repeat this section for displaying other measurements.

1.5 Saving Data in a Site File

A site file contains probe ID, calibration data and display setup information in a file so it can be recalled at the measurement site. Use the following steps to store the data you have entered into a file (see Figure 9 on page 17 for a menu map):

1.5.1 Accessing the Site Manager

1. If the menu is not active, press **[MENU]**.
2. Use the arrow key to scroll to Site and press **[ENTER]**.
3. Use the arrow key to scroll to Site Manager and press **[ENTER]**.
4. Press **[MENU]**.
5. Use the arrow key to scroll to File and press **[ENTER]**.

1.5.2 Entering a Site Name

1. Use the arrow keys to scroll to New and press **[ENTER]**. The screen appears similar to Figure 8.

New Site							
SITE01							
A	B	C	D	E	F	G	H
I	J	K	L	M	N	O	P
Q	R	S	T	U	V	W	X
Y	Z	0	1	2	3	4	5
6	7	8	9	-	_	@	#
&	()					
Delete		Cancel		OK			

Figure 8: New Site Name Entry Window

2. The PM880 AC displays a default name for the file. If you want to keep the default name, skip to step 4. Otherwise, use **[F1]** to erase the name and use the arrow keys to scroll to the desired letter or number and press **[ENTER]**.
 3. Repeat this procedure until you have created the desired site name of up to eight characters.
 4. When you have finished, press **[F3]** (OK).
 5. The PM880 AC prompts you to save the site file as a template. This is useful if you need to create multiple sites with similar data. At the prompt, do one of the following:
 - Press **[F2]** (No) if you do not need to use a template, or
 - Press **[F3]** (Yes) if you do want to use it as a template.
- Note:** If you are saving a new file as a template, the PM880 AC will ask if you want to Save Current Site, press **[F2]** (No) or **[F3]** (Yes).
6. Press **[F3]** (Exit).
 7. Press **[MENU]**. The new site name is displayed in the upper left corner of the screen. You have completed entering site data.

Next, do one of the following:

- If you are done entering site data, proceed to the next chapter, *Taking Measurements*.
- If you need to enter information for another site, go back to *Entering Setup Data* on page 2.

Note: If you need to create multiple site files with similar data, you can save time by creating one site file and then using *Save As* in the Site Manager to create a copy of that site file with a different name. Refer to *Renaming a Site File* on page 51.

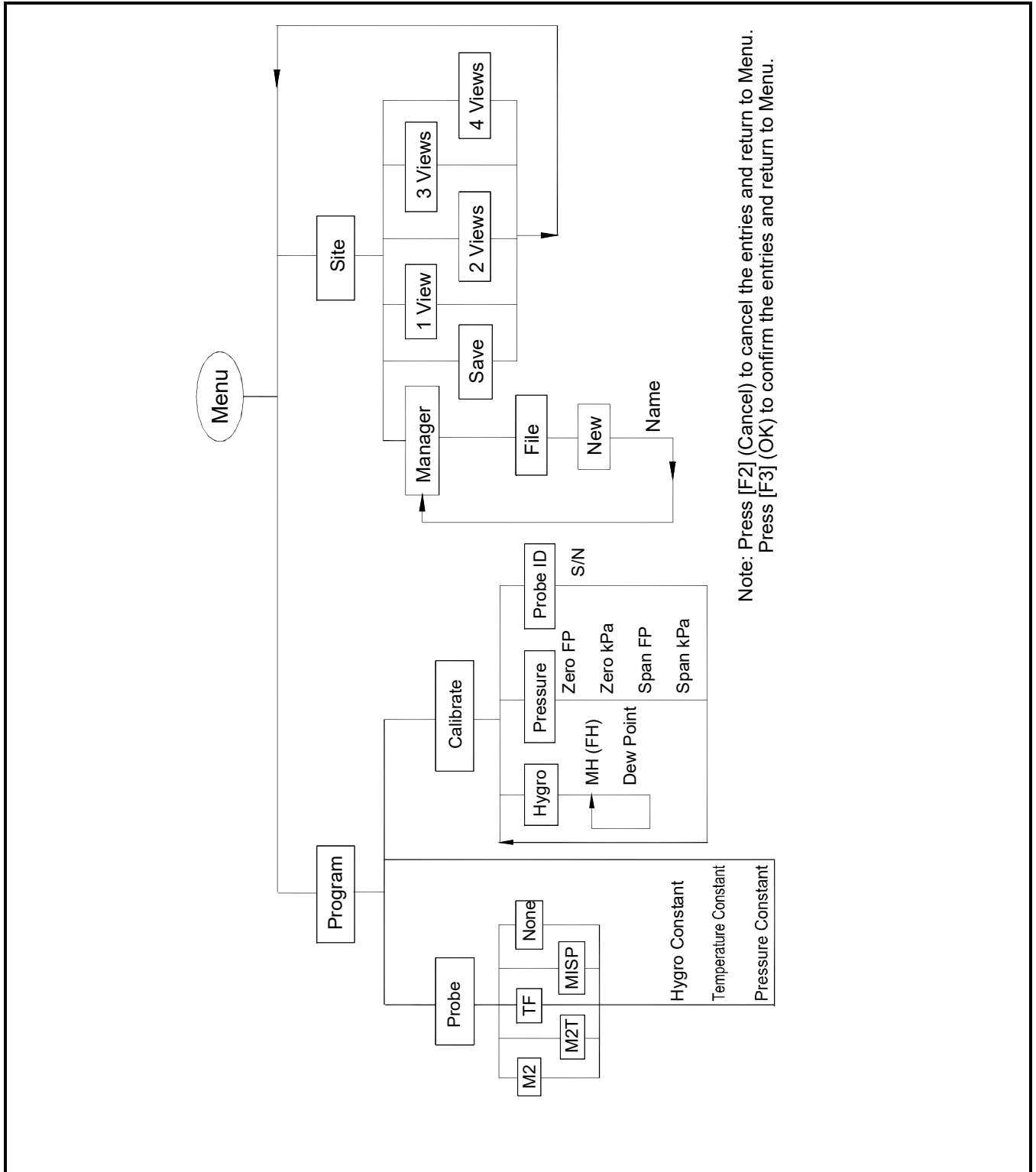

Note: Press [F2] (Cancel) to cancel the entries and return to Menu.
 Press [F3] (OK) to confirm the entries and return to Menu.

Figure 9: Startup Menu

[no content intended for this page]

Chapter 2. Taking Measurements

The PM880 AC hygrometer is part of a measurement system that includes the electronics, cable, probe and optional sample system. Once the electronics are properly programmed, you must connect the sample system and probes to begin taking measurements. This chapter discusses the steps needed to begin taking basic measurements.

Note: Refer to Appendix A, Measurement Considerations, for more information on selecting measurement sites and sample system construction.

- Installing the Probe in a Sample System
- Connecting the Sample System to the Process
- Connecting the Probe to the Electronics
- Recalling a Site File
- Operating the Sample System
- Conducting a Leak Test
- Shutting Down the Sample System

2.1 Installing the Probe in a Sample System

Moisture probes are installed into a portable sample system. The sample system protects the probes from coming into contact with damaging elements in the process.

CAUTION! If you are mounting the moisture probes directly into the process line, you must consult the factory for proper installation instructions and precautions.

2.1.1 Installing a Moisture Probe

1. Screw the probe into the receptacle fitting, making sure not to cross thread it (see Figure 10). Install moisture probes with different fittings in the appropriate manner.

Note: Standard moisture probes have a sintered stainless-steel shield that protects the aluminum oxide sensor. Leave the shield in place for maximum protection.

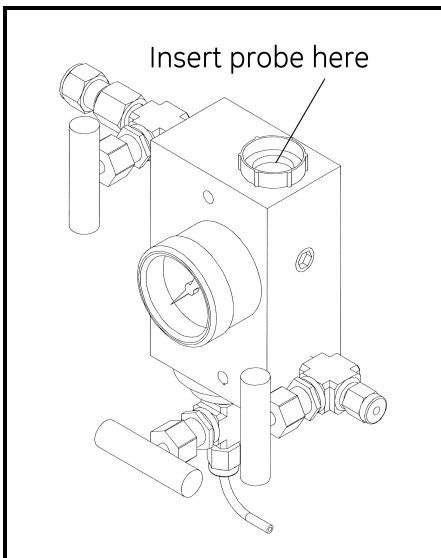

Figure 10: Probe Fitting Location

2. Hand-tighten the probe in a clockwise direction, then tighten it an additional 1/8 turn with a wrench.

2.2 Connecting the Sample System to the Process

To connect the sample system to the process at the measurement site, refer to Figure 11 and complete the following steps:

1. Crack open the existing pipeline sample tap valve to clean the sample tap.
2. Close the pipeline sample tap valve.
3. Remove the sample system from its case.
4. Be sure the sample system inlet needle valve is closed and the filter/coalescer outlet needle valve and sample outlet needle valve are open.
5. Connect the sample system to the sample tap. We recommend using 1/4" stainless steel tubing. The distance from the sample tap to the sample system should be as short as possible, typically 5 to 15 feet (1.5 to 4.5 m). A male NPT process connection is provided.

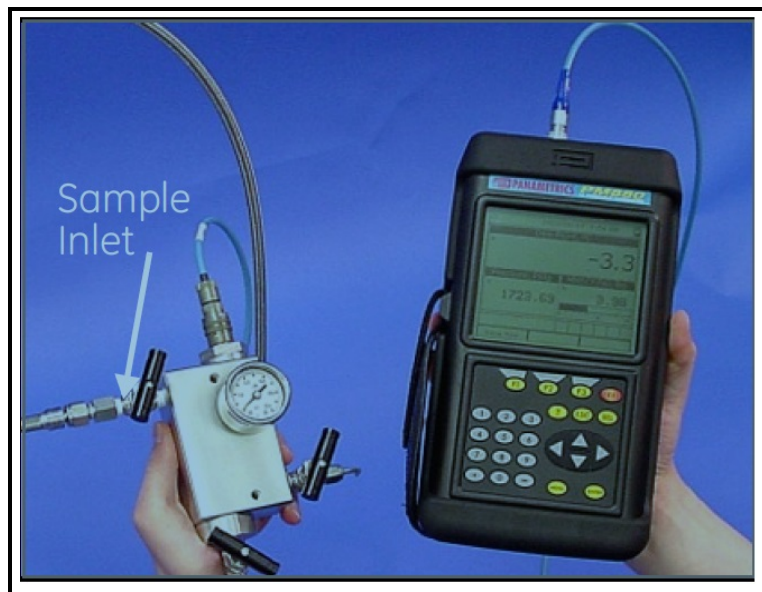

Figure 11: The Sample System and the PM880 AC

2.3 Making Probe Connections

Use the following steps to make probe connections:

1. Make sure the PM880 AC is turned off.
2. Connect the cable to the probe by inserting the bayonet-type connector onto the probe and twisting the shell clockwise until it snaps into a locked position.

Note: *The connector on the probe cable must be rotated until it aligns with the pins in the probe connector, before the cable may be properly inserted into the probe and secured.*

3. Connect the other end of the probe cable to the top of the unit by aligning the red dot on the cable connector at the 12 o'clock position. See Figure 12 for the connector location.

Note: Remove the probe cable by pulling back the spring-loaded sleeve and pulling the cable out of the connector.

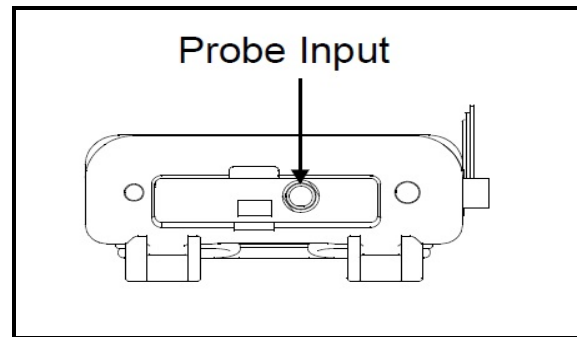

Figure 12: Connection Locations

WARNING! TO ENSURE THE SAFE OPERATION OF THE PM880 AC, YOU MUST INSTALL AND OPERATE IT AS DESCRIBED IN THIS MANUAL. IN ADDITION, BE SURE TO FOLLOW ALL APPLICABLE SAFETY CODES AND REGULATIONS FOR INSTALLING ELECTRICAL EQUIPMENT IN YOUR AREA.

2.4 Recalling a Site File

To begin taking measurements you must recall the site file that contains data for the measurement site where you want to take measurements.

2.4.1 Accessing the Site Manager

1. If the menu is not active, press **[MENU]**.
2. Use the arrow key to scroll to Site and press **[ENTER]**.
3. Use the arrow key to scroll to Site Manager and press **[ENTER]**.

2.4.2 Retrieving the Site File

1. Use the arrow key to scroll to the desired site and press **[MENU]**.
2. Use the arrow key to scroll to File and press **[ENTER]**.
3. Use the arrow key to scroll to Open and press **[ENTER]**.
4. The PM880 AC asks you to confirm, press **[F3]** (Yes).
5. Press **[F3]** (Exit).
6. Press **[MENU]**. The PM880 AC displays the selected site file in the upper-left corner of the screen.

2.5 Operating the Sample System

Refer to Figure 13 while performing this procedure.

1. Crack open the sample inlet valve allowing a low volume purge of the sample system.
2. **Very slowly** open the inlet valve allowing it to reach process pressure.
3. Begin closing the filter/coalescer outlet needle valve and the sample outlet valve until both valves are **nearly** closed.
4. Adjust the sample outlet needle valve and the filter/coalescer outlet valve until you feel a slight pressure against your finger at the venting tubes.
5. Open the inlet valve fully. Be sure the flow out of the venting tubes remains the same as in step 4. To prevent physical damage, do not subject the probe to excessive flow.

6. Turn on the PM880 AC.

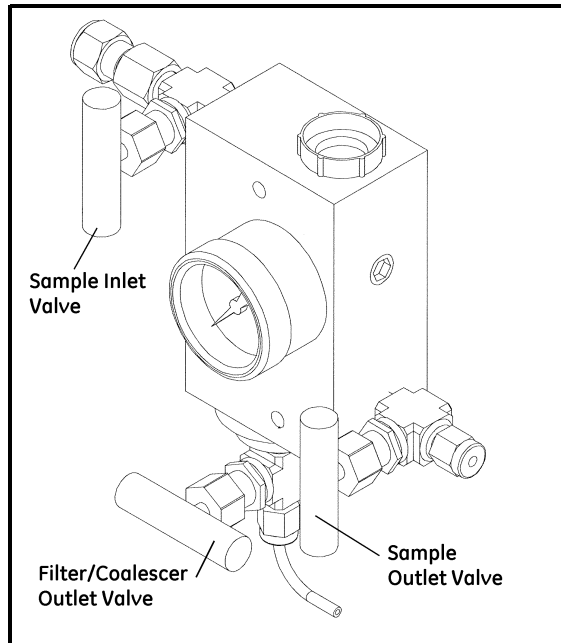

Figure 13: Sample System Valve Locations

2.6 Conducting a Leak Test

It is important to eliminate all leaks for safety reasons and to be sure that measurements are not affected by ambient contamination. Use Snoop Leak Detector or a soapy solution to verify that all connections, valves and fittings are leak tight. Tighten any fittings where a leak is detected.

2.7 Shutting Down the Sample System

1. Close the sample outlet needle valve.
2. Slowly open the filter/coalescer outlet needle valve several turns to blow out any contaminants that may have accumulated in the coalescer, valve, or venting tube.
3. Slowly close the sample inlet valve and allow the sample system to depressurize at a rate of approximately 10 psig per second.
4. Close the sample tap valve (permanently mounted on the pipeline).
5. Crack the inlet needle valve to relieve the pressure between the sample tap valve and the inlet needle valve.
6. Completely close all three sample system valves.
7. Remove the sample system from the process, while keeping all valves fully closed to avoid moisture contamination from the ambient air.

Chapter 3. Using the PM880 AC Screen

Use the sections that follow to setup and make adjustments to the PM880 AC screen. This chapter discusses the following:

- Screen Components - page 16
- Setting Up the Screen to Display Measurements - page 17
- Creating Function Key Shortcuts - page 19
- Using the Backlight - page 20
- Adjusting the Contrast - page 21
- Taking a Bitmap Screen Capture (Snapshot) - page 21

3.1 Screen Components

The PM880 AC screen displays various information (see Figure 14). The top line of the screen is the **status bar** that displays the current site, time, and date during normal operation. However, the status bar changes to a **menu bar** during programming.

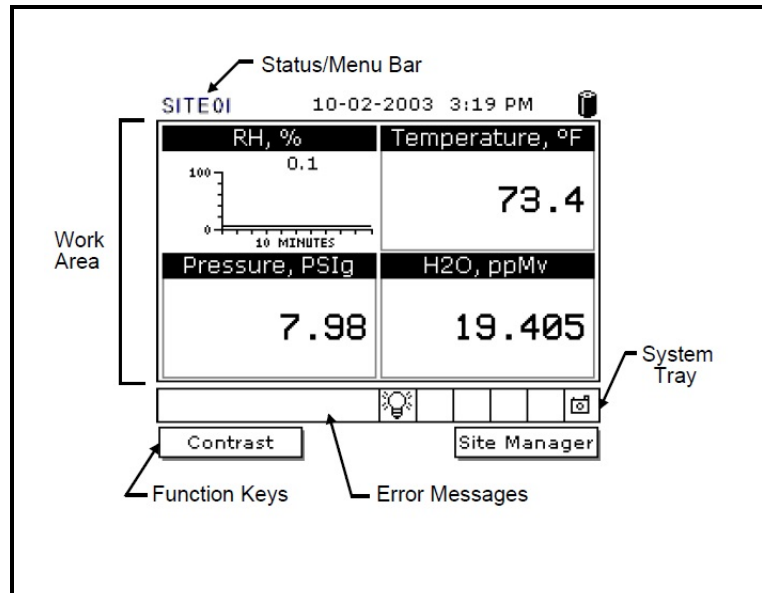







Figure 14: PM880 AC Screen in Operate Mode

The middle of the screen is the **work area** that displays measurements numerically or as bar or line graphs. During programming, the work area displays menu prompts. The bottom of the screen displays **error messages** (see *Error and Screen Messages* on page 80 for more details), the **system tray**, and the **function keys**. The system tray displays icons that indicate meter operations not otherwise shown (see Table 1 on page 17 for a list of icons). The three function keys (F1, F2 and F3) have different functions, depending on the task you are performing

Table 1: Icons in the System Tray

Icon	Function	Meaning
	IR Transfer	IR data transfer in progress.
	Alert	Indicates the meter encountered an error in operation.
	Log	Indicates a log is pending (no marks) or running (marks).
	Backlight	Indicates that backlight has been activated.
	Snapshot (To file)	Indicates that the Snapshot function has been activated, so users can take screen captures.
	(To Printer)	

3.2 Setting Up the Screen to Display Measurements

The PM880 AC can display one to four measurements simultaneously. After you select how many measurements to display, you can select the type of measurements (dewpoint, temperature, etc.) and the format (numeric, line or bar graph). In addition, the PM880 AC offers various options for displaying data numerically and graphically.

This section consists of the following:

- Selecting the Number of Views (Measurements) - page 17
- Selecting the Types of Measurements - page 17
- Selecting Numeric, Line or Bar Graph Format - page 18
- Setting Up the Numeric Format - page 18
- Adjusting the Line/Bar Graph Scale - page 19

Use the section(s) that follow to set up the PM880 AC screen.

3.2.1 Selecting the Number of Views (Measurements)

1. If the menu is not active, press **[MENU]**.
2. Use the arrow keys to scroll to Site and press **[ENTER]**.
3. Use the arrow keys to move to the desired number of views or measurement windows (1 View, 2 Views, etc.).
4. Press **[ENTER]** at your selection. The screen displays the designated number of views (measurement windows).

3.2.2 Selecting the Types of Measurements

1. Press **[SEL]** to move the pointer to the window you want to change and press **[ENTER]**.
2. Use the arrow keys to scroll to Measurement and press **[ENTER]**. The screen appears similar to Figure 15. The left column displays the five measurement types and the right column displays the measurement units.
3. Use the arrow keys to scroll to the desired measurement type and press **[SEL]**.
4. Use the arrow keys to select the desired measurement unit (or diagnostic parameter).

Note: Press **[F3]** (No Unit) to display a measurement with no units.

5. Press **[F3]** (OK).
6. Repeat this section for displaying other measurements.

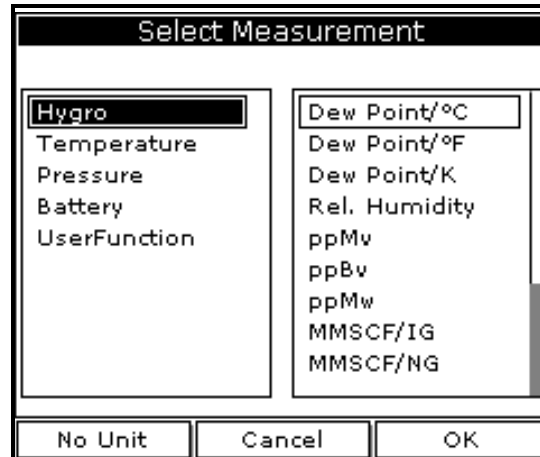

Figure 15: Select Measurement Window

3.2.3 Selecting Numeric, Line or Bar Graph Format

1. Press [SEL] to move the pointer to the window you want to change and press [ENTER].
2. Use the arrow keys to scroll to View and press [ENTER].
3. Use the arrow keys to select the desired format and press [ENTER].

The PM880 AC displays the desired format and returns to taking measurements.

3.2.4 Setting Up the Numeric Format

1. Press [SEL] to move the pointer to the window you want to change and press [ENTER].
2. Use the arrow keys to scroll to Format and press [ENTER]. The screen appears similar to Figure 16.

Note: If *FORMAT* does not appear in the menu, move to a window that is *not* displaying a line or bar graph, or change the window format to numeric as described in the previous section.

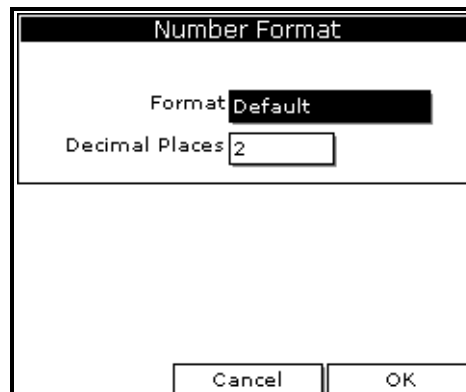

Figure 16: Number Format Window

3. Use the arrow keys to scroll to Format and press [ENTER].
4. Use the arrow keys to select the desired selection and press [ENTER]. You can select from the following:
 - Default - displays the factory default number of decimal digits for the selected measurement.
 - Fixed Decimal - specifies how many digits are to the right of the decimal.
 - Scientific format - displays the value in mantissa exponent format (expressed to the power of 10).
5. Repeat steps 3 and 4 for Decimal Places or proceed to the next step to exit. You can select from 0 to 4 places.
6. Press [F3] (OK). The PM880 AC displays the new format and resumes taking measurements.

3.2.5 Adjusting the Line/Bar Graph Scale

The scale of the line and bar graph can be adjusted at any time. You can also alter the graph to display details as follows:

1. Press **[SEL]** to move the pointer to the window you want to change and press **[ENTER]**.
2. Use the arrow keys to scroll to Limits and press **[ENTER]**. A screen similar to Figure 17 appears

Figure 17: Line Graph Parameters Window

3. Use the arrow keys to scroll to Minimum and press **[ENTER]**.
4. Use the numeric keys to enter the minimum value for the graph and press **[ENTER]**.
5. Repeat steps 3 and 4 for the maximum value.
6. Do one of the following:
 - If you are using a line graph, proceed to step 7.
 - If you are using a bar graph, proceed to step 10.
7. Use the arrow keys to scroll to the time interval and press **[ENTER]**.
8. There are two boxes for entering the time interval. The first box is for a number (1, 2, etc.). The second box asks for the interval (seconds, minutes, hours or days). Use the numeric keys or arrow keys to select the desired interval and press **[ENTER]**.
9. The last three selections enable you to enhance the line graph details. Use the arrow keys to scroll to the desired entry and press **[ENTER]**.
An X in the box activates the option. Choose from the following:
 - Use lines (connect points on graph with lines)
 - Plot average value (not currently available)
 - Show minimum and maximum (not currently available)
10. Press **[F3]** (OK).

The PM880 AC displays the new format and returns to taking measurements.

3.3 Creating Function Key Shortcuts

The three function keys at the bottom of the PM880 AC screen can be customized to provide shortcuts to the most commonly used functions. For example, the F1 key can be assigned to go directly to the Log Manager. Once assigned, a function key can also be cleared. Use the sections below to perform the desired function.

3.3.1 Assigning/Re-assigning a Function Key

The function keys can be assigned using two methods as described below.

Note: You can re-assign the function key at any time by assigning a different function.

3.3.1.1 Method 1: Using the Site Manager

1. If the menu is not active, press **[MENU]**.
2. Use the arrow key to scroll to Site and press **[ENTER]**.
3. Use the arrow key to scroll to FKeys and press **[ENTER]**.
4. Use the arrow keys to scroll to the desired key and press **[ENTER]**.
5. Use the arrow keys to scroll to the desired function from the displayed list.
6. Press **[F3]** (YES).

The PM880 AC returns to taking measurements. The newly assigned function appears above the assigned function key.

3.3.1.2 Method 2: Using the Program Menus

1. Use the keypad to go to the function that you want to assign to the function key.
2. Press the desired function key. A window appears with the question, "Assign current menu command (XX) to FKeyX?"
3. Press **[F3]** (OK).

The PM880 AC returns to taking measurements. The newly assigned function appears above the assigned function key.

3.3.2 Clearing a Function Key

1. If the menu is not active, press **[MENU]**.
2. Use the arrow key to scroll to Site and press **[ENTER]**.
3. Use the arrow key to scroll to FKeys and press **[ENTER]**.
4. Use the arrow keys to scroll to Clear F1 (F2 or F3) and press **[ENTER]**.

The PM880 AC returns to taking measurements. The previously assigned function is erased.

3.4 Using the Backlight

The PM880 AC has a backlight that helps in viewing data. Since the backlight uses more energy, the PM880 AC has a backlight timer that can be set to automatically turn the backlight off after a specified time. The PM880 AC also enables you to turn the backlight on and off manually. Use the sections that follow to operate the backlight.

3.4.1 Turning the Backlight On and Off Manually

To manually turn the backlight:

- On - press any key on the keypad and the backlight will stay on for the programmed interval. You can also press the power key briefly (about one-half second) and the backlight will stay on for 30 minutes.
- Off - press the red power key briefly (about one-half second).

3.4.2 Setting the Backlight Timer

1. If the menu is not active, press **[MENU]**.
2. Use the arrow key to scroll to Meter and press **[ENTER]**.
3. Use the arrow key to scroll to Backlight and press **[ENTER]**.
4. Use the arrow key to scroll to Backlight Off and press **[ENTER]**.
5. Use the numeric keys to enter the number of minutes that the backlight remains on (from 0 to 60).
6. Press **[ENTER]** to confirm the entry.
7. When you are done, press **[F3]** (OK).The PM880 AC returns to taking measurements.

3.5 Adjusting the Contrast

To adjust the screen contrast:

1. If the menu is not active, press **[MENU]**.
2. Use the arrow key to scroll to Meter and press **[ENTER]**.
3. Use the arrow key to scroll to Contrast and press **[ENTER]**. A screen similar to Figure 18 appears.

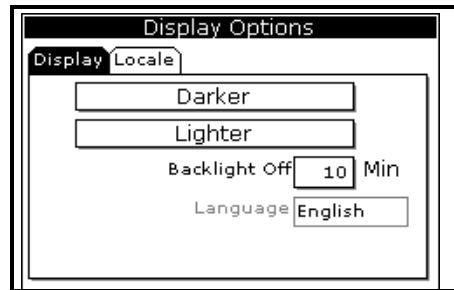

Figure 18: Display Options Window

4. Use the arrow keys to scroll to Darker or Lighter.
5. Press the **[ENTER]** button repeatedly until the screen has the desired contrast.
6. When you are done, press **[F3]** (OK).

The PM880 AC returns to taking measurements.

3.6 Taking a Bitmap Screen Capture – Snapshot

The Snapshot option enables you to take a screen capture of the current screen in bitmap format (.bmp). Bitmaps can be stored in a file or sent directly to a printer. To take a “snapshot” of the screen:

1. If the menu is not active, press **[MENU]**.
2. Use the arrow key to scroll to Meter and press **[ENTER]**.
3. Use the arrow key to scroll to Snapshot and press **[ENTER]**.
4. Use the arrow key to scroll to the desired selection and press **[ENTER]**. You can choose from the following:
 - Off - to turn the snapshot feature off.
 - To Printer - to send the snapshot to the printer.
 - To File - to send the snapshot to a file.

Note: *In order to send a screen capture to a printer, the PM880 AC must be properly configured to IR transfer. Refer to Setting Up the PM880 AC IR Communications on page 56.*

An icon of a printer or camera appears on the system tray (see page 16) indicating that you have activated the Snapshot option.

5. To capture a screen, press the “.” (decimal) button twice. The meter displays a clock and the message “Screen Dump,” indicating that it is performing a screen capture.

Note: *The snapshot function is deactivated once the power is turned off.*

6. If you selected:
 - To Printer - the PM880 AC indicates it is looking for a receiving printer and then transmits the file.

Note: *If the sensor cannot locate a printer, a window appears indicating that it cannot find a device. If it locates more than one compatible infrared device within its range, it asks you to select the desired device.*

- To File - the captured file appears as *ScreenXX.bmp* in the Drive Manager. To transfer the file to a PC, follow the instructions in *Transferring a File to a PC* on page 66.

[no content intended for this page]

Chapter 4. Using Special Features

The PM880 AC has a variety of other features to make operation even more convenient. Below are some of the features available. For other features related to testing and service functions, refer to Chapter 8, *Maintenance and Troubleshooting*.

- Selecting English or Metric Units - page 24
- Entering Date and Time - page 24
- Changing the Date and Time Appearance - page 24
- Adding a Message to a Site File - page 25
- Setting a Probe Calibration Reminder - page 25
- Using Automatic Calibration - page 26
- Entering Constants and User Functions - page 27
- Using Computer Enhanced Response - page 33
- Entering Reference Data - page 35
- Using the Sleep Mode - page 35
- Displaying Meter Information - page 37
- Changing the Display Language - page 38
- Using On-Line Help - page 38

4.1 Selecting English or Metric Units

The PM880 AC enables you to select either English or Metric for global measurement units. The selected units become the default settings for every measurement with the metric/English option. To select measurement units:

1. If the menu is not active, press **[MENU]**.
2. Use the arrow key to scroll to Meter and press **[ENTER]**.
3. Use the arrow key to scroll to Units and press **[ENTER]**.
4. Use the arrow keys to scroll to the desired units and press **[ENTER]**.
5. Press **[F3]** (OK) and then **[MENU]**.

The PM880 AC returns to taking measurements.

4.2 Entering Date and Time

The PM880 AC displays the current date and time above the measurements in the upper right corner of the screen. The Date/Time command enables you to set the date or time. The current date and time are required for correct data logging operation.

1. If the menu is not active, press **[MENU]**.
2. Use the arrow key to scroll to Meter and press **[ENTER]**.
3. Use the arrow key to scroll to Date/Time and press **[ENTER]**.
4. Use the arrow keys to scroll to Date and press **[ENTER]**.
5. Use the numeric and arrow keys to enter the current month, day and year, and press **[ENTER]**.
6. Use the arrow keys to scroll to Time and press **[ENTER]**.
7. Use the numeric and arrow keys to enter the current time and press **[ENTER]**.
8. Press **[F3]** (OK) and then **[MENU]**.

The PM880 AC returns to taking measurements. The new date and time are displayed.

4.3 Changing Date and Time Appearance

In addition to setting the correct date and time, you can also change its presentation to suit local preferences. You can select from various date formats and a time display of AM/PM or 24-hour time. Use the following steps to alter the date and time display:

4.3.1 Accessing the Locale Tab

1. If the menu is not active, press **[MENU]**.
2. Use the arrow key to scroll to Meter and press **[ENTER]**.
3. Use the arrow key to scroll to Locale and press **[ENTER]**. A screen similar to Figure 19 appears.

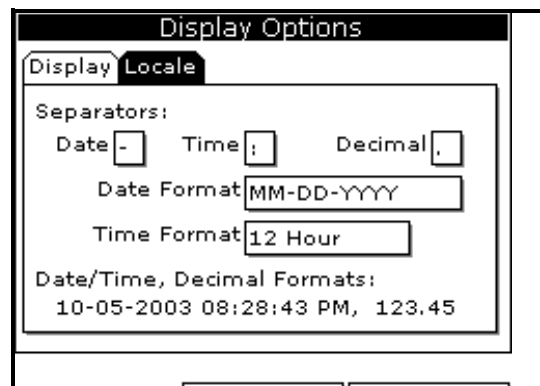

Figure 19: Locale Tab

4.3.2 Selecting the Separator

1. Use the arrow keys to scroll to the date separator and press **[ENTER]**.
2. Use the arrow keys to scroll to the desired separator and press **[ENTER]**.
3. Repeat steps 1 and 2 for the other separators.

4.3.3 Selecting the Date/Time Format

1. Use the arrow keys to scroll to Date Format and press **[ENTER]**.
2. Use the arrow keys to scroll to the desired format and press **[ENTER]**.
3. Repeat steps 1 and 2 for the time format.
4. Press **[F3]** (OK) and then press **[MENU]**.

The PM880 AC returns to taking measurements. The new date and time formats are displayed.

4.4 Adding a Message to a Site File

The Site Manager has a command that enables you to enter a message or description for each site file (up to 30 characters). The Site Manager displays the site message with the other file information. Use the following steps to add a site message:

4.4.1 Accessing the Site Manager

1. If the menu is not active, press **[MENU]**.
2. Use the arrow key to scroll to Site and press **[ENTER]**.
3. Use the arrow key to scroll to Site Manager and press **[ENTER]**.

4.4.2 Selecting a Site File

1. Use the arrow key to scroll to the desired site.

Note: *The list of site files in the Site Manager can be listed chronologically or alphabetically. Refer to Sorting Files in the Site/Drive/Log Manager on page 54.*

2. Press **[MENU]**.
3. Use the arrow key to scroll to Site and press **[ENTER]**.
4. Use the arrow key to scroll to Message and press **[ENTER]**.

4.4.3 Entering a Site Message

1. Press **[F1]** (Delete) to delete any unwanted letters or numbers. Use the arrow keys to scroll to the desired letter or number and press **[ENTER]**. To change case or use special characters, press **[SEL]** to change the character pages.
2. Repeat this procedure until you have created the desired site message.
3. When you have finished, press **[F3]** (OK).

New site information is displayed when the site is selected in Site Manager.

4. Press **[F3]** (Exit).

4.5 Setting a Probe Calibration Reminder

The Probe ID command enables you to enter the probe serial number, calibration dates and a calibration reminder. Use the following steps to enter probe data:

4.5.1 Accessing the Probe ID Tab

1. If the menu is not active, press **[MENU]**.
2. Use the arrow key to scroll to Program and press **[ENTER]**.
3. Use the arrow key to scroll to Calibrate and press **[ENTER]**.

- Use the arrow keys to scroll to the Probe ID tab and press **[ENTER]**. A screen similar to Figure 20 appears.

Figure 20: Probe ID Window

4.5.2 Entering Probe Information

- Use the arrow keys to scroll to S/N and press **[ENTER]**.
- Use the numeric keys to enter the serial number from the Calibration Data Sheet and press **[ENTER]**. The serial number is also scribed on the hex nut of the moisture probe.
- Use the arrow keys to scroll to the suffix box and press **[ENTER]** to open the drop-down list.
- Use the arrow keys to scroll to the desired suffix and press **[ENTER]**.
- Use the arrow keys to scroll to Calibrated On and press **[ENTER]**.
- Use the numeric and arrow keys to enter the most recent calibration date. When you have entered the desired month, day and year, press **[ENTER]**.

Note: Refer to the calibration data sheet for the most recent calibration date.

- Use the arrow keys to move to Cal Reminder and press **[ENTER]**. This prompt asks you to select a time period for the next probe calibration. The PM880 AC will display a calibration reminder for the probe based on the last calibration date. Panametrics recommends recalibrating a probe a minimum of once a year.
- Use the arrow keys to move to the desired selection and press **[ENTER]**.
- Press **[F3]** (OK) and then **[MENU]**.

The PM880 AC returns to taking measurements.

The calibration reminder is part of the site file; therefore, if you are not planning to make any more changes to the site file, you should save the new changes. Refer to *Saving a New Site File* on page 49.

4.6 Using Automatic Calibration (AutoCal)

The PM880 AC automatically calibrates the moisture and pressure measurement circuitry (AutoCal) at a user-selected interval. Autocal compensates for any drift in the electronics. Panametrics recommends setting the AutoCal interval to 8 hours. Set a smaller AutoCal interval more frequently if the meter is exposed to extreme temperatures or weather conditions.

Note: If you are using only Moisture Image Series (MIS) probes to measure moisture, the System Menu is not available.

Use the steps below to enter an AutoCal interval:

- If the menu is not active, press **[MENU]**.
- Use the arrow key to scroll to Program and press **[ENTER]**.

- Use the arrow key to scroll to System and press [ENTER]. A screen similar to Figure 21 appears.

System Configuration	
AutoCal Interval	60 Minutes
K x PPMv	1
Response	Norm
τ System	0.6
τ Sensor	0.035
<input type="button" value="Cancel"/> <input type="button" value="OK"/>	

Figure 21: System Configuration Window

- If necessary, use the arrow keys to move to the AutoCal interval text box.
- Press [ENTER] to open the text box. Use the numeric keys to enter the desired value (in minutes) and press [ENTER].

Note: Panametrics recommends setting the Autocal interval to 8 hours (480 minutes).

The next time AutoCal occurs will depend on the length of the time interval that was selected. See the example below.

EXAMPLE:

The PM880 AC establishes a fixed schedule, beginning at midnight, using the interval specified to determine the times of subsequent AutoCals. If you enter an 8 hour time interval, AutoCal will occur 3 times per day (1 day = 1440 minutes/480 minutes = 3). The fixed schedule will be as follows:

- 8:00 a.m.
- 4:00 p.m.
- 12:00 a.m. (midnight)

If you set the 8 hour AutoCal interval at 8:10 a.m., the next AutoCal will occur at 4:00 p.m. (excluding the AutoCal performed when first leaving the System Configuration window).

Next, do one of the following:

- Use the arrow keys to move to another text box and enter additional data.
- To exit and return to taking measurements, press [F3] (OK) and then [MENU].

4.7 Entering Constants and User Functions

The PM880 AC enables you to enter two types of constants, a user constant and a saturation constant, as well as user-defined functions and tables to manipulate data.

A user constant is a fixed value that is used to multiply the moisture ppm value ($K \times \text{PPMv}$). A saturation constant is used to calculate PPMw in non-aqueous liquids. If you do not know the saturation constant of the liquid, contact the factory.

To extend programming capability, user functions enable you to program up to 8 mathematical equations. The PM880 AC also enables you to enter up to 6 tables of non-linear or empirical data to support user function equations.

This section consists of the following information:

- Entering a User Constant - page 28

- Entering a Saturation Constant – page 28
- Entering User Functions – page 30
- Setting Up User Tables – page 32

4.8 Entering a User Constant

Use the following steps to enter a user constant. The default multiplier is 1.

1. If the menu is not active, press **[MENU]**.
2. Use the arrow key to scroll to Program and press **[ENTER]**.
3. Use the arrow key to scroll to System and press **[ENTER]**. A screen similar to Figure 22 appears.
4. Use the arrow keys to move to the $K \times \text{PPM}_v$ text box and press **[ENTER]**.
5. Use the numeric keys to enter the desired value and press **[ENTER]**.

The screenshot shows a 'System Configuration' window with the following fields and values:

AutoCal Interval	60	Minutes
K x PPM _v	1	
Response	Norm	
τ System	0.6	
τ Sensor	0.035	

At the bottom of the window are two buttons: 'Cancel' and 'OK'.

Figure 22: System Configuration Window

Next, do one of the following:

- Use the arrow keys to move to another text box and enter additional data.
- To exit and return to taking measurements, press **[F3]** (OK) and then **[MENU]**.

4.8.1 Entering a Saturation Constant

The PM880 AC requires a saturation constant in order to calculate ppm_w in non-aqueous liquids. If you do not know the saturation constants of the process liquid sample, contact the factory. To enter a saturation constant (C_s), you must enter 1 to 8 data points to represent a curve of C_s (values) versus temperature.

To enter data for a saturation constant:

1. If the menu is not active, press **[MENU]**.
2. Use the arrow key to scroll to Program and press **[ENTER]**.
3. Use the arrow key to scroll to Calibrate and press **[ENTER]**.
4. Use the arrow key to scroll to Saturation tab and press **[ENTER]**. A screen similar to Figure 23 appears.

Calibration - [0123456]				
Hygro		Pressure	Saturation	Probe ID
##	Temp C	Cs		
1	- - - -	- - - -		
2	- - - -	- - - -		
3	- - - -	- - - -		
4	- - - -	- - - -		
5	- - - -	- - - -		

Cancel OK

Figure 23: Saturation Window

5. Press [▼] to move the pointer to the Temp C box in the saturation table and press [ENTER].
 6. Use the numeric keys to enter the desired temperature value and press [ENTER].
 7. With the Cs text box highlighted, press [ENTER]. Use the numeric keys to enter the corresponding Cs value and press [ENTER].
 8. Repeat steps 6 and 7 until you have entered the values for each data point.
- Note:** To insert an additional data point, press [F1] (Insert).
To delete a data point, press [F2] (Delete).
9. When you have completed entering values, press [F3] (Exit).

Next, do one of the following:

- Use the arrow keys to scroll to another tab and program additional data (if available, depending on probe type).
- To exit and return to taking measurements, press [F3] (OK) and then [MENU].

4.8.2 Entering User Functions

User functions enable you to program mathematical equations. You can use any parameter in the meter to calculate a different parameter. Use the following steps to enter a user-defined equation:

4.8.2.1 Accessing the User Function Command

1. If the menu is not active, press **[MENU]**.
2. Use the arrow key to scroll to Program and press **[ENTER]**.
3. Use the arrow key to scroll to User Functions and press **[ENTER]**. A screen similar to Figure 24 appears.

Figure 24: User Functions Window

4.8.2.2 Entering a Label for the Function

1. The Function box should be highlighted. Press **[ENTER]** to open the drop-down menu.
2. Use the arrow keys to scroll to the desired function number (User1, User2, etc.) and press **[ENTER]**.
3. Use the arrow keys to move to the Label box and press **[ENTER]**. A screen similar to Figure 25 appears.

Figure 25: Text Creation Window

4. Press **[F1]** (Delete) to delete any unwanted letters or numbers. Use the arrow keys to scroll to the desired character and press **[ENTER]**. Press **[SEL]** to view additional character selections and symbols for creating a label for the function.
5. Repeat this procedure until you have created the desired units symbol for the function of up to thirty-two characters.
6. When you have finished, press **[F3]** (OK).

4.8.2.3 Entering the Units

The steps below describe how to create a units symbol (e.g. degrees C). This label will appear on the screen when you display the user function measurement.

1. Use the arrow keys to move to the Units Sym box and press **[ENTER]**. The text creation screen appears again.
2. Press **[SEL]** to view the three screens with the available characters and symbols for creating the symbol for the units.
3. Use the arrow keys to scroll to the desired character and press **[ENTER]**. Press **[F1]** (Delete) to delete any unwanted letters or numbers. Press **[SEL]** to view additional character selections and symbols for creating a label for the function.
4. Repeat this procedure until you have created the desired label for the function of up to thirty-two characters.
5. When you have finished, press **[F3]** (OK).

4.8.2.4 Selecting Decimal Digits

1. Use the arrow keys to move to the Dec box and press **[ENTER]** to open the drop-down menu.
2. Use the arrow keys to scroll to the desired value (0-4) and press **[ENTER]**. This value refers to the number of digits to the right of the decimal point.

4.8.2.5 Entering an Equation

1. Use the arrow keys to move to the blank box at the bottom of the screen and press **[ENTER]**. A screen similar to Figure 26 appears.
2. Press **[SEL]** to view additional characters, symbols and functions for creating an equation.
3. Use the arrow keys to scroll to the desired character and press **[ENTER]**. Press **[F1]** (Delete) to delete any unwanted letters or numbers.

IMPORTANT: To enter a measurement (dewpoint, temperature, etc.) into the equation, click on MODE in the middle of the third row. The Select Measurement window appears. Select the desired measurements, press **[SEL]**, select the desired units and press **[F3]** (OK).

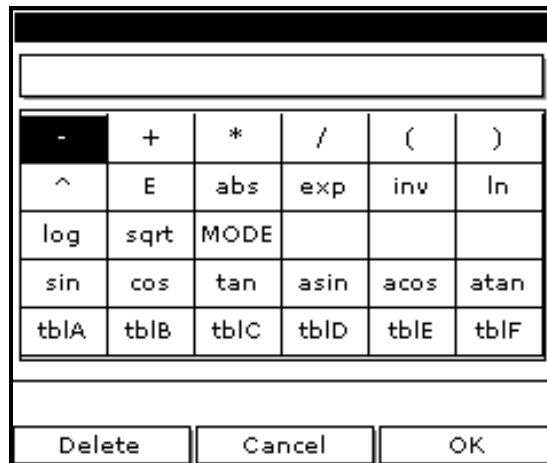

Figure 26: Function Creation Window

4. When you have finished entering the equation, press **[F3]** (OK).
5. Press **[F2]** (Check) to test the validity of the function. The PM880 AC displays either "OK" or a message such as "Syntax Error."
6. Do one of the following:
 - To edit the equation, press **[ENTER]**.
 - To delete the equation, press **[F1]** (Delete).
 - To confirm the equation and return taking measurements, press **[F3]** (Done) and then press **[MENU]**.

Note: To display the user function on the screen, refer to Displaying Measurements on page 7. In the Select Measurement window, choose Userfunction and then the units you entered above.

4.8.3 Setting Up User Tables

To support user-defined functions, the PM880 AC can hold up to 6 tables of non-linear or empirical data. Users can enter up to 21 X-Y pairs in each table. The user functions can supply an X value with Table (X). The meter then interpolates the Y value for a given X, and substitutes it for Table (X) in the function. (The results are extrapolated if the X value exceeds the bounds of the table.) Use the following steps to set up a user table:

4.8.3.1 Accessing the User Tables Command

1. If the menu is not active, press **[MENU]**.
2. Use the arrow key to scroll to Meter and press **[ENTER]**.
3. Use the arrow key to scroll to User Tables and press **[ENTER]**. A screen similar to Figure 27 appears.

Figure 27: User Tables Window

4.8.3.2 Entering a Label for the Table

1. The Table box should be highlighted. Press **[ENTER]** to open the drop-down menu.
2. Use the arrow keys to scroll to the desired table number and press **[ENTER]**.
3. Use the arrow keys to move to the Table ID box and press **[ENTER]**. A screen similar to Figure 28 appears.

A	B	C	D	E	F	G	H	I	J
K	L	M	N	O	P	Q	R	S	T
U	V	W	X	Y	Z	0	1	2	3
4	5	6	7	8	9	.	/	,	"
'	=	<	>						

Figure 28: Text Creation Window

4. Use the arrow keys to scroll to the desired character and press **[ENTER]**. Press **[F1]** (Delete) to delete any unwanted letters or numbers. Press **[SEL]** to view the three screens with the available characters and symbols for creating a label for the table.

5. Repeat this procedure until you have created the desired label for the table of up to thirty-two characters.
6. When you have finished, press **[F3]** (OK).

Note: *It is not necessary to enter the “#Data Points” or “Max Points” text boxes. The meter automatically enters this data.*

4.8.3.3 Editing the User Table

1. Use the arrow keys to move to Edit Tables box and press **[ENTER]**.
2. Press **[▼]** to move the pointer to the 1/Table ID column.
3. Press **[ENTER]** to open the text box. Use the numeric keys to enter the desired value and press **[ENTER]**.
4. Press **[▶]** to move to the next text box, and press **[ENTER]**. Use the numeric keys to enter the corresponding value and press **[ENTER]**.
5. Use the arrow keys to scroll to additional data points and repeat steps 2, 3 and 4 until you have entered the values for each data point.
6. When you have completed entering values, press **[F3]** (OK).
7. To confirm the table and return taking measurements, press **[F3]** (OK) and then press **[MENU]**.

4.9 Using Computer Enhanced Response

Computer Enhanced Response (CER) uses a dynamic moisture calibration technique to extrapolate the moisture level to the end point when making measurements in abrupt “dry down” conditions. The system response time depends on the relative change in dewpoint. For a change from ambient moisture levels to trace levels, the unit can respond in 3 to 5 minutes.

The accuracy of enhanced response is $\pm 2^{\circ}\text{C}$ of the reading the sensor would have read if it were allowed to reach equilibrium with the gas. To ensure that CER is as accurate as possible, your application should:

- have a reasonably constant final dewpoint and flow rate.
- have a minimum flow rate of one standard cubic foot per hour (SCFH).
- operate at atmospheric pressure (0 psig).
- have an actual moisture content equal to or wetter than a dew/frost point of
 - MIS Probe: -85°C
 - M Series and TF Series Probe: -110°C

Use the steps below to activate computer enhanced response:

4.9.0.1 Accessing the Response Command

1. If the menu is not active, press **[MENU]**.
2. Use the arrow key to scroll to Program and press **[ENTER]**.
3. Use the arrow key to scroll to System and press **[ENTER]**. A screen similar to Figure 29 on page 34 appears.

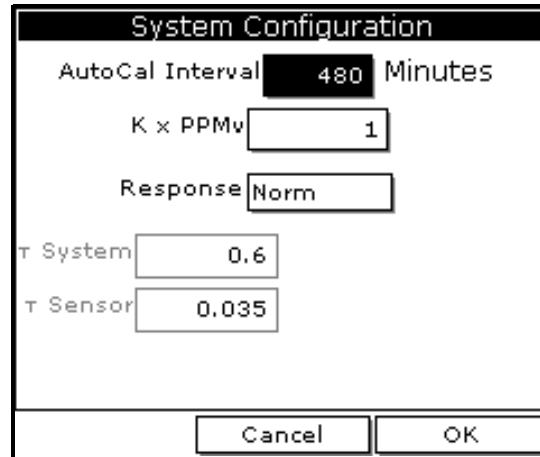

Figure 29: System Configuration Window

4.9.0.2 Selecting the Response Type

1. Use the arrow keys to move to the Response box and press [ENTER] to open the drop-down menu.
2. Use the arrow key to select the desired response type and press [ENTER]. You can choose from the following:
 - NORM - no computer enhanced response
 - CER - enable computer enhanced response
3. To return to taking measurements, press [F3] (OK) and then press [MENU].

4.9.1 Response Time Procedure

To effectively utilize CER, the following procedure should be followed:

1. Connect the moisture probe cable to the moisture probe.
2. Turn on the PM880 AC Hygrometer and activate CER per the instructions in the previous section.
3. Expose the moisture probe to the ambient air for approximately ten (10) minutes. This is the minimum amount of time needed for the sensing element to reach the equilibrium required for CER to operate properly.

Note: *The PM880 AC should display a dewpoint temperature reading in the range of 0°C to +14°C, depending on the local ambient conditions. If the dewpoint temperature exceeds +20°C, relocate the moisture probe to a drier environment to reduce the dewpoint temperature.*

Before using CER, it is necessary to purge the pressure regulator, sample tubing, and sample cell to remove trapped water molecules from the various surfaces.

Note: *The moisture probe should not be installed in the sample cell during this purge cycle. A blank probe mount can be used as a plug for the sample cell.*

4. Attach the sample gas line to a pressure regulator (set regulate to 0 psig) and sample cell with appropriate tubing (stainless steel is recommended), and allow the gas flow to purge the system.
5. After purging, remove the blank probe mount from the sample cell and install the moisture probe.

Note: *Do not disconnect the moisture probe cable from the moisture probe.*

The PM880 AC will display the actual dewpoint temperature during the initial dry-down. The display will indicate a bold "E" in the system tray which means the PM880 AC is in CER mode. After 2 to 5 minutes, the PM880 AC will perform its initial predicted calculation of the equilibrium dewpoint temperature. When the prediction is made, the display will indicate an "E" in inverse text (ie. dark background) in the system tray.

6. Continue to monitor the readings, as the PM880 AC will continue to update its prediction and record the reading once stabilized.

Note: If the dewpoint temperature increases to a wetter value during the dry down, the PM880 AC may not report a prediction and the bold "E" will remain on the display. This indicates an unstable moisture content in the gas. Verify that the system is leak tight and repeat this process.

4.10 Entering Reference Data

WARNING! DO NOT CHANGE THESE VALUES UNLESS INSTRUCTED BY Panametrics TO DO SO.

The PM880 AC requires reference values for its measurement circuitry for moisture and pressure inputs. The references are factory calibration values. These values can be found on a label.

If instructed by Panametrics to change these values, use the following steps.

1. If the menu is not active, press **[MENU]**.
2. Use the arrow keys to scroll to Service and press **[ENTER]**.
3. Use the arrow keys to scroll to References and press **[ENTER]**. The screen appears similar to Figure 30.

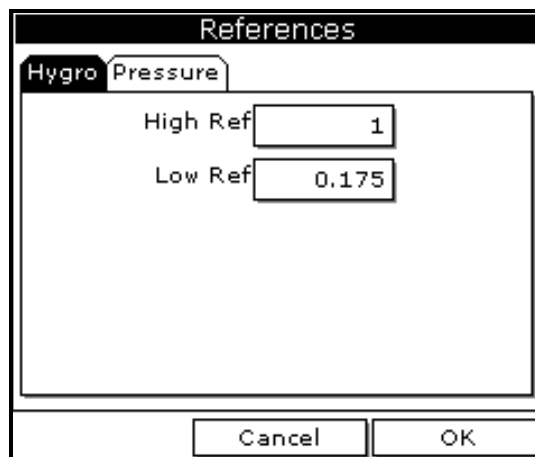

Figure 30: References Window

4. Use the arrow keys to move to the desired tab and press **[ENTER]**.
5. Use the arrow keys to move to High Ref and press **[ENTER]** to open the text box.
6. Use the numeric keys to enter the value recorded on the back of the PM880 AC and press **[ENTER]**.
7. Repeat steps 5 and 6 for the low reference value.

Next, do one of the following:

- To exit and return to taking measurements, press **[F3]** and then **[MENU]**.
- If you need to change values, use the arrow keys to move to the other tab and return to step 5 above.

4.11 Using Sleep Mode

The Sleep Mode keeps the PM880 AC in a state in which the unit appears to be off. During Sleep Mode the unit is idle and consumes less power. When you want to use the unit again, it comes out of Sleep Mode quickly, performs an AutoCal and is restored exactly as you left it.

4.11.1 Placing the PM880 AC in Sleep Mode

1. Press the red power key for 3 seconds. The screen now appears similar to Figure 31.

2. Press **[F2]** to place the PM880 AC in Sleep Mode.

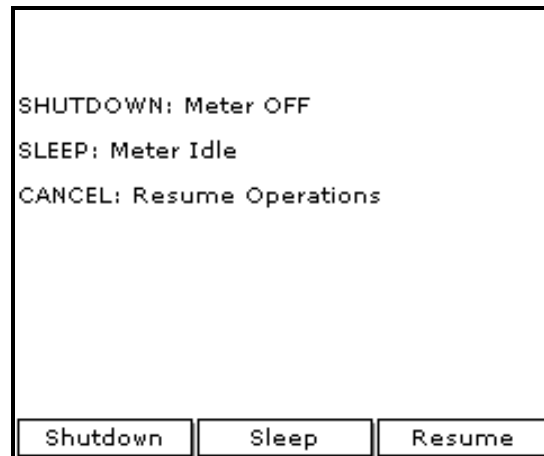

Figure 31: Shutdown Menu

4.11.2 Resuming Operation

Tap the red power key. The PM880 AC powers on, performs an AutoCal and returns to exactly where you left it.

4.12 Displaying Meter Information

The About command displays software information and other useful data specific to your meter. Use the following steps to display meter information:

1. If the menu is not active, press **[MENU]**.
2. Use the arrow key to scroll to Site and press **[ENTER]**.
3. Use the arrow key to scroll to About and press **[ENTER]**. A screen similar to Figure 32 appears.

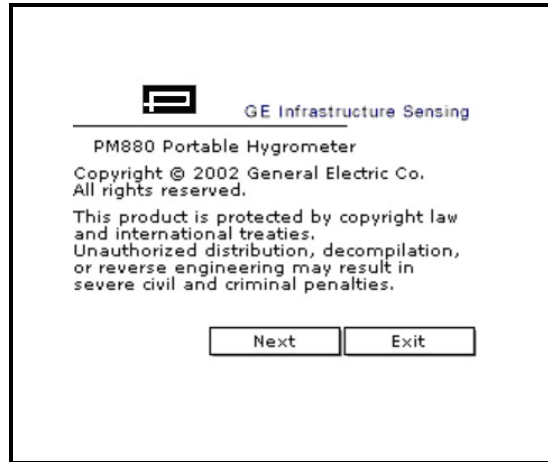

Figure 32: About Window

4. Press **[F2]** (Next) to list additional data such as the boot program, instrument program, FPGA (timing) program, language, help version, serial number and PCI number.
5. Press **[F3]** (Exit) and then press **[MENU]**.

The PM880 AC returns to taking measurements.

4.13 Changing the Display Language

The PM880 AC user program is available in several languages. To change the language:

Note: *The PM880 AC defaults to US English. However, one or more alternate languages can be installed at any time. Consult your Panametrics representative or www.bakerhughes.com for available languages.*

1. If the menu is not active, press **[MENU]**.
2. Use the arrow key to scroll to Meter and press **[ENTER]**.

Use the arrow key to scroll to Language and press **[ENTER]**. A screen similar to Figure 33 appears.

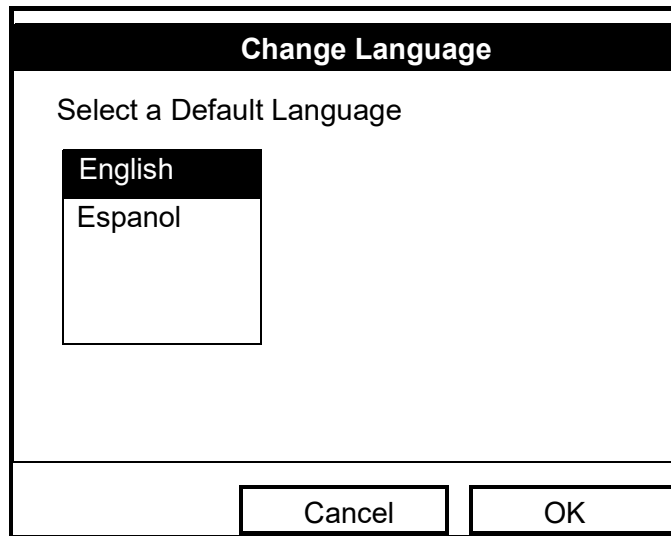

Figure 33: Language Change Window

3. Use the arrow keys to scroll to the desired language and press **[ENTER]**.
4. Press **[F3]** (OK) and then press **[MENU]**.

The meter restarts in the desired language.

4.14 Using On-Line Help

The PM880 AC offers on-line help screens that contain descriptions and instructions for various topics. You can access on-line help at any time by pressing the **[?]** key. The on-line help screen that appears depends on what the meter is doing at the time the **[?]** key is pushed. While:

- taking measurements - the on-line help screen displays a table of contents.
- in the user program - the on-line help screen displays the help screen relevant to the program menu.

Use the function keys at the bottom of the screen to navigate through on-line help.

Chapter 5. Logging Data

Data logging is one of the PM880 AC's most powerful and flexible features. The meter enables you to choose up to 12 measurements to log. Logs can run one at a time or simultaneously. Error and circular logs are also available. The logged data is internally stored in memory.

A fixed amount of memory is assigned to store logs. The frequency of the time interval, the length of the log run, and the number of logs affect the amount of memory required for a particular log. For example, a 2 hour log that records every 5 seconds will use up more memory than a 2 hour log that records every 5 minutes.

The PM880 AC also has various tools to enable the following:

- setting up a new log - page 39
- pausing a log - page 41
- starting and restarting a log - page 42
- ending a log - page 42
- viewing all logs - page 43
- viewing log setup details - page 43
- viewing logged data in graph or spreadsheet format - page 44

The PM880 AC has additional logging capabilities. For more details on these functions refer to Chapter 6, *Managing Files* and Chapter 7, *Using the PM880 AC with a PC and Printer*.

5.1 Setting Up a New Log

Use the following steps to create a new log.

Note: *If you need to create a log file that is similar to one you have already created, you can save time by copying the existing log and editing it. Refer to Copying a Log on page 52.*

5.1.1 Creating a New Log

1. If the menu is not active, press [MENU].
2. Use the arrow key to scroll to Logging and press [ENTER].
3. Use the arrow key to scroll to New Log and press [ENTER]. A screen similar to Figure 34 appears.

Note: *You can also create a new log by scrolling to Log Manager, press [ENTER], press [MENU], scroll to File, press [ENTER], scroll to New and press [ENTER].*

Create New Log							
LOG10							
A	B	C	D	E	F	G	H
I	J	K	L	M	N	O	P
Q	R	S	T	U	V	W	X
Y	Z	0	1	2	3	4	5
6	7	8	9	-	=	@	#
&	()					
Delete		Cancel		OK			

Figure 34: New Log Window

5.1.2 Entering a Log Name

1. Use the arrow keys to scroll to the desired letter or number and press [ENTER]. Press [F1] (Delete) to delete any unwanted letters or numbers.
2. Repeat this procedure until you have created the desired log name of up to eight characters.
3. When you have finished, press [F3] (OK). A screen similar to Figure 35 appears.

Figure 35: General Log Format Window

5.1.3 Selecting General Log Settings

1. The General tab displays various parameters for log setup. Use the [▼] key to scroll to Format and do the following:
 - Use the arrow keys to make a selection and press [ENTER]. Use the same procedure for Type.
 - To edit text boxes, scroll to the box and press [ENTER]. Use the [◀] and [▶] keys to scroll to the number to change and use the numeric keys to change the number and press [ENTER].

Note: If you choose to run a circular log, you will need to enter the number of records you want to log instead of an end date and time.

2. Use the arrow keys to move to the Measurements tab and press [ENTER]. A screen similar to Figure 36 appears.

NO UNIT	NO UNIT
NO UNIT	NO UNIT
NO UNIT	NO UNIT
NO UNIT	NO UNIT
NO UNIT	NO UNIT
NO UNIT	NO UNIT

Figure 36: Log Measurements Window

5.1.4 Selecting a Measurement to Log

1. Use the [▼] key to step to a box and press [ENTER]. A screen similar to Figure 37 appears.

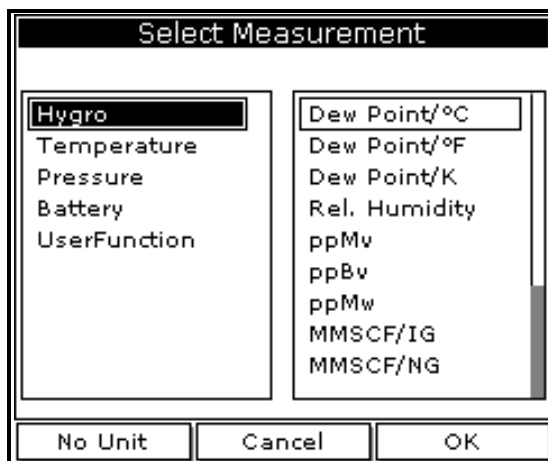

Figure 37: Select Measurement Window

2. Use the arrow keys to scroll to the desired measurement type and press [SEL].
3. Use the arrow keys to scroll to the desired units and press [F3] (OK).
4. Repeat steps 1 through 3 for up to 12 different parameters.
5. When you have finished, press [F3] (Activate) to start the log. The log will begin at the specified date and time.

Note: If you created the log from within the Log Manager, the meter returns to the Log Manager, press [F3] (Exit) and then press [MENU].

The PM880 AC returns to taking measurements. A Pencil icon appears in the bottom right-hand side of the screen.

5.2 Pausing a Log

The PM880 AC has two commands to pause logs: Pause and Pause All Logs. The PM880 AC can only pause logs that are currently running.

Note: The PM880 AC also has an End command that enables you to stop the log permanently. See Ending a Log on page 42.

Use the steps below to pause one or more logs:

5.2.0.1 Accessing the Log Manager

1. If the menu is not active, press [MENU].
2. Use the arrow key to scroll to Logging and press [ENTER].
3. Use the arrow key to scroll to Log Manager and press [ENTER].

5.2.0.2 Selecting a Log File

1. Use the arrow key to scroll to the desired log.

Note: The list of log files in the Log Manager can be listed chronologically or alphabetically. Refer to Sorting Files in the Site/Drive/Log Manager on page 54.

2. Press [MENU].
3. Use the arrow key to scroll to Log and press [ENTER].
4. Use the arrow key to scroll to Pause or Pause All Logs and press [ENTER].

The PM880 AC returns to the Log Manager, which displays the selected log as *Paused*.

Next, do one of the following:

- To pause another log, repeat the above steps.
- To return to taking measurements, press **[F3]** (Exit) and press **[MENU]**.

5.3 Starting or Restarting a Log

The Start and Start All Logs commands enable you to restart a paused log or start a pending log.

Note: *You cannot restart a log that is completed or ended using the End command.*

Use the following steps to start or restart one or more logs:

5.3.0.1 Accessing the Log Manager

1. If the menu is not active, press **[MENU]**.
2. Use the arrow key to scroll to Logging and press **[ENTER]**.
3. Use the arrow key to scroll to Log Manager and press **[ENTER]**.

5.3.0.2 Selecting a Log File

1. Use the arrow key to scroll to the desired log.

Note: *The list of log files in the Log Manager can be listed chronologically or alphabetically. Refer to Sorting Files in the Site/Drive/Log Manager on page 54.*

2. Press **[MENU]**.
3. Use the arrow key to scroll to Log and press **[ENTER]**.
4. Use the arrow key to scroll to Start or Start All Logs and press **[ENTER]**.

The PM880 AC returns to the Log Manager, which displays the selected log as *Running* or *Pending*.

Next, do one of the following:

- To start or restart another log, repeat the above steps.
- To return to taking measurements, press **[F3]** (Exit) and then press **[MENU]**.

5.4 Ending a Log

The End and End All Logs commands enables you to stop a log that is currently running or pending. Once you end a log it cannot be restarted.

Note: *The PM880 AC also has an Pause command that enables you to stop the log temporarily. See Pausing a Log on page 41.*

Use the following steps to start or restart one or more logs:

5.4.0.1 Accessing the Log Manager

1. If the menu is not active, press **[MENU]**.
2. Use the arrow key to scroll to Logging and press **[ENTER]**.
3. Use the arrow key to scroll to Log Manager and press **[ENTER]**.

5.4.0.2 Selecting a Log File

1. Use the arrow key to scroll to the desired log.

Note: *The list of log files in the Log Manager can be listed chronologically or alphabetically. Refer to Sorting Files in the Site/Drive/Log Manager on page 54.*

2. Press **[MENU]**.
3. Use the arrow key to scroll to Log and press **[ENTER]**.
4. Use the arrow key to scroll to End or End All Logs and press **[ENTER]**.

The PM880 AC returns to the Log Manager, which displays the selected log as *Finished*.

Next, do one of the following:

- To end another log, repeat the above steps.
- To return to taking measurements, press **[F3]** (Exit) and then press **[MENU]**.

5.5 Viewing All Logs

Logs are associated with the site in use at the time the log is created (or run). By default, the Log Manager displays only the logs created with the site file that is currently running. The Log Manager has a command that enables you to view all existing logs regardless of the current site file.

Use the following steps to view all existing logs (finished or pending):

5.5.0.1 Accessing the Log Manager

1. If the menu is not active, press **[MENU]**.
2. Use the arrow key to scroll to Logging and press **[ENTER]**.
3. Use the arrow key to scroll to Log Manager and press **[ENTER]**.
4. Press **[MENU]**.
5. Use the arrow keys to scroll to Log and press **[ENTER]**.
6. Use the arrow keys to scroll to View All Sites and press **[ENTER]**.
7. To return to taking measurements, press **[F3]** (Exit) and then press **[MENU]**.

5.6 Viewing Log Setup Details

The PM880 AC enables you to view more than the log details shown in Log Manager. The Details command enables you to see the log status, date and time, length, interval, types of measurements logged and service information.

5.6.0.1 Accessing the Log Manager

1. If the menu is not active, press **[MENU]**.
2. Use the arrow key to scroll to Logging and press **[ENTER]**.
3. Use the arrow key to scroll to Log Manager and press **[ENTER]**.

5.6.0.2 Selecting a Log

1. Use the arrow key to scroll to the desired log. Logs are associated with the site file in use at the time the log is created or run. If you do not see the desired log in the list, refer to *Viewing All Logs* on page 43 to display all the existing logs.

Note: *The list of log files in the Log Manager can be listed chronologically or alphabetically. Refer to Sorting Files in the Site/Drive/Log Manager on page 54.*

2. Press **[MENU]**.
3. Use the arrow key to scroll to View and press **[ENTER]**.
4. Use the arrow key to scroll to Details and press **[ENTER]**. A screen similar to Figure 38 on page 44 appears.
5. When you are done viewing the log details, press **[F3]** (Exit).

Next, do one of the following:

- To view the details of another log, press **[ESC]** and return to *Selecting a Log* on page 43.
- To exit and return to taking measurements, press **[F3]** (Exit) and then press **[MENU]**.

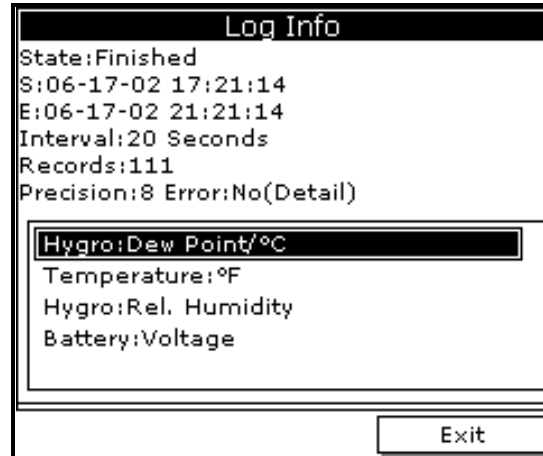

Figure 38: Log Details

5.7 Displaying Logged Data

The PM880 AC enables you to view logged data in a graph or spreadsheet format. Graphs and spreadsheets are set up in the Log Manager. Use the steps below to access the Log Manager and view logged data.

5.7.0.1 Accessing the Log Manager

1. If the menu is not active, press **[MENU]**.
2. Use the arrow key to scroll to Logging and press **[ENTER]**.
3. Use the arrow key to scroll to Log Manager and press **[ENTER]**.
4. To view logged data in:
 - graph format, refer to *Using the Graph Format* below.
 - spreadsheet format, refer to *Using the Spreadsheet Format* on page 46.

5.7.1 Using the Graph Format

5.7.1.1 Selecting a Log

1. Use the arrow key to scroll to the desired log. Logs are associated with the site file in use at the time the log is created or run. If you do not see the desired log in the list, refer to *Viewing All Logs* on page 43 and display all the existing logs in the Log Manager.

Note: *The list of log files in the Log Manager can be listed chronologically or alphabetically. Refer to Sorting Files in the Site/Drive/Log Manager on page 54.*

2. Press **[MENU]**.
3. Use the arrow key to scroll to View and press **[ENTER]**.
4. Use the arrow key to scroll to Graph and press **[ENTER]**.

5.7.1.2 Selecting a Measurement Parameter

1. The Select Measurement window appears and lists the log measurement parameters. Use the arrow keys to select the measurement parameter to graph.

Note: The above step will not appear if the log consists of one measurement type. Skip to step 3.

2. Press **[F3]**, View. A screen similar to Figure 39 appears.
3. Do one of the following:
 - To adjust the graph scale, press **[F1]** (Scale) and go to page 45.
 - To adjust the time scale, press **[F2]** (Time) and go to page 46.
 - To view the next measurement in the log, press **[SEL]**.
 - To zoom in and out by 200%, press **[▼]** to zoom in and **[▲]** to zoom out. when zoomed, use the **[◀]** and **[▶]** keys to scroll through the graph. The screen displays the range when zoomed. See Figure 39.
 - To exit and return to taking measurements, press **[F3]** (Exit) twice and then press **[MENU]**.

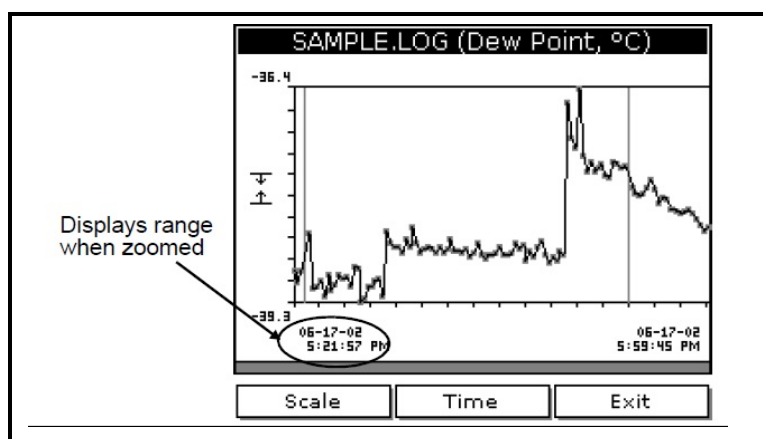

Figure 39: Log Graph Display Window

5.7.1.3 Adjusting the Graph Scale

1. The Y-Axis window appears. Use the arrow keys to scroll to one of the following and press **[ENTER]**:
 - Max - the graph extends to highest logged value.
 - Range - the graph extends from the lowest to the highest logged value.
 - Set - the graph extends between a specified minimum and maximum value.
2. Do one of the following:
 - If you selected Max or Range, proceed to step 6.
 - If you selected Set, proceed to the next step.
3. Use the arrow keys to scroll to the Minimum text box and press **[ENTER]**.
4. Use the numeric keys to enter the desired value and press **[ENTER]**.
5. Repeat steps 3 and 4 to enter the Maximum value.
6. When you have finished, press **[F3]** (OK) to exit and view the graph.

Next, do one of the following:

- To return to the Log Manager and view another log, press **[F3]** (Exit) and then press **[MENU]**. Return to *Using the Graph Format* on page 44.
- To view logs using the spreadsheet format, press **[F3]** (Exit), then press **[MENU]** and proceed to *Using the Spreadsheet Format* on page 46.
- To exit and return to taking measurements, press **[F3]** (Exit) twice and then press **[MENU]**.

5.7.1.4 Adjusting the Time Scale

1. The Enter Time window appears. Use the arrow keys to scroll to the desired text box. Press **[ENTER]** to open the box.
2. Use the numeric keys to enter the desired number and press **[ENTER]**.
3. Repeat steps 1 and 2 for other entries.
4. When you have finished, press **[F3]** (OK) to exit and view the graph.

Next, do one of the following:

- To return to the Log Manager and view another log, press **[F3]** (Exit) and then press **[MENU]**. Return to *Using the Graph Format* on page 44.
- To view logs using the spreadsheet format, press **[F3]** (Exit), then press **[MENU]** and proceed to *Using the Spreadsheet Format* on page 46.
- To exit and return to taking measurements, press **[F3]** (Exit) twice and then press **[MENU]**.

5.7.2 Using the Spreadsheet Format

1. Use the arrow key to scroll to the desired log. Logs are associated with the site file in use at the time the log is created or run. If you do not see the desired log in the list, refer to *Viewing All Logs* on page 43 to display all the existing logs.

Note: *The list of log files in the Log Manager can be listed chronologically or alphabetically. Refer to Sorting Files in the Site/Drive/Log Manager on page 54.*

2. Press **[MENU]**.

Use the arrow key to scroll to View and press **[ENTER]**.

3. Use the arrow key to scroll to Spreadsheet and press **[ENTER]**. A screen similar to Figure 40 appears.

SAMPLE.LOG		
Time	Hygro Dew Point/°C	Temperature °F
06-17-02		
17:21:57	-38.9	Error:8
17:22:17	-39.0	Error:8
17:22:38	-38.9	Error:8
17:22:59	Error:1	Error:8
17:23:20	-38.4	Error:8
17:23:40	-39.1	Error:8
17:24:01	-39.1	Error:8

Time Refresh Exit

Figure 40: Log Spreadsheet Window

4. Use the **[◀]** and **[▶]** keys to scroll to other columns, or the **[▼]** or **[▲]** keys to scroll backward or forward in time.
5. Do one of the following:
 - To adjust the time scale, press **[F1]** (Time) and refer to *Adjusting the Time Scale* on page 46.
 - To exit and return to taking measurements, press **[F3]** (Exit) twice and then press **[MENU]**.

5.7.2.1 Viewing Data at a Specific Time

1. The Enter Time window appears. Use the arrow keys to scroll to the desired text box. Press **[ENTER]** to open the box.
2. Use the numeric keys to enter the desired number and press **[ENTER]**.
3. Repeat steps 1 and 2 for other entries.

-
4. When you have finished, press **[F3]** (OK) to exit and view the spreadsheet. The PM880 AC displays the data nearest the time entered.

Next, do one of the following:

- To return to the Log Manager and view another log, press **[F3]** (Exit) and then press **[MENU]**. Return to *Using the Graph Format* on page 44.
- To view logs using the spreadsheet format, press **[F3]** (Exit), then press **[MENU]** and proceed to *Using the Spreadsheet Format* on page 46.
- To exit and return to taking measurements, press **[F3]** (Exit) twice and then press **[MENU]**.

Chapter 6. Managing Files

The PM880 AC program provides three useful tools for managing multiple files: the Site Manager, Drive Manager and Log Manager. The Site Manager enables you to create, recall, edit, rename and delete site files. The Drive Manager enables you to transfer and delete all types of files the PM880 AC can generate. The Log Manager lets you rename, copy and delete log files. Use the following sections to perform the desired task:

- save a new site file – page 49
- recall an existing site file – page 50
- save changes to an existing site file – page 50
- rename a site or log file – page 50
- copy (clone) a log – page 52
- delete all types of files – page 54
- sort files in the Site/Drive/Log Manager (chronologically or alphabetically) – page 54

The Site and Log Managers have additional commands for printing and all the Managers have the ability to transfer files to and from a PC. For more details on these functions refer to Chapter 7, *Using the PM880 AC with a PC and Printer*.

6.1 Saving a New Site File

Use the steps below to save a new site.

6.1.0.1 Accessing the Site Manager

1. Enter the necessary data and properly setup the screen. See Chapter 1, *Getting Started*, for entering data.
2. If the menu is not active, press **[MENU]**.
3. Use the arrow key to scroll to Site and press **[ENTER]**.
4. Use the arrow key to scroll to Site Manager and press **[ENTER]**.
5. Press **[MENU]**.
6. Use the arrow key to scroll to File and press **[ENTER]**.

6.1.0.2 Entering a Site Name

1. Use the arrow key to scroll to New and press **[ENTER]**. The screen appears similar to Figure 41.

New Site							
SITE13							
A	B	C	D	E	F	G	H
I	J	K	L	M	N	O	P
Q	R	S	T	U	V	W	X
Y	Z	0	1	2	3	4	5
6	7	8	9	-	_	@	#
&	()					
Delete		Cancel		OK			

Figure 41: Name Entry Window for a New Site

2. Use the arrow keys to scroll to the desired letter or number and press **[ENTER]**. Press **[F1]** (Delete) to delete any unwanted letters or numbers.
3. Repeat this procedure until you have created the desired site name of up to eight characters.

4. When you have finished, press **[F3]** (OK).
5. The PM880 AC prompt asks you if you want to save the site as a template. Saving the site file as a template is useful when you need to create multiple sites with similar data. At the prompt, do one of the following:
 - Press **[F2]** (No) if you do not want to use it as a template, or
 - Press **[F3]** (Yes) if you do want to use it as a template.
6. Press **[F3]** (Exit).
7. Press **[MENU]**. The new site file is displayed in the upper left corner of the screen.

6.2 Recalling a Site File

Use the following steps to recall a previously programmed site file:

6.2.0.1 Accessing the Site Manager

1. If the menu is not active, press **[MENU]**.
2. Use the arrow key to scroll to Site and press **[ENTER]**.
3. Use the arrow key to scroll to Site Manager and press **[ENTER]**.

6.2.0.2 Retrieving the Site File

1. Use the arrow key to scroll to the desired site.

Note: *The list of site files in the Site Manager can be listed chronologically or alphabetically. Refer to Sorting Files in the Site Manager on page 54.*

2. Press **[MENU]**.
3. Use the arrow key to scroll to File and press **[ENTER]**.
4. Use the arrow key to scroll to Open and press **[ENTER]**.
5. The PM880 AC asks you to confirm. Press **[F3]** (Yes).
6. Press **[F3]** (Exit).
7. Press **[MENU]**. The PM880 AC displays the new site file in the upper-left corner of the screen.

6.3 Saving a Site File

Saving changes to an existing site can be done from the Site Menu or the Site Manager.

6.3.0.1 Using the Site Menu

1. If the menu is not active, press **[MENU]**.
2. Use the arrow keys to scroll to Site and press **[ENTER]**.
3. Use the arrow keys to scroll to Save Now and press **[ENTER]**.
4. The PM880 AC prompts you to save the current site. Press **[F3]**, (Yes).
5. Press **[MENU]**. The PM880 AC displays the current site file in the upper-left corner of the screen.

6.3.0.2 Using the Site Manager

1. If the menu is not active, press **[MENU]**.
2. Use the arrow key to scroll to Site and press **[ENTER]**.
3. Use the arrow key to scroll to Site Manager and press **[ENTER]**.
4. Press **[MENU]**.
5. Use the arrow key to scroll to File and press **[ENTER]**.
6. Use the arrow key to scroll to Save and press **[ENTER]**.
7. The PM880 AC asks you to confirm. Press **[F3]** (Yes).
8. Press **[F3]** (Exit).
9. Press **[MENU]**. The PM880 AC displays the new site file in the upper-left corner of the screen.

6.4 Renaming a Site or Log File

Use the appropriate section that follows. To rename:

- a site file, refer to the section below.
- a log file, refer to page 51.

6.4.1 Renaming a Site File

The PM880 AC offers two ways to rename files. In the Site Manager you can use the following commands:

- Save As to create a copy of the file with a different name
- Rename to change the name of the site file.

Use the steps below to perform the desired task.

6.4.1.1 Accessing the Site Manager

1. If the menu is not active, press **[MENU]**.
2. Use the arrow key to scroll to Site and press **[ENTER]**.
3. Use the arrow key to scroll to Site Manager and press **[ENTER]**.

6.4.1.2 Renaming a Site File

1. Use the arrow key to scroll to the desired site.

Note: *The list of site files in the Site Manager can be listed chronologically or alphabetically. Refer to Sorting Files in the Site/Drive/Log Manager on page 54.*

2. Press **[MENU]**.
3. Use the arrow key to scroll to File and press **[ENTER]**.
4. Use the arrow key to scroll to:
 - Save As and press **[ENTER]** - to create a copy of the file with a different name.
 - Rename and press **[ENTER]** - to change the name of the site file.
5. Use the arrow keys to scroll to the desired letter or number and press **[ENTER]**. Press **[F1]** (Delete) to delete any unwanted letters or numbers.
6. Repeat this procedure until you have created the desired site name of up to eight characters.
7. When you have finished, press **[F3]** (OK).
8. Do one of the following:
 - If you selected Save As, the PM880 AC prompts you to save the current site, press **[F3]** (Yes).
 - If you selected Rename, the PM880 AC renames the file and returns to the Site Manager.

Next, do one of the following:

- If desired, repeat steps 1 through 8 above for another file.
- To exit and return to taking measurements, press **[F3]** (Exit) and then press **[MENU]**. The newly renamed site file is displayed in the upper left corner of the screen.

Note: *The PM880 AC uses the renamed site file to take measurements. To recall a different site file, refer to Recalling a Site File on page 50.*

6.4.2 Renaming a Log File

Use the steps below to rename a log file.

6.4.2.1 Accessing the Log Manager

1. If the menu is active, press **[MENU]**.
2. Use the arrow key to scroll to Logging and press **[ENTER]**.
3. Use the arrow key to scroll to Log Manager and press **[ENTER]**.

6.4.2.2 Renaming a Log File

1. Use the arrow key to scroll to the desired site.

Note: The list of site files in the Log Manager can be listed chronologically or alphabetically. Refer to Sorting Files in the Site/Drive/Log Manager on page 54.

2. Press **[MENU]**.
3. Use the arrow key to scroll to File and press **[ENTER]**.
4. Use the arrow key to scroll to Rename and press **[ENTER]**.
5. Use the arrow keys to scroll to the desired letter or number and press **[ENTER]**. Press **[F1]** (Delete) to delete any unwanted letters or numbers.
6. Repeat this procedure until you have created the desired log name of up to eight characters.
7. When you have finished, press **[F3]** (OK).

The PM880 AC renames the file and returns to the Log Manager.

Next, do one of the following:

- If desired, repeat steps 1 through 7 above for another file.
- To exit and return to taking measurements, press **[F3]** (Exit) and then press **[MENU]**.

6.5 Copying a Log

If you need to create another log file that is similar to a log you have already created, you can save time by copying the existing log and editing it. Use the followings steps to copy (clone) a log:

6.5.0.1 Accessing the Log Manager

1. If the menu is not active, press **[MENU]**.
2. Use the arrow key to scroll to Logging and press **[ENTER]**.
3. Use the arrow key to scroll to Log Manager and press **[ENTER]**.

6.5.0.2 Selecting a Log File

1. Use the arrow key to scroll to the desired log and press **[ENTER]**. If you do not see the desired log in the list, refer to Viewing All Logs on page 43 to display all the existing logs.

Note: The list of log files in the Log Manager can be listed chronologically or alphabetically. Refer to Sorting Files in the Site/Drive/Log Manager on page 54.

2. Press **[MENU]**.
3. Use the arrow key to scroll to File and press **[ENTER]**.
4. Use the arrow key to scroll to Clone Selected Log and press **[ENTER]**. The screen now appears similar to Figure 42 on page 52.

Note: If you try to copy a log that is associated with a site file that is not currently running, the Clone Selected Log command will be grayed out. Use a different log for cloning.

Create New Log							
LOG10							
A	B	C	D	E	F	G	H
I	J	K	L	M	N	O	P
Q	R	S	T	U	V	W	X
Y	Z	0	1	2	3	4	5
6	7	8	9	-	_	@	#
&	()					
Delete		Cancel		OK			

Figure 42: Name Entry Window for a New Log

6.5.0.3 Entering a Log Name

1. Use the arrow keys to scroll to the desired letter or number and press [ENTER]. Press [F1] (Delete) to delete unwanted characters.
2. Repeat this procedure until you have created the desired site name of up to eight characters.
3. When you have finished, press [F3] (OK).

6.5.0.4 Editing General Log Settings

1. The General tab displays various parameters for log setup. Use the [▼] key to scroll to Format and do the following:
 - Use the arrow keys to make a selection and press [ENTER]. Use the same procedure for Type.
 - To edit text boxes, scroll to the box and press [ENTER]. Use the [◀] and [▶] keys to scroll to the number to be changed, use the numeric keys to change the number, and then press [ENTER].

Note: If you choose to run a circular log, you will need to enter the number of records you want to log instead of an end date and time.

2. Use the arrow keys to move back to the General tab and then move to the Measurements tab and press [ENTER]. A screen similar to Figure 43 appears.

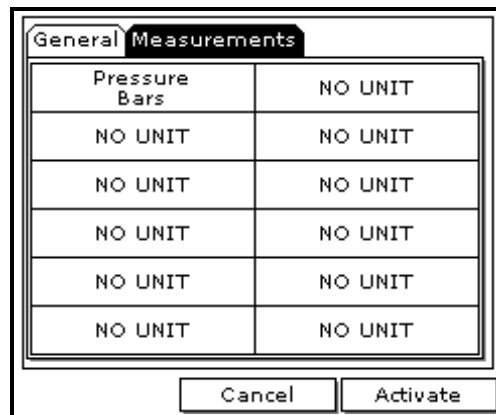

Figure 43: Log Measurements Window

6.5.0.5 Editing Measurement Settings

1. Use the [▼] key to step to a box and press [ENTER]. A screen similar to Figure 44 appears.

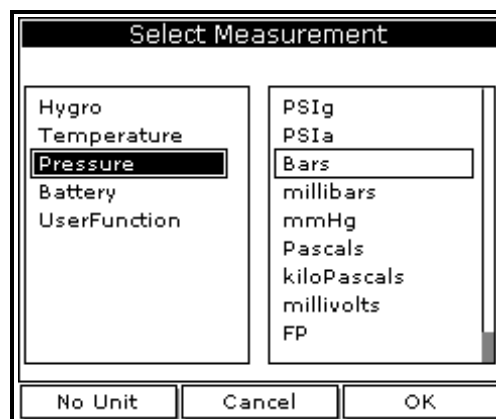

Figure 44: Select Measurement Window

2. Use the arrow keys to scroll to the desired measurement type and press [SEL].
3. Use the arrow keys to scroll to the desired units and press [F3] (OK).
4. Repeat steps 1 through 3 for up to 12 different parameters.

- When you have finished, press **[F3]** (Activate) to start the log. The PM880 AC returns to the Log Manager. The log will begin at the specified date and time.

Next, do one of the following:

- To copy another log, repeat the steps beginning in *Selecting a Log File* on page 52.
- To exit and return to taking measurements, press **[F3]** (Exit) and then press **[MENU]**. A Pencil icon appears in the bottom right-hand side of the screen.

6.6 Deleting All Types of Files

Use the steps below to delete unwanted files from the PM880 AC memory:

Note: *If the site file you want to delete is currently active, you must recall another site before you can delete it.*

6.6.0.1 Accessing the Site, Drive or Log Manager

- If the menu is active, press **[MENU]**.
- To delete:
 - site, meter, log or snapshot files, press Site and press **[ENTER]**.
 - log files only, press Logging and press **[ENTER]**.
- Use the arrow key to scroll to:
 - Site Manager and press **[ENTER]** - to delete site files only.
 - Drive Manager and press **[ENTER]** - to delete all types of files.
 - Log Manager and press **[ENTER]** - to delete log files only.

6.6.0.2 Deleting a File

- Use the arrow key to scroll to the desired file.

Note: *The list of site files in the Site/Drive/Log Manager can be listed chronologically or alphabetically. Refer to Sorting Files in the Site/Drive/Log Manager on page 54.*

- Press **[MENU]**.
- Use the arrow key to scroll to File and press **[ENTER]**.
- Use the arrow key to scroll to Delete and press **[ENTER]**. The Log Manager has an additional command to Delete All Logs?
- The PM880 AC asks you to confirm. Press **[F3]** (Yes). The PM880 AC returns to the Site/Drive/Log Manager.

Next, do one of the following:

- If desired, repeat steps 1 through 5 to delete another file.
- To exit and return to taking measurements, press **[F3]** (Exit) and then press **[MENU]**.

6.7 Sorting Files in the Site/Drive/Log Manager

The Site, Drive or Log Manager can list files in chronological or alphabetical order. Use the following steps to change the order in which the files are listed:

- From the Site, Drive or Log Manager, press **[MENU]**.
- Use the arrow key to scroll to Sort and press **[ENTER]**.
- Use the arrow key to scroll to select:
 - By Name and press **[ENTER]** - to list the files alphabetically.
 - By Date and press **[ENTER]** - to list the files chronologically.

Next, do one of the following:

- To exit, press **[F3]** (Exit) and then press **[MENU]** to leave the Manager and return to taking measurements.
- Return to performing the desired task(s) in the Manager.

Chapter 7. Using the PM880 AC with a PC and Printer

The PM880 AC has the ability to transfer files to and from a PC. Both the Site Manager and Drive Manager have a transfer command that allows you to select a file and beam it to and from the PC and the PM880 AC. The Site Manager has an additional command that enables you to send site files to a printer.

Note: *While sending or receiving files, the PM880 AC continues to take measurements, but at a slower rate.*

To transfer or print files, you must have a built-in infrared sensor or an infrared sensor connected to the PC and/or printer that is IrDA (Infrared Data Association) compatible. The PM880 AC is already setup for IrDA infrared communications. The PM880 AC can also communicate with other IR devices using an IR232 virtual interface; however, this protocol is used for other applications.

Before the PM880 AC can communicate with your PC or printer, the IR function for that device must be activated and set up properly. Consult the documentation for your device.

Note: *If you are using PanaView software (version 1.4.6 or greater), the communication connection is made automatically using IrOBEX (IR Object Exchange).*

If several IrDA meters will be used with one instance of PanaView, be sure to manually disconnect a meter and remove it from the startup connection list before breaking the connection and connecting another meter.

Note: *If an IrDA meter is not disconnected by the user, and removed from the "startup connection list," a meter of a different serial number will display with the ID of the first meter. |*

This chapter consists of the following:

- Setting Up PM880 AC IR Communications - page 56
- Transferring and Printing Files Key - page 64
- Printing Files from the PM880 AC - page 64
- Printing Reports - page 66
- Transferring Files to a PC - page 66
- Transferring Files from a PC - page 68

7.1 Setting Up PM880 AC IR Communications

The PM880 AC is already setup for IrDA (Infrared Data Association) infrared communications. Most PCs and devices use the IrDA protocol and the PM880 AC should not need to be reconfigured. If necessary, the PM880 AC can also be configured for IR232 communications.

The PM880 AC can communicate with PC's operating with Windows NT 4.0/95/98/2000 or XP. If you are using Windows NT 4.0, you must use QuickBeam® software. All other operating systems have IR software capable of communicating with the PM880 AC.

If you are using Windows 2000 or Windows XP, you must use the *Add Hardware* wizard to tell Windows that an IR adapter is attached to the serial port.

Note: The "IR adapter" is a device that plugs into a port and provides infrared data transfer.

7.1.1 Using the Add Hardware Wizard

Note: The following figures represent the Windows 2000 screens. The Windows XP process is similar.

For Windows 2000:

1. Right-click on My Computer, or use the Control panel to get the System Properties.
2. Choose the Hardware tab, and click on the Hardware Wizard button:

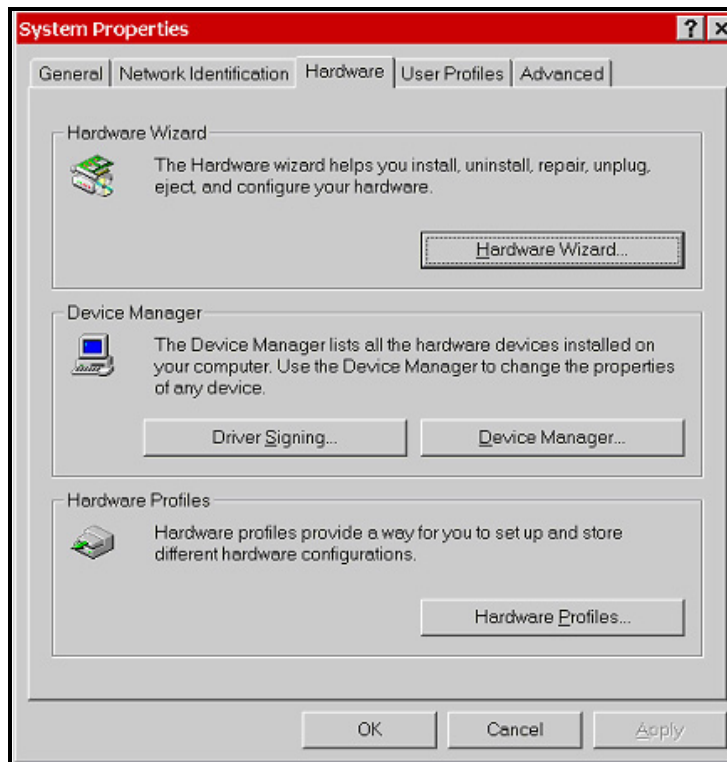

Figure 45: Hardware Screen

The Welcome screen appears.



Figure 46: Welcome Screen

3. Click Next. On the next screen, choose "Add/Troubleshoot a device" and click Next.

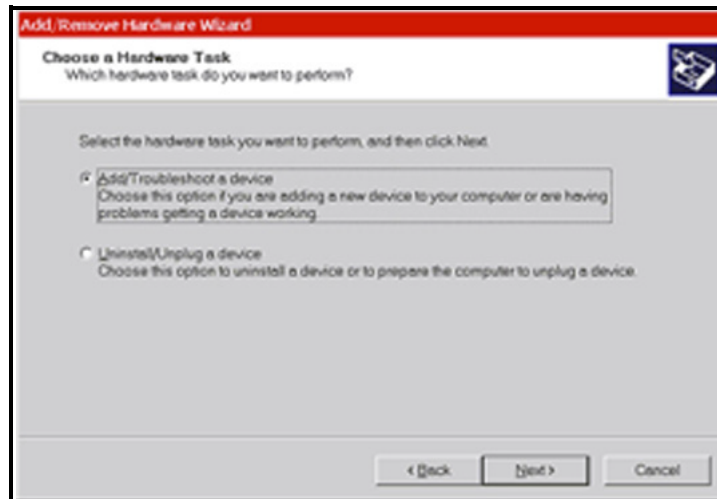

Figure 47: Choose a Hardware Task Screen

4. Windows will search, but will not find anything. Allow the search to complete.

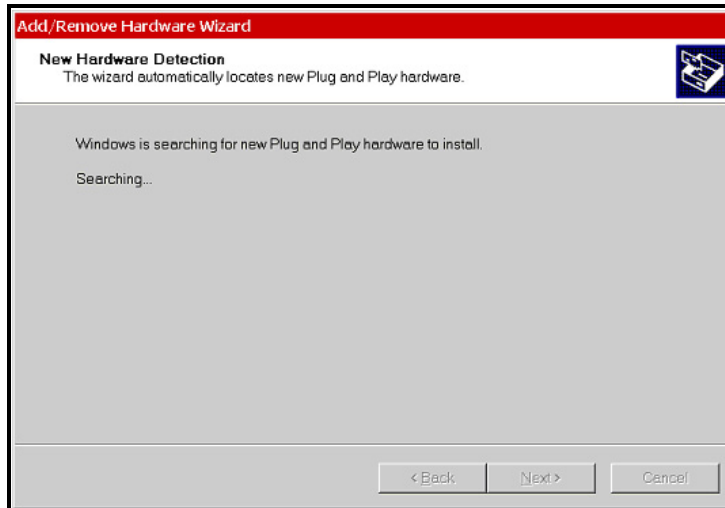

Figure 48: New Hardware Detection Screen

5. When the search finishes, you will see the dialog screen as in Figure 49. Choose “Add a new device,” and click Next.

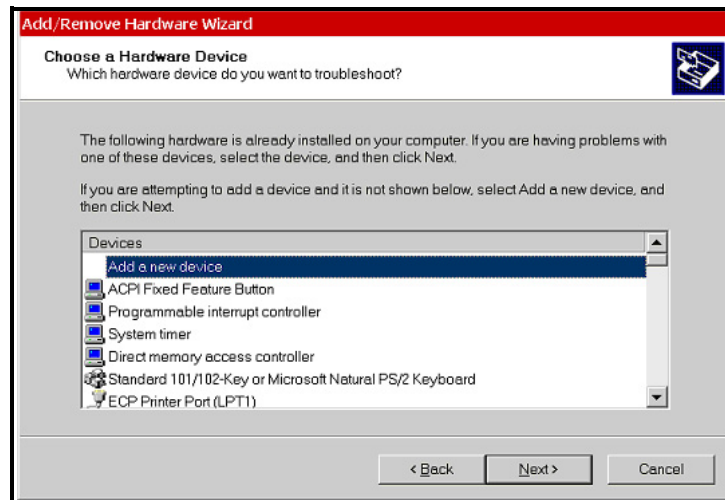

Figure 49: Choose a Hardware Device Screen

6. On the next screen, choose “No, I want to select the hardware from a list,” and click Next.



Figure 50: Find New Hardware Screen

7. Select Infrared Devices from the list, and click Next.

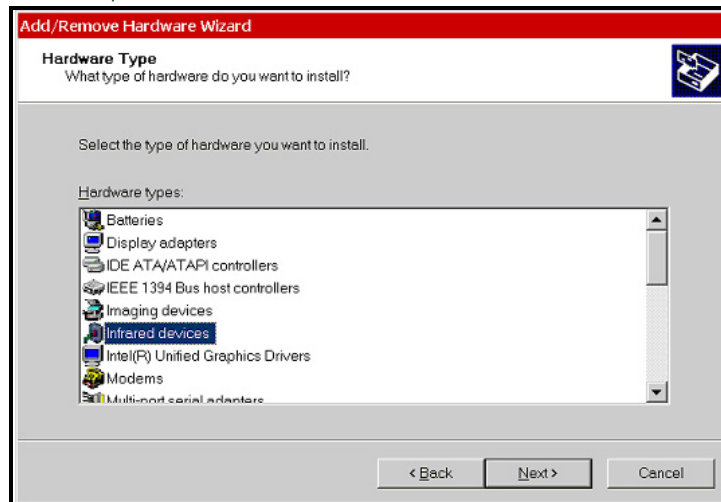

Figure 51: Hardware Type Screen

8. Select ACTiSYS and IR-220L+ Serial Infrared Device, and click Next.

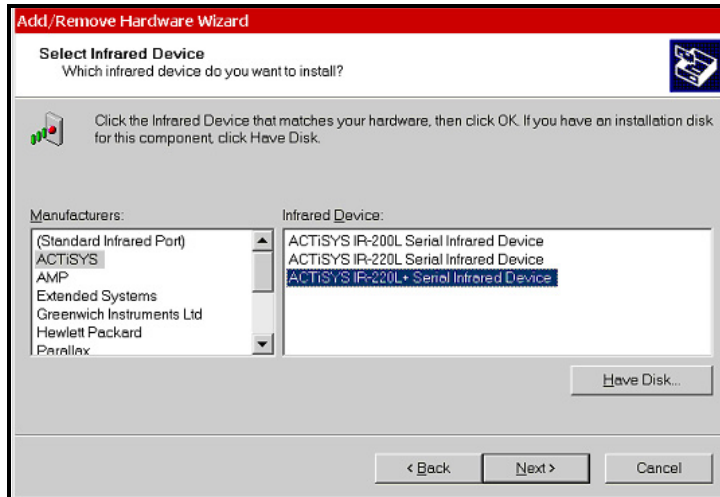

Figure 52: Select Infrared Device Screen

9. Windows supplies the appropriate driver, so click Next.

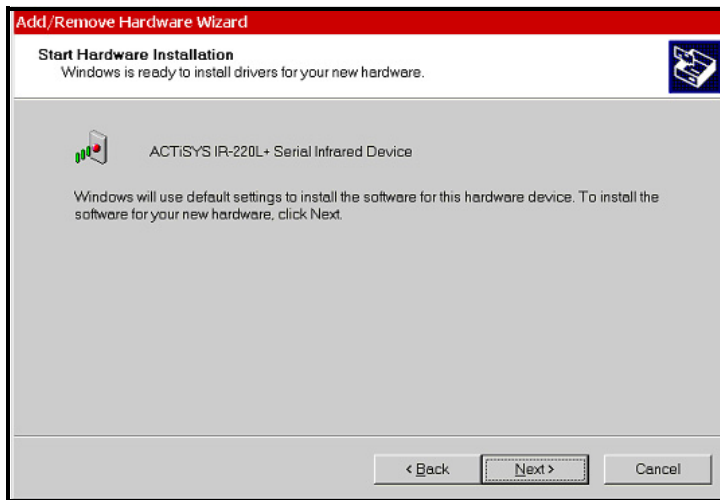

Figure 53: Start Hardware Installation Screen

10. Select the Com port to which the IR adapter is attached.

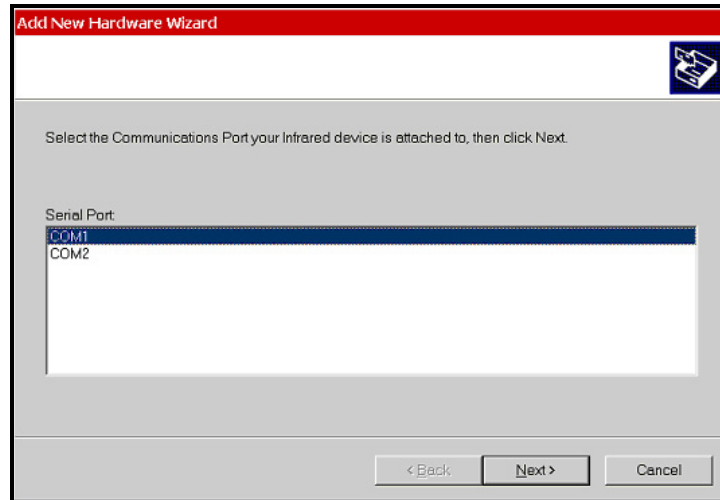

Figure 54: Select the Communications Port Screen

The IR support should then be installed automatically.

11. Place the IR adapter in front of the PM880 AC. You should hear a "bong" and the following message will pop up:

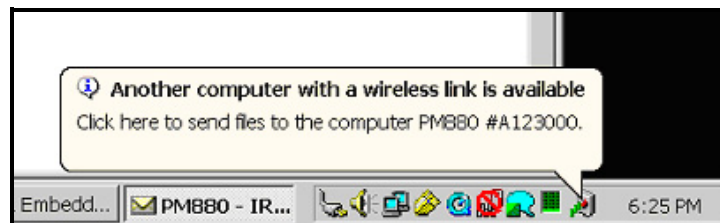

Figure 55: Another Available Computer Message

At this point, you can transfer files from the PM880 AC to the PC using its Site Manager/Log Manager/Drive Manager or by using PanaView.

Note: *The previous figures represent the Windows 2000 screens. The Windows XP process is similar.*

You may have to use the PanaView New Meter Browser to add the IrDA port. After that, discovery of the PM880 AC should be automatic:

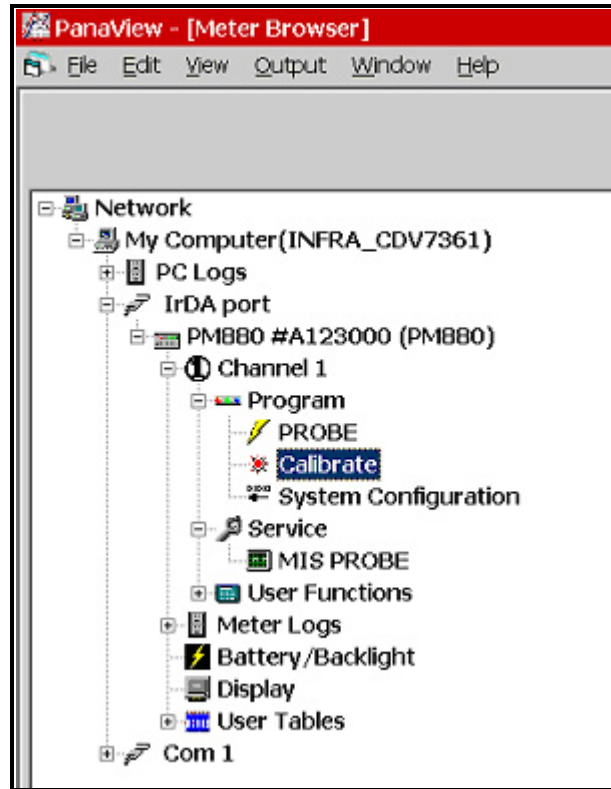

Figure 56: PanaView Meter Browser

7.1.2 Using Panaview

Panometrics offers PanaView software that enables you to perform many PM880 AC functions using your computer. With PanaView software (version 1.4.6 or greater), the communication connection is made automatically using IrOBEX (IR Object Exchange).

Use these steps if you need to change the PM880 AC IR set up:

7.1.2.1 Accessing the Meter Menu

1. If the menu is not active, press **[MENU]**.
2. Use the arrow key to scroll to Meter and press **[ENTER]**.
3. Use the arrow key to scroll to Communication and press **[ENTER]**. The Communications window appears similar to Figure 57.

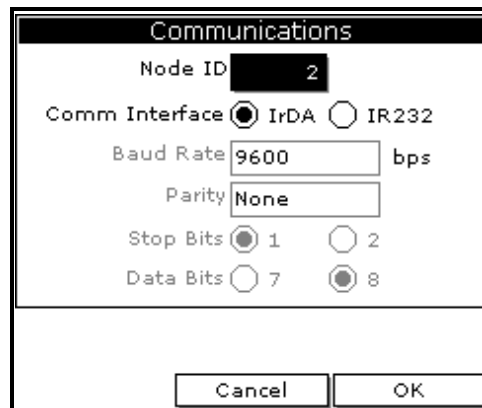

Figure 57: Communications Window

7.1.2.2 Changing Communication Setup

1. The Communications window displays the various parameters for IR setup. Use the arrow keys to scroll to the desired parameters and press **[ENTER]** to select or open a text box.

WARNING! Do NOT change the Node ID unless instructed to by Panametrics.

IMPORTANT: Baud rate, parity, stop bits and data bits are active only when IR232 is selected for the communication interface. IR232 requires the following parameters: 9600, None, 1 and 8 respectively.

2. Press **[F3]** (OK) and then press **[MENU]**. The PM880 AC returns to taking measurements.

7.2 Transferring and Printing Files Key

Since the PM880 AC offers many tools and options for file management, Table 2 breaks down each Manager and its transferring and printing capabilities.

Table 2: Manager Key

File Type	Transfer Direction	Transfer Using	Print Using
Site Files (.sit)	To and From PC	Site or Drive Manager	Site Manager
Meter Files (.met)	To and From PC	Drive Manager	No Printing
Log Files (.log)	To PC	Drive or Log Manager	Log Manager
Snapshot Files (.bmp)	To PC	Drive Manager	No Printing

7.3 Printing a Site or Log File

The PM880 AC can send site files, log files and snapshots (screen captures) to a printer. This section describes the steps for printing site and log files. To print a snapshot, refer to *Taking a Bitmap Screen Capture (Snapshot)* on page 21. Use the appropriate section that follows to print a site or log file.

IMPORTANT: The PM880 AC IR function is already setup for IrDA infrared communication. To change IR settings, refer to Setting Up PM880 AC IR Communications on page 56.

7.3.1 Printing a Site File

7.3.1.1 Accessing the Site Manager

1. If the menu is not active, press **[MENU]**.
2. Use the arrow key to scroll to Site and press **[ENTER]**.
3. Use the arrow key to scroll to Site Manager and press **[ENTER]**.

7.3.1.2 Selecting a Site File

1. Use the arrow key to scroll to the desired site.

Note: *The list of site files in the Site Manager can be listed chronologically or alphabetically. Refer to Sorting Files in the Site/Drive/Log Manager on page 54.*

2. Press **[MENU]**.
3. Use the arrow key to scroll to Site and press **[ENTER]**.
4. Make sure the IR beam on the PM880 AC has clear access to the IR sensor on the printer.
5. Use the arrow key to scroll to Print and press **[ENTER]**.

The PM880 AC indicates that it is searching for a receiving printer. If it spots more than one compatible infrared device within its range, it asks you to select the desired device.

6. Once the PM880 AC finds the printer, it asks you to confirm, press **[F3]** (Yes) and then press **[MENU]**. The PM880 AC returns to the Site Manager.

Next, do one of the following:

- If desired, repeat steps 1 through 6 in the previous section to print another site file.
- To exit and return to taking measurements, press **[F3]** (Exit) and then press **[MENU]**.

7.3.2 Printing a Log File

7.3.2.1 Accessing the Log Manager

1. If the menu is not active, press **[MENU]**.
2. Use the arrow key to scroll to Logging and press **[ENTER]**.
3. Use the arrow key to scroll to Log Manager and press **[ENTER]**.

7.3.2.2 Selecting a Log File

1. Use the arrow key to scroll to the desired log. Logs are associated with the site file in use at the time the log is created or run. If you do not see the desired log in the list, refer to *Viewing All Logs* on page 43 to display all the existing logs.

Note: *The list of site files in the Log Manager can be listed chronologically or alphabetically. Refer to Sorting Files in the Site/Drive/Log Manager on page 54.*

2. Press **[MENU]**.
3. Use the arrow key to scroll to File and press **[ENTER]**.
4. Use the arrow key to scroll to Print and press **[ENTER]**.

7.3.2.3 Entering a Time Window for Printing

1. The PM880 AC displays the start and end time of the log (see Figure 58). Use the arrow and **[ENTER]** keys to change the start date and/or time to indicate what portion of the log you want to print. Do not edit the time to print the entire log.

Enter Time	
Start Date	Start Time
2003/03/01	13:23:41 PM
End Date	End Time
2003/03/01	13:53:41 PM

Figure 58: Enter Time Window

2. Make sure the IR beam on the PM880 AC has clear access to the IR sensor on the printer and press **[F3]** (OK). The PM880 AC indicates that it is searching for a receiving printer and then sends the file. If it spots more than one compatible infrared device within its range, it asks you to select the desired device.

Note: *If the PM880 AC cannot detect an infrared device, a window appears indicating this problem. Reposition the PM880 AC and press **[F3]**, Yes. Consult the factory if the PM880 AC is unable to make contact with your PC.*

Next, do one of the following:

- If desired, repeat the steps beginning in *Selecting a Log File* on the previous page to print another log file.
- To exit and return to taking measurements, press **[F3]** (Exit) and then press **[MENU]**.

7.4 Printing Reports

When used with an IR-compatible printer, the PM880 AC can print out a variety of data (current site, logs, drive contents, and user functions, tables and settings) using the Reports command. Use the steps below to print the desired report:

IMPORTANT: The PM880 AC IR function is already setup for IrDA infrared communication. To change IR settings, refer to Setting Up PM880 AC IR Communications on page 56.

1. If the menu is not active, press **[MENU]**.
2. Use the arrow keys to scroll to Service and press **[ENTER]**.
3. Use the arrow keys to scroll to Reports and press **[ENTER]**. A screen similar to Figure 59 appears.



Figure 59: Reports Window

4. Use the arrow keys to select the desired report.
5. Make sure the IR beam on the PM880 AC has clear access to the IR sensor on the printer.
6. Press **[F2]** (Print) to print out the desired reports.

Next, do one of the following:

- If desired, repeat steps 4 through 6 to print another report.
- To exit and return to taking measurements, press **[F3]** (Exit) and then press **[MENU]**.

7.5 Transferring a File To a PC

You can use the Site Manager, Drive Manager or the Log Manager to transfer files to your PC. The Site Manager enables you to transfer site files only; the Drive Manager enables you to transfer any file in the PM880 AC; and, the Log Manager enables you to transfer log files only.

Use the steps below to transfer files to your PC:

7.5.0.1 Preparing for File Transfer

1. The PM880 AC IR function is already setup for IrDA infrared communication. To change IR settings, refer to *Setting Up PM880 AC IR Communications* on page 56.
2. If you are using Windows NT 4.0, open the QuickBeam[®] software. Proceed to the next section.

7.5.0.2 Accessing the Site, Drive or Log Manager

1. If the menu is not active, press **[MENU]**.
2. To transfer:
 - site, meter, log or snapshot files, press Site and press **[ENTER]**.
 - log files only, press Logging and press **[ENTER]**.

3. Use the arrow key to scroll to:
 - Site Manager and press **[ENTER]** - to transfer site files only.
 - Drive Manager and press **[ENTER]** - to transfer all types of files.
 - Log Manager and press **[ENTER]** - to transfer log files only.

7.5.0.3 Selecting a File

1. Use the arrow key to scroll to the desired file. Logs are associated with the site file in use at the time the log is created or run. If you do not see the desired log in the list, refer to *Viewing All Logs* on page 43 to display all the existing logs.

IMPORTANT: The list of site files in the Site/Drive/Log Manager can be listed chronologically or alphabetically. Refer to *Sorting Files in the Site/Drive/Log Manager* on page 54.

2. Press **[MENU]**.
3. Use the arrow key to scroll to:
 - *For Site Manager* - Site and press **[ENTER]**.
 - *For Drive or Log Manager* - File and press **[ENTER]**.
4. Make sure the IR beam on the PM880 AC has clear access to the IR sensor on the PC.
5. Use the arrow key to scroll to Transfer and press **[ENTER]**.
6. The PM880 AC establishes communications with your PC and uploads the selected file. Respond to any screen prompts from the PC.

When the upload is complete, the meter returns to the Site/Drive/Log Manager.

IMPORTANT: If the PM880 AC cannot detect an infrared device, a window appears indicating this problem. Reposition the PM880 AC and press **[F3]** Yes. Consult the factory if the PM880 AC is unable to make contact with your PC.

7.5.0.4 Locating and Viewing the Transferred File

Your PC stores the transferred file in a default location. The location depends on the PC's operating system:

- Windows NT 4.0 - the transferred file is in the QuickBeam Inbox folder.
- Windows 95/98/2000 - the transferred file appears in the default folder. The default folder is set in the *Windows Control Panel* using the *Wireless Link/Infrared* icon



Next, do one of the following:

- Use any text editor to open the file on your PC.
- If desired, repeat steps 1 through 6 (*Selecting a File* on the previous page) to transfer another file.
- To exit and return to taking measurements, press **[F3]** (Exit) and then press **[MENU]**.

7.6 Transferring a File from a PC

The PM880 AC enables you to transfer site (.sit) and meter (.met) files from your PC to the meter. If you rename another type of file with one of these extensions and transfer it, it will be transferred, but will not function if you open it.

Note: *The PM880 AC IR function is already setup for IrDA infrared communication. To change IR settings, Setting Up PM880 AC IR Communications on page 56.*

The transfer procedure differs depending on your PC's operating system. Use the appropriate section that follows to transfer files:

IMPORTANT: If you transfer a file and the meter already has a file with the identical name, the meter will overwrite its current file with the transferred file. If the transferred file has a name longer than eight characters, the meter will shorten the name to eight characters. It will also replace any spaces in the name with underbars.

- Using Windows Explorer for Windows 95/98/2000 – see below
- Windows NT 4.0 – see the next page
- Windows 95/98 – page 68
- Windows 2000 – page 68

7.6.1 Using Windows Explorer in Windows 95/98/2000

1. Open Windows Explorer.
2. Right click on the desired file.
3. Click Send to.
4. Click Infrared Recipient. A window appears indicating the file is downloading.

7.6.2 Using Windows NT 4.0

1. Open the QuickBeam[®] software.
2. Make sure the IR beam on the PM880 AC has clear access to the IR sensor on the PC.
3. In the Quickbeam window, click on Send.
4. Click on Files or Files on Clipboard and scroll to the desired file.
5. Click on Send. QuickBeam opens a window indicating that it is downloading the file.

Note: *A quicker way to send files (replace steps 4 and 5 above) is to click on the desired file, and drag it onto the rocket button in the QuickBeam window, as shown in Figure 60.*

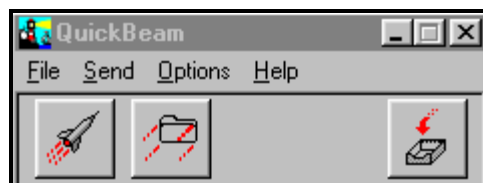

Figure 60: QuickBeam Window

7.6.3 Using Windows 95/98



1. Click on the *Infrared* icon in the System Tray - . A window similar to Figure 61 appears.
2. Select the desired file and click on Send. A window appears indicating the file is downloading.

7.6.4 Using Windows 2000

1. To activate infrared communications on your PC, line up the IR beam on the PM880 AC with the PC's IR sensor. A window appears indicating IR communications is activated.



2. Click on the *Infrared* icon in the System Tray - . A window similar to Figure 61 appears.

3. Select the desired file and click on Send. A window appears indicating the file is downloading.

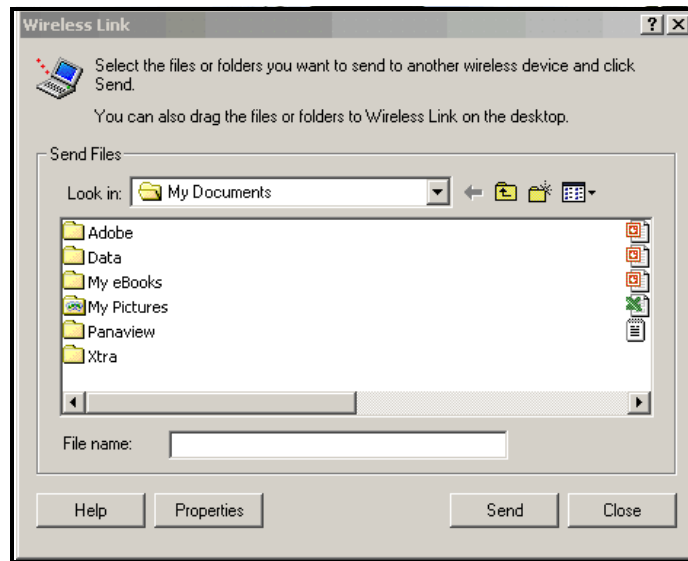

Figure 61: Wireless Link Window

[no content intended for this page]

Chapter 8. Maintenance and Troubleshooting

The PM880 AC is designed to be maintenance and trouble free. However, because of process conditions and other factors, minor problems may occur. The PM880 AC provides commands to monitor and check its various components. This section also includes information on some of the most common problems you may encounter. If you cannot find the information you need in this chapter, please consult the factory.

CAUTION! Do not attempt to troubleshoot the PM880 AC beyond the instructions in this chapter. If you do, you may damage the unit and void the warranty.

- Checking the Memory Status - page 72
- Testing the Screen - page 72
- Testing the Keypad - page 73
- Testing the Watchdog Timer Circuit - page 73
- Resetting to Factory Default Settings - page 74
- Viewing and Changing Security Settings - page 75
- Updating PM880 AC Software - page 77
- Error and Screen Messages - page 80
- Common Problems - page 82
- Replacing and Recalibrating the Moisture Probes - page 85
- Recalibrating the Pressure Sensors - page 85

Note: *While the MIS Probe and Factory Calibration options appear on the Service Menu, they are available only to operators with a Service level security code. Consult the factory for further information.*

8.1 Checking the PM880 AC Memory Status

The PM880 AC stores all types of files in its memory. Each type of Manager enables you to monitor the size of a file and the remaining amount of memory. Use the following steps to check the memory status:

8.1.0.1 Accessing the Site, Drive or Log Manager

1. If the menu is not active, press **[MENU]**.
2. To check:
 - site, meter, log or snapshot files, press Site and press **[ENTER]**.
 - log files only, press Logging and press **[ENTER]**.
3. Use the arrow key to scroll to:
 - Site Manager and press **[ENTER]** - to check site files only.
 - Drive Manager and press **[ENTER]** - to check all types of files.
 - Log Manager and press **[ENTER]** - to check log files only.

8.1.0.2 Selecting a Log File

1. Use the arrow key to scroll to the desired files. If you do not see the desired log in the list, refer to *Viewing All Logs* on page 43 to display all the existing logs.

Note: *The list of files in each Manager can be listed chronologically or alphabetically. Refer to Sorting Files in the Site/Drive/Log Manager on page 54.*

2. Check the lower right-hand corner of the window. You should see the current date and time, the size of the selected file and the remaining amount of memory.

Next, do one of the following:

- To check the size of another file, use the arrow keys to scroll to the desired file.
- To exit and return to taking measurements, press **[F3]** (Exit) and then press **[MENU]**.

8.2 Testing the Screen

1. If the menu is not active, press **[MENU]**.
2. Use the arrow keys to scroll to Service and press **[ENTER]**.
3. Use the arrow keys to scroll to Test and press **[ENTER]**.
4. Use the arrow keys to scroll to Test Screen and press **[ENTER]**. A screen with a checkerboard pattern appears as shown in Figure 62.



Figure 62: Functioning Test Screen

5. Press any key. The screen should redraw with the same checkerboard pattern. Make sure the screen redraws properly.

- Keep pressing keys to change the screen. The PM880 AC will sequence through a number of dark and light screens before returning to taking measurements. Make sure the screen keeps redrawing properly. If it does not, please consult the factory.

8.3 Testing the Keypad

- If the menu is not active, press **[MENU]**.
- Use the arrow keys to scroll to Service and press **[ENTER]**.
- Use the arrow keys to scroll to Test and press **[ENTER]**.
- Use the arrow keys to scroll to Test Keys and press **[ENTER]**. The screen appears similar to Figure 63.

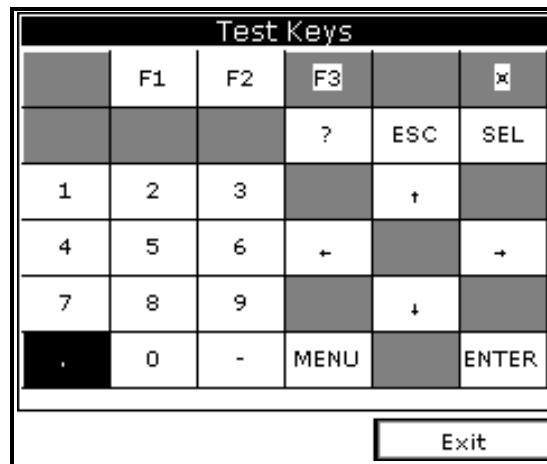

Figure 63: Test Keys Window

- Press any key on the keypad. The corresponding box on the screen should darken.

Note: If the box does not darken or if the key does not appear on the screen, contact the factory.
- Press **[F3]** and then **[MENU]** to return to taking measurements. If any key does not appear on the screen, contact the factory.

8.4 Testing the Watchdog Timer Circuit

The PM880 AC includes a watchdog timer circuit. If a software error causes the meter to stop responding, this circuit automatically resets the meter.

- If the menu is not active, press **[MENU]**.
- Use the arrow keys to scroll to Service and press **[ENTER]**.
- Use the arrow keys to scroll to Test and press **[ENTER]**.

- Use the arrow keys to scroll to Watchdog Test and press **[ENTER]**. The screen appears similar to Figure 64.

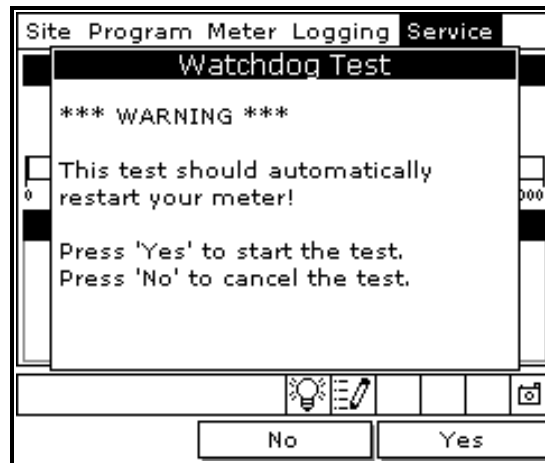

Figure 64: Watchdog Test Screen

- Press **[F3]** (Yes) to start the test. The PM880 AC screen becomes blank for a few seconds and then begins the boot sequence. If it does not follow this sequence, consult the factory.

8.5 Resetting to Factory Default Settings

The Factory Defaults command enables you to return the meter to its preprogrammed default settings. The PM880 AC replaces the default site file and the global meter settings with the factory default settings. To reset the meter:

- Transfer or print all sites and logs. Refer to Chapter 7, *Using the PM880 AC with a PC and Printer*.

WARNING! ALL SETTINGS IN THE DEFAULT SITE WILL BE RESET.
BE SURE TO TRANSFER OR PRINT ALL SITES AND LOGS BEFORE RESETTING!

- If the menu is not active, press **[MENU]**.
- Use the arrow keys to scroll to Service and press **[ENTER]**.
- Use the arrow keys to scroll to Factory Defaults and press **[ENTER]**. The screen appears similar to Figure 65.



Figure 65: Factory Defaults Window

- Press **[F3]** (OK) to restore the factory default settings.
- The program asks for confirmation: "Are you SURE?" Press **[F3]** (Yes).

The PM880 AC replaces the default site file and the global meter settings with the factory default settings. When the meter returns to taking measurements, it displays data using the default site.

8.6 Viewing or Changing Security Settings

To guard against accidental or intentional tampering, the PM880 AC includes a password-based security system. The system has three security levels. Individual passcodes protect the three security levels; they consist of one to eight digits. The three levels are as follows:

- User Level - allows access to the display and non-critical meter settings (such as resetting the clock).
- Operator Level - allows access to most of the meter settings used to set up the meter such as probe selection and calibration data. This level also allows you to delete files such as old logs and unneeded site files.
- Service Level - provides access to all meter settings, and is available to Panametrics representatives and authorized service agents only.

If the drive is erased, the passcodes will revert to the default values. For both the User and Operator level, the default code is 2719.

Use the sections that follow to set up security levels and enter new passcodes.

- Setting the Security Passcodes - see the next page
- Setting Remote Access Security - page 76

8.6.1 Setting the Security Passcodes

Use the following steps to enter new security passcodes:

1. If the menu is not active, press **[MENU]**.
2. Use the arrow keys to scroll to Service and press **[ENTER]**.
3. Use the arrow keys to scroll to Security Settings and press **[ENTER]**.
4. Use the arrow keys to move to the Passwords tab and press **[ENTER]**. The screen appears similar to Figure 66.

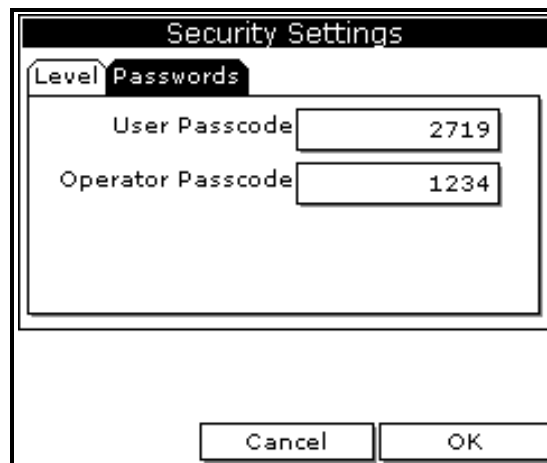

Figure 66: Passcode Entry Window

5. Use the arrow keys to scroll to the desired passcode text box and press **[ENTER]**.
6. Use the numeric keys to enter the new passcode (1 to 8 digits) and press **[ENTER]**.

IMPORTANT: Be sure to keep a record of the new passcode.

Next, do one of the following:

- To change remote access settings, refer step 4 in *Setting Remote Access Security* on page 76.
- To exit and return to taking measurements, press **[F3]** (OK) and then **[MENU]**.

8.6.2 Setting Remote Access Security

The PM880 AC enables you to set remote access security for each security level. Remote access consists of allowing the PM880 AC to communicate with PanaLink (Panametrics software), receive files from a PC using IrDA, and transmit files to a PC using IrDA. To set remote access:

Note: *The remote access security settings are available only to users with Operator or Service level passcodes.*

1. Press **[MENU]**.
2. Use the arrow keys to scroll to Service and press **[ENTER]**.
3. Use the arrow keys to scroll to Security Settings and press **[ENTER]**.
4. Use the arrow keys to move to the Level tab and press **[ENTER]**. The screen appears similar to Figure 67.



Figure 67: Security Level Window

5. Use the arrow keys to move to Security Level and press **[ENTER]** to open the drop-down menu.
6. Scroll to the desired level and press **[ENTER]**.
7. The PM880 AC may ask you to enter a passcode depending on the level you choose. Enter the passcode and press **[ENTER]**.

Note: *You can change the remote access security settings for the Service Level; however, you will need to enter the passcode for that level. Contact the factory.*

8. Use the arrow keys to scroll to the desired options. Press **[ENTER]**. When an "X" appears in the box, access is granted.

Next, do one of the following:

- To change security passcodes, refer to step 4 in *Setting the Security Passcodes* on page 75.
- To exit and return to taking measurements, press **[F3]** (OK) and then **[MENU]**.

8.7 Updating PM880 AC Software

As discussed in Chapter 7, *Using the PM880 AC with a PC or Printer*, the PM880 AC uses an IR transceiver to transfer files. The IR function can also be used to upgrade the meter's user program. The software upgrade includes the bootloader and instrument software, and the meter and Help string files.

Before you can upgrade the meter's user program, you should print out or download logs and other settings stored in the PM880 AC's memory.

IMPORTANT: To guard against mishap, you should print out, download or otherwise record all logs, settings and other data you wish to save.

Once you have backed up your data, refer to the section below to begin the upgrading procedure.

8.7.1 Upgrading Requirements

To use your PC to download the new user program, your computer must meet the following requirements.

8.7.1.1 Infrared Hardware

The PM880 AC is equipped with a built-in IR sensor. Your PC must have an infrared sensor (built-in or external). If your PC does not have a built-in IR sensor, you can purchase a compatible IR adapter. Panametrics recommends the ActiSys ACT-IR220L+ infrared to RS232 adapter.

8.7.1.2 MicroSoft Windows Operating System

The operating system software must be IrDA compatible. There are two IR standards supported by MicroSoft Windows operating systems: IrOBEX and IrCOMM.

- IrOBEX is the newest standard and is used by most Windows operating systems. This standard transfer files faster and tolerates IR interruptions better.
- IrCOMM is an older standard and is used by some Windows operating systems. This standard transfers files at a slower rate, but can still be used to upgrade the meter's user program.

Panametrics recommends updating software using the IrOBEX standard; however, the IrCOMM standard is available for users who have problems with IrOBEX. Use Table 3 to find out which standard your PC's operating system can use.

Table 3: Windows Operating Systems IrDA Compatibility

Operating System	IrCOMM	IrOBEX
Windows XP	No	Yes
Windows 2000	No	Yes
Windows NT 4.0	QuickBeam*	QuickBeam*
Windows Me*	Yes	Yes
Windows 98 SE*	Yes	Yes
Windows 98*	Yes	Yes
Windows 95*	Yes	Yes
Windows 3.1	No	No
DOS 6.22	No	No

*May require QuickBeam installation under some circumstances when Windows built-in support fails. QuickBeam is an infrared file software transfer utility from Extended Systems, Inc. Since Windows NT 4.0 does not provide built-in support for IR file transfer, QuickBeam is necessary with this operating system.

To upgrade using:

- IrOBEX - see *Updating Software using IrOBEX* on page 78.
- IrCOMM - see *Updating Software using IrCOMM* on page 78.

8.7.2 Updating Software Using IrOBEX

Use the sections below to upgrade the PM880 AC software using IrOBEX.

8.7.2.1 Setting Up PM880 AC

1. Press [MENU].
2. Use the arrow keys to scroll to Service and press [ENTER].
3. Use the arrow keys to scroll to Flash Update and press [ENTER]. The screen appears similar to Figure 68.



Figure 68: Flash Update Window

4. Press [F3] (OK) to confirm that you wish to erase the program.
5. The meter asks for confirmation. Press [F3] (OK) to continue with the update.
6. After the PM880 AC reboots, the meter will ask you a series of questions. Use the appropriate function key to respond, then refer to the next section.

8.7.2.2 Downloading User Program Upgrades

Note: You can also use Infrared Transfer Application (My Computer | Infrared Recipient) to download files.

1. Using your PC, open *Windows Explorer*.
2. Go to the folder where the upgrade files are stored.
3. Highlight the desired file(s) by clicking once. The software upgrade includes the bootloader and instrument software, and the meter and Help string files.
4. Right click on the file(s).
5. Be sure the infrared sensor on the meter has a clear path to the infrared adapter on the PC.
6. Select *Send To* → *Infrared Recipient* or *Nearby Computer* (or *QuickBeam* if QuickBeam has been installed)
7. The computer will display a window showing the status of the file upload.

8.7.3 Updating Software Using IrCOMM

Use the sections below to upgrade the PM880 AC software using IrCOMM.

8.7.3.1 Setting up the PC

Note: The use of Hyperterminal is shown here as an example. If you are using a different communications software, see its manual for detailed instructions.

1. From the Start Menu, click *Programs/Accessories/Hyperterminal* to open the Hyperterminal window.
2. If the call is not connected, click on *Connect* from the *Call* menu in Hyperterminal.
3. From the *File* menu, click *Properties*. Be sure the *New Connection Properties* window is set to your virtual infrared port.

Note: You can determine which virtual port your infrared is using by opening *Infrared Monitor* in the Control Panel and clicking on the *Options* tab. It displays the message, "Providing Application Support on:" and then lists the virtual infrared port.

8.7.3.2 Setting Up PM880 AC

1. If the menu is not active, press **[MENU]**.
2. Use the arrow keys to scroll to Service and press **[ENTER]**.
3. Use the arrow keys to scroll to Flash Update and press **[ENTER]**. Screen appears similar to Figure 69 on page 79.
4. Press **[F3]** (OK) to confirm that you wish to erase the program.
5. The meter asks for confirmation. Press **[F3]** (OK) to continue with the update.
6. After the PM880 AC reboots, the meter will ask you a series of questions. Use the appropriate function key to respond, then refer to the next section.

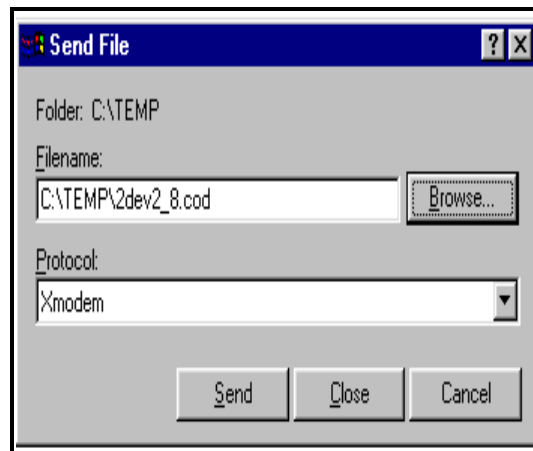

Figure 69: Flash Update Window

8.7.3.3 Downloading User Program Upgrades

1. Be sure the infrared sensor on the meter has a clear path to the infrared adapter on the PC.
2. Return to the PC Hyperterminal program. In the Hyperterminal window, pull down the *Transfer* menu and click *Send File*. A window opens similar to Figure 70.

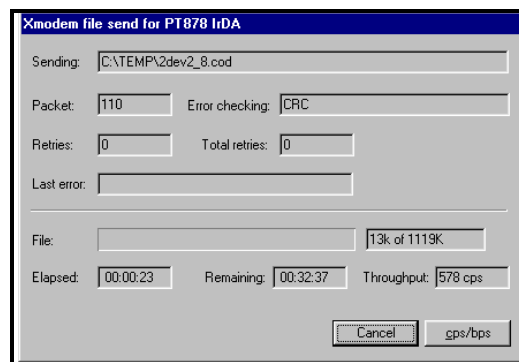

Figure 70: Transfer Menu Send File Window

3. Click on the replacement software (designated by a.cod extension) from the folder where it has been stored.
4. From the Protocol drop-down menu, select Xmodem.
5. Click *Send*. For a successful transfer, the PC window appears similar to Figure 71, while the PM880 AC screen displays the program ID, size, load address and a count of blocks being loaded.

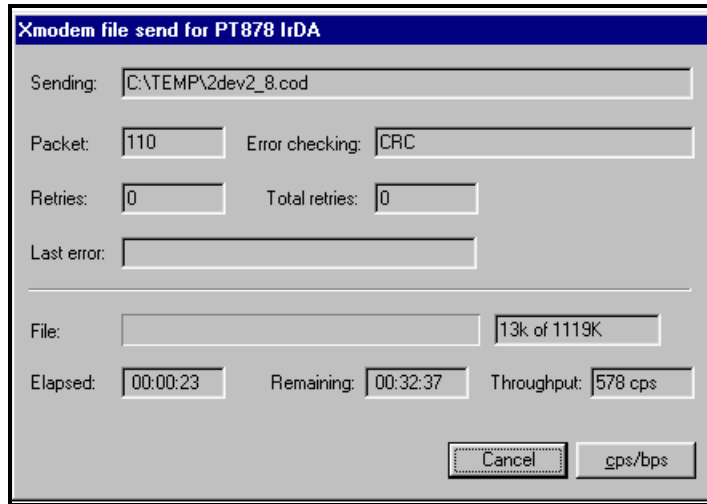

Figure 71: File Transmission Window

8.8 Error and Screen Messages

The PM880 AC has a series of error messages that display on the screen when the error occurs. The error messages are only general descriptions of the possible problems. The PM880 AC also has several screen messages that appear during operation and setup.

Use Table 4 to isolate and remedy the problem. If you are unable to remedy the problem, contact the factory.

Table 4: Error and Screen Messages

Error Message	Problem	Action
Error Codes		
Err 1: No Probe	A probe of type required has not been installed.	Connect the required probe.
Err 2: Out of Range	A calculated result exceeds the unit's capacity.	Contact the factory.
Err 3: Over Range	A calculated result exceeds the unit's calibration range.	Contact the factory. Change the measurement units so that the result is within range.
Err 4: Under Range	A calculated result is below the unit's calibration range.	Contact the factory.
Err 5: Not Avail	The mode or units selected require more data or a different sensor.	Choose a different mode and/or units. Connect the required probe.
Err 6: No Comm	The MIS Probe did not respond to a request for data.	Check the MIS Probe connections. Replace the MIS Probe.
Err 7: No Link	Communication with an MIS Probe has failed. The probe is disconnected or damaged.	Check the MIS Probe connections. Replace the MIS Probe.
Err 8: Bad CRC	Communication with an MIS Probe is intermittent or distorted.	Check for cable breaks or high electromagnetic interference (EMI).

Table 4: Error and Screen Messages

Error Message	Problem	Action
Err 9: Bad Msg	The MIS Probe sent a response not supported by a PM880 AC.	Consult the factory.
Err 11: No Reference	No reference values were entered for a moisture or pressure probe.	Enter reference values.
Err 12: No Calibration	No calibration curve was entered for a moisture or pressure probe.	Enter calibration curve.
Err 15: Cal Error	An internal calibration reference has failed during AutoCal, or a probe failure is interfering with AutoCal.	Contact the factory.
Err 25: No Data	The MIS Probe has not responded, or a calculation is not yet complete.	The PM880 AC will try to send data; wait for next update.
MIS Probe		
Calibration data will be written to the attached MIS probe.	This screen appears when new calibration data is manually entered in the Calibrate menu.	Press [F3] (OK) to overwrite existing data. Pressing OK overwrites the calibration data stored in the MIS probe electronics module. Press [F2] (Cancel) to discontinue.
These setup values will be written to the attached MIS probe.	This screen appears when new setup data is manually entered in the Service, MIS Probe menu.	Press [F3] (OK) to overwrite existing data. Pressing OK overwrites the setup data (e.g. reference values) stored in the MIS probe electronics module. Press [F2] (Cancel) to discontinue.
No link to the MIS probe.	This screen appears when trying to write to a disconnected MIS probe.	Press [F3] (OK) to cancel all writes. The PM880 AC will read from the next connected MIS probe. During the "No Link" condition, the Hygro and Pressure tabs in the Calibrate menu are disabled. These calibration values are erased until a new probe is connected.
A MIS probe change has been detected.	This screen appears after a probe change.	Press [F3] (OK) to cancel all writes. The PM880 AC will read data from the next connected MIS probe.
MISC		

Table 4: Error and Screen Messages

Error Message	Problem	Action
Probe due for calibraton.	This screen appears at the user-programmed interval in the Probe ID tab in the Calibrate menu.	<p>Send probe back to factory for recalibration. If you are recalibrating a MIS probe, make sure you send the electronics module back with the probe.</p> <p>Press [ENTER] to temporarily clear the reminder.</p> <p>To turn off the reminder, use the Program, Calibrate, Probe ID menus. Turn Cal Reminder to None.</p>
If you see this message, the watchdog test has FAILED. Please consult the factory for instructions.	This screen appears if the watchdog timer circuit fails the watchdog test (Service, Test, Watchdog Test menu).	Press [F3] (OK) to continue. Contact the factory.

8.9 Common Problems

If the PM880 AC measurement readings seem strange, or they do not make sense, there may be a problem with the probe or a component of the process system. Table 5 contains some of the most common measurement problems.

Table 5: Troubleshooting Guide for Common Problems

Possible Cause	System Response	Action
Symptom: Accuracy of moisture sensor is questioned.		
Insufficient time for system to equilibrate	Probe reads too wet in dry down conditions, or too dry in wet up conditions.	Change the flow rate. A change in dewpoint indicates the sample system is not at equilibrium, or there is a leak. Allow sufficient time for sample system to equilibrate and moisture reading to become steady. Check for leaks.
Dewpoint at sampling point is different than the dewpoint of the main stream.	Probe reads too wet or too dry.	Readings may be correct if the sampling point and main stream do not run under the same process conditions. The different process conditions cause readings to vary. If sampling point and main stream conditions are the same, check sample system pipes, and any pipe between the sample system and main stream for leaks. Also, check sample system for adsorbing water surfaces, such as rubber or plastic tubing, paper-type filters, or condensed water traps. Remove or replace contaminating parts with stainless steel parts.
Sensor or sensor shield affected by process contaminants (refer to <i>Application of the Hygrometer</i>).	Probe reads too wet or too dry.	Clean the sensor and the sensor shield as described in <i>Aluminum Oxide Probe Maintenance</i> in <i>Application of the Hygrometer</i> . Then reinstall the sensor.
Sensor is contaminated with conductive particles (refer to <i>Application of the Hygrometer</i>).	Probe reads high dewpoint.	Clean the sensor and the sensor shield as described in <i>Aluminum Oxide Probe Maintenance</i> in <i>Application of the Hygrometer</i> . Then reinstall the sensor.

Symptom: Accuracy of moisture sensor is questioned. (cont.)		
Sensor is corroded (refer to <i>Application of the Hygrometer</i>).	Probe reads too wet or too dry.	Return the probe to the factory for evaluation.
Sensor temperature is greater than 70°C (158°F).	Probe reads too dry.	Return the probe to the factory for evaluation.
Stream particles causing abrasion.	Probe reads too wet or too dry	Return the probe to the factory for evaluation.
Symptom: Screen always reads the wettest (highest) programmed moisture calibration value while displaying dew/frost point.		

Table 5: Troubleshooting Guide for Common Problems

Possible Cause	System Response	Action
Probe is saturated. Liquid water present on sensor surface and/or across electrical connections.		Clean the sensor and the sensor shield as described in <i>Aluminum Oxide Probe Maintenance in Application of the Hygrometer</i> . Then reinstall sensor.
Shorted circuit on sensor.		Run "dry gas" over sensor surface. If high reading persists, then probe is probably shorted and should be returned to the factory for evaluation.
Sensor is contaminated with conductive particles (refer to <i>Application of the Hygrometer</i>).		Clean the sensor and the sensor shield as described in <i>Aluminum Oxide Probe Maintenance in Application of the Hygrometer</i> . Then reinstall sensor.
Improper cable connection.		Check the cable connections to both the probe and the PM880 AC.
Symptom: Screen always reads the driest (lowest) programmed moisture calibration value while displaying dew/frost point.		
Open circuit on sensor.		Return probe to factory for evaluation.
Non-conductive material is trapped under the contact arm of the sensor.		Clean the sensor and the sensor shield as described in <i>Aluminum Oxide Probe Maintenance in Application of the Hygrometer</i> . Then reinstall the sensor. If the low reading persists, return the probe to the factory for evaluation.
Improper cable connection.		Check the cable connections to both the probe and the PM880 AC.
Symptom: Slow response.		
Slow outgassing of system.		Replace system components with stainless steel or electro-polished stainless steel.
Sensor is contaminated with non-conductive particles (refer to <i>Application of the Hygrometer</i>)		Clean the sensor and the sensor shield as described in <i>Aluminum Oxide Probe Maintenance in Application of the Hygrometer</i> . Then reinstall the sensor.
Symptom: Exception screen.		
Unrecoverable software error.		Contact the factory.

8.10 Replacing and Recalibrating the Moisture Probes

Note: Remove the probe cable by pulling back the spring-loaded sleeve and pulling the cable out of the connector.

For maximum accuracy you should send moisture probes back to the factory for recalibration every six months to one year, depending on the application. Under severe conditions you should send the probes back for recalibration more frequently; in milder applications you do not need to recalibrate probes as often. Contact a Panametrics applications engineer for the recommended calibration frequency for your application.

Note: You can program the PM880 AC to remind you when it is time to send the probes back for recalibration. Refer to Setting a Probe Calibration Reminder on page 25.

When you receive new or recalibrated probes, be sure to follow the instructions in Chapter 1, *Getting Started*, to install, connect and enter calibration data for the probe(s). Note that each probe has its own Calibration Data Sheet with the corresponding probe serial number printed on it.

You do not have to enter calibration data for the MISP2 Probe or for the Moisture Image Series (MIS) Probe if you returned both the sensor and the electronics module to the factory for recalibration. However, you should verify that the calibration data entered at the factory is correct (see *Entering Setup Data* on page 2). If you sent only the sensor part of the MIS Probe to the factory without the module, you must enter the calibration data manually.

8.11 Recalibrating the Pressure Sensors

Since the pressure sensor on a TF Probe or on Moisture Image Series (MIS) Probes is a strain gage type, the pressure calibration is linear and is calibrated at 2 data points. Each point consists of a voltage or FP value and a corresponding pressure value in psig. Check or change the two calibration data points using the steps below.

1. Set one of the boxes on the screen to display pressure in mV (or FP) and another box to display psig. Refer to *Displaying Measurements* on page 7 to set up the screen.
2. Expose the pressure sensor to air and record the mV (or FP) and psig readings. This reading is for the zero pressure.
3. Expose the pressure sensor to a known full scale pressure source and record the mV (or FP) and psig readings. This reading is for the span pressure.
4. Press **[MENU]**.
5. Use the arrow key to scroll to Program and press **[ENTER]**.
6. Use the arrow key to scroll to Calibration and press **[ENTER]**.
7. Proceed to *Entering Pressure Calibration Data* on page 5 to complete entering data.

[no content intended for this page]

Chapter 9. Features and Specifications

The Model PM880 AC is a microprocessor-based portable hygrometer designed to measure dissolved moisture concentration in gases and non-aqueous liquids. This highly-advanced industrial analyzer is adaptable to many applications.

The complete analyzer, including the hygrometer, cables and measurement probes, forms a “system” designed to monitor a process accurately and reliably. The following section discusses each part of this system and lists specifications.

9.1 The PM880 AC Hygrometer

The center of the measurement system is the PM880 AC hygrometer. The front of the meter has a Liquid Crystal Display, a membrane keypad and menu keys. See Figure 72.



Figure 72: PM880 AC Hygrometer

The top of the PM880 AC (shown in Figure 73) includes an input for connecting moisture probes. An internal infrared transceiver enables communication between the meter and other IR devices, particularly the IR ports or IR to RS232 adapters of Windows®-based PCs or printers. Users can send and receive site and log data; they can also program the meter using the optional PanaView software interface. The PM880 AC was designed for use with products that comply to the IrDA protocol.

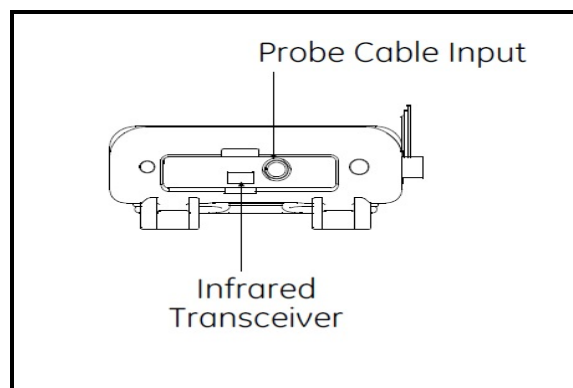

Figure 73: Probe Connection and Infrared Transceiver

9.2 Probes

Probes are the part of the system that come into contact with the process flow. The PM880 AC uses various types of probes to make moisture, temperature, and pressure measurements.

Note: Only Panametrics standard probes can be used with the PM880 AC.

- Moisture (M) Series – moisture and temperature.
- Three Function (TF) Series – moisture, temperature, and pressure.
- Moisture Image Series (MIS) – moisture, temperature, and pressure.

9.2.1 M Series and TF Series Moisture Probes

The M Series and the TF Series probes are very similar. Both probes use the Panametrics aluminum oxide sensors to measure moisture, and a thermistor bead (optional) to measure temperature. The TF Series also has an optional built-in strain-gage-type pressure transducer. The sensor assemblies are secured to a probe mount and are usually protected with a sintered stainless-steel shield (TF-9 probes do not have a shield). Other types of shields are available. See Figure 74.

If the optional temperature thermistor or pressure transducer is not used, the user can enter fixed values for temperature and pressure into the PM880 AC memory.

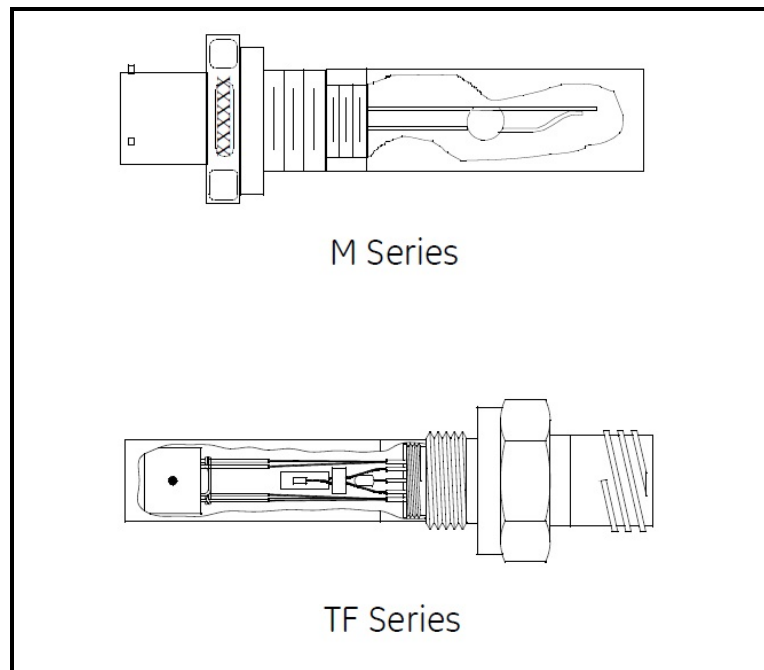

Figure 74: M & TF Series Probe (ref dwgs 750-042 & 901-152)

Although the M and the TF Series probes may be installed directly in the process line, more often these probes are inserted into a sample system. The sample system protects the probes and enables the user to easily remove the probes for calibrating, servicing and cleaning. Sample systems also control various process and environmental conditions so that the moisture probe or sample system operates within specifications.

The M and TF Series probes measure moisture content in a standard range from -110°C to 20°C (-166°F to 68°F) dew/frost point temperature and optionally from -110°C to 60°C (-166°F to 140°F). Both probes optionally measure temperature in a range of -30°C to 70°C (-22°F to 158°F). The TF probe optionally measures pressure from 30-300 / 50-500 / 100-1000 / 300-3000 / 500-5000 psig.

9.2.2 Moisture Image Series Probe

The Moisture Image Series probe measures moisture, temperature (optional), and pressure (optional). The Moisture Image Series probe has its own electronics module that consists of a built-in microcontroller with 16-bit resolution.

See Figure 75.

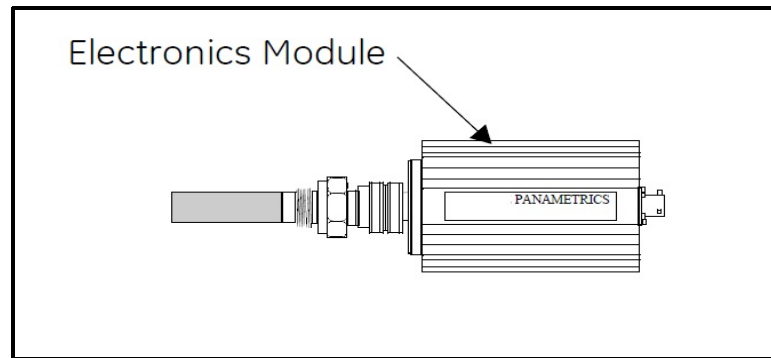

Figure 75: Moisture Image Series Probe

The MISP2 probe has an integral set of electronics that are permanently attached (see Figure 76). Do not attempt to separate the probe from the electronics.



Figure 76: MISP2 Probe

The electronics module stores the probe calibration and reference data in non-volatile memory; therefore, the user never needs to enter the data by hand. The Moisture Image Series probes also feature continuous compensation of their own analog circuitry to assure long-term electronic stability.

The Moisture Image Series probes measure moisture content in a standard range from -110°C to 20°C (-166°F to 68°F) dew/frost point temperature and optionally from -110°C to 60°C (-166°F to 140°F). In addition, it can be used to measure temperature in a range of -30°C to 70°C (-22°F to 158°F) and pressure 30–300/50–500/100–1000/300–3000/500–5000 psig.

9.3 Cabling

Each probe requires an interconnecting cable. Cables differ depending on the probe. The various cables are discussed below under the appropriate probe type. All of these cable assemblies can be ordered from the factory.

9.3.0.1 M Series and TF Series Probes

The M and the TF Series probes are connected to the analyzer with a special Panametrics shielded cable. Probes can be located up to 600 meters (2,000 feet) from the PM880 AC (consult the factory for distances up to 1,200 meters). To measure pressure with a TF probe, the maximum cable length is approximately 152 meters (500 feet).

9.3.0.2 Moisture Image Series Probes

The Moisture Image Series probes can be connected to the PM880 AC with an unshielded, twisted-pair cable. Each probe may be located up to 915 meters (3,000 feet) from the analyzer using 22 AWG twisted pair cable. (Consult the factory for longer cable lengths.)

9.4 Overall

Channels

Single Channel

Dimensions

- Size: 9.4 × 5.5 × 1.5 in. (238 × 138 × 38 mm)
- Weight, electronics: 2.5 lb (1.13 kg)
- Weight, sample system: 4 lb (1.8 kg)

Enclosure

NEMA 4X IP67

9.5 Operational

Site Parameter Programming

Menu-driven, graphic, operator interface uses keypad and sift-function keys. Online help functions. Memory storage for saving site parameters.

Data Logging

Memory capacity to log over 100,000 moisture data points. Programmable keypad for log units, update times, and start and stop times.

Display Functions

Displays measurements and logged data in alphanumeric or graphical format. Language options: Dutch, English, French, German, Italian, Portuguese, Russian, Castilian Spanish, Latin-American Spanish and Swedish.

Display Units

- Moisture: DP temperature, ppm_v, ppm_w, %RH, lb/MMSCF and others.
- Temperature: °F, °C and °K
- Pressure: psig, bar, kPa (gauge), kg/cm² (gauge) and others

9.6 Electronics

Memory

FLASH memory

Operating Temperature

14° to 122°F (−10° to 50°C)

Keypad

25-key, rubberized, tactile membrane

Display

240 × 200-pixel, graphic backlit LCD

Printer/Terminal Output

Infrared communications port

Cables

Cable type dependent on probe type: M Series, TF Series, or Moisture Image Series. LEMO[®]-to-bayonet connector

Cable Length

- Standard: 10 ft (3 m)
- Optional: Consult the factory for other lengths

Input/Output

Input: 115 VAC, 150 mA or 230 VAC, 74 mA, 50/60 Hz
Output: 7.5 VDC, 690 mA, 5.2 W

European Compliance

Complies with EMC Directive 2004/108/EC

For EN61000-4-3, the PM880 AC meets performance criteria A and in a limited number of frequencies, performance criteria B per EN61326.

EN 61326-2-3: 2006

9.7 Moisture Measurement

Compatibility

Compatible with all Panametrics aluminum-oxide moisture probes: M Series, TF Series and Moisture Image Series. Each probe type requires a different type of I/O cable.

Calibration

Panametrics moisture sensors are computer calibrated to NIST-traceable moisture concentrations.

9.8 Dew/frost Point Temperature

Overall Range Capability

- -110° to 60°C (-166 to 140°F)

Available Range Options

- Standard: -80° to 20°C (-112° to 68°F) with data to -110°C (-166°F)
- Ultra-Low: -110° to -50°C (-166° to -58°F)
- High Range Data: -80° to 60°C (-112° to 140°F)

Calibrated Accuracy at 25°C (77°F)

- $\pm 2^{\circ}\text{C}$ (3.6°F) from -65° to 10°C (-85° to 50°F)
- $\pm 3^{\circ}\text{C}$ (5.4°F) from -80° to -66°C (-112° to -87°F)

Repeatability

- $\pm 0.5^{\circ}\text{C}$ (0.9°F) from -65° to 10°C (-85° to 50°F)
- $\pm 1.0^{\circ}\text{C}$ (1.8°F) from -80° to -66°C (-112° to -87°F)

Operating Pressure

$5\ \mu$ of Hg to 5,000 psig (345 bar) limited by pressure sensor – (see pressure measurement specifications)

9.9 Temperature Measurement

Optional thermistor is available for all Panametrics moisture probes.

Range

-30°C to 70°C (-22° to 158°F)

Accuracy

$\pm 0.5^{\circ}\text{C}$ at -30°C

9.10 Pressure Measurement

Optional pressure sensor is available for TF Series and Moisture Image Series moisture probes

Ranges

- 30 to 300 psig (3 to 12 bar)
- 50 to 500 psig (4 to 35 bar)
- 100 to 1,000 psig (7 to 69 bar)
- 300 to 3,000 psig (21 to 207 bar)
- 500 to 5,000 psig (35 to 345 bar)

Accuracy

$\pm 1\%$ at full scale

Proof Pressure

3 times span of available range up to maximum 7,500 psig (518 bar)

9.11 Sample System

Specifications for SS880A standard sample system, comprising an inlet needle valve, a built-in coalescing filter and sample cell with bypass needle valve and venting tube, a pressure gage (various ranges), and an outlet needle valve with venting tube.

Wetted Parts

316 SS

Operating Pressure

Configurations available for 300, 500, 1,000, 2,000 or 3,000 psig (21, 35, 69, 207, or 345 bar), dependent on pressure gauge

Maximum Pressure Rating

- Standard: 3,000 psig (207 bar)
- Optional: 5,000 psig (345 bar)

Other Options

- Inlet pressure regulator, 0 to 500 psig (1 to 345 bar) outlet
- Armored flowmeter, 1.3 to 13 SCFH
- 10 ft (3 m), flexible, PTFE-lined, braided-stainless steel hose with 1/8-in. tube connections. Not recommended for dewpoint temperatures below -103°F (-75°C).

9.12 Optional Accessories

- Infrared adapter connects to serial port of desktop or laptop PCs to add infrared capability.
- Portable, infrared, thermal printer with rechargeable battery and 120 to 240 VAC battery charger.
Printer dimensions: 6.3 × 6.5 × 2.3 in. (160 × 164 × 59 mm).
Weight: 13 oz (370 g). Print width: 4 in. (104 mm).
- PC Interface Software - PanaView™ Graphical User Interface.

[no content intended for this page]

Chapter A. Measurement Considerations

There are a variety of environmental and installation factors that can affect measurements. These factors should be discussed with a Panametrics applications engineer or field sales person by the time you receive the PM880. However, if you decide to add additional measurement sites, this section contains some basic guidelines for selecting a measurement site and constructing a sample system. This section includes the following:

- Choosing a Measurement Site - see below
- Moisture/Temperature Probe Considerations - page A-95
- Sample System Guidelines - page A-97

A.1 Choosing a Measurement Site

You should have discussed environmental and installation factors with a Panametrics applications engineer or field sales person by the time you receive the PM880. The equipment should be suited to the application and installation site.

- Choose an installation site for the probes and sample systems that is as close to the process line as possible. Avoid long lengths of connecting tubing. If long distances are unavoidable, a fast sampling by-pass loop is recommended. Do not install any other components, such as filters, ahead of the probes or sample system unless instructed to do so by Panametrics.
- Observe all normal safety precautions. Use the probes within their maximum pressure and temperature ratings.
- Locate the electronics unit away from high temperatures, strong electrical transients, mechanical vibrations, corrosive atmospheres, and any other conditions that could damage or interfere with the meter operation.
- Protect the probe cables from excessive physical strain (bending, pulling, twisting, etc.). In addition, do not subject the cables to temperatures above 65°C (149°F) or below -50°C (-58°F).
- Observe the proper cable restrictions for the probes. You can locate the Moisture Image Series probe up to 915 meters (3,000 feet) away from the electronics unit with an unshielded twisted-pair cable. The M Series and TF Series probes require specially shielded cable. You can locate the M and TF probes up to 600 meters (2,000 feet) from the unit. If you are measuring pressure with a TF probe, the cable length should not exceed 152 meters (500 feet).

A.2 Moisture/Temperature Probe Considerations

The M Series, TF Series, and Moisture Image Series probes consist of an aluminum oxide sensor mounted on a connector head. Standard probe mounts include a protective stainless steel shield.

The probe sensor materials and housing maximize durability and insure a minimum of water absorbing surfaces in the vicinity of the aluminum oxide surface. A sintered stainless steel shield is used to protect the sensor from high flow rates and particulate matter. The end cap should not be removed except upon advice from Panametrics.

The sensor has been designed to withstand normal shock and vibration. You should make sure that the active sensor surface is never touched or allowed to come into direct contact with foreign objects, since this may adversely affect performance.

Observing these few simple precautions will result in a long and useful probe life. Panametrics recommends that probe calibration be checked routinely, at 12-month intervals, or as recommended by our applications engineers for your particular application.

The probe will measure the water vapor pressure in its immediate vicinity; therefore, readings will be influenced by its proximity to the system walls, materials of construction, and other environmental factors. The sensor can be operated under vacuum or pressure, flowing or static conditions.

Observe the following environmental precautions.

a. Temperature Range

The standard probe is operable from -110°C to +70°C (-166°F to 158°F).

b. Moisture Condensation

Be sure the temperature is at least 10°C higher than the dew/frost point temperature. If this condition is not maintained, moisture condensation could occur on the sensor or in the sample system, which will cause reading errors. If this happens, dry out the probe following the procedures outlined in *Application of the Hygrometer*.

c. Static or Dynamic Use

The sensor performs equally well in still air or where considerable flow occurs. Its small size makes it ideal for measuring moisture conditions within completely sealed containers or dry boxes. It will also perform well under gas flow conditions as high as 10,000 cm/sec and liquid flow conditions to 10 cm/sec. Refer to *Application of the Hygrometer*, for maximum flow rates in gases and liquids.

d. Pressure

The moisture probe directly measures water vapor pressure. The moisture sensor measures water vapor under vacuum or high pressure conditions from as little as 5 microns Hg to as high as 5,000 psi total pressure.

e. Long-Term Storage & Operational Stability

Sensors are not affected by continuous abrupt humidity changes, or damaged by exposure to saturation conditions, even when stored. However, you should store probes in their original shipping containers in a clean, dry location. If the probe is saturated during storage, refer to *b. Moisture Condensation* on the previous page before installing the probe. For best performance, do not store probes longer than one to two years from their calibration date.

f. Freedom from Interference

The sensor is completely unaffected by the presence of a wide variety of gases or organic liquids. Large concentrations of hydrocarbon gases, Freon™, carbon dioxide, carbon monoxide, and hydrogen have no effect on sensor water vapor indications. The sensor will operate properly in a multitude of gaseous or non-conductive liquid environments.

g. Corrosive Materials

Avoid all materials that are corrosive or otherwise damaging to aluminum or aluminum oxide. These include strongly acidic or basic materials and primary amines.

A.3 Sample System Guidelines

A sample system is highly recommended for moisture measurement. The purpose of a sample system is to condition or control a sample stream to within the specifications of a probe. The application requirements determine the design of the sample system. Panametrics applications engineers will make recommendations based on the following general guidelines:

- Typically, sample systems should be kept very simple. They should contain as few components as possible and all or most of those components should be located downstream of the measurement probe. Figure 77 on the next page shows an example of a simple sample system consisting of an explosion-proof housing with a sample cell, a filter, a flow meter, a vent valve and two shut off valves, one at the inlet and one at the outlet.
- The sample system components should not be made of any material that will affect measurements. A sample system may include a filter to remove particulates from the sample stream or a pressure regulator to reduce or control the pressure of the stream. However, most common filters and pressure regulators are not suitable for sample systems because they have wetted parts that may absorb or release components (such as moisture) into the sample stream. They may also allow ambient contamination to enter the sample stream. In general, you should use stainless steel material for all wetted parts.

Contact the Panametrics PCI Division at 1-800-833-9438 (within the USA) or 781-899-2719 (outside the USA) for further instructions.

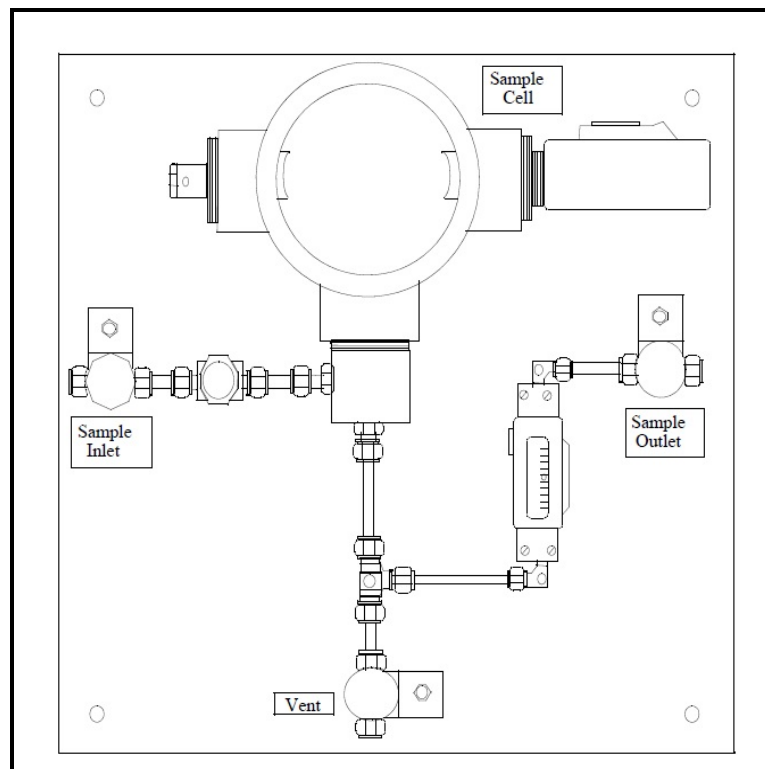

Figure 77: Typical Moisture Sample System

Note: The actual sample system design is dependent on the application requirements.

Chapter B. Menu Maps

This chapter includes menu maps of the PM880 AC program. Refer to the following:

- The Site Menu - page 101
- The Program Menu - page 102
- The Meter Menu - page 103
- The Logging Menu - page 104
- The Service Menu -

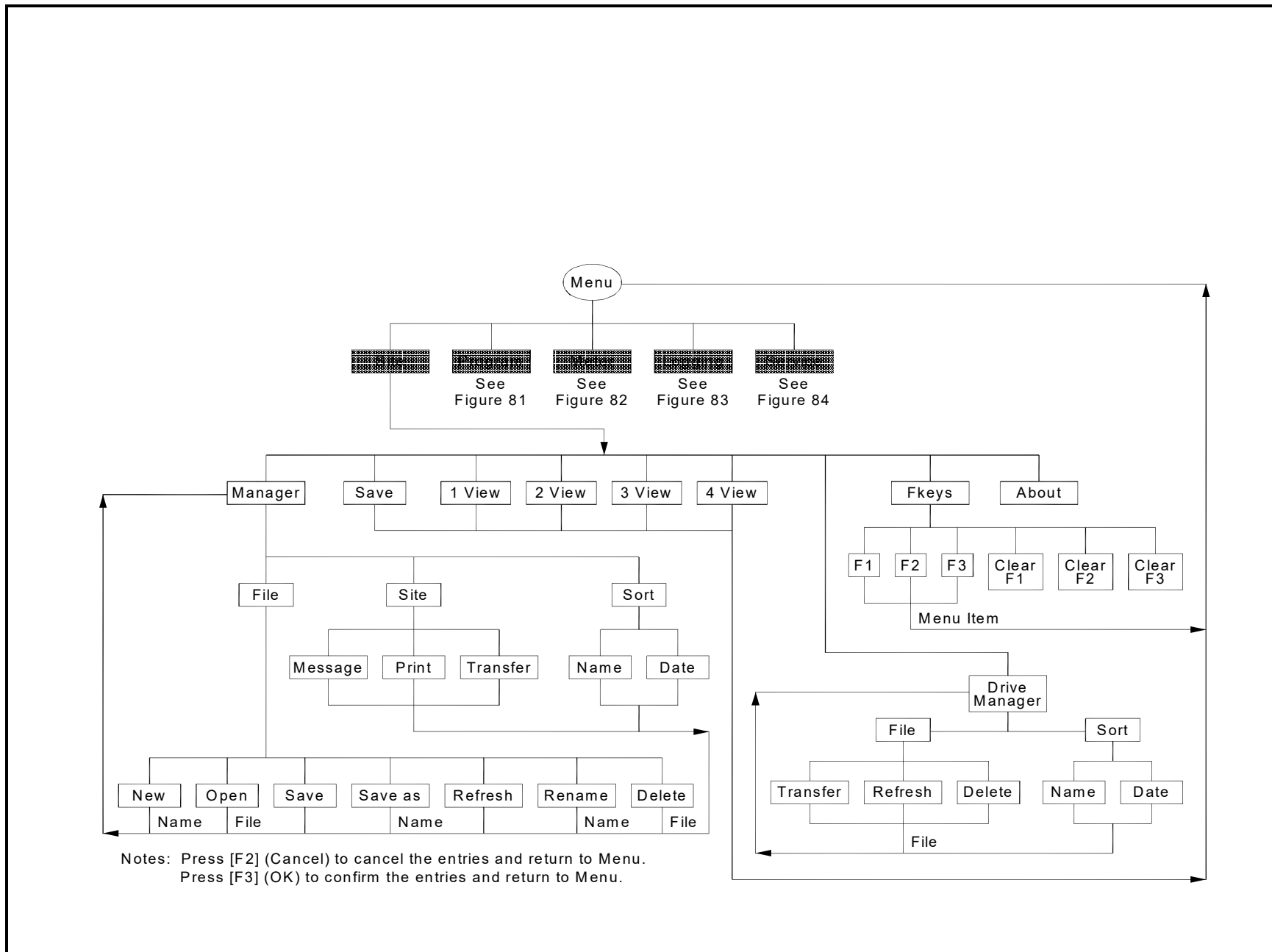

Figure 78: Site Menu

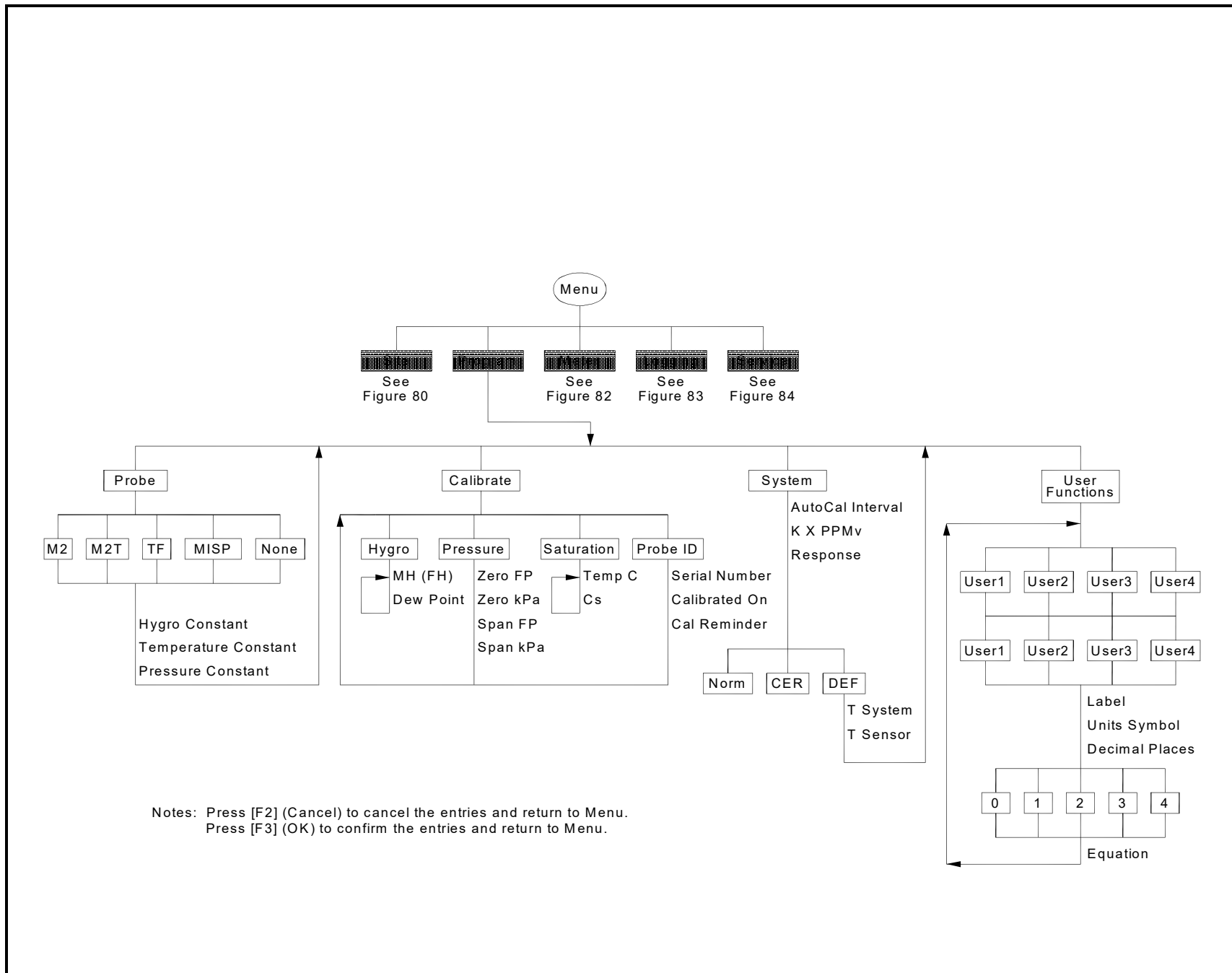

Figure 79: Program Menu

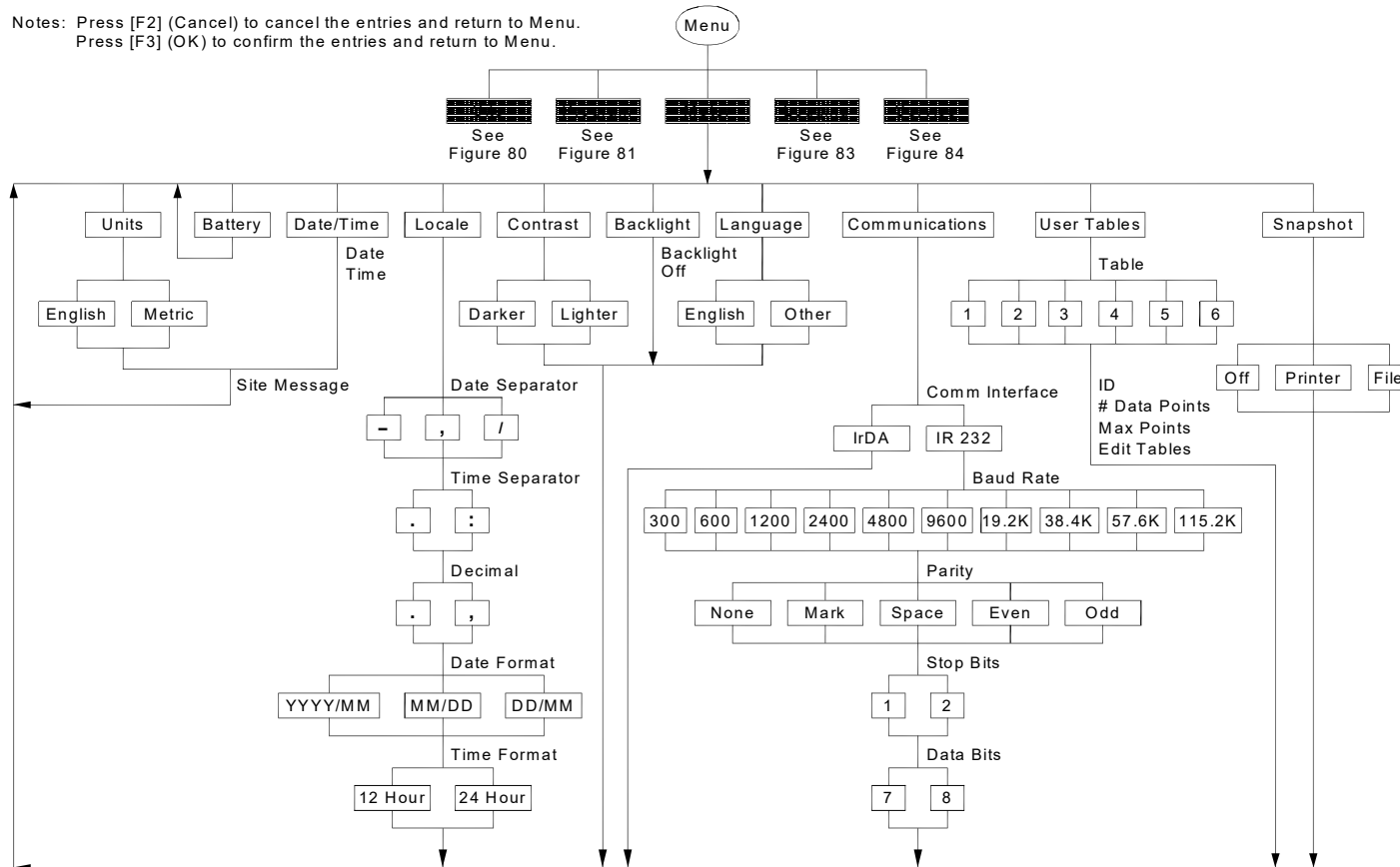

Figure 80: Meter Menu

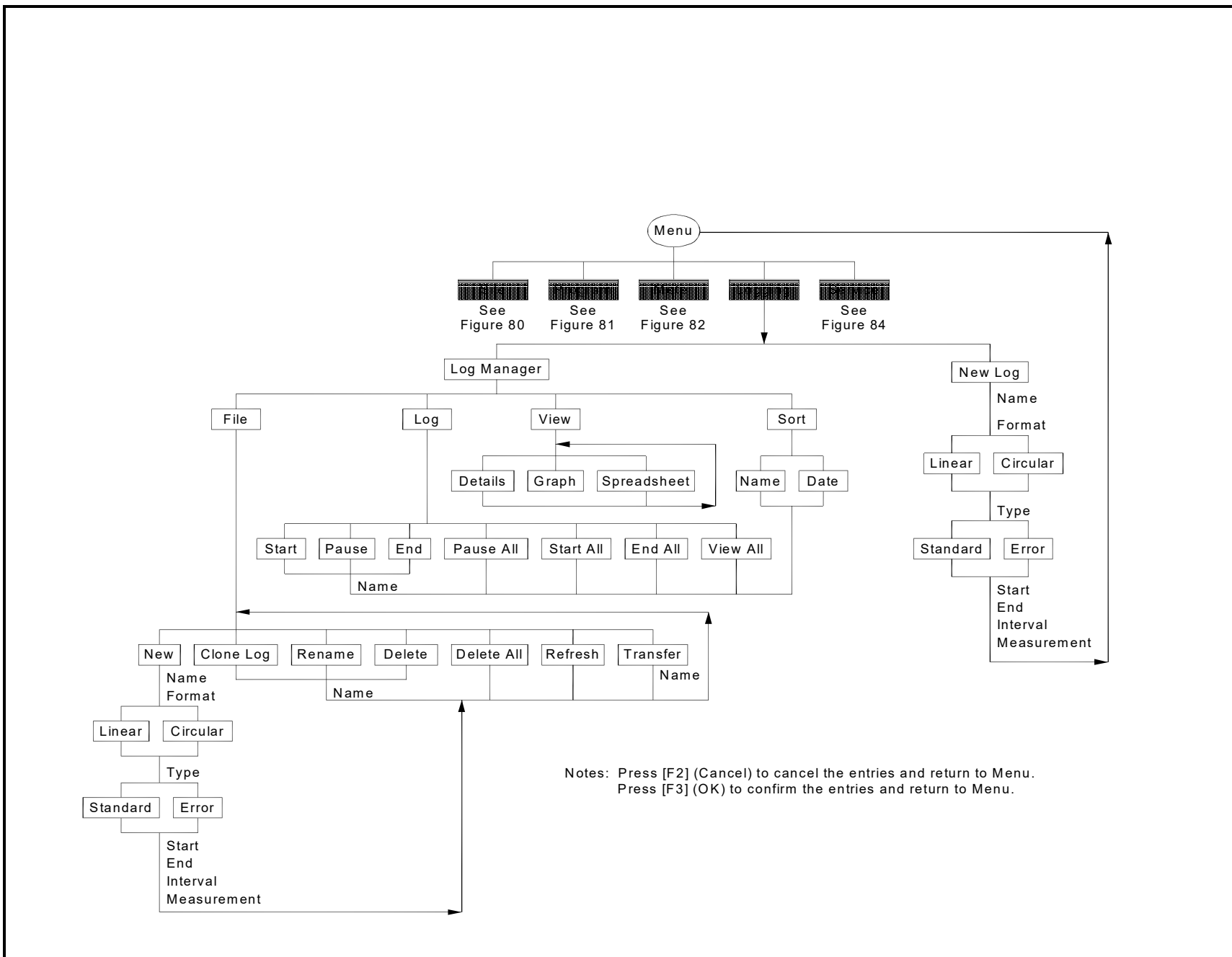

Figure 81: Logging Menu

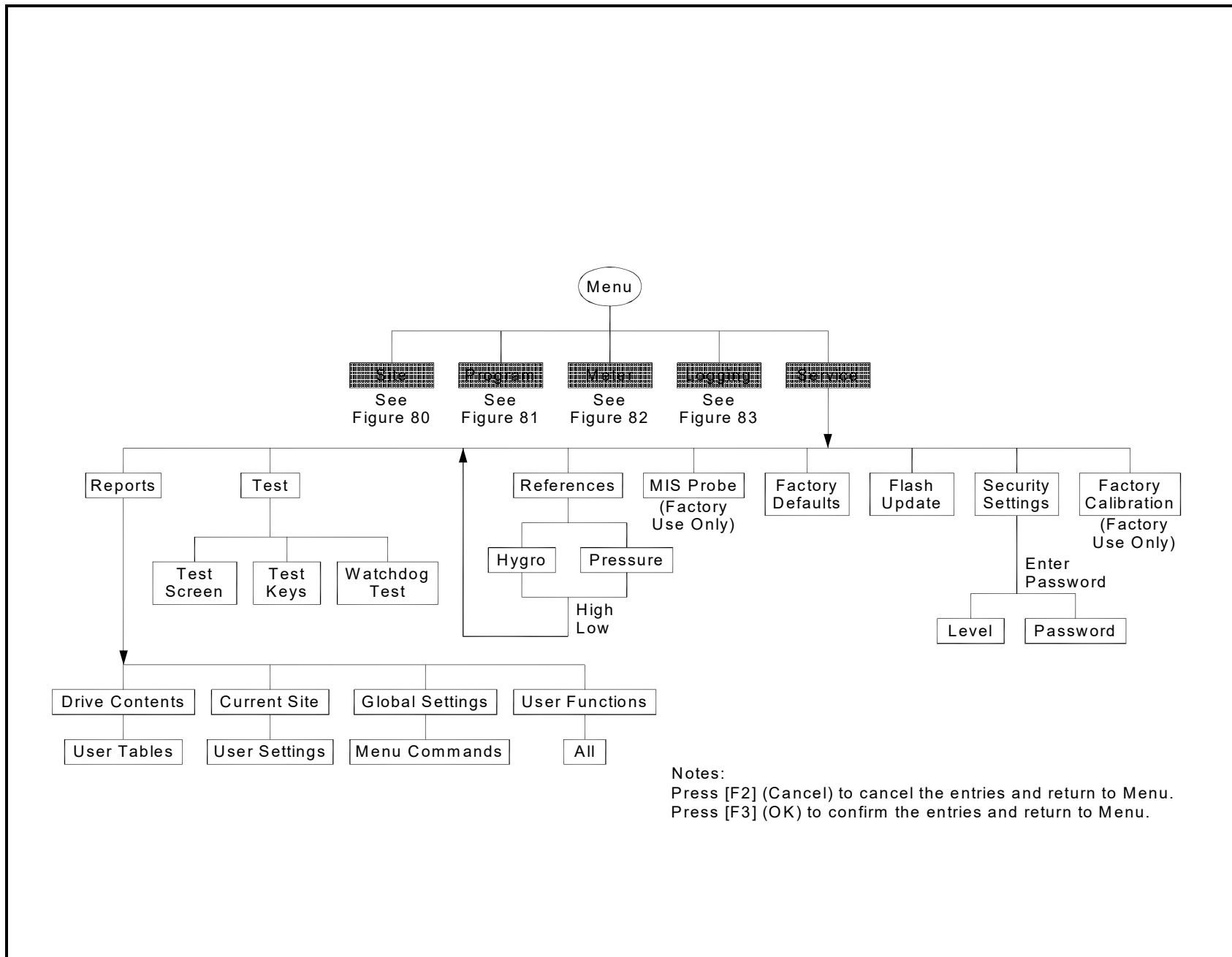

Figure 82: Service Menu

- A**
- About Option 37
 - Accessories 93
 - ActiSys ACT-IR220L+ infrared adapter 77
 - Adapter, IR 56
 - Add Hardware Wizard 56
 - Auto-Cal 26
- B**
- Backlight Option 20
 - Backlight, Timeout 20
 - Bar Graph, Adjusting Scale 19
 - Bitmap Screen Capture, Taking 21
- C**
- Cables
 - Installation Restrictions 95
 - M Series Probe 90
 - Moisture Image Series 90
 - Pressure Sensors 90
 - TF Series Probe 90
 - Calibration
 - Auto-Cal, Using 26
 - Calibration Reminder for Probes 25
 - Data for Probes 3
 - Entering Data for Pressure 5
 - Entering Moisture Data 4
 - Recalibrating Pressure Sensors 85
 - Replacing and Recalibrating Moisture Probes 85
 - Calibration Reminder, Entering 25
 - CER (Computer Enhanced Response) 33
 - Checking Memory Status 72
 - Checks at Power Up 1
 - Clearing Function Key 20
 - Common Problems 82
 - Communications Option 56, 64, 66, 68
 - Computer Enhanced Response 33
 - Response Time Procedure 34
 - Conducting a Leak Test 14
 - Constants, Entering 27
 - Contrast Option 21
 - Contrast, Adjusting 21
 - Copying a Log 52
- D**
- Date
 - Changing Appearance 24
 - Entering 24
 - Defaults, Resetting to 74
 - Deleting Files 54
 - Description
 - Error Messages 80
 - Screen 2
 - Diagnostics, Error Messages 80
- E**
- Display
 - Bitmap Screen Capture 21
 - Contrast, Adjust 21
 - Date and Time Appearance, Changing 24
 - Language, Changing 38
 - Messages 80
 - Screen 2
 - Selecting Format 18
 - Testing 72
 - Display Screen, Configuring 7
 - Displaying Details 43
- E**
- Electrical Connections 12
 - Electronics Unit
 - Features 87
 - Installation Site 95
 - Specifications 91
 - Ending a Log 42
 - English Units 24
 - Environmental Compliance iv
 - Error Messages 80
- F**
- Factory Defaults Option 74
 - Files
 - Deleting 54
 - Sorting 54
 - Transferring from a PC 68
 - Transferring to a PC 66
 - Flash Update, Setting up PC 78
 - Format Option 18
 - Function Keys
 - Clearing 20
 - Configuring 19
- G**
- Graph Scale, Adjusting 19
- H**
- Help, On-line 38
 - Hyperterminal, for Software Update 78
- I**
- Information Paragraphs iii
 - Installation 12
 - Conducting a Leak Test 14
 - Connecting the Sample System to the Process 12
 - Moisture Probe Considerations 95
 - Operating the Sample System 13
 - Probes in Sample System 11
 - Sample System 97
 - Shutting Down the Sample System 14
 - Site Selection 95
 - IR Adapter 56
 - IR Communications
 - Changing Parameters 56, 64, 66, 68
- K**
- Keypad, Testing 73
- L**
- Language Option 38

Language, Changing 38
 Limits Option 19
 Line Graph, Adjusting Scale 19
 Log 43
 Copying 52
 Deleting 54
 Ending 42
 in Graph Form 44
 in Spreadsheet Format 46
 New 39
 Printing 64
 Renaming 50
 Starting/Restarting 42
 Stopping 41
 Transferring from a PC 68
 Transferring to a PC 66
 Viewing 43
 Logging Menu Map 104

M

M Series Probe
 Cables 90
 Description 88
 Measurement Units, Selecting 24
 Measurements, Displaying 7
 Memory, Checking 72
 Meter Information, Displaying 37
 Meter Menu, Menu Map 103
 Metric Units 24
 Model Number, Viewing 37
 Moisture
 Auto-Cal, Using 26
 Calibration Data, Entering 4
 Computer Enhanced Response 33
 Moisture Image Series Probe 88, 89
 Moisture Probe Connection 12
 Moisture Probes
 Considerations for Installation 95
 Electrical Connections 12
 M Series 88
 Moisture Image Series 88, 89
 Sample System 97
 TF Series 88

O

On-line Help 38

P

Passcodes 75
 Passwords 75
 PC File Transfer 68
 Pipe, Option Menu Map 102
 PM880
 Powering On/Off 1
 Screen 16
 Software, Updating 77
 Power
 Sleep Mode 35
 Turning On and Off 1

Pressure
 Auto-Cal, Using 26
 Calibration Data, Entering 5
 Recalibrating Sensors 85
 Transducer Cables 90
 Transmitter Cables 90
 Printing a Log 64
 Printing a Site 64
 Printing Reports 66
 Probe ID 3, 25
 Probe ID, Entering 25
 Probe Type, Selecting 2
 Probes
 Auto-Cal, Using 26
 Cables 90
 Calibration Reminder, Entering 25
 Entering ID 3
 Reference Date, Entering 35
 Replacing and Recalibrating 85
 Selecting Type 2
 Program Menu, Menu Map 102

R

Recalling a Site 13, 50
 Reference Data, Entering 35
 Refreshing a Site 54
 Renaming a Log 50
 Renaming a Site 50
 Replacing and Recalibrating Moisture Probes 85
 Reports Option 66
 Reports, Printing 66
 Resetting to Factory Defaults 74
 Response Time Procedure 34
 Response Type 33
 Return Policy 111

S

Safety
 Auxiliary Equipment iii
 General Issues iii
 Personal Equipment iii
 Sample System
 Connecting to Process 12
 Description of 97
 Installing Probes 11
 Leak Test 14
 Operating 13
 Shutting Down 14
 Specifications 93
 Saturation Constants, Entering 27
 Saving a New Site 49
 Saving a Site 50
 Screen
 Bitmap Screen Capture 21
 Contrast, Adjust 21
 Date and Time Appearance, Changing 24
 Description 2
 Language, Changing 38
 Selecting Format 18
 Testing 72

Screen Components 16
 Screen Messages 80
 Security Settings, Viewing or Changing 75
 Service Menu, Menu Map 105
 Shortcuts, Function Key, Configuring 19
 Site
 Creating 49
 Creating a Message 25
 Deleting 54
 Opening 50
 Printing 64
 Recalling 13, 50
 Refreshing 54
 Renaming 50
 Saving 8, 50
 Saving New 49
 Transferring from a PC 68
 Transferring to a PC 66
 Site Selection 95
 Sleep Mode 35
 Snapshot, see Bitmap Screen Capture 21
 Soft Key, see Function Key 19
 Software version 37
 Software, Updating 77
 Sorting Files 54
 Specifications 23
 Accessories 93
 Cables 90
 Dew/Frost Point Temperature 92
 Electronics 91
 Moisture 92
 Operational 91
 Overall 90
 Pressure 92
 Sample System 93
 Temperature 92
 Starting/Restarting a Log 42
 Stop Log 41
 Symbols 16

T

Testing
 Keypad 73
 Screen 72
 Watchdog Timer Circuit 73
 TF Series Probe
 Cables 90
 Description 88
 Time
 Changing Appearance 24
 Entering 24
 Transferring Files from a PC 68
 Transferring Files to a PC 66
 Troubleshooting, Error Messages 80
 Turning On/Off 1

U

Units Option 24
 Updating Software 77
 User Constants, Entering 27

User Functions
 Entering 27, 30
 Option 30
 User Tables
 Creating 32
 Entering 27
 Option 32

V

View All Sites Option 43
 Viewing Logs 43

W

Warranty III
 Watchdog Timer Circuit, Testing 73
 Wizard, Add Hardware 56

Warranty

Each instrument manufactured by Panametrics Sensing is warranted to be free from defects in material and workmanship. Liability under this warranty is limited to restoring the instrument to normal operation or replacing the instrument, at the sole discretion of Panametrics Sensing. Fuses and batteries are specifically excluded from any liability. This warranty is effective from the date of delivery to the original purchaser. If Panametrics Sensing determines that the equipment was defective, the warranty period is:

- one year from delivery for electronic or mechanical failures
- one year from delivery for sensor shelf life

If Panametrics Sensing determines that the equipment was damaged by misuse, improper installation, the use of unauthorized replacement parts, or operating conditions outside the guidelines specified by Panametrics Sensing, the repairs are not covered under this warranty.

The warranties set forth herein are exclusive and are in lieu of all other warranties whether statutory, express or implied (including warranties or merchantability and fitness for a particular purpose, and warranties arising from course of dealing or usage or trade).

Return Policy

If a Panametrics Sensing instrument malfunctions within the warranty period, the following procedure must be completed:

1. Notify Panametrics Sensing, giving full details of the problem, and provide the model number and serial number of the instrument. If the nature of the problem indicates the need for factory service, Panametrics will issue a RETURN AUTHORIZATION NUMBER (RAN), and shipping instructions for the return of the instrument to a service center will be provided.
2. If Panametrics Sensing instructs you to send your instrument to a service center, it must be shipped prepaid to the authorized repair station indicated in the shipping instructions.
3. Upon receipt, Panametrics Sensing will evaluate the instrument to determine the cause of the malfunction.

Then, one of the following courses of action will then be taken:

- If the damage is covered under the terms of the warranty, the instrument will be repaired at no cost to the owner and returned.
- If Panametrics Sensing determines that the damage is not covered under the terms of the warranty, or if the warranty has expired, an estimate for the cost of the repairs at standard rates will be provided. Upon receipt of the owner's approval to proceed, the instrument will be repaired and returned.

[no content intended for this page]

Customer Support Centers

U.S.A.

The Boston Center
1100 Technology Park Drive
Billerica, MA 01821
U.S.A.
Tel: 800 833 9438 (toll-free)
978 437 1000
E-mail: mstechsupport@bakerhughes.com

Ireland

Sensing House
Shannon Free Zone East
Shannon, County Clare
Ireland
Tel: +35 361 470291
E-mail: mstechsupport@bakerhughes.com

Copyright 2021 Baker Hughes company.

This material contains one or more registered trademarks of Baker Hughes Company and its subsidiaries in one or more countries. All third-party product and company names are trademarks of their respective holders.

910-268 B

Baker Hughes ™