

BACHARACH®

The Measurable Difference

Fyrite® INSIGHT Combustion Gas Analyzer

Instruction 24-9460
Operation & Maintenance
Rev. 1 – July 2009

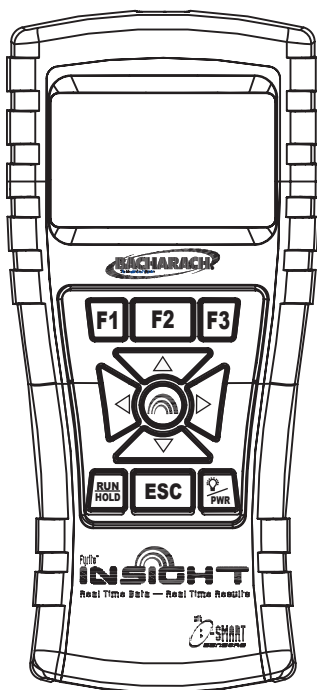

WARRANTY

Bacharach, Inc. warrants to Buyer that at the time of delivery this Product will be free from defects in material and manufacture and will conform substantially to Bacharach Inc.'s applicable specifications. Bacharach's liability and Buyer's remedy under this warranty are limited to the repair or replacement, at Bacharach's option, of this Product or parts thereof returned to Seller at the factory of manufacture and shown to Bacharach Inc.'s reasonable satisfaction to have been defective; provided that written notice of the defect shall have been given by Buyer to Bacharach Inc. within two (2) years after the date of delivery on Product and all gas sensors except the O2 sensor which has a one (1) year warranty by Bacharach, Inc.

Bacharach, Inc. warrants to Buyer that it will convey good title to this Product. Bacharach's liability and Buyer's remedy under this warranty of title are limited to the removal of any title defects or, at the election of Bacharach, to the replacement of this Product or parts thereof that are defective in title.

THE FOREGOING WARRANTIES ARE EXCLUSIVE AND ARE GIVEN AND ACCEPTED IN LIEU OF (I) ANY AND ALL OTHER WARRANTIES, EXPRESS OR IMPLIED, INCLUDING WITHOUT LIMITATION THE IMPLIED WARRANTIES OF MERCHANTABILITY AND FITNESS FOR A PARTICULAR PURPOSE; AND (II) ANY OBLIGATION, LIABILITY, RIGHT, CLAIM OR REMEDY IN CONTRACT OR TORT, WHETHER OR NOT ARISING FROM BACHARACH'S NEGLIGENCE, ACTUAL OR IMPLIED. The remedies of the Buyer shall be limited to those provided herein to the exclusion of any and all other remedies including, without limitation incidental or consequential damages. No agreement varying or extending the foregoing warranties, remedies or this limitation will be binding upon Bacharach, Inc. unless in writing, signed by a duly authorized officer of Bacharach.

**Register your warranty by visiting
www.mybacharach.com**

Notice:

Product improvements and enhancements are continuous, therefore the specifications and information contained in this document may change without notice.

Bacharach, Inc. shall not be liable for errors contained herein or for incidental or consequential damages in connection with the furnishing, performance, or use of this material.

No part of this document may be photocopied, reproduced, or translated to another language without the prior written consent of Bacharach, Inc.

Copyright © 2002–2008, Bacharach, Inc., all rights reserved.

BACHARACH, Fyrite, INSIGHT & B-SMART are registered trademarks of Bacharach, Inc. All other trademarks, trade names, service marks and logos referenced herein belong to their respective companies.

TABLE OF CONTENTS

1.0 Introduction	1
1.1 The Fyrite® INSIGHT.....	1
1.2 Fyrite® INSIGHT Features & Benefits.....	2
1.3 Operational Overview.....	4
2.0 Technical Characteristics.....	5
3.0 Setting Up the Analyzer	7
3.1 Preliminary Steps.....	7
3.2 Power.....	7
3.2.1 Installing or Replacing Batteries.....	7
3.2.2 Using the AC Power Adapter	7
3.3 Connecting the Probe Hose & Thermocouple.....	7
3.4 Front Panel Push Buttons.....	10
3.5 Setup Mode	11
3.5.1 Entering Setup.....	11
3.5.2 Temperature Units	11
3.5.3 Pressure Units	11
3.5.4 Clock.....	12
3.5.5 O ₂ Reference.....	13
3.5.6 Print Pressure	13
3.5.7 Zoom	13
3.5.8 Username.....	14
3.5.9 Run/Hold Format.....	15
3.5.10 Language Selection.....	17
3.5.11 Button Sound	17
3.5.12 CAL Reminder Period	17
3.5.13 Inactivity Timeout	18
3.5.14 Post-Purge Period	19
3.5.15 Date Format	19
4.0 Operation	20
4.1 Operating Tips	20
4.2 Analyzer Power ON and Warm Up.....	21
4.3 Fuel Selection.....	21
4.4 Sampling Point	22
4.5 Performing a Combustion Test	23
4.6 Making a Draft/Pressure Measurement	25
4.7 Temperature Measurement	26
4.8 Saving Test Data	27
4.9 Ending a Combustion Test	27

4.10 Emptying the Water Trap.....	27
4.11 Powering OFF the Analyzer & Purging	28
4.12 Low Battery Alarm.....	28
4.13 Memory.....	28
4.14 Printing Test Data	30
4.15 Fyrite® User Software Installation	31
4.16 Fyrite® User Software Description.....	34
5.0 Calibration & Maintenance	35
5.1 B-Smart Sensors.....	35
5.2 Starting a Calibration	35
5.3 B-Smart Sensor Replacement & Calibration	37
5.4 Pressure Sensor Calibration	37
5.5 T-Stack Calibration.....	39
5.6 T-Air Calibration	41
5.7 CO Sensor Calibration.....	43
6.0 Maintenance.....	44
6.1 Fyrite® INSIGHT Disassembly	44
6.2 Water Trap / Filter	46
6.2.1 Emptying the Water Trap Chamber.....	46
6.2.2 Replacing the Filter Element.....	46
6.3 O ₂ Sensor Replacement	47
6.4 CO Sensor Replacement	48
6.5 Thermocouple Replacement.....	49
6.6 Gas Pump Replacement.....	50
6.7 Cleaning the Probe	50
6.8 Error Messages	51
6.9 Diagnostics Screen	52
6.10 Status Screen	53
7.0 Parts & Service	54
7.1 Replacement Parts	54
7.2 Accessories	54
7.3 Service Centers	55

1.0 INTRODUCTION

1.1 The Fyrite® INSIGHT

The Fyrite® INSIGHT is a hand-held residential and commercial grade portable combustion analyzer that is designed for on-demand sampling of light industrial combustion equipment, residential furnaces, and appliances.

The Fyrite® INSIGHT is upgradeable from the Basic model to the Recording model which includes additional features such as software compatible for downloading data and the IrDA printer.

This manual contains information on all models of the Fyrite INSIGHT. Please disregard any information that does not pertain to your model.



WARNINGS!

This analyzer is not intended to be used on a continuous basis.

This analyzer is not intended to be used as a safety device.

Except for sensor and battery replacement, this analyzer should only be opened and serviced by authorized personnel.

When testing an appliance, a full visual inspection of the appliance should be carried out to ensure its safe operation.

	Basic	Reporting
	24-8250	24-8251
HARD CARRY CASE	X	X
PROBE ASSEMBLY	X	X
PRINTER IRDA		X
BOOT	X	X
PC SOFTWARE		X
USB CABLE		X
BATTERIES	X	X
QUICK START GUIDE	X	X

1.2 Fyrite® INSIGHT Features & Benefits

AUTOMATIC ZERO - The instrument will automatically zero all sensing channels on ambient air when it is powered on. If a particular sensor is in error during warm-up, the instrument will automatically display the error and continue to operate with the sensor in error. However, all information dependent on the sensor in error will not be presented.

TEMPERATURE UNITS - Temperatures can be displayed in Centigrade or Fahrenheit.

PRESSURE UNITS - Pressures can be displayed in milliBar (mB), Pascal (Pa), hectoPascal (hPa), Millimeters of Water Column (mmwc), or Inches of Water Column (inwc).

LANGUAGE - The display options are English, French or Spanish.

MEMORY - The Fyrite® INSIGHT has the ability to store, recall to display, and print a minimum of 100 sets of time and date coded combustion, differential pressure, or differential temperature test records.

DOWNLOAD - Test records can be downloaded to a personal computer via the USB port. Saved records are transferred using PC based software and will be automatically loaded into an Excel spreadsheet. PC based software will also have the capability to update the instrument time and date and upload custom fuels, username, customer logo, and future code updates. The INSIGHT can also be set up from PC software.

USER INFORMATION - The instrument will accept up to three lines of 20 characters of user information. This information will appear with the test records when they are printed or downloaded.

CALIBRATION - Calibration can be performed by applying gas and entering calibration gas concentrations through software menu selections.

SMART SENSORS - B-Smart sensor technology is employed for the CO channel. CO sensors are calibrated prior to shipment and provide data that can be entered through the software menu selections for easy calibration without applying gas.

CALIBRATION REMINDERS - Calibration reminders can be set for Never, 6, 8, 10, 12, or 15 months.

DISPLAY FORMAT - The Run/Hold display format can be presented in default or custom ordered for specific needs. Up to 8 lines can be customized in the Run/Hold screen.

DISPLAY ZOOM - Combustion test data in the Run/Hold screens can be shown with enlarged characters to make viewing easier. The complete list of Run/Hold data can be scrolled through for all zoom levels. Available zoom levels and information display are as follows:

- Standard - 4 lines of information
- 2X - 3 lines of enlarged characters
- 3X - 2 lines of enlarged characters

STATUS - A status menu displays the instrument software version, boot version, model number, and serial number.

DIAGNOSTICS - The diagnostics menu displays the O₂ sensor life, CO sensor information, and hours of operation for the instrument and the pump.

KEYPAD SOUND - Keypad sounds can be enabled or disabled with software menu selections.

LOW BATTERY - A tone will sound every 10 seconds when a low battery condition exists. A low battery message will also be displayed.

AUTOMATIC POWER DOWN - The instrument can be set to automatically power off after a period of inactivity unless the user presses any button; the CO is greater than 50 ppm, or the O₂ is less than 16.0%. Automatic power down can be set for None, 30, or 60 minutes.

PURGE - The sensors will be purged when the instrument is shutdown until sensor outputs indicate that they have been exposed to fresh air. Pressing the On/Off key a seconds time can defeat the purge routine. The minimum purge time can be set to None, 5 seconds, 1 , 5, or 10 minutes.

SENSOR ACCESS - Sensor replacement can be accomplished in the field. Easy access to the O₂ and CO sensors is provided through the back of the instrument.

POWER - The Fyrite® INSIGHT is powered by 4 AA alkaline batteries. A new set of alkaline batteries will provide a minimum of 20 hours of continuous operation with the pump running and the back light on. Optionally, the analyzer can operate with a universal AC adapter. When the AC adapter is plugged into the unit, batteries do not have to be removed.

1.3 Operational Overview

Pressing the **PWR** button turns the analyzer ON. Note that there is a warm-up period of 60 seconds that must elapse before the analyzer can be used.

To perform a combustion test, choose a fuel code that corresponds to the fuel being burned by the appliance being tested (Section 4.3), and then press the **RUN/HOLD** button to place the analyzer into its Run Mode. Begin testing by inserting the analyzer's probe tube into the flue-gas stream of the appliance under test. The analyzer will monitor the flue gas and display measured and calculated values that are relative to the combustion process. These values are displayed on the analyzer's LCD, and are chosen for display by pressing the Increment (**▲**) and Decrement (**▼**) buttons.

Pressing the **RUN/HOLD** button during a test will freeze all measured and calculated values at their current levels. Pressing the **RUN/HOLD** button again resumes testing.

A backlight enables an operator to read the display in dimly-lit areas. Pressing the **PWR** button turns the backlight ON and OFF.

An optional power saver function will shut the analyzer OFF after a set time period of inactivity. This feature is disabled if the CO value is greater than 50 ppm or the O₂ value is less than 16.0%.

Press the **PWR** button for at least two seconds to power the analyzer OFF. Note that there is a 5 second delay before the analyzer actually turns OFF, during which time the unit can be kept ON by pressing the **RUN/HOLD** button. There is a CO purge feature that keeps the analyzer's pump running until the measured CO level drops below 50 ppm.

2.0 TECHNICAL CHARACTERISTICS

The Analyzer measures & displays:	
Primary/Ambient Air Temperature	-4 to 600 °F (-20 to 316°C)
Oxygen	0.1 to 20.9% O ₂
Stack Temperature	-4 to 1202 °F (-20 to 650 °C)
Carbon Monoxide	0 to 2000 ppm CO
Differential Pressure/Draft	± 100 inwc
The Analyzer computes & displays:	
Combustion Efficiency	0.1 to 100%
Carbon Dioxide	0.1 to a fuel dependent maximum value in %
CO referenced to %O ₂	0 to 9,999 ppm
Excess Air	0 to 250%
Fuel Selection	
<ul style="list-style-type: none"> • Natural Gas • Oil #2 • Oil #4 • Oil #6 	<ul style="list-style-type: none"> • Propane • Kerosene • Wood • Coal
Normal Operating Conditions:	
Temperature <ul style="list-style-type: none"> • Analyzer • Probe 	32 to 104 °F (0 to 40 °C) 1,000 °F max (538 °C) at 5" insertion
Humidity	15 to 90% RH, Non-Condensing
Dimensions	Weight
7.9 in (20.1 cm) Height 3.6 in (9.1 cm) Width 2.3 in (5.8 cm) Depth	1lb. (0.45 kg)

General Characteristics:	
Power Requirements	Four disposable 'AA' Alkaline batteries (optional AC adapter is available)
Operating Time	Minimum of 20 hours continuous operation (pump running and backlight ON)
Warm Up Time	60 seconds
Memory	Up to 100 complete sets of combustion, temperature, & pressure tests can be saved in memory.
Display	128 x 64, LCD Graphic Display
Front Panel Controls	Eleven front panel push buttons (Refer to Section 3.4)
Interfaces	IrDA printer & USB connectivity
Accuracy:	
Oxygen	$\pm 0.3\%$ O ₂ with a typical flue gas concentration of CO ₂
Carbon Monoxide	$\pm 5\%$ of reading or ± 10 ppm, whichever is greater*, in the range of 0 to 1000 ppm.
Flue Gas Temperature	± 4 °F between 32 & 255 °F (± 2 °C between 0 & 124 °C) ± 6 °F between 256 & 480 °F (± 3 °C between 125 & 249 °C) ± 8 °F between 481 & 752 °F (± 4 °C between 250 & 400 °C)
Ambient/Primary Temperature	± 2 °F between 32 & 212 °F (± 1 °C between 0 & 100 °C)
Draft	$\pm 2\%$ of reading or ± 0.02 InWC, whichever is greater in the range of -10 to +10 InWC $\pm 3\%$ in the range of -10 to -40 InWC $\pm 3\%$ in the range of 10 to 40 InWC
* Tighter CO accuracy in the lower ranges, up to ± 2 ppm, may be attained if a lower range calibration gas (e.g. 100 ppm CO) is used.	

3.0 SETTING UP THE ANALYZER

3.1 Preliminary Steps

Before using the analyzer . . .

- Check batteries (Section 3.2)
- Connect probe to analyzer (Section 3.3)
- Check setup (Section 3.5)

3.2 Power

3.2.1 *Installing or Replacing Batteries*

Install fresh batteries as described below. Check the analyzer for sufficient charge prior to each use. Replace the batteries if the low-battery symbol appears in the upper right corner of the screen. To replace the batteries:

1. Remove battery cover from back of analyzer.
2. If old batteries are installed, remove them and properly discard.
3. Observing the polarity markings inside the battery compartment, install four 'AA' Alkaline batteries.
4. Replace battery cover.

3.2.2 *Using the AC Power Adapter*

The optional AC power adapter is capable of powering the analyzer on a continuous basis. The adapter plugs into an appropriate 100-240 VAC wall outlet and produces an output of +5 VDC. The adapter's output connector plugs into the analyzer's POWER jack located on the bottom of the unit. The batteries do not need to be removed when using the AC adapter.

3.3 Connecting the Probe Hose & Thermocouple

A rigid stainless steel probe with handle is connected to a flexible hose with integral water-trap / filter used to draw a gas sample into the analyzer from the room, grilles, diffusers, and furnace flues.

Inspect the flue-gas hose for cracks. If a hose is defective, replace the entire probe assembly.

Before using the analyzer, check that the Water Trap / Filter is dry and not dirty. If necessary, dry out the trap and replace the filter element per Section 6.2.

Perform the following steps to connect the probe assembly to the Fyrite INSIGHT:

1. Push the probe's sample-gas hose onto the GAS inlet fitting.
2. Push the probe's draft hose onto the "+" pressure fitting.
3. Push the probe's thermocouple into the T-STACK jack

Important: *DO NOT force the thermocouple connector into its jack. The connection tabs are different sizes, allowing the connector to fit in only one way.*

4. Push the optional ambient/primary-air thermocouple into the T-AIR jack.

Fyrite® INSIGHT Connectors

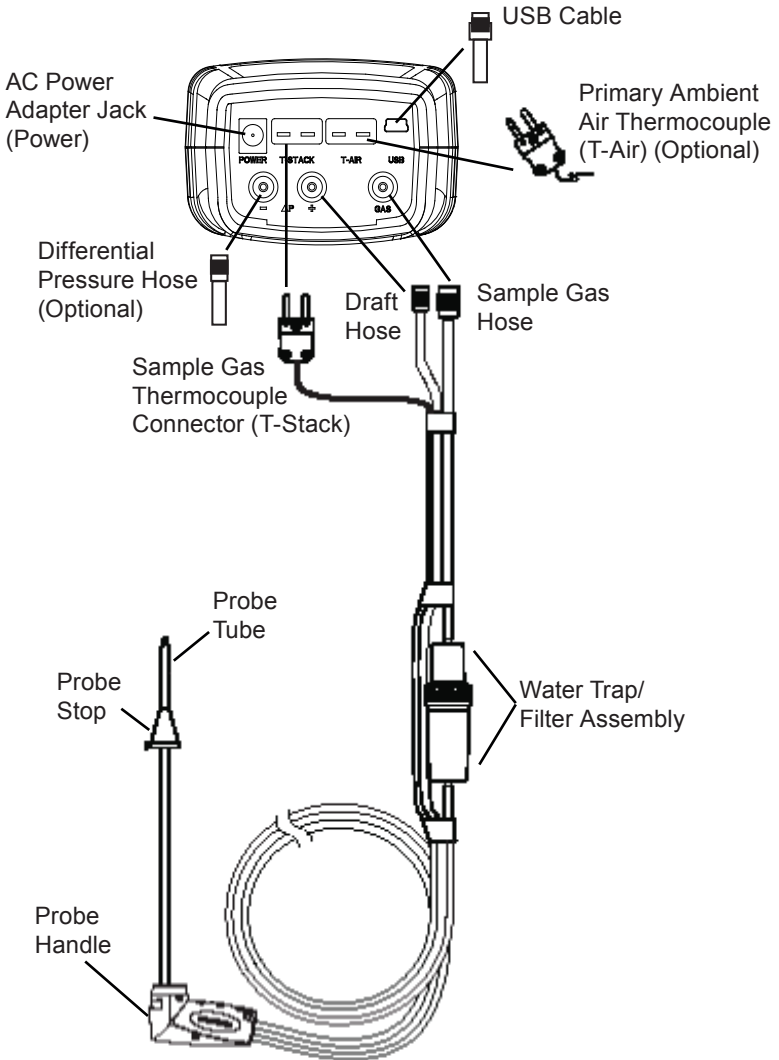







Fig. 3.1

3.4 Front Panel Push Buttons

Note that a push button may perform several functions, depending on the analyzer's model number and what screen is being displayed at the time.

	<ul style="list-style-type: none"> • Powers the analyzer ON and OFF. Hold this button down for at least 2 seconds to turn the power OFF. • Toggles the backlight ON and OFF while the analyzer is turned ON.
	<ul style="list-style-type: none"> • Scrolls up, down, left, and right through the display screen options. • Up and Down arrows cause the displayed value to increase or decrease correspondingly.
	<ul style="list-style-type: none"> • Acts as an ENTER button. Performs the action selected.
	<ul style="list-style-type: none"> • While in the HOLD screen, turns the sample pump on, displays the RUN screen, and begins a combustion test. • While in the RUN screen, turns the sample pump off, displays the HOLD screen and the last set of combustion data. • Displays the HOLD screen while pressing it from most menus. • Return the display to the HOLD screen while pressing it during the 5 second power down sequence.
	<ul style="list-style-type: none"> • Cancels most operations and displays the previous screen.
	<ul style="list-style-type: none"> • Pressing function keys accepts the corresponding function defined at the bottom of the display, including PRINT, SAVE, MENU, differential pressure ZERO, differential temperature ZERO, PAGE UP, PAGE DOWN and CLEAR data.

3.5 Setup Mode

The analyzer is preset at the factory for the parameters shown below, but can be changed as described in their corresponding sections.

Function	Parameter	To Change
Fuel	Natural Gas	Section 4.3
Temperature Unit	°F	Section 3.5.2
Pressure Unit	InWC	Section 3.5.3
Language	English	Section 3.5.10
CAL Reminder	Never	Section 3.5.12
Clock	Not Initialized	Section 3.5.4

3.5.1 Entering Setup

1. Display the MAIN MENU by pressing the **MENU (F2)** button.
2. Use the **▲▼** buttons to highlight **SETUP** and press **ENTER** to display the SETUP MENU.

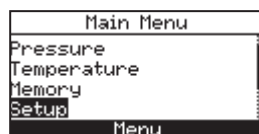

3.5.2 Temperature Units

Select to display temperature in either °F or °C as follows:

1. Enter the Setup Menu per Section 3.5.1. If necessary, press **ESC** until MENU appears above F2.
2. From the SETUP MENU, use the **▲▼** buttons to select **TEMPERATURE UNITS**. Press **ENTER** to display the Temperature Units Menu.
3. Use the **▲▼** buttons to select the desired temperature unit.
4. Press **ENTER** to save selection and return to the SETUP MENU or **ESC** to revert the previous setting.

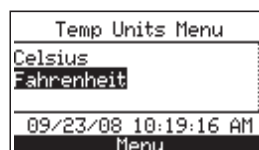

3.5.3 Pressure Units

Select to display pressure in inches of water column (inwc), millibar (mb), Pascals (Pa), hectoPascals (hPa), or millimeter of water column (mmwc) as follows:

1. Enter the Setup Menu per Section 3.5.1. If necessary, press **ESC** until MENU appears above **F2**.
2. From the SETUP MENU, use the ▲▼ buttons to select PRESSURE UNITS. Press **ENTER** to display the Pressure Units Menu.
3. Use the ▲▼ buttons to select the desired pressure unit.
4. Press **ENTER** to save selection and return to the SETUP Menu or **ESC** to revert to the previous setting.

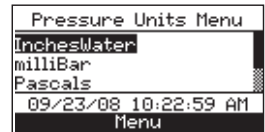
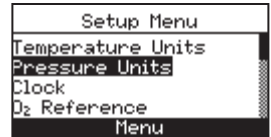

3.5.4 Clock

The clock settings (12 hr. AM/PM or 24 hr.) and date format options (MM/DD/YY or DD/MM/YY) are interdependent. (See DATE FORMAT, Section 3.5.15).

1. Enter the Setup Menu per Section 3.5.1. If necessary, press **ESC** until MENU appears above F2.
2. From the SETUP MENU, use the ▲▼ buttons to select CLOCK. Press **ENTER** to display the Clock Setup Screen.
3. Use the ▲▼ buttons to enter the current date and time. Use the the ◀▶ buttons to move the cursor across the screen.
4. Press **ENTER** to save the selection and return to the SETUP MENU or **ESC** to revert to the previous setting.

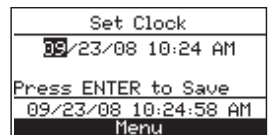
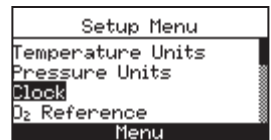

3.5.5 O₂ Reference

The measured value of CO can be referenced to a specific O₂ percentage of 0% to 15%. Set up the reference value as follows:

1. Enter the Setup Menu per Section 3.5.1. If necessary, press **ESC** until MENU appears above **F2**.
2. From the SETUP MENU, use the ▲▼ buttons to select O₂ REFERENCE. Press **ENTER** to display the O₂ Reference Screen.
3. Use the ▲▼ buttons to enter the O₂ reference value.
4. Press **ENTER** to save the selection and return to the SETUP MENU or **ESC** to revert to the previous setting.

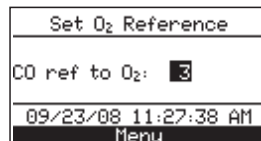
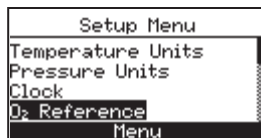

3.5.6 Print Pressure

Select whether to print or not print the pressure measurement on the combustion test printout as follows:

1. Enter the Setup Menu per Section 3.5.1. If necessary, press **ESC** until MENU appears above **F2**.
2. From the SETUP MENU, use the ▲▼ buttons to select PRINT PRESSURE. Press **ENTER** to display the O₂ Reference Screen.
3. Use the ▲▼ buttons to select YES or NO to print the pressure measurement.
4. Press **ENTER** to save the selection and return to the SETUP MENU or **ESC** to revert to the previous setting.

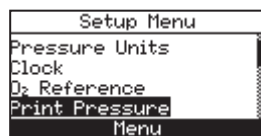

3.5.7 Zoom

Combustion test data in the Run/Hold screen can be shown with enlarged characters to make viewing easier. The operator can set zoom levels to Standard, 2X or 3X. The Standard zoom setting will display 4 lines of combustion test data at one time; 2X will display 3 lines of data with enlarged characters; 3X will display 2 lines of data with enlarged characters. The operator can scroll through the complete list of measured and calcu-

lated data no matter what zoom level has been selected. Select the desired zoom level as follows:

1. Enter the Setup Menu per Section 3.5.1. If necessary, press **ESC** until MENU appears above **F2**.
2. From the SETUP MENU, use the ▲▼ buttons to select ZOOM. Press **ENTER** to display the Zoom Menu.
3. Use the ▲▼ buttons to select the desired zoom level.
4. Press **ENTER** to save the selection and display the SETUP MENU or **ESC** to revert to the previous setting.



3.5.8 Username

The name of the user or owner (e.g. company name, address, phone number) can be stored in memory by manually entering up to three lines of text, with each line containing up to 20 alphanumeric characters. This information will appear at the top of each printout, until it is cleared or new information is entered.

Username Information can be entered as follows:

1. Enter the Setup Menu per Section 3.5.1. If necessary, press **ESC** until MENU appears above **F2**.
2. Use the ▲▼ buttons to select USERNAME. Press **ENTER** to display the most recently saved information.
3. Use the ▲▼ buttons to select the line of information which you would like to edit and press **ENTER**. A single cursor will appear denoting the character you are changing.
4. Use the ▲▼ buttons to scroll the the list of alphanumeric characters and the ◀▶ buttons to move across the screen.
5. Press **ENTER** to save the selection or **ESC** to revert to the previous input.



6. Repeat Steps 3-5 to edit the remaining lines.
7. Once the input is complete, use the ▲▼ buttons to select EDIT COMPLETE.
8. Press **ENTER** to accept the entered information or **ESC** to revert to the previous information and display the SETUP MENU.

Helpful Hint: Use the Fyrite® user software to upload this information from your computer.

To Clear a Username proceed as follows:

1. Enter the SETUP MENU per Section 3.5.1. If necessary, press **ESC** until MENU appears above F2.
2. Use the ▲▼ buttons to select USERNAME. Press **ENTER** to display the most recently saved information.
3. Clear the information by selecting the CLEAR option (F3).

3.5.9 Run/Hold Format

Fyrite INSIGHT test data is located in the Run/Hold screen. By pressing the **RUN/HOLD** key, you should hear the pump running and see the word RUN at the upper-left hand corner of the display. The instrument is continuously measuring and calculating the data that is shown in the Run/Hold screen. Press the **RUN/HOLD** key again. The pump should stop running and the word HOLD should be shown at the upper-left hand corner of the display. The instrument will now show the last measured and calculated data taken before the instrument was placed in HOLD. Use the ▲▼ buttons to scroll through the complete list of measured and calculated values when the instrument is running or in the HOLD mode.

The order in which data appears in the RUN/HOLD screen is as follows:

O ₂	=	Oxygen
CO	=	Carbon Monoxide
Eff	=	Combustion Efficiency
CO ₂	=	Carbon Dioxide
T-STK	=	Stack Temperature
T-AIR	=	Ambient/Primary Air Temperature
EA	=	Excess Air
CO(n)	=	Carbon Monoxide content referenced to an Oxygen percentage

NOTE: (n) is the current O₂ Reference selected.

Change the order in which data is displayed as follows:

1. Enter the SETUP MENU per Section 3.5.1. If necessary, press **ESC** until MENU appears above **F2**.
2. Use the ▲▼ buttons to select RUN/HOLD FORMAT. Press **ENTER** to display the Run/Hold Format options.
3. Use the ▲▼ buttons to select EDIT FORMAT. Press **ENTER** to display the current format.
4. Change data for a particular location by first using the ▲▼ buttons to select the location. Press **ENTER** and the cursor will start to flash.
5. Use the ▲▼ buttons to scroll through and select the desired data to appear in that location. Press **ENTER** to save the selection.
6. Change the data displayed at other locations by repeating steps 4 and 5
7. When finished, use the ▲▼ buttons to select EDIT COMPLETE, located at the bottom of the list. Press **ENTER** to save the new display format and return to the Run/Hold Format options.



Reset Display format back to factory default settings as follows:

1. Enter the SETUP MENU per Section 3.5.1. If necessary, press **ESC** until MENU appears above **F2**.
2. Use the ▲▼ buttons to select RESET FORMAT. Press **ENTER** to display the Reset Format option.
3. Use the ▲▼ buttons to select YES. Press **ENTER** to reset the format and return to the Run/Hold format options.

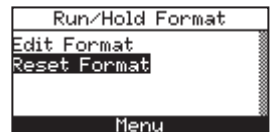

3.5.10 Language Selection

Information on the display screen can be shown in English, French, or Spanish.

Select the desired language as follows:

1. Enter the SETUP MENU per Section 3.5.1. If necessary, press **ESC** until MENU appears above **F2**.
2. Use the **▲▼** buttons to select LANGUAGE SELECTION. Press **ENTER** to display the Language Selection Menu.
3. Use the **▲▼** buttons to select the desired language. Press **ENTER** to activate the selection and return to the SETUP MENU.



3.5.11 Button Sound

The audible sound used to signal when a button is pressed can be turned OFF and ON as follows:

1. Enter the SETUP MENU per Section 3.5.1. If necessary, press **ESC** until MENU appears above **F2**.
2. Use the **▲▼** buttons to select BUTTON SOUND. Press **ENTER** to display the Button Sound Menu.
3. Use the **▲▼** buttons to select YES or NO button sound.
4. Press **ENTER** to save the selection and return to the SETUP MENU or **ESC** to revert to the previous setting.



3.5.12 CAL Reminder Period

The analyzer can be set to indicate a calibration reminder during the 60 second warm-up. Calibration reminders can be preset to occur never, 6, 8, 10, 12, or 15 months after the last calibration. When the preset period is exceeded the instrument will display the reminder, and how long since the sensors were last calibrated. If a calibration reminder is displayed the operator can press the **RUN/HOLD** key to move to the Run/Hold Screen for normal operation. Regular calibration periods of 6 months to 1 year are recommended.

NOTE: The default CAL Reminder period is set to NEVER.

Set the calibration reminder period as follows:

1. Enter the SETUP MENU per Section 3.5.1. If necessary, press **ESC** until MENU appears above **F2**.
2. Use the **▲▼** buttons to select CAL REMINDER PERIOD. Press **ENTER** to display the Cal Reminder Period Menu.
3. Use the **▲▼** buttons to select the desired time period.
4. Press **ENTER** to save selection and return to the SETUP MENU or **ESC** to revert to the previous setting.



NOTE: The date and time settings must be correct to get accurate cal reminders.

3.5.13 Inactivity Timeout

The analyzer can be placed in an inactivity timeout period of None, 30 or 60 minutes. With this time period set the analyzer will automatically shut off if there have been no button pushes made in the set period of time. The analyzer will not turn off if the CO value is greater than 50 ppm or the O2 value is less than 16%.

NOTE: The default set time is NONE which will not allow the analyzer to automatically turn off.

Set the Inactivity Timeout Period as follows:

1. Enter the SETUP MENU per Section 3.5.1. If necessary, press **ESC** until MENU appears above **F2**.
2. Use the **▲▼** buttons to select INACTIVITY TIMEOUT. Press **ENTER** to display the Inactivity Timeout Menu.
3. Use the **▲▼** buttons to select the desired timeout period.
4. Press **ENTER** to save the selection and return to the SETUP MENU or **ESC** to revert to the previous setting.

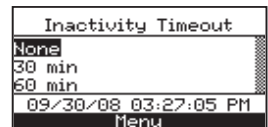

3.5.14 Post-Purge Period

The analyzer can be setup to purge the sensors following the combustion test. It can be programmed to purge for None, 5 seconds, 1, 5, or 10 minutes.

Set the Post-Purge Period as follows:

1. Enter the **SETUP MENU** per Section 3.5.1. If necessary, press **ESC** until **MENU** appears above F2.
2. Use the **▲▼** buttons to select **POST-PURGE PERIOD**. Press **ENTER** to display the Post-Purge Period Menu.
3. Use the **▲▼** buttons to select the desired time period.
4. Press **ENTER** to save the selection and return to the **SETUP MENU** or **ESC** to revert to the previous setting.

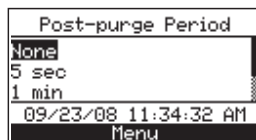
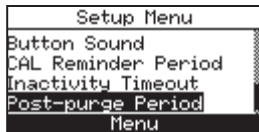

3.5.15 Date Format

The date format options and the clock settings are interdependent.

MM/DD/YY format - Used with a 12 or 24 hour time clock. The setup menu includes an AM/PM option.

DD/MM/YY format - Used with a 24 hour time clock.

Change the date format as follows:

1. Enter the **SETUP MENU** per Section 3.5.1. If necessary, press **ESC** until **MENU** appears above F2.
2. Use the **▲▼** buttons to select **DATE FORMAT**. Press **ENTER** to display the Date Format Menu.
3. Use the **▲▼** buttons to select the desired date format.
4. Press **ENTER** to save the selection and return to the **SETUP MENU** or **ESC** to revert to the previous setting.

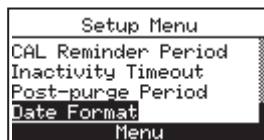

4.0 OPERATION

4.1 Operating Tips

- When an analyzer is brought in from a cold vehicle, let it warm up slowly to minimize condensation. Temperatures below freezing will not damage the analyzer; however, bringing a cold analyzer into a warm, humid environment may cause condensate to form inside the case.



Caution: Although the analyzer itself is not damaged by an extremely cold environment, the electrochemical sensors may be damaged. The O₂ sensor's electrolyte will freeze at approximately -20 °F and the CO sensor's at approximately -90 °F. If the analyzer is exposed to an extremely cold condition, it is strongly suggested that the sensor housings be examined for hairline cracks. Be aware that a leaking sensor can cause chemical burns to the skin and possibly damage the PCB assemblies.

- Ensure that the analyzer is sampling fresh air when turned ON. Pulling a stack-gas sample through the analyzer during its warm-up period will not damage the analyzer, but it will result in incorrect sensor readings, and may result in sensor error messages appearing after the warm-up cycle completes.
- Note that flue-gas condensate is acidic and very corrosive. It is important not to allow the analyzer's internal components to come in contact with condensate for long periods of time.
- Before each use, inspect the filter element of the water-trap / filter assembly. Replace the filter if it looks dirty.
- When sampling flue-gas, keep the analyzer above the water-trap, and keep the trap in a vertical position. This will maximize the effectiveness of the trap and keep liquid from being drawn directly into the analyzer.
- When liquid condensate is seen inside the water trap, empty the trap before it becomes full.
- When storing the analyzer, it's a good idea to empty the water trap and leave it open to further dry it out.
- Calibrate the analyzer every 6 months - 1 year to assure its accuracy.

4.2 Analyzer Power On & Warm Up

1. Connect the probe and make sure that the analyzer is properly set up per Section 3.

IMPORTANT! DO NOT insert probe into stack before powering ON the analyzer.

2. Place the probe in an area that contains fresh air. This ensures that the sensors will be properly zeroed during the warm-up cycle.
3. Power ON the analyzer by pressing the **PWR** button for at least 1 second, or until a single beep is heard. Observe that the analyzer's firmware version, model and serial numbers are briefly displayed followed by the Warm Up screen.



4. Wait for the analyzer to count down its 60 second warm-up period; after which, the instrument will display the Combustion Test HOLD screen.



If, however, any errors were detected during warm-up, the message "ERRORS DETECTED" is displayed along with a list of those errors. In this example, the O₂ sensor is missing and the T-Stack thermocouple is not connected. Refer to Section 6.8 for a listing and possible remedy for the errors displayed.



4.3 Fuel Selection

The top line of Combustion Test HOLD screen shows the fuel currently selected. If necessary, change the fuel as follows:

1. Display the MAIN MENU by pressing the **MENU (F2)** button. If necessary, press **ESC** until MENU appears above F2
2. Use the **▲▼** buttons to select FUEL. Press **ENTER** to display the Fuel Selection screen.
3. Use the **▲▼** buttons to select the desired fuel.

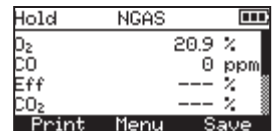

4. Press **ENTER** to save the selection and return to the Combustion Test HOLD screen or **ESC** to revert to the previous setting and return to the MAIN MENU.

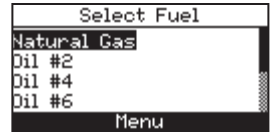

4.4 Sampling Point

Forced Air Furnace – When testing atmospheric burner or gravity vented, forced air heating equipment with a clamshell or sectional heat exchanger design, test each of the exhaust ports at the top of the heat exchanger. The probe should be inserted back into each of the exhaust ports to obtain a flue gas sample, before any dilution air is mixed in.

Hot Water Tank – Domestic hot water tanks with the ‘bell’ shaped draft diverter on top can be accurately tested by inserting the probe tip directly into the top of the fire tube below the diverter.

80% Efficiency Fan Assist or Power Vented – Combustion testing of fan assist or power vented, furnaces/boilers should be done through a hole drilled in the vent approximately 12 inches above the inducer fan.

90% Efficiency Condensing – Condensing furnaces/boilers can be tested through a hole drilled in the plastic vent pipe (when allowed by the manufacturer or local authority of jurisdiction) or taken from the exhaust termination. After testing, the hole should be sealed with high temperature silicon.

Atmospheric or Gravity Vented Boiler – Boilers, which have a ‘bell’ shaped draft diverter directly on top, should be tested directly below the diverter through a hole drilled in the vent connector.

NOTE: All drill holes should be sealed upon completion of combustion testing.

4.5 Performing a Combustion Test

Ensure that the following has been completed, and then proceed with the combustion test as described below:

- Power ON analyzer and allow it to warm up (Section 4.2).
- Select fuel being burned (Section 4.3).
- Inset probe into proper sample location (Section 4.4).
- If necessary, insert optional primary air thermocouple into combustion-air stream of burners that use an outside source of combustion air.

1. Press the **RUN/HOLD** button to start the test. You should hear the pump start running and see the word RUN appear at the top of the Combustion Test screen.

Sensor Indicators: The following indicators appear in the sensor's data field depending on certain conditions:

(* * *) Sensor that is not calibrated or installed.

(XXX) Sensor overrange

(- - -) The calculated data cannot be displayed because the measured data necessary to make the calculation is out of range (i.e., oxygen level above 16%).

2. Use the up and down arrow keys to scroll to the T-STK reading. Loosen the thumbscrew on probe stop and move probe in and out of the stack until the stack's core temperature (**hot spot**) is located as indicated by the highest T-STK reading; then tighten thumbscrew to prevent further probe movement. *Locating the highest stack temperature is very important for accurate efficiency calculations.*
3. You can now begin burner-service procedures. The analyzer readings will change quickly to show changes in burner performance.

 **CAUTION:** *Position the Water Trap with its gas-flow arrow pointing upward. Do not let water condensate go above the tip of the riser tube. The sensors could be damaged if water would enter the analyzer. Empty the Water Trap after every combustion test (refer to Section 4.10)*

4. Pressing the **RUN/HOLD** button freezes all readings, stops the pump and displays the Combustion-Test HOLD screen. Use the ▲▼ buttons to view all test values at the moment the **RUN/HOLD** button was pressed. Pressing **RUN/HOLD** again restarts the pump and resumes testing.

Display Name	Description of Measurement or Calculation
O ₂	% Oxygen
CO	ppm Carbon Monoxide
Eff	% Combustion Efficiency
CO ₂	% Carbon Dioxide
T-STK	Stack Temperature
T-AIR	Primary/Ambient Air Temperature
EA	% Excess Air
CO(O)	Carbon Monoxide ppm level referenced to a % of oxygen

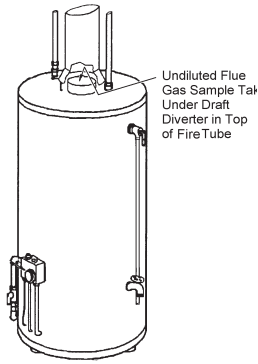

Hot Water Tank

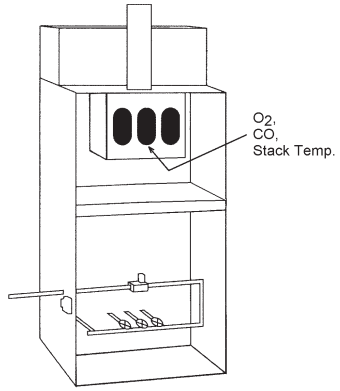

Atmospheric Burner or Gravity Vented Forced Air

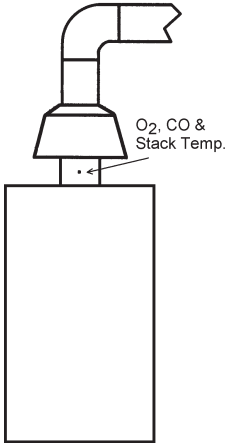

Atmospheric or Gravity Vented Boiler

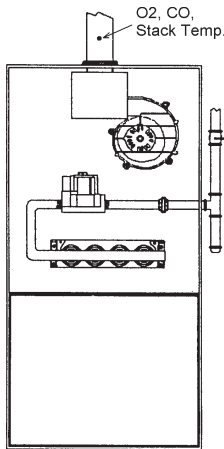

80% Eff. Fan Assist or Power Vented Furnace/Boiler

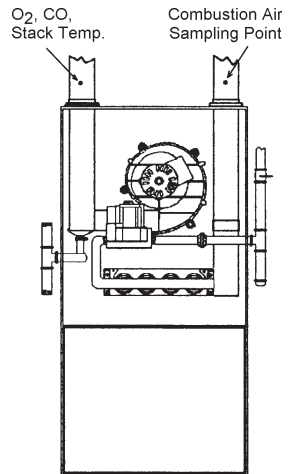

90% Eff. Condensing Furnace/Boiler

Fig. 4.1

4.6 Making a Draft / Pressure Measurement

The difference in pressure (ΔP) between two areas can be measured by using the analyzer's two pressure ports and the PRESSURE screen. By using the $-\Delta P$ port as the reference, the pressure applied to the $+\Delta P$ port will be displayed on the PRESSURE screen as the differential pressure between the two ports. Perform a draft / pressure measurement as follows:

1. Turn ON the analyzer and allow it to complete its warm-up cycle.
2. Display the MAIN MENU by pressing the **MENU (F2)** button. If necessary, press **ESC** until MENU appears above F2.

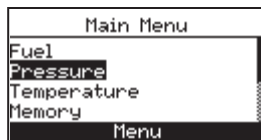

3. Use the **▲▼** buttons to select PRESSURE. Press **ENTER** to display the Pressure screen.

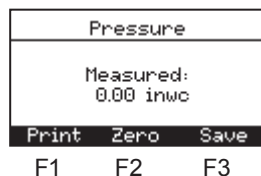

4. Before taking a measurement, the pressure sensor may need to be re-zeroed if it is not already displaying zero with both pressure ports open to the atmosphere. If necessary, zero the pressure sensor as follows:

- Press the **ZERO (F2)** button.
- Disconnect any hoses connected to the $+\Delta P$ and $-\Delta P$ ports, and then press **ENTER** to zero the pressure sensor.
- Reconnect any hoses. When measuring draft, leave the $-\Delta P$ port open to the atmosphere and connect the probe's draft hose to the $+\Delta P$ port.

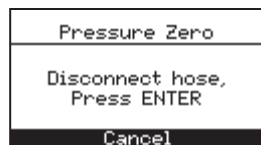

5. Do one of the following to measure draft or differential pressure:

- To measure draft, insert the probe into the stack and observe the draft reading on the PRESSURE screen.
- To measure differential pressure, connect two sampling hoses to the $+\Delta P$ and $-\Delta P$ ports, and place the open end of each hose into the areas being mea-

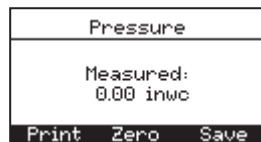
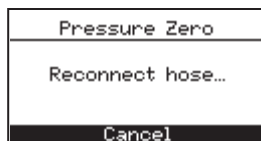

sured. The differential pressure between the two areas is now displayed on the PRESSURE screen. If the pressure at the + ΔP port is higher than the - ΔP port, the pressure reading will be positive. If it is lower, the reading will be negative.

4.7 Temperature Measurement

The difference in temperature between two areas can be measured by using the analyzer's two temperature channels and the Temperature Screen. By using the T-Air channel as a reference, the temperature applied to the T-Stack channel will be displayed on the Temperature Measurement screen as differential temperature between the two channels.

Perform a differential temperature measurement as follows:

1. Display the MAIN MENU by pressing the **MENU (F2)** button. If necessary, press **ESC** until MENU appears above F2.
2. Use the **▲▼** buttons to select TEMPERATURE. Press **ENTER** to display the Temperature Measurement screen.
3. Install thermocouples in both temperature channel connectors.
4. Before taking a measurement, the temperature channels may need to be zeroed, if not already displaying zero with both thermocouples exposed to the same condition. Press **ZERO (F2)** if necessary.

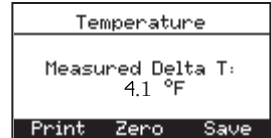

4.8 Saving Test Data

Up to 100 sets ("snap shots") of combustion test, pressure, or temperature data can be saved in memory, which can later be recalled for viewing from the Memory Directory.

1. First display the screen that contains the data to be saved. In the example to the right, all data associated with the Combustion Test RUN screen will be saved.

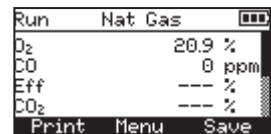

2. Press the **SAVE (F3)** button to save the test data in the next available memory location.

NOTE: When memory is full, the next reading will not be saved until space is made available by clearing previously saved data. (Section 4.13)

Saving Test		
Saved to memory location 11		
Print	Zero	Save

4.9 Ending a Combustion Test



WARNING! Burn Hazard. Do not touch the probe after removing it from the stack. Allow the probe to cool before handling (about 5 minutes).

1. Remove probe from the flue-gas stream.
2. Allow the pump to run until all combustion gases are flushed from the analyzer as indicated by the O₂ reading returning to 20.9%.

4.10 Emptying the Water Trap

The Water Trap / Filter Assembly removes stack-gas condensate, and also prevents soot from contaminating the internal components of the analyzer.

IMPORTANT! Use the Water Trap / Filter Assembly in a vertical position with the gas-flow arrow pointing up.

Empty the water trap chamber after each combustion test, or stop the test and empty the chamber if the liquid condensate level approaches the tip of the riser tube.

To empty the trap, first pull apart the two halves of the Water Trap using a slight twisting motion; empty the water trap chamber, and then reassemble the trap.

After each combustion test, also check the Water Trap's filter element. If it looks dirty, replace the filter per Section 6.2.

4.11 Powering OFF the Analyzer & Purging

Power OFF the analyzer by pressing the **PWR** button for at least 2 seconds, or until two beeps are heard. The unit will count down 5 seconds before shutting down, giving the operator an opportunity to keep the analyzer powered ON by pressing the **RUN/HOLD** button.



If the analyzer was not purged with fresh air then the analyzer may remain ON with its pump running and display the message "PURGING SENSORS" as the result of combustion gases still being present inside the analyzer. At this time the operator should ensure that the probe is removed from the stack, allowing the analyzer to purge itself with fresh air. The 5-second-shutdown sequence will not begin until the gas levels inside the analyzer drop below predetermined levels.

TIP: Although not recommended, the purging process can be bypassed by pressing the **PWR** button a second time.

4.12 Low Battery Alarm

When the batteries are nearly depleted, an empty battery icon appears in the upper-right corner of the display, and a short beep is sounded every 10 seconds.

After a low battery alarm occurs, the analyzer will continue to operate for only a few minutes. The amount of operating time that remains depends on many factors (e.g. pump and backlight being ON or OFF and the type and condition of the batteries).

4.13 Memory

All saved data can be retrieved for viewing through the MEMORY option.

To open and view saved test data:

1. Display the MAIN MENU by pressing the **MENU (F2)** button. If necessary, press **ESC** until MENU appears above F2.
2. Use the **▲▼** buttons to select MEMORY. Press **ENTER** to display the MEMORY MENU.

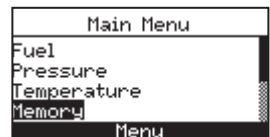

- Use the ▲▼ buttons to select Memory Directory. Press **ENTER** to display the saved data contained in the Memory Directory.

TIP: When displaying the contents of the memory directory, the operator can quickly page through the screens by pressing the **PAGE- (F1)** and **PAGE+ (F3)** buttons. Or move to the first or last memory location by pressing the ◀▶ buttons, respectively.

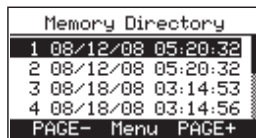

To Clear Test Data:

- Display the MAIN MENU by pressing the **MENU (F2)** button. If necessary, press **ESC** until MENU appears above F2.
- Use the ▲▼ buttons to select MEMORY. Press **ENTER** to display the Memory Screen.
- Use the ▲▼ buttons to select CLEAR MEMORY. Press **ENTER** to display the Clear Memory Options.
- Use the ▲▼ buttons to select YES and press **ENTER**. The screen will briefly display a confirmation that the memory has been cleared.

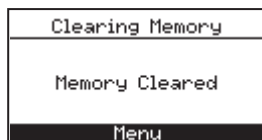

4.14 Printing Test Data

Combustion, pressure, or temperature data that is currently being displayed can be sent to a printer using IrDA protocol as described below.

Data that is stored in memory can also be printed by first displaying the stored test data as described in Section 4.13.

In addition to printing combustion, pressure, and temperature data, the contents of any screen that shows the label “PRINT” above the **F1** button can be printed. For example, the information shown in the DIAGNOSTIC screen can be printed.

1. Power up the printer.
Refer to the printer’s instruction manual for detailed operating information. If not previously done, select the following for the printer for:

- 8 bit
- No parity
- 9600 baud
- IrDA is set to IrDA-SIR
- DTR handshaking

2. Align the printer with the top of the analyzer.
3. Press the **PRINT (F1)** button to begin printing.

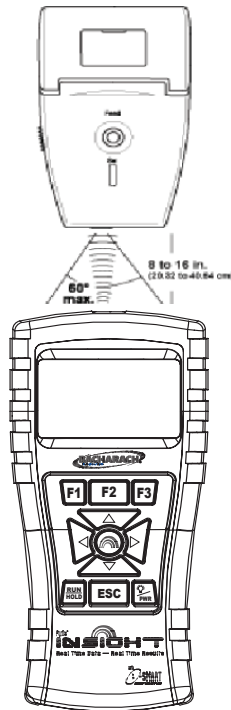

BACHARACH
ANALYTICAL SYSTEMS

BACHARACH, INC.
Fyrite Insight
SN: ENGR-CM03

Time: 01:28:27 PM
Date: 10/22/08

Fuel
Nat Gas

O ₂	4.0 %
CO	12 ppm
Eff	82.6 %
CO ₂	9.5 %
T-STK	374 °F
T-AIR	68.0 °F
EA	21.3 %
CO (3)	13 ppm

Comments:

Fig. 4.2

4.15 Fyrite® User Software Installation

Windows XP Operating System

After the CD is loaded, the Setup window will be displayed. Click on OK. (If applicable, wait for the Net 3.5 Framework set up to complete.)

Click "Next" on the "Welcome" screen to begin the installation.

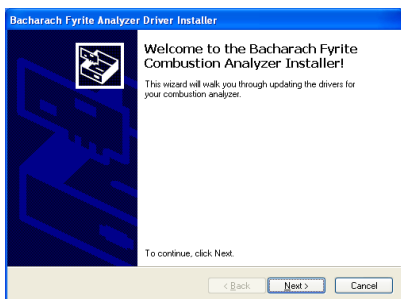

Respond to the prompts on the screens that follow.

Click on: "Finish"...

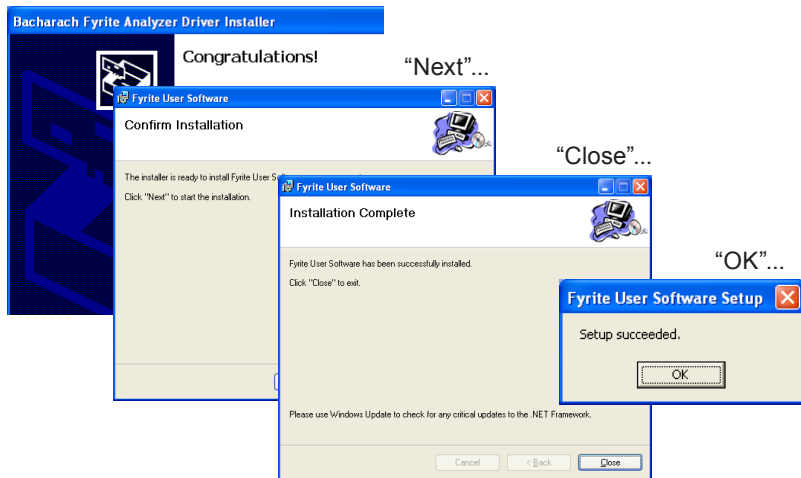

After the installation,

- Open Fyrite® User Software via the desktop icon.
- Connect the instrument to the PC with a USB cable and power up the unit.

When first connected, a “Found New Hardware Wizard” screen will be displayed. Again, respond to the prompts to completion.

Click on: "Next"...

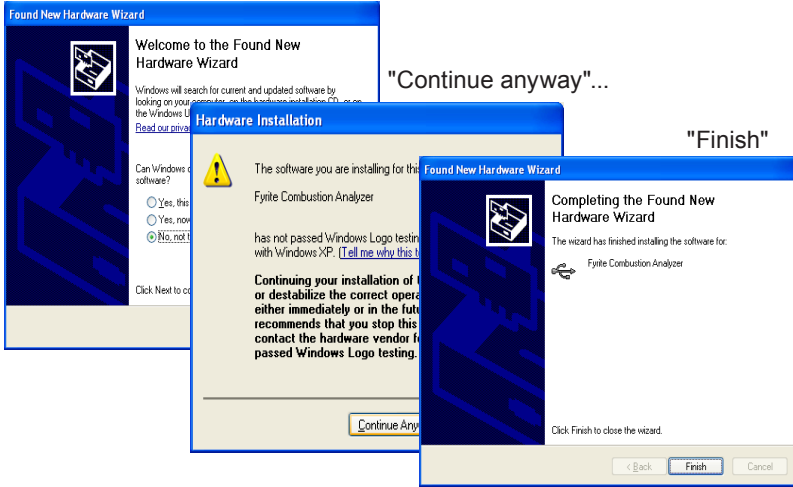

Windows Vista Operating System

After loading the CD, the Security window will be displayed. Click on OK. (If applicable, wait for the Net 3.5 Framework set up to complete.)

Click on: "Continue"...

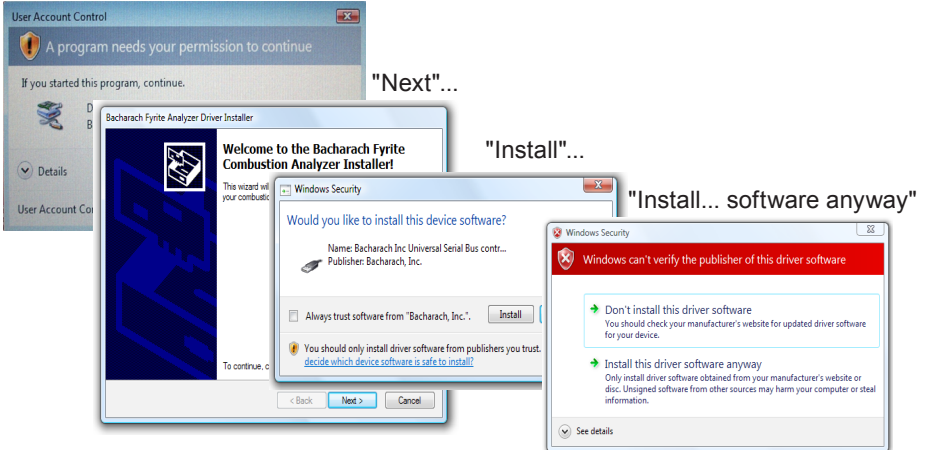

Click on: "Finish"...

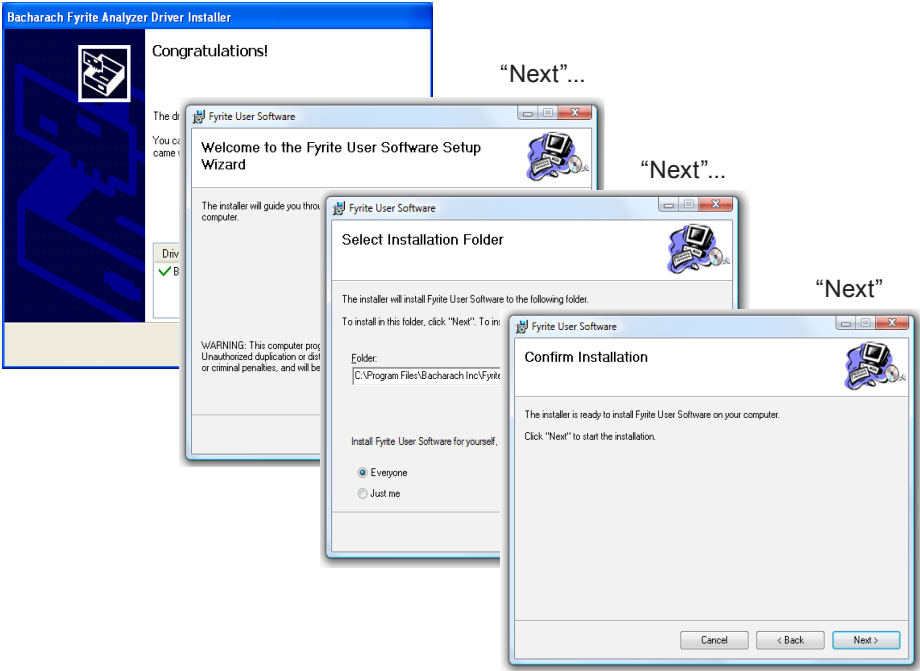

The installation will progress...

Click on: "Continue..."

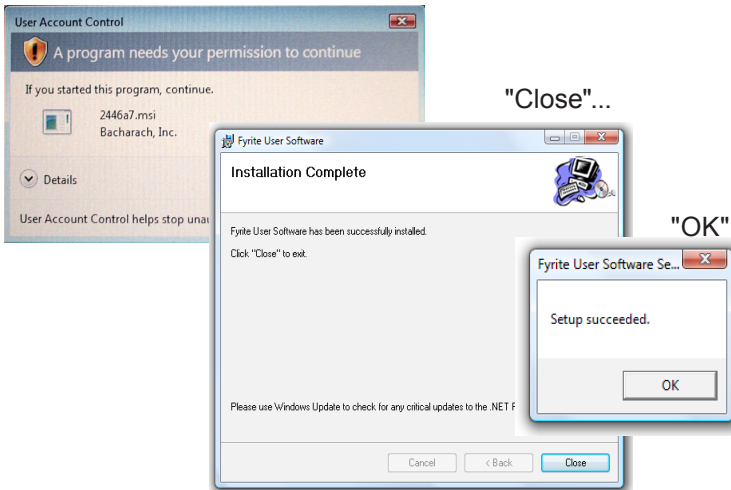

After the installation,

- Open Fyrite® User Software via the desktop icon.
- Connect the instrument to the PC with a USB cable.
- Power up the unit.
- When first connected, a “Found New Hardware Wizard” screen will be displayed.

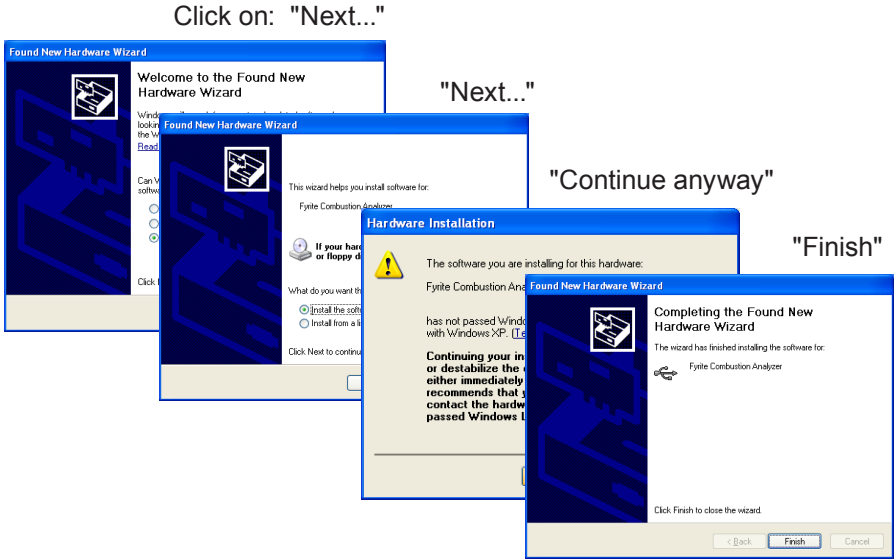

4.16 Fyrite® User Software Description

Fyrite® INSIGHT User Software	
Set Instrument time	Sync instrument with computer's time
Calibration Password	Change 4 digit numeric code
Time Meters	Provides instrument & pump run time
B-Smart	B-Smart calibration code entry
Saved Measurements	Downloads instrument memory to Excel
User/Customer ID	User ID entry
Settings	Change instrument set up parameter
Customer logo set up	Load custom logos for print out. Limited to 384 x 192.
Custom Fuel	Bacharach can supply fuel codes for custom fuel. Consult factory.
Update Instrument software	Remote upgrade of instrument software.

5.0 CALIBRATION & MAINTENANCE

IMPORTANT: *Before performing any calibration procedure, ensure that fresh batteries are installed or use the optional AC power adapter. Also, ensure that the analyzer is at room temperature and will be sampling fresh air when powered ON.*

IMPORTANT: *To maintain accuracy as listed in the Technical Characteristics Section of this manual, the standards used must be at least four times as accurate as the stated accuracy of the Fyrite® INSIGHT.*

5.1 B-Smart Sensors

The Fyrite INSIGHT utilizes Bacharach's new B-Smart Sensor technology for its CO sensor. The B-Smart sensor is marked with a 10-digit calibration code that can be entered in the instrument's memory via the keypad, or with Fyrite user software.

Benefits of B-Smart Sensors:

- New sensors can be installed without applying gas for calibration.
- Sensors can be pre-calibrated and installed when needed.
- Sensors can be moved from one analyzer to another.

The B-Smart sensors should be calibrated by an authorized Bacharach Service Center every 6 months to 1 year to assure that the analyzer continues to meet its published accuracy specifications. The B-Smart sensors, however, can be calibrated in the field if your facility has the necessary equipment and qualified personnel to perform the procedures described in the following sections of this instruction manual.

5.2 Starting a Calibration

Start any calibration by performing the following:

1. With the analyzer power OFF, place the unit in fresh, ambient air; then turn on the analyzer.

2. Allow the analyzer to cycle through its 60 second warm-up period. During warm-up the analyzer's operation is checked and the sensors are set to the following ambient conditions:

- Oxygen sensor spanned to 20.9%
- CO sensor zeroed
- Pressure sensor zeroed

Any errors detected during warm-up will be listed on the display immediately following warm-up. Correct any errors before proceeding. Refer to Section 6.8 for a list of error messages and their meaning.

3. Display the MAIN MENU by pressing the **MENU (F2)** button. If necessary, press **ESC** until MENU appears above F2.

4. Use the **▲▼** buttons to select CALIBRATION. Press **ENTER** to display the Calibration Password screen.



5. Before calibration can begin a 4-place numeric password must be entered. Use the **▲▼** and **◀▶** buttons to enter the password. (Note that the default password is 1111)



6. Press the **ENTER** button to accept the password. If the correct password was entered the CALIBRATION Menu will be displayed.

7. Use the **▲▼** buttons to select the desired sensor channel to be calibrated, and then perform the calibration procedure for that sensor as described in the following sections.

5.3 B-Smart Sensor Replacement & Calibration

To replace a B-Smart sensor and calibrate do the following:

1. Enter the CALIBRATION MENU per Section 5.2.
2. Use the ▲▼ buttons to select B-SMART. Press **ENTER** to display the B-Smart code screen.
3. Use the ▲▼ buttons to enter the 10 digit alphanumeric code supplied with the B-Smart sensor. Use the the ◀▶ buttons to move the cursor across the screen. Press **ENTER**.

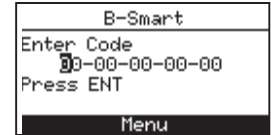

NOTE: If the correct code was entered, the analyzer accepts it and returns to the CALIBRATION MENU. If an incorrect code was entered, the screen will display "Invalid Code". Check to make sure the correct code has been entered. If problem persists, contact your nearest Bacharach Service Provider.

Bacharach also offers a convenient Exchange Program that allows the customer to regularly send in old sensors and, as scheduled, receive new replacements that are already calibrated and that include a code that can be entered into the analyzer for a quick convenient setup. Contact Bacharach customer service for more details about this program.

5.4 Pressure Sensor Calibration

This procedure calibrates the pressure sensor to a known pressure value.

Materials Required:

- Bellows
- Manometer
 - Range: ± 8 in. of water column (± 20 mb)
 - Accuracy: ± 0.01 in. of water column (± 0.025 mb)

Procedure:

NOTE: *The unit-of-measure for pressure is selected per Section 3.5.3. In the following procedure inwC is selected, but note that any unit-of-measure can be used for calibration purposes.*

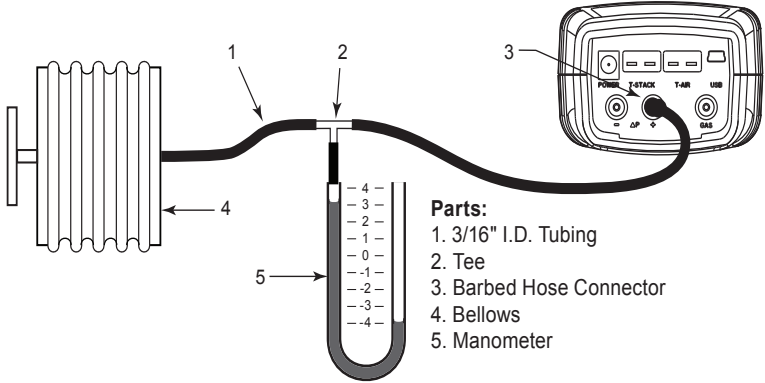
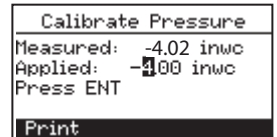

Figure 5-1 Pressure Sensor Calibration Equipment

1. Assemble the pressure sensor calibration equipment as shown in Figure 5.1, but **DO NOT** connect the analyzer to the calibration equipment at this time.
2. If not already done, power **ON** the analyzer and display the **CALIBRATION LIST** per Section 5.2.
3. Use the **▲▼** buttons to select **PRESSURE** and then press **ENTER** to display the **CALIBRATE PRESSURE** screen.



"Measured" is the pressure value currently being detected by the pressure sensor, while "Applied is a known value of pressure that will be applied for calibration purposes.



4. With both the $-\Delta P$ and $+\Delta P$ ports open to the atmosphere, observe that the current Measured pressure reading should be 0.00 ± 0.01 inwC. If necessary, zero the pressure sensor per Section 4.6 then repeat steps 2 through 4.

5. Connect the hose from the manometer to the + ΔP port and apply a *negative* pressure to this port by adjusting the bellows for a manometer reading of -4.00.
6. Use the ▲▼ buttons to enter an Applied value that exactly equals the manometer reading.

The calibration range is from -6 to -2 inwc (-15 to -5 mb). An attempt to calibrate outside this range will cause the message "Applied Value High" (or Low) to appear at the bottom of the screen.

7. Wait until the Measured reading stabilizes, and then press **ENTER** to calibrate the pressure sensor's Measured value to that of the Applied value. The message, "Good Calibration" should briefly appear, followed by the CALIBRATION LIST screen.

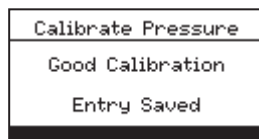

8. Remove calibration equipment.

5.5 T-Stack Calibration

This procedure first *zeroes* and then *spans* the stack-temperature channel to known temperature values.

The use of an electronic thermocouple simulator is the preferred method of producing the desired calibration temperatures. Alternatively, ice and boiling water baths can be used.

Materials Required:

- Thermocouple simulator (K-type)
 - Range: 0 to 600 °F
 - Accuracy: ± 0.5 °F
- (Alternatively) ice-water, boiling water, thermometer

TS-Zero Procedure:

1. Set the thermocouple simulator to room temperature and plug its output into the T-STACK connector located at the bottom of the analyzer.

Alternatively: Plug the probe's thermocouple into the T-STACK connector located at the bottom of the analyzer. **DO NOT attach the probe's gas hose to the analyzer's GAS port; otherwise water will be drawn into the analyzer!**

- If not already done, turn ON the analyzer and display the CALIBRATION LIST screen per Section 5.2.
- Use the ▲▼ buttons to highlight T-Stack, and then press **ENTER** to display the CALIBRATE TS-ZERO screen.



"Measured" is the current temperature reading, while "Applied" is a known temperature that will be applied for calibration purposes.

- Set thermocouple simulator to 32 °F (0 °C), and then use the ▲▼ and ◀▶ buttons to enter an Applied value that exactly equals the setting of the simulator.

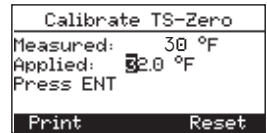

Alternatively: Submerge probe tip into an ice-water bath with a thermometer, wait several minutes, and then use the ▲▼ and ◀▶ buttons to enter an Applied value that exactly equals the thermometer reading.

The calibration range is from 32 to 41 °F (0 to 5 °C). An attempt to calibrate outside this range will cause the message "Applied Value High" (or Low) to appear at the bottom of the screen.

- Wait until the Measured reading stabilizes, and then press **ENTER** to calibrate the TS-Zero Measured value to that of the Applied value; after which the message "Good Calibration" should briefly appear followed by the CALIBRATE TS-SPAN screen.

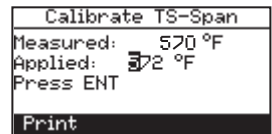

TS-Span Procedure:

- Set thermocouple simulator to 572 °F (300 °C), and then use the ▲▼ and ◀▶ buttons to enter an Applied value that exactly equals the setting of the simulator.

Alternatively: Submerge probe tip into a container of boiling water with a thermometer, wait several minutes, and then use the ▲▼ and ◀▶ buttons to enter an Applied value that exactly equals the thermometer reading.

The calibration range is from 175 to 625 °F (80 to 330 °C). An attempt to calibrate outside this range will cause the message “Applied Value High” (or Low) to appear at the bottom of the screen.

7. Wait until the Measured reading stabilizes, and then press **ENTER** to calibrate the TS-Span Measured value to that of the Applied value; after which the message “Good Calibration” should briefly appear followed by the CALIBRATION LIST screen being re-displayed.

5.6 T-Air Calibration

This procedure first *zeros* and then *spans* the ambient-temperature channel to known temperature values.

The use of an electronic thermocouple simulator is the preferred method of producing the desired calibration temperatures. Alternatively, ice and boiling water baths can be used.

Material Required:

- Thermocouple simulator (K-type)
 - Range: 0 to 600 °F
 - Accuracy: ± 0.5 °F
- (Alternatively) Ice-water, boiling water, thermometer

TA-Zero Procedure:

1. Set thermocouple simulator to room temperature and plug its output into the T-AIR connector located at the bottom of the analyzer.

Alternatively: Plug the probe’s thermocouple into the T-AIR connector located at the bottom of the analyzer. **DO NOT attach the probe’s gas hose to the analyzer’s GAS port; otherwise water will be drawn into the analyzer!**

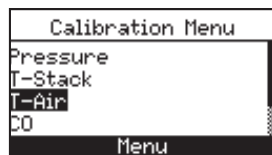

2. If not already done, turn ON the analyzer and display the CALIBRATION LIST screen per Section 5.2.
3. Use the **▲▼** buttons to highlight T-Air, and then press **ENTER** to display the CALIBRATE TA-ZERO screen.

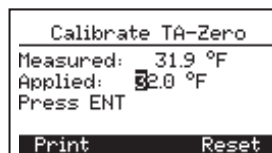

“Measured” is the current temperature reading, while “Applied” is a known temperature that will be applied for calibration purposes.

- Set thermocouple simulator to 32 °F (0 °C), and then use the ▲▼ and ◀▶ buttons to enter an Applied value that exactly equals the setting of the simulator.

Alternatively: Submerge probe tip into an ice-water bath with a thermometer, wait several minutes, and then use the ▲▼ and ◀▶ buttons to enter an Applied value that exactly equals the thermometer reading.

The calibration range is from 32 to 41 °F (0 to 5 °C). An attempt to calibrate outside this range will cause the message “Applied Value High” (or Low) to appear at the bottom of the screen.

- Wait until the Measured reading stabilizes, and then press **ENTER** to calibrate the TA-Zero Measured value to that of the Applied value; after which the message “Good Calibration” should briefly appear followed by the CALIBRATE TA-SPAN screen.

TA-Span Procedure:

- Set thermocouple simulator to 212 °F (100 °C), and then use the ▲▼ and ◀▶ buttons to enter an Applied value that exactly equals the setting of the simulator.

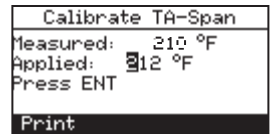

Alternatively: Submerge probe tip into a container of boiling water with a thermometer, wait several minutes, and then use the ▲▼ and ◀▶ buttons to enter an Applied value that exactly equals the thermometer reading.

The calibration range is from 194 to 230 °F (90 to 110 °C). An attempt to calibrate outside this range will cause the message “Bad Calibration Wrong CAL Entry” to appear in the following step.

- Wait until the Measured reading stabilizes, and then press **ENTER** to calibrate the TA-Span Measured value to that of the Applied value; after which the message “Good Calibration” should briefly appear followed by the CALIBRATION LIST screen being re-displayed.

5.7 CO Sensor Calibration

Material required:

- Calibration kit, P/N 24-7059
- Gas cylinder: 500 ppm CO in air, P/N 24-0492

To improve the accuracy of the CO reading, we suggest that if the analyzer will be primarily used for flue gas testing, then calibrate using 500 ppm CO. If the analyzer, however, will be primarily used for ambient testing, then calibrate using 100 ppm CO.

Procedure:

1. If not already done, turn ON the analyzer and display the CALIBRATION LIST screen per Section 5.2.
2. Use the ▲▼ buttons to highlight CO, and then press **ENTER** to display the CALIBRATE CO screen.



“Measured” is the current CO reading, while “Applied” is a known CO level that will be applied for calibration purposes.

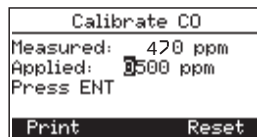

3. Attach a 500 ppm CO cylinder to the regulator of the calibration fixture.
4. Use the ▲▼ and ◀▶ buttons to enter an Applied value that exactly equals the concentration stamped on the CO cylinder.

The calibration range is from 20 to 1,000 ppm. An attempt to calibrate outside this range will cause the message “Applied Value High” (or Low) to appear at the bottom of the screen.

5. Wait until the Measured reading stabilizes and then press **ENTER** to calibrate the CO Measured value to that of the Applied value. The message “Good Calibration” should briefly appear.

*If the sensor’s output is low, but still usable, then the message “Good Calibration WARNING Low Sensor” will appear. The sensor will now be marked as being **Low** in the DIAGNOSTICS screen.*

*If the sensor's output is too low to be usable, then the message "Bad Calibration Sensor End of Life, Entry Not Saved" will appear. The sensor will now be marked as being **BAD** in the DIAGNOSTICS screen.*

6. Power OFF the regulator of calibration fixture and remove the CO cylinder.

6.0 Maintenance

6.1 Fyrite® INSIGHT Disassembly

The following section describes how to disassemble the Fyrite INSIGHT to perform necessary periodic maintenance. (See Figure 6.1 for diagram.)

Tools Required:

- Medium Phillips screwdriver

Procedure:

1. Unplug all thermocouples from bottom of analyzer.
2. Remove battery cover and then remove batteries.
3. Remove sensor caps, disconnect tubing, and then unplug all sensors.
4. Lay analyzer face down on a padded work surface; and then using a medium Phillips screwdriver, remove the unit's four rear-case screws.
5. Lift rear case from analyzer and set aside.
6. Unplug electrical connector J11 from printed circuit board.
7. Lift printed circuit board from analyzer.

Fyrite® Insight Components

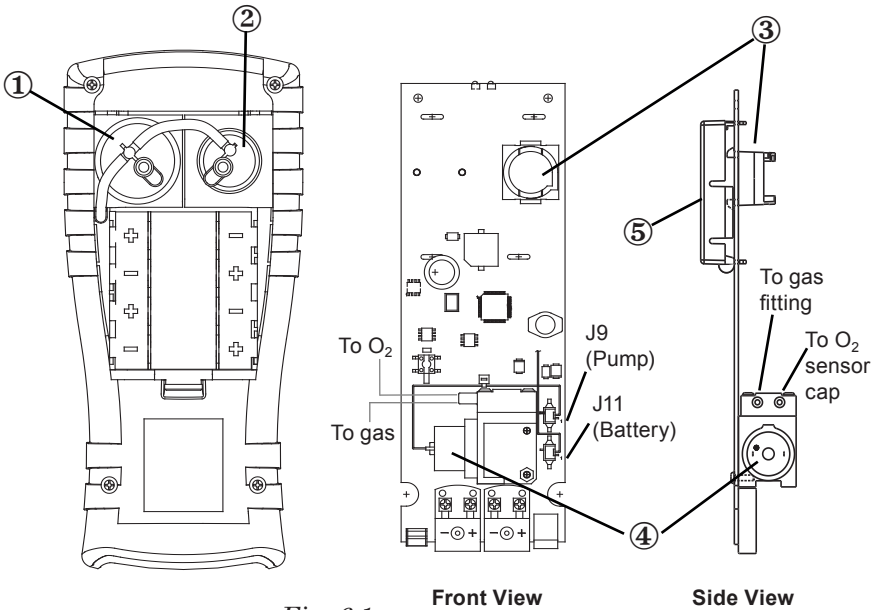

Fig. 6.1

- | | |
|-------------------|----------------|
| 1. O2 Sensor | 4. Sample Pump |
| 2. CO Sensor | 5. LCD Screen |
| 3. CO Sensor Base | |

Fyrite® Insight End Plate Connectors

- | |
|--|
| 6. AC Power Adapter Jack (Power) |
| 7. Sample Gas Thermocouple Connector (T-Stack) |
| 8. Primary Air Thermocouple (T-Air) |
| 9. USB Connector |
| 10. Differential Pressure Hose (Optional) |
| 11. Draft Hose |
| 12. Sample Gas Hose |

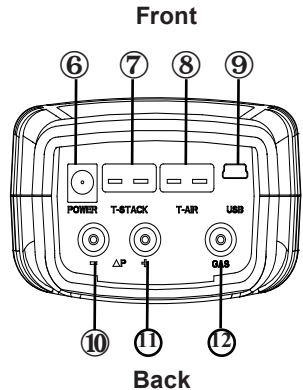

Fig. 6.2

6.2 Water Trap / Filter

6.2.1 Emptying the Water Trap Chamber

The water trap chamber should be emptied after every test, or when the water condensate approaches the tip of the riser tube.

1. Remove water trap chamber per Figure 6.3.
2. Pour out liquid condensate, and then reassemble trap.

6.2.2 Replacing the Filter Element

Replace the filter element when it becomes visibly dirty or becomes saturated with water.

Material Required:

- Filter element, P/N 07-1644
- Small flat blade screwdriver

1. Remove water trap chamber per Figure 6.3.
2. Pry apart filter chamber using a small flat-blade screwdriver. Remove and discard old filter.
3. Install new filter and reassemble filter chamber, making sure that surfaces “A” and “B” contact each other.
4. Reassemble trap.

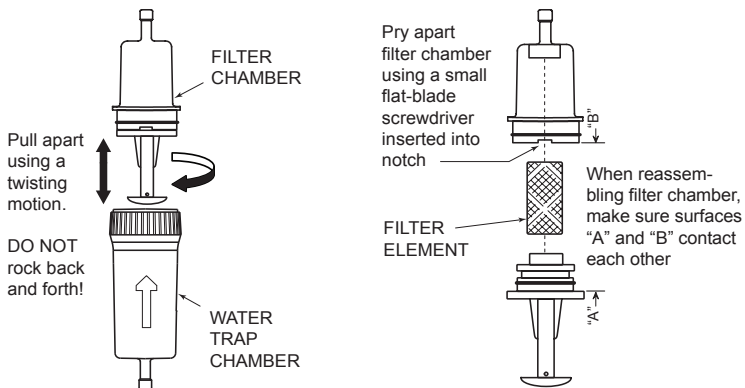

Fig. 6.3

6.3 O₂ Sensor Replacement

Material Required:

- O₂ Sensor (P/N 24-0788)

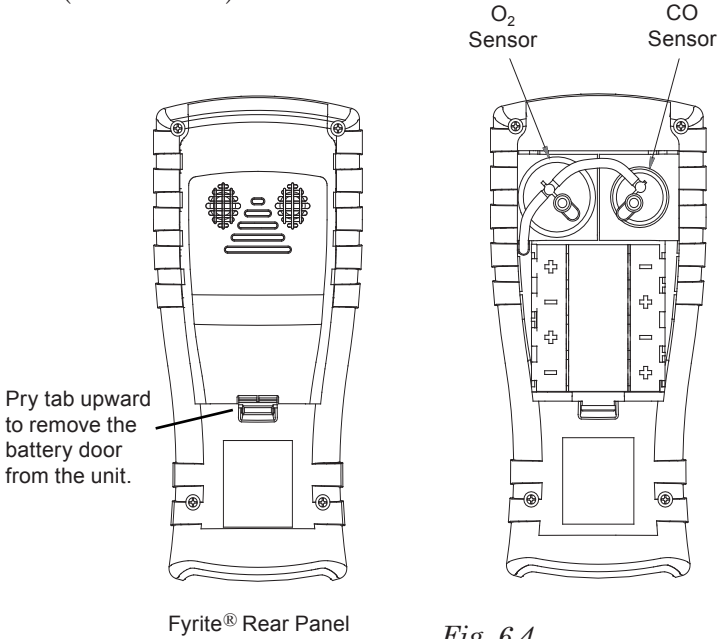

Fig. 6.4

Procedure:

1. After battery door is removed, remove connector tubing from both sensors.
2. Pull O₂ sensor from its socket and remove the O₂ cap.
3. Properly dispose of the old sensor. Engage the nub on the new sensor within the slot on the cap's side and twist to secure the cap and sensor together.
4. Install the cap and sensor unit by
 - Aligning the ribs on the sides of the sensor with the corresponding shape in the base.
 - Inserting the pins into the connectors in the base.
5. Reattach tubing.

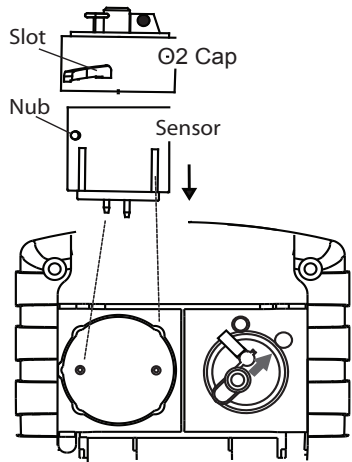

Fig. 6.5

6.4 CO Sensor Replacement

Material Required:

- CO Sensor (P/N 24-7265) or B-Smart sensor (P/N 24-1467)

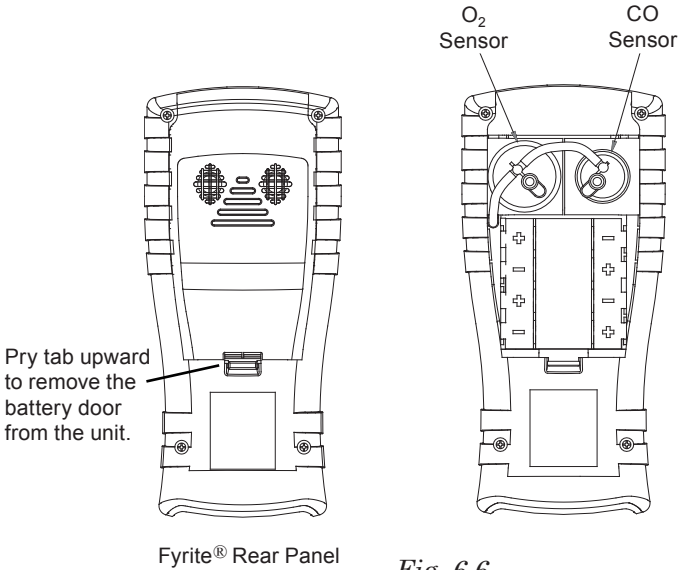

Fig. 6.6

Procedure:

1. After battery door is removed, remove the connector tubing from the CO sensor.
2. Gently pull CO sensor out of its socket. Remove CO cap by twisting counter clockwise.
3. Properly dispose of the old CO sensor.
4. Plug the new CO sensor into its socket.
5. Install the CO cap by aligning the arrow on the cap with the "OPEN" marker, then twisting to the "CLOSED" marker. Reattach tubing.

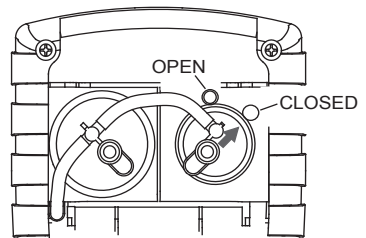
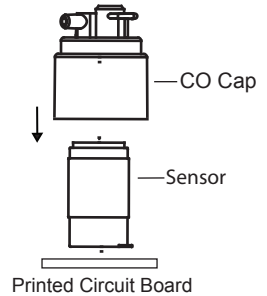

Fig. 6.7

6.5 Thermocouple Replacement

Using the appropriate thermocouple replacement kit listed below, replace the probe's thermocouple as follows:

Each kit contains a thermocouple assembly, two O-rings, and two wire-splice connectors.

Tools Required:

- Small flat blade screwdriver
- Wire cutter
- Wire stripper
- Slip joint pliers

Procedure:

1. Gain access to the thermocouple connections by first removing three screws from probe handle, and then separating the two handle pieces.
2. Cut wires attached to old crimp connectors, leaving behind as much of the probe's thermocouple-connector wire as possible

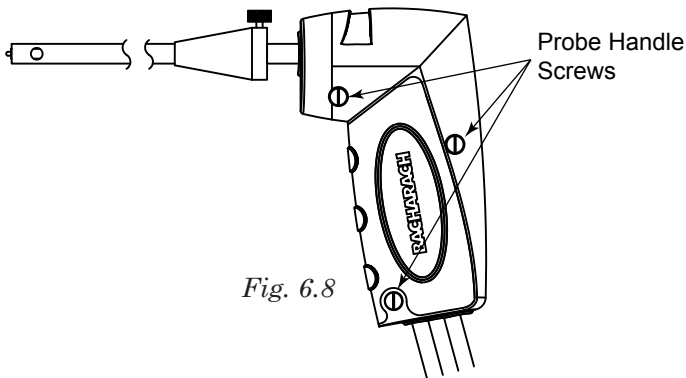

3. Pull old thermocouple from probe body and discard.
4. The new thermocouple has been coiled for shipping purposes. Straighten the thermocouple using your thumb and index finger.
5. If not already done, install supplied O-Rings onto thermocouple.
6. Insert thermocouple into probe body until it “bottoms out.”

- Strip $\frac{1}{4}$ inch of insulation from each of the probe's thermocouple connector wires.

IMPORTANT: *In Step 8, the thermocouple wires must first be twisted together and then crimped.*

- Twist** both red thermocouple wires together; insert them into the supplied wire-splice connector; and then crimp the connector using a pair of pliers. Repeat this step for the yellow thermocouple wires.
- Reassemble the probe handle, being careful not to pinch the thermocouple wires between the handle pieces. In addition, ensure that the end of the thermocouple is in front of the rib molded into the bottom handle piece; otherwise, the handle pieces will not fit tightly together.

6.6 Gas Pump Replacement

Parts & Tools Required:

- Replacement pump (P/N 24-3049)
- Medium phillips screwdriver

Procedure:

- Gain access to the gas pump by removing the rear case. Refer to Section 6.1.
- Disconnect J9 (pump) and J11 (Battery) connectors.
- Lift the circuit board out of the unit.
- Remove the screw that secures the pump to the board in order to separate the pump from the board.
- Remove tubing from pump.
- Install new pump by reversing this procedure.

6.7 Cleaning the Probe

The probe tube and gas-sample hose will become dirty under normal use. Note that the water trap's filter element should prevent soot from reaching the analyzer's internal components. If the probe is not kept clean, it could become clogged and restrict the flow of gas into the analyzer, resulting in incorrect combustion test readings and calculations.

NOTE: *An analyzer that is used to test natural gas furnaces normally requires less frequent cleaning than an analyzer used for testing coal or oil fired furnaces.*

Equipment Required:

- Alcohol
- Aerosol can of automotive carburetor cleaner
- Clean rag
- Source of compressed air (optional)

Procedure:

1. Remove gas-sample hose from top of water trap.



CAUTION: *Carburetor cleaner attacks plastic components! Take precautions not to spray cleaner onto the probe handle or analyzer.*

2. Insert the plastic-spray tube of the carburetor cleaner into the gas-sample hose, and then liberally spray carburetor cleaner through the hose and out the probe tube.
3. After spraying, remove all the residual cleaner by repeatedly flushing the gas hose and probe tube with alcohol.
4. Wipe off the surfaces of the probe and tubing with a clean rag.
5. Allow the parts to dry completely. If available, blow compressed air through the probe to expedite the drying process.
6. Reconnect gas-sample hose to top of water trap.

6.8 Error Messages

O2 Sensor Missing - The O2 sensor is not installed.

T-STK Disconnected - The probe thermocouple is not connected to the analyzer's T-Stack connector. Plug the probe thermocouple plug into the T-Stack connector at the bottom of the instrument.

Bad Sensor - O2 sensor is too low and can not be calibrated in the instrument and needs replaced.

Low Sensor- O₂ or CO sensor outputs were low but still usable. Sensor(s) may need to be replaced in the near future. Message will indicate which sensor(s) were in warning.

Warmup Sensor Error -

- CO sensor was not zeroed at warmup because of high output. Run instrument on fresh air then restart instrument to re-zero sensor. If message persists, CO sensor may need to be replaced.
- Stack or Air temperature channel is measuring temperature outside the range of -4 to 212 °F at startup. Make sure that the Stack and Air thermocouples are sampling ambient room air within the temperature range at startup.
- Pressure sensor is measuring pressure outside the range of ± 3 inwc at startup. Ensure that the analyzer is sampling atmospheric pressure and restart the instrument.
- The analyzer was turned on with the probe sampling flue gas. Move the probe to fresh air and restart the instrument.
- Message will indicate which channel is in error.

Low Battery - Battery voltage is low. Replace the batteries.

XXXX - Occurs in the number fields of sensors that have achieved over-range condition.

******** - Occurs in the number fields of sensors and the calculated values that depend on the sensors that were in error coming out or warmup.

--- - Occurs in the number fields of calculated values when Oxygen is above 16.0%.

6.9 Diagnostics Screen

The DIAGNOSTICS menu provides information regarding the operation of the analyzer. Information includes the following:

Time Meters - Displays the run time of the analyzer and sample pump in hours of operation.

Main Diagnostics - Lists the current status of the Stack and Air Thermocouple channels, Reference Temperature channel, Pressure channel, CO channel, O₂ channel and Battery.

O2 Sensor Life - Displays the approximate remaining life of the Oxygen sensor.

Fresh Air Diagnostics - Fresh air diagnostics will cycle the instrument through the 60 second warm-up to check on the status of the sensors. The probe must be in fresh air to perform a valid check.

Access the DIAGNOSTIC menu as follows:

1. Display the MAIN MENU by pressing the **MENU (F2)** button. If necessary, press **ESC** until MENU appears above **F2**.
2. Use the **▲▼** buttons to highlight DIAGNOSTICS and then press **ENT** to display the DIAGNOSTIC MENU.
3. Use the **▲▼** buttons to highlight the desired diagnostic topic and then press **ENT** to display the information under that topic.
4. Press the **ESC** key to exit back to the DIAGNOSTIC MENU or the **MENU (F2)** key to exit back to the MAIN MENU.

6.10 Status Screen

The Status Screen provides a quick reference to key items when troubleshooting:

- Version
- ADC Version
- Boot Version
- Model
- SN

Access the Status menu as follows:

1. Display the **MAIN MENU** by pressing the **MENU (F2)** button. If necessary, press **ESC** until MENU appears above **F2**.
2. Use the **▲▼** buttons to highlight STATUS and then press **ENT** to display the DEVICE STATUS screen.
3. Press the **ESC** key to exit back to the MAIN MENU.

7.0 PARTS & SERVICE

7.1 Replacement Parts

Description	Part No.
O2 Sensor	24-0788
CO Sensor	24-7265
B-Smart CO Sensor	24-1467
O2 Sensor Cover	24-1421
CO Sensor Cover Assembly	24-1484
Probe and Hose Assembly	24-3004
Water Trap	19-3265
Filter (pkg of 3).....	07-1644
Thermocouple Replacement (12 in.).....	24-8414
Probe Stop	19-3037
Gas Connector	24-0877
Draft Connector	24-0878
Connector Plate Assembly	24-1483
O-Ring Kit (2 sets)	24-1471
USB cable	104-4032
Carry Case.....	24-0865
Replacement Pump.....	24-3049
PC Software.....	24-1470
Battery / Sensor Cover	24-1453

7.2 Accessories

IrDA Printer	24-1400
Printer Paper (pkg of 5)	24-1310
Printer Paper (pkg of 1)	06-8733
Boot.....	24-1461
AC Adapter	24-1254
Calibration Kit	24-7059
Calibration Gas, 500 ppm CO.....	24-0492
Calibration Gas, 100 ppm CO.....	51-1994
Thermocouple, 1 IN.....	104-1798
Thermocouple, 10 FT.....	104-1797
Smoke Kit	21-7006
Differential Pressure & Temperature Kit.....	24-8242

7.3 Service Centers

Replacement parts and service can be obtained by contacting one of the following Bacharach Service Centers:

United States

Pennsylvania

621 Hunt Valley Circle
New Kensington, PA 15068
Phone: 724-334-5051
Fax: 724-334-5723
Email: help@mybacharach.com

Canada

Bacharach of Canada, Inc.
250 Shields Court Unit #3
Markham, Ontario L3R 9W7 Canada
Phone: 905-470-8985
Fax: 905-470-8963
Email: bachcan@idirect.com

México

Bacharach de México
Playa Regatas No. 473 Tercer Piso
Col. Militar Marte
Delegación Iztacalco, 08830
México D.F. México
Phones: +52-555-634-7740
 +52-555-634-7741
FAX: +52-555-634-7738
Email: bacharach@prodigy.net.mx



Headquarters:

621 Hunt Valley Circle, New Kensington, PA 15068

Ph: 724-334-5000 • Fax: 724-334-5001 • Toll Free: 800-736-4666

Website: www.mybacharach.com • E-mail: help@mybacharach.com