



# Greyline DFM 6.1

**Instruction Manual**



Note: This page has been left blank intentionally.

**CONTENTS**

CONNECTIONS .....	4
KEYPAD SYSTEM.....	6
CALIBRATION MENU .....	7
ICONS .....	8
MAIN DISPLAY.....	9
MESSAGE ICON.....	9
STATUS.....	9
PASSWORD.....	10
MENU SELECTIONS .....	10
UNITS/MODE .....	11
CALIBRATION.....	13
RELAY PARAMETERS.....	15
DATA LOGGING.....	16
COMMUNICATION (Optional).....	18
SPECIAL FUNCTIONS .....	20
SENSOR MOUNTING LOCATION.....	23
ENCLOSURE INSTALLATION .....	27
FIELD TROUBLESHOOTING .....	28
COMMON QUESTIONS AND ANSWERS .....	31
APPLICATIONS HOTLINE.....	33
PRODUCT RETURN PROCEDURE .....	33
OPTIONS.....	35
MODBUS® COMMUNICATION .....	41
HART® COMMUNICATION .....	52
SPECIFICATIONS.....	64
PIPE CHARTS.....	66

**IMPORTANT NOTE:** This instrument is manufactured and calibrated to meet product specifications. Please read this manual carefully before installation and operation. Any unauthorized repairs or modifications may result in a suspension of the warranty.

If this product is not used as specified by the manufacturer, protection may be impaired.

Available in Adobe Acrobat pdf format

**CONNECTIONS:**

POWER INPUT: The standard model requires AC power input between 100 to 240 VAC 50/60Hz. No adjustments are necessary for voltages within this range. Connect L (Live) N (Neutral) and AC Ground.

Optional DC input model requires 9-32 VDC/10 Watts. Connect to + and - terminals.

Optional Thermostat and Heater modules are available rated for 115 VAC or 230 VAC.

IMPORTANT NOTE: To comply with CSA/UL electrical safety standards, AC power input and relay connection wires must have conduit entry to the instrument enclosure. Installation requires a switch, overcurrent fuse or circuit breaker in the building (in close proximity to the equipment) that is marked as the disconnect switch.



Risk of electric shock. Loosen cover screw to access connections. Only qualified personnel should access connections.

Note: Use of instrumentation over 40°C ambient requires special field wiring.

**QUICK BENCH TEST:**

Connect Sensor as shown on next page, then Power. Test operation of the DFM 6.1 by holding the sensor in one hand and rubbing your thumb or fingers briskly across the face (plastic surface) of the sensor. Allow 15 seconds for the DFM 6.1 to process the signal and display a flow value.

**CONNECTIONS**

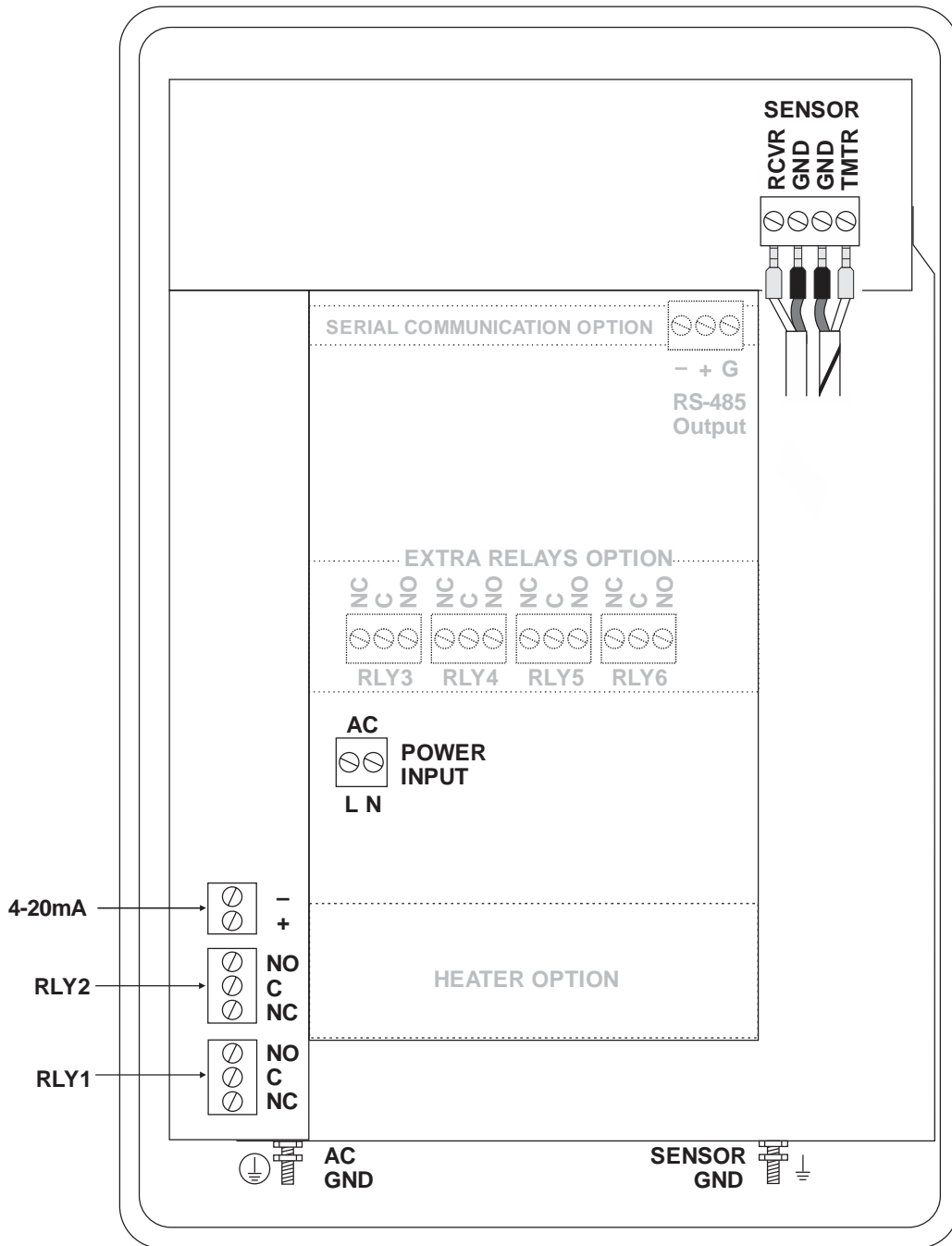

**KEYPAD SYSTEM**

The diagram on the next page shows the DFM 6.1 menu system. Arrows show the four directions to leave a menu box. Pressing a corresponding keypad arrow will move to the next item in the direction shown. Move the cursor (highlighted) under numerals and increase or decrease numerals with the ▲ and ▼ keys.

To store calibration values permanently (even through power interruptions), press the ✓ button.

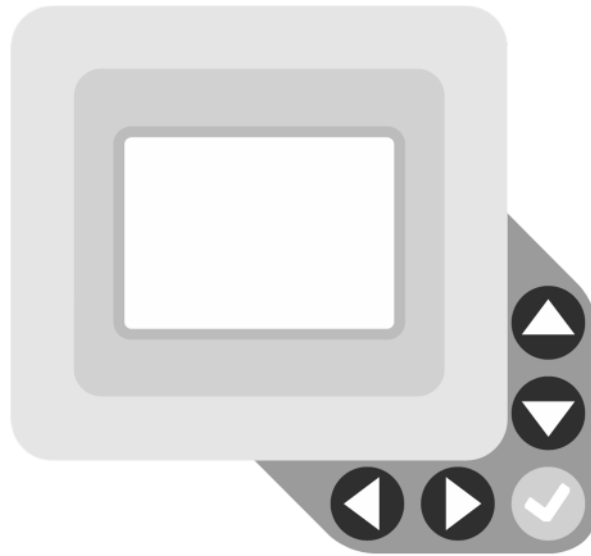

**CALIBRATION MENU**

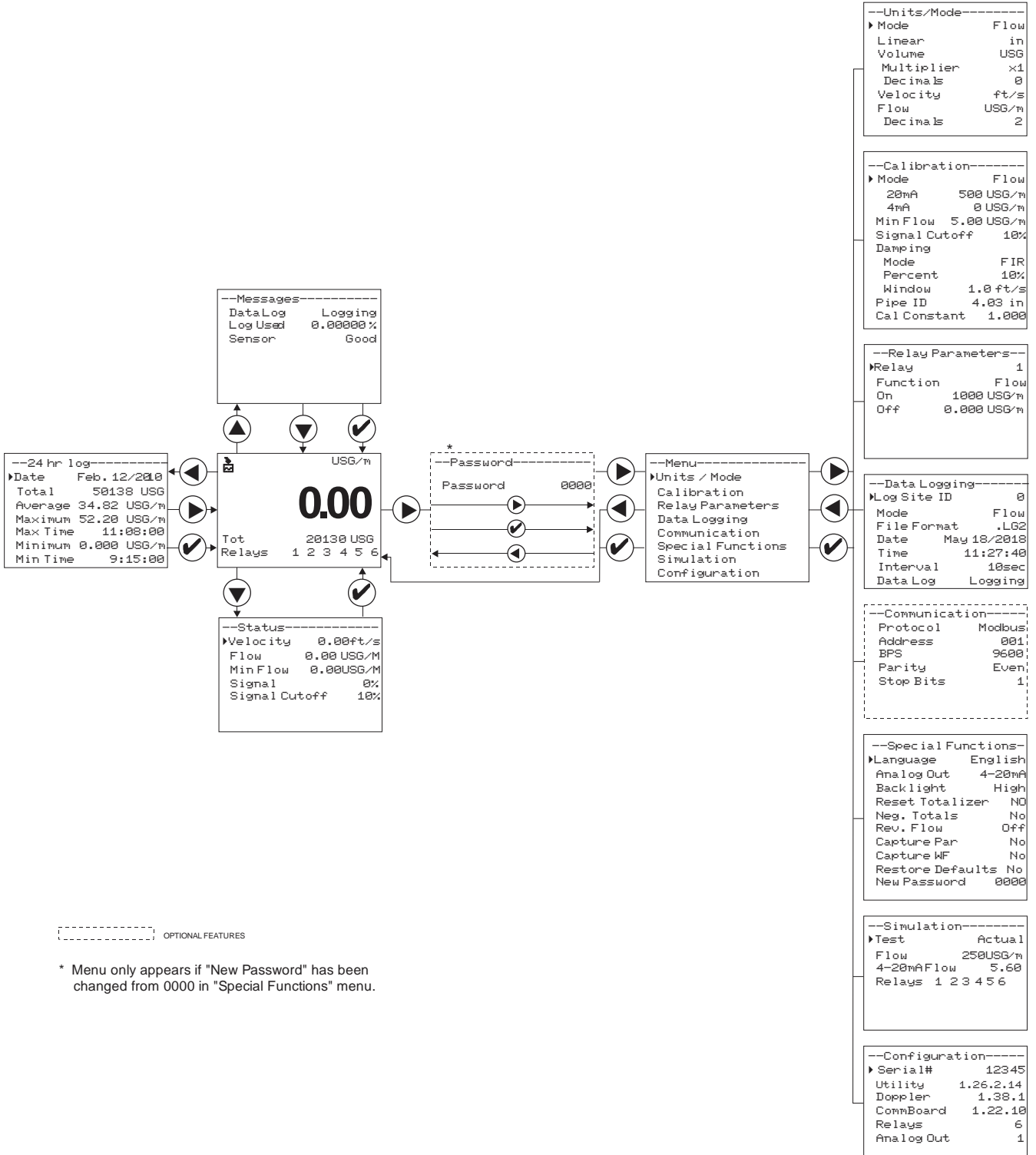

OPTIONAL FEATURES

\* Menu only appears if "New Password" has been changed from 0000 in "Special Functions" menu.

**ICONS**



1.



2.

Message waiting. Press ▲.



Data logging off.



1.



2.

Data logging on.



1.



2.



3.



4.

USB file download.



File download completed.



Download Error.



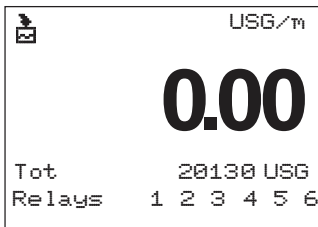

## MAIN DISPLAY

The main display shows the units selected from the Units/Mode menu, flow or velocity rate being measured, totalizer and relay states. The DFM 6.1 will start-up with this display.

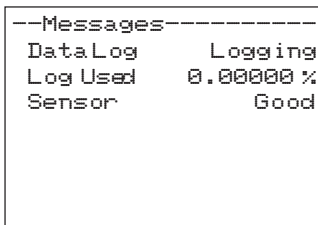

## MESSAGE ICON

Press ▲ from the main display to view status of the data logger and error/warning messages provided by the instrument. The Message Icon will appear on the main display if error messages are being generated by the instrument. Press ✓ to return to the main display.

**Sensor** Displays the status of the sensor hardware. Even with the sensor disconnected or shorted, the DFM will display Good. To check sensor integrity, use the sensor resistance test procedure on page 28. If HardwareFault is detected, navigate to the Configuration page in the Main Menu to determine which circuit board is not communicating.

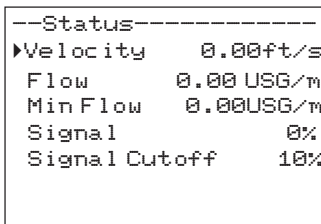

## STATUS

Press ▼ from the main display to view instrument status. Velocity will be displayed in ft/sec or m/sec.

**Velocity** Displays the measured flow velocity in units selected in the Units/Mode menu.

**Flow** Displays the measured flow rate in units selected in the Units/Mode menu.

**Min Flow** Displays the minimum flow rate setting. This value is read-only. The Min Flow can be changed in the Calibration programming menu. A measured Flow value below the Min Flow value will display as 0 flow on the meter's LCD display.

**Signal** Displays the strength of the received Doppler signal on a 0-100% scale.

**Signal Cutoff** Displays the signal cutoff. This value is read-only. The Signal Cutoff can be changed in the Calibration programming menu. If Signal Strength is less than Signal Cutoff, the meter will report 0 velocity and flow on the LCD display. Setting may need to be adjusted in the case of unstable flow near zero, or when high levels of industrial noise are present.

```

--24 hr log-----
▶Date      Feb. 12/2010
Total      50138 USG
Average    34.82 USG/m
Maximum    52.20 USG/m
Max Time   11:00:00
Minimum    0.000 USG/m
Min Time   9:15:00

```

## 24 HR LOG

Press ◀ from the main display to view a formatted flow report from instruments with a built-in data logger. Press ▼ to scroll down one day or repeatedly to scroll to a specific date. Up to 365 days can be stored. Newest date will overwrite the oldest. Press ✓ to return to the main display.

**IMPORTANT:** Inserting a USB drive into the meter while on this screen will transfer 24 HR Log data to the USB drive in .csv format.

```

--Password-----
Password      0000

```

## PASSWORD

The Password (a number from 0000 to 9999) prevents unauthorized access to the Calibration menu.

From the Main Display press the ▶ key to get to `Password`. Factory default password is 0000 and if it has not been changed, this screen will be bypassed completely.

A new password can be stored by going to the `Special Functions New Password` menu.

If a user password is required, press ▶ to place the cursor under the first digit and ▼ or ▲ to set the number, then ▶ to the second digit, etc. Press ▶ or ✓ to proceed to the Menu Selections screen.

```

--Menu-----
▶Units / Mode
Calibration
Relay Parameters
Data Logging
Communication
Special Functions
Simulation
Configuration

```

## MENU SELECTIONS

The Menu selections page is used to navigate to specific menus which are described in more detail on the following pages.

Press ▲ or ▼ to navigate to different menus, and ▶ to enter the selected menu.

--Units/Mode-----	
► Mode	Flow
Linear	in
Volume	USG
Multiplier	×1
Decimals	0
Velocity	ft/s
Flow	USG/m
Decimals	2

## UNITS/MODE

At **Mode**, press the ► and then the ▲ or ▼ to select Flow or Velocity. Flow mode displays the flow rate in engineering units (e.g. gpm, litres/sec, etc.) Press the ✓ to store your selection then the ▼ to the next menu item.

At **Linear** press the ► key and then the ▲ or ▼ to select your units of measurement. The Linear units define what units the pipe dimensions and sensor spacing will be displayed in. Typically inches or mm is selected. Press the ✓ to store your selection then the ▼ to the next menu item.

At **Volume**, press the ► and then the ▲ or ▼ to select units for volume. Note: "bbl" denotes US oil barrels. Press the ✓ to store your selection then the ▼ to the next menu item.

At **Multiplier**, press the ► and then the ▲ or ▼ to select the totalizer multiplier. Multipliers are used when resolution down to single digit is not required, or when you don't want to convert from gallons to thousands of gallons, as an example. Press ✓ to store your selection then ▼ to the next menu item.

At **Decimals (Volume)**, press the ► and then the ▲ or ▼ to select the number of decimal points to be present on the totalizer display on the LCD screen. Default = 0. Options = 0, 1, 2. Press the ✓ to store your selection then the ▼ to the next menu item.

At **Velocity**, press the ► and then the ▲ or ▼ to select the engineering units for flow velocity. Press ✓ to store your selection then ▼ to the next menu item.

```

--Units/Mode-----
▶ Mode           Flow
Linear          in
Volume         USG
Multiplier     x1
Decimals       0
Velocity       ft/s
Flow           USG/m
Decimals       2
    
```

**UNITS/MODE (cont.)**

At **F l o w**, press the ▶ and then the ▲ or ▼ to select the engineering units for flow rate. Press ✓ to store your selection then ▼ to the next menu item.

Available Flow Rate Engineering Units:

Abbreviation	Description	Abbreviation	Description
USG/d	US gallons per day	L/d	liters per day
USG/h	US gallons per hour	L/h	liters per hour
USG/m	US gallons per minute	L/m	liters per minute
USG/s	US gallons per second	L/s	liters per second
ft <sup>3</sup> /d	cubic feet per day	m <sup>3</sup> /d	cubic meters per day
ft <sup>3</sup> /h	cubic feet per hour	m <sup>3</sup> /h	cubic meters per hour
ft <sup>3</sup> /m	cubic feet per minute	m <sup>3</sup> /m	cubic meters per minute
ft <sup>3</sup> /s	cubic feet per second	m <sup>3</sup> /s	cubic meters per second
bbl/d	barrels per day (1 bbl = 42 USG)	IG/d	Imperial gallons per day
bbl/h	barrels per hour (1 bbl = 42 USG)	IG/d	Imperial gallons per day
bbl/m	barrels per minute (1 bbl = 42 USG)	IG/d	Imperial gallons per day
bbl/d	barrels per second (1 bbl = 42 USG)	IG/d	Imperial gallons per day
USMG/d	US million gallons per day	IMG/d	Imperial million gallons per day
USMG/h	US million gallons per hour	IMG/h	Imperial million gallons per hour
USMG/m	US million gallons per minute	IMG/m	Imperial million gallons per minute
USMG/s	US million gallons per second	IMG/s	Imperial million gallons per second

At **D e c i m a l s** (Flow), press the ▶ and then the ▲ or ▼ to select the number of decimal points to be present on the flow rate display on the LCD screen. Default = 2. Options = 0, 1, 2. Press the ✓ to store your selection then the ▼ to the next menu item.

```

--Calibration-----
▶ Mode           Flow
  20mA          500 USG/m
  4mA           0 USG/m
Min Flow       5.00 USG/m
Signal Cutoff  10%
Damping
  Mode          FIR
  Percent       10%
  Window        1.0 ft/s
  Pipe ID       4.03 in
  Cal Constant  1.000

```

## CALIBRATION

Press ▼ or ▲ to position cursor at Calibration menu, and ▶ to enter. Use ▼ or ▲ to position cursor before each menu item and ▶ to enter. When settings are completed press ✓ to store and ✓ again to return to the Main Menu.

20mA  
(5V)

Press ▶ then ▼ or ▲ to change the numbers and decimal point. Use this menu to set the corresponding flow rate that will be represented by 20mA analog output. If maximum flow is unknown, enter an estimated flow rate and observe actual flow to determine the correct maximum value. Any velocity or flow rate up to +40 ft/sec (12.2 m/sec) may be selected.

4mA  
(0V)

Press ▼ or ▲ to set the flow rate corresponding to 4mA analog output. This setting may be left at zero flow (or velocity) or can be raised to any value less than the 20mA setting, or lowered to any velocity or corresponding flow rate down to -40 ft/sec (-12.2 m/sec).

Min Flow

Press ▶ and enter a minimum flow cutoff. Forward and reverse flows less than **Min Flow** will be forced to zero.

Signal  
Cutoff

Adjust the setting in percent to suppress flow readings at zero flow when fluid swirling or pipe vibration may cause the instrument to continue reading. Example: Signal Cutoff at 5% will force the display and outputs to zero when signal strength drops below 5%.

```

--Calibration-----
▶ Mode           Flow
  20mA          500 USG/m
  4mA           0 USG/m
Min Flow       5.00 USG/m
Signal Cutoff  10%
Damping
  Mode          FIR
  Percent       10%
  Window        1.0 ft/s
  Pipe ID       4.03 in
  Cal Constant  1.000

```

## CALIBRATION (cont.)

**Damping** Choose between OFF, FIR (Default), or LOW PASS.

**Mode** When measured flows are outside the Window of the running average, the FIR filter will reduce the damping average so that a fast response can be made to the sudden change in flow rate.

The LOW PASS filter will ignore measured flow rates outside the Window, while holding the running average, until there are enough data points outside the Window to cause a step-response to the new measured value.

While measured flows are within the Window of the running average, both the FIR and LOW PASS filter behave the same.

**Percent** Higher percentages increase the number of measurements which are averaged together to produce a stable flow reading. Higher percentages also increase the time it takes for the meter to make a step-response to the measured flow rate outside the Window in the LOW PASS Mode.

**Window** Defines the Window around the running average, in units of Velocity set in the Units/Mode menu. Measurements made inside the Window are added to the running average, and measurements outside the Window effect the response of the meter as described in the Mode section.

**Pipe ID** Place the cursor under the digits and then ▼ or ▲ to change the numbers and decimal point. **Pipe ID** should be entered as the exact inside diameter of the pipe where the sensor is mounted. Refer to the Pipe Charts Appendix in this manual for inside diameter of common pipe types and sizes.

**Cal Constant** Scales the velocity reading. Factory value is close to 1.000 for a SE4-A sensor.

Press ✓ to return to Menu Selections screen.

```

--Relay Parameters--
▶Relay                1
Function              Flow
On                   1000 USG/m
Off                   0.000 USG/m

```

## RELAY PARAMETERS

Press ▼ or ▲ to position cursor at Relay Parameters, and ▶ to enter. Use ▼ or ▲ to position cursor before each menu item and ▶ to enter. When settings are completed press ✓ to store and ✓ again to return to the Main Menu.

- Relay** Press ▶ and ▼ or ▲ to select a corresponding relay number (2 relays are standard, 4 additional are optional).
- Function** Press ▼ or ▲ to select `Off`, `On`, `Pulse` or `Flow`.
- Flow** `On` Highlight the numerals and press ▼ or ▲ to set digits to the required relay `On` set point.  
`Off` set digits to the required `Off` set point.
- Direction** When flow is in the positive direction, the relay will be disengaged, when flow is negative, the relay engages.  
Note: Rev. Flow in the Special Functions menu must be `ON` or `INVERT` for this to work properly.
- Pulse** Press ▼ and set digits to the flow volume increment required between relay pulses. Use this feature for remote samplers, chlorinators or totalizers. Minimum time between pulses is 2.25 seconds and pulse duration is 350 milliseconds.  
  
Return to `Relay` and change settings for each relay number.  
  
Press ✓ to return to `Menu Selections`.
- ON** Sets relay in energized state.

```

--Data Logging-----
▶Log Site ID      0
Mode              Flow
File Format       .LG2
Date             May 18/2018
Time             11:27:40
Interval         10sec
                 60min
                 30min
                 15min
                 10min
                 5min
                 2min
                 1min
                 30sec
Data Log         Stop
                 Start
                 Delete

```

## DATA LOGGING

Press ▼ or ▲ to position cursor at Data Logging, and ▶ to enter. Use ▼ or ▲ to position cursor before each menu item and ▶ to enter. When settings are completed press ✓ to store and ✓ again to return to the Main Menu.

Log Site ID	Enter a number from 00 to 99. The site ID will become part of the downloaded file name to help distinguish downloads from different instruments. Press ✓ to store the setting.
Mode	Select Velocity (e.g. ft/sec or m/sec) or Flow (e.g. USGPM or l/sec). Press ✓ to store the setting.
File Format	Choose .LG2 to download data in .lg2 format for viewing on Greyline Logger Software. Choose .CSV to download data in .csv format for import directly to Excel. This menu option can be changed at any time without adversely affecting existing data.
Date	Press ▶, and ▲ or ▼ to scroll and select Month, Day and Year. Press ✓ to store the setting.
Time	Press ▶, and ▲ or ▼ to select the current time in Hours, Minutes and Seconds. Press ✓ to store the setting.
Interval	Press ▲ or ▼ to select the logging interval. Press ✓ to store the setting. Pulsar Measurement recommends choosing an interval which will give you as much resolution as required and no more. Choosing too often of an interval for what is required will result in larger data files, which may take a long time to download to USB. Reference page 15 for specific download times. In critical installations, data should be downloaded often.
Data Log	Stop, Start or Delete the log file. Press ▲ or ▼ to select Delete and ✓ to delete the log file. Press ▲ or ▼ to select Start and ✓ to start the logger.

**Important Note:** You MUST Delete an old log and Start a new log AFTER having made changes to Log Site ID, Mode, Date, Time and/or Interval for those changes to be applied.

**Important Note:** Changing any of the parameters in the Units/Mode menu will start a new log. It is recommended that you Delete and start a new log after changing any Units/Mode settings.



## RETRIEVING LOG FILE

Plug a USB Flash Memory Drive (one is included with the DFM 6.1) into the USB output port on the Panel of the meter. The instrument display will show the data download icon until the log file is transferred to the memory card. The USB flash drive may be removed when the icon for download successful appears.

Download file names will appear in this format:

```

DFM__00A.LG2
      or
DFM__00A.CSV
  ↑   ↑   ↑
MODEL TAG DOWNLOAD

```

Tag is set according to the `Log Site ID` entered in the instrument `Data Logging` menu.

Download letter will be A for the first download from an instrument. B for the second, then C etc. At the letter Z a - character will appear indicating that the maximum number of downloads for that instrument are on the USB flash drive. Older files can be erased or moved from the flash memory drive or a new memory drive can be used.

Note: Downloading files in .lg2 format will take approximately 35 seconds per 1% of internal log memory used.

Downloading files in .csv format will take approximately 8 minutes per 1% of internal log memory used.

## OPENING .LG2 FILES

Install Greyline Logger Software on your PC or laptop. Select File/Open/Instrument Log (.log) to open the log file from your USB flash drive. Greyline Logger Software is available for download on the Pulsar Measurement website, [www.pulsarmeasurement.com/downloads](http://www.pulsarmeasurement.com/downloads). Data can also be converted to .CSV via Greyline Logger Software.

## OPENING .CSV FILES

Use a datasheet program such as Microsoft Excel® to import data in a comma delimited format. Use Excel to manipulate or graph data.

```

--Communication-----
Protocol      Modbus
Address      001
BPS          9600
Parity       Even
Stop Bits    1
    
```

**COMMUNICATION (Optional)**

Press ▼ or ▲ to position cursor at Communication, and ► to enter. Use ▼ or ▲ to position cursor before each menu item and ► to enter. When settings are completed press ✓ to store and ✓ again to return to the Main Menu.

MODBUS Protocol Information:

- Transceiver: 2-wire, half-duplex
- Data format: 8 Data Bits
- Floating Point Byte Order: ABCD
- Termination: Jumper JP1 selectable 120Ω resistor. TB1 & TB2 = OFF, TB2 & TB3 = ON
- Biasing: None

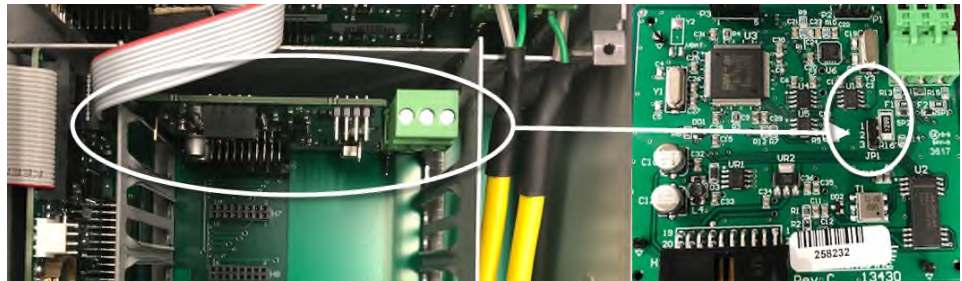

HART® (Highway Addressable Remote Transducer) Protocol Information:

HART Version: 7.0

**Device Description Files:** DD files allow the user’s handheld HART communicator to fully configure the DFM 6.1 Pulsar Measurement provides DD files for the Emerson 475 Communicator. The files are included in the USB drive provided with your DFM 6.1 meter. You may also request the files from Pulsar Measurement by calling or emailing us at [info@pulsarmeasurement.com](mailto:info@pulsarmeasurement.com).

**Warning:** The DFM 6.1 and associated DDs are pending certification from the Fieldcomm Group.

**Connections:** HART Protocol uses a digital signal superimposed on the 4-20mA output. When the 4-20mA output of the DFM 6.1 is connected with a load resistor (230Ω to 600Ω), the HART communicator can be connected on the loop in order to communicate.

**Protocol** Choose MODBUS or HART.

```

--Communication-----
Protocol      Modbus
Address      001
BPS          9600
Parity       Even
Stop Bits    1

```

### **COMMUNICATION (Optional) cont.**

**Address** (Modbus) Device address for the DFM. Valid range: 001-247 (Default: 001). This number should be unique across the bus. Press ▲ or ▼ to scroll, ► to select digits, and press ✓ to store the setting.

**BPS** (Modbus) Baud rate for the MODBUS communications. Press ▲ or ▼ to select, and ✓ to store the setting. Options: 4800, 9600, 19200, 38400, 57600, 76800, and 115200 (Default: 9600).

**Parity** (Modbus) Error checking parity for the MODBUS communications. Press ▲ or ▼ to select, and ✓ to store the setting. Options: None, Even, and Odd (Default: Even).

**Stop Bits** (Modbus) Press ▲ or ▼ to select, and ✓ to store the setting. Options: 1 or 2 (Default: 1).

```

--Special Functions--
▶Language      English
Analog Out     4-20mA
Backlight      High
Reset Totalizer NO
Neg. Totals    No
Rev. Flow      Off
Capture Par    No
Capture WF     No
Restore Defaults No
New Password   0000
    
```

**SPECIAL FUNCTIONS**

**Language**            Select English, French or Spanish

**Analog Out**           Select 4-20mA or 0-5V mode for the analog output.

**Backlight**            Select High, Medium or Low for continuous backlight.

Select **Key Hi/Lo** for high backlight for 1 minute after a keypress and then Lo backlight until a key is pressed again.

Select **Key High, Med or Low** for backlight for 1 minute after a keypress and then backlight off until a key is pressed again.

**Reset Totalizer**       Press ▶ and select **Yes** to erase and restart the totalizer at zero.

**Neg. Totals**           Select **Yes** to have reverse flow readings deducted from the totalizer. Select **No** to totalize forward flow only and ignore reverse flow

**Rev. Flo**              Select **On** to enable flow direction measurement. Select **Off** to disable flow direction measurement. Select **Invert** to invert the sense of the flow measurement.

**Capture Par**          This function captures the programming parameters in the meter. Select **Yes**, wait for **Insert USB** to appear, then insert a USB drive into the USB port to transfer the parameters. After Saving flashes, **Done** will appear on the screen, meaning it is safe to remove the USB.

```

--Special Functions--
▶Language      English
Analog Out     4-20mA
Backlight      High
Reset Totalizer NO
Neg. Totals    No
Rev. Flow      Off
Capture Par    No
Capture WF     No
Restore Defaults No
New Password   0000

```

### **SPECIAL FUNCTIONS (cont.)**

**Capture WF** This function should only be used when instructed by a Pulsar Measurement representative to do so. The function captures the ultrasonic signal so that it can be evaluated by Pulsar Measurement.

Select **Yes** to start the waveform download process. After pressing **Yes**, the screen will flash **Working** for approximately 20 seconds, until the message **Insert USB** appears. When **Insert USB** is on the screen, connect a flash drive to the USB port on the front of the meter. The screen will flash **Saving** for a couple seconds, and then return to **Done**. The waveform is now stored on your flash drive and ready to be sent to Pulsar Measurement.

**Restore Defaults** Select **Yes** and press **✓** to erase all user settings and return the instrument to factory default settings.

**New Password** Select any number from 0000 to 9999 and press **✓**. Default setting of 0000 will allow direct access to the calibration menus. Setting of any password greater than 0000 will require the password to be entered to access the calibration menus.

Press **✓** to return to **Menu Selections**.

```
--Simulation-----
▶Test           Actual
Flow           250USG/m
4-20mAFlow     5.60
Relays 1 2 3 4 5 6
```

### SIMULATION

Press ▼ or ▲ to position cursor at Simulation, and ► to enter. Use ▼ or ▲ to position cursor before each menu item and ► to enter. When settings are completed press ✓ to store and ✓ again to return to the Main Menu.

Changes made in the Simulation menu exercise the 4-20mA output, digital display and control relays.

Simulate a Flow /Velocity reading. Press ► and then ▼ or ▲ to change the simulated output. Press ✓ to begin simulation. The 4-20mA output and relay states will be displayed on the screen below.

Press the ✓ to terminate simulation and return to the Menu Selections screen.

## SENSOR MOUNTING LOCATION

The position of the sensor is one of the most important considerations for accurate flow measurement. The same location guidelines apply to Doppler as most other types of flow meters.

**VERTICAL OR HORIZONTAL PIPE** - Vertical pipe runs generally provide evenly distributed flow. On Horizontal pipes and liquids with high concentrations of gas or solids, the sensor should be mounted on the side (3 or 9 o'clock position) to avoid concentrations of gas at the top of the pipe, or solids at the bottom. For liquids with minimal gas bubbles (e.g. potable water) the sensor should be mounted on the top of a horizontal pipe (12 o'clock position) to obtain the best signal strength.

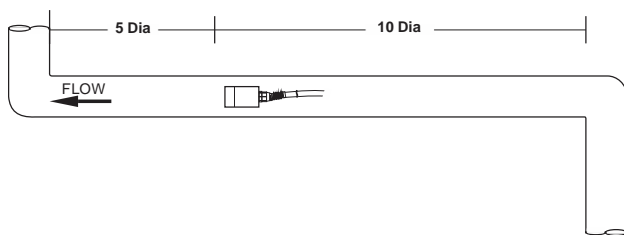
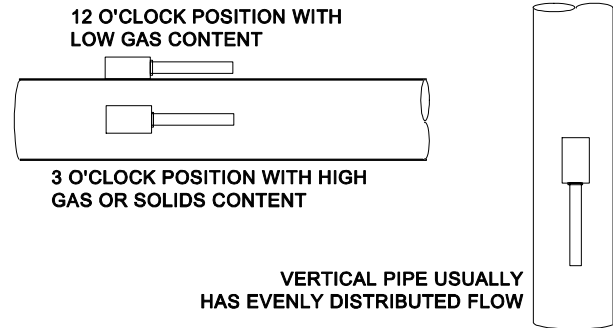

**STRAIGHT RUN REQUIREMENTS** – For best results, the transducers must be installed on a straight run of pipe, free of bends, tees, valves, transitions, insertion probes and obstructions of any kind. **For most installations, ten straight unobstructed pipe diameters upstream and five diameters downstream of the transducers is the minimum recommended distance for proper operation.** Additional considerations are outlined below.

- Do not, if possible, install the transducers downstream from a throttling valve, a mixing tank, the discharge of a positive displacement pump or any other equipment that could possibly aerate the liquid. The best location will be as free as possible from flow disturbances, vibration, sources of heat, noise, or radiated energy.
- Avoid mounting the transducers on a section of pipe with any external scale. Remove all scale, rust, loose paint, etc., from the location prior to mounting the transducers.
- Do not mount the transducers on a surface aberration (pipe seam, etc.).
- Do not mount transducers from different ultrasonic flow meters on the same pipe.
- Do not run the transducer cable in common bundles with cables from other instrumentation. You can run these cables through a common conduit **ONLY** if they originate at the same flow meter.
- Never mount transducers under water.

**IMPORTANT NOTE:** In some cases, longer straight runs may be necessary where the transducers are placed downstream from devices which cause unusual flow profile disruptions or swirl. For example: modulating valves, or two elbows in close proximity and out of plane.

### SENSOR MOUNTING

Prepare an area 2" wide by 4" long (50mm x 100mm) for sensor bonding by removing loose paint, scale and rust. The objective of site preparation is to eliminate any discontinuity between the sensor and the pipe wall, which would prevent acoustical coupling.

A PC4 Sensor Mounting Kit is supplied with each flow meter. It includes recommended coupling compound and a stainless steel mounting bracket with adjustable pipe straps.

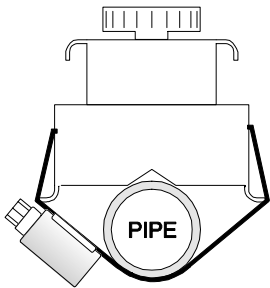

END VIEW

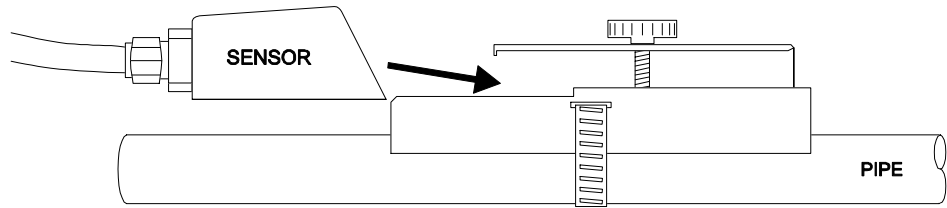

Mount the PC4 pipe clamp as illustrated on pipes 0.6" / 15 mm OD or larger. Stainless steel bands are included for mounting on pipes up to 32" / 81 cm OD.

Additional stainless steel bands (by customer) may be combined to mount on pipes up to 180" / 4.5 m OD.

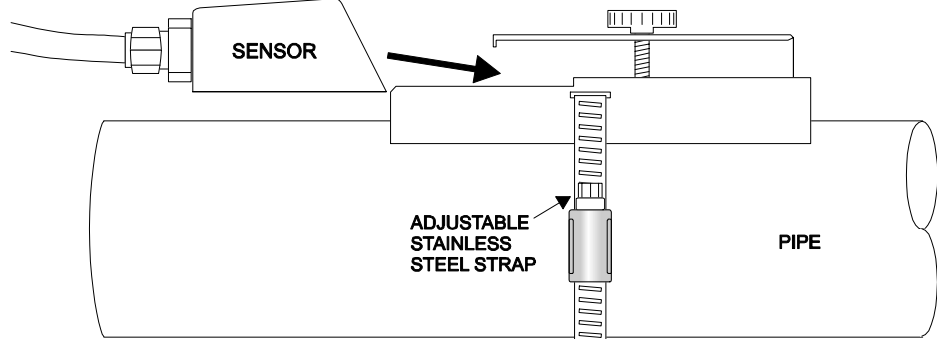
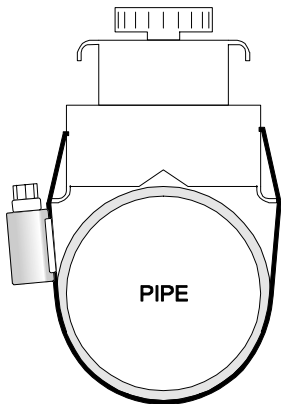



## SENSOR COUPLING

For permanent or temporary bonding, the following are recommended:

- a) Super Lube<sup>®</sup> (supplied)  
Additional supply: order Option CC-SL30 or your local home improvement store.
- b) Electrocardiograph gel
- c) Petroleum gel (Vaseline)

The above are arranged in their order of preferred application.

b & c are only good for temporary bonding at room temperature.

DO NOT USE: Silicon RTV caulking compound (silicon rubber).

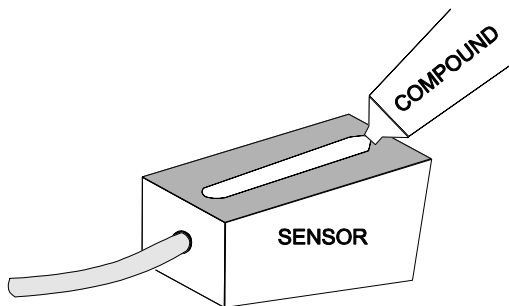

Use the PC4 pipe clamp (supplied) as illustrated on the previous page. Apply Super Lube<sup>®</sup> to the colored face of the sensor. A bead, similar to toothpaste on a toothbrush, is ideal. Do not overtighten (crush the sensor).

The sensor must be fixed securely to the pipe with coupling material between the sensor face and the pipe. Sensor installation with excessive coupling compound can result in gaps or voids in the coupling and cause errors or loss of signal. Insufficient coupling compound will create similar conditions.

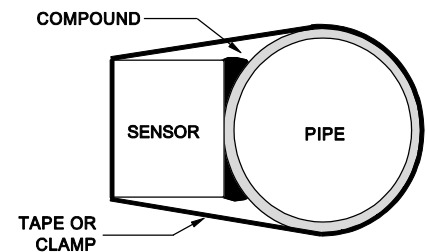

Over time temporary coupling compounds (e.g. Petroleum Gel) may gradually sag away from the sensor resulting in reduced signal strength and finally complete loss of signal. Warm temperatures, moisture and vibration will accelerate this process. Super Lube<sup>®</sup> as supplied with the DFM 6.1 (and available from Pulsar Measurement or home improvement stores) is recommended for semi-permanent installations.

**SENSOR MOUNTING/COUPLING RECOMMENDATIONS**

**BAD**

Avoid air traveling at the top of a horizontal pipe.

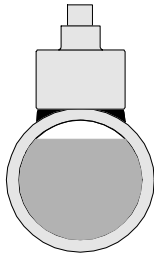

Avoid debris traveling at the bottom of a horizontal pipe.

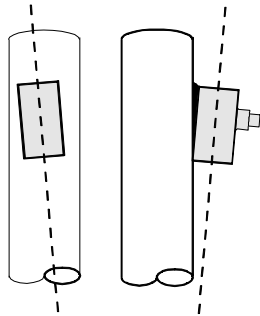
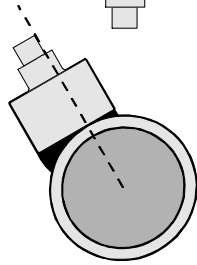
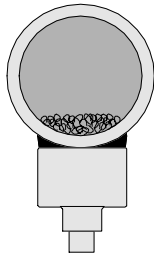

**GOOD**

Installing between 1 and 5 o'clock, and 7 and 11 o'clock on horizontal pipes is acceptable.

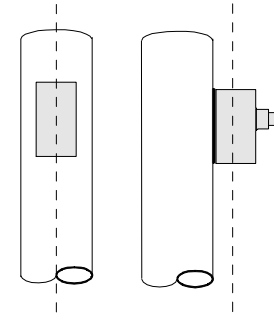
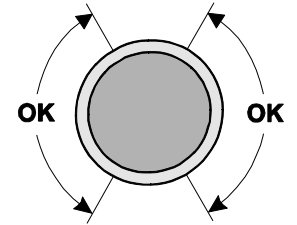
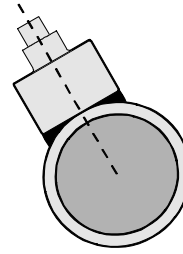
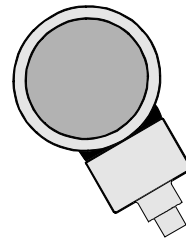
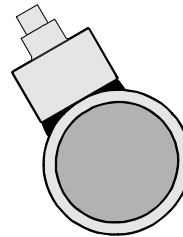

## ENCLOSURE INSTALLATION

Locate the enclosure within 20 ft (6 m) of the sensor (500 ft -150 m optional). The enclosure can be wall mounted with the four mounting screws (included) or panel mounted with Option PM Panel Mount kit from Pulsar Measurement.

Avoid mounting the enclosure in direct sunlight to protect the electronics from damage due to overheating and condensate. In high humidity atmospheres, or where temperatures fall below freezing, Option TH Enclosure Heater and Thermostat is recommended. **IMPORTANT:** Seal conduit entries to prevent moisture from entering enclosure.

### NEMA4X (IP66) WITH CLEAR COVER

1. Open hinged enclosure cover.
2. Insert #12 screws (supplied) through the four enclosure mounting holes to secure the enclosure to the wall or mounting stand.

Additional conduit holes can be cut in the bottom of the enclosure when required. Use a hole saw or Greenlee-type hole cutter to cut the required holes.

DO NOT make conduit/wiring entries into the top of the enclosure.

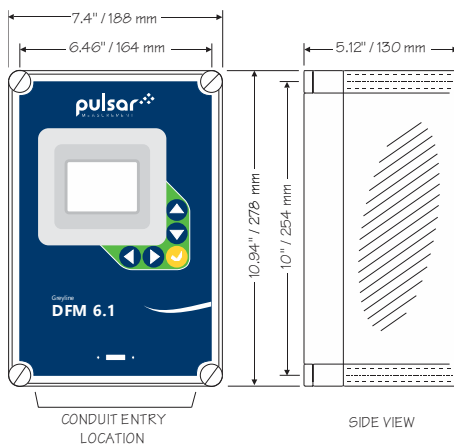
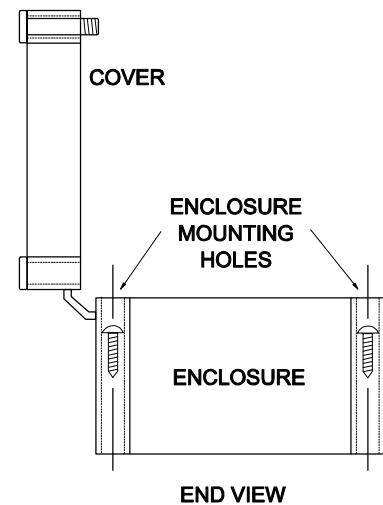

Note: This non-metallic enclosure does not automatically provide grounding between conduit connections. Grounding must be provided as part of the installation. Ground in accordance with the requirements of the National Electrical Code. System grounding is provided by connecting grounding wires from all conduit entries to the steel mounting plate or another point which provides continuity.

### CLEANING

Cleaning is not required as a part of normal maintenance.

**FIELD TROUBLESHOOTING**

<b>POSSIBLE CAUSES:</b>	<b>CORRECTIVE ACTION:</b>
<b>METER READING LOWER THAN EXPECTED</b>	
<b>Calibration Error</b>	<ul style="list-style-type: none"> <li>Review <b>UNITS/MODE</b> menu and <b>Pipe ID</b></li> </ul>
<b>Lower flow rate than expected</b>	<ul style="list-style-type: none"> <li>Investigate pump/valves. Compare velocity with alternate instrument</li> <li>Check "Cal Constant" in Special Functions menu.</li> </ul>
<b>Improper mounting of sensor</b>	<ul style="list-style-type: none"> <li>Reinstall Sensor with careful application of Coupling Compound</li> </ul>
<b>Pipe is not full</b>	<ul style="list-style-type: none"> <li>Remount Sensor on vertical pipe</li> </ul>
<b>METER READING WHEN THERE IS NO FLOW</b>	
<b>Local electrical noise</b>	<ul style="list-style-type: none"> <li>Adjust Signal Cutoff in Calibration Menu</li> <li>Ensure all Flowmeter wiring is in METAL conduit and sensor shield is properly grounded.</li> <li>Ensure correct power input Ground connection (&lt;1 ohm resistance).</li> <li>Ensure 4-20mA Shield connected to Instrument Ground stud.</li> </ul>
<b>Cross talk between two or more DFM 6.1 flowmeters on same pipe</b>	<ul style="list-style-type: none"> <li>Refer to Synchronization instructions</li> </ul>
<b>Variable Speed Drive interference</b>	<ul style="list-style-type: none"> <li>Follow Drive manufacturers wiring and Grounding instructions</li> <li>Relocate Flowmeter electronics, Sensor and wiring away from VSD</li> </ul>
<b>Sensor cable connections incorrect or loose</b>	<ul style="list-style-type: none"> <li>Refer to Connections diagram. Disconnect and reconnect sensor cables ensuring that cable is properly inserted into terminals and tightened.</li> </ul>
<b>METER READING ERRATIC</b>	
<b>Sensor mounted too close to valve, pump or elbow</b>	<ul style="list-style-type: none"> <li>Change sensor placement. Recommended 6-10 diameters from elbows, and 30 diameters from pumps, controlling valves, orifice plates, nozzles or open pipe discharge</li> </ul>

**POSSIBLE CAUSES:****CORRECTIVE ACTION:****NO FLOW INDICATION**

**Not enough suspended particles or gases in the fluid**

- Relocate sensor in more turbulent pipe section.
- Mount sensor at 12 o'clock position on horizontal pipe

**Coupling compound washed out, or sensor loose on pipe**

- Remount sensor
- Use Super Lube ®

**Power interruption. No flow.**

- Check fuse/breaker. Confirm flow

**METER READING TOO HIGH**

**Calibration error**

- Review **UNITS/MODE** menu and **Pipe ID**

**Pipe is not full**

- Remount Sensor on vertical pipe

**Nearby velocity increasing device (pump, valve, orifice plate)**

- Relocate sensor >30 pipe diameters from velocity increasing device

**Local electrical noise**

- Ensure all Flowmeter wiring is in METAL conduit and sensor cable shield is connected to Ground stud

**Variable Speed Drive interference**

- Follow Drive manufacturers wiring and Grounding instructions
- Relocate Flowmeter electronics, Sensor and wiring away from VSD

**METER READING DOES NOT TRACK FLOW**

**Sensor and GND wires reversed or not properly connected**

- Check Sensor connections

**Improper AC power input Ground**

- Use direct connection with 12 AWG wire to nearest Ground pole (<1 ohm resistance).

### **SENSOR CABLE RESISTANCE TEST**

Unplug the green sensor terminal from the Doppler board and connect the sensor wires as shown. With a multimeter, perform resistance checks for each set of wires. One single loose terminal may cause false readings.

Test across shield and core of each wire: TMTR (black/white) and RCVR (black). Resistance should be around 82.5K ohms for any cable length. High readings indicate an open circuit and low readings indicate a short or partial short in the sensor cable.

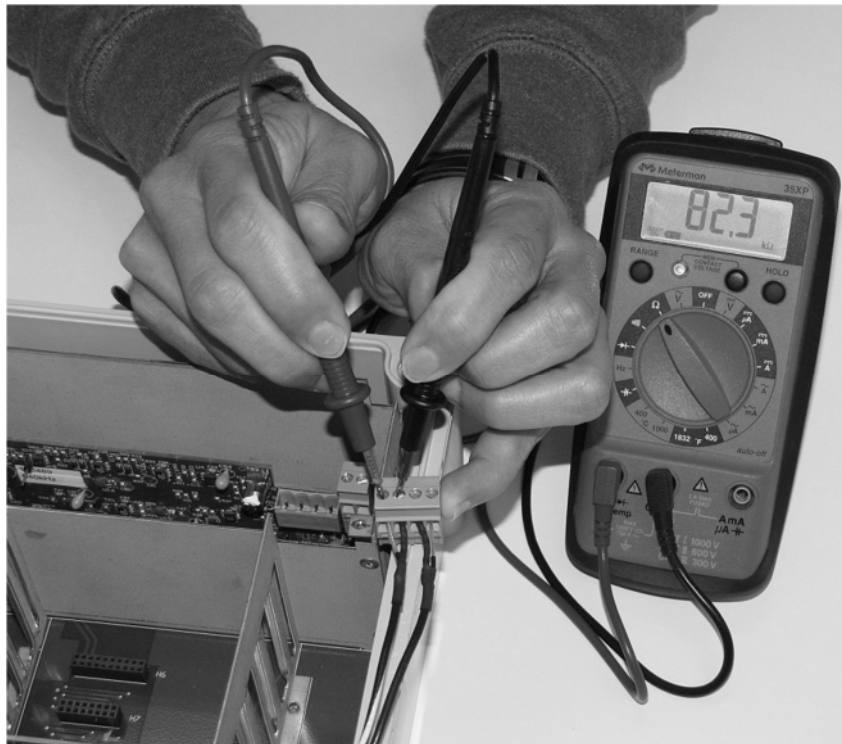

## COMMON QUESTIONS AND ANSWERS

*The pipe vibrates. Will it affect the flow meter?*

Common vibration frequencies are far lower than the sonic frequencies used by the flow meter and will not normally affect accuracy or performance. However, applications where very weak Doppler signal is present (when sensitivity is adjusted to maximum and signal strength is low), accuracy may be affected by pipe vibration, or the flow meter may show readings under no-flow conditions. Attempt to relocate the sensor on a pipe section where vibration is reduced, or arrange pipe mounting brackets to reduce vibration at the sensor mounting location.

*The flow meter must be installed in a high noise environment. Will this affect operation?*

Our flow meters are designed to discriminate between environmental noise and the Doppler signal. High noise environments may affect the flow meter's performance where low signal strength and/or low flow velocities are being measured.

*Will pipe corrosion affect accuracy of the flow meter?*

Yes. Rust, loose paint etc. must be removed from the outside of the pipe to provide a clean mounting position when installing a Doppler sensor. Severe corrosion/oxidation on the inside of the pipe may prevent the Doppler signal from penetrating into the flow. If the pipe cannot be cleaned, a spool piece (PVC recommended) should be installed for sensor mounting.

*What effect do pipe liners have on the flow meter?*

The air gap between loose insertion liners and the pipe wall prevent the Doppler signal from entering the flow. Better results can be expected with bonded liners such as cement, epoxy or tar, however an on site test is recommended to determine if the application is suitable for a Doppler flow meter.

*Why is Doppler only recommended for liquids containing suspended solids or gases?*

The Doppler sensor transmits sound into the flow stream which must be reflected back to the sensor to indicate flow velocity. Gas bubbles or suspended solids act as reflectors for the Doppler signal. As a guideline, our Doppler flow meters are recommended for liquids containing solids or bubbles with a minimum size of 100 microns and a minimum concentration of 75 ppm. Most applications (except potable, distilled or deionized water) will meet this minimum requirement.

*Can the sensor be submerged in water?*

Yes, for short periods of time or by accident, but it is not recommended for continuous operation. The sensor is constructed to withstand submersion to 10 psi without damage, but external liquid moving in contact with the sensor can be interpreted as flow and cause false readings.

*What is the purpose of the Signal Strength Display?*

Doppler signals of very low strength are not accepted or processed by the instrument. This feature assists in rejection of environmental noise and vibration. Use the display to evaluate signal strength in your application. Strong signals will increase in percentage to a maximum of 100% or greater.

*Can I change the length of the sensor cable?*

Yes. Our Doppler's design allow cable lengths up to 500 ft (152 m) with no loss of signal strength. Extended cable (Option DXC) should be installed in rigid or flexible conduit for mechanical protection. Use only our shielded coaxial pair (RG174U) cable. Cable junctions should be made through a terminal block and housed in a watertight metal junction box (Option 'JB2X'). BNC coaxial connectors (TV cable type) are not recommended for cable splices.

*Does the DFM 6.1 require periodic recalibration?*

DFM 6.1 calibration does not drift over time. The solid-state sensor has no moving parts to wear and affect calibration. The Doppler flow technique generates an ultrasonic signal proportional to the velocity of flow. All timing/counting circuits use crystal-controlled frequency references to eliminate any drift in the processing circuitry.

ISO 9000 or similar quality management systems may require periodic and verifiable recalibration of flow meters. DFM 6.1 Doppler Flow Meters may be returned to Pulsar Measurement for factory calibration and issue of a new NIST traceable certificate. Refer to the 'Product Return Procedure' section of this manual for return instructions.



**APPLICATIONS HOTLINE**

For applications assistance, advice or information on any Pulsar Measurement Instrument contact your Sales Representative, write to Pulsar Measurement or phone the Applications Hotline below:

COUNTRY	TEL	FAX	E-MAIL	ADDRESS
<b>United States</b>	315-788-9500	315-764-0419	<a href="mailto:northamerica@pulsarmeasurement.com">northamerica@pulsarmeasurement.com</a>	11451 Belcher Road South Largo, FL 33773
<b>Canada</b>	613-938-8956	613-938-4857	<a href="mailto:northamerica@pulsarmeasurement.com">northamerica@pulsarmeasurement.com</a>	16456 Sixsmith Drive Long Sault, Ont. K0C 1P0
<b>UK</b>	+44 (0) 1684 891371	+44 (0) 1684 575985	<a href="mailto:europa@pulsarmeasurement.com">europa@pulsarmeasurement.com</a>	Cardinal Building Enigma Commercial Centre Sandy's Road, Malvern WR14 1JJ
<b>Asia</b>	N/A	N/A	<a href="mailto:asiapacific@pulsarmeasurement.com">asiapacific@pulsarmeasurement.com</a>	34-1A, Jalan 10A/KU5 Taman Aman Perdana 41050 Klang, Selangor, Malaysia
<b>Oceania</b>	+61 428 692 274	N/A	<a href="mailto:oceania@pulsarmeasurement.com">oceania@pulsarmeasurement.com</a>	N/A

**PRODUCT RETURN PROCEDURE**

Instruments may be returned to Pulsar Measurement for service or warranty repair.

**1 Obtain an RMA Number from Pulsar Measurement -**

Before shipping a product to the factory please contact Pulsar Measurement by telephone, fax or email to obtain an RMA number (Returned Merchandise Authorization). This ensures fast service and correct billing or credit.

When you contact Pulsar Measurement please have the following information available:

1. Model number / Software Version
2. Serial number
3. Date of Purchase
4. Reason for return (description of fault or modification required)
5. Your name, company name, address and phone number

**2 Clean the Sensor/Product -**

***Important: unclean products will not be serviced and will be returned to the sender at their expense.***

1. Rinse sensor and cable to remove debris.
2. If sensor has been exposed to sewage, immerse both sensor and cable in a solution of 1 part household bleach (Javex, Clorox etc.) to 20 parts water for 5 minutes. Important: do not immerse open end of sensor cable.
3. Dry with paper towels and pack sensor and cable in a sealed plastic bag.
4. Wipe the outside of the enclosure to remove dirt or deposits.
5. Return to Pulsar Measurement for service.

## LIMITED WARRANTY

---

Pulsar Measurement warrants, to the original purchaser, its products to be free from defects in material and workmanship for a period of two years from date of invoice. Pulsar Measurement will replace or repair, free of charge, any Pulsar product if it has been proven to be defective within the warranty period. This warranty does not cover any expenses incurred in the removal and re-installation of the product.

If a product manufactured by Pulsar should prove defective within the first year, return it freight prepaid to Pulsar Measurement along with a copy of your invoice.

This warranty does not cover damages due to improper installation or handling, acts of nature, or unauthorized service. Modifications to or tampering with any part shall void this warranty. This warranty does not cover any equipment used in connection with the product or consequential damages due to a defect in the product.

All implied warranties are limited to the duration of this warranty. This is the complete warranty by Pulsar Measurement and no other warranty is valid against Pulsar Measurement. Some states do not allow limitations on how long an implied warranty lasts or limitation of incidental or consequential damages, so the above limitations or exclusions may not apply to you.

This warranty gives you specific legal rights, and you may also have other rights which vary from state to state.

Pulsar Measurement

**OPTIONS**

**EXTRA SENSOR CABLE  
(OPTION DXC)**

Each flow meter includes 25 ft / 7.6m (or 50 ft / 15m or 100 ft / 30m optional) continuous shielded coaxial pair cable. Additional cable and Cable Junction Box (Option JB2X) may be ordered to extend cable up to 500 ft (152m) as required during installation. No adjustment is required when the sensor cable is extended or shortened. **IMPORTANT:** Use only our shielded coaxial pair (RG174U) cable.

Extended sensor cable should be installed in conduit for mechanical protection. Recommended installation is illustrated below:

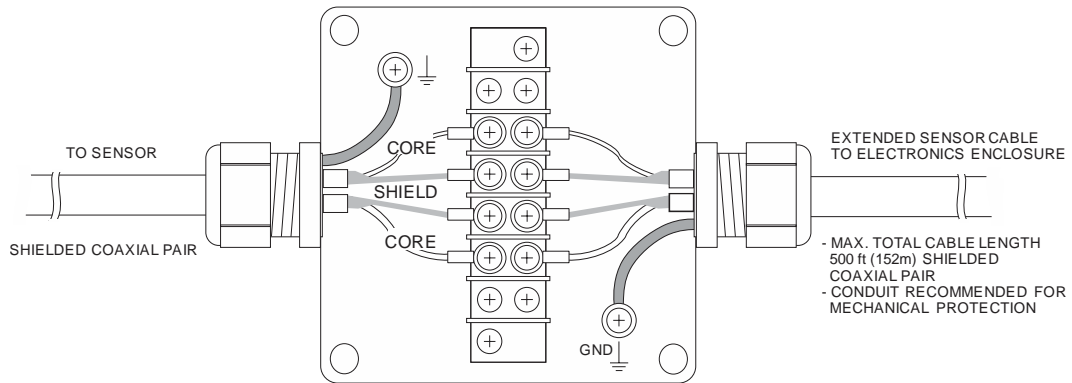

**COAXIAL CABLE PREPARATION**

DXC Doppler sensor cable can be cut and spliced up to a maximum length of 500 ft (152 m). Cable ends must be prepared as illustrated below.



**SENSOR CABLE JUNCTION BOX  
(OPTION JB2X)**

Optional Watertight steel NEMA4 Junction Boxes with terminal strips are available from Pulsar Measurement.

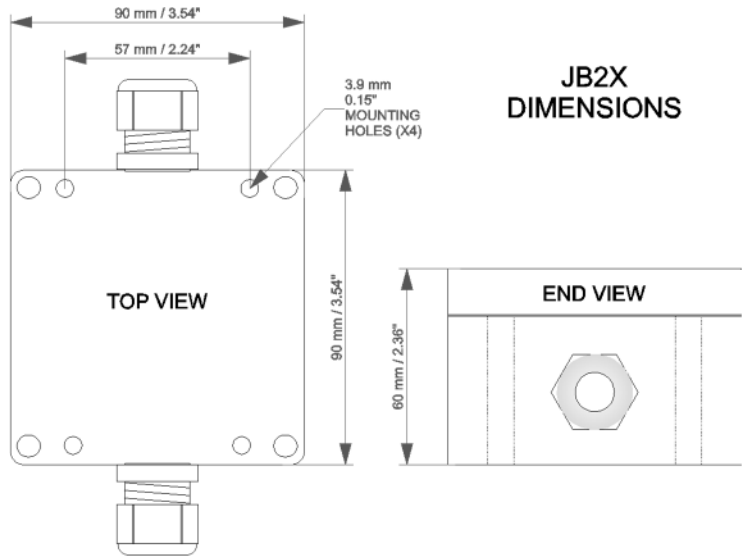

**Velocity Sensor QZ02L-B (Optional)**

- Minimum Velocity: 0.1 ft/sec (0.03 m/sec)
- Maximum Velocity: 20 ft/sec (6.2 m/sec)
- Operating Temperature: 5 to 150°F (-15 to 65°C)
- Exposed Materials: 316SS
- Sensor Cable: 25 ft. (7.6 m) submersible polyurethane jacket, shielded, 3 coaxial
- Hazardous Rating: CSA rated Intrinsically Safe Class I, Groups C,D, Class II, Groups E,F,G with optional Intrinsic Safety Barrier

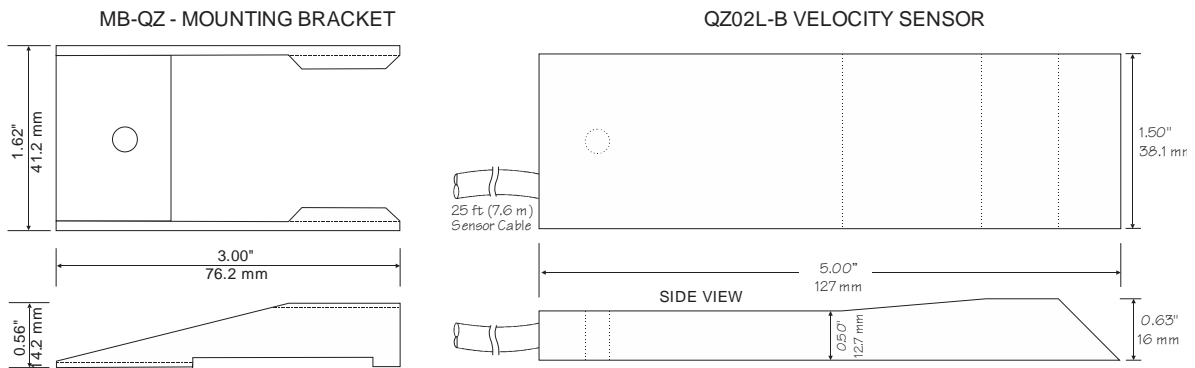

***SENSOR INTRINSIC SAFETY  
(OPTION 2ISB)***

When connected through Intrinsic Safety Barriers, the Sensor Model SE4 is CSA certified for installation in a hazardous location rated:

Class I, Groups C,D

Class II, Groups E,F,G

Class III

Intrinsic Safety Barriers may be ordered with the instrument and are supplied mounted in the electronics enclosure. Replacement barrier fuses (Part No. ISB- 011239) may be purchased separately. The instrument enclosure containing the 2ISB Intrinsic Safety Barriers must be installed in a non-hazardous location.

### GN3SPEC-ISB-09

The intrinsic safety barrier assemblies installed in the DFM 6.1/ TTFM 6.1 limit the voltage and current supplied to the transducers to the values listed under 'Barrier Specifications'. To safely install a Greyline transducer certified for use in hazardous locations you must refer to the installation drawings/specifications of the certified transducer.

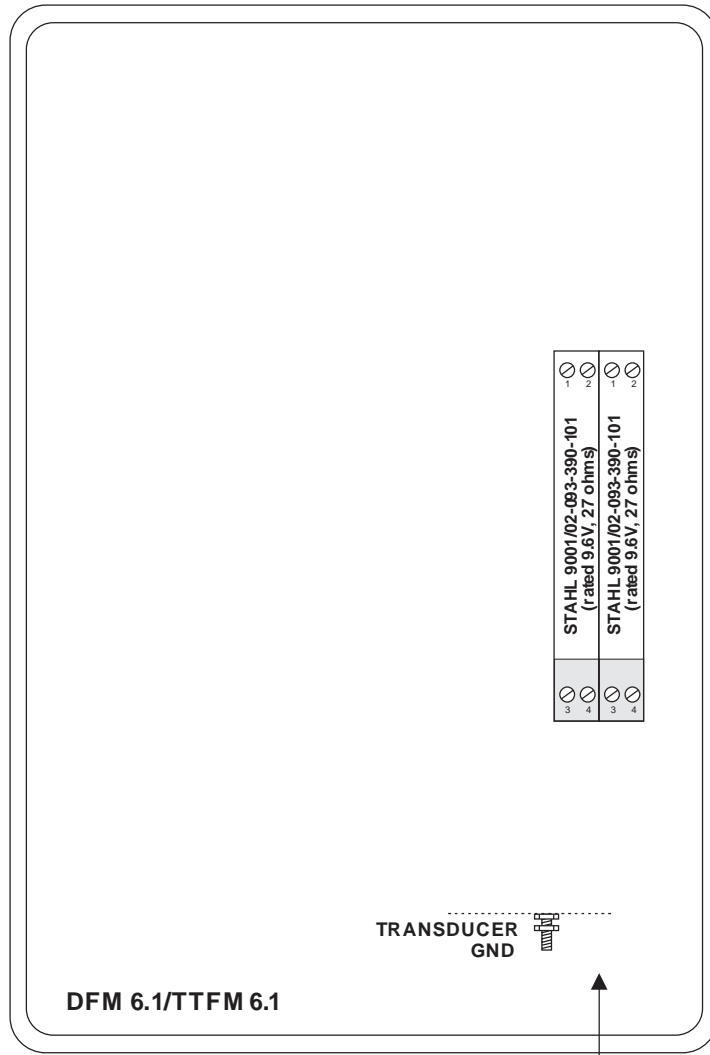

Installed in  
Non-Hazardous Location

TRANSUCER  
CONNECTIONS

#### BARRIER SPECIFICATIONS

STAHL BARRIER	System Parameters	Entity Parameters					
		$U_m$	$V_{oc}$	$I_{sc}$	$P_0$	$C_a$	$L_a$
9001/02-093-390-101	9.6V, 27 ohms	250V	9.3V	390mA	906.8mW	4.1 $\mu$ F	0.16mH

### ENCLOSURE HEATER AND THERMOSTAT - Option TH

Instruments can be factory-equipped with an Enclosure Heater and Thermostat or the module can be customer-installed. The Thermostat is factory set to turn ON at 40°F (4.5°C) and OFF at 60°F (15.5°C). Power consumption is 15 Watts.

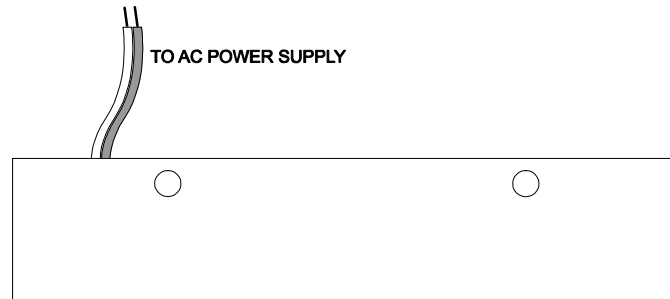

### ENCLOSURE SUNSCREEN - Option SCR

Do not mount instrument electronics in direct sunlight. Overheating will reduce the life of electronic components and condensate may form during the heat/cool cycles and cause electrical shorts.

#### Note:

Exposure to direct sunlight can cause overheating and moisture condensation which will reduce the operating life of electronics.

Protect Instruments from direct sunlight with this iridite finished aluminum sun screen (Option SCR).

Seal conduit entries with caulking compound to further reduce moisture condensation.

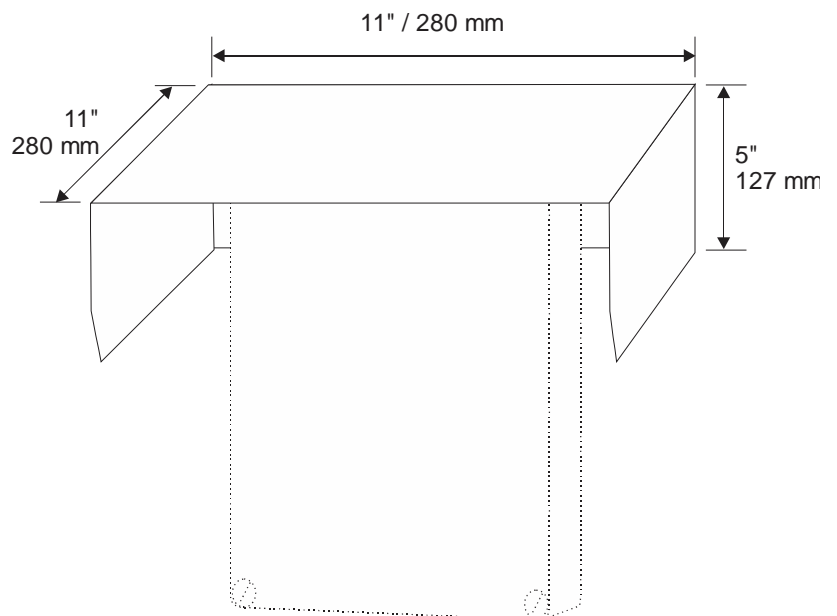

**POWER INPUT OPTION**  
**9-32VDC**

DFM 6.1 Flow Meters may be ordered factory-configured for 9-32VDC power input, or a 9-32VDC Power Input card can be installed in the place of the 100-240VAC card in the field.

**QUICK BENCH TEST:**

Connect Sensor as shown below, then Power. Test operation of the DFM 6.1 by holding the sensor in one hand and rubbing your thumb or fingers briskly across the face (plastic surface) of the sensor. Allow 15 seconds for the DFM 6.1 to process the signal and display a flow value.

**CONNECTIONS:**

**POWER INPUT:** Connect 9-32VDC to the + and - terminals. The Power Input GND terminal must be connected to the nearest Ground pole. A 1amp fuse in line is recommended.

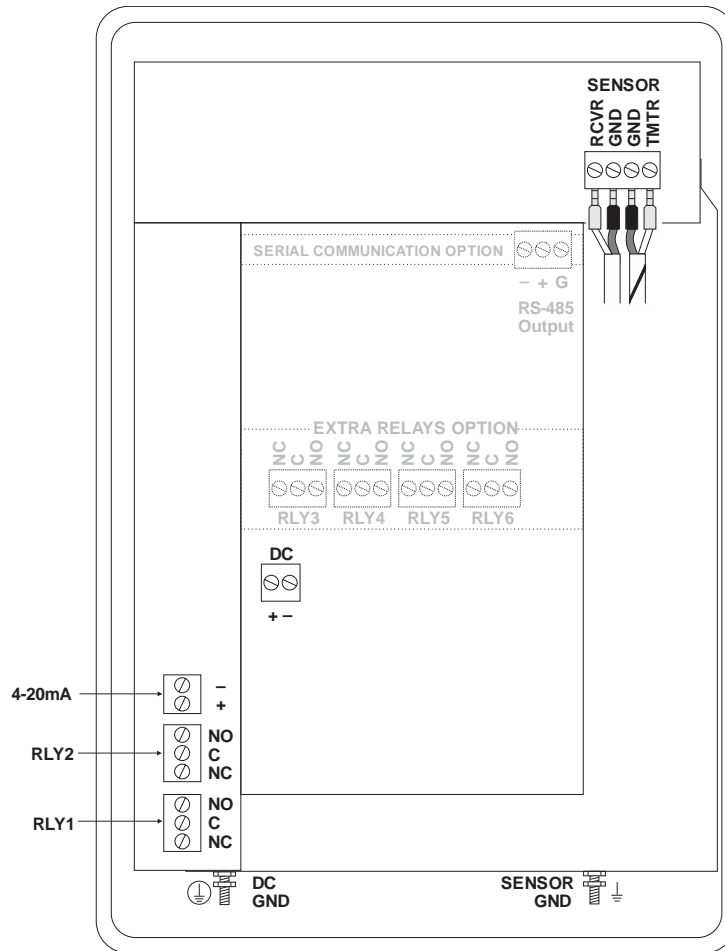



**MODBUS® COMMUNICATION**

MODBUS® serial interface connections are made at the RS485 card's terminal block if your DFM 6.1 was ordered with this card, or if one was added after installation. Card location:

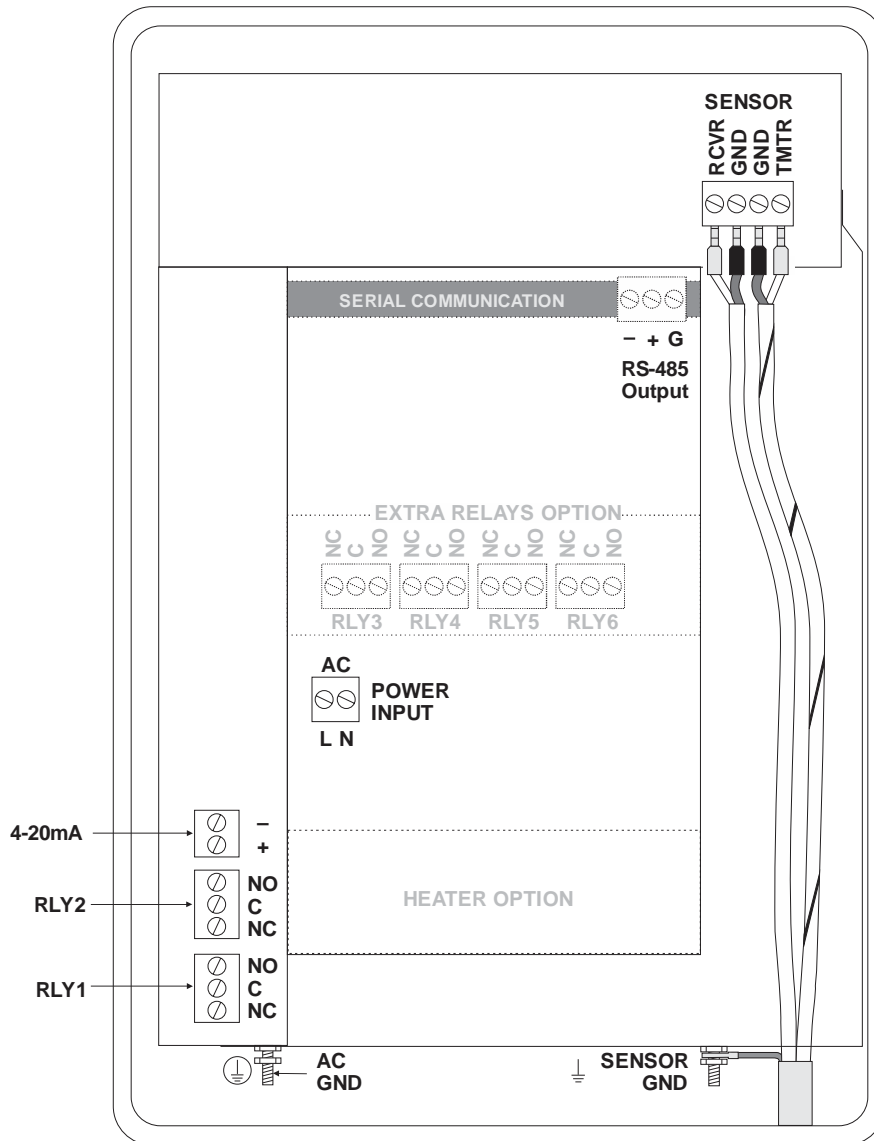

Transceiver: 2-wire, half-duplex  
 MODBUS Address (MAC address) range: 1-255 (Default: 001)  
 BAUD rates: 4800, 9600, 19200, 38400, 57600, 76800 or 115200 (Default: 9600)  
 Data Bits: 8  
 Parity: None, Even, Odd (Default: Even)  
 Stop Bits: 1, 2 (Default: 1)  
 Termination: 120 Ohms or none (Default: None)  
 Jumper JP1 position 1 & 2 = OFF (No term)  
 Jumper JP1 position 2 & 3 = ON (Term)  
 Biasing: None  
 Flow Control: None

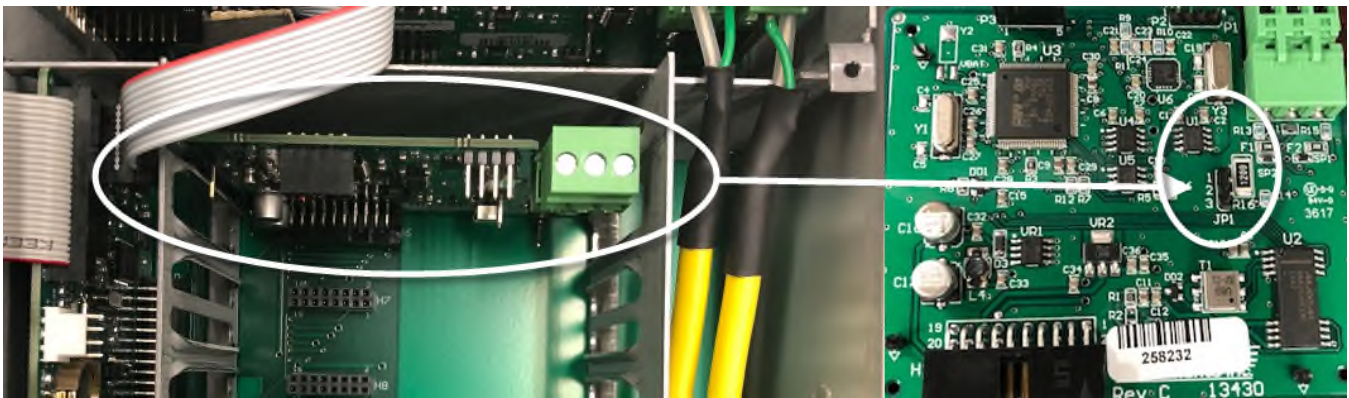

Termination Jumper Position

Function Codes Supported:
01 – Read Coil(s)
02 – Read Discreet Input(s)
04 – Read Input Register(s)
05 – Write Single Coil
06 – Write Single Register
15 – Write Multiple Coils
16 – Write Multiple Registers
17 – Report Slave ID

**MODBUS® MEMORY MAP**

Register Address	Description	Register Type	Data Range	Over Range	Read/ Write	Comments
1	Reset Volume Total	Coil	NA	NA	Read/ Write	Turn coil ON (1) to reset total on DFM 6.1. Turn coil to OFF (0) once reset is complete.

Register Address	Description	Register Type	Data Range	Over Range	Read/ Write	Comments
10001	Pulse Output 1 Status	Discreet Input	NA	NA	Read	(0) indicates pulse output is OFF or inactive. (1) indicates pulse output is ON or active.
10002	Pulse Output 2 Status	Discreet Input	NA	NA	Read	(0) indicates pulse output is OFF or inactive. (1) indicates pulse output is ON or active.

Register Address	Description	Register Type	Format Type	Comments
30001	Flow Velocity - ft/s	Input Register	Floating Point Register (1 of 2)	
30002	Flow Velocity - ft/s	Input Register	Floating Point Register (2 of 2)	
30003	Flow Velocity - m/s	Input Register	Floating Point Register (1 of 2)	
30004	Flow Velocity - m/s	Input Register	Floating Point Register (2 of 2)	
30101	Flow Rate - GPM (USG/min)	Input Register	Floating Point Register (1 of 2)	
30102	Flow Rate - GPM (USG/min)	Input Register	Floating Point Register (2 of 2)	
30103	Flow Rate - L/sec	Input Register	Floating Point Register (1 of 2)	
30104	Flow Rate - L/ssec	Input Register	Floating Point Register (2 of 2)	
30105	Flow Rate - ft <sup>3</sup> /min	Input Register	Floating Point Register (1 of 2)	
30106	Flow Rate - ft <sup>3</sup> /min	Input Register	Floating Point Register (2 of 2)	
30107	Flow Rate - m <sup>3</sup> /hr	Input Register	Floating Point Register (1 of 2)	
30108	Flow Rate - m <sup>3</sup> /hr	Input Register	Floating Point Register (2 of 2)	
30109	Flow Rate - USG/sec	Input Register	Floating Point Register (1 of 2)	
30110	Flow Rate - USG/sec	Input Register	Floating Point Register (2 of 2)	
30111	Flow Rate - USG/hr	Input Register	Floating Point Register (1 of 2)	
30112	Flow Rate - USG/hr	Input Register	Floating Point Register (2 of 2)	
30113	Flow Rate - USG/day	Input Register	Floating Point Register (1 of 2)	

Register Address	Description	Register Type	Format Type	Comments
30114	Flow Rate - USG/day	Input Register	Floating Point Register (2 of 2)	
30115	Flow Rate - ft <sup>3</sup> /s	Input Register	Floating Point Register (1 of 2)	
30116	Flow Rate - ft <sup>3</sup> /s	Input Register	Floating Point Register (2 of 2)	
30117	Flow Rate - ft <sup>3</sup> /hr	Input Register	Floating Point Register (1 of 2)	
30118	Flow Rate - ft <sup>3</sup> /hr	Input Register	Floating Point Register (2 of 2)	
30119	Flow Rate - ft <sup>3</sup> /day	Input Register	Floating Point Register (1 of 2)	
30120	Flow Rate - ft <sup>3</sup> /day	Input Register	Floating Point Register (2 of 2)	
30121	Flow Rate - USMG/sec	Input Register	Floating Point Register (1 of 2)	USMG = US Million Gallons
30122	Flow Rate - USMG/sec	Input Register	Floating Point Register (2 of 2)	USMG = US Million Gallons
30123	Flow Rate - USMG/min	Input Register	Floating Point Register (1 of 2)	USMG = US Million Gallons
30124	Flow Rate - USMG/min	Input Register	Floating Point Register (2 of 2)	USMG = US Million Gallons
30125	Flow Rate - USMG/hr	Input Register	Floating Point Register (1 of 2)	USMG = US Million Gallons
30126	Flow Rate - USMG/hr	Input Register	Floating Point Register (2 of 2)	USMG = US Million Gallons
30127	Flow Rate - USMG/day	Input Register	Floating Point Register (1 of 2)	USMG = US Million Gallons
30128	Flow Rate - USMG/day	Input Register	Floating Point Register (2 of 2)	USMG = US Million Gallons
30129	Flow Rate - L/min	Input Register	Floating Point Register (1 of 2)	
30130	Flow Rate - L/min	Input Register	Floating Point Register (2 of 2)	
30131	Flow Rate - L/hr	Input Register	Floating Point Register (1 of 2)	
30132	Flow Rate - L/hr	Input Register	Floating Point Register (2 of 2)	
30133	Flow Rate - L/day	Input Register	Floating Point Register (1 of 2)	
30134	Flow Rate - L/day	Input Register	Floating Point Register (2 of 2)	
30135	Flow Rate - m <sup>3</sup> /sec	Input Register	Floating Point Register (1 of 2)	
30136	Flow Rate - m <sup>3</sup> /sec	Input Register	Floating Point Register (2 of 2)	
30137	Flow Rate - m <sup>3</sup> /min	Input Register	Floating Point Register (1 of 2)	
30138	Flow Rate - m <sup>3</sup> /min	Input Register	Floating Point Register (2 of 2)	
30139	Flow Rate - m <sup>3</sup> /day	Input Register	Floating Point Register (1 of 2)	

Register Address	Description	Register Type	Format Type	Comments
30140	Flow Rate - m <sup>3</sup> /day	Input Register	Floating Point Register (2 of 2)	
30141	Flow Rate - IG/sec	Input Register	Floating Point Register (1 of 2)	IG = Imperial Gallons
30142	Flow Rate - IG/sec	Input Register	Floating Point Register (2 of 2)	IG = Imperial Gallons
30143	Flow Rate - IG/min	Input Register	Floating Point Register (1 of 2)	IG = Imperial Gallons
30144	Flow Rate - IG/min	Input Register	Floating Point Register (2 of 2)	IG = Imperial Gallons
30145	Flow Rate - IG/hr	Input Register	Floating Point Register (1 of 2)	IG = Imperial Gallons
30146	Flow Rate - IG/hr	Input Register	Floating Point Register (2 of 2)	IG = Imperial Gallons
30147	Flow Rate - IG/day	Input Register	Floating Point Register (1 of 2)	IG = Imperial Gallons
30148	Flow Rate - IG/day	Input Register	Floating Point Register (2 of 2)	IG = Imperial Gallons
30149	Flow Rate - IMG/sec	Input Register	Floating Point Register (1 of 2)	IMG = Imperial Million Gallons
30150	Flow Rate - IMG/sec	Input Register	Floating Point Register (2 of 2)	IMG = Imperial Million Gallons
30151	Flow Rate - IMG/min	Input Register	Floating Point Register (1 of 2)	IMG = Imperial Million Gallons
30152	Flow Rate - IMG/min	Input Register	Floating Point Register (2 of 2)	IMG = Imperial Million Gallons
30153	Flow Rate - IMG/hr	Input Register	Floating Point Register (1 of 2)	IMG = Imperial Million Gallons
30154	Flow Rate - IMG/hr	Input Register	Floating Point Register (2 of 2)	IMG = Imperial Million Gallons
30155	Flow Rate - IMG/day	Input Register	Floating Point Register (1 of 2)	IMG = Imperial Million Gallons
30156	Flow Rate - IMG/day	Input Register	Floating Point Register (2 of 2)	IMG = Imperial Million Gallons
30157	Flow Rate - bbl/sec	Input Register	Floating Point Register (1 of 2)	bbl = US Oil Barrel = 42 Gallons
30158	Flow Rate - bbl/sec	Input Register	Floating Point Register (2 of 2)	bbl = US Oil Barrel = 42 Gallons
30159	Flow Rate - bbl/min	Input Register	Floating Point Register (1 of 2)	bbl = US Oil Barrel = 42 Gallons
30160	Flow Rate - bbl/min	Input Register	Floating Point Register (2 of 2)	bbl = US Oil Barrel = 42 Gallons
30161	Flow Rate - bbl/hr	Input Register	Floating Point Register (1 of 2)	bbl = US Oil Barrel = 42 Gallons
30162	Flow Rate - bbl/hr	Input Register	Floating Point Register (2 of 2)	bbl = US Oil Barrel = 42 Gallons
30163	Flow Rate - bbl/day	Input Register	Floating Point Register (1 of 2)	bbl = US Oil Barrel = 42 Gallons

Register Address	Description	Register Type	Format Type	Comments
30164	Flow Rate - bbl/day	Input Register	Floating Point Register (2 of 2)	bbl = US Oil Barrel = 42 Gallons
30165	Previous day Average Flow Rate - GPM (USG/min)	Input Register	Floating Point Register (1 of 2)	
30166	Previous day Average Flow Rate - GPM (USG/min)	Input Register	Floating Point Register (2 of 2)	
30167	Previous day Average Flow Rate - L/sec	Input Register	Floating Point Register (1 of 2)	
30168	Previous day Average Flow Rate - L/ssec	Input Register	Floating Point Register (2 of 2)	
30169	Previous day Average Flow Rate - ft3/min	Input Register	Floating Point Register (1 of 2)	
30170	Previous day Average Flow Rate - ft3/min	Input Register	Floating Point Register (2 of 2)	
30171	Previous day Average Flow Rate - m3/hr	Input Register	Floating Point Register (1 of 2)	
30172	Previous day Average Flow Rate - m3/hr	Input Register	Floating Point Register (2 of 2)	
30173	Previous day Average Flow Rate - USG/sec	Input Register	Floating Point Register (1 of 2)	
30174	Previous day Average Flow Rate - USG/sec	Input Register	Floating Point Register (2 of 2)	
30175	Previous day Average Flow Rate - USG/hr	Input Register	Floating Point Register (1 of 2)	
30176	Previous day Average Flow Rate - USG/hr	Input Register	Floating Point Register (2 of 2)	
30177	Previous day Average Flow Rate - USG/day	Input Register	Floating Point Register (1 of 2)	
30178	Previous day Average Flow Rate - USG/day	Input Register	Floating Point Register (2 of 2)	
30179	Previous day Average Flow Rate - ft3/s	Input Register	Floating Point Register (1 of 2)	
30180	Previous day Average Flow Rate - ft3/s	Input Register	Floating Point Register (2 of 2)	
30181	Previous day Average Flow Rate - ft3/hr	Input Register	Floating Point Register (1 of 2)	
30182	Previous day Average Flow Rate - ft3/hr	Input Register	Floating Point Register (2 of 2)	
30183	Previous day Average Flow Rate - ft3/day	Input Register	Floating Point Register (1 of 2)	
30184	Previous day Average Flow Rate - ft3/day	Input Register	Floating Point Register (2 of 2)	
30185	Previous day Average Flow Rate - USMG/sec	Input Register	Floating Point Register (1 of 2)	USMG = US Million Gallons
30186	Previous day Average Flow Rate - USMG/sec	Input Register	Floating Point Register (2 of 2)	USMG = US Million Gallons

Register Address	Description	Register Type	Format Type	Comments
30187	Previous day Average Flow Rate - USMG/min	Input Register	Floating Point Register (1 of 2)	USMG = US Million Gallons
30188	Previous day Average Flow Rate - USMG/min	Input Register	Floating Point Register (2 of 2)	USMG = US Million Gallons
30189	Previous day Average Flow Rate - USMG/hr	Input Register	Floating Point Register (1 of 2)	USMG = US Million Gallons
30190	Previous day Average Flow Rate - USMG/hr	Input Register	Floating Point Register (2 of 2)	USMG = US Million Gallons
30191	Previous day Average Flow Rate - USMG/day	Input Register	Floating Point Register (1 of 2)	USMG = US Million Gallons
30192	Previous day Average Flow Rate - USMG/day	Input Register	Floating Point Register (2 of 2)	USMG = US Million Gallons
30193	Previous day Average Flow Rate - L/min	Input Register	Floating Point Register (1 of 2)	
30194	Previous day Average Flow Rate - L/min	Input Register	Floating Point Register (2 of 2)	
30195	Previous day Average Flow Rate - L/hr	Input Register	Floating Point Register (1 of 2)	
30196	Previous day Average Flow Rate - L/hr	Input Register	Floating Point Register (2 of 2)	
30197	Previous day Average Flow Rate - L/day	Input Register	Floating Point Register (1 of 2)	
30198	Previous day Average Flow Rate - L/day	Input Register	Floating Point Register (2 of 2)	
30199	Previous day Average Flow Rate - m3/sec	Input Register	Floating Point Register (1 of 2)	
30200	Previous day Average Flow Rate - m3/sec	Input Register	Floating Point Register (2 of 2)	
30201	Previous day Average Flow Rate - m3/min	Input Register	Floating Point Register (1 of 2)	
30202	Previous day Average Flow Rate - m3/min	Input Register	Floating Point Register (2 of 2)	
30203	Previous day Average Flow Rate - m3/day	Input Register	Floating Point Register (1 of 2)	
30204	Previous day Average Flow Rate - m3/day	Input Register	Floating Point Register (2 of 2)	
30205	Previous day Average Flow Rate - IG/sec	Input Register	Floating Point Register (1 of 2)	IG = Imperial Gallons
30206	Previous day Average Flow Rate - IG/sec	Input Register	Floating Point Register (2 of 2)	IG = Imperial Gallons
30207	Previous day Average Flow Rate - IG/min	Input Register	Floating Point Register (1 of 2)	IG = Imperial Gallons
30208	Previous day Average Flow Rate - IG/min	Input Register	Floating Point Register (2 of 2)	IG = Imperial Gallons
30209	Previous day Average Flow Rate - IG/hr	Input Register	Floating Point Register (1 of 2)	IG = Imperial Gallons
30210	Previous day Average Flow Rate - IG/hr	Input Register	Floating Point Register (2 of 2)	IG = Imperial Gallons

Register Address	Description	Register Type	Format Type	Comments
30211	Previous day Average Flow Rate - IG/day	Input Register	Floating Point Register (1 of 2)	IG = Imperial Gallons
30212	Previous day Average Flow Rate - IG/day	Input Register	Floating Point Register (2 of 2)	IG = Imperial Gallons
30213	Previous day Average Flow Rate - IMG/sec	Input Register	Floating Point Register (1 of 2)	IMG = Imperial Million Gallons
30214	Previous day Average Flow Rate - IMG/sec	Input Register	Floating Point Register (2 of 2)	IMG = Imperial Million Gallons
30215	Previous day Average Flow Rate - IMG/min	Input Register	Floating Point Register (1 of 2)	IMG = Imperial Million Gallons
30216	Previous day Average Flow Rate - IMG/min	Input Register	Floating Point Register (2 of 2)	IMG = Imperial Million Gallons
30217	Previous day Average Flow Rate - IMG/hr	Input Register	Floating Point Register (1 of 2)	IMG = Imperial Million Gallons
30218	Previous day Average Flow Rate - IMG/hr	Input Register	Floating Point Register (2 of 2)	IMG = Imperial Million Gallons
30219	Previous day Average Flow Rate - IMG/day	Input Register	Floating Point Register (1 of 2)	IMG = Imperial Million Gallons
30220	Previous day Average Flow Rate - IMG/day	Input Register	Floating Point Register (2 of 2)	IMG = Imperial Million Gallons
30221	Previous day Average Flow Rate - bbl/sec	Input Register	Floating Point Register (1 of 2)	bbl = US Oil Barrel = 42 Gallons
30222	Previous day Average Flow Rate - bbl/sec	Input Register	Floating Point Register (2 of 2)	bbl = US Oil Barrel = 42 Gallons
30223	Previous day Average Flow Rate - bbl/min	Input Register	Floating Point Register (1 of 2)	bbl = US Oil Barrel = 42 Gallons
30224	Previous day Average Flow Rate - bbl/min	Input Register	Floating Point Register (2 of 2)	bbl = US Oil Barrel = 42 Gallons
30225	Previous day Average Flow Rate - bbl/hr	Input Register	Floating Point Register (1 of 2)	bbl = US Oil Barrel = 42 Gallons
30226	Previous day Average Flow Rate - bbl/hr	Input Register	Floating Point Register (2 of 2)	bbl = US Oil Barrel = 42 Gallons
30227	Previous day Average Flow Rate - bbl/day	Input Register	Floating Point Register (1 of 2)	bbl = US Oil Barrel = 42 Gallons
30228	Previous day Average Flow Rate - bbl/day	Input Register	Floating Point Register (2 of 2)	bbl = US Oil Barrel = 42 Gallons
30301	Volume Total - Gallons	Input Register	Floating Point Register (1 of 2)	
30302	Volume Total - Gallons	Input Register	Floating Point Register (2 of 2)	
30303	Volume Total - Liters	Input Register	Floating Point Register (1 of 2)	
30304	Volume Total - Liters	Input Register	Floating Point Register (2 of 2)	
30305	Volume Total - ft <sup>3</sup>	Input Register	Floating Point Register (1 of 2)	
30306	Volume Total - ft <sup>3</sup>	Input Register	Floating Point Register (2 of 2)	
30307	Volume Total - m <sup>3</sup>	Input Register	Floating Point Register (1 of 2)	



Register Address	Description	Register Type	Format Type	Comments
30308	Volume Total - m <sup>3</sup>	Input Register	Floating Point Register (2 of 2)	
30309	Volume Total - USMG	Input Register	Floating Point Register (1 of 2)	USMG = US Million Gallons
30310	Volume Total - USMG	Input Register	Floating Point Register (2 of 2)	USMG = US Million Gallons
30311	Volume Total - IG	Input Register	Floating Point Register (1 of 2)	IG = Imperial Gallons
30312	Volume Total - IG	Input Register	Floating Point Register (2 of 2)	IG = Imperial Gallons
30313	Volume Total - IMG	Input Register	Floating Point Register (1 of 2)	IMG = Imperial Million Gallons
30314	Volume Total - IMG	Input Register	Floating Point Register (2 of 2)	IMG = Imperial Million Gallons
30315	Volume Total - bbl	Input Register	Floating Point Register (1 of 2)	bbl = US Oil Barrel = 42 Gallons
30316	Volume Total - bbl	Input Register	Floating Point Register (2 of 2)	bbl = US Oil Barrel = 42 Gallons
30317	Previous day Volume Total - Gallons	Input Register	Floating Point Register (1 of 2)	
30318	Previous day Volume Total - Gallons	Input Register	Floating Point Register (2 of 2)	
30319	Previous day Volume Total - Liters	Input Register	Floating Point Register (1 of 2)	
30320	Previous day Volume Total - Liters	Input Register	Floating Point Register (2 of 2)	
30321	Previous day Volume Total - ft <sup>3</sup>	Input Register	Floating Point Register (1 of 2)	
30322	Previous day Volume Total - ft <sup>3</sup>	Input Register	Floating Point Register (2 of 2)	
30323	Previous day Volume Total - m <sup>3</sup>	Input Register	Floating Point Register (1 of 2)	
30324	Previous day Volume Total - m <sup>3</sup>	Input Register	Floating Point Register (2 of 2)	
30325	Previous day Volume Total - USMG	Input Register	Floating Point Register (1 of 2)	USMG = US Million Gallons
30326	Previous day Volume Total - USMG	Input Register	Floating Point Register (2 of 2)	USMG = US Million Gallons
30327	Previous day Volume Total - IG	Input Register	Floating Point Register (1 of 2)	IG = Imperial Gallons
30328	Previous day Volume Total - IG	Input Register	Floating Point Register (2 of 2)	IG = Imperial Gallons
30329	Previous day Volume Total - IMG	Input Register	Floating Point Register (1 of 2)	IMG = Imperial Million Gallons
30330	Previous day Volume Total - IMG	Input Register	Floating Point Register (2 of 2)	IMG = Imperial Million Gallons
30331	Previous day Volume Total - bbl	Input Register	Floating Point Register (1 of 2)	bbl = US Oil Barrel = 42 Gallons

Register Address	Description	Register Type	Format Type	Comments
30332	Previous day Volume Total - bbl	Input Register	Floating Point Register (2 of 2)	bbl = US Oil Barrel = 42 Gallons
30901	Signal Strength - %	Input Register	Integer	0-100
30904	Run Hours	Input Register	Floating Point Register (1 of 2)	
30905	Run Hours	Input Register	Floating Point Register (2 of 2)	
30923	Sensor Status	Input Register	Index (0-10)	0 = Sensor Good 4 = Sensor Open 5 = Sensor Short 7 = Low Signal
30925	Logging Status	Input Register	Index (0-2)	0 = Stopped 1 = Active 2 = Full
30926	Logging Used - %	Input Register	Floating Point Register (1 of 2)	
30927	Logging Used - %	Input Register	Floating Point Register (2 of 2)	
30962	Confidence	Input Register	Integer	
30963	Direction	Input Register	Integer	
30964	Pot 1	Input Register	Integer	
30965	Peak to Peak	Input Register	Integer	
30966	Correlation Strength	Input Register	Integer	

30947	Velocity Units	Input Register	Index (0 to 1)	0 = Feet per Second 1 = Meter per Second
30948	Flow Units	Input Register	Index (0 to 31)	0 = US Gallons per Minute 1 = Litres per Second 2 = Cubic Feet per Minute 3 = Cubic Meters per Hour 4 = US Gallons per Second 5 = US Gallons per Hour 6 = US Gallons per Day 7 = Cubic Feet per Second 8 = Cubic Feet per Hour 9 = Cubic Feet per Day 10 = US Million Gallons per Second 11 = US Million Gallons per Minute 12 = US Million Gallons per Hour 13 = US Million Gallons per Day 14 = Litres per Minute 15 = Litres per Hour 16 = Litres per Day 17 = Cubic Meters per Second 18 = Cubic Meters per Minute 19 = Cubic Meters per Day 20 = Imperial Gallons per Second 21 = Imperial Gallons per Minute 22 = Imperial Gallons per Hour 23 = Imperial Gallons per Day 24 = Imperial Million Gallons per Second 25 = Imperial Million Gallons per Minute 26 = Imperial Million Gallons per Hour 27 = Imperial Million Gallons per Day 28 = Barrels per Second 29 = Barrels per Minute 30 = Barrels per Hour 31 = Barrels per Day
30949	Linear Units	Input Register	Index (0 to 3)	0 = Feet 1 = Inches 2 = Millimeters 3 = Meters
30950	Volume Units	Input Register	Index (0 to 7)	0 = Cubic Feet 1 = US Gallons 2 = US Million Gallons 3 = Imperial Gallons 4 = Imperial Million Gallons 5 = Cubic Meters 6 = Litre 7 = Barrel
30951	Time Units	Input Register	Index (0 to 3)	0 = Second 1 = Minute 2 = Hour 3 = Day

**HART® COMMUNICATION**

HART® (Highway Addressable Remote Transducer) connections are made on the 4-20mA output of the DFM 6.1. The DFM 6.1 must be equipped with the optional serial communication card for the Communication menu to appear, and for the HART option to be able to be selected in the Communication menu. 4-20mA output location:

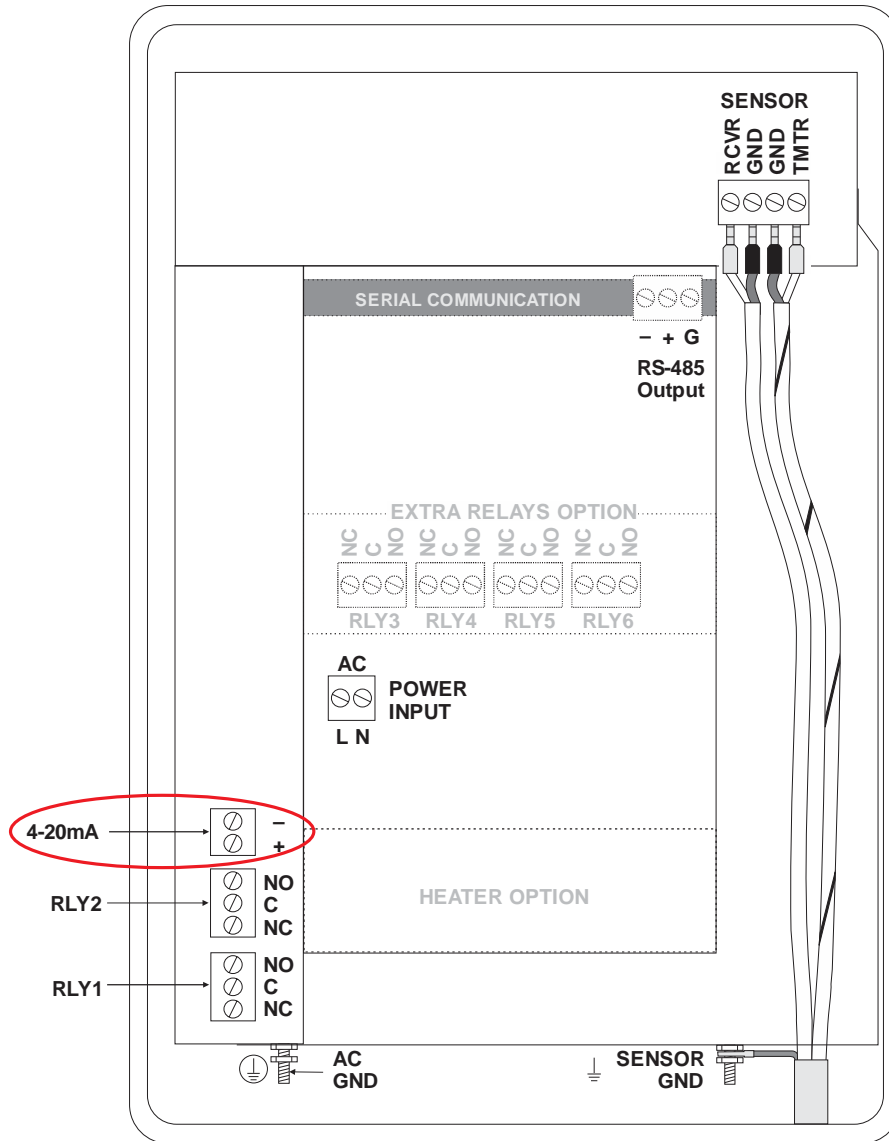

## HART® (Highway Addressable Remote Transducer) Protocol Information:

HART Version: 7.0

Device Description Files: DD files allow the user's handheld HART communicator to fully configure the DFM 6.1. Pulsar Measurement provides DD files for the Emerson 475 Communicator. The files are included in the USB drive provided with your DFM 6.1 meter. You may also request the files from Pulsar Measurement by calling or emailing us at [info@pulsarmeasurement.com](mailto:info@pulsarmeasurement.com). **Warning:** The DFM 6.1 and associated DDs are pending certification from the Fieldcomm Group.

Connections: HART Protocol uses a digital signal superimposed on the 4-20mA output. When the 4-20mA output of the DFM 6.1 is connected with a load resistor (230Ω to 600Ω), the HART communicator can be connected on the loop in order to communicate.

### Loading the DD Files to the 475 Field Communicator

1. Install Emerson Field Communicator Easy Upgrade Utility from Emerson website
  - a. <http://www3.emersonprocess.com/ams/fieldcommunicatorsupport/>
2. Run Field Communicator Easy Upgrade utility.
3. Locate the DD Files from the Pulsar Measurement USB drive included with the DFM 6.1.
  - a. *6109E3FD0101.hdd*
4. Make sure your PC software is up to date by clicking *Update PC*.

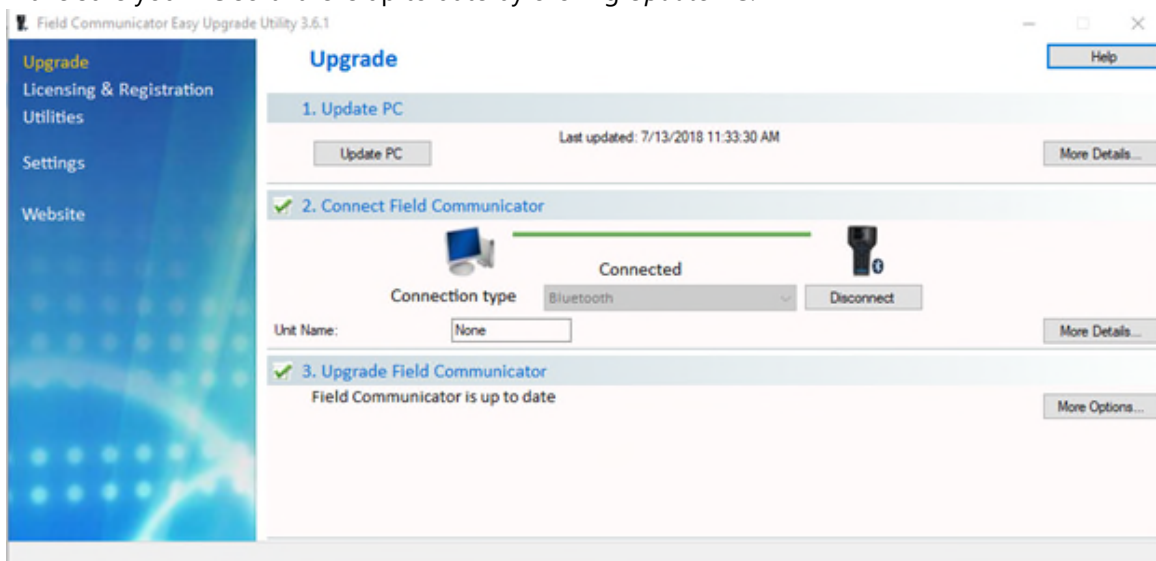

5. Click on *Utilities* from the left menu pane.
6. Click on *Import DDs from a local source*.

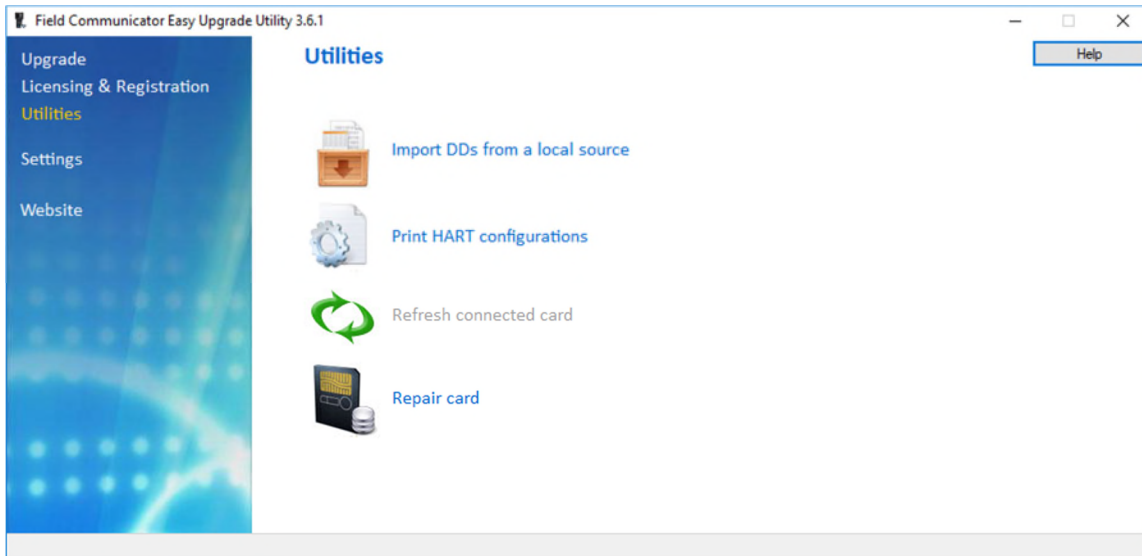

7. A popup window is displayed as shown below. Navigate to the directory containing the DD files using the *Browse* button. Select the desired DD files that shows up for your HART device. Click *OK*.

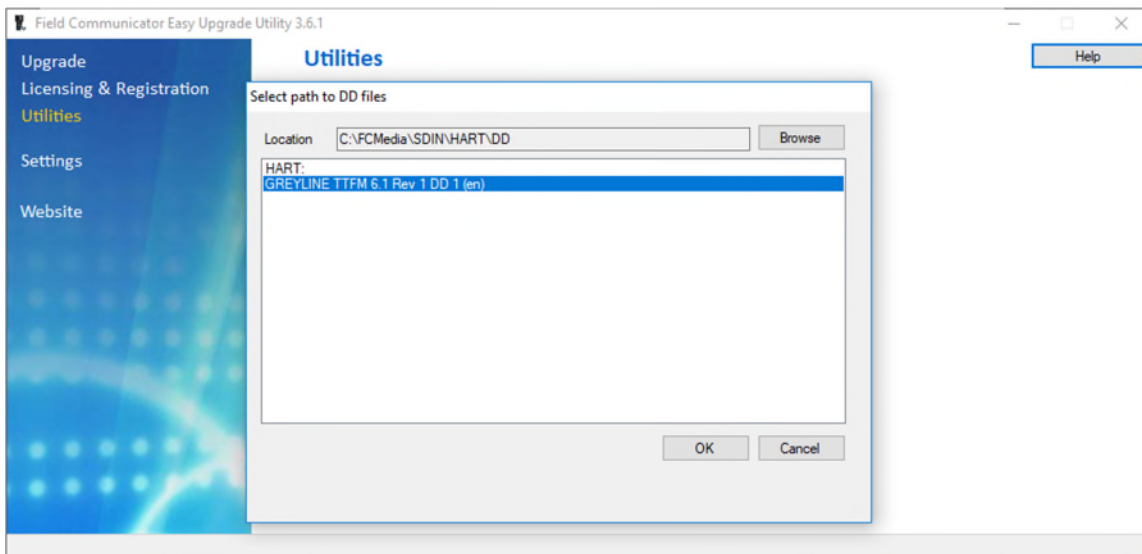

8. Navigate back to the previous screen by clicking on *Upgrade* from the left menu pain.

- Under Connect Field Communicator, select the type of the connection your device utilizes. Then click *Connect*.

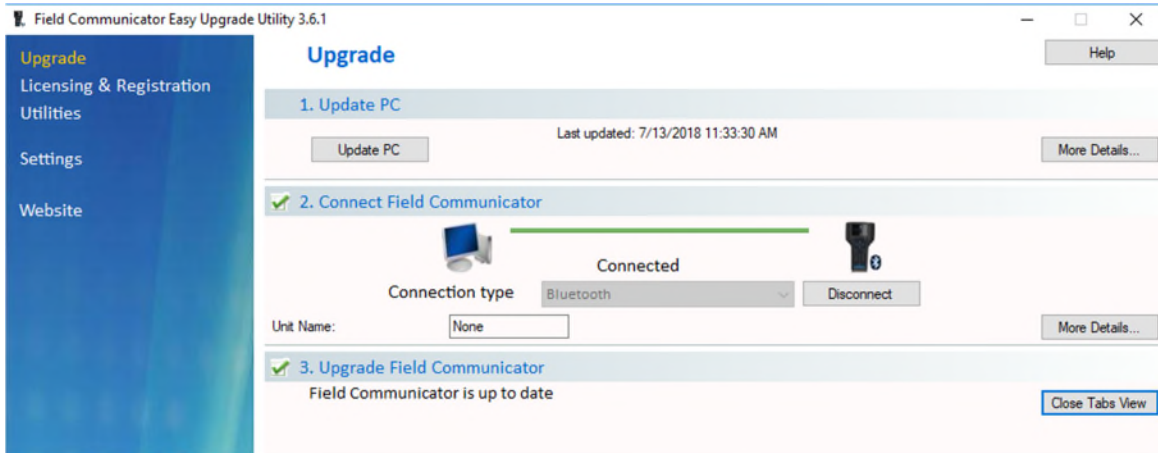

- Select Field Communicator from list shown below.

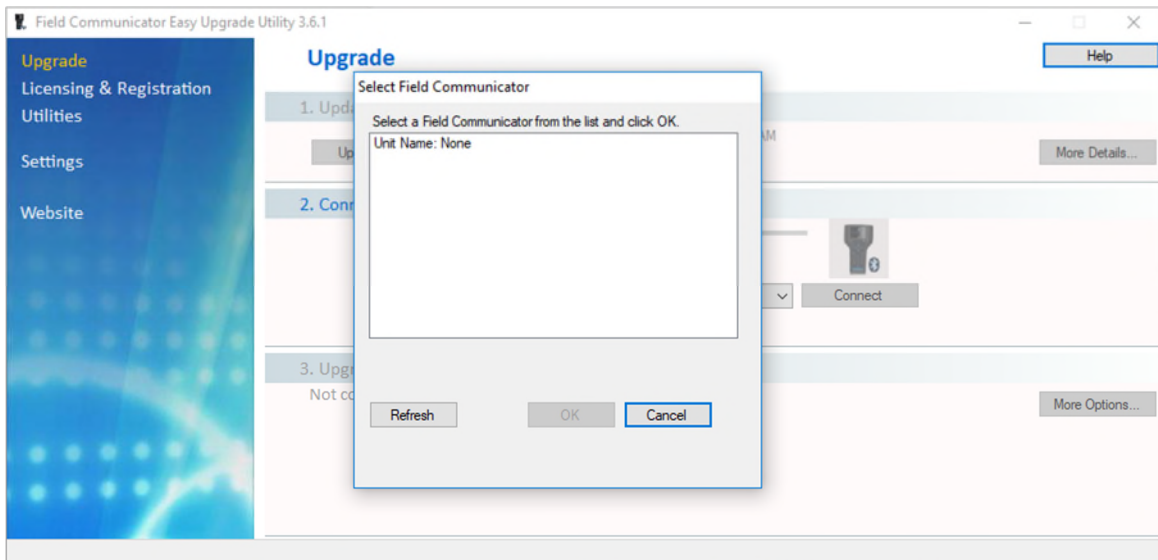

11. Once connected, click *More Options*. The *System Software* Tab Is now opened. Click the *DDs* tab.

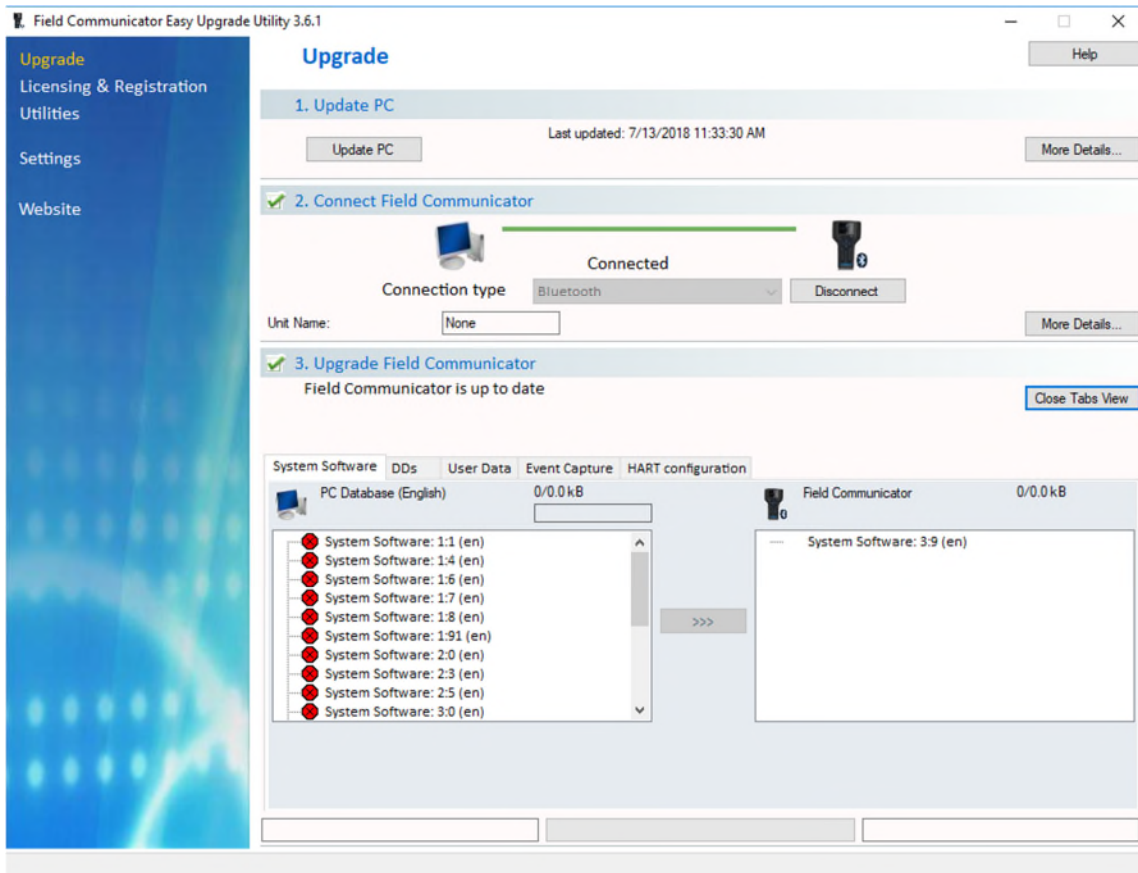



12. The newly uploaded DD from the Utilities: Import DDs from Local source. Select the DD file you wish to send to the Field communicator. If package is untested, select **Yes in the** *Check an untested package dialog box*.

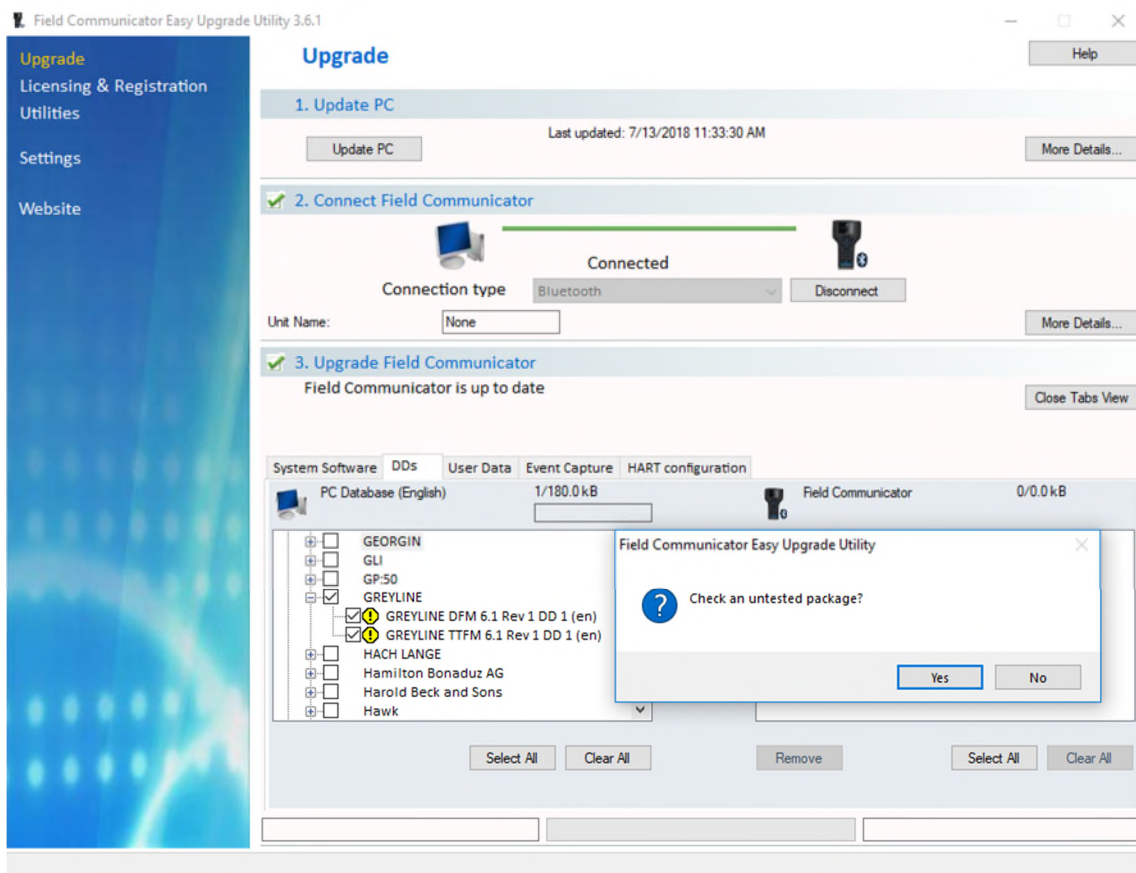

13. Click on the *Transfer Button* (Button with 3 arrows/Chevrons facing right). Wait until download complete dialog appears, then close out or continue with program as needed.

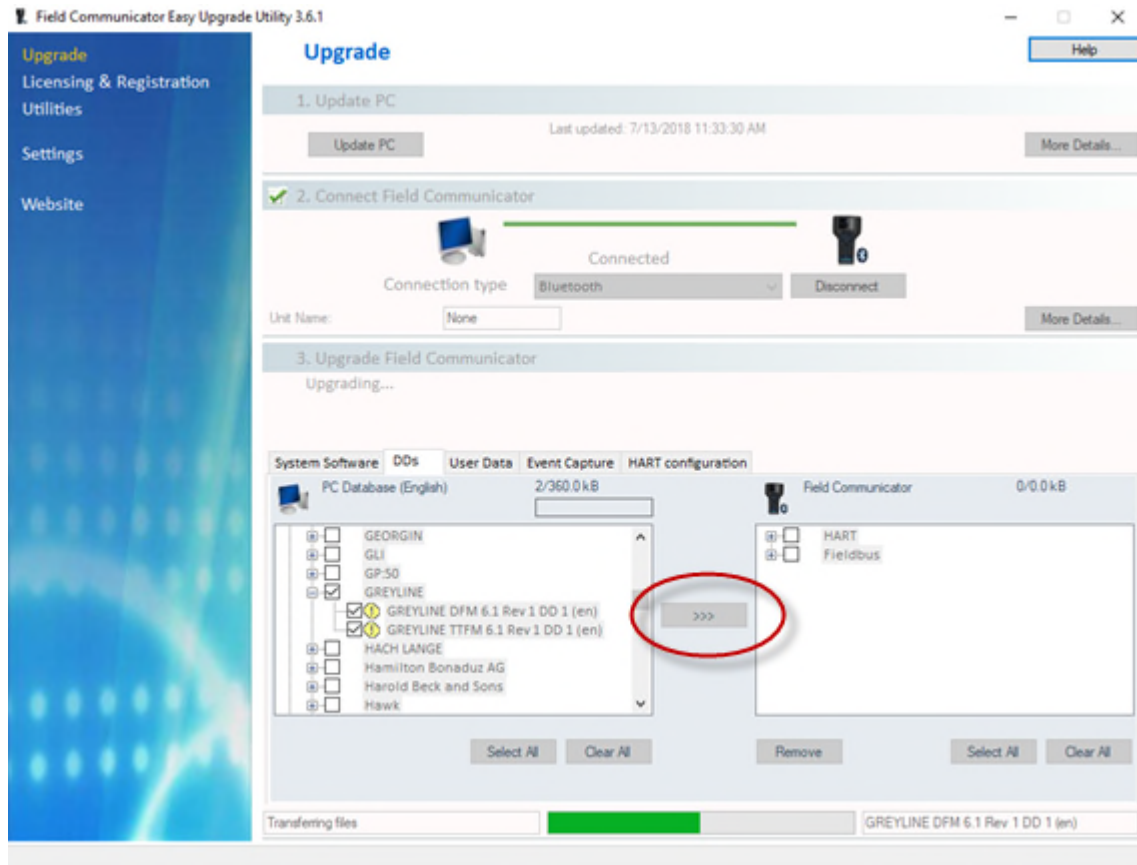

**Device Descriptor Menu Structure**

Level 1	Level 2	Level 3	Level 4	Level 5	Level 6
Device Setup	Process Variables	PV PV% Range PV Loop Current Dynamic Variables			
	Basic Setup	PV Unit PV Xfer fnctn PV Damp Device Information	Distributor Model Dev id Serial Number Relay Count Cfg chng count Tag Long Tag Date Write Protect Descriptor Message Final asmbly num Revision #'s Device Image		
	Detailed Setup	Sensors	Flow Rate Sensor	Flow Rate Flow Rate Unit Sensor Information	Flow Rate Class Flow Rate PDQ Flow Rate LS

**Device Descriptor Menu Structure (Cont.)**

Level 1	Level 2	Level 3	Level 4	Level 5	Level 6
			Velocity Sensor	Velocity Velocity Unit Sensor Information	Flow Rate LSL Flow Rate USL Flow Rate Damp  Velocity Class Velocity PDQ Velocity LS Velocity LSL Velocity USL Velocity Damp
			Volume Sensor	Volume Volume Unit Sensor Information	Volume Class Volume PDQ
		PV is Signal condition	Max dev vars  PV LRV PV URV PV % Range PV Xfer fnctn PV Damp		
		Output Condition	Analog Output	PV Loop Current PV Alrm typ PV Channel flags Loop current mode	
			HART Output	Poll addr	

**Device Descriptor Menu Structure (Cont.)**

Level 1	Level 2	Level 3	Level 4	Level 5	Level 6
		Device Information	Distributor Model Dev id Serial Number Relay Count Cfg chng count Tag Long Tag Date Write Protect Descriptor Message Final asmbly num Revision #'s Device Image	Num req preams Num resp preams	
	Review	Model Distributor Write protect Dev id Serial Number Relay Count Cfg chng count Max dev vars Tag Long tag			

**Device Descriptor Menu Structure (Cont.)**

Level 1	Level 2	Level 3	Level 4	Level 5	Level 6
		Descriptor Message Date Final asmbly num Universal rev Fld dev rev Software rev Hardware rev Poll addr Loop current mode Num req preams Num resp preams			
Status	Relay Count				
	Relay 1				
	Relay 2				
	Pri Sen Stat				
	Prim Read Quality				
	Device Status	Device Status Cfg chng count Reset Configuration			
	Dev Spec Stat 0	Status group 0			
	Dev Spec Stat 1	Status group 1			
	Dev Spec Stat 2	Status group 2			
	Dev Spec Stat 3	Status group 3			
	Dev Spec Stat 4	Status group 4			
	Dev Spec Stat 5	Status group 5			
	Ext Dev Stat	Ext dev status			

**Device Descriptor Menu Structure (Cont.)**

<b>Level 1</b>	<b>Level 2</b>	<b>Level 3</b>	<b>Level 4</b>	<b>Level 5</b>	<b>Level 6</b>
Logging	Logger Options	Log Status Log Mode Percent Log Used			
PV					
PV Loop Current					
PV LVR					
PV URV					

**SPECIFICATIONS**

**Flow Rate Range:** ±0.1 to 40 ft/sec, (±0.03 to 12.2 m/sec) in most applications

**Pipe Size:** Any pipe ID from ½ " to 180" (12.7 mm to 4.5 m)

**Accuracy:** ±2% of reading or 0.1 ft/sec (0.03 m/sec) whichever is greater  
Requires solids or bubbles minimum size of 100 microns, minimum concentration 75 ppm.  
Repeatability: ±0.1%,  
Linearity ±0.5%

**Displays:** White, backlit matrix - displays flow rate, 16-digit totalizer, relay states, operating mode and calibration menu

**Configuration:** built-in 5-key calibrator with English, French or Spanish language selection

**Power Input:** 100-240VAC, 50/60Hz, 10VA maximum  
Optional: 9-32VDC, 10 watts maximum

**Output:** Isolated 4-20mA (1000 ohm load max.)

**Control Relays:** Qty 2, rated 5 amp 240VAC SPDT, programmable flow alarm and/or proportional pulse

**Data Logger:** Built-in 26 million point Logger with USB output and Windows™ software

**Enclosure:** watertight, dust tight NEMA4X (IP 66) polycarbonate with a clear shatter-proof face

**Electronics Operating Temperature:** -10° to 140°F (-23° to 60°C)  
Approximate Shipping Weight: 10 lbs (4.5 kg)

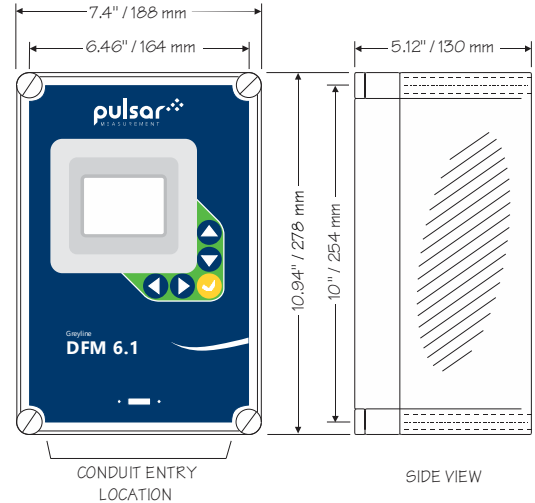

**SE4 Doppler Sensor**

**Minimum Pipe Diameter:** 0.5" (12.5 mm)

**Maximum Pipe Diameter:** 180" (4.5 m)

**Operating Temperature:** -40° to 300°F (-40° to 150°C)

**Operating Frequency:** 640 KHz

**Sensor Housing:** Stainless Steel

**Sensor Cable:** 25 ft. (7.6 m) shielded coaxial pair (RG174U)  
Optional 50 ft (15 m) or 100 ft (30 m) continuous

**Submersion Rating:** Withstands accidental submersion pressure up to 10 psi (0.7 Bar)

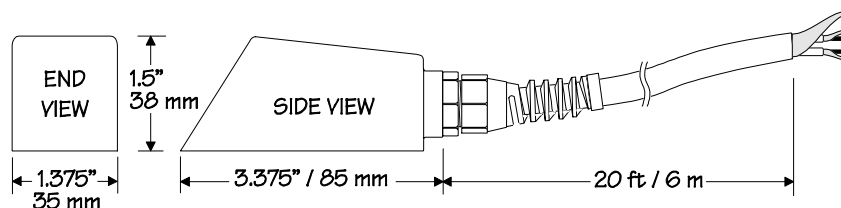



**CONVERSION TABLE**

<b>CONVERSION GUIDE</b>		
<b>FROM</b>	<b>TO</b>	<b>MULTIPLY BY</b>
US GALLONS	CUBIC FEET	0.1337
US GALLONS	IMPERIAL GALS	0.8327
US GALLONS	LITRES	3.785
US GALLONS	CUBIC METERS	0.003785
LITRES/SEC	GPM	15.85
LITRES	CUBIC METERS	0.001
BARRELS	US GALLONS	42
BARRELS	IMPERIAL GALS	34.9726
BARRELS	LITRES	158.9886
INCHES	MM	25.4
DEGREES F	DEGREES C	$(^{\circ}\text{F}-32) \times 0.556$
POUNDS	KILOGRAMS	0.453
PSI	BAR	0.0676
FOOT <sup>2</sup>	METER <sup>2</sup>	0.0929

Note: BARRELS are U.S. oil barrels

**PIPE CHARTS**

**Carbon Steel & PVC Pipe**

Pipe Size	Pipe O.D.	Standard Schedule 40		Extra Heavy Schedule 80		Dbl. Extra Heavy		Schedule 10		Schedule 20		Schedule 30		Schedule 40	
		I.D.	WALL	I.D.	WALL	I.D.	WALL	I.D.	WALL	I.D.	WALL	I.D.	WALL	I.D.	WALL
½	.840	.622	.109	.546	.147	.252	.294							.622	.109
¾	1.050	.824	.113	.742	.154	.434	.308							.824	.113
1	1.315	1.049	.133	.957	.179	.599	.358							1.049	.133
1¼	1.660	1.380	.140	1.278	.191	.896	.382							1.380	.140
1½	1.900	1.610	.145	1.500	.200	1.100	.400							1.610	.145
2	2.375	2.067	.154	1.939	.218	1.503	.436							2.067	.154
2½	2.875	2.469	.203	2.323	.276	1.771	.552							2.469	.203
3	3.500	3.068	.216	2.900	.300	2.300	.600							3.068	.216
3½	4.000	3.548	.226	3.364	.318	2.728	.636							3.548	.226
4	4.500	4.026	.237	3.826	.337	3.152	.674							4.026	.237
5	5.563	5.047	.258	4.813	.375	4.063	.750							5.047	.258
6	6.625	6.065	.280	5.761	.432	4.897	.864							6.065	.280
8	8.625	7.981	.322	7.625	.500	6.875	.875			8.125	.250	8.071	.277	7.981	.322
10	10.750	10.020	.365	9.750	.500	8.750	1.000			10.250	.250	10.136	.307	10.020	.365
12	12.750	12.000	.375	11.750	.500	10.750	1.000			12.250	.250	12.090	.330	11.938	.406
14	14.000	13.250	.375	13.000	.500			13.500	.250	13.376	.312	13.250	.375	13.124	.438
16	16.000	15.250	.375	15.000	.500			15.500	.250	15.376	.312	15.250	.375	15.000	.500
18	18.000	17.250	.375	17.000	.500			17.500	.250	17.376	.312	17.124	.438	16.876	.562
20	20.000	19.250	.375	19.000	.500			19.500	.250	19.250	.375	19.000	.500	18.814	.593
22	22.000	21.250	.375	21.000	.500			21.500	.250	21.250	.375	21.000	.500		
24	24.000	23.250	.375	23.000	.500			23.500	.250	23.250	.375	22.876	.562	22.626	.687
26	26.000	25.250	.375	25.000	.500			25.376	.312	25.000	.500				
28	28.000	27.250	.375	27.000	.500			27.376	.312	27.000	.500	26.750	.625		
30	30.000	29.250	.375	29.000	.500			29.376	.312	29.000	.500	28.750	.625		
32	32.000	31.250	.375	31.000	.500			31.376	.312	31.000	.500	30.750	.625		
34	34.000	33.250	.375	33.000	.500			33.376	.312	33.000	.500	32.750	.625		
36	36.000	35.250	.375	35.000	.500			35.376	.312	35.000	.500	34.750	.625		
42	42.000	41.250	.375	41.000	.500					41.000	.500	40.750	.625		

**Ductile Iron Pipe - Standard Classes**

Size INCH	OUTSIDE DIA. INCH	Class 50		Class 51		Class 52		Class 53		Class 54		Class 55		Class 56		CEMENT LINING	
		WALL	I.D.	WALL	I.D.	WALL	I.D.	WALL	I.D.	WALL	I.D.	WALL	I.D.	WALL	I.D.	**S TD	**DOUBLE
																THICKNESS	THICKNESS
3	3.96			0.25	3.46	0.28	3.40	0.31	3.34	0.34	3.28	0.37	3.22	0.41	3.14		
4	4.80			0.26	4.28	0.29	4.22	0.32	4.16	0.35	4.10	0.38	4.04	0.44	3.93		
6	6.90	0.25	6.40	0.28	6.34	0.31	6.28	0.34	6.22	0.37	6.16	0.40	6.10	0.43	6.04	.125	.250
8	9.05	0.27	8.51	0.30	8.45	0.33	8.39	0.36	8.33	0.39	8.27	0.42	8.21	0.45	8.15		
10	11.10	0.39	10.32	0.32	10.46	0.35	10.40	0.38	10.34	0.41	10.28	0.44	10.22	0.47	10.16		
12	13.20	0.31	12.58	0.34	12.52	0.37	12.46	0.40	12.40	0.43	12.34	0.46	12.28	0.49	12.22		
14	15.30	0.33	14.64	0.36	14.58	0.39	14.52	0.42	14.46	0.45	14.40	0.48	14.34	0.51	14.28		
16	17.40	0.34	16.72	0.37	16.66	0.40	16.60	0.43	16.54	0.46	16.48	0.49	16.42	0.52	16.36	.1875	.375
18	19.50	0.35	18.80	0.38	18.74	0.41	18.68	0.44	18.62	0.47	18.56	0.50	18.50	0.53	18.44		
20	21.60	0.36	20.88	0.39	20.82	0.42	20.76	0.45	20.70	0.48	20.64	0.51	20.58	0.54	20.52		
24	25.80	0.38	25.04	0.41	24.98	0.44	24.92	0.47	24.86	0.50	24.80	0.53	24.74	0.56	24.68		
30	32.00	0.39	31.22	0.43	31.14	0.47	31.06	0.51	30.98	0.55	30.90	0.59	30.82	0.63	30.74	.250	.500
36	38.30	0.43	37.44	0.48	37.34	0.62	37.06	0.58	37.14	0.63	37.04	0.68	36.94	0.73	36.84		
42	44.50	0.47	43.56	0.53	43.44	0.59	43.32	0.65	43.20	0.71	43.08	0.77	42.96	0.83	42.84		
48	50.80	0.51	49.78	0.58	49.64	0.65	49.50	0.72	49.36	0.79	49.22	0.86	49.08	0.93	48.94		
54	57.10	0.57	55.96	0.65	55.80	0.73	55.64	0.81	55.48	0.89	55.32	0.97	55.16	1.05	55.00		

\*\*REDUCE I.D. BY DIMENSION SHOWN

**Stainless Steel, Hastelloy "C" & Titanium Pipe**

Pipe Size	Pipe O.D.	Schedule 5 S (a)		Schedule 10 S (a)		Schedule 40 S		Schedule 80 S	
		I.D.	WALL	I.D.	WALL	I.D.	WALL	I.D.	WALL
½	.840	.710	.065	.674	.083	.622	.109	.546	.147
¾	1.050	.920	.065	.884	.083	.824	.113	.742	.154
1	1.315	1.185	.065	1.097	.109	1.049	.133	.957	.179
1¼	1.660	1.530	.065	1.442	.109	1.380	.140	1.278	.191
1½	1.900	1.770	.065	1.682	.109	1.610	.145	1.500	.200
2	2.375	2.245	.065	2.157	.109	2.067	.154	1.939	.218
2½	2.875	2.709	.083	2.635	.120	2.469	.203	2.323	.276
3	3.500	3.334	.083	3.260	.120	3.068	.216	2.900	.300
3½	4.000	3.834	.083	3.760	.120	3.548	.226	3.364	.318
4	4.500	4.334	.083	4.260	.120	4.026	.237	3.826	.337
5	5.563	5.345	.109	5.295	.134	5.047	.258	4.813	.375
6	6.625	6.407	.109	6.357	.134	6.065	.280	5.761	.432
8	8.625	8.407	.109	8.329	.148	7.981	.322	7.625	.500
10	10.750	10.482	.134	10.420	.165	10.020	.365	9.750	.500
12	12.750	12.438	.156	12.390	.180	12.000	.375	11.750	.500
14	14.000	13.688	.156	13.624	.188				
16	16.000	15.670	.165	15.624	.188				
18	18.000	17.670	.165	17.624	.188				
20	20.000	19.634	.188	19.564	.218				
22	22.000	21.624	.188	21.564	.218				
24	24.000	23.563	.218	23.500	.250				

Pipe Size	Pipe O.D.	Schedule 60		Schedule 80		Schedule 100		Schedule 120		Schedule 140		Schedule 160	
		I.D.	WALL	I.D.	WALL	I.D.	WALL	I.D.	WALL	I.D.	WALL	I.D.	WALL
½	.840			.546	.147							.466	.187
¾	1.050			.742	.154							.614	.218
1	1.315			.957	.179							.815	.250
1¼	1.660			1.278	.191							1.160	.250
1½	1.900			1.500	.200							1.338	.281
2	2.375			1.939	.218							1.689	.343
2½	2.875			2.323	.276							2.125	.375
3	3.500			2.900	.300							2.624	.438
3½	4.000			3.364	.318								
4	4.500			3.826	.337			3.624	.438			3.438	.531
5	5.563			4.813	.375			4.563	.500			4.313	.625
6	6.625			5.761	.432			5.501	.562			5.189	.718
8	8.625	7.813	.406	7.625	.500	7.439	.593	7.189	.718	7.001	.812	6.813	.906
10	10.750	9.750	.500	9.564	.593	9.314	.718	9.064	.843	8.750	1.000	8.500	1.125
12	12.750	11.626	.562	11.376	.687	11.064	.843	10.750	1.000	10.500	1.125	10.126	1.312
14	14.000	12.814	.593	12.500	.750	12.126	.937	11.814	1.093	11.500	1.250	11.188	1.406
16	16.000	14.688	.656	14.314	.843	13.938	1.031	13.564	1.218	13.124	1.438	12.814	1.593
18	18.000	16.500	.750	16.126	.937	15.688	1.156	15.250	1.375	14.876	1.562	14.438	1.781
20	20.000	18.376	.812	17.938	1.031	17.438	1.281	17.000	1.500	16.500	1.750	16.064	1.968
22	22.000	20.250	.875	19.750	1.125	19.250	1.375	18.750	1.625	18.250	1.875	17.750	2.125
24	24.000	22.064	.968	21.564	1.218	20.938	1.531	20.376	1.812	19.876	2.062	19.314	2.343

**Cast Iron Pipe - ASA Standard**

Pipe Size	Pipe O.D.	Class 50		Class 100		Class 150		Class 200		Class 250		Class 300		Class 350	
		WALL	I.D.	WALL	I.D.	WALL	I.D.	WALL	I.D.	WALL	I.D.	WALL	I.D.	WALL	I.D.
3	3.96	0.32	3.32	0.32	3.32	0.32	3.32	0.32	3.32	0.32	3.32	0.32	3.32	0.32	3.32
4	4.80	0.35	4.10	0.35	4.10	0.35	4.10	0.35	4.10	0.35	4.10	0.35	4.10	0.35	4.10
6	6.90	0.38	6.14	0.38	6.14	0.38	6.14	0.38	6.14	0.38	6.14	0.38	6.14	0.38	6.14
8	9.05	0.41	8.23	0.41	8.23	0.41	8.23	0.41	8.23	0.41	8.23	0.41	8.23	0.41	8.23
10	11.10	0.44	10.22	0.44	10.22	0.44	10.22	0.44	10.22	0.44	10.22	0.48	10.14	0.52	10.06
12	13.20	0.48	12.24	0.48	12.24	0.48	12.24	0.48	12.24	0.52	12.16	0.52	12.16	0.56	12.08
14	15.30	0.48	14.34	0.51	14.28	0.51	14.28	0.55	14.20	0.59	14.12	0.59	14.12	0.64	14.02
16	17.40	0.54	16.32	0.54	16.32	0.54	16.32	0.58	16.24	0.63	16.14	0.68	16.04	0.68	16.04
18	19.50	0.54	18.42	0.58	18.34	0.58	18.34	0.63	18.24	0.68	18.14	0.73	18.04	0.79	17.92
20	21.60	0.57	20.46	0.62	20.36	0.62	20.36	0.67	20.26	0.72	20.16	0.78	20.04	0.84	19.92
24	25.80	0.63	24.54	0.68	24.44	0.73	24.34	0.79	24.22	0.79	24.22	0.85	24.10	0.92	23.96

**Cast Iron Pipe - AWWA Standard**

Pipe Size	Class A 100 Ft. 43 PSIG			Class B 200 Ft. 86 PSIG			Class C 300 Ft. 130 PSIG			Class D 400 Ft. 173 PSIG		
	O.D.	WALL	I.D.	O.D.	WALL	I.D.	O.D.	WALL	I.D.	O.D.	WALL	I.D.
3	3.80	0.39	3.02	3.96	0.42	3.12	3.96	0.45	3.06	3.96	0.48	3.00
4	4.80	0.42	3.96	5.00	0.45	4.10	5.00	0.48	4.04	5.00	0.52	3.96
6	6.90	0.44	6.02	7.10	0.48	6.14	7.10	0.51	6.08	7.10	0.55	6.00
8	9.05	0.46	8.13	9.05	0.51	8.03	9.30	0.56	8.18	9.30	0.60	8.10
10	11.10	0.50	10.10	11.10	0.57	9.96	11.40	0.62	10.16	11.40	0.68	10.04
12	13.20	0.54	12.12	13.20	0.62	11.96	13.50	0.68	12.14	13.50	0.75	12.00
14	15.30	0.57	14.16	15.30	0.66	13.98	15.65	0.74	14.17	15.65	0.82	14.01
16	17.40	0.60	16.20	17.40	0.70	16.00	17.80	0.80	16.20	17.80	0.89	16.02
18	19.50	0.64	18.22	19.50	0.75	18.00	19.92	0.87	18.18	19.92	0.96	18.00
20	21.60	0.67	20.26	21.60	0.80	20.00	22.06	0.92	20.22	22.06	1.03	20.00
24	25.80	0.76	24.28	25.80	0.89	24.02	26.32	1.04	24.22	26.32	1.16	24.00
30	31.74	0.88	29.98	32.00	1.03	29.94	32.40	1.20	30.00	32.74	1.37	30.00
36	37.96	0.99	35.98	38.30	1.15	36.00	38.70	1.36	39.98	39.16	1.58	36.00
42	44.20	1.10	42.00	44.50	1.28	41.94	45.10	1.54	42.02	45.58	1.78	42.02
48	50.50	1.26	47.98	50.80	1.42	47.96	51.40	1.71	47.98	51.98	1.96	48.06
54	56.66	1.35	53.96	57.10	1.55	54.00	57.80	1.90	54.00	58.40	2.23	53.94
60	62.80	1.39	60.02	63.40	1.67	60.06	64.20	2.00	60.20	64.82	2.38	60.06
72	75.34	1.62	72.10	76.00	1.95	72.10	76.88	2.39	72.10			
84	87.54	1.72	84.10	88.54	2.22	84.10						

Pipe Size	Class E 500 Ft. 217 PSIG			Class F 600 Ft. 260 PSIG			Class G 700 Ft. 304 PSIG			Class H 800 Ft. 347 PSIG		
	O.D.	WALL	I.D.	O.D.	WALL	I.D.	O.D.	WALL	I.D.	O.D.	WALL	I.D.
6	7.22	0.58	6.06	7.22	0.61	6.00	7.38	0.65	6.08	7.38	0.69	6.00
8	9.42	0.66	8.10	9.42	0.71	8.00	9.60	0.75	8.10	9.60	0.80	8.00
10	11.60	0.74	10.12	11.60	0.80	10.00	11.84	0.86	10.12	11.84	0.92	10.00
12	13.78	0.82	12.14	13.78	0.89	12.00	14.08	0.97	12.14	14.08	1.04	12.00
14	15.98	0.90	14.18	15.98	0.99	14.00	16.32	1.07	14.18	16.32	1.16	14.00
16	18.16	0.98	16.20	18.16	1.08	16.00	18.54	1.18	16.18	18.54	1.27	16.00
18	20.34	1.07	18.20	20.34	1.17	18.00	20.78	1.28	18.22	20.78	1.39	18.00
20	22.54	1.15	20.24	22.54	1.27	20.00	23.02	1.39	20.24	23.02	1.51	20.00
24	26.90	1.31	24.28	26.90	1.45	24.00	27.76	1.75	24.26	27.76	1.88	24.00
30	33.10	1.55	30.00	33.46	1.73	30.00						
36	39.60	1.80	36.00	40.04	2.02	36.00						

**Copper Tubing**

Pipe Size	K			L			M			Copper & Brass Pipe			Aluminum		
	O.D.	I.D.	WALL	O.D.	I.D.	WALL	O.D.	I.D.	WALL	O.D.	I.D.	WALL	O.D.	I.D.	WALL
2"	2.125	1.959	0.083	2.125	1.985	0.070	2.125	2.009	0.058	2.375	2.062	0.157			
2 ½"	2.625	2.435	0.095	2.625	2.465	0.080	2.625	2.495	0.065	2.875	2.500	0.188	2.500	2.400	0.050
3"	3.125	2.907	0.109	3.125	2.945	0.090	3.125	2.981	0.072	3.500	3.062	0.219	3.000	2.900	0.050
3 ½"	3.625	3.385	0.120	3.625	3.425	0.100	3.625	3.459	0.083	4.000	3.500	0.250			
4"	4.125	3.857	0.134	4.125	3.905	0.110	4.125	3.935	0.095	4.500	3.935	0.095	4.000	4.000	0.250
4 ½"													5.000	4.500	0.250
5"	5.125	4.805	0.160	5.125	4.875	0.125	5.125	4.907	0.109	5.563	5.063	0.250	5.000	4.874	0.063
6"	6.125	5.741	0.192	6.125	5.845	0.140	6.125	5.881	0.122	6.625	6.125	0.250	6.000	5.874	0.063
7"										7.625	7.062	0.282	7.000	6.844	0.078
8"	8.125	7.583	0.271	8.125	7.725	0.200	8.125	7.785	0.170	8.625	8.000	0.313	8.000	7.812	0.094
10"	10.125	9.449	0.338	10.125	9.625	0.250	10.125	9.701	0.212	10.000	9.812	0.094			
12"	12.125	11.315	0.405	12.125	11.565	0.280	12.125	11.617	0.254						

**HDPE**

Pipe Size	OD	DR 7		DR 7.3		DR 9		DR 11		DR 13.5		DR 15.5	
		Wall	ID	Wall	ID	Wall	ID	Wall	ID	Wall	ID	Wall	ID
2"	2.375"	0.339"	1.656"	0.325"	1.685"	0.264"	1.816"	0.216"	1.917"	0.176"	2.002"	0.153"	2.050"
3"	3.500"	0.500"	2.440"	0.479"	2.484"	0.389"	2.676"	0.318"	2.825"	0.259"	2.950"	0.226"	3.021"
4"	4.500"	0.643"	3.137"	0.616"	3.193"	0.500"	3.440"	0.409"	3.633"	0.333"	3.793"	0.290"	3.885"
5"	5.563"	0.795"	3.878"	0.762"	3.947"	0.618"	4.253"	0.506"	4.491"	0.412"	4.689"	0.347"	4.640"
6"	6.625"	0.946"	4.619"	0.908"	4.701"	0.736"	5.064"	0.602"	5.348"	0.491"	5.585"	0.359"	4.802"
7"	7.125"	1.018"	4.967"	0.976"	5.056"	0.792"	5.447"	0.648"	5.752"	0.528"	6.006"	0.427"	5.719"
8"	8.625"	1.232"	6.013"	1.182"	6.120"	0.958"	6.593"	0.784"	6.963"	0.639"	7.271"	0.460"	6.150"
10"	10.750"	1.536"	7.494"	1.473"	7.628"	1.194"	8.218"	0.977"	8.678"	0.796"	9.062"	0.556"	7.445"
12"	12.750"	1.821"	8.889"	1.747"	9.047"	1.417"	9.747"	1.159"	10.293"	0.944"	10.748"	0.694"	9.280"
14"	14.000"	2.000"	9.760"	1.918"	9.934"	1.556"	10.702"	1.273"	11.302"	1.037"	11.801"	0.823"	11.006"
16"	16.00"	2.286"	11.154"	2.192"	11.353"	1.778"	12.231"	1.455"	12.916"	1.185"	13.487"	0.903"	12.085"
18"	18.00"	2.571"	12.549"	2.466"	12.773"	2.000"	13.760"	1.636"	14.531"	1.333"	15.173"	1.032"	13.812"
20"	20.00"	2.857"	13.943"	2.740"	14.192"	2.222"	15.289"	1.818"	16.145"	1.481"	16.859"	1.161"	15.538"
22"	22.00"	3.143"	15.337"	3.014"	15.611"	2.444"	16.818"	2.000"	17.760"	1.630"	18.545"	1.290"	17.265"
24"	24.00"	3.429"	16.731"	3.288"	17.030"	2.667"	18.347"	2.182"	19.375"	1.778"	20.231"	1.419"	18.991"
26"	26.00"	---	---	3.562"	18.449"	2.889"	19.876"	2.364"	20.989"	1.926"	21.917"	1.548"	20.717"
28"	28.00"	---	---	---	---	3.111"	21.404"	2.545"	22.604"	2.074"	23.603"	1.677"	22.444"
30"	30.00"	---	---	---	---	3.333"	22.933"	2.727"	24.218"	2.222"	25.289"	1.806"	24.170"
32"	32.00"	---	---	---	---	3.556"	24.462"	2.909"	25.833"	2.370"	26.975"	1.935"	25.897"
34"	34.00"	---	---	---	---	---	---	3.091"	27.447"	2.519"	28.661"	2.065"	27.623"
36"	36.00"	---	---	---	---	---	---	3.273"	29.062"	2.667"	30.347"	2.194"	29.350"
42"	42.00"	---	---	---	---	---	---	---	---	3.111"	35.404"	2.323"	31.076"
48"	48.00"	---	---	---	---	---	---	---	---	3.556"	40.462"	2.710"	36.255"

**C900/C905 PVC AWWA Water Distribution Pipe (Blue)**

Pipe Size	OD	DR14		DR18		DR-21		DR25	
		Wall	ID	Wall	ID	Wall	ID	Wall	ID
4	4.80	0.343	4.114	0.267	4.266			0.192	4.416
6	6.90	0.493	5.914	0.383	6.134			0.276	6.348
8	9.05	0.646	7.758	0.503	8.044			0.362	8.326
10	11.10	0.793	9.514	0.617	9.866			0.444	10.212
12	13.20	0.943	11.314	0.733	11.734			0.528	12.144
14	15.30			0.850	13.600	0.729	13.842	0.612	14.076
16	17.40			0.967	15.466	0.829	15.742	0.696	16.008
18	19.50			1.083	17.334	0.929	17.642	0.780	17.94
20	21.60			1.200	19.200	1.029	19.542	0.864	19.872
24	25.80			1.433	22.934	1.229	23.342	1.032	23.736





**[www.pulsarmeasurement.com](http://www.pulsarmeasurement.com)**  
**[service@pulsarmeasurement.com](mailto:service@pulsarmeasurement.com)**

*Copyright © 2020 Pulsar Measurement Ltd.  
Registered Address: 1 Chamberlain Square CS, Birmingham B3 3AX  
Registered No.: 3345604 England & Wales  
Rev 1.0*