



Instruction Manual

**INTEGRAL ULTRASONIC
FLOWMETER S-FLOW**

TYPE: FSZ

PREFACE

Thank you for purchasing Fuji Electric's ultrasonic flowmeter.

This instruction manual describes ultrasonic flowmeter (FSZ) installation, operation, inspection, and maintenance, and should be read carefully before use.

- First read this instruction manual carefully until an adequate understanding is acquired, and then proceed to installation, operation, and maintenance of the flow meter.
Improper handling may result in an accident or a failure.
- The specifications of this flow meter are subject to change without prior notice for improvement of the product.
- Do not attempt to modify the flow meter without permission. Fuji will not bear any responsibility for a trouble caused by such a modification. If it becomes necessary to modify the flow meter, contact our office in advance.

Manufacturer: Fuji Electric Co., Ltd.
Type: Described in the nameplate attached to the main body
Date of manufacture: Described in the nameplate attached to the main body
Country of manufacture: Japan

Note

- Reproduction of any part or the whole of this manual without permission is strictly prohibited by laws.
- Contents of the manual are subject to change without prior notice.

©Fuji Electric Co., Ltd. 2023

Issued in Mar., 2023

Date:

To: Fuji Electric Co., Ltd.

Company name

Department

Name

Seal

Certificate of Conformance with RoHS Directive

This certificate certifies that flowmeters returned to your company for the purpose of repair or calibration shall not be contaminated with substances of environmental concern applicable to RoHS regulations (EU Directive 2011/65/EU + (EU)2015/863) listed in (1) below which exceed standard values, and pledges that these flowmeters shall not adversely affect your company's repair equipment or instrumental error calibration equipment.







(1) Applicable substances of environmental concern

Substance name	Max. tolerance
Cadmium	100 ppm
Lead	1000 ppm
Mercury	1000 ppm
Hexavalent chromium	1000 ppm
Polybrominated biphenyl (PBB)	1000 ppm
Polybrominated diphenyl ethers (PBDE)	1000 ppm
Bis (2-ethylhexyl) phthalate (DEHP)	1000 ppm
Butyl benzyl phthalate (BBP)	1000 ppm
Dibutyl phthalate (DBP)	1000 ppm
Diisobutyl phthalate (DIBP)	1000 ppm

SAFETY PRECAUTIONS

Before using this product, read the following safety precautions and use the product correctly.

- The following items are important for safe operation and must be fully observed. These safety precautions are ranked in 2 levels; "DANGER" and "CAUTION".

Warning/Symbol	Meaning
 DANGER	Incorrect handling of the device may result in death or serious injury.
 CAUTION	Incorrect handling may lead to a risk of medium or light injury, or to a risk of physical damage.
	Protective ground terminal. Be sure to connect the product with the ground before starting operation.
	This symbol indicates direct current (DC).
	This symbol indicates alternating current (AC).
	This symbol urges caution.
	This symbol indicates that care should be taken to prevent electric shock due to high voltage.

- Failure to heed the information indicated by “  **CAUTION** ” may also result in serious consequences. All items indicate important content and must therefore be observed.

Precautions for mounting



DANGER

- This product is not explosion-proof. Do not use in atmospheres with explosive gas. Otherwise, it may cause a serious accident such as explosion or fire.



CAUTION

- Install it in a location that meets the requirements of this instruction manual. Not complying with the installation conditions may cause electric shock, fire or malfunction.
- EMC standards
This product is intended for use in industrial areas and environments. This equipment has been designed as a Class A product (for industrial environment applications). Use in home environments may cause jamming, and therefore use in such environments should be avoided. If absolutely necessary to use the product in a home environment, take appropriate external countermeasures.
- Mount it securely as described in the instruction manual. If it isn't secured properly, it may fall off, fail, or malfunction, etc.
- Be sure to follow the "Precautions for mounting" described in the instruction manual. Otherwise, it may result in trouble, malfunction, etc.

When installing on hot pipes, pay attention to the following items when carrying out installation work. Failure to observe this may result in burns.

- Keep bare skin away from hot parts. If there is a risk of bare skin coming into contact with hot parts, cover the skin by wearing gloves, long-sleeves, long pants, and socks, etc.
- Take heat insulation measures if required for work (wearing heat-resistant gloves, etc.).
- Perform a safety check of the area below the installation location to ensure that there are no problems even if it is accidentally falls.

Caution in wiring



CAUTION

- To prevent output failure due to moisture intrusion, condensation, or damage due to flooding, handle the wiring ports in accordance with the "2.3 Wiring" of the instruction manual.
- Before performing the wiring work, be sure to turn OFF the main power. Otherwise, it may cause electric shock.
- Do not perform wiring work outdoors in rainy days to prevent insulation deterioration and dew condensation. Otherwise, it may result in trouble, malfunction, etc.
- Be sure to connect a power source of correct rating. Use of power source out of rating may cause fire.
- This will result in malfunction, and therefore every effort should be made to keep the dedicated cables away from other heavy-current lines in order to protect them from the effects of noise.
- This will result in malfunction. Therefore, be sure to wire the dedicated cables separately in conduits.
- Connect isolated, ungrounded equipment to the power supply, analog output, and contact output.

Caution on maintenance and inspection



CAUTION

- The unit should be inspected every day to always obtain good results of measurements.
- Keep away from direct sunlight and water.

CAUTION ON INSTALLATION LOCATION



CAUTION

- (1) Places where the ambient temperature and humidity are -15 to +60°C and 95% RH or less.
- (2) Indoor or outdoor locations where there is no exposure to direct sunlight or wind and rain.
- (3) A place that provides enough space for periodic inspection and wiring work.
- (4) A place not subjected to radiated heat from a heating furnace, etc.
- (5) A place not subjected to corrosive atmosphere.
- (6) A place not to be submerged.
- (7) A place free from excessive vibration, dust, dirt, and moisture.
- (8) A place remote from electrical devices (motor, transformer, etc.) which generate electromagnetic induction noise, electrostatic noise, etc.
- (9) A place not subjected to excessive fluid pulsation such as pump discharge side.
- (10) A place that provides enough place for the length of the straight pipe.
- (11) Altitude: up to 2000 m

Table of Contents

PREFACE	i	3.11. System settings	30
SAFETY PRECAUTIONS	iii	3.11.1. ON/OFF setting of measurement display	30
CAUTION ON INSTALLATION LOCATION	v	3.11.2. How to set the ID No.	30
1. PRODUCT OUTLINE	1	3.11.3. How to check the software version	30
1.1. Overview	1	3.11.4. Key operations for system settings	31
1.2. Checking delivered items	1	3.12. Maintenance	33
1.3. Check on type and specifications	2	3.12.1. Calibration and verification of analog output	33
1.4. Name and function of each part	3	3.12.2. Checking the status output and total pulse operation	34
1.4.1. Flowmeter unit (FSZ)	3	3.12.3. How to set the test mode (flow simulated output)	35
1.4.2. Dedicated cable (FLYF)	3	4. MAINTENANCE AND INSPECTION	37
2. INSTALLATION	4	4.1. Daily check	37
2.1. Installation location	4	4.2. Periodic inspection	37
2.1.1. Conditions on straight pipe	5	4.2.1. Checking zero point	37
2.1.2. Mounting orientation	6	4.3. Errors and countermeasures	37
2.2. Installation	7	4.3.1. Display errors	37
2.2.1. Mounting on pipes	7	4.3.2. Error and countermeasures when an alarm is displayed	38
2.3. Wiring	8	4.3.2.1. Diagnosis when there is no receipt wave or it is weak or the receipt wave is abnormal	39
2.3.1. Caution in wiring	8	4.3.3. Measured value error	40
2.3.2. Applicable wires	8	4.3.4. Analog output errors	41
2.3.3. Cable connection	8	4.3.5. Key errors	41
2.4. Operation	8	4.3.6. Hardware failure countermeasures	41
3. PARAMETERS	9	5. APPENDIX	42
3.1. Description of display/setting unit	9	5.1. Specification	42
3.1.1. Display/setting unit	9	5.2. Outline diagram	44
3.1.2. Description of measurement display	10	5.3. Pipe data	45
3.1.3. 7-segment display	11	5.4. EMC CONFORMITY	49
3.2. Composition of key operation	12		
3.3. Parameter initial value list	16		
3.4. Setting when the power is turned ON for the first time	18		
3.5. Measurement display setting	19		
3.6. Parameter protection (protect)	20		
3.7. Zero point adjustment	21		
3.8. Measurement settings	22		
3.8.1. Piping parameter setting method	22		
3.8.2. Key operations for measurement settings	22		
3.9. Range setting	24		
3.9.1. Damping	24		
3.9.2. Flow rate unit setting	24		
3.9.3. Low-flow cutoff setting	24		
3.9.4. Method for correcting measurement value	24		
3.9.5. Range setting	25		
3.9.6. Analog output setting at time of error (burnout)	25		
3.9.7. Key operations for range settings	25		
3.10. Status settings	27		
3.10.1. DO output settings	27		
3.10.2. Total flow pulse setting (total rate, pulse width)	28		
3.10.3. Totalization processing setting at time of error (burnout)	28		
3.10.4. Key operations for status settings	29		

1. PRODUCT OUTLINE

1.1. Overview

This ultrasonic flowmeter measures the flow rate of fluids in pipes by attaching onto the outside of existing piping.

1.2. Checking delivered items

After opening the packing box, please check for the following parts.
Please note that delivered items may differ depending on product types.

Flowmeter unit × 1

Fixing bracket × 1

Fixing screws, stopping washers × 4

Dedicated cable × 1 (sold separately)

User-friendly Instruction Manual × 1

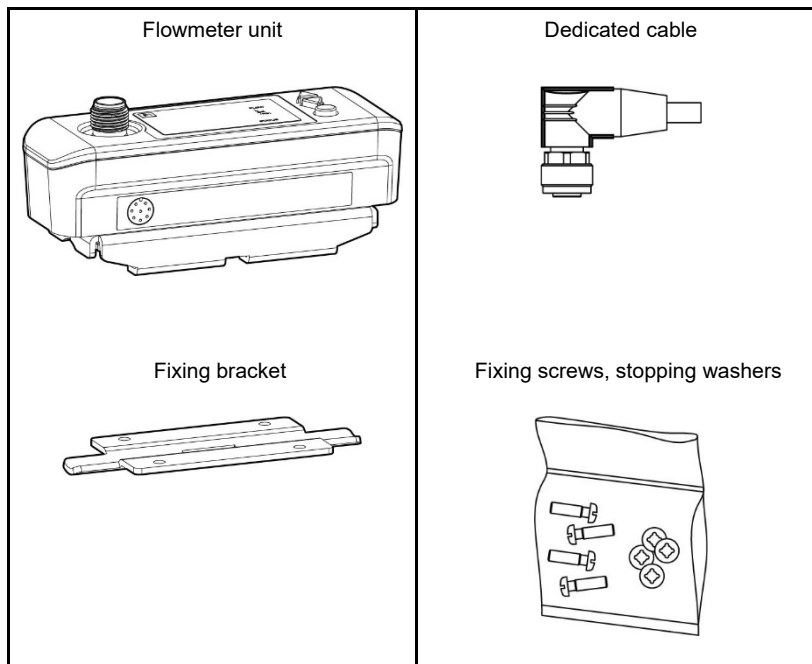

1.3. Check on type and specifications

The product type and specifications are listed on the specification nameplate attached to the flow transmitter. Confirm the product type when ordering by referring to the following product type table.

<Flowmeter Unit (FSZ)>

1	2	3	4	5	6	7	8	Description
F	S	Z					1	Diameter (4th, 5th digit)
	0	8						8A, 10A (1/4B, 3/8B)
	1	5						15A, 20A (1/2B, 3/4B)
	2	5						25A, 32A (1B, 1•1/4B)
	Y							Power supply (6th digit) 20 to 27.5 V DC
	Y							Flowmeter option (7th digit) None
	T							Pipe temperature measurement
							1	Revision No. (8th digit)

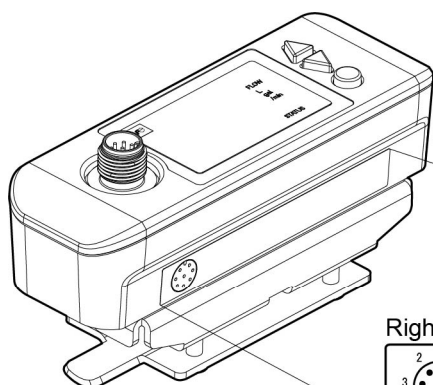

Right side (example)

PIN	COLOR	IN/OUTPUT	PIN	COLOR	IN/OUTPUT	PIN	COLOR	IN/OUTPUT
1	WHT	RS485A	4	YEL	Do1+	7	BLU	RS485B
2	BRN	AO-	5	GRY	PWR DC20-27V	8	RED	GND
3	GRN	AO+	6	PNK	Do2+			

Left side (example)

INTEGRAL ULTRASONIC FLOWMETER S-Flow		CE	UK	CA	10	RoHS	QR
TYPE: FSZ08YT1-**** SER. NO.: N2X1234							
POWER: DC20-27.5V OUTPUT: 4-20mA DC							
MFD: 202210	Made in Japan		Fuji Electric Co., Ltd.				

<Dedicated signal cable (FLYF)>

1	2	3	4	5	6	7	8	Description
F	L	Y					1	Application (4th digit) Integral Ultrasonic Flowmeter <FSZ>
	0	0	3					Dedicated signal cable length (5, 6 and 7th digit) 3 m
	0	1	0					10 m
							1	Revision No. (8th digit)

1.4. Name and function of each part

1.4.1. Flowmeter unit (FSZ)

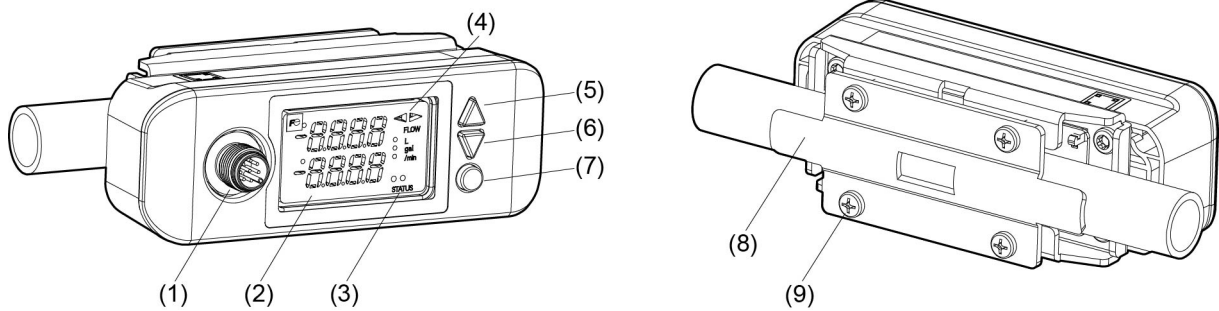

No.	Name	Key	Description
(1)	Dedicated cable connector connection port		This is a wire connection port for the power supply, current output, and contact output.
(2)	LED display unit		It displays the flow rate and settings.
(3)	Diagnostic indicator lamp (LED)		It displays normal (green) and abnormal (red) flow measurements.
(4)	Flow direction (LED)		It displays the flow direction.
(5)	UP key	△	Selects items, numeric values, and symbols.
(6)	DOWN key	▽	Selects items, numeric values, and symbols.
(7)	Entry key	○	Enters a selection or registers a setting.
(8)	Fixing bracket		It is a metal fixing bracket for installing the main unit to the piping.
(9)	Fixing screws (x 4)		These are screws for fixing the main unit and metal fixing bracket.

1.4.2. Dedicated cable (FLYF)

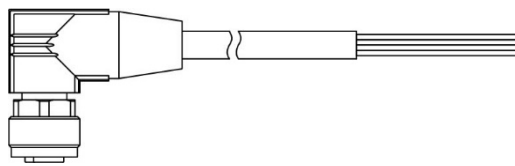

Connection name	Wiring
Power supply	(5) Gray (GRY) _____ (+) 20 to 27.5 V DC (8) Red (RED) _____ (-)
Analog current output	(3) Green (GRN) _____ (+) 4 to 20 mA (2) Brown (BRN) _____ (-)
Digital output 1	(4) Yellow (YEL) _____ (+) 27.5 V DC max., (8) Red (RED) _____ (-) 0.1 A max.
Digital output 2	(6) Pink (PNK) _____ (+) 27.5 V DC max., (8) Red (RED) _____ (-) 0.1 A max.
Unused	(7) Blue (BLU) _____ NC (RESERVED) (1) White (WHT) _____ NC (RESERVED) (8) Red (RED) _____ (GND)

2. INSTALLATION

Select the mounting location in consideration of the following items from the viewpoint of ease of maintenance and inspection, and maintaining the life and reliability of the flowmeter.

CAUTION

- (1) Places where the ambient temperature and humidity are -15 to +60°C and 95% RH or less.
- (2) Indoor or outdoor locations where there is no exposure to direct sunlight or wind and rain.
- (3) A place that provides enough space for periodic inspection and wiring work.
- (4) A place not subjected to radiated heat from a heating furnace, etc.
- (5) A place not subjected to corrosive atmosphere.
- (6) A place not to prone to submerging.
- (7) A place free from excessive vibration, dust, dirt, and moisture.
- (8) A place remote from electrical devices (motor, transformer, etc.) which generate electromagnetic induction noise, electrostatic noise, etc.
- (9) A place not subjected to excessive fluid pulsation such as pump discharge side.
- (10) A place that provides enough place for the length of the straight pipe.
- (11) Altitude: up to 2000 m

2.1. Installation location

The flowmeter mounting location, in other words the place on the pipe at which the flow rate is measured, will greatly affect measurement accuracy, and therefore a location which satisfies the following conditions should be selected.

- (1) Ensure that the location is a straight pipe as indicated in “2.1.1 Conditions on straight pipe”.
- (2) Ensure there is space for maintenance around the pipe to which the flowmeter is to be mounted. (Refer to “Fig. 2-1”.)

Note) Secure enough space so that you can reach around the piping and work. The following is a general guideline regarding space.

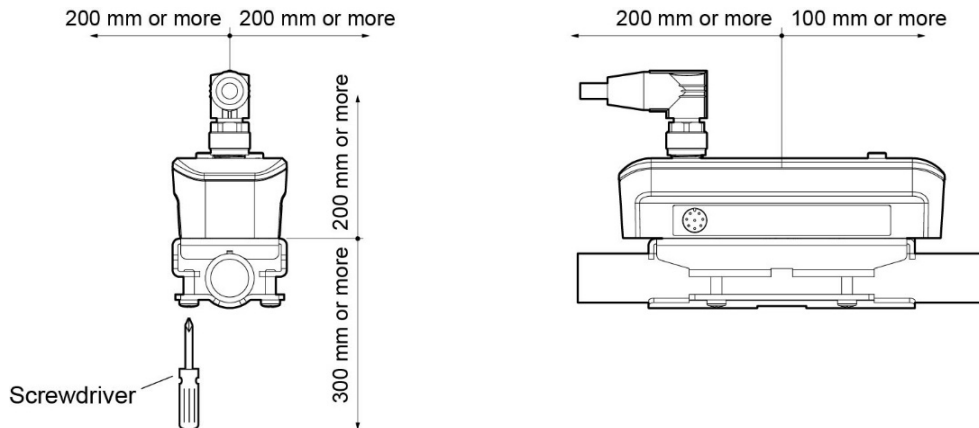

Fig. 2-1 Space required for flowmeter mounting location

2.1.1. Conditions on straight pipe

(D: inside diameter of pipe)

Classification	Upstream side	Downstream side
90° bend	<p>10D or more</p> <p>$L \geq 10D$</p> <p>Flowmeter</p>	<p>$L \geq 5D$</p>
Tee	<p>10D or more</p> <p>$L \geq 50D$</p> <p>10D or more</p>	<p>$L \geq 10D$</p>
Diffuser	<p>0.5D or more</p> <p>$L \geq 30D$</p> <p>1.5D or more</p>	<p>$L \geq 5D$</p>
Reducer	<p>$L \geq 10D$</p>	<p>$L \geq 5D$</p>
Various valve	<p>$L \geq 30D$</p> <p>In the case where a flow control valve exists on upstream side</p>	<p>$L \geq 10D$</p> <p>In the case where a flow control valve exists on downstream side</p>
Pump	<p>Stop valve</p> <p>Check valve</p> <p>P</p> <p>$L \geq 50D$</p>	

(Note) The source: JEMIS-032

2.1.2. Mounting orientation

The flowmeter can be mounted vertically, horizontally, or in any other position. The flow direction is configurable (see "3.8.1 Piping parameter setting method") and it can be mounted in a direction that makes the LED display more visible. Pay attention to the following when installing the flowmeter.

- (1) If installing on a horizontal pipe, mount the flowmeter within $\pm 45^\circ$ from the center surface to avoid air bubbles and sediments.

If installing on a vertical pipe, it can be mounted anywhere on the outer perimeter.

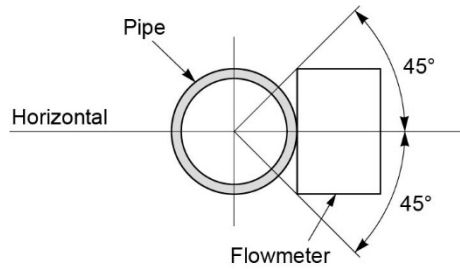

- (2) Do not mount in an area where the pipe is deformed, where there is a flange, or where there are welding joints.

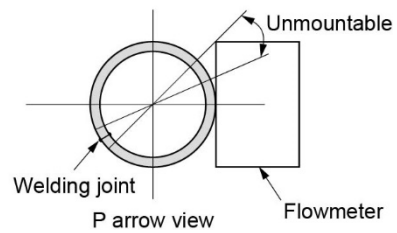
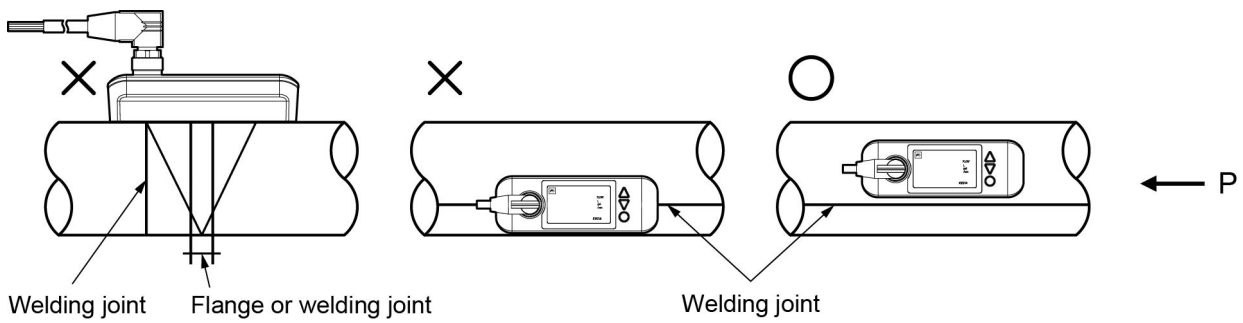

2.2. Installation

CAUTION

- Remove dirt and rust from the piping surface where the flowmeter will be mounted, as dirt and rust can cause measurement failure and measurement error.
- Be careful not to over-tighten the screws, as this may cause damage.
- To prevent damaging it, do not rotate it in the direction of the pipe circumference after tightening the screws.

2.2.1. Mounting on pipes

- (1) Attach the fixing screws to the fixing bracket and secure them with the stopping washers. Place the main unit and the fixing bracket so that they clamp the piping at the installation location, and temporarily secure it with the 4 fixing screws.

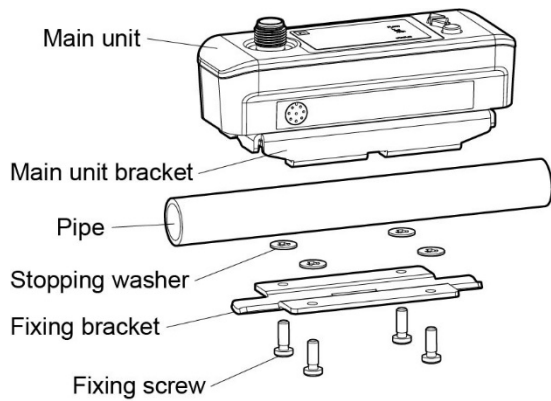

- (2) Turn the 4 screws evenly clockwise.

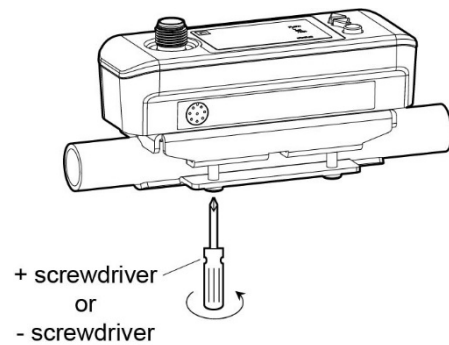

- (3) Adjust the orientation before tightening the screws. When changing the mounting direction, be sure to loosen and rotate the 4 fixing screws.

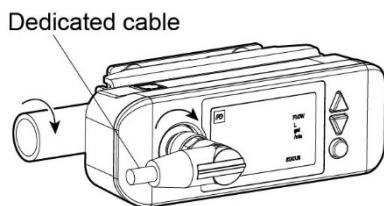

Connector tightening torque: 0.6 [N•m]

- (4) Tighten the screws evenly in the mounting direction. Adjust it so that the gap between the main unit and the fixing bracket is uniform.

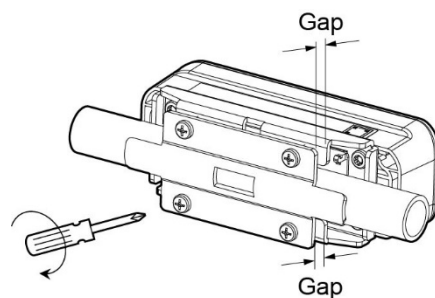

- (5) Connect the dedicated cable to the main unit. Be sure to fix the cable on the main unit.

Recommended tightening torque: 1 [N•m]

Type	Applicable pipe outer diameter	Applicable pipe diameter (small)	Applicable pipe diameter (large)
FSZ08	ø13 to ø18	8A (1/4")	10A (3/8") to ø13 to ø18
FSZ15	ø20 to ø28	15A (1/2")	20A (3/4")
FSZ25	ø30 to ø43	25A (1")	32A (1 1/4")

2.3. Wiring

2.3.1. Caution in wiring



- (1) We recommend using a shielded cable to extend the length of the cable for the output signal.
- (2) To prevent noise intrusion, do not run the signal cable inside the same duct as that used for wires such as power lines.
- (3) If the power cable has an integrated ground wire, ground it as is.
- (4) The flowmeter is not equipped with a power switch, and therefore a separate switch or breaker must be installed for each unit.
Also, please use it while observing the following.
 - Integrate the switch or breaker into the equipment.
 - Position the switch or breaker appropriately, and ensure that they can be easily accessed.
 - Clearly indicate that the switch or breaker is an equipment disconnecting device.
 - Use a switch or breaker that conforms to local standards in the region in which they are used, or to international standards.
- (5) Connect a load resistor of 550 Ω or less to ensure a stable maximum output current of 120%.

2.3.2. Applicable wires

Use the following cables.

- Dedicated cable: Power input/output signal cable based on type designation (Type FLYF) See "1.3 Check on type and specifications".

2.3.3. Cable connection

Indicates the cable name of the dedicated cable. Connect it to the power supply and output signal.

Connection name	Wiring
Power supply	(5) Gray (GRY) _____ (+) 20 to 27.5 V DC (8) Red (RED) _____ (-)
Analog current output	(3) Green (GRN) _____ (+) 4 to 20 mA (2) Brown (BRN) _____ (-)
Digital output 1	(4) Yellow (YEL) _____ (+) 27.5 V DC max., (8) Red (RED) _____ (-) 0.1 A max.
Digital output 2	(6) Pink (PNK) _____ (+) 27.5 V DC max., (8) Red (RED) _____ (-) 0.1 A max.
Unused	(7) Blue (BLU) _____ NC (RESERVED) (1) White (WHT) _____ NC (RESERVED) (8) Red (RED) _____ (GND)

2.4. Operation

After turning ON the power, it takes 20 seconds to reach the measurement status.

Please warm it up for at least 30 minutes.

After warming it up, perform zero point adjustment.

3. PARAMETERS

3.1. Description of display/setting unit

The display/setting unit are shown below.

3.1.1. Display/setting unit

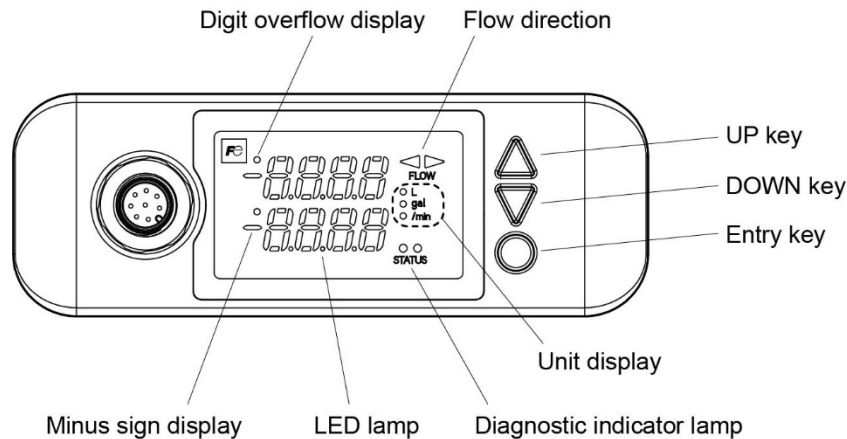

Name	Key display	Description
UP key	△	Use to select items, numeric values, and symbols. Use to move the cursor.
DOWN key	▽	Use to select items, numeric values, and symbols. Use to move the cursor.
Entry key	○	Use to send one display item, confirm a selection, and register a setting.
UP key + Entry key	△+○	Press the UP key while holding down the Entry key. Use to return one display item in the same hierarchy.
Diagnostic indicator lamp STATUS		Displays the wave receipt error diagnosis. (Green) wave receipt normal, (red) wave receipt abnormal
Flow direction FLOW		It displays the flow direction. (Green) ◀ : Flow direction from right to left from the front of the flowmeter (Green) ▶ : Flow direction from left to right from the front of the flowmeter
Digit overflow display		Displayed when there is digit overflow.
Minus sign display		Displayed when the flow direction is reversed.
LED lamp		Displays measurement values and setting values. 4-digit 2-row 7-segment display, 1 to 3 decimal places
Unit display		Displays the flow rate and total value switchover, as well as the flow rate unit. Top (green): Liter (L) Middle (green): Gallons (US gal) Bottom (green): /min, ON: Flow rate display, OFF: Total value display

3.1.2. Description of measurement display

- LED lamp: Displays measurement values and setting values (4-digit, 2-row, 7-segment display).
 "Measurement display"
 - Measurement display indicates 2 types of flow rates and 3 types of total values. Press the Entry key to switch the display. The data unit is displayed with up to 4 digits.
 - When the displayed digits are over, the digit overflow display (•) at the top will light up in "red" for the most significant digit.
 - When it is a negative flow rate, the minus sign (-) will light up in "red" for the corresponding most significant digit.
 - When it is over the range, "OVER" will blink at the bottom of the LED display.
 - When the temperature sensor reaches a temperature outside the measurement range (-20 to 90°C), "T. ALM" will blink at the bottom of the LED display.
 - When a device error occurs, "E1-1", "E1-2" or "E1-3" will blink at the bottom of the LED display.
 - When a measurement error occurs, "E2-1", "E2-2", "E2-3", "E2-4" or "E2-5" will blink at the bottom of the LED display.
 - In test mode, "TEST" will blink at the top of the LED display.

- (1) Flow rate display 1
 Row 1: Instantaneous flow rate value
 Row 2: Instantaneous flow rate % value



The second row "P" displays "%".

- (2) Flow rate display 2
 Row 1: Instantaneous flow rate value
 Row 2: Pipe temperature



The second row "C" displays "degC".
 When there is no piping temperature measurement option, it will be "----".

- (3) Total value display
 Forward total flow rate
 (2-row 8-digit display)
 Most significant digit:
 Fourth digit at the top
 Least significant digit:
 First digit at the bottom



Unit display "/min" turns OFF.
 Press the Δ+▽ keys simultaneously to clear the total value to zero.

- Diagnostic indicator lamp STATUS: Displays the wave receipt error diagnosis.
 (Green) wave receipt normal, (red) wave receipt abnormal

3.1.3. 7-segment display

7-segment characters, numbers, and alphabetic characters used in the character display of the unit are supported.

Number and 7-segment character support

1 2 3 4 5 6 7 8 9 0
1234567890

Alphabetic character and 7-segment support

A B C D E F G H I J K L M N O P Q R S T U V W X Y Z
AbCdEfGh iJkL nNoP qR sT uU vW xYz

3.2. Composition of key operation

1. Measurement display

Press and hold for about 1 second
The underlined selection is the default value

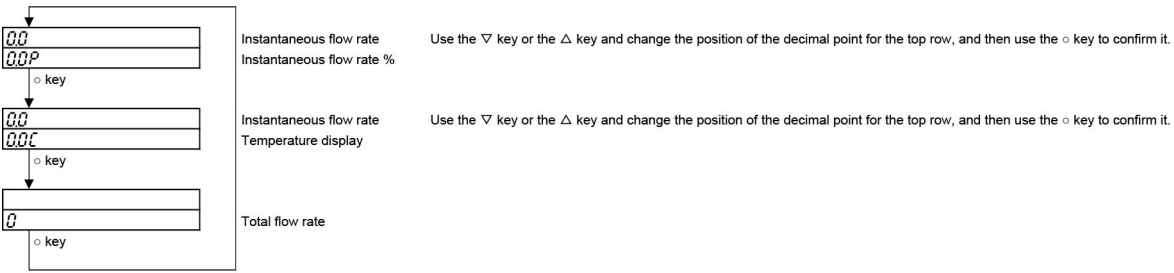

2. Initial setting

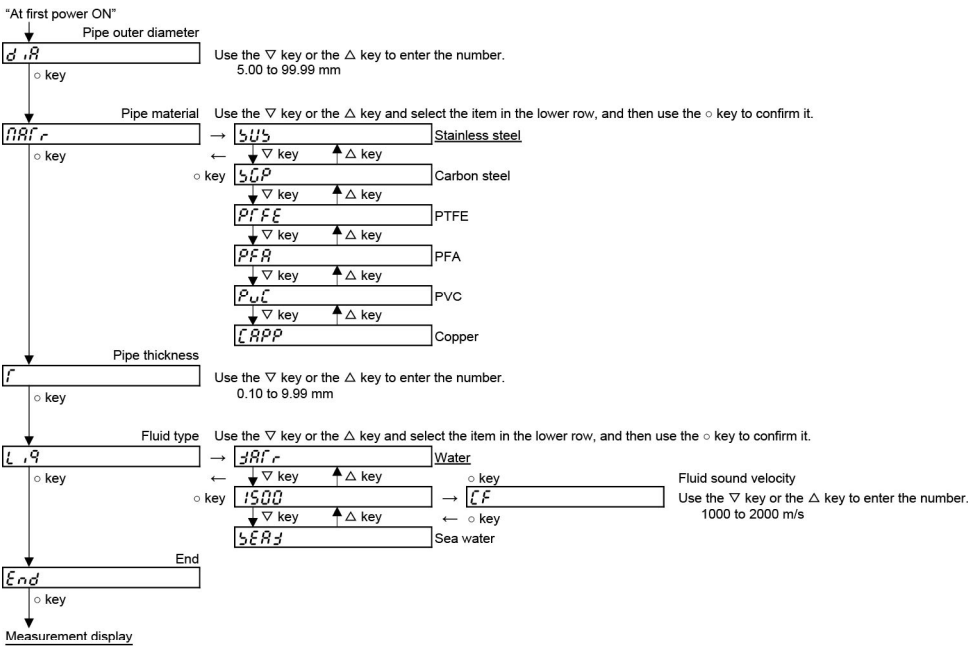

3. Key lock

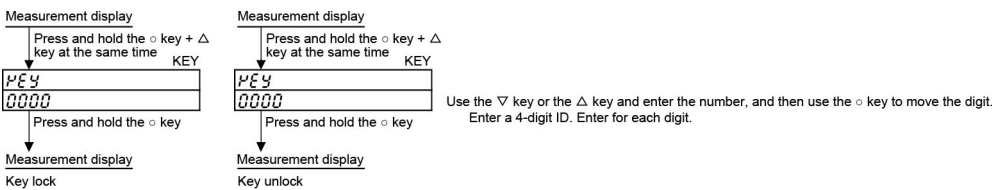

4. Zero point adjustment

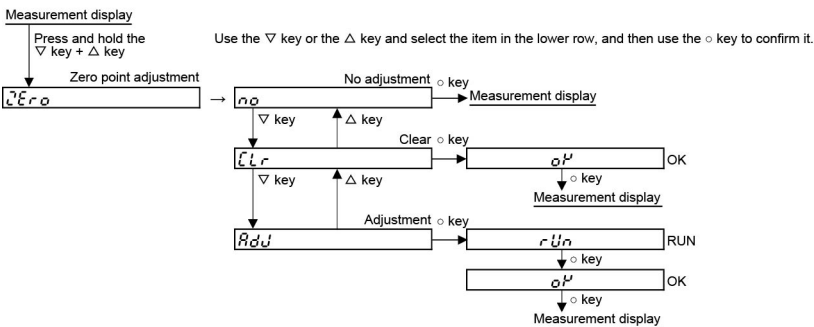

5. Application setting

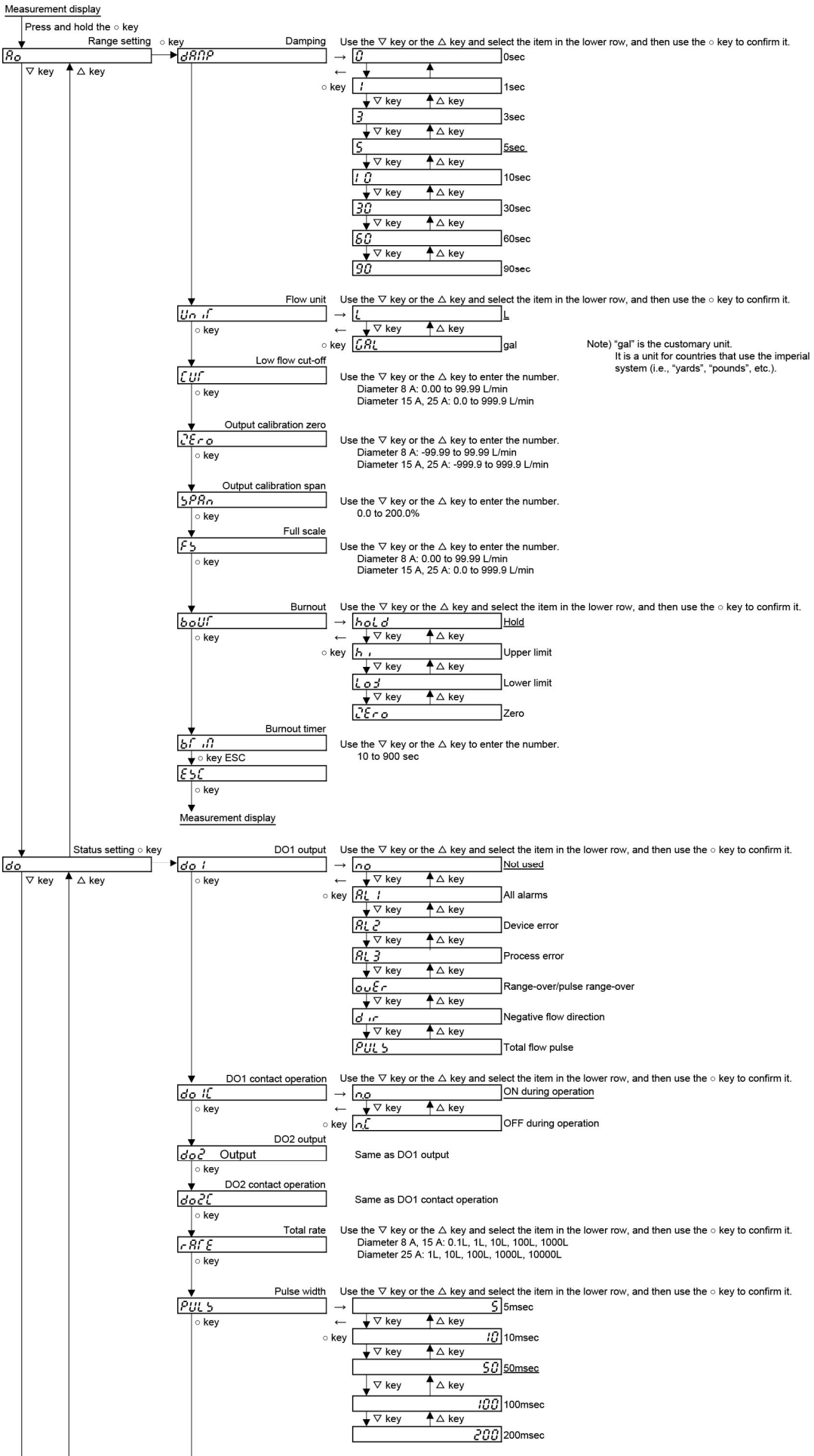

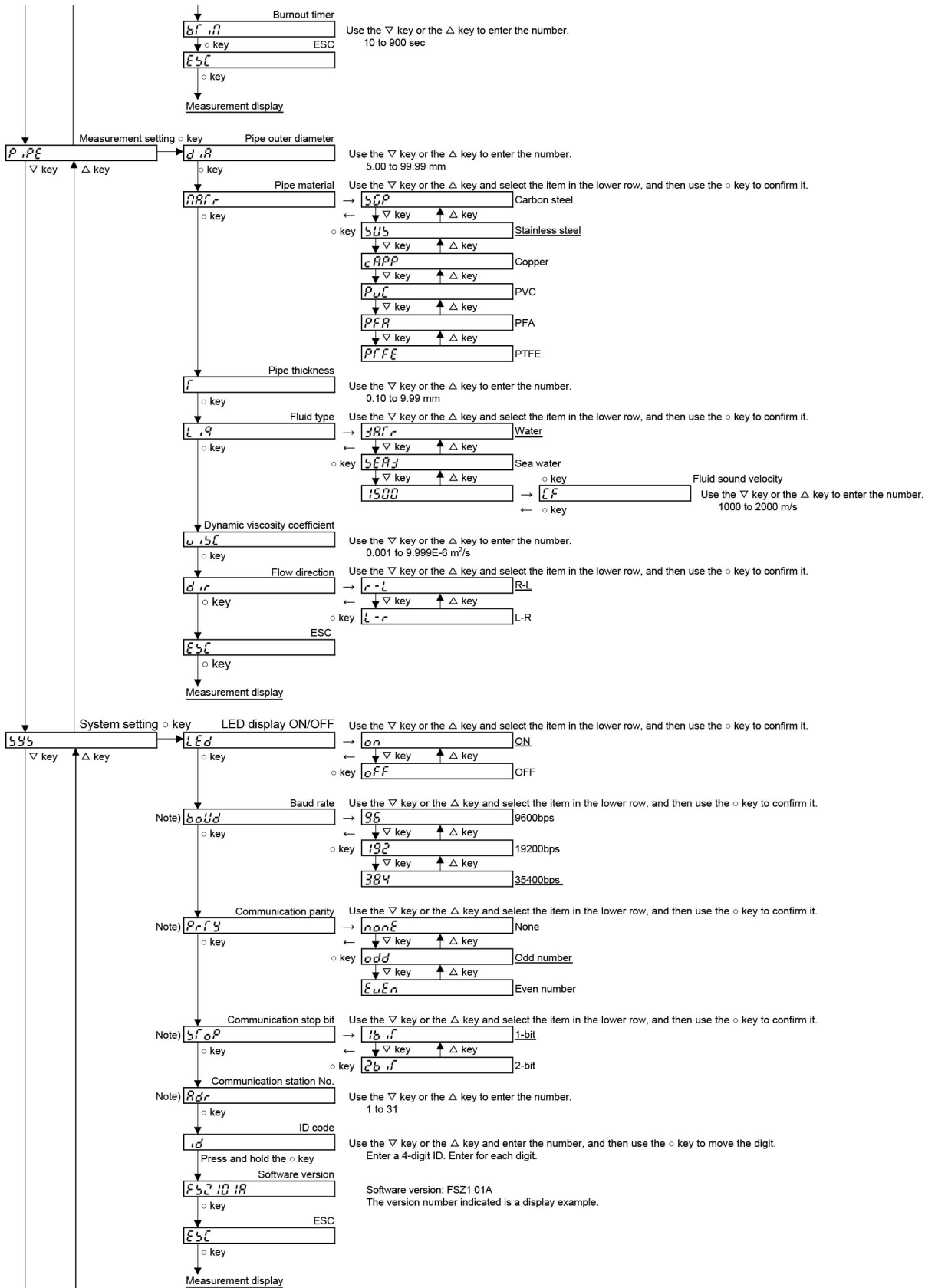

Note) No communication function is provided.

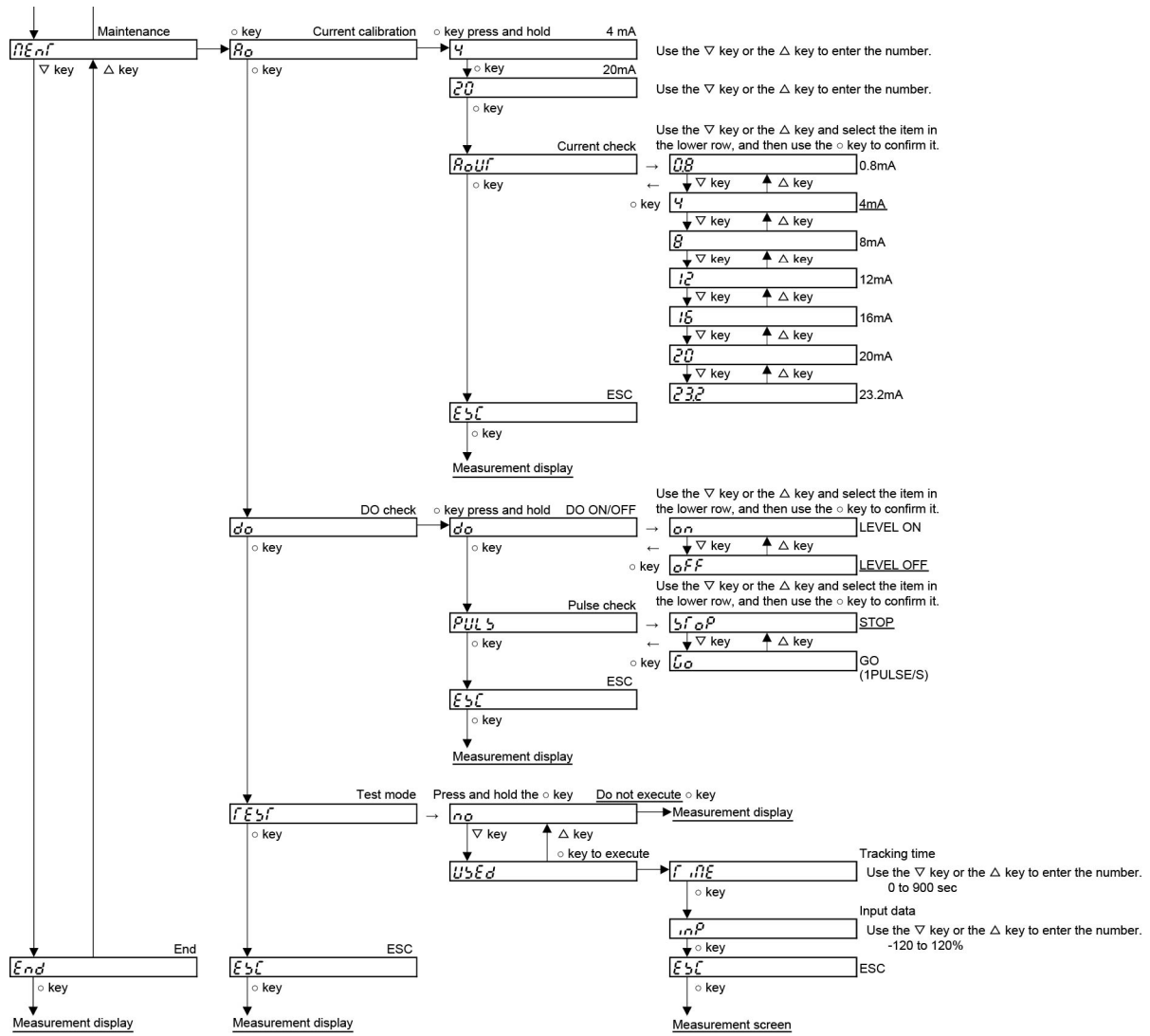

3.3. Parameter initial value list

These are factory default settings.

Setting item/7-segment display		Initial value 7-segment display		Setting range	
				7-segment display (selection items)	
1	Key lock	KEY	0000	0000 to 9999	
2	Zero point adjustment	ZERO	no	No adjustment, clear, adjustment no, CLR, ADJ	
3	Measurement display Instantaneous flow rate decimal place position	FSZ08	***.	**.,***.,****	[L/min]
		FSZ15	***.	***.,****	[L/min]
		FSZ25	****	***.,****	[L/min]
4	DAMPING	DAMP	5	0, 1, 3, 5, 10, 30, 60, 90 [sec]	
5	Flow unit	Unit	L	L L	
6	CUT OFF	FSZ08	0.15	0.00 to 99.99 [L/ min]	
		FSZ15	0.5	0.0 to 999.9 [L/ min]	
		FSZ25	1.5	0.0 to 999.9 [L/ min]	
7	CALIBRATION ZERO	FSZ08	0.00	-99.99 to 99.99 [L/ min]	
		FSZ15	0.0	-999.9 to 999.9 [L/ min]	
		FSZ25	0.0	-999.9 to 999.9 [L/ min]	
8	CALIBRATION SPAN	SPAN	1000	0.0 to 200.0 [%]	
9	FULL SCALE	FSZ08	1500	0.00 to 99.99 [L/ min]	
		FSZ15	500	0.0 to 999.9 [L/ min]	
		FSZ25	1500	0.0 to 999.9 [L/ min]	
10	Burnout	boff	hold	Hold, upper, lower, zero hold, h, LoJ, ZERO	
11	BURNOUT TIMER	bf n	10	10 to 900 [SEC]	
12	DO1 output	no		Not used, all alarms, device error, process error, range over/pulse range over, negative flow direction, total flow pulse no, AL 1, AL 2, AL 3, over, dir, PULS	
		no		ON when operating, OFF when operating no, nC	
		no		Not used, all alarms, device error, process error, range over/pulse range over, negative flow direction no, AL 1, AL 2, AL 3, over, dir	
		no		ON when operating, OFF when operating no, nC	
		no		ON when operating, OFF when operating no, nC	
13	DO1 contact operation	no		ON when operating, OFF when operating no, nC	
		no		ON when operating, OFF when operating no, nC	
		no		ON when operating, OFF when operating no, nC	
14	DO2 output	no		Not used, all alarms, device error, process error, range over/pulse range over, negative flow direction no, AL 1, AL 2, AL 3, over, dir	
		no		ON when operating, OFF when operating no, nC	
		no		ON when operating, OFF when operating no, nC	
15	DO2 contact operation	no		ON when operating, OFF when operating no, nC	
		no		ON when operating, OFF when operating no, nC	
		no		ON when operating, OFF when operating no, nC	
16	Total rate	FSZ08	10	0.1, 1, 10, 100, 1000 [L]	
		FSZ15	10	0.1, 1, 10, 100, 1000 [L]	
		FSZ25	100	1, 10, 100, 1000, 10000 [L] 1, 10, 100, 1000, 0000	
17	Pulse width	PULS	50	5, 10, 50, 100, 200 [msec]	
18	BURNOUT TIMER	bf n	10	10 to 900 [sec]	

	Setting item/7-segment display		Initial value		Setting range
			7-segment display		7-segment display
19	Piping outer diameter	<i>d . R</i>	FSZ08	<i>1380</i>	5.00 to 99.99 [mm]
			FSZ15	<i>2170</i>	
			FSZ25	<i>3400</i>	
20	Piping material	<i>RRFR</i>	<i>SUS</i>		Carbon steel, stainless steel, copper, PVC, PFA, PTFE <i>SOP, SUS, CAPP, PVC, PFA, PTFE</i>
21	Pipe thickness	<i>t</i>	FSZ08	<i>200</i>	0.10 to 9.99 [mm]
			FSZ15	<i>250</i>	
			FSZ25	<i>300</i>	
22	Kind of fluid	<i>L . R</i>	<i>RRFR</i>		Water, seawater, 1500 <i>RRFR, SEAJ, 1500</i>
23	Fluid sound velocity	<i>CF</i>	<i>1500</i>		1000 to 2000 [m/s]
24	Dynamic viscosity coefficient	<i>u . b C</i>	<i>1004</i>		0.001 to 9.999 [E-6m ² /s]
25	Flow direction	<i>d ir</i>	<i>r - L</i>		R-L, L-R <i>r - L, L - r</i>
26	LED display ON/OFF	<i>LED</i>	<i>on</i>		ON, OFF <i>on, off</i>
27	Communication baud rate (Note)	<i>baud</i>	<i>384</i>		9600 bps, 1: 19200 bps, 2: 38400 bps <i>96, 192, 384</i>
			<i>odd</i>		None, 1: Odd, 2: Even <i>none, odd, even</i>
28	Communication parity (Note)	<i>PRFY</i>	<i>odd</i>		None, 1: Odd, 2: Even <i>none, odd, even</i>
29	Communication stop bit (Note)	<i>stop</i>	<i>1b if</i>		1 bit, 1: 2 bits <i>1b if, 2b if</i>
30	Communication station No. (Note)	<i>Adr</i>	<i>01</i>		01 to 31
31	ID code	<i>id</i>	<i>0000</i>		0000 to 9999

Note) No communication function is provided.

3.4. Setting when the power is turned ON for the first time

Description

- Sets parameters for piping and measurement fluids.
You can set and change them later in 3.8 Measurement settings.



CAUTION

Be sure to set the following parameters before mounting the flowmeter to a pipe.

- Set the accurate pipe outer diameter and wall thickness dimensions. Otherwise, performance can be impaired.
- If the exact parameters are not set, there will be large measurement errors.
- Wave receipt errors may also occur.

Item

- Pipe outer diameter : 5.00 to 99.99 [mm] (Factory default: FSZ08: 13.80, FSZ15: 21.70, FSZ25: 34.00 [mm])
- Pipe material : Carbon Steel, stainless steel (factory default), copper, PVC, PFA, PTFE
- Pipe thickness : 0.10 to 9.99 [mm] (factory default: FSZ 08: 2.00, FSZ 15: 2.50, FSZ 25: 3.00 [mm])
- Measurement fluids : Water (factory default), seawater, fluid sound velocity
Fluid sound velocity: (Sound velocity: 1000 to 2000 [m/s])

For specific key operations, refer to the typical operation indicated below.

Operation (example)

Display and keystrokes	Description
1 Measurement display ○ Key	Press the ○ key to go to Display 2.
2 d. A 13.80 ○ Key	Pipe outer diameter: 5.00 to 99.99 [mm] Press the Δ∇ keys to set the values. Press the ○ key to go to Display 3.
3 MATERIAL SUS ○ Key	Pipe material: Carbon steel, stainless steel, copper, PVC, PFA, PTFE SUS, SUS, CFPP, PVC, PFA, PTFE Press the Δ∇ keys to set the items. Press the ○ key to go to Display 4.
4 r 2.00 ○ Key	Pipe thickness: 0.10 to 9.99 [mm] Press the Δ∇ keys to set the values. Press the ○ key to go to Display 5.
5 L. 9 MATERIAL ○ key, ○ key	Measurement fluids: Water, seawater, fluid sound velocity MATERIAL, SEAW, 1500 (initial values) Press the Δ∇ keys to set the items. Select water or seawater and press the ○ key to go to Display 7. Select the fluid sound velocity and press the ○ key to go to Display 6.
6 CF 1500 ○ Key	Fluid speed velocity: 1000 to 2000 [m/s] Press the Δ∇ keys to set the values. Press the ○ key to go to Display 7.
7 End ○ Key	Press the ○ key to return to the measurement display.
8 Measurement display	

3.5. Measurement display setting

Description

- The measurement display indicates 2 types of flow rates and 3 types of total values.
- Flow display 1
Row 1: Instantaneous flow value, Row 2: Instantaneous flow rate % value
You can set the decimal place position of the instantaneous flow rate value for the first row.
- Flow display 2
Row 1: Instantaneous flow rate value, Row 2: Temperature display
You can set the decimal place position of the instantaneous flow rate value for the first row.
- Total flow value
Forward total flow value (2-row 8-digit display)
Most significant digit: Fourth digit on top
Least significant digit: First digit on bottom

Item

1. Decimal places : FSZ08:***.*** (factory default**.)
 FSZ15:***.*** (factory default**.)
 FSZ25:***.*** (factory default**.)

For specific key operations, refer to the typical operation indicated below.

Operation (example)

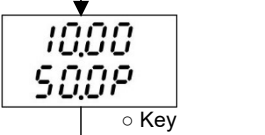
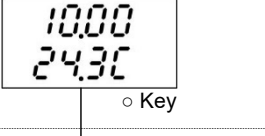
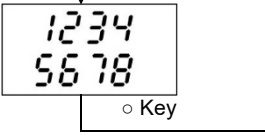
	Display and keystrokes	Description
1		<p>Flow rate display 1 Press the Δ/∇ keys to set the decimal places for the first row. Press the \circ key to change the decimal places. Press the \circ key to go to Flow display 2.</p>
2		<p>Flow rate display 2 Press the Δ/∇ keys to set the decimal places for the first row. Press the \circ key to change the decimal places. Press the \circ key to go to Flow display 3.</p>
3		<p>Total value display (2-row 8-digit display) Most significant digit: Fourth digit at the top Least significant digit: First digit at the bottom</p>





3.6. Parameter protection (protect)

Description

- You can protect parameters to prevent accidental changes to the flowmeter settings.
- You can lock the unprotected parameters by setting the "ID code" (Note) in the system settings.
- You can unlock the protected parameters by setting the "ID code" (Note) in the system settings.
- (Note) 4-digit The factory default setting is "0000". (Refer to 3.11.2)

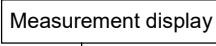
For specific key operations, refer to the typical operation indicated below.

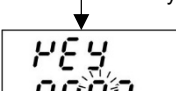
Operation (example)

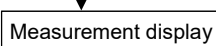
Display and keystrokes	Description
<p>1</p>  <p>Press and hold the ◯ key + △ key at the same time</p> <p>2</p>  <p>◯ Key</p> <p>3</p>  <p>◯ Key</p> <p>4</p>  <p>◯ Key</p> <p>5</p>  <p>◯ Key</p> <p>Press and hold the ◯ key</p> <p>6</p>  <p>7</p> 	<p>Press the ◯ key + △ key directly at the same time to go to Display 2.</p> <p>When the fourth digit of the ID code blinks, it will enter into the input status. Press the △▽ keys to set the values. Press the ◯ key to go to Display 3.</p> <p>When the third digit of the ID code blinks, it will enter into the input status. Press the △▽ keys to set the values. Press the ◯ key to go to Display 4.</p> <p>When the second digit of the ID code blinks, it will enter into the input status. Press the △▽ keys to set the values. Press the ◯ key to go to Display 5.</p> <p>When the first digit of the ID code blinks, it will enter into the input status. Press the △▽ keys to set the values. Press the ◯ key to go to Display 2. Press and hold the ◯ key to go to Display 6.</p> <ul style="list-style-type: none"> •Execute this operation while the parameters are unprotected to protect them with a lock. After the "LOCK" display on the left blinks, it will return to the measurement display. •Execute this operation while the parameters are protected to unlock the protection. After the "ENE" display on the left blinks, it will return to the measurement display.

! CAUTION

Changing parameter settings

If the parameters of the flow transmitter set for analog output or alarm output are changed after start of use or while being used, the output may suddenly change after the item affecting the output or alarm is changed, causing an output abnormality or alarm. In particular, if output signals are used for control, change the parameters after performing signal lock processing on the system side in advance.

Notes on changing parameter settings

To change the parameter settings, press the Entry key to store the parameters in the internal nonvolatile memory. The stored parameters will be saved when the power is turned OFF.

If you change the parameter settings and shut down without pressing the Entry key, the parameters will not be saved and must be reconfigured.

3.7. Zero point adjustment

Description

- Calibrates the zero point.

No adjustment : Does not adjust the zero point.

"no"

Clear : Sets the zero point calibration value to "0".

"CLR"

Use it when zero point calibration cannot be performed after stopping the flow.
 Note 1) Stop the flow as much as possible and perform "ADJ" described below.
 A zero point error may occur.

Adjustment : Sets the "ADJ" state to zero.

"ADJ"

Use it to perform zero point calibration after stopping the flow.
 Note 2) Stop the flow completely.
 If it is performed without stopping the flow, an error will occur due to it attempting to become zero.

The adjustment could take 10 seconds or considerably longer depending on the pipe diameter.

Note) Display Flow display 1 and Flow display 2 on the measurement display to perform zero point calibration.

For specific key operations, refer to the example operations indicated below.

Operation (example)	
Display and keystrokes	Description
<p>1</p> <div style="border: 1px solid black; padding: 5px; width: fit-content; margin-bottom: 10px;">Measurement display</div> <p style="text-align: center;">Press and hold the Δ key + ∇ key at the same time</p> <p>2</p> <div style="display: flex; align-items: center;"> <div style="border: 1px solid black; padding: 5px; margin-right: 10px;"> 0Err no </div> <div style="text-align: right;">No adjustment</div> </div> <p style="text-align: center;">○ Key</p> <div style="display: flex; justify-content: space-between;"> <div style="width: 30%;"> <p>Adjus</p> </div> <div style="width: 30%;"> <p>Clear</p> </div> <div style="width: 30%;"> <p>No adjustment</p> </div> </div> <p>3</p> <div style="border: 1px solid black; padding: 5px; margin-bottom: 10px;"> ADJ rUN </div> <p style="text-align: center;">○ Key</p> <p>4</p> <div style="border: 1px solid black; padding: 5px; margin-bottom: 10px;"> ADJ OK </div> <p style="text-align: center;">○ Key</p>	<p>Set Flow display 1 and Flow display 2. Press the Δ key + ∇ key directly at the same time to go to Display 2.</p> <p>Zero point adjustment: No adjustment, clear, adjustment no, CLR, ADJ</p> <p>Press the $\Delta$$\nabla$ keys to set the items. When you select adjustment and press the ○ key, it changes to Display 3.</p> <p>Execute adjustment to display "ADJ" on the first row and cause "RUN" to blink on the second row. The adjustment will take 10 seconds or longer, and it will then go to Display 4.</p> <p>Adjustment is complete. Press the ○ key to return to the measurement display.</p> <p>Note) If adjustment is executed when there is a measurement error, an adjustment error will occur and "Err" will blink.</p>
<p>5</p> <div style="display: flex; align-items: center; justify-content: center;"> <div style="border: 1px solid black; padding: 5px; margin-right: 10px;"> CLR OK </div> <div style="text-align: right;">○ key</div> </div> <p>6</p> <div style="border: 1px solid black; padding: 5px; width: fit-content;">Measurement display</div>	<p>Execute Clear to display "CLR" on the first row and cause "OK" to blink on the second row. Press the ○ key to return to the measurement display.</p>

3.8. Measurement settings

3.8.1. Piping parameter setting method

Description

- Sets parameters for piping and measurement fluids.



Be sure to set the following parameters before mounting the flowmeter to a pipe.

- Set the accurate pipe outer diameter and wall thickness dimensions. Otherwise, performance can be impaired.
- If the exact parameters are not set, there will be large measurement errors.
- Wave receipt errors may also occur.

Item

1. Pipe outer diameter : 5.00 to 99.99 [mm] (Factory default: FSZ08: 13.80, FSZ15: 21.70, FSZ25: 34.00 [mm])
2. Pipe material : Carbon Steel, stainless steel (factory default), copper, PVC, PFA, PTFE
3. Pipe thickness : 0.10 to 9.99 [mm] (factory default: FSZ 08: 2.00, FSZ 15: 2.50, FSZ 25: 3.00 [mm])
4. Measurement fluids : Water (factory default), seawater, fluid sound velocity
Fluid sound velocity: (Sound velocity: 1000 to 2000 [m/s])
5. Dynamic viscosity coefficient : (Factory default: 1.004×10^{-6} [m²/s])
6. Flow direction : R-L, L-R
R-L: Flow direction from right to left from the front of the flowmeter
L-R: Flow direction from left to right from the front of the flowmeter

For specific key operations, refer to the example in 3.8.2.

3.8.2. Key operations for measurement settings

Operation (example)	Description
<p>1</p> <p>Press and hold the ○ key</p>	Press and hold the ○ key to go to Display 2.
<p>2</p> <p>○ Key</p>	Press the ▽ key twice and select "SET PIPE". Press the ○ key to go to Display 3.
<p>3</p> <p>○ Key</p>	Pipe outer diameter: 5.00 to 99.99 [mm] Press the Δ▽ keys to set the values. Press the ○ key to go to Display 4.
<p>4</p> <p>○ Key</p>	Pipe material: Carbon steel, stainless steel, copper, PVC, PFA, PTFE 50P, 505, CRPP, PVC, PFA, PTFE *For PP or PVDF, select "PVC". Press the Δ▽ keys to set the items. Press the ○ key to go to Display 5.
<p>5</p> <p>○ Key</p>	Pipe thickness: 0.10 to 9.99 [mm] Press the Δ▽ keys to set the values. Press the ○ key to go to Display 6.
<p>6</p> <p>○ key</p> <p>○ key</p>	Measurement fluids: Water, seawater, fluid sound velocity 3000, SEAS, 1500 (initial values) Press the Δ▽ keys to set the items. Select water or seawater and press the ○ key to go to Display 8. Select the fluid sound velocity and press the ○ key to go to Display 7.

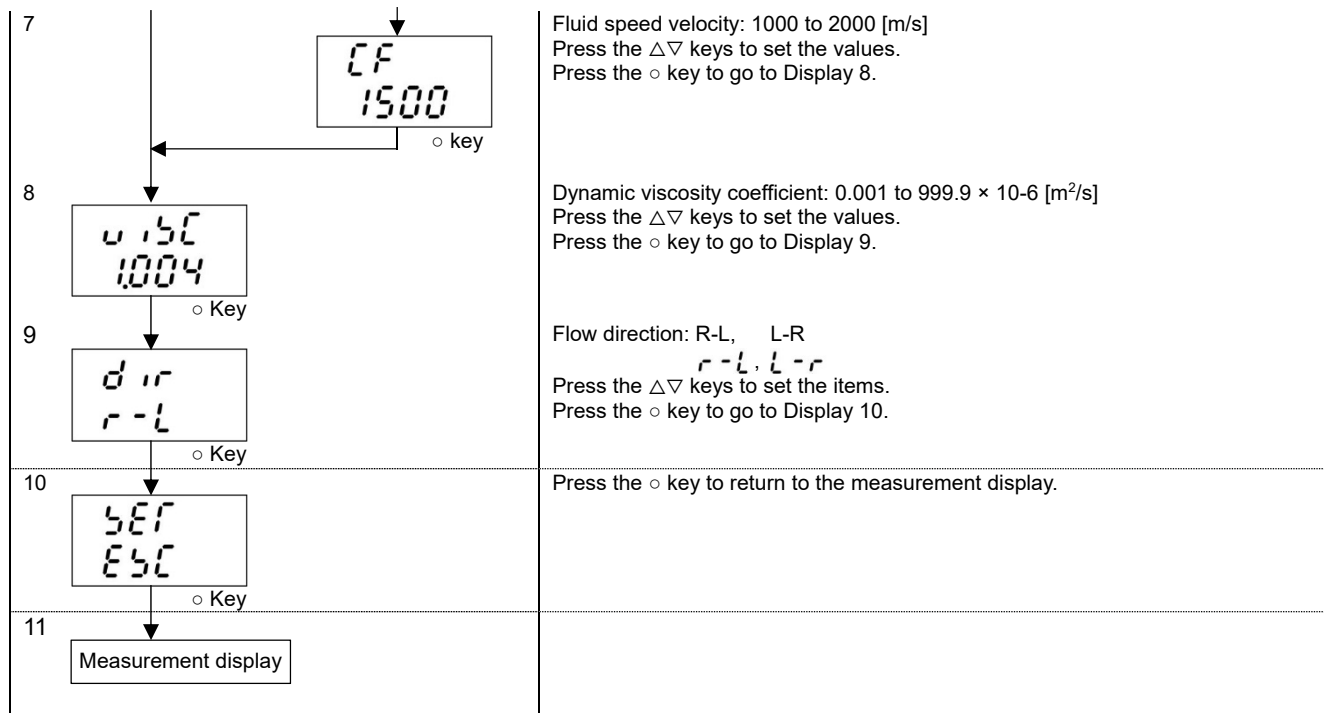

3.9. Range setting

3.9.1. Damping

Description

- Used to reduce fluctuation of measured values.
The setting value is a time constant. (Response time of about 63%.)
Setting range: 0 sec, 1 sec, 3 sec, 5 sec, 10 sec, 30 sec, 60 sec, 90 sec

Note) When the damping setting is set to 0 seconds, the response time is as follows.

- System cycle 0.2 sec
- Elapsed time of 0.2 sec or less; Time constant of 0.1 sec

For specific key operations, refer to the example in 3.9.7.

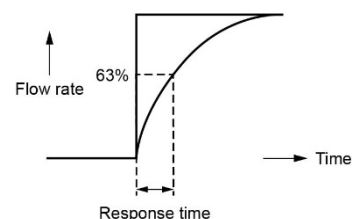

3.9.2. Flow rate unit setting

Description

- You can set the flow rate unit and total value unit from two different systems of measurement, i.e., the metric and imperial systems.
- Metric system (factory default) L
When L is set, the flow rate unit becomes L/min.
When L is set, the total value unit becomes L.

For specific key operations, refer to the example in 3.9.7.

3.9.3. Low-flow cutoff setting

Description

- Output can be cut off when the flow rate is low.
- Enabled for display, analog output (4 to 20 mA), and total value.

Setting range: FSZ08: 0.00 to 99.99 [L/min], (Factory default 0.15 [L/min])
FSZ15: 0.0 to 999.9 [L/min], (Factory default 0.5 [L/min])
FSZ25: 0.0 to 999.9 [L/min], (Factory default 1.5 [L/min])

Note 1) The flowmeter may issue a flow indication when the fluid in the piping is moving due to convection, even when the valve is closed. Therefore, set the low-flow cutoff point as necessary.

Note 2) The flow rate unit is the unit selected in "Flow rate unit". (Refer to 3.9.2)

For specific key operations, refer to the example in 3.9.7.

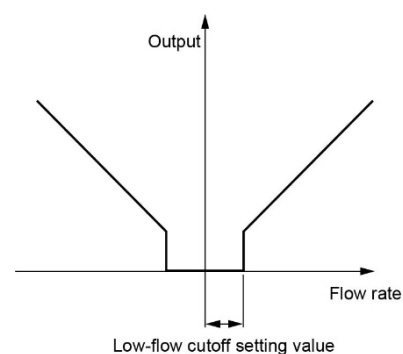

3.9.4. Method for correcting measurement value

Description

- Used when you want to arbitrarily adjust the measurement value.
Zero point and span adjustments are possible.

Setting range

- (1) Zero point: FSZ08: -99.99 to 99.99 [L/min], (Factory default 0.00 [L/min])
FSZ15: -999.9 to 999.9 [L/min], (Factory default 0.0 [L/min])
FSZ25: -999.9 to 999.9 [L/min], (Factory default 0.0 [L/min])

- (2) Span: 0.0 to 200.0%

The output value (display value, analog output, and total value output) is calculated using the following formula.

$$\text{Output} = \frac{\text{Measured value} \times [\text{Span}\%]}{100} + \text{Zero point}$$

Note 1: The flow rate unit is the unit selected in "Flow rate unit". (Refer to 3.9.2)

For specific key operations, refer to the example in 3.9.7.

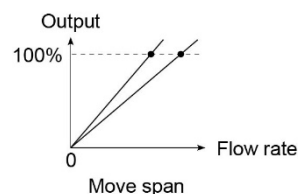
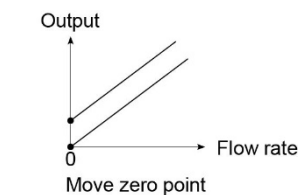

3.9.5. Range setting

Description

- Sets the range value (full scale value) for the flow rate being measured.
 - * The analog output (4 to 20 mA) corresponds to the range setting.
 - Setting range: FSZ08: 0.00 to 99.99 [L/min], (Factory default 15.00 [L/min])
 FSZ15: 0.0 to 999.9 [L/min], (Factory default 50.0 [L/min])
 FSZ25: 0.0 to 999.9 [L/min], (Factory default 150.0 [L/min])
 - * The lower limit of output is -20% (0.8 mA).
 - * The upper limit of output is 120% (23.2 mA).
- Note 1: The flow rate unit is the unit selected in "Flow rate unit". (Refer to 3.9.2)

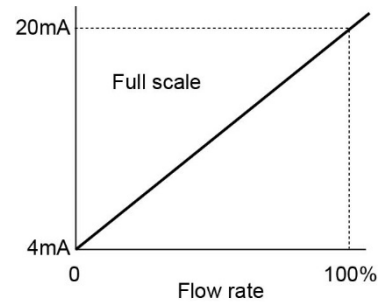

For specific key operations, refer to the example in 3.9.7.



3.9.6. Analog output setting at time of error (burnout)

Description

- Establishes measures for dealing with analog output in the case where wave receipt errors, etc. occur due to device errors or air-bubble contamination inside the pipe.
- Setting range
 - (1) Analog output (4 to 20 mA) setting range at time of error
 - Hold : Outputs the current value immediately before the error occurred. (Factory default setting)
 - Upper limit : Sets the analog output to the upper limit of 23.2 mA for the output limit (overscale)
 - Lower limit : Sets the analog output to the lower limit of 0.8 mA for the output limit (underscale)
 - Zero : Outputs 4 mA.
 - (2) Burnout timer (time from error detection to burnout processing) of 10 to 900 seconds (the factory default value is 10 seconds)
 - * The LED display works with the analog output during the burnout process.

For specific key operations, refer to the example in 3.9.7.

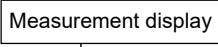
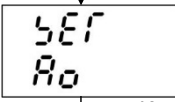
3.9.7. Key operations for range settings

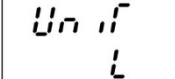
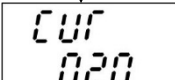
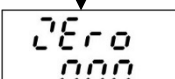
Operation (example)	
Display and keystrokes	Description
1  Press and hold the ◯ key	Press and hold the ◯ key to go to Display 2.
2  ◯ Key	Displays "SET AO". Press the ◯ key to go to Display 3.
3  ◯ Key	Damping: 0 sec, 1 sec, 3 sec, 5 sec, 10 sec, 30 sec, 60 sec, 90 sec Press the Δ∇ keys to set the items. Press the ◯ key to go to Display 4.
4  ◯ Key	Flow rate unit: L Press the Δ∇ keys to set the items. Press the ◯ key to go to Display 5.
5  ◯ Key	Low flow cut-off: FSZ08: 0.00 to 99.99, FSZ15: 0.0 to 999.9, FSZ25: 0.0 to 999.9 [L/min] Press the Δ∇ keys to set the values. Press the ◯ key to go to Display 6.
6  ◯ Key	Output calibration zero FSZ08: -99.99 to 99.99, FSZ15: -999.9 to 999.9, FSZ25: -999.9 to 999.9 [L/min] Press the Δ∇ keys to set the values. Press the ◯ key to go to Display 7.

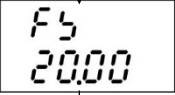
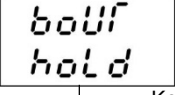
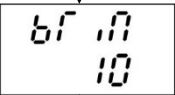
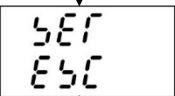
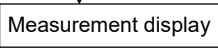
<p>7</p>  <p>○ Key</p> <p>8</p>  <p>○ Key</p> <p>9</p>  <p>○ Key</p>	<p>Output calibration span: 0.0 to 200.0 [%] Press the Δ/∇ keys to set the values. Press the ○ key to go to Display 8.</p> <p>Full scale: FSZ08: 0.00 to 99.99, FSZ15: 0.0 to 999.9, FSZ25: 0.0 to 999.9 [L/min] Press the Δ/∇ keys to set the values. Press the ○ key to go to Display 9.</p> <p>Burnout: Hold, upper limit, lower limit, zero <i>hold, hi, lo, zero</i> Press the Δ/∇ keys to set the items. Press the ○ key to go to Display 10.</p>
<p>10</p>  <p>○ Key</p>	<p>Burnout timer: 10 to 900 [sec] Press the Δ/∇ keys to set the values. Press the ○ key to go to Display 11.</p>
<p>11</p>  <p>○ Key</p>	<p>Press the ○ key to return to the measurement display.</p>
<p>12</p> 	

3.10. Status settings

3.10.1. DO output settings

Description

- Selects the total pulse and status (warning and flow rate switch, total switch, etc.) output.

- DO output types (common to DO1 and DO2):

Settable range

Not used	:	<i>no</i>	:	Does not use the contact output.
All alarm	:	<i>AL1</i>	:	Contact output is activated upon instances of device error or process error
Device error	:	<i>AL2</i>	:	Contact output is activated when a circuit error (memory, etc.) or a temperature circuit error occurs.
Process error	:	<i>AL3</i>	:	Contact output is activated when no waves are received or waves are unstable.
Range-over/Pulse range-over	:	<i>over</i>	:	Contact output is activated when the instantaneous flow rate exceeds the upper limit of 120% or lower limit of -20% of the range. Contact output is activated when the flow rate total pulse output exceeds the maximum frequency limit.
Negative flow direction	:	<i>dir</i>	:	Contact output is activated when the flow is in the reverse direction.
Forward total flow pulse	:	<i>PUL5</i>	:	Outputs the forward total flow pulse.

<Note> Only DO1 is set for forward total flow pulse.

Contact operation

Operation ON	:	<i>no</i>	:	Normally OFF
Operation OFF	:	<i>nc</i>	:	Normally ON



CAUTION

- When the contact operation setting is "Operation OFF", DO is output when the power is turned ON.
- Before setting, confirm in advance that you want to change the DO output.

<Note> DO output specification

DO1/DO2 : Open collector, contact capacity 27.5 V DC, 100 mA

When total pulse output is selected

(Note: Refer to 3.10.2 Total flow pulse setting (total rate, pulse width))

100 pulses/sec or less (at full scale flow rate)

Pulse width: 5 ms, 10 ms, 50 ms, 100 ms, 200 ms

For specific key operations, refer to the example in 0.

3.10.2. Total flow pulse setting (total rate, pulse width)

Description

- When totaling the flow rate into the integrator, set the output pulse as follows.
- Total rate: Total rate (volume) per pulse.

When the total volume reaches the amount set by the total flow rate, one total flow pulse is output.

Setting range: FSZ08: 0.1, 1, 10, 100, 1000 [L] (Factory default: 10 [L])

FSZ15: 0.1, 1, 10, 100, 1000 [L] (Factory default 10 [L])

FSZ25: 1, 10, 100, 1000, 10000 [L] (Factory default 100 [L])

*The unit of the total flow rate is the unit selected in the "Flow rate unit". (Refer to 3.9.2)

Note 1: Setting the total flow rate clears the total value to zero.

- Pulse width: The pulse width of the total pulse output.
Select the pulse width from the menu according to the corresponding integrator. Setting range: 5 ms, 10 ms, 50 ms, 100 ms, 200 ms
- Setting limits

The maximum output frequency for the total pulse output is limited according to the pulse width settings.

Pulse width	Frequency range of pulse output (At full-scale flow rate)
5 ms	100 pulses per sec
10 ms	50 pulses per sec
50 ms	10 pulses per sec
100 ms	5 pulses per sec
200 ms	2 pulses per sec

Set the pulse width and total rate so that both conditions 1 and 2 below are satisfied.

If the setting does not satisfy conditions 1 and 2, it may not perform the correct operation.

Condition 1:

$$\frac{\text{Full-scale (Note 1) [L/s]}}{\text{Total flow rate [L]}} \leq 100 \text{ [Hz]}$$

Condition 2:

$$\frac{\text{Full-scale (Note 1) [L/s]}}{\text{Total flow rate [L]}} \leq \frac{100}{2 \times \text{Pulse width [ms]}}$$

Note 2: The DO1 maximum output frequency limit also applies if the volume flow rate exceeds the setting range. Therefore, if the volume flow rate exceeds 100% when the maximum frequency is set at 100% of the flow setting range, the total pulse output may not be able to follow and the accurate total value may not be obtained if over-range continues for an extended amount of time. Therefore, when the volume flow rate exceeds 100%, revise the range or the total constant and set the maximum frequency to be below the limit.

Calculation example

Find the range where the total rate can be set for the following range and pulse width.

When the set values of the range and pulse width are as follows:

Flow full scale: 60 [L/min] (= 1 [L/s]), Pulse width: 50 [ms]

According to Condition 1

$$\text{Total flow rate} \geq \frac{\text{Full-scale [L/s]}}{100 \text{ [Hz]}} = \frac{1 \text{ [L/s]}}{100 \text{ [Hz]}} = 0.01 \text{ [L]}$$

According to the above:

0.01 [L] =< Total flow rate A

According to 2:

$$\text{Total flow rate} \geq \text{Full-scale [L/s]} \times \frac{2 \times \text{Pulse width [ms]}}{1000} = 1 \text{ [L/s]} \times \frac{2 \times 50 \text{ [ms]}}{1000} = 0.1 \text{ [L]} \dots\dots\dots B$$

The range in which the total constant satisfying both conditions 1 and 2 can be set is as follows from the calculation results A and B.

0.1 [L] ≤ Total flow rate

For specific key operations, refer to the example in 0.

3.10.3. Totalization processing setting at time of error (burnout)

Description

Burnout timer (total value)

- Set totalization processing for measurement errors that may occur due to such reasons as air-bubble contamination in the fluid. (same for both total display, total pulse output)
- Sets the time from the occurrence of an error to the time when the error is handled.
- Setting range: 10 to 900 sec (Factory default: 10 sec)
The totalization continues until the burnout timer starts. After the burnout timer is activated, the totalization stops.

For specific key operations, refer to the example in 0.

3.10.4. Key operations for status settings

Operation (example)		
	Display and keystrokes	Description
1	<div style="border: 1px solid black; padding: 2px; display: inline-block;">Measurement display</div> ↓ Press and hold the ○ key	Press and hold the ○ key to go to Display 2.
2	<div style="border: 1px solid black; padding: 2px; display: inline-block;">SET do</div> ↓ ○ Key	Press the ▽ key once and select "SET DO". Press the ○ key to go to Display 3.
3	<div style="border: 1px solid black; padding: 2px; display: inline-block;">do 1 no</div> ↓ ○ Key	DO1 output: Not used, all alarms, device error, process errors, range over/pulse range over, negative flow direction, total flow pulse <i>no, AL 1, AL 2, AL 3, ouEr, d ir, PUL 5</i>
4	<div style="border: 1px solid black; padding: 2px; display: inline-block;">do 1C no</div> ↓ ○ Key	DO1C: ON when operating, OFF when operating <i>no, nC</i>
5	<div style="border: 1px solid black; padding: 2px; display: inline-block;">do 2 no</div> ↓ ○ Key	DO2 output: Not used, all alarms, device error, process errors over/pulse range over, negative flow direction <i>no, AL 1, AL 2, AL 3, ouEr, d ir</i>
6	<div style="border: 1px solid black; padding: 2px; display: inline-block;">do 2C no</div> ↓ ○ Key	DO1C: ON when operating, OFF when operating <i>no, nC</i>
7	<div style="border: 1px solid black; padding: 2px; display: inline-block;">rATE 10</div> ↓ ○ Key	Total rate: FSZ08: 0.1, 1, 10, 100, 1000, FSZ15: 0.1, 1, 10, 100, 1000 FSZ25: 1, 10, 100, 1000, 10000 [L]
8	<div style="border: 1px solid black; padding: 2px; display: inline-block;">PUL 5 50</div> ↓ ○ Key	Pulse width: 5 ms, 10 ms, 50 ms, 100 ms, 200 ms
9	<div style="border: 1px solid black; padding: 2px; display: inline-block;">bf in 10</div> ↓ ○ Key	Burnout timer: 10 to 900 [sec]
10	<div style="border: 1px solid black; padding: 2px; display: inline-block;">SET ESC</div> ↓ ○ Key	Press the ○ key to return to the measurement display.
11	<div style="border: 1px solid black; padding: 2px; display: inline-block;">Measurement display</div>	

3.11. System settings

3.11.1. ON/OFF setting of measurement display

Description

- This function turns the LED display ON and OFF.
- Even when set to OFF, the diagnostic indicator lamp STATUS and the flow direction FLOW LED will still be ON.

Settings

LED display ON/OFF: The "ON" LED is always ON.

: After "OFF" is set, the measurement display will turn OFF 3 minutes later.

The LED turns ON during key operation and turns OFF after 3 minutes if no key is pressed.

For specific key operations, refer to the example in 3.11.4.

3.11.2. How to set the ID No.

Description

- You can set an ID No. to enable protection (Refer to 3.6).
If an ID No. is set, you will need to enter the ID No. when unlocking the protection.
ID No. setting range: 0000 to 9999 (4 digits)

For specific key operations, refer to the example in 3.11.4. Set the protection to OFF beforehand. (See Section 3.6)

Contact us if you forget the set ID No.

3.11.3. How to check the software version

Description

- Displays the software version.

For specific key operations, refer to the example in 3.11.4.

3.11.4. Key operations for system settings

Operation (example)		
Display and keystrokes		Description
1 Measurement display ↓ Press and hold the ○ key		Press and hold the ○ key to go to Display 2.
2 SET SYS ○ Key		Press the ▽ key three times and select "SET SYS". Press the ○ key to go to Display 3.
3 LED on ○ Key		LED display ON/OFF: ON, OFF <i>on, off</i> Press the Δ▽ keys to set the items. Press the ○ key to go to Display 4.
4 baud 384 ○ Key		Transmission speed (baud rate): 9600 bps, 19200 bps, 38400 bps Note) <i>96, 192, 384</i> Press the Δ▽ keys to set the items. Press the ○ key to go to Display 5.
5 Parity odd ○ Key		Parity: None, Odd, Even Note) <i>none, odd, even</i> Press the Δ▽ keys to set the items. Press the ○ key to go to Display 6.
6 SfOP 1b if ○ Key		Speed bit: 1-bit, 2-bit Note) <i>1b if, 2b if</i> Press the Δ▽ keys to set the items. Press the ○ key to go to Display 7.
7 Adr 1 ○ Key		Station No. 1 to 31 Note) Note) Does not come with communication function. Press the Δ▽ keys to set the values. Press the ○ key to go to Display 8.
8 id 0000 ○ Key		Setting the ID code: When the fourth digit of the ID code blinks, it will enter into the input status. Press the Δ▽ keys to set the values. Press the ○ key to go to Display 9.
9 id 0000 ○ Key		Setting the ID code: When the third digit of the ID code blinks, it will enter into the input status. Press the Δ▽ keys to set the values. Press the ○ key to go to Display 10.
10 id 0000 ○ Key		Setting the ID code: When the second digit of the ID code blinks, it will enter into the input status. Press the Δ▽ keys to set the values. Press the ○ key to go to Display 11.
11 id 0000 ○ Key Press and hold the ○ key		Setting the ID code: When the first digit of the ID code blinks, it will enter into the input status. Press the Δ▽ keys to set the values. Press the ○ key to go to Display 8. Press and hold the ○ key to go to Display 12.
12 FSZ1 01A ○ Key		Software version: FSZ1 01A The version number indicated is a display example. Press the ○ key to go to Display 13.

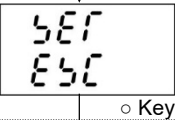
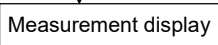
13 	Press the o key to return to the measurement display.
14 	

3.12. Maintenance

3.12.1. Calibration and verification of analog output

Description



- Current calibration mode
Calibrates the analog signal (4 to 20 mA DC) so that the output is 4 mA at 0% and 20 mA at 100%.
Select 4 mA and 20 mA in the current calibration mode, and adjust it by pressing the Δ (UP) key or ∇ (DOWN) key.
- Constant current setting mode
This function generates the constant value output for the analog signal.
Usage example: Check the operation of the connected receiver by generating a constant value output for the analog signal.
Setting range: 0.8 mA, 4 mA, 8 mA, 12 mA, 16 mA, 20 mA, 23.2 mA



CAUTION

- Before operating, confirm in advance that you want to change the analog output.
- Connect a load resistor of 550 Ω or less to ensure a stable maximum output current of 120%.

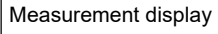
For specific key operations, refer to the example operations indicated below.

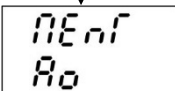
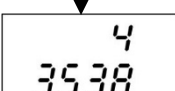
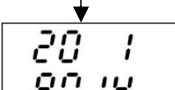
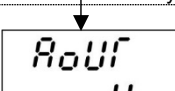
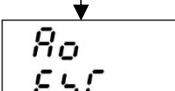
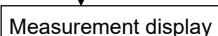
Operation (example)	
Display and keystrokes	Description
1  Press and hold the \circ key	Connect the ammeter to the AO cable. Cable colors: AO+ (green), AO- (brown) Press and hold the \circ key to go to Display 2.
2  \circ Key	Press the ∇ key four times and select "SET MENT". Press and hold the \circ key to go to Display 3.
3  \circ Key	Displays "MENT AO". Press and hold the \circ key to go to Display 4.
4  \circ Key	4mA Current calibration mode: Adjust the value to 4 mA using the Δ / ∇ keys while looking at the output of the ammeter or other calibrator. The indicated numerical value "3538" is a display example. Press the \circ key to go to Display 5. Calibration to 4mA completed.
5  \circ Key	20mA Current calibration mode: Adjust the value to 20 mA using the Δ / ∇ keys while looking at the output of the ammeter or other calibrator. The indicated numerical value "18014" is a display example. Press the \circ key to go to Display 6. Calibration to 20 mA completed.
6  \circ Key	Constant current setting mode: 0.8 mA, 4 mA, 8 mA, 12 mA, 16 mA, 20 mA, 23.2 mA <i>0.8, 4, 8, 12, 16, 20, 23.2</i> Press the Δ / ∇ keys and set the constant current output. Check the output of the calibrator using an ammeter. Press the \circ key to go to Display 7.
7  \circ Key	Press the \circ key to return to the measurement display.
12 	

3.12.2. Checking the status output and total pulse operation

Description

- Status simulated output (DO1, DO2)
This function checks the status output.
Setting ON: Sets the contact to short-circuit. OFF: Opens the contact.
- Total pulse simulated output (DO1 only)
This function checks the total pulse output.
You can check the output by outputting one pulse per second.
Setting STOP: Stops simulated pulses. GO: Outputs simulated pulses.
Note 1: The output pulse width corresponds to the currently selected pulse width. (Refer to 3.10.2)



- This operation produces the same output for DO1 and DO2 at the same time.
- Before activating it, confirm in advance that you want to change the DO output.

Operation (example)

Display and keystrokes	Description
<p>1</p> <p>Measurement display</p> <p>Press and hold the ○ key</p>	<p>Press and hold the ○ key to go to Display 2.</p>
<p>2</p> <p>SET MENT</p> <p>○ Key</p>	<p>Press the ▽ key four times and select "SET MENT". Press and hold the ○ key to go to Display 3.</p>
<p>3</p> <p>MENT Ro</p> <p>○ Key</p>	<p>Press the ○ key to go to Display 4.</p>
<p>4</p> <p>MENT do</p> <p>○ Key</p>	<p>Displays "MENT DO". Press and hold the ○ key to go to Display 5.</p>
<p>5</p> <p>do off</p> <p>○ Key</p>	<p>Status simulated output: OFF, ON <i>off, on</i> Use the △▽ keys and set OFF or ON to check the contact output. Press the ○ key to go to Display 6.</p>
<p>6</p> <p>PULS STOP</p> <p>○ Key</p>	<p>Total pulse simulated output: STOP, GO <i>STOP, GO</i> Use the △▽ keys and set GO to output simulated pulses. Use the △▽ keys and set STOP to stop simulated pulses. Press the ○ key to go to Display 7.</p>
<p>7</p> <p>PULS E5C</p> <p>○ Key</p>	<p>Press the ○ key to return to the measurement display.</p>
<p>8</p> <p>Measurement display</p>	

3.12.3. How to set the test mode (flow simulated output)

Description

- This function sets simulated output for the volume flow rate and checks each output (LED display, analog output, DO output).
The output at the time of setting is set as the initial value, changes according to the time of the set "tracking time" until it reaches the input value (simulated flow rate target value), and becomes a constant value output according to the input value.
Each output changes according to the variation of the simulated flow rate output. When operating in test mode, "TEST" will blink on the first row of the LED.

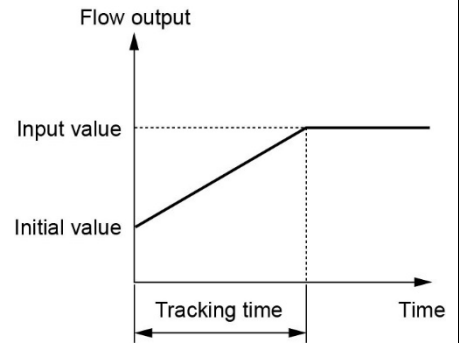

Settings

- Test mode switching : Enables or disables test mode.
- Tracking time: Time to reach simulated flow target value (input value mentioned above)
- Input data : Simulated flow target value (percentage of full scale).

Setting range

- Test mode switching: Do not execute (NO), Execute (USED)
- Tracking time : 0 to 900 seconds
- Input data : ±120%

*When setting the follow-up time, set the damping in "3.9.1" to 0 sec.

! CAUTION

- This operation changes the output of the analog outputs AO, DO1 and DO2 according to the settings. Confirm in advance that you want to change each output.
- After testing, be sure to change the setting back to "Do not execute". Otherwise, the input value output state will be saved until the power is turned off.

For specific key operations, refer to the example operations indicated below.

Operation (example)	
Display and keystrokes	Description
<p>1</p> <div style="border: 1px solid black; padding: 5px; width: fit-content; margin: 5px auto;">Measurement display</div> <p style="text-align: center;">Press and hold the \circ key</p>	Connect the ammeter to the AO cable. Cable colors: AO+ (green), AO- (brown) Press and hold the \circ key to go to Display 2.
<p>2</p> <div style="border: 1px solid black; padding: 5px; width: fit-content; margin: 5px auto;"> <pre> SET MENf </pre> </div> <p style="text-align: center;">\circ Key</p>	Press the ∇ key four times and select "MENT". Press and hold the \circ key to go to Display 3.
<p>3</p> <div style="border: 1px solid black; padding: 5px; width: fit-content; margin: 5px auto;"> <pre> MENf Ro </pre> </div> <p style="text-align: center;">\circ Key</p>	Press the \circ key twice to go to Display 4.
<p>4</p> <div style="border: 1px solid black; padding: 5px; width: fit-content; margin: 5px auto;"> <pre> MENf TESf </pre> </div> <p style="text-align: center;">\circ Key</p>	Displays "MENT TEST". Press and hold the \circ key to go to Display 5.
<p>5</p> <div style="border: 1px solid black; padding: 5px; width: fit-content; margin: 5px auto;"> <pre> TESf no </pre> </div> <p style="text-align: center;">\circ Key</p>	Test mode switching: NO, USED <i>no, USED</i> Use the $\Delta\nabla$ keys and set USED to activate test mode. Press the \circ key to go to Display 6.
<p>6</p> <div style="border: 1px solid black; padding: 5px; width: fit-content; margin: 5px auto;"> <pre> T ME 0 </pre> </div> <p style="text-align: center;">\circ Key</p>	Tracking time: 0 to 900 sec Press the $\Delta\nabla$ keys to set the values. Press the \circ key to go to Display 7.
<p>7</p> <div style="border: 1px solid black; padding: 5px; width: fit-content; margin: 5px auto;"> <pre> inp 0 </pre> </div> <p style="text-align: center;">\circ Key</p>	Input data: -120% to 120% Press the $\Delta\nabla$ keys to set the values. Press the \circ key to go to Display 8.

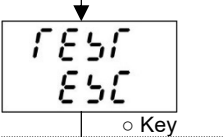
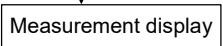
<p>8</p> 	<p>Press the \circ key to return to the measurement display.</p>
<p>9</p> 	<p>The LED on the first row will blink "TEST" and the output will change. After the set follow-up time elapses, the output will become the simulated flow target value and stabilize. Note: After you finish checking the output, be sure to set the test mode to "Do not execute".</p>

4. MAINTENANCE AND INSPECTION

4.1. Daily check

Check the following items externally and visually.

- Is the mounting bracket loose? => Tighten it to the recommended tightening torque.
- Is there any abnormality in the receipt wave (STATUS is red)? => Check "4.3.2 Error and countermeasures when an alarm is displayed".
- Is there any dirt or dust on the main unit? => Moisten a soft cloth with water, wring it out tightly, and wipe off the dirt or dust. Be careful when wiping the display, as it is easily scratched.
Note) Do not use volatile solvents such as benzine or thinner. Otherwise, plastic parts may deteriorate.

4.2. Periodic inspection

4.2.1. Checking zero point

Stop the fluid flow, fill the measuring tube, and check the zero point.

4.3. Errors and countermeasures

4.3.1. Display errors

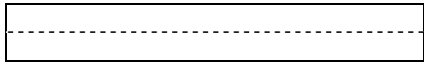
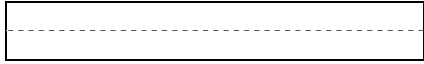
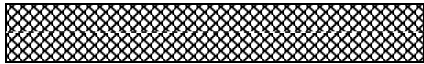
Condition	Cause
 <p>Nothing is displayed</p>	<ul style="list-style-type: none"> • The power does not turn on. • The power supply voltage is too low. • A fuse has blown. • The polarity of the DC power supply was reversed. • Turn the power OFF and then back ON again. <p>=> Proceed to "4.3.6.Hardware failure countermeasures" if the problem is not resolved.</p>
 <p>The display blinks every 5 seconds.</p>	<ul style="list-style-type: none"> • The display board has an error. • Turn the power OFF and then back ON again. <p>=> Proceed to "4.3.6.Hardware failure countermeasures" if the problem is not resolved.</p>
 <p>It is displaying randomly.</p>	<ul style="list-style-type: none"> • Turn the power OFF and then back ON again. <p>=> Proceed to "4.3.6.Hardware failure countermeasures" if the problem is not resolved.</p>
<p>The LED display is off. Some LEDs are not lit.</p>	<ul style="list-style-type: none"> • The LEDs are not on. => Go to "4.3.6.Hardware failure countermeasures"
<p>STATUS is displayed in red.</p>	<ul style="list-style-type: none"> • Check "4.3.2 Error and countermeasures when an alarm is displayed".
<p>Symbols are displayed on the second row of the LED</p>	

4.3.2. Error and countermeasures when an alarm is displayed

Diagnostic indicator lamp STATUS	LED lamp Second row	Condition	Countermeasure
● (Red lamp)	E1-1	Backup memory error	<ul style="list-style-type: none"> • Turn the power ON again (OFF, ON). If it is not restored, the backup memory will fail. => Go to "4.3.6.Hardware failure countermeasures"
● (Red lamp)	E1-2	Temperature circuit error	<ul style="list-style-type: none"> • Turn the power ON again (OFF, ON). If it is not restored, the temperature circuit will fail. => Go to "4.3.6.Hardware failure countermeasures"
● (Red lamp)	E1-3	(Display board error)	<ul style="list-style-type: none"> • Turn the power ON again (OFF, ON). If it is not restored, the display board will fail. => Go to "4.3.6.Hardware failure countermeasures"
● (Red lamp)	E2-1	There is no received signal. (There is no receipt wave)	<ul style="list-style-type: none"> • Check for non-filled water, air bubbles, or foreign matter. • Check the pipe parameters. • Change the mounting position of the flowmeter. => Refer to "4.3.2.1Diagnosis when there is no receipt wave or it is weak or the receipt wave is abnormal".
● (Red lamp)	E2-2	Receipt signal error (Weak receipt wave or abnormal receipt wave shape)	<ul style="list-style-type: none"> • There is a weak receipt wave or abnormal receipt wave shape. • Check for air bubbles or foreign matter. • Check the pipe parameters. • Change the mounting position of the flowmeter. => Refer to "4.3.2.1Diagnosis when there is no receipt wave or it is weak or the receipt wave is abnormal".
● (Red lamp)	E2-3	Calculation error (Error in the detected measurement data)	<ul style="list-style-type: none"> • Check if the pipe parameter setting values (pipe outer diameter dimensions, pipe thickness, and fluid type) are correct, and if there are any mistakes, re-enter them correctly.
● (Red lamp)	E2-4	Threshold error (Sensitivity of the receipt signal is low)	<ul style="list-style-type: none"> • Check for air bubbles or foreign matter. • Check the pipe parameters. => Refer to "4.3.2.1Diagnosis when there is no receipt wave or it is weak or the receipt wave is abnormal".
● (Red lamp)	E2-5	Data collection error	<ul style="list-style-type: none"> • Turn the power ON again (OFF, ON). If it is not restored, the measurement circuit will fail. => Go to "4.3.6.Hardware failure countermeasures"
● (Green lamp)	T.ALAM	The temperature exceeds the measurement range.	<ul style="list-style-type: none"> • The fluid temperature exceeds the temperature measurement range (-20 to 90°C). Check the fluid temperature.
● (Green lamp)	----	When there is no pipe temperature measurement option	<ul style="list-style-type: none"> • There is no pipe temperature measurement option, so the temperature will not be displayed. The operation is normal.
● (Green lamp)	OVER	The analog output or total pulse output exceeds the range.	<ul style="list-style-type: none"> • Check the range setting. • Check the total rate and total pulse width. • Check the actual flow rate.

Response to alarm output of DO output

"ALL ALARMS" ; An alarm is output when E1-1, E1-2, E1-3, E2-1, E2-2, E2-3, E2-4, or E2-5 occurs. "BURNOUT TIMER ENABLE"

"DEVICE ERROR" ; An alarm is output when E1-1, E1-2, or E1-3 occurs. "BURNOUT TIMER DISABLE"

"PROCESS ERROR" ; An alarm is output when E2-1, E2-2, E2-3, E2-4, or E2-5 occurs. "BURNOUT TIMER ENABLE"

The burnout timer sets the time from the occurrence of an error to the time when there is contact output.

4.3.2.1. Diagnosis when there is no receipt wave or it is weak or the receipt wave is abnormal

When there is no receipt wave or it is weak or the receipt wave shape is abnormal, it is likely that there are incorrect pipe parameter settings, incomplete installation, fluid and pipe problems, and/or flowmeter failures. Check the following in order.

Incorrect pipe parameter settings

Cause of error	Countermeasure
The setting for the outer dimensions is incorrect.	Please enter it correctly (Refer to "3.8.1 Piping parameter setting method").
The setting for pipe thickness is incorrect.	
The setting for pipe material is incorrect.	
The setting for fluid type is incorrect.	

Installation is incomplete

Cause of error	Countermeasure
The length of the straight pipe is less than specified in "2.1.1 Conditions on straight pipe".	Reinstall it in a place that complies with the straight pipe length.
For horizontal piping, the sensor is not mounted horizontally or within $\pm 45^\circ$ of the horizontal surface (for vertical piping, it can be mounted anywhere on the outer perimeter).	Remount the sensor horizontally or within $\pm 45^\circ$ of the horizontal surface (Refer to "2.1.2 Mounting orientation").
The sensor is mounted to the welded part of the pipe.	Remount it while avoiding the welded part (Refer to "2.1.2 Mounting orientation").
The sensor is not mounted securely to the pipe.	Mount the sensor correctly (Refer to "2.2.1 Mounting on pipes").

Fluid and pipe problems

Cause of error	Countermeasure
Partially filled pipe	Find a location where the fluid is full in the same pipe line and move the flowmeter to that location. <ul style="list-style-type: none"> Mount it to the lowest location on the piping line.
Air bubble contamination <ul style="list-style-type: none"> The cause is air-bubble contamination if measurement is normal when the fluid flow is stopped. If the sensor is mounted immediately after a valve, cavitation can cause the same phenomenon as air-bubble contamination. 	Remove the air bubbles. <ul style="list-style-type: none"> Raise the level of the pump well. Check the pump shaft seal. Tighten the negative pressure pipe flange. Do not allow it to cascade down into the pump well.
	Move the sensor to a location with no air-bubble contamination. <ul style="list-style-type: none"> Inlet side of the pump Upstream from the valve
There is high turbidity	Move it to another location or another pipe.
The interior and exterior surfaces of the pipe are rough due to rust, debris, and deposits.	Remove roughness from the exterior surface of the pipe using a file, etc. ("2.2.1 Mounting on pipes"). If there is possibility of rust on the interior surface of the pipe, reinstall it at a location where it is considered to be rust-free.
Scaling on the inside due to old piping	Move it to another location or another pipe.
It is a lining pipe	

Flowmeter failure

Cause of error	Countermeasure
Defective circuit, sensor, etc.	Go to "4.3.6. Hardware failure countermeasures"

4.3.3. Measured value error

Condition	Cause	Countermeasure
The measured value is displayed as “-” (minus).	<ul style="list-style-type: none"> That is actually how it flows. 	<p>→ Change the flow direction setting. (Refer to “3.8.1Piping parameter setting method”)</p>
Abnormal fluctuation in measured values at constant flow rate	<ul style="list-style-type: none"> Straight pipe is not long enough 	<p>→ Move to a location where you can secure the length in “2.1.1 Conditions on straight pipe”.</p>
	<ul style="list-style-type: none"> There are pumps, valves, or other things that disturb the flow in the vicinity. 	<p>→ Mount it at least 50 D apart from these things.</p>
	<ul style="list-style-type: none"> Actually, there is pulsation in the fluid. 	<p>→ Increase the response time using the damping setting. (“3.9.1Damping”)</p>
The measured values are not changing even though the flow rate is changing. (STATUS is red)	Refer to “4.3.2 Error and countermeasures when an alarm is displayed”.	
The measured value does not reach zero even when the fluid is stopped.	<ul style="list-style-type: none"> Fluid is flowing in the pipe. 	<p>→ This is normal.</p>
	<ul style="list-style-type: none"> When performing zero adjustment 	<ul style="list-style-type: none"> Perform zero adjustment again when the fluid has completely stopped.
	<ul style="list-style-type: none"> When the fluid stops, the piping will be either not full or empty. (STATUS: Red) 	<p>→ This is normal.</p>
There is an error in the measured value.	<ul style="list-style-type: none"> The entered piping specification is different from the actual one. 	<p>→ A 1% difference in the inner diameter will result in an error of approximately 3% or more.</p> <ul style="list-style-type: none"> Please enter it correctly.
	<ul style="list-style-type: none"> The straight pipe is not long enough (Refer to “2.1.1 Conditions on straight pipe”). 	<p>→ Find a different location for mounting the sensor. (Go upstream of the object of disturbance)</p> <p>→ Ensure that there are no pumps, valves, junction pipes, etc. within 30 D upstream that significantly disrupt the flow.</p> <ul style="list-style-type: none"> Mount the flowmeter at various angles at the piping cross-section, and finally mount it at a location that produces the average measured value.
	<ul style="list-style-type: none"> The inside of the piping is either not full or has deposits of muddy sand. 	<p>→ There tends to be much build-up at locations with small cross-sectional area.</p> <ul style="list-style-type: none"> Move it to the vertical piping.
The measured temperatures values are not changing even though the temperature rate is changing.	<ul style="list-style-type: none"> Hardware failures 	<p>→ Go to “4.3.6.Hardware failure countermeasures”</p>

4.3.4. Analog output errors

Condition	Cause	Countermeasure
The current output is not correct.	The range setting is not correct.	→ • Set the correct range setting.
When the display is 0, it will not reach 4 mA.	The analog output is out of alignment.	→ • Calibrate the analog output.
The output is 0 mA.	There is a cable disconnection.	
The output is 20 mA or more.	The LED display shows "OVER".	→ It is over the range. • Reconfigure the analog output range data.
The output is 4 mA or less.	The LED display shows "OVER".	→ It is flowing in the reverse direction. • Install it correctly upstream or downstream.
The display value changes, but the analog output remains constant.	The output load is 550 ohms or more.	→ • Do not exceed 550 ohms.
The display value does not match the analog output.	The analog output is out of alignment.	→ • Calibrate the analog output.
The output does not change even after performing analog output calibration.	Hardware failures	→ Go to "4.3.6.Hardware failure countermeasures"

4.3.5. Key errors

Condition	Cause
It is not responding to keystroke input.	• Hardware failures => Go to "4.3.6 Hardware failure countermeasures".
Certain keys are not responding. It is behaving differently than defined.	

4.3.6. Hardware failure countermeasures

If there is a hardware failure after following the above mentioned procedures 4.3.1 to 4.3.5, please contact us with the details of the error.

5. APPENDIX

5.1. Specification

SPECIFICATIONS

Applications and operating environment

System configuration:

Single-path system using an integrated flow transmitter and detector

Applicable types:

FSZ08, FSZ15, FSZ25

Applicable fluid:

Homogenous liquid where the ultrasonic signal can be transmitted

Aerated flow: 0 to 12vol% (15A diameter, water, flow velocity 1 m/s)

Fluid turbidity: 10,000 (mg/L) or less

Flow profile: Fully-developed turbulent or laminar flow in a fully-filled circular pipe

Flow velocity range:

0 to $\pm 0.2 \dots \pm 5$ m/s

Power supply

20 to 27.5 V DC

Installation environment:

Non-explosion-proof area with no direct sunlight, corrosive gas, or radiant heat

Ambient temperature:

During operation: -15 to +60°C

During storage: -15 to +65°C

Ambient humidity:

95%RH or less with no dew condensation

Applicable piping:

Type	Pipe size(B)
FSZ08	8A, 10A (1/4, 3/8)
FSZ15	15A, 20A (1/2, 3/4)
FSZ25	25A, 32A (1, 1 1/4)

Applicable pipe material:

Metal piping (stainless steel, steel pipes, copper pipes)
Plastic (PVC, PP, PVDF)

Note 1: Lining pipes are not supported

Note 2: Piping thickness of 1.2 to 4.9 mm

Straight pipe length: Upstream side 10D, downstream side 5D (D: Pipe inner diameter). Details depend on straight pipe conditions. (Japan Electric Measuring Instruments Manufacturers' Association JEMIS-032)

Fluid temperature:

-15 to +85°C

When ambient temperature is 50°C or below	Fluid temperature is 85°C or below
When ambient temperature is 50 to 55°C	Fluid temperature is 75°C or below
When ambient temperature is 55 to 60°C	Fluid temperature is 60°C or below

Performance specifications

Rated accuracy:

Flow rate of 1 m/s to 5 m/s	Flow rate of less than 1 m/s
$\pm 2.0\%$ of rate	± 0.02 m/s

Note) Accuracy in water at 20°C (standard)

Response time:

0.5 s

Power consumption:

2.5 W or less

Functional specifications

Analog signal:

4 to 20 mA DC: 1 signal

Load resistance: 550 Ω max.

Digital output:

Forward total and alarms can be assigned as desired
Transistor contact (open collector)

- Outputs: 2
- Normal: ON/OFF selectable
- Contact capacity: 27.5 V DC, 100 mA
- Output frequency: Max. of 100 P/s (Pulse width of 5, 10, 50, 100, 200 ms)

Temperature measurements (optional):

Pipe surface temperature measurement accuracy: $\pm 2^\circ\text{C}$ (at an ambient temperature of 20°C)

Measurement range: -15 to +85°C

Display device:

LED display, 4-digit, 7-segment, 2-line

Status LED (green when normal, red when abnormal)

Flow direction LED (setting)

Flow rate indication:

Instantaneous flow rate indication

(minus indication for reverse flow)

Numbers: 4 digits (excluding decimal point)

Unit: L/min, gal/min

Total indication:

Forward total value indication

Numbers: 8 digits (no decimal point)

Unit: L, gal

Configuration:

Three keys (UP, DOWN, ENTER)

Zero adjustment:

Set zero / clear zero

Damping:

0, 1, 3, 5, 10, 30, 60, 90 s for analog output and flow rate display

Low flow rate cutoff:

Low flow rate cutoff value can be set as desired

Alarm:

Hardware or process abnormalities
Contact output available

Burnout:

Analog output: Hold/Overscale/Underscale/Zero selectable

Burnout timer: 10 to 900 s (every 1 s)

Total reset:

Total value can be set to zero

Backup of power failure:

Backup by non-volatile memory

Physical specifications**Type of enclosure:**

IP65/IP67

When connected to dedicated signal cable

Mounting method:

Clamped on pipe surface

Material:

Plastic (PPS, PC, PPO), rubber, stainless steel

Signal cable:

Type: FLYF

- Material: Polyurethane (PUR)
- Outer diameter: \varnothing 6 mm
- Cable length: 3 m, 10 m
- Termination:

Flowmeter body side: M12, 8-pin connector

Connection point: No terminal processing

Flowmeter body size:

FSZ08: Max. of H65×W120×D42 mm

FSZ15: Max. of H75×W120×D50 mm

FSZ25: Max. of H90×W120×D68 mm

Mass:

FSZ08: 400 g

FSZ15: 500 g

FSZ25: 600 g

EU Directive Compliance

CE

EMC (2014/30/EU)

EN 61326-1 (Table 2)

EN 61326-2-3

RoHS (2011/65/EU) + (EU)2015/863

EN IEC 63000:2018

UK
CA

EMC (S.I.2016 No.1091)

EN 61326-1 (Table 2)

EN 61326-2-3

RoHS (S.I.2012 No.3032)

EN IEC 63000:2018

5.2. Outline diagram

1. Flowmeter

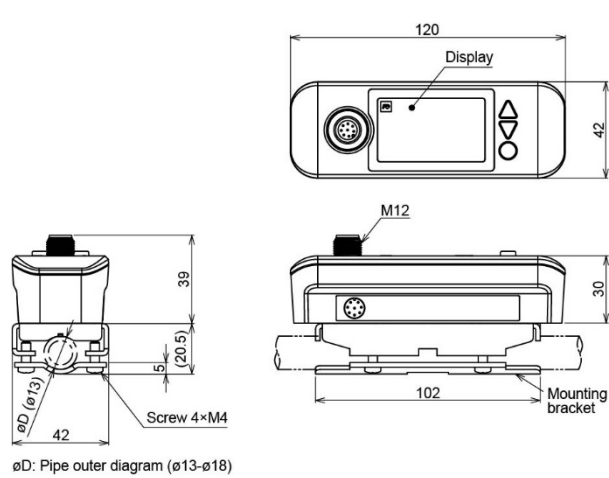

Type: FSZ08

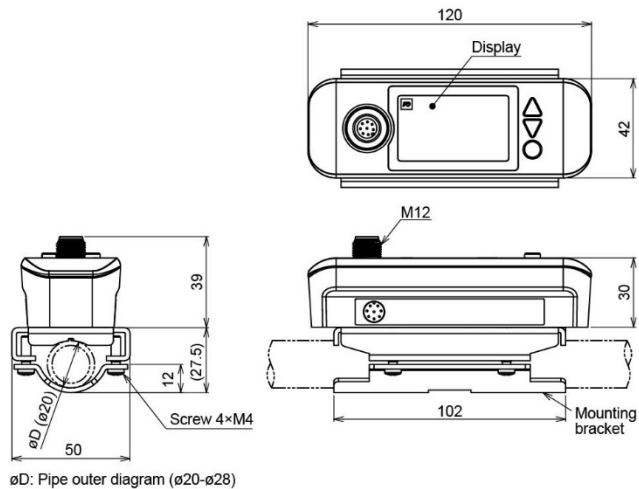

Type: FSZ15

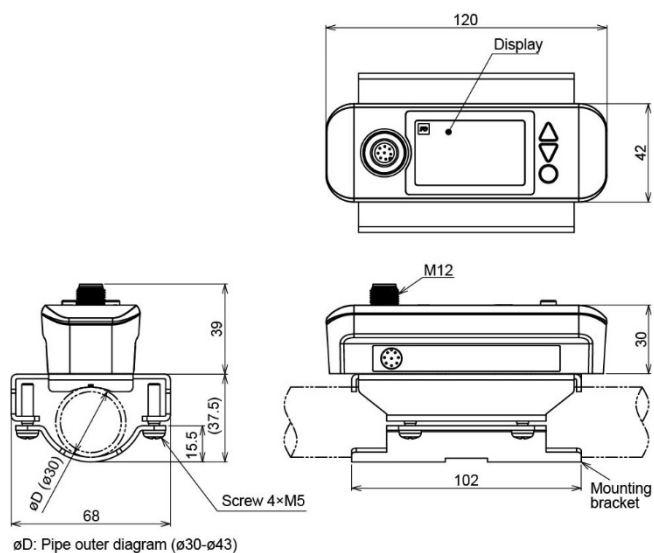

Type: FSZ25

2. Dedicated cable

Type	FLYF003	FLYF010
L [m]	3 ± 0.15	10 ± 0.2

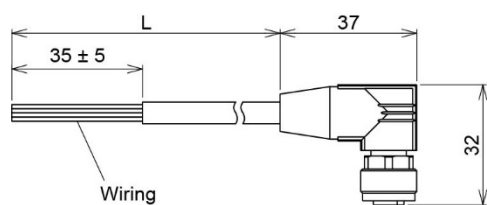

* For connections, see the section on External Connections on the next page.

5.3. Pipe data

Carbon steel pipe SGP for piping applications (JIS G3452-2014) *1: The setting for the pipe material is carbon steel SGP.

Pipe designation		Outer diameter (mm)	Thickness (mm)
(A)	(B)		
8	1/4	13.8	2.3
10	3/8	17.3	2.3
15	1/2	21.7	2.8
20	3/4	27.2	2.8
25	1	34.0	3.2
32	1 1/4	42.7	3.5

Carbon steel pipe for pressure service STPG (JIS G3454-2017) *1

JIS pipe size		Outer diameter (mm)	Nominal thickness					
			Schedule 10	Schedule 20	Schedule 30	Schedule 40	Schedule 60	Schedule 80
A	B		Thickness (mm)	Thickness (mm)	Thickness (mm)	Thickness (mm)	Thickness (mm)	Thickness (mm)
8	1/4	13.8	-	-	-	2.2	2.4	3.0
10	3/8	17.3	-	-	-	2.3	2.8	3.2
15	1/2	21.7	-	-	-	2.8	3.2	3.7
20	3/4	27.2	-	-	-	2.9	3.4	3.9
25	1	34.0	-	-	-	3.4	3.9	4.5
32	1 1/4	42.7	-	-	-	3.6	4.5	4.9

Galvanized steel pipes for ordinary piping SGPW (JIS G3442-212) *1

Pipe designation		Outer diameter (mm)	Thickness (mm)
(A)	(B)		
10	3/8	17.3	2.3
15	1/2	21.7	2.8
20	3/4	27.2	2.8
25	1	34.0	3.2
32	1 1/4	42.7	3.5

Stainless steel pipe SUS-TP for piping applications (JIS G3459-2016) *2: The setting for the pipe material is stainless SUS.

JIS pipe size		Outer diameter (mm)	Nominal thickness						
			Schedule 5S	Schedule 10S	Schedule 20S	Schedule 40	Schedule 80	Schedule 120	Schedule 160
A	B		Thickness (mm)	Thickness (mm)	Thickness (mm)	Thickness (mm)	Thickness (mm)	Thickness (mm)	Thickness (mm)
8	1/4	13.8	1.2	1.65	2.0	2.2	3.0	-	-
10	3/8	17.3	1.2	1.65	2.0	2.3	3.2	-	-
15	1/2	21.7	1.65	2.1	2.5	2.8	3.7	-	4.7
20	3/4	27.2	1.65	2.1	2.5	2.9	3.9	-	5.5
25	1	34.0	1.65	2.8	3.0	3.4	4.5	-	6.4
32	1 1/4	42.7	1.65	2.8	3.0	3.6	4.9	-	6.4

Polyethylene pipe for waterworks applications (JIS K6762-2004) *3: The setting for the pipe material is PVC.

Nominal diameter (mm)	Outer diameter (mm)	Type 1 (flexible pipe)		Type 2 (rigid pipe)	
		Thickness (mm)	Weight (kg/m)	Thickness (mm)	Weight (kg/m)
13	21.5	3.5	0.184	2.5	0.143
20	27.0	4.0	0.269	3.0	0.217
25	34.0	5.0	0.423	3.5	0.322
30	42.0	5.6	0.595	4.0	0.458

Unplasticized poly (vinyl chloride) (PVC-U) pipes for water supply (JIS K6742-2007) *3

VP: Unplasticized poly(vinyl chloride) (PVC-U) pipes

HIVP: High impact resistance unplasticized poly (vinyl chloride) (PVC-U) pipes

JIS pipe size	Outer diameter	Pipe thickness
13	18.0	2.5
16	22.0	3.0
20	26.0	3.0
25	32.0	3.5
30	38.0	3.5

Polyethylene pipes for general purposes (JIS K6761-2004) *3

JIS pipe size	Outer diameter (mm)	Type 1 (flexible pipe)	Type 2 (rigid pipe)
		Thickness (mm)	Thickness (mm)
13	21.5	2.7	2.4
20	27.0	3.0	2.4
25	34.0	3.0	2.6
30	42.0	3.5	2.8

Unplasticized poly (vinyl chloride) (PVC-U) pipes (JIS K6741-2007) *3

Category Nominal mm	V P		V U	
	Outer diameter	Thickness	Outer diameter	Thickness
13	18	2.2	—	—
16	22	2.7	—	—
20	26	2.7	—	—
25	32	3.1	—	—
30	38	3.1	—	—

PVDF-HP *3

	SDR33 S16 PN10	SDR21 S10 PN16	SDR17 S8 PN20
Outer diameter (mm)	Thickness (mm)	Thickness (mm)	Thickness (mm)
16	—	1.5	1.5
20	—	1.9	1.9
25	—	1.9	1.9
32	—	2.4	2.4

Chlorinated poly (vinyl chloride) (PVC-C) pipes for hot and cold water supply (JIS K6776:2007) *3

JIS pipe size	Outer diameter (mm)	Thickness (mm)	Weight (kg/m)
13	18.0	2.5	0.180
16	22.0	3.0	0.265
20	26.0	3.0	0.321
25	32.0	3.5	0.464
30	38.0	3.5	0.561

(a) Sound velocity with temperature change in water (0 to 100°C)

T°C	V m/s	T°C	V m/s	T°C	V m/s	T°C	V m/s
0	1402.74						
1	1407.71	26	1499.64	51	1543.93	76	1555.40
2	1412.57	27	1502.20	52	1544.95	77	1555.31
3	1417.32	28	1504.68	53	1545.92	78	1555.18
4	1421.98	29	1507.10	54	1546.83	79	1555.02
5	1426.50	30	1509.44	55	1547.70	80	1554.81
6	1430.92	31	1511.71	56	1548.51	81	1554.57
7	1435.24	32	1513.91	57	1549.28	82	1554.30
8	1439.46	33	1516.05	58	1550.00	83	1553.98
9	1443.58	34	1518.12	59	1550.68	84	1553.63
10	1447.59	35	1520.12	60	1551.30	85	1553.25
11	1451.51	36	1522.06	61	1551.88	86	1552.82
12	1455.34	37	1523.93	62	1552.42	87	1552.37
13	1459.07	38	1525.74	63	1552.91	88	1551.88
14	1462.70	39	1527.49	64	1553.35	89	1551.35
15	1466.25	40	1529.18	65	1553.76	90	1550.79
16	1469.70	41	1530.80	66	1554.11	91	1550.20
17	1473.07	42	1532.37	67	1554.43	92	1549.58
18	1476.35	43	1533.88	68	1554.70	93	1548.92
19	1479.55	44	1535.33	69	1554.93	94	1548.23
20	1482.66	45	1536.72	70	1555.12	95	1547.50
21	1485.69	46	1538.06	71	1555.27	96	1546.75
22	1488.63	47	1539.34	72	1555.37	97	1545.96
23	1491.50	48	1540.57	73	1555.44	98	1545.14
24	1494.29	49	1541.74	74	1555.47	99	1544.29
25	1497.00	50	1542.87	75	1555.45	100	1543.41

(Note) T: Temperature, V: Sound velocity

(b) Sound velocity and density of various fluids

Fluid name	T°C	ρg/cm ³	V m/s
Acetone	20	0.7905	1190
Aniline	20	1.0216	1659
Alcohol	20	0.7893	1168
Ether	20	0.7135	1006
Ethylene glycol	20	1.1131	1666
n-octane	20	0.7021	1192
o-xylene	20	0.871	1360
Chloroform	20	1.4870	1001
Chlorobenzene	20	1.1042	1289
Glycerol	20	1.2613	1923
Acetic acid	20	1.0495	1159
Methyl acetate	20	0.928	1181
Ethyl acetate	20	0.900	1164
Cyclohexane	20	0.779	1284
Dioxane	20	1.033	1389
Heavy water	20	1.1053	1388
Carbon tetrachloride	20	1.5942	938
Mercury	20	13.5955	1451
Nitrobenzene	20	1.207	1473
Carbon disulfide	20	1.2634	1158
Bromoform	20	2.8904	931
n-propyl alcohol	20	0.8045	1225
n-pentane	20	0.6260	1032
n-hexane	20	0.654	1083
Diesel fuel	25	0.81	1324
Transformer oil	32.5	0.859	1425
Spindle oil	32	0.905	1342
Petroleum	34	0.825	1295
Gasoline	34	0.803	1250
Water	13.5	1.	1460
Sea water (3.5% salt content)	16	1.	1510

(Note) T: Temperature, ρ: Density, V: Sound velocity

(c) Dynamic viscosity coefficient of various fluids

Fluid name	T°C	ρ/cm^3	V m/s	$\nu (\times 10^{-6}\text{m}^2/\text{s})$
Acetone	20	0.7905	1190	0.407
Aniline	20	1.0216	1659	1.762
Ether	20	0.7135	1006	0.336
Ethylene glycol	20	1.1131	1666	21.112
Chloroform	20	1.4870	1001	0.383
Glycerol	20	1.2613	1923	11.885
Acetic acid	20	1.0495	1159	1.162
Methyl acetate	20	0.928	1181	0.411
Ethyl acetate	20	0.900	1164	0.499
Heavy water	20	1.1053	1388	1.129
Carbon tetrachloride	20	1.5942	938	0.608
Mercury	20	13.5955	1451	0.114
Nitrobenzene	20	1.207	1473	1.665
Carbon disulfide	20	1.2634	1158	0.290
n-pentane	20	0.6260	1032	0.366
n-hexane	20	0.654	1083	0.489
Spindle oil	32	0.905	1324	15.7
Gasoline	34	0.803	1250	0.4 to 0.5
Water	13.5	1.	1460	1.004 (20°C)

(Note) T: Temperature, ρ : Density, V: Sound velocity, ν : Dynamic viscosity coefficient

5.4. EMC CONFORMITY

EMC CONFORMITY: EMC Directive(2014/30/EU)

Emission measurements: EN IEC 61326-2-3:2021 and EN IEC 61326-1:2021

Requirements	Standard and limits
Radiated emission	EN 55011:2016+A1:2017+A11:2020+A2:2021 Group 1, Class A

Immunity tests: EN IEC 61326-2-3:2021 and EN IEC 61326-1:2021

Requirements	Basic EMC standard or test method
Electrostatic discharge	EN 61000-4-2:2009
Radiated, radio-frequency, electromagnetic field	EN IEC 61000-4-3:2020
Electrical fast transient/burst	EN 61000-4-4:2012
Surge	EN 61000-4-5:2014+A1:2017
Conducted disturbances, induced by radio-frequency fields	EN 61000-4-6:2014
Power frequency magnetic field	EN 61000-4-8:2010

The performance criteria are according to EN IEC 61326-1:2021.

Performance criterion A
The equipment shall continue to operate as intended during and after the test. No DEGRADATION OF PERFORMANCE or LOSS OF FUNCTION is allowed below a PERFORMANCE LEVEL specified in the user documentation, when the equipment is used as intended. In the case of applying immunity tests with continuous electromagnetic phenomena, the PERFORMANCE LEVEL may be replaced by a permissible LOSS OF PERFORMANCE which shall recover, without user intervention. A permissible LOSS OF PERFORMANCE is allowed within the PERFORMANCE LEVEL only when this information is clearly provided to the end user via documentation, such as the product user manual. No change in the operating state is allowed nor is loss of data.
Performance criterion B
The equipment shall continue to operate as intended after the test. No DEGRADATION OF PERFORMANCE or LOSS OF FUNCTION is allowed below a PERFORMANCE LEVEL specified in the user documentation, when the equipment is used as intended. During the test, the equipment PERFORMANCE LEVEL may be replaced by a permissible LOSS OF PERFORMANCE if such LOSS OF PERFORMANCE is detailed in the EMC test plan. A permissible LOSS OF PERFORMANCE is allowed within the PERFORMANCE LEVEL only when this information is clearly provided to the end user via documentation, such as the product user manual. An unintended change of the operating state is allowed if self-recoverable. No loss of stored data is allowed.

Immunity tests specification

Test items	Criterion	Output fluctuation during the tests	Output fluctuation before and after the tests
Electrostatic discharge	B	N/A	±2% f.s.
Radiated, radio-frequency, electromagnetic field	A	±2% f.s.	±2% f.s.
Electrical fast transient/burst	B	N/A	±2% f.s.
Surge	B	N/A	±2% f.s.
Conducted disturbances, induced by radio-frequency fields	A	±10% f.s.	±2% f.s.
Power frequency magnetic field	A	±2% f.s.	±2% f.s.

 Fuji Electric Co., Ltd.

Gate City Ohsaki, East Tower, 11-2, Osaki 1-chome, Shinagawa-ku, Tokyo 141-0032, Japan
Phone: +81-3-5435-7111
www.fujielectric.com
www.fujielectric.com/products/instruments/
