

# Technical information

## Solphant M

### FTM50, FTM51, FTM52

Vibronic



## Universal point level switch for fine-grained bulk solids

### Application

Solphant M is a robust point level switch for silos with fine-grained or dusty bulk solids even with a low bulk weight.

The various designs mean the device has a wide range of applications.

Many certificates are available for use in dust or gas incensive hazard areas.

### FTM50:

Compact design for installation in any position. A wide range of applications thanks to various variations e.g.

- Polished short fork with stainless steel housing (F15) and Tri-Clamp
- Coated standard fork with aluminum housing (F17) and flange
- Standard fork with 280 °C (536 °F) rating and aluminum housing (F13)

### FTM51:

With extension pipe up to 4 m (13 ft) for installation in any position

### FTM52:

With rope up to 20 m (66 ft) for installation from above

### Typical applications:

Cereals, flour, cocoa, sugar, animal feed, detergents, dye powder, chalk, gypsum, cement, plastic granules, fly ash

### Your benefits

- Market leader in the area of level detection of bulk solids
- Functional safety up to SIL 2 as per IEC 61508
- No mechanically moving parts
- Insensitive to external vibrations and build-up
- Various electronic inserts
- Configurable density setting (bulk weight setting) and switching delay
- Process temperature up to 280 °C (536 °F)
- Choice of coated or polished sensor
- Warning in the event of impending device failure due to buildup or abrasion

## Table of contents

<b>Function and system design</b> .....	<b>3</b>	Versions with extensions .....	20
Measuring principle .....	3	Versions with temperature spacer .....	21
Measuring system .....	3	Surface refinement .....	21
<b>Cable specifications</b> .....	<b>4</b>	Version with separate housing .....	22
Immunity to temperature change of connecting cable .....	4	Weights .....	23
Connecting cables .....	4	Materials and surfaces .....	23
Cable entry .....	4	<b>Operability</b> .....	<b>24</b>
<b>Input</b> .....	<b>4</b>	Display elements .....	24
Measured variable .....	4	Operating elements of FEM51, FEM52, FEM54, FEM55, FEM58 .....	25
Measuring range (detection range) .....	4	Operating elements of FEM57 .....	26
Input signal .....	4	Sediment detection with FTM50 and FTM51 .....	26
Measuring frequency .....	4	<b>Certificates and approvals</b> .....	<b>27</b>
<b>Output</b> .....	<b>4</b>	CE mark .....	27
Galvanic isolation .....	4	Ex approval .....	27
Switch-on behavior .....	4	Other standards and guidelines .....	27
Fail-safe mode .....	4	RCM-Tick marking .....	28
Switching delay .....	5	Pressure Equipment Directive 2014/68/EU (PED) .....	28
Switch behavior .....	5	CRN approval .....	28
<b>Electronic insert</b> .....	<b>5</b>	EAC conformity .....	28
FEM51 electronic insert (AC 2-wire) .....	5	RoHS .....	28
FEM52 electronic insert (DC PNP) .....	7	ASME B 31.3 .....	28
FEM54 electronic insert AC/DC with relay output) .....	8	Process sealing as per ANSI/ISA 12.27.01 .....	28
FEM55 electronic insert (8/16 mA) .....	9	Other certificates .....	28
FEM58 electronic insert (NAMUR H-L edge) .....	10	Functional safety (SIL validation) .....	28
FEM57 electronic insert (PFM) .....	12	<b>Ordering information</b> .....	<b>29</b>
<b>Installation</b> .....	<b>13</b>	<b>Accessories</b> .....	<b>29</b>
Installation instructions .....	13	Removing tool .....	29
<b>Environment</b> .....	<b>14</b>	Weather protection cover .....	29
Ambient temperature range .....	14	Sliding sleeve .....	30
Storage temperature .....	14	Rope shortening kit .....	30
Climate class .....	14	<b>Documentation</b> .....	<b>30</b>
Degree of protection .....	14	Operating Instructions .....	30
Vibration resistance .....	14	Certificates .....	30
Shock resistance .....	14	Functional safety .....	31
Electrical safety .....	14		
Electromagnetic compatibility .....	14		
<b>Process</b> .....	<b>15</b>		
Medium temperature limits .....	15		
Thermal shock resistance .....	15		
Limiting medium pressure range .....	16		
State of aggregation .....	16		
Grain size .....	16		
Bulk weight .....	16		
Lateral load (static) .....	16		
Tensile strength rope FTM52 .....	16		
<b>Mechanical construction</b> .....	<b>17</b>		
Housing and process connection .....	17		
Dimensions .....	19		

## Function and system design

### Measuring principle

A piezoelectric drive excites the tuning fork of Soliphant M to its resonance frequency. If medium covers the tuning fork, the fork's vibrating amplitude changes (the vibration is damped). Soliphant M's electronics compare the actual amplitude with a target value and indicate whether the tuning fork is vibrating freely or whether it is covered by medium.

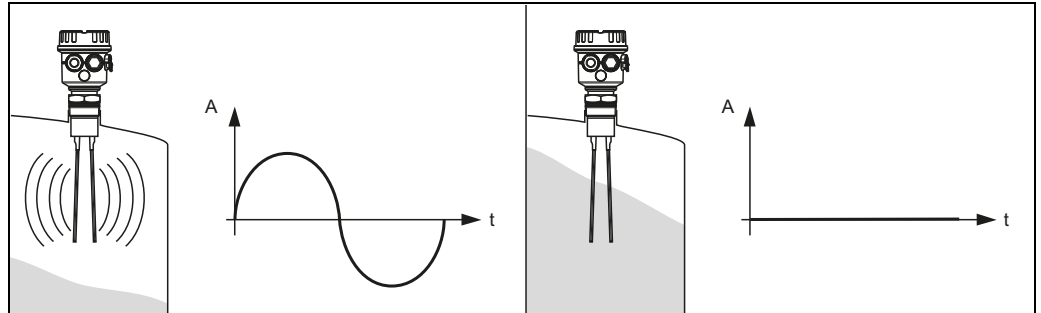

A: Amplitude  
t: Time

L00-FTM5xxxx-15-06-xx-xx-001

### Measuring system

The measuring system is available either with compact instrumentation or separate instrumentation with a switching unit. The following electronic versions are available:

#### Compact instrumentation

##### FEM51:

- Two-wire AC version
- Switch the load directly into the power supply circuit via the thyristor

##### FEM52:

- Three-wire DC version
- Switch the load via the transistor (PNP) and separate connection

##### FEM54:

- Universal current version with relay output
- Switch the loads via 2 floating change-over contacts (DPDT)

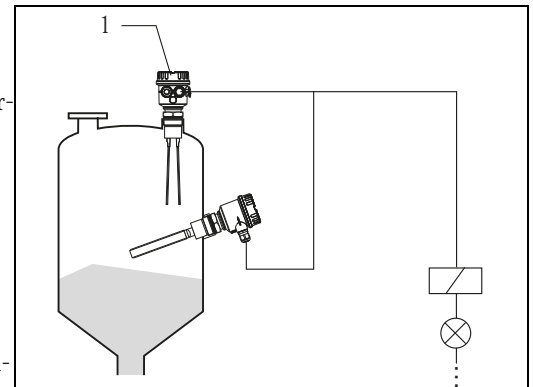

L00-FTM5xxxx-15-05-xx-xx-000

1 Electronic version

#### Separate instrumentation with switching unit

For connecting to a separate switching unit or isolating amplifier such as Nivotester:

- FTL325N, FTL375N (NAMUR) or
- FTL325P, FTL375P (PFM)

##### FEM55:

Signal transmission 8/16 mA along two-wire cabling:

##### FEM57:

- PFM signal transmission
- Current pulses superposed on the power supply along the two-wire cabling
- Self-test from the switching unit without changing levels

##### FEM58:

- Signal transmission H-L edge 2.2 to 4.8 / 0.4 to 1.0 mA to EN 50227 (NAMUR) along two-wire cabling
- Checking of connecting cabling and other devices by pressing a key on the electronic insert

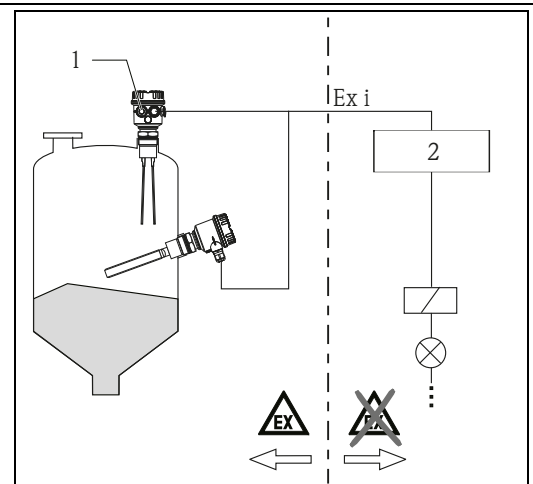

L00-FTM5xxxx-15-05-xx-en-000

1 Electronic version

2 Switching unit, PLC, isolating amplifier, segment coupler

## Cable specifications

Within the indicated standards and guidelines to interference immunity (see also "Electromagnetic compatibility", → 14) a normal instrument cable is sufficient. If higher interference levels are present, a shielded cable must be used.

<b>Immunity to temperature change of connecting cable</b>	In non-Ex applications the connecting cables must withstand the ambient temperature +5 K. For Ex applications, the specifications of the respective certificate (XA) must be observed → 30 Certificates.
---	--

<b>Connecting cables</b>	<ul style="list-style-type: none"> <li>▪ Electronic inserts: cross-section max. 2.5 mm<sup>2</sup> (13 AWG); strand in ferrule to DIN 46228</li> <li>▪ Protective ground in housing: cross-section max. 2.5 mm<sup>2</sup> (13 AWG)</li> <li>▪ Equipotential bonding connection on housing: cross-section max. 4 mm<sup>2</sup> (11 AWG)</li> </ul>
--------------------------	---

<b>Cable entry</b>	<p>Housing-specific: screw terminal on electronic insert.</p> <p>Cable gland M20x1,5 for cable:</p> <ul style="list-style-type: none"> <li>▪ Nickel-plated brass: ø7...10,5 mm (0.28...0.41 in)</li> <li>▪ Plastic: ø5...10 mm (0.2...0.38 in)</li> <li>▪ Stainless steel: ø7...12 mm (0.28...0.47 in)</li> </ul>
--------------------	---

## Input

<b>Measured variable</b>	Level (according to the mounting location and the overall length)
--------------------------	---

<b>Measuring range (detection range)</b>	<ul style="list-style-type: none"> <li>▪ FTM50: overall length see, → 19</li> <li>▪ FTM51: overall length 300 to 4000 mm (11.8 to 157 in)</li> <li>▪ FTM52: overall length 750 to 20000 mm (29.5 to 787 in)</li> </ul> <p>The measuring range of Soliphant M depends on the medium, mounting location and fork length. The detection range is located within the length of the fork.</p> <p><b>Distinction between the forks:</b></p> <ul style="list-style-type: none"> <li>▪ For light media: <ul style="list-style-type: none"> <li>Standard fork with a fork length of 155 mm (6.1 in) (bulk weight of the medium ≥ 10 g/l)</li> </ul> </li> <li>▪ For confined installation conditions, high lateral load or increased buildup: <ul style="list-style-type: none"> <li>Short fork with a fork length of 100 mm (3.94 in) (bulk weight of the medium ≥ 50 g/l)</li> </ul> </li> </ul>
--	---

<b>Input signal</b>	<ul style="list-style-type: none"> <li>▪ Probes covered =&gt; little to no vibrating amplitude</li> <li>▪ Probes not covered =&gt; large vibrating amplitude</li> </ul> <p>Selectable frequency monitoring (diagnosis) for detection of abrasion and build-up.</p>
---------------------	--

<b>Measuring frequency</b>	<ul style="list-style-type: none"> <li>▪ Standard fork: approx. 140 Hz (in air)</li> <li>▪ Short fork: approx. 350 Hz (in air)</li> </ul>
----------------------------	---

## Output

<b>Galvanic isolation</b>	<ul style="list-style-type: none"> <li>▪ FEM51, FEM52, FEM55: Between sensor and power supply</li> <li>▪ FEM54: Between sensor, power supply and load</li> <li>▪ FEM57, FEM58: See switching unit connected</li> </ul>
---------------------------	--

<b>Switch-on behavior</b>	When the power supply is switched on the switching status of the outputs corresponds to "signal on alarm". The correct switching status is assumed after a maximum of 3 s.
---------------------------	--

<b>Fail-safe mode</b>	Minimum/maximum residual current safety selectable on electronic insert. (with FEM57 only at Nivotester).
-----------------------	---

MAX = maximum safety:

The output switches safety-oriented when the fork is covered (signal on alarm)  
For use with overflow prevention for example.

MIN = minimum safety:

The output switches safety-oriented when the fork is uncovered (signal on alarm)  
For use with dry running protection for example.

<b>Switching delay</b>	0.5 s when the sensor is covered. Version 150 °C (302 °F): 1.5 s when the sensor is uncovered (1.0 s for short fork) Version 230/280 °C (446/536 °F): 2 s when the sensor is uncovered (1.0 s for short fork) Can be changed to 5 s for covering and uncovering.
<b>Switch behavior</b>	Binary

## Electronic insert

### FEM51 electronic insert (AC 2-wire)

#### Power supply

- Supply voltage AC: 19 to 253 V
- Power consumption: < 1.0 W
- Residual current consumption ( $I_R$ ): < 4 mA; 5.5 mA for short fork (in switch-off moment < 1 mA for 100 ms)
- Short-circuit protection
- Separation voltage: 3.6 kV
- FEM51 overvoltage protection: overvoltage category II

#### Two-wire AC connection

Always connect in series with a load!

Check the following:

- the residual current consumption in blocked state.
- that for low voltage
  - the voltage drop across the load is such that the minimum terminal voltage at the electronic insert (19 V) when blocked is not undershot.
  - the voltage drop across the electronics when switched through is observed (up to 12 V).
- when selecting the relay, pay attention to the holding power/rated power (see "Connectable load").

\* External load "R" must be connected

\*\* AC: U~max. 253 V, 50/60 Hz

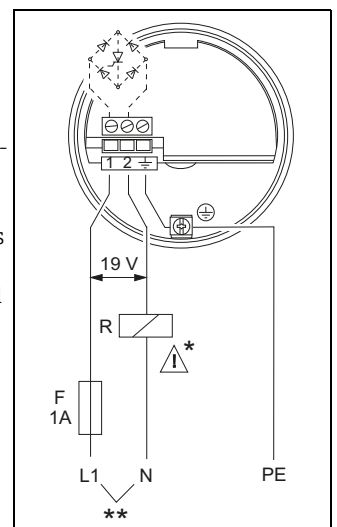



**Output signal**

$I_L$  = load current (switched through)

$I_R$  = residual current (blocked)

























 = lit

 = flashes

 = unlit

\* See also "Operating elements",

→  25

Safety mode	Level	Output signal	LEDs green yellow red
MAX		1 $I_L$ → 2	  
		1 $I_R$ → 2	  
MIN		1 $I_L$ → 2	  
		1 $I_R$ → 2	  
Maintenance required *		1 $I_L / I_R$ → 2	  
Instrument failure		1 $I_R$ → 2	  

L00-FTM5xxxx-04-05-xx-en-001

**Signal on alarm**

Output signal on power failure or in the event of device failure:  $I_R$

**Connectable load**

- For relays with a minimum holding power/rated power > 2.5 VA at 253 V (10 mA) or > 0.5 VA at 24 V (20 mA)
- For relays with a maximum holding power/rated power < 89 VA at 253 V or 8.4 VA at 24 V
- Voltage drop across FEM51 max. 12 V
- Residual current with blocked thyristor max. 4 mA (5.5 mA for short fork)
- Load current max. 350 mA (short-circuit proof)

**FEM52 electronic insert (DC PNP)**

**Power supply**

- DC voltage: 10 to 55 V
- Ripple: max. 1.7 V, 0 to 400 Hz
- Current consumption: max. 16 mA
- Power consumption: max. 0.86 W
- Reverse polarity protection/short-circuit protection
- Separation voltage: 3.6 kV
- FEM52 overvoltage protection: overvoltage category III

**Three-wire DC connection with cable entry / M12 plug**

- Preferably used with programmable logic controllers (PLC)
- DI modules as per EN 61131-2
- Positive signal at switching output of the electronics (PNP)

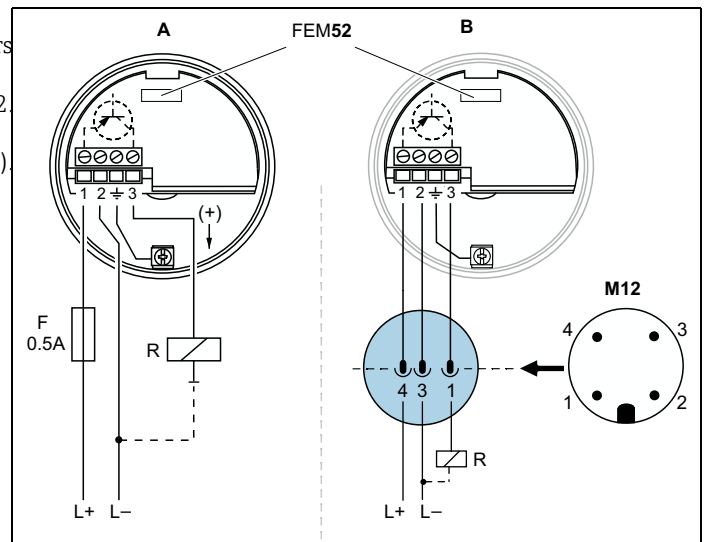

L00-FTM5xxxx-04-05-xx-xx-027a

DC:  $U = 10 \text{ V} \dots 55 \text{ V}$

A: With cable entry wired by customer (Ordering feature 80, options 2, 3, 4, 7)

B: With M12 plug wired at the factory (Ordering feature 80, option 1)

**Output signal**

$I_L$  = load current (switched through)

$I_R$  = residual current (blocked)

☀ = lit

⚡ = flashes

● = unlit

\* See also "Operating elements", → 25

Safety mode	Level	Output signal	LEDs green yellow red
MAX		$L^+ \xrightarrow{I_L} 3$	☀ ☀ ●
		$1 \xrightarrow{I_R} 3$	☀ ● ●
MIN		$L^+ \xrightarrow{I_L} 3$	☀ ☀ ●
		$1 \xrightarrow{I_R} 3$	☀ ● ●
Maintenance required *		$1 \xrightarrow{I_L / I_R} 3$	☀ ● ⚡
Instrument failure		$1 \xrightarrow{I_R} 3$	☀ ● ☀

L00-FTM5xxxx-04-05-xx-en-007

**Signal on alarm**

Output signal on power failure or in the event of device failure: < 100  $\mu\text{A}$

**Connectable load**

- Load switched via transistor and separate PNP connection, max. 55 V
- Load current max. 350 mA (pulsed overload and short-circuit protection)
- Residual current < 100  $\mu\text{A}$  (with transistor blocked)
- Capacitance load max. 0.5  $\mu\text{F}$  at 55 V, max. 1.0  $\mu\text{F}$  at 24 V
- Residual voltage < 3 V (with transistor switched through);

**FEM54 electronic insert  
AC/DC with relay output)**

**Power supply**

- Alternating voltage AC: 19 to 253 V, 50/60 Hz  
DC voltage: 19 to 55 V
- Power consumption: max. 1.5 W
- Reverse polarity protection/short-circuit protection
- Separation voltage: 3.6 kV
- FEM54 overvoltage protection: overvoltage category II

**Universal current connection with relay output (DPDT)**

Note!

Please note the different voltage ranges for AC and DC.

Output:

When connecting a device with high inductance, provide a spark arrester to protect the relay contact. A fine-wire fuse (depending on the load connected) protects the relay contact on short-circuiting. The relay contacts switch simultaneously.

\* When jumpered, the relay output works with NPN logic.

\*\* See "Connectable load"

- 1 Relay outputs: normally open/closed (NO, NC)
- 2 AC: U~19 to 253 V, DC: U=19 to 55 V

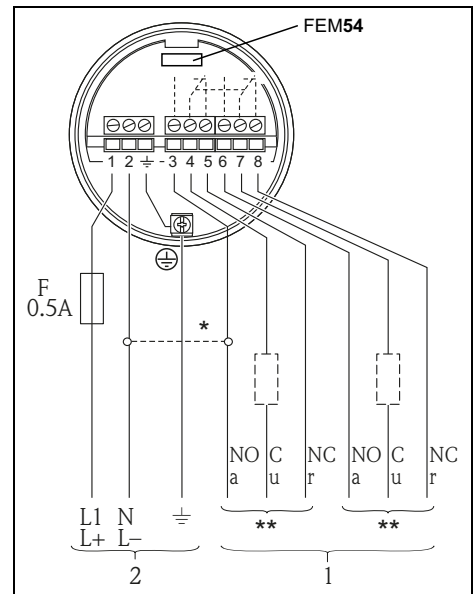

L00-FTM5xxxx-04-05-xxx-en-003

**Output signal**

⏏ = relay energized

⏏ = relay de-energized

☀ = lit

☀ = flashes

● = unlit

\* See also "Operating elements",  
→ 25

Safety mode	Level	Output signal	LEDs green yellow red
MAX			☀ ☀ ●
			☀ ● ●
MIN			☀ ☀ ●
			☀ ● ●
Maintenance required *			☀ ● ☀
Instrument failure			☀ ● ☀

L00-FTM5xxxx-04-05-xxx-en-008

**Signal on alarm**

Output signal on power failure or in the event of device failure: relay de-energized

**Connectable load**

- Loads switched via 2 floating change-over contacts (DPDT)
- AC: I~ max. 6 A (Ex de 4 A), U~ max. 253 V; P~ max. 1500 VA, cos φ = 1, P~ max. 750 VA, cos φ > 0.7
- DC: I= max. 6 A (Ex de 4 A) to 30 V, I= max. 0.2 A to 125 V
- The following applies when connecting a functional low-voltage circuit with double isolation as per IEC 1010: Sum of voltages of relay output and power supply max. 300 V



**FEM55 electronic insert  
(8/16 mA)**

**Power supply**

- DC supply voltage: 11 to 36 V
- Power consumption: < 600 mW
- Reverse polarity protection/short-circuit protection
- Separation voltage: 3.6 kV
- FEM55 overvoltage protection: overvoltage category II

**Two-wire connection for separate switching unit with cable entry / M12 plug**

For connecting to programmable logic controllers (PLC), AI modules 4-20 mA to EN 61131-2. Output signal jump from high to low current on point level.

Use only power supply with safe galvanically isolation (e.g. SELV).

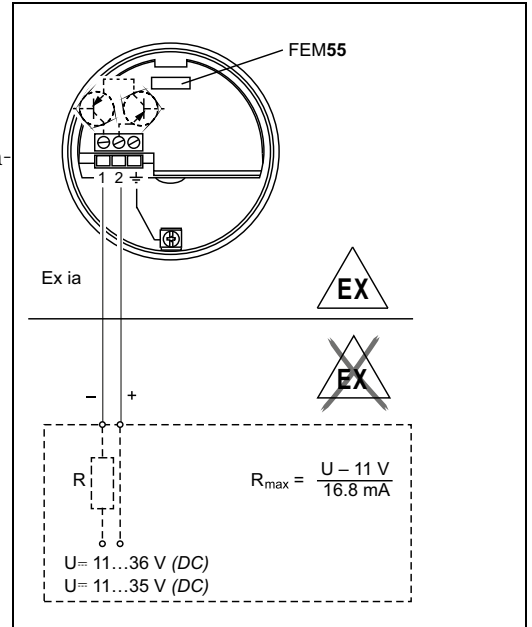

*U= 11 to 36 e.g. PLC  
With cable entry wired by customer (Ordering feature 80,  
options 2, 3, 4, 7)*

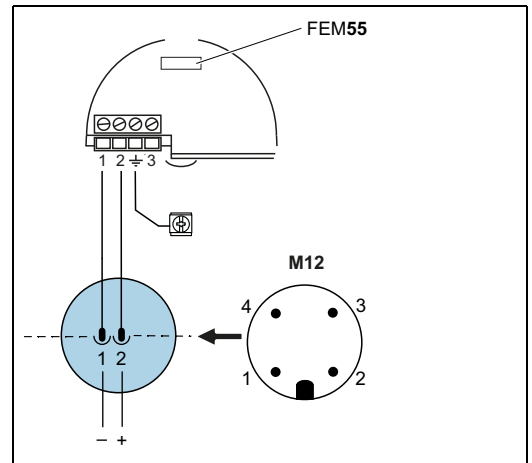

*With M12 plug wired at the factory (Ordering feature 80,  
option 1)*

**Output signal**

$\sim 16 \text{ mA} = 16 \text{ mA} \pm 5 \%$

$\sim 8 \text{ mA} = 8 \text{ mA} \pm 6 \%$



= lit



= flashes



= unlit

\* See also "Operating elements", → 25

Safety mode	Level	Output signal	LEDs		
			green	yellow	red
MAX		$\begin{matrix} + \\ 2 \end{matrix} \xrightarrow{\sim 16 \text{ mA}} 1$			
		$\begin{matrix} + \\ 2 \end{matrix} \xrightarrow{\sim 8 \text{ mA}} 1$			
MIN		$\begin{matrix} + \\ 2 \end{matrix} \xrightarrow{\sim 16 \text{ mA}} 1$			
		$\begin{matrix} + \\ 2 \end{matrix} \xrightarrow{\sim 8 \text{ mA}} 1$			
Maintenance required *		$\begin{matrix} + \\ 2 \end{matrix} \xrightarrow{8/16 \text{ mA}} 1$			
		 3.6 mA			
Instrument failure		$\begin{matrix} + \\ 2 \end{matrix} \xrightarrow{3.6 \text{ mA}} 1$			

L00-FTM5xxxx-04-05-xx-en-006

**Signal on alarm**

Output signal on power failure or in the event of device failure:  $< 3.6 \text{ mA}$

**Connectable load**

- $R = (U - 11 \text{ V}) / 16.8 \text{ mA}$
- $U =$  connection DC voltage 11 V to 36 V (in wet location DC 11...35 V)

**FEM58 electronic insert  
(NAMUR H-L edge)**

Note!

Only in combination with standard fork (fork length 155 mm (6.1 in)).

**Power supply**

- DC supply voltage:  $8.2 \text{ V} \pm 20 \%$
- Power consumption:  $< 8 \text{ mW}$  at  $I < 1 \text{ mA}$ ;  $< 36 \text{ mW}$  at  $I = 2.2$  to  $4.8 \text{ mA}$
- Separation voltage: 1.9 kV
- Connection data interface: IEC 60947-5-6

**Two-wire connection for separate switching unit with cable entry / M12 plug**

For connecting to isolating amplifiers acc. to NAMUR (IEC 60947-5-6), z.B. FTL325N or FTL375N from Endress+Hauser.

**H-L edge:**

Output signal jump from high to low current on point level.

Additional function:

Test key on the electronic insert.

Pressing the key breaks the connection to the isolating amplifier.

Note!

- For Ex d applications, the additional function can only be used if the housing is not exposed to an explosive atmosphere.
- Connecting to multiplexer: Set clock time to min. 5 s.

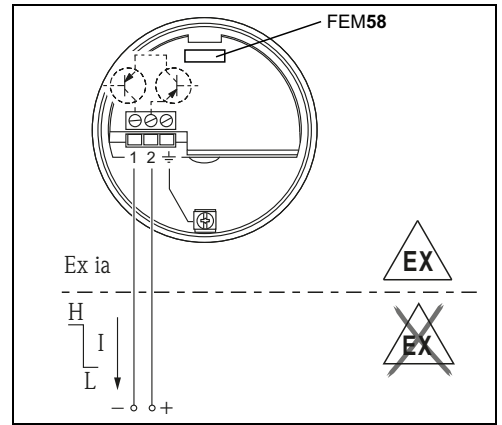

Isolating amplifier to IEC 60947-5-6 (NAMUR) With cable entry wired by customer (Ordering feature 80, options 2, 3, 4, 7)

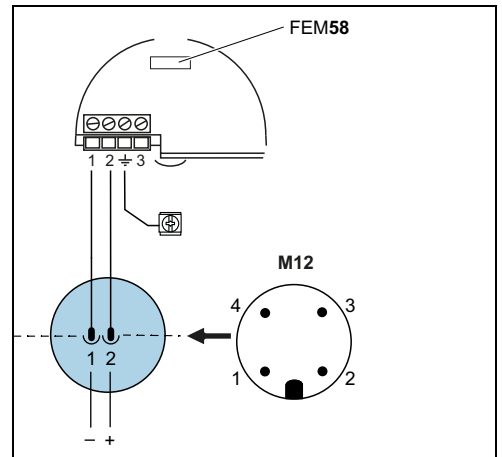

With M12 plug wired at the factory (Ordering feature 80, option 1)

**Output signal**

- = lit
- = flashes
- = unlit

\* See also "Operating elements", → 25

Safety mode	Level	Output signal	LEDs green yellow red
MAX		+ 2.2 ... 4.8 mA → 1	
		+ 0.4 ... 1.0 mA → 1	
MIN		+ 2.2 ... 4.8 mA → 1	
		+ 0.4 ... 1.0 mA → 1	
Maintenance required *		+ 0.4 ... 4.8 mA → 1	
Instrument failure		+ 0.4 ... 1.0 mA → 1	

**Signal on alarm**

Output signal  
in event of device failure: < 1.0 mA

**Connectable load**

- See "Technical Data" of the isolating amplifier connected according to IEC 60947-5-6 (NAMUR)
- Connection also to safety isolating amplifiers (I = 3 to 4.8 mA)

**FEM57 electronic insert (PFM)**

**Power supply**

- DC supply voltage: 9.5 to 12.5 V
- Power consumption: < 150 mW
- Reverse polarity protection/short-circuit protection
- Current consumption: 10 to 13 mA
- Separation voltage: 2.6 kV

**Two-wire connection for separate switching unit / M12 plug**

For connecting to Nivotester (see graphic) from Endress+Hauser.  
Output signal jump of PFM signal from high to low frequency when sensor is covered. Switching between minimum/maximum safety on the Nivotester.

Additional function "self test":  
After interruption of the power supply, a test cycle is activated which checks the sensor and electronics without any change in level.  
For this purpose, the operating elements must be configured as follows:

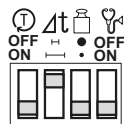

The test is activated at the switching unit.  
LEDs indicate the progress of the test.

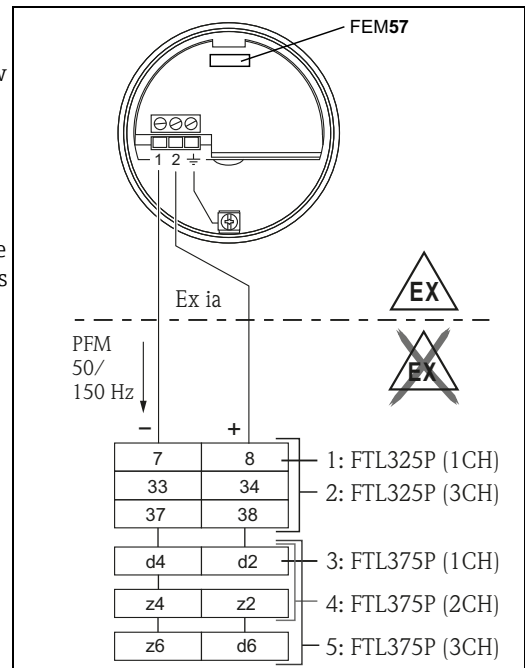

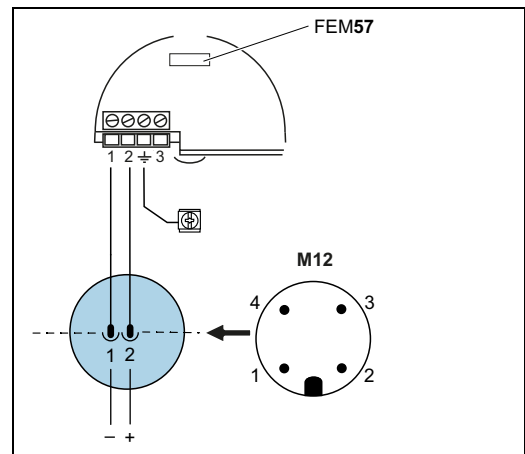

*With cable entry wired by customer (Ordering feature 80, options 2, 3, 4, 7)*

























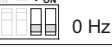

*With M12 plug wired at the factory (Ordering feature 80, option 1)*

**Output signal**

-  = lit
-  = flashes
-  = unlit

\* See also "Operating elements", → 25

Safety mode	Level	Output signal (PFM)	LEDs green yellow red
		150 Hz 	  
		50 Hz 	  
Maintenance required *		150 Hz 	  
		0 Hz 	  
Instrument failure		0 Hz 	  

L00-FTM5xxxx-04-05-xx-en-009

**Signal on alarm**

Output signal on power failure or in the event of device failure: 0 Hz

**Connectable load**

- Floating relay contacts in connected switching unit Nivotester (see drawing above)
- For contact load, see the Technical Data of the switching unit

**Installation**

**Installation instructions**

**Orientation FTM50**

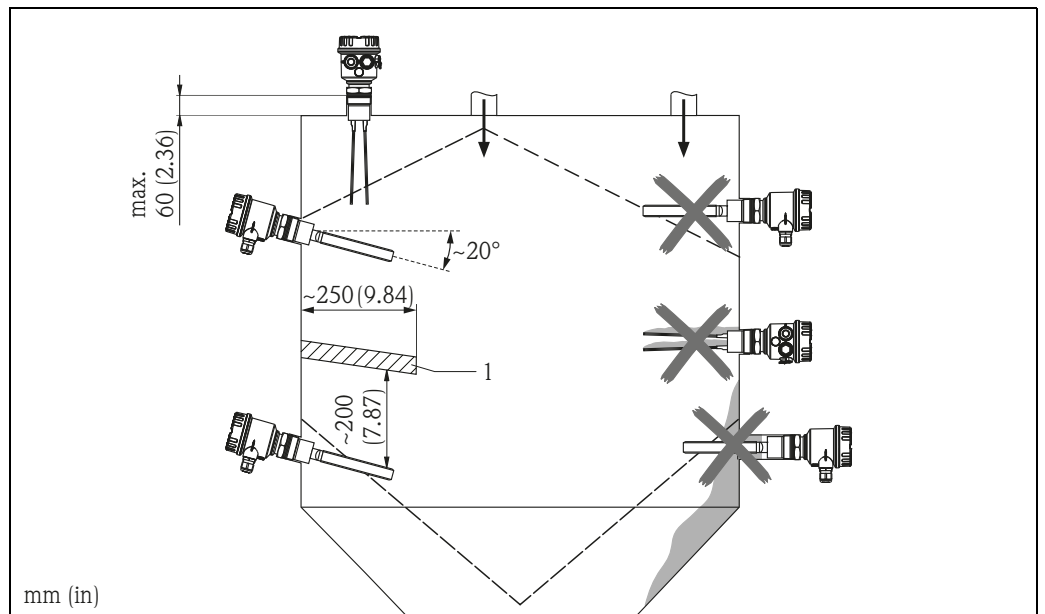

L00-FTM5xxxx-11-06-xx-xx-004

1 Protective cover (provided by the customer)

Orientation  
FTM51, FTM52

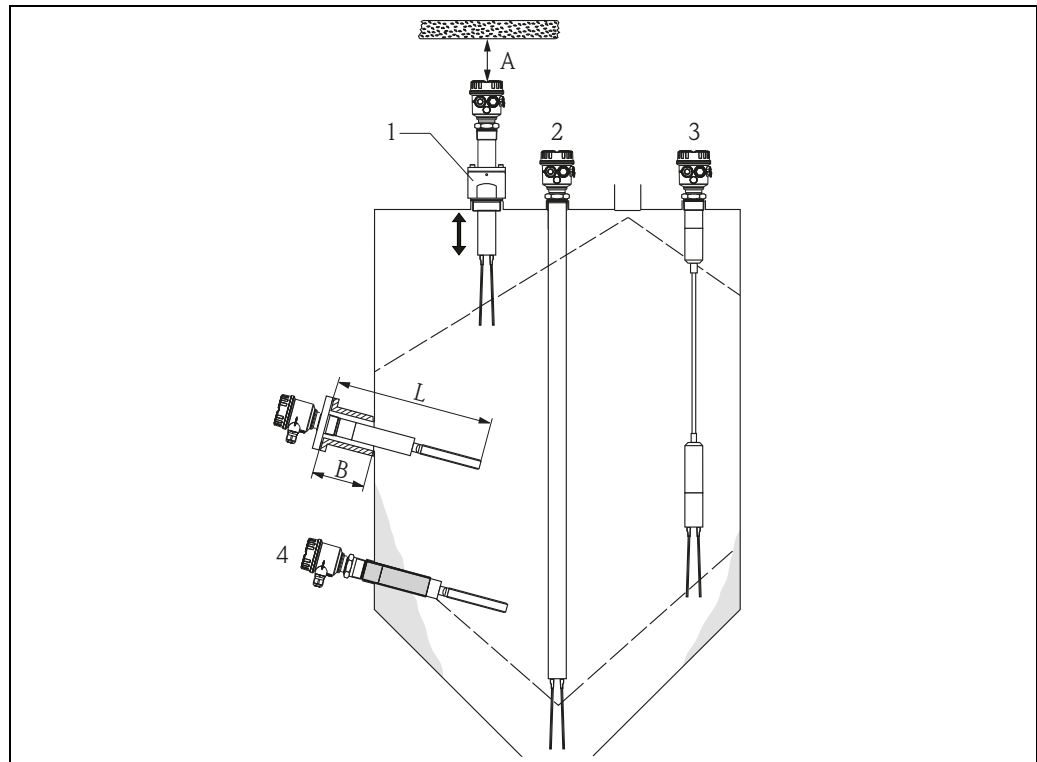

L00-FTM5xxxx-11-06-xx-xx-001

- 1 Sliding sleeve  
 2 FTM51  
 3 FTM52  
 4 FTM51 with supporting tube (not included in the delivery)  
 A Clearance  
 B Maximum nozzle length: = L Sensor length - 145 mm (5.71 in) for short fork  
 = L Sensor length - 200 mm (7.87 in) for standard fork

## Environment

<b>Ambient temperature range</b>	-50 °C to +70 °C (-58 °F to +158 °F); With F16 housing: -40 °C to +70 °C (-40 °F to +158 °F)
<b>Storage temperature</b>	-50 °C to +85 °C (-58 °F to +185 °F)
<b>Climate class</b>	Climate protection as per DIN IEC 68, Part 2-38, Fig. 2a
<b>Degree of protection</b>	<ul style="list-style-type: none"> <li>■ Housing F15, F16, F17, separate housing: IP66/IP67, NEMA4X</li> <li>■ Housing F13, T13, F27: IP66/IP68, NEMA4X/6P</li> </ul>
<b>Vibration resistance</b>	To EN 60068-2-64: 0.01 g <sup>2</sup> /Hz
<b>Shock resistance</b>	To EN 60068-2-27: 30 g
<b>Electrical safety</b>	IEC 61010, CAN/CSA-C22.2 No. 61010-1-04 US standard UL 61010-1, 2 <sup>nd</sup> Edition
<b>Electromagnetic compatibility</b>	<ul style="list-style-type: none"> <li>■ Interference emission to EN 61326, Equipment Class B,</li> <li>■ Interference immunity to EN 61326; Annex A (Industrial) and NAMUR Recommendation NE21 (EMC).</li> </ul>

## Process

### Medium temperature limits

### Non-hazardous area and Ex d + DIP certificates

(Ex ia certificates see Seite 30, "Certificates")

#### NOTICE

Permitted ambient temperature  $T_a$  at housing depending on the process temperature  $T_p$  in the container.

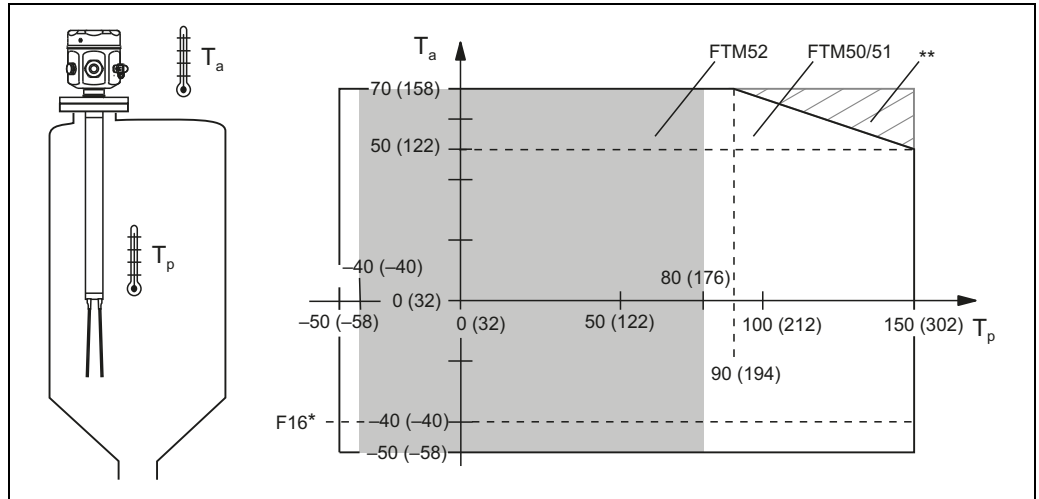

\* Restriction to -40 °C with F16 housing

\*\* Additional temperature range for sensors (FTM50, FTM51) with temperature spacer

### High temperature (only FTM50, FTM51)

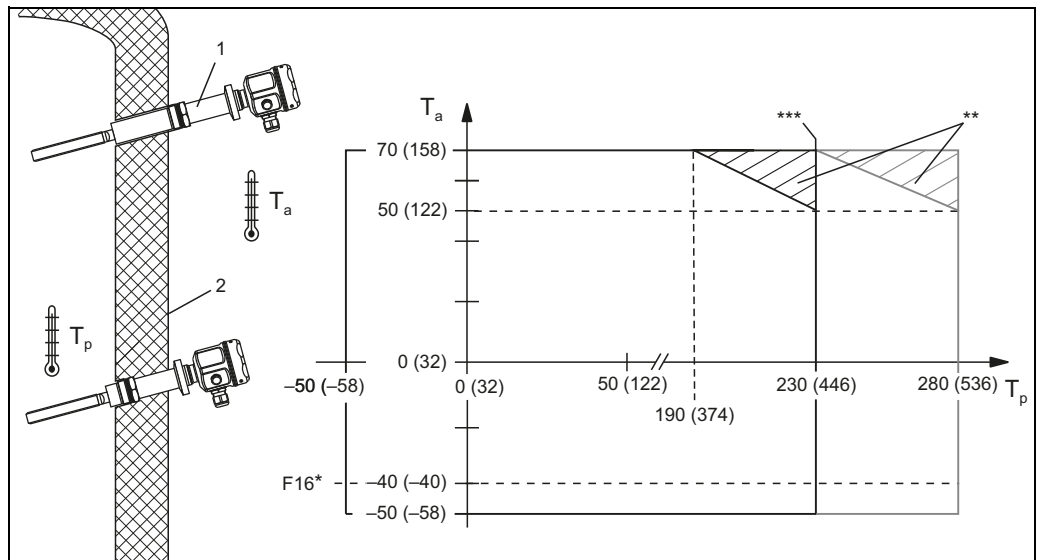

\* Restriction to -40 °C with F16 housing

\*\* Additionally utilizable temperature range when using the temperature spacer "1"

\*\*\* Antistick coating possible up to max. 230 °C

2 Insulation

### Thermal shock resistance

- Maximum 120 K
- At high temperature 260 K

<b>Limiting medium pressure range</b>	-1 to 25 bar (362.5 psi)
	<p>Maximum Working Pressure (MWP)</p> <ul style="list-style-type: none"> <li>■ FTM50/51: 25 bar (362.5 psi)</li> <li>■ FTM52: 2 bar (29 psi) (6 bar (87 psi) for Ex d, Ex de and FM/CSA XP)</li> </ul> <p>The specified range may be reduced by the selected process connection. The pressure rating (PN) specified on the flanges refers to a reference temperature of 20 °C (68 °F), for ASME flanges to 100 °F. Observe pressure-temperature dependency.</p> <p>The pressure values permitted at higher temperatures can be found in the following standards:</p> <ul style="list-style-type: none"> <li>■ EN 1092-1: 2001 Tab.18 With regard to their stability-temperature property, the materials 1.4404 and 1.4435 are grouped together under 13E0 in EN 1092-1, Tab. 18. The chemical composition of the two materials can be identical.</li> <li>■ ASME B 16.5a - 1998 Tab. 2-2.2 F316</li> <li>■ ASME B 16.5a - 1998 Tab. 2.3.8 N10276</li> <li>■ JIS B 2220</li> </ul>
<b>Burst pressure</b>	FTM50/51: 100 bar (1450 psi)

<b>State of aggregation</b>	Solids
<b>Grain size</b>	≤ 10 mm (0.39 in)
<b>Bulk weight</b>	<p>Depends on the density setting on the electronic insert:</p> <ul style="list-style-type: none"> <li>■ Standard fork: ≥ 10 or 50 g/l (for light media)</li> <li>■ Short fork: ≥ 50 or 200 g/l (for confined installation conditions, high lateral load or increased buildup)</li> </ul>

**Lateral load (static)** The following graphic shows the maximum permitted lateral load  $F$  in N (lbf) in relation to the length  $L$  in mm (in).

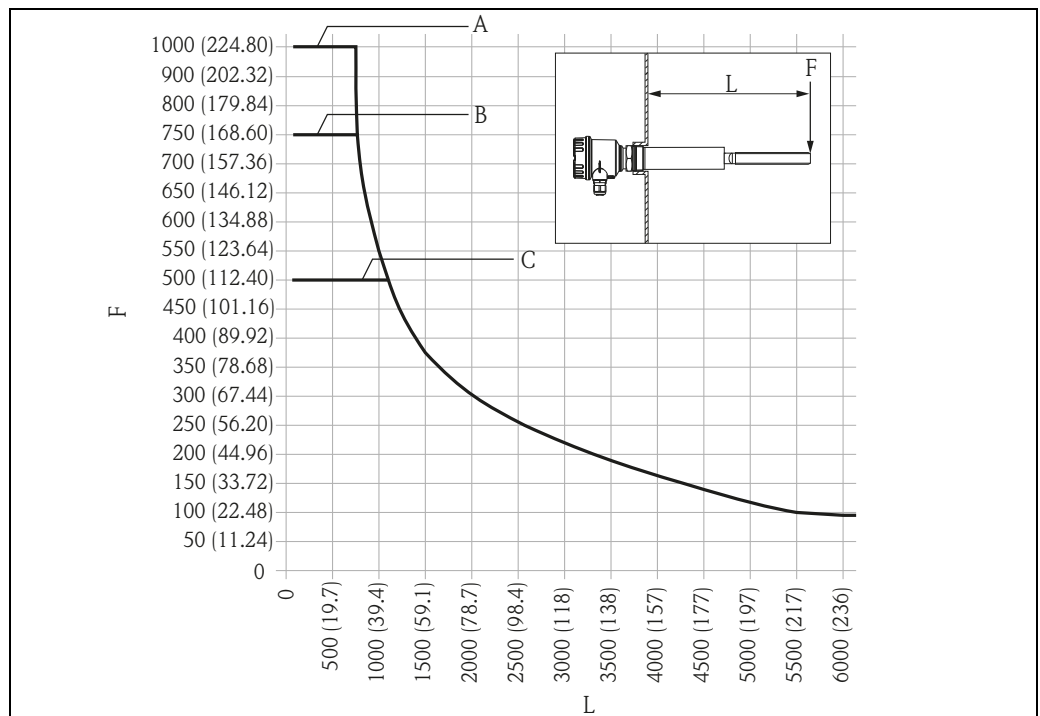

- A Short fork, sensor Ø36 mm (1.42 in), → 19  
 B Short fork, sensor Ø43 mm (1.69 in), → 19;  
 C Standard fork, sensor Ø43 mm (1.69 in), → 19.

**Tensile strength rope FTM52** 3000 N (lbf)



## Mechanical construction

### Housing and process connection

#### Polyester housing F16

Process connection:

- R 1½
- 1½ NPT
- 1¼ NPT

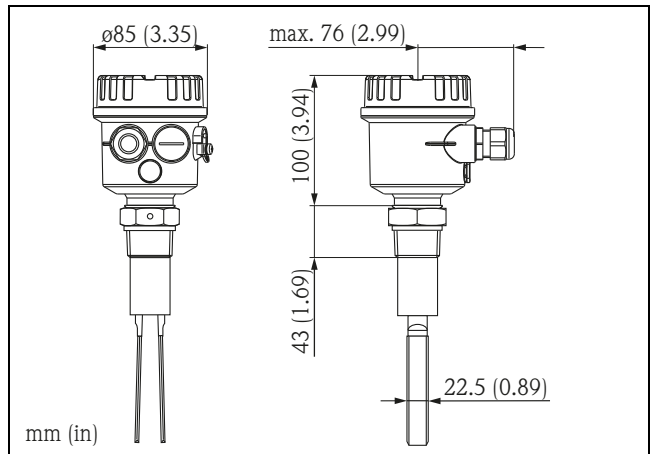

#### Stainless steel housing F15

Process connection:

Tri-Clamp

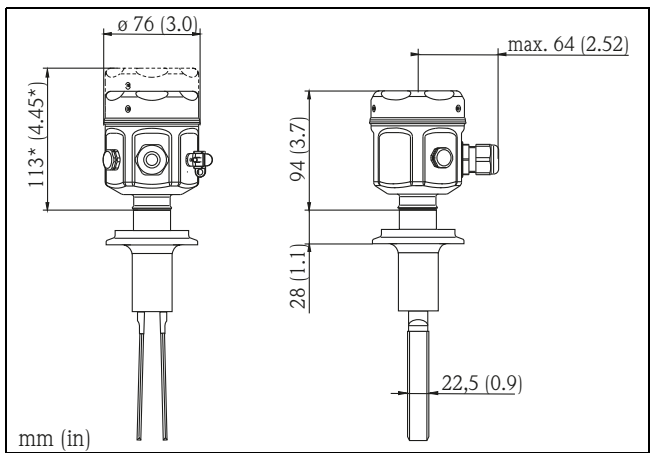

\* Cover with glass insert

#### Aluminum housing F17

Process connection:

Flange

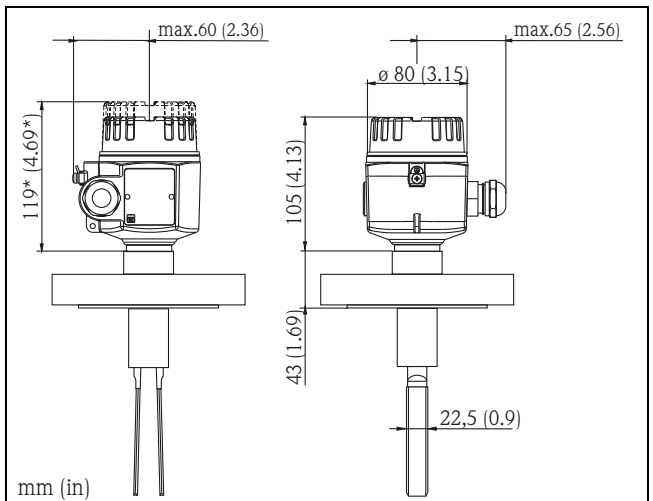

\* Cover with glass insert

**Aluminum housing F13 (Ex d)**  
(Adaption to sensor threaded.)

Process connection

- Flange
- R1½
- 1½ NPT
- 1¼ NPT

**Stainless steel housing F27 (Ex d)**  
(Adaption to sensor threaded.)

Process connection

- Flange
- R1½
- 1½ NPT
- 1¼ NPT

\* Cover with glass insert

(only for aluminum housing F13)

\*\* For Tri-Clamp 36 mm (1.42 in)

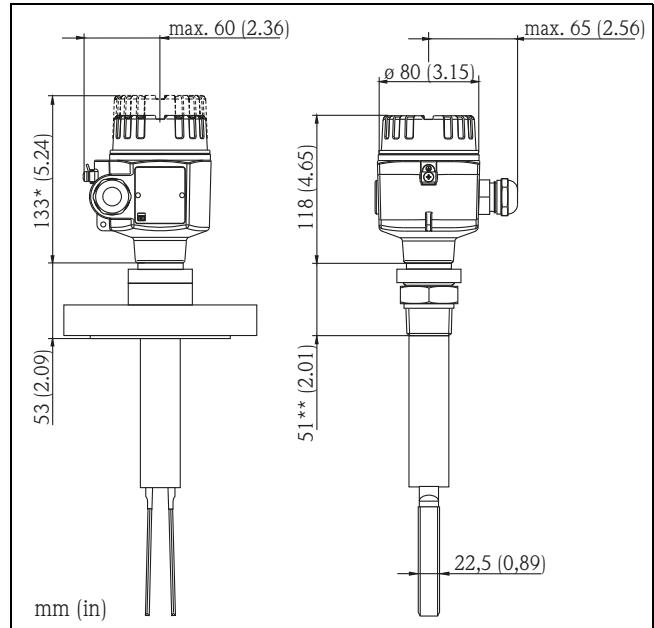

**Aluminum housing T13 (Ex de)**

With separate connection compartment.

Process connection

- R1½
- 1½ NPT
- 1¼ NPT

With Ex d(e) for FTM51 and FTM52:  
for flange and thread dimensions see  
the previous graphic

- R 1½
- 1½ NPT
- 1¼ NPT

\* Cover with glass insert

\*\* For Tri-Clamp 16 mm (0.63 in)

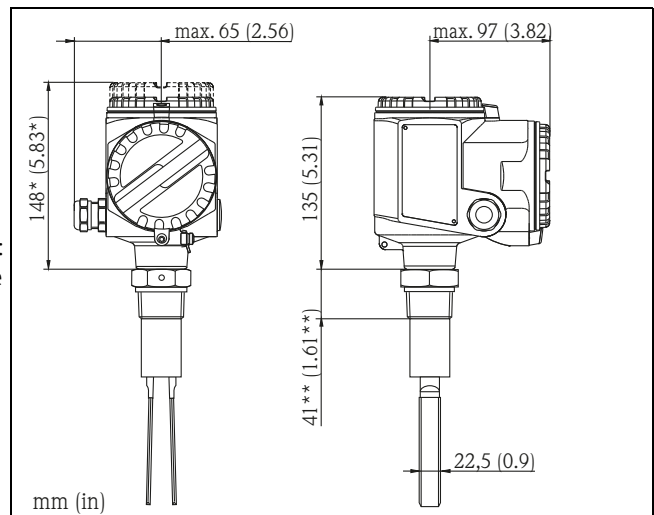

Dimensions

Compact version FTM50

Dimensions: mm (in)

Process connection	Code	Dimensions	Accessories	Pressure Temperature (for FTM50/51)
<p>1½ NPT ANSI B 1.20.1</p> <p>R 1½ EN 10226</p>	<p>GJ</p> <p>GG</p>	<p>L00-FTM5xxxx-06-05-xx-xx-004</p>		<p>max. 25 bar (362.5 psi) max. 280 °C (536 °F)</p>
<p>1½ NPT ANSI B 1.20.1</p>	GX	<p>L00-FTM5xxxx-06-05-xx-xx-006</p>		<p>max. 25 bar (362.5 psi) max. 150 °C (302 °F)</p>
<p>1¼ NPT ANSI B 1.20.1</p>	GK	<p>L00-FTM5xxxx-06-05-xx-xx-005</p>		<p>max. 25 bar (362.5 psi) max. 150 °C (302 °F)</p>
<p><b>Flange</b> ANSI B 16.5 EN 1092-1 (DIN 2527 B) JIS B2220</p>	A# B# K#	<p>L00-FTM5xxxx-06-05-xx-xx-013</p>	<p>Seal according to design installed on site FDA approval available</p>	<p>See nominal pressure of flange, however max. 25 bar (362.5 psi) max. 280 °C (536 °F)</p>
<p><b>Tri-Clamp 2"</b> ISO 2852</p>	TD	<p>L00-FTM5xxxx-06-05-xx-xx-014</p>	<p>Clamping ring and front seal installed on site FDA approval available</p>	<p>max. 16 bar (232 psi) max. 120 °C (248 °F)</p> <p>max. 2 bar (29 psi) max. 150 °C (302 °F)</p>
<p>L00-FTM5xxxx-06-05-xx-xx-030</p> <p>Dimensions of standard fork and short fork</p> <p>¹) Length of standard fork ²) Length of short fork</p>				

Rope version FTM52

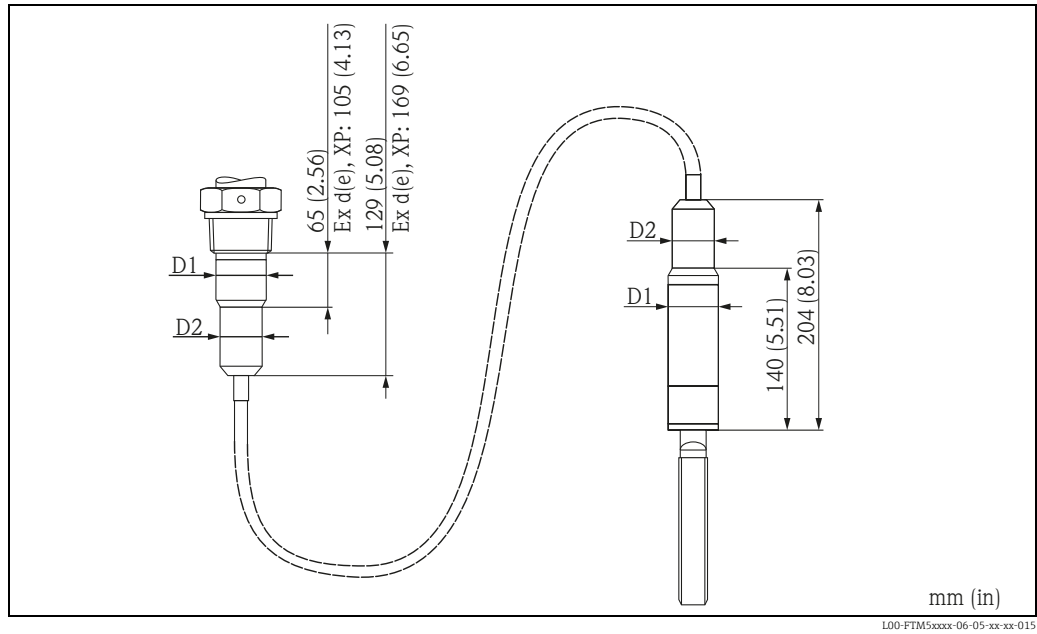

Process connection:	GJ, GG, A#, B#, K#, TD	GK, GX
ø D1 (mm [in])	43 (1.69)	36 (1.42)
ø D2 (mm [in])	37 (1.46)	37 (1.46)

Versions with extensions

**FMI51 (pipe):** Dimensions depend on process connection and selected pipe extension  
**FTM52 (rope):** Dimensions depend on process connection and selected rope extension

Process connection: <ul style="list-style-type: none"> <li>▪ 1½ NPT</li> <li>▪ 1¼ NPT</li> <li>▪ R 1½</li> </ul>		Flange and Tri-Clamp	
FTM51	FTM52	FTM51	FTM52
<p>L00-FTM5xxxx-06-05-xx-xx-016</p>	<p>L00-FTM5xxxx-06-05-xx-xx-017</p>	<p>L00-FTM5xxxx-06-05-xx-xx-018</p>	<p>L00-FTM5xxxx-06-05-xx-xx-022</p>
<p>L = Length (from lower edge of thread), X = fork length                      For further information on the overall length and fork length see "Measuring range (detection range)", → 4.                      Diameter of pipe extension FTM51: see dimensions of FTM50, → 19.</p>			

Versions with temperature spacer

Length and version depend on temperature and certificate:

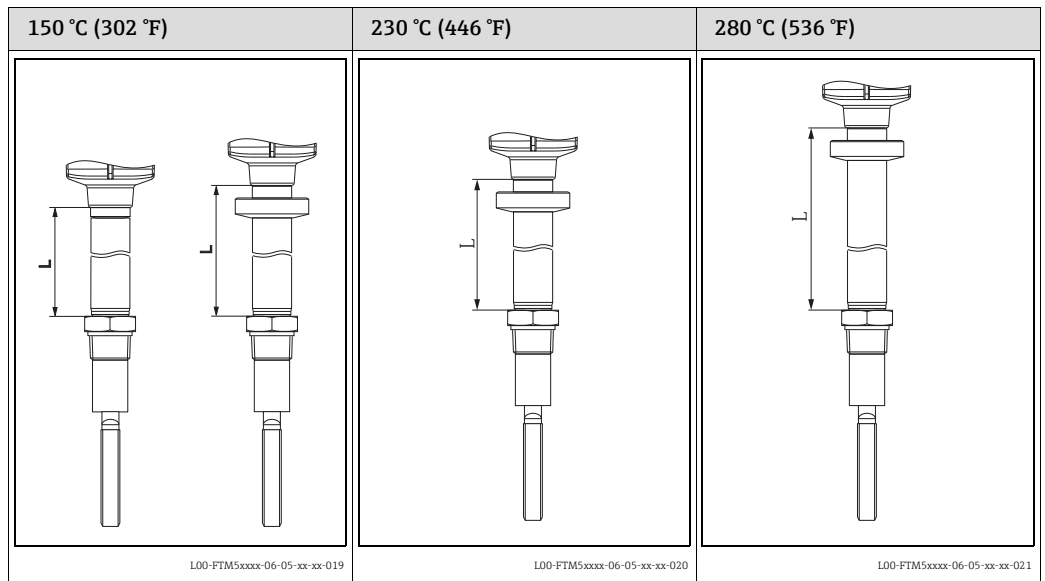

mm (in)	150 °C (302 °F)		230 °C (446 °F)	280 °C (536 °F)
L: for housing F15, F16, F17	145 (5.71)	--	175 (6.89)	215 (8.46)
L: for housing F13, F27, T13	145 (5.71)	165 (6.5)	165 (6.5)	205 (8.07)
Certificate	A, 1, 2, 3, 4, 7, 8, C, D, F, X	5, 6, H, Z	Not relevant	Not relevant

Surface refinement

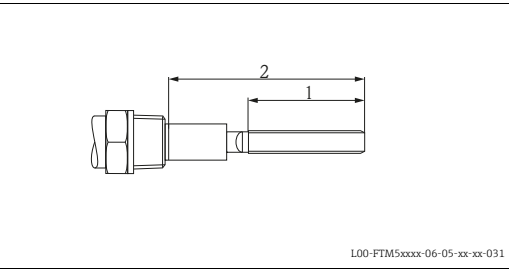
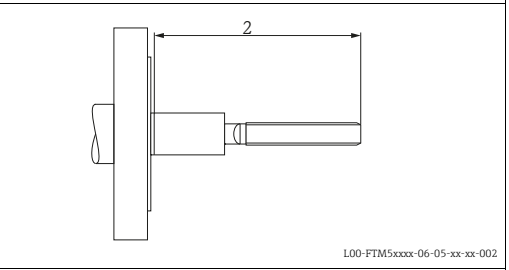
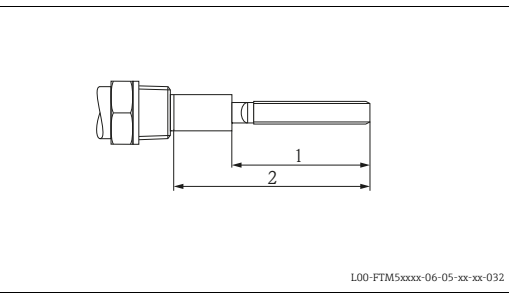
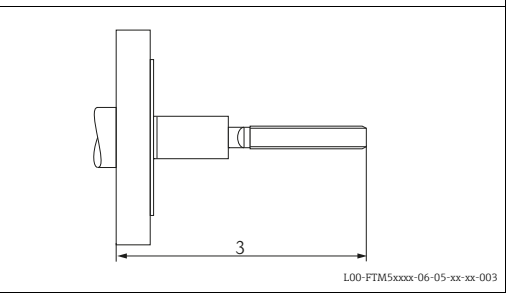
Electropolishing	Device with thread	Device with flange
		
	<p>1: Electropolished fork (0.76 µm)                  2: Fork and pipe electropolished as far as welding seam on process connection (0.76 µm)</p> <p><b>NOTICE</b></p> <ul style="list-style-type: none"> <li>▶ In the area of the welding seams, the roughness is not defined due to the production process.</li> <li>▶ In the area of the fork base a deviation of the surface roughness can occur.</li> </ul>	
Coating		
	<p>1: Fork coated                  2: Fork and pipe coated as far as welding seam on process connection                  3: Fully coated</p>	

### Version with separate housing

#### Applications:

For high ambient temperatures and applications with confined installation locations (e.g. filling nozzle applications). The cable between the separate housing and sensor can be shortened at the customer's.

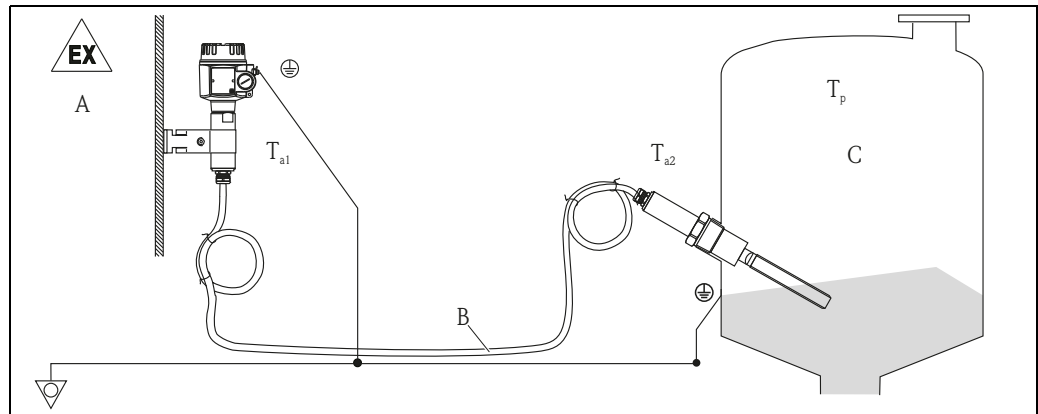

A: Zone 1, Zone 21; B: Length max. 6 m (20 ft); C: Zone 0, Zone 20

	T <sub>a1</sub>	T <sub>a2</sub>	T <sub>p</sub>
FTM50/51	70 °C (158 °F)	120 °C (248 °F)	Versions: 150 °C (302 °F), 230 °C (446 °F), 280 °C (536 °F)
FTM52	70 °C (158 °F)	80 °C (176 °F)	80 °C (176 °F)

#### Housing extension heights for wall and pipe mounting

The wall holder unit forms part of the scope of supply for device versions with a separate housing.

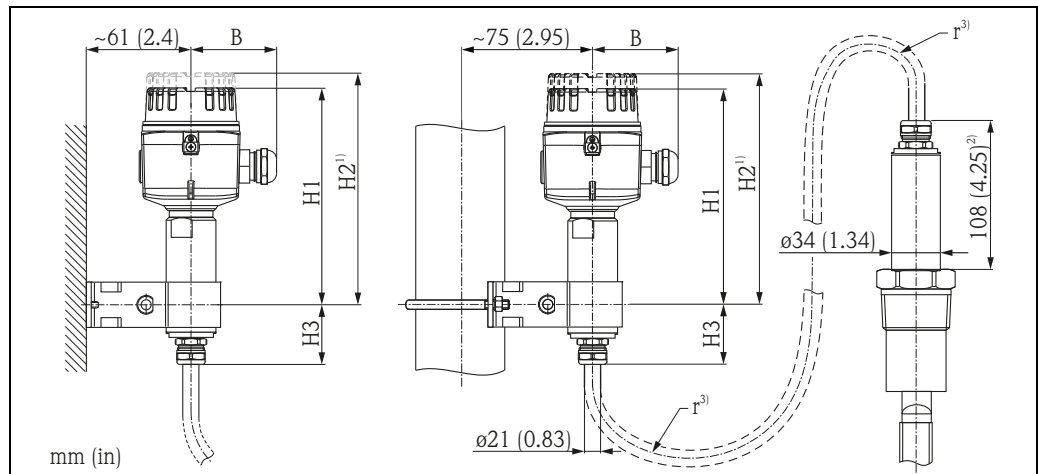

1) Cover with glass insert;

2) - With optional temperature spacer up to 150 °C (302 °F) → 108 + 145 = 253 mm (4.25 + 5.71 = 9.96 in)

- With high-temperature version 230 °C (446 °F) → 108 + 175 = 283 mm (4.25 + 6.89 = 11.1 in)

- With high-temperature version 280 °C (536 °F) → 108 + 215 = 323 mm (4.25 + 8.46 = 12.7 in)

3) The bending radius is  $r \geq 100$  mm (3.94 in); with armored tube  $r \geq 75$  mm (2.95 in)

Dimen- sions mm (in)	Housing				
	Polyester (F16)	Stainless steel (F15)	Aluminum (F17)	Aluminum (F13) Stainless steel (F27)	Aluminum (T13) Separate connection com- partment
B	76 (2.99)	64 (2.52)	65 (2.56)	65 (2.56)	97 (3.82)
H1	155 (6.1)	166 (6.54)	160 (6.3)	243 (9.57)	260 (10.2)
H2	--	185 (7.28)	174 (6.85)	258 (10.2)	273 (10.7)
H3	41 (1.61)		62 (2.44)		

---

**Weights** Depends on type; see last column on "Additional weight" in the ordering information

---

**Materials and surfaces** Material specifications as per AISI and DIN-EN.

**Surface roughness**

**NOTICE**

- ▶ In the area of the welding seams, the roughness is not defined due to the production process.
- ▶ In the area of the fork base a deviation of the surface roughness can occur.

Electropolished for simple cleaning and to avoid build-up and corrosion.

Choice of surface roughness (version => type): Ra < 0.76 µm

**Parts in contact with process**

- Process connection and extension pipe: 316L (1.4404, 1.4435)
- Tuning fork: 316L (1.4404, 1.4435)
- Flanges: 316L (1.4435 or 1.4404)
- PTFE coating: prevents buildup, FDA compliant
- ETFE coating: prevents corrosion
- FTM52: PUR/silicone for rope insulation, PBT

**Parts with no process contact**

- Seal between process connection/housing: EPDM
- Ground terminals outside on housing: 304 (1.4301), 316L (1.4404)
- Polyester housing F16: PBT-FR with PBT-FR cover or with PA12 transparent cover,
  - Cover seal: EPDM
  - Nameplate glued: polyester film (PET)
  - Pressure compensation filter: PBT-GF20
- Stainless steel housing F15: 316L (1.4404)
  - Cover seal: silicone/PTFE
  - Safety claw: 316L (1.4404)
  - Pressure compensation filter: PA, VMQ/VA
  - Nameplate labeling directly on the device
- Aluminum housing F17/F13: EN-AC-ALSi10Mg, plastic-coated,
  - Cover seal: EPDM
  - Safety claw: nickel-plated brass
  - Pressure compensation filter (only F17): silicone
  - Nameplate: 304 (1.4301)
- Stainless steel housing F27: 316L (1.4435)
  - Cover seal: FVMQ (optional: EPDM seal available as spare part)
  - Safety claw: 316L (1.4435)
  - Nameplate: 316L (1.4404)
- Aluminum housing T13: EN-AC-ALSi10Mg, plastic-coated,
  - Cover seal: EPDM
  - Safety claw: nickel-plated brass
  - Nameplate: 304 (1.4301)
- Cable gland versions:
  - Polyamide (PA)
  - Nickel-plated brass
  - 316L (1.4435)
  - M12 connector (nickel-plated brass)

## Operability

### Display elements

#### NOTICE

The switch settings in the following graphics are in the as-delivered state.

#### FEM51

- Green LED lit:
  - Indicates operational status
- Yellow LED lit:
  - Indicates switching status
- Red LED
  - flashing: flashes alternately with green LED if maintenance is required
  - lit: indicates device failure

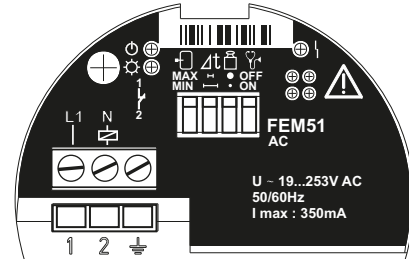

L00-FTM5xxxx-03-05-xx-xx-001

#### FEM52

- Green LED lit:
  - Indicates operational status
- Yellow LED lit:
  - Indicates switching status
- Red LED
  - flashing: indicates maintenance is required
  - lit: indicates device failure

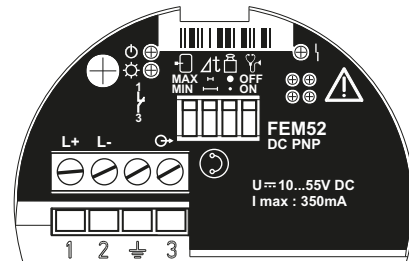

L00-FTM5xxxx-03-05-xx-xx-002

#### FEM54

- Green LED lit:
  - Indicates operational status
- Yellow LED lit:
  - Indicates switching status
- Red LED
  - flashing: indicates maintenance is required
  - lit: indicates device failure

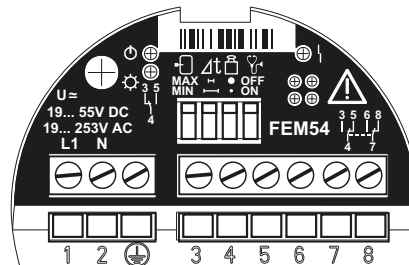

L00-FTM5xxxx-03-05-xx-xx-004

#### FEM55

- Green LED lit:
  - Indicates operational status
- Yellow LED lit:
  - Indicates switching status
- Red LED
  - flashing: indicates maintenance is required
  - lit: indicates device failure

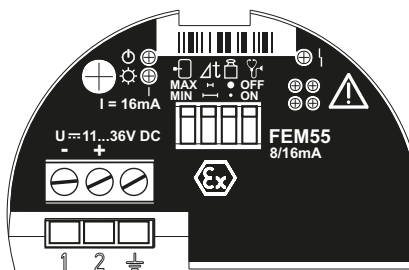

L00-FTM5xxxx-03-05-xx-xx-005



**FEM57**

- Green LED lit:  
Indicates operational status
- Yellow LED lit:  
Indicates covered status
- Red LED
  - flashing: indicates maintenance is required
  - lit: indicates device failure

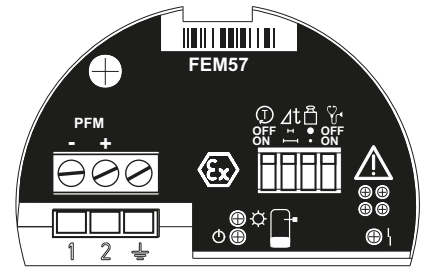

L00-FTM5xxxx-03-05-xx-xx-007

**FEM58**

- Green LED flashing:  
Indicates operational status
- Yellow LED lit:  
Indicates switching status
- Red LED
  - flashing: flashes alternately with green LED if maintenance is required
  - flashing: indicates device failure

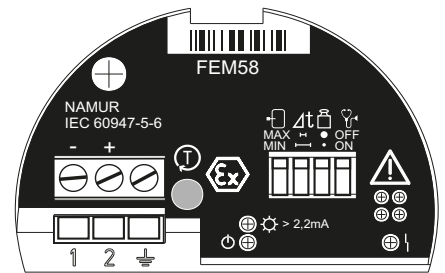

L00-FTM5xxxx-03-05-xx-xx-008

**NOTICE**



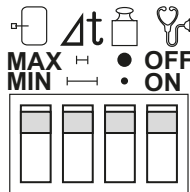

If the test key is pressed this breaks the cable connection.

**Operating elements of FEM51, FEM52, FEM54, FEM55, FEM58**

**Factory setting:**



L00-FTM5xxxx-19-05-xx-xx-001

	<b>Switch for safety mode</b>	
	MAX	Overfill prevention
	MIN	Dry running protection
	<b>Switch for switching delay</b>	
	dt	0.5 s when covered 150 °C (302 °F): 1.5 s when uncovered (short fork 1 s) 230/280 °C (446/536 °F): 2 s when uncovered (short fork 1 s)
	dt	5 s when covered, 5 s when uncovered
	<b>Switch for bulk weight/density setting</b>	
	●	50 g/l standard fork, 200 g/l short fork (high bulk weight)
	•	10 g/l standard fork, 50 g/l short fork (low bulk weight)
	<b>Switch for diagnosis</b>	
	OFF	Diagnosis of abrasion and buildup switched OFF
	ON	Diagnosis of abrasion and buildup switched ON <ul style="list-style-type: none"> <li>■ For additional density setting to high bulk density: abrasion and build-up are indicated per LED at the electronic insert only</li> <li>■ For additional density setting to low bulk density: output of "signal on alarm" for abrasion and build-up</li> </ul>

## Operating elements of FEM57

### Factory setting:

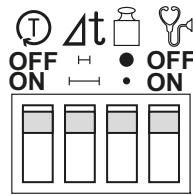

L00-FTM5xxxx-19-05-xx-xx-002

	<b>Switch for switching the self-test on or off</b>	
	OFF	Self-test switched off
	ON	At the same time, switching delay 0.5 s when covered, density setting for low bulk weight and diagnostics on (see also Seite 12): Self-test performed when voltage returns.
	<b>Switch for switching delay</b>	
	⇐	0.5 s when covered 150 °C (302 °F): 1.5 s when uncovered (short fork 1 s) 230/280 °C (446/536 °F): 2 s when uncovered (short fork 1 s)
	⇐⇐	5 s when covered, 5 s when uncovered
<b>One switch for bulk weight/density setting</b>		
	●	Standard fork: 50 g/l Short fork: 200 g/l (high bulk weight)
	•	Standard fork: 10 g/l (low bulk weight) Short fork: 50 g/l
<b>One switch for diagnosis</b>		
	OFF	Diagnosis of abrasion and buildup switched OFF
	ON	Diagnosis of abrasion and buildup switched ON <ul style="list-style-type: none"> <li>■ For additional density setting to high bulk density: abrasion and build-up are indicated per LED at the electronic insert only</li> <li>■ For additional density setting to low bulk density: output of "signal on alarm" for abrasion and build-up</li> </ul>

## Sediment detection with FTM50 and FTM51

### Detection of solids under water

Only sediment is detected.  
Water-like liquids or entrained substances are not detected.

The standard version of FTM52 is not suitable for immersion due to the IP67 rope seal!  
Version with IP68 available on request.

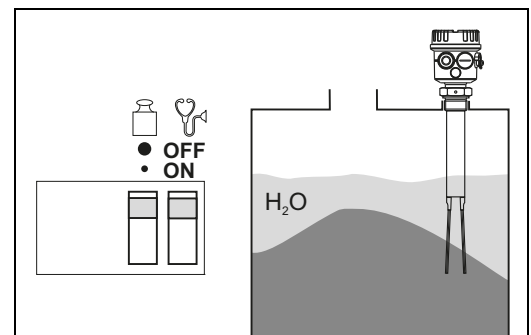

L00-FTM5xxxx-19-05-xx-xx-014

## Certificates and approvals

### CE mark

The measuring system is in conformity with the statutory requirements of the applicable EC Directives. These are listed in the corresponding EC Declaration of Conformity along with the standards applied. Endress+Hauser confirms successful testing of the device by affixing to it the CE mark.

### Ex approval

FEM51, FEM52, FEM54, FEM55:

- Explosion protection for potentially explosive gas/air mixtures:  
Ex d, Ex de, XP, intrinsically safe sensor circuit Ex ia, IS
- Explosion protection for potentially explosive dust/air mixtures:  
Dust ignition-proof as per EN 50281-1-1, DIP as per EN 61241-0

FEM57, FEM58:

- Explosion protection for potentially explosive gas/air mixtures:  
Ex ia, IS (intrinsically safe power supply + intrinsically safe sensor circuit)
- Explosion protection for potentially explosive dust/air mixtures:  
Ex ia D, IS (intrinsically safe power supply + intrinsically safe sensor circuit)

See "Ordering information", → [29](#) and "Documentation", → [30](#).

Your Endress+Hauser distributor will supply you with information about hazardous area versions that are currently available.

All explosion protection data are given in a separate documentation (see "Documentation") which is available upon request. Copies of certificates available upon request.

	F16 housing	F15 housing	F17 housing	F13 / F27 housing	T13 housing with separate connection compartment	Separate housing
Dust ignition-proof	X (except II 1/2 D)	X	X	X	X	X
Ex ia	X	X	X	X	X	X
Ex nA/nL/nC	X	X	X	X	X	X
Ex d	-	-	-	X	X	X
Ex de	-	-	-	-	X	X
IP66/67	X	X	X	-	-	X
IP66/68	-	-	-	X	X	-
Recommended in event of severe external vibrations	-	-	-	X	X	X
Goretex filter	X	X	X	-	-	-

### Other standards and guidelines

Other standards and guidelines that were taken into consideration in designing and developing Soliphant M FTM50, FTM51, FTM52:

- Low Voltage Directive (73/23/EEC)
- DIN EN 61010 Part 1, 2001  
Protection Measures for Electrical Equipment for Measurement, Control, Regulation and Laboratory Procedures  
Part 1: General requirements
- EN 61326  
Electrical Equipment for Measurement, Control and Laboratory Use  
EMC requirements

**RCM-Tick marking**

The supplied product or measuring system meets the ACMA (Australian Communications and Media Authority) requirements for network integrity, interoperability, performance characteristics as well as health and safety regulations. Here, especially the regulatory arrangements for electromagnetic compatibility are met. The products are labelled with the RCM- Tick marking on the name plate.



A0029561

**Pressure Equipment Directive 2014/68/EU (PED)****Pressure instruments with permitted pressure ≤ 200 bar (2 900 psi)**

Pressure instruments with permitted pressure ≤ 200 bar (2 900 psi) Pressure instruments with a flange and threaded boss that do not have a pressure-bearing housing do not fall within the scope of the Pressure Equipment Directive, irrespective of the maximum permitted pressure.

**Reason:**

According to Article 2, point 5 of EU Directive 2014/68/EU, pressure accessories are defined as "devices with an operational function and having pressure-bearing housings".

If a pressure instrument does not have a pressure-bearing housing (no identifiable pressure chamber of its own), there is no pressure accessory present within the meaning of the Directive.

**CRN approval**

CRN-approved devices are fitted with a separate plate bearing the registration number No.: OF10907:5C ADD1.

**EAC conformity**

The measuring system meets the legal requirements of the applicable EAC guidelines. These are listed in the corresponding EAC Declaration of Conformity together with the standards applied. Endress+Hauser confirms successful testing of the device by affixing to it the EAC mark.

**RoHS**

The measuring system complies with the substance restrictions of the EU Directive on the restriction of the use of certain hazardous substances 2011/65/EU (RoHS 2).

**ASME B 31.3**

Design and materials in accordance with ASME B31.3. The welding seams are through-penetration welded and comply with ASME Boiler and Pressure Vessel Code Section IX and EN ISO 15614-1.

**Process sealing as per ANSI/ISA 12.27.01**

North American practice for the installation of process seals.

Soliphant M instruments are designed by Endress+Hauser according to ANSI/ISA 12.27.01 as single seal devices with annunciation, allowing the user to waive the use and save the cost of installing external secondary process seals in the conduit as required by the process sealing sections of ANSI/NFPA 70 (NEC) and CSA 22.1 (CEC). The instruments comply with the North American installation practice and provide a very safe and cost-saving installation for pressurized applications with hazardous fluids. Please refer to the Safety Instructions (XA) of the relevant device for further information → 30ff.

Product	Type	Maximum process pressure	Marking	Approval
Soliphant M	FTM50-D/F/H##...	25 bar (362.5 psi)	Single Seal	FM, CSA
	FTM51-D/F/H##...	25 bar (362.5 psi)	Single Seal	FM, CSA
	FTM52-D/F/H##...	2 bar (29 psi)	Single Seal	FM, CSA

**Other certificates**

- Material certificate as per EN 10204/3.1 for all wetted parts,
- AD2000 on request
- TSE Certificate of Suitability
  - The following applies to wetted device components:
    - They do not contain any materials derived from animals.
    - No additives or operating materials derived from animals are used in production or processing.

**Functional safety (SIL validation)**

Use in safety systems requiring functional safety to SIL2 in accordance with IEC 61508. See "Documentation", → 30.

## Ordering information

Detailed ordering information is available from the following sources:

- In the Product Configurator on the Endress+Hauser website: [www.endress.com](http://www.endress.com) → Click "Corporate" → Select country → Click "Products" → Select product using the filters and search field → Open product page → The "Configuration" button to the right of the product image opens the Product Configurator.
- Endress+Hauser Sales Center: [www.addresses.endress.com](http://www.addresses.endress.com)

### NOTICE

#### Product Configurator - the tool for individual product configuration

- ▶ Up-to-the-minute configuration data
- ▶ Depending on the device: Direct input of measuring point-specific information such as measuring range or operating language
- ▶ Automatic verification of exclusion criteria
- ▶ Automatic creation of the order code and its breakdown in PDF or Excel output format
- ▶ Ability to order directly in the Endress+Hauser Online Shop

## Accessories

### Removing tool

For Soliphant M FTM50, FTM51, FTM52.  
Order No.: 71026213

### Weather protection cover

For Soliphant M FTM50, FTM51, FTM52  
with F13, F17 and F27 housing.  
Order No.: 71040497

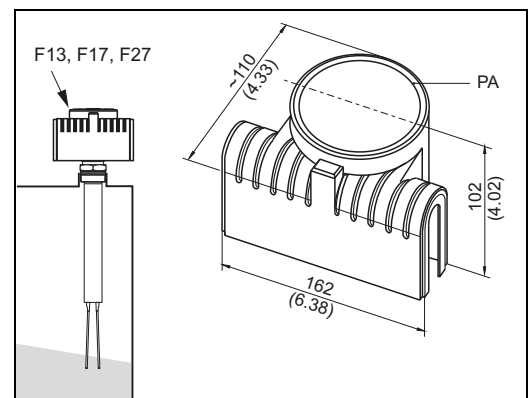

L00-FTM5xxxx-03-05-xxx-xx-009

**Sliding sleeve**

Only for Soliphant M FTM51 with pipe diameter  $d=43$  mm (1,69 in), see ordering information, ordering feature "Process connection", options GG, GJ and ordering feature "Material", options A, 2, 5.

For pressurized containers up to 5 bar (362.5 psi).

Sliding sleeve version:

- G2  
DIN ISO 228/1  
Order No.: 52024631
- 2NPT  
ANSI B 1.20.1  
Order No.: 52024630

**NOTICE**

Suitable for switch point configuration!

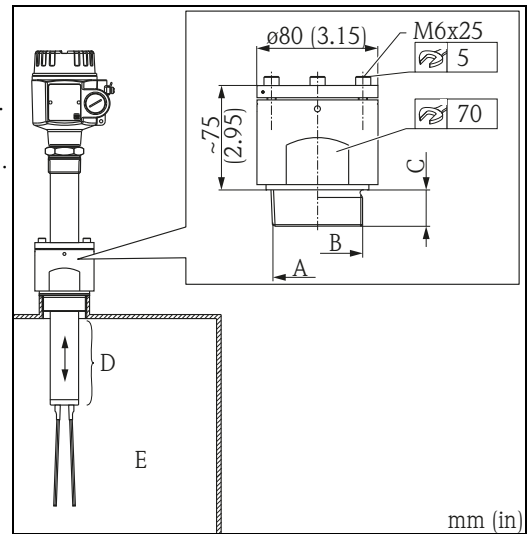

L00-FTM5xxxx-03-05-xx-xx-002

- A G2 (316L)
- B 2NPT (316L)
- C For G2: 24 mm (0.94 in); for 2NPT: 27.5 mm (1.08 in)
- D MWP = 25 bar (362.5 psi)
- E  $T_p = \text{max. } 280$  °C (536 °F)

**Rope shortening kit**

Only for Soliphant M FTM52.  
Order No.: 52024632

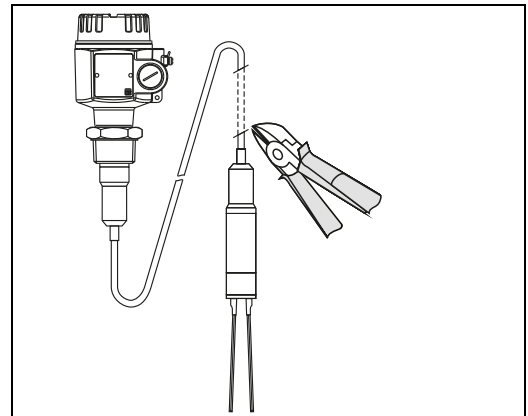

L00-FTM5xxxx-00-00-xx-xx-001

**Documentation****NOTICE**

You can find the following supplementary documentation on our product pages at [www.endress.com](http://www.endress.com).

**Operating Instructions**

- |  |          |
|--|----------|
| ■ Soliphant M FTM50, FTM51   | KA00229F |
| ■ Soliphant M FTM52  | KA00230F |
| ■ Soliphant M FTM51, sliding sleeve, pressurized:  | KA00239F |
| ■ Soliphant M FTM52, rope shortening   | KA00231F |
| ■ Soliphant M FTM50, FTM51, FTM52  |          |
| – Separate housing; installation and shortening instructions (housing side)                  | KA00264F |
| – Separate housing and armored tube; installation and shortening instructions (housing side) | KA00265F |
| – Separate housing; removing and installing the sensor                                       | KA00273F |

**Certificates**

- |           |          |                    |          |
|-----------|----------|--------------------|----------|
| ATEX      |          |                    |          |
| ■ ATEX II | Ex i     | 1D, 1/2D, 1G, 1/2G | XA00305F |
| ■ ATEX II | Ex i (X) | 1D, 1G             | XA00319F |

---

▪ ATEX II	Ex d/Ex de	1D, 1/2D Ex t, 1/2G	XA00306F
▪ ATEX II	Ex t	1/2D, 1/3D	XA00307F
▪ ATEX II	Ex t, Ex n	3D, 3G	XA00331F
NEPSI			
▪ NEPSI	Ex t		XA00393F
▪ NEPSI	Ex ia		XA00393F
▪ NEPSI	Ex d, Ex t		XA00395F
IECEX			
▪ IECEX	Ex ia		XA00391F
▪ IECEX	Ex t		XA00392F
▪ IECEX	Ex d, Ex de, Ex t		XA00633F
INMETRO			
▪ INMETRO	Ex t		XA01336F
▪ INMETRO	Ex d, Ex de, Ex t		XA01354F
EAC			
▪ EAC	Ex d, Ex t	Ga/Gb, Da/Db	XA01590F
FM			
▪ FM	IS, NI		XA01337F
CSA			
▪ CSA	IS, NI		XA01248F
▪ CSA	XP, DIP		XA01042F

---

**Functional safety**

▪ Soliphant M + electronic insert FEM51		SD00203F
▪ Soliphant M + electronic insert FEM52		SD00204F
▪ Soliphant M + electronic insert FEM54		SD00205F
▪ Soliphant M + electronic insert FEM55		SD00208F
▪ Soliphant M + electronic insert FEM57 + Nivotester FTL325P		SD00207F
▪ Soliphant M + electronic insert FEM58		SD00206F



[www.addresses.endress.com](http://www.addresses.endress.com)

---