

**i400s**

AC Current Clamp

*Calibration Information***Introduction****⚠ ⚠ Warning**

**To avoid electric shock or injury, do not perform the performance tests or calibration procedures unless you are qualified to do so.**

**The information provided in this manual is for the use of qualified personnel only.**

The *i400s Calibration Information* provides the information necessary to verify the performance and adjust the calibration of the Fluke i400s AC Current Clamp, hereafter known as the Current Clamp.

The following information is included in this document:

- Safety Information and Electrical Symbols
- Specifications
- Maintenance
- Performance Tests
- Calibration Adjustment
- User-Replaceable Parts
- Warranty Statement

See the *i400s Instruction Sheet* for complete operating instructions.

**Contact Information**

To contact Fluke, call:

USA: 1-888-44-FLUKE (1-888-443-5853)

Canada: 1-800-36-FLUKE (1-800-363-5853)

Europe: +31 402-675-200

Japan: +81-3-3434-0181

Singapore: +65-738-5655

Anywhere in the world: +1-425-446-5500

USA Service: 1-888-99-FLUKE (1-888-993-5853)

For additional information about Fluke, its products, and services, visit Fluke's web site at:

[www.fluke.com](http://www.fluke.com)

To register this product, go to [register.fluke.com](http://register.fluke.com)

## Safety Information

### **⚠ ⚠ Read First: Safety Information**







To ensure safe operation and service of the Current Clamp, follow these instructions:

- Read the operating instructions before use and follow all safety instructions.
- Use the Current Clamp only as specified in the operating instructions, otherwise the clamp's safety features may not protect you.
- Adhere to local and national safety codes. Individual protective equipment must be used to prevent shock and arc blast injury where hazardous live conductors are exposed.
- Do not hold the Current Clamp anywhere beyond the tactile barrier, see Figure 1.
- Before each use, inspect the Current Clamp. Look for cracks or missing portions of the clamp housing or output cable insulation. Also look for loose or weakened components. Pay particular attention to the insulation surrounding the jaws.
- Never use the Current Clamp on a circuit with voltages higher than 1000 V CAT III or 600 V CAT IV.
  - CAT III equipment is designed to protect against transients in equipment in fixed-equipment installations, such as distribution panels, feeders and short branch circuits, and lighting systems in large buildings.
  - CAT IV equipment is designed to protect against transients from the primary supply level, such as an electricity meter or an overhead or underground utility service.
- Use extreme caution when working around bare conductors or bus bars. Contact with the conductor could result in electric shock.
- Use caution when working with voltages above 60 V dc or 30 V ac. Such voltages pose a shock hazard.

## Electrical Symbols

The symbols in Table 1 appear in this document and on the Current Clamp.

**Table 1. Electrical Symbols**

Symbol	Explanation
	Application around and removal from hazardous live conductors is permitted.
	Product is protected by double insulation.
	Risk of Danger. Important information. See Instruction Sheet.
	Hazardous voltage.
	Conforms to relevant Canadian Standards Association directives.
	Conforms to relevant European Union directives.

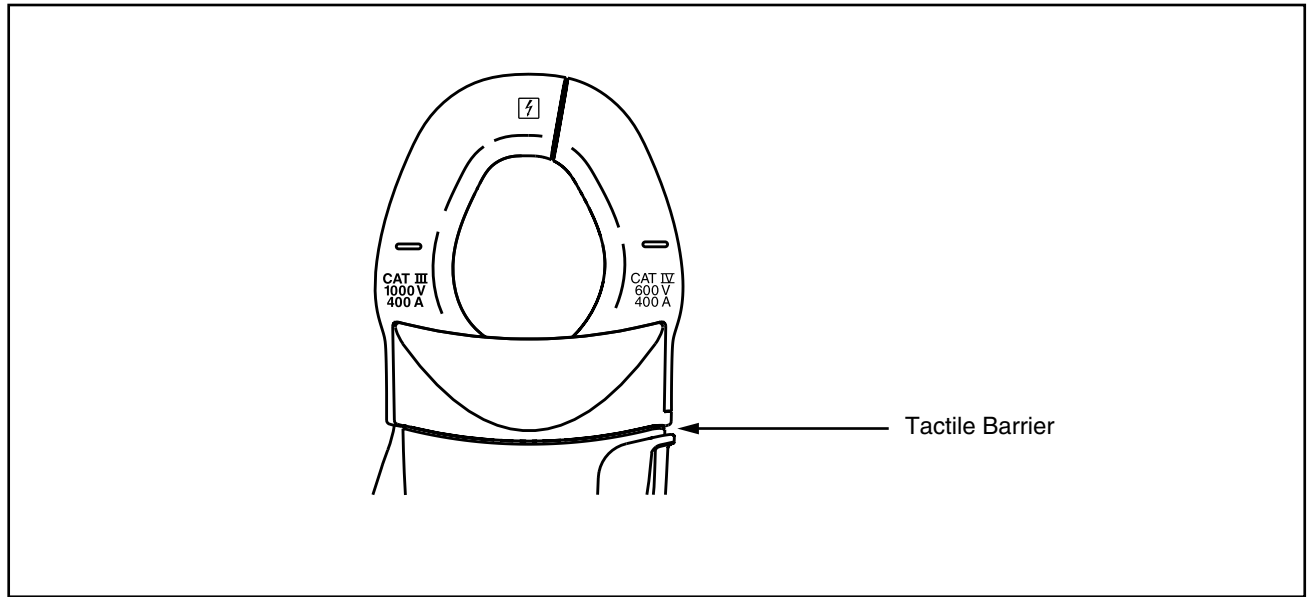

bbc03f.eps

**Figure 1. Tactile Barrier**

### **Safety Specifications**

**Category Rating:** CAT III 1000 V and CAT IV 600 V per EN61010-1, Pollution Degree 2

**EMC:** EN 61326-1, FCC for emission and immunity

**UL:** Tested to US and Canadian standards for compliance to UL61010-1 and CAN/CSA C22.2 No. 101.1:2004

**IEC:** IEC 61010-1 2<sup>nd</sup> Edition IEC 61010-02-032

### **Electrical Specifications**

**Reference Conditions:** 23 ± 5 °C, 20 to 75 % RH; conductor centered in jaw opening; no DC component; no adjacent conductor.

	<b>40 A Range</b>	<b>400 A Range</b>
<b>Measurement Range</b>	0.5 A to 40 A	5 A to 400 A
<b>Output</b>	10 mV/A	1 mV/A
<b>Accuracy</b> 45 Hz to 400 Hz	2 % + 0.015 A	2 % + 0.04 A
<b>Phase Shift:</b> (45 Hz to 400 Hz)		
0.5 A to 1 A	Unspecified	NA
1 A to 5 A	4°	NA
5 A to 10 A	3°	Unspecified
10 A to 20 A	3°	2°
20 A to 40 A	2°	2°
40 A to 400 A	NA	1.5°
<b>Crest Factor</b>	• 3	• 3 to 300 A • 2.5 to 400 A

**Typical Bandwidth:** 5 Hz to 10 kHz

**Working Voltage:** 1000 V ac rms, in compliance with EN61010

**Common Mode Voltage:** 1000 V ac rms from earth ground, in compliance with EN61010

**Input Load Impedance (of host instrument):** > 1 M  $\Omega$  in parallel with up to 47 pF

**Maximum Non-destructive Current:** 1000 A

**Duty Cycle:** 0.5 A to 400 A continuous

**Influence of Adjacent Conductor:** < 9.0 mA/A

**Influence of Conductor Position in Jaw Opening:**  $\pm$  1.0 % of reading + 0.05 A

## **General Specifications**

**Output Cable Length:** 2.5 m (8.2 ft)

**Maximum Conductor Size:** 32 mm (1.25 in)

**Storage Temperature:** -20 °C to 60 °C (-4 °F to 140 °F)

**Operating Temperature:** 0 °C to 50 °C (32 °F to 122 °F)

**Relative Humidity:** 10 °C to 30 °C: 95 % (50 °F to 86 °F)

30 °C to 40 °C: 75 % (86 °F to 104 °F)

40 °C to 50 °C: 45 % (104 °F to 122 °F)

**Temperature Coefficient:** 0.01 % X (specified accuracy)/ °C (< 18 °C or > 28 °C)

0.01 % X (specified accuracy)/ °F (< 64.4 °F or > 82.4 °F )

### **Altitude:**

Operating: 2000 m; 2000 m to 4000 m, derate category rating to 1000 V CAT II/600 V CAT III

Non-operating: 12000 m

**Dimensions:** (LxWxH) 150 x 70 x 30 mm (5.09 x 2.75 x 1.18 in)

**Weight:** 114 g (4 oz)

## **Maintenance**

### **⚠ ⚠ Warning**

**To avoid possible electric shock or personal injury:**

- **Before each use, inspect the Current Clamp. Look for cracks or missing portions of the clamp housing and output cable insulating cover and for loose or weakened components. Pay particular attention to the insulation surrounding the clamp jaws.**
- **Do not use a damaged Current Clamp. If a clamp is damaged, tape it shut to prevent unintended operation. A damaged clamp under warranty will be promptly repaired or replaced (at Fluke's discretion) and returned at no extra charge.**

If the Current Clamp does not work or perform properly, use the following steps to help isolate the problem:

1. Inspect the jaw-mating surface for cleanliness. If any foreign material is present, the jaw will not close properly and measurement errors will result.
2. Verify that the function selection and range on the Multimeter are correct and adjusted to the sensitivity of the Current Clamp.

**Cleaning**

Periodically wipe the case with a damp cloth and mild detergent.

**⚠ Caution**

**To avoid damaging the Current Clamp, do not use abrasives or solvents to clean the clamp.**

**Open the jaws and wipe the magnetic pole pieces with a lightly oiled cloth. Do not allow rust or corrosion to form on the magnetic core ends.**

**Performance Tests**

**⚠⚠ Warning**

**To avoid electric shock or injury, do not perform the performance tests or calibration procedures unless you are qualified to do so.**

**The information provided in this manual is for the use of qualified personnel only.**

The following performance tests verify the complete operation of the Current Clamp and checks the accuracy of each function against the Clamp’s specifications. If the Current Clamp fails any part of the test, calibration adjustment and/or repair is indicated.

In the performance tests, the Current Clamp is referred to as the unit under test (UUT).

Required test equipment is defined in Table 2.

**Table 2. Required Test Equipment**

Equipment	Required Characteristics	Recommended Model
Calibrator	AC Current: 0 - 8 A Max. Accuracy: 0.15 % Frequency: 45 Hz - 400 Hz	Fluke 5520A Multi-Product Calibrator
Multimeter	AC Voltage: 20 mV - 400 mV Accuracy: 0.45 % Frequency: 45 Hz - 400 Hz	Fluke-45 Digital Multimeter (DMM)
Toroid Coil	Turns: 50	Fluke 5500A/Coil

**Current Accuracy Tests**

1. Connect the equipment as shown in Figure 2.
2. Center the UUT jaws around the 5500A/Coil windings.
3. Set the UUT range and 5520A output as called out in Table 3. Check that the Multimeter readings are within the specified limits in Table 3.

**Table 3. Accuracy Tests**

i400s Range	Nominal Value	5520A Output LCOMP = ON	Multimeter Reading Limits	
			Lower	Upper
1 mV/A	20 A, 50 Hz	0.4 A, 50 Hz	19.56	20.44
1 mV/A	20 A, 400 Hz	0.4 A, 400 Hz	19.56	20.44
1 mV/A	400 A, 50 Hz	8.0 A, 50 Hz	391.96	408.04
1 mV/A	400 A, 100 Hz	8.0 A, 100 Hz	391.96	408.04
10 mV/A	2 A, 50 Hz	40 mA, 50 Hz	19.45	20.55
10 mV/A	2 A, 400 Hz	40 mA, 400 Hz	19.45	20.55
10 mV/A	40 A, 50 Hz	0.8 A, 50 Hz	391.85	408.15
10 mV/A	40 A, 100 Hz	0.8 A, 100 Hz	391.85	408.15

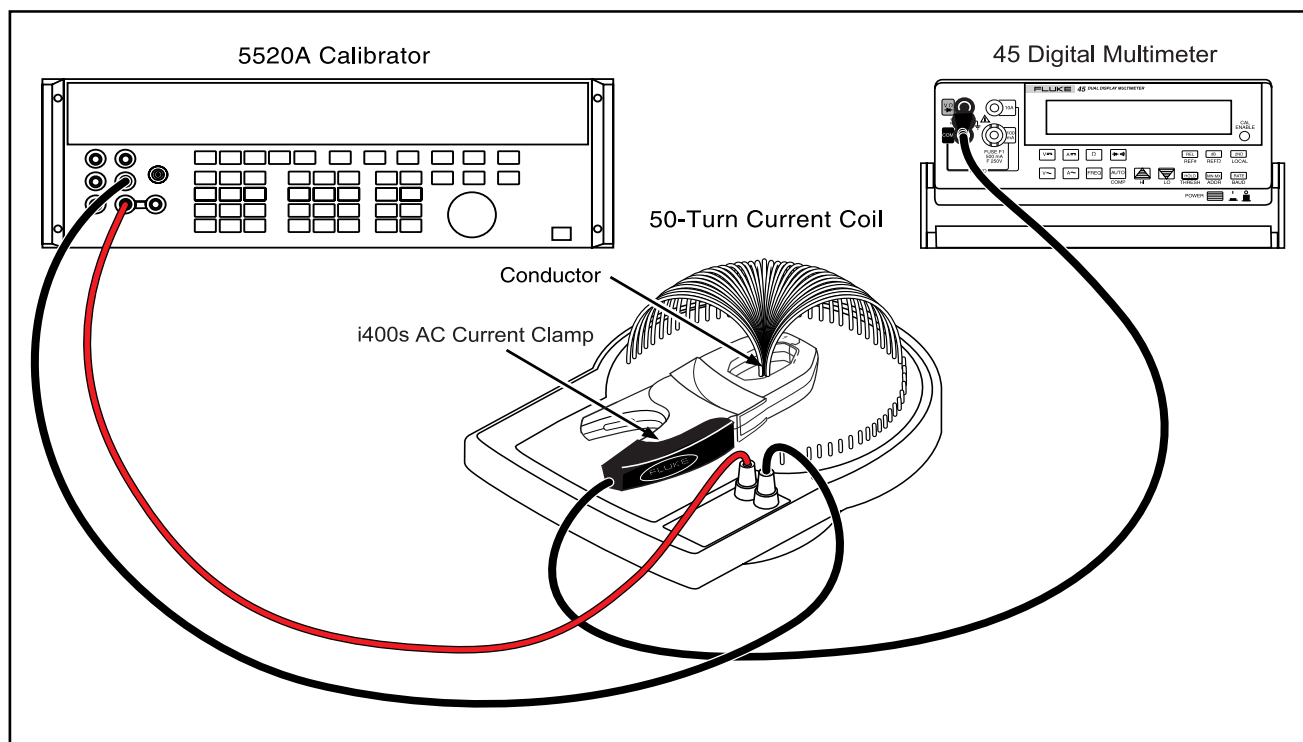
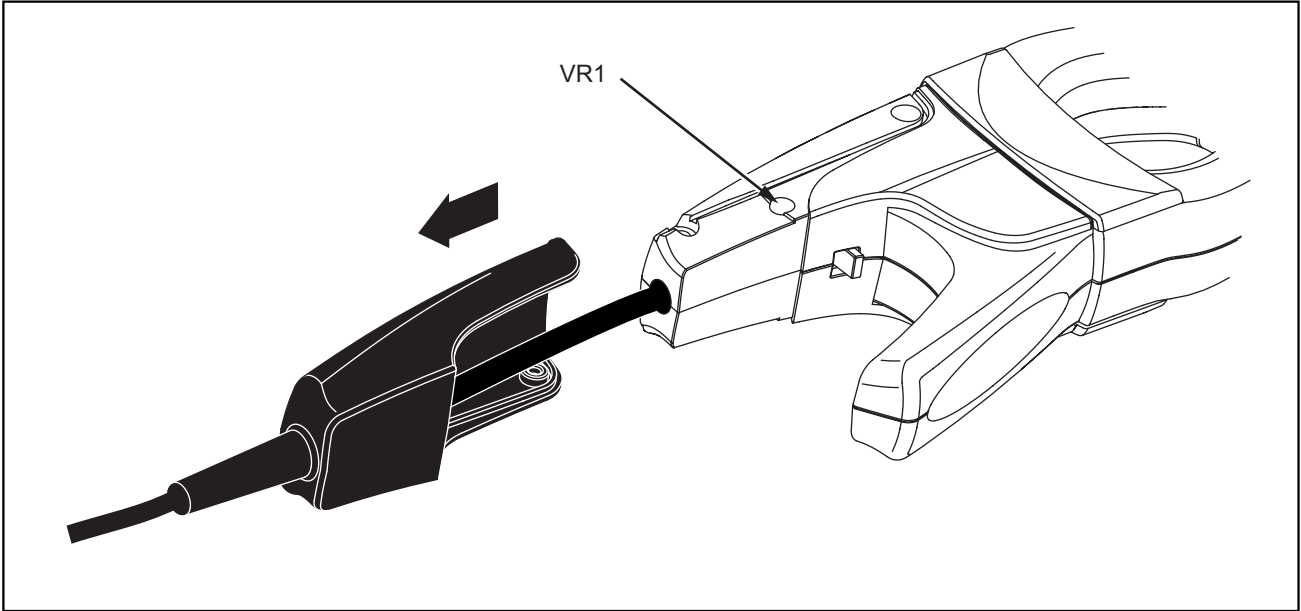

**Figure 2. Current Accuracy Test Connections**

bbc01f.eps

**Calibration Adjustment**

- 1. Using the equipment connections shown in Figure 2, set the 5520A output for 2 A, 45 Hz.
- 2. Referring to Figure 3, slide the rubber boot on the UUT handle back to access the adjustment point, VR1.
- 3. Using a small flat-head screwdriver, adjust VR1 for a meter reading of 99.9 mV to 100.1 mV.



**Figure 3. i400s Calibration Point**

bbc02f.eps

**User-Replaceable Parts**

The Current Clamp contains no user-replaceable parts. The following user documentation is available for this product.

<b>Description</b>	<b>Part No</b>	<b>Qty</b>
<i>i400s Instruction Sheet</i>	2282671	1
<i>i400s Calibration Information</i> (this document)	2414327	1

**LIMITED WARRANTY AND LIMITATION OF LIABILITY**

Each Fluke product is warranted to be free from defects in material and workmanship under normal use and service. The warranty period is one year and begins on the date of shipment. Parts, product repairs, and services are warranted for 90 days. This warranty extends only to the original buyer or end-user customer of a Fluke authorized reseller, and does not apply to fuses, disposable batteries, or to any product which, in Fluke's opinion, has been misused, altered, neglected, contaminated, or damaged by accident or abnormal conditions of operation or handling. Fluke warrants that software will operate substantially in accordance with its functional specifications for 90 days and that it has been properly recorded on non-defective media. Fluke does not warrant that software will be error free or operate without interruption.

Fluke authorized resellers shall extend this warranty on new and unused products to end-user customers only but have no authority to extend a greater or different warranty on behalf of Fluke. Warranty support is available only if product is purchased through a Fluke authorized sales outlet or Buyer has paid the applicable international price. Fluke reserves the right to invoice Buyer for importation costs of repair/replacement parts when product purchased in one country is submitted for repair in another country.

Fluke's warranty obligation is limited, at Fluke's option, to refund of the purchase price, free of charge repair, or replacement of a defective product which is returned to a Fluke authorized service center within the warranty period.

To obtain warranty service, contact your nearest Fluke authorized service center to obtain return authorization information, then send the product to that service center, with a description of the difficulty, postage and insurance prepaid (FOB Destination). Fluke assumes no risk for damage in transit. Following warranty repair, the product will be returned to Buyer, transportation prepaid (FOB Destination). If Fluke determines that failure was caused by neglect, misuse, contamination, alteration, accident, or abnormal condition of operation or handling, including overvoltage failures caused by use outside the product's specified rating, or normal wear and tear of mechanical components, Fluke will provide an estimate of repair costs and obtain authorization before commencing the work. Following repair, the product will be returned to the Buyer transportation prepaid and the Buyer will be billed for the repair and return transportation charges (FOB Shipping Point).

**THIS WARRANTY IS BUYER'S SOLE AND EXCLUSIVE REMEDY AND IS IN LIEU OF ALL OTHER WARRANTIES, EXPRESS OR IMPLIED, INCLUDING BUT NOT LIMITED TO ANY IMPLIED WARRANTY OF MERCHANTABILITY OR FITNESS FOR A PARTICULAR PURPOSE. FLUKE SHALL NOT BE LIABLE FOR ANY SPECIAL, INDIRECT, INCIDENTAL, OR CONSEQUENTIAL DAMAGES OR LOSSES, INCLUDING LOSS OF DATA, ARISING FROM ANY CAUSE OR THEORY.**

Since some countries or states do not allow limitation of the term of an implied warranty, or exclusion or limitation of incidental or consequential damages, the limitations and exclusions of this warranty may not apply to every buyer. If any provision of this Warranty is held invalid or unenforceable by a court or other decision-maker of competent jurisdiction, such holding will not affect the validity or enforceability of any other provision.

Fluke Corporation  
P.O. Box 9090  
Everett, WA 98206-9090  
U.S.A.

Fluke Europe B.V.  
P.O. Box 1186  
5602 BD Eindhoven  
The Netherlands

11/99

To register your product online, visit [register.fluke.com](http://register.fluke.com)