



Instrument Training Guide

Model 990X



1.0 Product Introduction

1.1 The System

The 990x is a versatile full-featured measurement and control instrument - with precision multiple port and channel capabilities. Its operating control primarily supports point-n-click navigation.

It supports an optional mix of up to eight independent full function input measurement ports and advanced technology output ports. Extensive local and remote information communication is provided.

Superior technology is combined with operating simplicity, versatility and ruggedness. Easy to install - and easy to operate. An extensive open architecture enables a wide range of special operating capabilities organized to meet the needs of nearly any high-accuracy precision measure, process, alarm monitoring and communication application requirements.

1.2 The Technology

The system is all digital based on microcomputer technology - no power switch to be left off, no feature selection switches or jumpers, no analog trimming potentiometers. Just all digital.

It employs surface mount technology and incorporates a powerful package of floating-point digital signal processing arithmetic. Built-in test capabilities enable simple installation, and extensive self-tests insures long term operating reliability. The rugged package is modular - and represents an ideal solution for use in demanding applications and tough environments. Mounting options are available for rack-panel, desk-top with support for various input and output signal types.

1.3 The Applications

This system suits applications requiring advanced multiple port and channel, supported by extensive integrated information communication capabilities. It services nearly all process and sensor signal measurements for manufacturing and batch processing, proportional blending, machine control, bio-medical pressure and temperature, chemical and pharmaceutical, laboratory, ecologic, agriculture, petroleum, heating and air conditioning, water filtration and purification, beverage and fluid delivery, automatic billing systems, asset accounting and service programs, performance tracking and verification, quality assurance programs, operations and maintenance management information gathering, regulatory compliance, liability mitigation, and public safety programs.

1.4 The Organization

The system has port based architecture, modularly organized as independent ports, or ports combined as channels, to meet present and future instrumentation requirements.

The systems ports support universal input and output signal types. Ports may be intermixed to support an extremely wide variety of signal service requirements.

Input ports provide value measurements for quantity accumulation, rate measurements, scalar measurements, supported by value scaling for process frequency, pulse, voltage, current or resistance signals.

Independent value scaling and smoothing filters compensate for specific signal service requirements.

Signal acquisition uses digital signal processing to reject ambient noise and interference. Programmable excitation selections are available to power most sensors. Advanced signal output ports provide extremely stable voltages, currents, and supports isolated relay contacts.

1.5 Communication

The communication facilities provide data acquisition, command and control functions, and support information gathering and reporting, and alarm signaling. It has a built-in EIA-TIA232 standard interface, and is optionally configurable for EIA-TIA485 two wire multi-drop LAN operations. Wide Area Networking is supported by optional built-in modem, or optional 10/100 BaseT Ethernet.

WAN capabilities support collision avoidance and error control capabilities, and may be user set with multiple destination address used to send information to multiple computer. Communication is initiated by command (solicited), alarms (unsolicited), and real-time scheduled reporting using its internal Y2K compliant date-time clock.

1.6 Alarm Monitoring

Independent user-programmable alarm threshold limits are available for every measured value. Included in each port are two independent quantity accumulators, scalar value, process rate and service time. Alarms are programmable to activate local annunciation, local display alert, and drive relay or analog output, instigate local and remote computer communication.

1.7 Process Controls

Batch delivery, proportional blending, and closed loop PID control are readily achieved using either the front panel key controls or serial commands.

1.8 Operator Controls

The instrument has no power switch to be accidentally turned off. Operation may be completely controlled from its integral eight key pad used to view operation and programmed operation values. Key activations are single touch and repeat when the key is held. The key pad provides front panel splash proofing and environment protection.

1.9 Operator Indicators

The primary indicator is a large variable-brightness back lit liquid crystal graphic display - visible at a distance even in low light conditions for value viewing, programming, process state information, and alarm status. A built-in audio indicator annunciates alarm conditions and key activations.

1.10 Diagnostic Capabilities

Powerful automatic built-in tests support easy installation and ensure a long, trouble-free operating life. Tests include scans of all memory facilities, peripheral input-output status, communication adapter status, clock and data logging operation, keypad tests, and proper operation of the display and audio indicator.

1.11 Table of Contents

Section	Title
1.0	Product Introduction
1.1	The System
1.2	The Technology
1.3	The Applications
1.4	The Organization
1.5	Communication
1.6	Alarm Monitoring
1.7	Process Controls
1.8	Operator Controls
1.9	Operator Indicators
1.10	Diagnostic Capabilities
1.11	Table of Contents
1.12	Revision History
2.0	Installation
	Signal Wiring
	Accessories
3.0	Indicators
3.1	Normal home screen fields
3.2	Home Screen Alarm Fields
4.0	System Controls
4.1	Navigate Controls
4.2	Operation Controls
5.0	Navigation
5.1	System Navigate Map
5.2	Menu Selection
6.0	Process Value Set-Points
6.1	PV Measures
6.2	PV Programming
6.3	SP Status
6.4	SP Programming
7.0	Global Settings
7.1	Information Screen
7.2	System Power Control
7.3	Control Service Screen
7.4	Communication Screen
7.5	Date-Time Screen
7.6	Data Logging Screen
8.0	Process Controls
8.1	Manual Set-Point
8.2	Batch Delivery
8.3	Proportional Blending
8.4	Monitor
8.5	Proportional-Integral-Differential (PID)

9.0

Notices

9.1

Medical Alert

9.2

FCC Compliances

9.3

EU Compliances

9.4

Copy Rights

9.5

Hazardous Wastes

9.6

Legal Notices

1.12 Revision History

<u>Effective Date</u>	<u>Revision Enhancement</u>
05Jul2007	1. Initial assembly of documents and organization
20Nov2007	1. Completion of pictorials
05Dec2007	1. Complete initial section text coordinated with pictorials
11Dec2007	1. Initial release revision complete - serial protocol exception
28Jan2008	1. Revised calibrate section pictorials
28Jan2009	1. General publication release

2.0 Installation and Accessories

This section describes the various system electrical wiring requirements, and provides information on the various available mounting accessories including table top, panel and rack.

990x Signals and Wiring Installation

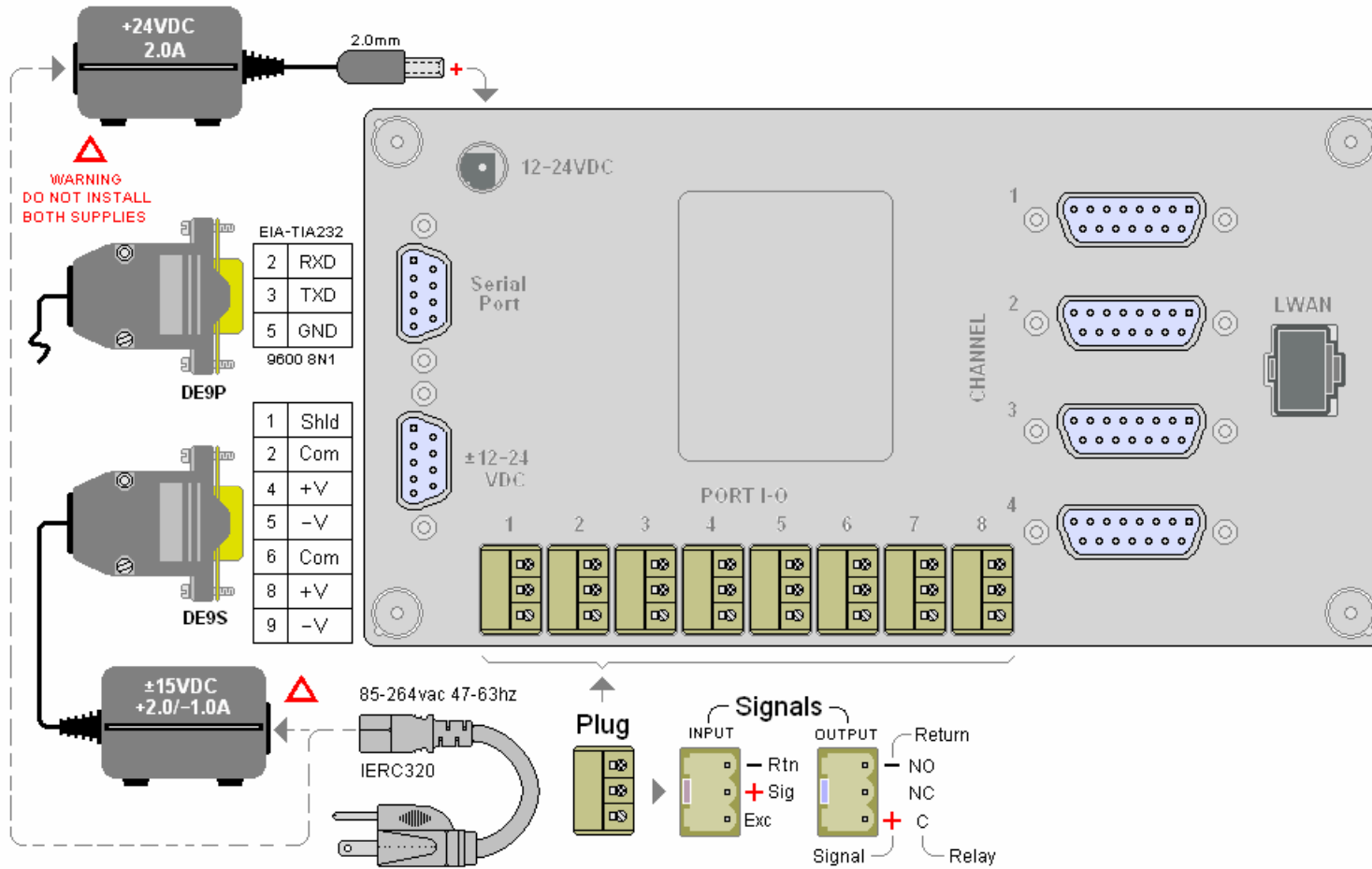

Florite International, Inc. warrants that every reasonable effort has been made to assure the accuracy of the information contained herein, however, assumes no responsibility for its use. The information is subject to change at any time without notice, and no part of it may be reproduced without prior agreement and written consent of Florite International, Inc.

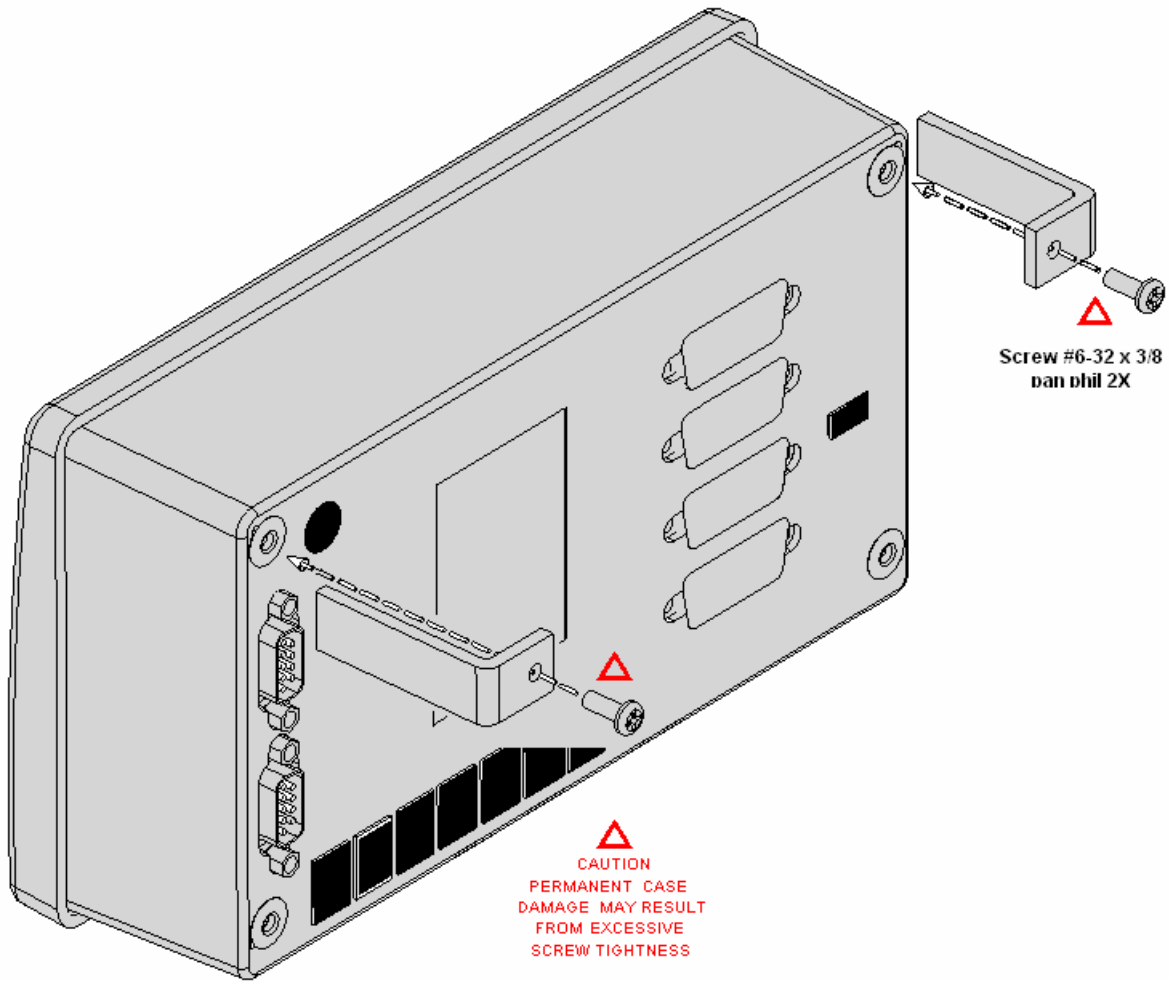

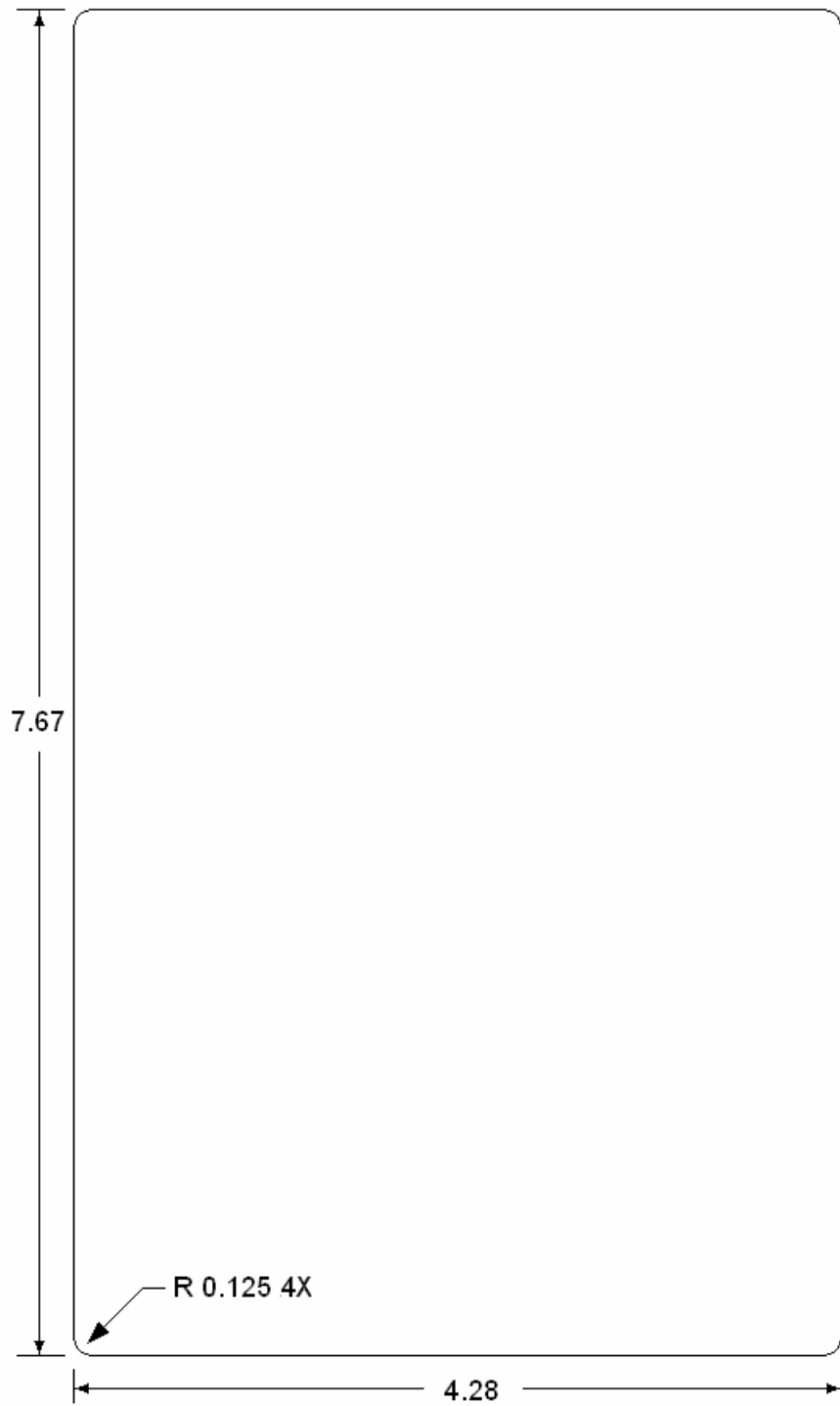

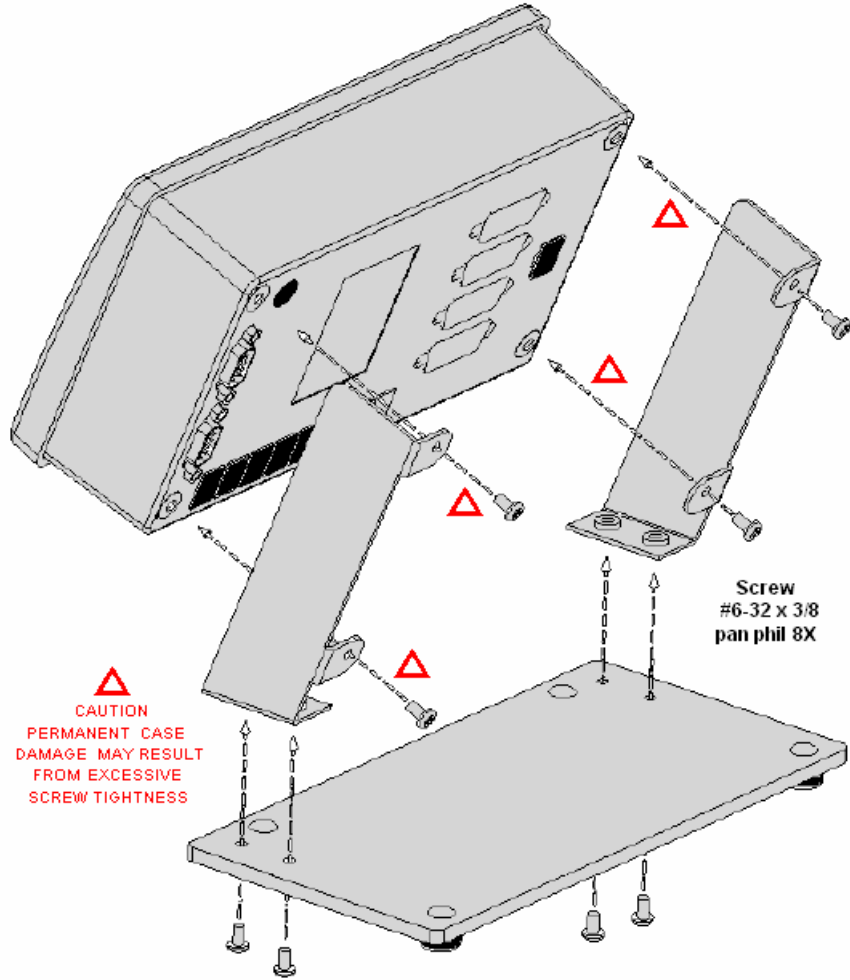

CAUTION
PERMANENT CASE
DAMAGE MAY RESULT
FROM EXCESSIVE
SCREW TIGHTNESS

Screw
#6-32 x 3/8
pan phil 8X

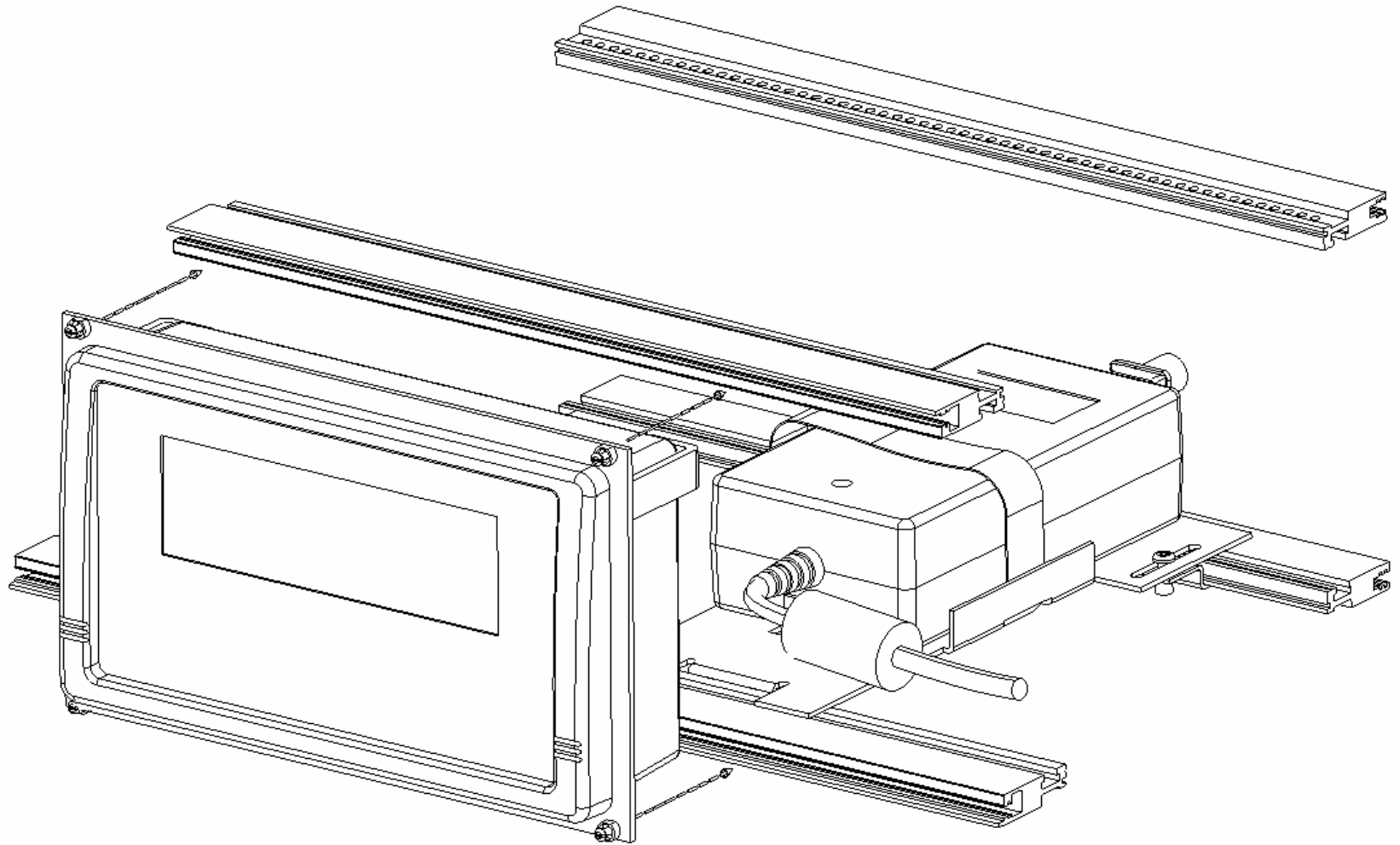

3.0 Indicators

The home screen is the instruments central information and navigation indicator. The home screen is displayed following initial power application, and automatically follows the make-model screen banner. It provides an over-all view of instruments normal operation, and includes display of alarm conditions.

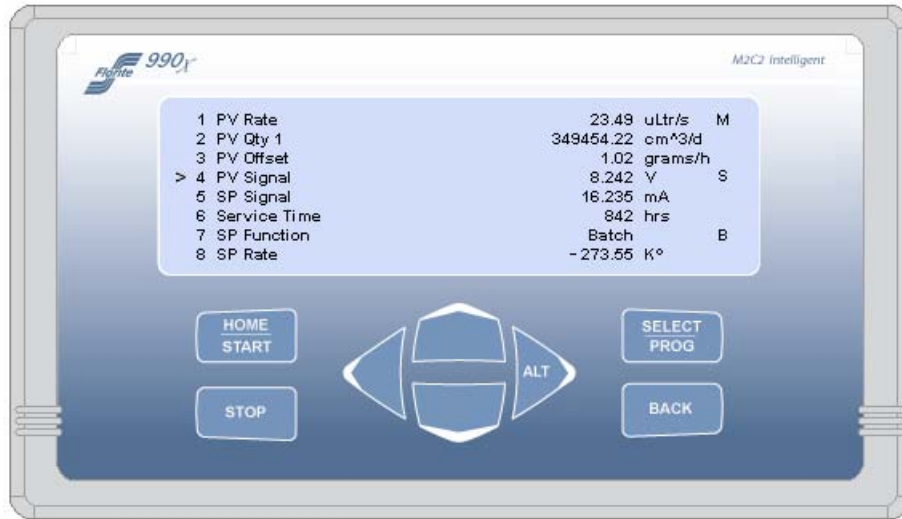

3.1 Normal home screen fields

- 3.1.1 Cursor - points to port even when port is Off
- 3.1.2 Channel - numbers 1-4 (Ports 1-8)
- 3.1.3 Description - process value text name
- 3.1.4 Value - numeric process value
- 3.1.5 Unit / Time-base - combined measure units and rate time-base
- 3.1.6 Control - process control state indicators

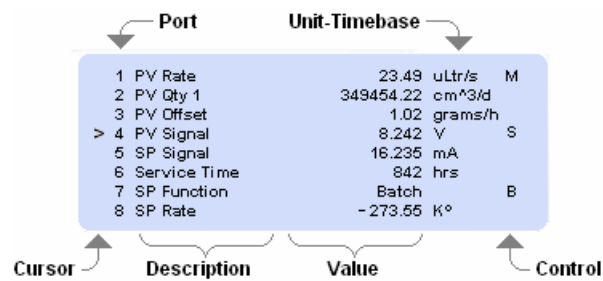

3.2 Home Screen Alarm Fields

3.2.1 Alarm conditions are displayed in the display Value field every four seconds, for one second, when one or more alarms are enabled for an input port, and when one or more alarms are detected.

1	PV Rate		23.49	uLtr/s	M
2	PV Qty 1	→ TM Q1 Q2 LO HI			
3	PV Offset		1.02	grams/h	
> 4	PV Signal		8.242	V	S
5	SP Signal		16.235	mA	
6	Service Time		842	hrs	
7	SP Function		Batch		B
8	SP Rate		-273.55	K°	

Value

3.2.2 Alarm Type Definitions

Abbreviated indicators for each alarm type are shown on the display and are defined as shown below. The strings of one or more indicators are justified to begin in the least-significant position of a value field.

- TM Service Time
- Q1 Quantity 1
- Q2 Quantity 2
- LO Low rate
- HI High rate

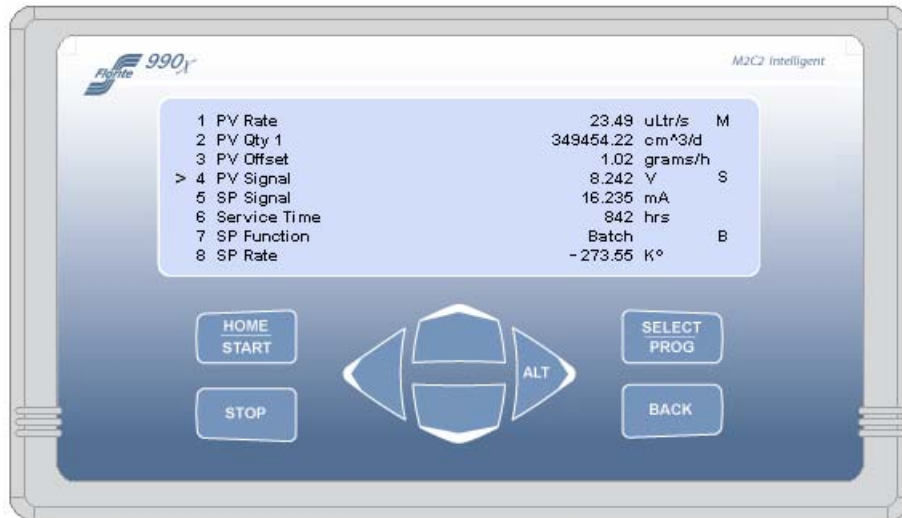

4.0 System Controls

The primary instrument controls consists of eight front panel tactile snap-action keys - and a serial communication capability. Every function that can be accomplished by using the keys can also be accomplished by serial communication commands - the aspects of which are described in the Protocol section.



4.1 Navigate Controls







Navigation functions performed from the home screen are follows:

- 4.1.1 Select a port using the  and  keys
- 4.1.2 Select a port process value to be shown show on the home screen
- 4.1.3 Change the value of a channel program variable
- 4.1.4 Enter the Global System Settings selection menus
- 4.1.5 Quickly navigate to certain special values requiring frequent changes
- 4.1.6 Start and stop control functions
- 4.1.7 Select a blend control master
- 4.1.8 Perform analog signal calibration

Instructions for the using the above are described in their respective sections.

4.2 Operate Controls

The control function of the keys is dependant on the context of the function that has been requested to be accomplished as follows:

- | | | | |
|-------|---|--|--|
| 4.2.1 |  | Home Screen
Port I-O Screen
View Screen
Program Screen | <ul style="list-style-type: none">- navigates to port I-O Screen- selects view or program- selects home screen value- programs value cursor points to - then saves the value |
| 4.2.2 |  | Home Screen
NOT Home Screen | <ul style="list-style-type: none">- press 3X to enter Global System Settings- navigates immediately to previous screen |
| 4.2.3 |  | Home Screen
Power Down | <ul style="list-style-type: none">- press 3X to start batch and-or blend control operation- press to restore power |
| 4.2.4 |  | Home Screen | <ul style="list-style-type: none">- terminate controls operation if any operating |
| 4.2.5 |  | Cursor Control
Program Screen | <ul style="list-style-type: none">- move cursor up- increase blinking program selection to succeeding choice |
| 4.2.6 |  | Cursor Control
Program Screen | <ul style="list-style-type: none">- move cursor down- decrease blinking program selection to preceding choice |
| 4.2.7 |  | Cursor Control
Home Screen

View Screen
Program Screen | <ul style="list-style-type: none">- move cursor left- select input port pointed to by cursor as blend master unless the port is already the master in which case the existing master is deselected and no master is chosen- zero quantity when cursor points to quantity- move blinking program selection to next left choice |
| 4.2.8 |  | Cursor Control | <ul style="list-style-type: none">- move cursor right |

5.0 Navigation

This navigation section provides an overview of the various values that are available to set-up desired operating characteristics that establish how the instrument is desired to perform, and to review the operating state of the desired performance.

Although navigation is described for keypad operation - the same operating characteristics set using the keypad are supported by serial communication - for which a detailed description is contained in the Serial Protocol section of this document.

A complete system map is provided to support the overview of the instrument. It shows the entire organization of all of the instrument process values (PV), all set-point (SP) values, and all system global settings.

5.1 System Navigation 990x

Home Screen

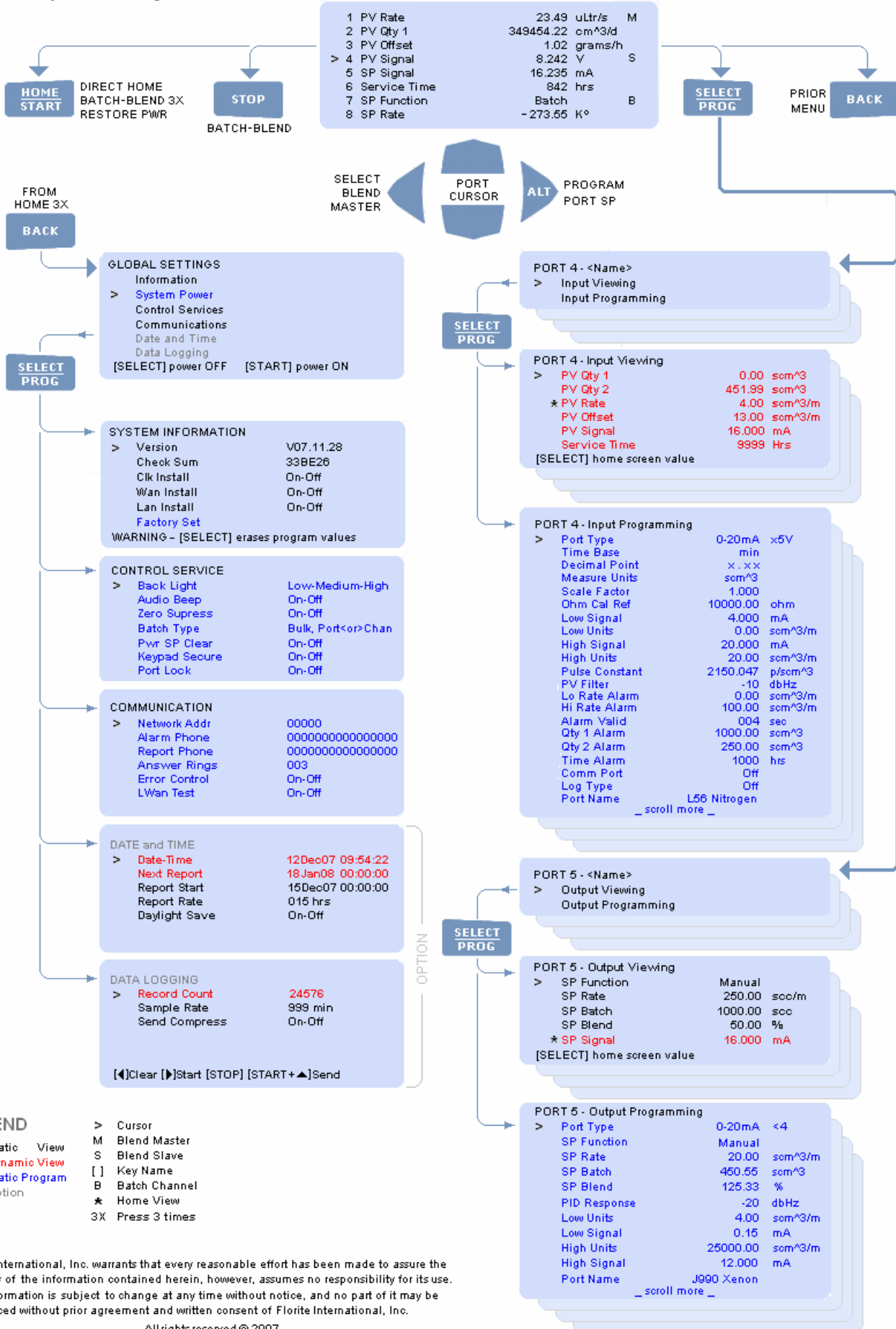

LEGEND

- > Cursor
- M Blend Master
- S Blend Slave
- RED Dynamic View
- BLU Static Program
- GRY Option
- [] Key Name
- B Batch Channel
- ★ Home View
- 3X Press 3 times

Florite International, Inc. warrants that every reasonable effort has been made to assure the accuracy of the information contained herein, however, assumes no responsibility for its use. The information is subject to change at any time without notice, and no part of it may be reproduced without prior agreement and written consent of Florite International, Inc.

5.2 Navigate Select

The selection screens provide a secondary navigation layer for the operator to specify whether viewing or programming is desired for a port that is an input, an output or is now OFF. The screens shown below are displayed as a result of having pressed the [SELECT] key while viewing the home screen.

The <Name> following the Port number allows the operator to program an application specific purpose, type, location, or other - so the port is more easily identified with respect to its function. Name is a free-form open space consisting of up to twenty alpha-numeric characters. Name may be independently programmed for each port.

5.2.1 Input Port Function Select

The screen below is shown as port 4 which had previously been programmed as an input port. Use the cursor keys to point to either view Input Viewing (PV Measurements), or Input Programming (PV Programming) and then press [SELECT] to proceed to the desired selection.



5.2.2 Output Port Function Select

This screen below is shown as port 5 which had previously been programmed as an output port. Use the cursor keys to point to either Output Viewing (SP Status), or Output Programming (SP Programming) and then press [SELECT] to proceed to the desired selection.



6.0 Process and Set-Point Values

This Process Values (PV) and Set-Point Values (SP) section provides a detailed description of the various system map values that are used to set-up the instruments desired operating characteristics that establish how the instrument is desired to perform, and discusses the various process values that show the operating state that are the outcome of the set-up.

6.1 PV Measurements

This section describes special screen services - and describes each of PV Measurements which are functions of a signal input into the instrument.

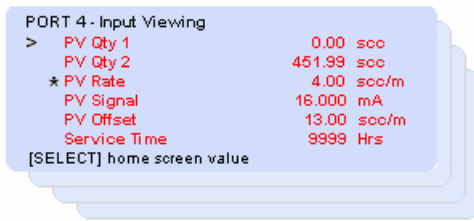

6.1.1 Change Home Screen Value

The present value shown on the home screen is indicated by a star (*) prefix. To change which value is displayed - point the cursor to the desired value and press the [SELECT] key. Note that the star indicator is now prefixed to the new value.

6.1.2 Screen Value Descriptions

6.1.2.1 PV Qty 1 and PV Qty 2

Dual quantity accumulators are provided to service applications that require a grand total and a running total.

The quantity values are displayed when the port or channel time base is NOT programmed for Scalar measurement. Quantity is not accumulated for Scalar values, and neither quantity will be shown on the screen. The value displayed is updated live as the value changes.

An accumulated quantity is cleared to zero by pointing the cursor to the quantity to be cleared and pressing the [◀] key. Note the value becomes zero.

6.1.2.2 PV Rate

This value is Rate defined as quantity per unit time, or a scalar measurement. The value displayed is updated live as the value changes.

PV Rate may be tare-offset to zero by pointing the cursor at PV Rate and pressing the [◀] key. Note the PV Rate is now zero, and the PV Offset value becomes equal to the PV Rate present just prior to activating the [◀] key.

6.1.2.3 PV Signal

This value is the measured electrical value being input to the instrument. It is provided to assist system installations, and is used to support instrument calibration. The value displayed is updated live as the value changes.

6.1.2.4 PV Offset

This value is a Rate tare-offset amount that was acquired from PV Rate resulting from having previously pressed the [◀] key. The PV Offset value remains constant and does not change in real time. It is cleared to zero by pointing the cursor to PV Offset and pressing the [◀] key. Note the PV Offset becomes zero, and the PV Rate becomes larger, or smaller, by the PV Offset amount just prior to activating the [◀] key.

6.1.2.5 Service Time

This value is the accumulated instrument operating time in hours. It is often used for utility purposes such as a Hobbs Hour-Meter to schedule maintenance. The value displayed is updated live as the value changes. This value is cleared to zero by pointing the cursor at the value and pressing the [◀] key.

6.2 PV Program Value

This section describes how to program the various PV values - which determine input signal service, alarm functions, measured value communication type, logging type, and the port name. PV Program values are static and updated only after the value is saved.

6.2.1 Value Programming

6.2.1.1 Program a value by pointing the cursor to its line and pressing the [SELECT] key. Note a character or string (character-string) will be blinking - ready to be edited.

6.2.1.2 Edit the character-string as follows:

Change character-string to next value [▲] key - or previous value [▼] key

Move blinking character-string edit field left [◀] key - or right [▶] key

6.2.1.3 Edit completion

Press [SELECT] key to save the changed value - ANY other key causes the edited value to be ignored and not saved - and the original value to be edited will remain unchanged.

6.2.1.4 Edit Time Expired

When editing and a character-field is blinking - the program state will be terminated if a key is not detected within 30 seconds of the last detected key. In this case, the value edited will not be saved, and the original value to be edited will remain unchanged.



6.2.2 Port Type

6.2.2.1 A port is not prohibited from being programmed for active signal input, active signal output or OFF. Refer to the **SP Program Values** section of this document to program active output signals.

6.2.2.2 Port Type - select OFF to suspend service for an active input or output port. An inactive OFF port is indicated on the home screen as a blank line.

When a port is set to OFF from an active state - the instrument remembers the active port type prior to having been set to OFF. This is so that when the port is re-activated, the instrument continues with the same port type that existed before it was set to be OFF so the factory installed module configuration remains operable. Refer to **Global Settings** section for a description of **Port Lock** selection prohibiting ANY port type change.

6.2.2.3 When the port is desired be an active output from being an active input, or become an active input from being an active output - contact factory for interface module re-configuration.

6.2.2.4 Active Signal Input

An active signal input Port Type has two separate fields - input signal type field, and sensor excitation voltage field. Each of these fields are programmed independently of each other.

6.2.2.1 Signal Type Field

Program the signal type field if desired - then use the [▶] key to move to the voltage excitation field. Save the new Port Type. Refer to the Specifications section for supported input signal types and excitation selections.

6.2.3 Time Base

This selection is used to set a quantity per unit time rate measurement base as Sec, Min, Hrs, Days. The Scalar time base does not perform quantity accumulation.

6.2.4 Decimal Point

The decimal point for measured values may be freely selected for none, one, two, and three places which sets the number of measurement value digits are to the right of the decimal point. Setting the decimal point has no arithmetic affect.

6.2.5 Measure Units

Measure units are a combination of symbols used to identify a physical engineering measurement. The measure units may freely be selected from large set of alpha-numeric and numerous punctuation oriented selections enabling construction of a string of up to five characters which can include spaces. Setting the Measure Units has no arithmetic affect.

6.2.6 Scale Factor

This value is a unit-less factor by which measured input rates or values is multiplied to change the values magnitude - particularly useful for calibrating or matching sensors or process signals exhibiting unit-to-unit tolerances differences. Refer to the Signal Services section for additional information on special Scale Factor or Sensor Factor uses.

6.2.7 Interpolate Constants - Low Signal, Low Units, High Signal, High Units

These four values work jointly to establish the meaning in engineering units of an observed analog signal. The interpolator is full four quadrant implementation - supporting negative values. Set each of the four values as required to match the analog or frequency input signal.

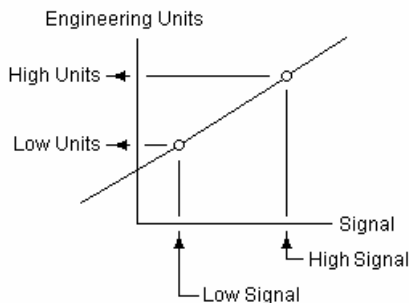

6.2.8 Pulse Constant

This value is shown on the displayed when the input signal type is **In Freq**, frequency, used with pulse output sensors or process signals and represents the number of pulses-per-unit of quantity. This value is the factor by which the pulses are converted to engineering rates and quantities.

An option is available that performs a two-point frequency interpolation using the analog signal process to be interpolated as shown above. The pulse signal is input directly in Hz (pulses/sec) to evolve engineering rates.

6.2.9 PV Rate Filter

This value determines the amount of filtering applied to rate or value input measurements. Filtering ranges from +0 to -20 dBHz (1-10 sec) of noise and jitter suppression. Filtering is customarily used to average pulsations and reject transients in the process signals being measured. Larger minus values represent increased filtering.

6.2.10 Lo Rate Alarm, Hi Rate Alarm Limits

6.2.10.1 The Low Rate Alarm limit is a bipolar value below which a low rate alarm will be detected. This alarm type is disabled when set to zero.

6.2.10.2 The High Rate Alarm limit is a bipolar value above which a high rate alarm will be detected. This alarm type is disabled when set to zero.

6.2.10.3 The Low and High rate limits are jointly used to detect in-window (inclusive) alarms, or for detecting out-of-window (exclusive) alarms. Alarm detection is always computed based on both limits which together yield four distinct alarm types. The combinational alarms types are described as follows:

6.2.10.3.1 ►◀ Inclusive Alarm - is detected when the low limit is greater than the high limit for an observed rate that is between the low and high limits.

6.2.10.3.2 ◀► Exclusive Alarm - is detected when the low limit is less than the high limit for an observed rate that is outside the set low and high limits - when the rate is greater than the high limit OR less than the low limit.

6.2.11 Alarm Delay

This delay assures that false intermittent or spurious alarm conditions are rejected. The value in seconds is a period over which any of the rate alarm types above must remain continuously detected and persistent, prior to declaring a qualified alarm condition.

6.2.12 Qty 1 and Qty 2 Alarm Limits

These quantity limits are used to detect alarm conditions when either or both of their respective accumulations are exceeding the limit values. Either alarm is disabled when its limit value is zero.

6.2.13 Service Time

This value is a time in hours above which a service time alarm condition is detected. The service time alarm detection is disabled when the limit is zero.

6.2.14 Comm Port

This selection is used to program which of the available communication facilities from which to send unsolicited alarms, scheduled value reports, or logged data, where the user data system does not provide a query facility for such information. In these cases the instrument automatically sends the information type to the users system.

6.2.15 Log Type

This selection sets an input port for the type of measured value information to be periodically saved in the date-time stamped record log. Selections include Off, Rate, Quantity 1, or Quantity 2.

6.2.16 Port Name

A string of up to twenty free-form alpha-numeric characters may freely be programmed for use in identifying input measurement purpose, type, or location.

6.3 SP Status

This screen provides output port status information to the operator and is shown below. Refer to the **Control Functions** section which describes in greater detail the set-up, operation and termination.

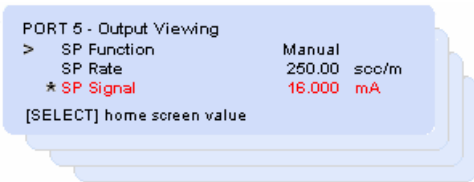

6.3.1 SP Function

This control service type reflects the selected service type that has been programmed for the port or channel. It identifies the type of process control the output is required to perform, and the amount of the control output as appropriate. Control selections include Monitor, Manual, Batching, Blending and PID.

6.3.2 Set-Points

Separate set-points are provided for PID rate control (SP Rate), Batch quantity (SP Batch) and Blend proportion (SP Blend). The set-points shown on the screen above are dependant on the SP Function control type that has been selected. The value displayed may update live in real time as the value changes - such as for a Blend Slave. Set-point values are bipolar and are required to be set for positive values for control functions to perform correctly.

6.3.3 SP Signal

This value is the output type and amount being sent from an output port, and is expressed in appropriate analog units such as volts or mA, or relay.

6.4 SP Programming

This section describes how to program the various SP values which determine output signal service, linked input signal source, output service function, set-points, units de-interpolation, and the port name. SP Program values are static and updated only after a changed value is saved.

6.4.1 Value Programming

6.4.1.1 Program a value by pointing the cursor to its line and pressing the [SELECT] key. Note a character or string (character-string) will be blinking - ready to be edited.

6.4.1.2 Edit the character-string as follows:

Change character-string to next value [▲] key - or previous value [▼] key

Move blinking character-string edit field left [◀] key - or right [▶] key

6.4.1.3 Edit completion

Press [SELECT] key to save the changed value - ANY other key causes the edited value to be ignored and not saved - and the original value to be edited will remain unchanged.

6.4.1.4 Edit Time Expired

When editing and a character-field is blinking - the program state will be terminated if a key is not detected within 30 seconds of the last detected key. In this case, the value edited will not be saved, and the original value to be edited will remain unchanged.

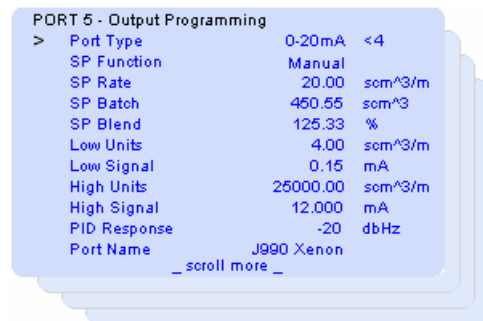

6.4.2 Port Type

6.4.2.1 A port is not prohibited from being programmed for active signal input, active signal output or OFF. Refer to the **SP Program Values** section of this document to program active output signals.

6.4.2.2 Port Type - select OFF to suspend service for an active input or output port. An inactive OFF port is indicated on the home screen as a blank line.

When a port is set to OFF from an active state - the instrument remembers the active port type prior to having been set to OFF. This is so that when the port is re-activated, the instrument continues with the same port type that existed before it was set to be OFF so the factory installed module configuration remains operable. Refer to **Global Settings** section for a description of **Port Lock** selection prohibiting ANY port type change.

6.4.2.3 When the port is desired be an active output from being an active input, or become an active input from being an active output - contact factory for interface module re-configuration.

6.4.2.4 Active Output Signal

An active signal output Port Type has two separate fields - an output signal type field, and a link to an input port from which the output port is responsive. Each of these fields are programmed independently of each other.

6.4.2.5 Signal Type Field

Program the signal type field as desired - then use the [▶] key to move to the output link field and select the desired **INPUT** port from which the output gets the signal for it to perform its selected Function. Save the new Port Type. Refer to the **Specifications** section for supported output signal types.

6.4.3 SP Function

6.4.3.1 Monitor

Analog Output Port

Converts and outputs its linked input port measurement as an analog signal which has been scaled and de-interpolated.

Relay Output Port with Input Port Link

Non-Zero link - relay energized when linked input port has at least one pending alarm

Zero link - relay energized when any input port has at least one pending alarm

6.4.3.2 Manual

Measurements from a linked input port are ignored. The value set for SP Rate register is de-interpolated to a corresponding analog signal, and sends the analog signal to the output port or channel.

6.4.3.3 Batching

Batching is a discontinuous control process that delivers the quantity set in the SP Batch register. This process is started using either the keypad or a serial communication command. Batching is terminated any time the [STOP] key is pressed.

6.4.3.4 Blending

Blending is a continuous control process after being started that delivers a proportion set in the SP Blend register of the rate that is detected by a selected Master input port. This process is started using either the keypad or a serial communication command. Blending is terminated any time the [STOP] key is pressed.

6.4.3.5 PID

Proportional-Integral-Differential is a continuous control process that requires no start or stop. The process causes output signal that causes the linked input rate to be maintained to the value set in the SP Rate register.

6.4.4 Set-Points

Separate set-points are provided for PID rate control (SP Rate), Batch quantity (SP Batch) and Blend proportion (SP Blend). The set-points shown on the screen are related to the selected SP Function that have been selected. Set-point values are bipolar and require to be set with positive values for control functions to perform correctly.

6.4.5 PID Response

This value is shown when the SP Function is set for PID, and is used to match the plant bandwidth - time response - to the PID signal output. The response range is from +0 to -20 dBHz which represents the response rate. Larger negative values represent lower bandwidth (slower) response.

6.4.6 De-Interpolate Constants - Low Signal, Low Units, High Signal, High Units

These four values work jointly to establish the meaning from engineering units to an analog signal to be output. The de-interpolator is full four quadrant implementation - supporting negative values. Set each of the four values as required to convert engineering units to an output analog signal.

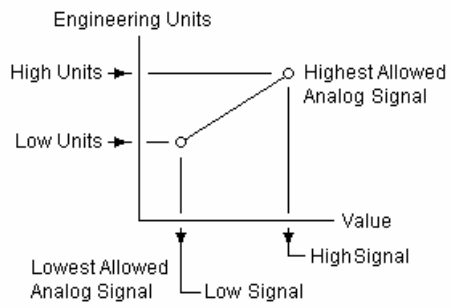

6.4.7 Port Name

A string of up to twenty free-form alpha-numeric characters may freely be programmed for use in identifying input measurement purpose, type, or location.

7.0 Global Settings

This section provides a detailed description of the various system wide variables used to set-up and review the overall operating characteristics that establish how the entire instrument is desired to perform. The values include those provided only for review, those that can be selected, and those that invoke immediately action.

7.1 Information

To enter the information service screen - point the cursor to Information on the Global Settings screen and press the [SELECT] key.



This screen contains system information values and configuration states. These values are not programmable, with the only exception being the Factory Set immediate action selection described below which erases present programmed values and replaces them with factory default values.

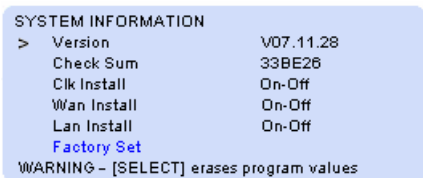

7.1.1 Version

This is the date the firmware was last upgraded represented as year, month and day, and is only for review.

7.1.2 Check Sum

This value is the hexadecimal double word sum of the instruction read only memory used for factory quality assurance, and is only for review.

7.1.3 Start Vector

This is the address in hexadecimal at which the firmware begins operating following a power-up reset, and is only for review.

7.1.4 Clk (Clock) Install

This state indicates whether the real time clock is installed and operating which is detected immediately after a power-up reset. The clock is used for scheduling data or log reports, and for date-time stamping logged records.

7.1.5 Wan Install

This state indicates whether the wide area network modem adapter is installed and operating which is detected immediately after a power-up reset. This adapter supports public switched telephone network (PSTN) data communication.

7.1.6 Lan Install

This state indicates whether a local area network adapter is installed and operating which is detected immediately after a power-up reset. This adapter detects local area EIA-TIA485 or 10/100 BaseT Ethernet data communication support.

7.1.7 Factory Set

When the cursor is pointing to Factory Set, a pop-up warning displays "WARNING - [SELECT] erases program values" at the bottom of the display. Pressing [SELECT] will cause all user program values to be immediately erased and over-written with factory standard default values. Factory Set does NOT erase factory pre-set calibration values which continue to be retained.

7.2 System Power

To enter the System Power function - point the cursor to System Power on the Global Settings screen and press the [SELECT] key. This is an immediate action selection.



7.2.1 System Power

The System Power functions allows the user to cause power to equipment connected to the instrument to be placed in an Off state, allowing the user to conduct installation services and diagnostics. The power off state is also useful for placing the instrument and connected equipments in an un-powered state when the instrument is expected to remain unused for extended periods.

7.2.1.1 The pop-up at the bottom of the display is shown on the screen only when the cursor is pointing to System Power.

7.2.1.2 Power OFF - press the [SELECT] key with the cursor pointing to System Power. This will cause entry into the power down state, the screen to become blank with its back-light off, and all signals and power to be removed from connected equipment.

7.2.1.3 Power ON - press the [START] key to restore normal system operation.

7.3 Control Service

To enter the Control Services screen - point the cursor to Control Services on the Global Settings screen and press the [SELECT] key.



These Control Service settings are programmable but are not live updated. They establish operation of the several system level operating controls.

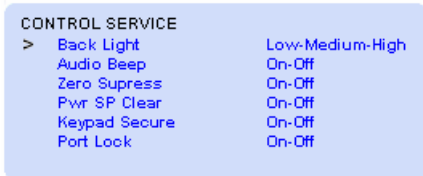

7.3.1 Back Light

This control selects the display back light intensity to have intensity values of Low, Medium or High.

7.3.2 Audio Beep

When this control is selected ON - allows normal audio annunciation for alarms and key activation - otherwise all audio indications remain disabled.

7.3.3 Zero Suppress

When this control is selected ON - numeric measured values are displayed with leading zeros suppressed.

7.3.4 Batch Type

This control determines how batch operation is to be conducted - selectable as either Bulk (all output batch port at the same time), or Port<or>Chan allowing user selection of which port(s)<or>Chan(s) are to be batched.

7.3.4 Pwr SP Clear

When this control is selected ON - power restoration causes every channel SP value to be erased and made zero.

7.3.5 Keypad Secure

When this control is selected ON - all program values are prohibited from being changed.

7.3.6 Port Lock

When this control is selected ON - Port Type or SP Signal Type changes are prohibited - and remain locked.

7.4 Communications

To enter the Communications service screen - point the cursor to Communications on the Global Settings screen and press the [SELECT] key. The communication variables are programmable selections.



The Communications settings are programmable and are used to establish the instruments communication parameters that control the systems three serial ports to send alarm, log, or data reports. The communication parameters are not live updated.

When the DATE and TIME clock is not installed - only the Network Addr (address) is shown on the service screen.



7.4.1 Network Address

This address is a unique identification for the instrument operating in a network environment.

7.4.2 Alarm Phone

This number is used as the destination address to which alarm information is to be sent. The WAN interprets the number as a PSTN dial number. The LAN interprets the number as an internet-protocol (IP) destination.

7.4.3 Report Phone

This number is used as the destination address to which log or data information is to be sent. The WAN interprets the number as a PSTN dial number. The LAN interprets the number as an internet-protocol (IP) destination.

7.4.4 Answer Rings

This value is used when communicating by WAN and determines the number of detected rings that must occur before answering the line.

7.4.5 Error Control

This state is selected to be ON to conduct data communication with error control.

7.4.6 Lwan Com Test

This state is selected to be ON when operating with WAN and LAN communications to test that network communication is established and is suitable.

7.5 Date and Time (OPTION)

DATE and TIME is an option. When the option is not installed - the Global Settings will not list it as an available choice, and the service screen will not appear.

When the option is installed - enter the service screen by pointing the cursor to DATE and TIME on the Global Settings screen and press the [SELECT] key.



The Date and Time service screen settings enable real-time operation of data logging, report sending, and local enabling daylight-savings time service.

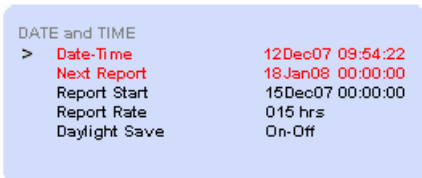

7.5.1 Date and Time

This is a real-time live update programmable value set by the user to the users local date-time.

7.5.2 Next Report

This is a real-time live update view value indicating the date-time in the future that a report of logged or selected data values for each input port or channel are to be sent either from the local RS232 serial port, or LAN serial port, or Wan serial port.

7.5.3 Report Start

Report Start is set by the user for a desired future, or past, date-time when it is desired that log or data reporting is to begin being sent - and continue thereafter at the programmed Report Rate below.

7.5.4 Report Rate

Report Rate is set by the user to establish the exact elapsed time between successive reports.

7.5.5 Daylight Savings

When this selection is ON - instrument will adjust the real-time clock for daylight savings time.

7.6 Data Logging (OPTION)

DATA LOGGING is an option which requires the DATE and TIME option to additionally be installed. When either option is not installed - the Global Settings will not list DATA LOGGING as an available choice, and the service screen will not appear.

When the option is installed - enter the service screen by pointing the cursor to DATA LOGGING listed on the Global Settings screen and press the [SELECT] key.



Data Logging settings control the operation of the built-in logging function - which stores date-time stamped records for later download, review and processing.

The logging function is used to sequentially acquire periodic samples in real-time of channel PV or Input Port values. Event logging is an additional option for taking samples based on one or more events having occurred instead of samples being taken on a periodic sample rate. Contact factory for custom event logging application requirements.

The service screen provides a pop-up of the loggers operating keys. Refer to the Serial Protocol section for serial logger operation.

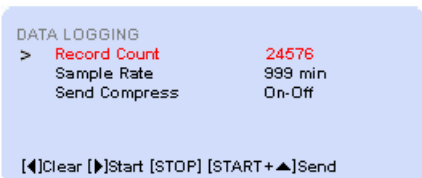

[◀]Clear causes the Record Count to become zero, [▶] Start causes logging to begin, [STOP] halts periodic sample acquisition, and [START+▲] causes all log records to be sent from the RS232 serial port.

7.6.1 RECORD COUNT

This value is the number of records that have been acquired. The acquired records may be erased when the cursor is pointing to record count and the [◀] key is pressed.

7.6.2 SAMPLE RATE

This value has a numeric part, and a units part. The combination sets the time between sequential value acquisitions - programmable from 0-999 seconds, minutes, hours, days or months. Periodic logging is disabled when the numeric portion of sample rate is zero.

When event logging has optionally been installed in the instrument - the numeric part of the Sample Rate must remain set to zero.

7.6.3 SEND COMPRESS

This state when Off causes log records to be sent as ASCII serial values, and when On, causes the value portion of log records to be sent as straight eight bit binary.

8.0 Process Controls

This section provides a detailed description and operation of the instruments various control functions.

8.1 Manual Control

Manual control is a continuous manually oriented process - performed on a port-by-port basis. This control type causes an SP Rate signal programmed by the operator to be output to a controller. The controllers' delivery rate signal is independently monitored and may be indicated by a linked port PV Rate.

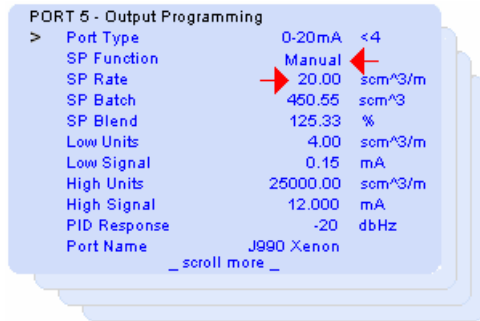

PORT 5 - Output Programming		
> Port Type	0-20mA	<4
SP Function	Manual	←
SP Rate	20.00	scm ³ /m →
SP Batch	450.55	scm ³
SP Blend	125.33	%
Low Units	4.00	scm ³ /m
Low Signal	0.15	mA
High Units	25000.00	scm ³ /m
High Signal	12.000	mA
PID Response	-20	dbHz
Port Name	J990 Xenon	
_ scroll more _		

8.1.1 Set-Up

The operator programs values shown above for each output port desired to perform Rate control.

8.1.1.2 SP Function - select Manual

8.1.1.1 SP Rate - desired delivery rate

8.1.2 Start Rate Control

This control type is continuous - requiring no start action to be taken by the operator. The delivery process can be monitored as shown on the live update screens below, observing that the SP Rate is the same as the monitored PV Rate.

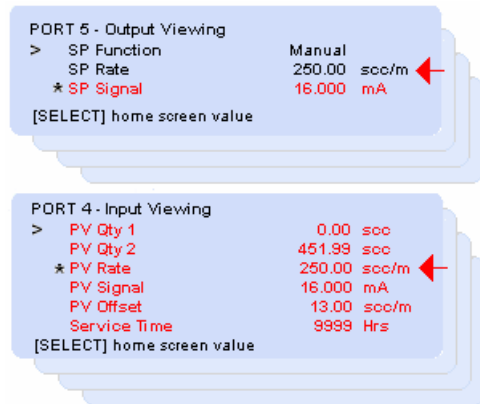

PORT 5 - Output Viewing		
> SP Function	Manual	
SP Rate	250.00	scm/m ←
* SP Signal	16.000	mA
[SELECT] home screen value		

PORT 4 - Input Viewing		
> PV Qty 1	0.00	scm
PV Qty 2	451.99	scm
* PV Rate	250.00	scm/m ←
PV Signal	16.000	mA
PV Offset	13.00	scm/m
Service Time	9999	Hrs
[SELECT] home screen value		

8.1.3 Terminate Rate Control

When the operator sets the channel SP Rate to zero - the process is off.

8.2 Batch Control

Batch processing is a non-continuous process that is started, conducted, and terminated when a desired quantity has completed delivery. The operator may stop batch delivery at any time prior to completion.

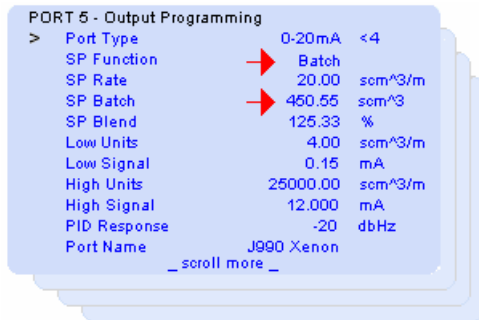

PORT 5 - Output Programming		
> Port Type	0-20mA	<4
SP Function	→ Batch	
SP Rate	20.00	scm ³ /m
SP Batch	→ 450.55	scm ³
SP Blend	125.33	%
Low Units	4.00	scm ³ /m
Low Signal	0.15	mA
High Units	25000.00	scm ³ /m
High Signal	12.000	mA
PID Response	-20	dbHz
Port Name	J990 Xenon	
_ scroll more _		

8.2.1 Set-Up

The operator programs values shown above for each output port that is desired to perform batch delivery.

8.2.1.1 SP Function - select Batch

8.2.1.2 SP Batch - set desired delivery quantity

8.2.2 Start Batch

8.2.2.1 Return to home screen - note home screen indicates a 'B' control indicator for all output ports selected to perform batching.

8.2.2.2 Press [START] key three (3) times - and note 'B' indicators now blinking to indicate channels with batch now in process.

8.2.2.3 The delivery process can be monitored as shown on the screens below observing that the PV Qty 2 increases toward the SP Batch amount. The screen below is updated real-time live. Since the SP Function was set for Batch - the Batch quantity SP will appear on this screen.

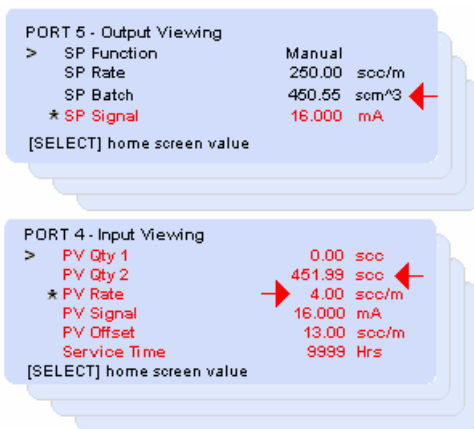

PORT 5 - Output Viewing		
> SP Function	Manual	
SP Rate	250.00	scm/m
SP Batch	450.55	scm ³ ←
* SP Signal	16.000	mA
[SELECT] home screen value		

PORT 4 - Input Viewing		
> PV Qty 1	0.00	scm
PV Qty 2	→ 451.99	scm ←
* PV Rate	→ 4.00	scm/m
PV Signal	16.000	mA
PV Offset	13.00	scm/m
Service Time	9999	Hrs
[SELECT] home screen value		

8.2.3 Terminate Batches

8.2.3.1 Batching for each channel set for batch will automatically terminate when each batch channel PV Total has reached or exceeded their programmed SP Batch set-point.

8.2.3.2 The operator may terminate any channels that continue with batching remaining in process by first returning to the home screen, then pressing the [STOP] key once. Note that the 'B' control indicators on the home screen stop blinking indicating that all batch processes are stopped.

8.2.4 Batch Type Selection

The Global Selections for Control Service includes a "Batch Type" selection to be either "Bulk" or "Port<or>Chan".

8.2.4.1 Bulk Batching - when selected will cause all output ports with Function selected as Batch to be started at the same time when the Start key is depressed three times from the Home Screen. No batch will be started when any batch output port quantity SP is set to zero.

8.2.4.2 Port<or>Channel Batching - when selected causes a single batch process to start when the Home Screen cursor is pointing to an output port with its Function set for Batch. No batch will be started when the batch output port quantity SP is set to zero.

8.2.4.3 The operator may terminate any single port or channels by first returning to the home screen, then pressing the [STOP] key once with the home screen cursor pointing to an active batch output. Note that the 'B' control indicators on the home screen stop blinking indicating that the selected batch process is stopped.

8.3 Blend Control <PRELIMINARY>

Blending is a continuous process that when started, causes slave SP Rates to be proportionate to the actual rate being delivered by the master.

CAUTION

Blending operate parameters are saved when power is lost allowing blending to continue after power is restored unless Pwr SP Clear is ON. - - See Global Settings - Controls Section

The operator selects an input port as the blend master, and then sets its linked output port SP Function to blend, and delivery SP Rate.

One or more input ports are linked to the output port and become slaves, and the process is started from the home screen. Once started - blending will continue and may ONLY be terminated by the operator.



8.3.1 Set-Up

The operator selects the input port above as the master input port, and then all desired slave output ports to perform blending.

8.3.1.1 Select Blend Master

From the home screen - point to an input port desired to be the master and press the [◀] master blend key. This causes the home screen show an 'M' indicating the master input port. Should the operator press the master key again at that moment - the 'M' control indicator will no longer be present - no master is then selected - and blending will not be conducted.

To de-select a blend master - point to the present master input port and press the [◀] master blend key. Note the 'M' control indicator is no longer present and the master has been de-selected.

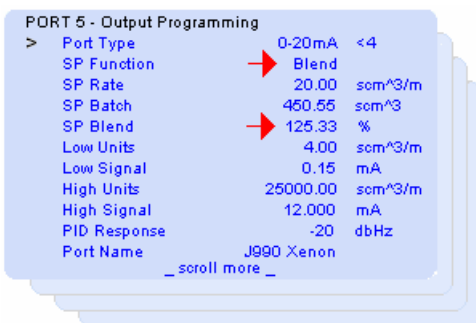

8.3.1.2 Master Input Port Set-up

The operator navigates to the output programming screen linked to the selected master input port, and sets the output port, linked to the input master, SP Function to Rate, and desired SP Rate.

8.3.1.3 Slave Channels Set-up

The operator navigates to each desired slave output port and sets each SP Function to Blend, then sets the desired SP Blend rate percentage referenced to the master channels actual delivery rate. Note the home screen shows 'S' indicating the selected blend slave output ports.

NOTE

Once a slave channel is set to Blend
SP Rate programming is prohibited for both keypad and serial command

8.3.2 Start Blend

8.3.2.1 Return to the home screen

8.3.2.2 Press [START] key three (3) times - and note the 'M' and 'S' suffix are now blinking to indicate output port blends are now in process.

8.3.2.3 The blending process can be viewed on the screen below observing that the SP Rate is the programmed proportion of the master rate.

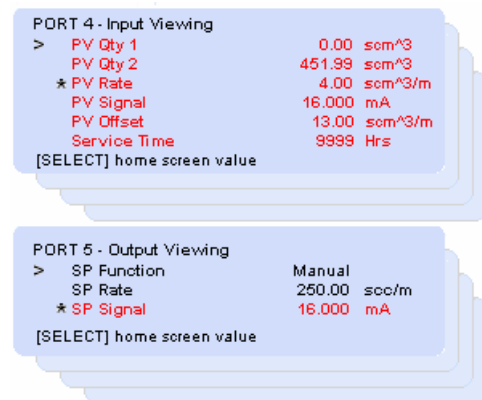

8.3.3 Terminate blend in-process

Once the operator has started blending - it will continue unless specifically terminated by the operator. To terminate - return to the home screen and press the [STOP] key. Observe that the 'M' and 'S' process indicators no longer blink.

NOTE

Terminating a blend in-process causes the blend master channel SP Rate value to be cleared to zero

8.4 Monitor Service

Monitor is an output port service that acquires the PV Rate from its linked input port, de-interpolates the rate to a selected output Port Type signal, and outputs the signal to other system process monitoring equipment.

When an output port link is zero - it is not linked to an input port. The output port then functions to search all input ports for at least one alarm. When an alarm is detected - the output port provides an analog signal or relay activation to annunciate one or more system alarms are detected.

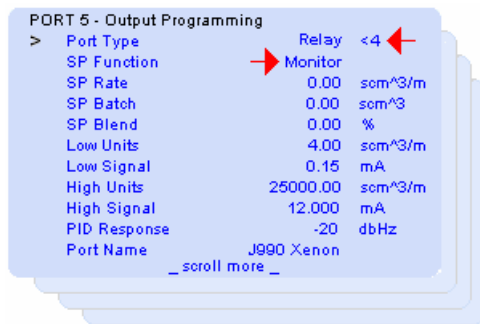

The image shows a terminal window titled "PORT 5 - Output Programming". The menu is as follows:

Parameter	Value	Units
Port Type	Relay	<4
SP Function	Monitor	
SP Rate	0.00	scm ³ /m
SP Batch	0.00	scm ³
SP Blend	0.00	%
Low Units	4.00	scm ³ /m
Low Signal	0.15	mA
High Units	25000.00	scm ³ /m
High Signal	12.000	mA
PID Response	-20	dbHz
Port Name	J990 Xenon	

Red arrows point to "Relay <4" and "Monitor". The text "_ scroll more _" is at the bottom.

8.1.1 Set-Up

The operator programs the output port SP Function to Monitor.

8.1.2 Start Monitor Control

This control type is continuous - requiring no start action by the operator.

8.1.3 Terminate Monitor Control - no support except to change the output port to off.

8.5 PID Rate Control

The function of PID control is to produce output signals that will cause the rate of a process observed by the linked input port to be held constant to equal the output ports SP Rate.

Proportional-Integral-Differential (PID) is a continuous rate control process performed by the combination of an output port whose SP Function is set for PID; and an input port linked to the PID output.

When the output port is not linked to an input port - the PID control function is not serviced - and is ignored.

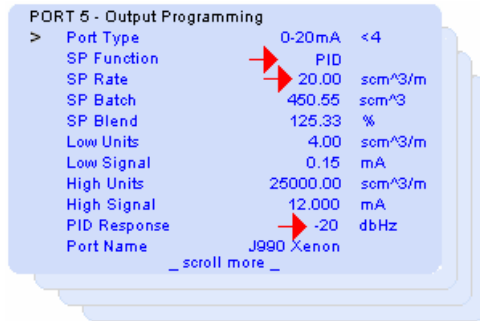

8.1.1 Set-Up

The operator programs the output port SP Function to PID, SP Rate as desired to be held constant, and initially sets the PID Response for 0 dbHz - fastest response.

The PID Response is the control that matches the response time of the controlled plant to the PID controller. It is adjusted increasingly more negative to the point where the most suitable control loop stability is achieved.

8.1.2 Start Monitor Control

This control type is continuous - requiring no start action to be taken by the operator.

8.1.3 Terminate Monitor Control - no support except to set the output port to off.

9.1 Bio-Medical Alert

NOTICE
WRITTEN AUTHORIZATION BY THE PRESIDENT OF FLORITE
INTERNATIONAL, INC. IS REQUIRED PRIOR TO USING ANY FLORITE
PRODUCTS OR SERVICES AS CRITICAL COMPONENTS IN
LIFE SUPPORT DEVICES OR SYSTEMS.

9.1.1 A critical component is any component of a life support device or system whose failure to perform can reasonably be expected to cause the failure of the life support device or system, or affect its safety or effectiveness.

9.1.2 Life support devices or systems are devices or systems which are as follows: Intended for surgical implant into the body; or Intended to support or sustain life; and in any case, whose failure to perform when properly used in accordance with the instructions provided in the labeling or operators manuals, can reasonably be expected to result in significant life threatening injury.

9.2 Federal Communications Commission Compliances

9.2.1 Part 15 Compliance

9.2.1.1 This equipment has been tested and found to comply with the limits for **Class B Class A** digital device pursuant to part 15 of the FCC rules. These limits are designed to provide reasonable protection against harmful interference when the equipment is operated in **[residential] [commercial-industrial]** environment. This equipment generates, uses, and can radiate frequency energy and, if not installed and used in accordance with the instruction manual, may cause harmful interference to radio communications.

9.2.1.2 Notice To User

This equipment complies with FCC Part governing limitations for radio frequency emissions. Operation is subject to two conditions as follows: (1) this device may not cause harmful interference, and (2) this device must accept any interference that may cause undesired operation.

9.2.1.3 Equipment Modification

Changes or modifications not expressly approved by the party responsible for compliance will void the user's authority to operate the equipment.

9.2.2 Part 68 Notice

9.2.2.1 A Federal Communication Commission (FCC) compliant telephone cord with modular plug is provided with your equipment to connect it to the public switched telephone line using a Universal Order Service Code (USOC) RJ-11 jack. Do not connect to party or coin lines. The sum of the REM numbers printed on the telephone line device for ALL devices connected to the telephone line, shall not exceed 5.0. This insures that each device connected to the line may respond properly when the line rings

9.2.2.2 You must provide the FCC Part 68 compliance registration information from the equipment label when requested by the telephone company.

Registrant: Florite International, Inc.
Number: 5TUUSA-23969-DT-E

9.2.2.3 The telephone company will notify you of network changes that may affect proper functioning of your equipment, and may temporarily discontinue service, or require the equipment to be disconnected from the line, if it is suspected of causing harm to the network. You will be informed by your telephone company of your rights to file complaints with the FCC.

9.3 EU Compliances

9.3.1 EMC Directive

The European Union directive on electromagnetic compatibility (2004/108/EC) requires a non-European manufacturer to designate an authority representative in the Union-Community. Our European representative is: Compatible Electronics, Inc., 2337 Troutdale Dr., Agoura, CA 91301.

9.3.2 Waste Electrical and Electronic Equipment Directive (WEEE)

The European directive WEEE aims to minimize the impact of electrical and electronic equipment waste on the environment and human health. For proper treatment, recovery, and recycling, return the equipment to your local supplier upon the purchase of equivalent new equipment, or dispose of it in designated collection points. For further information - visit www.recyclethis.com.

9.4 Copyright

Florite International, Inc. warrants that every reasonable effort has been made to assure the accuracy of the information contained herein, however, assumes no responsibility for its use. The information is subject to change at any time without notice, and no part of it may be reproduced without prior written agreement and the consent of Florite International, Inc. All rights reserved © 2005-2008.

9.5 Hazardous Waste

9.5.1 Florite instruments may incorporate real-time clock operation which is supported by a 3.0 volt, 35 milliamp-hour lithium battery during periods during which the instruments power is disconnected. the battery is not a user serviceable component, and is guaranteed for a period of nine (9) years from the date the original purchaser purchased the instrument.

9.5.2 Contact Florite International, Inc. to return the instrument for battery replacement service should it be observed that the clock time is affected following instrument power loss. The battery is exclusively a factory replacement component, and in no case shall the original product purchaser attempt to remove or replace the battery, which requires the instrument to be opened, which will immediately void the terms and conditions of the instruments Limited Warranty. Prior to sending the instrument to Florite for service, contact www.florite.com, Service Department, who will issue a return-materials-authorization number. The instrument must return a copy of the original purchase invoice to receive service.

9.5.3 In no circumstance will Florite be responsible for customer expenses associated with the need for battery replacement, such as, but not limited to, unit de-installation, re-installation, or in all cases, irrespective of the instruments Warranty status.

9.5.4. Returned instrument for battery replacement shall be shipped by the customer return freight prepaid. Instruments beyond the original Warranty period are subject to a battery service charge in the of 50% of the prevailing clock option list price.

9.6 Legal Notices

9.6.1 Trademarks and Patents

Florite and the Florite Logo symbol are trademarks of Florite International, Inc. Other trade names which may be used in this document may be trademarks or registered trademarks of the manufacturers or vendors of the respective products.

9.6.2 Disclaimer

9.6.2.1 The information in this document is subject to change without notice at any time. Florite International, Inc. assumes no responsibility for inaccuracies or omissions, and specifically disclaims any liabilities, losses, or risks, personal or otherwise, incurred as a consequence, directly or indirectly, of the use or application of any of the contents of this document. For the latest documentation, contact your local supplier or visit us online at www.florite.com.

9.6.2.2 This publication may contain examples of screen captures and reports used in daily operation. Any such examples may include fictitious names of individuals and companies. Any similarity to names and addresses of actual businesses or persons is entirely coincidental.

9.6.2.2 This equipment contains no user serviceable internal constituents. Opening the equipment case voids the original product Limited Warranty terms and conditions.

9.6.3 Intended Equipment Use

This product shall be used only for the purpose it was designed and manufactured; refer to the product Data Sheet and user documentation. For the latest product information, contact your local supplier, or visit us online at www.florite.com.

9.6.4 This Document Copyright © 2009 Florite International, Inc.

All rights are reserved. This document may not be copied in whole, or in part, or otherwise reproduced without prior written consent received from Florite International, Inc., except where specifically permitted under US and international copyright law.