



Badger Meter

Industrial Flow Computer

FC-5000 BTU Monitor



CONTENTS

Scope of This Manual	5
Unpacking and Inspection	5
Safety Considerations.	5
Terminology and Symbols.	5
Safety Instructions	6
Safety Rules and Precautionary Measures	6
Description	7
Functions and Features	7
Flow Meter Input	7
Digital Inputs	7
Relay Control Outputs	8
Power Supply	8
Configuring the Unit	8
Display Information	9
Installing the BTU Monitor.	9
Mounting Options.	10
Wiring the BTU Monitor	12
Operator Interface.	19
Keypad and Soft Keys	19
Scrolling	19
Control Panel Keys	19
Icon Functionality	20
Numeric Editing	21
Alpha-Numeric Editing.	21
Selection/Enumeration Editing	22
Confirmation Screen	22
Navigating the Menus	23
Menu Structure	24
Info/Sensor Data	25
System Information	26
Basic Setup	27
Display	27
Resets	27
Passcode Setup	28
Units	29
Advanced Setup	32
Configuring a Flow Sensor	32

Configuring a Temperature Sensor	34
Configuring Outputs	35
Configuring Digital I/O	39
Configuring Fluid Properties	40
Configuring Communications	41
Troubleshooting	43
Modbus Interface	45
Modbus Function Code Support.	45
Modbus Register Map	45
BACnet Interface	46
BACnet Map	46
Flow Sensor Types	46
Part Numbering Construction	47
Replacement Parts/Accessories	47
Specifications	48
Standards and Certifications	51
Agency Approval/Standards	51
EMI/EMC Compliance.	51
Enclosure Protection	51

SCOPE OF THIS MANUAL

This manual describes how to install and program the FC-5000 BTU Monitor. The electronic version of this manual is available on our website at www.badgermeter.com.

IMPORTANT

Read this manual carefully before attempting any installation or operation. Keep the manual in an accessible location for future reference.

UNPACKING AND INSPECTION

Upon opening the shipping container, visually inspect the product and applicable accessories for any physical damage such as scratches, loose or broken parts, or any other sign of damage that may have occurred during shipment.

NOTE: If damage is found, request an inspection by the carrier's agent within 48 hours of delivery and file a claim with the carrier. A claim for equipment damage in transit is the sole responsibility of the purchaser.

SAFETY CONSIDERATIONS

Terminology and Symbols



Indicates a hazardous situation, which, if not avoided, will result in death or serious personal injury.



Indicates a hazardous situation, which, if not avoided, could result in death or severe personal injury.



Indicates a hazardous situation, which, if not avoided, could result in minor or moderate personal injury or damage to property.



Please read the information in this manual in all cases where this symbol is used in order to find out the nature of potential hazards, and any actions which have to be taken to avoid them.



This symbol signifies that the FC-5000 BTU Monitor may be powered by a DC power supply. Acceptable DC input voltage range is: 10...40V DC.



This symbol signifies that the FC-5000 BTU Monitor may be powered by an AC power supply. Acceptable AC input voltage range is: 9...28V AC RMS (50...60 Hz).

- Operating temperature is 32...130° F (0...55° C) with a maximum humidity of 85% non-condensing. Always select a mounting location with proper ventilation and environmental protection.
- Maximum operating altitude: 2000 meters (6561 feet)
- Pollution Degree 2: Only non-conductive pollution occurs except that occasionally a temporary conductivity caused by condensation is to be expected
- Over-Voltage Rating: CAT II

Safety Instructions

WARNING

- **LIFE SUPPORT APPLICATIONS: THE FC-5000 IS NOT DESIGNED FOR USE IN LIFE SUPPORT APPLIANCES, DEVICES, OR SYSTEMS WHERE MALFUNCTION OF THE PRODUCT CAN REASONABLY BE EXPECTED TO RESULT IN A PERSONAL INJURY. CUSTOMERS USING OR SELLING THESE PRODUCTS FOR USE IN SUCH APPLICATIONS DO SO AT THEIR OWN RISK AND AGREE TO FULLY INDEMNIFY THE MANUFACTURER AND SUPPLIER FOR ANY DAMAGES RESULTING FROM SUCH IMPROPER USE OR SALE.**
- **ELECTROSTATIC DISCHARGE INFLECTS IRREPARABLE DAMAGE TO ELECTRONICS. BEFORE INSTALLING OR OPENING THE UNIT, INSTALLERS MUST DISCHARGE THEMSELVES BY TOUCHING A WELL-GROUNDED OBJECT.**
- **THIS UNIT MUST BE INSTALLED IN ACCORDANCE WITH THE EMC (ELECTROMAGNETIC COMPATIBILITY) GUIDELINES.**

Safety Rules and Precautionary Measures

The manufacturer accepts no responsibility whatsoever if the following safety rules and precaution instructions and the procedures as described in this manual are not followed.

- Modifications of the BTU Monitor implemented without preceding written consent from the manufacturer will result in the immediate termination of product liability and warranty period.
- Installation, use, maintenance, and servicing of this equipment must be carried out by authorized technicians.
- Check the mains voltage and information on the manufacturer's nameplate before installing the unit.
- Check all connections, settings and technical specifications of the various peripheral devices with the BTU Monitor supplied.
- Never open the enclosure.
- Never touch the electronic components (ESD sensitivity).
- Never expose the system to heavier conditions than allowed according to the casing classification (see manufacturer's nameplate).
- If the operator detects errors or dangers, or disagrees with the safety precautions taken, then inform the owner or the principal responsible.
- Adhere to the local labor and safety laws and regulations.

DESCRIPTION

The FC-5000 BTU Monitor is a microprocessor-driven device that is designed for energy (BTU) and flow monitoring. The FC-5000 BTU Monitor is compatible with the complete line of Badger Meter industrial flow meters and temperature sensors, creating a solution to monitor hydronic energy usage, flow rates and totals. This manual was written for firmware version 1.2.8.655.

Functions and Features

This product is designed with a focus on:

- Large display for easy viewing
- Ease-of-use with softkeys and a full numeric keypad
- Ruggedness for its application with a robust enclosure, keypad and mechanical relays
- Info/Sensor Data Screen—view raw and calculated data, both to and from the unit, including flow data, energy data, temperature readings and output statuses
- User-friendly installation with quality plug-and-play terminals
- A wide range of outputs and functions for a broad fulfillment in many applications
- User defined relay triggers for flow rates and totals, temperatures or energy rates and totals

Flow Meter Input

The FC-5000 BTU Monitor accepts passive or active signal outputs. The input circuit supports low and high frequency (0.5...3500 Hz) flow meters. A 12V DC excitation terminal is available for flow meter sensors that require power.

Digital Inputs

The FC-5000 BTU Monitor control inputs allow the following functions:

- Unlatch Relays
- Reset Totalizers
- Unlatch Relays and Reset Totalizers

Relay Control Outputs

The FC-5000 BTU Monitor has two relay outputs, either a mechanical Form C switch or a solid state Form A switch. The product configuration determines which switches are available. All control functions are always available by dedicated relay outputs. Unneeded outputs may be left disconnected or disabled within the firmware.

Relays can be used for alarm indication or as a totalizing output.

Form-C

- Can be powered directly from mains circuits rated up to 240V.
- Must be powered through circuits that are insulated from mains by at least basic insulation.
- Connected sources of power need to be limited to 240V AC and fused at 5A or less.
- Not suitable for connection to external circuits that are insulated from mains by at least double insulation (SELV).

Form A

- Located on TB4 and recommended to use, if configured as a high-rate, totalizing output.
- Relay energizes (contact closes) with a minimum input current of 3 mA through the input LED.
- The relay turns off (contact opens) with an input voltage of 0.8V or less.

Power Supply

The power supply used must be isolated from mains by double or reinforced insulation (for instance, SELV power supply).

The FC-5000 BTU Monitor operates on 10...40V DC or 9...28V AC supplied by any suitable source that also meets the requirement listed above. Badger Meter has power supplies available for the FC-5000 BTU Monitor.

Power Supply Part Numbers:

- 68334-001: includes wall mount (wall wart) power supply and various adapters
- 68334-002: power module that allows discrete power wiring

A power supply not sourced from the factory must be capable of supplying a minimum of 8 Watts.

Configuring the Unit

The FC-5000 BTU Monitor is designed for many types of applications. See *“Advanced Setup” on page 32* for instructions on configuring your FC-5000 BTU Monitor to your specific requirements.

All information is stored in EEPROM memory and will not be lost in the event of power failure.

Display Information

The FC-5000 BTU Monitor has a large transfective LCD with a bright LED backlight that displays symbols and digits for measuring units, status information and keyword messages. See “Units” on page 29.

INSTALLING THE BTU MONITOR

⚠ CAUTION

MOUNTING, ELECTRICAL INSTALLATION, STARTUP AND MAINTENANCE OF THIS INSTRUMENT MAY ONLY BE CARRIED OUT BY TRAINED PERSONNEL AUTHORIZED BY THE OPERATOR OF THE FACILITY. PERSONNEL MUST READ AND UNDERSTAND THIS OPERATING MANUAL BEFORE CARRYING OUT ITS INSTRUCTIONS.

⚠ CAUTION

THE FC-5000 BTU MONITOR MAY ONLY BE OPERATED BY PERSONNEL WHO ARE AUTHORIZED AND TRAINED BY THE OPERATOR OF THE FACILITY. OBSERVE ALL INSTRUCTIONS IN THIS MANUAL.

⚠ CAUTION

OBAY ALL SAFETY PRECAUTIONS MENTIONED IN “SAFETY CONSIDERATIONS” ON PAGE 5.

NOTE: For a complete list of parts and accessories, refer to “Replacement Parts/ Accessories” on page 47.

Mounting Options

The FC-5000 BTU Monitor can be mounted on a wall, shelf or instrumentation panel. Wall-mount units are shipped in a NEMA 4X enclosure, ready to mount.

Panel-Mount Installations

NOTE: Mounting clips can accommodate a maximum panel thickness of 1.5 in. (38.1 mm).

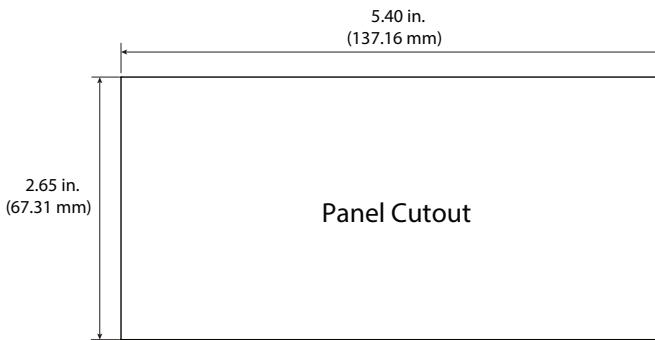

Figure 1: Panel cutout

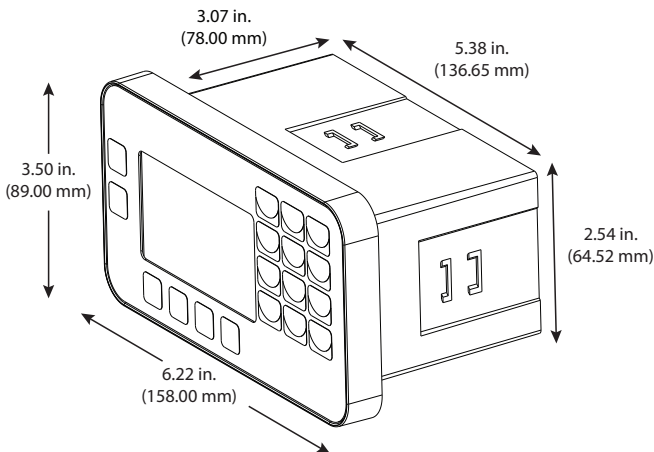

Figure 2: Mounting dimensions

To install:

1. Measure and cut a mounting hole to the dimensions shown in *Figure 1*.
2. Verify that the gasket is secure inside the mounting bezel.
3. Insert the unit through the panel cutout.
4. Secure the unit to the panel with the provided mounting clips.

Wall-Mount Installations

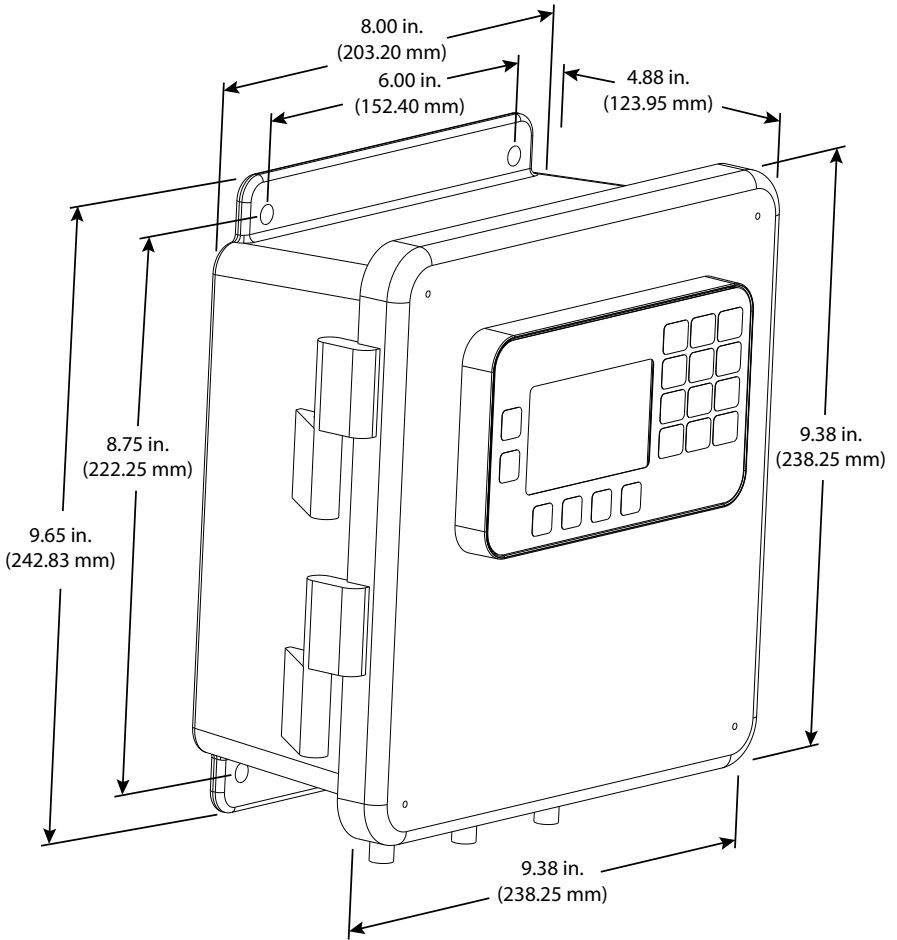

Figure 3: FC-5000 BTU Monitor in an enclosure

To install the FC-5000 BTU Monitor on a wall, secure the enclosure to the wall with four mounting screws (customer-supplied).

Wiring the BTU Monitor

At installation, be sure to comply with the following requirements:

- Disconnect power to the unit before attempting any connection or service to the unit.
- Avoid using machine power service for AC power. When possible, use a dedicated circuit or a lighting circuit.
- Observe all local electrical codes.
- The unit must be wired with wires and/or cables with a minimum temperature rating of 167° F (75° C).



TO PREVENT ACCIDENTS, DO NOT APPLY POWER UNTIL ALL OTHER CONNECTIONS HAVE BEEN COMPLETED.

Terminal Connectors

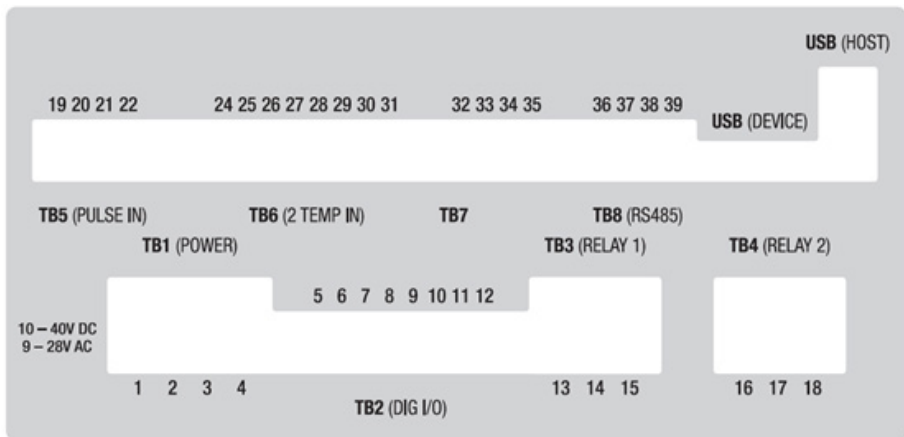

Figure 4: Terminal connectors, analog out

NOTE: Terminal/pin descriptions shown on next page.

The plug-in connectors on the rear panel of the FC-5000 BTU Monitor are:

Terminal Block	Connection Pin	Configurations/Part Numbers			
		FC5-BM-P1-FC6A-*	FC5-BM-P1-FA6A-*	FC5-BM-P1-AC6A-*	FC5-BM-P1-AA6A-*
TB1 Power	1	+			
	2	SHLD			
	3	-			
	4	I/O GND			
TB2 Digital I/O	5	PWR +			
	6	I/O 1			
	7	I/O 2			
	8	I/O 3			
	9	I/O 4			
	10	I/O 5			
	11	I/O 6			
TB3 Relay 1	12	I/O GND			
	13	N.O.			
	14	COM			
TB4 Relay 2	15	N.C.			
	16	N.O.	X1	N.O.	X1
	17	COM	N.C.	COM	N.C.
TB5 Pulse Input	18	N.C.	X2	N.C.	X2
	19	EXCI +			
	20	IN +			
	21	SNS GND			
TB6 Temperature Inputs	22	SHLD			
	24	EXCI 1 +			
	25	SENS 1 +			
	26	SENS 1 -			
	27	EXCI 1 -			
	28	EXCI 2 +			
	29	SENS 2 +			
	30	SENS 2 -			
TB7 Scaled Outputs	31	EXCI 2 -			
	32	OUT 1		OUT 1	
	33	OUT 2		OUT 2	
	34	OUT GND		A GND	
TB8 Comms	35	SHLD		SHLD	
	36	SHLD			
	37	-			
	38	+			
	39	485 GND			
USB	Device	Mini-B Receptacle (Used for Firmware Updates)			
	Host	Type-A Receptacle (Not Used)			

Power Input

⚠ CAUTION

THE FC-5000 IS MICROPROCESSOR CONTROLLED. IT IS VERY IMPORTANT THAT THE POWER SUPPLY BE FREE OF ELECTRICAL NOISE. AVOID USING POWER LINES THAT FEED HEAVY LOAD ELECTRICAL DEVICES SUCH AS PUMPS AND MOTORS.

The FC-5000 BTU Monitor power input is internally fused and protected from common line noise by a filtering network.

TB1 (POWER)

Connector Pin	Function		Reference Pin
	AC Power	DC Power	
1	Line (L)	Positive (L+)	1
2	Shield (Chassis GND)		2
3	Neutral (N)	Negative (L-)	3
4	Digital I/O GND		4



Table 1: Power input

Temperature Inputs

Two temperature inputs allow the FC-5000 BTU Monitor to measure hydronic energy usage with potentially varying temperature readings.

TB6 (2 TEMP IN)

Connector Pin	Function	Reference Pin
1	T1 Excitation (+)	24
2	T1 Sensor Input (+)	25
3	T1 Sensor Input (-)	26
4	T1 Excitation (-)	27
5	T2 Excitation (+)	28
6	T2 Sensor Input (+)	29
7	T2 Sensor Input (-)	30
8	T2 Excitation (-)	31



Table 2: Temperature inputs

NOTE: See Figure 5 on page 15 for a wiring diagram.

2-Wire RTD or Thermistor

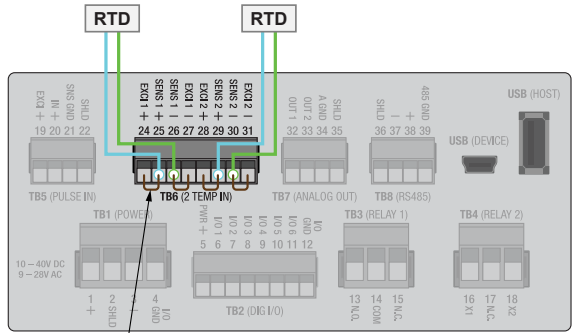

3-Wire RTD

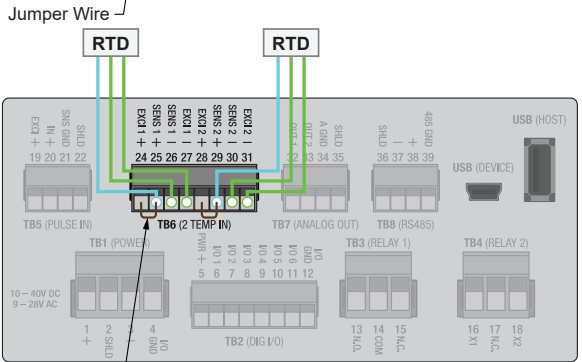

4-Wire RTD

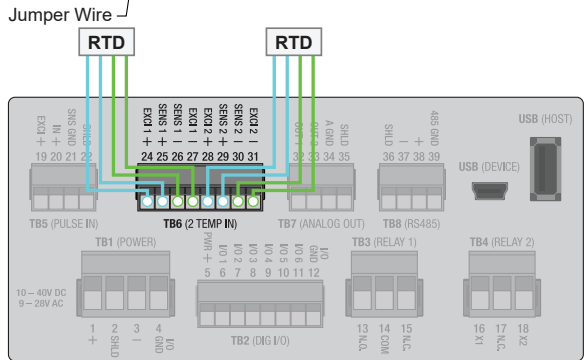

NOTE: The wires in your application may not be the same color as the wires in the diagram. The number of each color represents the number of a color of wire that your application will have. For example, the 3-Wire RTD diagram has two green wires and one blue wire. Your application may have two yellow wires and one red wire. To wire the system you would wire the two yellow wires the same way the green wires are in the diagram, and the same with the red and blue wires.

Figure 5: RTD Wiring Diagram

Digital Inputs

The FC-5000 BTU Monitor has six independent channels available for digital input. The channels accept TTL voltage signals in the 0...5V DC range. The control inputs are triggered when the voltage signal on the pin is pulled low (active low). Input range for a logic low signal is 0...1V, logic high is 4...5V.

TB2 (DIG I/O)

Connector Pin	Function	Reference Pin
1	Excitation or Power	5
2	Input/Output 1 Signal	6
3	Input/Output 1 Signal	7
4	Input/Output 1 Signal	8
5	Input/Output 1 Signal	9
6	Input/Output 1 Signal	10
7	Input/Output 1 Signal	11
8	Ground or Neutral	12

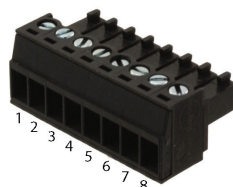

Table 3: Digital inputs

Communications

The FC-5000 BTU Monitor comes with Modbus (RTU or ASCII) and BACnet communication protocols. Signals are transmitted over an EIA-485 (RS-485) physical layer.

TB8 (RS-485)

Connector Pin	Function	Reference Pin
1	Shield (Chassis GND)	36
2	Negative (-)	37
3	Positive (+)	38
4	Output Ground	39



Table 4: Communications input

Scaled Outputs

The FC-5000 BTU Monitor has two scaled output channels for use in applications requiring remote data collection and/or monitoring. The outputs are firmware configurable, and can be tied to parameters such as rates, temperature or totalizer values.

TB7 (FREQ OUT) or (ANALOG OUT)

Connector Pin	Function	Reference Pin
1	Output 1 Signal	32
2	Output 2 Signal	33
3	Output Ground	34
4	Shield (Chassis GND)	35



Table 5: Scaled output channels



ANALOG OUTPUT CONFIGURATIONS ARE DESIGNED TO PROVIDE A SOURCING OUTPUT SIGNAL. THE RECEIVING DEVICE MUST NOT PROVIDE POWER TO THE LOOP.

Relay Output Connectors

The FC-5000 BTU Monitor has either two Form C relay output terminals or one Form C and one Form A terminal.

Two Form C

TB3 (RELAY 1) and TB4 (RELAY 2)

Connector Pin	Function	Reference Pin	
		Relay 1	Relay 2
1	Normally Open (N.O.)	13	16
2	Signal Common	14	17
3	Normally Closed (N.C.)	15	18



Table 6: Relay output connectors, relay option "C"

One Form C and One Form A

TB3 (RELAY 1) - Form C

Connector Pin	Function	Reference Pin
		Relay 1
1	Normally Open (N.O.)	13
2	Signal Common	14
3	Normally Closed (N.C.)	15



Figure 6: Form C Relay Output Connector

TB4 (RELAY 2) - Form A

Connector Pin	Function	Reference Pin
		Relay 2
1	Connection Point 1	16
2	Not Used (No Contact)	17
3	Connection Point 2	18



Figure 7: Form A Relay Output Connector

Flow Sensor Input

The FC-5000 BTU Monitor is designed to accept pulses from open collector transistors or dry contact closure transmitters.

Before making any connections:

- Always use shielded wire to protect the signal line from external noise (ground shield to terminal #3).
- Make sure the signal lines are not bundled with or touching power lines.

NOTE: In the table below, **RF Pin** refers to RF type pickups/amplifiers.

TB5 (PULSE IN)

Connector Pin	Function	Reference Pin	RF Pin
1	Sensor Excitation (+)	19	A
2	Sensor Input (+)	20	C
3	Sensor Input/Common (-)	21	B
4	Shield (Chassis GND)	22	—



Table 7: Flow sensor input

Powering Radio Frequency (RF) Type Pickups

Radio Frequency (RF) type pickups require a power source to generate a radio frequency field. Similar to magnetic pickups, as fluid velocity provides rotational energy on the flow meter rotor, the field generated by the pickup is disturbed, producing output pulses that are proportional to flow rate.

NOTE: Maximum current draw from the Excitation pin cannot exceed 200 mA. RF style pickups will require a signal conditioning amplifier.

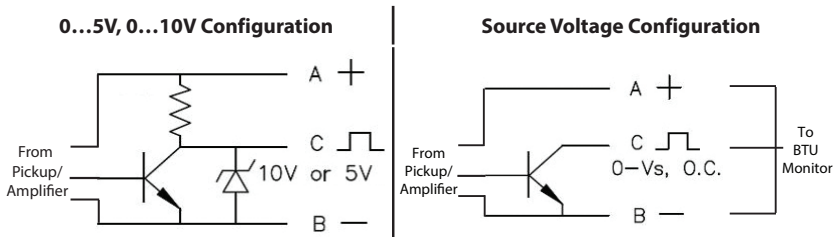

Table 8: Pickup configurations

OPERATOR INTERFACE

Keypad and Soft Keys

The keypad and soft keys are for programming, editing and changing views.

Scrolling

The screens can display up to four lines at a time. Some menus have more than four items to display. To see the off-screen items, press **UP/DOWN** to scroll through the entire list.

⚠ CAUTION

THE BTU MONITOR MAY BE OPERATED ONLY BY PERSONNEL WHO ARE AUTHORIZED AND TRAINED BY THE FACILITY. OBSERVE ALL INSTRUCTIONS IN THIS MANUAL. OBEY ALL SAFETY PRECAUTIONS MENTIONED IN "SAFETY CONSIDERATIONS" ON PAGE 5.

Control Panel Keys

NOTE: Always press  (ENTER) to save a new value.









	The numbered keys are used to enter or change parameter values.			
	In editing mode, BACKSPACE deletes the character to the left of the cursor. While navigating, BACKSPACE moves to a previous menu selection.			
	Depending on the current screen, ENTER : <ul style="list-style-type: none"> • Saves the current value and ends the editing session • Advances deeper into the menu structure • Toggles enumerations 			
	The UP/DOWN keys: <ul style="list-style-type: none"> • Toggle the display views on the home screen • While editing, use UP/DOWN to advance the cursor to the right or left • In the menu structure, scroll through the menus and parameters 			
				The F1-F4 function keys are soft keys that change function to whichever icon is present above them. See "Icon Functionality" on page 20.

Table 9: Control panel keys

Icon Functionality

Depending on the task being performed, one or more of the following icons may appear on the screen. To activate an icon, press the Function key (**F1**, **F2**, **F3** or **F4**) directly under the icon, where applicable.













Icon	Function
	Display the <i>Home</i> screen or cancel an edit (if you press the button without saving first)
	Display the menu structure
	Create a custom label (name) for a unit of measure
	Return to <i>Setup</i> menu
	Cycle through alpha characters
	Enter a decimal point
	Cycle through special characters
	Reveal raw and calculated info/sensor data for the BTU Monitor
	Clear the selected value or cancel edit (press twice, consecutively)
	Enter conversion factor for custom unit of measure
	Change selected value to positive (+) or negative (-)
	Set totalizer rollover point
	Appears on <i>Home</i> screen for various events. Refer to “ <i>Troubleshooting</i> ” on page 43 for details.

Table 10: Icon functionality

Numeric Editing

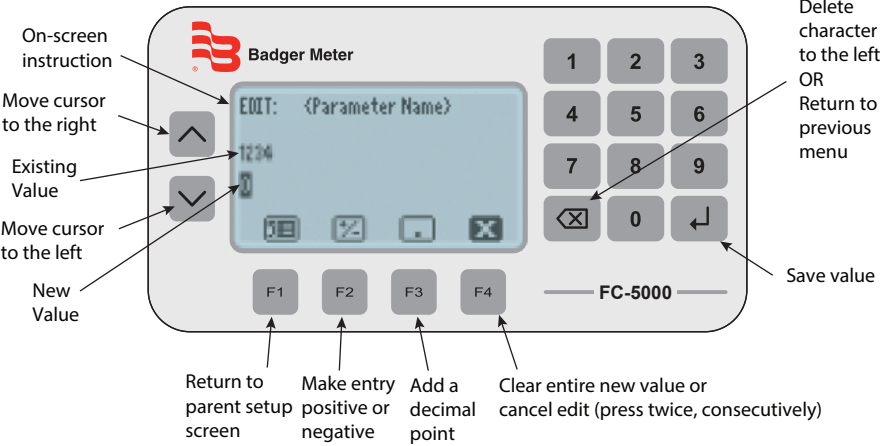

Figure 8: Numeric editing

Alpha-Numeric Editing

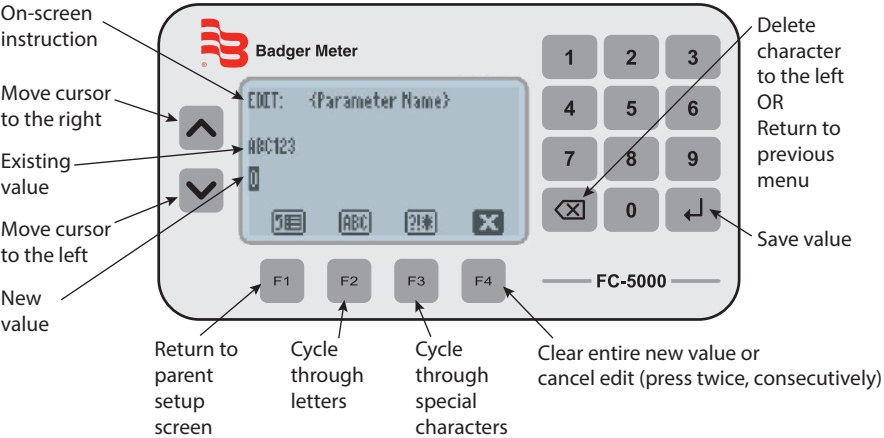

Figure 9: Alpha-numeric editing

Selection/Enumeration Editing

NOTE: Depending on the menu, the selection during an enumeration style edit may appear different.

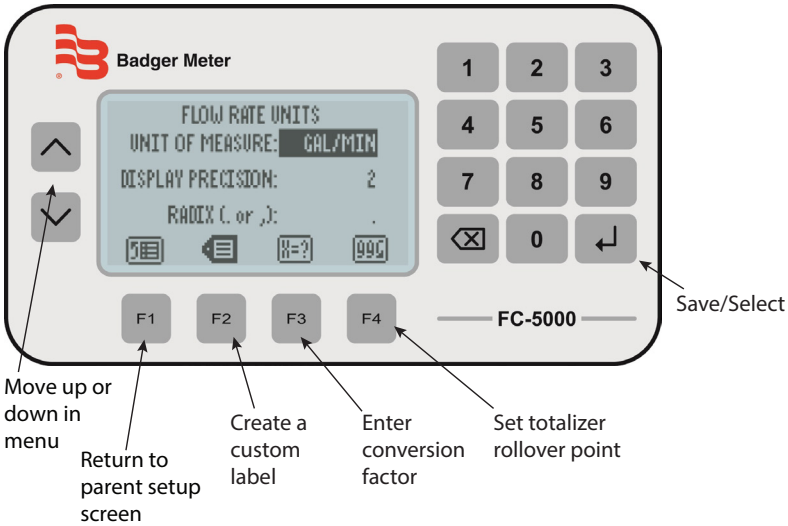

Figure 10: Selection editing

Confirmation Screen

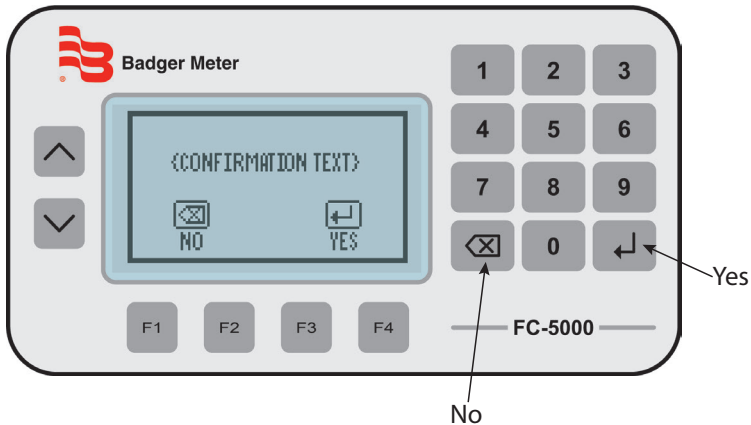
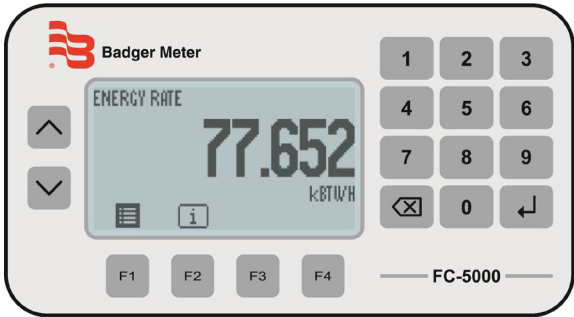

Figure 11: Confirmation screens

Navigating the Menus

The *Home* screen display shows rates and totals, either separately or simultaneously. Status and alarm messages or alarm icons appear on the display when appropriate.

Press **UP/DOWN** to toggle views on the *Home* screen:



- Flow Rate
- Flow Total
- Energy/BTU Rate
- Energy/BTU Total

Figure 12: Single display

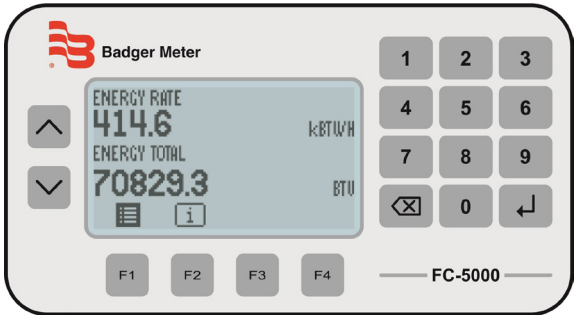

- Flow Rate and Flow Total
- Energy/BTU Rate and Energy/BTU Total

Figure 13: Dual display

Press **F1** to enter the *Main* menu to access *Setup* and *System Information*, or press **F2** to enter the *INFO/SENSOR DATA* menu.

Menu Structure

The available menu items depend on the BTU Monitor configuration. Each menu item is explained in detail in the following pages.

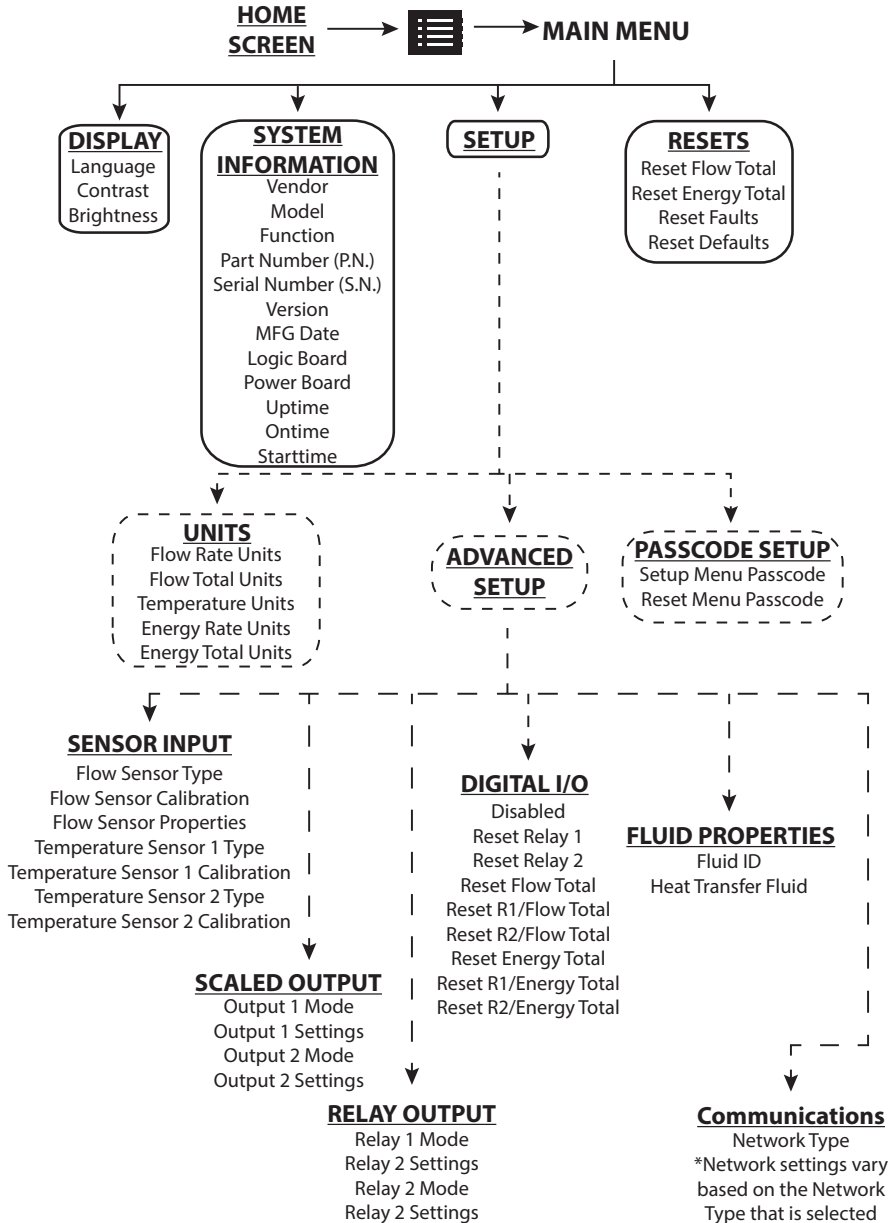

Figure 14: Menu structure

INFO/SENSOR DATA

The FC-5000 BTU Monitor features a quick method to view measured data transmitting to and from the device. You can use the data for informational purposes or for troubleshooting. The type of data displayed can include raw input frequency, relay status or calculated data, such as flow rate.

Item	Description
FLOW FREQ	Raw frequency of the flow sensor
FLOW COUNT	Raw pulse count of the flow sensor
FLOW RATE	Calculated flow rate of the flow sensor
FLOW TOT	Calculated flow total of the flow sensor
ENERGY RATE	Calculated energy rate
ENERGY TOT	Calculated energy total
TEMP 1	Displays the calculated temperature and raw resistance (ohms) value of temperature sensor 1. Displays "NO SENSOR" if no sensor is connected.
TEMP 2	Displays the calculated temperature and raw resistance (ohms) value of temperature sensor 2. Displays "NO SENSOR" if no sensor is connected.
DELTA T	The difference between TEMP 1 and TEMP 2
DENSITY	Density of the fluid (Programmed)
SP HT	Specific heat of the fluid (Programmed)
RELAY 1	ENERGIZED/OFF status of relay 1
RELAY 2	ENERGIZED/OFF status of relay 2
D-I/O 1	ENABLED/DISABLED status of digital I/O port 1
D-I/O 2	ENABLED/DISABLED status of digital I/O port 2
D-I/O 3	ENABLED/DISABLED status of digital I/O port 3
D-I/O 4	ENABLED/DISABLED status of digital I/O port 4
D-I/O 5	ENABLED/DISABLED status of digital I/O port 5
D-I/O 6	ENABLED/DISABLED status of digital I/O port 6

To return to the home screen, press **BACKSPACE** or **F1** (home).



Figure 15: Info/sensor data screen

SYSTEM INFORMATION

The *System Information* menu contains build information specific to the configuration of the unit.

To view your system information, navigate to *System Information* from the *Main* menu.

Item	Description
VENDOR	Manufacturer of the product
MODEL	Product family/series
FUNCTION	For factory/diagnostic purposes only
P.N.	Configured part number
S.N.	Serial number
MFG DATE	The original manufacture/build date
VERSION	Loaded firmware version
LOGIC BRD	For factory/diagnostic purposes only
POWER BRD	For factory/diagnostic purposes only
UPTIME	Time, in seconds, since last power-on session start
ONTIME	Total lifetime power-on, in seconds
STARTTIME	Ontime at start of power-on session

Table 11: System information menu

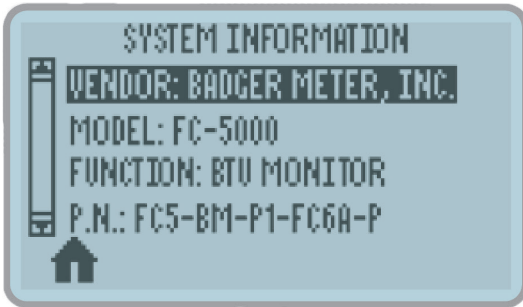

Figure 16: System information screen

BASIC SETUP

Display

Use this menu to change the display settings for *Language*, *Contrast* or *Brightness*.

1. Navigate to *Display* from the main menu.
2. Press **UP/DOWN** to scroll through the available display parameters, then press **ENTER**.
3. Scroll through available options, then press **ENTER** to select and save your changes.



Figure 17: Display configuration screen

Resets

Use this menu to reset *Totalizers*, *Faults*, *Defaults* and *latched relays*:

1. Navigate to *Resets* from the main menu.

NOTE: If a passcode was configured, enter the passcode, then press **ENTER** to access this menu.

2. Press **UP/DOWN** to scroll through the available reset options, then press **ENTER**.
3. On the confirmation screen press **ENTER** to confirm the reset.

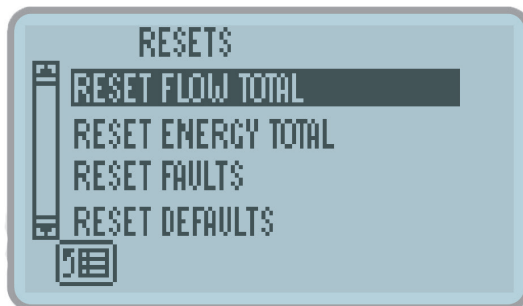

Figure 18: Resets menu

Clearing a Latched Relay

To clear a relay that latches after a trigger:

1. Navigate to the main menu.
2. Press **UP/DOWN** to scroll to *UNLATCH R1* or *UNLATCH R2*, then press **ENTER**.

Passcode Setup

Enabling Passcodes

FC-5000 units are shipped without passcode protection enabled. You can enable a unique password for the *Setup Menu* and the *Reset Menu*. To enable a passcode:

1. Navigate to *SETUP > PASSCODE SETUP*.
2. Press **UP/DOWN** to scroll to the passcode you want to enable, then press **ENTER**.



Figure 19: Enable passcode screen

3. Enter a numeric passcode from 4 to 8 digits in length, then press **ENTER**.
4. On the confirmation screen, press **ENTER** again to confirm the passcode.

NOTE: An asterisk (*) appears next to each passcode if it is enabled.



Figure 20: Asterisk indicates enabled passcode

Disabling a Passcode

1. Navigate to *SETUP > PASSCODE SETUP*.
2. Press **UP/DOWN** to scroll to the passcode you want to delete, then press **F4** (clear).
3. On the confirmation screen, press **ENTER** to confirm removal of the passcode.

Forgotten Passcodes

If you have forgotten your passcode, call Badger Meter customer service and they will be able to assist you in resetting the passcode.

1. Navigate to *System Information* from the main menu.
2. Locate and write down the valves shown for "STARTTIME" and "S.N. (Serial Number)".
3. Call Badger Meter customer service. See "*Troubleshooting*" on page 43 for contact information.

Units

Use the *UNITS* menu to configure units of measure, display precision (resolution) and radix (comma or decimal point). You can configure these settings for each Parameter Unit: Flow (Rate and Total), Temperature and Energy (Rate and Total).

1. Navigate to *SETUP > UNITS*.
2. Press **UP/DOWN** to scroll through the available parameter units.
3. Scroll to *Unit of Measure, Display Precision or Radix*, then press **ENTER** to activate the drop-down menu for that setting.

Unit of Measure

The *Unit of Measure* setting determines the engineering unit and/or time interval for calculated measurements of the selected parameter unit.

1. Press **UP/DOWN** to scroll through the available units of measure, then press **ENTER** to select and save the new setting.

NOTE: For most rate measurements, all options are available in time intervals of seconds (S), minutes (M), hours (H) and days (D).

For any of the *Flow* parameters (*Rate* or *Total*), the available units are:

Unit	Description	Unit	Description
US GAL	US Gallon	M ³	Cubic Meters
IG	Imperial Gallon	AC-FT	Acre Feet
MG	US Million Gallons	BBL	Oil Barrels [42 US Gallons]
MIG	Imperial Million Gallons	FBBL	Liquid Barrels [31.5 US Gallons]
L	Liters	US OZ	US Ounces
ML	Million Liters	I OZ	Imperial Ounces
FT ³	Cubic Feet	CUST	Custom

Table 12: Flow units

For *Energy Rate* the available units are:

Unit	Description	Unit	Description
kBTU/H	Thousand BTU per Hour	Ton (RT)	12,000 BTU/H
BTU/MIN	BTU per Minute	J/S	Joules per Second
KW	Kilowatts	CUST	Custom

Table 13: Energy rate units

For *Energy Total* the available units are:

Unit	Description	Unit	Description
BTU	British Thermal Unit	MWH	Megawatt Hour
kBTU	1000 BTU	KJ	Kilojoule
MMBTU	Million BTU	TON(RT)-H	12,000 BTU/H Hour
KWH	Kilowatt Hour	CUST	Custom

Table 14: Energy total units

For *Temperature* the available units are:

Unit	Description	Unit	Description
°F	Degrees Fahrenheit	°C	Degrees Celsius
K	Kelvin	R	Rankine

Table 15: Temperature units

Creating Custom Units for Rate or Total Measurement

1. Follow the procedure outlined in “*Unit of Measure*” on page 29 to enter the Unit of Measure menu for a parameter.
2. Press **UP/DOWN** to choose *CUST*, then press **ENTER**.

NOTE: The display populates with additional icons that need to be modified for custom units.

3. Press **F2** (custom label). Use the soft keys in conjunction with the numeric keypad and **UP/DOWN** to create a custom label, then press **ENTER**.

NOTE: See Table 9 on page 19 and Table 10 on page 20 for button functionality.

4. On the confirmation screen, press **ENTER** to confirm the new custom unit. The new label displays in the selection list.
5. Press **F3** (conversion) to assign a conversion factor for this custom unit. The number entered will be a factor related to the specific parameter.
 - ◇ FLOW RATE: GAL/MIN
 - ◇ FLOW TOTAL: GALLONS (GAL)
 - ◇ ENERGY RATE: BTU/MIN
 - ◇ ENERGY TOTAL: BTU
 - ◇ TEMPERATURE: °F (Fahrenheit)
6. Press **ENTER** to save the change.
7. On the confirmation screen, press **ENTER** to confirm the change.

NOTE: For example, if making a custom unit for Energy Rate and 2 is programmed as a conversion factor, the custom unit is equivalent to 2 BTU/MIN. If 0.5 is entered, the custom unit is equivalent to 0.5 BTU/MIN.

Display Precision

The *Display Precision* setting determines the resolution of a value, indicated by the number of digits after the decimal place, for the selected parameter unit.

1. Press **UP/DOWN** to scroll to *DISPLAY PRECISION*, then press **ENTER**.
2. Scroll through the available options (0...4), then press **ENTER** to select and save the change.

Radix

The *Radix* parameter determines if a period or comma is used to represent a decimal place for the selected parameter unit.

1. Press **UP/DOWN** to scroll to *RADIX*, then press **ENTER**.
2. Scroll through available options (decimal point or comma), then press **ENTER** to select and save the change.

ADVANCED SETUP

Use the *ADVANCED SETUP* menu to configure flow meters, temperature sensors, outputs, relays and communication.

Configuring a Flow Sensor

Flow Sensor Type

See "*Flow Sensor Types*" on page 46 for more details on flow type selection for Badger Meter products. Use this menu to select the flow meter that the device is connected to.

1. Navigate to *SETUP > ADVANCED SETUP > SENSOR INPUTS*.
2. Press **UP/DOWN** to scroll to *FLOW SENSOR TYPE*, then press **ENTER**.
3. Scroll through the available sensor types, then press **ENTER** to select and save the new settings.

The flow sensor types are shown in *Table 16*.

Option	Description
NO SENSOR/ DISABLED	Disables the sensor input in the firmware
SINE: K-FACTOR	<ul style="list-style-type: none"> • Frequency input channel <ul style="list-style-type: none"> ◊ Examples: Mag pick-offs, Low level signals (~100 mV) • Single K-Factor entry
PULSE: K-FACTOR	<ul style="list-style-type: none"> • Pulse input channel <ul style="list-style-type: none"> ◊ Any pulse producing sensor ◊ Examples: TTL, RF carriers w/ amplifier • Single K-Factor entry • Active sensor: No pullup resistor
PULSE: K-FACTOR PULLUP	<ul style="list-style-type: none"> • Pulse input channel <ul style="list-style-type: none"> ◊ Any pulse producing sensor ◊ Examples: TTL, RF carriers w/ amplifier • Single K-Factor entry <ul style="list-style-type: none"> ◊ Pulses per unit of volume • Passive sensor: Pullup resistor to 12V for excitation
PULSE: DEBOUNCE K-FACTOR	<ul style="list-style-type: none"> • Unique to products with raw reed switches • Pulse input channel <ul style="list-style-type: none"> ◊ Any pulse producing sensor coupled with a reed switch ◊ Example: Industrial Oval Gear • Single K-Factor entry <ul style="list-style-type: none"> ◊ Pulses per unit of volume • Passive sensor: Pullup resistor to 12V for excitation
PULSE: DIC	<ul style="list-style-type: none"> • Unique to the Data Industrial (DIC) product line • Pulse input channel <ul style="list-style-type: none"> ◊ Any pulse producing sensor ◊ Examples: TTL, RF carriers w/ amplifier • K & Offset values entered <ul style="list-style-type: none"> ◊ K = unit of volume per pulse • Active sensor: No pullup resistor

Table 16: Flow sensor types

Flow Sensor Calibration

Use this menu to change the calibration settings (K-factor, offset and low flow cutoff) for the selected Flow Meter Type.

1. Navigate to *SETUP > ADVANCED SETUP > SENSOR INPUTS*.
2. Press **UP/DOWN** to scroll to *FLOW SENSOR CAL*, then press **ENTER**.
3. Scroll to and edit each option, as necessary. The options include:

Option	Description
K-FACTOR	A singular K-factor entry point.
OFFSET	Used to apply an offset to sensor input calibration
LOW FLOW CUTOFF	The point at which the display reads zero. Represented in configured unit of measure

Table 17: Flow sensor calibration options

Flow Sensor Properties

Use this menu to change flow meter damping. Damping is a smoothing coefficient. As the number increases, averaging becomes greater. As the number decreases, it approaches the raw reading. Values range from 0...10.

1. Navigate to *SETUP > ADVANCED SETUP > SENSOR INPUTS*.
2. Press **UP/DOWN** to scroll to *FLOW SENSOR PROP*, then press **ENTER**.
3. Press **ENTER** to select the *DAMPING* option and edit it.

NOTE: Each time you press **ENTER**, the value (0...10) will increase. If the value is 10, pressing **ENTER** again will restart the list at 0.

Configuring a Temperature Sensor

Temperature Sensor Type

Use this menu to select the temperature sensor type the device is connected to.

1. Navigate to *SETUP > ADVANCED SETUP > SENSOR INPUTS*.
2. Press **UP/DOWN** to scroll to either temperature sensor, then press **ENTER**.

NOTE: In most applications, Temperature Sensor 1 is used for the supply line, and Temperature Sensor 2 is used for the return line.

3. Scroll through the available sensor types, the press **ENTER** to select and save the new setting.

The temperature sensor types are shown in *Table 18*.

NOTE: TCR is the temperature coefficient of resistance.

Option	Description
NO SENSOR/DISABLED	No sensor. Disables the input in the firmware
2-WIRE RTD: PT100 (385)	2-Wire RTD; 100 Ohm; Platinum; 0.0385 TCR
2-WIRE RTD: CUSTOM	2-Wire RTD; Custom Calibration
3-WIRE RTD: PT100 (385)	3-Wire RTD; 100 Ohm; Platinum; 0.0385 TCR
3-WIRE RTD: CUSTOM	3-Wire RTD; Custom Calibration
4-WIRE RTD: PT100 (385)	4-Wire RTD; 100 Ohm; Platinum; 0.0385 TCR
4-WIRE RTD: CUSTOM	4-Wire RTD; Custom Calibration
4-WIRE RTD: PT1000 (385)	4-Wire RTD; 1000 Ohm; Platinum; 0.0385 TCR
2-PT RTD: CUSTOM	Platinum RTD with 2-point calibration
THERMISTOR: DI TYPE	Data Industrial thermistor configuration
THERMISTOR: CUSTOM	Custom Thermistor

Table 18: Temperature sensor types

Temperature Sensor Calibration

Use this menu to change calibration settings for the respective Temperature Sensor Type.

NOTE: This menu is only available when a custom temperature sensor type is selected.

1. Navigate to *SETUP > ADVANCED SETUP > SENSOR INPUTS*.
2. Press **UP/DOWN** to scroll to the temperature sensor calibration setting for the respective temperature sensor type, then press **ENTER**.
3. Scroll to and edit each option, as necessary.

The calibration setting options are described below. The settings that appear on the device are relative to the sensor type and will only show if a sensor type is chosen.

Temperature Sensor Type	Option	Description
2, 3 and 4-Wire RTDs	ALPHA COEFF	Callendar-Van Dusen coefficients
	BETA COEFF	
	DELTA COEFF	
2-PT RTD: Custom	OHMS: LOW	Resistance (Ω) at 0° C / Resistance (Ω) at "TEMP: LOW"
	TEMP: LOW	Temperature at "OHMS: LOW" (° C)
	OHMS: HIGH	Resistance (Ω) at temperature "TEMP: HIGH"
	TEMP: HIGH	Temperature at "OHMS: HIGH" (° C)
Thermistor	OFFSET	Temperature calibration offset
	COEFF A	Steinhart-Hart coefficients
	COEFF B	
	COEFF C	

Table 19: Temperature sensor calibration descriptions

NOTE: The temperature sensor calibration for Temperature Sensor 2 includes an adjustment field "TEMP 2 ADJ (° F)". Changing this setting will increase or decrease the temperature variance by the value entered, in degrees Fahrenheit.

Configuring Outputs

Scaled Outputs: Output Mode

Use this menu to change the mode of one or both scaled outputs. The mode defines the behavior of the output.

1. Navigate to *SETUP > ADVANCED SETUP > SCALED OUTPUTS*
2. Press **UP/DOWN** to scroll to an output mode, then press **ENTER**.
3. Scroll through the available modes, then press **ENTER** to select and save the setting.

The *Output Mode* options will vary based on device configuration.

Device Configuration	Option	Description
Frequency Output FC5-BM-**-F****	NO OUTPUT/DISABLED	Disables Output
	PULSE: TOTAL	Sends pulse(s)-per-total unit of measure
	PULSE: RATE	Sends pulse(s)-per-rate unit of measure
Analog Output FC5-BM-**-A****	NO OUTPUT/DISABLED	Disables Output
	ANALOG: 0...5V	0...5V output signal, scaled to an output source
	ANALOG: 0...10V	0...10V output signal, scaled to an output source
	ANALOG: 4...20 mA	4...20 mA output signal, scaled to an output source

Table 20: Output mode options

Scaled Outputs: Output Settings

Use this menu to change the output settings for the respective output mode.

1. Navigate to *SETUP > ADVANCED SETUP > SCALED OUTPUTS*.
2. Press **UP/DOWN** to scroll to the applicable output settings, then press **ENTER**.
3. Scroll to and edit each option, as necessary.
 - a. If using the frequency output configuration

Output Mode	Option	Description
PULSE: RATE	OUTPUT SOURCE	Parameter assignment of the output (such as rate, total or temperature)
	SCALE MINIMUM	Minimum parameter value associated with output minimum
	SCALE MAXIMUM	Maximum parameter value associated with output maximum
	MAXIMUM FREQUENCY	Maximum frequency output value
	OUTPUT FREQ	(Read Only) Real-time output frequency
PULSE: TOTAL	OUTPUT SOURCE	Parameter assignment of the output (such as rate, total or temperature)
	SCALING FACTOR	Units of measure transmitted, per pulse
	SCALED PULSE COUNT	(Read Only) Number of transmitted pulses

Table 21: Frequency output settings

- b. If using the analog output configuration

Option	Description
OUTPUT SOURCE	Parameter assignment of the output (such as rate, total or temperature)
ANALOG FULL SCALE	Maximum value associated with output maximum
ANALOG LOW SCALE	Minimum value associated with output minimum

Table 22: Analog output settings

Relay Outputs: Relay Mode

Use this menu to change the mode of one or both relay outputs. The mode defines the behavior of the output.

1. Navigate to *SETUP > ADVANCED SETUP > RELAY OUTPUTS*.
2. Press **UP/DOWN** to scroll to an output mode, then press **ENTER**.
3. Scroll through the available modes, then press **ENTER** to select and save the setting.

Option	Description
NO RELAY/DISABLED	Disables output
TOTALIZER	Totalizer output
ALARM: HIGH	On/Off function, energized at the high set point
ALARM: LOW	On/Off function, energized at the low set point
ALARM: RANGE	On/Off function, energized beyond high and low set points
MANUAL	On/Off function of manual operation

Table 23: Relay mode options

Relay Outputs: Relay Settings

Use this menu to change the relay settings for the respective relay mode.

1. Navigate to *SETUP > ADVANCED SETUP > RELAY OUTPUTS*.
2. Press **UP/DOWN** to scroll to the applicable relay setting, then press **ENTER**.
3. Scroll to and edit each option, as necessary.

NOTE: Alarm icons "R1" and "R2" will appear in the upper right section of the Home Screen to provide a local indication when a relay condition has been met and when the relay has been energized.

Output Mode	Option	Description
TOTALIZER	OUTPUT SOURCE	Parameter assignment (e.g. Flow Total or Energy Total)
	SCALING FACTOR	Pulse(s) transmitted per unit of measure
	UNITS	Converts output unit of measure
	PULSE WIDTH	Time between the rising and falling edges of a single pulse
ALARM: HIGH	OUTPUT SOURCE	Parameter assignment (such as Flow Rate or Temperature)
	HIGH SETPOINT	Instructs the device to energize the relay if this value reached/exceeded. This value is linked to the <i>OUTPUT SOURCE</i> and its unit of measure (for example, Flow Rate in GPM)
	HYSTERESIS HI	Creates a window/zone below the <i>HIGH SETPOINT</i> value where the relay remains in an energized state
	SET DELAY	Time in seconds that will elapse before the relay energizes, if the <i>HIGH SETPOINT</i> value is reached/exceeded
	RELEASE DELAY	Time in seconds that the relay will remain energized, if the <i>HYSTERESIS HI</i> value is reached/exceeded
	LATCHING	Leaves the relay in an energized state until it is manually cleared on the device, either through the keypad interface or through the Digital I/O channels
ALARM: LOW	OUTPUT SOURCE	Parameter assignment (such as Flow Rate or Temperature)
	LOW SETPOINT	Instructs the device to energize the relay if this value reached/exceeded. This value is linked to the <i>OUTPUT SOURCE</i> and its unit of measure (for example, Flow Rate in GPM)
	HYSTERESIS LO	Creates a window/zone above the <i>LOW SETPOINT</i> value where the relay remains in an energized state
	SET DELAY	Time in seconds that will elapse before the relay energizes, if the <i>LOW SETPOINT</i> value is reached/exceeded
	RELEASE DELAY	Time in seconds that the relay will remain energized, if the <i>HYSTERESIS LO</i> value is reached/exceeded
	LATCHING	Leaves relay in an energized state until it is manually cleared on the device, either through the keypad interface or through the Digital I/O channels

Output Mode	Option	Description
ALARM: RANGE	OUTPUT SOURCE	Parameter assignment (such as Flow Rate or Temperature)
	HIGH SETPOINT	Instructs the device to energize the relay if this value reached/exceeded. This value is linked to the <i>OUTPUT SOURCE</i> and its unit of measure (for example, Flow Rate in GPM)
	HYSTERESIS HI	Creates a window/zone below the <i>HIGH SETPOINT</i> value, where the relay remains in an energized state
	LOW SETPOINT	Instructs the device to energize the relay if this value reached/exceeded. This value is linked to the <i>OUTPUT SOURCE</i> and its unit of measure (for example, Flow Rate in GPM)
	HYSTERESIS LO	Creates a window/zone above the <i>LOW SETPOINT</i> value, where the relay remains in an energized state
	SET DELAY	Time in seconds that will elapse before the relay energizes, if either setpoint value is reached/exceeded
	RELEASE DELAY	Time in seconds that the relay will remain energized, if either hysteresis value is reached/exceeded
	LATCHING	Leaves relay in an energized state until it is manually cleared on the device, either through the keypad interface or through the Digital I/O channels
MANUAL	OVERRIDE	Bypasses any programmed triggers to trigger the relay, which will remain triggered until deactivated

Table 24: Relay settings

Configuring Digital I/O

The FC-5000 BTU Monitor has remote reset capabilities for relays and totalizers through any one of six different channels.

All six channels are input-only and can be configured for any combination of the following.

Option	Description
DISABLED	The I/O channel will have no function
RESET: RELAY 1	Resets latch on Relay 1
RESET: RELAY 2	Resets latch on Relay 2
RESET: ALL RELAYS	Resets latches on Relays 1 and 2
RESET: FLOW TOTAL	Resets <i>Flow Total</i>
RESET: ENERGY TOTAL	Resets <i>Energy Total</i>
RESET: RELAY 1 AND FLOW TOTAL	Resets latch on Relay 1 and resets <i>Flow Total</i>
RESET: RELAY 2 AND FLOW TOTAL	Resets latch on Relay 2 and resets <i>Flow Total</i>
RESET: RELAY 1 AND ENERGY TOTAL	Resets latch on Relay 1 and resets <i>Energy Total</i>
RESET: RELAY 2 AND ENERGY TOTAL	Resets latch on Relay 2 and resets <i>Energy Total</i>
RESET: FLOW/ENERGY TOTALS	Resets <i>Flow Total</i> and <i>Energy Total</i>
RESET: ALL RELAYS AND ALL TOTALS	Resets Relay 1, Relay 2, <i>Flow Total</i> and <i>Energy Total</i>

Table 25: Channel options

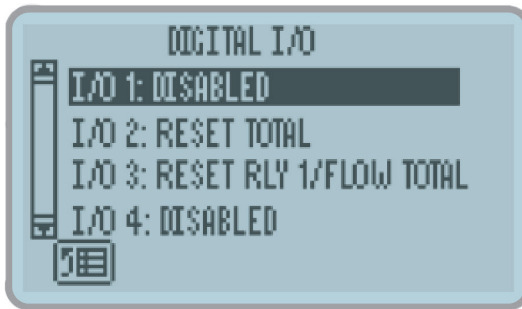

Figure 21: Digital I/O menu

1. Navigate to *SETUP* > *ADVANCED SETUP* > *DIGITAL I/O*.
2. Press **UP/DOWN** to scroll to any of the six input channels.
3. Press **ENTER** repeatedly until the desired function appears. Each time **ENTER** is pressed, the channel toggles through the available functions.

To disable any channel, simply highlight the digital I/O channel, and press **ENTER** until *DISABLED* appears.

Configuring Fluid Properties

The Fluid Properties menu configures the device for the fluid medium that is being measured.

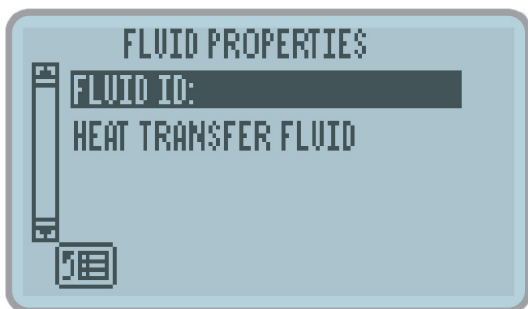

Figure 22: Fluid properties menu

Fluid ID

Use this menu to enter a user-defined text entry for naming or identification.

1. Navigate to *SETUP > ADVANCED SETUP > FLUID PROPERTIES*.
2. Press **UP/DOWN** to select *FLUID ID*, then press **ENTER**.
3. Use the soft keys and numeric keypad to enter the desired name, then press **ENTER** to save.
4. On the confirmation screen, press **ENTER** to confirm any changes.

Heat Transfer Fluid

Use this menu to select from a list of pre-programmed fluid types. A custom option is available.

1. Navigate to *SETUP > ADVANCED SETUP > FLUID PROPERTIES*.
2. Press **UP/DOWN** to select *HEAT TRANSFER FLUID*, then press **ENTER**.
3. Scroll through the available options, then press **ENTER** to save the change.

Option	Description
WATER	Water only.
20% PROPYLENE GLYCOL	20% Propylene Glycol / 80% water mixture
30% PROPYLENE GLYCOL	30% Propylene Glycol / 70% water mixture
50% PROPYLENE GLYCOL	50% Propylene Glycol / 50% water mixture
CUSTOM FLUID	Custom fluid (requires additional settings)

Table 26: Heat Transfer Fluid options

Creating a Custom Heat Transfer Fluid

If CUSTOM FLUID is selected, the polynomials for Specific Heat and Density must be programmed. These settings will not appear unless CUSTOM FLUID is selected as a fluid type.

1. Navigate to *SETUP > ADVANCED SETUP > FLUID PROPERTIES*.
2. Press **UP/DOWN** to scroll to *SP HEAT POLY* or *DENSITY POLY*, then press **ENTER**.
3. Scroll to and edit each selection, as necessary.

The options include:

Polynomial Curve	Option	Description
Specific Heat SP POLY (BTU/LB F)	C3	Polynomial curve coefficients for specific heat
	C2	
	C1	
	C0	
Density DENSITY POLY (LB/GAL)	B3	Polynomial curve coefficients for density
	B2	
	B1	
	B0	

Table 27: Custom fluid options

4. Make sure the settings for both specific heat and density are programmed

The polynomial equations for specific heat and density are as follows:

- $SP\ HT = (C3)x^3 + (C2)x^2 + (C1)x + (C0)$
- $DENSITY = (B3)x^3 + (B2)x^2 + (B1)x + (B0)$

Where "x" is the inlet temperature value (TEMPERATURE1 or TEMP1).

Configuring Communications

The *Communications* menu configures the device to communicate to other systems via Modbus or BACnet.

The available communication settings vary based on Network Type.

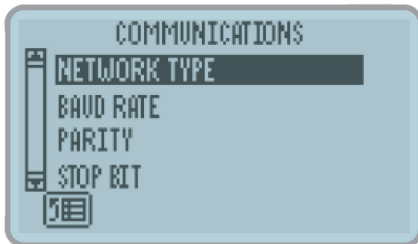

Figure 23: Modbus communications menu



Figure 24: BACnet communications menu

1. Navigate to *SETUP > ADVANCED SETUP > COMMUNICATIONS*.
2. Press **UP/DOWN** to scroll to *NETWORK TYPE*, then press **ENTER**.
3. Scroll through the available options, then press **ENTER** to select save the change.

4. Press **BACKSPACE** to return to the *COMMUNICATIONS* menu.
5. Scroll to and edit each option, as necessary. The options are:

Modbus RTU and Modbus ASCII

Settings	Options
BAUD RATE	1200, 2400, 4800, 9600, 14400, 19200, 28800, 34800, 57600 or 115200
PARITY	No Parity, Odd Parity or Even Parity
STOP BIT	No Stop Bit, One or Two Stop Bit
SLAVE ADDRESS	1...255
DEVICE NAME	User-defined ID

*Table 28: Modbus settings***BACnet**

Settings	Options
BAUD RATE	1200, 2400, 4800, 9600, 14400, 19200, 28800, 34800, 57600 or 115200
MSTP ADDRESS	1...255
MAX MASTER	
DEVICE INSTANCE	1...4,294,967,295
DEVICE NAME	User-defined ID

Table 29: BACnet settings

TROUBLESHOOTING

This section lists common problems that may be encountered with the BTU Monitor, the possible causes and the recommended remedies. Most problems are due to improper wiring and/or programming procedures. The problem may also be in the flow meter, valve, pump or other piece of equipment.

Be sure that all other equipment is functioning properly. The FC-5000 BTU Monitor is extensively tested at the factory before shipment. However, the unit may get damaged during transit or installation. If after all possible remedies have been tried and the problem persists, contact your local representative or Badger Meter.

Problem	Possible Causes	Remedies
Unit has power but display does not light up	1. Incorrect power wiring	1. Re-check power wiring
Transmitter is connected but the FC-5000 does not count	1. Incorrect transmitter wiring or broken wire 2. Transmitter is defective 3. No sensory type selected 4. Wrong scale factor 5. Low frequency input must be on terminal #7 6. Meter is defective, rotor not turning	1. Check wiring diagrams 2. Replace parts or entire unit 3. Select a sensor type. See <i>"Flow Sensor Type"</i> on page 32 4. Check scale factor calculation. For example, if programmed 0.001 instead of 0.100, unit will wait for 100 pulses before decrementing one count 5. Verify connection 6. Disassemble meter, check rotor, replace if defective
Valve does not close at setpoints	1. Relay output is not properly connected 2. Relay is defective 3. Valve components are defective	1. Reconnect relay wiring 2. Contact factory for replacement 3. Check and replace valve components.
Counter accumulates too many counts	1. Wrong scale factor 2. Electrical noise causing extra pulses. 3. Excessive vibration.	1. Check scale factor calculation 2. Check wiring. Make sure power lines are not touching or close to pulse signal line. Always use shielded cable 3. Dampen vibration
Some of the keys on the control panel are not operational	1. Broken switch behind control panel 2. Function not available on this model 3. Problem with internal components	1. Replace the BTU Monitor 2. See <i>"Operator Interface"</i> on page 19 3. Return the BTU Monitor to the factory for repair 4. Cycle the power to the BTU Monitor
DISPLAY OVERRUN error	1. There are more than 8 digits in the display	1. Check that the unit of measure you entered will not result in a readout greater than 8 digits 2. Check the display precision and reduce it, if possible

Problem	Possible Causes	Remedies
Alarm notification from the Home screen 	<ol style="list-style-type: none"> The rate or total values indicated on the Home Screen are in an overrun condition (value exceeds 8 digits) There is a negative value associated with Energy Rate, where $T1 > T2$ Temperature sensor 1 and/or 2 is configured in the unit, but there is no sensor hardware detected 	<ol style="list-style-type: none"> Change the unit of measure associated with the parameter (see "Unit of Measure" on page 29) or reset the totalizer (see "Resets" on page 27) Rewire the temperature sensors on the unit or swap sensors in the application Make sure that the temperature sensors are appropriately wired to the unit
"R1" and/or "R2" appear on home screen	<ol style="list-style-type: none"> Relay 1 and/or Relay 2 are latched Relay 1 and/or 2 are energized 	<ol style="list-style-type: none"> See "Clearing a Latched Relay" on page 28 The programmed alarm conditions are met. Check process or programming
"TSENSERR" displayed on home screen	<ol style="list-style-type: none"> Temperature sensors not configured Temperature sensor disconnected 	<ol style="list-style-type: none"> Configure temperature sensor. See "Configuring a Temperature Sensor" on page 34 Check wiring to TB6
"DISABLED" displays on home screen	<ol style="list-style-type: none"> Flow sensor type setting set to "NO SENSOR/DISABLED" 	<ol style="list-style-type: none"> Configure a flow sensor. See "Configuring a Flow Sensor" on page 32

Table 30: Troubleshooting

CAUTION

THERE ARE NO FIELD-REPLACEABLE PARTS INSIDE. OPENING THE UNIT WILL VOID ALL WARRANTIES.

If a repair or evaluation from the factory is required, call your local representative or the factory to obtain a Return Material Approval (RMA).

The shipping address, RMA number and any other required information will be provided to send the unit to an appropriate location.

Company Website	www.badgermeter.com
Customer Service Email	indorders@badgermeter.com
Customer Service Number	(877) 243-1010

Table 31: Contact information

MODBUS INTERFACE

Modbus Function Code Support

The FC-5000 BTU Monitor supports access through all four of the Modbus data types. Both single and multiple write-access commands are supported for register and coil data types. For multiple register writes, the command must initiate on a valid parameter address and end on last register of a valid parameter address. Multiple register writes that start in the middle of a multiple register parameter or do not end on the last register of a multiple register parameter are not supported. The table below lists the supported function codes.

Description	Function Code	Subcode
Read Coils	01	—
Read Discrete Inputs	02	—
Read Holding Registers	03	—
Read Input Registers	04	—
Write Single Coil	05	—
Write Single Register	06	—
Diagnostic – Return Query Data	08	00
Write Multiple Coils	15	—
Write Multiple Registers	16	—
Report Slave ID	17	—

Table 32: Supported Modbus function codes

Modbus Register Map

Register Name	Register Address	Coil Addr.	Data Type	Read/Write	Access Type
FLOW RATE	0x0000	—	Float	Read Only	Register
FLOW TOTAL	0x0002	—	Float	Read Only	Register
FLOW TOTAL PRECISION	0x0004	—	Double	Read Only	Register
ENERGY RATE	0x0100	—	Float	Read Only	Register
ENERGY TOTAL	0x0102	—	Float	Read Only	Register
ENERGY TOTAL PRECISION	0x0104	—	Double	Read Only	Register
TEMPERATURE 1	0x0200	—	Float	Read Only	Register
TEMPERATURE 2	0x0202	—	Float	Read Only	Register
FLUID DENSITY	0x0400	—	Float	Read Only	Register
SPECIFIC HEAT	0x0402	—	Float	Read Only	Register

Table 33: Modbus register map

BACNET INTERFACE

BACnet Map

Object Description	BACnet Object ID	BACnet Object Type
FLOW RATE	2	Analog Value
FLOW TOTAL	3	Analog Value
FLOW TOTAL PRECISION	4	Large Analog Value
ENERGY RATE	11	Analog Value
ENERGY TOTAL	12	Analog Value
ENERGY TOTAL PRECISION	13	Large Analog Value
TEMPERATURE 1	14	Analog Value
TEMPERATURE 2	15	Analog Value
FLUID DENSITY	16	Analog Value
SPECIFIC HEAT	17	Analog Value

Table 34: BACnet register map

FLOW SENSOR TYPES

The table below lists the Badger Meter products suitable for use with the FC-5000 BTU Monitor.

Meter Technology	Product Line	Output Type	Flow Sensor Input
Impeller	Impeller	Square Wave Frequency	PULSE: DIC
Oval Gear	Oval Gear	Reed Switch Pulse	PULSE: DEBOUNCE K-FACTOR
Positive Displacement	OP Meters	Unscaled Pulse	PULSE: DEBOUNCE K-FACTOR
		Scaled Pulse	PULSE: DEBOUNCE K-FACTOR
	Recordall	Unscaled Pulse	PULSE: DEBOUNCE K-FACTOR
		Scaled Pulse	PULSE: DEBOUNCE K-FACTOR
Turbine	Blancett	MAG Pickup	SINE: K-FACTOR
		MAG Pickup with K-Factor Scaler	PULSE: K-FACTOR
	Cox	MAG Pickup	SINE: K-FACTOR
		MAG Pickup with K-Factor Scaler	PULSE: K-FACTOR
		RF Pickup	PULSE: K-FACTOR
	Turbo	Unscaled Pulse	PULSE: DEBOUNCE K-FACTOR
		Scaled Pulse	PULSE: DEBOUNCE K-FACTOR
	Flo-tech	MAG Pickup	SINE: K-FACTOR
		MAG Pickup with K-Factor Scaler	PULSE: K-FACTOR
Vision	Frequency	PULSE: K-FACTOR PULLUP	

Table 35: Badger Meter flow sensors

PART NUMBERING CONSTRUCTION

Badger Meter

FC-5000 BTU Monitor

FC5 - BM - P1 - [] [] [] 6 A - []

FUNCTION

BTU Monitor

BM

SENSOR INPUTS

One Pulse / Two Temperature

P1

SCALED OUTPUTS

Two Analog Outputs

A

Two Frequency Outputs

F

RELAY OUTPUTS

One Form C Relay / One Form A Relay

A

Two Form C Relays

C

DIGITAL INPUTS/OUTPUTS

Six Programable Inputs/Outputs

6

COMMUNICATIONS

EIA-485(RS-485); Modbus; BACnet; USB

A

MOUNTING METHOD

Panel Mount

P

Wall Mount | Includes NEMA 4X (IP67) Rated Enclosure

W

REPLACEMENT PARTS/ACCESSORIES

Part Number	Description
68334-001	P/S Plug; 100-264V AC In; 24V DC out
68334-002	P/S Module; 85-264V AC In; 24V DC out
809041	Panel mounting clips (2)
68788-001	Wall-mount enclosure kit
68231-002	Terminal connector kit

Consult factory for other parts/accessories.

SPECIFICATIONS

Power Supply	Input range: 10...40V DC and 9...28V AC RMS (50...60 Hz)		
	Maximum power consumption: 8 Watts (power supply must provide 8 watts at minimum)		
	Isolated from power ground		
	Over-voltage, transient and reverse polarity protected		
Flow Meter Input	Input Range: 0.3 Hz...10 kHz		
	One (1) independent channel		
	Configurable as square wave 0...30V pulse with 2.5V threshold		
	Configurable as sine wave, zero-centered with 200 mV amplitude and 45 mV threshold		
	Configurable debounce		
	Excitation Output	12V DC source	
	Voltage	Low: -0.3...1.85V DC High: 2.5...25V DC	
	Impedance	Pullup to 12V DC	
VDC Current	±50 mA, short circuit current		
Response	100 µs/3.5 ms min pulse (high/low speed)		
Temperature Inputs	Two (2) independent channels		
	RTD Specifications	50 µA/1000 µA Excitation current source	
		2, 3 and 4-wire compatible	Platinum, 100 and 1000 Ohm RTDs Optional two-point or customizable calibration configuration
		Callendar-Van Dusen coefficients	
	Thermistor Specifications	Type II Thermistors or customizable calibration configuration Steinhart-Hart coefficients	
Scaled Outputs	Two (2) independent channels		
	Isolated from power ground		
	Over-voltage, transient and reverse polarity protected		
	Output is multiplexed on the process out pins		
	Analog Output (option A)	Configurable to 0...5V, 0...10V or 4...20 mA	
		Uncertainty: ±0.1% of reading	
		16-bit resolution (0...10V and 4...20 mA), 15-bit resolution (0...5V)	
Frequency Output (option F)	200 ms, 90-10% step response		
	Sourcing analog output signal		
	TTL, 1...4000 Hz, square wave		
	Uncertainty: ±0.01% reading Resolution: 0.01 Hz		
Digital I/O	Six (6) independent channels		
	Isolated from power ground		
	Over-voltage, transient and reverse polarity protected		
	0...30V as input		
	Debounce 0...5V, TTL, 200 ms 90-10% step response, driving < 0.1 uF		

Calculations	Flow Calculation	Uncertainty: $\pm 0.01\%$	
	BTU Calculation	Adjustable FIR/IIR filtering Meets EN 1434 requirements	
Relay Outputs	Configuration Option "C"	Two (2) Form C Mechanical Relays	
	Configuration Option "A"	One (1) Form C Mechanical Relay and One (1) Form A Solid State Relay	
	Isolated coil drivers		
	Over-voltage, transient and reverse polarity protected		
	Form C Relay	Load	Resistive
		Rated Carry Current	5 A (N.C. or N.O.)
		Maximum Switching Voltage	250V AC, 30V DC
		Minimum Permissible Load	10 mA at 5V DC
		Coil Rating	5...24V DC
	Form A Relay (N.O. SPST)	Life Expectancy	5,000,000 operations
		Switching Speed	On (0.25 ms), Off (0.02 ms)
		Current Rating (IO)	1 A
		Maximum Output Voltage (VO)	60V
Output On-Resistance (R(ON))		0.5 Ohms (Ω) @ IF = 5 mA, IO = 1 A	
Output Withstand Voltage (VO(OFF))		60-65V @ VF = 0.8V, IO = 250 μ A, TA = 77° F (25° C)	
Network Communications	Network Types/Communication Protocols	Modbus RTU, Modbus ASCII and BACnet	
	Physical Layer	EIA-485 (RS-485)	
	Baud Rates	1200...115.2K	
	4-wire interface/half duplex		
	Over-voltage/ESD Protection Isolated from power ground		
USB Communications	USB (HOST)	Type-A Receptacle Currently not supported	
	USB (DEVICE)	Mini-B Receptacle (used for field updates)	
	Over-voltage/ESD/transient protected		
Display/User interface	Keypad	Membrane overlay, domed tactile response keys	
	Display	128 x 64 pixel LCD graphical display, LED backlight	
	Protected from EMI/RFI		
	Keypad interface is protected from ESD		
Environmental Ratings	Pollution Degree	2	
	Altitude Restriction	Up to 2000 m (6561 ft)	
	Over-Voltage Rating	Category II (CAT II)	
	Ambient Temperature Range	32...130° F (0...55° C)	
	Storage Temperature Range	-40...160° F (-40...70° C)	
	Humidity	0...85%, non-condensing	
Weights (Approx.)	Panel Mount	1.25 lb (0.57 kg)	
	Wall Mount (Including Unit)	4.54 lb (2.06 kg)	
Operator Functions	Unlatch Relays, Reset Totalizers, Unlatch Relays and Reset Totalizers		

Parameters	Maximum Displayed Digits	Rates	Max 8 (7 with decimal)
		Totals	Max 9 (8 with decimal)
	Resolution/Display Precision	Configurable, 0...4	
	Volumetric Flow Rate Units Seconds (S), Minute (MIN), Hour (H), Day (D)	US Gallons (US GAL), Imperial Gallons (I GAL), Mega US Gallons (US MGAL), Mega Imperial Gallons (I MGAL), Liters (L), Mega Liters (ML), Cubic Meters (M ³), Cubic Feet (FT ³), Acre Feet (AC-FT), Oil Barrels (OBBL), Liquid Barrels (LBBL), US Ounces (US OZ), Imperial Ounces (I OZ), Custom (user-specified)	
	Volumetric Flow Total Units	US Gallons (US GAL), Imperial Gallons (I GAL), Mega US Gallons (US MGAL), Mega Imperial Gallons (I MGAL), Liters (L), Mega Liters (ML), Cubic Meters (M ³), Cubic Feet (FT ³), Acre Feet (AC-FT), Oil Barrels (OBBL), Liquid Barrels (LBBL), US Ounces (US OZ), Imperial Ounces (I OZ), Custom (user-specified)	
	Energy Units	kBTU, BTU, KW, TONS (RT), Custom (user-defined)	
Temperature Units	° F (Fahrenheit), ° C (Celsius), R (Rankine) or K (Kelvin)		

STANDARDS AND CERTIFICATIONS

Agency Approval/Standards

- CE Marked for Low Voltage Directive and RoHS
- CSA Marked per Class C225286 and C225206, Process Control Equipment
- CSA C22.2 No. 61010-1-12, General requirements
- CAN/CSA-C22.2 No. 61010-1-12 Safety requirements for electrical equipment for measurement, control and laboratory use. Part 1: General requirements—Tri-national standard with UL 61010-1 and ANSI/ISA-61010-1 (82.02.01)

EMI/EMC Compliance

Conducted and Radiated Emissions per CISPR11:2009 / EN55011	Class A, Group 1
IEC 61000-4-2:2008 Electrostatic Discharge	2/4 kV - Contact Discharge, 2/4/8 kV Air Discharge Performance Criteria B
IEC 61000-4-3:2006 Radiated RF Immunity	Test levels: 80...1000 MHz & 1400...2000 MHz Performance Criteria A
IEC 61000-4-4:2004 EFT Immunity (Signal and Power lines)	Tested per specification to Performance Criteria B
IEC 61000-4-5:2005 Surge Protection	Tested per specification to Performance Criteria B
IEC 61000-4-6:2008 Conducted RF Immunity (Signal and Power lines)	Test Levels: 0.15...80 MHz Level 3, Performance Criteria A
IEC 61000-4-11:2004 Voltage Dips, Interruptions, and Dropouts	Tested per specification to Performance Criteria B & C

Table 36: EMI/EMC compliance

Enclosure Protection

- IEC/CSA/UL 60529-1: Degrees of protection provided by enclosures (IP65), when installed with all four mounting clips in a similarly rated enclosure, which includes the optional wall mount enclosure.
- Additional Protection (optional): NEMA 4X (wall mount enclosure only).

Control. Manage. Optimize.

Trademarks appearing in this document are the property of their respective entities. Due to continuous research, product improvements and enhancements, Badger Meter reserves the right to change product or system specifications without notice, except to the extent an outstanding contractual obligation exists.
© 2019 Badger Meter, Inc. All rights reserved.

www.badgermeter.com

The Americas | Badger Meter | 4545 West Brown Deer Rd | PO Box 245036 | Milwaukee, WI 53224-9536 | 800-876-3837 | 414-355-0400
México | Badger Meter de las Americas, S.A. de C.V. | Pedro Luis Ogazón N°32 | Esq. Angelina N°24 | Colonia Guadalupe Inn | CP 01050 | México, DF | México | +52-55-5662-0882
Europe, Eastern Europe Branch Office (for Poland, Latvia, Lithuania, Estonia, Ukraine, Belarus) | Badger Meter Europe | ul. Korfantego 6 | 44-193 Knurów | Poland | +48-32-236-8787
Europe, Middle East and Africa | Badger Meter Europa GmbH | Nürtinger Str 76 | 72639 Neuffen | Germany | +49-7025-9208-0
Europe, Middle East Branch Office | Badger Meter Europe | PO Box 341442 | Dubai Silicon Oasis, Head Quarter Building, Wing C, Office #C209 | Dubai / UAE | +971-4-371 2503
Slovakia | Badger Meter Slovakia s.r.o. | Raciarska 109/B | 831 02 Bratislava, Slovakia | +421-2-44 63 83 01
Asia Pacific | Badger Meter | 80 Marine Parade Rd | 19-07 Parkway Parade | Singapore 449269 | +65-63464836
Switzerland | Badger Meter Swiss AG | Mittelholzerstrasse 8 | 3006 Bern | Switzerland | +41-31-932 01 11