



Badger Meter

Industrial Flow Computer

FC-5000 Flow Display



CONTENTS

Scope of This Manual	5
Unpacking and Inspection	5
Safety Considerations.	5
Terminology and Symbols.	5
Safety Instructions	6
Safety Rules and Precautionary Measures	6
Description	7
Functions and Features	7
Flow Meter Input(s)	7
Digital Inputs	7
Relay Control Outputs	8
Power Supply.	8
Configuring the Unit	8
Display Information.	9
Installing the Flow Display.	9
Mounting Options.	10
Wiring the Flow Display	12
Operator Interface.	17
Keypad and Soft Keys	17
Scrolling	17
Control Panel Keys	17
Icon Functionality	18
Navigating the Menus	19
Numeric Editing	20
Alpha-Numeric Editing.	20
Selection/Enumeration Editing	21
Confirmation Screen	21
Menu Structure	22
Info/Sensor Data	23
Info/Sensor Data Table.	23
System Information	24
Basic Setup	25
Display	25
Resets	25
Passcode Setup	26
Disabling a Passcode	26
Units	27

Advanced Setup	29
Configuring a Flow Sensor	29
Configuring Outputs	31
Configuring Digital I/O	34
Configuring Communications	35
Troubleshooting	36
Modbus Interface	38
Modbus Function Code Support.	38
Modbus Register Map	38
Flow Sensor Types	39
Part Numbering Construction	40
Replacement Parts/Accessories	40
Specifications	41
Standards and Certifications	44
Agency Approval/Standards	44
EMI/EMC Compliance.	44
Enclosure Protection	44

SCOPE OF THIS MANUAL

This manual describes how to install and program the FC-5000 Flow Display. The electronic version of this manual is available on our website at www.badgermeter.com.

IMPORTANT

Read this manual carefully before attempting any installation or operation. Keep the manual in an accessible location for future reference.

UNPACKING AND INSPECTION

Upon opening the shipping container, visually inspect the product and applicable accessories for any physical damage such as scratches, loose or broken parts, or any other sign of damage that may have occurred during shipment.

NOTE: If damage is found, request an inspection by the carrier's agent within 48 hours of delivery and file a claim with the carrier. A claim for equipment damage in transit is the sole responsibility of the purchaser.

SAFETY CONSIDERATIONS

Terminology and Symbols



Indicates a hazardous situation, which, if not avoided, will result in death or serious personal injury.



Indicates a hazardous situation, which, if not avoided, could result in death or severe personal injury.



Indicates a hazardous situation, which, if not avoided, could result in minor or moderate personal injury or damage to property.



Please consult the user manual in all cases where this symbol is used in order to find out the nature of potential hazards, and any actions which have to be taken to avoid them.



This symbol signifies that the FC-5000 Flow Display may be powered by a DC power supply. Acceptable DC input voltage range is: 10...40V DC.



This symbol signifies that the FC-5000 Flow Display may be powered by an AC power supply. Acceptable AC input voltage range is: 9...28V AC RMS (50...60 Hz).

- Operating temperature is 32...130° F (0...55° C) with a maximum humidity of 85% non-condensing. Always select a mounting location with proper ventilation and environmental protection.
- Maximum operating altitude: 2000 meters (6561 feet)
- Pollution Degree 2: Only non-conductive pollution occurs except that occasionally a temporary conductivity caused by condensation is to be expected
- Over-Voltage Rating: CAT II

Safety Instructions

WARNING

- **LIFE SUPPORT APPLICATIONS: THE FC-5000 IS NOT DESIGNED FOR USE IN LIFE SUPPORT APPLIANCES, DEVICES, OR SYSTEMS WHERE MALFUNCTION OF THE PRODUCT CAN REASONABLY BE EXPECTED TO RESULT IN A PERSONAL INJURY. CUSTOMERS USING OR SELLING THESE PRODUCTS FOR USE IN SUCH APPLICATIONS DO SO AT THEIR OWN RISK AND AGREE TO FULLY INDEMNIFY THE MANUFACTURER AND SUPPLIER FOR ANY DAMAGES RESULTING FROM SUCH IMPROPER USE OR SALE.**
- **ELECTROSTATIC DISCHARGE INFLECTS IRREPARABLE DAMAGE TO ELECTRONICS. BEFORE INSTALLING OR OPENING THE UNIT, INSTALLERS MUST DISCHARGE THEMSELVES BY TOUCHING A WELL-GROUNDED OBJECT.**
- **THIS UNIT MUST BE INSTALLED IN ACCORDANCE WITH THE EMC (ELECTROMAGNETIC COMPATIBILITY) GUIDELINES.**

Safety Rules and Precautionary Measures

The manufacturer accepts no responsibility whatsoever if the following safety rules and precaution instructions and the procedures as described in this manual are not followed.

- Modifications of the Flow Display implemented without preceding written consent from the manufacturer will result in the immediate termination of product liability and warranty period.
- Installation, use, maintenance, and servicing of this equipment must be carried out by authorized technicians.
- Check the mains voltage and information on the manufacturer's nameplate before installing the unit.
- Check all connections, settings and technical specifications of the various peripheral devices with the Flow Display supplied.
- Never open the enclosure.
- Never touch the electronic components (ESD sensitivity).
- Never expose the system to heavier conditions than allowed according to the casing classification (see manufacturer's nameplate).
- If the operator detects errors or dangers, or disagrees with the safety precautions taken, then inform the owner or the principal responsible.
- Adhere to the local labor and safety laws and regulations.

DESCRIPTION

The FC-5000 Flow Display is a microprocessor-driven device that is designed for flow monitoring. The FC-5000 Flow Display is compatible with the complete line of Badger Meter industrial flow meters, creating a solution to monitor flow rates and totals.

Functions and Features

This product is designed with a focus on:

- Large display for easy viewing
- Ease-of-use with softkeys and a full numeric keypad
- Ruggedness for its application with a robust enclosure, keypad and mechanical relays
- Info/Sensor Data Screen—view raw and calculated data, both to and from the unit, including flow data and output statuses
- User-friendly installation with quality plug-and-play terminals
- A wide range of outputs and functions for a broad fulfillment in many applications
- User defined relay triggers for flow rates and totals

Flow Meter Input(s)

Depending on the configuration, one or two sensor inputs are available, allowing a passive or active pulse signal output to be connected. The input circuit supports low and high frequency (0.5...3500 Hz) flow meters. A 12V DC excitation terminal is available for flow meter sensors that require power.

Digital Inputs

The FC-5000 Flow Display control inputs allow the following functions:

- Unlatch Relays
- Reset Totalizers
- Unlatch Relays and Reset Totalizers

Relay Control Outputs

The FC-5000 Flow Display has two relay outputs, either a mechanical Form C switch or a solid state Form A switch. The product configuration determines which switches are available. All control functions are always available by dedicated relay outputs. Unneeded outputs may be left disconnected or disabled within the firmware.

Relays can be used for alarm indication or as a totalizing output.

Form-C

- Can be powered directly from mains circuits rated up to 240V.
- Must be powered through circuits that are insulated from mains by at least basic insulation.
- Connected sources of power need to be limited to 240V AC and fused at 5A or less.
- Not suitable for connection to external circuits that are insulated from mains by at least double insulation (SELV).

Form A

- Located on TB4 and recommended to use, if configured as a high-rate, totalizing output.
- Relay energizes (contact closes) with a minimum input current of 3 mA through the input LED.
- The relay turns off (contact opens) with an input voltage of 0.8V or less.

Power Supply

The power supply used must be isolated from mains by double or reinforced insulation (for instance, SELV power supply).

The FC-5000 Flow Display operates on 10...40V DC or 9...28V AC supplied by any suitable source that also meets the requirement listed above. Badger Meter has power supplies available for the FC-5000 Flow Display.

Power Supply Part Numbers:

- 68334-001: includes wall mount (wall wart) power supply and various adapters
- 68334-002: power module that allows discrete power wiring

A power supply not sourced from the factory must be capable of supplying a minimum of 8 Watts.

Configuring the Unit

The FC-5000 Flow Display is designed for many types of applications. See *"Advanced Setup"* on page 29 for instructions on configuring your FC-5000 Flow Display to your specific requirements.

All information is stored in EEPROM memory and will not be lost in the event of power failure.

Display Information

The FC-5000 Flow Display has a large transfective LCD with a bright LED backlight that displays symbols and digits for measuring units, status information and keyword messages. See “Units” on page 27 for more information on how to configure the units.

INSTALLING THE FLOW DISPLAY

⚠ CAUTION

MOUNTING, ELECTRICAL INSTALLATION, STARTUP AND MAINTENANCE OF THIS INSTRUMENT MAY ONLY BE CARRIED OUT BY TRAINED PERSONNEL AUTHORIZED BY THE OPERATOR OF THE FACILITY. PERSONNEL MUST READ AND UNDERSTAND THIS OPERATING MANUAL BEFORE CARRYING OUT ITS INSTRUCTIONS.

⚠ CAUTION

THE FC-5000 FLOW DISPLAY MAY ONLY BE OPERATED BY PERSONNEL WHO ARE AUTHORIZED AND TRAINED BY THE OPERATOR OF THE FACILITY. OBSERVE ALL INSTRUCTIONS IN THIS MANUAL.

⚠ CAUTION

OBEEY ALL SAFETY PRECAUTIONS MENTIONED IN “SAFETY CONSIDERATIONS” ON PAGE 5.

NOTE: For a complete list of parts and accessories, refer to “Replacement Parts/ Accessories” on page 40.

Mounting Options

The FC-5000 Flow Display can be mounted on a wall, shelf or instrumentation panel. Wall-mount units are shipped in a NEMA 4X enclosure, ready to mount.

Panel-Mount Installations

NOTE: Mounting clips can accommodate a maximum panel thickness of 1.5 in. (38.1 mm).

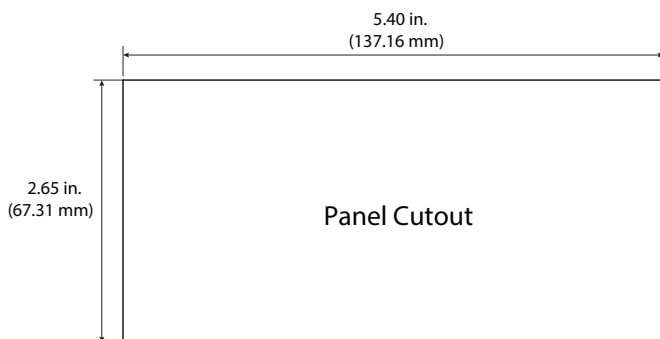

Figure 1: Panel cutout

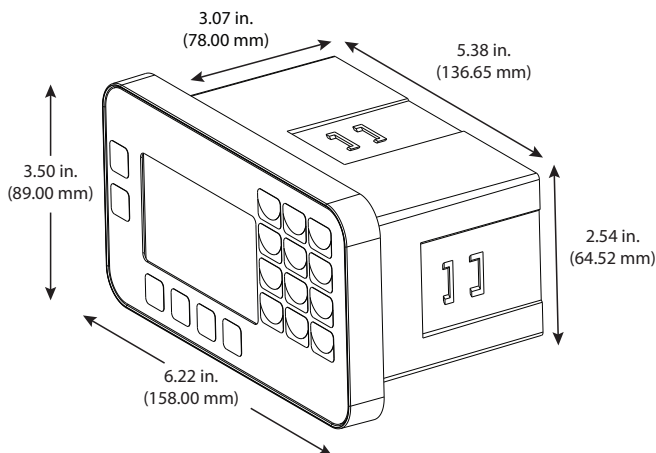

Figure 2: Mounting dimensions

To install:

1. Measure and cut a mounting hole to the dimensions shown in *Figure 1*.
2. Verify that the gasket is secure inside the mounting bezel.
3. Insert the unit through the panel cutout.
4. Secure the unit to the panel with the provided mounting clips.

Wall-Mount Installations

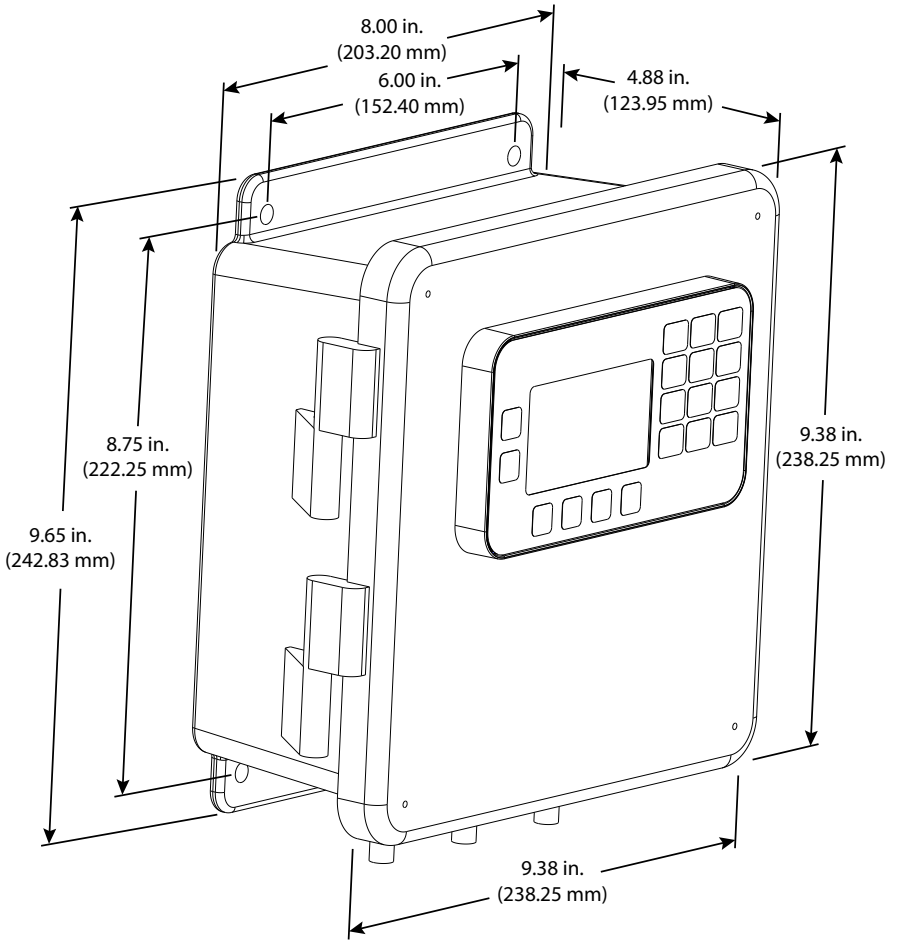

Figure 3: FC-5000 Flow Display in an enclosure

To install the FC-5000 Flow Display on a wall, secure the enclosure to the wall with four mounting screws (customer-supplied).

Wiring the Flow Display

At installation, be sure to comply with the following requirements:

- Disconnect power to the unit before attempting any connection or service to the unit.
- Avoid using machine power service for AC power. When possible, use a dedicated circuit or a lighting circuit.
- Observe all local electrical codes.
- The unit must be wired with wires and/or cables with a minimum temperature rating of 167° F (75° C).



TO PREVENT ACCIDENTS, DO NOT APPLY POWER UNTIL ALL OTHER CONNECTIONS HAVE BEEN COMPLETED.

Terminal Connectors

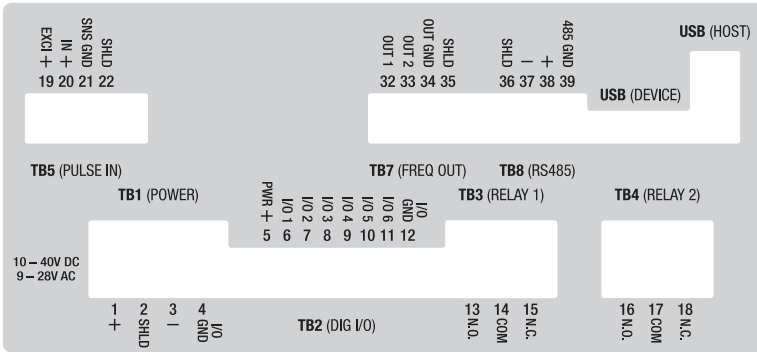

Figure 4: One sensor input, frequency output

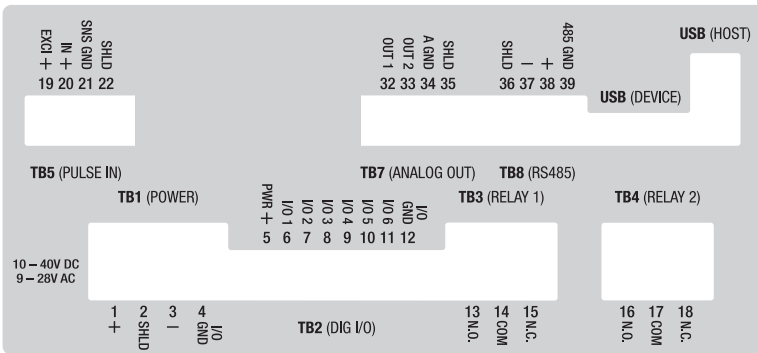

Figure 5: One sensor input, analog out

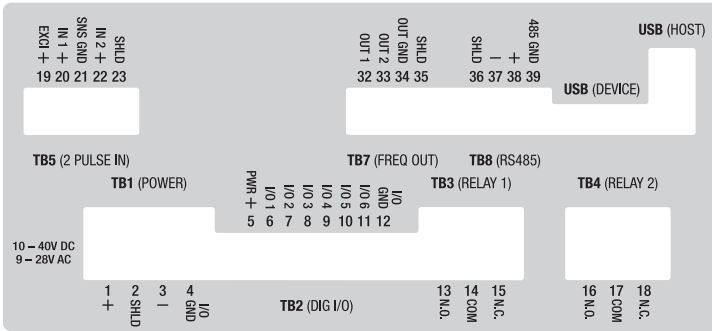

Figure 6: Two sensor inputs, frequency output

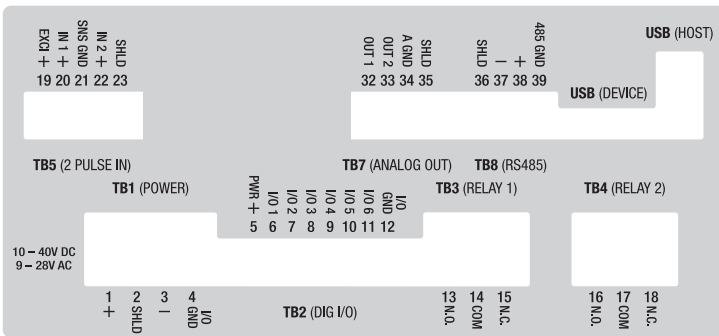

Figure 7: Two sensor inputs, analog output

Power Input

The FC-5000 Flow Display power input is internally fused and protected from common line noise by a filtering network.

TB1 (POWER)

Connector Pin	Function		Reference Pin
	AC Power	DC Power	
1	Line (L)	Positive (L+)	1
2	Shield (Chassis GND)		2
3	Neutral (N)	Negative (L-)	3
4	Digital I/O GND		4



Table 1: Power input

⚠ CAUTION

THE FC-5000 IS MICROPROCESSOR CONTROLLED. IT IS VERY IMPORTANT THAT THE POWER SUPPLY BE FREE OF ELECTRICAL NOISE. AVOID USING POWER LINES THAT FEED HEAVY LOAD ELECTRICAL DEVICES SUCH AS PUMPS AND MOTORS.

Digital Inputs and Outputs

The FC-5000 Flow Display has six independent channels available for digital input. The channels accept TTL voltage signals in the 0...5V DC range. The control inputs are triggered when the voltage signal on the pin is pulled low (active low). Input range for a logic low signal is 0...1V, logic high is 4...5V.

TB2 (DIG I/O)

Connector Pin	Function	Reference Pin
1	Excitation or Power	5
2	Input/Output 1 Signal	6
3	Input/Output 1 Signal	7
4	Input/Output 1 Signal	8
5	Input/Output 1 Signal	9
6	Input/Output 1 Signal	10
7	Input/Output 1 Signal	11
8	Ground or Neutral	12



Table 2: Digital inputs

Communications

The FC-5000 Flow Display comes with a Modbus (RTU or ASCII) communication protocol. Signals are transmitted over an EIA-485 (RS-485) physical layer.

TB8 (RS485)

Connector Pin	Function	Reference Pin
1	Shield (Chassis GND)	36
2	Negative (-)	37
3	Positive (+)	38
4	Output Ground	39



Table 3: Communications input

Scaled Outputs

The FC-5000 Flow Display has two scaled output channels for use in applications requiring remote data collection and/or monitoring. The outputs are firmware configurable, and can be tied to parameters such as rates or total volume.

TB7 (FREQ OUT) or (ANALOG OUT)

Connector Pin	Function	Reference Pin
1	Output 1 Signal	32
2	Output 2 Signal	33
3	Output Ground	34
4	Shield (Chassis GND)	35



Table 4: Scaled output channels



ANALOG OUTPUT CONFIGURATIONS ARE DESIGNED TO PROVIDE A SOURCING OUTPUT SIGNAL. THE RECEIVING DEVICE MUST NOT PROVIDE POWER TO THE LOOP.

Relay Output Connectors

The FC-5000 Flow Display has either two Form C relay output terminals or one Form C and one Form A terminal.

Two Form C

TB3 (RELAY 1) and TB4 (RELAY 2)

Connector Pin	Function	Reference Pin	
		Relay 1	Relay 2
1	Normally Open (N.O.)	13	16
2	Signal Common	14	17
3	Normally Closed (N.C.)	15	18



Table 5: Relay output connectors, relay option "C"

One Form C and One Form A

TB3 (RELAY 1) - Form C

Connector Pin	Function	Reference Pin
		Relay 1
1	Normally Open (N.O.)	13
2	Signal Common	14
3	Normally Closed (N.C.)	15



Figure 8: Form C Relay Output Connector

TB4 (RELAY 2) - Form A

Connector Pin	Function	Reference Pin
		Relay 2
1	Connection Point 1	16
2	Not Used (No Contact)	17
3	Connection Point 2	18



Figure 9: Form A Relay Output Connector

Flow Sensor Input

The FC-5000 Flow Display is designed to accept pulses from open collector transistors or dry contact closure transmitters.

Before making any connections:

- Always use shielded wire to protect the signal line from external noise (ground shield to terminal #3).
- Make sure the signal lines are not bundled with or touching power lines.

NOTE: In the tables below, **RF Pin** refers to RF type pickups/amplifiers.

TB5 - Single Channel Pulse Input Terminal

Connector Pin	Function	Reference Pin	RF Pin
1	Sensor Excitation (+)	19	A
2	Sensor Input (+)	20	C
3	Sensor Input/Common (-)	21	B
4	Shield (Chassis GND)	22	—



Table 6: Flow sensor input, single

TB5 - Dual Channel Pulse Input Terminal

Connector Pin	Function	Reference Pin	RF Pin
1	Excitation (+12V output)	19	A
2	Sensor Input CH1	20	C
3	Sensor Common (GND)	21	B
4	Sensor Input CH2	22	C
5	Shield (Earth GND)	23	-



Table 7: Flow sensor input, dual

Powering Radio Frequency (RF) Type Pickups

Radio Frequency (RF) type pickups require a power source to generate a radio frequency field. Similar to magnetic pickups, as fluid velocity provides rotational energy on the flow meter rotor, the field generated by the pickup is disturbed, producing output pulses that are proportional to flow rate.

NOTE: Maximum current draw from the Excitation pin cannot exceed 200 mA. RF style pickups will require a signal conditioning amplifier.

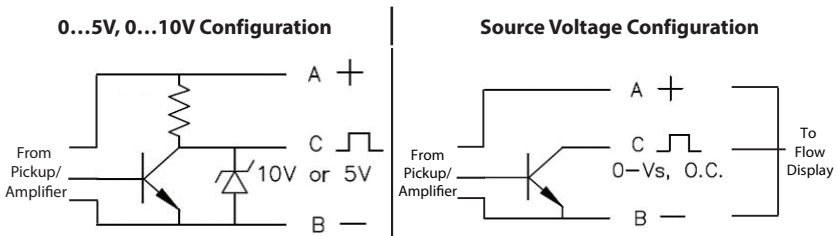

Figure 10: Pickup configurations

OPERATOR INTERFACE

Keypad and Soft Keys

The keypad and soft keys are for programming, editing and changing views.

Scrolling

The screens can display up to four lines at a time. Some menus have more than four items to display. To see the off-screen items, press **UP/DOWN** to scroll through the entire list.

⚠ CAUTION

THE FLOW DISPLAY MAY BE OPERATED ONLY BY PERSONNEL WHO ARE AUTHORIZED AND TRAINED BY THE FACILITY. OBSERVE ALL INSTRUCTIONS IN THIS MANUAL. OBEY ALL SAFETY PRECAUTIONS MENTIONED IN "SAFETY CONSIDERATIONS" ON PAGE 5.

Control Panel Keys

NOTE: Always press  (ENTER) to save a new value.









	The numbered keys are used to enter or change parameter values.
	In editing mode, BACKSPACE deletes the character to the left of the cursor. While navigating, BACKSPACE moves to a previous menu selection.
	Depending on the current screen, ENTER : <ul style="list-style-type: none"> • Saves the current value and ends the editing session • Advances deeper into the menu structure • Toggles enumerations
 	The UP/DOWN keys: <ul style="list-style-type: none"> • Toggle the display views on the home screen • While editing, use UP/DOWN to advance the cursor to the right or left • In the menu structure, scroll through the menus and parameters
   	The F1...F4 function keys are soft keys that change function to whichever icon is present above them. See "Icon Functionality" on page 18.

Table 8: Key functions

Icon Functionality

Depending on the task being performed, one or more of the following icons may appear on the screen. To activate an icon, press the Function key (**F1**, **F2**, **F3** or **F4**) directly under the icon, where applicable.

Icon	Function
	Display the <i>Home</i> screen or cancel an edit (if you activate it without saving first)
	Display the menu structure
	Create a custom label (name) for unit of measure
	Return to <i>Setup</i> menu
	Cycle through alpha characters
	Enter a decimal point
	Cycle through special characters
	Reveal raw and calculated info/sensor data for the Flow Display
	Clear the selected value or cancel edit (press twice, consecutively)
	Enter conversion factor for custom unit of measure
	Change selected value to positive (+) or negative (-)
	Set totalizer rollover point
	Appears on Home screen for various events. Refer to <i>“Troubleshooting”</i> on page 36 for details.
	Enter K-factor in multi-point calibration table
	Enter frequency-in-hertz calibration data
	Toggle flow sensor channels



Display the *Home* screen or cancel an edit (if you activate it without saving first)



Display the menu structure



Create a custom label (name) for unit of measure



Return to *Setup* menu



Cycle through alpha characters



Enter a decimal point



Cycle through special characters



Reveal raw and calculated info/sensor data for the Flow Display



Clear the selected value or cancel edit (press twice, consecutively)



Enter conversion factor for custom unit of measure



Change selected value to positive (+) or negative (-)



Set totalizer rollover point



Appears on Home screen for various events. Refer to *“Troubleshooting”* on page 36 for details.



Enter K-factor in multi-point calibration table



Enter frequency-in-hertz calibration data



Toggle flow sensor channels

Table 9: Icon functions

Navigating the Menus

The *Home* screen display shows rates and totals, either separately or simultaneously. Status and alarm messages or alarm icons appear on the display when appropriate.

Single Input Configurations

Press **UP/DOWN** to toggle between parameter views on the *Home* screen:

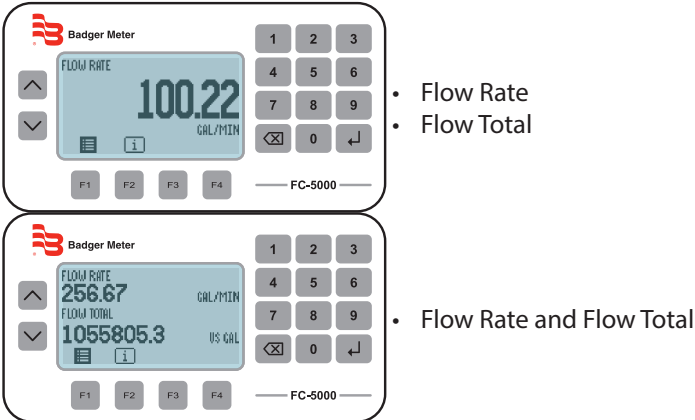

Figure 11: Single input display

Dual Input Configurations

Press **UP/DOWN** to toggle between parameter views on the *Home* screen. Press **F3** to toggle between flow meters/sensors 1 and 2.

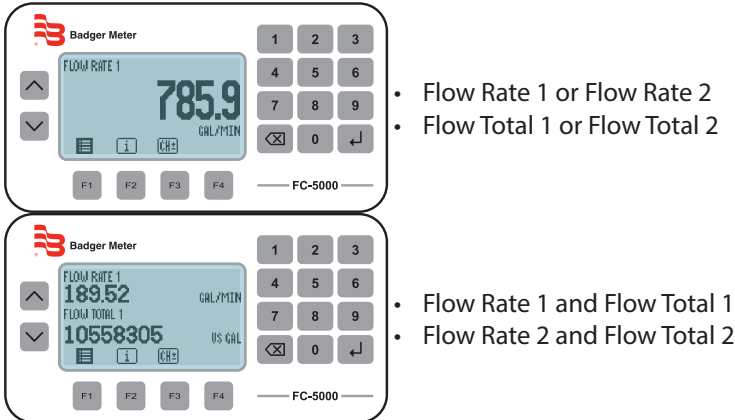

Figure 12: Dual input display

Press **F1** to enter the *Main* menu to access *Setup* and *System Information*, or press **F2** to enter the *INFO/SENSOR DATA* menu.

Numeric Editing

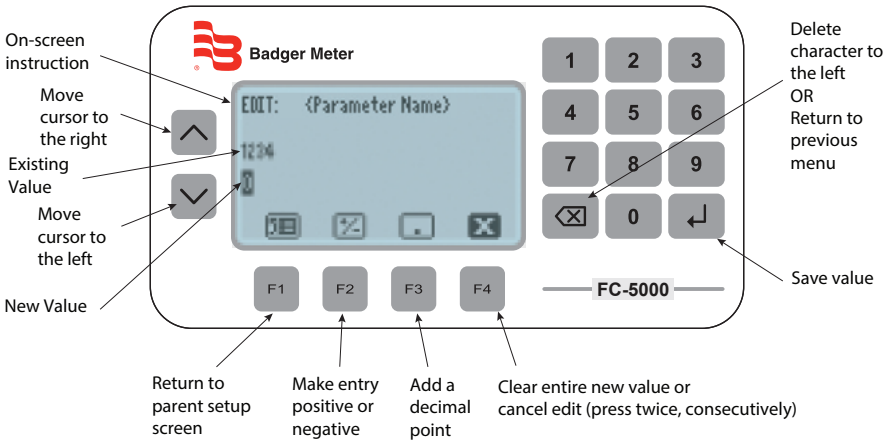

Figure 13: Numeric editing

Alpha-Numeric Editing

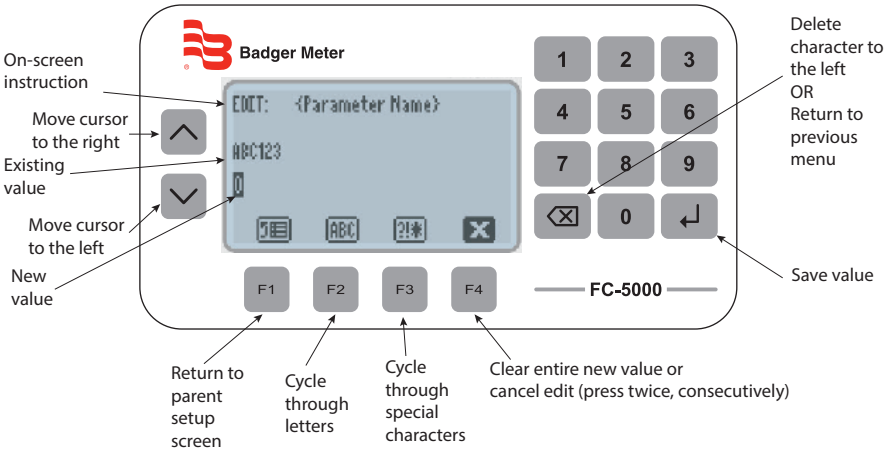

Figure 14: Alpha-numeric editing

Selection/Enumeration Editing

NOTE: Depending on the menu, the selection during an enumeration style edit may appear different.

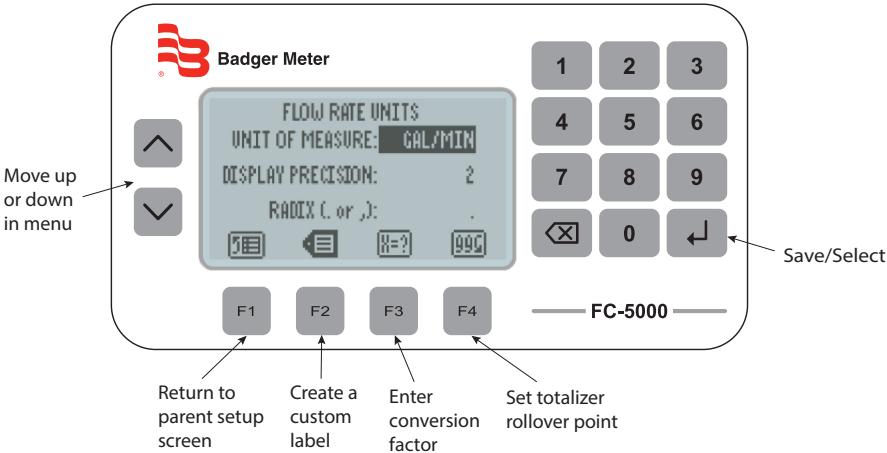

Figure 15: Selection editing

Confirmation Screen

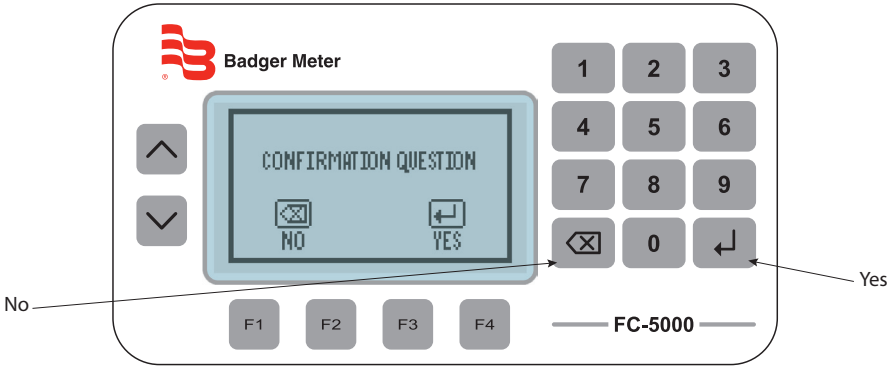

Figure 16: Confirmation screens

Menu Structure

The available menu items depend on the Flow Display configuration. Each menu item is explained in detail in the following pages.

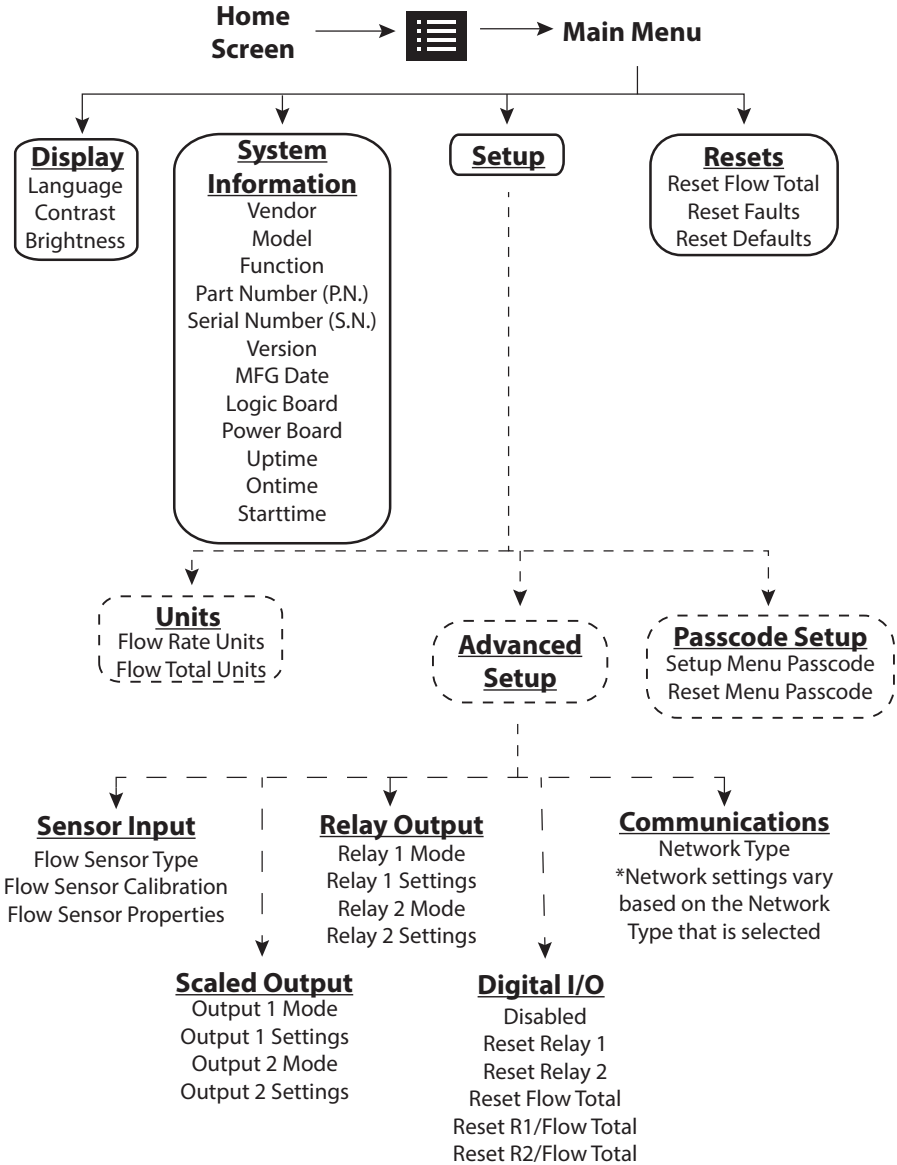

Figure 17: Menu structure

INFO/SENSOR DATA

The FC-5000 Flow Display features a quick method to view measured data transmitting to and from the device. You can use the data for informational purposes or for troubleshooting. The type of data displayed can include raw input frequency, relay status or calculated data, such as flow rate.

Info/Sensor Data Table

Item	Description
Flow Freq	Raw frequency of the flow sensor
Flow Count	Raw pulse count of the flow sensor
Flow Rate	Calculated flow rate of the flow sensor
Flow Tot	Calculated flow total of the flow sensor
Flow Freq 1*	Raw frequency of flow sensor 1
Flow Count 1*	Raw pulse count of flow sensor 1
Flow Rate 1*	Calculated flow rate of flow sensor 1
Flow Tot 1*	Calculated flow total of flow sensor 1
Flow Freq 2*	Raw frequency of flow sensor 2
Flow Count 2*	Raw pulse count of flow sensor 2
Flow Rate 2*	Calculated flow rate of flow sensor 2
Flow Tot 2*	Calculated flow total of flow sensor 2
Relay 1	ENABLED/DISABLED status of relay 1
Relay 2	ENABLED/DISABLED status of relay 2
D-I/O 1	ENABLED/DISABLED status of digital I/O port 1
D-I/O 2	ENABLED/DISABLED status of digital I/O port 2
D-I/O 3	ENABLED/DISABLED status of digital I/O port 3
D-I/O 4	ENABLED/DISABLED status of digital I/O port 4
D-I/O 5	ENABLED/DISABLED status of digital I/O port 5
D-I/O 6	ENABLED/DISABLED status of digital I/O port 6

*For Dual pulse input configurations, rate and total data appear with a 1 or 2 to indicate which flow meter/sensor its depicting

Table 10: Info/sensor data

To return to the home screen, press **BACKSPACE** or **F1** (home).

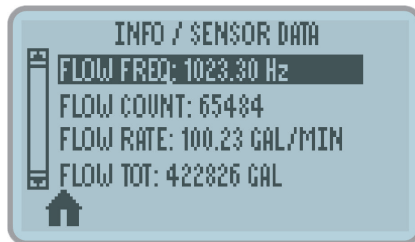

Figure 18: Info/sensor data screen

SYSTEM INFORMATION

The *System Information* menu contains build information specific to the configuration of the unit.

To view your system information, navigate to *System Information* from the *Main* menu.

Item	Description
Vendor	Manufacturer of the product
Model	Product family/series
Function	For factory/diagnostic purposes only
P.N.	Configured part number
S.N.	Serial number
Mfg Date	The original manufacture/build date
Version	Loaded firmware version
Logic Brd	For factory/diagnostic purposes only
Power Brd	For factory/diagnostic purposes only
Uptime	Time, in seconds, since last power-on session start
Ontime	Total lifetime power-on, in seconds
Starttime	Ontime at start of power-on session

Table 11: System information menu

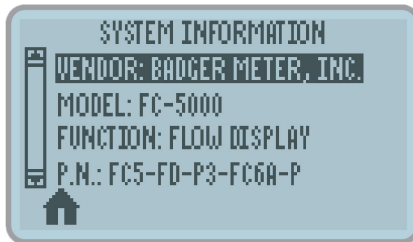

Figure 19: System information screen

BASIC SETUP

Display

Use this menu to change the display settings for *Language*, *Contrast* or *Brightness*.

1. Navigate to *Display* from the main menu.
2. Press **UP/DOWN** to scroll through the available display parameters, then press **ENTER**.
3. Scroll through available options, then press **ENTER** to select and save your changes.



Figure 20: Display configuration screen

Resets

Use this menu to reset *Totalizers*, *Faults*, *Defaults* and *latched relays*:

1. Navigate to *Resets* from the main menu.

NOTE: If a passcode was configured, enter the passcode, then press **ENTER** to access this menu.

2. Press **UP/DOWN** to scroll through the available reset options, then press **ENTER**.
3. On the confirmation screen press **ENTER** to confirm the reset.

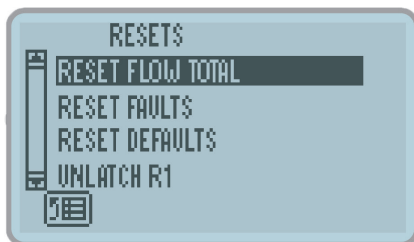

Figure 21: Resets menu

Clearing a Latched Relay

To clear a relay that latches after a trigger:

1. Navigate to the main menu.
2. Press **UP/DOWN** to scroll to *UNLATCH R1* or *UNLATCH R2*, then press **ENTER**.

Passcode Setup

Enabling Passcodes

FC-5000 units are shipped without passcode protection enabled. You can enable a unique password for the *Setup Menu* and the *Reset Menu*. To enable a passcode:

1. Navigate to *SETUP > PASSCODE SETUP*.
2. Press **UP/DOWN** to scroll to the passcode you want to enable, then press **ENTER**.



Figure 22: Enable passcode screen

3. Enter a numeric passcode from 4 to 8 digits in length, then press **ENTER**.
4. On the confirmation screen, press **ENTER** again to confirm the passcode.

NOTE: An asterisk (*) appears next to each passcode if it is enabled.



Figure 23: Asterisk indicates enabled passcode

Disabling a Passcode

1. Navigate to *SETUP > PASSCODE SETUP*.
2. Press **UP/DOWN** to scroll to the passcode you want to delete, then press **F4** (clear).
3. On the confirmation screen, press **ENTER** to confirm removal of the passcode.

Forgotten Passcodes

If you have forgotten your passcode, call Badger Meter customer service and they will be able to assist you in resetting the passcode.

1. Navigate to *System Information* from the main menu.
2. Locate and write down the valves shown for "STARTTIME" and "S.N. (Serial Number)".
3. Call Badger Meter customer service. See "*Troubleshooting*" on page 36 for contact information.

Units

Use the *UNITS* menu to configure units of measure, display precision (resolution) and radix (comma or decimal point). You can configure these settings for each Parameter Unit: Flow (Rate and Total).

1. Navigate to *SETUP > UNITS*.
2. Press **UP/DOWN** to scroll through the available parameter units.
3. Scroll to *Unit of Measure, Display Precision or Radix*, then press **ENTER** to activate the drop-down menu for that setting.

Unit of Measure

The *Unit of Measure* setting determines the engineering unit and/or time interval for calculated measurements of the selected parameter unit.

Press **UP/DOWN** to scroll through the available units of measure, then press **ENTER** to select and save the new setting.

NOTE: For most rate measurements, all options are available in time intervals of seconds (S), minutes (M), hours (H) and days (D).

For any of the *Flow* parameters (*Rate* or *Total*), the available units are:

Unit	Description	Unit	Description
US GAL	US Gallon	M ³	Cubic Meters
IG	Imperial Gallon	AC-FT	Acre Feet
MG	US Million Gallons	BBL	Oil Barrels [42 US Gallons]
MIG	Imperial Million Gallons	FBBL	Liquid Barrels [31.5 US Gallons]
L	Liters	US OZ	US Ounces
ML	Million Liters	I OZ	Imperial Ounces
FT ³	Cubic Feet	CUST	Custom

Table 12: Flow units

Creating Custom Units for Rate or Total Measurement

1. Follow the procedure outlined in “Unit of Measure” on page 27 to enter the Unit of Measure menu for a parameter.
2. Press **UP/DOWN** to choose *CUST*, then press **ENTER**.

NOTE: The display populates with additional icons that need to be modified for custom units.

3. Press **F2** (custom label). Use the soft keys in conjunction with the numeric keypad and **UP/DOWN** to create a custom label, then press **ENTER**.

NOTE: See Table 8 on page 17 and Table 9 on page 18 for button functionality.

4. On the confirmation screen, press **ENTER** to confirm the new custom unit. The new label displays in the selection list.
5. Press **F3** (conversion) to assign a conversion factor for this custom unit. The number entered will be a factor related to the specific parameter.
 - ◇ FLOW RATE: GAL/MIN
 - ◇ FLOW TOTAL: GALLONS (GAL)
6. Press **ENTER** to save the change.
7. On the confirmation screen, press **ENTER** to confirm the change.

NOTE: For example, if making a custom unit for Flow Rate and 2 is programmed as a conversion factor, the custom unit is equivalent to 2 GAL/MIN. If 0.5 is entered, the custom unit is equivalent to 0.5 GAL/MIN.

Display Precision

The *Display Precision* setting determines the resolution of a value, indicated by the number of digits after the decimal place, for the selected parameter unit.

1. Press **UP/DOWN** to scroll to *DISPLAY PRECISION*, then press **ENTER**.
2. Scroll through the available options (0...4), then press **ENTER** to select and save the change.

Radix

The *Radix* parameter determines if a period or comma is used to represent a decimal place for the selected parameter unit.

1. Press **UP/DOWN** to scroll to *RADIX*, then press **ENTER**.
2. Scroll through available options (decimal point or comma), then press **ENTER** to select and save the change.

ADVANCED SETUP

Use the *ADVANCED SETUP* menu to configure flow meters, outputs, relays and communication.

Configuring a Flow Sensor

Flow Sensor Type

See "*Flow Sensor Types*" on page 39 for more details on flow type selection for Badger Meter products. Use this menu to select the flow meter that the device is connected to.

1. Navigate to *SETUP > ADVANCED SETUP > SENSOR INPUTS*.
2. Press **UP/DOWN** to scroll to *FLOW SENSOR TYPE*, then press **ENTER**.
3. Scroll through the available sensor types, then press **ENTER** to select and save the new settings. The flow sensor types are shown in *Table 13*.

Option	Description
No Sensor/Disabled	Disables the sensor input in the firmware
Sine K-Factor	<ul style="list-style-type: none"> • Frequency input channel <ul style="list-style-type: none"> ◊ Examples: Mag pick-offs, Low level signals (~100 mV) • Single K-Factor entry
Pulse: K-Factor	<ul style="list-style-type: none"> • Pulse input channel <ul style="list-style-type: none"> ◊ Any pulse producing sensor ◊ Examples: TTL, RF carriers w/ amplifier • Single K-Factor entry • Active sensor: No pullup resistor
Sine Multi-Point Cal	<ul style="list-style-type: none"> • Frequency input channel <ul style="list-style-type: none"> ◊ Examples: Mag pick-offs, Low level signals (~100 mV) • Multi-point linearization
Pulse Multi-Point Cal	<ul style="list-style-type: none"> • Pulse input channel <ul style="list-style-type: none"> ◊ Any pulse producing sensor ◊ Examples: TTL, RF carriers w/ amplifier • Multi-point linearization • Active sensor: No pullup resistor
Pulse K-Factor Pullup	<ul style="list-style-type: none"> • Pulse input channel <ul style="list-style-type: none"> ◊ Any pulse producing sensor ◊ Examples: TTL, RF carriers w/ amplifier • Single K-Factor entry <ul style="list-style-type: none"> ◊ Pulses per unit of volume • Passive sensor: Pullup resistor to 12V for excitation
Pulse Debounce K-Factor	<ul style="list-style-type: none"> • Unique to products with raw reed switches • Pulse input channel <ul style="list-style-type: none"> ◊ Any pulse producing sensor coupled with a reed switch ◊ Example: Industrial Oval Gear • Single K-Factor entry <ul style="list-style-type: none"> ◊ Pulses per unit of volume • Passive sensor: Pullup resistor to 12V for excitation
Pulse Dic	<ul style="list-style-type: none"> • Unique to the Data Industrial (DIC) product line • Pulse input channel <ul style="list-style-type: none"> ◊ Any pulse producing sensor ◊ Examples: TTL, RF carriers w/ amplifier • K and Offset values entered <ul style="list-style-type: none"> ◊ K = unit of volume per pulse • Active sensor: No pullup resistor

Table 13: Flow sensor types

Flow Sensor Calibration

Use this menu to change the calibration settings (K-factor, offset and low flow cutoff) for the selected Flow Meter Type.

1. Navigate to *SETUP > ADVANCED SETUP > SENSOR INPUTS*.
2. Press **UP/DOWN** to scroll to *FLOW SENSOR CAL*, then press **ENTER**.
3. Scroll to and edit each option, as necessary. The options include:

Option	Description
K-Factor	A singular K-factor entry point.
Offset	Used to apply an offset to sensor input calibration
Low Flow Cutoff	The point at which the display reads zero. Represented in configured unit of measure
Multi-Point Table	Appears when a "Multi-Point Cal" option is picked for a flow sensor type, to replace a single K-Factor. Allows you to program a linearization table.

Table 14: Flow sensor calibration options

10-Point Linearization

The FC-5000 Flow Display can be set up to linearize the output from an eligible flow meter. The calibration data for a particular flow meter are included when the meter, calibration and FC-5000 unit are ordered from the factory. The calibration data is represented as FREQUENCY (f: Hz) vs K-FACTOR (KFct). To manipulate or enter the linearization parameters:

1. Navigate to *SYSTEM SETUP > ADVANCED SETUP > SENSOR INPUT > FLOW SENSOR CAL*.

NOTE: For dual pulse input versions, navigate to *FLOW SENSOR 1 CAL* or *FLOW SENSOR 2 CAL*.

2. Press **UP/DOWN** to scroll to *MULTI-POINT TABLE*, then press **ENTER**.
3. For each calibration point, press **F2** (f:Hz) to enter a frequency value or press **F3** (kFct) to enter or edit the *K-factor* value.
4. On the numeric entry screens, enter the value, then press **ENTER** to save the value and return to the previous screen.

NOTE: Each entry, 1...10, represents each calibration data point. Any number of points can be entered, up to 10. Leave the fields at 0.000 if no data exists.

Flow Sensor Properties

Use this menu to change flow meter damping. Damping is a smoothing coefficient. As the number increases, averaging becomes greater. As the number decreases, it approaches the raw reading. Values range from 0...10.

1. Navigate to *SETUP > ADVANCED SETUP > SENSOR INPUTS*.
2. Press **UP/DOWN** to scroll to *FLOW SENSOR PROP*, then press **ENTER**.
3. Press **ENTER** to select the *DAMPING* option and edit it.

NOTE: Each time you press **ENTER**, the value (0...10) will increase. If the value is 10, pressing **ENTER** again will restart the list at 0.

Configuring Outputs

Scaled Outputs: Output Mode

Use this menu to change the mode of one or both scaled outputs. The mode defines the behavior of the output.

1. Navigate to *SETUP > ADVANCED SETUP > SCALED OUTPUTS*
2. Press **UP/DOWN** to scroll to an output mode, then press **ENTER**.
3. Scroll through the available modes, then press **ENTER** to select and save the setting.

The *Output Mode* options will vary based on device configuration.

Device Configuration	Option	Description
Frequency Output FC5-FD-**-F***.*	NO OUTPUT/DISABLED	Disables Output
	PULSE: TOTAL	Sends pulse(s)-per-total unit of measure
	PULSE: RATE	Sends pulse(s)-per-rate unit of measure
Analog Output FC5-FD-**-A***.*	NO OUTPUT/DISABLED	Disables Output
	ANALOG: 0...5V	0...5V output signal, scaled to an output source
	ANALOG: 0...10V	0...10V output signal, scaled to an output source
	ANALOG: 4...20 mA	4...20 mA output signal, scaled to an output source

Table 15: Output mode options

Scaled Outputs: Output Settings

Use this menu to change the output settings for the respective output mode.

1. Navigate to *SETUP > ADVANCED SETUP > SCALED OUTPUTS*.
2. Press **UP/DOWN** to scroll to the applicable output settings, then press **ENTER**.
3. Scroll to and edit each option, as necessary.
 - a. Frequency output options are:

Output Mode	Option	Description
PULSE: RATE	OUTPUT SOURCE	Parameter assignment of the output (such as rate or total)
	SCALE MINIMUM	Minimum parameter value associated with output minimum
	SCALE MAXIMUM	Maximum parameter value associated with output maximum
	MAXIMUM FREQUENCY	Maximum frequency output value
	OUTPUT FREQ	(Read Only) Real-time output frequency
PULSE: TOTAL	OUTPUT SOURCE	Parameter assignment of the output (such as rate or total or temperature)
	SCALING FACTOR	Units of measure transmitted, per pulse
	SCALED PULSE COUNT	(Read Only) Number of transmitted pulses

Table 16: Frequency output settings

b. Analog output options are:

Option	Description
OUTPUT SOURCE	Parameter assignment of the output (such as rate or total)
ANALOG FULL SCALE	Maximum value associated with output maximum
ANALOG LOW SCALE	Minimum value associated with output minimum

Table 17: Analog output settings

Relay Outputs: Relay Mode

Use this menu to change the mode of one or both relay outputs. The mode defines the behavior of the output.

1. Navigate to *SETUP > ADVANCED SETUP > RELAY OUTPUTS*.
2. Press **UP/DOWN** to scroll to an output mode, then press **ENTER**.
3. Scroll through the available modes, then press **ENTER** to select and save the setting.

Option	Description
NO RELAY/DISABLED	Disables output
TOTALIZER	Totalizer output
ALARM: HIGH	On/Off function, energized at the high set point
ALARM: LOW	On/Off function, energized at the low set point
ALARM: RANGE	On/Off function, energized beyond high and low set points
MANUAL	On/Off function of manual operation

Table 18: Relay mode options

Relay Outputs: Relay Settings

Use this menu to change the relay settings for the respective relay mode.

1. Navigate to *SETUP > ADVANCED SETUP > RELAY OUTPUTS*.
2. Press **UP/DOWN** to scroll to the applicable relay setting, then press **ENTER**.
3. Scroll to and edit each option, as necessary.

NOTE: Alarm icons "R1" and "R2" will appear in the upper right section of the Home Screen to provide a local indication when a relay condition has been met and when the relay has been energized.

Output Mode	Option	Description
TOTALIZER	OUTPUT SOURCE	Parameter assignment (e.g. Flow Total)
	SCALING FACTOR	Pulse(s) transmitted per unit of measure
	UNITS	Converts output unit of measure
	PULSE WIDTH	Time between the rising and falling edges of a single pulse
ALARM: HIGH	OUTPUT SOURCE	Parameter assignment (such as Flow Rate)
	HIGH SETPOINT	Instructs the device to energize the relay if this value reached/exceeded. This value is linked to the <i>OUTPUT SOURCE</i> and its unit of measure (for example, Flow Rate in GPM)
	HYSTERESIS HI	Creates a window/zone below the <i>HIGH SETPOINT</i> value where the relay remains in an energized state
	SET DELAY	Time in seconds that will elapse before the relay energizes, if the <i>HIGH SETPOINT</i> value is reached/exceeded
	RELEASE DELAY	Time in seconds that the relay will remain energized, if the <i>HYSTERESIS HI</i> value is reached/exceeded
	LATCHING	Leaves the relay in an energized state until it is manually cleared on the device, either through the keypad interface or through the Digital I/O channels
ALARM: LOW	OUTPUT SOURCE	Parameter assignment (such as Flow Rate)
	LOW SETPOINT	Instructs the device to energize the relay if this value reached/exceeded. This value is linked to the <i>OUTPUT SOURCE</i> and its unit of measure (for example, Flow Rate in GPM)
	HYSTERESIS LO	Creates a window/zone above the <i>LOW SETPOINT</i> value where the relay remains in an energized state
	SET DELAY	Time in seconds that will elapse before the relay energizes, if the <i>LOW SETPOINT</i> value is reached/exceeded
	RELEASE DELAY	Time in seconds that the relay will remain energized, if the <i>HYSTERESIS LO</i> value is reached/exceeded
	LATCHING	Leaves relay in an energized state until it is manually cleared on the device, either through the keypad interface or through the Digital I/O channels

Output Mode	Option	Description
ALARM: RANGE	OUTPUT SOURCE	Parameter assignment (such as Flow Rate)
	HIGH SETPOINT	Instructs the device to energize the relay if this value reached/exceeded. This value is linked to the <i>OUTPUT SOURCE</i> and its unit of measure (for example, Flow Rate in GPM)
	HYSTERESIS HI	Creates a window/zone below the <i>HIGH SETPOINT</i> value, where the relay remains in an energized state
	LOW SETPOINT	Instructs the device to energize the relay if this value reached/exceeded. This value is linked to the <i>OUTPUT SOURCE</i> and its unit of measure (for example, Flow Rate in GPM)
	HYSTERESIS LO	Creates a window/zone above the <i>LOW SETPOINT</i> value, where the relay remains in an energized state
	SET DELAY	Time in seconds that will elapse before the relay energizes, if either setpoint value is reached/exceeded
	RELEASE DELAY	Time in seconds that the relay will remain energized, if either hysteresis value is reached/exceeded
	LATCHING	Leaves relay in an energized state until it is manually cleared on the device, either through the keypad interface or through the Digital I/O channels
MANUAL	OVERRIDE	Bypasses any programmed triggers to trigger the relay, which will remain triggered until deactivated

Table 19: Relay settings

Configuring Digital I/O

The FC-5000 Flow Display has remote reset capabilities for relays and totalizers through any one of six different channels.

All six channels are input-only and can be configured for any combination of the following.

Option	Description
Disabled	The I/O channel will have no function
Reset: Relay 1	Resets latch on Relay 1
Reset: Relay 2	Resets latch on Relay 2
Reset: All Relays	Resets latches on Relays 1 and 2
Reset: Flow Total	Resets <i>Flow Total</i>
Reset: Relay 1 And Flow Total	Resets latch on Relay 1 and resets <i>Flow Total</i>
Reset: Relay 2 And Flow Total	Resets latch on Relay 2 and resets <i>Flow Total</i>
Reset: All Relays And All Totals	Resets Relay 1, Relay 2 and <i>Flow Total</i>

Table 20: Channel options

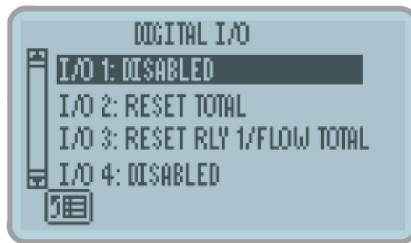

Figure 24: Digital I/O menu

1. Navigate to *SETUP* > *ADVANCED SETUP* > *DIGITAL I/O*.
2. Press **UP/DOWN** to scroll to any of the six input channels.
3. Press **ENTER** repeatedly until the desired function appears. Each time **ENTER** is pressed, the channel toggles through the available functions.

To disable any channel, simply highlight the digital I/O channel, and press **ENTER** until *DISABLED* appears.

Configuring Communications

The *Communications* menu configures the device to communicate to other systems via Modbus.

The available communication settings vary based on Network Type.



Figure 25: Modbus communications menu

1. Navigate to *SETUP* > *ADVANCED SETUP* > *COMMUNICATIONS*.
2. Press **UP/DOWN** to scroll to *NETWORK TYPE*, then press **ENTER**.
3. Scroll through the available options, then press **ENTER** to select save the change.
4. Press **BACKSPACE** to return to the *COMMUNICATIONS* menu.
5. Scroll to and edit each option, as necessary. The options are listed in “Table 21: Modbus settings” on page 36.

Modbus RTU and Modbus ASCII

Settings	Options
BAUD RATE	1200, 2400, 4800, 9600, 14400, 19200, 28800, 34800, 57600 or 115200
PARITY	No Parity, Odd Parity or Even Parity
STOP BIT	No Stop Bit, One or Two Stop Bit
SLAVE ADDRESS	1...255
DEVICE NAME	User-defined ID

Table 21: Modbus settings

TROUBLESHOOTING

This section lists common problems that may be encountered with the Flow Display, the possible causes and the recommended remedies. Most problems are due to improper wiring and/or programming procedures. The problem may also be in the flow meter, valve, pump or other piece of equipment.

Be sure that all other equipment is functioning properly. The FC-5000 Flow Display is extensively tested at the factory before shipment. However, the unit may get damaged during transit or installation. If after all possible remedies have been tried and the problem persists, contact your local representative or Badger Meter.

Problem	Possible Causes	Remedies
Unit has power but display does not light up.	Incorrect power wiring.	Re-check power wiring.
Transmitter is connected but the FC-5000 does not count.	<ol style="list-style-type: none"> 1. Incorrect transmitter wiring or broken wire. 2. Transmitter is defective. 3. No sensory type selected. 4. Wrong scale factor. 5. Low frequency input must be on terminal #7. 6. Meter is defective, rotor not turning. 	<ol style="list-style-type: none"> 1. Check wiring diagrams. 2. Replace parts or entire unit. 3. Select a sensor type. See "Flow Sensor Type" on page 29. 4. Check scale factor calculation. For example, if programmed 0.001 instead of 0.100, unit will wait for 100 pulses before decrementing one count. 5. Verify connection. 6. Disassemble meter, check rotor, replace if defective.
Valve does not close at setpoints.	<ol style="list-style-type: none"> 1. Relay output is not properly connected. 2. Relay is defective. 3. Valve components are defective. 	<ol style="list-style-type: none"> 1. Reconnect relay wiring. 2. Contact factory for replacement. 3. Check and replace valve components.
Counter accumulates too many counts.	<ol style="list-style-type: none"> 1. Wrong scale factor. 2. Electrical noise causing extra pulses. 3. Excessive vibration. 	<ol style="list-style-type: none"> 1. Check scale factor calculation. 2. Check wiring. Make sure power lines are not touching or close to pulse signal line. Always use shielded cable. 3. Dampen vibration.

Problem	Possible Causes	Remedies
Some of the keys on the control panel are not operational.	<ol style="list-style-type: none"> 1. Broken switch behind control panel. 2. Function not available on this model. 3. Problem with internal components. 	<ol style="list-style-type: none"> 1. Replace the Flow Display. 2. See <i>"Operator Interface"</i> on page 17. 3. Return the Flow Display to the factory for repair. 4. Cycle the power to the Flow Display
Display Overrun Error (Shown as "DISPOVR")	There are more digits to display than the maximum quantity.	<ol style="list-style-type: none"> 1. Check the unit of measure and change to a larger unit if possible (for example, change gallons to mega gallons) 2. Check the display precision and reduce it, if possible.
	<ol style="list-style-type: none"> 1. The rate or total values indicated on the Home Screen are in an overrun condition (value exceeds 8 digits) 	<ol style="list-style-type: none"> 1. Change the unit of measure associated with the parameter (see <i>"Unit of Measure"</i> on page 27) or reset the totalizer (see <i>"Resets"</i> on page 25).
Alarm notification from the Home screen		
"R1" and/or "R2" appear on home screen	<ol style="list-style-type: none"> 1. Relay 1 and/or Relay 2 are latched 2. Relay 1 and/or 2 are energized 	<ol style="list-style-type: none"> 1. See <i>"Clearing a Latched Relay"</i> on page 26 2. The programmed alarm conditions are met. Check process or programming
"DISABLED" displays on home screen	<ol style="list-style-type: none"> 1. Flow sensor type setting set to "NO SENSOR/DISABLED" 	<ol style="list-style-type: none"> 1. Configure a flow sensor. See <i>"Configuring a Flow Sensor"</i> on page 29

Table 22: Troubleshooting

CAUTION

THERE ARE NO FIELD-REPLACEABLE PARTS INSIDE. OPENING THE UNIT WILL VOID ALL WARRANTIES.

If a repair or evaluation from the factory is required, call your local representative or the factory to obtain a Return Material Approval (RMA).

The shipping address, RMA number and any other required information will be provided to send the unit to an appropriate location.

Company Website	www.badgermeter.com
Customer Service Email	indorders@badgermeter.com
Customer Service Number	(877) 243-1010

Table 23: Contact information

MODBUS INTERFACE

Modbus Function Code Support

The FC-5000 Flow Display supports access through all four of the Modbus data types. Both single and multiple write-access commands are supported for register and coil data types. For multiple register writes, the command must initiate on a valid parameter address and end on last register of a valid parameter address. Multiple register writes that start in the middle of a multiple register parameter or do not end on the last register of a multiple register parameter are not supported. The table below lists the supported function codes.

Description	Function Code	Subcode
Read Coils	01	—
Read Discrete Inputs	02	—
Read Holding Registers	03	—
Read Input Registers	04	—
Write Single Coil	05	—
Write Single Register	06	—
Diagnostic – Return Query Data	08	00
Write Multiple Coils	15	—
Write Multiple Registers	16	—
Report Slave ID	17	—

Table 24: Supported Modbus function codes

Modbus Register Map

Register Name	Register Address	Coil Addr.	Data Type	Read/Write	Access Type
Single Pulse Input					
Flow Rate	0x0000	—	Float	Read Only	Register
Flow Total	0x0002	—	Float	Read Only	Register
Flow Total Precision	0x0004	—	Double	Read Only	Register
Dual Pulse Input					
Flow Rate 1	0x0000	—	Float	Read Only	Register
Flow Total 1	0x0002	—	Float	Read Only	Register
Flow Total Precision 1	0x0004	—	Double	Read Only	Register
Flow Rate 2	0x0008	—	Float	Read Only	Register
Flow Total 2	0x000A	—	Float	Read Only	Register
Flow Total Precision 2	0x000C	—	Double	Read Only	Register
Flow Rate Quad	0x0010	—	Float	Read Only	Register
Flow Total Quad	0x0012	—	Float	Read Only	Register
Flow Total Precision Quad	0x0014	—	Double	Read Only	Register

Table 25: Modbus register map

FLOW SENSOR TYPES

The table below lists the Badger Meter products suitable for use with the FC-5000 Flow Display.

Meter Technology	Product Line	Output Type	Flow Sensor Input
Impeller	Impeller	Square Wave Frequency	Pulse: DIC
Oval Gear	Oval Gear	Reed Switch Pulse	Pulse: Debounce K-Factor
Positive Displacement	OP Meters	Unscaled Pulse	Pulse: Debounce K-Factor
		Scaled Pulse	Pulse: Debounce K-Factor
	Recordall	Unscaled Pulse	Pulse: Debounce K-Factor
		Scaled Pulse	Pulse: Debounce K-Factor
Turbine	Blancett	MAG Pickup	Sine: K-Factor Sine Multi-Point Cal
		MAG Pickup with K-Factor Scaler	Pulse: K-Factor Pulse Multi-Point Cal
	Cox	MAG Pickup	Sine: K-Factor
		MAG Pickup with K-Factor Scaler	Pulse: K-Factor
		RF Pickup	Pulse: K-Factor
	Turbo	Unscaled Pulse	Pulse: Debounce K-Factor
		Scaled Pulse	Pulse: Debounce K-Factor
	Flo-tech	MAG Pickup	Sine: K-Factor Sine Multi-Point Cal
		MAG Pickup with K-Factor Scaler	Pulse: K-Factor Pulse Multi-Point Cal
	Vision	Frequency	Pulse: K-Factor Pullup

Table 26: Badger Meter flow sensors

PART NUMBERING CONSTRUCTION

FC-5000 Flow Display

Frequency Output



FUNCTION

Flow Display FD

SENSOR INPUTS

One Pulse P0
Two Pulse P3

SCALED OUTPUTS

Two Frequency Outputs F

RELAY OUTPUTS

Two Form C Relays C

DIGITAL INPUTS/OUTPUTS

Six Programmable Inputs/Outputs 6

COMMUNICATIONS

EIA-485(RS-485); Modbus; USB A

MOUNTING METHOD

Panel Mount P
Wall Mount | Includes NEMA 4X (IP67) Rated Enclosure W

FC-5000 Flow Display

Analog Output



FUNCTION

Flow Display FD

SENSOR INPUTS

One Pulse P1
Two Pulse P2

SCALED OUTPUTS

Two Analog Outputs A

RELAY OUTPUTS

Two Form C Relays C

DIGITAL INPUTS/OUTPUTS

Six Programmable Inputs/Outputs 6

COMMUNICATIONS

EIA-485(RS-485); Modbus; USB A

MOUNTING METHOD

Panel Mount P
Wall Mount | Includes NEMA 4X (IP67) Rated Enclosure W

Figure 26: Part numbering construction

Replacement Parts/Accessories

Part Number	Description
68334-001	P/S Plug; 100-264V AC In; 24V DC out
68334-002	P/S Module; 85-264V AC In; 24V DC out
809041	Panel mounting clips (2)
68788-001	Wall-mount enclosure kit
68231-001	Terminal connector kit (P2 configuration)
68231-002	Terminal connector Kit (P1 configuration)
68231-004	Terminal connector kit (P0 configuration)
68231-005	Terminal connector kit (P3 configuration)

Table 27: Replacement parts/accessories

SPECIFICATIONS

Power Supply	Input range: 10...40V DC and 9...28V AC RMS (50...60 Hz)	
	Maximum power consumption: 8 Watts (power supply must provide 8 watts at minimum)	
	Isolated from power ground	
	Over-voltage, transient and reverse polarity protected	
Flow Meter Input	Input Range: 0.3 Hz...10 kHz	
	One (1) or two (2) independent channels	
	Configurable as square wave 0...30V pulse with 2.5V threshold	
	Configurable as sine wave, zero-centered with 45 mV threshold	
	Configurable debounce	
	Excitation Output	12V DC source
	Voltage	Low: -0.3...1.85V DC
		High: 2.5...25V DC
	Impedance	Pullup to 12V DC
	VDC Current	±50 mA, short circuit current
Response	100 µs/3.5 ms min pulse (high/low speed)	
Scaled Outputs	Two (2) independent channels	
	Isolated from power ground	
	Over-voltage, transient and reverse polarity protected	
	Output is multiplexed on the process out pins	
	Analog Output (option A)	Configurable to 0...5V, 0...10V or 4...20 mA
		Uncertainty: ±0.1% of reading
		16-bit resolution (0...10V and 4...20 mA), 15-bit resolution (0...5V)
		200 ms, 90-10% step response
	Sourcing analog output signal	
	Frequency Output (option F)	TTL, 1...4000 Hz, square wave
Uncertainty: ±0.01% reading		
Resolution: 0.01 Hz		
Digital I/O	Six (6) independent channels	
	Isolated from power ground	
	Over-voltage, transient and reverse polarity protected	
	0...30V as input	
	Debounce	
	0...5V, TTL, 200 ms 90-10% step response, driving < 0.1 µF	

Calculations	Flow Calculation	± 0.01% uncertainty	
		Adjustable FIR/IIR filtering	
Relay Outputs	Configuration Option "C"	Two (2) Form C Mechanical Relays	
	Configuration Option "A"	One (1) Form C Mechanical Relay and One (1) Form A Solid State Relay	
	Isolated coil drivers		
	Over-voltage, transient and reverse polarity protected		
	Form C Relay	Load	Resistive
		Rated Carry Current	5 A (N.C. or N.O.)
		Maximum Switching Voltage	250V AC, 30V DC
		Minimum Permissible Load	10 mA at 5V DC
		Coil Rating	5...24V DC
		Life Expectancy	5,000,000 operations
	Form A Relay (N.O. SPST)	Switching Speed	On (0.25 ms), Off (0.02 ms)
		Current Rating (I_o)	1 A
Maximum Output Voltage (V_o)		60V	
Output On-Resistance (R_{o(N)})		0.5 Ohms (Ω) @ I _e = 5 mA, I _o = 1 A	
Output Withstand Voltage (V_{o(OFF)})		60-65V @ V _e = 0.8V, I _o = 250 μA, T _A = 77° F (25° C)	
Network Communications	Network Types/ Communication Protocols	Modbus RTU or Modbus ASCII	
	Physical Layer	EIA-485 (RS-485)	
	Baud Rates	1200...115.2K	
	4-wire interface/half duplex		
	Over-voltage/ESD Protection		
	Isolated from power ground		
USB Communications	USB (HOST)	Type-A Receptacle Currently not supported	
	USB (DEVICE)	Mini-B Receptacle (used for field updates)	
	Over-voltage/ESD/transient protected		
Display/User interface	Keypad	Membrane overlay, domed tactile response keys	
	Display	128 × 64 pixel LCD graphical display, LED backlight	
	Protected from EMI/RFI		
	Keypad interface is protected from ESD		

Environmental Ratings	Pollution Degree	2	
	Altitude Restriction	Up to 2000 m (6561 ft)	
	Over-Voltage Rating	Category II (CAT II)	
	Ambient Temperature Range	32...130° F (0...55° C)	
	Storage Temperature Range	-40...160° F (-40...70° C)	
	Humidity	0...85%, non-condensing	
Weights (Approx.)	Panel Mount	1.25 lb (0.57 kg)	
	Wall Mount (Including Unit)	4.54 lb (2.06 kg)	
Operator Functions	Unlatch Relays, Reset Totalizers, Unlatch Relays and Reset Totalizers		
Parameters	Maximum Displayed Digits	Rates	Max 8 (7 with decimal)
		Totals	Max 9 (8 with decimal)
	Resolution/Display Precision	Configurable, 0...4	
	Volumetric Flow Rate Units Seconds (S), Minute (MIN), Hour (H), Day (D)	US Gallons (US GAL), Imperial Gallons (I GAL), Mega US Gallons (US MGAL), Mega Imperial Gallons (I MGAL), Liters (L), Mega Liters (ML), Cubic Meters (M ³), Cubic Feet (FT ³), Acre Feet (AC-FT), Oil Barrels (OBBL),	
	Volumetric Flow Total Units	Liquid Barrels (LBBL), US Ounces (US OZ), Imperial Ounces (I OZ), Custom (user-specified)	

STANDARDS AND CERTIFICATIONS

Agency Approval/Standards

- CE Marked for Low Voltage Directive and RoHS
- CSA Marked per Class C225286 and C225206, Process Control Equipment
- CSA C22.2 No. 61010-1-12, General requirements
- CAN/CSA-C22.2 No. 61010-1-12 Safety requirements for electrical equipment for measurement, control and laboratory use. Part 1: General requirements— Tri-national standard with UL 61010-1 and ANSI/ISA-61010-1 (82.02.01)

EMI/EMC Compliance

Conducted and Radiated Emissions per CISPR11:2009 / EN55011	Class A, Group 1
IEC 61000-4-2:2008 Electrostatic Discharge	2/4 kV - Contact Discharge, 2/4/8 kV Air Discharge Performance Criteria B
IEC 61000-4-3:2006 Radiated RF Immunity	Test levels: 80...1000 MHz & 1400...2000 MHz Performance Criteria A
IEC 61000-4-4:2004 EFT Immunity (Signal and Power lines)	Tested per specification to Performance Criteria B
IEC 61000-4-5:2005 Surge Protection	Tested per specification to Performance Criteria B
IEC 61000-4-6:2008 Conducted RF Immunity (Signal and Power lines)	Test Levels: 0.15...80 MHz Level 3, Performance Criteria A
IEC 61000-4-11:2004 Voltage Dips, Interruptions, and Dropouts	Tested per specification to Performance Criteria B & C

Table 28: EMI/EMC compliance

Enclosure Protection

- IEC/CSA/UL 60529-1: Degrees of protection provided by enclosures (IP65), when installed with all four mounting clips in a similarly rated enclosure, which includes the optional wall mount enclosure.
- Additional Protection (optional): NEMA 4X (wall mount enclosure only).

Control. Manage. Optimize.

Trademarks appearing in this document are the property of their respective entities. Due to continuous research, product improvements and enhancements, Badger Meter reserves the right to change product or system specifications without notice, except to the extent an outstanding contractual obligation exists. © 2019 Badger Meter, Inc. All rights reserved.

www.badgermeter.com

The Americas | Badger Meter | 4545 West Brown Deer Rd | PO Box 245036 | Milwaukee, WI 53224-9536 | 800-876-3837 | 414-355-0400
 México | Badger Meter de las Americas, S.A. de C.V. | Pedro Luis Ogazón N°32 | Esq. Angelina N°24 | Colonia Guadalupe Inn | CP 01050 | México, DF | México | +52-55-5662-0882
 Europe, Eastern Europe Branch Office (for Poland, Latvia, Lithuania, Estonia, Ukraine, Belarus) | Badger Meter Europe | ul. Korfantego 6 | 44-193 Knurow | Poland | +48-32-236-8787
 Europe, Middle East and Africa | Badger Meter Europa GmbH | Nürtinger Str 76 | 72639 Neuffen | Germany | +49-7025-9208-0
 Europe, Middle East Branch Office | Badger Meter Europe | PO Box 341442 | Dubai Silicon Oasis, Head Quarter Building, Wing C, Office #C209 | Dubai | UAE | +971-4-371 2503
 Slovakia | Badger Meter Slovakia s.r.o. | Račianska 109/B | 831 02 Bratislava, Slovakia | +421-2-44 63 83 01
 Asia Pacific | Badger Meter | 80 Marine Parade Rd | 19-07 Parkway Parade | Singapore 449269 | +65-63464836
 Switzerland | Badger Meter Swiss AG | Mittelholzerstrasse 8 | 3006 Bern | Switzerland | +41-31-932 01 11