



# Series F4S/D

---

## User's Manual



**96mm x 96mm Ramping Controller (1/4 DIN)  
with Guided Setup and Programming**



1241 Bundy Boulevard, Winona, Minnesota USA  
Phone: +1 (507) 454-5300, Fax: +1 (507) 452-4507 <http://www.watlow.com>



**TOTAL  
CUSTOMER  
SATISFACTION**  
3 Year Warranty

**ISO 9001**



Registered Company  
Winona, Minnesota USA





## About Watlow Winona

Watlow Winona is a division of Watlow Electric Mfg. Co., St. Louis, Missouri, a manufacturer of industrial electric heating products since 1922. Watlow begins with a full set of specifications and completes an industrial product that is manufactured in-house, in the U.S.A. Watlow products include electric heaters, sensors, controllers and switching devices. The Winona operation has been designing solid-state electronic control devices since 1962, and has earned the reputation as an excellent supplier to original equipment manufacturers. These OEMs and end users depend upon Watlow Winona to provide compatibly engineered controls that they can incorporate into their products with confidence. Watlow Winona resides in a 100,000-square-foot marketing, engineering and manufacturing facility in Winona, Minnesota.

## About This Manual

The Series F4 User's Manual covers hardware and software in both the **Single-Channel** and **Dual-Channel** controllers. Instructions and illustrations pertain to both unless otherwise specified. If a given feature or parameter operates on only the Single or the Dual Channel controller, it will be identified by an icon in the margin or nearby.



## Your Comments

Your comments or suggestions on this manual are welcome. Please send them to the Technical Literature , Watlow Winona, 1241 Bundy Boulevard, P.O. Box 5580, Winona, Minnesota, 55987-5580 U.S.; Telephone: +1 (507) 454-5300; fax: +1 (507) 452-4507.

Copyright July 2002 by Watlow, Inc., with all rights reserved. (2249)

# T

# Series F4S/D: Table of Contents

## Introduction

Chapter 1: Introduction ..... 1.1

Chapter 2: Keys, Displays and Navigation ... 2.1

## Operations

Chapter 3: Operations ..... 3.1

## Profiles

Chapter 4: Profile Programming ..... 4.1

## Setup

Chapter 5: Setup ..... 5.1

Chapter 6: Features ..... 6.1

Chapter 7: Communications ..... 7.1

## Factory

Chapter 8: Security and Locks ..... 8.1

Chapter 9: Calibration ..... 9.1

Chapter 10: Diagnostics ..... 10.1

## Installation and Wiring

Chapter 11: Installation ..... 11.1

Chapter 12: Wiring ..... 12.1

## Appendix

Glossary ..... A.2

CE Declaration of Conformity ..... A.5

Product Specifications ..... A.6

Ordering Information ..... A.7

Index ..... A.8

List of Figures ..... A.13

Software Map ..... A.16

*A downloadable electronic copy of this user manual is available free of charge through Watlow's web site:  
<http://www.watlow.com/prodtechinfo>. Search on **Series F4**.*



**Safety Alert  
CAUTION or  
WARNING**



**Electrical Shock  
Hazard**

**CAUTION or  
WARNING**

## Safety Information in this Manual

Note, caution and warning symbols appear throughout this book to draw your attention to important operational and safety information.

A “NOTE” marks a short message to alert you to an important detail.

A “CAUTION” safety alert appears with information that is important for protecting your equipment and performance.

A “WARNING” safety alert appears with information that is important for protecting you, others and equipment from damage. Pay very close attention to all warnings that apply to your application.

The  symbol (an exclamation point in a triangle) precedes a general CAUTION or WARNING statement.

The  symbol (a lightning bolt in a lightning bolt in a triangle) precedes an electric shock hazard CAUTION or WARNING safety statement.

## Technical Assistance

If you encounter a problem with your Watlow controller, review all configuration information to verify that your selections are consistent with your application: inputs; outputs; alarms; limits; etc. If the problem persists after checking the above, you can get technical assistance by calling your local Watlow representative (see back cover of this manual), or in the U.S., dial +1 (507) 494-5656. For technical support, ask for an Applications Engineer.

**Please have the following information available when you call:**

- Complete model number
- All configuration information
- User’s Manual
- Diagnostic menu readings

## Warranty

The Watlow Series F4 is warranted to be free of defects in material and workmanship for 36 months after delivery to the first purchaser for use, providing that the units have not been misapplied. Since Watlow has no control over their use, and sometimes misuse, we cannot guarantee against failure. Watlow’s obligations hereunder, at Watlow’s option, are limited to replacement, repair or refund of purchase price, and parts which upon examination prove to be defective within the warranty period specified. This warranty does not apply to damage resulting from transportation, alteration, misuse or abuse.

## Returns

- Call or fax your distributor or the nearest Watlow sales office for best information about returns. (See outside back cover.)
- To return directly to Watlow Winona in the U.S., first call or fax Customer Service for a Return Material Authorization (RMA) number (telephone: +1 (507) 454-5300; fax: +1 (507) 452-4507).
- Put the RMA number on the shipping label, along with on a written description of the problem.
- A restocking charge of 20% of the net price is charged for all standard units returned to stock. Returned units must be in like new condition and must be returned within 120 days of initial receipt of the product.

# 1

## Chapter One: Introduction

### Overview

Watlow's Series F4 1/4 DIN industrial ramping controllers are easy to set up, program and operate in the most demanding ramp-and-soak-processing applications. The F4 includes:

- four-line, high resolution LCD display
- guided setup and programming software
- 16-bit microprocessor
- 256 possible ramp steps in as many as 40 variable-length, nameable profiles
- six step types
- eight programmable event outputs, compressor control, boost heat/boost cool, power-out selections and a real-time clock.
- Note: the F4S has two less analog inputs and two less control outputs than the F4D.

### Inputs and Outputs

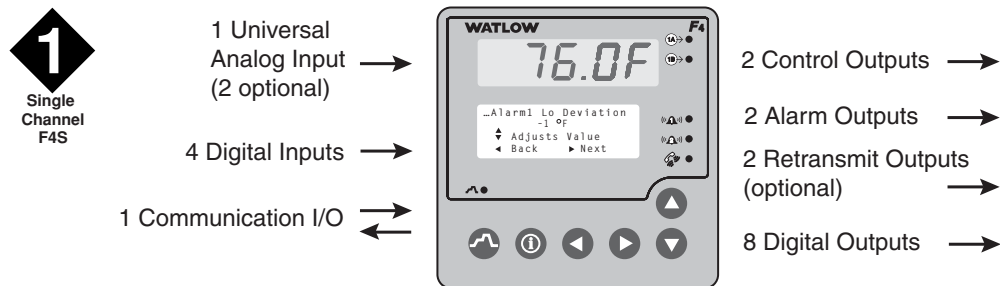

Figure 1.1a — Single-Channel Series F4 (F4S\_ - - - - - ) Inputs and Outputs.

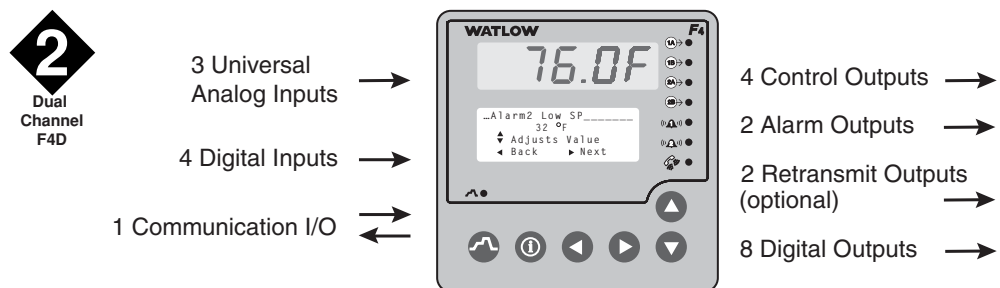

Figure 1.1b — Dual-Channel Series F4 (F4D\_ - - - - - ) Inputs and Outputs.

# Sample Application: Environmental Testing with a Dual Channel F4 Using Multiple Inputs and Outputs

## Overview

Andy, an engineer with the Ajax Testing Company, is running temperature and humidity tests on navigational equipment. He wants to be able to control temperature and humidity in the environmental chamber, and monitor the temperature of the equipment itself. With the Watlow Series F4 ramping controller, he can:

- program the test as a ramping profile and control it remotely;
- use boost heat and cool to maintain precise temperatures;
- record the equipment temperature on a chart recorder;
- notify the operator with a bell if process temperatures do not follow the profile;
- pause the profile if someone opens the chamber door during the test;
- set up communications with a PC later.

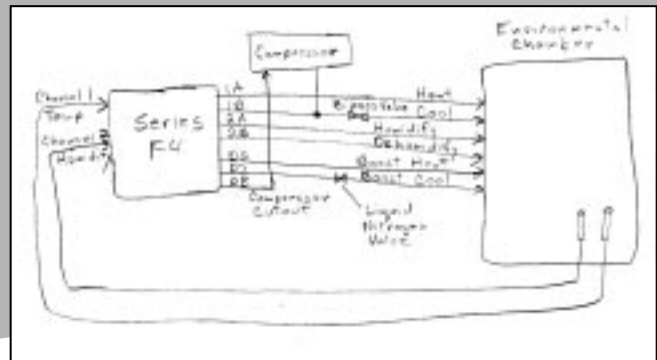

## 1. Wire

Following diagrams in the user manual, Andy connected the analog input terminals to temperature and humidity sensors, channel 1 output terminals to the heater and cooler, channel 2 outputs to the humidifier/dehumidifier, alarm output 1 to an alarm bell and retransmit output 1 to a chart recorder to track the equipment temperature. Digital output 6 and 7 controlled the boost heater and cooler, and 8 controlled the mechanical refrigeration compressor.

See the Wiring Chapter.

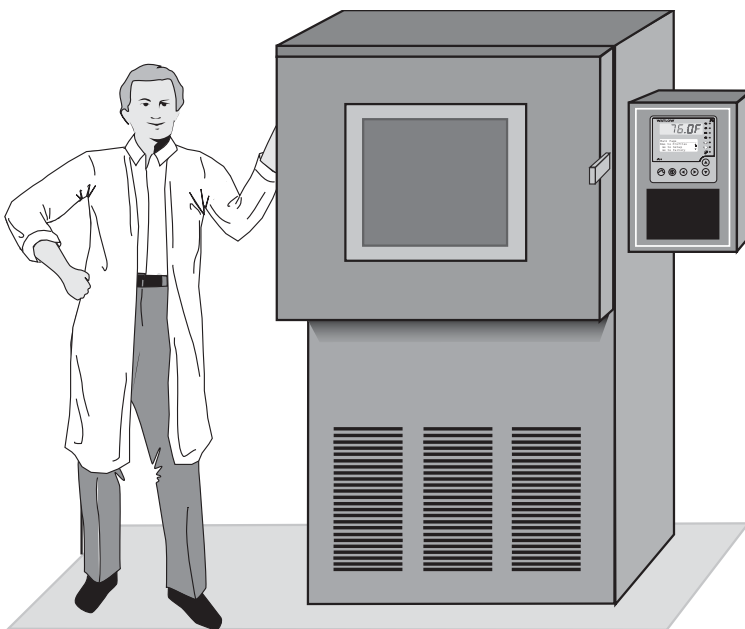

## 5. Run the Profile

Andy pressed the Profile Key and selected the test profile. He monitored the progress of the test on the display and the equipment temperature on the chart recorder.

See the Operations Chapter.

Figure 1.2 — Sample Application 1: Series F4 Dual Channel Using Multiple Inputs and Outputs.

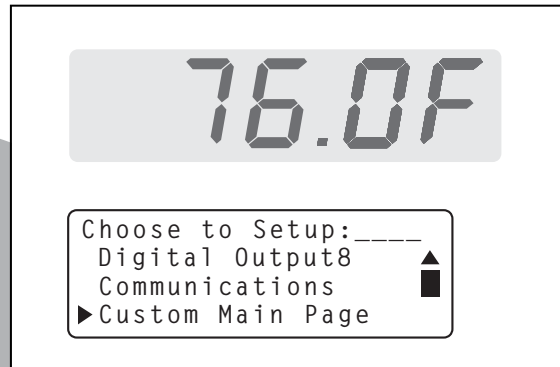
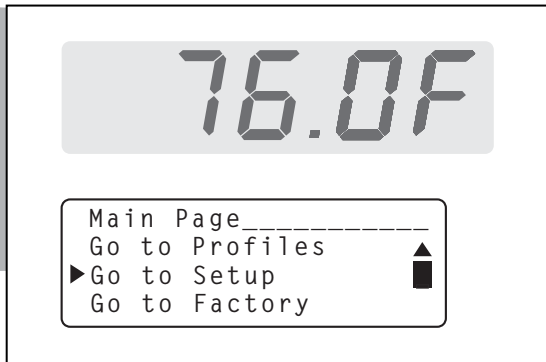

## 2. Set up the F4

After checking the navigation instructions in the user manual, Andy went to the Setup Page of the software to configure the controller for the equipment and the ramping profiles. He named the alarm to make it easier to identify an alarm condition. The alarm message will appear on the Lower Display, which also informs about the progress of the test.

See the **Keys, Displays and Navigation Chapter**.  
See the **Setup Chapter**.

## 3. Customize and Name

Andy customized the Main Page so he could tell the status of the digital outputs by glancing at the controller's Lower Display (Setup Page > Custom Main Page Menu).

He also named one of the Alarms "TEMP DEV", which will make it easy to identify the alarm condition (Setup Page > Alarm Output 1 Menu). Three digital inputs, two alarms and eight digital outputs can be given 10-character names.

See the **Setup Chapter**.

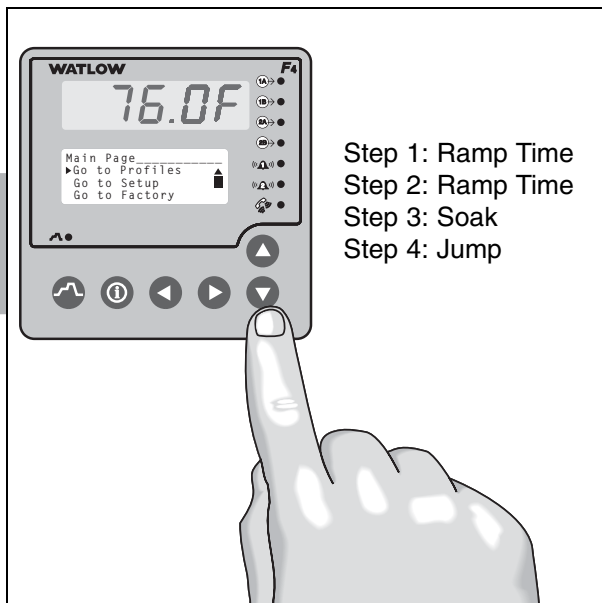

## 4. Program the Profile

Andy programmed the test as a ramping profile of 21 steps. To make sure the equipment is at the ambient chamber temperature, he put a Wait condition on Step 2. Step 20 is a Jump step that puts the equipment through the same heat and humidity cycle 21 times.

See the **Profile Programming Chapter**.

### ✓ NOTE:

*The profile in this sample application is embedded in the Series F4 software for use as a teaching tool or a template. It is the first profile, MILSTD810D, located in the Profiles Page > Edit Profile Menu. You can change or delete this profile and later recall it through factory defaults. If you have a single-channel controller, you will see only the temperature on Channel 1. This is not the true Military Standard Test 810D.*

This sample application is continued in the **Operations, Profile Programming and Setup Chapters**.

# Setup Steps

- If the Series F4 is an independent unit, start with Step 1 below.
- If the Series F4 is already installed in and set up for a piece of equipment, proceed to Steps 4, 5, 6 and 7 below.
- If the Series F4 is already installed in a piece of equipment and the setup and profile programming functions are locked, proceed directly to Step 5 or 7.

## What to do

## How to do it

<b>1</b> Install the controller.	<i>See Chapter 11, Installation. (This step will not be necessary if the Series F4 is already installed in equipment.)</i>
<b>2</b> Wire the controller.	<i>See Chapter 12, Wiring. (This step will not be necessary if the Series F4 is already installed in equipment.)</i>
<b>3</b> Set up the controller to suit your basic application.	<i>Learn to navigate the software in Chapter 2, Keys, Displays and Navigation, and then go to Chapter 5, Setup. For background, you may also want to refer to Chapter 6, Features. (This step may not be necessary if the Series F4 is already installed in the equipment.)</i>
<b>4</b> Tune the system and set alarm set points.	<i>See Chapter 3, Operations.</i>
<b>5</b> Set up serial communications.	<i>See Chapter 7, Communications.</i>
<b>6</b> Program a profile.	<i>See Chapter 4, Profile Programming.</i>
<b>7</b> Run the profile (or establish a set point for static set point control).	<i>See Chapter 3, Operations.</i>

## The Key

During all these steps, the Information Key will summon helpful definitions and setup tips. Just position the cursor next to the item you want to know more about, then press the key. Press it again to return to your task.



# 2

## Chapter Two: Keys, Displays & Navigation

Displays and Indicator Lights . . . . .	.2.2
Custom Main Page . . . . .	.2.3
Keys and Navigation . . . . .	.2.4
Guided Setup . . . . .	.2.5
How to Enter Numbers and Names . . . . .	.2.6
❏ Information Key Answers Your Questions . . . . .	.2.7
Main Page Parameter Table . . . . .	.2.8

### Overview

This chapter introduces the user interface of the Series F4S/D controller — the displays, keys and indicator lights, and the principles of navigating the software to program profiles and change setup settings. The Series F4 is designed with user-friendly features to facilitate setup, programming and operation of the Series F4.

The four-line LCD display facilitates setup and programming, and presents informative messages about status, error and alarm conditions.

Digital inputs, digital outputs, profiles and alarms can be named for easy reference.

The Information Key summons information about the pages, menus, parameters and values, as well as error and alarm conditions if they occur.

The software is organized into five pages of menus. The Main Page gives access to the other four — Operations, Profiles, Setup and Factory. The Main Page can be customized to display user-chosen information.

# Displays and Indicator Lights

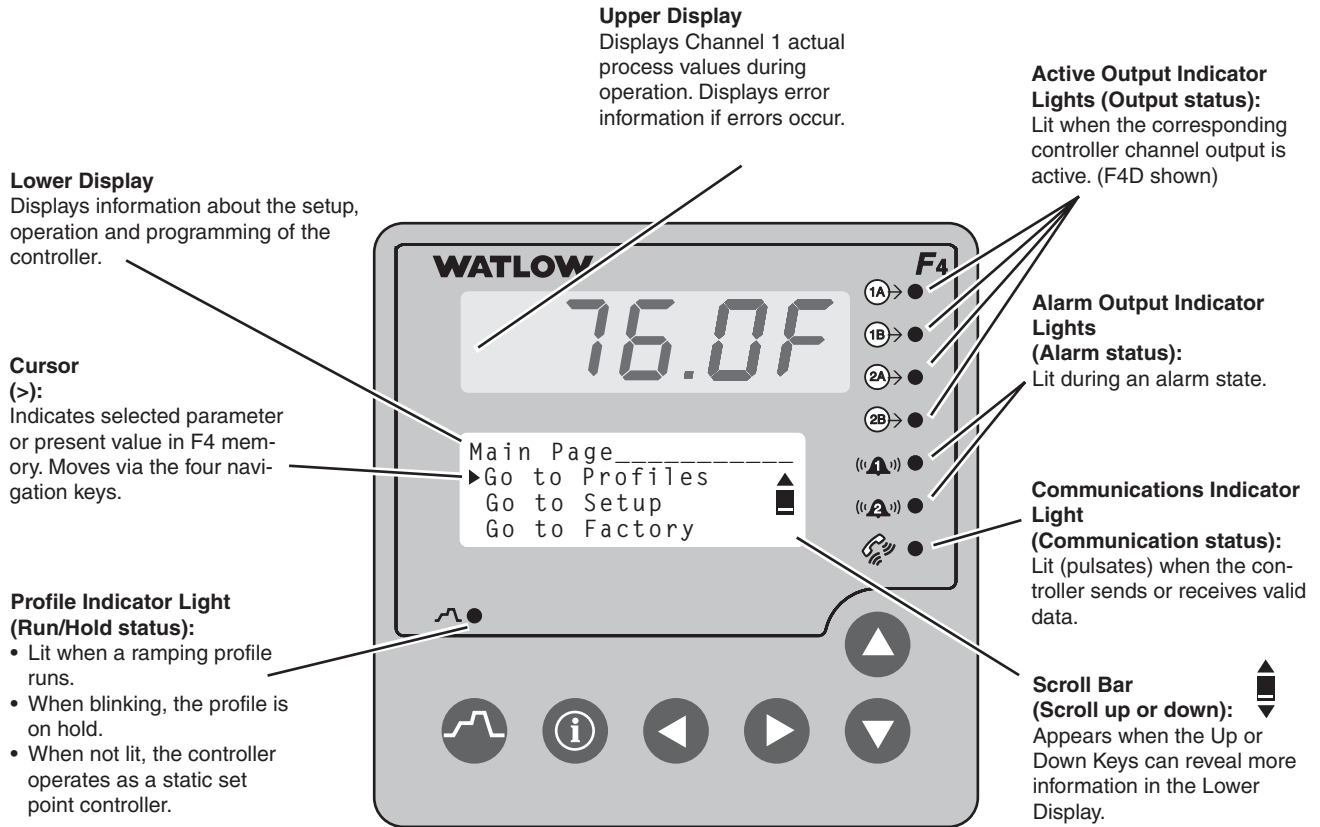

Figure 2.2 — Series F4S/D Displays and Indicator Lights. (F4D shown)

# Custom Main Page

The first and central page on the Lower Display is the Main Page, which shows error messages, input, output and profile status, and allows access to controller software (Go to Operations, Profiles, Setup and Factory).

The Main Page can be customized to display cho-

sen information. (To do so, go to the Setup Page, Custom Main Page Menu. See Chapter 5, Setup, for instructions.)

The following parameters will appear by default on the Main Page, unless the Main Page has been customized.

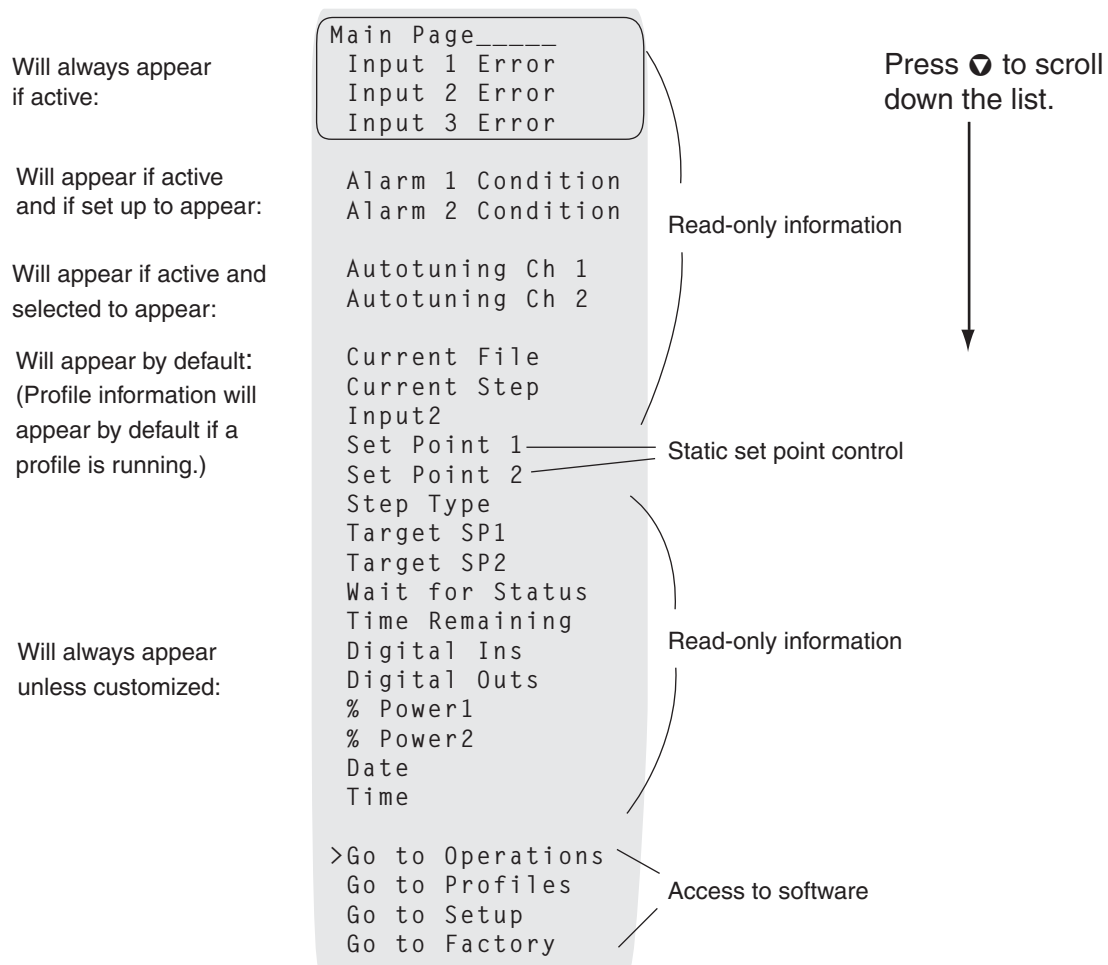

Figure 2.3 — Default Main Page Parameters.

# Keys and Navigation

**Setup Page**

```

Main>Setup
  Choose to Setup
    ▶ System
      Analog Input 1
  
```

Think of this display as a window into the software table. You move around in the software using the following navigation keys:

- ▲ Move Up/Increase
- ▼ Move Down/Decrease
- ◀ Back
- ▶ Next

**Profile Key (Profile Run/Hold):**  
Summons a menu that allows you to start, hold, resume or terminate a profile.

**Information Key (Toggle for more information):**  
Provides information in the Lower Display about the cursor-selected parameter. Another press toggles the display back to the parameter.

**Up and Down Keys (Move Up/Increase and Move Down/Decrease):**  
Move the cursor (>) position in the Lower Display through the software in the direction of the key arrow. Increase or decrease a value, or change a letter in a user-nameable field, such as alarms, events and profile names.





**Left and Right Keys (Back Out and Next):**  
Move right to select the choice to the right of the cursor and proceed to the next screen. Move left to exit.



The diagram shows a Watlow Series F4 controller with a large LCD display. The display is split into two sections. The top section shows a menu path: 'Main>Setup', 'Choose to Setup', '▶ System', and 'Analog Input 1'. The bottom section shows a menu with a cursor pointing to 'Go to Profiles'. The menu options are: 'Main Page', '▶Go to Profiles', 'Go to Setup', and 'Go to Factory'. To the right of the display are six function keys labeled 1A, 1B, 2A, 2B, and two arrow keys. Below the display are four physical buttons: a profile key (wavy line icon), an information key (i icon), a left arrow key, and a right arrow key. A hand is shown pointing at the right arrow key. Below the controller, a list of menu options is shown: '4 - 20mA', '0 - 20mA', '0 - 10V', '0 - 5V', '1 - 5V', '0 - 50mV', 'Choose Units', 'Temperatur', '%rh', 'PSI', 'units', 'Choose Decimal', '0', '0.0', '0.00', and '0.000'.

Figure 2.4 — Series F4 Keys and Navigation.

# Guided Setup

In most F4 menus, setup and programming tasks are guided. For example, once you select Analog Input 1 on the Setup Page, all parameters necessary to configure that input are linked:



1. Use   to move the cursor to select an item in a list.
2. Press the Right Key .
3. Enter the value and make a choice.
4. Press  again.
5. Repeat until you return to the original list.

-  saves the value and proceeds to the next parameter in the series.
-  saves the value and backs out of the series, and returns to the Main Page.

For initial setup and programming, we recommend that you answer all the questions in the series, entering values for all linked parameters and pressing  until you return to your starting point.

To edit a parameter, proceed through the series without changing values until you find the parameter you want to change. After making the change, you may back out or proceed to the end of the series.

✓NOTE:

The Edit PID Menu (Operations Page) presents lists of parameters that can be entered and edited individually. Press either  or  to enter the value and return to the list.



✓NOTE:

Make sure your setup is complete before entering profiles. Certain analog input setup changes will delete profiles.

```
Main Page_____ 
  Go to Operations
  Go to Profiles
>Go to Setup
```

```
Choose to Setup:_____ 
>Control Output 1A▲
  Control Output 1B■
  Control Output 2A▼
```

```
Choose Function:_____ 
>Heat
  Cool
```

```
Choose Cycle Time:___ 
>Variable Burst
  Fixed Time 
```

```
Enter Hi Power Limit 
  100%
▲▼ Adjusts Value
  < Back > Next
```

```
Enter Lo Power Limit 
  0%
▲▼ Adjusts Value
  < Back > Next
```

```
Choose to Setup:_____ 
>Control Output 1A▲
  Control Output 1B■
  Control Output 2A▼
```

```
Save setup changes
or restore values?
  ▼Restore ▲Save
```



# How to Enter Numbers and Names

Many parameters require users to enter a numerical value. Alarms, digital inputs, digital outputs and profiles can be customized with easily recog-

nized names, such as TOO HOT for an alarm, DOOR OPEN for a digital input and GLAZE 6 for a profile.

Z	If the cursor is at Z, press
Y	▼ to go
X	down to A,
W	then from 9
...	to 0. Blank is
C	on the end.
B	
A	
9	
8	
7	
6	
5	
4	
3	
2	
1	
0	
Blank	

## Numbers

1. Navigate to the parameter you want to change.

You'll change the value on this line.

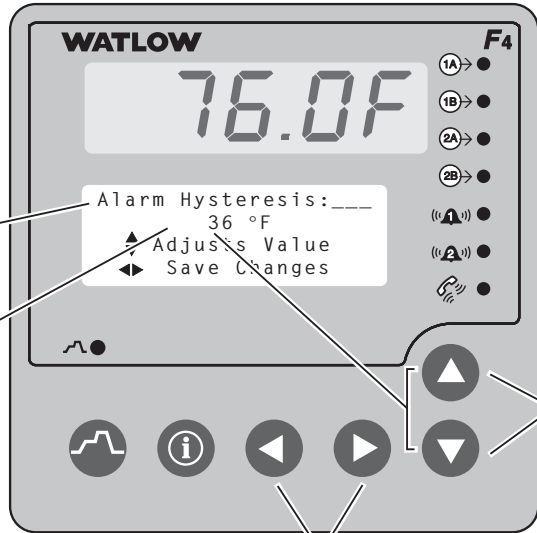

2. Move right or left, if necessary, to choose the digit to change. (Some numbers increase or decrease as single units; others digit by digit.) The active position is underlined.

4. Press **▶** to enter the value.

3. Scroll to increase or decrease the value of the digit.

## Names

1. Navigate to the parameter you want to name.

You'll change each letter on this nameable 10-character line.

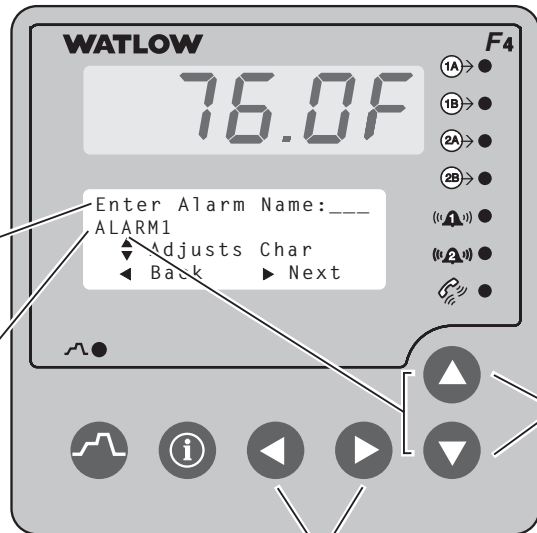

2. Move right or left to choose the character to change. (The position is underlined.)



4. Press **▶** to move to the end of the 10-character name space and proceed to the next screen. This enters the name.

3. Scroll to choose the new letter or a number.

Figure 2.6 — How to Enter Numbers and Names. (F4D shown)

# Information Key Answers Your Questions

There's a wealth of information about features and parameters right in the Series F4 controller. Use the Information Key to get this information.

1. Use the four navigation keys (⏪ ⏩ ⏴ ⏵) to position the cursor (>) next to the parameter you want to know more about.
2. Press the  key. The displayed information will assist you during setup and operation. When information takes more than four lines, the scroll bar will be filled or weighted at the end, directing you to press ⏴ or ⏵ to see the rest.
3. Press  again to return to your task.

Toggle the Information Key  between the parameter you need to know about and its functional definition.

The second press takes you back to where you were.

The scroll bar indicates more information above or below; use the ⏴ and ⏵ keys.

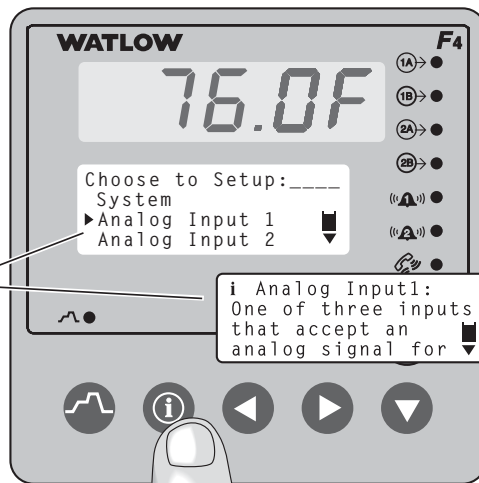

Figure 2.7 — The Information Key. (F4D shown)

# Main Page Parameter Table

Parameter	Description	Range (Modbus Value)	Default	Modbus Register read/write [I/O, Set, Ch]	Conditions for Parameters to Appear
<b>Main Page</b>					
Main > Setup > Main Page					
<b>Input x (1 to 3) Error</b>					
<b>Alarm x (1 to 2) Condition</b>					
<b>Autotuning Channel x (1 or 2)</b>					
<b>Parameter x (1 to 16)</b>	None		Current File		
View customized parameter list.	Input 1 Value		Current Step		
	Input 2 Value		Input 2 value		
	Input 3 Value		Set Point 1		
	Set Point 1		Set Point 2		
	Set Point 2		Step Type		
	% Power 1		Target SP1		
	% Power 2		Target SP2		
	Tune status 1		Wait for		
	Tune status 2		Status		
	Time		Time		
	Date		Remaining		
	Digital Ins		Digital Ins		
	Digital Outs		Digital Outs*		
	Time Remaining		% Power 1		*Digital outputs configured as events can be turned on/off in the static set point mode or when a running profile is on hold. The event output status will remain as set until reset by the profile or by the operator.
	Current File		% Power 2		
	Current Step		Date		
	Active Ch1 PID Set		Time		
	Active Ch2 PID Set				
	Last Jump Step				
	Jump Count				
	WaitFor Status				
	Step Type				
	Target SP1				
	Target SP2				
	Inner Set Point				
	Custom Message 1				
	Custom Message 2				
	Custom Message 3				
	Custom Message 4				
	Input 1 Cal. Offset				
	Input 2 Cal. Offset				
	Input 3 Cal. Offset				
<b>Go to Operations</b>					
	Auto-tune PID sets, edit PID parameters and select alarm set points.				
<b>Go to Profiles</b>					
	Create, edit, delete and rename profiles.				
<b>Go to Setup</b>					
	Set up inputs and outputs, configure the system and design the Main Page.				
<b>Go to Factory</b>					
	Set security settings, and calibrate and restore factory settings.				



# 3

## Chapter Three: Operations

Static Set Point Control	3.1
Profile Control	3.2
Alarm Set Points	3.4
Clearing Alarms and Errors	3.4
Auto-tune PID	3.4
Edit PID	3.4
Multiple PID Sets	3.5
Cascade	3.6
Sample Application	3.7
Troubleshooting Alarms and Errors	3.8
Operations Page Map	3.10
Operations Page Parameter Table	3.11
Operations Page Parameter Record	3.15

### Series F4S/D Operation

The Series F4S/D controller can function as either a **static set point** controller or as a **profile** controller. The information shown on the Lower Display during operation (the Main Page) is programmable and can be customized to support both modes of operation. (See Setup Page.)

In either the static set point mode or the profile mode, the Series F4 can only be operated in a closed-loop configuration. Manual operation (open-loop) mode is not allowed.

#### Static Set Point Control

The Series F4 is in static mode when it is not controlling a ramping profile. When in static mode:

- The Profile Indicator Light is off.
- The Upper Display shows the actual process temperature of input 1, 2 or 3 depending upon Setup Page configuration.

**NOTE:**

All control activity stops when you enter the Setup Page, Analog Input, Digital Input, Control Output, Alarm Output, Retransmit, and Digital Output menus.

- The Lower Display shows the default or user-configured information set. See the Setup Chapter for instructions in programming the Main Page to display the information you want.

To operate the Series F4 as a static set point controller, use the navigation keys (▲ ▼ ◀ ▶) to select the preferred channel and adjust the set point.

```
Static Set Point1____
          ____ °F
▲▼ Adjusts Value
< Back > Next
```

Limits may be placed on the set point in the Set Point Low Limit and Set Point High Limit parameters (Setup Page > Analog Inputx).

Setting the set point to Set Point Low Limit minus 1 (-1) will turn control Output 1 off and display the set point as off.

```
Static Set Point1____
          OFF
▲▼ Adjusts Value
< Back > Next
```

# Profile Control

The main purpose of the Series F4 is to control profiles for ramp-and-soak-processing applications. The instructions below explain how to use an existing profile. To program a profile, see Chapter 4, Profile Programming.

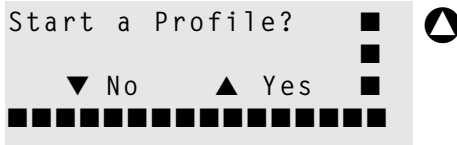

## To Start/Run a Profile

To initiate the profile mode, press the Profile Key  and answer the questions that follow.

While running a profile, the Profile Status message on the lower display will keep you informed about the progress of the profile. For example, it could read like the screen at right:

✓ **NOTE:**

As a protective measure, all stored profiles will be cleared if you enter the Setup Page and change values in the Analog Input 1, 2, 3 menus —specifically, the Sensor, Sensor Type, Decimal, Scale (for process inputs), and Set Point High and Low Limits. Pop-up messages will warn that the profiles will be erased from the controller’s memory.

✓ **NOTE:**

You must configure the software for your inputs and outputs before programming a profile. See the Setup Chapter.

✓ **NOTE:**

You must program a profile or use the pre-programmed MILSTD810D profile before running it. See the Profile Programming Chapter.

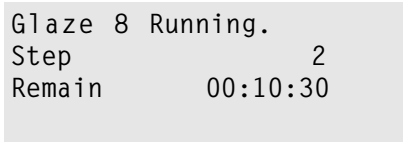
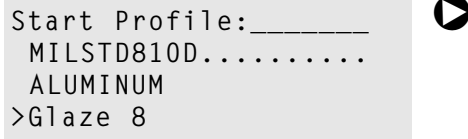

✓ **NOTE:**

While a profile is running, the controller will not recognize digital inputs that are programmed to start a profile. Such digital inputs will be recognized only while the controller is in the static set point mode.

✓ **NOTE:**

While a profile is running, profiles can be either created or renamed only while a profile is running. All other pages and menus can be entered only during Static Set Point Control mode.

### **WARNING**

Check the configuration of the controller on the Setup Page before starting and running a profile (if the Setup Page is not locked). Make sure the settings are appropriate to the profile: input sensor ranges and limits, digital inputs and outputs as events, guaranteed soak band, response to power out and Celsius or Fahrenheit scales. If the Setup Page is accessible, failure to check the configuration before running a profile could result in damage to equipment and/or property, and/or injury or death to personnel.

## To Hold a Running Profile

1. **Press the Profile Key**  while running a profile. The Profile Action Menu appears.
2. **Choose to Don't Hold, Hold or Terminate the profile.** (Default is to Don't Hold.) If you choose to hold the profile, the Main Page reappears, and the Profile Status message reads "Profile X holding." The Profile Indicator Light is off.

If you do not make a choice when the Profile Action Menu appears, the profile continues running and the profile indicator light stays on.

```
Hold Profile: _____
Don't Hold
>Hold
Terminate
```

✓ **NOTE:**

While profiles are on hold, the step set point value can be adjusted using the Static Set Point parameter on the Main Page.

---

## To Resume a Profile on Hold

1. **Press the Profile Key**  while a profile is holding. The Resume Profile Menu appears.
2. **Choose to Continue Holding, Resume or Terminate the profile.**

If you do not make a choice, the profile continues holding and the Profile Indicator Light stays off.

```
Resume Profile: _____
>Continue Holding
Resume
Terminate
```

✓ **NOTE:**

When a profile is resumed during a Ramp step, the controller uses the Static Set Point from the Main Page to calculate the rate of change needed to get to the set point at the end of the step. When a profile is resumed in a soak step, the new set point value will be used as the soak value for the time remaining in the step.

---

## To Terminate a Running/Holding Profile

1. **Press the Profile Key**  while a profile is running. The Profile Action Menu appears.
2. **Choose to Continue, Hold or Terminate the profile.** (Default is to Continue.) If you choose to terminate, the profile ends with all outputs off. The set point on the Main Page reads off.

If you do not make a choice when the Profile Action Menu appears, the profile continues as it was — running or holding.

```
Hold Profile: _____
Don't Hold
Hold
>Terminate
```

✓ **NOTE:**

The Profile Status message takes precedence over all other information except errors, alarm messages and input status. Errors and alarm messages always take precedence over Profile Status.

### **The Profile Key:**

- initiates the ramping profile mode;
- initiates the Hold-profile state;
- initiates the Resume-profile command;
- initiates the Terminate-profile command.

The Profile Key functions only from the Main Page. It will not function from any of the other pages — Operations, Profile, Setup or Factory.

# Alarm Set Points

The Series F4 includes two alarm outputs, which can be programmed as process or deviation alarms.

Process alarms notify the operator when process values exceed or fall below Alarm Low and Alarm High Set Points. Deviation alarms notify the operator when the process has deviated from the set point beyond the deviation limits. For more information, see the Features Chapter. To set up the alarms, see the Setup Chapter.

Alarm set points are the points at which alarms switch on or off, depending on the alarm setting. Alarm set points can be viewed or changed in the Alarm Set Point Menus (Operations Page).

**The Alarm High Set Point** defines the high temperature that, if exceeded, will trigger an alarm. This temperature must be higher than the alarm low set point and lower than the high limit of the sensor range.

**The Alarm Low Set Point** defines the low temperature that, if exceeded, will trigger an alarm. This temperature must be lower than the alarm high set point and higher than the low limit of the sensor range.

✓ **TIP:**

*You may want to set up the alarms with names that will identify the alarm conditions. See the Setup Page.*

## To Clear an Alarm or Error

In an alarm condition, an alarm message will appear on the Main Page (if this option has been selected on the Setup Page). To silence it, move the cursor to the alarm message and press the Right Key . A pop-up message will confirm the silencing of the alarm, and the indicator light will go off.

When the condition causing the error or alarm is corrected, return to the error or alarm message on the Main Page, and press the Right Key again. A pop-up message confirms the alarm is unlatched.

# Auto-tune PID

In autotuning, the controller automatically selects the PID parameters for optimal control, based on the thermal response of the system. In the Series F4, five sets of PID values are available for each channel of the controller: sets 1 to 5 for channel 1, and sets 6 to 10 for channel 2. Default PID values exist for all PID sets, although these values typically do not provide optimal control. PID values can be auto-tuned or adjusted manually. When autotuning is complete, the PID values will be stored in the Edit PID Menu.

✓ **NOTE:**

*PID Set 1 for Channel 1 and PID Set 6 for Channel 2 are used in the Static Set Point mode.*

## Autotuning Procedure

Autotuning cannot be initiated while a profile is running. It can only be initiated in the static set point control mode.

1. Before initiating auto-tune, go to the System Menu (Setup Page), and set the Channel 1 or 2 Autotune Set Point to the percentage of set point you choose to begin with. This percentage is based on your knowledge of the system and how much overshoot or undershoot there is likely to be in on-off control.

In the Custom Main Page, select to display Tune Status 1 and Tune Status 2. This displays Tune Status in the Main Page.

2. Go to the Main Page and set the static set point.
3. Go to the Autotune PID Menu (Operations Page) and choose the channel to auto-tune and the PID set in which to store the settings. A message will be displayed on the Main Page during the autotuning process. (Auto-tune cannot be initiated when a profile is running. It can only be initiated in the static set point mode.)
4. When autotuning is complete, the controller will store the values for optimum control in the PID set specified.

✓ **NOTE:**

*While the controller is autotuning, profiles cannot be run and only the Profiles Page and Operation Page of the software can be entered.*



**CAUTION:** Choose an auto-tune set point value that will protect your product from possible damage from overshoot or undershoot during the autotuning oscillations. If the product is sensitive, select the auto-tune set point very carefully to prevent product damage.

For additional information about autotuning and proportional, integral and derivative control, see the Features Chapter.

## Edit PID

Edit PID is useful when Auto-tune PID does not provide adequate control. Each of the PID parameters can be adjusted manually:

**Proportional Band:** Define a band for PID control, entered in degrees or units. Lower values increase gain, which reduces droop but can cause oscillation. Increase the proportional band to eliminate oscillation.

**Integral (Reset):** Define the integral time in minutes per repeat; define reset in repeats per minute. Set repeats per minute if units are U.S.; minutes per repeat if units are SI.

**Derivative (Rate):** Define the derivative (rate) time in minutes. Large values prevent overshoot but can cause sluggishness. Decrease if necessary.

**Dead Band:** Define the dead band in degrees or units. Heating dead band shifts the set point down. Cooling dead band shifts the set point up. For more information, see the Features Chapter.

## Manual Tuning Procedure

1. Apply power to the Series F4 and enter a set point. Go to the Operations Page, Edit PID Menu and begin with Proportional Band set to 5; Integral (Reset) set to 0; Derivative (Rate) set to 0; and Autotune set to Tune Off.
2. Start manual tuning by entering the desired set point and let the system stabilize. Once the system stabilizes, observe the value of Input 1 on the Main Page. If the Input 1 value fluctuates, increase the proportional band setting until it stabilizes. Adjust the proportional band in 5° to 10° increments, allowing time between adjustments for the system to stabilize.
3. Once Input 1 has stabilized, observe the percent power on the Main Page. It should be stable,  $\pm 2\%$ . At this point, the process temperature should also be stable, but it will exhibit droop (stabilized below set point). The droop can be eliminated with reset or integral.
4. Start with a reset setting of 0.01, and allow 10 minutes for the process temperature to come up to set point. If it has not, increase the setting to 0.05 and wait another 10 minutes. After this, double the reset setting and wait another 10 minutes until the process value equals the set point. If the process becomes unstable, the reset value is too large. Decrease the setting until the process stabilizes.
5. Increase Derivative/Rate to *0.10 minute*. Then raise the set point by 20° to 30°F, or 11° to 17°C. Observe the system's approach to the set point. If the load process value overshoots the set point, increase Derivative/Rate to *0.50 minute*.

Raise the set point by 20° to 30°F, or 11° to 17°C and watch the approach to the new set point. If you increase Derivative/Rate too much, the approach to the set point will be very sluggish. Repeat as necessary until the system rises to the

new set point without overshooting or approaching the set point too slowly.

For additional information about manual tuning and proportional, integral and derivative control, see the Features Chapter.

## Multiple PID Sets

Environmental chambers, ovens and furnaces typically have different thermal requirements when they operate at high and low temperatures or pressures. To accommodate varying thermal requirements, the F4 is capable of storing five different PID sets for each channel. One set for each channel can be chosen in each profile step.

For example, a controller in an environmental chamber with PID settings optimized for control at subzero temperatures may not control well when the set point is set to temperatures above the boiling point of water. With the F4, one PID set could be used for subzero operation and another set for temperatures above boiling.

## Multiple Tuning Procedure

1. To auto-tune a single PID set, begin by setting the static set point on the Main Page.
2. Go to the Autotune PID Menu (Operations Page), and choose a channel and a set. Autotuning begins when you select the set. The Main Page displays information about the autotuning process when Tune Status is selected in the Custom Main Page.
3. When autotuning is finished, proceed with another PID set.

In the example above, the user would first auto-tune a PID set for subzero operation, and then another for operation at boiling temperatures. When programming a profile, the user could then select a different PID set for each step, depending on the thermal requirements.

### ✓ NOTE:

*Autotuning cannot be done while running a profile. It can only be initiated when the controller is in the Static Set Point Control mode.*

# Cascade

Cascade control is available on the Series F4 controllers. For background information about cascade control, see the Features Chapter.

Select cascade control through the Analog Input 3 Menu (Setup Page) and choose Process Cascade or Deviation Cascade. To set the range for the Process Cascade Inner Loop set point, use Low and High Range settings. These are independent of the Channel 1 set point. Deviation Cascade uses Deviation Low and High settings that are referenced to the Channel 1 set point.

Deviation Cascade is used in applications with large set point ranges or where limiting heating or cooling equipment temperatures is required.

When tuning a cascade system, the inner loop must be tuned first. The inner loop comprises outputs 1A and 1B and the Analog Input 1 sensor, which usually measures the energy source temperature. The output device controls a power switching device, which in turn switches the heating and cooling. The set point for the inner loop is generated by the outer loop. For Process Cascade, this will have a range between the Cascade Low Range and Cascade High Range.

## Cascade Setup Procedure

1. First, configure Analog Input 3, Cascade Low Range and Cascade High Range.

Go to the Analog Input 3 Menu (Setup Page). Choose Process or Deviation Cascade. Deviation Cascade references Channel 1 set point allowing a range above and below the current control set point. For Process Cascade control of a heat/cool or cool only system, set the Cascade Low Range to a value slightly lower than the lowest temperature desired in the chamber. For heat-only systems, set the Cascade Low Range to a value slightly lower than the ambient temperature; otherwise the heat output will never turn fully off.

For heat/cool or heat only systems, set the Cascade High Range to a value slightly higher than the highest temperature desired in the chamber. For cool-only systems, set the Cascade High Range to a value slightly higher than the ambient temperature; otherwise the cooling will never fully turn off.

2. Next, configure the controller to tune and display data for the outer loop. To view Inner Loop Set Point in the upper display, go to the Setup Page, Custom Main Page Menu, select the Inner Set point as one of the parameters, P1 to P16, to be displayed in the Main Page.

To also view Analog Input 3 in the upper display, go to the Setup Page, Process Display Menu, and choose Alternating. Under Set Display Time, choose a duration for the display of the Input 1 and Input 3 variables.

## Cascade Autotuning Procedure

1. Go to Setup Page, Custom Main Page Menu. Choose Tune Status 1 and Tune Status 2 to appear as 2 of the 16 parameters that can be displayed on the Main Page. The Main Page will now display the status of the autotuning process.
2. Autotune the inner loop. Go to the Autotune PID Menu (Operations Page), and select Cascade Inner-loop. Choose Cascade Inner Loop PID Set 1 to 5, where PID values will be stored after autotuning. Autotuning begins when you choose the PID set. While autotuning, the F4 controller will control the energy source in an on-off mode to a temperature equal to the Cascade High Range setting x Channel 1 Autotune Set Point. For best results, use proportional control only on the inner loop.
3. Next, autotune the outer loop. Go to the Autotune PID Menu (Operations Page). Choose Cascade Outer Loop, then choose Outer Loop PID set 1 to 5, where PID values will be stored after autotuning. Autotuning begins when you choose the PID set. While autotuning, the outer loop will be controlled in an on-off mode at a set point equal to static set point x Ch 1 Autotune Set Point. In most cases, the autotuning feature will tune for acceptable control. If not, manually tune the outer loop (step 4 below). Before manually tuning, record the values generated by the autotuning feature.
4. To manually tune the outer loop, go to the Edit PID Menu (Operations Page). Choose Cascade Outer Loop, then choose Outer Loop PID set 1 to 5. Begin manual tuning by setting the Proportional Band to 5, Integral (Reset) to 0, and Rate to 0. Establish the desired set point and let the system stabilize. When the system stabilizes, watch the Inner Loop Set Point on the Main Page. If this value fluctuates, increase the proportional band until it stabilizes. Adjust the proportional band in 3° to 5° increments, allowing time for the system to stabilize between adjustments.
5. When Input 1 has stabilized, watch the percent power on the Main Page. It should be stable,  $\pm 2\%$ . At this point, the process temperature should also be stable, but it will exhibit droop (stabilized below set point). The droop can be eliminated with Integral (reset).
6. Start with an integral setting of 99.9 minutes, and allow 10 minutes for the process temperature to come up to set point. If it has not, decrease the setting by half and wait another 10 minutes. Then halve the setting again and wait another 10 minutes until the process value equals the set point. If the process becomes unstable, the integral value is too small. Increase it until the process stabilizes.

# Sample Application: Environmental Testing, Running a Profile

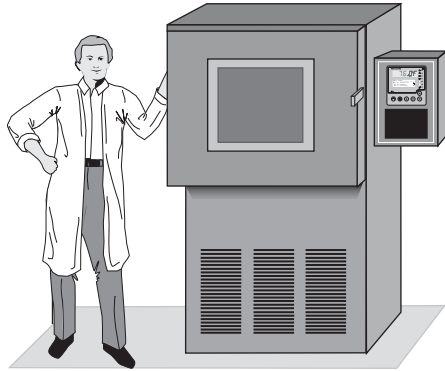

Andy, an engineer with the Ajax Testing Company, is running temperature and humidity tests on navigational equipment. He runs the test profile, Military Standard Test 810D, having already set up the controller and programmed the profile.

In Step 4, the temperature in the chamber exceeded the Alarm 1 setting. This triggered the alarm, causing the indicator light on the front panel (next to the bell-shaped icon) to light up and a message to appear on the lower display: "TEMP DEV High."



Because Alarm 1 was set up as a latching alarm (Setup Page), Andy had to clear it manually. First he corrected the alarm condition by widening the gap between low and high deviation alarm settings on the Operations Page. He then unlatched the alarm by returning to the Main Page alarm line and pressing the Right Key  again.

If your Series F4 is a single-channel controller, you will see only the temperature on Channel 1. This is **not** the true Military Standard Test 810D.

✓ **NOTE:**

*This profile is embedded in the Series F4 as a teaching tool and a template. Go to the Edit Profile Menu (Profiles Page) and look for MILSTD810D.*

## RUN

Andy presses the Profile Key , moves the cursor to "MILSTD810D" on the Run Profile Menu, then presses the Right Key . He wants to begin at Step 1, so he presses  to select that step. The Profile Status Message (on the Lower Display) now says: "MILSTD810D Running. Step 1 Remains: XX:XX."



```
Start Profile: _____
>MILSTD810D.....
  ALUMINUM
  Glaze 8
```

## HOLD

When the alarm occurred, Andy put the profile on hold while he corrected the Alarm Set Points.



```
Hold Profile: _____
  Don't Hold
>Hold
  Terminate
```

```
MILSTD810D Holding.
Step 1
Remains      00:01:40
```



## RESUME

After clearing the alarm, Andy entered the command to resume the profile.



```
Resume Profile: _____
  Continue Holding
>Resume
  Terminate
```

# Troubleshooting Alarms and Errors

Indication	Probable Cause(s)	Corrective Action
<b>Power</b>		
<ul style="list-style-type: none"> <li>• Displays are dead.</li> </ul>	<ul style="list-style-type: none"> <li>• Power to unit may be off.</li> <li>• Fuse may be blown.</li> <li>• Breaker may be tripped.</li> <li>• Safety Interlock door switch, etc., may be activated.</li> <li>• Separate system limit control may be latched.</li> <li>• Wiring may be open.</li> <li>• Input power may be incorrect.</li> </ul>	<ul style="list-style-type: none"> <li>• Check switches, fuses, breakers, interlocks, limits, connectors, etc. for energized conditions and proper connection.</li> <li>• Measure power upstream for required level. Check part number for input power required.</li> <li>• Check wire size.</li> <li>• Check for bad connections.</li> </ul>
<b>Communications</b>		
<ul style="list-style-type: none"> <li>• Unit will not communicate.</li> </ul>	<ul style="list-style-type: none"> <li>• Address parameter may be incorrectly set.</li> <li>• Baud rate parameter may be incorrectly set.</li> <li>• Unit-to-unit daisy chain may be disconnected.</li> <li>• Communications wiring may be reversed, short or open.</li> <li>• EIA-485 converter box may be incorrectly wired.</li> <li>• Computer communications port may be incorrectly set up.</li> <li>• Communications software setup or address may be incorrect.</li> <li>• Protocol or parity may be wrong, should be 8, n, 1.</li> <li>• Application software not working properly.</li> <li>• May need termination and pull-up and pull-down resistors.</li> </ul>	<ul style="list-style-type: none"> <li>• Check Communications Setup Menu and set to correct address.</li> <li>• Check Communications Setup Menu and set to correct baud rate.</li> <li>• Look for a break in the daisy chain.</li> <li>• Verify correct connections and test wiring paths.</li> <li>• Check converter box wiring and its documentation.</li> <li>• Reconfigure computer's communications port setup and verify that communications are okay.</li> <li>• Check the communication card documentation for settable variables and operational testing.</li> <li>• Restart communications software and check for settings agreement. Verify the communications bus is active.</li> <li>• Verify operation with Watlow communications tool.</li> </ul>
<b>Alarms</b>		
<ul style="list-style-type: none"> <li>• Alarm won't occur.</li> </ul>	<ul style="list-style-type: none"> <li>• Alarm output may be off.</li> <li>• Alarm set points may be incorrect.</li> <li>• Alarm sides may be incorrect.</li> <li>• Controller may be in diagnostics mode.</li> </ul>	<ul style="list-style-type: none"> <li>• Configure output as an alarm.</li> <li>• Check alarm set points.</li> <li>• Check the alarm sides setting.</li> <li>• Check the alarm type setting.</li> </ul>
<ul style="list-style-type: none"> <li>• Alarm won't clear. (To clear the alarm, correct the alarm condition. If the alarm is latched, press <b>▶</b> with the cursor at the alarm message on the Main Page.)</li> </ul>	<ul style="list-style-type: none"> <li>• Alarm may be latched. Move cursor to alarm message. Press <b>▶</b>.</li> <li>• Alarm set points may be incorrect.</li> <li>• Alarm hysteresis may be incorrect.</li> <li>• Input may be in error condition.</li> </ul>	<ul style="list-style-type: none"> <li>• Check the alarm logic for compatibility with system peripherals and annunciators.</li> <li>• Check the power limit setting.</li> <li>• Check the operation mode.</li> <li>• Check the alarm output function.</li> <li>• Check the °C and °F setting.</li> <li>• Check the calibration offset value. Set it to a lower level.</li> </ul>



Indication	Probable Cause(s)	Corrective Action
<b>Input Errors</b>		
(Upper Display shows error code for input 1 only. Lower Display shows error message. Alarm Output Indicator is lit.)	<ul style="list-style-type: none"> <li>• Input is in error condition.</li> </ul>	<ul style="list-style-type: none"> <li>• Check sensor connections.</li> </ul>
<b>Upper</b> <span style="border: 1px solid black; padding: 2px;">R-dLD</span> <b>Lower</b> !Input x (1 to 3) AtoD -	<ul style="list-style-type: none"> <li>• Check sensor connections and sensor wiring.</li> </ul>	<ul style="list-style-type: none"> <li>• Check sensor connections and sensor wiring.</li> </ul>
<b>Upper</b> <span style="border: 1px solid black; padding: 2px;">R-dh</span> <b>Lower</b> !Input x (1 to 3) AtoD+	<ul style="list-style-type: none"> <li>• Input type may be set to wrong sensor or may not be calibrated.</li> </ul>	<ul style="list-style-type: none"> <li>• Check the Sensor parameter to match the sensor hardware.</li> </ul>
<b>Upper</b> <span style="border: 1px solid black; padding: 2px;">SEnLo</span> <b>Lower</b> !Input x (1 to 3) Sensor-	<ul style="list-style-type: none"> <li>• Power may be incorrect.</li> </ul>	<ul style="list-style-type: none"> <li>• Measure power upstream for required level. Check part number for power requirements.</li> </ul>
<b>Upper</b> <span style="border: 1px solid black; padding: 2px;">SEnh</span> <b>Lower</b> !Input x (1 to 3) Sensor+	<ul style="list-style-type: none"> <li>• The open loop detect feature shows a broken sensor.</li> </ul>	<ul style="list-style-type: none"> <li>• Check sensor function. The Open Loop Detect parameter indicates it may be broken.</li> </ul>
<b>Upper</b> <span style="border: 1px solid black; padding: 2px;">RtOd</span> <b>Lower</b> !Timeout	<ul style="list-style-type: none"> <li>• The Calibration Offset parameter is set much too high or low.</li> </ul>	<ul style="list-style-type: none"> <li>• Check the Calibration Offset parameter value. Set it to a lower level.</li> </ul>
<hr/>		
<b>System Errors</b>		
(Upper Display shows error numbers. Lower Display messages indicate cause and action to take.)	<ul style="list-style-type: none"> <li>• Input is in error condition.</li> </ul>	<ul style="list-style-type: none"> <li>• Check sensor connections.</li> </ul>
<ul style="list-style-type: none"> <li>• Input 1 Module Error! Only single-channel modules supported.</li> </ul>	<ul style="list-style-type: none"> <li>• Input 2-3 module in input 1 slot.</li> </ul>	<ul style="list-style-type: none"> <li>• Move module to correct input slot.</li> </ul>
<ul style="list-style-type: none"> <li>• Input 1 Module Error! Only dual-channel modules supported.</li> </ul>	<ul style="list-style-type: none"> <li>• Input 1 module in input 2-3 slot.</li> </ul>	<ul style="list-style-type: none"> <li>• Move module to correct input slot.</li> </ul>
<ul style="list-style-type: none"> <li>• Retransmit 1 Module Error! Only process modules supported.</li> </ul>	<ul style="list-style-type: none"> <li>• Wrong module in retransmit 1 slot.</li> </ul>	<ul style="list-style-type: none"> <li>• Replace incorrect module with retransmit module.</li> </ul>
<ul style="list-style-type: none"> <li>• Retransmit 2 Module Error! Only process modules supported.</li> </ul>	<ul style="list-style-type: none"> <li>• Wrong module in retransmit 2 slot.</li> </ul>	<ul style="list-style-type: none"> <li>• Replace incorrect module with retransmit module.</li> </ul>
<ul style="list-style-type: none"> <li>• Cannot identify: Modify: Replace module.</li> </ul>	<ul style="list-style-type: none"> <li>• Component failure.</li> </ul>	<ul style="list-style-type: none"> <li>• Remove the module just installed and replace with a new module.</li> </ul>
<ul style="list-style-type: none"> <li>• Module change. Defaults will occur. Accept with any key.</li> </ul>	<ul style="list-style-type: none"> <li>• Module changed.</li> </ul>	<ul style="list-style-type: none"> <li>• Press any key. All parameters will default.</li> </ul>
<ul style="list-style-type: none"> <li>• First power-up. Parameters are initializing.</li> </ul>	<ul style="list-style-type: none"> <li>• Firmware upgrade.</li> </ul>	<ul style="list-style-type: none"> <li>• Wait until initialization is done.</li> </ul>
<ul style="list-style-type: none"> <li>• Firmware change. Parameters are initializing.</li> </ul>	<ul style="list-style-type: none"> <li>• Firmware upgrade.</li> </ul>	<ul style="list-style-type: none"> <li>• Wait until initialization is done.</li> </ul>
<hr/>		
<b>Fatal Errors</b> (Controller shuts down.)		
<ul style="list-style-type: none"> <li>• Checksum Error!, Parameter memory.</li> </ul>	<ul style="list-style-type: none"> <li>• Loss of power during memory setup.</li> </ul>	<ul style="list-style-type: none"> <li>• Turn the controller off, then on again.</li> </ul>
<ul style="list-style-type: none"> <li>• Checksum Error!, Unit config memory.</li> </ul>	<ul style="list-style-type: none"> <li>• Loss of power during memory setup.</li> </ul>	<ul style="list-style-type: none"> <li>• Turn the controller off, then on again.</li> </ul>
<ul style="list-style-type: none"> <li>• Checksum Error!, Profile memory.</li> </ul>	<ul style="list-style-type: none"> <li>• Loss of power during memory setup.</li> </ul>	<ul style="list-style-type: none"> <li>• Turn the controller off, then on again.</li> </ul>
<ul style="list-style-type: none"> <li>• RAM Test Failed! Return controller to the Factory.</li> </ul>	<ul style="list-style-type: none"> <li>• Component failure.</li> </ul>	<ul style="list-style-type: none"> <li>• Call your Watlow distributor or representative.</li> </ul>
<ul style="list-style-type: none"> <li>• Flash Memory Failed. Return controller to the Factory.</li> </ul>	<ul style="list-style-type: none"> <li>• Component failure, loss of power during download.</li> </ul>	<ul style="list-style-type: none"> <li>• Call your Watlow distributor or representative.</li> </ul>

# Operations Page Map

## Autotune PID

### Channel 1 Autotune

Tune Off

PID Set 1

PID Set 2

PID Set 3

PID Set 4

PID Set 5

### Channel 2 Autotune

Tune Off

PID Set 6

PID Set 7

PID Set 8

PID Set 9

PID Set 10

### Channel 1 Outer Loop Autotune

PID Set C1

PID Set C2

PID Set C3

PID Set C4

PID Set C5

## Edit PID

### PID Set Channel 1

#### PID Set 1-5

Proportional Band A

IntegralA / ResetA

DerivativeA / RateA

Dead Band A

Hysteresis A

Proportional Band B

IntegralB / ResetB

DerivativeB / RateB

Dead Band B

Hysteresis B

## PID Set Channel 2

### PID Set 6-10

Proportional Band A

IntegralA / ResetA

DerivativeA / RateA

Dead Band A

Hysteresis A

Proportional Band B

IntegralB / ResetB

DerivativeB / RateB

Dead Band B

Hysteresis B

## Cascade PID Set

### Cascade Set 1-5

Proportional Band A

IntegralA / ResetA

DerivativeA / RateA

Dead Band A

Hysteresis A

Proportional Band B

IntegralB / ResetB

DerivativeB / RateB

Dead Band B

Hysteresis B

## Alarm Set Points

Alarm1 Low SP

Alarm1 High SP

Alarm1 Lo Deviation

Alarm1 Hi Deviation

Alarm2 Low SP

Alarm2 High SP

Alarm2 Lo Deviation

Alarm2 Hi Deviation

### ✓ NOTE:

*Some parameters may not appear, depending on the model and configuration of the controller.*

# Operations Page Parameter Table

Parameter	Description	Range (Modbus Value)	Default	Modbus Register read/write [I/O, Set, Ch]	Conditions for Parameters to Appear
<b>Autotune PID</b>					
Main > Operations > <b>Autotune PID</b>					
<b>Channel x (1 to 2) Autotune</b>	Select whether PID parameters will be automatically selected.	Tune Off (0) Ch1 PID Set 1 (1) Ch1 PID Set 2 (2) Ch1 PID Set 3 (3) Ch1 PID Set 4 (4) Ch1 PID Set 5 (5) Ch2 PID Set 6 (1) Ch2 PID Set 7 (2) Ch2 PID Set 8 (3) Ch2 PID Set 9 (4) Ch2 PID Set 10 (5)	Tune Off (0)	305 324 r/w	Channel [1] [2] Active: Always (Channel 1). Active if controller is set to Dual Channel Ramping (Channel 2).
<b>Autotune PID Cascade</b>					
Main > Operations > Autotune PID > <b>Cascade</b>					
<b>Cascade Inner Loop</b>	Select which PID parameters will be automatically tuned.	Tune Off (0) Inner Loop PID Set 1 (1) Inner Loop PID Set 2 (2) Inner Loop PID Set 3 (3) Inner Loop PID Set 4 (4) Inner Loop PID Set 5 (5)	Tune Off (0)	305 r/w	Active if Analog Input 3 Control Type is set to Cascade.
<b>Cascade Outer Loop</b>	Select which PID parameters will be automatically tuned.	Tune Off (0) Outer Loop PID Set 1 (1) Outer Loop PID Set 2 (2) Outer Loop PID Set 3 (3) Outer Loop PID Set 4 (4) Outer Loop PID Set 5 (5)	Tune Off (0)	343 r/w	Active if Analog Input 3 Control Type is set to Cascade.
<b>Edit PID</b>					
Main > Operations > <b>Edit PID</b>					
<b>PID Set x (1 to 5)* (Optional Inner Loop)</b>					
Main > Operations > Edit PID > PID Set Channel 1 > <b>PID Set x (1 to 5)</b>					
<b>Proportional Band x (A or B)</b>	Define the proportional band for PID control.	0 to 30000 (0 to 30000)	25°F (25) 14°C (14)	1A 1B Set 500 550 [1] 510 560 [2] 520 570 [3] 530 580 [4] 540 590 [5] r/w	Active: Always (Channel 1). °F Default for US °C Default for SI
<b>Integral x (A or B)</b>	Set the integral time in minutes.	0.00 to 300.00 minutes (0 to 30000)	0 minutes (0)	1A 1B Set 501 551 [1] 511 561 [2] 521 571 [3] 531 581 [4] 541 591 [5] r/w	Active if PID Units (Setup Page) is set to SI and Proportional Band is not set to 0.
<b>Reset x (A or B)</b>	Set the reset time in repeats per minute.	0.00 per minute to 99.99 per minute (0 to 9999)	0 per minute (0)	1A 1B Set 502 552 [1] 512 562 [2] 522 572 [3] 532 582 [4] 542 592 [5] r/w	Active if PID Units (Setup Page) is set to U.S. and Proportional Band is not set to 0.
<b>Derivative x (A or B)</b>	Set the derivative time.	0.00 to 9.99 minutes (0 to 999)	0.00 minutes (0)	1A 1B Set 503 553 [1] 513 563 [2] 523 573 [3] 533 583 [4] 543 593 [5] r/w	Active if PID Units (Setup Page) is set to SI and Proportional Band is not set to 0.

\*This section is also applicable for Cascade Inner Loop.

✓NOTE: For more information about how parameter settings affect the controller's operation, see the Features Chapter.

# Operations Page Parameter Table

Parameter	Description	Range (Modbus Value)	Default	Modbus Register			Conditions for Parameters to Appear
				read/write	I/O, Set, Ch		
<b>Rate x (A or B)</b>	Set the rate time.	0.00 to 9.99 minutes (0 to 999)	0.00 minutes (0)	1A 504 514 524 534 544 r/w	1B 554 564 574 584 594	Set [1] [2] [3] [4] [5]	Active if PID Units (Setup Page) is set to U.S. and Proportional Band is not set to 0.
<b>Dead Band x (A or B)</b>	Define the effective shift in the heating and cooling set points to prevent conflict.	0 to 30000 (0 to 30000)	0 (0)	1A 505 515 525 535 545 r/w	1B 555 565 575 585 595	Set [1] [2] [3] [4] [5]	Active if Proportional Band is not set to 0 and one output is set to heat and the other to cool (Setup Page).
<b>Hysteresis x (A or B)</b>	Define the process variable change from the set point re-quired to re-energize the output (in on-off mode).	1 to 30000 (1 to 30000)	3 (3)	1A 507 517 527 537 547 r/w	1B 557 567 577 587 597	Set [1] [2] [3] [4] [5]	Active if Proportional Band is set to 0 and one channel is set to heat and the other to cool (Setup Page).

## PID Set x (6 to 10)

Main > Operations > Edit PID > PID Set Channel 2 > **PID Set x (6 to 10)**

<b>Proportional Band x (A or B)</b>	Set the proportional band.	0 to 30000 (1 to 30000)	25°F (25) 14°C (14)	2A 2500 2510 2520 2530 2540 r/w	2B 2550 2560 2570 2580 2590	Set [6] [7] [8] [9] [10]	Active: Always (Channel 1).
<b>Integral x (A or B)</b>	Set the integral time in minutes.	0.00 to 99.99 minutes (0 to 9999)	0 minutes (0)	2A 2501 2511 2521 2531 2541 r/w	2B 2551 2561 2571 2581 2591	Set [6] [7] [8] [9] [10]	Active if PID Units (Setup Page) is set to SI and Proportional Band is not set to 0.
<b>Reset x (A or B)</b>	Set the reset time in repeats per minute.	0.00 per minute to 99.99 per minute (0 to 9999)	0 per minute (0)	2A 2502 2512 2522 2532 2542 r/w	2B 2552 2562 2572 2582 2592	Set [6] [7] [8] [9] [10]	Active if PID Units (Setup Page) is set to U.S. and Proportional Band is not set to 0.
<b>Derivative x (A or B)</b>	Set the derivative time.	0.00 to 9.99 minutes (0 to 999)	0.00 minutes (0)	2A 2503 2513 2523 2533 2543 r/w	2B 2553 2563 2573 2583 2593	Set [6] [7] [8] [9] [10]	Active if PID Units (Setup Page) is set to SI and Proportional Band is not set to 0.
<b>Rate x (A or B)</b>	Set the rate time.	0.00 to 9.99 minutes (0 to 999)	0.00 minutes (0)	2A 2504 2514 2524 2534 2544 r/w	2B 2554 2564 2574 2584 2594	Set [6] [7] [8] [9] [10]	Active if PID Units (Setup Page) is set to U.S. and Proportional Band is not set to 0.

✓ **NOTE:** Press the Information Key  for more task-related tips.

# Operations Page Parameter Table

Parameter	Description	Range (Modbus Value)	Default	Modbus Register read/write [I/O, Set, Ch]	Conditions for Parameters to Appear
<b>Dead Band x (A or B)</b>	Define the effective shift in the heating and cooling set points to prevent conflict.	0 to 30000 (1 to 30000)	0 (0)	2A 2B Set 2505 2555 [6] 2515 2565 [7] 2525 2575 [8] 2535 2585 [9] 2545 2595 [10] r/w	Active if Proportional Band is not set to 0 and one output is set to heat and the other to cool (Setup Page).
<b>Hysteresis x (A or B)</b>	Define the process variable change from the set point required to re-energize the output (in on-off mode).	1 to 30000 (1 to 30000)	3 (3)	2A 2B Set 2507 2557 [6] 2517 2567 [7] 2527 2577 [8] 2537 2587 [9] 2547 2597 [10] r/w	Active if Proportional Band is set to 0 and one channel is set to heat and the other to cool (Setup Page).
<b>Cascade Outer Loop PID Set x (1 to 5)</b>					
<b>Main &gt; Operations &gt; Edit PID &gt; Cascade Outer Loop PID Set X (1 to 5)</b>					
<b>Proportional Band x (A or B)</b>	Define the proportional band for PID control.	0 to 30000 (0 to 30000)	25°F (25) 14°C (14)	1A 1B Set 2600 2650 [1] 2610 2660 [2] 2620 2670 [3] 2630 2680 [4] 2640 2690 [5] r/w	Active: Always (Channel 1). °F Default for US °C Default for SI
<b>Integral x (A or B)</b>	Set the integral time in minutes.	0.00 to 99.99 minutes (0 to 9999)	0 minutes (0)	1A 1B Set 2601 2651 [1] 2611 2661 [2] 2621 2671 [3] 2631 2681 [4] 2641 2691 [5] r/w	Active if PID Units (Setup Page) is set to SI and Proportional Band is not set to 0.
<b>Reset x (A or B)</b>	Set the reset time in repeats per minute.	0.00 per minute to 99.99 per minute (0 to 9999)	0 per minute (0)	1A 1B Set 2602 2652 [1] 2612 2662 [2] 2622 2672 [3] 2632 2682 [4] 2642 2692 [5] r/w	Active if PID Units (Setup Page) is set to U.S. and Proportional Band is not set to 0.
<b>Derivative x (A or B)</b>	Set the derivative time.	0.00 to 9.99 minutes (0 to 999)	0.00 minutes (0)	1A 1B Set 2603 2653 [1] 2613 2663 [2] 2623 2673 [3] 2633 2683 [4] 2643 2693 [5] r/w	Active if PID Units (Setup Page) is set to SI and Proportional Band is not set to 0.
<b>Rate x (A or B)</b>	Set the rate time.	0.00 to 9.99 minutes (0 to 999)	0.00 minutes (0)	1A 1B Set 2604 2654 [1] 2614 2664 [2] 2624 2674 [3] 2634 2684 [4] 2644 2694 [5] r/w	Active if PID Units (Setup Page) is set to U.S. and Proportional Band is not set to 0.
<b>Dead Band x (A or B)</b>	Define the effective shift in the heating and cooling set points to prevent conflict.	0 to 30000 (0 to 30000)	0 (0)	1A 1B Set 2605 2655 [1] 2615 2665 [2] 2625 2675 [3] 2635 2685 [4] 2645 2695 [5] r/w	Active if Proportional Band is not set to 0 and one output is set to heat and the other to cool (Setup Page).

✓NOTE: For more information about how parameter settings affect the controller's operation, see the Features Chapter.

## Operations Page Parameter Table

Parameter	Description	Range (Modbus Value)	Default	Modbus Register read/write [I/O, Set, Ch]	Conditions for Parameters to Appear
<b>Hysteresis x (A or B)</b>	Define the process variable change from the set point required to re-energize the output (in on-off mode).	1 to 30000 (1 to 30000)	3 (3)	1A 1B Set 2607 2657 [1] 2617 2667 [2] 2627 2677 [3] 2637 2687 [4] 2647 2697 [5] r/w	Active if Proportional Band is set to 0 and one channel is set to heat and the other to cool (Setup Page).

### Alarm Set Points

#### Main > Operations > Alarm Set Points

<b>Alarm 1 Low SP</b>	Set low value at which alarm is triggered.	<per sensor> to Alarm 1 High Set Point	<per sensor>	302 r/w	Active if Alarm 1 Type (Setup Page) is set to Process.
<b>Alarm 1 High SP</b>	Set high value at which alarm is triggered.	<per sensor> to Alarm 1 Low Set Point	<per sensor>	303 r/w	Active if Alarm 1 Type (Setup Page) is set to Process.
<b>Alarm 1 Low Deviation</b>	Set the deviation below set point 1 that will trigger an alarm.	-19999 to -1 (-1 to 19999)	-999 (-999)	302 r/w	Active if Alarm 1 Type (Setup Page) is set to Deviation.
		-.1 to -1999.9 (-1 to 19999)	-99.9 (999)		Active if decimal is set to 0.0.
<b>Alarm 1 High Deviation</b>	Set the deviation above set point 1 that will trigger an alarm.	1 to 30000 (1 to 30000)	999 (999)	303 r/w	Active if Alarm 1 Type (Setup Page) is set to Deviation.
		.1 to 3000.0 (1 to 30000)	99.9 (999)		Active if decimal is set to 0.0
<b>Alarm 2 Low SP</b>	Set low value at which alarm is triggered.	<per sensor> to Alarm 2 High Set Point	<per sensor>	321 r/w	Active if Alarm 2 Type (Setup Page) is set to Process.
<b>Alarm 2 High SP</b>	Set high value at which alarm is triggered.	<per sensor> to Alarm 2 Low Set Point	<per sensor>	322 r/w	Active if Alarm 2 Type (Setup Page) is set to Process.
<b>Alarm 2 Low Deviation</b>	Set the deviation below set point 2 that will trigger an alarm.	-19999 to -1 (-1 to -19999)	-999 (-999)	321 r/w	Active if Alarm 2 Type (Setup Page) is set to Deviation.
		-.1 to -1999.9 (-1 to -19999)	-99.9 (-999)		Active if decimal is set to 0.0
<b>Alarm 2 High Deviation</b>	Set the deviation above set point 2 that will trigger an alarm.	0 to 30000 (0 to 30000)	999 (999)	322 r/w	Active if Alarm 2 Type (Setup Page) is set to Deviation.

# Operations Page Parameter Record

Make a photocopy of this page and enter your settings on that copy.

Name \_\_\_\_\_

Date \_\_\_\_\_

<b>PID Set Chan 1 Menu or Cascade Inner Loop</b>	<b>PID Set 1</b>	<b>PID Set 2</b>	<b>PID Set 3</b>	<b>PID Set 4</b>	<b>PID Set 5</b>
Proportional Band A					
IntegralA / ResetA					
DerivativeA / RateA					
Dead Band A					
Hysteresis A					
Proportional Band B					
IntegralB / ResetB					
DerivativeB / RateB					
Dead Band B					
Hysteresis B					
<b>PID Set Chan 2 Menu</b>	<b>PID Set 6</b>	<b>PID Set 7</b>	<b>PID Set 8</b>	<b>PID Set 9</b>	<b>PID Set 10</b>
Proportional Band A					
IntegralA / ResetA					
DerivativeA / RateA					
Dead Band A					
Hysteresis A					
Proportional Band B					
IntegralB / ResetB					
DerivativeB / RateB					
Dead Band B					
Hysteresis B					
<b>Cascade Outer Loop</b>	<b>PID Set 1</b>	<b>PID Set 2</b>	<b>PID Set 3</b>	<b>PID Set 4</b>	<b>PID Set 5</b>
Proportional Band A					
IntegralA / ResetA					
DerivativeA / RateA					
Dead Band A					
Proportional Band B					
IntegralB / ResetB					
DerivativeB / RateB					
Dead Band B					
<b>Alarm Set Point Menu</b>	<b>Alarm 1</b>	<b>Alarm 2</b>			
Low Set Point					
High Set Point					
Lo Deviation					
Hi Deviation					

# Notes



# Chapter Four: Profile Programming

What is a Ramping Profile? . . . . .	4.2
Step Types . . . . .	4.2
Profile Plan Checklist . . . . .	4.3
How to Program a New Profile . . . . .	4.4
How to Edit a Profile . . . . .	4.6
User Profile Record . . . . .	4.7
A Sample Application . . . . .	4.8
Frequently Asked Questions . . . . .	4.10
Profiles Page Map . . . . .	4.11
Profiles Page Parameter Table . . . . .	4.12

## Overview

This chapter explains how to program a ramp-and-soak profile so that it will be stored in the Series F4 memory.

- The first section explains profiles, steps and step types.
- The second section explains how to name and program a ramping profile. The Series F4 presents a sequence of questions that prompt you to define the steps and the step properties. While reading this section, refer to the profile already embedded in the Series F4 software. You can use this profile, Military Standard Test 810 (MILSTD 810D), as a template and learning tool.
- The third section explains how to edit and delete an existing profile. In the Series F4, you

✓ **NOTE:**

*For more information about how parameter settings affect the controller's operation, see the Features Chapter.*

✓ **NOTE:**

*If your Series F4 is a single-channel controller, you will see only the temperature on Channel 1 of the embedded profile. This is not the true Military Standard Test 810D.*

choose from a list of the steps and their parameters, much like in previous controllers.

- You will also find a User Profile Record to use to record the steps and parameters for your profiles.

If you receive this controller as a separate unit, you will have to install, wire and configure the Series F4 before you set up a ramping profile.

If you receive this controller already installed in an environmental chamber, furnace or other equipment, continue with this chapter. You will not have to configure the controller if the manufacturer has done this for you. You should check the Setup Page in the controller software for settings of relevant inputs and outputs.

✓ **NOTE:**

*Make sure your controller inputs are properly configured before entering profiles. Analog Input setup changes may delete profiles.*

# What Is a Ramping Profile?

A **ramp** is a programmed change from one set point to another. A **soak** maintains the set point over a period of time.

A **profile** is a set of instructions programmed as a sequence of steps. The controller handles the profile steps automatically, in sequence. As many as 40 different profiles and a total of 256 steps can be stored in the Series F4's non-volatile memory.

The 256 steps are grouped by profile. So, one profile could have 256 steps; or 39 profiles could have 6 steps and one could have 22; or 32 profiles could have eight steps each. The maximum number of steps is 256, and the maximum number of profiles is 40.

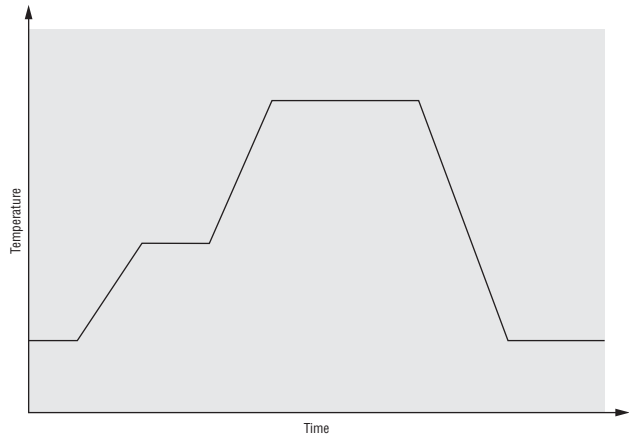

Figure 4.2 — An eight-step profile, as it might be logged on a chart recorder.

## Step Types — Building Blocks of Profiles

Six types of steps are available in the Series F4. They are the building blocks of ramping profiles.

Use the six step types to create simple or complex profiles involving all inputs and outputs. The Series F4 prompts you to define each step's properties, listed below.

- Autostart
- Ramp Time
- Ramp Rate
- Soak
- Jump
- End

2. Event outputs to turn on or off (if digital outputs are set up as events in the Setup Page);
3. Time (in hours, minutes and seconds);
4. Channel 1 Set Point;
5. Channel 2 Set Point (if dual channel);
6. PID set (one of five sets of heat/cool PID parameters per channel, pre-defined in the Operations Page);
7. Guaranteed Soak (requires the actual process value to stay within the Soak Band as set in the System Menu).

### Autostart

Autostart pauses a profile until the specified date or day, and time (of a 24-hour-clock). Define the Autostart by choosing:

1. Day (of the week) or Date,
2. Time

Note: To invoke an Autostart step in a profile, you must activate the profile via the Profile Key and select the Autostart step.

### Ramp Time

Ramp Time changes the set point to a new value in a chosen period of time. Ramp Time is the same for both channels of a dual-channel controller. Define the Ramp Time step by choosing:

1. Wait for an event or process value;  
(Wait for Events are set up in the Setup Page.)

### Ramp Rate

Ramp Rate (for single channel only) changes the set point to a new value at a chosen rate. Define the Ramp Rate step by choosing:

1. Wait for an event or process value;  
(Wait for Events are set up in the Setup Page.)
2. Event outputs to turn on or off (if digital outputs are set up as events in the Setup Page);
3. Rate (units per minute);
4. Channel 1 Set Point;
5. PID set (one of five sets of heat/cool PID parameters, pre-defined in the Operations Page);
6. Guaranteed Soak (requires the actual process value to stay within the Soak Band as set in the System Menu).



## Soak

Soak maintains the set point from the previous step for a chosen time in hours, minutes and seconds. Define the Soak step by choosing:

1. Wait for an event or process value;  
(Wait for Events are set up in the Setup Page.)
2. Event outputs to turn on or off (if digital outputs are set up as events in the Setup Page);
3. Time;
4. PID set (one of five sets of heat/cool PID parameters per channel, pre-defined in the Operations Page); or
5. Guaranteed Soak (requires the actual process value to stay within the Soak Band as set in the System Menu).

## Jump

Jump initiates another step or profile. Define the Jump step by choosing:

1. Profile to jump to;
2. Step to jump to; and
3. Number of Repeats.

### ✓NOTE:

If a **power out condition** occurs during a profile and more than 20 jump steps are stored in the F4's Profile Program memory, the controller will terminate the profile and turn off all outputs if Continue, Hold or Terminate was selected as the Power Out action. If Profile Reset or Go to Idle Set Point was selected, the controller will take those actions. A pop-up message will warn of this when the 21st jump step is programmed

## End

End terminates the profile in a chosen state. All profiles must have an End step. It cannot be deleted or changed to another step type. Define the End by choosing:

- End with Hold, Control Off, All Off or Idle end state.

## Another Option: Wait For

Wait For is not a step type, but Ramp Time, Ramp Rate and Soak steps can be programmed to wait for events and processes. This means the wait conditions must be satisfied before the time clock and the step activity proceeds.

If the step is to wait for an analog input, the actual

process value must arrive at or cross the specified value before the step proceeds.

Digital inputs must first be configured in the Setup Page as Wait for Events, with the condition to be met also specified. Then, to wait for this digital input, you must specify On, meaning the condition as configured in the Setup Page, or Off, meaning the opposite of that condition.

## Profile Plan Checklist

**1. Configure the controller** (Setup Page) to provide the right foundation for the profile:

- Set the appropriate input sensor ranges and limits (Input Menus).
- Establish digital inputs and outputs as events if required (Digital Input and Output Menus).
- Set the guaranteed soak band (System Menu).
- Decide the controller response to a power-out situation (System Menu).
- Choose Celsius or Fahrenheit (System Menu) scale.
- If Setup Page values have not been recorded, note them on the Setup Page Parameter Record in the Setup Chapter.

**2. Check the Operations Page:**

- If defaults are not acceptable, establish PID values (through the Autotune or Edit PID Menu).
- Set the alarm set points (Alarm Set Points Menu).

**3. Plan the profile on paper.** The User Profile Record (later in this chapter) will give you a framework for your plan.

**4. Program the profile.** Make sure the User Profile Record is an accurate record of the program.

**5. Store the Setup Page Parameter Record** along with the User Profile Record to document your programmed settings.

# How to Program a New Profile

The Series F4 uses a question-and-answer format to prompt you to define the steps and step types of a new profile. Here's how:

## 1. Go to the Profiles Page.





Move the cursor to Go to Profiles (at the bottom of the Main Page), then press the Right Key  .

## 2. Create a new profile.

Press  .

## 3. Name the profile.

Unless the equipment manufacturer has locked out this function, you can name your profiles for easy reference. (Names can have up to 10 characters.) To name a profile,

- Press  to enter the name space and the first position.
- Press the Up or Down Key   to scroll through the alphabet and choose the letter or number. (See Chapter 2, Navigation, for the character selections available.)
- Press  to move to the next position.
- Continue until the name is complete, or until you move through the name space into the next screen.
- Enter  to save the name of the profile. This name will be stored in the Series F4's memory and will appear on the Main Page when you run the profile.

## 4. Choose the step type.

There are six step types, each of which must be defined through different parameters. (See "Step Types," earlier in this chapter.)

## 5. Define each step type.

The Series F4 prompts you to define the parameters of each step type. For example, when you choose Ramp Time, the Profile Guide asks:

- if you want the step to wait for an event or process input before starting;
- whether events outputs are on or off (digital outputs must be set up as events in the Setup Page);

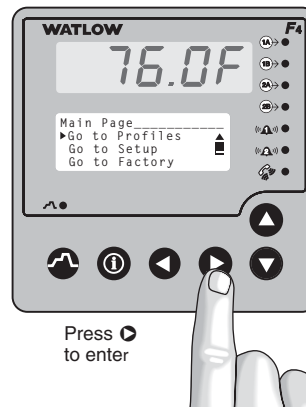

```
Main>Profile_____
>Create Profile
  Edit Profile
  Delete Profile
```

```
Choose to Name:_____
  No
>Yes
```

```
Enter Profile Name: _
ALUMINUM8
▲▼ Adjusts Char
  < Back      > Next
```

```
Choose Step1 Type: __
  Autostart
>Ramp Time      ■
  Ramp Rate     ▼
```

```
Choose to wait: _____
>Step does not wait
  Step waits for...
```



# How to Edit a Profile

To change one or more parameters in any step of a profile, choose Edit Profile on the Profiles Page.

## 1. Go to the Profiles Page.

Move the cursor to Go to Profile (at the bottom of the Main Page), then press **▶** .

## 2. Choose to edit a profile.

Press **▶** .

```
Main>Profile_____▶
  Create Profile
>Edit Profile
  Delete Profile
```

## 3. Choose the profile you want to edit.

Press **▶** .

```
...Edit Profile_____▶
>Glaze 42          ▲
  Glaze 43          ■
  Glaze 56          ▼
```

## 4. Choose how you change the profile.

Choose whether you want to insert a new step, edit a specific step or delete a step.

### To edit a step:

- Select the number of the step you wish to edit from a list of steps and step types.
- The next screen presents a list of all possible step types. The cursor will be positioned on the current step type. To keep it, press **▶** and make your changes to the properties listed on succeeding screens.
- If you choose to change a Step Type, the Series F4 will prompt you to program all necessary parameters.

```
Choose to:_____▶
  Insert Step
>Edit Step
  Delete Step
```

### To insert a step:

Move the cursor to the number of the step that the new step will precede. Press **▶** . The Series F4 will prompt you to program all necessary parameters of the new step. Inserting a step changes the numbers of all steps that follow.

### To delete a step:

Move the cursor to the number of the step to be deleted. Press **▶** . Deleting a step changes the numbers of all steps that follow.

A Jump Step that jumps to an End Step cannot be deleted.

```
Edit Step:_____▶
>Step 1 Autostart
  Step 2 Ramp Time  ■
  Step 3 Soak       ▼
```

### ✓NOTE:

*Inserting a step changes the numbers of all steps that follow.*



# A Sample Application: Environmental Testing

## Programming a Profile

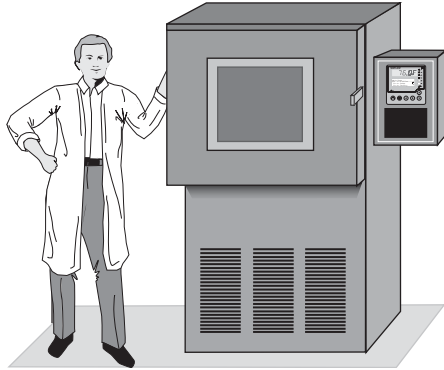

This profile is embedded in the Series F4 software for use as a teaching tool and as a template. To see how it is programmed in steps, and how each step is defined, go to the Profiles Page, choose Edit Profile and open MILSTD 810D.

If your Series F4 is a single-channel controller, you will see only the temperature on Channel 1. This is NOT the true Military Standard Test 810D.

To test its customers' navigational equipment, Ajax Testing Co. selected a version of Military Standard Test 810D, which is often used to test navigational or other military equipment under hot, humid conditions. The full test requires a two-channel controller to manipulate both temperature and humidity in an environmental chamber.

### Andy planned his profile on the User Profile Record,

after checking the Setup Page to make sure the controller's inputs, outputs, limits and ranges were configured properly. Andy then programmed the profile into the Series F4.

## Military Standard 810D

<b>Step 1:</b>	<b>Ramp Time</b>	Initialize the set point for channels 1 and 2.
<b>Step 2:</b>	<b>Soak</b>	Wait for channels 1 and 2 process values to reach their set points before the test proceeds.
<b>Step 3:</b>	<b>Soak</b>	To ensure that the equipment temperature has stabilized, expose the equipment in the chamber to a temperature of 88°F and an RH of 88% for five hours.
<b>Steps 4 to 11:</b>	<b>Ramp Time</b>	The test calls for a programmed increase in temperature and decrease in relative humidity over a period of eight hours.
<b>Step 12:</b>	<b>Soak</b>	Expose the equipment in the chamber to a temperature of 105°F and an RH of 59% for three hours.
<b>Steps 13 to 19:</b>	<b>Ramp Time</b>	The test calls for a programmed decrease in temperature and increase in relative humidity over a period of seven hours.
<b>Step 20:</b>	<b>Jump</b>	Jump to step 3 and repeat steps 3 to 20 twenty times.
<b>Step 21:</b>	<b>End</b>	End the profile and turn off all outputs.



Step Nbr	Step Type	Date/Day, Time	Wait for	Set Events								Time H M S	Rate	Set Pt 1	Set Pt 2	PID Set	Guar. Soak	Jump to Profile	Step	Repeats	End Step
				1	2	3	4	5	6	7	8										
1	Ramp Time													88°F	88%						
2	Soak		Process 1&2																		
3	Soak																				
4	Ramp Time													90°F	85%						
5	Ramp Time													93°F	80%						
6	Ramp Time													96°F	76%						
7	Ramp Time													98°F	73%						
8	Ramp Time													100°F	69%						
9	Ramp Time													102°F	65%						
10	Ramp Time													104°F	62%						
11	Ramp Time													105°F	59%						
12	Soak		Process 1&2																		
13	Ramp Time													102°F	65%						
14	Ramp Time													99°F	69%						
15	Ramp Time													97°F	73%						
16	Ramp Time													94°F	79%						
17	Ramp Time													91°F	85%						
18	Ramp Time													90°F	85%						
19	Ramp Time													89°F	88%						
20	Jump																3	20			
21	End																			All Off	

Figure 9a — Profile Chart for Military Standard 810D Test.

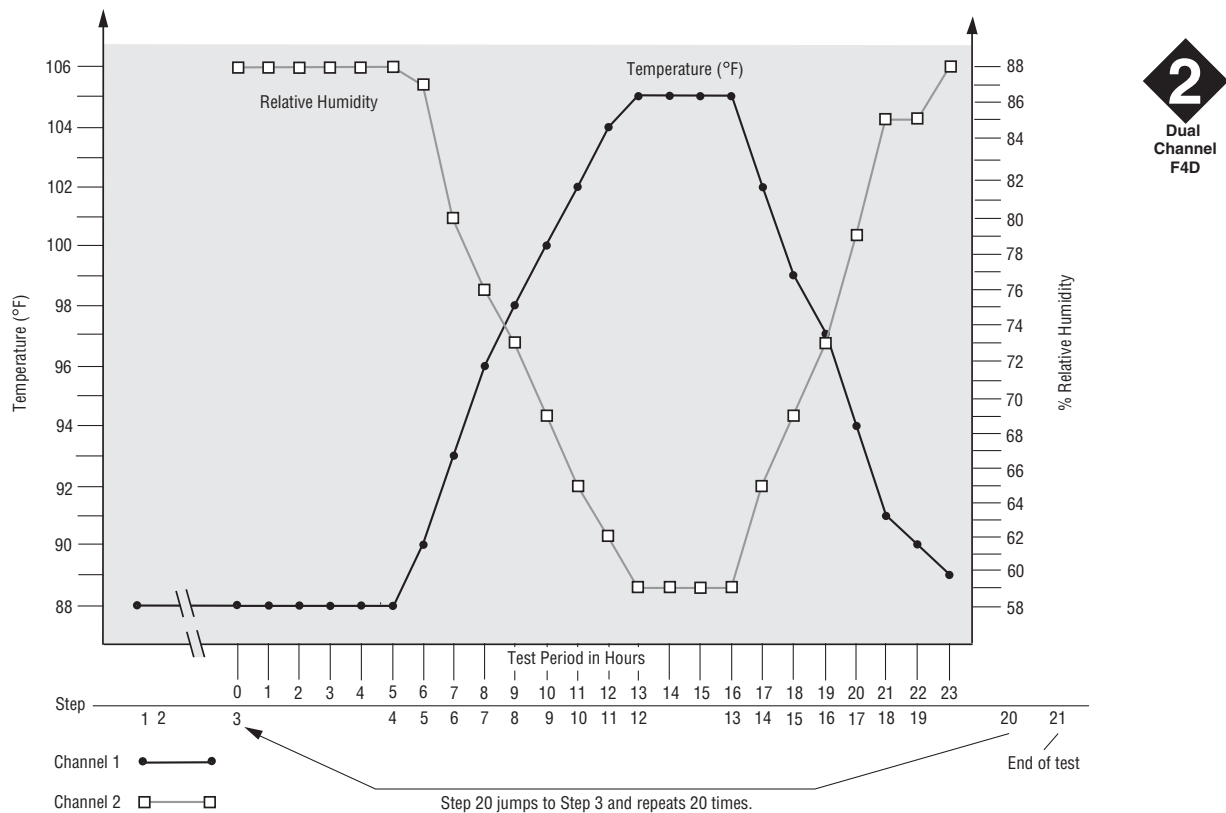

Figure 9b — Graph of Military Standard 810D Test.

# Frequently Asked Questions About Profiles

## 1. Why should I check the Setup Page before programming a profile?

Complex, sophisticated profile control is possible with the Series F4's two or three analog inputs, four digital inputs, four control outputs (two for a single-channel controller), two alarm outputs, two retransmit outputs and eight digital outputs, but they must be configured correctly. Don't assume that the controller has been set up correctly for the profile you want to program and run. Checking the Setup Page first will save time.

## 2. Why can't I program a Ramp Rate step on Channel 2?

Ramp Rate is available only on single-channel controllers.

## 3. Why can't I set the Channel 2 parameters?

Channel 2 parameters do not appear in single-channel controllers, or Input 2 is Off in a dual-channel controller.

## 4. Why can't I adjust the set point to get the value I want?

Check the configuration of the inputs (Setup Page) and the set point limits (Setup Page).

## 5. Why don't the digital inputs appear as Wait for conditions?

They must first be configured as events in the Setup Page.

## 6. Why can't I delete a particular step of my profile?

You cannot delete a step that another step jumps to, or a step that is an End step.

## 7. Why can't I delete the End step?

Because every profile must have an End step, and this End step is programmed into the profile. If you wish to add a step before the end, use the Insert Step command under the Edit Profiles Menu.

## 8. How do I start or run a profile?

You must be on the the Main Page to run a profile. Press the Profile Key, select the profile you want to run and choose the step you want to start on.

## 9. I just programmed the profile, but when I press the Profile Key nothing happens. What's wrong?

You must return to the Main Page before running a profile. The Profile Key does not function from any other page but the Main Page.

## 10. How do I know which profile is running?

When a profile is running, the profile name and current step number is displayed on the Main Page. You may have to scroll up or down to find this information.

## 11. Why can't I access certain pages, menus or parameters?

The parameters you are looking for may not be available in your model of controller.

The OEM that installed the F4 may have locked users out of certain pages and menus.

The F4's software may have been locked by a supervisor or someone else at your facility.

If a profile is running, you can enter only the Profiles Page.

# Profiles Page Map

```
Create Profile
  Name Profile
  Step x (1 to 256) Type
    Autostart
      Date
      Day
      Time
    Ramp Time
      Wait For
      Event Output (1 to 8)
      Time
      Ch1 SP
      Ch2 SP
      Ch1 PID Set x (1 to 5)
      Ch2 PID Set x (6 to 10)
      Guar. Soak1
      Guar. Soak2
    Ramp Rate
      Wait For
      Event Output (1 to 8)
      Rate
      Ch1 SP
      Ch1 PID Set x (1 to 5)
      Guar. Soak1
    Soak
      Wait For
      Event Output (1 to 8)
      Time
      Ch1 PID Set x (1 to 5)
      Ch2 PID Set x (6 to 10)
      Guar. Soak1
      Guar. Soak2
    Jump
      Jump to Profile x (1 to 40)
      Jump to Step x
      Number of Repeats
    End
      Hold
      Control Off
      All Off
      Idle
      Ch1 Idle Set Point
      Ch2 Idle Set Point
```

```
Edit Profile
  Profile x (1 to 40)
    Insert Step
      Insert Before Step x
      Step x (1 to 256) Type (see below)
    Edit Step
      Step x (1 to 256) Type
        Autostart
          Date
          Day
        Ramp Time
          Wait For
          Event Output (1 to 8)
          Time
          Ch1 SP
          Ch2 SP
          Ch1 PID Set x (1 to 5)
          Ch2 PID Set x (6 to 10)
          Guarantee Soak1
          Guarantee Soak2
        Ramp Rate
          Wait For
          Event Output (1 to 8)
          Rate
          Ch1 SP
          Ch1 PID Set x (1 to 5)
          Guarantee Soak1
        Soak
          Wait For
          Event Output (1 to 8)
          Time
          Ch1 PID Set x (1 to 5)
          Ch2 PID Set x (6 to 10)
          Guarantee Soak1
          Guarantee Soak2
        Jump
          Jump to Profile x (1 to 40)
          Jump to Step x
          Number of Repeats
        End
          Hold
          Control Off
          All Off
          Idle
          Ch1 Idle Set Point
          Ch2 Idle Set Point
      Delete Step
      Done
    Delete Profile
      Profile x (1 to 40)
    Re-Name Profile
      Profile x (1 to 40)
```

✓ **NOTE:**  
*Some parameters may not appear, depending on the model and configuration of the controller.*

## Profiles Page Parameter Table

Parameter	Description	Range (Modbus Value)	Default	Modbus Register read/write [I/O, Set, Ch]	Conditions for Parameters to Appear
<b>Autostart</b>					
...>Edit Profile > Profile x (1 to 40) > Edit Step > Step x (1 to 256) > <b>Autostart Step</b>					
<b>Date</b>	Set date to autostart.	M/D/Y	today's date	4004 [Date] or [Day]	Active: Always.
		[Date] (0) [Day] (1) [mo] (1 to 12) [day] (1 to 31) [yr] (1998 to 2035)		4005 [mo] 4006 [day] 4007 [yr] r/w	
<b>Day</b>	Set day of the week to autostart.	Every Day (0)	Every Day (0)	4008 r/w	Active: Always.
		Sunday (1) Monday (2) Tuesday (3) Wednesday (4) Thursday (5) Friday (6) Saturday (7)			
<b>Time</b>	Set time to autostart.	00:00:00 to 23:59:59	00:00:00	4009 4010	Active: Always.
		[h] (0 to 23) [m] (0 to 59) [s] (0 to 59)	[h] (0) [m] (0) [s] (0)	4011 r/w	
<b>Ramp Time or Ramp Rate or Soak Step</b>					
...>Edit Profile > Profile x (1 to 40) > Edit Step > Step x (1 to 256) > <b>Ramp Time or Ramp Rate or Soak Step</b>					
<b>Wait for</b>	Wait for an event or process value. (Digital inputs must be configured in the Setup Page before they can be used here.) The F4 can be programmed to wait for up to 4 event inputs and 3 analog inputs.	Step does not wait (0)	Step does not wait (0)	4012 r/w	Active if digital inputs are configured as wait for events.
		Step waits for...(1)		4103 r	
<b>Event Output</b>	Turn an event output on or off. (Digital outputs must be configured in the Setup Page before they can be used here. Verify that the setup matches events.)	Digital Outputs 1 to 8			Active if digital outputs are configured as events.
		Off (0) On (1)		4030 r/w [1] 4111 r [1] 4031 r/w [2] 4112 r [2] 4032 r/w [3] 4113 r [3] 4033 r/w [4] 4114 r [4] 4034 r/w [5] 4115 r [5] 4035 r/w [6] 4116 r [6] 4036 r/w [7] 4117 r [7] 4037 r/w [8] 4118 r [8]	

✓ **NOTE:** To edit profiles through serial communications, see p. 7.17,

✓ **NOTE:** Two sets of Modbus registers contain profile information: In edit mode, the number of the profile being edited is at 4000, and the number of the step being edited is at 4001. When the profile is running, the number of the profile being run is at 4100, and the number of the step being run is at 4101. All run addresses are read only.

# Profiles Page Parameter Table

Parameter	Description	Range (Modbus Value)	Default	Modbus Register read/write [I/O, Set, Ch]	Conditions for Parameters to Appear
<b>Time</b>	Set the time in hours, minutes and seconds.	00:00:01 to 99:59:59 [h] (0 to 99) [m] (0 to 59) [s] (0 to 59)	00:00:01 (0) (0) (1)	4009 r/w [h] 4119 r [h] 4010 r/w [m] 4120 r [m] 4011 r/w [s] 4121 r [s]	Active if Step is set to Ramp Time or Soak.
<b>Rate</b>	Select the rate of change by entering degrees per minute.	.1 to 3,000.0 degrees per minute (1 to 30000)	.1	4043 r/w	Active if Step is set to Rate and controller is not Dual Channel.
<b>Set Point Channel 1</b>	Set the target for the Channel 1 process value (temperature, etc.) at the end of this step.	Set point low limit to set point high limit	75 (75)	4044 r/w 4122 r	Active if Step is set to Time or Rate.
<b>Set Point Channel 2</b>	Set the target for the Channel 2 process value (temperature, etc.) at the end of this step.	Set point low limit to set point high limit	75 (75)	4045 r/w 4123 r	Active if Step is set to Time and controller is Dual Channel.
<b>PID Set</b>	Select the PID set for each channel.	Channel 1 PID 1 to 5 Channel 2 PID 6 to 10 [1] (0 to 4) [2] (0 to 4)	[1] (0) [2] (0)	4046 r/w [1] 4124 r [1] 4047 r/w [2] 4125 r [2]	Active: Always.
<b>Guarantee Soak</b>	Select this feature.	No (0) Yes (1)	No (0)	4048 r/w [1] 4049 r/w [2]	Active: Always.
<b>Wait for:</b>					
... > Profile (1 to 40) > Edit Step > Step x (1 to 256) > Ramp Time or Ramp Rate or Soak Step > <b>Wait for:</b>					
<b>Step Does/Does Not Wait</b>	Do not wait for any condition.	Does not wait (0) Wait for (1)	—	4012 r/w	—
<b>Step Wait For...</b>	Wait for the chosen condition.	Event Input x (1 to 4) Analog Input x (1 to 3)		4012 r/w	Active: Always.

✓ **NOTE:** Two sets of Modbus registers contain profile information: In edit mode, the number of the profile being edited is at 4000, and the number of the step being edited is at 4001. When the profile is running, the number of the profile being run is at 4100, and the number of the step being run is at 4101. All run addresses are read only.

✓ **NOTE:** For more information about how parameter settings affect the controller's operation, see the Features Chapter.

## Profiles Page Parameter Table

Parameter	Description	Range (Modbus Value)	Default	Modbus Register read/write [I/O, Set, Ch]	Conditions for Parameters to Appear
<b>Event Input x (1 to 4)</b>	Select whether or not to wait for a digital signal to initiate this step.	Don't Wait (0)	Don't Wait (0)	Input	Active if the selected Event Input is Enabled.
		Wait for Off (1)		4013 r/w [1]	
		Wait for On (2)		4104 r [1]	
				4014 r/w [2]	
				4105 r [2]	
				4015 r/w [3]	
				4106 r [3]	
				4016 r/w [4]	
		4107 rw [4]			
<b>Analog Input x (1 to 3)</b>	Select whether or not to wait for a process value to initiate this step.	Don't Wait (0)	Don't Wait (0)	4021 r/w [1]	Active if the selected Analog Input is present (Analog Input 1 always is).
		Wait (1)		4108 r [1]	
				4023 r/w [2]	
				4109 r [2]	
				4025 r/w [3]	
				4110 r [3]	
<b>Analog Input x (1 to 3)</b>					
... > Ramp Time or Ramp Rate or Soak Step > Wait for: > To Wait for > <b>Analog Input x (1 to 3)</b>					
<b>Enter Analog Input x</b>	Select the process value that will initiate this step.	Range Low to Range High	Follow input selected	Input	Active: Always.
				4022 r/w [1]	
				4024 r/w [2]	
				4026 r/w [3]	
<b>Event Output</b>					
... > Edit Step > Step x (1 to 256) > Ramp Time or Ramp Rate or Soak Step > <b>Event Output</b>					
<b>Output x (1 to 8)</b>	Select this Digital Output to be on or off.	Off (0)	Off (0)	Output	Active if the associated Digital Output is set to Event.
		On (1)		4030 r/w [1]	
				4111 r [1]	
				4031 r/w [2]	
				4112 r [2]	
				4032 r/w [3]	
				4113 r [3]	
				4033 r/w [4]	
				4114 r [4]	
				4034 r/w [5]	
				4115 r [5]	
				4035 r/w [6]	
				4116 r [6]	
				4036 r/w [7]	
				4117 r [7]	
				4037 r/w [8]	
		4118 r [8]			



### WARNING:

Check the configuration of the controller on the Setup Page before starting and running a profile (if the Setup Page is not locked). Make sure settings are appropriate to the profile. If the Setup Page is accessible, failure to check the configuration before running a profile could result in damage to equipment and/or property, and/or injury or death to personnel.

✓ **NOTE:** Two sets of Modbus registers contain profile information: In edit mode, the number of the profile being edited is at 4000, and the number of the step being edited is at 4001. When the profile is running, the number of the profile being run is at 4100, and the number of the step being run is at 4101. All run addresses are read only.

# Profiles Page Parameter Table

Parameter	Description	Range (Modbus Value)	Default	Modbus Register read/write [I/O, Set, Ch]	Conditions for Parameters to Appear
<b>PID Set</b>					
... > Profile x (1 to 40) > Edit Step > Step x (1 to 256) > Ramp Time or Ramp Rate or Soak Step > <b>PID Set</b>					
<b>Channel 1</b>	Select a PID set for channel 1.	PID Set 1 (0)	PID Set 1 (0)	4046 r/w 4124 r	Active: Always.
		PID Set 2 (1)			
		PID Set 3 (2)			
		PID Set 4 (3)			
		PID Set 5 (4)			
<b>Channel 2</b>	Select a PID set for channel 2.	PID Set 6 (0)	PID Set 6 (0)	4047 r/w 4125 r	Active if controller is Dual Channel.
		PID Set 7 (1)			
		PID Set 8 (2)			
		PID Set 9 (3)			
		PID Set 10 (4)			
<b>Jump</b>					
Main > Profiles > Edit Profile > Profile x (1 to 40) > Edit Step > Step x (1 to 256) > <b>Jump Step</b>					
<b>Jump To Profile</b>	Select name or number of profile to jump to.	1 to 40 or name (1 to 40)	—	4050 r/w	—
<b>Step x (1 to 256)</b>		1 to 256 (1 to 256)	1 (1)	4051 r/w	Active: Always.
<b>Number of Repeats*</b>	Set number of times to repeat the chosen Jump.	1 to 999 (1 to 999)	1 (1)	4052 r/w	Active: Always.
<b>End</b>					
Main > Profiles > Edit Profile > Profile x (1 to 40) > Edit Step > Step x (1 to 256) > <b>End</b>					
<b>Action</b>	Select what state the controller will be in at the end of the profile.	Hold (0)	All Off (2)	4060 r/w	Active: Always.
		Control Off (1)			
		All Off (2)			
		Idle (3)			

**\*✓ NOTE:**

If a **power out condition** occurs during a profile and more than 20 jump steps are stored in the F4's Profile Program memory, the controller will terminate the profile and turn off all outputs if Continue, Hold or Terminate was selected as the Power Out action. If Profile Reset or Go to Idle Set Point was selected, the controller will take those actions. A pop-up message will warn of this when the 21st jump step is programmed

✓ NOTE: Two sets of Modbus registers contain profile information: In edit mode, the number of the profile being edited is at 4000, and the number of the step being edited is at 4001. When the profile is running, the number of the profile being run is at 4100, and the number of the step being run is at 4101. All run addresses are read only.

✓ NOTE: For more information about how parameter settings affect the controller's operation, see the Features Chapter.

## Profiles Page Parameter Table

Parameter	Description	Range (Modbus Value)	Default	Modbus Register read/write [I/O, Set, Ch]	Conditions for Parameters to Appear
<b>Idle</b>					
Main > Profiles > Edit Profile > Profile x (1 to 40) > Edit Step / Step x (1 to 256) > Step > End > <b>Idle</b>					
<b>Enter Channel 1 Idle Set Point</b>	Set Point 1 Low Limit to Set Point 1 High Limit  Select the channel 1 set point to be maintained after the profile ends.		75 (75)	4061 r/w	Active: Always (Channel 1).
<b>Enter Channel 2 Idle Set Point</b>	Set Point 2 Low Limit to Set Point 2 High Limit  Select the channel 2 set point to be maintained after the profile ends.		75 (75)	4062 r/w	Active if controller is set to Dual Channel Ramping (Channel 2).

✓ *NOTE: Two sets of Modbus registers contain profile information: In edit mode, the number of the profile being edited is at 4000, and the number of the step being edited is at 4001. When the profile is running, the number of the profile being run is at 4100, and the number of the step being run is at 4101. All run addresses are read only.*

✓ *NOTE: Press the Information Key  for task-related tips.*



# Chapter Five: Setup

Setup Guidelines .....	5.1
Parameter Setup Order .....	5.1
Customizing the Main Page .....	5.2
Custom Main Page Parameter Record .....	5.3
Sample Application .....	5.4
Setup Page Map .....	5.6
Setup Page Parameter Table .....	5.7
Setup Page Parameter Record .....	5.16

## Overview

This chapter presents information about configuring the controller software through the Setup Page. This is where you:

- indicate what hardware the input and output pins will be connected to;
- indicate how the inputs and outputs will function (Some of the inputs, outputs and functions may not be visible, depending on the model number of your controller);
- choose Celsius or Fahrenheit scales;
- make other choices about the display of information on the Main Page and in the Upper (LED) Display; and
- set up computer communications with the controller.

Many control features are explained in greater depth in the Features Chapter.

To reach the Setup Page from the Main Page, move the cursor to Go to Setup, then press the Right **►** Key.

### ✓NOTE:

*If the Series F4 is already installed in an environmental chamber, oven, furnace or other equipment, most parameters will already be configured and access to the Setup Page may be limited (locked).*

## Setup Guidelines

Setup Page parameters affect many areas of the controller's function:

- which parameters and functions are visible in other pages;
- the way the controller responds to your application; and
- the way information is displayed on the Main Page.

Setting up the controller properly will provide a sound foundation for settings in other pages.

## Parameter Setup Order

Initial configuration of the Series F4 is best done in the following order:

1. Go to the System Menu (Setup Page). Here you will indicate:
  - the current time and date;
  - preference of PID units — U.S. (Reset, Rate) or SI (Integral, Derivative);
  - preference of Celsius or Fahrenheit scales;
  - whether or not to display these units in the controller's Upper Display,

### ✓NOTE:

*To see how all the pages, menus and parameters are grouped, see the software map on the inside back cover of this manual.*

### ✓NOTE:

*For more information about how parameter settings affect the controller's operation, see the Features Chapter.*

- the guaranteed soak band for each channel;
  - open-loop detection warnings on or off; and
  - profile-power outage actions.
2. Go the Setup Page and define all inputs, outputs and alarms:
    - Analog Input x (1 to 3);
    - Digital Input x (1 to 4);
    - Control Output x (1A, 1B, 2A or 2B);
    - Alarm Output x (1 or 2);
    - Retransmit Output x (1 or 2);
    - Digital Output x (1 to 8); and
    - Communications
  3. Go to the Operations Page and tune or set the PID sets.
  4. Go to the Operations Page and set the alarm set points.
  5. Go to the Profiles Page to program the profiles.

After the initial configuration of the controller, the most frequent changes will be to profiles, alarm set points and PID sets. The Setup Page is likely to be the least frequently accessed for changes. Some manufacturers may prefer to lock out this page to prevent user access.

Changing parameters may change other parameters. For example, changing the type of units (temperature, relative humidity, etc.) will affect settings that assume either Reset or Rate and Integral or Derivative. Changing from the Celsius to the Fahrenheit scale will affect every parameter with a numerical value in one or the other scale. In some cases, a change in one parameter will affect the defaults of others.

✓ **NOTE:**

*Changes to some parameters will affect other parameters.*

## Customizing the Main Page

Up to 16 lines can be added to the Main Page to display status and information from the controller.

Go to the Setup Main Page menu on the Setup Page. The first screen will prompt you to choose one of the 16 lines to customize. "P1 Parameter" is the first line; "P16 Parameter" is the 16th. After choosing this line by pressing **►**, select a parameter to monitor. Your choices are:

- None
- Input 1 Value
- Input 2 Value
- Input 3 Value
- Set Point 1
- Set Point 2
- % Power 1
- % Power 2
- Tune Status 1
- Tune Status 2
- Time
- Date
- Digital Ins\*
- Digital Outs\*
- Time Remaining
- Current File
- Current Step
- Active Ch1 PID Set
- Active Ch2 PID Set
- Last Jump Step
- Jump Count
- WaitFor Status
- Step Type
- Target SP1
- Target SP2
- Inner Set Point
- Custom Message 1
- Custom Message 2
- Custom Message 3
- Custom Message 4
- Input 1 Cal. Offset
- Input 2 Cal. Offset
- Input 3 Cal. Offset

\* When a digital input or output is active, its number will appear in the Main Page display; when it is inactive, its position will be underlined. When a Wait for condition is still pending, its number will appear in the Main Page display; when it is no longer being awaited, it will be underlined.

```
Choose P:1 Display__
>None
Input 1 Value 30°C ■
Input 2 Value 76% ▼
```

```
SP                26°C
TargetSP1         30°C
SP2               10%
TargetSP2         100%
```

```
Input1            26°C
Input2            4%
Input3            20°C
PROFILE_2        Waiting
Step 2           Ramp Time
Wait             A_2_4 D1_34
Remain           00:00:00
Jump Step        0_0
Jump Count       0
Ch1 PID Set     1
Ch2 PID Set     3
Power1           0%
Power2          55%
Digital In      _234
Digital Out    _2_4_678
Time            14:15:30
Date            10/7/99
```

**Figure 2 — Example Parameters on the Custom Main Page.**

✓ **NOTE:**

*For defaults, see the Keys, Displays and Navigation Chapter.*

# Custom Main Page Parameter Record

Make a photocopy of this page and enter your settings on that copy.

Name \_\_\_\_\_ Date \_\_\_\_\_

<p><b>Will always appear if active:</b></p>	<p>Main Page            Input 1 Error            Input 2 Error            Input 3 Error</p>	
<p><b>Will appear if active and set up to appear:</b></p>	<p>Alarm 1 Condition            Alarm 2 Condition            Autotuning Channel 1            Autotuning Channel 2</p>	
<p><b>Choose from the column at the far right the information you want to appear on the Main Page (in any order):</b></p>	<p><b>(Position on Main Page)</b></p> <p>P1 _____            P2 _____            P3 _____            P4 _____            P5 _____            P6 _____            P7 _____            P8 _____            P9 _____            P10 _____            P11 _____            P12 _____            P13 _____            P14 _____            P15 _____            P16 _____</p>	<p><b>(Possible parameters)</b></p> <p>None            Input 1 Value            Input 2 Value            Input 3 Value            Set Point 1            Set Point 2            % Power 1            % Power 2            Tune status 1            Tune status 2            Time            Date            Digital Inputs            Digital Outputs            Time Remaining            Current File            Current Step            Active Ch1 PID Set            Active Ch2 PID Set            Last Jump Step            Jump Count            WaitFor Status            Step Type            Target SP1            Target SP2            Inner Set Point            Custom Message 1            Custom Message 2            Custom Message 3            Custom Message 4            Input1 Cal. Offset            Input2 Cal. Offset            Input3 Cal. Offset</p>
<p><b>Will always appear:</b></p>	<p>Go to Operations            Go to Profiles            Go to Setup            Go to Factory</p>	

# Sample Application: Setup for Environmental Testing



Before programming the profile to run the temperature and humidity tests in the environmental chamber, Andy had to configure the controller to suit the equipment and the test.

He went to the Setup Page, System Menu, and established the global system parameters, including the real-time clock, the date and the PID units. Then he continued through the list of inputs and outputs, configuring each and keeping notes about his settings on the User Setup Chart.

---

To enter, press the Right Key. ▶

To exit, press the Left Key repeatedly. ◀

Use a copy of the chart at the end of this chapter to record your settings.

## Analog Input 1

For greatest accuracy in measuring the chamber temperature, a resistance temperature detection (RTD) sensor has been wired to analog input 1. Andy wanted to measure tenths of degrees Fahrenheit, with an alarm that would clear by itself if the temperature exceeded or fell below the active alarm set point band. Alarm set points are determined in the Operations Page.

Sensor: RTD	Set Point High: 450.0°F
Type: DIN	No Calibration Offset
Decimal Point: 0.0	0-second Filter
Set Point Low: 32.0°F	Self-Clearing Error

---

## Retransmit Output 1

To track the temperature of the equipment inside the chamber, Andy configured a retransmit output to match input 3. He scrolled down the list of inputs and outputs on the Setup Page and found Retransmit Output. He chose 50°F and 150°F, respectively, for the Scale Low and Scale High; the smaller the range, the higher the resolution on the chart.

Source: Input 3  
Current: 4-20mA  
Scale Low: 50°F  
Scale High: 150°F  
Scale Offset: 0°F

## Control Output x (1A, 1B, 2A, 2B)

Next, he scrolled back up to set the control outputs controlling heat and humidity. For the fastest possible switching rate, tighter control and longer heater life, he selected Burst Fire control for each of them, designating 1A and 1B as heat/cool outputs, and 2A and 2B as humidify/de-humidify outputs.

---

## Digital Output 7

Digital output 7 was wired to an SSR (solid-state relay) that switched a solenoid valve controlling the flow of liquid nitrogen used for cooling.

Name: Default  
Function: Boost cool  
Boost Power Level: -90%  
Boost Delay: 20 seconds

## Analog Input 2

The humidity sensor on analog input 2 was a process sensor using a 4 to 20 mA signal, so Andy set the high end of the scale (20mA) for 100% and the low (4mA) for 0% relative humidity (rh). Knowing that process sensor displays are sometimes jumpy, he put a 1-second filter on it to stabilize it.

Sensor: Process  
Type: Vaisala  
Units: % RH  
Scale Low: 0%  
Scale High: 100%

Set Point Low: 10%  
Set Point High: 90%  
No Calibration Offset  
1-second Filter  
Self-clearing Error

## Analog Input 3

A thermocouple (type J) sensor was adequate to measure the temperature of the equipment itself (analog input 3). The other settings remained the same as analog input 1.

Sensor: Thermocouple  
Type: J  
Decimal Point: Whole numbers only

## Alarms

He assigned an alarm output to indicate a temperature deviation on input 1, which would monitor chamber temperature, and gave it a name that would state the problem.

Name: TEMP DEV  
Type: Deviation  
Source: Input 1  
Latch: Yes  
Silencing: Self-clear  
Alarm Hysteresis: 1, 1.0  
Sides: Both  
Condition: Close on alarm  
Show: Yes

## Digital Inputs

Then he set up the digital inputs for remote functions. Digital input 1 would be wired to a key-lock switch that requires the operator to have a key to operate the controller and chamber. Digital input 2 would be wired to a door switch to stop the profile if the chamber door opens.

**Digital Input 1**  
Name: KEYLOCK  
Function: Panel lock  
Condition: Start on high

**Digital Input 2**  
Name: Default  
Function: Pause  
Condition: High

## Digital Output 6

For heating and cooling capacity and to accommodate the compressor, Andy assigned these functions to Digital outputs 6, 7 and 8.

Digital output 6, wired to a big auxiliary heater, was set up to kick in only when the main heater worked at greater than 90% power (boost power level) for more than 20 seconds (boost delay).

Name: BOOST HEAT  
Function: Boost heat  
Boost Power Level: 90%  
Boost Delay: 20 seconds

## Digital Output 8

Andy set the compressor control parameter to have the compressor run only when cooling is needed.

% on Power: 0%  
% off Power: 9%  
Off Delay: 30 seconds  
On Delay: 60 seconds

There was no computer connection, so Andy skipped Communications.

Then he left the Setup Page and went to the Factory Page where he put a password lock on the Setup Page, Profile Page and Factory Page.

Finally, he went to the Operations Page and set the active alarm band:

-20°F  
+20°F

# Setup Page Map

## System

- Guar. Soak Band1
- Guar. Soak Band2
- Current Time
- Current Date
- PID Units
- °F or °C
- Show °F or °C
- Ch1 Autotune SP
- Ch2 Autotune SP
- Input 1 Fail
- Input 2 Fail
- Open Loop Ch1
- Open Loop Ch2
- Power-Out Time
- Power-Out Action

## Analog Input x (1 to 3)

- Sensor
- Type
- Units
- Decimal
- Scale Low
- Scale High
- Choose Scaling
- Ch2 Output Disable?
- Enter In1 Temp Low
- Enter In1 Temp High
- SP Low Limit
- SP High Limit
- Calibration Offset
- Filter Time
- Error Latch
- Cascade

## Digital Input x (1 to 4)

- Name
- Function
- Condition

## Control Output x (1A, 1B, 2A or 2B)

- Function
- Cycle Time
- Process
- Hi Power Limit
- Lo Power Limit

## Alarm Output x (1 and 2)

- Name
- Alarm Type
- Alarm Source
- Latching
- Silencing
- Alarm Hysteresis
- Alarm Sides
- Alarm Logic
- Alarm Messages

## Retransmit Output x (1 and 2)

- Retransmit Source
- Analog Range
- Low Scale
- High Scale
- Scale Offset

## Digital Output x (1 to 8)

- Name
- Function
- Off
- Event Output
- Complementary Output  
(Output 5 only)
- Control Output
- Boost Heat (Output 6 only)
- Boost %Power
- Boost Delay Time
- Boost Cool (Output 7 only)
- Boost %Power
- Boost Delay Time
- Compressor (Output 8 only)
- Compressor On %Power
- Compressor Off %Power
- Compressor On Delay
- Compressor Off Delay

## Communications

- Baud Rate
- Address
- Custom Main Page
- Px (Parameter 1 to 16)

## Process Display

- Input 1 only
- Alternating Display
- IN1 Display Time
- IN2 Display Time
- IN3 Display Time

## Static Message

- Message 1 to 4

# Setup Page Parameter Table

Parameter	Description	Range (Modbus Value)	Default	Modbus Register read/write (I/O, Set, Ch)	Conditions for Parameters to Appear
<b>System</b>					
Main > Setup > System					
<b>Guarantee Soak Band x (1 or 2)</b>	Select value above and below set point to define the soak band.	Decimal choice dependent: 1 to 30000, or .1 to 3000.0, or .01 to 300.0, or .001 to 30.0 (1 to 30000)	1	Band 1205 [1] 1212 [2] r/w	Active: Always (1). Active if controller is Dual Channel (2).
<b>Current Time</b>	Enter actual time. (24-hour-clock)	hh:mm:ss 00:00:00 to 23:59:59 [hh] (0 to 23) [mm] (0 to 59) [ss] (0 to 59)	current time	Time 1916 [hh] 1917 [mm] 1918 [ss] r/w	Active: Always.
<b>Current Date</b>	Enter actual date.	M/D/Y 01/01/1998 to 12/31/2035 [mm] (1 to 12) [dd] (1 to 31) [yy] (1998 to 2035)	current date	Time 1919 [mm] 1920 [dd] 1921 [yy] r/w	Active: Always.
<b>PID Units</b>	Choose units for PID control.	U S (Reset/Rate) (0) SI (Integral/Derivative) (1)	U S (Reset/Rate) (0)	900 r/w	Active: Always.
<b>°F or °C</b>	Choose temperature scale.	°F (0) °C (1)	°F (0)	901 r/w	Active: Always.
<b>Show °F or °C</b>	Choose whether to display or hide °C or °F in top display.	No, Upper Display (0) Yes, Upper Display (1)	Yes, Upper Display (1)	1923 r/w	Active: Always.
<b>Channel x Autotune Set Point (1 or 2)</b>	Set percent of set point to auto-tune to.	50 to 150% (50 to 150)	90% (90)	Point 304 [1] 323 [2] r/w	Active: Always (1). Active if controller is Dual Channel (2).
<b>Input x Fail (1 or 2)</b>	Enter percent of power supplied to the output if analog input sensor fails.	0 to 100% Heat only 0 to 100% Cool only -100% to +100% Cool/Heat or Heat/Cool	0% (0)	Fail 903 [1] 906 [2] r/w	Active: Always (1). Active if controller is Dual Channel (2).
<b>Open Loop Channel x (1 or 2)</b>	Select whether to turn off outputs and display an error message.	Off (0) On (1)	Off (0)	Channel 904 [1] 907 [2] r/w	–
<b>Power-Out Time</b>	Define a power outage in seconds.	0 to 30000 seconds (0 to 30000)	10 seconds (10)	1213 r/w	–
<b>Power-Out Action</b>	Choose controller response to power outage while running a profile.	Continue (0) Hold (1) Terminate (2) Reset (3) Idle Set Point 1 (4) Idle Set Point 2 (5)	Continue (0)	1206 r/w	Active: Always.

✓ **NOTE:**

For more information about how parameter settings affect the controller's operation, see the Features Chapter.

# Setup Page Parameter Table

Parameter	Description	Range (Modbus Value)	Default	Modbus Register read/write [I/O, Set, Ch]	Conditions for Parameters to Appear
<b>Analog Input x (1 to 3)</b>					
Main > Setup > Analog Input x (1 to 3)					
<b>Sensor</b>	Select the sensor.	Thermocouple (0) RTD (1) Process (2) Wet Bulb-Dry Bulb* (3) Off (4)	Thermo- couple (0)	Input 600 [1] 610 [2] 620 [3] r/w	Active: Always.
<b>Type</b>	Select the lineariza- tion table to apply to the sensor.	If Sensor is set to thermocouple: J (0) K (1) T (2) E (3) N (4) C (5) D (6) PT2 (7) R (8) S (9) B (10)  If Sensor is set to RTD or Wet/Dry Bulb: 100Ω DIN (11) 100Ω JIS (12) 500Ω DIN (23) 500Ω JIS (24) 1kΩ DIN (25) 1kΩ JIS (26)  If Sensor is set to Process: 4 to 20mA (13) 0 to 20mA (14) 0 to 5V (15) 1 to 5V (16) 0 to 10V (17) 0 to 50mV (18)  If Analog Input 2 Sen- sor is set to Process and Analog Input 2 is selected: •Vaisala 0 to 5V** (19) •Vaisala 0 to 10V (20) •Vaisala 0 to 20mA** (21) •Rotronics 0 to 5V*** (22)	J (0)  100Ω DIN (11) for 100Ω RTD models  500Ω DIN (23) for 500Ω or 1kΩ models  4 to 20mA (13)	Input 601 [1] 611 [2] 621 [3] r/w	Active: Always.   <b>CAUTION: Changes to Sensor, Type, Units, Decimals, Scales and Set Point Limits will delete all profiles stored in the F4's memory.</b>  <b>The tenth character of your model number determines your RTD base resistance.</b> <b>F4 _ _ _ _ _ (1 to 4) <u>R</u> <u>G</u></b> <b>for 100Ω</b> <b>F4 _ _ _ _ _ (5 to 8) <u>R</u> <u>G</u></b> <b>for 500Ω and 1kΩ</b>

\* A wet bulb at input 2 uses the input 1 value to calculate the relative humidity on channel 2. The humidify and dehumidify outputs (2A and 2B) are disabled when the input 1 temperature is too low (32°F [0°C]) or too high (212°F [100°C]). The relative humidity display in the Main Page will display “RH Disabled” for a low temperature error and “RH Disabled” for a high temperature error.

\*\* The Series F4 provides temperature compensation for the Vaisala HMM-30C Solid-state Humidity Sensor to calculate relative humidity on channel 2. The humidify and dehumidify outputs (2A and 2B) are disabled when the input 1 temperature is too low (-40°F [-40°C]) or too high (320°F [160°C]). The relative

humidity display in the Main Page will display “RH Disabled” for a low temperature error and “RH Disabled” for a high temperature error.

\*\*\* The Series F4 provides temperature compensation for the Rotronics Model H260 Capacitive Relative Humidity Sensor to calculate relative humidity on channel 2. The humidify and dehumidify outputs (2A and 2B) are disabled when the input 1 temperature is too low (-5°F [-20°C]) or too high (320°F [160°C]). The relative humidity display in the Main Page will display “RH Disabled” for a low temperature error and “RH Disabled” for a high temperature error.



# Setup Page Parameter Table

Parameter	Description	Range (Modbus Value)	Default	Modbus Register read/write (I/O, Set, Ch)	Conditions for Parameters to Appear
<b>Altitude</b>	Select an elevation to compensate for wet bulb evaporation rates.	0 to 2499 ft (0) 2500 to 4999 ft (1) 5000 ft and above (2)	0 to 2499 ft (0)	1902 r/w	Active if Analog Input 2 Type is Wet Bulb-Dry Bulb.
<b>Units</b>	Select the units of measure for the input.	Temperature (0) %rh (1) psi (2) units (3)	Temperature (0)	Input 608 [1] 618 [2] 628 [3] r/w	Active if Sensor Type is set to Process.
<b>Decimal</b>	Set the decimal point for input.	0 (0) 0.0 (1) 0.00 process (2) 0.000 process (3)	0 (0)	Input 606 [1] 616 [2] 626 [3] r/w	Active if Sensor Type is set to Process.
<b>Scale Low</b>	Set unit value for low end of current or voltage range.	Depends on sensor and decimal point selection.	—	Input 680 [1] 682 [2] 684 [3] r/w	Active if Sensor Type is set to Process.
<b>Scale High</b>	Set unit value for high end of current or voltage range.	Depends on sensor and decimal point selection.	—	Input 681 [1] 683 [2] 685 [3] r/w	Active if Sensor Type is set to Process.
<b>Choose Scaling</b>	Select normal or inverse scaling.	Normal Scaling (0) Scale Inversion (1) (Scale High corresponds to the lowest process value, and Scale Low corresponds to the highest process value.)	Normal (0)	Input 693 [1] 694 [2] 695 [3] r/w	Active if Sensor Type is set to Process.
<b>Ch2 Output Disable?</b>	Disables Channel 2 outside the range defined by Enter In1 Temp Low and Enter In1 Temp High.	No (0) Yes (1)	No (0)	696 r/w	Active if Analog Input 2, Sensor is set to Process and Units is set to %rh and Analog Input 1, Units is set to Temperature.
<b>Enter In1 Temp Low</b>	Choose the lowest temperature at which the channel 2 output is active.	Sensor range low to In1 Temp High - 1	—	697 r/w	Active if Ch2 Output Disable is set to Yes.
<b>Enter In1 Temp High</b>	Choose the highest temperature at which the channel 2 output is active.	Sensor range high to In1 Temp Low + 1	—	698 r/w	Active if Ch2 Output Disable is set to Yes.
<b>Set Point Low Limit</b>	Set limit for minimum set point.	Depends on sensor.	—	Input 602 [1] 612 [2] 622 [3] r/w	Active: Always, except when Cascade is set to Process Cascade or Deviation Cascade this is masked for Analog Input 1.

✓ **NOTE:**

For more information about how parameter settings affect the controller's operation, see the *Features Chapter*.

## Setup Page Parameter Table

Parameter	Description	Range (Modbus Value)	Default	Modbus Register read/write (I/O, Set, Ch)	Conditions for Parameters to Appear
<b>Set Point High Limit</b>	Set limit for maximum set point.	Depends on sensor.	—	Input 603 [1] 613 [2] 623 [3] r/w	Active: Always, except when Cascade is set to Process Cascade or Deviation Cascade this is masked for Analog Input 1.
<b>Calibration Offset</b>	Compensate for sensor errors or other factors.	-19999 to 30000	0	Input 605 [1] 615 [2] 625 [3] r/w	Active: Always.
<b>Filter Time</b>	Set the filter time for input in seconds.	-60.0 to 60.0 (-600 to 600)	0.0 (0) 1.0 if Decimal is set to 0.0 and Sensor Type is set to Thermocouple or RTD. (10)	Input 604 [1] 614 [2] 624 [3] r/w	Active: Always.
<b>Error Latch</b>	Select whether error clear is automatic or manual.	Self Clear (0) Latch (1)	Self Clear (0)	Input 607 [1] 617 [2] 627 [3] r/w	Active: Always.
<b>Cascade</b>	Select whether to use the cascade algorithm.	No Cascade (0) Process Cascade (1) Deviation Cascade (2)	No Cascade (0)	1925 r/w	Active if Analog Input 3 is not set to Off (variable selection only).
<b>Cascade Low Range, Process</b>		Depends on sensor and decimal point selection.	—	1926 r/w	Active if Input 3 is not set to off and Process Cascade is selected.
<b>Cascade High Range, Process</b>		Depends on sensor and decimal point selection.	—	1927 r/w	Active if Input 3 is not set to off and Process Cascade is selected.
<b>Cascade Low Range, Deviation</b>		Depends on sensor and decimal point selection.	—	1926 r/w	Active if Input 3 is not set to off and Deviation Cascade is selected.
<b>Cascade High Range, Deviation</b>		Depends on sensor and decimal point selection.	—	1927 r/w	Active if Input 3 is not set to off and Deviation Cascade is selected.

### Digital Input x (1 to 4)

Main > Setup > Digital Input x (1 to 4)

<b>Name</b>	<selected by user> (ASCII Values)	DIGIT IN1	3000-3009 3010-3019 3020-3029 3030-3039 r/w	Active: Always.
	Name the input for easy reference.			

✓ **NOTE:**

Press the Information Key **i** for more task-related tips.

# Setup Page Parameter Table

Parameter	Description	Range (Modbus Value)	Default	Modbus Register read/write (I/O, Set, Ch)	Conditions for Parameters to Appear
<b>Function</b>	Select the digital input function.	Off (0) Panel Lock (1) Reset Alarm (2) Control Outputs Off (3) All Outputs Off (4) Digital Outputs Off (5) Start Profile (6)* Pause Profile (7) Resume Profile (8) Terminate Profile (9) Wait for Event (10)	Off (0)	Input 1060 [1] 1062 [2] 1064 [3] 1066 [4] r/w	Active: Always. While a profile is running, the controller will not recognize digital inputs that are programmed to start a profile.  <i>Only one profile can be run at a time.</i>  * This prompt only appears if the F4 memory contains a profile.
<b>Condition</b>	Select the condition to trigger digital input.	Low (0) High (1)	Low (0)	Input 1061 [1] 1063 [2] 1065 [3] 1067 [4] r/w	Active: Always. Digital inputs are edge triggered and require a transition from high to low or low to high.
<b>Control Output x (1A,1B, 2A and 2B)</b>					
Main > Setup > <b>Control Output x (1A,1B, 2A and 2B)</b>					
<b>Function</b>	Select type of function for output.	Off (0) Heat (1) Cool (2)	Heat (1A and 2A) (1) Off (1B, 2B) (0)	Output 700 [1A] 717 [1B] 734 [2A] 751 [2B] r/w	Active if Analog Inputs 1 and 2 are enabled.
<b>Choose Cycle Time</b>	Enter the value of the variable burst cycle time.	Variable Burst (0) Fixed Time (1)		Output 509 [1A] 559 [1B] 2509 [2A] 2559 [2B] r/w	Active always.
<b>Enter Cycle Time</b>	Select the duration of cycle.	.1 to 60 (1 to 600)	Fixed Time 1.0 sec. (10)	Output 506 [1A] 556 [1B] 2506 [2A] 2556 [2B] r/w	Active if the selected output is not Process and Burst is set to No.
<b>Process</b>	Set process output type.	4 to 20mA (0) 0 to 20mA (1) 0 to 5V (2) 1 to 5V (3) 0 to 10V (4)	4 to 20mA (0)	Output 701 [1A] 718 [1B] 735 [2A] 752 [2B] r/w	Active if the selected output is set to a process output.
<b>High Power Limit</b>	Set high limit control (PID mode only) output power level.	Low Limit +1 to 100% (Low Limit +1 to 100)	100% (100)	Output 714 [1A] 731 [1B] 748 [2A] 765 [2B] r/w	Active: Always.
<b>Low Power Limit</b>	Set low limit control (PID mode only) output power level.	0% to High Limit -1 (0 to High Limit -1)	0% (0)	Output 715 [1A] 732 [1B] 749 [2A] 766 [2B] r/w	Active: Always.

✓ **NOTE:**

For more information about how parameter settings affect the controller's operation, see the Features Chapter.

## Setup Page Parameter Table

Parameter	Description	Range (Modbus Value)	Default	Modbus Register read/write (I/O, Set, Ch)	Conditions for Parameters to Appear
<b>Alarm Output x (1 and 2)</b>					
Main > Setup > Alarm Output x (1 and 2)					
<b>Name</b>	Name the alarm for easy reference.	<selected by user> (ASCII Values)	ALARMX	3200-3209 3210-3219 r/w	Active always.
<b>Alarm Type</b>	Select the alarm type.	Off (0) Process (1) Deviation (2)	Off (0)	Output 702 [1] 719 [2] r/w	Active always.
<b>Alarm Source</b>	Select the alarm source.	Input 1 (0) Input 2 (1) Input 3 (2)	Off (0)	Output 716 [1] 733 [2] r/w	Active if the source is enabled.
<b>Latching</b>	Choose automatic or manual clearing of alarms.	Alarm Self-Clears (0) Alarm Latches (1)	Alarm Self-Clears (0)	Output 704 [1] 721 [2] r/w	Active if Alarm Output is enabled.
<b>Silencing</b>	Choose whether to mask alarms on power-up.	No (0) Yes (1)	No (0)	Output 705 [1] 722 [2] r/w	Active if Alarm Output is enabled.
<b>Alarm Hysteresis</b>	Set the alarm hysteresis.	1 to 30000 (1 to 30000)	3 (3)	Output 703 [1] 720 [2] r/w	Active if Alarm Output is enabled.
<b>Alarm Sides</b>	Choose to enable Low, High or both alarm set points.	Both (0) Low (1) High (2)	Both (0)	Output 706 [1] 723 [2] r/w	Active if Alarm Output is enabled.
<b>Alarm Logic</b>	Select the alarm logic option.	Open on Alarm (0) Close on Alarm (1)	Open on Alarm (0)	Output 707 [1] 724 [2]	Active if Alarm Output is enabled.
<b>Alarm Messages</b>	Select the alarm message option.	Yes on Main Page (0) No (1)	Yes on Main Page (0)	Output 708 [1] 725 [2] r/w	Active if Alarm Output is enabled.
<b>Retransmit Output x (1 and 2)</b>					
Main > Setup > Retransmit Output x (1 and 2)					
<b>Retransmit Source</b>	Choose a source for retransmit signal.	Input 1 (0) Input 2 (1) Input 3 (2) Set Point 1 (3) Set Point 2 (4) Channel 1 Power (5) Channel 2 Power (6)	Input 1 (0)	Output 709 [1] 726 [2] r/w	Active: Always. (Values appear only if the source is enabled.)
<b>Analog Range</b>	Select voltage or current range to retransmit.	4 to 20mA (0) 0 to 20mA (1) 0 to 5V (2) 1 to 5V (3) 0 to 10V (4)	4 to 20mA (0)	Output 836 [1] 837 [2] r/w	Active: Always.
<b>Low Scale</b>	Set low end of current or voltage range to retransmit.	-19999 to high scale -1 (minimum sensor range) (-19999 to High Scale -1)	Low end of sensor range	Output 710 [1] 727 [2] r/w	Active: Always.

✓ **NOTE:**

Press the Information Key  for more task-related tips.

# Setup Page Parameter Table

Parameter	Description	Range (Modbus Value)	Default	Modbus Register read/write (I/O, Set, Ch)	Conditions for Parameters to Appear
<b>High Scale</b>	Set high end of current or voltage range to retransmit.	Low Scale +1 to 30000 (maximum sensor range) (Low Scale +1 to 30000)	High end of sensor range	Output 711 [1] 728 [2] r/w	Active: Always.
<b>Scale Offset</b>	Shift the scale up (+) or down (-) to agree with source signal.	-19999 to 30000 Range Low to Range High (-19999 to 30000)	0 (0)	Output 712 [1] 729 [2] r/w	Active: Always.
<b>Digital Output x (1 to 8)</b>					
Main > Setup > <b>Digital Output x (1 to 8)</b>					
<b>Name</b>	Name the digital output for easy reference.	<selected by user> (ASCII Values)	DIGIT OUTX	3100-3109 3110-3119 3120-3129 3130-3139 3140-3149 3150-3159 3160-3169 3170-3179 r/w	Active: Always.
<b>Function</b>	Choose a function for each digital output.	Off (0) Event Output (1) Complementary Output (Digital 5) (2) *Control Output 1A *Control Output 1B *Control Output 2A *Control Output 2B **Boost Heat (Digital 6) (3) **Boost Cool (Digital 7) (4) **Compressor (Digital 8) (5)	Off (0)	2001 [1] 2011 [2] 2021 [3] 2031 [4] 2041 [5] 2051 [6] 2061 [7] 2071 [8] r/w	Active: Always.  <i>*Active if the selected output is not Process.</i>  <i>**Operates based on Channel 1 power requirements.</i>
<b>Boost Percent Power</b>	Enable boost above chosen power level.	0% to 100% for Heat -100% to 0% for Cool	Heat 100% (100) Cool -100% (-100)	Output 2052 [6] 2062 [7] r/w	Active if Digital 6 or 7 Function is set to Boost Heat or Boost Cool.
<b>Boost Time Delay</b>	Set time to delay boost.	0 to 9999 seconds (0 to 9999)	30 seconds (30)	Output 2054 [6] 2064 [7] r/w	Active if Digital 6 or 7 Function is set to Boost Heat or Boost Cool.



**WARNING:** Provide a labeled switch or circuit breaker near peripheral equipment permanently connected to the Series F4 digital outputs as the means of disconnection for servicing. Failure to do so could result in damage to equipment and/or property, and/or injury or death to personnel.

**NOTE:**

For more information about how parameter settings affect the controller's operation, see the Features Chapter.

## Setup Page Parameter Table

Parameter	Description	Range (Modbus Value)	Default	Modbus Register read/write (I/O, Set, Ch)	Conditions for Parameters to Appear
<b>Compressor On % Power</b>	The compressor will be on below this chosen power level.	-100% to 100% (-100 to 100)	0% (0)	2072 r/w	Active if Digital 8 Function is Compressor.
<b>Compressor Off % Power</b>	The compressor will be off above this chosen power level.	Compressor on % power to 100%	Compressor on % power	2073 r/w	Active if Digital 8 Function is Compressor.
<b>Compressor Off Delay</b>	Set time to delay compressor turn-off.	0 to 9999 seconds (0 to 9999)	10 seconds (10)	2075 r/w	Active if Digital 8 Function is Compressor.
<b>Compressor On Delay</b>	Set time to delay compressor turn-on.	1 to 9999 seconds (1 to 9999)	30 seconds (30)	2074 r/w	Active if Digital 8 Function is Compressor.



**WARNING:** Provide a labeled switch or circuit breaker near peripheral equipment permanently connected to the Series F4 digital outputs as the means of disconnection for servicing. Failure to do so could result in damage to equipment and/or property, and/or injury or death to personnel.

### Communications

Main > Setup > **Communications**

<b>Baud Rate</b>	19200 (0) 9600 (1)	19200	Not available	Active: Always.
<b>Address</b>	1 to 247 (1 to 247)	1	Not available	Active: Always.

✓ **NOTE:**

Press the Information Key  for more task-related tips.

# Setup Page Parameter Table

Parameter	Description	Range (Modbus Value)	Default	Modbus Register read/write (I/O, Set, Ch)	Conditions for Parameters to Appear	
<b>Custom Main Page</b>						
Main > Setup > <b>Custom Main Page</b>						
<b>P x (1 to 16)</b>	Choose parameters to appear on Main Page.	None (0)	[1] Current	Par.	Active: Always.	
		Input 1 Value (1)	File (15)	1400		[1]
		Input 2 Value (2)	[2] Current	1401		[2]
		Input 3 Value (3)	Step (16)	1402		[3]
		Set Point 1 (4)	[3] Input 2	1403		[4]
		Set Point 2 (5)	Value (2)	1404		[5]
		% Power 1 (6)	[4] Set Point 1	1405		[6]
		% Power 2 (7)	(4)	1406		[7]
		Tune status 1 (8)	[5] Set Point 2	1407		[8]
		Tune status 2 (9)	(5)	1408		[9]
		Time (10)	[6] Step Type	1409		[10]
		Date (11)	(22)	1410		[11]
		Digital Inputs (12)	[7] Target SP1	1411		[12]
		Digital Outputs (13)	(23)	1412		[13]
		Time Remaining (14)	[8] Target SP2	1413		[14]
		Current File (15)	(24)	1414		[15]
	Current Step (16)	[9] WaitFor	1415	[16]		
	Active Ch1 PID Set(17)	Status (21)	r/w			
	Active Ch2 PID Set(18)	[10] Time Re-				
	Last Jump Step (19)	maining (14)				
	Jump Count (20)	[11] Digital In-				
	WaitFor Status (21)	puts (12)				
	Step Type (22)	[12] Digital				
	Target SP1 (23)	Outputs (13)				
	Target SP2 (24)	[13] % Power 1				
	Inner Set Point (25)	(6)				
	Custom Message 1 (26)	[14] % Power 2				
	Custom Message 2 (27)	(7)				
	Custom Message 3 (28)	[15] Date (11)				
	Custom Message 4 (29)	[16] Time (10)				
	Input1 Cal. Offset (30)					
	Input2 Cal. Offset (31)					
	Input3 Cal. Offset (32)					
<b>Process Display</b>						
Main > Setup > <b>Process Display</b>						
<b>Input 1 Only</b>		Input 1 (0)	Input 1 (0)	5500	Active: Always.	
		Alternating (1)				
<b>Alternating Display</b>		Input 1 Display Time (0 to 999)		5501 [1] 5502 [2]	Active if Inputs 2 and/or 3 are active.	
		Input 2 Display Time (0 to 999)		5503 [3]		
		Input 3 Display Time (0 to 999)				
<b>Static Message</b>						
Main > Setup > <b>Static Message</b>						
<b>Message 1 to 4</b>		<selected by user> (ASCII Values)	Message X	4501-4518[1] 4521-4538[2] 4541-4558[3] 4561-4578[4]	Active: Always.	

✓ **NOTE:**

For more information about how parameter settings affect the controller's operation, see the *Features Chapter*.





# 6

## Chapter Six: Features

### Inputs

Calibration Offset	.6.2
Filter Time Constant	.6.2
Set Point Low Limit and High Limit	.6.3
High Scale and Low Scale	.6.3
Event	.6.3
Retransmit	.6.3

### Control Methods

On-Off Control	.6.4
Proportional Control	.6.4
PI Control	.6.5
PID Control	.6.5
Dead Band	.6.5
Multiple PID Sets	.6.6
Burst Fire	.6.6

### Other Features

Autotuning	.6.7
Power-Out Time/Action	.6.7

### Alarms

Alarm Set Points	.6.8
Alarm Hysteresis	.6.8
Process or Deviation Alarms	.6.8
Alarm Latching	.6.9
Alarm Silencing	.6.9
Alarm Sides	.6.9

### Advanced Features

Boost Heat and Boost Cool	.6.10
Compressor Control	.6.10
Cascade	.6.11

# Inputs/Outputs

## Calibration Offset

Calibration offset allows a device to compensate for an inaccurate sensor, lead resistance or other factors that affect the input value. A positive offset increases the input value, and a negative offset decreases the input value.

You can view or change the offset value of inputs 1, 2 or 3 with the Calibration Offset parameter.

Location in software: Setup Page > Analog Input x (1 to 3).

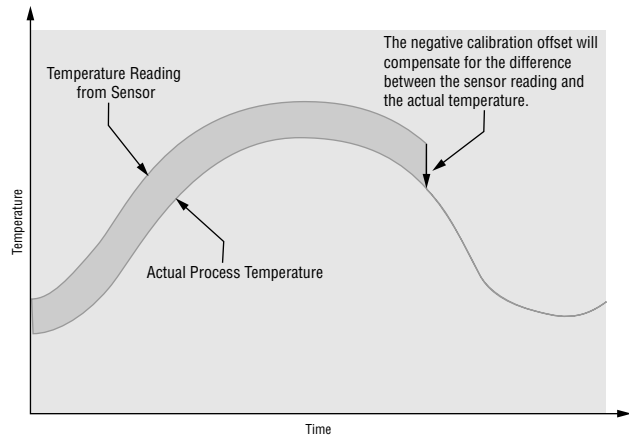

Figure 6.2a — Calibration Offset.

## Filter Time Constant

A time filter smooths an input signal by applying a first-order filter time constant to the signal. Either the displayed value or both the displayed and control values can be filtered. Filtering the displayed value makes it easier to monitor. Filtering the signal may improve the performance of PID control in a noisy or very dynamic system.

A positive value affects only the viewed values. A negative value affects both the viewed and control values.

Location in software: Setup Page > Analog Inputs x (1 to 3).

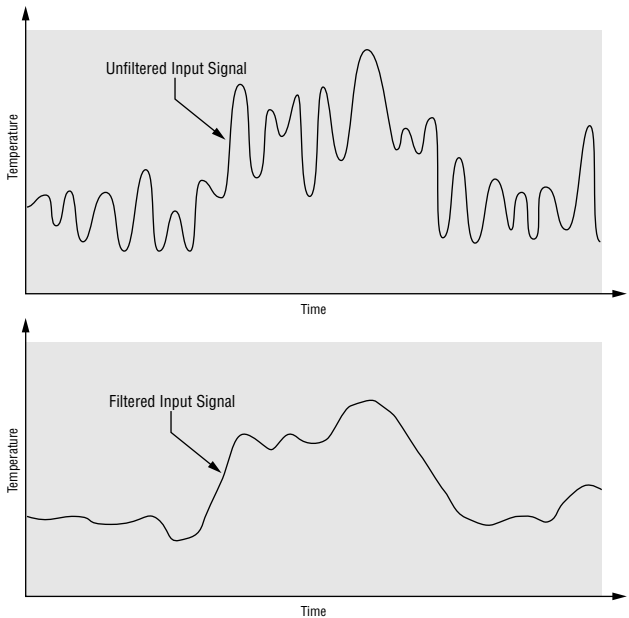

Figure 6.2b — Filtered and Unfiltered Input Signals.

## Open Loop Detect

Open loop checks the integrity of the control loop, consisting of the controller output, power control, heater and sensor.

If the output power is at its maximum for a period of time equal to the reset time and the input has not changed at least  $\pm 5^{\circ}\text{F}$ , the controller will switch to Manual Mode at 0% output power. The upper screen will display [oPLP] and the lower screen will display "Open Loop."

To clear an open loop error, after correcting the problem that caused it, turn the controller off then back on.

Location in software: Setup Page > System.

## Set Point Low Limit and High Limit

The controller constrains the set point to a value between a low limit and a high limit. The high limit cannot be set higher than the sensor high limit or lower than the low limit. The low limit cannot be set lower than the sensor low limit or higher than the high limit.

You can view or change the input low limit (SP Low Limit) and the input high limit (SP High Limit) for analog inputs 1, 2 or 3.

Location in software: Setup Page > Analog Input x (1 to 3).

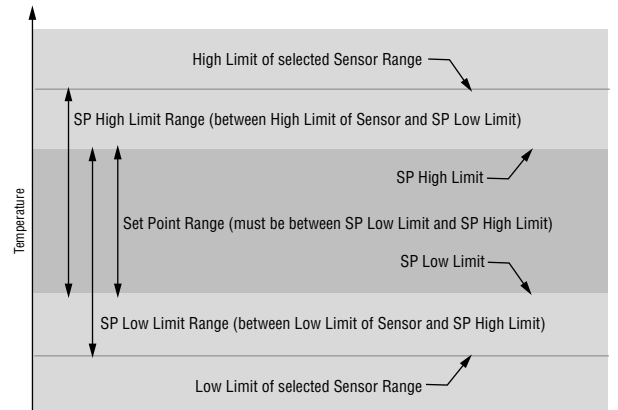

Figure 6.3a — Sensor Ranges.

## High Scale and Low Scale

When an analog input is selected as a process input, you must choose a value to represent the low and high ends of the current or voltage range. For example, if an analog input with a process sensor type 4 to 20mA is selected and the units are % Relative Humidity, then 0% could represent 4mA and 100% could represent 20mA. The set point will be limited to the range between scale low and scale high.

Location in software: Setup Page > Retransmit Output x (1 or 2).

## Event

With an event input an operator can perform certain operations on a system by opening or closing a switch or applying a dc logic signal to the controller. This feature can add convenience, safety or security to a system.

In the Series F4, digital inputs 1 to 4 can be assigned as wait for events, as well as other process control features.

Location in software: Setup Page > Digital Input x (1 to 4) Condition.

## Retransmit

Retransmit outputs 1 and 2 can retransmit an analog signal to serve as an input variable for another device. The signal may serve as a remote set point for another controller or as input for a chart recorder to document system performance over time.

Location in software: Setup Page.

# Control Methods

## On-Off Control

On-off control switches the output either full on or full off, depending on the input, set point and hysteresis values. The hysteresis value indicates the amount the process value must deviate from the set point to turn on the output. Increasing the value decreases the number of times the output will cycle. Decreasing hysteresis improves controllability. With hysteresis set to 0 the process value would stay closer to the set point, but the output would switch on and off more frequently, causing “chattering.”

Set the proportional band to 0 to set the controller to on-off control mode.

Proportional Band x (A or B) location in software: Operations Page > Edit PID > PID Channel x (1 or 2) > PID Set x (1 to 5) or (6 or 10).

Hysteresis x (A or B) location in software: Operations Page > Edit PID > PID Set Channel x (1 or 2) > PID Set x (1 to 5) or (6 or 10).

✓ **NOTE:**

*Fail power does not function in on/off control mode.*

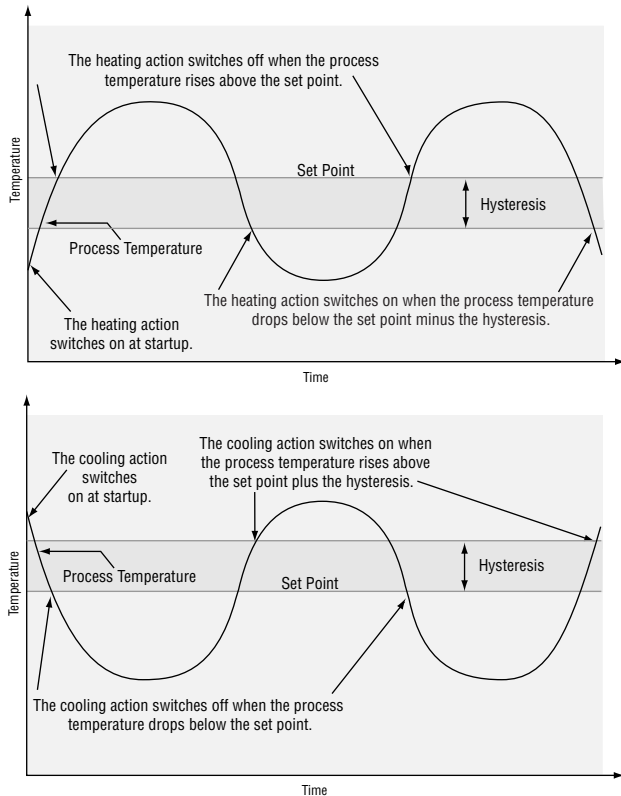

Figure 6.4a — On-off Control for Heating and Cooling.

## Proportional Control

Some processes need to maintain a temperature or process value closer to the set point than on-off control can provide. Proportional control provides closer control by adjusting the output when the temperature or process value is within a proportional band. When the value is in the band, the controller adjusts the output based on how close the process value is to the set point; the closer to set point the lower the output. This is similar to backing off on the gas pedal of a car as you approach a stop sign. It keeps the temperature or process value from swinging as widely as it would with simple on-off control. However, when a system settles down, the temperature or process value tends to “droop” short of the set point.

With proportional control the output power level equals (set point minus process value) divided by proppband.

Location in software: Operations Page > Edit PID > PID Set Channel x (1 or 2) > PID Set x (1 to 5) or (6 to 10).

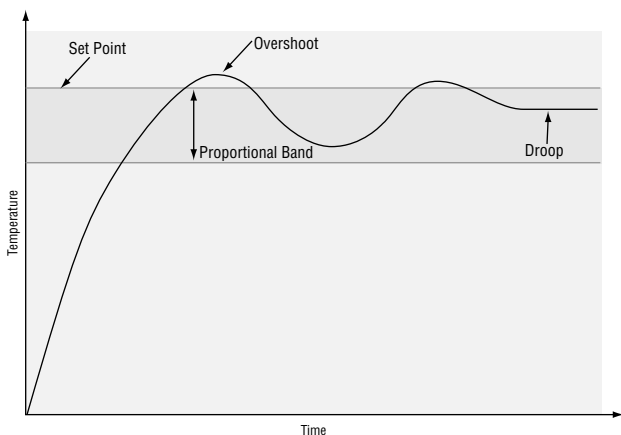

Figure 6.4b — Proportional Control.

## Proportional plus Integral (PI) Control

The droop caused by proportional control (reset) can be corrected by adding integral control. When the system settles down the integral value is tuned to bring the temperature or process value closer to the set point. Integral determines the speed of the correction, but this may increase the overshoot at startup or when the set point is changed. Too much integral action will make the system unstable. Integral is cleared when the process value is outside of the proportional band.

Integral (if units are set to SI) is measured in minutes per repeat. A low integral value causes a fast integrating action.

Reset rate (if units are set to U.S.) is measured in repeats per minute. A high reset value causes a fast integrating action.

Location in software: Operations Page > Edit PID > PID Set Channel x (1 or 2) > PID Set x (1 to 5) or (6 to 10).

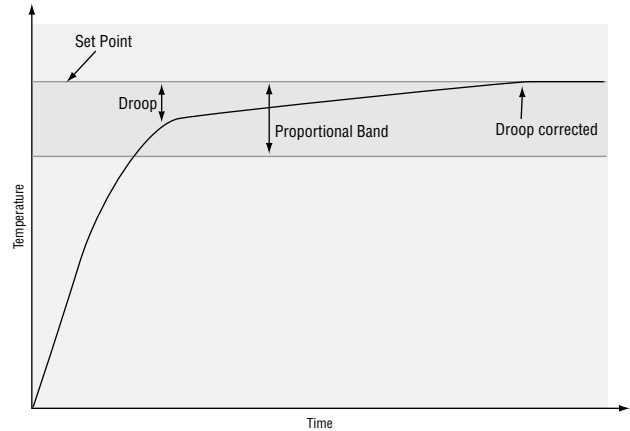

Figure 6.5a — Proportional Plus Integral Control.

## Proportional Integral Derivative (PID) Control

Use derivative rate control to minimize overshoot in a PI-controlled system. Derivative adjusts the output based on the rate of change in the temperature or process value. Too much derivative will make the system sluggish.

Location in software: Operations Page > Edit PID > PID Set Channel x (1 or 2) > PID Set x (1 to 5) or (6 to 10).

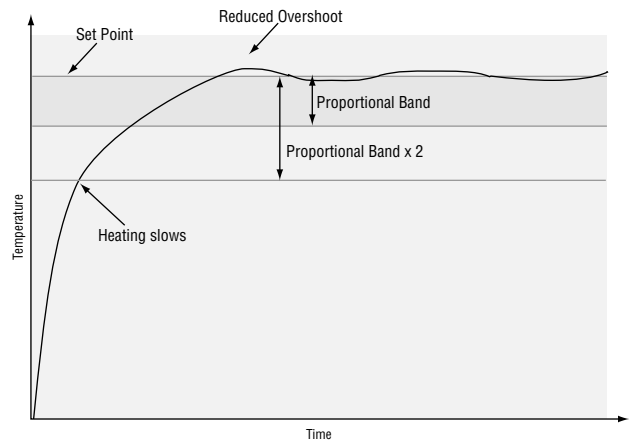

Figure 6.5b — PID Control.

## Dead Band

In a multiple PID application the dead bands above and below the set point can save an application's energy and wear by maintaining process temperature within acceptable ranges. Shifting the effective cooling set point and heating set point keeps the two systems from fighting each other.

Proportional action ceases when the process value is within the dead band. Integral action continues to bring the process temperature to the set point. When the dead band value is zero, the heating element activates when the temperature drops below the set point, and the cooling element switches on when the temperature exceeds the set point.

Location in software: Operations Page > Edit PID > PID Set Channel x (1 or 2) > PID Set x (1 to 5) or (6 to 10).

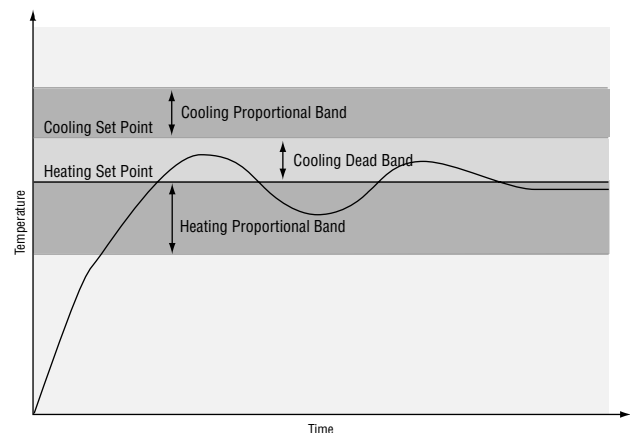

Figure 6.5c — Cooling Dead Band.

## Multiple PID Sets

The Series F4 has five PID sets available for each channel, sets 1 to 5 for Channel 1 and sets 6 to 10 for Channel 2, allowing optimal performance under different conditions, loads and temperatures. In the Static Set Point mode, PID Set 1 is used for Channel 1 and PID Set 6 is used for Channel 2 control. When programming a profile, you can assign different sets to each Ramp step and Soak step.

A PID set includes proportional, integral and derivative settings for outputs A and B. It also includes dead band, as long as the proportional band is not set to 0.

Location in software: Operations Page > Edit PID > PID Set Channel x (1 or 2) > PID Set x (1 to 5) or (6 to 10).

Channel 1 (Heat/Cool)	Channel 2 (Relative Humidity)
Output 1A Heat	Output 2A Humidify
Output 1B Cool	Output 2B Dehumidify
PID Sets 1 to 5	PID Sets 6 to 10
PropBand A	PropBand A
Integral A	Integral A
Derivative A	Derivative A
Dead Band A	Dead Band A
PropBand B	PropBand B
Integral B	Integral B
Derivative B	Derivative B
Dead Band B	Dead Band B

## Burst Fire

Burst firing provides even output power with the lowest level of noise generation (RFI). Burst fire is the preferred method for controlling a resistive load, providing a very short time base for longer heater life.

The controller determines when the ac sine wave will cross the 0-volts point, then switches the load on or off only at this point, minimizing RFI.

Location in software: Setup Page > Control Output x (1 to 3).

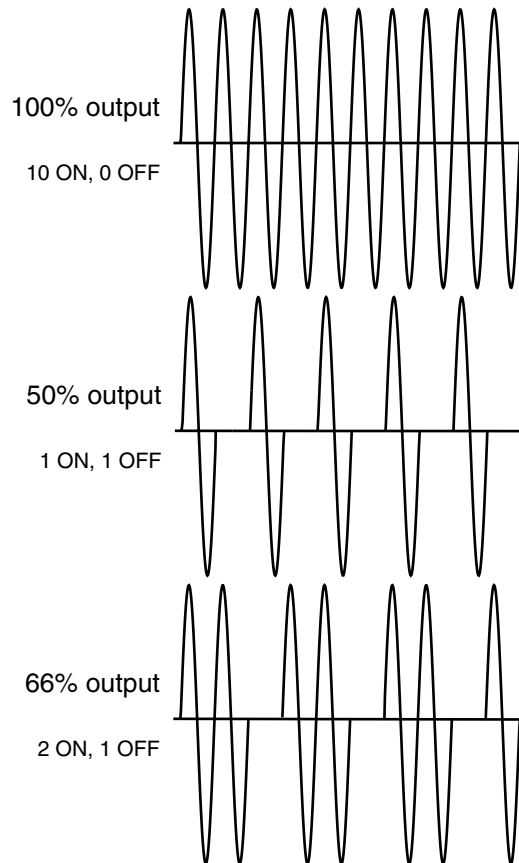

Figure 6.6 — Burst Fire.

# Other Features

## Autotuning

The autotuning feature allows the controller to measure the system response to determine effective settings for PID control. When autotuning is initiated the controller reverts to on-off control. The temperature must cross the auto-tune set point four times to complete the autotuning process. Once complete, the controller controls at the normal set point, using the new parameters. The F4 stores the value in the PID set specified.

Location in software: Operations Page > Autotune PID > Channel 1 Autotune > PID Set x (1 to 5) or Channel 2 Autotune > PID Set x (6 to 10).



**CAUTION:** Choose an auto-tune set point value that will protect your product from possible damage from overshoot or undershoot during the autotuning oscillations. If the product is sensitive, carefully select the auto-tune set point to prevent product damage.

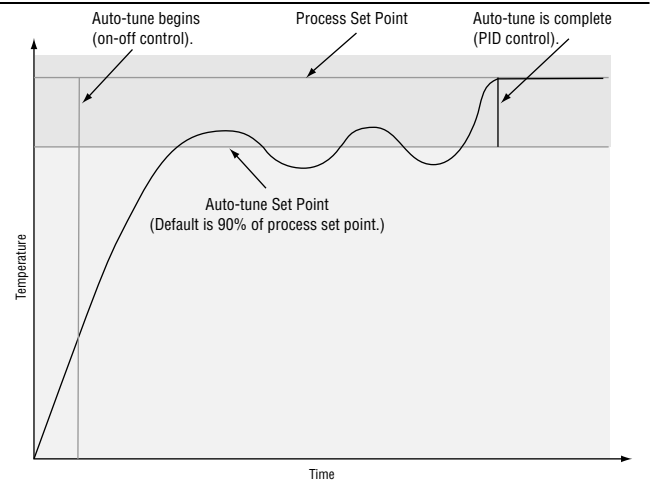

Figure 6.7 — Autotuning.

✓ **NOTE:**

For manual tuning, see the Operations Chapter.

## Power-Out Time/Power-Out Action

The Power-Out Time and Power-Out Action parameters direct the F4's response to the interruption of electrical power while running a profile. The F4's battery-powered real-time clock tracks the amount of time the power is out. When power is restored, the controller compares this amount of time to the Power-Out Time setting and takes whatever action is selected in the Power-Out Action setting.

First, determine how long the power can be interrupted without adversely affecting results. Set the Power-Out Time to this time. If power is returned in less time than this setting, the profile will resume running. (The profile run time stops while the power is off.) If power is returned after a time longer than this setting, the F4 will take action based on the user-configured Power-Out Action parameter: **Continue** (resume the profile at the point that power was interrupted); **Hold** (hold the profile at the point that power was interrupted); **Terminate** (stop the profile using the End step conditions); **Reset** (restart the profile from Step 1); **Idle** (stop the profile and transfer to an idle setpoint).

Location in software: Setup Page > System > Power-Out Time > Power-Out Action.

✓ **NOTE:**

The Power Out Action occurs only if a profile was running when the power went out. If a profile was on hold, it will return to its Hold status when the power returns.

# Alarms

Alarms are activated when the process value or temperature leaves a defined range. A user can configure how and when an alarm is triggered, what action it takes and whether it turns off automatically when the alarm condition is over.

Configure alarm outputs in the Setup Page before setting alarm set points.

---

## Alarm Set Points

The alarm high set point defines the process value or temperature that will trigger a high side alarm. It must be higher than the alarm low set point and lower than the high limit of the sensor range.

The alarm low set point defines the temperature that will trigger a low side alarm. It must be lower than the alarm high set point and higher than the low limit of the sensor range.

Location in software: Operations Page > Alarm Set Point > Alarm x (1 or 2).

---

## Alarm Hysteresis

An alarm state is triggered when the process value reaches the alarm high or alarm low set point. Alarm hysteresis defines how far the process must return into the normal operating range before the alarm can be cleared.

Alarm hysteresis is a zone inside each alarm set point. This zone is defined by adding the hysteresis value to the alarm low set point or subtracting the hysteresis value from the alarm high set point.

Location in software: Setup Page > Alarm Output x (1 or 2).

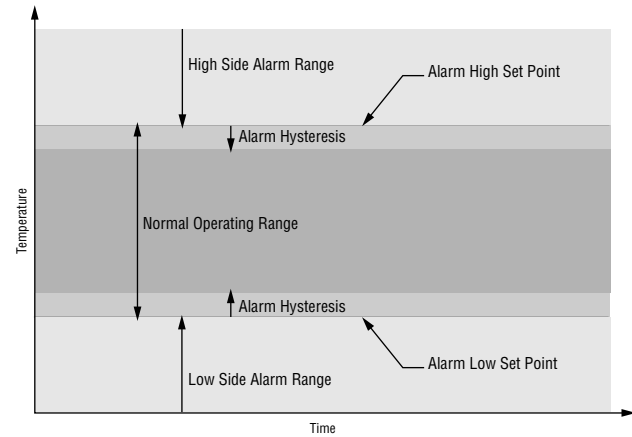

Figure 6.8 — Alarm Settings.

---

## Process or Deviation Alarms

A process alarm uses one or two absolute set points to define an alarm condition. A deviation alarm uses one or two set points that are defined relative to the control set point. High and low alarm set points are calculated by adding and/or subtracting offset values from the control set point. If the set point changes, the window defined by the alarm set points automatically changes with it.

In the Series F4 you must configure each alarm output as either a process or deviation alarm.

Location in software: Setup Page > Alarm Output x (1 or 2).



## Alarm Latching

A latched alarm will remain active after the alarm condition has passed. It can only be deactivated by the user. An alarm that is not latched (self-clearing) will deactivate automatically when the alarm condition has passed.

Location in software: Setup Page > Alarm x (1 or 2).

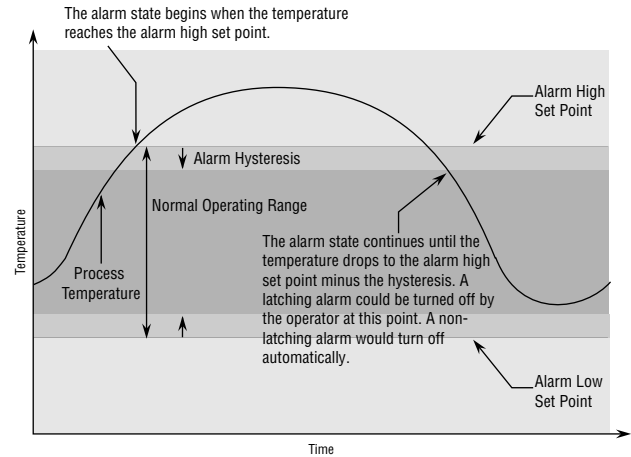

Figure 6.9a — Alarm Latching.

## Alarm Silencing

Alarm silencing has two uses:

1. It is often used to allow a system to warm up after it has been started up. With alarm silencing on, an alarm is not triggered when the process temperature is initially lower than the alarm low set point. The process temperature has to enter the normal operating range beyond the hysteresis zone to activate the alarm function.
2. Alarm silencing also allows the operator to disable the alarm output while the controller is in an alarm state. The process temperature has to enter the normal operating range beyond the hysteresis zone to activate the alarm output function.

If the Series F4 has an output that is functioning as a deviation alarm, the alarm is silenced when the set point is changed, until the process value re-enters the normal operating range.

Location in software: Setup Page > Alarm x (1 or 2).

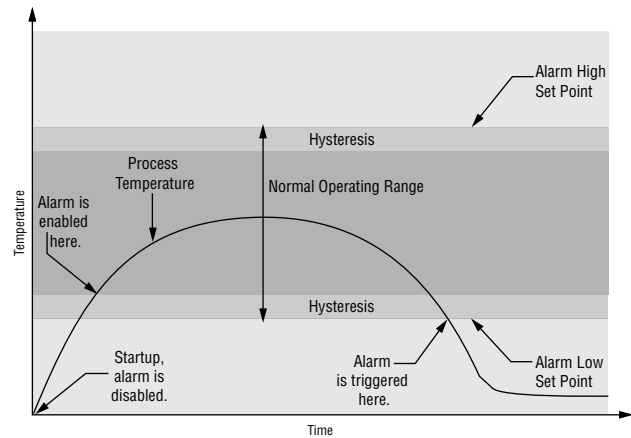

Figure 6.9b — Alarm Silencing.

## Alarm Sides

Alarms can be configured to trigger when the process exceeds the High Alarm Set Point, the Low Alarm Set Point or both.

Location in software: Setup Page > Alarm x (1 or 2).

(Alarm set points are established in the Operations Page.)

# Advanced Features

## Boost Heat and Boost Cool

The boost heat feature uses a digital output to turn on an additional heater to speed up the heating. As the process temperature approaches the set point, the boost heat output switches off so that the process temperature doesn't overshoot the set point.

Boost cool uses a digital output to speed up the cooling process, typically by activating a solenoid valve that releases liquid nitrogen.

For either boost heat or boost cool, set **Boost % Power** to define the power level that must be exceeded before the boost output is activated. Use a positive value for heating, a negative value for cooling.

To prevent the output from cycling and to extend hardware life, define **Boost Time Delay** in seconds to set the minimum period of time that the output will remain off after an on cycle.

The Series F4 uses digital output 6 for boost heat and digital output 7 for boost cool. Hysteresis for boost heat and cool is fixed at 5%.

Location in software: Setup > Digital Output x (6 or 7).

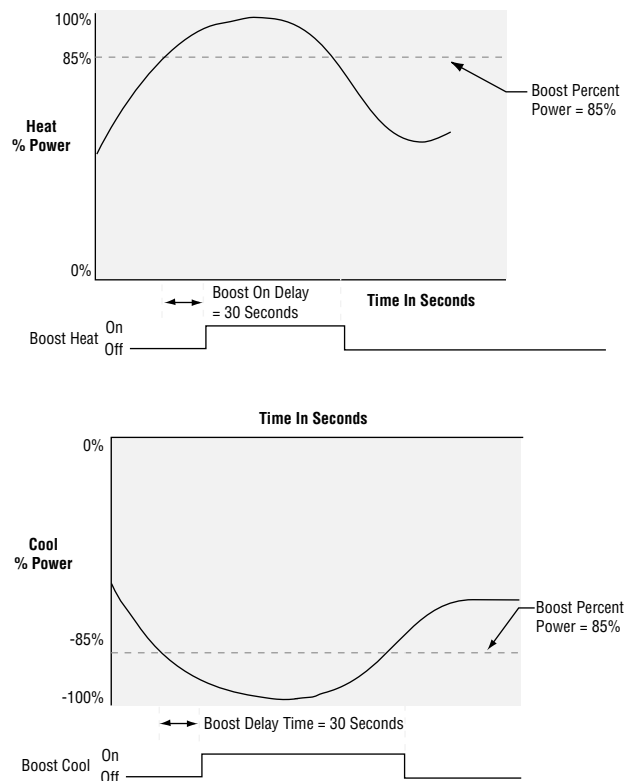

Figure 6.10a — Boost Heat and Boost Cool.

## Compressor Control

The compressor control can save wear on a compressor and prevent it from locking up from short cycling. A bypass valve operated by a control output regulates how the process is cooled, while a digital output switches the compressor on and off.

The Series F4 uses digital output 8 for compressor control. **Compressor On % Power** sets the power level that will switch the compressor on. **Compressor Off % Power** sets the power level that will switch the compressor off.

The compressor will not turn on until the output power exceeds the **Compressor On % Power** for a time longer than the **Compressor On Delay**. The compressor will not turn off until the output power exceeds the **Compressor Off % Power** for a time longer than the **Compressor Off Delay**.

Location in software: Setup Page > Digital Output 8.

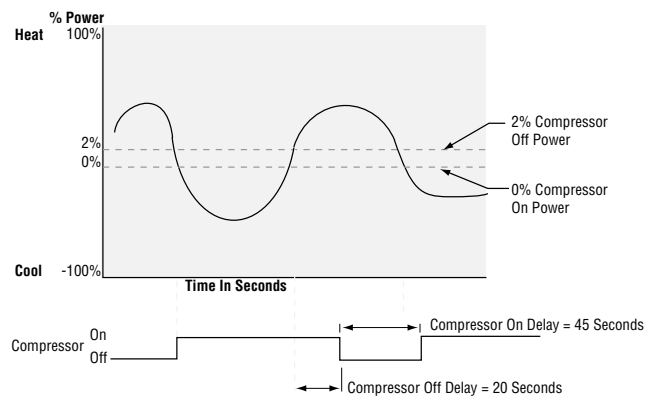

Figure 6.10b — Compressor Power.

## Cascade

Cascade control is a control strategy in which one control loop provides the set point for another loop. It allows the process or part temperature to be reached quickly while minimizing overshoot. Cascade is used to optimize the performance of thermal systems with long lag times.

This graph illustrates a thermal system with a long lag time. Curve A represents a single-loop control system with PID parameters that allow a maximum heat-up rate. Too much energy is introduced and the set point is overshoot. In most systems with long lag time, the process value may never settle out to an acceptable error. Curve C represents a single-control system tuned to minimize overshoot. This results in unacceptable heat-up rates, taking hours to reach the final value. Curve B shows a cascade system that limits the energy introduced into the system, allowing an optimal heat-up rate with minimal overshoot.

Cascade control uses two control loops (outer and inner) to control the process. The outer loop (analog input 3) monitors the process or part temperature, which is then compared to the set point. The result of the comparison, the error signal, is acted on by the settings in a Cascade Outer Loop PID set (1 to 5), which then generates a power level for the outer loop. The set point for the inner loop is determined by the outer-loop power level and the Cascade Low Range/Deviation and the Cascade High Range/Deviation settings for analog input 3.

The inner loop (analog input 1) monitors the energy source (heating and cooling), which is compared to the inner loop set point generated by the outer loop. The result of the comparison, the error signal, is acted on by the settings in a Cascade Inner Loop PID set (1 to 5), which generates an output power level between -100% to +100%. If the power level is positive the heat will be on; if the power level is negative the cool will come on.

In Series F4 controllers, cascade control is available on channel 1. Analog input 3 is used to measure the outer-loop process while analog input 1, the inner loop, is used to measure the energy source. Power from the energy sources are supplied by outputs 1A and 1B.

To set up and tune a system for cascade control, see the Operations Chapter.

Location in software: Setup Page and Operations Page.

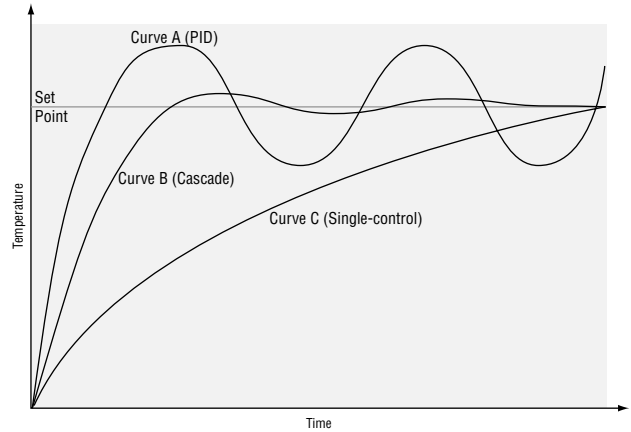
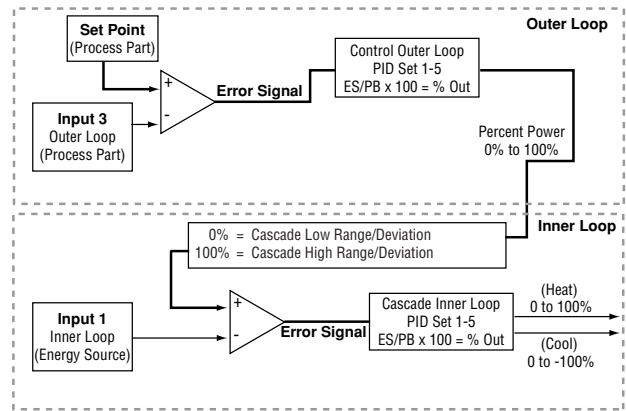

Figure 6.11a — Control Lag Times.



✓NOTE: Cascade Low Range and Cascade High Range Set Points for Input 1 (as shown above) are setup under Analog Input 3. Refer to Setup Chapter.

Figure 6.11b — Cascade Control.

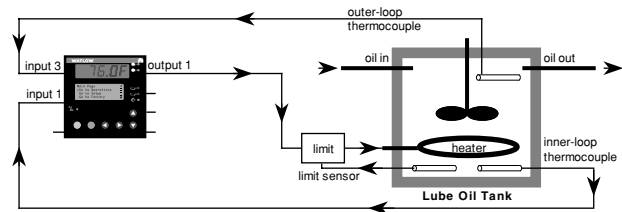

Figure 6.11 — Cascade Example

# Notes

# Chapter Seven: Communications

Exception Responses .....	7.2
Modbus Registers (Alphabetical Order) .....	7.2
Profiling Registers .....	7.10
Modbus Registers (Numerical Order) .....	7.13
Communications Page Parameter Table .....	7.16
Profiling Flow Charts .....	7.17

## Overview

The Series F4 uses Modbus as its communications protocol. Modbus is a standard protocol developed by A.E.G. Schneider. Modbus RTU enables a computer or PLC to read and write directly to registers containing the controller's parameters. With it you can read all of the controller's parameters with a few read commands.

If you already have a software application that uses Modbus, the Modbus Registers Table in this chapter will provide the register number and values (sometimes called enumerated types) for each parameter.

Dependencies between parameters do exist. For best results, program the parameters in the order in which they appear in the Software Map (inside back cover).

To program a profile using Modbus, refer to the Profiling Flow Charts in this chapter.

For basic information about writing an application using Modbus protocol, you may want to download the electronic *Watlow Controls Data Communications Guide* from the Watlow web site:

<http://www.watlow.com/prodtechinfo>

Search on **data communications reference**.

## Exception Responses

When a controller cannot process a command it returns an exception response and sets the high bit (0x80) of the command.

0x01 illegal command

0x02 illegal data address

0x03 illegal data value

**Packet returned by controller:**

nn	nn	nn	nn	nn	
----	----	----	----	----	--

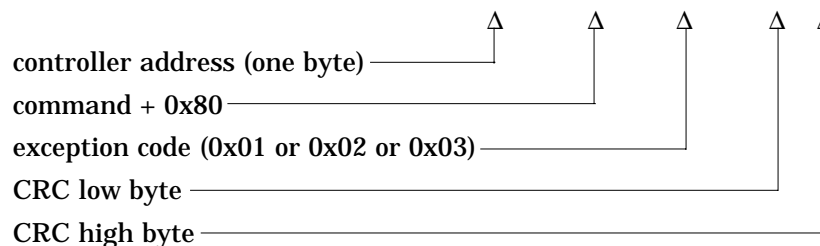

### ✓ NOTE:

For ranges, conditions and other information, look up parameter names in the Index, which will direct you to earlier chapters in this book.

# Series F4 Modbus Registers

## Parameters Sorted Alphabetically

Register numbers listed are relative values. To convert to absolute values, add 40001. Registers for profiling parameters are in a separate section at the end of this list, followed by a list of all Modbus registers in numerical order. For more information about parameters, see the Index.

<b>103</b>	<b>% Power Output 1A, Status</b>	<b>722</b>	<b>Alarm Silencing, Alarm Output 2</b>
r	0 to 100 (expressed in %)	r/w	0 No
<b>107</b>	<b>% Power Output 1B, Status</b>		1 Yes
r	0 to 100 (expressed in %)	<b>716</b>	<b>Alarm Source, Alarm Output 1</b>
<b>111</b>	<b>% Power Output 2A, Status</b>	r/w	0 Input 1
r	0 to 100 (expressed in %)		1 Input 2
<b>115</b>	<b>% Power Output 2B, Status</b>		2 Input 3
r	0 to 100 (expressed in %)	<b>733</b>	<b>Alarm Source, Alarm Output 2</b>
<b>102</b>	<b>Alarm 1, Status</b>	r/w	0 Input 1
r			1 Input 2
<b>106</b>	<b>Alarm 2, Status</b>		2 Input 3
r		<b>702</b>	<b>Alarm Type, Alarm Output 1</b>
<b>303</b>	<b>Alarm High Deviation, Alarm 1, Value</b>	r/w	0 Off
r/w	1 to 30000		1 Process
<b>322</b>	<b>Alarm High Deviation, Alarm 2, Value</b>		2 Deviation
r/w	1 to 30000	<b>719</b>	<b>Alarm Type, Alarm Output 2</b>
<b>303</b>	<b>Alarm High Set Point, Alarm 1, Value</b>	r/w	0 Off
r/w	<per sensor> to Alarm 1 Low Set Point		1 Process
<b>322</b>	<b>Alarm High Set Point, Alarm 2, Value</b>		2 Deviation
r/w	<per sensor> to Alarm 2 Low Set Point	<b>1902</b>	<b>Altitude, Analog Input 2</b>
<b>703</b>	<b>Alarm Hysteresis, Alarm Output 1</b>	r/w	0 0 to 2499 ft
r/w	1 to 30000		1 2500 to 4999 ft
<b>720</b>	<b>Alarm Hysteresis, Alarm Output 2</b>		2 5000 ft and above
r/w	1 to 30000	<b>606</b>	<b>Analog Input 1 Decimal Point</b>
<b>704</b>	<b>Alarm Latching, Alarm Output 1</b>	r/w	0 0
r/w	0 Alarm Self-clears		1 00
	1 Alarm Latches		2 000
<b>721</b>	<b>Alarm Latching, Alarm Output 2</b>		3 0000
r/w	0 Alarm Self-clears	<b>616</b>	<b>Analog Input 2 Decimal Point</b>
	1 Alarm Latches	r/w	0 0
<b>707</b>	<b>Alarm Logic, Alarm Output 1</b>		1 00
r/w	0 Open on Alarm		2 000
	1 Close on Alarm		3 0000
<b>724</b>	<b>Alarm Logic, Alarm Output 2</b>	<b>626</b>	<b>Analog Input 3 Decimal Point</b>
r/w	0 Open on Alarm	r/w	0 0
	1 Close on Alarm		1 00
<b>302</b>	<b>Alarm Low Deviation, Alarm 1, Value</b>		2 000
r/w	-19999 to -1		3 0000
<b>321</b>	<b>Alarm Low Deviation, Alarm 2, Value</b>	<b>836</b>	<b>Analog Range, Retransmit Output 1</b>
r/w	-19999 to -1	r/w	0 4 to 20mA
<b>302</b>	<b>Alarm Low Set Point, Alarm 1, Value</b>		1 0 to 20mA
r/w	<per sensor> to Alarm 1 High Set Point		2 0 to 5V
<b>321</b>	<b>Alarm Low Set Point, Alarm 2, Value</b>		3 1 to 5V
r/w	<per sensor> to Alarm 2 High Set Point		4 1 to 10V
<b>708</b>	<b>Alarm Messages, Alarm Output 1</b>	<b>837</b>	<b>Analog Range, Retransmit Output 2</b>
r/w	0 Yes on Main Page	r/w	0 4 to 20mA
	1 No		1 0 to 20mA
<b>725</b>	<b>Alarm Messages, Alarm Output 2</b>		2 0 to 5V
r/w	0 Yes on Main Page		3 1 to 5V
	1 No		4 1 to 10V
<b>1308</b>	<b>Alarm Set Point, Lockout</b>	<b>305</b>	<b>Autotune Channel 1</b>
r/w	0 Full Access	r/w	0 Tune Off
	1 Read Only		1 PID Set 1
	2 Password		2 PID Set 2
	3 Hidden		3 PID Set 3
<b>706</b>	<b>Alarm Sides, Alarm Output 1</b>		4 PID Set 4
r/w	0 Both		5 PID Set 5
	1 Low	<b>324</b>	<b>Autotune Channel 2</b>
	2 High	r/w	0 Tune Off
<b>723</b>	<b>Alarm Sides, Alarm Output 2</b>		1 PID Set 6
r/w	0 Both		2 PID Set 7
	1 Low		3 PID Set 8
	2 High		4 PID Set 9
<b>705</b>	<b>Alarm Silencing, Alarm Output 1</b>		5 PID Set 10
r/w	0 No	<b>343</b>	<b>Autotune Cascade</b>
	1 Yes	r/w	0 Tune Off
			1 PID Set 1
			2 PID Set 2
			3 PID Set 3
			4 PID Set 4
			5 PID Set 5

**1306 Autotune PID, Lockout**  
r/w 0 Full Access  
1 Read Only  
2 Password  
3 Hidden

**304 Autotune Set Point, Channel 1, Value**  
r/w 50 to 150 (expressed in %)

**323 Autotune Set Point, Channel 2, Value**  
r/w 50 to 150 (expressed in %)

**2062 Boost Cool % Power, Digital Output 7**  
r/w -100 to 0 for Cool (expressed in %)

**2064 Boost Cool Delay On Time, Digital Output 7**  
r/w 0 to 9999 seconds

**2062 Boost Cool Power**  
r/w Value

**2064 Boost Cool Time**  
r/w Value

**2052 Boost Heat % Power, Digital Output 6**  
r/w 0 to 0 for Heat (expressed in %)

**2054 Boost Heat Delay On Time, Digital Output 6**  
r/w 0 to 9999 seconds

**2052 Boost Heat Power**  
r/w Value in %

**2054 Boost Heat Time**  
r/w Value in seconds

**605 Calibration Offset, Analog Input 1**  
r/w -19999 to 30000

**615 Calibration Offset, Analog Input 2**  
r/w -19999 to 30000

**625 Calibration Offset, Analog Input 3**  
r/w -19999 to 30000

**1922 Cascade Inner Set Point**  
r

**1925 Cascade Type**  
r/w 0 No Cascade  
1 Process Cascade  
2 Deviation Cascade

**1926 Cascade, Range Low**  
r/w Depends on Sensor

**1927 Cascade, Range High**  
r/w Depends on Sensor

**1330-33 Change Password**  
r/w ASCII codes 0-9, A-Z

**1501 CJC1 AtoD, Diagnostics**  
r HHHH see In 1 AD

**1500 CJC1 Temp, Diagnostics**  
r value

**1532 CJC2 AtoD, Diagnostics**  
r HHHH

**1531 CJC2 Temp, Diagnostics**  
r value

**312 Clear Alarm 1, Key Press Simulation**  
w write any value

**331 Clear Alarm 2, Key Press Simulation**  
w write any value

**311 Clear Error 1, Key Press Simulation**  
w write any value

**330 Clear Error 2, Key Press Simulation**  
w write any value

**349 Clear Error 3, Key Press Simulation**  
w write any value

**1315 Clear Locks**  
0 yes

**2046 Complementary Output, Digital Output 5**  
0 1A  
1 1B  
2 2A  
3 2B

**2073 Compressor Off % Power, Digital Output 8**  
r/w Compressor On % Power to 100%

**2075 Compressor Off Delay, Digital Output 8**  
r/w 0 to 9999 seconds

**2072 Compressor On % Power, Digital Output 8**  
r/w -100 to 100 (expressed in percent)

**2074 Compressor On Delay, Digital Output 8**  
r/w 1 to 9999 seconds

**Control Output Calibration — see Process Output Calibration**

**700 Control Output 1A Function**  
r/w 1 Heat  
2 Cool

**717 Control Output 1B Function**  
r/w 0 Off  
1 Heat  
2 Cool

**734 Control Output 2A Function**  
r/w 1 Heat  
2 Cool

**751 Control Output 2B Function**  
r/w 0 Off  
1 Heat  
2 Cool

**1920 Current Date, Day**  
r/w 1 to 31

**1919 Current Date, Month**  
r/w 1 to 12

**1921 Current Date, Year**  
r/w 1998 to 2035

**1916 Current Time, Hour**  
r/w 0 to 23

**1917 Current Time, Minutes**  
r/w 0 to 59

**1918 Current Time, Seconds**  
r/w 0 to 59

**1400-15 Custom Main Page Parameters (P1 to P16)**  
r/w 0 None  
1 Input 1 Value  
2 Input 2 Value  
3 Input 2 Value  
4 Set Point 1  
5 Set Point 2  
6 % Power 1  
7 % Power 2  
8 Tune Status 1  
9 Tune Status 2  
10 Time  
11 Date  
12 Digital Inputs  
13 Digital Outputs  
14 Time Remaining  
15 Current File  
16 Current Step  
17 Active Ch1 PID Set  
18 Active Ch2 PID Set  
19 Last Jump Step  
20 Jump Count  
21 Wait For Status  
22 Step Type  
23 Target Set Point 1  
24 Target Set Point 2  
25 Internal Cascade Set Point  
26 Custom Message 1  
27 Custom Message 2  
28 Custom Message 3  
29 Custom Message 4  
30 Input1 Cal. Offset  
31 Input2 Cal. Offset  
32 Input3 Cal. Offset

**4501-18 Custom Message 1**  
r/w

**4521-38 Custom Message 2**  
r/w

**4541-58 Custom Message 3**  
r/w

**4561-78 Custom Message 4**  
r/w

**509 Cycle Time (type), Control Output 1A**  
r/w 0 Variable Burst  
1 Fixed Time

**506 Cycle Time Value, Control Output 1A**  
r/w number

**559 Cycle Time (type), Control Output 1B**  
r/w 0 Variable Burst  
1 Fixed Time

**556 Cycle Time Value, Control Output 1B**  
r/w number

**2509 Cycle Time (type), Control Output 2A**  
r/w 0 Variable Burst  
1 Fixed Time

**2506 Cycle Time Value, Control Output 2A,**  
r/w number

**2559 Cycle Time (type), Control Output 2B**  
0 Variable Burst  
1 Fixed Time

**NOTE:**

For more information about parameters, see the Index.

**2556** **Cycle Time Value, Control Output 2B**  
 r/w number  
**2605** **Dead Band 1A, Cascade PID Set 1, Channel 1**  
 r/w 0 to 30000  
**2615** **Dead Band 1A, Cascade PID Set 2, Channel 1**  
 r/w 0 to 30000  
**2625** **Dead Band 1A, Cascade PID Set 3, Channel 1**  
 r/w 0 to 30000  
**2635** **Dead Band 1A, Cascade PID Set 4, Channel 1**  
 r/w 0 to 30000  
**2645** **Dead Band 1A, Cascade PID Set 5, Channel 1**  
 r/w 0 to 30000  
**505** **Dead Band 1A, PID Set 1, Channel 1**  
 r/w 0 to 30000  
**515** **Dead Band 1A, PID Set 2, Channel 1**  
 r/w 0 to 30000  
**525** **Dead Band 1A, PID Set 3, Channel 1**  
 r/w 0 to 30000  
**535** **Dead Band 1A, PID Set 4, Channel 1**  
 r/w 0 to 30000  
**545** **Dead Band 1A, PID Set 5, Channel 1**  
 r/w 0 to 30000  
**2655** **Dead Band 1B, Cascade PID Set 1, Channel 1**  
 r/w 0 to 30000  
**2665** **Dead Band 1B, Cascade PID Set 2, Channel 1**  
 r/w 0 to 30000  
**2675** **Dead Band 1B, Cascade PID Set 3, Channel 1**  
 r/w 0 to 30000  
**2685** **Dead Band 1B, Cascade PID Set 4, Channel 1**  
 r/w 0 to 30000  
**2695** **Dead Band 1B, Cascade PID Set 5, Channel 1**  
 r/w 0 to 30000  
**555** **Dead Band 1B, PID Set 1, Channel 1**  
 r/w 0 to 30000  
**565** **Dead Band 1B, PID Set 2, Channel 1**  
 r/w 0 to 30000  
**575** **Dead Band 1B, PID Set 3, Channel 1**  
 r/w 0 to 30000  
**585** **Dead Band 1B, PID Set 4, Channel 1**  
 r/w 0 to 30000  
**595** **Dead Band 1B, PID Set 5, Channel 1**  
 r/w 0 to 30000  
**2505** **Dead Band 2A, PID Set 6, Channel 2**  
 r/w 1 to 30000  
**2515** **Dead Band 2A, PID Set 7, Channel 2**  
 r/w 1 to 30000  
**2525** **Dead Band 2A, PID Set 8, Channel 2**  
 r/w 1 to 30000  
**2535** **Dead Band 2A, PID Set 9, Channel 2**  
 r/w 1 to 30000  
**2545** **Dead Band 2A, PID Set 10, Channel 2**  
 r/w 1 to 30000  
**2555** **Dead Band 2B, PID Set 6, Channel 2**  
 r/w 1 to 30000  
**2565** **Dead Band 2B, PID Set 7, Channel 2**  
 r/w 1 to 30000  
**2575** **Dead Band 2B, PID Set 8, Channel 2**  
 r/w 1 to 30000  
**2585** **Dead Band 2B, PID Set 9, Channel 2**  
 r/w 1 to 30000  
**2595** **Dead Band 2B, PID Set 10, Channel 2**  
 r/w 1 to 30000  
**2603** **Derivative 1A, Cascade PID Set 1, Channel 1**  
 r/w 000 to 999 (expressed in hundredths of minutes)  
**2613** **Derivative 1A, Cascade PID Set 2, Channel 1**  
 r/w 000 to 999 (expressed in hundredths of minutes)  
**2623** **Derivative 1A, Cascade PID Set 3, Channel 1**  
 r/w 000 to 999 (expressed in hundredths of minutes)  
**2633** **Derivative 1A, Cascade PID Set 4, Channel 1**  
 r/w 000 to 999 (expressed in hundredths of minutes)  
**2643** **Derivative 1A, Cascade PID Set 5, Channel 1**  
 r/w 000 to 999 (expressed in hundredths of minutes)  
**503** **Derivative 1A, PID Set 1, Channel 1**  
 r/w 000 to 999 (expressed in hundredths of minutes)  
**513** **Derivative 1A, PID Set 2, Channel 1**  
 r/w 000 to 999 (expressed in hundredths of minutes)  
**523** **Derivative 1A, PID Set 3, Channel 1**  
 r/w 000 to 999 (expressed in hundredths of minutes)  
**533** **Derivative 1A, PID Set 4, Channel 1**  
 r/w 000 to 999 (expressed in hundredths of minutes)

**543** **Derivative 1A, PID Set 5, Channel 1**  
 r/w 000 to 999 (expressed in hundredths of minutes)  
**2653** **Derivative 1B, Cascade PID Set 1, Channel 1**  
 r/w 000 to 999 (expressed in hundredths of minutes)  
**2663** **Derivative 1B, Cascade PID Set 2, Channel 1**  
 r/w 000 to 999 (expressed in hundredths of minutes)  
**2673** **Derivative 1B, Cascade PID Set 3, Channel 1**  
 r/w 000 to 999 (expressed in hundredths of minutes)  
**2683** **Derivative 1B, Cascade PID Set 4, Channel 1**  
 r/w 000 to 999 (expressed in hundredths of minutes)  
**2693** **Derivative 1B, Cascade PID Set 5, Channel 1**  
 r/w 000 to 999 (expressed in hundredths of minutes)  
**553** **Derivative 1B, PID Set 1, Channel 1**  
 r/w 000 to 999 (expressed in hundredths of minutes)  
**563** **Derivative 1B, PID Set 2, Channel 1**  
 r/w 000 to 999 (expressed in hundredths of minutes)  
**573** **Derivative 1B, PID Set 3, Channel 1**  
 r/w 000 to 999 (expressed in hundredths of minutes)  
**583** **Derivative 1B, PID Set 4, Channel 1**  
 r/w 000 to 999 (expressed in hundredths of minutes)  
**593** **Derivative 1B, PID Set 5, Channel 1**  
 r/w 000 to 999 (expressed in hundredths of minutes)  
**2503** **Derivative 2A, PID Set 6, Channel 2**  
 r/w 000 to 999 (expressed in hundredths of minutes)  
**2513** **Derivative 2A, PID Set 7, Channel 2**  
 r/w 000 to 999 (expressed in hundredths of minutes)  
**2523** **Derivative 2A, PID Set 8, Channel 2**  
 r/w 000 to 999 (expressed in hundredths of minutes)  
**2533** **Derivative 2A, PID Set 9, Channel 2**  
 r/w 000 to 999 (expressed in hundredths of minutes)  
**2543** **Derivative 2A, PID Set 10, Channel 2**  
 r/w 000 to 999 (expressed in hundredths of minutes)  
**2553** **Derivative 2B, PID Set 6, Channel 2**  
 r/w 000 to 999 (expressed in hundredths of minutes)  
**2563** **Derivative 2B, PID Set 7, Channel 2**  
 r/w 000 to 999 (expressed in hundredths of minutes)  
**2573** **Derivative 2B, PID Set 8, Channel 2**  
 r/w 000 to 999 (expressed in hundredths of minutes)  
**2583** **Derivative 2B, PID Set 9, Channel 2**  
 r/w 000 to 999 (expressed in hundredths of minutes)  
**2593** **Derivative 2B, PID Set 10, Channel 2**  
 r/w 000 to 999 (expressed in hundredths of minutes)  
**201** **Digital Input 1, Status**  
 0 Low  
 1 High  
**1061** **Digital Input 1 Condition**  
 r/w 0 Low  
 1 High  
**1060** **Digital Input 1 Function**  
 r/w 0 Off  
 1 Panel Lock  
 2 Reset Alarm  
 3 Control Outputs Off  
 4 All Outputs Off  
 5 Digital Outputs Off  
 6 Start Profile  
 7 Pause Profile  
 8 Resume Profile  
 9 Terminate Profile  
 10 Wait For Event  
**1075** **Digital Input 1, Start Profile**  
 r/w 1 to 40  
**1076** **Digital Input 1, Start Step**  
 r/w 1 to 256  
**213** **Digital Input 2, Status**  
 0 Low  
 1 High  
**1063** **Digital Input 2 Condition**  
 r/w 0 Low  
 1 High  
**1062** **Digital Input 2 Function**  
 r/w 0 Off  
 1 Panel Lock  
 2 Reset Alarm  
 3 Control Outputs Off  
 4 All Outputs Off  
 5 Digital Outputs Off  
 6 Start Profile  
 7 Pause Profile  
 8 Resume Profile  
 9 Terminate Profile  
 10 Wait For Event



**1077 Digital Input 2, Start Profile**  
 r/w 1 to 40  
**1078 Digital Input 2, Start Step**  
 r/w 1 to 256  
**225 Digital Input 3, Status**  
 0 Low  
 1 High  
**1065 Digital Input 3 Condition**  
 r/w 0 Low  
 1 High  
**1064 Digital Input 3 Function**  
 r/w 0 Off  
 1 Panel Lock  
 2 Reset Alarm  
 3 Control Outputs Off  
 4 All Outputs Off  
 5 Digital Outputs Off  
 6 Start Profile  
 7 Pause Profile  
 8 Resume Profile  
 9 Terminate Profile  
 10 Wait For Event  
**1079 Digital Input 3, Start Profile**  
 r/w 1 to 40  
**1080 Digital Input 3, Start Step**  
 r/w 1 to 256  
**237 Digital Input 4, Status**  
 0 Low  
 1 High  
**1067 Digital Input 4 Condition**  
 r/w 0 Low  
 1 High  
**1066 Digital Input 4 Function**  
 r/w 0 Off  
 1 Panel Lock  
 2 Reset Alarm  
 3 Control Outputs Off  
 4 All Outputs Off  
 5 Digital Outputs Off  
 6 Start Profile  
 7 Pause Profile  
 8 Resume Profile  
 9 Terminate Profile  
 10 Wait For Event  
**1081 Digital Input 4, Start Profile**  
 r/w 1 to 40  
**1082 Digital Input 4, Start Step**  
 r/w 1 to 256  
**2000 Digital Output 1, Condition**  
 r/w 0 Off  
 1 On  
**2001 Digital Output 1 Function**  
 r/w 0 Off  
 1 Event Output  
**2010 Digital Output 2, Condition**  
 r/w 0 Off  
 1 On  
**2011 Digital Output 2 Function**  
 r/w 0 Off  
 1 Event Output  
**2020 Digital Output 3, Condition**  
 r/w 0 Off  
 1 On  
**2021 Digital Output 3 Function**  
 r/w 0 Off  
 1 Event Output  
**2030 Digital Output 4, Condition**  
 r/w 0 Off  
 1 On  
**2031 Digital Output 4 Function**  
 r/w 0 Off  
 1 Event Output  
**2040 Digital Output 5, Condition**  
 r/w 0 Off  
 1 On  
**2041 Digital Output 5 Function**  
 r/w 0 Off  
 1 Event Output  
 2 Complementary Output

**2946 Control Output**  
 r/w 0 1A  
 1 1B  
 2 2A  
 3 2B  
**2050 Digital Output 6, Condition**  
 r/w 0 Off  
 1 On  
**2051 Digital Output 6 Function**  
 r/w 0 Off  
 1 Event Output  
 3 Boost Heat  
**2060 Digital Output 7, Condition**  
 r/w 0 Off  
 1 On  
**2061 Digital Output 7 Function**  
 r/w 0 Off  
 1 Event Output  
 4 Boost Cool  
**2070 Digital Output 8, Condition**  
 r/w 0 Off  
 1 On  
**2071 Digital Output 8 Function**  
 r/w 0 Off  
 1 Event Output  
 5 Compressor  
**2072 Power On**  
 r/w Value  
**2073 Power Off**  
 r/w Value  
**2074 Delay On**  
 r/w Value  
**2055 Delay Off**  
 r/w Value  
**1513 Display Test, Test**  
 w 0 Off  
 1 On  
**1307 Edit PID, Lockout**  
 r/w 0 Full Access  
 1 Read Only  
 2 Password  
 3 Hidden  
**607 Error Latching, Analog Input 1**  
 r/w 0 Self Clear  
 1 Latch  
**617 Error Latching, Analog Input 2**  
 r/w 0 Self Clear  
 1 Latch  
**627 Error Latching, Analog Input 3**  
 r/w 0 Self Clear  
 1 Latch  
**1303 Factory Page, Lockout**  
 r/w 0 Full Access  
 1 Read Only  
 2 Password  
**604 Filter Time, Analog Input 1**  
 r/w -600 to 600 (expressed in tenths of seconds)  
**614 Filter Time, Analog Input 2**  
 r/w -600 to 600 (expressed in tenths of seconds)  
**624 Filter Time, Analog Input 3**  
 r/w -600 to 600 (expressed in tenths of seconds)  
**1602 Full Defaults**  
 800 yes  
**1205 Guaranteed Soak Band, Channel 1**  
 r/w 1 to 9999  
**1212 Guaranteed Soak Band, Channel 2**  
 r/w 1 to 9999  
**1220 Guaranteed Soak Band 1 Source**  
 r/w 0 Input 1  
 1 Input 2  
 2 Input 3  
**1221 Guaranteed Soak Band 2 Source**  
 r/w 0 Input 1  
 1 Input 2  
 2 Input 3  
**714 High Power Limit, Control Output 1A**  
 r/w Low Limit+1 to 100 (expressed in %)  
**731 High Power Limit, Control Output 1B**  
 r/w Low Limit+1 to 100 (expressed in %)

✓NOTE:  
 For more information  
 about parameters, see  
 the Index.

<b>748</b>	<b>High Power Limit, Control Output 2A</b>	<b>8</b>	<b>Input 1 Type, Diagnostics</b>
r/w	Low Limit+1 to 100 (expressed in %)	r	Univ
<b>765</b>	<b>High Power Limit, Control Output 2B</b>	<b>100</b>	<b>Input 1 Value, Status</b>
r/w	Low Limit+1 to 100 (expressed in %)	r	value
<b>711</b>	<b>High Scale, Retransmit Output 1</b>	<b>1603</b>	<b>Input 1, Calibrate</b>
r/w	Low Scale +1 to 30000 (maximum sensor range)	1	0 mV Thermocouple
<b>728</b>	<b>High Scale, Retransmit Output 2</b>	2	50 mV Thermocouple
r/w	Low Scale +1 to 30000 (maximum sensor range)	3	32° Type J
<b>2607</b>	<b>Hysteresis 1A, Cascade PID Set 1, Channel 1</b>	4	Ground
r/w	1 to 30000 (dependent on decimal setting)	5	Lead
<b>2617</b>	<b>Hysteresis 1A, Cascade PID Set 2, Channel 1</b>	6	15.0 ohms
r/w	1 to 30000 (dependent on decimal setting)	7	380.0 ohms
<b>2627</b>	<b>Hysteresis 1A, Cascade PID Set 3, Channel 1</b>	8	0.000 V
r/w	1 to 30000 (dependent on decimal setting)	9	10.000 V
<b>2637</b>	<b>Hysteresis 1A, Cascade PID Set 4, Channel 1</b>	10	4.000 mA
r/w	1 to 30000 (dependent on decimal setting)	11	20.000 mA
<b>2647</b>	<b>Hysteresis 1A, Cascade PID Set 5, Channel 1</b>	<b>1505</b>	<b>Input 2 AtoD, Diagnostics</b>
r/w	1 to 30000 (dependent on decimal setting)	r	HHHH
<b>507</b>	<b>Hysteresis 1A, PID Set 1, Channel 1</b>	<b>105</b>	<b>Input 2 Error, Status</b>
r/w	1 to 30000 (dependent on decimal setting)	<b>906</b>	<b>Input 2 Fail % Power, System</b>
<b>517</b>	<b>Hysteresis 1A, PID Set 2, Channel 1</b>	r/w	-100 to 100 (expressed in %)
r/w	1 to 30000 (dependent on decimal setting)	<b>222</b>	<b>Input 2 Open Loop, Status</b>
<b>527</b>	<b>Hysteresis 1A, PID Set 3, Channel 1</b>	<b>9</b>	<b>Input 2 Type, Diagnostics</b>
r/w	1 to 30000 (dependent on decimal setting)	r	Univ
<b>537</b>	<b>Hysteresis 1A, PID Set 4, Channel 1</b>		None
r/w	1 to 30000 (dependent on decimal setting)	<b>104</b>	<b>Input 2 Value, Status</b>
<b>547</b>	<b>Hysteresis 1A, PID Set 5, Channel 1</b>	r	value
r/w	1 to 30000 (dependent on decimal setting)	<b>1608</b>	<b>Input 2, Calibrate</b>
<b>2657</b>	<b>Hysteresis 1B, Cascade PID Set 1, Channel 1</b>	1	0 mV Thermocouple
r/w	1 to 30000 (dependent on decimal setting)	2	50 mV Thermocouple
<b>2667</b>	<b>Hysteresis 1B, Cascade PID Set 2, Channel 1</b>	3	32° Type J
r/w	1 to 30000 (dependent on decimal setting)	4	Ground
<b>2677</b>	<b>Hysteresis 1B, Cascade PID Set 3, Channel 1</b>	5	Lead
r/w	1 to 30000 (dependent on decimal setting)	6	15.0 ohms
<b>2687</b>	<b>Hysteresis 1B, Cascade PID Set 4, Channel 1</b>	7	380.0 ohms
r/w	1 to 30000 (dependent on decimal setting)	8	0.000 V
<b>2697</b>	<b>Hysteresis 1B, Cascade PID Set 5, Channel 1</b>	9	10.000 V
r/w	1 to 30000 (dependent on decimal setting)	10	4.000 mA
<b>557</b>	<b>Hysteresis 1B, PID Set 1, Channel 1</b>	11	20.000 mA
r/w	1 to 30000 (dependent on decimal setting))	<b>1506</b>	<b>Input 3 AtoD, Diagnostics</b>
<b>567</b>	<b>Hysteresis 1B, PID Set 2, Channel 1</b>	r	HHHH
r/w	1 to 30000 (dependent on decimal setting)	<b>109</b>	<b>Input 3 Error, Status</b>
<b>577</b>	<b>Hysteresis 1B, PID Set 3, Channel 1</b>	<b>10</b>	<b>Input 3 Type, Diagnostics</b>
r/w	1 to 30000 (dependent on decimal setting)	r	Univ
<b>587</b>	<b>Hysteresis 1B, PID Set 4, Channel 1</b>		None
r/w	1 to 30000 (dependent on decimal setting)	<b>108</b>	<b>Input 3 Value, Status</b>
<b>597</b>	<b>Hysteresis 1B, PID Set 5, Channel 1</b>	r	value
r/w	1 to 30000 (dependent on decimal setting)	<b>1613</b>	<b>Input 3, Calibrate</b>
<b>2507</b>	<b>Hysteresis 2A, PID Set 6, Channel 2</b>	1	0 mV Thermocouple
r/w	1 to 30000 (dependent on decimal setting)	2	50 mV Thermocouple
<b>2517</b>	<b>Hysteresis 2A, PID Set 7, Channel 2</b>	3	32° Type J
r/w	1 to 30000 (dependent on decimal setting)	4	Ground
<b>2527</b>	<b>Hysteresis 2A, PID Set 8, Channel 2</b>	5	Lead
r/w	1 to 30000 (dependent on decimal setting)	6	15.0 ohms
<b>2537</b>	<b>Hysteresis 2A, PID Set 9, Channel 2</b>	7	380.0 ohms
r/w	1 to 30000 (dependent on decimal setting)	8	0.000 V
<b>2547</b>	<b>Hysteresis 2A, PID Set 10, Channel 2</b>	9	10.000 V
r/w	1 to 30000 (dependent on decimal setting)	10	4.000 mA
<b>2557</b>	<b>Hysteresis 2B, PID Set 6, Channel 2</b>	11	20.000 mA
r/w	1 to 30000 (dependent on decimal setting)	<b>2601</b>	<b>Integral 1A , Cascade PID Set 1, Channel 1</b>
<b>2567</b>	<b>Hysteresis 2B, PID Set 7, Channel 2</b>	r/w	000 to 9999 (expressed in hundredths of minutes)
r/w	1 to 30000 (dependent on decimal setting)	<b>2611</b>	<b>Integral 1A , Cascade PID Set 2, Channel 1</b>
<b>2577</b>	<b>Hysteresis 2B, PID Set 8, Channel 2</b>	r/w	000 to 9999 (expressed in hundredths of minutes)
r/w	1 to 30000 (dependent on decimal setting)	<b>2621</b>	<b>Integral 1A , Cascade PID Set 3, Channel 1</b>
<b>2587</b>	<b>Hysteresis 2B, PID Set 9, Channel 2</b>	r/w	000 to 9999 (expressed in hundredths of minutes)
r/w	1 to 30000 (dependent on decimal setting)	<b>2631</b>	<b>Integral 1A , Cascade PID Set 4, Channel 1</b>
<b>2597</b>	<b>Hysteresis 2B, PID Set 10, Channel 2</b>	r/w	000 to 9999 (expressed in hundredths of minutes)
r/w	1 to 30000 (dependent on decimal setting)	<b>2641</b>	<b>Integral 1A , Cascade PID Set 5, Channel 1</b>
<b>308</b>	<b>Idle Set Point, Channel 1, Power Out Action</b>	r/w	000 to 9999 (expressed in hundredths of minutes)
r/w	number	<b>501</b>	<b>Integral 1A , PID Set 1, Channel 1</b>
<b>327</b>	<b>Idle Set Point, Channel 2, Power Out Action</b>	r/w	000 to 9999 (expressed in hundredths of minutes)
r/w	number	<b>511</b>	<b>Integral 1A , PID Set 2, Channel 1</b>
<b>1504</b>	<b>Input 1 AtoD, Diagnostics</b>	r/w	000 to 9999 (expressed in hundredths of minutes)
r	HHHH	<b>521</b>	<b>Integral 1A , PID Set 3, Channel 1</b>
<b>101</b>	<b>Input 1 Error, Status</b>	r/w	000 to 9999 (expressed in hundredths of minutes)
<b>903</b>	<b>Input 1 Fail % Power, System</b>	<b>531</b>	<b>Integral 1A , PID Set 4, Channel 1</b>
r/w	-100 to 100 (expressed in %)	r/w	000 to 9999 (expressed in hundredths of minutes)
<b>210</b>	<b>Input 1 Open Loop, Status</b>	<b>541</b>	<b>Integral 1A , PID Set 5, Channel 1</b>
		r/w	000 to 9999 (expressed in hundredths of minutes)

**2651 Integral 1B , Cascade PID Set 1, Channel 1**  
r/w 000 to 9999 (expressed in hundredths of minutes)

**2661 Integral 1B , Cascade PID Set 2, Channel 1**  
r/w 000 to 9999 (expressed in hundredths of minutes)

**2671 Integral 1B , Cascade PID Set 3, Channel 1**  
r/w 000 to 9999 (expressed in hundredths of minutes)

**2681 Integral 1B , Cascade PID Set 4, Channel 1**  
r/w 000 to 9999 (expressed in hundredths of minutes)

**2691 Integral 1B , Cascade PID Set 5, Channel 1**  
r/w 000 to 9999 (expressed in hundredths of minutes)

**551 Integral 1B, PID Set 1, Channel 1**  
r/w 000 to 9999 (expressed in hundredths of minutes)

**561 Integral 1B, PID Set 2, Channel 1**  
r/w 000 to 9999 (expressed in hundredths of minutes)

**571 Integral 1B, PID Set 3, Channel 1**  
r/w 000 to 9999 (expressed in hundredths of minutes)

**581 Integral 1B, PID Set 4, Channel 1**  
r/w 000 to 9999 (expressed in hundredths of minutes)

**591 Integral 1B, PID Set 5, Channel 1**  
r/w 000 to 9999 (expressed in hundredths of minutes)

**2501 Integral 2A, PID Set 6, Channel 2**  
r/w 000 to 9999 (expressed in hundredths of minutes)

**2511 Integral 2A, PID Set 7, Channel 2**  
r/w 000 to 9999 (expressed in hundredths of minutes)

**2521 Integral 2A, PID Set 8, Channel 2**  
r/w 000 to 9999 (expressed in hundredths of minutes)

**2531 Integral 2A, PID Set 9, Channel 2**  
r/w 000 to 9999 (expressed in hundredths of minutes)

**2541 Integral 2A, PID Set 10, Channel 2**  
r/w 000 to 9999 (expressed in hundredths of minutes)

**2551 Integral 2B, PID Set 6, Channel 2**  
r/w 000 to 9999 (expressed in hundredths of minutes)

**2561 Integral 2B, PID Set 7, Channel 2**  
r/w 000 to 9999 (expressed in hundredths of minutes)

**2571 Integral 2B, PID Set 8, Channel 2**  
r/w 000 to 9999 (expressed in hundredths of minutes)

**2581 Integral 2B, PID Set 9, Channel 2**  
r/w 000 to 9999 (expressed in hundredths of minutes)

**2591 Integral 2B, PID Set 10, Channel 2**  
r/w 000 to 9999 (expressed in hundredths of minutes)

**1515 Line Frequency, Diagnostics**  
r xx

**715 Low Power Limit, Control Output 1A**  
r/w 0 to High Limit-1000 to 9999 (expressed in %)

**732 Low Power Limit, Control Output 1B**  
r/w 0 to High Limit-1 (expressed in %)

**749 Low Power Limit, Control Output 2A**  
r/w 0 to High Limit-1 (expressed in %)

**766 Low Power Limit, Control Output 2B**  
r/w 0 to High Limit-1 (expressed in %)

**710 Low Scale, Retransmit Output 1**  
r/w -19999 to Scale High-1 (minimum sensor range)

**727 Low Scale, Retransmit Output 2**  
r/w -19999 to Scale High-2 (minimum sensor range)

**5 Mfg. Date, Diagnostics**  
r xxxx

**0 Model, Diagnostics**  
r F4

**3200-09 Name, Alarm 1 (10 characters)**  
r/w ASCII equivalent decimal code — see Modbus Naming Flowchart

**3210-19 Name, Alarm 2 (10 characters)**  
r/w ASCII equivalent decimal code — see Modbus Naming Flowchart

**3000-06 Name, Digital Input 1 (7 characters)**  
r/w ASCII equivalent decimal code — see Modbus Naming Flowchart

**3010-16 Name, Digital Input 2 (7 characters)**  
r/w ASCII equivalent decimal code — see Modbus Naming Flowchart

**3020-26 Name, Digital Input 3 (7 characters)**  
r/w ASCII equivalent decimal code — see Modbus Naming Flowchart

**3030-36 Name, Digital Input 4 (7 characters)**  
r/w ASCII equivalent decimal code — see Modbus Naming Flowchart

**3100-09 Name, Digital Output 1 (10 characters)**  
r/w ASCII equivalent decimal code — see Modbus Naming Flowchart

**3110-19 Name, Digital Output 2 (10 characters)**  
r/w ASCII equivalent decimal code — see Modbus Naming Flowchart

**3120-29 Name, Digital Output 3 (10 characters)**  
r/w ASCII equivalent decimal code — see Modbus Naming Flowchart

**3130-39 Name, Digital Output 4 (10 characters)**  
r/w ASCII equivalent decimal code — see Modbus Naming Flowchart

**3140-49 Name, Digital Output 5 (10 characters)**  
r/w ASCII equivalent decimal code — see Modbus Naming Flowchart

**3150-59 Name, Digital Output 6 (10 characters)**  
r/w ASCII equivalent decimal code — see Modbus Naming Flowchart

**3160-69 Name, Digital Output 7 (10 characters)**  
r/w ASCII equivalent decimal code — see Modbus Naming Flowchart

**3170-79 Name, Digital Output 8 (10 characters)**  
r/w ASCII equivalent decimal code — see Modbus Naming Flowchart

**904 Open Loop Channel 1**  
r/w 0 Off  
1 On

**907 Open Loop Channel 2**  
r/w 0 Off  
1 On

**200 Operation Mode, Status**  
r 0 Terminate Profile  
1 Pre-run Profile  
2 Running Profile  
3 Holding Profile

**16 Output 1A Type, Diagnostics**  
r 1 DC  
2 SSR  
3 Process

**17 Output 1B Type, Diagnostics**  
r 0 None  
1 DC  
2 SSR  
3 Process

**18 Output 2A Type, Diagnostics**  
r 0 None  
1 DC  
2 SSR  
3 Process

**19 Output 2B Type, Diagnostics**  
r 0 None  
1 DC  
2 SSR  
3 Process

**900 PID Units, System**  
r/w 0 US (Reset/Rate)  
1 SI (Integral/Derivative)

**1206 Power-Out Action**  
r/w 0 Continue  
1 Hold  
2 Terminate  
3 Reset  
4 Idle Set Point 1  
5 Idle Set Point 2

**1213 Power-Out Time**  
r/w 0 to 9999 seconds

**5500 Process Display**  
r/w 0 Input 1 only  
1 Alternating

**5501 Process Display, Input 1 Time**  
r/w 0 to 999

**5502 Process Display, Input 2 Time**  
r/w 0 to 999

**5503 Process Display, Input 3 Time**  
r/w 0 to 999

**1606 Process Output 1A, 1.000V, Calibrate**  
w 0000 to 3000 (expressed in thousandths volts)

**1607 Process Output 1A, 10.000V, Calibrate**  
w 0000 to 12000 (expressed in thousandths volts)

**1605 Process Output 1A, 20.000mA, Calibrate**  
w 0000 to 24000 (expressed in microamps)

**1604 Process Output 1A, 4.000mA, Calibrate**  
w 0000 to 6000 (expressed in microamps)

**1611 Process Output 1B, 1.000V, Calibrate**  
w 0000 to 3000 (expressed in thousandths volts)

**1612 Process Output 1B, 10.000V, Calibrate**  
w 0000 to 12000 (expressed in thousandths volts)

**1610 Process Output 1B, 20.000mA, Calibrate**  
w 0000 to 24000 (expressed in microamps)

✓**NOTE:**  
For more information  
about parameters, see  
the Index.

1609	<b>Process Output 1B, 4.000mA, Calibrate</b>	540	<b>Proportional Band 1A, PID Set 5, Channel 1</b>
w	0000 to 6000 (expressed in microamps)	r/w	0 to 30000
1616	<b>Process Output 2A, 1.000V, Calibrate</b>	2650	<b>Proportional Band 1B, Cascade PID Set 1, Channel 1</b>
w	0000 to 3000 (expressed in thousandths volts)	r/w	0 to 30000
1617	<b>Process Output 2A, 10.000V, Calibrate</b>	2660	<b>Proportional Band 1B, Cascade PID Set 2, Channel 1</b>
w	0000 to 12000 (expressed in thousandths volts)	r/w	0 to 30000
1615	<b>Process Output 2A, 20.000mA, Calibrate</b>	2670	<b>Proportional Band 1B, Cascade PID Set 3, Channel 1</b>
w	0000 to 24000 (expressed in microamps)	r/w	0 to 30000
1614	<b>Process Output 2A, 4.000mA, Calibrate</b>	2680	<b>Proportional Band 1B, Cascade PID Set 4, Channel 1</b>
w	0000 to 6000 (expressed in microamps)	r/w	0 to 30000
1621	<b>Process Output 2B, 1.000V, Calibrate</b>	2690	<b>Proportional Band 1B, Cascade PID Set 5, Channel 1</b>
w	0000 to 3000 (expressed in thousandths volts)	r/w	0 to 30000
1622	<b>Process Output 2B, 10.000V, Calibrate</b>	550	<b>Proportional Band 1B, PID Set 1, Channel 1</b>
w	0000 to 12000 (expressed in thousandths volts)	r/w	0 to 30000
1620	<b>Process Output 2B, 20.000mA, Calibrate</b>	560	<b>Proportional Band 1B, PID Set 2, Channel 1</b>
w	0000 to 24000 (expressed in microamps)	r/w	0 to 30000
1619	<b>Process Output 2B, 4.000mA, Calibrate</b>	570	<b>Proportional Band 1B, PID Set 3, Channel 1</b>
w	0000 to 6000 (expressed in microamps)	r/w	0 to 30000
608	<b>Process Units, Analog Input</b>	580	<b>Proportional Band 1B, PID Set 4, Channel 1</b>
r/w	0 Temperature	r/w	0 to 30000
	1 %rh	590	<b>Proportional Band 1B, PID Set 5, Channel 1</b>
	2 psi	r/w	0 to 30000
	3 units	2500	<b>Proportional Band 2A, PID Set 6, Channel 2</b>
618	<b>Process Units, Analog Input 2</b>	r/w	0 to 30000
r/w	0 Temperature	2510	<b>Proportional Band 2A, PID Set 7, Channel 2</b>
	1 %rh	r/w	0 to 30000
	2 psi	2520	<b>Proportional Band 2A, PID Set 8, Channel 2</b>
	3 units	r/w	0 to 30000
628	<b>Process Units, Analog Input 3</b>	2530	<b>Proportional Band 2A, PID Set 9, Channel 2</b>
r/w	0 Temperature	r/w	0 to 30000
	1 %rh	2540	<b>Proportional Band 2A, PID Set 10, Channel 2</b>
	2 psi	r/w	0 to 30000
	3 units	2550	<b>Proportional Band 2B, PID Set 6, Channel 2</b>
701	<b>Process, Control Output 1A</b>	r/w	0 to 30000
r/w	0 4 to 20mA	2560	<b>Proportional Band 2B, PID Set 7, Channel 2</b>
	1 0 to 20mA	r/w	0 to 30000
	2 0 to 10V	2570	<b>Proportional Band 2B, PID Set 8, Channel 2</b>
	3 0 to 5V	r/w	0 to 30000
	4 1 to 5V	2580	<b>Proportional Band 2B, PID Set 9, Channel 2</b>
718	<b>Process, Control Output 1B</b>	r/w	0 to 30000
r/w	0 4 to 20mA	2590	<b>Proportional Band 2B, PID Set 10, Channel 2</b>
	1 0 to 20mA	r/w	0 to 30000
	2 0 to 10V	2604	<b>Rate 1A, Cascade PID Set 1, Channel 1</b>
	3 0 to 5V	r/w	000 to 999 (expressed in hundredths of minutes)
	4 1 to 5V	2614	<b>Rate 1A, Cascade PID Set 2, Channel 1</b>
735	<b>Process, Control Output 2A</b>	r/w	000 to 999 (expressed in hundredths of minutes)
r/w	0 4 to 20mA	2624	<b>Rate 1A, Cascade PID Set 3, Channel 1</b>
	1 0 to 20mA	r/w	000 to 999 (expressed in hundredths of minutes)
	2 0 to 10V	2634	<b>Rate 1A, Cascade PID Set 4, Channel 1</b>
	3 0 to 5V	r/w	000 to 999 (expressed in hundredths of minutes)
	4 1 to 5V	2644	<b>Rate 1A, Cascade PID Set 5, Channel 1</b>
752	<b>Process, Control Output 2B</b>	r/w	000 to 999 (expressed in hundredths of minutes)
r/w	0 4 to 20mA	504	<b>Rate 1A, PID Set 1, Channel 1</b>
	1 0 to 20mA	r/w	000 to 999 (expressed in hundredths of minutes)
	2 0 to 10V	514	<b>Rate 1A, PID Set 2, Channel 1</b>
	3 0 to 5V	r/w	000 to 999 (expressed in hundredths of minutes)
	4 1 to 5V	524	<b>Rate 1A, PID Set 3, Channel 1</b>
1309	<b>Profiles, Lockout</b>	r/w	000 to 999 (expressed in hundredths of minutes)
r/w	0 Full Access	534	<b>Rate 1A, PID Set 4, Channel 1</b>
	1 Read Only	r/w	000 to 999 (expressed in hundredths of minutes)
	2 Password	544	<b>Rate 1A, PID Set 5, Channel 1</b>
	3 Hidden	r/w	000 to 999 (expressed in hundredths of minutes)
2600	<b>Proportional Band 1A, Cascade PID Set 1, Channel 1</b>	2654	<b>Rate 1B, Cascade PID Set 1, Channel 1</b>
r/w	0 to 30000	r/w	000 to 999 (expressed in hundredths of minutes)
2610	<b>Proportional Band 1A, Cascade PID Set 2, Channel 1</b>	2664	<b>Rate 1B, Cascade PID Set 2, Channel 1</b>
r/w	0 to 30000	r/w	000 to 999 (expressed in hundredths of minutes)
2620	<b>Proportional Band 1A, Cascade PID Set 3, Channel 1</b>	2674	<b>Rate 1B, Cascade PID Set 3, Channel 1</b>
r/w	0 to 30000	r/w	000 to 999 (expressed in hundredths of minutes)
2630	<b>Proportional Band 1A, Cascade PID Set 4, Channel 1</b>	2684	<b>Rate 1B, Cascade PID Set 4, Channel 1</b>
r/w	0 to 30000	r/w	000 to 999 (expressed in hundredths of minutes)
2640	<b>Proportional Band 1A, Cascade PID Set 5, Channel 1</b>	2694	<b>Rate 1B, Cascade PID Set 5, Channel 1</b>
r/w	0 to 30000	r/w	000 to 999 (expressed in hundredths of minutes)
500	<b>Proportional Band 1A, PID Set 1, Channel 1</b>	554	<b>Rate 1B, PID Set 1, Channel 1</b>
r/w	0 to 30000	r/w	000 to 999 (expressed in hundredths of minutes)
510	<b>Proportional Band 1A, PID Set 2, Channel 1</b>	564	<b>Rate 1B, PID Set 2, Channel 1</b>
r/w	0 to 30000	r/w	000 to 999 (expressed in hundredths of minutes)
520	<b>Proportional Band 1A, PID Set 3, Channel 1</b>		
r/w	0 to 30000		
530	<b>Proportional Band 1A, PID Set 4, Channel 1</b>		
r/w	0 to 30000		

**574 Rate 1B, PID Set 3, Channel 1**  
 r/w 000 to 999 (expressed in hundredths of minutes)  
**584 Rate 1B, PID Set 4, Channel 1**  
 r/w 000 to 999 (expressed in hundredths of minutes)  
**594 Rate 1B, PID Set 5, Channel 1**  
 r/w 000 to 999 (expressed in hundredths of minutes)  
**2504 Rate 2A, PID Set 6, Channel 2**  
 r/w 000 to 999 (expressed in hundredths of minutes)  
**2514 Rate 2A, PID Set 7, Channel 2**  
 r/w 000 to 999 (expressed in hundredths of minutes)  
**2524 Rate 2A, PID Set 8, Channel 2**  
 r/w 000 to 999 (expressed in hundredths of minutes)  
**2534 Rate 2A, PID Set 9, Channel 2**  
 r/w 000 to 999 (expressed in hundredths of minutes)  
**2544 Rate 2A, PID Set 10, Channel 2**  
 r/w 000 to 999 (expressed in hundredths of minutes)  
**2554 Rate 2B, PID Set 6, Channel 2**  
 r/w 000 to 999 (expressed in hundredths of minutes)  
**2564 Rate 2B, PID Set 7, Channel 2**  
 r/w 000 to 999 (expressed in hundredths of minutes)  
**2574 Rate 2B, PID Set 8, Channel 2**  
 r/w 000 to 999 (expressed in hundredths of minutes)  
**2584 Rate 2B, PID Set 9, Channel 2**  
 r/w 000 to 999 (expressed in hundredths of minutes)  
**2594 Rate 2B, PID Set 10, Channel 2**  
 r/w 000 to 999 (expressed in hundredths of minutes)  
**2602 Reset 1A, Cascade PID Set 1, Channel 1**  
 r/w 000 to 999 (expressed in hundredths of minutes)  
**2612 Reset 1A, Cascade PID Set 2, Channel 1**  
 r/w 000 to 999 (expressed in hundredths of minutes)  
**2622 Reset 1A, Cascade PID Set 3, Channel 1**  
 r/w 000 to 999 (expressed in hundredths of minutes)  
**2632 Reset 1A, Cascade PID Set 4, Channel 1**  
 r/w 000 to 999 (expressed in hundredths of minutes)  
**2642 Reset 1A, Cascade PID Set 5, Channel 1**  
 r/w 000 to 999 (expressed in hundredths of minutes)  
**502 Reset 1A, PID Set 1, Channel 1**  
 r/w 000 to 999 (expressed in hundredths of minutes)  
**512 Reset 1A, PID Set 2, Channel 1**  
 r/w 000 to 999 (expressed in hundredths of minutes)  
**522 Reset 1A, PID Set 3, Channel 1**  
 r/w 000 to 999 (expressed in hundredths of minutes)  
**532 Reset 1A, PID Set 4, Channel 1**  
 r/w 000 to 999 (expressed in hundredths of minutes)  
**542 Reset 1A, PID Set 5, Channel 1**  
 r/w 000 to 999 (expressed in hundredths of minutes)  
**2652 Reset 1B, Cascade PID Set 1, Channel 1**  
 r/w 000 to 999 (expressed in hundredths of minutes)  
**2662 Reset 1B, Cascade PID Set 2, Channel 1**  
 r/w 000 to 999 (expressed in hundredths of minutes)  
**2672 Reset 1B, Cascade PID Set 3, Channel 1**  
 r/w 000 to 999 (expressed in hundredths of minutes)  
**2682 Reset 1B, Cascade PID Set 4, Channel 1**  
 r/w 000 to 999 (expressed in hundredths of minutes)  
**2692 Reset 1B, Cascade PID Set 5, Channel 1**  
 r/w 000 to 999 (expressed in hundredths of minutes)  
**552 Reset 1B, PID Set 1, Channel 1**  
 r/w 000 to 999 (expressed in hundredths of minutes)  
**562 Reset 1B, PID Set 2, Channel 1**  
 r/w 000 to 999 (expressed in hundredths of minutes)  
**572 Reset 1B, PID Set 3, Channel 1**  
 r/w 000 to 999 (expressed in hundredths of minutes)  
**582 Reset 1B, PID Set 4, Channel 1**  
 r/w 000 to 999 (expressed in hundredths of minutes)  
**592 Reset 1B, PID Set 5, Channel 1**  
 r/w 000 to 999 (expressed in hundredths of minutes)  
**2502 Reset 2A, PID Set 6, Channel 2**  
 r/w 000 to 999 (expressed in hundredths of minutes)  
**2512 Reset 2A, PID Set 7, Channel 2**  
 r/w 000 to 999 (expressed in hundredths of minutes)  
**2522 Reset 2A, PID Set 8, Channel 2**  
 r/w 000 to 999 (expressed in hundredths of minutes)  
**2532 Reset 2A, PID Set 9, Channel 2**  
 r/w 000 to 999 (expressed in hundredths of minutes)  
**2542 Reset 2A, PID Set 10, Channel 2**  
 r/w 000 to 999 (expressed in hundredths of minutes)  
**2552 Reset 2B, PID Set 6, Channel 2**  
 r/w 000 to 999 (expressed in hundredths per minutes)

**2562 Reset 2B, PID Set 7, Channel 2**  
 r/w 000 to 999 (expressed in hundredths of minutes)  
**2572 Reset 2B, PID Set 8, Channel 2**  
 r/w 000 to 999 (expressed in hundredths of minutes)  
**2582 Reset 2B, PID Set 9, Channel 2**  
 r/w 000 to 999 (expressed in hundredths of minutes)  
**2592 Reset 2B, PID Set 10, Channel 2**  
 r/w 000 to 999 (expressed in hundredths of minutes)  
**1601 Restore Factory Calibration**  
 0 Input 1  
 1 Input 2  
 2 Input 3  
**20 Retransmit 1 Type, Diagnostics**  
 r 0 None  
 1 Process  
**21 Retransmit 2 Type, Diagnostics**  
 r 0 None  
 1 Process  
**1626 Retransmit Output 1, 1.000V, Calibrate**  
 r/w 0000 to 3000 (expressed in thousandths volts)  
**1627 Retransmit Output 1, 10.000V, Calibrate**  
 r/w 0000 to 12000 (expressed in thousandths volts)  
**1625 Retransmit Output 1, 20.000mA, Calibrate**  
 r/w 0000 to 24000 (expressed in microamps)  
**1624 Retransmit Output 1, 4.000mA, Calibrate**  
 r/w 0000 to 6000 (expressed in microamps)  
**1631 Retransmit Output 2, 1.000V, Calibrate**  
 r/w 0000 to 3000 (expressed in thousandths volts)  
**1632 Retransmit Output 2, 10.000V, Calibrate**  
 r/w 0000 to 12000 (expressed in thousandths volts)  
**1630 Retransmit Output 2, 20.000mA, Calibrate**  
 r/w 0000 to 24000 (expressed in microamps)  
**1629 Retransmit Output 2, 4.000mA**  
 r/w 0000 to 6000 (expressed in microamps)  
**709 Retransmit Source, Retransmit Output 1**  
 r/w 0 Input 1  
 1 Input 2  
 2 Input 3  
 3 Set Point 1  
 4 Set Point 2  
 5 Channel 1 Power  
 6 Channel 2 Power  
**726 Retransmit Source, Retransmit Output 2**  
 r/w 0 Input 1  
 1 Input 2  
 2 Input 3  
 3 Set Point 1  
 4 Set Point 2  
 5 Channel 1 Power  
 6 Channel 2 Power  
**25 Save Changes to EE**  
 0 Save  
**681 Scale High, Analog Input 1**  
 r/w Depends on sensor and decimal point selection.  
**683 Scale High, Analog Input 2**  
 r/w Depends on sensor and decimal point selection.  
**685 Scale High, Analog Input 3**  
 r/w Depends on sensor and decimal point selection.  
**680 Scale Low, Analog Input 1**  
 r/w Depends on sensor and decimal point selection.  
**682 Scale Low, Analog Input 2**  
 r/w Depends on sensor and decimal point selection.  
**684 Scale Low, Analog Input 3**  
 r/w Depends on sensor and decimal point selection.  
**712 Scale Offset, Retransmit Output 1**  
 r/w -19999 to 30000  
 Range Low to Range High  
**729 Scale Offset, Retransmit Output 2**  
 r/w -19999 to 30000  
 Range Low to Range High  
**601 Sensor Type, Analog Input 1**  
 r/w 0 J  
 1 K  
 2 T  
 3 E  
 4 N  
 5 C  
 6 D  
 7 PT2  
 8 R  
 9 S  
 10 B

**✓NOTE:**  
*For more information  
 about parameters, see  
 the Index.*

- 11 100Ω DIN RTD
- 12 100Ω JIS RTD
- 13 4 to 20 mA
- 14 0 to 20 mA
- 15 0 to 5V
- 16 1 to 5V
- 17 0 to 10V
- 18 0 to 50mV
- 23 500Ω DIN RTD
- 24 500Ω JIS RTD
- 25 1kΩ DIN RTD
- 26 1kΩ JIS RTD

- 611** **Sensor Type, Analog Input 2**  
r/w
- 0 J
  - 1 K
  - 2 T
  - 3 E
  - 4 N
  - 5 C
  - 6 D
  - 7 PT2
  - 8 R
  - 9 S
  - 10 B
  - 11 100Ω DIN RTD
  - 12 100Ω JIS RTD
  - 13 4 to 20 mA
  - 14 0 to 20 mA
  - 15 0 to 5V
  - 16 1 to 5V
  - 17 0 to 10V
  - 18 0 to 50mV
  - 19 Vaisala 0 to 5V
  - 20 Vaisala 0 to 10V
  - 21 Vaisala 0 to 20mA
  - 22 Rotronics 0 to 5V
  - 23 500Ω DIN RTD
  - 24 500Ω JIS RTD
  - 25 1kΩ DIN RTD
  - 26 1kΩ JIS RTD

- 621** **Sensor Type, Analog Input 3**  
r/w
- 0 J
  - 1 K
  - 2 T
  - 3 E
  - 4 N
  - 5 C
  - 6 D
  - 7 PT2
  - 8 R
  - 9 S
  - 10 B
  - 11 100Ω DIN RTD
  - 12 100Ω JIS RTD
  - 13 4 to 20 mA
  - 14 0 to 20 mA
  - 15 0 to 5V
  - 16 1 to 5V
  - 17 0 to 10V
  - 18 0 to 50mV
  - 23 500Ω DIN RTD
  - 24 500Ω JIS RTD
  - 25 1kΩ DIN RTD
  - 26 1kΩ JIS RTD

- 600** **Sensor, Analog Input 1**  
r/w
- 0 Thermocouple
  - 1 RTD
  - 2 Process
  - 4 Off

- 610** **Sensor, Analog Input 2**  
r/w
- 0 Thermocouple
  - 1 RTD
  - 2 Process
  - 3 Wet Bulb-Dry Bulb
  - 4 Off

- 620** **Sensor, Analog Input 3**  
r/w
- 0 Thermocouple
  - 1 RTD
  - 2 Process
  - 4 Off

- 1** **Serial Number, First Part, Diagnostics**  
r
- 0 to 999999

- 2** **Serial Number, Second Part, Diagnostics**  
r
- 0 to 999999

**Set Locks — see individual items to lock**

- 1330-33** **Set Password**  
r/w
- ASCII codes 0-9, A-Z

- 300** **Set Point 1, Value**  
r/w
- Range Low 1 to Range High 1

- 319** **Set Point 2, Value**  
r/w
- Range Low 2 to Range High 2

- 603** **Set Point High Limit, Analog Input 1**  
r/w
- Depends on Sensor

- 613** **Set Point High Limit, Analog Input 2**  
r/w
- Depends on Sensor

- 623** **Set Point High Limit, Analog Input 3**  
r/w
- Depends on Sensor

- 602** **Set Point Low Limit, Analog Input 1**  
r/w
- Depends on Sensor

- 612** **Set Point Low Limit, Analog Input 2**  
r/w
- Depends on Sensor

- 622** **Set Point Low Limit, Analog Input 3**  
r/w
- Depends on Sensor

- 1300** **Set Point, Lockout**  
r/w
- 0 Full Access
  - 1 Read Only

- 1302** **Setup Page, Lockout**  
r/w
- 0 Full Access
  - 1 Read Only
  - 2 Password
  - 3 Hidden

- 1923** **Show °F or °C**  
r/w
- 0 No, Upper Display
  - 1 Yes, Upper Display

- 313** **Silence Alarm 1, Key Press Simulation**  
w
- Write any value

- 332** **Silence Alarm 2, Key Press Simulation**  
w
- Write any value

- 4** **Software Revision, Diagnostics**  
2
- 000 to 999

- 3** **Software Number, Diagnostics**  
r
- 0 to 99

- 1514** **Test Outputs, Test**
- 0 All Off
  - 1 Output 1A
  - 2 Output 1B
  - 3 Output 2A
  - 4 Output 2B
  - 5 Retransmit 1
  - 6 Retransmit 2
  - 7 Alarm 1
  - 8 Alarm 2
  - 9 Digital Out 1)
  - 10 Digital Out 2
  - 11 Digital Out 3
  - 12 Digital Out 4
  - 13 Digital Out 5
  - 14 Digital Out 6
  - 15 Digital Out 7
  - 16 Digital Out 8
  - 17 All On
  - 18 Communications

- 901** **°F or °C, System**  
r/w
- 0 °F
  - 1 °C

✓**NOTE:**  
For more information  
about parameters, see the  
Index.

## Profile Parameters

- 4004** **Autostart Profile Date or Day**  
r/w
- 0 Date
  - 1 Day

- 4009** **Autostart Time (hours)**  
r/w
- 0 to 99

- 4010** **Autostart Time (minutes)**  
r/w
- 0 to 59

- 4011** **Autostart Time (seconds)**  
r/w
- 0 to 59

<b>4006</b>	<b>Autostart, Date (day)</b>	<b>4030</b>	<b>Event Output 1, Ramp Rate or Ramp Time or Soak Steps</b>
r/w	1 to 31	r/w	0 Off
<b>4005</b>	<b>Autostart, Date (month)</b>		1 On
r/w	0 to 12	<b>4031</b>	<b>Event Output 2, Ramp Rate or Ramp Time or Soak Steps</b>
<b>4007</b>	<b>Autostart, Date (year)</b>	r/w	0 Off
r/w	1998 to 2035		1 On
<b>4008</b>	<b>Autostart, Day (of week)</b>	<b>4032</b>	<b>Event Output 3, Ramp Rate or Ramp Time or Soak Steps</b>
r/w	0 Every Day	r/w	0 Off
	1 Sunday		1 On
	2 Monday	<b>4033</b>	<b>Event Output 4, Ramp Rate or Ramp Time or Soak Steps</b>
	3 Tuesday	r/w	0 Off
	4 Wednesday		1 On
	5 Thursday	<b>4034</b>	<b>Event Output 5, Ramp Rate or Ramp Time or Soak Steps</b>
	6 Friday	r/w	0 Off
	7 Saturday		1 On
<b>4046</b>	<b>Channel 1 PID Set, Ramp Rate or Ramp Time or Soak Steps</b>	<b>4035</b>	<b>Event Output 6, Ramp Rate or Ramp Time or Soak Steps</b>
r/w	0 Channel 1 PID	r/w	0 Off
	1 Channel 2 PID		1 On
<b>4124</b>	<b>Channel 1 PID, Ramp Rate, Ramp Time or Soak Step, Current Profile Status</b>	<b>4036</b>	<b>Event Output 7, Ramp Rate or Ramp Time or Soak Steps</b>
r	0 Channel 1 PID	r/w	0 Off
	1 Channel 2 PID		1 On
<b>4047</b>	<b>Channel 2 PID Set, Ramp Rate or Ramp Time or Soak Steps</b>	<b>4037</b>	<b>Event Output 8, Ramp Rate or Ramp Time or Soak Steps</b>
r/w	0 Channel 1 PID	r/w	0 Off
	1 Channel 2 PID		1 On
<b>4125</b>	<b>Channel 2 PID Set, Ramp Rate, Ramp Time or Soak Step, Current Profile Status</b>	<b>4048</b>	<b>Guaranteed Soak Channel 1, Ramp Rate or Ramp Time or Soak Steps</b>
r	0 Channel 1 PID	r/w	0 No
	1 Channel 2 PID		1 Yes
	<b>Create Profile — see Edit Profile Action</b>	<b>4049</b>	<b>Guaranteed Soak Channel 2, Ramp Rate or Ramp Time or Soak Steps</b>
	<b>Delete Profile or Step — see Edit Profile Action</b>	r/w	0 No
<b>4111</b>	<b>Digital Output 1, Monitor Current Status (Profile)</b>		1 Yes
r	0 Off	<b>1210</b>	<b>Hold a Profile, Key Press Simulation</b>
	1 On	w	1 Hold
<b>4112</b>	<b>Digital Output 2, Monitor Current Status (Profile)</b>	<b>4119</b>	<b>Hours Remaining, Ramp Time or Soak Step, Current Profile Status</b>
r	0 Off	r	0 to 23
	1 On		<b>Insert Step — see Edit Profile Action</b>
<b>4113</b>	<b>Digital Output 3, Monitor Current Status (Profile)</b>	<b>4126</b>	<b>Jump Count, Current Profile Status</b>
r	0 Off	r	1 to 999
	1 On	<b>4127</b>	<b>Jump Profile, Current Profile Status</b>
<b>4114</b>	<b>Digital Output 4, Monitor Current Status (Profile)</b>	r	0 to 40
r	0 Off	<b>4052</b>	<b>Jump Repeats, Jump Step</b>
	1 On	r/w	1 to 999
<b>4115</b>	<b>Digital Output 5, Monitor Current Status (Profile)</b>	<b>4128</b>	<b>Jump Step, Current Profile Status</b>
r	0 Off	r	1-256
	1 On	<b>4050</b>	<b>Jump to Profile, Jump Step</b>
<b>4116</b>	<b>Digital Output 6, Monitor Current Status (Profile)</b>	r/w	1 to 40
r	0 Off	<b>4051</b>	<b>Jump to Step, Jump Step</b>
	1 On	r/w	1 to 256
<b>4117</b>	<b>Digital Output 7, Monitor Current Status (Profile)</b>	<b>4120</b>	<b>Minutes Remaining, Ramp Time or Soak Step, Current Profile Status</b>
r	0 Off	r	0 to 59
	1 On	<b>3500-09 Name, Profile 1 (10 characters)</b>	
<b>4118</b>	<b>Digital Output 8, Monitor Current Status (Profile)</b>	r/w	ASCII equivalent decimal code — see Modbus Naming Flowchart
r	0 Off	<b>3510-19 Name, Profile 2 (10 characters)</b>	
	1 On	r/w	ASCII equivalent decimal code — see Modbus Naming Flowchart
<b>4002</b>	<b>Edit Profile Action</b>	<b>3520-29 Name, Profile 3 (10 characters)</b>	
	1 Create	r/w	ASCII equivalent decimal code — see Modbus Naming Flowchart
	2 Insert Step	<b>3530-39 Name, Profile 4 (10 characters)</b>	
	3 Delete Current Profile	r/w	ASCII equivalent decimal code — see Modbus Naming Flowchart
	4 Delete Step	<b>3540-49 Name, Profile 5 (10 characters)</b>	
	5 Start Profile	r/w	ASCII equivalent decimal code — see Modbus Naming Flowchart
	255 Delete All Profiles	<b>3550-59 Name, Profile 6 (10 characters)</b>	
<b>4060</b>	<b>End Action, End Step</b>	<b>3560-69 Name, Profile 7 (10 characters)</b>	
r/w	0 Hold	<b>3570-79 Name, Profile 8 (10 characters)</b>	
	1 Control Off	<b>3580-89 Name, Profile 9 (10 characters)</b>	
	2 All Off	<b>3590-99 Name, Profile 10 (10 characters)</b>	
	3 Idle	<b>3600-09 Name, Profile 11 (10 characters)</b>	
<b>4061</b>	<b>End Idle Setpoint Channel 1, End Step</b>	<b>3610-19 Name, Profile 12 (10 characters)</b>	
r/w	Set Point 1 Low Limit to Set Point 1 High Limit	<b>3620-29 Name, Profile 13 (10 characters)</b>	
<b>4062</b>	<b>End Idle Setpoint Channel 2, End Step</b>	<b>3630-39 Name, Profile 14 (10 characters)</b>	
r/w	Set Point 2 Low Limit to Set Point 2 High Limit	<b>3640-49 Name, Profile 15 (10 characters)</b>	
<b>4129</b>	<b>End Set Point Channel 1, Current Profile Status</b>	<b>3650-59 Name, Profile 16 (10 characters)</b>	
r	Range Low 1 to Range High 1	<b>3660-69 Name, Profile 17 (10 characters)</b>	
<b>4130</b>	<b>End Set Point Channel 2, Current Profile Status</b>	<b>3670-79 Name, Profile 18 (10 characters)</b>	
r	Range Low 2 to Range High 2	<b>3680-89 Name, Profile 19 (10 characters)</b>	
		<b>3690-99 Name, Profile 20 (10 characters)</b>	

3700-09	Name, Profile 21 (10 characters)	4011	Ramp Time (seconds)
3710-19	Name, Profile 22 (10 characters)	r/w	0 to 59
3720-29	Name, Profile 23 (10 characters)	4043	Rate, Ramp Rate Step
3730-39	Name, Profile 24 (10 characters)	r/w	1 to 3000 units per minute
3740-49	Name, Profile 25 (10 characters)		ReName Profile — see Name, Profile x
3750-59	Name, Profile 26 (10 characters)	1209	Resume a Profile, Key Press Simulation
3760-69	Name, Profile 27 (10 characters)	w	1 Resume
3770-79	Name, Profile 28 (10 characters)	25	Save Changes to EE
3780-89	Name, Profile 29 (10 characters)	w	0
3790-99	Name, Profile 30 (10 characters)	4119	Hours Remaining, Ramp Time or Soak Step, Current Profile Status
3800-09	Name, Profile 31 (10 characters)	r	0 to 99
3810-19	Name, Profile 32 (10 characters)	4120	Minutes Remaining, Ramp Time or Soak Step, Current Profile Status
3820-29	Name, Profile 33 (10 characters)	r	0 to 59
3830-39	Name, Profile 34 (10 characters)	4121	Seconds Remaining, Ramp Time or Soak Step, Current Profile Status
3840-49	Name, Profile 35 (10 characters)	r	0 to 59
3850-59	Name, Profile 36 (10 characters)	4122	Set Point Ch. 1, Ramp Rate, Ramp Time or Soak Step, Current Profile Status
3860-69	Name, Profile 37 (10 characters)	r	Range low to range high
3870-79	Name, Profile 38 (10 characters)	4123	Set Point Ch. 2, Ramp Rate, Ramp Time or Soak Step, Current Profile Status
3880-89	Name, Profile 39 (10 characters)	r	Range low to range high
3890-99	Name, Profile 40 (10 characters)	4009	Soak Step Time (hours)
	Profile Edit Action — see Edit Profile Action	r/w	0 to 99
4000	Profile Number	4010	Soak Step Time (minutes)
4100	Profile Number, Current Status	r/w	0 o 59
4103	Profile Ramp Waiting, Current Status	4011	Soak Step Time (seconds)
1218	Profiles Remaining	r/w	0 o 59
r	0-40	1217	Terminate a Profile, Key Press Simulation
4001	Profile Step Number	w	1 Terminate
4101	Profile Step Number, Current Status	4021	Wait For Analog 1, Ramp Rate or Ramp Time or Soak Steps
1219	Profile Steps Remaining	r/w	0 Don't Wait
r	0-256	1	Wait
4003	Profile Step Type	4022	Wait For Analog 1, Value, Ramp Rate or Ramp Time or Soak Steps
r/w	1 Ramp Time	r/w	Range Low to Range High
	2 Ramp Rate	4023	Wait For Analog 2, Ramp Rate or Ramp Time or Soak Steps
	3 Soak	r/w	0 Don't Wait
	4 Jump	1	Wait
	5 End (read only)	4024	Wait For Analog 2, Value, Ramp Rate or Ramp Time or Soak Steps
4102	Profile Step Type, Current Status	r/w	Range Low to Range High
r	1 Ramp Time	4026	Wait For Analog 3 Value, Ramp Rate or Ramp Time or Soak Steps
	2 Ramp Rate	r/w	Range Low to Range High
	3 Soak	4025	Wait For Analog 3, Ramp Rate or Ramp Time or Soak Steps
	4 Jump	r/w	0 Don't Wait
	5 End	1	Wait
4108	Profile Waiting for Analog Input 1, Current Status	4013	Wait For Event 1, Ramp Rate or Ramp Time or Soak Steps
r	0 Don't Wait	r/w	0 Don't Wait
	1 Wait	1	Wait for Off
4109	Profile Waiting for Analog Input 2, Current Status	2	Wait for On
r	0 Don't Wait	4014	Wait For Event 2, Ramp Rate or Ramp Time or Soak Steps
	1 Wait	r/w	0 Don't Wait
4110	Profile Waiting for Analog Input 3, Current Status	1	Wait for Off
r	0 Don't Wait	2	Wait for On
	1 Wait	4015	Wait For Event 3, Ramp Rate or Ramp Time or Soak Steps
4104	Profile Waiting for Event 1, Current Status	r/w	0 Don't Wait
r	0 Don't Wait	1	Wait for Off
	1 Wait for Off	2	Wait for On
	2 Wait for On	4016	Wait For Event 4, Ramp Rate or Ramp Time or Soak Steps
4105	Profile Waiting for Event 2, Current Status	r/w	0 Don't Wait
r	0 Don't Wait	1	Wait for Off
	1 Wait for Off	2	Wait for On
	2 Wait for On	4012	Wait/Don't Wait, Ramp Rate or Ramp Time or Soak Steps
4106	Profile Waiting for Event 3, Current Status	r/w	0 Don't Wait
r	0 Don't Wait	1	Wait for
	1 Wait for Off		
	2 Wait for On		
4107	Profile Waiting for Event 4, Current Status		
r/w	0 Don't Wait		
	1 Wait for Off		
	2 Wait for On		
4044	Ramp Set Point Channel 1, Ramp Rate or Ramp Time Step		
r/w	Range low to range high		
4045	Ramp Set Point Channel 2, Ramp Time Step		
r/w	Range low to range high		
4009	Ramp Time (hours)		
r/w	0 to 99		
4010	Ramp Time (minutes)		
r/w	0 o 59		



## Parameters Sorted by Modbus Register

0	Model, Diagnostics	517	Hysteresis 1A, PID Set 2, Channel 1	616	Decimal Point, Analog Input 2
1	Serial Number, First Part, Diagnostics	520	Proportional Band 1A, PID Set 3, Channel 1	617	Error Latching, Analog Input 2
2	Serial Number, Second Part, Diagnostics	521	Integral 1A , PID Set 3, Channel 1	618	Process Units, Analog Input 2
3	Software Number, Diagnostics	522	Reset 1A, PID Set 3, Channel 1	620	Sensor, Analog Input 3
4	Software Revision, Diagnostics	523	Derivative 1A, PID Set 3, Channel 1	621	Sensor Type, Analog Input 3
5	Mfg. Date, Diagnostics	524	Rate 1A, PID Set 3, Channel 1	622	Set Point Low Limit, Analog Input 3
8	Input 1 Type, Diagnostics	525	Dead Band 1A, PID Set 3, Channel 1	623	Set Point High Limit, Analog Input 3
9	Input 2 Type, Diagnostics	527	Hysteresis 1A, PID Set 3, Channel 1	624	Filter Time, Analog Input 3
10	Input 3 Type, Diagnostics	530	Proportional Band 1A, PID Set 4, Channel 1	625	Calibration Offset, Analog Input 3
16	Output 1A Type, Diagnostics	531	Integral 1A , PID Set 4, Channel 1	626	Decimal Point, Analog Input 3
17	Output 1B Type, Diagnostics	532	Reset 1A, PID Set 4, Channel 1	627	Error Latching, Analog Input 3
18	Output 2A Type, Diagnostics	533	Derivative 1A, PID Set 4, Channel 1	628	Process Units, Analog Input 3
19	Output 2B Type, Diagnostics	534	Rate 1A, PID Set 4, Channel 1	680	Scale Low, Analog Input 1
20	Retransmit 1 Type, Diagnostics	535	Dead Band 1A, PID Set 4, Channel 1	681	Scale High, Analog Input 1
21	Retransmit 2 Type, Diagnostics	537	Hysteresis 1A, PID Set 4, Channel 1	682	Scale Low, Analog Input 2
25	Save Changes to EE	540	Proportional Band 1A, PID Set 5, Channel 1	683	Scale High, Analog Input 2
100	Input 1 Value, Status	541	Integral 1A , PID Set 5, Channel 1	684	Scale Low, Analog Input 3
101	Input 1 Error, Status	542	Reset 1A, PID Set 5, Channel 1	685	Scale High, Analog Input 3
102	Alarm 1, Status	543	Derivative 1A, PID Set 5, Channel 1	700	Function, Control Output 1A
103	% Power Output 1A, Status	544	Rate 1A, PID Set 5, Channel 1	701	Process, Control Output 1A
104	Input 2 Value, Status	545	Dead Band 1A, PID Set 5, Channel 1	702	Alarm Type, Alarm Output 1
105	Input 2 Error, Status	547	Hysteresis 1A, PID Set 5, Channel 1	703	Alarm Hysteresis, Alarm Output 1
106	Alarm 2 , Status	550	Proportional Band 1B, PID Set 1, Channel 1	704	Alarm Latching, Alarm Output 1
107	% Power Output 1B, Status	551	Integral 1B, PID Set 1, Channel 1	705	Alarm Silencing, Alarm Output 1
108	Input 3 Value, Status	552	Reset 1B, PID Set 1, Channel 1	706	Alarm Sides, Alarm Output 1
109	Input 3 Error, Status	553	Derivative 1B, PID Set 1, Channel 1	707	Alarm Logic, Alarm Output 1
111	% Power Output 2A, Status	554	Rate 1B, PID Set 1, Channel 1	708	Alarm Messages, Alarm Output 1
115	% Power Output 2B, Status	555	Dead Band 1B, PID Set 1, Channel 1	709	Retransmit Source, Retransmit Output 1
200	Operation Mode, Status	556	Cycle Time value, Control Output 1B	710	Low Scale, Retransmit Output 1
201	Digital Input 1, Status	557	Hysteresis 1B, PID Set 1, Channel 1	711	High Scale, Retransmit Output 1
210	Input 1 Open Loop, Status	559	Cycle Time Type, Control Output 1B	712	Scale Offset, Retransmit Output 1
213	Digital Input 2, Status	560	Proportional Band 1B, PID Set 2, Channel 1	714	High Power Limit, Control Output 1A
222	Input 2 Open Loop, Status	561	Integral 1B, PID Set 2, Channel 1	715	Low Power Limit, Control Output 1A
225	Digital Input 3, Status	562	Reset 1B, PID Set 2, Channel 1	716	Alarm Source, Alarm Output 1
237	Digital Input 4, Status	563	Derivative 1B, PID Set 2, Channel 1	717	Function, Control Output 1B
300	Set Point 1, value	564	Rate 1B, PID Set 2, Channel 1	718	Process, Control Output 1B
302	Alarm Low Set Point and Deviation, Alarm 1, value	565	Dead Band 1B, PID Set 2, Channel 1	719	Alarm Type, Alarm Output 2
303	Alarm High Set Point and Deviation, Alarm 1, value	567	Hysteresis 1B, PID Set 2, Channel 1	720	Alarm Hysteresis, Alarm Output 2
304	Autotune Set Point, Channel 1, value	570	Proportional Band 1B, PID Set 3, Channel 1	721	Alarm Latching, Alarm Output 2
305	Autotune Channel 1	571	Integral 1B, PID Set 3, Channel 1	722	Alarm Silencing, Alarm Output 2
308	Idle Set Point, Channel 1, Power Out Action	572	Reset 1B, PID Set 3, Channel 1	723	Alarm Sides, Alarm Output 2
311	Clear Error 1, Key Press Simulation	573	Derivative 1B, PID Set 3, Channel 1	724	Alarm Logic, Alarm Output 2
312	Clear Alarm 1, Key Press Simulation	574	Rate 1B, PID Set 3, Channel 1	725	Alarm Messages, Alarm Output 2
313	Silence Alarm 1, Key Press Simulation	575	Dead Band 1B, PID Set 3, Channel 1	726	Retransmit Source, Retransmit Output 2
319	Set Point 2, value	577	Hysteresis 1B, PID Set 3, Channel 1	727	Low Scale, Retransmit Output 2
321	Alarm Low Set Point and Deviation, Alarm 2, value	580	Proportional Band 1B, PID Set 4, Channel 1	728	High Scale, Retransmit Output 2
322	Alarm High Set Point and Deviation, Alarm 2, value	581	Integral 1B, PID Set 4, Channel 1	729	Scale Offset, Retransmit Output 2
323	Autotune Set Point, Channel 2, value	582	Reset 1B, PID Set 4, Channel 1	731	High Power Limit, Control Output 1B
324	Autotune Channel 2	583	Derivative 1B, PID Set 4, Channel 1	732	Low Power Limit, Control Output 1B
327	Idle Set Point, Channel 2, Power Out Action	584	Rate 1B, PID Set 4, Channel 1	733	Alarm Source, Alarm Output 2
330	Clear Error 2, Key Press Simulation	585	Dead Band 1B, PID Set 4, Channel 1	734	Function, Control Output 2A
331	Clear Alarm 2, Key Press Simulation	587	Hysteresis 1B, PID Set 4, Channel 1	735	Process, Control Output 2A
332	Silence Alarm 2, Key Press Simulation	590	Proportional Band 1B, PID Set 5, Channel 1	748	High Power Limit, Control Output 2A
343	Autotune Cascade	591	Integral 1B, PID Set 5, Channel 1	749	Low Power Limit, Control Output 2A
349	Clear Error 3, Key Press Simulation	592	Reset 1B, PID Set 5, Channel 1	751	Function, Control Output 2B
500	Proportional Band 1A, PID Set 1, Channel 1	593	Derivative 1B, PID Set 5, Channel 1	752	Process, Control Output 2B
501	Integral 1A , PID Set 1, Channel 1	594	Rate 1B, PID Set 5, Channel 1	765	High Power Limit, Control Output 2B
502	Reset 1A, PID Set 1, Channel 1	595	Dead Band 1B, PID Set 5, Channel 1	766	Low Power Limit, Control Output 2B
503	Derivative 1A, PID Set 1, Channel 1	597	Hysteresis 1B, PID Set 5, Channel 1	836	Analog Range, Retransmit Output 1
504	Rate 1A, PID Set 1, Channel 1	600	Sensor, Analog Input 1	837	Analog Range, Retransmit Output 2
505	Dead Band 1A, PID Set 1, Channel 1	601	Sensor Type, Analog Input 1	900	PID Units, System
506	Cycle Time value, Control Output 1A	602	Set Point Low Limit, Analog Input 1	901	°F or °C, System
507	Hysteresis 1A, PID Set 1, Channel 1	603	Set Point High Limit, Analog Input 1	903	Input 1 Fail % Power, System
509	Cycle Time Type, Control Output 1A	604	Filter Time, Analog Input 1	904	Open Loop Channel 1
510	Proportional Band 1A, PID Set 2, Channel 1	605	Calibration Offset, Analog Input 1	906	Input 2 Fail % Power, System
511	Integral 1A , PID Set 2, Channel 1	606	Decimal Point, Analog Input 1	907	Open Loop Channel 2
512	Reset 1A, PID Set 2, Channel 1	607	Error Latching, Analog Input 1	1060	Function, Digital Input 1
513	Derivative 1A, PID Set 2, Channel 1	608	Process Units, Analog Input 1	1061	Condition, Digital Input 1
514	Rate 1A, PID Set 2, Channel 1	610	Sensor, Analog Input 2	1062	Function, Digital Input 2
515	Dead Band 1A, PID Set 2, Channel 1	611	Sensor Type, Analog Input 2	1063	Condition, Digital Input 2
		612	Set Point Low Limit, Analog Input 2	1064	Function, Digital Input 3
		613	Set Point High Limit, Analog Input 2	1065	Condition, Digital Input 3
		614	Filter Time, Analog Input 2	1066	Function, Digital Input 4
		615	Calibration Offset, Analog Input 2	1067	Condition, Digital Input 4

1075	Digital Input 1, Start Profile	1925	Cascade Type	2564	Rate 2B, PID Set 7, Channel 2
1076	Digital Input 1, Start Step	1926	Cascade, Range Low	2565	Dead Band 2B, PID Set 7, Channel 2
1077	Digital Input 2, Start Profile	1927	Cascade, Range High	2567	Hysteresis 2B, PID Set 7, Channel 2
1078	Digital Input 2, Start Step	2000	Digital Output 1, Condition	2570	Proportional Band 2B, PID Set 8, Channel 2
1079	Digital Input 3, Start Profile	2001	Function, Digital Output 1	2571	Integral 2B, PID Set 8, Channel 2
1080	Digital Input 3, Start Step	2010	Digital Output 2, Condition	2572	Reset 2B, PID Set 8, Channel 2
1081	Digital Input 4, Start Profile	2011	Function, Digital Output 2	2573	Derivative 2B, PID Set 8, Channel 2
1082	Digital Input 4, Start Step	2020	Digital Output 3, Condition	2574	Rate 2B, PID Set 8, Channel 2
1205	Guaranteed Soak Band, Channel 1	2021	Function, Digital Output 3	2575	Dead Band 2B, PID Set 8, Channel 2
1206	Power-Out Action	2030	Digital Output 4, Condition	2577	Hysteresis 2B, PID Set 8, Channel 2
1209	Resume a Profile, Key Press Simulation	2031	Function, Digital Output 4	2580	Proportional Band 2B, PID Set 9, Channel 2
1210	Hold a Profile, Key Press Simulation	2040	Digital Output 5, Condition	2581	Integral 2B, PID Set 9, Channel 2
1212	Guaranteed Soak Band, Channel 2	2041	Function, Digital Output 5	2582	Reset 2B, PID Set 9, Channel 2
1213	Power-Out Time	2046	Complementary Output, Digital Output 5	2583	Derivative 2B, PID Set 9, Channel 2
1217	Terminate a Profile, Key Press Simulation	2050	Digital Output 6, Condition	2584	Rate 2B, PID Set 9, Channel 2
1218	Profiles Remaining	2051	Function, Digital Output 6	2585	Dead Band 2B, PID Set 9, Channel 2
1219	Profile Steps Remaining	2052	Boost Heat % Power, Digital Output 6	2587	Hysteresis 2B, PID Set 9, Channel 2
1220	Guaranteed Soak Band 1 Source	2054	Boost Heat Delay On Time, Digital Output 6	2590	Proportional Band 2B, PID Set 10, Channel 2
1221	Guaranteed Soak Band 2 Source	2060	Digital Output 7, Condition	2591	Integral 2B, PID Set 10, Channel 2
1300	Set Point, Lockout	2061	Function, Digital Output 7	2592	Reset 2B, PID Set 10, Channel 2
1302	Setup Page, Lockout	2062	Boost Cool % Power, Digital Output 7	2593	Derivative 2B, PID Set 10, Channel 2
1303	Factory Page, Lockout	2064	Boost Cool Delay On Time, Digital Output 7	2594	Rate 2B, PID Set 10, Channel 2
1306	Autotune PID, Lockout	2070	Digital Output 8, Condition	2595	Dead Band 2B, PID Set 10, Channel 2
1307	Edit PID, Lockout	2071	Function, Digital Output 8	2597	Hysteresis 2B, PID Set 10, Channel 2
1308	Alarm Set Point, Lockout	2072	Compressor On % Power, Digital Output 8	2600	Proportional Band 1A, Cascade PID Set 1, Channel 1
1309	Profiles, Lockout	2073	Compressor Off % Power, Digital Output 8		
1315	Clear Locks	2074	Compressor On Delay, Digital Output 8	2601	Integral 1A , Cascade PID Set 1, Channel 1
1330-33	Set Password	2075	Compressor Off Delay, Digital Output 8		2602Reset 1A, Cascade PID Set 1, Channel 1
1400-15	Custom Main Page Parameters (P1 to P16)	2500	Proportional Band 2A, PID Set 6, Channel 2	2603	Derivative 1A, Cascade PID Set 1, Channel 1
1500	CJC1 Temp, Diagnostics	2501	Integral 2A, PID Set 6, Channel 2	2604	Rate 1A, Cascade PID Set 1, Channel 1
1501	CJC1 AtoD, Diagnostics	2502	Reset 2A, PID Set 6, Channel 2	2605	Dead Band 1A, Cascade PID Set 1, Channel 1
1504	Input 1 AtoD, Diagnostics	2503	Derivative 2A, PID Set 6, Channel 2	2607	Hysteresis 1A, Cascade PID Set 1, Channel 1
1505	Input 2 AtoD, Diagnostics	2504	Rate 2A, PID Set 6, Channel 2	2610	Proportional Band 1A, Cascade PID Set 2, Channel 1
1506	Input 3 AtoD, Diagnostics	2505	Dead Band 2A, PID Set 6, Channel 2		
1513	Display Test, Test	2506	Cycle Time Value, Control Output 2A	2611	Integral 1A , Cascade PID Set 2, Channel 1
1514	Test Outputs, Test	2507	Hysteresis 2A, PID Set 6, Channel 2	2612	Reset 1A, Cascade PID Set 2, Channel 1
1515	Line Frequency, Diagnostics	2509	Cycle Time (type), Control Output 2A	2613	Derivative 1A, Cascade PID Set 2, Channel 1
1531	CJC2 Temp, Diagnostics	2510	Proportional Band 2A, PID Set 7, Channel 2	2614	Rate 1A, Cascade PID Set 2, Channel 1
1532	CJC2 AtoD, Diagnostics	2511	Integral 2A, PID Set 7, Channel 2	2615	Dead Band 1A, Cascade PID Set 2, Channel 1
1601	Restore Factory Calibration	2512	Reset 2A, PID Set 7, Channel 2	2617	Hysteresis 1A, Cascade PID Set 2, Channel 1
1602	Full Defaults	2513	Derivative 2A, PID Set 7, Channel 2	2620	Proportional Band 1A, Cascade PID Set 3, Channel 1
1603	Input 1, Calibrate	2514	Rate 2A, PID Set 7, Channel 2		
1604	Process Output 1A, 4.000mA, Calibrate	2515	Dead Band 2A, PID Set 7, Channel 2	2621	Integral 1A , Cascade PID Set 3, Channel 1
1605	Process Output 1A, 20.000mA, Calibrate	2517	Hysteresis 2A, PID Set 7, Channel 2	2622	Reset 1A, Cascade PID Set 3, Channel 1
1606	Process Output 1A, 1.000V, Calibrate	2520	Proportional Band 2A, PID Set 8, Channel 2	2623	Derivative 1A, Cascade PID Set 3, Channel 1
1607	Process Output 1A, 10.000V, Calibrate	2521	Integral 2A, PID Set 8, Channel 2	2624	Rate 1A, Cascade PID Set 3, Channel 1
1608	Input 2, Calibrate	2522	Reset 2A, PID Set 8, Channel 2	2625	Dead Band 1A, Cascade PID Set 3, Channel 1
1609	Process Output 1B, 4.000mA, Calibrate	2523	Derivative 2A, PID Set 8, Channel 2	2627	Hysteresis 1A, Cascade PID Set 3, Channel 1
1610	Process Output 1B, 20.000mA, Calibrate	2524	Rate 2A, PID Set 8, Channel 2	2630	Proportional Band 1A, Cascade PID Set 4, Channel 1
1611	Process Output 1B, 1.000V, Calibrate	2525	Dead Band 2A, PID Set 8, Channel 2		
1612	Process Output 1B, 10.000V, Calibrate	2527	Hysteresis 2A, PID Set 8, Channel 2	2631	Integral 1A , Cascade PID Set 4, Channel 1
1613	Input 3, Calibrate	2530	Proportional Band 2A, PID Set 9, Channel 2	2632	Reset 1A, Cascade PID Set 4, Channel 1
1614	Process Output 2A, 4.000mA, Calibrate	2531	Integral 2A, PID Set 9, Channel 2	2633	Derivative 1A, Cascade PID Set 4, Channel 1
1615	Process Output 2A, 20.000mA, Calibrate	2532	Reset 2A, PID Set 9, Channel 2	2634	Rate 1A, Cascade PID Set 4, Channel 1
1616	Process Output 2A, 1.000V, Calibrate	2533	Derivative 2A, PID Set 9, Channel 2	2635	Dead Band 1A, Cascade PID Set 4, Channel 1
1617	Process Output 2A, 10.000V, Calibrate	2534	Rate 2A, PID Set 9, Channel 2	2637	Hysteresis 1A, Cascade PID Set 4, Channel 1
1619	Process Output 2B, 4.000mA, Calibrate	2535	Dead Band 2A, PID Set 9, Channel 2	2640	Proportional Band 1A, Cascade PID Set 5, Channel 1
1620	Process Output 2B, 20.000mA, Calibrate	2537	Hysteresis 2A, PID Set 9, Channel 2		
1621	Process Output 2B, 1.000V, Calibrate	2540	Proportional Band 2A, PID Set 10, Channel 2	2641	Integral 1A , Cascade PID Set 5, Channel 1
1622	Process Output 2B, 10.000V, Calibrate	2541	Integral 2A, PID Set 10, Channel 2	2642	Reset 1A, Cascade PID Set 5, Channel 1
1624	Retransmit Output 1, 4.000mA, Calibrate	2542	Reset 2A, PID Set 10, Channel 2	2643	Derivative 1A, Cascade PID Set 5, Channel 1
1625	Retransmit Output 1, 20.000mA, Calibrate	2543	Derivative 2A, PID Set 10, Channel 2	2644	Rate 1A, Cascade PID Set 5, Channel 1
1626	Retransmit Output 1, 1.000V, Calibrate	2544	Rate 2A, PID Set 10, Channel 2	2645	Dead Band 1A, Cascade PID Set 5, Channel 1
1627	Retransmit Output 1, 10.000V, Calibrate	2545	Dead Band 2A, PID Set 10, Channel 2	2647	Hysteresis 1A, Cascade PID Set 5, Channel 1
1629	Retransmit Output 2, 4.000mA, Calibrate	2547	Hysteresis 2A, PID Set 10, Channel 2	2650	Proportional Band 1B, Cascade PID Set 1, Channel 1
1630	Retransmit Output 2, 20.000mA, Calibrate	2550	Proportional Band 2B, PID Set 6, Channel 2		
1631	Retransmit Output 2, 1.000V, Calibrate	2551	Integral 2B, PID Set 6, Channel 2	2651	Integral 1B , Cascade PID Set 1, Channel 1
1632	Retransmit Output 2, 10.000V, Calibrate	2552	Reset 2B, PID Set 6, Channel 2	2652	Reset 1B, Cascade PID Set 1, Channel 1
1902	Altitude, Analog Input 2	2553	Derivative 2B, PID Set 6, Channel 2	2653	Derivative 1B, Cascade PID Set 1, Channel 1
1915	Cascade, Analog Input 3	2554	Rate 2B, PID Set 6, Channel 2	2654	Rate 1B, Cascade PID Set 1, Channel 1
1916	Current Time, Hour	2555	Dead Band 2B, PID Set 6, Channel 2	2655	Dead Band 1B, Cascade PID Set 1, Channel 1
1917	Current Time, Minutes	2556	Cycle Time Value, Control Output 2B	2657	Hysteresis 1B, Cascade PID Set 1, Channel 1
1918	Current Time, Seconds	2557	Hysteresis 2B, PID Set 6, Channel 2	2660	Proportional Band 1B, Cascade PID Set 2, Channel 1
1919	Current Date, Month	2559	Cycle Time (type), Control Output 2B		
1920	Current Date, Day	2560	Proportional Band 2B, PID Set 7, Channel 2	2661	Integral 1B , Cascade PID Set 2, Channel 1
1921	Current Date, Year	2561	Integral 2B, PID Set 7, Channel 2	2662	Reset 1B, Cascade PID Set 2, Channel 1
1922	Cascade Inner Set Point	2562	Reset 2B, PID Set 7, Channel 2	2663	Derivative 1B, Cascade PID Set 2, Channel 1
1923	Show °F or °C	2563	Derivative 2B, PID Set 7, Channel 2	2664	Rate 1B, Cascade PID Set 2, Channel 1

2665	Dead Band 1B, Cascade PID Set 2, Channel 1	3770-79	Name, Profile 28 (10 characters)		Ramp Time or Soak Steps
		3780-89	Name, Profile 29 (10 characters)	4049	Guaranteed Soak Channel 2, Ramp Rate or Ramp Time or Soak Steps
2667	Hysteresis 1B, Cascade PID Set 2, Channel 1	3790-99	Name, Profile 30 (10 characters)		Jump to Profile, Jump Step
		3800-09	Name, Profile 31 (10 characters)	4050	Jump to Step, Jump Step
2670	Proportional Band 1B, Cascade PID Set 3, Channel 1	3810-19	Name, Profile 32 (10 characters)	4051	Jump Repeats, Jump Step
		3820-29	Name, Profile 33 (10 characters)	4052	End Action, End Step
2671	Integral 1B, Cascade PID Set 3, Channel 1	3830-39	Name, Profile 34 (10 characters)	4060	End Idle Setpoint Channel 1, End Step
2672	Reset 1B, Cascade PID Set 3, Channel 1	3840-49	Name, Profile 35 (10 characters)	4061	End Idle Setpoint Channel 2, End Step
2673	Derivative 1B, Cascade PID Set 3, Channel 1	3850-59	Name, Profile 36 (10 characters)	4062	Profile Number, Current Status
		3860-69	Name, Profile 37 (10 characters)	4100	Profile Step Number, Current Status
2674	Rate 1B, Cascade PID Set 3, Channel 1	3870-79	Name, Profile 38 (10 characters)	4101	Profile Step Type, Current Status
2675	Dead Band 1B, Cascade PID Set 3, Channel 1	3880-89	Name, Profile 39 (10 characters)	4102	Profile Ramp Waiting, Current Status
		3890-99	Name, Profile 40 (10 characters)	4103	Profile Waiting for Event 1, Current Status
2677	Hysteresis 1B, Cascade PID Set 3, Channel 1	4000	Profile Number	4104	Profile Waiting for Event 2, Current Status
		4001	Profile Step Number	4105	Profile Waiting for Event 3, Current Status
2680	Proportional Band 1B, Cascade PID Set 4, Channel 1	4002	Profile Edit Action	4106	Profile Waiting for Event 4, Current Status
		4003	Profile Step Type	4107	Profile Waiting for Analog Input 1, Current Status
2681	Integral 1B, Cascade PID Set 4, Channel 1	4004	Autostart Profile Date or Day	4108	Status
2682	Reset 1B, Cascade PID Set 4, Channel 1	4005	Autostart, Date (month)		Profile Waiting for Analog Input 2, Current Status
2683	Derivative 1B, Cascade PID Set 4, Channel 1	4006	Autostart, Date (day)	4109	Status
		4007	Autostart, Date (year)		Profile Waiting for Analog Input 3, Current Status
2684	Rate 1B, Cascade PID Set 4, Channel 1	4008	Autostart, Day (of week)	4110	Status
2685	Dead Band 1B, Cascade PID Set 4, Channel 1	4009	Autostart Time (hours)		Digital Output 1, Current Status
		4010	Autostart Time (minutes)	4111	Digital Output 2, Current Status
2687	Hysteresis 1B, Cascade PID Set 4, Channel 1	4011	Autostart Time (seconds)	4112	Digital Output 3, Current Status
		4009	Ramp Time (hours)	4113	Digital Output 4, Current Status
2690	Proportional Band 1B, Cascade PID Set 5, Channel 1	4010	Ramp Time (minutes)	4114	Digital Output 5, Current Status
		4011	Ramp Time (seconds)	4115	Digital Output 6, Current Status
2691	Integral 1B, Cascade PID Set 5, Channel 1	4009	Soak Step Time (hours)	4116	Digital Output 7, Current Status
2692	Reset 1B, Cascade PID Set 5, Channel 1	4010	Soak Step Time (minutes)	4117	Digital Output 8, Current Status
2693	Derivative 1B, Cascade PID Set 5, Channel 1	4011	Soak Step Time (seconds)	4118	Hours Remaining, Ramp Time or Soak Step, Current Profile Status
		4012	Wait/Don't Wait, Ramp Rate or Ramp Time or Soak Steps	4119	Minutes Remaining, Ramp Time or Soak Step, Current Profile Status
2694	Rate 1B, Cascade PID Set 5, Channel 1		Wait For Event 1, Ramp Rate or Ramp Time or Soak Steps	4120	Seconds Remaining, Ramp Time or Soak Step, Current Profile Status
2695	Dead Band 1B, Cascade PID Set 5, Channel 1	4013	Wait For Event 2, Ramp Rate or Ramp Time or Soak Steps	4121	Set Point Channel 1, Ramp Rate, Ramp Time or Soak Step, Current Profile Status
2697	Hysteresis 1B, Cascade PID Set 5, Channel 1	4014	Wait For Event 3, Ramp Rate or Ramp Time or Soak Steps	4122	Set Point Channel 2, Ramp Rate, Ramp Time or Soak Step, Current Profile Status
		4015	Wait For Event 4, Ramp Rate or Ramp Time or Soak Steps	4123	Channel 1 PID, Ramp Rate, Ramp Time or Soak Step, Current Profile Status
3000-06	Name, Digital Input 1 (7 characters)		Wait For Analog 1, Value, Ramp Rate or Ramp Time or Soak Steps	4124	Channel 2 PID Set, Ramp Rate, Ramp Time or Soak Step, Current Profile Status
3010-16	Name, Digital Input 2 (7 characters)		Wait For Analog 2, Ramp Rate or Ramp Time or Soak Steps	4125	Jump Count, Current Profile Status
3020-26	Name, Digital Input 3 (7 characters)		Wait For Analog 3, Value, Ramp Rate or Ramp Time or Soak Steps	4126	Jump Profile, Current Profile Status
3030-36	Name, Digital Input 4 (7 characters)		Wait For Analog 4, Value, Ramp Rate or Ramp Time or Soak Steps	4127	Jump Step, Current Profile Status
3100-09	Name, Digital Output 1 (10 characters)	4021	Wait For Analog 2, Value, Ramp Rate or Ramp Time or Soak Steps	4128	End Set Point Channel 1, Current Profile Status
3110-19	Name, Digital Output 2 (10 characters)		Wait For Analog 3, Ramp Rate or Ramp Time or Soak Steps	4129	Status
3120-29	Name, Digital Output 3 (10 characters)	4022	Wait For Analog 3 Value, Ramp Rate or Ramp Time or Soak Steps	4130	End Set Point Channel 2, Current Profile Status
3130-39	Name, Digital Output 4 (10 characters)		Event Output 1, Ramp Rate or Ramp Time or Soak Steps	4501-18	Custom Message 1
3140-49	Name, Digital Output 5 (10 characters)	4023	Event Output 2, Ramp Rate or Ramp Time or Soak Steps	4521-38	Custom Message 2
3150-59	Name, Digital Output 6 (10 characters)		Event Output 3, Ramp Rate or Ramp Time or Soak Steps	4541-58	Custom Message 3
3160-69	Name, Digital Output 7 (10 characters)	4024	Event Output 4, Ramp Rate or Ramp Time or Soak Steps	4561-78	Custom Message 4
3170-79	Name, Digital Output 8 (10 characters)		Event Output 5, Ramp Rate or Ramp Time or Soak Steps	5500	Process Display
3200-09	Name, Alarm 1 (10 characters)	4025	Event Output 6, Ramp Rate or Ramp Time or Soak Steps	5501	Process Display Input 1, Time
3210-19	Name, Alarm 2 (10 characters)		Event Output 7, Ramp Rate or Ramp Time or Soak Steps	5502	Process Display Input 2, Time
3500-09	Name, Profile 1 (10 characters)	4026	Event Output 8, Ramp Rate or Ramp Time or Soak Steps	5503	Process Display Input 3, Time
3510-19	Name, Profile 2 (10 characters)		Rate, Ramp Rate Step		
3520-29	Name, Profile 3 (10 characters)	4030	Ramp Setpoint Channel 1, Ramp Rate or Ramp Time Step		
3530-39	Name, Profile 4 (10 characters)		Ramp Setpoint Channel 2, Ramp Rate or Ramp Time Step		
3540-49	Name, Profile 5 (10 characters)	4031	Channel 1 PID Set, Ramp Rate or Ramp Time or Soak Steps		
3550-59	Name, Profile 6 (10 characters)		Channel 2 PID Set, Ramp Rate or Ramp Time or Soak Steps		
3560-69	Name, Profile 7 (10 characters)	4032	Guaranteed Soak Channel 1, Ramp Rate or Ramp Time Step		
3570-79	Name, Profile 8 (10 characters)				
3580-89	Name, Profile 9 (10 characters)	4033			
3590-99	Name, Profile 10 (10 characters)				
3600-09	Name, Profile 11 (10 characters)	4034			
3610-19	Name, Profile 12 (10 characters)				
3620-29	Name, Profile 13 (10 characters)	4035			
3630-39	Name, Profile 14 (10 characters)				
3640-49	Name, Profile 15 (10 characters)	4036			
3650-59	Name, Profile 16 (10 characters)				
3660-69	Name, Profile 17 (10 characters)	4037			
3670-79	Name, Profile 18 (10 characters)				
3680-89	Name, Profile 19 (10 characters)	4043			
3690-99	Name, Profile 20 (10 characters)	4044			
3700-09	Name, Profile 21 (10 characters)				
3710-19	Name, Profile 22 (10 characters)	4045			
3720-29	Name, Profile 23 (10 characters)	4046			
3730-39	Name, Profile 24 (10 characters)				
3740-49	Name, Profile 25 (10 characters)	4047			
3750-59	Name, Profile 26 (10 characters)				
3760-69	Name, Profile 27 (10 characters)	4048			

✓NOTE:  
For more information about parameters, see the Index.

## Communications Page Parameter Table

Parameter	Description	Range (Modbus Value)	Default	Modbus Register read/write [I/O, Set, Ch]	Conditions for Parameters to Appear
<b>Communications</b>					
Main > Setup > <b>Communications</b>					
<b>Baud Rate</b>	Set the transmission speed in bits/seconds.	19200 9600	19200	No Modbus address.	Active: Always.
<b>Address</b>	Set the controller's address between 1 and 247.	1 to 247	1	No Modbus address.	Active: Always.

*NOTE: For more information about how parameter settings affect the controller's operation, see the Features Chapter.*

# F4 Modbus Applications: Profile Programming Procedures

## F4 Modbus Applications: Profile Overview

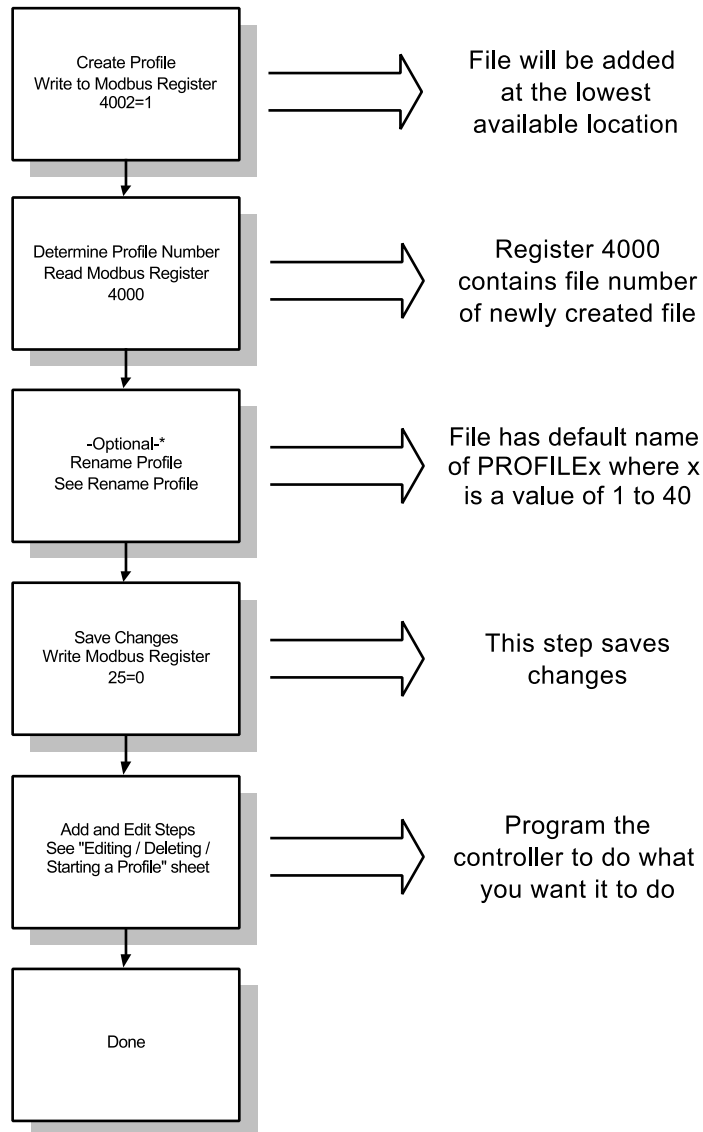

A maximum of 40 files may be created, with a total of 256 steps. Each time a new file is created, the file is placed after the previously created file. As files are deleted, newly created files are placed into these locations. Modbus Register 4000 returns the file number of the newly created file.

*\*Profiles without custom-written names are referred to by their numbers (Profile 1, Profile 2, etc.).*

## F4 Modbus Applications: Creating a Profile

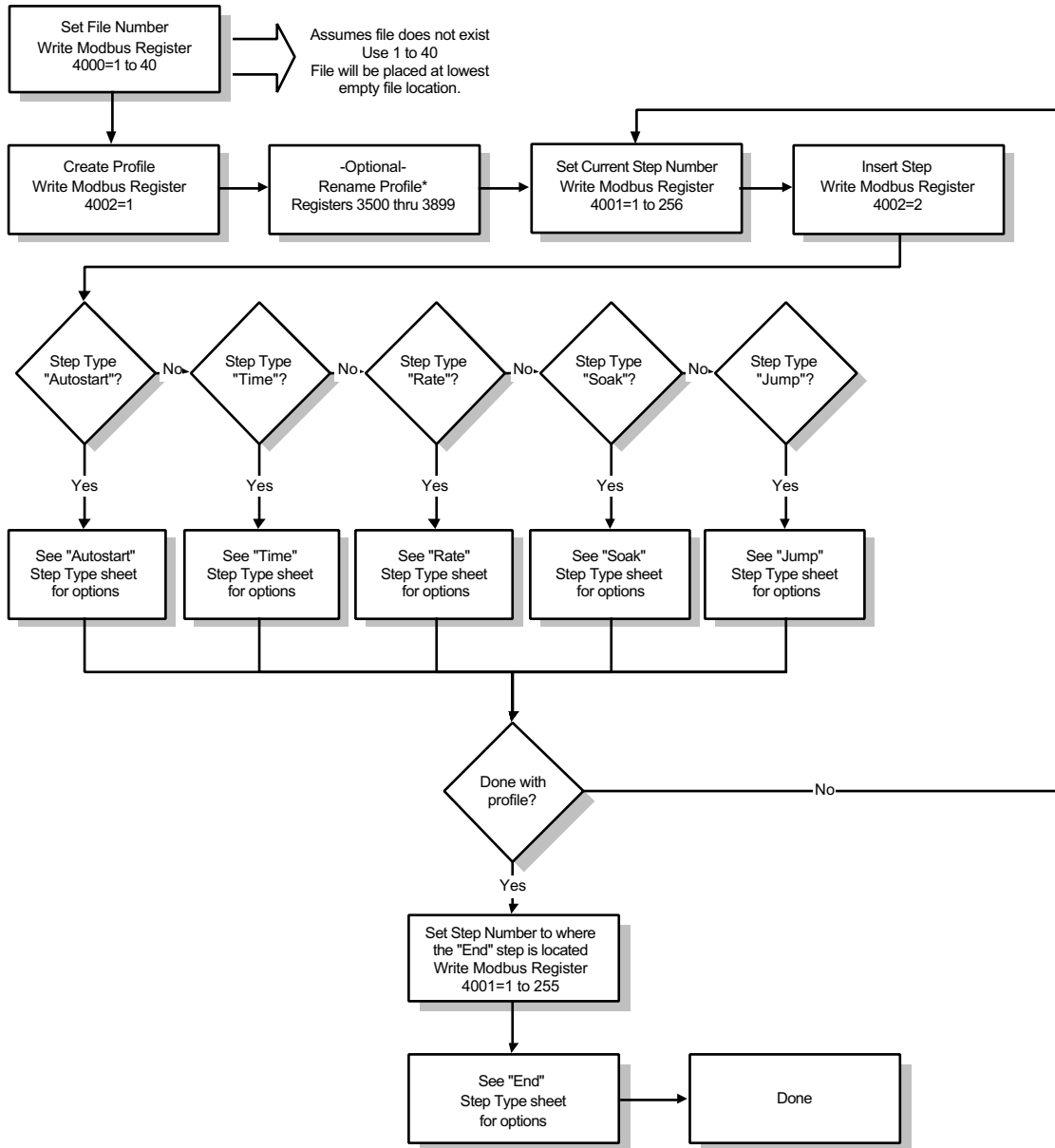

*\*Profiles without custom-written names are referred to by their numbers (Profile 1, Profile 2, etc.),*

# F4 Modbus Applications: Autostart Step

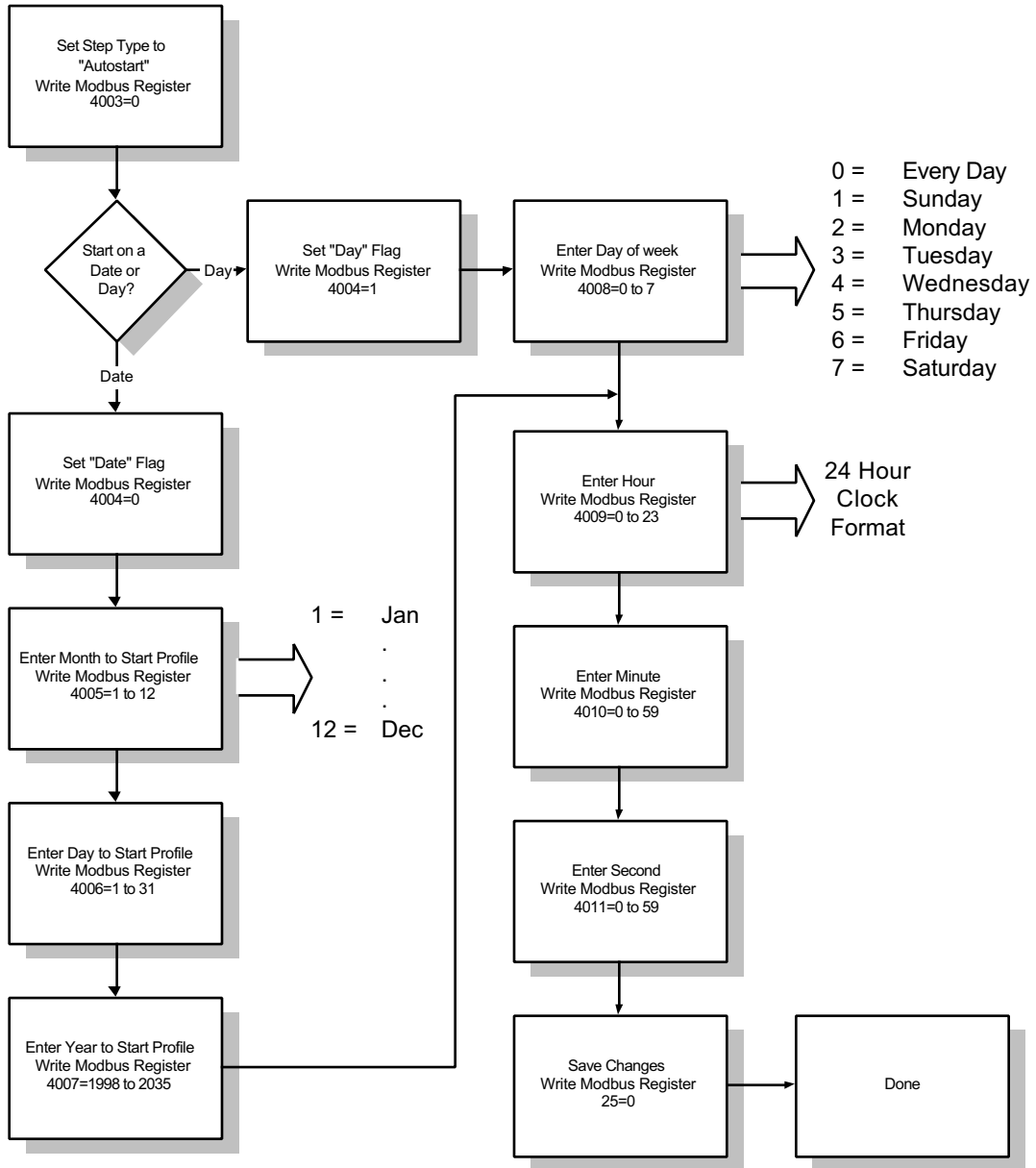

Autostart pauses a profile until the specified date or day, and time (of a 24-hour-clock).

# F4 Modbus Applications: Ramp Time, Ramp Rate, Soak Steps (page 1 of 3)

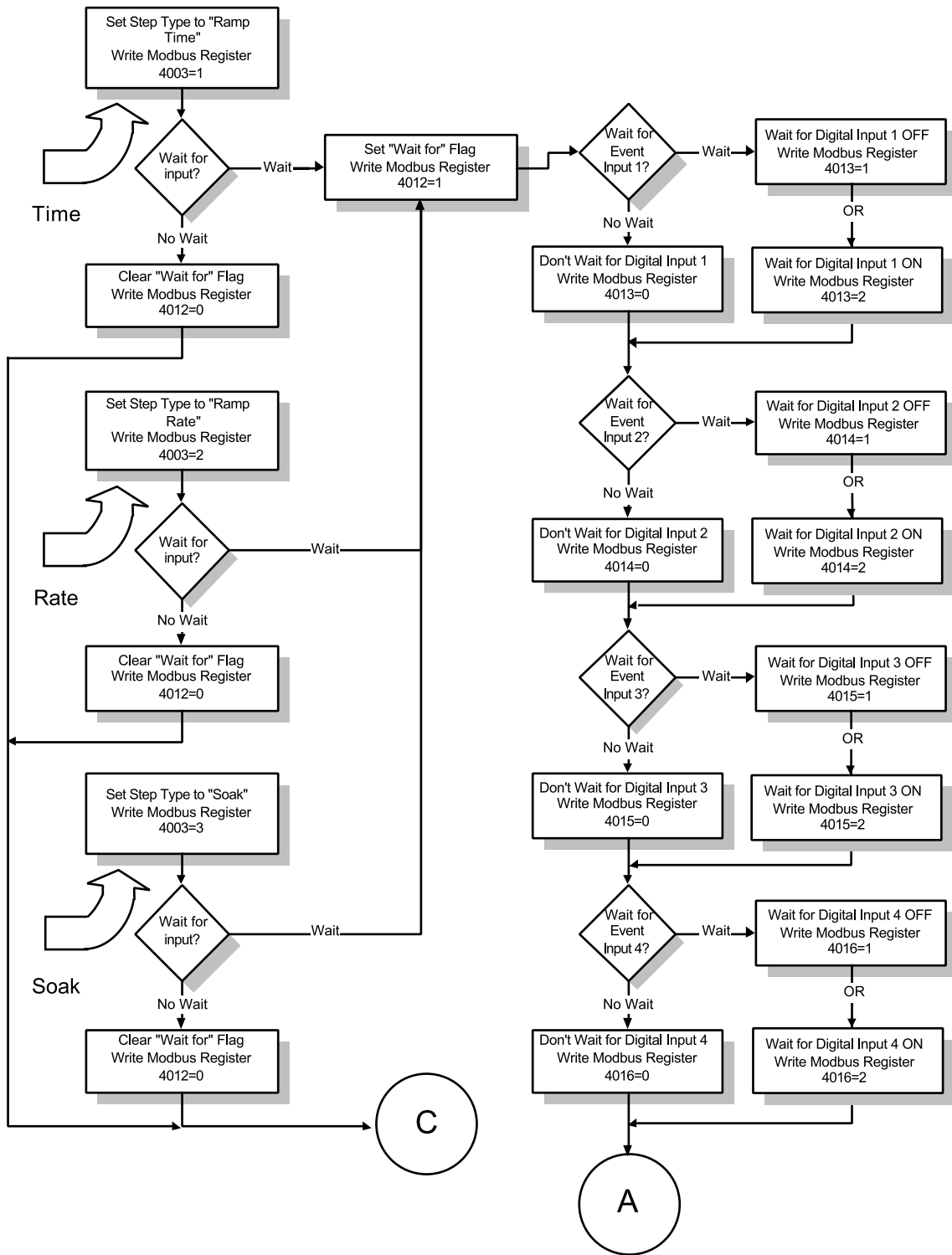

Digital inputs must be configured as Events before profiling: "Digital Input 1 to 4 Function = Wait for Event" and "Digital Input 1 to 4 Condition = Low or High." Modbus Registers 1060 through 1067. See Setup Page Map.



# F4 Modbus Applications: Ramp Time, Ramp Rate, Soak Steps (page 2 of 3)

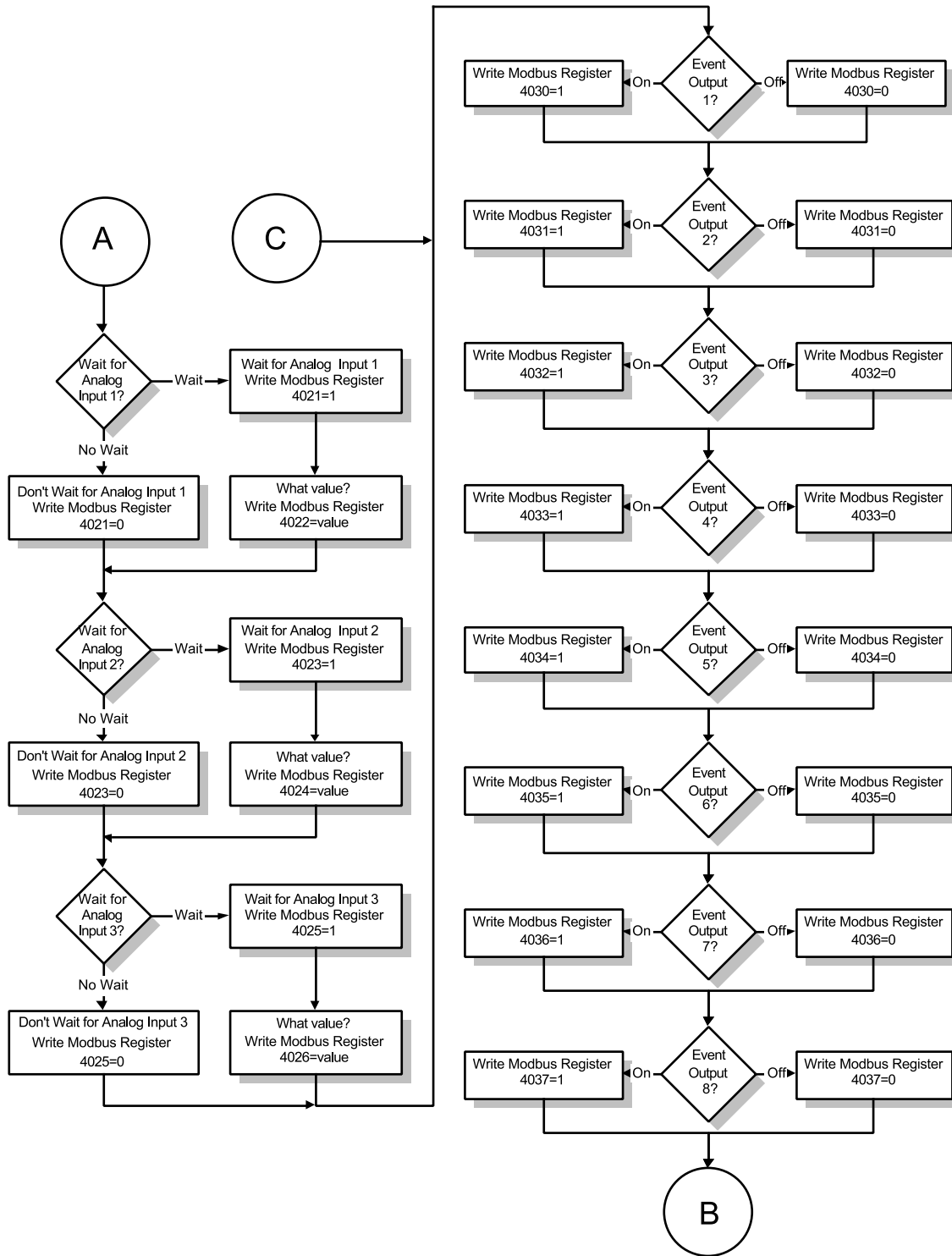

Analog inputs and digital outputs must be configured before programming a profile. See Setup Page Map.

# F4 Modbus Applications: Ramp Time, Ramp Rate, Soak Steps (page 3 of 3)

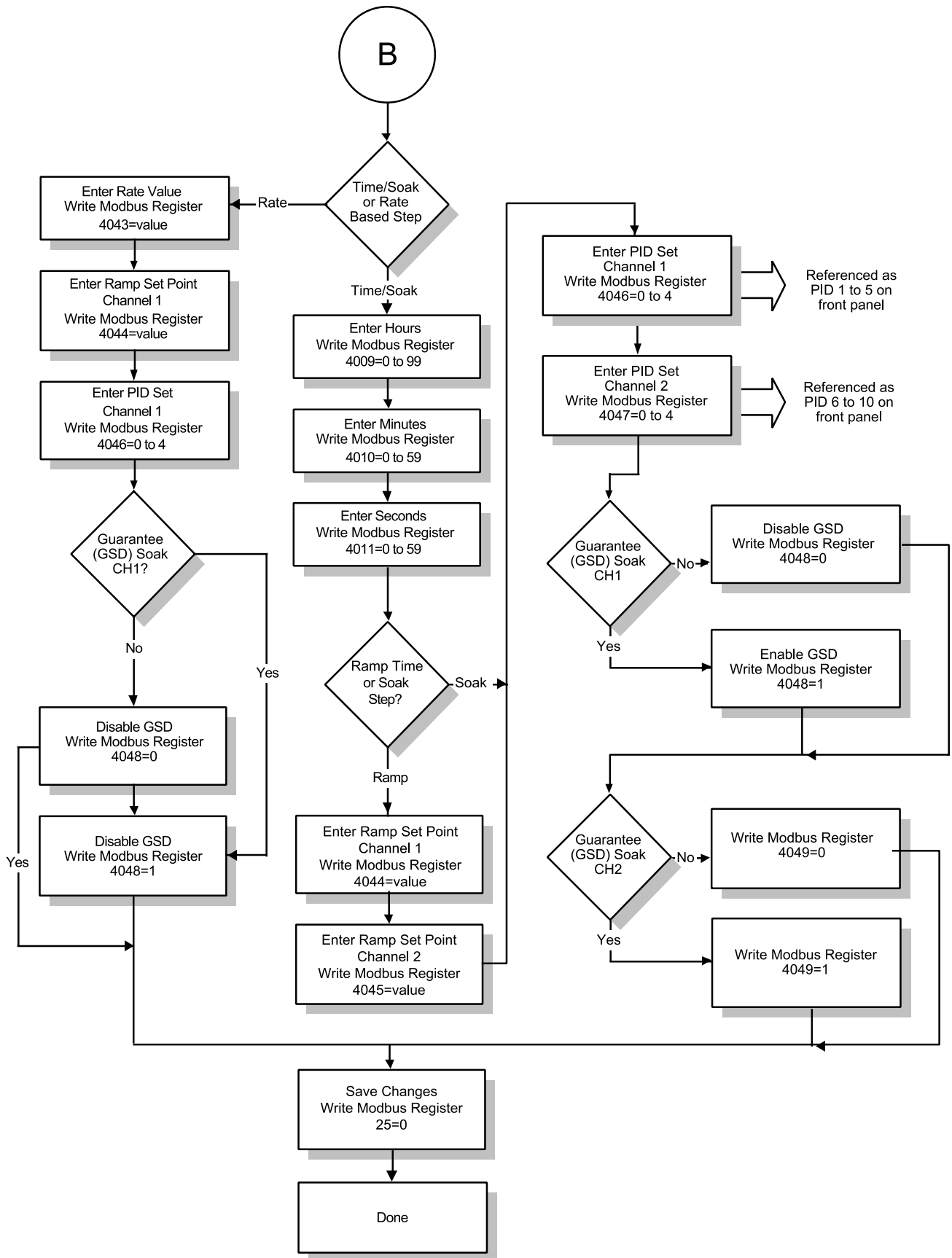

## F4 Modbus Applications:

### Jump Step

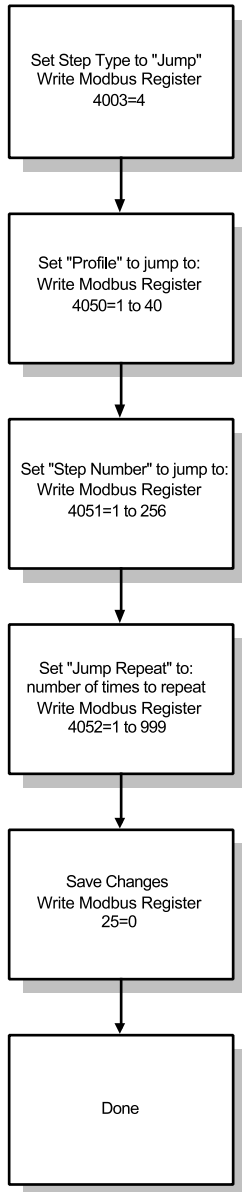

Jump initiates another step or profile. File must exist at location specified.

## F4 Modbus Applications:

### End Step

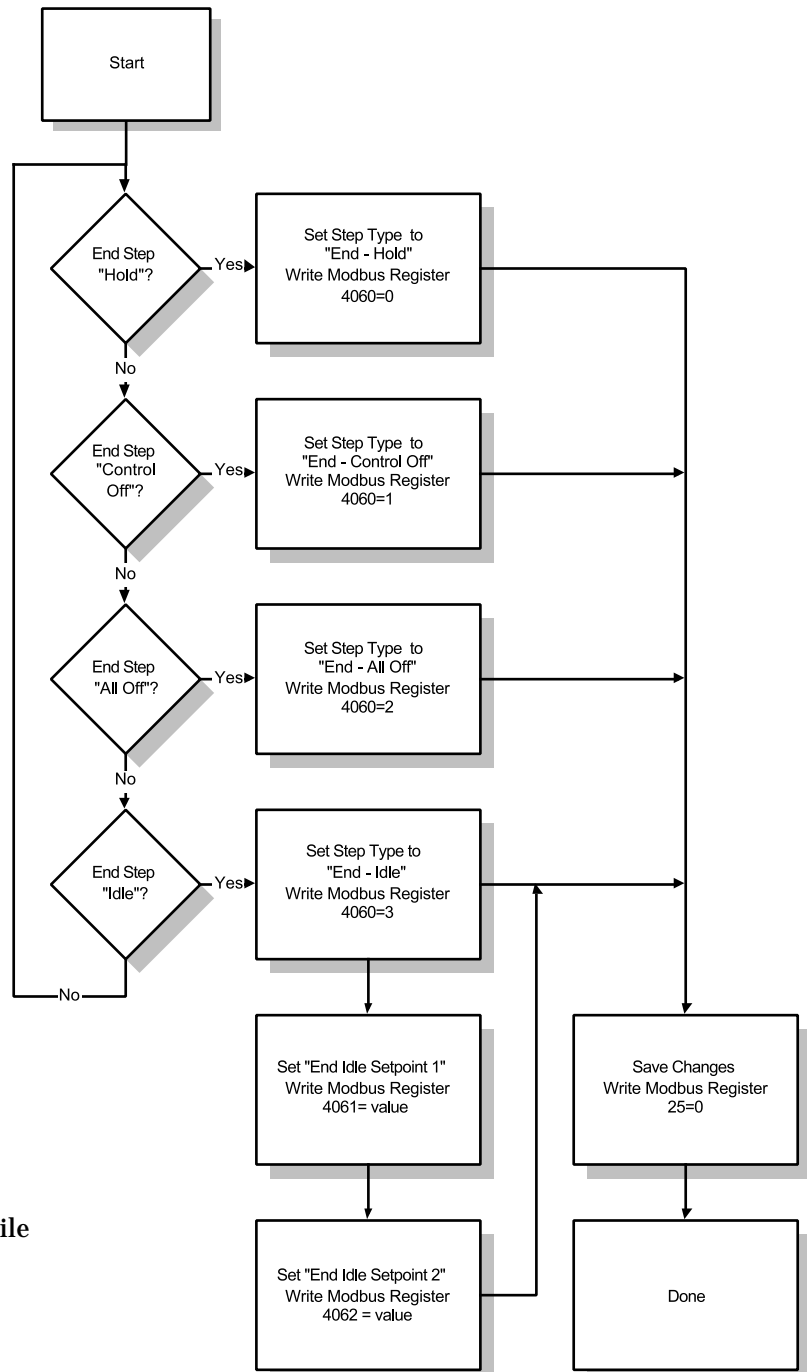

# F4 Modbus Applications: Editing, Deleting, Starting a Profile

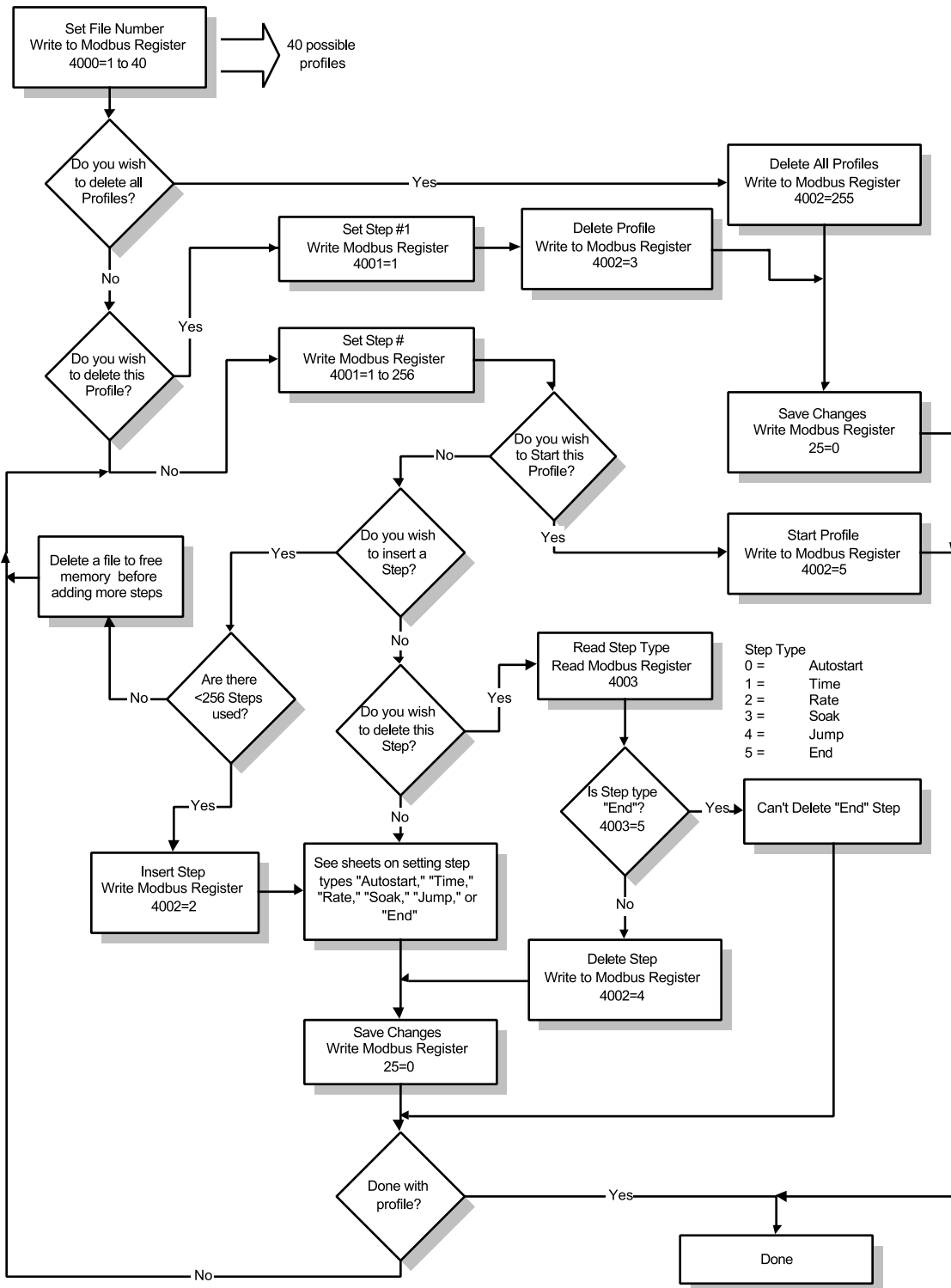

# F4 Modbus Applications: Naming a Profile

Profiles without custom-written names are referred to by their numbers (Profile 1, Profile 2, etc.). Follow this procedure to customize the profile name, using ASCII-equivalent decimal codes (in the column labeled “Dec” in the chart below).

Renaming a Profile - F4 via Modbus Communication

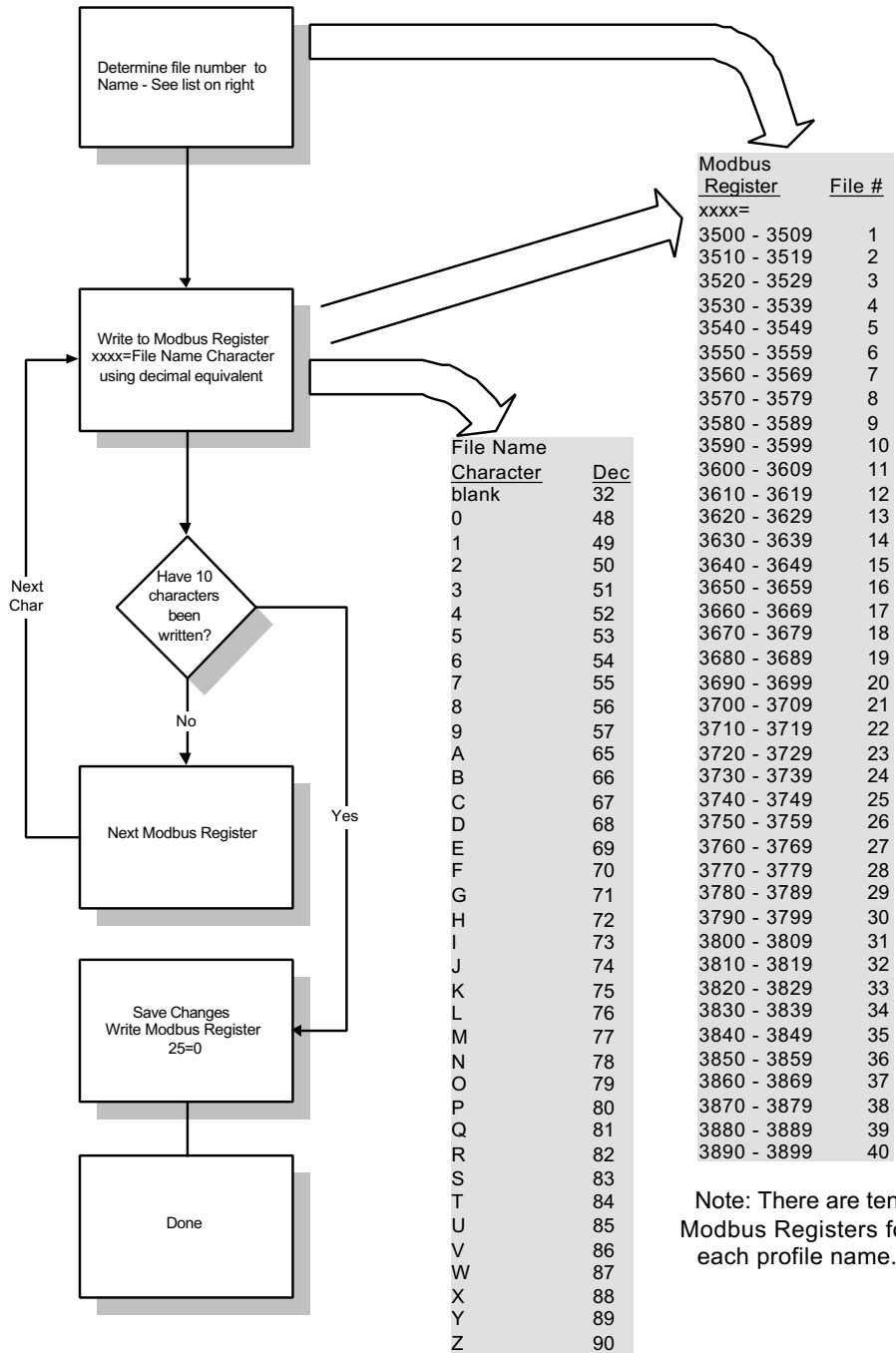

Note: There are ten Modbus Registers for each profile name.

## F4 Modbus Applications: Monitor Current Step

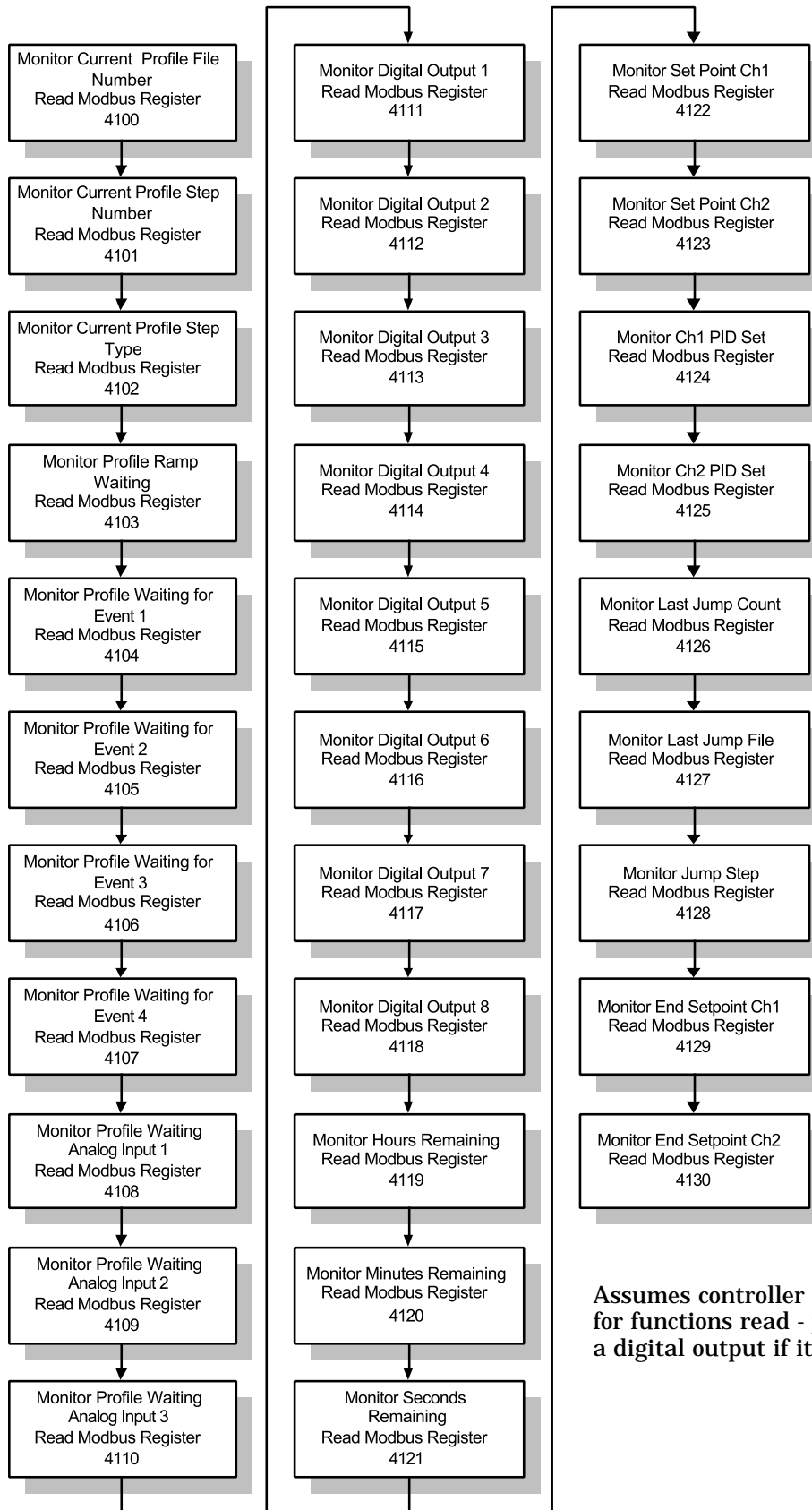

Assumes controller is configured for functions read - you can't read a digital output if it doesn't exist.

# 8

## Chapter Eight: Security and Locks

### Overview

The Series F4 allows users to set separate security levels for the Static Set Point prompt on the Main Page, for all menus on the Operations Page, as well as for the Profiles Page, Setup Page and Factory Page. Four levels of security are available:

- **Full Access** (operators can enter and change settings);
- **Read Only** (operators can read but not change settings);

- **Password** (operators can enter and change settings after entering a password); and
- **Hidden** (operators cannot see the menu or page — it is not displayed). Set Point settings cannot be Hidden.

Full Access is the default for all menus. Unless you change the level of access, operators will be able to read and change every setting in every menu in the Series F4 software.

### Set Lock Levels

To set levels of security, go to “Set Lockout,” on the Factory Page. Press the Right Key . This menu lists the menus for which access can be limited:

- **Set Point** on Main Page
- **Operations Page Autotune PID**
- **Operations Page Edit PID**
- **Operations Page Alarm Set Point**
- **Profiles Page**
- **Setup Page**
- **Factory Page**

After choosing the item to lock out, press  and choose the level of access: Full, Read Only, Password or Hidden. If you choose Password, you must set the password — see below.

```
Main>Factory_____   
>Set Lockout  
Diagnostic  
Test
```

```
...Factory>Set Lock____   
Set Point  
>Oper. Autotune PID ■  
Oper. Edit PID ▼
```

```
...Lock>Autotune PID____  
Full Access  
Read Only  
>Password
```

✓ **NOTE:**

*Full Access is the default for all menus. Unless you change the level of access, operators will be able to read and change every setting in every menu in the Series F4 software.*

✓ **NOTE:**

*For more information about how parameter settings affect the controller’s operation, see the Features Chapter.*

# Enter a Password

If you try to set password security before any password has been established, a pop-up message will give you the opportunity to enter one. Use the **◂ ◃ ▴ ▾** keys to enter a four-character password, which can consist of letters, numbers or both. After entering and confirming the password, re-enter the chosen menu or page and select Password Security. Record your password and keep it secure.

Must have password before choosing the password lock! **◂**

Must reset lock after setting the password **■ ■ ■ ■** Press any key! **■ ■ ■ ■**

Enter New Password:  
\_ \_ \_ \_  
**▲ ▼** Adjusts Char  
**◂ ◃** Save Changes

Confirm Password:  
\_ \_ \_ \_  
**▲ ▼** Adjusts Char  
**◂ ◃** Save Changes

# Use a Password

To enter a password-protected area, users must enter the password. If an incorrect password is entered, a pop-up message will tell you it is invalid and you may try again. When the password is correct, choose again to enter the menu or page of your choice.

Invalid, Re-Enter: \_\_\_\_  
**▲ ▼** Adjusts Char  
**◂ ◃** Save Changes

# Change a Password

The Change Password parameter is near the end of the list under Set Lockout on the Factory Page. To change a password, you must first enter the old password for confirmation.

...Factory>Set Lock \_\_\_\_ **◂**  
Setup **▲**  
Factory **■**  
>Change Password **▼**

Enter Password:  
\_ \_ \_ \_  
**▲ ▼** Adjusts Char  
**◂ ◃** Save Changes

---

## Set Lockout Menu Map

- Set Point
- Oper. Autotune PID
- Oper Edit PID
- Oper. Alarm SP
- Profile
- Setup
- Factory
- Change Password
- Clear Locks



## Set Lockout Menu Parameter Table

Parameter	Description	Range (Modbus Value)	Default	Modbus Register read/write [I/O, Set, Ch]	Conditions for Parameters to Appear
<b>Set Lockout</b>					
<b>Main &gt; Factory &gt; Set Lock</b>					
<b>Set Point</b>	Set the set point access level.	Full Access (0) Read Only (1)	Full Access	1300 r/w	Active: Always.
<b>Operations, Autotune PID</b>	Limit access to this menu.	Full Access (0) Read Only (1) Password (2) Hidden (3)	Full Access	1306 r/w	Active: Always.
<b>Operations, Edit PID</b>	Limit access to this menu.	Full Access (0) Read Only (1) Password (2) Hidden (3)	Full Access	1307 r/w	Active: Always.
<b>Operations, Alarm Set Point</b>	Limit access to this menu.	Full Access (0) Read Only (1) Password (2) Hidden (3)	Full Access	1308 r/w	Active: Always.
<b>Profile Page</b>	Limit access to this page.	Full Access (0) Read Only (1) Password (2) Hidden (3)	Full Access	1309 r/w	Active: Always.
<b>Setup Page</b>	Limit access to this page.	Full Access (0) Read Only (1) Password (2) Hidden (3)	Full Access	1302 r/w	Active: Always.
<b>Factory Page</b>	Limit access to this page.	Full Access (0) Read Only (1) Password (2)	Full Access	1303 r/w	Active: Always.
<b>Set/Change Password</b>	Reset or change password. Choose Yes to change the password.	Yes (0) No (1)		1314 r/w	Active: Always.
<b>Clear Locks</b>	Unlock set point and all pages and menus.	Yes (0)		1315 w	

*NOTE: For more information about how parameter settings affect the controller's operation, see the Features Chapter.*

# Notes

# 9

## Chapter Nine: Calibration

Thermocouple Input Procedure . . . . .	9.2
RTD Input Procedure . . . . .	9.2
Voltage Process Input Procedure . . . . .	9.3
Current Process Input Procedure . . . . .	9.3
Process Output Procedure . . . . .	9.4
Retransmit Output Procedure . . . . .	9.5
Calibration Menu Map . . . . .	9.6
Factory Page Parameter Table . . . . .	9.7

### Overview

The Calibration Menu on the Factory Page allows calibration of inputs and outputs. Calibration procedures should be done only by qualified technical personnel with access to the equipment listed in each section.

Before beginning calibration procedures, warm up the controller for at least 20 minutes.

### Restore Factory Values

**Each controller is calibrated before leaving the factory.** If at any time you want to restore the factory calibration values, use the last parameters in the menu: Restore In x (1 to 3) Cal. Press **►** . No special equipment is necessary.

✓ **NOTE:**  
*To see how all the pages, menus and parameters are grouped, refer to the inside back cover of this manual.*

✓ **NOTE:**  
*For more information about how parameter settings affect the controller's operation, see the Features Chapter.*

# Calibrating the Series F4

## Thermocouple Input Procedure

### Equipment

- Type J reference compensator with reference junction at 32°F (0°C), or type J thermocouple calibrator to 32°F (0°C).
- Precision millivolt source, 0 to 50mV minimum range, 0.002mV resolution.

### Input x (1 to 3) Setup and Calibration

1. Connect the correct power supply to terminals 1, 2 and 3 (see the Wiring Chapter and the Appendix).
2. Connect the millivolt source to Input 1 terminals 62 (-) and 61 (+), Input 2 terminals 58 (-) and 57 (+), or Input 3 terminals 56 (-) and 55 (+), with copper wire.
3. Enter 50.000mV from the millivolt source. Allow at least 10 seconds to stabilize. Press the Right Key **➤** once at the Calibrate Input x (1 to 3) prompt (Factory Page). At the 50.00mV prompt press **➤** once and to store 50.00mV press the Up Key **▲** once.
4. Enter 0.000mV from the millivolt source. Allow at least 10 seconds to stabilize. At the 0.00mV prompt press **➤** once and to store 0.00mV press **▲** once.
5. Disconnect the millivolt source and connect the reference compensator or thermocouple calibrator to Input 1 terminals 62 (-) and 61 (+) or Input 2 or 3 terminals 58 (-) and 57 (+). With type J thermocouple wire, if using a compensator, turn it on and short the input wires. When using a type J calibrator, set it to simulate 32°F (0°C). Allow 10 seconds for the controller to stabilize. Press **➤** once at the Calibrate Input x (1 or 2) prompt (Factory Page). At the 32°F Type J prompt press **➤** once and to store type J thermocouple calibration press **▲** once.
6. Rewire for operation and verify calibration.

#### ✓NOTE:

You need the equipment listed and technical skills. Controllers come calibrated from the factory. Recalibrate only for other agency requirements or if temperatures aren't accurate as verified by another calibrated instrument.

## RTD Input Procedure

### Equipment

- 1kΩ decade box with 0.01Ω resolution.

### Input x (1 to 3) Setup and Calibration

1. Connect the correct power supply to terminals 1, 2 and 3 (see the Wiring Chapter and the Appendix).
2. Short Input 1 terminals 60, 61 and 62; Input 2 terminals 54, 57 and 58; or Input 3 terminals 52, 55 and 56 together with less than 0.1Ω. Press the Right Key **➤** once at the Calibrate Input x (1 to 3) prompt. At the Ground prompt press **➤** once and to store ground input press the Up Key **▲** once.
3. Short Input 1 terminals 60 and 61; Input 2 terminals 54 and 57; or Input 3 terminals 52 and 55 together with less than 0.5Ω. Press **➤** once at the Calibrate Input x (1 to 3) prompt. At the Lead prompt press **➤** once and to store lead resistance press **▲** once.
4. Connect the decade box to Input 1 terminals 60 (S2), 61 (S1) and 62 (S3); Input 2 terminals 54 (S2), 57 (S1) and 58 (S3); or Input 3 terminals 52 (S2), 55 (S1) and 56 (S3), with 20- to 24-gauge wire.
5. For 100Ω RTD, enter 15.00Ω. For 500Ω or 1kΩ RTD, enter 240.00Ω. Allow at least 10 seconds to stabilize. Press **➤** once at the Calibrate Input x (1 to 3) prompt (Factory Page). At the 15.00Ω or 240.00Ω\* prompt press **➤** once and to store the 15.00Ω or 240.00Ω input press **▲** once.
6. For 100Ω RTD, enter 380.00Ω. For 500Ω or 1kΩ RTD, enter 6080.00Ω. Allow at least 10 seconds to stabilize. Press **➤** once at the Calibrate Input x (1 to 3) prompt. At the 380.0Ω or 6080.00Ω\* prompt press **➤** once and to store the 380.00Ω or 6080.00Ω input press **▲** once.
7. Rewire for operation and verify calibration.

\*The tenth character of your model number determines what prompts appear and what input resistance values to use for the RTD calibration.

F4\_ \_ \_ \_ \_ (1 to 4)RG: 15.00 and 380.00Ω

F4\_ \_ \_ \_ \_ (5 to 8)RG: 240.00 and 6080.00Ω

# Voltage Process Input Procedure

## Equipment

- Precision voltage source, 0 to 10V minimum range, with 0.001V resolution.

## Input x (1 to 3) Setup and Calibration

1. Connect the correct power supply to terminals 1, 2 and 3 (see the Wiring Chapter and the Appendix).

### Input 1

2. Connect the voltage source to terminals 59 (+) and 62 (-) of the controller.
3. Enter 0.000V from the voltage source to the controller. Allow at least 10 seconds to stabilize. Press the Right Key **➤** once at the Calibrate Input 1 prompt. At the 0.000V prompt press **➤** once and to store the 0.000V input press the Up Key **▲** once.
4. Enter 10.000V from the voltage source to the controller. Allow at least 10 seconds to stabilize. Press **➤** once at the Calibrate Input 1 prompt. At the 10.000V prompt press **➤** once and to store the 10.000V input press **▲** once.

### Input 2

5. Connect the voltage source to terminals 53 (+) and 58 (-) of the controller.
6. Enter 0.000V from the voltage source to the controller. Allow at least 10 seconds to stabilize. Press **➤** once at the Calibrate Input 2 prompt. At the 0.000V prompt press **➤** once and to store the 0.000V input press **▲** once.
7. Enter 10.000V from the voltage source to the controller. Allow at least 10 seconds to stabilize. Press **➤** once at the Calibrate Input 2 prompt (Factory Page). At the 10.000V prompt press **➤** once and to store the 10.000V input press **▲** once.

### Input 3

8. Connect the voltage source to terminals 51 (+) and 56 (-) of the controller.
9. Enter 0.000V from the voltage source to the controller. Allow at least 10 seconds to stabilize. Press **➤** once at the Calibrate Input 3 prompt. At the 0.000V prompt press **➤** once and to store the 0.000V input press **▲** once.
10. Enter 10.000V from the voltage source to the controller. Allow at least 10 seconds to stabilize.

Press **➤** once at the Calibrate Input 3 prompt (Factory Page). At the 10.000V prompt press **➤** once and to store the 10.000V input press **▲** once.

11. Rewire for operation and verify calibration.
- 

# Current Process Input Procedure

## Equipment

- Precision current source, 0 to 20mA range, with 0.01mA resolution.

## Input x (1 to 3) Setup and Calibration

1. Connect the correct power supply to terminals 1, 2 and 3 (see the Wiring Chapter and the Appendix).

### Input 1

2. Connect the current source to terminals 60 (+) and 62 (-).
3. Enter 4.000mA from the current source to the controller. Allow at least 10 seconds to stabilize. Press the Right Key **➤** once at the Calibrate Input 1 prompt. At the 4.000mA prompt press **➤** once and to store 4.000mA press the Up Key **▲** once.
4. Enter 20.000mA from the current source to the controller. Allow at least 10 seconds to stabilize. Press **➤** once at the Calibrate Input 1 prompt. At the 20.000mA prompt press **➤** once and to store 20.000mA press **▲** once.

### Input 2

5. Connect the current source to terminals 54 (+) and 58 (-).
6. Enter 4.00mA from the current source to the controller. Allow at least 10 seconds to stabilize. Press **➤** once at the Calibrate Input 2 prompt. At the 4.000mA prompt press **➤** once and to store 4.000mA press **▲** once.
7. Enter 20.00mA from the current source to the controller. Allow at least 10 seconds to stabilize. Press **➤** once at the Calibrate Input 2 prompt. At the 20.000mA prompt press **➤** once and to store 20.000mA press **▲** once.

### Input 3

8. Connect the voltage source to terminals 52 (+) and 56 (-) of the controller.
9. Enter 4.000mA from the current source to the controller. Allow at least 10 seconds to stabilize.

- Press **▶** once at the Calibrate Input 3 prompt. At the 4.000mA prompt press **▶** once and to store the 4.000mA input press **▲** once.
- Enter 20.000mA from the current source to the controller. Allow at least 10 seconds to stabilize. Press **▶** once at the Calibrate Input 3 prompt (Factory Page). At the 20.000mA prompt press **▶** once and to store the 20.000mA input press **▲** once.
  - Rewire for operation and verify calibration.

---

## Process Output Procedure

### Equipment

- Precision volt/ammeter with 3.5-digit resolution.

### Output 1A Setup and Calibration

- Connect the correct power supply to terminals 1, 2 and 3 (see the Wiring Chapter and the Appendix).

#### Milliamperes

- Connect the volt/ammeter to terminals 42 (+) and 43 (-).
- Press the Right Key **▶** at the Calibrate Output 1A prompt. At the 4.000mA prompt press **▶** once. Use the Up Key **▲** or the Down Key **▼** to adjust the display to the reading on the volt/ammeter. The controller should stabilize within one second. Repeat until the volt/ammeter reads 4.000mA. Press **▶** to store the value.
- Press the Right Key **▶** at the Calibrate Output 1A prompt. At the 20.000mA prompt press **▶** once. Use the Up Key **▲** or the Down Key **▼** to adjust the display to the reading on the volt/ammeter. The controller should stabilize within one second. Repeat until the volt/ammeter reads 20.000mA. Press **▶** to store the value.

#### Volts

- Connect the volt/ammeter to terminals 44 (+) and 43 (-).
- Press the Right Key **▶** at the Calibrate Output 1A prompt. At the 1.000V prompt press **▶** once. Use the Up Key **▲** or the Down Key **▼** to adjust the display to the reading on the volt/ammeter. The controller should stabilize within one second. Repeat until the volt/ammeter reads 1.000V. Press **▶** to store the value.

- Press the Right Key **▶** at the Calibrate Output 1A prompt. At the 10.000V prompt press **▶** once. Use the Up Key **▲** or the Down Key **▼** to adjust the display to the reading on the volt/ammeter. The controller should stabilize within one second. Repeat until the volt/ammeter reads 10.000V. Press **▶** to store the value.
- Rewire for operation and verify calibration.

### Output 1B Setup and Calibration

- Connect the correct power supply to terminals 1, 2 and 3 (see the Wiring Chapter and the Appendix).

#### Milliamperes

- Connect the volt/ammeter to terminals 39 (+) and 40 (-).
- Press the Right Key **▶** at the Calibrate Output 1B prompt. At the 4.000mA prompt press **▶** once. Use the Up Key **▲** or the Down Key **▼** to adjust the display to the reading on the volt/ammeter. The controller should stabilize within one second. Repeat until the volt/ammeter reads 4.000mA. Press **▶** to store the value.
- Press the Right Key **▶** at the Calibrate Output 1B prompt. At the 20.000mA prompt press **▶** once. Use the Up Key **▲** or the Down Key **▼** to adjust the display to the reading on the volt/ammeter. The controller should stabilize within one second. Repeat until the volt/ammeter reads 20.000mA. Press **▶** to store the value.

#### Volts

- Connect the volt/ammeter to terminals 41 (+) and 40 (-).
- Press the Right Key **▶** at the Calibrate Output 1B prompt. At the 1.000V prompt press **▶** once. Use the Up Key **▲** or the Down Key **▼** to adjust the display to the reading on the volt/ammeter. The controller should stabilize within one second. Repeat until the volt/ammeter reads 1.000V. Press **▶** to store the value.
- Press the Right Key **▶** at the Calibrate Output 1B prompt. At the 10.000V prompt press **▶** once. Use the Up Key **▲** or the Down Key **▼** to adjust the display to the reading on the volt/ammeter. The controller should stabilize within one second. Repeat until the volt/ammeter reads 10.000V. Press **▶** to store the value.
- Rewire for operation and verify calibration.

## Output 2A Setup and Calibration

1. Connect the correct power supply to terminals 1, 2 and 3 (see the Wiring Chapter and the Appendix).

### Milliamperes

2. Connect the volt/ammeter to terminals 36 (+) and 37 (-).
3. Press the Right Key **▶** at the Calibrate Output 2A prompt. At the 4.000mA prompt press **▶** once. Use the Up Key **▲** or the Down Key **▼** to adjust the display to the reading on the volt/ammeter. The controller should stabilize within one second. Repeat until the volt/ammeter reads 4.000mA. Press **▶** to store the value.
4. Press the Right Key **▶** at the Calibrate Output 2A prompt. At the 20.000mA prompt press **▶** once. Use the Up Key **▲** or the Down Key **▼** to adjust the display to the reading on the volt/ammeter. The controller should stabilize within one second. Repeat until the volt/ammeter reads 20.000mA. Press **▶** to store the value.

### Volts

5. Connect the volt/ammeter to terminals 38 (+) and 37 (-).
6. Press the Right Key **▶** at the Calibrate Output 2A prompt. At the 1.000V prompt press **▶** once. Use the Up Key **▲** or the Down Key **▼** to adjust the display to the reading on the volt/ammeter. The controller should stabilize within one second. Repeat until the volt/ammeter reads 1.000V. Press **▶** to store the value.
7. Press the Right Key **▶** at the Calibrate Output 2A prompt. At the 10.000V prompt press **▶** once. Use the Up Key **▲** or the Down Key **▼** to adjust the display to the reading on the volt/ammeter. The controller should stabilize within one second. Repeat until the volt/ammeter reads 10.000V. Press **▶** to store the value.
8. Rewire for operation and verify calibration.

## Output 2B Setup and Calibration

1. Connect the correct power supply to terminals 1, 2 and 3 (see the Wiring Chapter and the Appendix).

### Milliamperes

2. Connect the volt/ammeter to terminals 33 (+) and 34 (-).
3. Press the Right Key **▶** at the Calibrate Out-

put 2B prompt. At the 4.000mA prompt press **▶** once. Use the Up Key **▲** or the Down Key **▼** to adjust the display to the reading on the volt/ammeter. The controller should stabilize within one second. Repeat until the volt/ammeter reads 4.000mA. Press **▶** to store the value.

4. Press the Right Key **▶** at the Calibrate Output 2B prompt. At the 20.000mA prompt press **▶** once. Use the Up Key **▲** or the Down Key **▼** to adjust the display to the reading on the volt/ammeter. The controller should stabilize within one second. Repeat until the volt/ammeter reads 20.000mA. Press **▶** to store the value.

### Volts

5. Connect the volt/ammeter to terminals 35 (+) and 34 (-).
6. Press the Right Key **▶** at the Calibrate Output 2B prompt. At the 1.000V prompt press **▶** once. Use the Up Key **▲** or the Down Key **▼** to adjust the display to the reading on the volt/ammeter. The controller should stabilize within one second. Repeat until the volt/ammeter reads 1.000V. Press **▶** to store the value.
7. Press the Right Key **▶** at the Calibrate Output 2B prompt. At the 10.000V prompt press **▶** once. Use the Up Key **▲** or the Down Key **▼** to adjust the display to the reading on the volt/ammeter. The controller should stabilize within one second. Repeat until the volt/ammeter reads 10.000V. Press **▶** to store the value.
8. Rewire for operation and verify calibration.

---

## Retransmit Output Procedure

### Equipment

- Precision volt/ammeter with 3.5-digit resolution.

## Retransmit 1 Setup and Calibration

1. Connect the correct power supply to terminals 1, 2 and 3 (see the Wiring Chapter and the Appendix).

### Milliamperes

2. Connect the volt/ammeter to terminals 50 (+) and 49 (-).
3. Press the Right Key **▶** at the Calibrate Rexmit 1 prompt. At the 4.000mA prompt press **▶** once. Use the Up Key **▲** or the Down Key

◀ to adjust the display to the reading on the volt/ammeter. The controller should stabilize within one second. Repeat until the volt/ammeter reads 4.000mA. Press ▶ to store the value.

4. Press the Right Key ▶ at the Calibrate Rexmit 1 prompt. At the 20.000mA prompt press ▶ once. Use the Up Key ▲ or the Down Key ▼ to adjust the display to the reading on the volt/ammeter. The controller should stabilize within one second. Repeat until the volt/ammeter reads 20.000mA. Press ▶ to store the value.

#### Volts

5. Connect the volt/ammeter to terminals 48 (+) and 49 (-).
6. Press the Right Key ▶ at the Calibrate Rexmit 1 prompt. At the 1.000V prompt press ▶ once. Use the Up Key ▲ or the Down Key ▼ to adjust the display to the reading on the volt/ammeter. The controller should stabilize within one second. Repeat until the volt/ammeter reads 1.000V. Press ▶ to store the value.
7. Press the Right Key ▶ at the Calibrate Rexmit 1 prompt. At the 10.000V prompt press ▶ once. Use the Up Key ▲ or the Down Key ▼ to adjust the display to the reading on the volt/ammeter. The controller should stabilize within one second. Repeat until the volt/ammeter reads 10.000V. Press ▶ to store the value.
8. Rewire for operation and verify calibration.

### Retransmit 2 Setup and Calibration

1. Connect the correct power supply to terminals

1, 2 and 3 (see the Wiring Chapter and the Appendix).

#### Milliamperes

2. Connect the volt/ammeter to terminals 47 (+) and 46 (-).
3. Press the Right Key ▶ at the Calibrate Rexmit 2 prompt. At the 4.000mA prompt press ▶ once. Use the Up Key ▲ or the Down Key ▼ to adjust the display to the reading on the volt/ammeter. The controller should stabilize within one second. Repeat until the volt/ammeter reads 4.000mA. Press ▶ to store the value.
4. Press the Right Key ▶ at the Calibrate Rexmit 2 prompt. At the 20.000mA prompt press ▶ once. Use the Up Key ▲ or the Down Key ▼ to adjust the display to the reading on the volt/ammeter. The controller should stabilize within one second. Repeat until the volt/ammeter reads 20.000mA. Press ▶ to store the value.

#### Volts

5. Connect the volt/ammeter to terminals 45 (+) and 46 (-).
6. Press the Right Key ▶ at the Calibrate Rexmit 2 prompt. At the 1.000V prompt press ▶ once. Use the Up Key ▲ or the Down Key ▼ to adjust the display to the reading on the volt/ammeter. The controller should stabilize within one second. Repeat until the volt/ammeter reads 1.000V. Press ▶ to store the value.
7. Press the Right Key ▶ at the Calibrate Rexmit 2 prompt. At the 10.000V prompt press ▶ once. Use the Up Key ▲ or the Down Key ▼ to adjust the display to the reading on the volt/ammeter. The controller should stabilize within one second. Repeat until the volt/ammeter reads 10.000V. Press ▶ to store the value.

---

## Calibration Menu Map

```
Calibrate Input 1
Calibrate Input 2
Calibrate Input 3
Calibrate Output 1A
Calibrate Output 1B
Calibrate Output 2A
Calibrate Output 2B
Calibrate Rexmit 1
Calibrate Rexmit 2
Restore In1 Cal
Restore In2 Cal
Restore In3 Cal
```



# Factory Page Parameter Table

Parameter	Description	Range (Modbus Value)	Default	Modbus Register read/write [I/O, Set, Ch]	Conditions for Parameters to Appear
<b>Calibrate Input x (1 to 3)</b>					
Main Page > Factory > Calibration > <b>Calibrate Input x (1 to 3)</b>					
<b>0.00mV Thermocouple</b>	Store 0.000mV calibration for the thermocouple input.	Yes (1)		Input 1603 [1] 1608 [2] 1613 [3] w	Active: Always.
<b>50.00mV Thermocouple</b>	Store 50.000mV calibration for the thermocouple input.	Yes (2)		Input 1603 [1] 1608 [2] 1613 [3] w	Active: Always.
<b>32°F Type J</b>	Store 32°F type J calibration.	Yes (3)		Input 1603 [1] 1608 [2] 1613 [3] w	Active: Always.
<b>Ground</b>	Store calibration for ground at gains of 1 and 32.	Yes (4)		Input 1603 [1] 1608 [2] 1613 [3] w	Active: Always.
<b>Lead</b>	Store calibration for lead resistance.	Yes (5)		Input 1603 [1] 1608 [2] 1613 [3] w	Active: Always.
<b>15.0 Ohms*</b>	Store 15.00Ω calibration for the 100Ω RTD input.	Yes (6)		Input 1603 [1] 1608 [2] 1613 [3] w	Active: Always.
<b>240.0 Ohms*</b>	Store 240.00Ω calibration for the 500Ω or 1kΩ RTD input.	Yes (6)		Input 1603 [1] 1608 [2] 1613 [3] w	Active: Always.
<b>380.0 Ohms*</b>	Store 380.00Ω calibration for the 100Ω RTD input.	Yes (7)		Input 1603 [1] 1608 [2] 1613 [3] w	Active: Always.
<b>6080.0 Ohms*</b>	Store 6080.00Ω calibration for the 500Ω or 1kΩ RTD input.	Yes (7)		Input 1603 [1] 1608 [2] 1613 [3] w	Active: Always.
<b>0.000V</b>	Store 0.000V calibration for the process input.	Yes (8)		Input 1603 [1] 1608 [2] 1613 [3] w	Active: Always.
<b>10.000V</b>	Store 10.000V calibration for the process input.	Yes (9)		Input 1603 [1] 1608 [2] 1613 [3] w	Active: Always.

\*The tenth character of your model number determines what prompts appear and what input resistance values to use for the RTD calibration.

F4\_ \_ \_ \_ \_ (1 to 4)RG: 15.00 and 380.00Ω

F4\_ \_ \_ \_ \_ (5 to 8)RG: 240.00 and 6080.00Ω

✓NOTE:

For more information about how parameter settings affect the controller's operation, see Features Chapter.

## Factory Page Parameter Table

Parameter	Description	Range (Modbus Value)	Default	Modbus Register read/write [I/O, Set, Ch]	Conditions for Parameters to Appear
<b>Calibrate Input x (1 to 3)</b>					
Main Page > Factory > Calibration > Calibrate Input x (1 to 3)					
<b>4.000mA</b>	Store 4mA calibration for the process input.	Yes (10)		Input 1603 [1] 1608 [2] 1613 [3] w	Active: Always.
<b>20.000mA</b>	Store 20mA calibration for the process input.	Yes (11)		Input 1603 [1] 1608 [2] 1613 [3] w	Active: Always.
<b>Calibrate Output x (1A, 1B, 2A, 2B ) and Retransmit x (1 and 2)</b>					
Main > Factory > Calibration / Calibrate Output x (1A, 1B, 2A, 2B) and Retransmit x (1 and 2)					
<b>4.000mA</b>	Store 4mA calibration for the process output.	0.000mA to 6.000mA (0 to 6000)	4.000mA (4000)	Output 1604 [1A] 1609 [1B] 1614 [2A] 1619 [2B] Retxmit 1624 [1] 1629 [2] w	Active: Always.
<b>20.000mA</b>	Store 20mA calibration for the process output.	0.000 to 24.000mA (0 to 24000)	20.000mA (20000)	Output 1605 [1A] 1610 [1B] 1615 [2A] 1620 [2B] Retxmit 1625 [1] 1630 [2] w	Active: Always.
<b>1.000V</b>	Store 1.000V calibration for the process output.	0.000 to 3.000V (0 to 3000)	1.000V (1000)	Output 1606 [1A] 1611 [1B] 1616 [2A] 1621 [2B] Retxmit 1626 [1] 1631 [2] w	Active: Always.
<b>10.000V</b>	Store 10.000V calibration for the process output.	0.000 to 12.000V (0 to 12000)	10.000V (10000)	Output 1607 [1A] 1612 [1B] 1617 [2A] 1622 [2B] Retxmit 1627 [1] 1632 [2] w	Active: Always.
<b>Restore Input x (1 to 3) Calibration</b>					
Main > Factory > Calibration / Restore Input x (1 to 3) Calibration					
<b>Restore Input x (1 to 3) Calibration</b>	Restores original factory calibration values.	Modbus: Input 1 (0) Input 2 (1) Input 3 (2)		1601 w	

✓ **NOTE:**

Press the Information Key **i** for more task-related tips.

# 10

## Chapter Ten: Diagnostics

### Overview

Diagnostic Menu parameters (on the Factory Page) provide information about the controller unit that is useful in troubleshooting. For example, the Model parameter will identify the 12-digit Series F4 part number. The Out1A parameter will identify what type of output has been selected for Output 1A.

Select the parameter by pressing the Right Key **➤**. The information will appear on the Lower Display.

Some of the parameters in the Diagnostic Menu provide information for factory use only.

To reset all parameters to their original factory values, use the Full Defaults parameter under the Test Menu.

### Diagnostic Menu Map

Model  
Mfg Date  
Serial #  
Software #  
Revision  
In1  
In2  
In3  
Out1A  
Out1B  
Out2A  
Out2B  
Retrans1  
Retrans2  
In1 AtoD  
In2 AtoD  
In3 AtoD  
CJC1 AtoD  
CJC2 AtoD  
CJC1 Temp  
CJC2 Temp  
Line Freq

✓ **NOTE:**

To see how all the pages, menus and parameters are grouped, refer to the inside back cover of this manual.

### Test Menu Map

Test Outputs  
Display Test  
Full Defaults

✓ **NOTE:**

For more information about how parameter settings affect the controller's operation, see the Features Chapter.

## Diagnostic Menu Parameter Table (Factory Page)

Parameter	Description	Range (Modbus Value)	Default	Modbus Register read/write [I/O, Set, Ch]	Conditions for Parameters to Appear
<b>Diagnostic</b>					
Main > Factory > <b>Diagnostic</b>					
<b>Model</b>	Identifies the 12-digit Series F4 part number.	F4xx-xxxx-xxxx	F4xx-xxxx-xxxx	0 r	Active: Always.
<b>Mfg Date</b>	Identifies the manufacture date.	xxxx	0198	5 r	Active: Always.
<b>Serial Number</b>	Identifies the individual controller.	0 to 999999	0	1 r 2 r	Active: Always.
<b>Software Number</b>	Identifies the software ID number.	00 to 99 (0 to 99)	1	3 r	Active: Always.
<b>Software Revision</b>	Identifies the software revision.	0.00 to 9.99 (0 to 990)	2.01 (201)	4 r	Active: Always.
<b>In1</b>	Displays the input 1 type.	Univ. Single (7)		8 r	Active: Always.
<b>In2</b>	Displays the input 2 type.	Univ. Dual (8) None (0)		9 r	Active: Always.
<b>In3</b>	Displays the input 3 type.	Univ. Dual (8) None (0)		10 r	Active: Always.
<b>Out1A</b>	Displays the output 1A type.	DC (3) SSR (2) Process (4)		16 r	Active: Always.
<b>Out1B</b>	Displays the output 1B type.	DC (3) SSR (2) Process (4) None (0)		17 r	Active: Always.
<b>Out2A</b>	Displays the output 2A type.	DC (3) SSR (2) Process (4) None (0)		18 r	Active: Always.
<b>Out2B</b>	Displays the output 2B type.	DC (3) SSR (2) Process (4) None (0)		19 r	Active: Always.

✓ **NOTE:** Press the Information Key  for more task-related tips.

## Diagnostic Menu Parameter Table (Factory Page)

Parameter	Description	Range (Modbus Value)	Default	Modbus Register read/write [I/O, Set, Ch]	Conditions for Parameters to Appear
<b>Retrans1</b>	Displays the retransmit 1 option.	Process (4) None (0)		20 r	Active: Always.
<b>Retrans2</b>	Displays the retransmit 2 option.	Process (4) None (0)		21 r	Active: Always.
<b>In1 AtoD</b>	Factory use only.	HHHH		1504 r	Active: Always.
<b>In2 AtoD</b>	Factory use only.	HHHH		1505 r	Active: Always.
<b>In3 AtoD</b>	Factory use only.	HHHH		1506 r	Active: Always.
<b>CJC1 AtoD</b>	Factory use only.	HHHH		1501 r	Active: Always.
<b>CJC2 AtoD</b>	Factory use only.	HHHH		1532 r	Active: Always.
<b>CJC1 Temp</b>	Cold junction compensation for analog input 1. Reads the ambient temperature of the controller.	xx.x (xxx)		1500 r	Active: Always.
<b>CJC2 Temp</b>	Cold junction compensation for analog input 2. Reads the ambient temperature of the controller.	xx.x (xxx)		1531 r	Active: Always.
<b>Line Freq</b>	Display the ac line frequency in hertz.	xx (xx)		1515 r	Active: Always.

✓ **NOTE:** For more information about how parameter settings affect the controller's operation, see the Features Chapter.

## Diagnostic Menu Parameter Table (Factory Page)

Parameter	Description	Range (Modbus Value)	Default	Modbus Register read/write [I/O, Set, Ch]	Conditions for Parameters to Appear
<b>Test</b>					
Main > Factory > <b>Test</b>					
<b>Test Outputs</b>		All Off (0)		1514 w	Active: Always.
Choose output to test.		Output 1A (1)			
		Output 1B (2)			
		Output 2A (3)			
		Output 2B (4)			
		Retransmit 1 (5)			
		Retransmit 2 (6)			
		Alarm 1 (7)			
		Alarm 2 (8)			
		Digital Out 1 (9)			
		Digital Out 2 (10)			
		Digital Out 3 (11)			
		Digital Out 4 (12)			
		Digital Out 5 (13)			
		Digital Out 6 (14)			
		Digital Out 7 (15)			
		Digital Out 8 (16)			
		All On (17)			
		Communications (18)			
<b>Display Test</b>		Yes (1)		1513 w	Active: Always.
Checks LED display segments by turning them on and off.					
<b>Full Defaults</b>		Default all values? Yes (800)		1602 w	Active: Always.
Causes all parameters and profile values to revert to their factory default settings.					

✓ *NOTE: For more information about how parameter settings affect the controller's operation, see the Features Chapter.*

# 11

## Chapter Eleven: Installation

### Dimensions

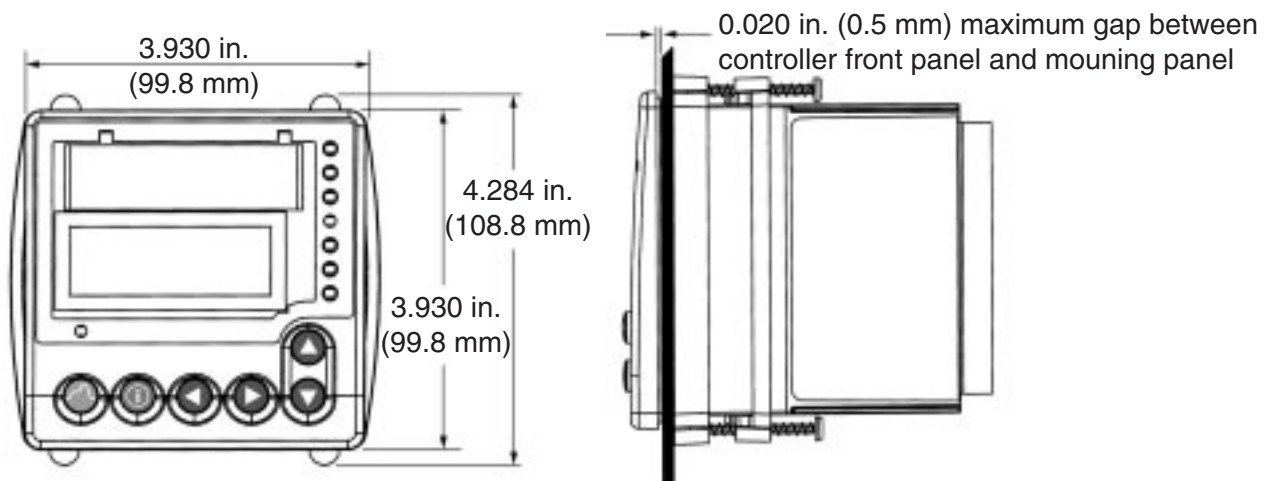

Figure 11.1a — Front View Dimensions and Gasket Gap Dimension.

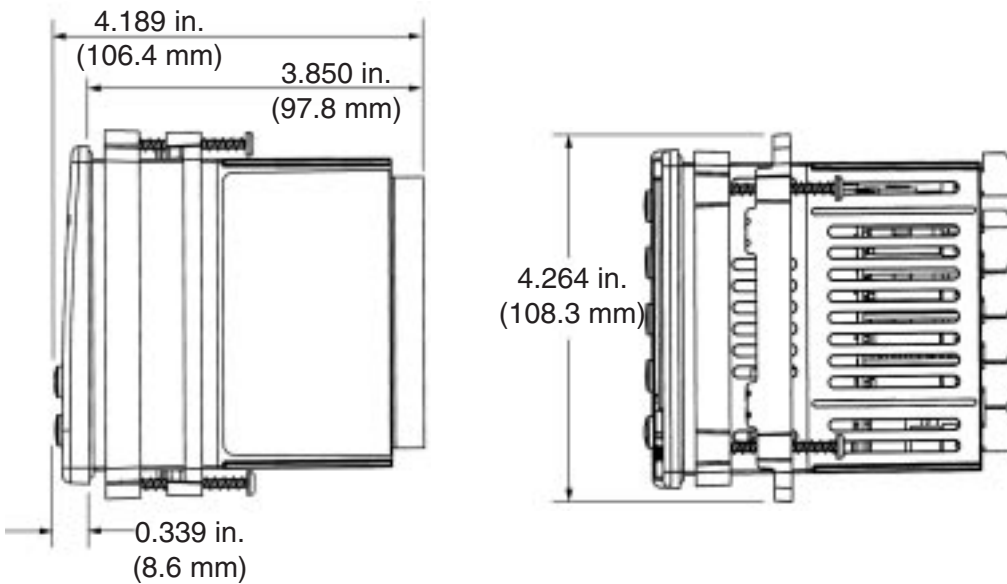

Figure 11.1b — Side and Top View and Dimensions.

## Panel Dimensions

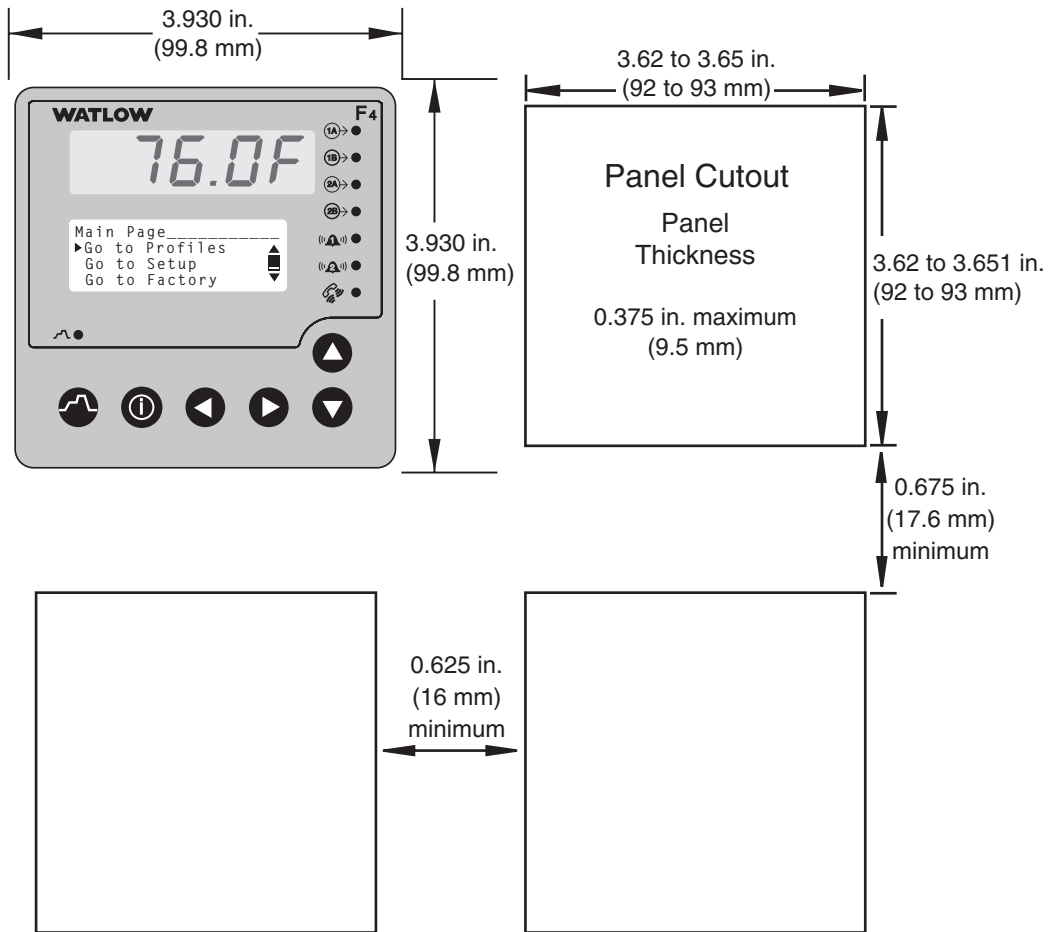

Figure 11.2a — Multiple Panel Cutout Dimensions.

## Installing the Series F4 Controller

Installing and mounting requires access to the back of the panel.

Tools required: one #2 Phillips screwdriver.

1. Make the panel cutout using the mounting template dimensions in this chapter.
2. Insert the controller into the panel cutout. Check that the rubber gasket lies in its slot at the back of the bezel. Slide the retention collar over the case, with open holes facing the back of the case.
3. Align the mounting bracket with the screws tips pointed toward the panel. Squeezing the bowed sides of the bracket, push it gently but firmly over the case until the hooks snap into the slots at the front of the case.



Figure 11.2b — Gasket Seated on the Bezel.



4. If the installation does not require a NEMA 4X seal, tighten the four screws with the Phillips screwdriver just enough to eliminate the spacing between the rubber gasket and the mounting panel.

For a NEMA 4X seal, tighten the four screws until the gap between the bezel and panel surface is .020 in. maximum. (See figure 11.1b). Make sure that you cannot move the controller back and forth in the cutout. If you can, you do not have a proper seal. **Do not over tighten.** Over tightening could damage the the mounting bracket.

---

### Removing the Series F4 Controller

The controller can be removed most easily by disengaging the mounting bracket hooks and pushing the controller forward through the panel. Be ready to support it as it slides forward through the panel.

Tools required: one #2 Phillips screwdriver, one flat-head screwdriver and some means of supporting the controller as it slides out the front of the panel.

1. Remove all the wiring connectors from the back of the controller. Using the Phillips screwdriver, unscrew the four screws on the mounting bracket (two on top, two on bottom) until the tips are completely retracted into the shafts.
2. Slide the tip of a flat screwdriver between the case and the center top side of the mounting bracket. Rotate the screwdriver 90 degrees, stretching the bracket away from the case so the hooks on the bracket disengage from the slots on the case. Hold the bracket and press the controller forward slightly to prevent the disengaged hooks from snapping back into the slots.
3. Repeat this operation to disengage the hooks on the bottom side of the mounting bracket.
4. Press with one or two fingers on the lower half of the back of the unit so that the controller slides forward through the panel. Hold the bracket steady; do not pull back. Be ready to support the controller as it comes through the front panel. Remove the mounting brackets and retention collar from the back side of the panel.

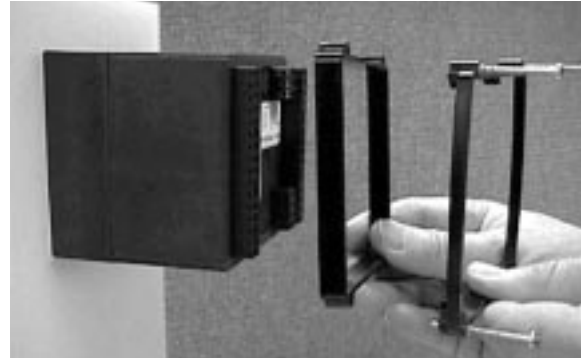

Figure 11.3a — Retention Collar and Mounting Bracket.

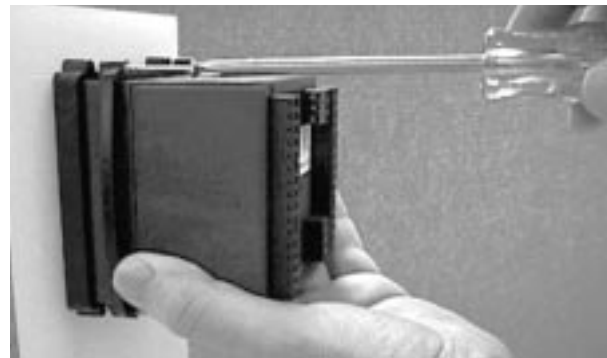

Figure 11.3b — Tightening the Screws.



Figure 11.3c — Disengaging the Mounting Bracket.

# Notes

## Chapter Twelve: Wiring

- Input-to-Output Isolation .....12.1
- Power Wiring .....12.2
- Sensor Installation Guidelines .....12.2
- Input 1 .....12.3
- Inputs x (2 and 3) .....12.4
- Digital Inputs x (1 to 4) .....12.6
- Outputs x (1A, 1B, 2A and 2B) .....12.7
- Retransmit and Alarm Output .....12.8
- Digital Outputs x (1 to 8) .....12.9
- Communications Wiring .....12.10
- Wiring Example .....12.12
- Wiring Notes .....12.13

### Wiring the Series F4

Wiring options depend on the model number, which is printed on the label on the back of the controller. The model number codes are explained in the Appendix.

The labels on the sides and back of the controller contain some basic wiring information.

#### Input-to-Output Isolation

The Series F4 uses optical and transformer isolation to provide a barrier to prevent ground loops when using grounded sensors and/or peripheral equipment.

Here is a breakdown of the isolation barriers:

- Analog input 1 and all the digital inputs and outputs are grouped together.
- Analog inputs 2 and 3 are grouped together.
- All the control outputs and retransmit outputs are grouped together.
- Both alarm outputs are grouped together.
- Communications is isolated from the other inputs and outputs.

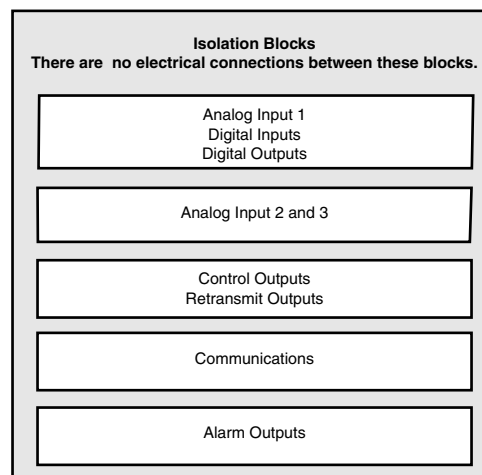

Figure 12.1 — Isolation Blocks.



**CAUTION:**

If high voltage is applied to a low-voltage unit, irreversible damage will occur.



**WARNING:**

Provide a labeled switch or circuit breaker connected to the Series F4 power wiring as the means of disconnection for servicing. Failure to do so could result in damage to equipment and/or property, and/or injury or death to personnel.



**WARNING:**

To avoid damage to property and equipment, and/or injury or loss of life, use National Electric Code (NEC) standard wiring practices to install and operate the Series F4. Failure to do so could result in such damage, and/or injury or death.



**CAUTION:**

Maintain isolation between analog inputs 2 and 3, and between analog input 1 and digital inputs 1 to 4 to prevent a ground loop. A ground loop may cause incorrect readings. Failure to follow this guideline could result in damage to equipment and product.

# Power Wiring

Use only number 14, AWG copper conductor rated for at least 60°C.

100 to 240V≈ (ac/dc), nominal (85 to 264 actual) F4 \_ H - \_ \_ \_ \_ - \_ \_ \_ \_

24 to 28V≈ (ac/dc), nominal (21 to 30 actual) F4 \_ L - \_ \_ \_ \_ - \_ \_ \_ \_

The Series F4 has a non-operator-replaceable fuse Type T (time-lag) rated at 2.0 or 5.0A @ 250V.

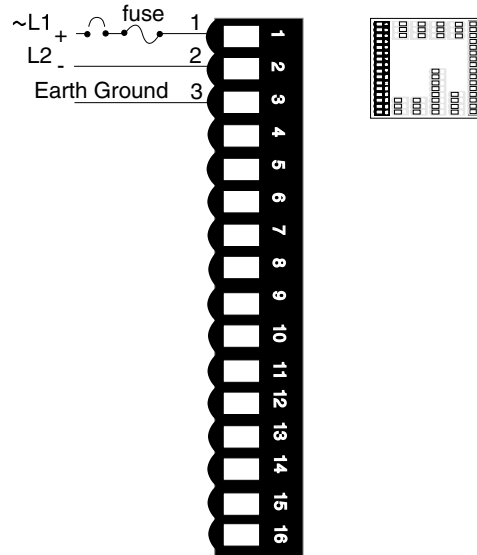

Figure 12.2 — Power wiring.

# Sensor Installation Guidelines

**Thermocouple inputs:** Extension wire for thermocouples must be of the same alloy as the thermocouple to limit errors.

If a grounded thermocouple is required for input 2, the signal to input 3 must be isolated to prevent possible ground loops.

**RTD input:** Each 1Ω of lead wire resistance can cause a +2°F error when using a two-wire RTD. A three-wire RTD sensor overcomes this problem. All three wires must have the same electrical resistance (i.e., same gauge, same length, multi-stranded or solid, same metal).

**Process input:** Isolation must be maintained between input 2 and input 3. If both input 2 and input 3 are process signals, a separate power supply and transmitter must be used for each input. These inputs must be electrically isolated from one another to prevent ground loops.

# Input 1



**WARNING:**

To avoid damage to property and equipment, and/or injury of loss of life, use National Electric Code (NEC) standard wiring practices to install and operate the Series F4. Failure to do so could result in such damage, and/or injury or death.



**CAUTION:** Maintain isolation between analog inputs 2 and 3, and between analog input 1 and digital inputs 1 to 4 to prevent a ground loop. A ground loop may cause incorrect readings. Failure to follow this guideline could result in damage to equipment and product.

Figure 12.3a — **Thermocouple**

Available on all units  
Impedance: 20MΩ

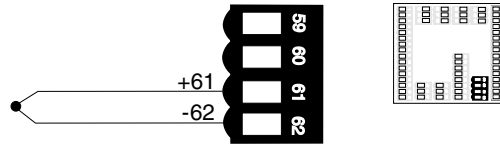

Figure 12.3b — **RTD (2- or 3-Wire) 100Ω Platinum**

Available on all units

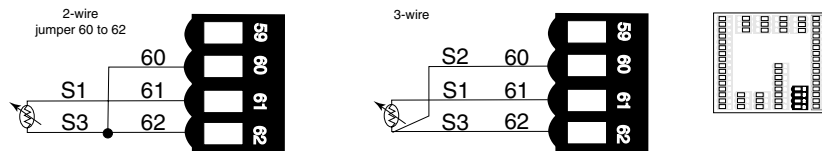

Figure 12.3c — **0-5V<sub>DC</sub>, 1-5V<sub>DC</sub> or 0-10V<sub>DC</sub> (dc) Process**

Available on all units.  
Input impedance: 20kΩ

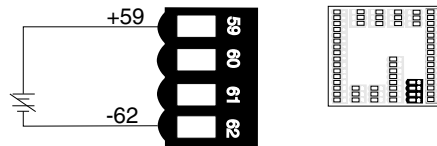

Figure 12.3d — **0-20mA or 4-20mA Process**

Available on all units.  
Input impedance: 100Ω

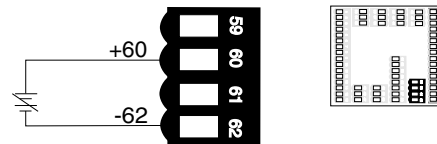
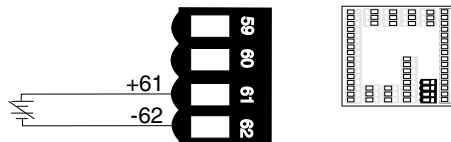

Figure 12.3e — **0 to 50mV**

Available on all units  
Impedance: 20MΩ



# Inputs x (2 and 3)



## WARNING:

To avoid damage to property and equipment, and/or injury of loss of life, use National Electric Code (NEC) standard wiring practices to install and operate the Series F4. Failure to do so could result in such damage, and/or injury or death.



## CAUTION:

Maintain isolation between analog inputs 2 and 3, and between analog input 1 and digital inputs 1 to 4 to prevent a ground loop. A ground loop may cause incorrect readings. Failure to follow this guideline could result in damage to equipment and product.

Figure 12.4a — Thermocouple

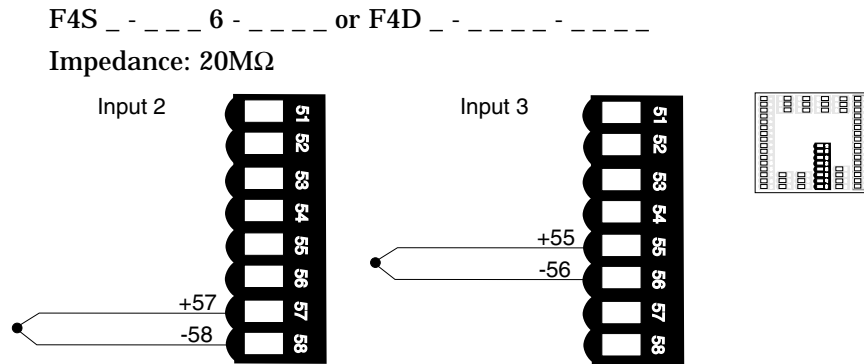

Figure 12.4b — RTD (2-wire) 100Ω Platinum

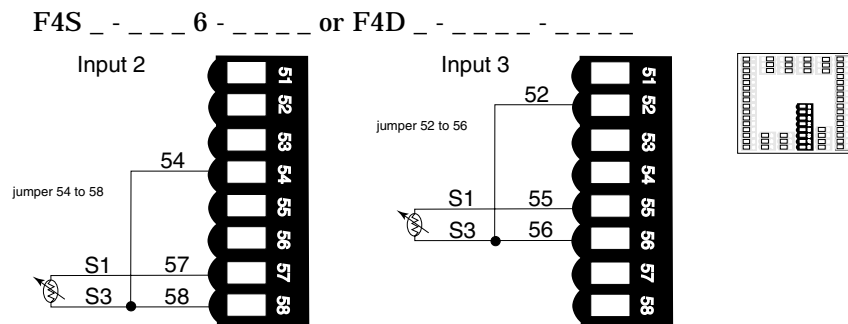
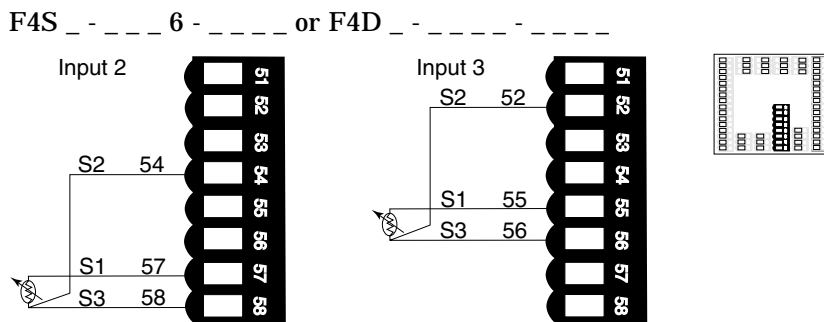

Figure 12.4c — RTD (3-wire) 100Ω Platinum



# Inputs x (2 and 3) (continued)



**WARNING:**

To avoid damage to property and equipment, and/or injury or loss of life, use National Electric Code (NEC) standard wiring practices to install and operate the Series F4. Failure to do so could result in such damage, and/or injury or death.

Figure 12.5a — 0 to 5V<sub>rms</sub>, 1 to 5V<sub>rms</sub> or 0 to 10V<sub>rms</sub> (dc) Process

F4S \_ \_ \_ \_ 6 - \_ \_ \_ \_ or F4D \_ \_ \_ \_ \_ \_ \_ \_

Input impedance: 20kΩ

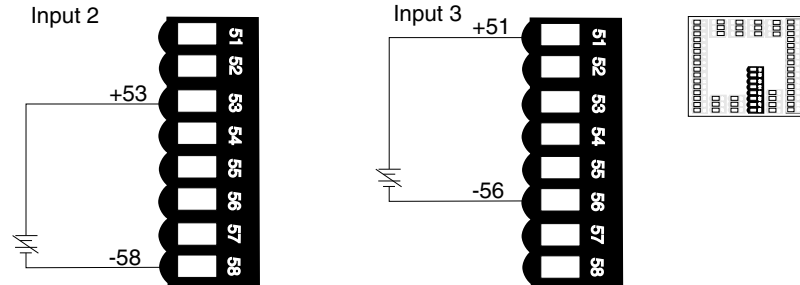

**CAUTION:**

Maintain isolation between analog inputs 2 and 3, and between analog input 1 and digital inputs 1 to 4 to prevent a ground loop. A ground loop may cause incorrect readings. Failure to follow this guideline could result in damage to equipment and product.

Figure 12.5b — 0 to 20mA or 4 to 20mA Process

F4S \_ \_ \_ \_ 6 - \_ \_ \_ \_ or F4D \_ \_ \_ \_ \_ \_ \_ \_

Input impedance: 100Ω

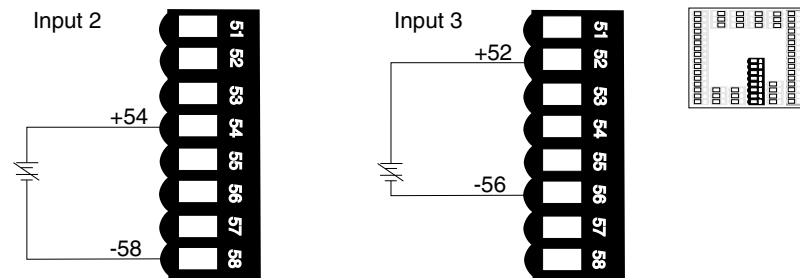
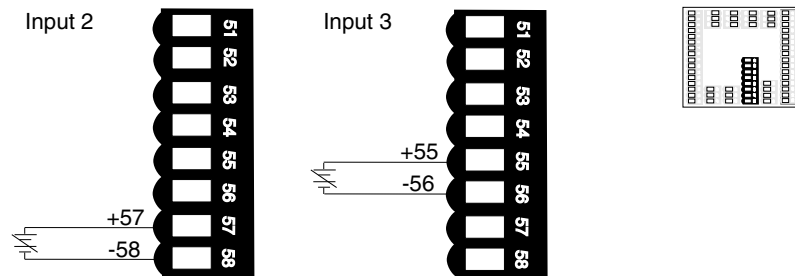

Figure 12.5c — 0 to 50mV

F4S \_ \_ \_ \_ 6 - \_ \_ \_ \_ or F4D \_ \_ \_ \_ \_ \_ \_ \_

Impedance: 20MΩ



# Digital Inputs x (1 to 4)



**WARNING:**

To avoid damage to property and equipment, and/or injury or loss of life, use National Electric Code (NEC) standard wiring practices to install and operate the Series F4. Failure to do so could result in such damage, and/or injury or death.



**CAUTION:**

Maintain isolation between analog inputs 2 and 3, and between analog input 1 and digital inputs 1 to 4 to prevent a ground loop. A ground loop may cause incorrect readings. Failure to follow this guideline could result in damage to equipment and product.

Figure 12.6 — Digital Inputs x (1 to 4)

**Voltage input**

0 to 2V<sub>DC</sub> (dc) Event Input Low State

3 to 36V<sub>DC</sub> (dc) Event Input High State

**Contact closure**

0 to 2kΩ Event Input Low State

> 23kΩ Event Input High State

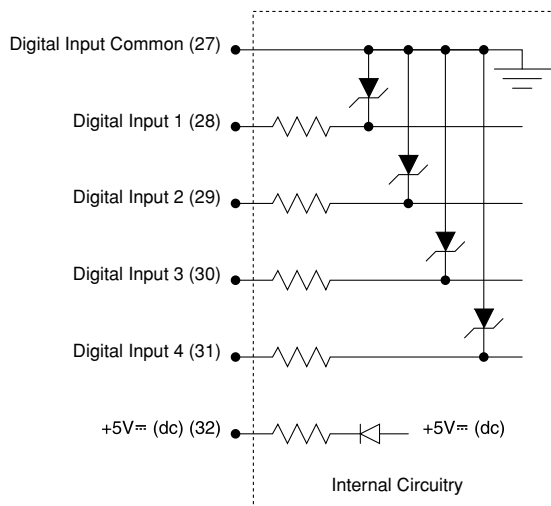
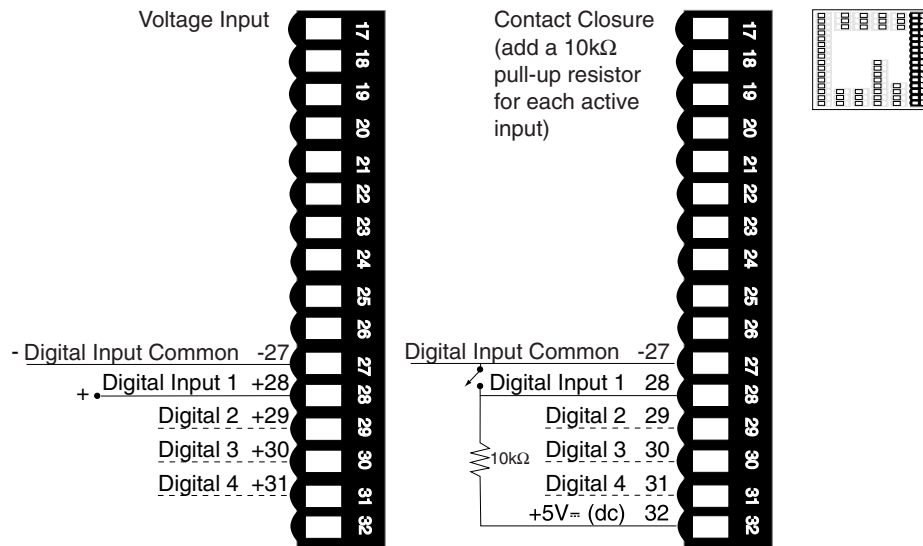



# Outputs x (1A, 1B, 2A and 2B)

**NOTE:**

Switching inductive loads (relay coils, solenoids, etc.) with the mechanical relay, switched dc or solid-state relay output options requires use of an R.C. suppressor.

Watlow carries the R.C. suppressor Quencharc brand name, which is a trademark of ITW Paktron. Watlow Part No. 0804-0147-0000.



**WARNING:**

To avoid damage to property and equipment, and/or injury or loss of life, use National Electric Code (NEC) standard wiring practices to install and operate the Series F4. Failure to do so could result in such damage, and/or injury or death.

Figure 12.7a — **Solid-state Relay**

24V~ (ac) minimum, 253V~ (ac) maximum  
0.5 amps, off-state impedance 31MΩ

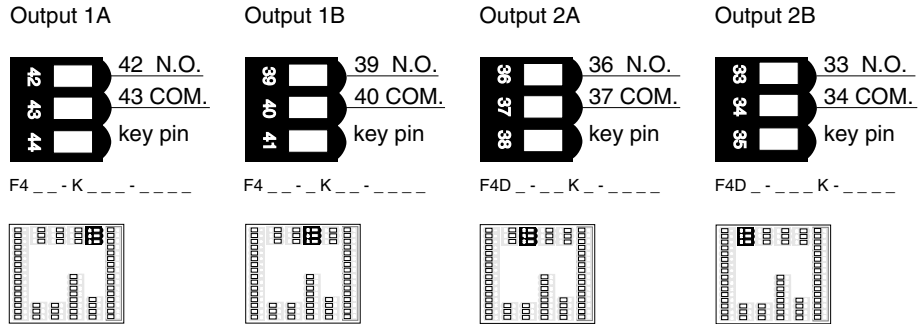

Figure 12.7b — **Switched DC, Open Collector**

- Switched dc configuration  
COM not used  
DC+ = 22 to 28V $\approx$  (dc)  
Maximum supply current is 30mA
- Open collector output  
DC+ not used  
DC- = 42V $\approx$  (dc) maximum  
Off: 10mA maximum leakage  
On: 0.2V @ 0.5 amps sink

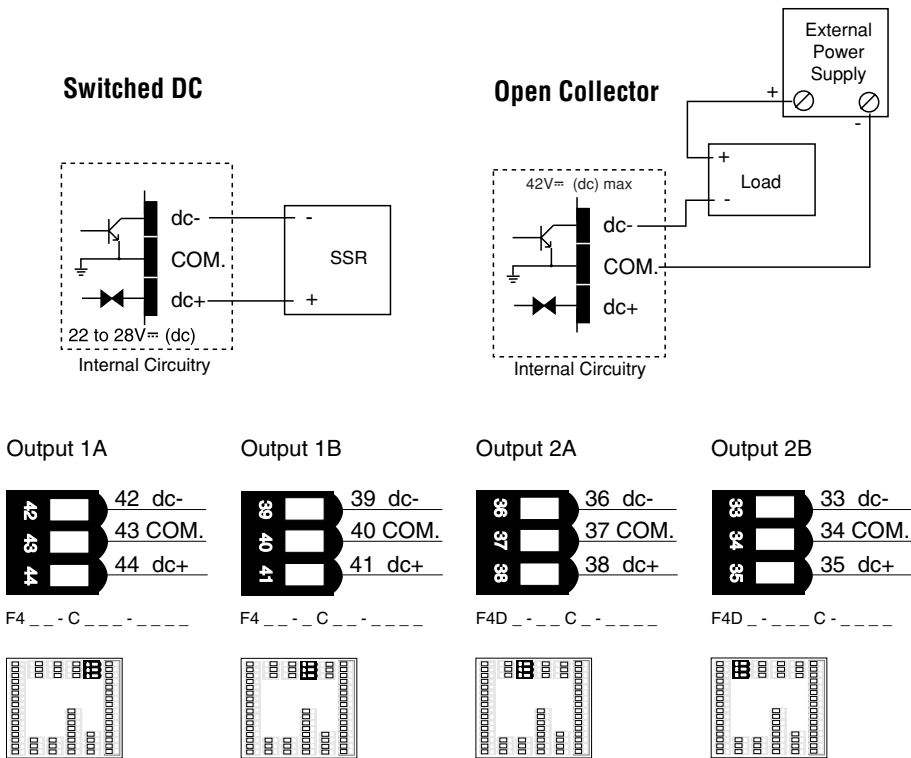
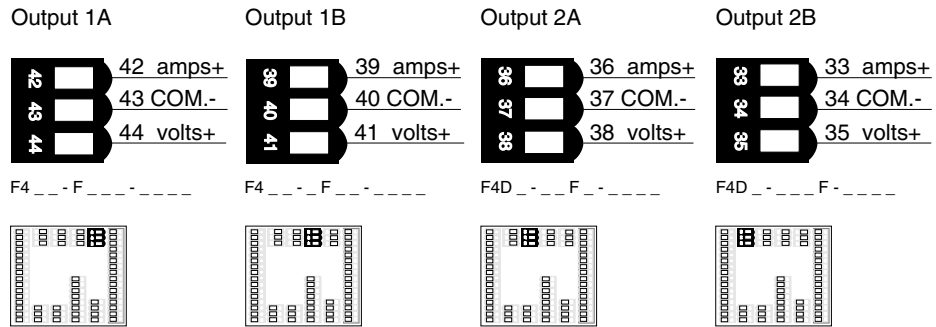

Figure 12.8a — 0 to 20mA, 4 to 20mA, 0 to 5V<sub>DC</sub>, 1 to 5V<sub>DC</sub> and 0 to 10V<sub>DC</sub> Process

**NOTE:**

Switching inductive loads (relay coils, solenoids, etc.) with the mechanical relay, switched dc or solid-state relay output options requires use of an R.C. suppressor.

Watlow carries the R.C. suppressor Quencharc brand name, which is a trademark of ITW Paktron. Watlow Part No. 0804-0147-0000.



## Retransmit and Alarm Output

Figure 12.8b — Retransmit Outputs x (1 and 2)

mA maximum load impedance: 800Ω  
volts (dc) minimum load impedance: 1kΩ



**WARNING:**

To avoid damage to property and equipment, and/or injury or loss of life, use National Electric Code (NEC) standard wiring practices to install and operate the Series F4. Failure to do so could result in such damage, and/or injury or death.

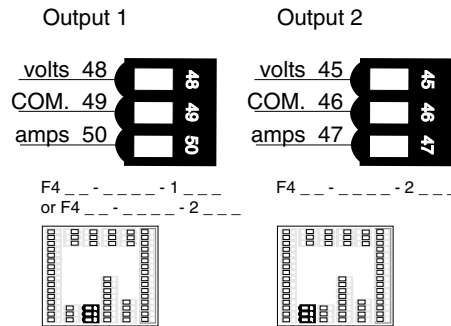
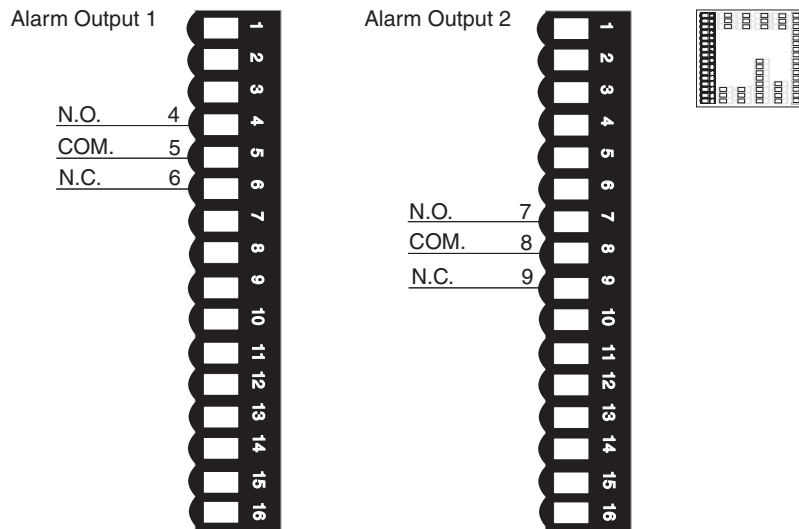

Figure 12.8c — Alarm Outputs x (1 and 2)



Electromechanical relay without contact suppression  
Form C, 2 amp, off-state impedance: 31MΩ

# Digital Outputs x (1 to 8)



**WARNING:**

To avoid damage to property and equipment, and/or injury of loss of life, use National Electric Code (NEC) standard wiring practices to install and operate the Series F4. Failure to do so could result in such damage, and/or injury or death.

Figure 12.9a — Digital Outputs x (1 to 8)

Digital output supply: +5V<sub>DC</sub> (dc) ±5%

Maximum source current: 80mA (total for all 8 switch dc)

Open collector:

Off (open): 42V<sub>DC</sub> (dc) maximum @ 10μA

On (closed): 0.2V<sub>DC</sub> (dc) maximum @ 50mA sink

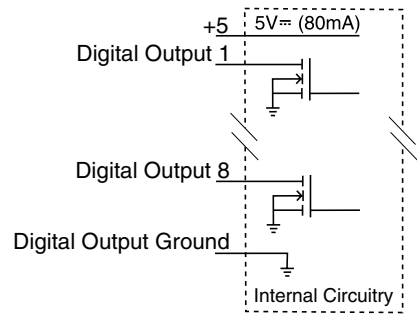
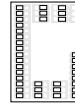
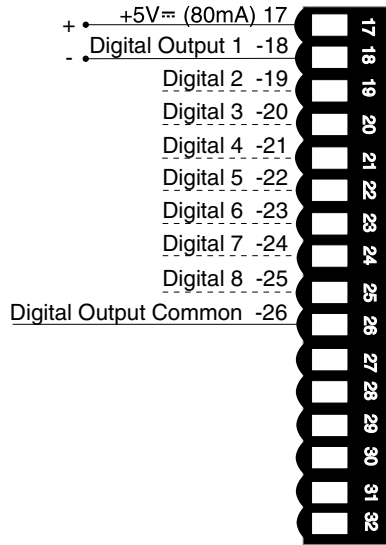

Figure 12.9b — Open Collector Example

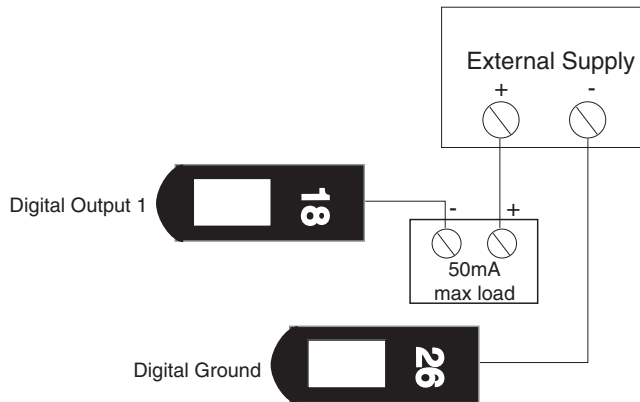

Figure 12.9c — Switched DC Example



# Communications Wiring



**WARNING:**

To avoid damage to property and equipment, and/or injury of loss of life, use National Electric Code (NEC) standard wiring practices to install and operate the Series F4. Failure to do so could result in such damage, and/or injury or death.

Figure 12.10a — EIA/TIA 485 and EIA/TIA 232 Communications

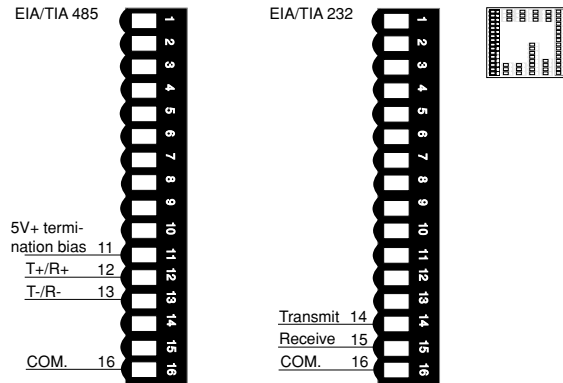
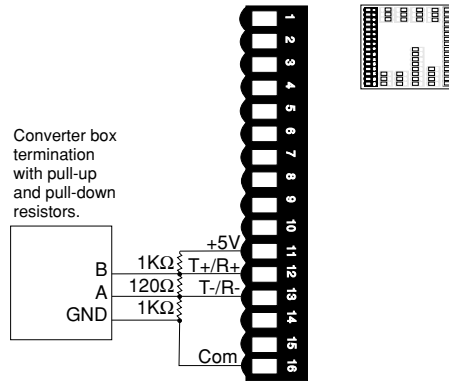
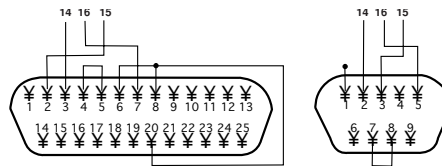

Figure 12.10b — Termination for EIA-232 to EIA-485 Converter



If the system does not work properly, it may need termination resistors at each end of the network. A typical installation would require a 120-ohm resistor across the transmit/receive terminals (12 and 13) of the last controller in the network and the converter box or serial card. Pull-up and pull-down 1k resistors may be needed on the first unit to maintain the correct voltage during the idle state.

Figure 12.10c — EIA/TIA-232 Connections



Wire Color	F4 232	DB 9 Connector	DB25 Connector
White	TX Pin 14	RX Pin 2	RX Pin 3
Red	RX Pin 15	TX Pin 3	TX Pin 2
Black	GND Pin 16	Gnd Pin 5	GND Pin 7
Green	GND Pin 24	N/U Pin 9	N/U Pin 22
Shield	N/C	Gnd Pin 5	Gnd Pin 7

# Communications Wiring (continued)



**WARNING:**

To avoid damage to property and equipment, and/or injury of loss of life, use National Electric Code (NEC) standard wiring practices to install and operate the Series F4. Failure to do so could result in such damage, and/or injury or death.

**NOTE:**

The CMC converter requires an external power supply when used with a laptop computer.

Figure 12.11a — EIA/TIA 232 to EIA/TIA 485 Conversion

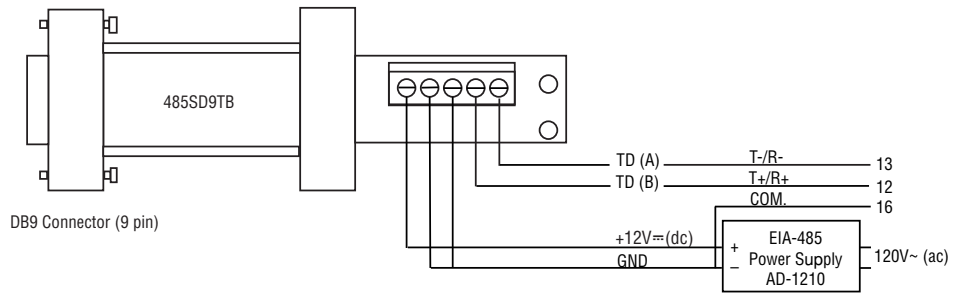

B&B Converter (B&B Electronics Manufacturing Company, (815) 433-5100, [www.bb-elec.com](http://www.bb-elec.com))

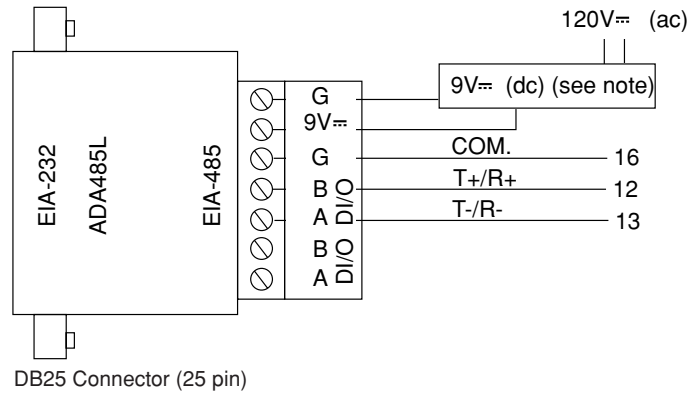

CMC Converter (CMC Connecticut Micro-Computer, Inc., 800-426-2872, [www.2cmc.com](http://www.2cmc.com))

Figure 12.11b — GPIB Conversion to EIA/TIA 232 or EIA/TIA 485 Communications with Modbus RTU

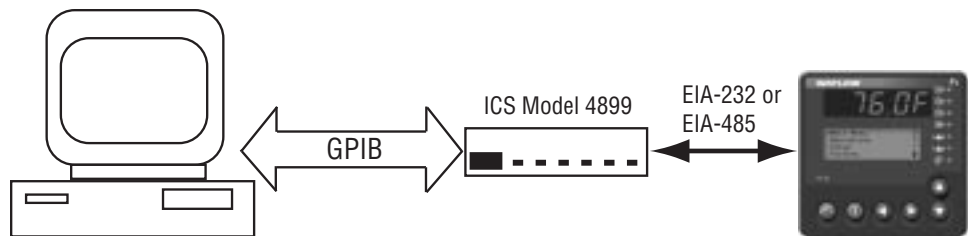

ICS GPIB Bus Interface (ICS Electronics, (925) 416-1000, [www.icselect.com](http://www.icselect.com))

# Wiring Example



**WARNING:**

To avoid damage to property and equipment, and/or injury or loss of life, use National Electric Code (NEC) standard wiring practices to install and operate the Series F4. Failure to do so could result in such damage, and/or injury or death.

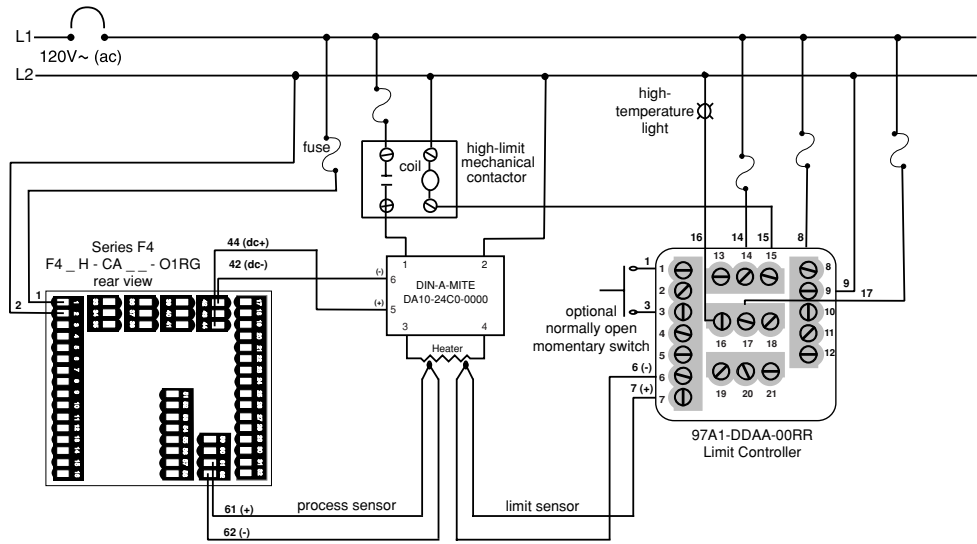

**WARNING:**

Install high- or low-temperature-limit control protection in systems where an over-temperature fault condition could present a fire hazard or other hazard. Failure to install temperature limit control protection where a potential hazard exists could result in damage to equipment, property and injury to personnel.

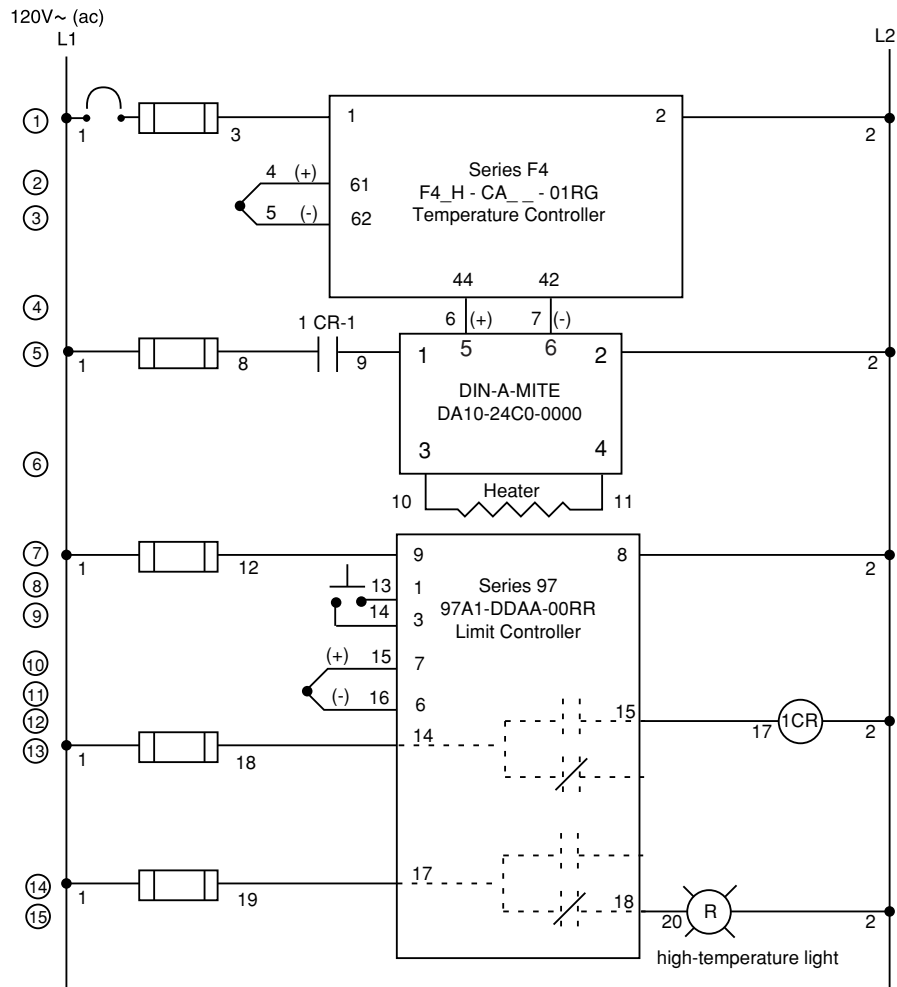

Figure 12.12 — System Wiring Example.

# A

---

## Appendix

---

Glossary .....	A.2
Declaration of Conformity .....	A.5
Specifications (Single and Dual Channel) .....	A.6
Ordering Information (Single and Dual) .....	A.7
Index .....	A.8
List of Figures .....	A.13
Software Map .....	A.16

# Glossary

**ac** (~) — See alternating current.

**ac/dc** (≈) — Both direct and alternating current.

**alternating current** — An electric current that reverses at regular intervals, and alternates positive and negative values.

**American Wire Gauge (AWG)** — A standard of the dimensional characteristics of wire used to conduct electrical current or signals. AWG is identical to the Brown and Sharpe (B & S) wire gauge.

**auto-tune** — A feature that automatically sets temperature control PID values to match a particular thermal system.

**battery** — BR1225, retains volatile memory. Seven-year shelf life, indefinite life with power applied to unit.

**baud rate** — The rate of information transfer in serial communications, measured in bits per second.

**burst fire** — A power control method that repeatedly turns on and off full ac cycles. Also called zero-cross fire, it switches close to the zero-voltage point of the ac sine wave. Variable-time-base burst fire selectively holds or transits ac cycles to achieve the desired power level. See zero cross.

**calibration accuracy** — Closeness between the value indicated by a measuring instrument and a physical constant or known standard.

**calibration offset** — An adjustment to eliminate the difference between the indicated value and the actual process value.

**cascade** — Control algorithm in which the output of one control loop provides the set point for another loop. The second loop, in turn, determines the control action.

**CE** — A manufacturer's mark that demonstrates compliance with European Union (EU) laws governing products sold in Europe.

**chatter** — The rapid on-off cycling of an electromechanical relay or mercury displacement relay due to insufficient controller bandwidth. It is commonly caused by excessive gain, little hysteresis and short cycle time.

**CJC** — See cold junction compensation.

**closed loop** — A control system that uses a sensor to measure a process variable and makes decisions based on that feedback.

**cold junction** — See junction, cold.

**cold junction compensation** — Electronic means to compensate for the effective temperature at the

cold junction.

**control mode** — The type of action that a controller uses. For example, on/off, time proportioning, PID, automatic or manual, and combinations of these.

**cycle time** — The time required for a controller to complete one on-off-on cycle. It is usually expressed in seconds.

**deadband** — The range through which a variation of the input produces no noticeable change in the output. In the dead band, specific conditions can be placed on control output actions. Operators select the deadband value.

**default parameters** — The programmed instructions that are permanently stored in the microprocessor software.

**derivative** — The rate of change in a process variable. Also known as rate. See PID.

**derivative control (D)** — The last term in the PID control algorithm. Action that anticipates the rate of change of the process, and compensates to minimize overshoot and undershoot. Derivative control is an instantaneous change of the control output in the same direction as the proportional error. This is caused by a change in the process variable (PV) that decreases over the time of the derivative (TD). The TD is in units of seconds.

**Deutsche Industrial Norm (DIN)** — A set of technical, scientific and dimensional standards developed in Germany. Many DIN standards have worldwide recognition.

**droop** — In proportional controllers, the difference between set point and actual value after the system stabilizes.

**duty cycle** — The percentage of a cycle time in which the output is on.

**EIA** — See Electronics Industries of America.

**EIA/TIA -232, -422, -423 and -485** — Data communications standards set by the Electronic Industries of America and Telecommunications Industry Association. Formerly referred to as RS- (Recognized Standard).

**Electronics Industries of America (EIA)** — An association in the US that establishes standards for electronics and data communications.

**external transmitter power supply** — A dc voltage source that powers external devices.

**filter, digital** — A means to slow the response of a system when inputs change unrealistically or too fast. Equivalent to a standard resistor-capacitor (RC) filter.



**form A** — A single-pole, single-throw relay that uses only the normally open (NO) and common contacts. These contacts close when the relay coil is energized. They open when power is removed from the coil.

**form B** — A single-pole, single-throw relay that uses only the normally closed (NC) and common contacts. These contacts open when the relay coil is energized. They close when power is removed from the coil.

**form C** — A single-pole, double-throw relay that uses the normally open (NO), normally closed (NC) and common contacts. The operator can choose to wire for a form A or form B contact.

**Hertz (Hz)** — Frequency, measured in cycles per second.

**hysteresis** — A change in the process variable required to re-energize the control or alarm output. Sometimes called switching differential.

**integral** — Control action that automatically eliminates offset, or droop, between set point and actual process temperature.

**integral control (I)** — A form of temperature control. The I of PID. See integral.

**isolation** — Electrical separation of sensor from high voltage circuitry. Allows use of grounded or ungrounded sensing element.

**JIS** — See Joint Industrial Standards.

**Joint Industrial Standards (JIS)** — A Japanese agency that establishes and maintains standards for equipment and components. Also known as JISC (Japanese Industrial Standards Committee), its function is similar to Germany's Deutsche Industrial Norm (DIN).

**junction, cold** — Connection point between thermocouple metals and the electronic instrument. See junction, reference.

**junction, reference** — The junction in a thermocouple circuit held at a stable, known temperature (cold junction). Standard reference temperature is 32°F (0°C).

**LCD** — See liquid crystal display.

**LED** — See light emitting diode.

**light emitting diode (LED)** — A solid state electronic device that glows when electric current passes through it.

**liquid crystal display (LCD)** — A type of digital display made of a material that changes reflectance or transmittance when an electrical field is applied to it.

**limit or limit controller** — A highly reliable, discrete safety device (redundant to the primary controller) that monitors and limits the temperature of the process, or a point in the process. When temperature exceeds or falls below the limit set point, the limit controller interrupts power through the load circuit. A limit controller can protect equipment and people when it is correctly installed with its own power supply, power lines, switch and sensor.

**manual mode** — A selectable mode that has no automatic control aspects. The operator sets output levels.

**Modbus™** — A digital communications protocol owned by AEG Schneider Automation for industrial computer networks.

**Modbus™ RTU** — Remote Terminal Unit, an individual Modbus™-capable device on a network.

**NEMA 4X** — A NEMA (National Electrical Manufacturer's Association) specification for determining resistance to moisture infiltration. This rating certifies the controller as washable and corrosion resistant.

**on/off controller** — A temperature controller that operates in either full on or full off modes.

**open loop** — A control system with no sensory feedback.

**output** — Control signal action in response to the difference between set point and process variable.

**overshoot** — The amount by which a process variable exceeds the set point before it stabilizes.

**page** — A fixed length block of data that can be stored as a complete unit in the computer memory.

**P control** — Proportioning control.

**PD control** — Proportioning control with derivative (rate) action.

**PDR control** — Proportional derivative control with manual reset, used in fast responding systems where the reset causes instabilities. With PDR control, an operator can enter a manual reset value that eliminates droop in the system.

**PI control** — Proportioning control with integral (auto-reset) action.

**PID** — Proportional, integral, derivative. A control mode with three functions: proportional action dampens the system response, integral corrects for droop, and derivative prevents overshoot and undershoot.

**process variable** — The parameter that is controlled or measured. Typical examples are temperature, relative humidity, pressure, flow, fluid level,

events, etc. The high process variable is the highest value of the process range, expressed in engineering units. The low process variable is the lowest value of the process range.

**proportional** — Output effort proportional to the error from set point. For example, if the proportional band is 20° and the process is 10° below set point, the heat proportioned effort is 50 percent. The lower the PB value, the higher the gain.

**proportional band (PB)** — A range in which the proportioning function of the control is active. Expressed in units, degrees or percent of span. See PID.

**proportional control** — A control using only the P (proportional) value of PID control.

**radio frequency interference (RFI)** — Electromagnetic waves between the frequencies of 10 KHz and 300 GHz that can affect susceptible systems by conduction through sensor or power input lines, and by radiation through space.

**ramp** — A programmed increase in the temperature of a set point system.

**range** — The area between two limits in which a quantity or value is measured. It is usually described in terms of lower and upper limits.

**rate** — Anticipatory action that is based on the rate of temperature change, and compensates to minimize overshoot and undershoot. See derivative.

**rate band** — A range in which the rate function of a controller is active. Expressed in multiples of the proportional band. See PID.

**reference junction** — see junction, reference.

**reset** — Control action that automatically eliminates offset, or droop, between set point and actual process temperature. Also see integral.

**automatic reset** — The integral function of a PI or PID temperature controller that adjusts the process temperature to the set point after the system stabilizes. The inverse of integral.

**automatic power reset** — A feature in latching limit controls that does not recognize power outage as a limit condition. When power is restored, the output is re-energized automatically, as long as the temperature is within limits.

**manual reset** — 1) A feature on a limit control that requires human intervention to return the limit to normal operation after a limit condition has occurred. 2) The adjustment of a proportional control to raise the proportional band to compensate for droop.

**resistance temperature detector (RTD)** — A sensor that uses the resistance temperature charac-

teristic to measure temperature. There are two basic types of RTDs: the wire RTD, which is usually made of platinum, and the thermistor, which is made of a semiconductor material. The wire RTD is a positive temperature coefficient sensor only, while the thermistor can have either a negative or positive temperature coefficient.

**RFI** — See radio frequency interference.

**RTD** — See resistance temperature detector.

**serial communications** — A method of transmitting information between devices by sending all bits serially over a single communication channel.

**set point** — The desired value programmed into a controller. For example, the temperature at which a system is to be maintained.

**SI (Système Internationale)** — The system of standard metric units.

**switching differential** — See hysteresis.

**thermal system** — A regulated environment that consists of a heat source, heat transfer medium or load, sensing device and a control instrument.

**thermocouple (t/c)** — A temperature sensing device made by joining two dissimilar metals. This junction produces an electrical voltage in proportion to the difference in temperature between the hot junction (sensing junction) and the lead wire connection to the instrument (cold junction).

**thermocouple break protection** — The ability of a control to detect a break in the thermocouple circuit and take a predetermined action.

**time proportioning control** — A method of controlling power by varying the on/off duty cycle of an output. This variance is proportional to the difference between the set point and the actual process temperature.

**transmitter** — A device that transmits temperature data from either a thermocouple or a resistance temperature detector (RTD) by way of a two-wire loop. The loop has an external power supply. The transmitter acts as a variable resistor with respect to its input signal. Transmitters are desirable when long lead or extension wires produce unacceptable signal degradation.

**WatView** — A Windows-based software application for communicating with and configuring Watlow controllers.

**zero cross** — Action that provides output switching only at or near the zero-voltage crossing points of the ac sine wave. See burst fire.

**zero switching** — See zero cross.

# Declaration of Conformity

## Series F4

WATLOW Winona, Inc.  
1241 Bundy Boulevard  
Winona, Minnesota 55987 USA



Declares that the following product: **English**  
Designation: Series F4  
Model Number(s): F4(S, D or P)(H or L) – (C, E, F or K)(A, C, E, F or K)(A, C, F or K)(A, C, F, K, 0 or 6) – (0, 1 or 2) – (Any three letters or numbers)  
Classification: Temperature control, Installation Category II, Pollution degree 2  
Rated Voltage: 100 to 240 V~ (ac) or 24 to 28 V≈ (ac or dc)  
Rated Frequency: 50 or 60 Hz  
Rated Power Consumption: 39 VA maximum

Meets the essential requirements of the following European Union Directives by using the relevant standards show below to indicate compliance.

### 89/336/EEC Electromagnetic Compatibility Directive

EN 61326:1997 With A1:1998 – Electrical equipment for measurement, control and laboratory use – EMC requirements (Industrial Immunity, Class A Emissions).

EN 61000-4-2:1996 With A1, 1998 – Electrostatic Discharge Immunity  
EN 61000-4-3:1997 – Radiated Field Immunity  
EN 61000-4-4:1995 – Electrical Fast-Transient / Burst Immunity  
EN 61000-4-5:1995 With A1, 1996 – Surge Immunity  
EN 61000-4-6:1996 – Conducted Immunity  
EN 61000-4-11:1994 Voltage Dips, Short Interruptions and Voltage Variations Immunity  
EN 61000-3-2:1995 With A1-3:1999 – Harmonic Current Emissions  
EN 61000-3-3:1995 With A1:1998 – Voltage Fluctuations and Flicker

### 73/23/EEC Low-Voltage Directive

EN 61010-1:1993 With A1:1995 Safety Requirements of electrical equipment for measurement, control and laboratory use. Part 1: General requirements

déclare que le produit suivant: **Français**  
Désignation : Séries F4  
Numéros de modèles : F4(S, D ou P)(H ou L) – (C, E, F ou K)(A, C, E, F ou K)(A, C, F ou K)(A, C, F, K, 0 ou 6) – (0, 1 ou 2) – (N'importe quelle combinaison de trois lettres ou chiffres)  
Classification : Régulation de température, Catégorie d'installation II, Degré de pollution 2  
Tension nominale : 100 à 240 V~ (c.a) ou 24 à 28 V ≈ (c.a ou c.c)  
Fréquence nominale : 50 ou 60 Hz  
Consommation d'alimentation nominale : 39 VA maximum

Répond aux normes essentielles des directives suivantes de l'Union européenne en utilisant les standards normalisés ci-dessous qui expliquent les normes auxquelles répondre :

**Directive 89/336/CEE sur la compatibilité électromagnétique**  
EN 61326:1997 avec A1 :1998 – Matériel électrique destiné à l'étalonnage, au contrôle et à l'utilisation en laboratoire – Exigences CEM (Immunité industrielle, Émissions de catégorie A).

EN 61000-4-2:1996 Avec A1, 1998 – Immunité aux décharges électrostatiques  
EN 61000-4-3:1997 – Immunité aux champs de radiation  
EN 61000-4-4:1995 – Immunité contre les surtensions électriques rapides/ Rafale  
EN 61000-4-5:1995 avec A1, 1996 – Immunité contre les surtensions  
EN 61000-4-6:1996 – Immunité conduite  
EN 61000-4-11:1994 Immunité contre les écarts de tension, interruptions courtes et variations de tension  
EN 61000-3-2:1995 avec A1-3 :1999 – Emissions de courant harmoniques  
EN 61000-3-3:1995 avec A1 :1998 – Fluctuations et vacillements de tension

**Directive 73/23/CEE sur les basses tensions**  
EN 61010-1:1993 avec A1 :1995 Normes de sécurité du matériel électrique pour la mesure, le contrôle et l'utilisation en laboratoire. 1ère partie : Conditions générales

(2250)

Erklärt, dass das folgende Produkt: **Deutsch**  
Bezeichnung: Serie F4  
Modell-Nummern: F4(S, D oder P)(H or L) – (C, E, F oder K)(A, C, E, F oder K)(A, C, F or K)(A, C, F, K, 0 oder 6) – (0, 1 oder 2) – (Beliebige drei Ziffern oder Buchstaben)  
Klassifikation: Temperaturregler, Installationskategorie II, Verschmutzungsgrad 2  
Nennspannung: 100 bis 240 V~ (ac) oder 24 bis 28 V ≈ (ac oder dc)  
Nennfrequenz: 50 oder 60 Hz  
Nennstromverbrauch: Max. 39 VA

Erfüllt die wichtigsten Normen der folgenden Anweisung(en) der Europäischen Union unter Verwendung des wichtigsten Abschnitts bzw. der wichtigsten Abschnitte die unten zur Befolgung aufgezeigt werden.

**89/336/EEC Elektromagnetische Kompatibilitätsrichtlinie**  
EN 61326:1997 mit A1:1998 – Elektrisches Gerät für Messung, Kontrolle und Laborgebrauch – EMV-Anforderungen (Störfestigkeit Industriebereich, Klasse A Emissionen)

EN 61000-4-2:1996 mit A1, 1998 – Störfestigkeit gegen elektronische Entladung  
EN 61000-4-3:1997 – Störfestigkeit gegen Strahlungsfelder  
EN 61000-4-4:1995 – Störfestigkeit gegen schnelle Stöße/Burst  
EN 61000-4-5:1995 mit A1, 1996 – Störfestigkeit gegen Überspannung  
EN 61000-4-6:1996 – Geleitete Störfestigkeit  
EN 61000-4-11:1994 Störfestigkeit gegen Spannungsabfall, kurze Unterbrechungen und Spannungsschwankungen  
EN 61000-3-2:1995 mit A1-3:1999 – Harmonische Stromemissionen  
EN 61000-3-3:1995 mit A1:1998 – Spannungsfuktationen und Flimmern  
EN 61000-3-3: 1995 Grenzen der Spannungsschwankungen und Flimmern

### 73/23/EEC Niederspannungsrichtlinie

EN 61010-1:1993 mit A1:1995 Sicherheitsanforderungen für elektrische Geräte für Messungen, Kontrolle und Laborgebrauch. Teil 1: Allgemeine Anforderungen

Declara que el producto siguiente: **Español**  
Designación: Serie F4  
Números de modelo: F4(S, D o P)(H or L) – (C, E, F o K)(A, C, E, F o K)(A, C, F o K)(A, C, F, K, 0 o 6) – (0, 1 o 2) – (Cualesquiera tres letras o números)  
Clasificación: Control de temperatura, Categoría de instalación II, Grado de contaminación 2  
Tensión nominal: 100 a 240 V~ (CA) o 24 a 28 V ≈ (CA o CD)  
Frecuencia nominal: 50 o 60 Hz  
Consumo nominal de energía: 39 VA máximo

Cumple con los requisitos esenciales de las siguientes Directrices de la Unión Europea mediante el uso de las normas aplicables que se muestran a continuación para indicar su conformidad.

**89/336/EEC Directriz de compatibilidad electromagnética**  
EN 61326:1997 CON A1:1998.– Equipo eléctrico para medición, control y uso en laboratorio – Requisitos EMC (Inmunidad industrial, Emisiones Clase A).

EN 61000-4-2:1996 con A1, 1998 – Inmunidad a descarga electrostática  
EN 61000-4-3:1997 – Inmunidad a campo radiado  
EN 61000-4-4:1995 – Inmunidad a incremento repentino/rápidas fluctuaciones eléctricas transitorias  
EN 61000-4-5:1995 con A1, 1996 – Inmunidad a picos de voltaje o corriente  
EN 61000-4-6:1996 – Inmunidad por conducción  
EN 61000-4-11:1994 Inmunidad a caídas de voltaje, variaciones y pequeñas interrupciones de voltaje  
EN 61000-3-2:1995 con A1-3:1999 – Emisiones de corriente armónica  
EN 61000-3-3:1995 con A1:1998 – Fluctuaciones de voltaje y centelleo.

### 73/23/EEC Directriz de bajo voltaje

EN 61010-1:1993 con A1:1995 Requisitos de seguridad de equipo eléctrico para medición, control y uso en laboratorio. Parte 1: Requisitos generales

Jim Boigenzahn Winona, Minnesota, USA  
Name of Authorized Representative Place of Issue

General Manager September 2001  
Title of Authorized Representative Date of Issue

Signature of Authorized Representative

# Specifications

## Universal Analog Inputs 1 (2 and 3 optional)

- Update rates, In1: 20Hz; In2 and In3: 10Hz

### Thermocouple

- Type J, K, T, N, C (W5), E, PTII, D (W3), B, R, S

### RTD

- 2- or 3-wire platinum, 100  $\Omega$
- JIS or DIN curves, 1.0 or 0.1 indication

### Process

- Input resolution  $\approx$  50,000 bits at full scale
- Range selectable: 0 to 10V $\approx$  (dc), 0 to 5V $\approx$  (dc), 1 to 5V $\approx$  (dc), 0 to 50mV, 0 to 20 mA, 4 to 20 mA
- Voltage input impedance 20 k $\Omega$
- Current input impedance 100  $\Omega$

## Digital Inputs (4)

- Update rate: 10 Hz
- Contact or dc voltage (36 V $\approx$  (dc) maximum)
- 10 k $\Omega$  input impedance

## Control Outputs (1A, 1B, 2A, 2B)

- Update rate: 20 Hz

### Open Collector/Switched DC

- Internal load switching (nominal):  
Switched dc, 22 to 28V $\approx$  (dc), limited @ 30 mA
- External load switching (maximum):  
Open collector 42V $\approx$  (dc) @ 0.5 A

### Solid-state Relay

- Zero switched, optically coupled, 0.5 A @ 24V $\sim$  (ac) minimum, 253V $\sim$  (ac) maximum

### Process Outputs (Optional Retransmit)

- Update rate: 1 Hz
- User-selectable 0 to 10V $\approx$  (dc), 0 to 5V $\approx$  (dc), 1 to 5V $\approx$  (dc) @ 1 k $\Omega$  min., 0 to 20 mA, 4 to 20 mA @ 800  $\Omega$  max.
- Resolution:  
dc ranges: 2.5mV nominal  
mA ranges: 5  $\mu$ A nominal
- Calibration accuracy:  
dc ranges:  $\pm$ 15 mV  
mA ranges:  $\pm$ 30  $\mu$ A
- Temperature stability 100ppm/ $^{\circ}$ C

## Alarm Outputs

- Output update rate 1 Hz
- Electromechanical relay, Form C, 2 A @ 30V $\approx$  (dc) or 240V $\sim$  (ac) maximum

## Digital Outputs (8)

- Update rate: 10 Hz
- Open collector output
- Off: 42V $\approx$  (dc) max @ 10  $\mu$ A
- On: 0.2V $\approx$  (dc) max @ 50 mA sink
- Internal supply: 5V $\approx$  (dc), @ 80 mA

## Communications

EIA-232 and EIA-485 serial communications with Modbus™ RTU protocol

## Safety and Agency Approvals

- UL@/C-UL 916-listed, File # E185611
- Process Control Equipment
- CE EMC to EN 61326
- CE Safety to EN 61010
- IP65 and NEMA 4X

## Terminals

- Touch-safe, removable terminal blocks, accepts 12- to 22-gauge wire

## Power

- 100 to 240V $\sim$  (ac), -15%, +10%; 50/60Hz,  $\pm$ 5%
- 24 to 28V $\approx$  (ac/dc), -15%, +10% (order option)
- 39VA maximum power consumption

- Data retention upon power failure via nonvolatile memory (seven years for battery-backed RAM).  
Sensor input isolation from input to input to output to communication circuitry is 500V $\sim$  (ac).

## Operating Environment

- 32 to 130 $^{\circ}$ F (0 to 55 $^{\circ}$ C)
- 0 to 90% RH, non-condensing
- Storage temperature: -40 to 158 $^{\circ}$ F (-40 to 70 $^{\circ}$ C)

## Accuracy

- Calibration accuracy and sensor conformity:  $\pm$ 0.1% of span  $\pm$ 1 $^{\circ}$ C @ 77 $^{\circ}$ F  $\pm$ 5 $^{\circ}$ F (25 $^{\circ}$ C  $\pm$ 3 $^{\circ}$ C) ambient, and rated line voltage  $\pm$ 10% with the following exceptions:  
Type T, 0.12% of span for -200 $^{\circ}$ C to -50 $^{\circ}$ C  
Types R and S, 0.15% of span for 0 $^{\circ}$ C to 100 $^{\circ}$ C  
Type B, 0.24% of span for 870 $^{\circ}$ C to 1700 $^{\circ}$ C
- Accuracy span: Less than or equal to operating ranges, 1000 $^{\circ}$ F (540 $^{\circ}$ C) minimum
- Temperature stability:  $\pm$ 0.1 $^{\circ}$ F/ $^{\circ}$ F ( $\pm$ 0.1 $^{\circ}$ C/ $^{\circ}$ C) rise in ambient for thermocouples
- $\pm$ 0.05 $^{\circ}$ F/ $^{\circ}$ F ( $\pm$ 0.05 $^{\circ}$ C/ $^{\circ}$ C) rise in ambient for RTD sensors

## Displays

- Update rate: 2 Hz
- Process: 5, seven-segment LED red
- Control interface display: high-definition LCD green

## Sensor Operating Ranges:

Type J:	32 to 1500 $^{\circ}$ F	or	0 to 815 $^{\circ}$ C
Type K:	-328 to 2500 $^{\circ}$ F	or	-200 to 1370 $^{\circ}$ C
Type T:	-328 to 750 $^{\circ}$ F	or	-200 to 400 $^{\circ}$ C
Type N:	32 to 2372 $^{\circ}$ F	or	0 to 1300 $^{\circ}$ C
Type E:	-328 to 1470 $^{\circ}$ F	or	-200 to 800 $^{\circ}$ C
Type C:	32 to 4200 $^{\circ}$ F	or	0 to 2315 $^{\circ}$ C
Type D:	32 to 4352 $^{\circ}$ F	or	0 to 2400 $^{\circ}$ C
Type PTII:	32 to 2543 $^{\circ}$ F	or	0 to 1395 $^{\circ}$ C
Type R:	32 to 3200 $^{\circ}$ F	or	0 to 1760 $^{\circ}$ C
Type S:	32 to 3200 $^{\circ}$ F	or	0 to 1760 $^{\circ}$ C
Type B:	32 to 3300 $^{\circ}$ F	or	0 to 1816 $^{\circ}$ C
RTD (DIN):	-328 to 1472 $^{\circ}$ F	or	-200 to 800 $^{\circ}$ C
RTD (JIS):	-328 to 1166 $^{\circ}$ F	or	-200 to 800 $^{\circ}$ C

Process: 19999 to 30000 units

## Sensor Accuracy Ranges:

### Input ranges

Type J:	32 to 1382 $^{\circ}$ F	or	0 to 750 $^{\circ}$ C
Type K:	-328 to 2282 $^{\circ}$ F	or	-200 to 1250 $^{\circ}$ C
Type T:	-328 to 662 $^{\circ}$ F	or	-200 to 350 $^{\circ}$ C
Type N:	32 to 2282 $^{\circ}$ F	or	0 to 1250 $^{\circ}$ C
Type E:	-328 to 1470 $^{\circ}$ F	or	-200 to 800 $^{\circ}$ C
Type C(W5)	32 to 4200 $^{\circ}$ F	or	0 to 2315 $^{\circ}$ C
Type D(W3)	32 to 4352 $^{\circ}$ F	or	0 to 2400 $^{\circ}$ C
Type PTII:	32 to 2540 $^{\circ}$ F	or	0 to 1393 $^{\circ}$ C
Type R:	32 to 2642 $^{\circ}$ F	or	0 to 1450 $^{\circ}$ C
Type S:	32 to 2642 $^{\circ}$ F	or	0 to 1450 $^{\circ}$ C
Type B:	1598 to 3092 $^{\circ}$ F	or	870 to 1700 $^{\circ}$ C
RTD (DIN):	-328 to 1472 $^{\circ}$ F	or	-200 to 800 $^{\circ}$ C
RTD (JIS):	-328 to 1166 $^{\circ}$ F	or	-200 to 630 $^{\circ}$ C

Process: -19999 to 30000 units



## Ordering Information

### 1/4 DIN Single-Channel Ramping Controller

#### Series F4

¼ DIN, Single-Channel Ramping Controller

#### Single-Channel Ramping Controller

1 universal analog input, 4 digital inputs, 8 digital outputs, 2 alarms, EIA-232/485 communications

#### Power Supply

H = 100 to 240V $\approx$  (ac/dc)

L = 24 to 28V $\approx$  (ac/dc)

#### Output 1A

C = Open collector/switched dc

F = Process, 0 to 5, 1 to 5, 0 to 10V $\approx$  (dc), 0 to 20 mA, 4 to 20 mA

K = Solid-state Form A 0.5-amp relay

#### Output 1B

A = None

C = Open collector/switched dc

F = Process, 0 to 5, 1 to 5, 0 to 10V $\approx$  (dc), 0 to 20 mA, 4 to 20 mA

K = Solid-state Form A 0.5-amp relay

#### Auxiliary Input Module

0 = None

6 = Dual universal inputs

#### Auxiliary Retransmit Module

0 = None

1 = Single retransmit output 0 to 5, 1 to 5, 0 to 10V $\approx$  (dc), 0 to 20 mA, 4 to 20 mA

2 = Dual retransmit outputs 0 to 5, 1 to 5, 0 to 10V $\approx$  (dc), 0 to 20 mA, 4 to 20 mA

#### Language and RTD Options

1 = English with 100  $\Omega$  RTD

2 = German with 100  $\Omega$  RTD

3 = French with 100  $\Omega$  RTD

4 = Spanish with 100  $\Omega$  RTD

5 = English with 500 and 1 k $\Omega$  RTD

6 = German with 500 and 1 k $\Omega$  RTD

7 = French with 500 and 1 k $\Omega$  RTD

8 = Spanish with 500 and 1 k $\Omega$  RTD

#### Display and Custom Options

RG = Standard Display (Red/Green display only)

XX = Custom options: software, setting parameters, overlay

F4 S - A -



## Ordering Information

### 1/4 DIN Dual-Channel Ramping Controller

#### Series F4

¼ DIN, Dual-Channel Ramping Controller

#### Dual-Channel Ramping Controller

3 universal analog inputs, 4 digital inputs, 8 digital outputs, 2 alarms, EIA-232/485 comms

#### Power Supply

H = 100 to 240V $\approx$  (ac/dc)

L = 24 to 28V $\approx$  (ac/dc)

#### Output 1A

C = Open collector/switched dc

F = Process, 0 to 5, 1 to 5, 0 to 10V $\approx$  (dc), 0 to 20 mA, 4 to 20 mA

K = Solid-state Form A 0.5-amp relay

#### Output 1B

A = None

C = Open collector/switched dc

F = Process, 0 to 5, 1 to 5, 0 to 10V $\approx$  (dc), 0 to 20 mA, 4 to 20 mA

K = Solid-state Form A 0.5-amp relay

#### Output 2 A

C = Open collector/switched dc

F = Process, 0 to 5, 1 to 5, 0 to 10V $\approx$  (dc), 0 to 20 mA, 4 to 20 mA

K = Solid-state Form A 0.5-amp relay

#### Output 2 B

A = None

C = Open collector/switched dc

F = Process, 0 to 5, 1 to 5, 0 to 10V $\approx$  (dc), 0 to 20 mA, 4 to 20 mA

K = Solid-state Form A 0.5-amp relay

#### Auxiliary Retransmit Module

0 = None

1 = Single retransmit output 0 to 5, 1 to 5, 0 to 10V $\approx$  (dc), 0 to 20 mA, 4 to 20 mA

2 = Dual retransmit outputs 0 to 5, 1 to 5, 0 to 10V $\approx$  (dc), 0 to 20 mA, 4 to 20 mA

#### Language and RTD Options

1 = English with 100  $\Omega$  RTD

2 = German with 100  $\Omega$  RTD

3 = French with 100  $\Omega$  RTD

4 = Spanish with 100  $\Omega$  RTD

5 = English with 500 and 1 k $\Omega$  RTD

6 = German with 500 and 1 k $\Omega$  RTD

7 = French with 500 and 1 k $\Omega$  RTD

8 = Spanish with 500 and 1 k $\Omega$  RTD

#### Display and Custom Options

RG = Standard Display, (Red/Green display only)

XX = Custom options: software, setting parameters, overlay

F4 D - - - - -

# Index

°F or °C 5.7

## A

A to D 10.3  
accuracy A.6  
Action, End 4.15  
active output indicator lights 2.2  
add step 4.6  
Address 5.14, 7.16  
agency approvals A.6  
Alarm 1 High Deviation 3.14  
Alarm 1 High SP 3.14  
Alarm 1 Low Deviation 3.14  
Alarm 1 Low SP 3.14  
Alarm 2 High Deviation 3.14  
Alarm 2 High SP 3.14  
Alarm 2 Low Deviation 3.14  
Alarm 2 Low SP 3.14  
alarm band example 5.5  
alarm clearing 3.4  
Alarm High Set Point 3.4  
Alarm Hysteresis 5.12, 6.8  
Alarm Latching 5.12, 6.9  
Alarm Logic 5.12  
Alarm Low Set Point 3.4  
alarm messages 3.8  
Alarm Messages 5.12  
Alarm Name 5.12  
alarm output indicator lights 2.2  
Alarm Output x Menu 5.12  
Alarm Set Point Menu 3.14  
alarm set points 3.4, 3.14, 6.8, 8.3  
Alarm Sides 5.12, 6.9, 7.2  
Alarm Silencing 5.12, 6.9  
Alarm Source 5.12  
alarm status, indicator lights 2.2  
Alarm Type 5.12  
alarms  
    deviation 3.4, 6.8  
    features 6.8–6.9  
    operation 3.4  
    process 3.4, 6.8  
    self-clearing 6.9  
    troubleshooting 3.8  
Altitude 5.9  
Alternating Display 5.15  
ambient temperature A.6  
Analog Input x  
    A To D, Diagnostics 10.3  
    Calibration Offset 5.10

Decimal 5.9, 7.2  
Deviation Cascade High Range 5.10  
Deviation Cascade Low Range 5.10  
Error Latch 5.10  
Filter Time 5.10  
Open Loop 5.7  
Process Cascade High Range 5.10  
Process Cascade Low Range 5.10  
Sensor 5.8  
Type 5.8  
Units 5.9  
Wait for 4.14  
Analog Input x Menu 5.8  
Analog Range, Retransmit Output 5.12  
Automatic Operation 3.1  
automatic tuning 3.5, 3.6  
Autostart Menu 4.2, 4.12  
    Date 4.12  
    Day 4.12  
    Time 4.12  
Autostart Profile Date Or Day 4.12  
autostart step application 7.19  
Autotune, selecting set points 3.4  
Autotune PID Cascade Menu 3.11  
Autotune PID Menu 3.4–3.5, 3.11  
autotuning 3.4–3.5, 6.7  
    cascade 3.6  
    lockout 8.3  
    operation 3.4, 3.11, 6.7  
    PID Autotune 3.4, 3.11, 6.7  
Autotuning Channel x 2.8, 3.4, 5.7

## B

B&B Converter 12.11  
Battery A.2  
Baud Rate 5.14, 7.16  
Boost Cool, Digital Output Function 6.10  
Boost Heat, Digital Output Function 6.10  
Boost Percent Power 5.13, 6.10  
Boost Time Delay 5.13, 6.10  
burst fire 6.6  
    heater life 6.6  
    noise generation (RFI) 6.6  
    sine wave 6.6

## C

Calibration, overview 9.1  
    inputs 9.2–9.4  
    outputs 9.4–9.6

Calibration Offset 5.10, 6.2  
Cascade 6.11, 7.3  
    Analog Input 3 5.10  
    Autotuning 3.6  
    cascade system 3.6, 6.11  
    cascade system, tuning 3.6  
    control, selecting 3.6  
    inner loop 3.6, 6.11  
    internal set point 6.11  
    long lag times 6.11  
    outer loop 3.6, 6.11  
    overshoot 3.6, 6.11  
    parameters 3.13–3.14  
    PID 6.11  
    setup 3.6  
Cascade High Range  
    Deviation 5.10  
    Process 5.10  
Cascade Inner Loop 3.11  
Cascade Low Range  
    Deviation 5.10  
    Process 5.10  
Cascade Outer Loop 3.11  
CE Declaration of Conformity A.5  
Ch2 Output Disable? 5.9  
changing and setting password 8.2  
Channel 1, PID Set 4.15  
Channel 2, PID Set 4.15  
Channel x Autotune 3.11  
Channel x Autotune Set Point 5.7  
charts  
    Custom Main Page 5.3  
    Operations Page Record 3.15  
    Setup Page Record 5.16  
    User Profile Record 4.7  
Choose Cycle Time, Control Output x 5.11  
Choose Scaling 5.9  
CJCx A to D, Diagnostics 10.3  
CJCx Temp, Diagnostics 10.3  
clear alarm, key press simulation 3.4, 7.3  
clear error, key press simulation 3.4, 7.3  
Clear Locks, Set Lockout 8.3  
closed-loop configuration 3.1  
closed-loop control, see automatic operation  
CMC converter 12.11  
communications 5.14, 7.1, 7.16  
communications indicator light 2.2  
Communications Menu 5.14, 7.16  
communications wiring

- B&B converter 12.11
- CMC converter 12.11
- EIA-232 to EIA-485 conversion 12.11
- EIA/TIA 485 12.10
- EIA/TIA 232 12.10
- termination for EIA-232 to EIA-485 converter 12.10
- Complementary Output, Digital Output 5, Function 5.13
- Compressor Control 6.10
- Compressor Off % Power 5.14, 6.10
- Compressor Off Delay 5.14, 6.10
- Compressor On % Power 5.14, 6.10
- Compressor On Delay 5.14, 6.10
- Condition, Digital Input x 5.11
- conformity A.5
- continue profile 3.3
- Control Output Function 5.10, 12.7
- Control Output x Menu 3.5, 5.11
- controller, overview 1.1
- cooling compressor 6.10
- creating a profile application 7.18
- Current Date 5.7
- Current Process Input, Calibration 9.3
- Current Time 5.7
- cursor 2.2
- Custom Main Page Menu 5.15
- Custom Main Page Record 5.3
- Custom Message 1 to 4 7.3
- customizing the Main Page 5.2
- Cycle Time 5.11
- cycle time adjustment 3.5

## D

- Dead Band 3.5, 3.12, 3.13, 6.5
  - Cascade Inner Loop 3.12
  - Cascade Outer Loop 3.13
  - integral action 6.5
  - PID set 3.13, 6.4–6.5
  - PID Set 1 to 5 3.12
  - PID Set 6 to 10 3.13
  - proportional action 6.5
- Decimal 5.9
- Declaration of Conformity A.5
- default Main Page parameters 2.3, 2.8
- Delete Profile 4.6
- Delete Step 4.6
- Derivative 3.11, 3.12, 3.13
- derivative rate adjustment 3.5

- deviation alarm 3.4
- diagnostics
  - overview 10.1
  - menu map 10.1
- Digital Inputs x 5.10–5.11, 6.3
  - Condition 2.3, 2.8, 5.10, 5.11
  - Function 5.11
  - Name 5.10
  - number of 1.1
  - see, event input
  - specifications A.6
  - status 2.3, 2.8
  - wiring 12.6
- Digital Outputs x
  - condition 2.3, 2.8
  - Function 5.13
  - Name 5.13
  - number of 1.1
  - see, event output
  - specifications A.6
  - wiring 12.9
- dimensions 11.1–11.2
- Display Test 10.4
- displays 2.2–2.4
  - cursor 2.2
  - front panel 2.2
  - Lower Display 2.2
  - scroll bar 2.2
  - Upper Display 2.2
- displays, overview 2.1
- dry bulb 5.8
- dual channel 1.1
- dwelt — see soak, soak step

## E

- edit PID 3.4, 3.11
- Edit PID Menu 2.5, 3.4–3.5, 3.11–3.12
- edit profile 4.6
- End step 4.3, 4.15
  - action, end step 4.6
  - Idle Set Point, Channel x 4.16
- Enter Cycle Time 5.11
- Enter In1 Temp High 5.9
- Enter In1 Temp Low 5.9
- enter key 2.6
- environmental testing 1.2–1.3
- Error Latch, Analog Input x 5.10
- errors
  - fatal errors 3.8–3.9
  - input errors 3.8–3.9
  - operation 3.8–3.9

- system errors 3.8–3.9
- troubleshooting 3.8–3.9
- event input 4.13, 6.3
  - see, Digital Input x
- event output, ramp rate or ramp time or soak steps 4.12
  - see, Digital Output x

## F

- Factory Page 2.1, 8.1, 9.1, 10.1
  - lockout 8.3
  - parameter table 9.7
- Fahrenheit scale 5.1
- Filter Time 5.10, 6.2
- filter time constant 6.2
- Frequently Asked Questions 4.10
- Full Access 8.1, 8.3
- Full Default 10.1, 10.4
- Function
  - Control Output x 5.11
  - Digital Input x 5.11
  - Digital Output x 5.13

## G

- global system parameters 5.4
- Guarantee Soak 4.3
- Guarantee Soak Band x 5.7
- Guarantee Soak, ramp rate or ramp time or soak steps 4.13
- guided setup and programming 2.5

## H

- High Power Limit 5.6, 5.11
- High Scale 5.13, 6.3
- Hold 3.3, 4.5
- hold profile 3.3
- holdback, see guaranteed soak
- hours remaining, ramp time or soak step, current profile status 4.13
- Hysteresis 6.4
  - boost heat & cool 6.10
  - Cascade Inner Loop 3.12
  - Cascade Outer Loop 3.14
  - PID Set 1 to 5 3.12
  - PID Set 6 to 10 3.13

## I

- “i” key 1.4, 2.4, 2.7
- Idle 4.5
- Idle Set Point 4.5, 4.16
- Idle Set Point, Channel x, power out

- action 5.7
- indicator lights 2.2
- Information Key 1.4, 2.4, 2.7
- Input 1 Only, Process Display 5.15
- Input 1 wiring 12.3
- Input 2 wiring 12.4–12.5
- Input 3 wiring 12.4–12.5
- input calibration 9.2–9.4
- input errors 3.9
- input status 2.8
- input wiring 12.3–12.5
- Input x Error 2.8
- Input x Failure 5.7
- input-to-output isolation 12.1
- inputs and outputs 1.1
  - calibration 9.2–9.6
    - dual-channel Series F4 1.1
    - single-channel Series F4 1.1
  - wiring, overview 12.1–12.2
- insert step 4.6
- installation
  - dimensions 11.1
  - installing 11.2
  - overview 11.2–11.3
  - tools required 11.2
- Integral Reset Adjustment 3.5
- Integral x
  - Cascade Inner Loop 3.11
  - Cascade Outer Loop 3.13
  - PID Set 1 to 5 3.11
  - PID Set 6 to 10 3.12
- Internal Cascade SP 6.11
- isolation barriers 12.1

## J

- Jump
  - Count 4.15
  - Profile 4.15
  - Repeats 4.15
  - Step 4.13, 4.15

## K

- keys
  - Information Key 1.4, 2.4, 2.7
  - Left and Right Keys 2.4, A.17
  - Profile Key 2.4, A.17
  - Up and Down Keys 2.4, A.17
- keys, displays and navigation,
  - overview 2.1, A.17

## L

- Latching, Alarm Output x 5.12

- Line Frequency 10.3
- linearization table 5.8
- lockout 8.1–8.3
- locks 8.3
  - Clear Locks 8.3
  - levels 8.1
  - Set Lock 8.3
- Low Power Limit 5.11
- Low Scale 5.12, 6.3
- Lower Display 2.2

## M

- Main Page 2.3, 2.8
  - Alarm x Condition 2.8
  - Autotuning Channel x 2.8
  - Custom Main Page 2.3, 5.2, 5.3
  - default Main Page 2.3
  - error messages on 2.3
  - parameter table 2.8
- manual operation, not allowed, 3.1
- manual tuning 3.5–3.6
- Manufacture Date 10.2
- map, software A.16–A.17
- menu and page maps
  - all A.16–A.17
  - Calibration Menu 9.6
  - Communications Menu 5.14, 7.16
  - Diagnostics Menu 10.1
  - Operations Page 3.10
  - Profiles Page 4.11
  - Set Lockout Menu 8.2
  - Setup Page 5.6
- Message 1 to 4, Static Message 5.15
- Military Standard Test 810D 3.7,
  - 4.8–4.9

## Modbus registers

- alphabetical listing 7.2–7.10
- numerical listing 7.13–7.15
- profile parameters 7.10–7.12
- Modbus Remote Terminal Unit (RTU)
  - 7.1
- Modbus RTU protocol 7.1
- Model Number 12.1, A.7
- Model, Diagnostic 10.2
- multiple PID sets 3.5, 6.6
- multiple tuning procedure 3.5

## N

- Name
  - Alarm Output x 5.12
  - Digital Input x 5.10
  - Digital Output x 5.13

- names, how to enter 2.6
- naming
  - alarm output 2.6, 5.13
  - digital input 2.6, 5.10
  - digital output 2.6, 5.12
  - profiles 2.6, 4.4
- navigation 2.4
- navigation keys 2.4
- noise filter 6.2
- non-volatile memory 4.2
- numbers, how to enter 2.6

## O

- On-Off control 6.4
  - chattering 6.4
  - Hysteresis x (A or B) 6.4
  - Proportional Band x (A or B) 6.4
- Open Loop Channel x, enable 5.7
- Open Loop Detect 6.2
- operations
  - overview 3.1
  - profile control 3.2
  - sample application 3.7
- Operations Page
  - map 3.10
  - Parameter Record 3.15
  - parameter table 3.11
- operator's display, see lower display
- ordering information A.7
- Output Calibration 9.4–9.6
- output condition, indicators 2.2
- Outputs, Event, number of 1.1
- outputs x (1A, 1B, 2A and 2B)
  - type 10.2
  - wiring 12.7–12.8

## P

- P (Parameter) x, Custom Main Page
  - 5.15
- page and menu maps
  - all A.16–A.17
  - Calibration Menu 9.6
  - Communications Menu 5.14, 7.16
  - Diagnostics Menu 10.1
  - Operations Page 3.10
  - Profiles Page 4.11
  - Set Lockout Menu 8.2
  - Setup Page 5.6
- pages, software 2.1, A.16–A.17
- Panel Lock 5.5
- parameter record
  - Custom Main Page 5.3



- Operations Page 3.15
  - Profile 4.7
  - Setup Page 5.16
  - parameter setup order 5.1–5.2
  - parameter tables
    - Calibration Menu 9.7–9.8
    - Communications Menu 5.14, 7.16
    - Diagnostic Menu 10.2–10.3
    - Main Page 2.8
    - Operations Page 3.11–3.14
    - Profiles Page 4.12–4.16
    - Set Lockout Menu 8.3
    - Setup Page 5.7–5.15
    - Test Menu 10.4
  - password lock 8.1
  - password, setting or changing 8.2
  - pattern — see profile
  - pause (Hold) profile 4.3
  - Percent Power Output, status 7.2
  - PI control 6.5
    - droop 6.5
    - Integral 6.5
    - overshoot 6.5
    - reset 6.5
  - PID block, see PID set
  - PID control 6.5
    - autotuning 6.8
    - derivative 6.5
  - PID parameters, adjusting manually 3.5
  - PID sets 6.6
  - PID Units 5.1, 5.7
  - PID values, defaults 3.4
  - Power Out Condition 4.3
  - power wiring 12.2
  - Power-Out Action 5.7
  - Power-Out Time 5.7
  - Process Display 5.15
  - process input range limits
  - process input, wiring 12.2
  - process or deviation alarms 3.4, 6.8
  - Process Output, Calibration 7.7, 9.4
    - Output 1 Calibration 7.7, 9.4
    - Output 2 Calibration 7.7, 9.4
  - Process, Control Output x 5.11
  - Profile Action Menu 3.3
  - profile control 3.2, 5.10
  - profile indicator light 2.2
  - Profile Key 2.4, 3.2, 3.3
    - hold a profile 3.3
    - resume a profile 3.3
    - run a profile 3.2
    - start a profile 3.2
    - terminate a profile 3.3
  - profile lockout 7.8, 8.1
  - profile mode 3.2
  - profile number 7.12
  - profile plan checklist 4.3
  - profile programming
    - editing a profile 4.6
    - frequently asked questions 4.10
    - Modbus flowcharts 7.17–7.26
    - new profile 4.4
    - overview 4.1
    - procedures 7.17–7.26
    - Profiles Page parameters 4.12–4.16
    - sample profile 4.8–4.9
    - step types 4.2–4.3, 4.12, 4.16
    - User Profile Record 4.7
  - profile Modbus registers 7.10–7.12
  - Profile Status message 3.2
  - profile wait for, analog input x or event x 4.13
  - profile, defined 4.2
  - Profiles Page 4.4
    - create profile 4.4
    - edit profile 4.6
    - map 4.11
  - programming new profile 4.4–4.5
  - Proportional Band x 6.4
    - adjustment 3.5
    - Cascade Inner Loop 3.11
    - Cascade Outer Loop 3.13
    - PID Set 1 to 5 3.11
    - PID Set 6 to 10 3.12
  - proportional control 6.4
    - droop 6.4
  - proportional plus integral (PI) control 6.5
    - droop 6.5
    - integral 6.5
    - overshoot 6.5
    - reset 6.5
  - proportional plus integral plus derivative (PID) control 6.5
    - derivative 6.5
  - PV bias, see calibration offset
- Q**
- questions 4.10
- R**
- Ramp Rate 4.2, 4.12–4.13
  - Ramp Set Point Channel x 4.13
  - ramp steps, number of 1.1
  - Ramp Time 4.12–4.13
  - ramping mode 3.2
  - ramping profile 4.2
  - range high 6.3
  - range low 6.3
  - Rate 6.5
    - Cascade Inner Loop 3.12
    - Cascade Outer Loop 3.13
    - PID Set 1 to 5 3.11
    - PID Set 6 to 10 3.12
  - read only 8.1
  - real-time clock 1.1
  - recipe —see file or profile
  - Records
    - Custom Main Page 5.3
    - Operations Page Record 3.15
    - Profile Page Record 4.7
    - Setup Page Record 5.15
  - reference compensator 9.2
  - registers
    - Modbus 7.2–7.15
    - profile 7.10–7.12
  - relative humidity (RH) 5.5
  - removing the controller 11.3
  - renaming profiles, see naming, profiles
  - Reset 6.5
    - Cascade Inner Loop 3.11
    - Cascade Outer Loop 3.13
    - PID Set 1 to 5 3.11
    - PID Set 6 to 10 3.12
  - resistance temperature detector (RTD) 5.4
  - restore factory calibration values 9.1
  - Resume Profile 3.3
  - retransmit outputs
    - calibration 9.5–9.6
    - diagnostics 10.3
    - wiring 12.8
  - Retransmit Source 5.12
  - retransmitting 6.3
    - chart recorder 6.3
    - outputs 1 and 2 6.3
    - remote set point 6.3
  - Rotronics 5.8
  - RTD 5.4, A.6
    - input, calibration 9.2
    - inputs, wiring 12.3–12.4
- S**
- safety info ii
  - sample application, environmental

- testing 1.2–1.3, 3.7, 4.8–4.9, 5.4–5.5
- Scale High 5.9, 6.3
- Scale Low 5.9, 6.3
- Scale Offset 5.13
- scroll bar 2.2
- security and locks, overview 8.1
  - full access 8.1
  - hidden 8.1
  - password 8.1
  - read-only 8.1
  - security levels 8.1
- segment —see step
- self-clearing alarm 6.9
- self tune —see autotune
- sensor installation guidelines 12.2
  - accuracy ranges A.6
  - process input wiring 12.3–12.5
  - RTD input wiring 12.3–12.5
  - thermocouple input wiring 12.3–12.5
- Sensor, Analog Input x 5.8
- serial number, diagnostics 10.2
- Set Lockout Menu map 8.2
- Set Point
  - Channel x, ramp or soak 4.13
  - High Limit 5.10, 6.3
  - Lockout 8.1
  - Low Limit 5.9, 6.3
- set point, autotuning 3.4
- set point, beginning percentage 3.4
- set points, cooling dead band 3.5
- set points, heating dead band 3.5
- set variable, see setpoint
- setting and changing password 8.2
- setting lock levels 8.1
  - Clear Locks 8.3
  - Factory Page 8.1
  - Operations 8.1
  - Password 8.2, 8.3
  - Profile Page 8.1
  - Set Point 8.1
  - Setup Page 8.1
- settings 2.5
  - change 2.5
  - program 2.5
  - set up 2.5
- setup steps 1.4
- Setup, overview 5.1
  - customizing the Main Page 5.2
  - parameter record 5.16
  - parameter setup order 5.1
  - parameter table 5.7–5.15

- sample application 5.4–5.5
- setup guidelines 5.1
- Setup Page Map 5.6
- Show °F or °C 5.7
- silence, alarm 5.12, 6.9
- Silencing, Alarm Output x 5.12
- single channel 1.1
- Soak Step 4.3
- Soak Step Time 4.13
- software map A.16–A.17
- Software Number 10.2
- software, page and menu maps
  - Calibration Menu 9.6
  - Diagnostics Menu 10.2
  - Operations Page 3.10
  - Profiles Page 4.11
  - Set Lockout Menu 8.2
  - Setup Page 5.6
- solenoid valve 5.4
- solid-state relay 5.4, 12.7
- SP High Limit 5.10, 6.3
- SP Low Limit 5.9, 6.3
- specifications A.6
- Static Message 5.15
- static set point 3.1
- step types 4.2–4.3
  - Autostart 4.2
  - End 4.3
  - Jump 4.3
  - Ramp Rate 4.2
  - Ramp Time 4.2
  - Soak 4.3
- stop bit 3.9
- system errors 3.9
- System Menu 3.4, 5.7
- Système Internationale (SI) 5.1

**T**

- technical assistance ii
- temperature scale (°F or °C) 5.1, 5.7
- terminals A.6
- terminate profile 3.3
- test menu map 10.1
- Test Outputs 10.1, 10.4
- thermocouple 5.8, A.6
- thermocouple compensator 9.2
- thermocouple input
  - calibration 9.2
  - wiring 12.2–12.4
- Time 4.13
- time, setting current 5.1
- transformer isolation 12.1

## U

- U.S. units 5.1, 5.7
- Units
  - Analog Input 5.9
  - input measurement 5.9
  - PID 5.7
  - SI, U.S. 5.1, 5.7
- upper display 2.2
- use password 8.2
- user ramp chart 4.7

## V

- Vaisala 5.5, 5.8
- values, enter 2.5
- Variable Burst, Cycle Time 5.10
- voltage process input, calibration 9.3

## W

- wait for event 4.3
- warranty ii
- wet bulb 5.8
- wiring example 12.12
- wiring, overview 12.1

## X, Y, Z

- zero-cross switching 6.6
  - heater life 6.6
  - noise generation (RFI) 6.6
  - sine wave 6.6



# List of Figures

## Chapter 1

Single-Channel Series F4 Inputs/Outputs	1.1a
Dual-Channel Series F4 Inputs/Outputs	1.1b
Sample Application: Environmental Testing	1.2–1.3

## Chapter 2

Series F4 Displays and Indicator Lights	2.2
Default Main Page Parameters	2.3
Series F4 Keys and Navigation	2.4
How to Enter Numbers and Names	2.6
The Information Key	2.7

## Chapter 3

Sample Application: Running a Profile	3.7
---------------------------------------	-----

## Chapter 4

Eight-Step Profile	4.2
Sample Application: Programming a Profile	4.8
Profile Chart for Military Standard 810D Test	4.9a
Graph of Military Standard 810D Test	4.9b

## Chapter 5

Parameters on the Custom Main Page	5.2
Sample Application: Setup	5.4–5.5

## Chapter 6

Calibration Offset	6.2a
Filtered and Unfiltered Input Signals	6.2b
Sensor Ranges	6.3a
On-off Control for Heating and Cooling	6.4a
Proportional Control	6.4b
Proportional Plus Integral Control	6.5a
PID Control	6.5b
Cooling Dead Band	6.5c
Burst Fire	6.6
Autotuning	6.7
Alarm Settings	6.8
Alarm Latching	6.9a
Alarm Silencing	6.9b
Boost Heat and Boost Cool	6.10a
Compressor Power	6.10b
Control Lag Times	6.11a
Cascade Control	6.11b
Cascade Example	6.11c

## Chapter 11

Front View Dimensions and Gap Dimension	11.1a
Side and Top View and Dimensions	11.1b
Multiple Panel Cutout Dimensions	11.2a
Gasket Seated on the Bezel	11.2b
Retention Collar and Mounting Bracket	11.3a
Tightening the Screws	11.3b
Disengaging the Mounting Bracket	11.3c

## Chapter 12

Isolation Blocks	12.1
Power Wiring	12.2
Input 1, Thermocouple	12.3a
Input 1, RTD (2- or 3-Wire) 100 Ω Platinum	12.3b
Input 1, 0 to 5V <sub>rms</sub> , 1 to 5V <sub>rms</sub> or 0 to 10V <sub>rms</sub> Process	12.3c
Input 1, 0 to 20 mA or 4 to 20 mA Process	12.3d
Input 1, 0 to 50mV	12.3e
Input 2 & 3, Thermocouple	12.4a
Input 2 & 3, RTD (2-wire) 100Ω Platinum	12.4b
Input 2 & 3, RTD (3-wire) 100Ω Platinum	12.4c
In. 2 & 3, 0 to 5V <sub>rms</sub> , 1 to 5V <sub>rms</sub> or 0 to 10V <sub>rms</sub> Process	12.5a
Input 2 and 3, 0 to 20 mA or 4 to 20 mA Process	12.5b
Input 2 & 3, 0 to 50mV	12.5c
Digital Inputs 1 to 4	12.6
Output x, Solid-state Relay	12.7a
Output x, Switched DC, Open Collector	12.7b
Output x, 0 to 20 mA, 4 to 20 mA, 0 to 5V <sub>rms</sub> , 1 to 5V <sub>rms</sub> and 0 to 10V <sub>rms</sub> (dc) Process	12.8a
Retransmit Outputs 1 and 2	12.8b
Alarm Outputs 1 and 2	12.8c
Digital Outputs 1 to 8	12.9a
Digital Output, Open Collector Example	12.9b
Digital Output, Switched DC Example	12.9c
EIA/TIA 485 and 232 Communications	12.10a
Termination for EIA-232 to -485 Converter	12.10b
EIA/TIA-232 Connections	12.10c
EIA-232 to EIA-485 Conversion	12.11a
GPIO Conversion to EIA-232 or EIA-485	12.11b
System Wiring Example	12.12





# Series F4 Software Map

For ranges, defaults, Modbus numbers and other information about the parameters, refer to the Parameter Tables in the chapters noted below.

## Main Page see Chapter 2

- Input x (1 to 3) Error
- Alarm x (1 to 2) Condition
- Autotuning Ch x (1 to 2)
- Parameter x (1 to 16)
  - Current File
  - Current Step
  - Input 2 Value
  - Set Point 1
  - Set Point 2
  - Step Type
  - Target SP1
  - Target SP2
  - Wait for Status
  - Time Remaining
  - Digital Ins
  - Digital Outs
  - % Power 1
  - % Power 2
  - Date
  - Time
- Go to Operations
- Go to Profiles
- Go to Setup
- Go to Factory

## Operations Page

see Chapter 3

- Autotune PID
  - Channel 1 Autotune
    - Tune Off
    - PID Set x (1 to 5)
  - Channel 2 Autotune
    - Tune Off
    - PID Set x (6 to 10)
- Edit PID
  - PID Set Channel 1
    - PID Set x (1 to 5)
  - PID Set Channel 2
    - PID Set x (6 to 10)
      - Proportional BandA
      - Integral A / ResetA
      - Derivative A / RateA
      - Dead Band A
      - Hysteresis A
      - Proportional Band B
      - Integral B / ResetB
      - Derivative B / RateB
      - Dead Band B
      - Hysteresis B
- Alarm Set Points
  - Alarm1
    - Alarm1 Lo Deviation
    - Alarm1 Hi Deviation
  - Alarm2 Low SP
    - Alarm2 Low SP
    - Alarm2 High SP

## Profiles Page

see Chapter 4

- Create Profile
  - Name Profile
  - Step x (1 to 256) Type
    - Autostart
      - Date
      - Day
    - Ramp Time
      - Wait For
      - Event Output
      - Time
      - Ch1 SP
      - Ch2 SP
      - Ch1 PID Set x (1 to 5)
      - Ch2 PID Set x (6 to 10)
      - Guarantee Soak1
      - Guarantee Soak2
    - Ramp Rate
      - Wait For
      - Event Output
      - Rate
      - Ch1 SP
      - Ch2 SP
      - Ch1 PID Set x (1 to 5)
      - Guarantee Soak1
      - Ch2 PID Set x (6 to 10)
      - Guarantee Soak2
    - Soak
      - Wait For
      - Event Output
      - Time
      - Ch1 PID Set x (1 to 5)
      - Guarantee Soak1
      - Ch2 PID Set x (6 to 10)
      - Guarantee Soak2
    - Jump
      - Jump to Profile x (1 to 40)
      - Jump to Step x
      - Number Of Repeats
    - End
      - Hold
      - Control Off
      - All Off
      - Idle

- Edit Profile
  - Profile x (1 to 40)
    - Insert Step x (1 to 256)
      - Insert Before Step x
      - Step x Type (**see below**)
    - Edit Step
      - Step x Type
        - Autostart
          - Date
          - Day
        - Ramp Time
          - Wait For
          - Event Output
          - Time
          - Ch1 SP
          - Ch2 SP
          - Ch1 PID Set x (1 to 5)
          - Ch2 PID Set x (6 to 10)
          - Guarantee Soak1
          - Ch2 PID Set x (6 to 10)
          - Guarantee Soak2
        - Ramp Rate
          - Wait For
          - Event Output
          - Rate
          - Ch1 SP
          - Ch2 SP
          - Ch1 PID Set x (1 to 5)
          - Guarantee Soak1
          - Ch2 PID Set x (6 to 10)
          - Guarantee Soak2
        - Soak
          - Wait For
          - Event Output
          - Time
          - Ch1 PID Set x (1 to 5)
          - Guarantee Soak1
          - Ch2 PID Set x (6 to 10)
          - Guarantee Soak2
        - Jump
          - Jump to Profile x (1 to 40)
          - Jump to Step x
          - Number Of Repeats
        - End
          - Hold
          - Control Off
          - All Off
          - Idle
      - Delete Step
      - Done
    - Delete Profile x (1 to 40)
    - Re-Name Profile x (1 to 40)

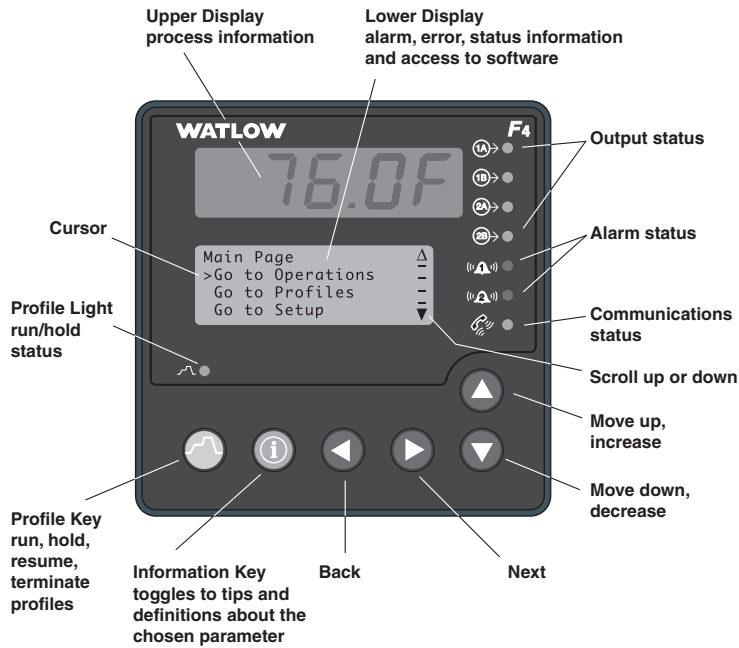

## Setup Page see Chapter 5

### System

Guar. Soak Band1  
 Guar. Soak Band2  
 Current Time  
 Current Date  
 PID Units  
 °F or °C  
 Show °F or °C  
 Ch1 Autotune SP  
 Ch2 Autotune SP  
 Input 1 Fail  
 Input 2 Fail  
 Open Loop Ch1  
 Open Loop Ch2  
 Power-Out Time  
 Power-Out Action

### Analog Input x (1 to 3)

Sensor  
 Type  
 Decimal  
 Altitude  
 Units  
 Scale Low  
 Scale High  
 Choose Scaling  
 Ch2 Output Disable?  
 Enter In1 Temp Low  
 Enter In1 Temp High  
 SP Low Limit  
 SP High Limit  
 Calibration Offset  
 Filter Time  
 Error Latch  
 Cascade

### Digital Input x (1 to 4)

Name  
 Function  
 Condition

### Control Output x (1A, 1B, 2A, or 2B)

Function

### Cycle Time

Process  
 Hi Power Limit  
 Lo Power Limit

### Alarm Output x (1 and 2)

Name  
 Alarm Type  
 Alarm Source  
 Latching  
 Silencing  
 Alarm Hysteresis  
 Alarm Sides  
 Alarm Logic  
 Alarm Messages

### Retransmit Output x (1 and 2)

Retransmit Source  
 Analog Range  
 Low Scale  
 High Scale  
 Scale Offset

### Digital Output x (1 to 8)

Name  
 Function  
 Off  
 Event Output  
 Boost Heat  
 Boost %Power  
 Boost Delay Time  
 Boost Cool  
 Boost %Power  
 Boost Delay Time  
 Compressor  
 Compressor On %Power  
 Compressor Off %Power  
 Compressor On Delay  
 Compressor Off Delay

### Communications (see Chapter 7)

Baud Rate  
 Address

### Custom Main Page P x (Parameter 1 to 16)

## Factory Page

see Chapters 8, 9, 10

### Set Lockout

Set Point  
 Oper. Autotune PID  
 Oper. Edit PID  
 Oper. Alarm SP  
 Profile  
 Setup  
 Factory  
 Change Password  
 Clear Locks

### Diagnostic

Model  
 Mfg Date  
 Serial #  
 Software #  
 Revision  
 Inx (1 to 3)  
 Out x (1A, 1B, 2A, or 2B)  
 Retrans x (1 or 2)  
 In x (1 to 3) AtoD  
 CJC x (1 or 2) AtoD  
 CJC x (1 or 2) Temp  
 Line Freq

### Test

Test Outputs  
 Display Test  
 Full Defaults

### Calibration

Calibrate Input x (1 to 3)  
 Calibrate Output x (1A, 1B, 2A, or 2B)  
 Calibrate Rexmit x (1 or 2)  
 Restore In x (1 to 3) Cal

### ✓ NOTE:

*Some parameters may not appear, depending on the controller model and how it is configured. Some menus may not appear if the controller has already been installed in equipment and the manufacturer has locked out portions of the software.*

# How to Reach Us



Your Authorized Watlow Distributor:

## United States (headquarters):

Watlow Electric Manufacturing Company  
12001 Lackland Road  
St. Louis, Missouri USA 63146  
Telephone: +1 (314) 878-4600  
Fax: +1 (314) 878-6814

## Europe:

Watlow GmbH  
Industriegebiet Heidig  
Lauchwasenstr. 1, Postfach 1165,  
Kronau 76709 Germany  
Telephone: +49 7253-9400 0  
Fax: +49 7253-9400 44

Watlow France S.A.R.L.  
Immeuble Somag, 16 Rue Ampère,  
Cergy Pontoise CEDEX 95307 France  
Telephone: +33 (1) 3073-2425  
Fax: +33 (1) 3073-2875

Watlow Italy S.R.L.  
Via Meucci 14  
20094 Corsico MI  
Italy  
Telephone: +39 (02) 4588841  
Fax: +39 (02) 458-69954

Watlow Limited  
Robey Close, Linby Industrial Estate,  
Linby Nottingham England, NG15 8AA  
Telephone: +44 (0) 115 9640777  
Fax: +44 (0) 115 9640071

## Latin America:

Watlow de México  
Av. Fundación #5,  
Col. Parques Industriales,  
Querétaro, Qro. México CP-76130  
Telephone: +52 (442) 217-6235  
Fax: +52 (442) 217-6403

## Asia/Pacific:

Watlow Australia Pty., Ltd.  
23 Gladstone Park Drive,  
Tullamarine, Victoria 3043 Australia  
Telephone: +61 (39) 335-6449  
Fax: +61 (39) 330-3566

Watlow China, Inc.  
179, Zhong Shan Xi Road  
Hong Qiao Cointek Bldg, Fl. 4, Unit P  
Shanghai 200051 China  
Telephone: +86 (21) 6229-8917  
Fax: +86 (21) 6228-4654

Watlow Japan Ltd. K.K.  
Azabu Embassy Heights 106,  
1-11-12 Akasaka,  
Minato-ku, Tokyo 107-0052 Japan  
Telephone: +81 (03) 5403-4688  
Fax: +81 (03) 5403-4646

Watlow Korea Co., Ltd.  
Hanil Bldg., 3rd Floor  
210-5 Yangje-Dong Seocho-Gu  
Seoul, 137-130 Korea  
Telephone: +82 (2) 575-9804  
Fax: +82 (2) 575-9831

Watlow Malaysia Sdn Bhd  
38B Jalan Tun Dr Awang  
11900 Bayan Lepas  
Penang Malaysia  
Telephone: +60 (4) 641-5977  
Fax: +60 (4) 641-5979

Watlow Singapore Pte. Ltd.  
Ayer Rajah Crescent  
#03-23 Ayer Rajah Industrial Estate  
Singapore 139949  
Telephone: +65 773 9488  
Fax: +65 778 0323

Watlow Electric Taiwan  
10F-1 No. 189  
Chi-Shen 2nd Road,  
Kaohsiung, Taiwan  
Telephone: +886 (7) 288-5168  
Fax: +886 (7) 288-5568