

Hauptmenü Main menu

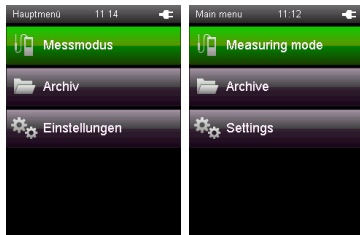

Messmodus Measuring mode



- Messmodus:** Messungen durchführen (mit angeschlossenem Fühler oder integriertem Luftdrucksensor)
- Archiv:** Archivierte Messwerte aufrufen
- Einstellungen:** Geräteeinstellungen vornehmen
- Measuring mode:** Carry out measurements (with connected probe or integrated air pressure sensor)
- Archive:** Open archived measurements
- Settings:** Change device settings

- 6** Auswahl der jeweiligen Messgröße
- 7** Messperiode für MIN, MAX, AVG bzw. HOLD zurücksetzen
- 8** Darstellung der Messwerte festlegen:
Minimum: Kleinsten ermittelten Messwert einer Messperiode anzeigen
Maximum: Größten ermittelten Messwert einer Messperiode anzeigen
Durchschnitt: Durchschnittswert aller ermittelten Messwerte einer Messperiode anzeigen

- Halten:** Aktuell ermittelten Messwert (HOLD) halten und dauerhaft anzeigen
- Aus:** Anzeige der Messwerte ausschalten

- 9** Für die Dauer eines zuvor bestimmten Aufzeichnungsintervalls eine automatische Messung durchführen
- 10** Aktuell angezeigten Messwert als Einzelmessung mit Zeitstempel und Datum im Archiv speichern.

- 6** Selection of the respective measured value
- 7** Reset of measuring period for MIN, MAX, AVG or HOLD
- 8** Specification of how measured values are displayed:
Minimum: Display smallest measured value from a measuring period
Maximum: Display largest measured value from a measuring period
Average: Display of the average value of all measured values from a measuring period

- Hold:** Hold and continuously display the current measured value
- Off:** Switch-off of the display of measured values

- 9** Perform automatic measurement for the duration of a previously specified recording interval
- 10** Save currently displayed measured value as single measurement in the archive with date and time stamp.

Micro-USB-Kabel verbinden Micro-USB cable connection

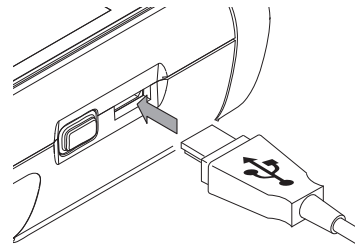

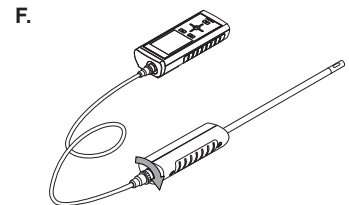
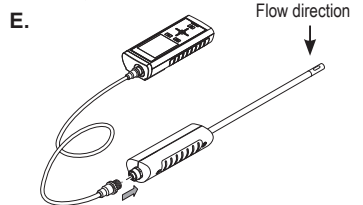
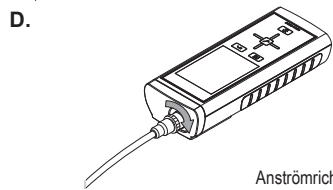
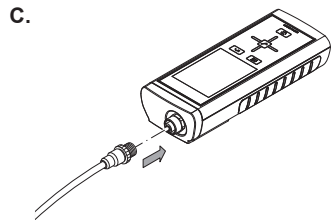
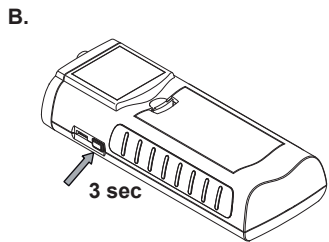
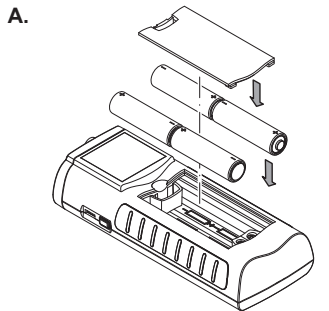

Bedienungsanleitung:



www.epluse.com/omniport30_manual_de.pdf

Bedienelemente
Operating elements

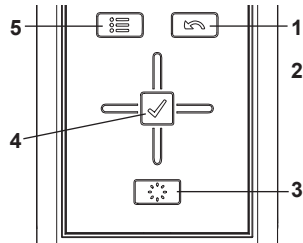

1 Zurück 2 Steuerkreuz
 3 Beleuchtung ein/aus 4 OK 5 Hauptmenü

1 back 2 control cross
 3 illumination on/off 4 OK 5 main menu

Manual:



www.epluse.com/omniport30_manual_en.pdf

PC-Software SmartGraph3:
www.epluse.com/smartgraph3

