

## Specification E2 Interface

### Version 4.1

|                    | Name             | Date       |
|--------------------|------------------|------------|
| Created:           | Haider A.        | 16.05.2011 |
| Checked:           | Robert Mayr      | 16.05.2011 |
| Approved:          | Schwarz Roswitha | 20.05.2011 |
| Reason for change: | Text corrections |            |

## TABLE OF CONTENTS

|          |  |           |
|----------|--|-----------|
| <b>1</b> | <b>INTRODUCTION .....</b>                              | <b>3</b>  |
| 1.1      | Overview.....  | 3         |
| 1.2      | Agreements .....                                       | 3         |
| <b>2</b> | <b>CHARACTERISTICS .....</b>                           | <b>3</b>  |
| 2.1      | Layer 1: Physical Layer .....                          | 3         |
| 2.2      | Layer 2: Data Link Layer.....                          | 5         |
| 2.2.1    | Bit-transfer .....                                     | 5         |
| 2.2.2    | Data Transfer Formats.....                             | 5         |
| 2.2.3    | Control Byte .....                                     | 6         |
| 2.2.4    | PEC Packet Error Code (Checksum).....                  | 6         |
| 2.3      | Layer 3: Network Layer (Protocol) .....                | 7         |
| 2.3.1    | Read Byte from Slave .....                             | 7         |
| 2.3.2    | Write Byte to Slave .....                              | 10        |
| 2.4      | Memory areas.....                                      | 12        |
| 2.4.1    | Custom memory .....                                    | 12        |
| <b>3</b> | <b>APPENDIX: FLOW-CHARTS .....</b>                     | <b>18</b> |
| 3.1      | “Addressing + Read/Write distinction” flow chart ..... | 18        |
| 3.2      | “Read from Memory” flow chart .....                    | 19        |
| 3.2.1    | “Read from Custom Memory” flow chart .....             | 19        |
| 3.3      | “Write to Memory” flow chart.....                      | 20        |
| 3.3.1    | “Write to Custom Memory” flow chart .....              | 20        |

## 1 Introduction

### 1.1 Overview

The E2 interface has been specified by E+E Elektronik in 2004 and represents a subset of the E2 interface protocol. The E2 interface is based on similar principles to the I<sup>2</sup>C Bus<sup>1</sup> or the SMBus<sup>1</sup> introduced by Phillips Semiconductors in 1982. The most significant differences to the I<sup>2</sup>C Bus are the slower transmission rate, the slightly divergent addressing mechanism and the error detection (checksum). The E2 interface is used for the digital, bi-directional data transmission between a master module (e.g.: climate controller, microcontroller, etc.) and a slave module (often an E+E transmitter). The data transmission takes place in synchronous and serial modes, whereby the master is responsible for generating the clock pulse. The slave cannot send any data independently.

### 1.2 Agreements

The technical specifications in this document are to be regarded as recommendations and apply for all E+E transmitters with E2 interface, assuming nothing to the contrary is specified in their data sheets.

#### Terms:

Master: Module with E2 interface that initiates communication and can drive a clock signal.

Slave: Module with E2 interface that cannot drive a clock signal

## 2 Characteristics

In the following, the E2 interface will be specified in accordance with the ISO-OSI Layer Model up to Layer 3. In addition, it should also be noted that due to the significant similarity to the SM Bus or the I<sup>2</sup>C Bus, the E2 interface is hardware-compatible with popular microcontrollers with interfaces of that type. This means that E2-slaves can be directly connected to the corresponding pins of these controllers.

### 2.1 Layer 1: Physical Layer

The E2 interface consists of two active lines (Clock and Data) as well as an earthing line as reference potential. The Clock and Data lines are connected with the operating voltage via pull-up resistors. In the idle state, both lines are at High-Level (positive logic). The respective inputs and outputs of the modules are designed as Open Drain (or Open Collector), and thus can be connected directly as „wired AND“.

---

<sup>1</sup> All brands, names, product names and logos listed are registered trademarks or brands of their respective owners that we hereby explicitly acknowledge.

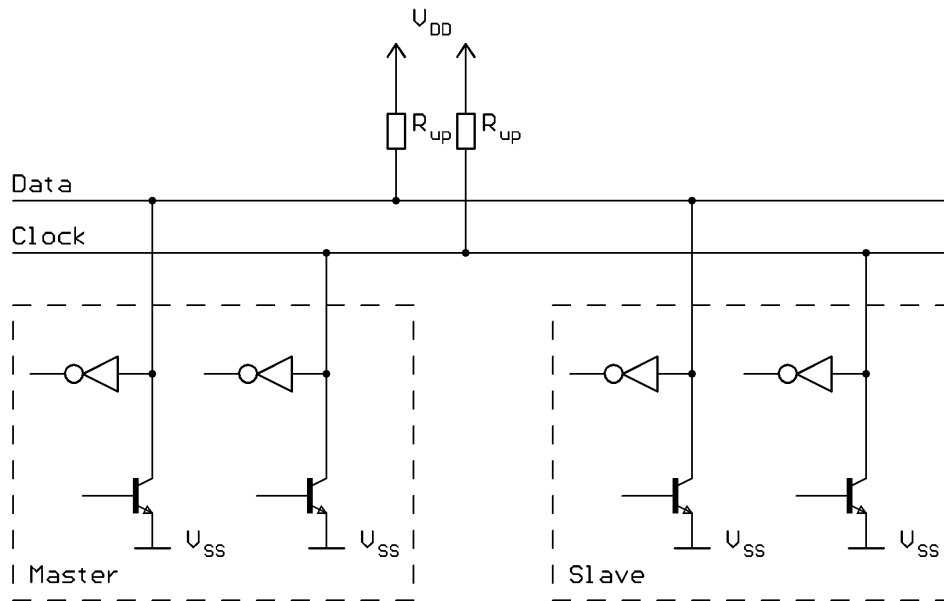

**Fig. 1: Principle joining together of master- and slave Module**

**Parameter**

| Symbol     | Parameter                   | Minimum        | Maximum                    | Unit             | Remark  |
|------------|-----------------------------|----------------|----------------------------|------------------|---|
| $V_{DD}$   | Operating Voltage           |                |                            | V                | See module description                          |
| $V_{IH}$   | Input High Level            | $0,8 V_{DD}$   | $V_{DD} + 0,3$             | V                |   |
| $V_{IL}$   | Input Low Level             | $V_{SS} - 0,3$ | $0,2 * V_{DD}$<br>or $0,8$ | V                | Smallest value is valid                         |
| $V_{OL}$   | Output Low Level            |                | $0,7$                      | V                | $I_{in} = 0,5 \text{ mA}$                       |
| $C_{max}$  | Line capacity to ground     |                | $1$                        | nF               | @ $R_{up} = 22 \text{ k}\Omega$<br>see Remark 1 |
| $f_{CLK}$  | Clock frequency (data rate) | $500$          | $5000$                     | Hz               | see Remark 1                                    |
| $t_{CLKH}$ | Clock-High time             | $100$          |                            | $\mu\text{s}$    |   |
| $t_{CLKL}$ | Clock-Low time              | $100$          |                            | $\mu\text{s}$    |   |
| $R_{up}$   | Pull-up resistor            | $1$            | $100$                      | $\text{k}\Omega$ | see Remark 1                                    |

For any other parameters not specified here, the specifications in the data sheets of the modules used apply.

Remark 1: The maximum data rate that can be achieved depends on the combination of the line capacity and the pull-up resistors. The  $R_{UP}$  value is the value of all pull-up resistors connected in parallel.

## 2.2 Layer 2: Data Link Layer

### 2.2.1 Bit-transfer

The data transmission always takes place serially by bit and synchronously. The clock line is used as a synchronisation line, which is always controlled by the master. With the exception of the start and stop conditions, a change of the level on the data line is only permissible during a LOW-phase of the clock line. At the beginning of every communication there is a start condition. This is realised by a negative edge on the data line, with simultaneous sustained high-level on the clock line. After a delay of at least 4µs the clock line is drawn to low-level, and the first data bit (MSB) can be placed on the data line. The data transfer takes place during the high-phase of the clock line. After all data bits (incl. ACK/ NACK) have been sent, the communication is terminated with a stop condition. A stop condition is defined by a positive edge on the data line with simultaneous high-level on the clock line.

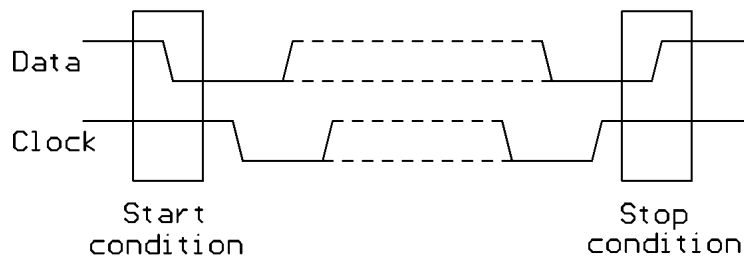

**Fig. 2: Bit Transfer**

### Clock Low Extension

The slave has the option of holding the clock line at low level for up to 25ms after every transmitted data bit to gain a little time for internal operations. The total transmission time for a complete byte may not exceed 35ms, however.

### 2.2.2 Data Transfer Formats

The data is transmitted from the transmitter in bytes, and confirmed by the receiver individually (for each byte) with ACK (data line = Low) or NACK (data line = High) as ninth bit. The first data byte (control byte) is always sent from the master to the slave. The first four bits represent the main command and the next three bits represent the „address“ of the slave module. The eighth bit (R/W) specifies the direction of the data transfer (R/W=0 data from master to slave; R/W='1' data from slave to master).

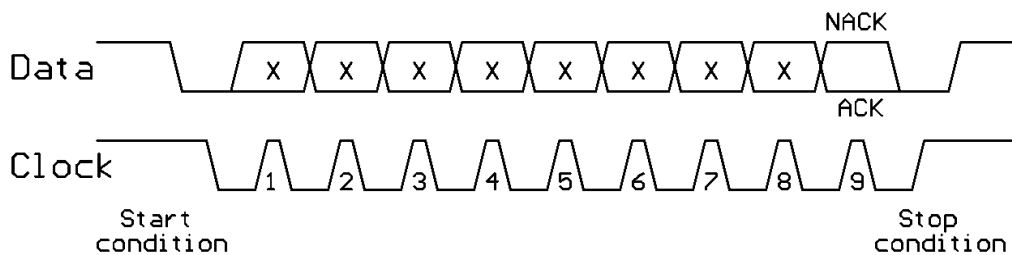

**Fig. 3: Byte Transfer**

### 2.2.3 Control Byte

The control byte of the E2 interface is used only for the differentiation of various command modes (which are defined in what is referred to as the main command) and the data flow direction (R/W). The control byte is defined as follows:

| Control Byte |       |       |       |                |       |       |       |
|--------------|-------|-------|-------|----------------|-------|-------|-------|
| Bit 7        | Bit 6 | Bit 5 | Bit 4 | Bit 3          | Bit 2 | Bit 1 | Bit 0 |
| Main Command |       |       |       | Device Address |       |       | R/W   |

**Fig. 4: Control Byte Structure**

| Bit     | Meaning                 |
|---------|-------------------------|
| 0 (LSB) | R/W                     |
| 1       | Device address low bit  |
| 2       | Device address          |
| 3       | Device address high bit |
| 4       | Main command low bit    |
| 5       | Main command            |
| 6       | Main command            |
| 7 (MSB) | Main command high bit   |

### 2.2.4 PEC Packet Error Code (Checksum)

For the detection of transmission errors a checksum byte is transmitted as the last data byte of every transmission. The checksum byte corresponds to the low byte of the sum (unsigned char) of all transmitted bytes.

Read: Checksum byte = (Control byte + Data byte) MOD 0x100

Write: Checksum byte = (Control byte + Address byte + Data byte) MOD 0x100

## 2.3 Layer 3: Network Layer (Protocol)

All defined commands of the E2 interface are described in this section. Refer to the data sheets of the modules used for the data format of the transmitted data bytes.

### 2.3.1 Read Byte from Slave

This command is supported by all modules with E2 interface and is used to read individual data bytes.

Command structure:

| Start | Control Byte |   |   |   |   |   |   |   | Data Byte |   |   |   |   |   |   |   | Checksum |     |   |   |   |   |   |   | Stop |    |      |  |
|-------|--------------|---|---|---|---|---|---|---|-----------|---|---|---|---|---|---|---|----------|-----|---|---|---|---|---|---|------|----|------|--|
|       | 7            | 6 | 5 | 4 | 3 | 2 | 1 | 0 | ACK       | 7 | 6 | 5 | 4 | 3 | 2 | 1 | 0        | ACK | 7 | 6 | 5 | 4 | 3 | 2 | 1    | 0  | ACK  |  |
| Start |              |   |   |   |   |   | 1 | A | x         | x | x | x | x | x | x | x | A        | x   | x | x | x | x | x | x | x    | NA | Stop |  |

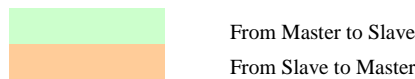

**Attention:** For the Read command, the bit 0 of the control byte is always '1' (High). The Read command is terminated by a **NACK** and a stop condition of the master.

For Read Byte from Slave, the Main Commands are organised so that important data and information bytes (all measured values, status byte, sensor type, etc.) can be read out with one single command (at the expense of I<sup>2</sup>C address space).

Non-implemented main commands will be answered as „0x55“ or “0xFF”.

The following Main Commands are defined:

| Control byte | Bit number |   |   |   | Type of command                   |
|--------------|------------|---|---|---|-----------------------------------|
|              | 7          | 6 | 5 | 4 |                                   |
| 0x11         | 0          | 0 | 0 | 1 | Sensor type (group L-Byte)        |
| 0x21         | 0          | 0 | 1 | 0 | Sensor type (subgroup)            |
| 0x31         | 0          | 0 | 1 | 1 | Available physical measurements   |
| 0x41         | 0          | 1 | 0 | 0 | Sensor type (group H-Byte)        |
| 0x51         | 0          | 1 | 0 | 1 | Read from internal custom address |
| 0x71         | 0          | 1 | 1 | 1 | Status byte                       |
| 0x81         | 1          | 0 | 0 | 0 | Measurement value 1 low byte      |
| 0x91         | 1          | 0 | 0 | 1 | Measurement value 1 high byte     |
| 0xA1         | 1          | 0 | 1 | 0 | Measurement value 2 low byte      |
| 0xB1         | 1          | 0 | 1 | 1 | Measurement value 2 high byte     |
| 0xC1         | 1          | 1 | 0 | 0 | Measurement value 3 low byte      |
| 0xD1         | 1          | 1 | 0 | 1 | Measurement value 3 high byte     |
| 0xE1         | 1          | 1 | 1 | 0 | Measurement value 4 low byte      |
| 0xF1         | 1          | 1 | 1 | 1 | Measurement value 4 high byte     |

### 2.3.1.2 Sensor type (group L-Byte & H-Byte, control byte 0x11 & 0x41)

Identifies the current sensor type (16 bits)

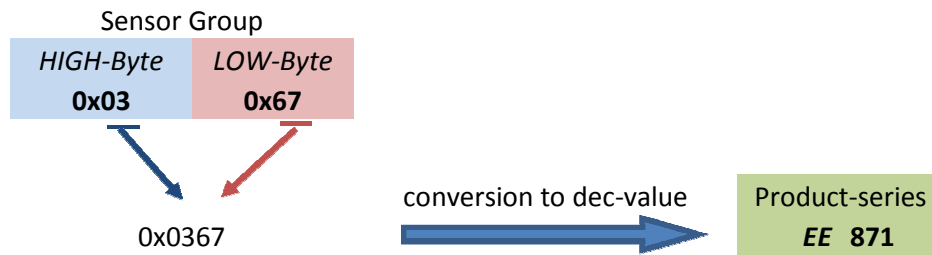

### 2.3.1.3 Sensor type (sub-group, control byte 0x21)

Indicate the slave sub-group (upper 4 bits) and the output type (lower 4 bits)

Example: sub-group = 19 hex for EE<sub>xxx</sub>-1 in FT9 implementation (E2 interface).  
sub-group = 46 hex for EE<sub>xxx</sub>-4 in FT6 implementation (4-20mA).

For detailed information see slave product description. Available physical measurements (control byte 0x31)

This byte explains the supported active physical measurements of the slave (which is physical measured from the Slave), independent from the (analog) output. Every bit represents a physical measurement:

| Available physical measurements |          |          |          |                 |              |             |          |
|---------------------------------|----------|----------|----------|-----------------|--------------|-------------|----------|
| Bit 7                           | Bit 6    | Bit 5    | Bit 4    | Bit 3           | Bit 2        | Bit 1       | Bit 0    |
| reserved                        | reserved | reserved | reserved | CO <sub>2</sub> | air velocity | temperature | humidity |

1...supported  
0...**not** supported (unsupported)

### 2.3.1.5 Read from internal custom address (control byte 0x51)

When you read out the slave with the “read from internal custom address” command (Control byte = 0x51) you will get the data (one Byte) from the actual custom address (internal address pointer). After powering up the slave, this internal address pointer is always ‘0x00’ and increments after every reading (Control byte 0x51). A direct write operation to this address pointer is only possible by a write command. See 2.3.2 Write Byte to Slave. If the internal custom address is greater than 1Byte the High-Byte is ignored (Internal address = 0xFF → read from internal address → increment internal address → new internal address = 0x00)



### 2.3.1.7 Read Status byte (control byte 0x71)

Reading the Status byte starts a new measurement (within the slave). After the slave specific measurement time the measurement values are ready for read out.

The status byte provides information about the validity of the last measurement.

Every bit represents a physical quantity (equal to the “Available physical measurements”):

| Status byte |          |          |          |                 |              |             |          |
|-------------|----------|----------|----------|-----------------|--------------|-------------|----------|
| Bit 7       | Bit 6    | Bit 5    | Bit 4    | Bit 3           | Bit 2        | Bit 1       | Bit 0    |
| reserved    | reserved | reserved | reserved | CO <sub>2</sub> | air velocity | temperature | humidity |

Bit value:

- 1...error during measurement (see slave description)
- 0...measurement is OK

### 2.3.1.8 Read measurements (control byte 0x81 to 0xF1)

When reading out a 16 bit measured variable, it is necessary to read out the low byte first and then the associated high byte. This ensures, that two associated bytes are always read out (when reading the low byte together, the high byte is „captured“ in the slave). For the data format of the measured values **refer to the data sheets of the corresponding modules.**

Often used but not compulsory is the following assignment (similar to the bit order):

Measurement value 1 = humidity

Measurement value 2 = temperature

Measurement value 3 = air velocity

Measurement value 4= carbon dioxide (CO<sub>2</sub>)

### 2.3.2 Write Byte to Slave

The “write Byte to Slave” is used to configure the slave.

After a “write byte to slave” command it is required to verify that the data is at the right address. The slave ACK only indicates only that the last command was transferred correctly. The checksum is verified afterwards, meaning it is possible for the previous command to be invalid. Command structure:

| Start | Control byte |   |   |   |   |   |   |   |     | Address byte |   |   |   |   |   |   |   |     | Data byte |   |   |   |   |   |   |   |     | Checksum |   |   |   |   |   |   |   |     | Stop |
|-------|--------------|---|---|---|---|---|---|---|-----|--------------|---|---|---|---|---|---|---|-----|-----------|---|---|---|---|---|---|---|-----|----------|---|---|---|---|---|---|---|-----|------|
|       | 7            | 6 | 5 | 4 | 3 | 2 | 1 | 0 | ACK | 7            | 6 | 5 | 4 | 3 | 2 | 1 | 0 | ACK | 7         | 6 | 5 | 4 | 3 | 2 | 1 | 0 | ACK | 7        | 6 | 5 | 4 | 3 | 2 | 1 | 0 | ACK |      |
| Start | x            | x | x | x | x | x | x | 0 | A   | x            | x | x | x | x | x | x | x | A   | x         | x | x | x | x | x | x | x | A   | x        | x | x | x | x | x | x | x | A   | Stop |

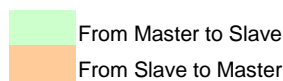

**Attention:** The Bit 0 of the Control byte during the write command is always ‘0’ (low).

For “Write Byte to Slave”, the main commands are organized in such a form, that important bytes can be written with one single command. (at the expense of I<sup>2</sup>C address space)

The main command is not implemented on all components using the E2 interface. Therefore please check the written variables by an additional read command.

Defined main commands:

| Control byte | Bit number |   |   |   | Command description         |
|--------------|------------|---|---|---|-----------------------------|
|              | 7          | 6 | 5 | 4 |                             |
| 0x10         | 0          | 0 | 0 | 1 | Direct write to custom area |
| 0x50         | 0          | 1 | 0 | 1 | Set internal custom pointer |

### 2.3.2.2 Direct write to custom area (0x10)

The main command 0x10 can be used to write one byte directly into the custom area. The address in the custom area and the data is stated directly in the command structure (see command structure above).

### 2.3.2.5 Set internal custom (address) pointer (0x50)

When there is a custom area in a slave, there will also be a custom (address) pointer.

Internal custom (address) pointer low Byte = Data byte

Internal custom (address) pointer high Byte = Address byte

This pointer increments automatically after every read from an internal address.

This custom pointer can be used to read out data from the custom area:

- 1.) Set the custom (address) pointer to the desired value with the **write** main command (Control Byte = 0x50)
- 2.) Read the custom area with the main command “**read** from internal custom address” (Control Byte = 0x51, auto increment after reading)

## 2.4 Memory areas

### 2.4.1 Custom memory

This page is also a functional overview. If in “supported functions” (bytes 0x03...0x3F) a bit is set, the function could be read (and written). See bytes 0x40 and following

| Adr.         | R / W | Group description   | Description                 | Detail   |                          |                             |                           |                        |                |             |                   | Comment   |   |   |   |   |   |   |   |            |                          |                             |                           |                        |                |             |                   |     |  |  |  |     |  |  |     |  |
|--------------|-------|---------------------|-----------------------------|--|--------------------------|-----------------------------|---------------------------|------------------------|----------------|-------------|-------------------|---|---|---|---|---|---|---|---|------------|--------------------------|-----------------------------|---------------------------|------------------------|----------------|-------------|-------------------|-----|--|--|--|-----|--|--|-----|--|
| 0x00         | R     | Firmware-Version    | Main version                | 1 = Version 1.xx   |                          |                             |                           |                        |                |             |                   | FW-version = 0x55.0x55 means, that no command is supported      |   |   |   |   |   |   |   |            |                          |                             |                           |                        |                |             |                   |     |  |  |  |     |  |  |     |  |
| 0x01         | R     | Firmware-Version    | Sub-Version                 | 12 = Version x.12  |                          |                             |                           |                        |                |             |                   | FW-version = 0x55.0x55 means, that no command is supported      |   |   |   |   |   |   |   |            |                          |                             |                           |                        |                |             |                   |     |  |  |  |     |  |  |     |  |
| 0x02         | R     | E2-Spec             | Version of E2-specification | 4 = Version 4  |                          |                             |                           |                        |                |             |                   | Version of the E2 specification used during product development |   |   |   |   |   |   |   |            |                          |                             |                           |                        |                |             |                   |     |  |  |  |     |  |  |     |  |
| 0x03         | R     | Supported functions | Custom adjustment           | <table border="1" style="width:100%; text-align:center;"> <tr> <td>7</td><td>6</td><td>5</td><td>4</td><td>3</td><td>2</td><td>1</td><td>0</td> </tr> <tr> <td>reserved</td><td>reserved</td><td>reserved</td><td>reserved</td><td>OG- CO<sub>2</sub></td><td>OG-v</td><td>OG-T</td><td>OG-RH</td> </tr> <tr> <td colspan="4">MSB</td><td colspan="4">LSB</td> </tr> </table>  |                          |                             |                           |                        |                |             |                   | 7   | 6 | 5 | 4 | 3 | 2 | 1 | 0 | reserved   | reserved                 | reserved                    | reserved                  | OG- CO <sub>2</sub>    | OG-v           | OG-T        | OG-RH             | MSB |  |  |  | LSB |  |  |     | OG = Offset and Gain<br>(each physical quantity)<br>0= not supported   |
|              |       |                     |                             | 7  | 6                        | 5                           | 4                         | 3                      | 2              | 1           | 0                 |   |   |   |   |   |   |   |   |            |                          |                             |                           |                        |                |             |                   |     |  |  |  |     |  |  |     |  |
|              |       |                     |                             | reserved   | reserved                 | reserved                    | reserved                  | OG- CO <sub>2</sub>    | OG-v           | OG-T        | OG-RH             |   |   |   |   |   |   |   |   |            |                          |                             |                           |                        |                |             |                   |     |  |  |  |     |  |  |     |  |
| MSB          |       |                     |                             | LSB  |                          |                             |                           |                        |                |             |                   |   |   |   |   |   |   |   |   |            |                          |                             |                           |                        |                |             |                   |     |  |  |  |     |  |  |     |  |
| 0x04         | R     |                     | Custom adjustment           | <table border="1" style="width:100%; text-align:center;"> <tr> <td>7</td><td>6</td><td>5</td><td>4</td><td>3</td><td>2</td><td>1</td><td>0</td> </tr> <tr> <td>reserved</td><td>reserved</td><td>reserved</td><td>reserved</td><td>APt- CO<sub>2</sub></td><td>APt -v</td><td>APt -T</td><td>APt -RH</td> </tr> <tr> <td colspan="4">MSB</td><td colspan="4">LSB</td> </tr> </table>   |                          |                             |                           |                        |                |             |                   | 7   | 6 | 5 | 4 | 3 | 2 | 1 | 0 | reserved   | reserved                 | reserved                    | reserved                  | APt- CO <sub>2</sub>   | APt -v         | APt -T      | APt -RH           | MSB |  |  |  | LSB |  |  |     | Availability of “save adjustment point value at custom Calibration” (each physical quantity)<br>0= not supported |
|              |       |                     |                             | 7  | 6                        | 5                           | 4                         | 3                      | 2              | 1           | 0                 |   |   |   |   |   |   |   |   |            |                          |                             |                           |                        |                |             |                   |     |  |  |  |     |  |  |     |  |
|              |       |                     |                             | reserved   | reserved                 | reserved                    | reserved                  | APt- CO <sub>2</sub>   | APt -v         | APt -T      | APt -RH           |   |   |   |   |   |   |   |   |            |                          |                             |                           |                        |                |             |                   |     |  |  |  |     |  |  |     |  |
| MSB          |       |                     |                             | LSB  |                          |                             |                           |                        |                |             |                   |   |   |   |   |   |   |   |   |            |                          |                             |                           |                        |                |             |                   |     |  |  |  |     |  |  |     |  |
| 0x05         | R     |                     | Custom adjustment           | <table border="1" style="width:100%; text-align:center;"> <tr> <td>7</td><td>6</td><td>5</td><td>4</td><td>3</td><td>2</td><td>1</td><td>0</td> </tr> <tr> <td>reserved</td><td>reserved</td><td>reserved</td><td>reserved</td><td>reserved</td><td>reserved</td><td>reserved</td><td>ATime-gen</td> </tr> <tr> <td colspan="4">MSB</td><td colspan="4">LSB</td> </tr> </table>  |                          |                             |                           |                        |                |             |                   | 7   | 6 | 5 | 4 | 3 | 2 | 1 | 0 | reserved   | reserved                 | reserved                    | reserved                  | reserved               | reserved       | reserved    | ATime-gen         | MSB |  |  |  | LSB |  |  |     | Availability of the timestamp<br>(custom adjustment, general)<br>0= not supported                                |
|              |       |                     |                             | 7  | 6                        | 5                           | 4                         | 3                      | 2              | 1           | 0                 |   |   |   |   |   |   |   |   |            |                          |                             |                           |                        |                |             |                   |     |  |  |  |     |  |  |     |  |
|              |       |                     |                             | reserved   | reserved                 | reserved                    | reserved                  | reserved               | reserved       | reserved    | ATime-gen         |   |   |   |   |   |   |   |   |            |                          |                             |                           |                        |                |             |                   |     |  |  |  |     |  |  |     |  |
| MSB          |       |                     |                             | LSB  |                          |                             |                           |                        |                |             |                   |   |   |   |   |   |   |   |   |            |                          |                             |                           |                        |                |             |                   |     |  |  |  |     |  |  |     |  |
| 0x06         | R     |                     | Custom adjustment           | <table border="1" style="width:100%; text-align:center;"> <tr> <td>7</td><td>6</td><td>5</td><td>4</td><td>3</td><td>2</td><td>1</td><td>0</td> </tr> <tr> <td>reserved</td><td>reserved</td><td>reserved</td><td>reserved</td><td>ATime- CO<sub>2</sub></td><td>ATime-v</td><td>ATime-T</td><td>ATime-RH</td> </tr> <tr> <td colspan="4">MSB</td><td colspan="4">LSB</td> </tr> </table>  |                          |                             |                           |                        |                |             |                   | 7   | 6 | 5 | 4 | 3 | 2 | 1 | 0 | reserved   | reserved                 | reserved                    | reserved                  | ATime- CO <sub>2</sub> | ATime-v        | ATime-T     | ATime-RH          | MSB |  |  |  | LSB |  |  |     | Availability of the timestamp (custom Adjustment each physical quantity)<br>0= not supported                     |
|              |       |                     |                             | 7  | 6                        | 5                           | 4                         | 3                      | 2              | 1           | 0                 |   |   |   |   |   |   |   |   |            |                          |                             |                           |                        |                |             |                   |     |  |  |  |     |  |  |     |  |
|              |       |                     |                             | reserved   | reserved                 | reserved                    | reserved                  | ATime- CO <sub>2</sub> | ATime-v        | ATime-T     | ATime-RH          |   |   |   |   |   |   |   |   |            |                          |                             |                           |                        |                |             |                   |     |  |  |  |     |  |  |     |  |
| MSB          |       |                     |                             | LSB  |                          |                             |                           |                        |                |             |                   |   |   |   |   |   |   |   |   |            |                          |                             |                           |                        |                |             |                   |     |  |  |  |     |  |  |     |  |
| 0x07         | R     |                     | Operating functions         | <table border="1" style="width:100%; text-align:center;"> <tr> <td>7</td><td>6</td><td>5</td><td>4</td><td>3</td><td>2</td><td>1</td><td>0</td> </tr> <tr> <td>Error Code</td><td>Measurement Value Filter</td><td>Specific Measuring Interval</td><td>Global Measuring Interval</td><td>reserved</td><td>E2 Bus address</td><td>Custom name</td><td>E+E serial number</td> </tr> <tr> <td colspan="4">MSB</td><td colspan="4">LSB</td> </tr> </table> |                          |                             |                           |                        |                |             |                   | 7   | 6 | 5 | 4 | 3 | 2 | 1 | 0 | Error Code | Measurement Value Filter | Specific Measuring Interval | Global Measuring Interval | reserved               | E2 Bus address | Custom name | E+E serial number | MSB |  |  |  | LSB |  |  |     | Availability of several functions<br>0= not supported  |
|              |       |                     |                             | 7  | 6                        | 5                           | 4                         | 3                      | 2              | 1           | 0                 |   |   |   |   |   |   |   |   |            |                          |                             |                           |                        |                |             |                   |     |  |  |  |     |  |  |     |  |
|              |       |                     |                             | Error Code   | Measurement Value Filter | Specific Measuring Interval | Global Measuring Interval | reserved               | E2 Bus address | Custom name | E+E serial number |   |   |   |   |   |   |   |   |            |                          |                             |                           |                        |                |             |                   |     |  |  |  |     |  |  |     |  |
| MSB          |       |                     |                             | LSB  |                          |                             |                           |                        |                |             |                   |   |   |   |   |   |   |   |   |            |                          |                             |                           |                        |                |             |                   |     |  |  |  |     |  |  |     |  |
| 0x08         | R     |                     | Operating mode              | <table border="1" style="width:100%; text-align:center;"> <tr> <td>7</td><td>6</td><td>5</td><td>4</td><td>3</td><td>2</td><td>1</td><td>0</td> </tr> <tr> <td>reserved</td><td>reserved</td><td>reserved</td><td>reserved</td><td>reserved</td><td>reserved</td><td>E2 priority</td><td>Measure mode</td> </tr> <tr> <td colspan="4">MSB</td><td colspan="4">LSB</td> </tr> </table>  |                          |                             |                           |                        |                |             |                   | 7   | 6 | 5 | 4 | 3 | 2 | 1 | 0 | reserved   | reserved                 | reserved                    | reserved                  | reserved               | reserved       | E2 priority | Measure mode      | MSB |  |  |  | LSB |  |  |     | Availability of several functions<br>0= not supported  |
|              |       |                     |                             | 7  | 6                        | 5                           | 4                         | 3                      | 2              | 1           | 0                 |   |   |   |   |   |   |   |   |            |                          |                             |                           |                        |                |             |                   |     |  |  |  |     |  |  |     |  |
|              |       |                     |                             | reserved   | reserved                 | reserved                    | reserved                  | reserved               | reserved       | E2 priority | Measure mode      |   |   |   |   |   |   |   |   |            |                          |                             |                           |                        |                |             |                   |     |  |  |  |     |  |  |     |  |
| MSB          |       |                     |                             | LSB  |                          |                             |                           |                        |                |             |                   |   |   |   |   |   |   |   |   |            |                          |                             |                           |                        |                |             |                   |     |  |  |  |     |  |  |     |  |
| 0x09         | R     |                     | Special features            | <table border="1" style="width:100%; text-align:center;"> <tr> <td>7</td><td>6</td><td>5</td><td>4</td><td>3</td><td>2</td><td>1</td><td>0</td> </tr> <tr> <td>reserved</td><td>reserved</td><td>reserved</td><td>reserved</td><td>reserved</td><td>reserved</td><td>reserved</td><td>Auto adjustment</td> </tr> <tr> <td colspan="7">MSB</td><td>LSB</td> </tr> </table>  |                          |                             |                           |                        |                |             |                   | 7   | 6 | 5 | 4 | 3 | 2 | 1 | 0 | reserved   | reserved                 | reserved                    | reserved                  | reserved               | reserved       | reserved    | Auto adjustment   | MSB |  |  |  |     |  |  | LSB | Availability of several functions<br>0= not supported  |
|              |       |                     |                             | 7  | 6                        | 5                           | 4                         | 3                      | 2              | 1           | 0                 |   |   |   |   |   |   |   |   |            |                          |                             |                           |                        |                |             |                   |     |  |  |  |     |  |  |     |  |
|              |       |                     |                             | reserved   | reserved                 | reserved                    | reserved                  | reserved               | reserved       | reserved    | Auto adjustment   |   |   |   |   |   |   |   |   |            |                          |                             |                           |                        |                |             |                   |     |  |  |  |     |  |  |     |  |
| MSB          |       |                     |                             |  |                          |                             | LSB                       |                        |                |             |                   |   |   |   |   |   |   |   |   |            |                          |                             |                           |                        |                |             |                   |     |  |  |  |     |  |  |     |  |
| 0x0A to 0x3F | R     |                     | 54 reserved                 |  |                          |                             |                           |                        |                |             |                   |   |   |   |   |   |   |   |   |            |                          |                             |                           |                        |                |             |                   |     |  |  |  |     |  |  |     |  |

| Adr.               | R/W | Group description | Description     | Detail                                 | L/H-Byte | Comment  |
|--------------------|-----|-------------------|-----------------|--|----------|--|
| 0x40               | R/W | Custom adjustment | Humidity        | Offset                                 | L-Byte   | Offset = signed Int [1/100 %RH]  |
| 0x41               | R/W |                   |                 | Offset                                 | H-Byte   |  |
| 0x42               | R/W |                   |                 | Gain                                   | L-Byte   | Gain = GainValue/32768 ( Example: GainValue = 32768 → Gain of 1,0000000) |
| 0x43               | R/W |                   |                 | Gain                                   | H-Byte   |  |
| 0x44               | R/W |                   |                 | Fpoint_L                               | L-Byte   | [1/100 %RH] Level of last "lower" adjustment point                       |
| 0x45               | R/W |                   |                 | Fpoint_L                               | H-Byte   |  |
| 0x46               | R/W |                   |                 | Fpoint_U                               | L-Byte   | [1/100 %RH] Level of last "upper" adjustment point                       |
| 0x47               | R/W |                   |                 | Fpoint_U                               | H-Byte   |  |
| 0x48               | R/W |                   | Temp.           | Offset                                 | L-Byte   | Offset = signed Int [1/100 K]  |
| 0x49               | R/W |                   |                 | Offset                                 | H-Byte   |  |
| 0x4A               | R/W |                   |                 | Gain                                   | L-Byte   | Gain = GainValue/32768 ( Example: GainValue = 32768 → Gain of 1,0000000) |
| 0x4B               | R/W |                   |                 | Gain                                   | H-Byte   |  |
| 0x4C               | R/W |                   |                 | Tpoint_L                               | L-Byte   | [1/100 K] Level of last "lower" adjustment point                         |
| 0x4D               | R/W |                   |                 | Tpoint_L                               | H-Byte   |  |
| 0x4E               | R/W |                   |                 | Tpoint_U                               | L-Byte   | [1/100 K] Level of last "upper" adjustment point                         |
| 0x4F               | R/W |                   |                 | Tpoint_U                               | H-Byte   |  |
| 0x50               | R/W |                   | Air velocity    | Offset                                 | L-Byte   | Offset = signed Int [1/100 m/s]  |
| 0x51               | R/W |                   |                 | Offset                                 | H-Byte   |  |
| 0x52               | R/W |                   |                 | Gain                                   | L-Byte   | Gain = GainValue/32768 ( Example: GainValue = 32768 → Gain of 1,0000000) |
| 0x53               | R/W |                   |                 | Gain                                   | H-Byte   |  |
| 0x54               | R/W |                   |                 | Vpoint_L                               | L-Byte   | [1/100 m/s] Level of last "lower" adjustment point                       |
| 0x55               | R/W |                   |                 | Vpoint_L                               | H-Byte   |  |
| 0x56               | R/W |                   |                 | Vpoint_U                               | L-Byte   | [1/100 m/s] Level of last "upper" adjustment point                       |
| 0x57               | R/W |                   |                 | Vpoint_U                               | H-Byte   |  |
| 0x58               | R/W |                   | CO <sub>2</sub> | Offset                                 | L-Byte   | Offset = signed Int [ppm]  |
| 0x59               | R/W |                   |                 | Offset                                 | H-Byte   |  |
| 0x5A               | R/W |                   |                 | Gain                                   | L-Byte   | Gain = GainValue/32768 ( Example: GainValue = 32768 → Gain of 1,0000000) |
| 0x5B               | R/W |                   |                 | Gain                                   | H-Byte   |  |
| 0x5C               | R/W |                   |                 | CO2point_L                             | L-Byte   | [ppm] Level of last "lower" adjustment point                             |
| 0x5D               | R/W |                   |                 | CO2point_L                             | H-Byte   |  |
| 0x5E               | R/W |                   |                 | CO2point_U                             | L-Byte   | [ppm] Level of last "upper" adjustment point                             |
| 0x5F               | R/W |                   |                 | CO2point_U                             | H-Byte   |  |
| 0x60<br>to<br>0x7F | R/W |                   | 32 reserved     | Reserved for other physical quantities |          |  |

| Adr.         | R /W | Group description     | Description            | Detail  | L/H-Byte | Comment   |
|--------------|------|-----------------------|------------------------|---|----------|---|
| 0x80         | R/W  | Custom adjustment     | CA - global            | Year  |          | Last custom adjustment (date); Year = 6 → 2006                              |
| 0x81         | R/W  |                       | CA - global            | Month   |          | 1 to 12   |
| 0x82         | R/W  |                       | CA - global            | Day   |          |   |
| 0x83         | R/W  |                       | CA- Humidity           | Year  |          | Last custom adjustment (date) RH; Year = 6 → 2006                           |
| 0x84         | R/W  |                       | CA- Humidity           | Month   |          | 1 to 12   |
| 0x85         | R/W  |                       | CA- Humidity           | Day   |          |   |
| 0x86         | R/W  |                       | CA- Temperature        | Year  |          | Last custom adjustment (date)Temp.; Year = 6 → 2006                         |
| 0x87         | R/W  |                       | CA- Temperature        | Month   |          | 1 to 12   |
| 0x88         | R/W  |                       | CA- Temperature        | Day   |          |   |
| 0x89         | R/W  |                       | CA-Velocity            | Year  |          | Last custom adjustment (date) V; Year = 6 → 2006                            |
| 0x8A         | R/W  |                       | CA-Velocity            | Month   |          | 1 to 12   |
| 0x8B         | R/W  |                       | CA-Velocity            | Day   |          |   |
| 0x8C         | R/W  |                       | CA-CO <sub>2</sub>     | Year  |          | Last custom adjustment (date) CO <sub>2</sub> ; Year = 6 → 2006             |
| 0x8D         | R/W  |                       | CA-CO <sub>2</sub>     | Month   |          | 1 to 12   |
| 0x8E         | R/W  |                       | CA- CO <sub>2</sub>    | Day   |          |   |
| 0x8F to 0x9A | R/W  |                       | <b>12 reserved</b>     | <b>Reserved for other physical quantities</b> |          |   |
| 0x9B to 0x9F | R/W  |                       | <b>5 reserved</b>      |   |          |   |
| 0xA0 to 0xAF | R    | Configuration         | Serial number          | Unique E+E serial number                      |          |   |
| 0xB0 to 0xBF | R/W  |                       | Part name              | Free usable part name                         |          | On delivery it is filled with the E+E sensor type. eg.EE871                 |
| 0xC0         | R/W  |                       | Bus-address            | Configurable bus-address (0...7)              |          | On delivery the Bus-Address = 0   |
| 0xC1         | R/W  | Error handling        | <b>Error code</b>      | Relevant if status byte marks an error        |          | Gives information about failure   |
| 0xC2 to 0xC5 | R/W  |                       | <b>4 reserved</b>      |   |          |   |
| 0xC6         | R/W  | Time interval         | measurement interval   | Global measurement interval                   | L-Byte   | unsigned int // unit = 1/10 s   |
| 0xC7         | R/W  |                       | measurement interval   | Global measurement interval                   | H-Byte   | unsigned int // unit = 1/10 s   |
| 0xC8         | R/W  |                       | measurement interval   | Specific interval moisture                    |          | Positive = global Interval multiplier // Negative = global Interval divider |
| 0xC9         | R/W  |                       | measurement interval   | Specific interval temperature                 |          | Positive = global Interval multiplier // Negative = global Interval divider |
| 0xCA         | R/W  |                       | measurement interval   | Specific interval velocity                    |          | Positive = global Interval multiplier // Negative = global Interval divider |
| 0xCB         | R/W  |                       | measurement interval   | Specific interval CO <sub>2</sub>             |          | Positive = global Interval multiplier // Negative = global Interval divider |
| 0xCC to 0xCF | R/W  |                       | <b>4 reserved</b>      | <b>Reserved for other physical quantities</b> |          |   |
| 0xD0         | R/W  | Measurement filter    | Filter Humidity        | Details see product datasheet                 |          |   |
| 0xD1         | R/W  |                       | Filter temperature     | Details see product datasheet                 |          |   |
| 0xD2         | R/W  |                       | Filter velocity        | Details see product datasheet                 |          |   |
| 0xD3         | R/W  |                       | Filter CO <sub>2</sub> | Details see product datasheet                 |          |   |
| 0xD4 to 0xD7 | R/W  |                       | <b>4 reserved</b>      | <b>Reserved for other physical quantities</b> |          |   |
| 0xD8         | R/W  |                       | Operating mode         | See chapter operating mode                    |          |   |
| 0xD9         | R/W  |                       | Special features       | See chapter special features                  |          |   |
| 0xDA to 0xDF | R/W  |                       | <b>6 reserved</b>      | <b>Reserved for other configurations</b>      |          |   |
| 0xE0 to 0xFD | R/W  |                       | <b>30 reserved</b>     |   |          |   |
| 0xFE         | R    | <b>Addresspointer</b> | Custom area            |   | L-Byte   |   |
| 0xFF         | R    |                       | Custom area            |   | H-Byte   |   |

### 2.4.1.1 Supported functions

Group description “supported functions” (see table above, column “group description”):

At this addresses you can “ask the slave” if the described functions are supported

See the column “Comment” and “Detail” in the table above.

Appropriate Bit = 0 → function not supported

Appropriate Bit = 1 → function supported

### 2.4.1.2 Custom adjustment

With this feature you can adjust the physical values in offset and gain.

The values you can set are (if supported):

- 1.) Offset (signed int)
- 2.) Gain (unsigned int → gain in “unsigned int” = gain in “float” \*38 )
- 3.) Lower calibration point (unsigned int)
- 4.) Upper calibration point (unsigned int)
- 5.) Last custom adjustment (Calibration time) global (year, month, day)
- 6.) Last custom adjustment (Calibration time) every physical quantity (year, month, day)

### 2.4.1.3 Operating functions

| Adr. | R/W        | R/W            | R/W                 | R/W               | R/W      | R/W            | R/W         | R/W               |
|------|------------|----------------|---------------------|-------------------|----------|----------------|-------------|-------------------|
| 0x07 | Error code | M.Value Filter | Specific M.Interval | Global M.Interval | reserved | E2 bus address | Custom name | E+E serial number |
|      | BIT7       | BIT6           | BIT5                | BIT4              | BIT3     | BIT2           | BIT1        | BIT0              |

BIT0: E+E serial number

- 1: It is possible to read (only) the unique E+E serial number
- 0: Reading the E+E serial number isn't possible.

BIT1: Custom namer

- 1: It is possible to read and write a free usable part name (16 Byte)
- 0: A free usable part name is unsupported

BIT2: E2 bus address

- 1: It is possible to change the device address. You can control up to 8 devices on the same E2-lines (CLK & DATA). That means one master and up to 8 slaves
- 0: Only a single master to slave connection is possible

BIT3: reserved

- 1:
- 0:

BIT4: Global measurement interval

- 1: Changing the global measurement interval is possible
- 0: A fixed measurement interval is implemented (see product datasheet)

BIT5: Specific measurement interval

- 1: Changing the specific measurement interval is possible (see product datasheet)
- 0: no specific measurement intervals. Only a global measurement interval is possible. (see product datasheet)

BIT6: Measurement value filter

- 1: Changing the measurement value filter is possible (see product datasheet)
- 0: There is a fixed measurement value filter implemented

BIT7: Error code

- 1: An error code can be requested if the status byte marks an error (see product datasheet)
- 0: No error code supported

## 2.4.1.4 Operating mode

### Supported function

|              |          |          |          |          |          |          |                |                      |
|--------------|----------|----------|----------|----------|----------|----------|----------------|----------------------|
|              | R/W      | R/W      | R/W      | R/W      | R/W      | R/W      | R/W            | R/W                  |
| Adr.<br>0x08 | reserved | reserved | reserved | reserved | reserved | reserved | E2<br>priority | Low<br>power<br>mode |
|              | BIT7     | BIT6     | BIT5     | BIT4     | BIT3     | BIT2     | BIT1           | BIT0                 |

BIT0: Low power mode

- 0: going into Low power mode is not possible
- 1: going into Low power mode is supported

BIT1: E2-priority (slave measurement and E2 communication at the same time)

- 0: Changing the E2-priority is not possible. Slave answers with NACK during measurement
- 1: Changing the E2-priority is supported

BIT2-7: reserved

### Documentation

|              |          |          |          |          |          |          |                |                      |
|--------------|----------|----------|----------|----------|----------|----------|----------------|----------------------|
|              | R/W      | R/W      | R/W      | R/W      | R/W      | R/W      | R/W            | R/W                  |
| Adr.<br>0xD8 | reserved | reserved | reserved | reserved | reserved | reserved | E2<br>priority | Low<br>power<br>mode |
|              | BIT7     | BIT6     | BIT5     | BIT4     | BIT3     | BIT2     | BIT1           | BIT0                 |

BIT0: Measure mode

- 0: Free running mode or trigger mode
- 1: Low power mode (measurement only after "read statusbyte")

BIT1: E2-priority (slave measurement and E2 communication at the same time)

- 0: Priority to measurement. Slave answers with NACK during measurement
- 1: Priority to E2 communication

BIT2-7: reserved



## 2.4.1.5 Special features

### Supported function

|              |          |          |          |          |          |          |          |                    |
|--------------|----------|----------|----------|----------|----------|----------|----------|--------------------|
|              | R/W      | R/W      | R/W      | R/W      | R/W      | R/W      | R/W      | R/W                |
| Adr.<br>0x09 | reserved | reserved | reserved | reserved | reserved | reserved | reserved | Auto<br>adjustment |
|              | BIT7     | BIT6     | BIT5     | BIT4     | BIT3     | BIT2     | BIT1     | BIT0               |

BIT0: Auto adjustment  
 0: A manually triggered auto adjustment is not supported  
 1: A manually triggered auto adjustment is supported

BIT1-7: reserved

### Documentation

|              |          |          |          |          |          |          |          |                    |
|--------------|----------|----------|----------|----------|----------|----------|----------|--------------------|
|              | R/W      | R/W      | R/W      | R/W      | R/W      | R/W      | R/W      | R/W                |
| Adr.<br>0xD9 | reserved | reserved | reserved | reserved | reserved | reserved | reserved | Auto<br>adjustment |
|              | BIT7     | BIT6     | BIT5     | BIT4     | BIT3     | BIT2     | BIT1     | BIT0               |

BIT0: Auto adjustment  
 read = 1 → an auto adjustment is currently running  
 read = 0 → currently normal operation (no auto adjustment)  
 set to 1 → starts an auto adjustment. After the auto adjustment is finished, this bit will be cleared automatically.  
 set to 0 → interrupting the auto adjustment is not allowed and not possible

During the auto adjustment the measurement values are held on the last measured value.

BIT1-7: reserved

### 3 Appendix: Flow-charts

#### 3.1 “Addressing + Read/Write distinction” flow chart

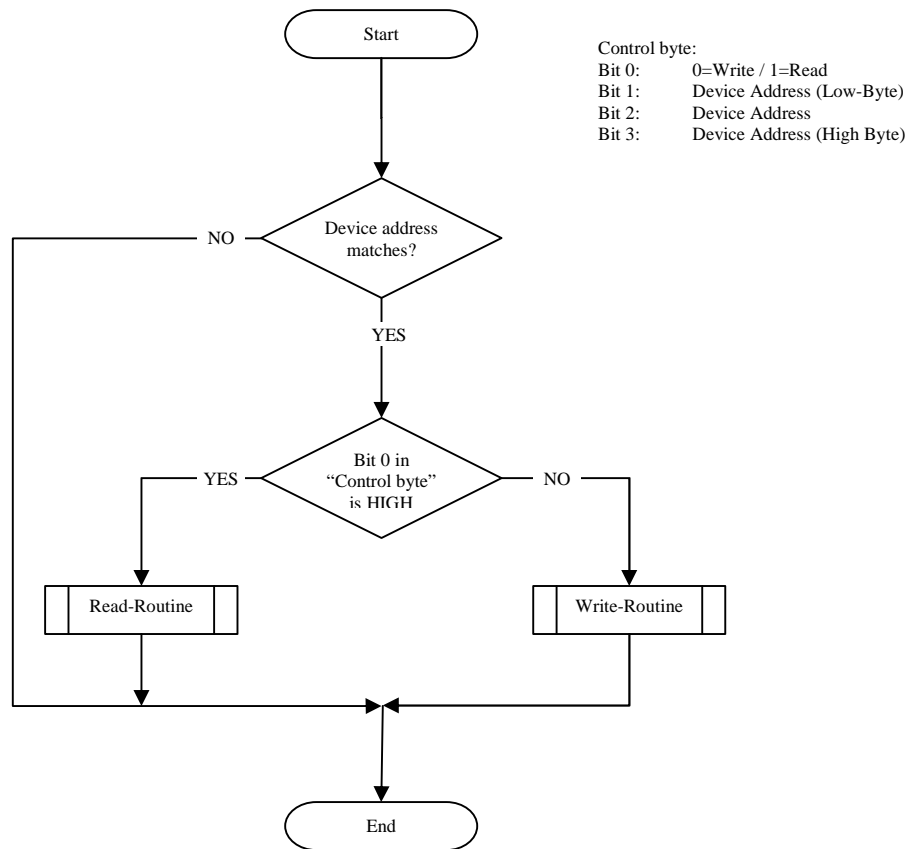

### 3.2 “Read from Memory” flow chart

#### 3.2.1 “Read from Custom Memory” flow chart

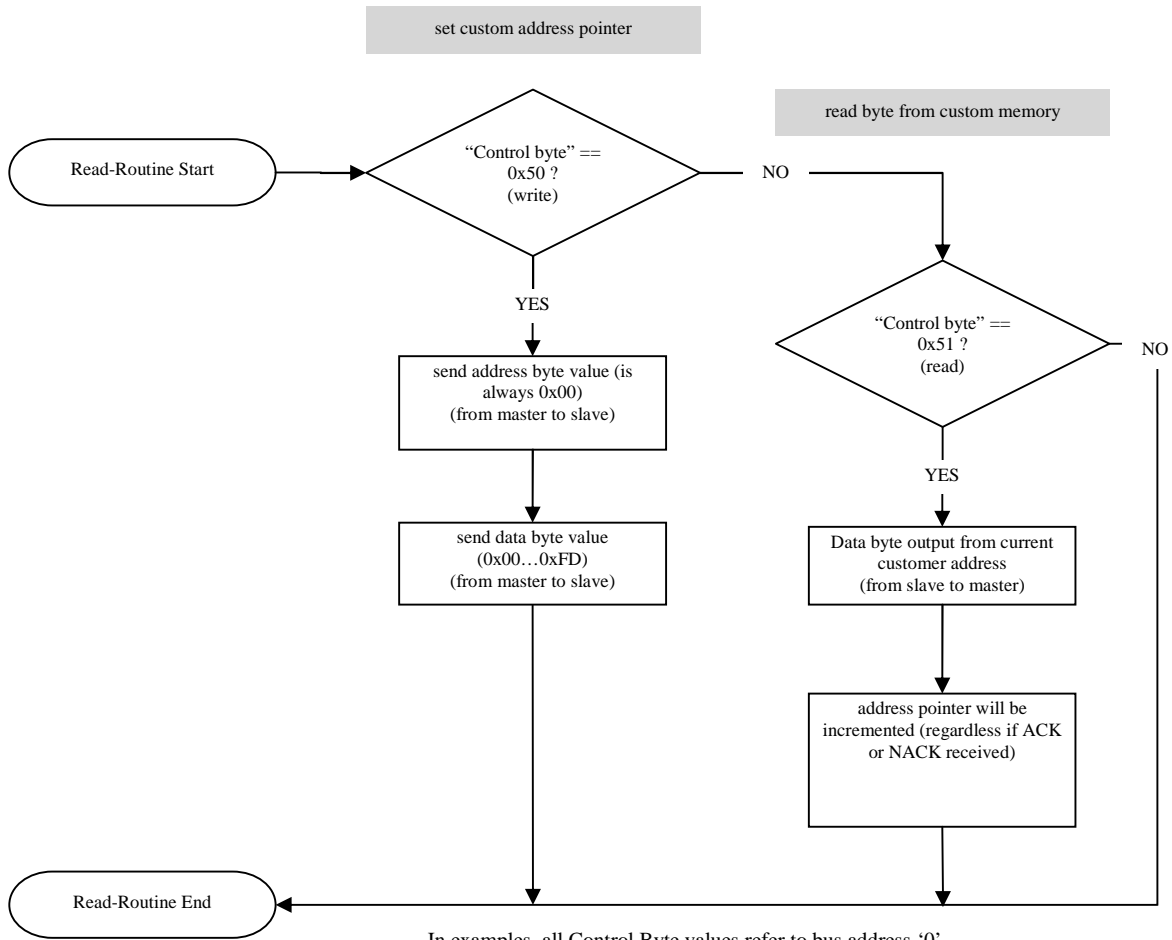

In examples, all Control Byte values refer to bus address '0'.  
Unsupported commands or address values will be answered with 0x55 or 0xFF

### 3.3 “Write to Memory” flow chart

#### 3.3.1 “Write to Custom Memory” flow chart

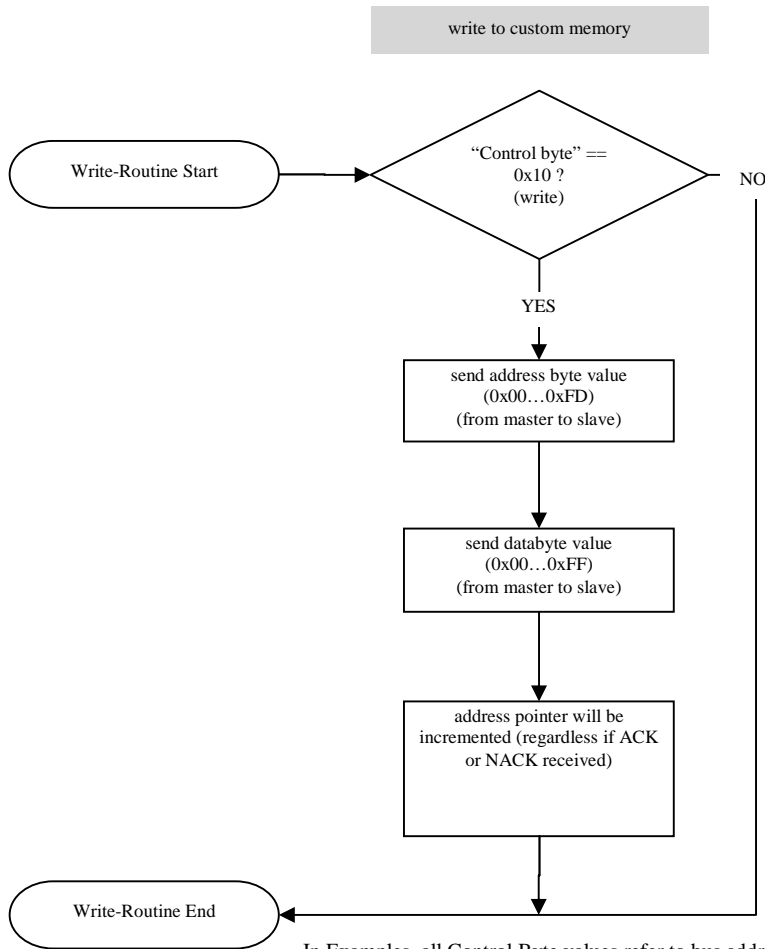

In Examples, all Control Byte values refer to bus address '0'.  
Unsupported commands or address values will be answered with 0x55 or 0xFF