

## LI25 Series Instruction Manual



2 V drop (5.7 V with backlight)  
5 Digit LCD, 0.6" (15.2 mm) High  
Custom Engineering Units  
20 Segment Bar graph Display  
Type 4X, NEMA 4X, IP65 Front  
Maximum & Minimum Display  
Linear, Square Root, or Programmable Exponent  
Non-Volatile Memory – No Battery Needed



**Loop-  
Powered  
Backlight  
Standard!**

## INTRODUCTION

The LI25-2001 is an intrinsically safe and non-incendive loop-powered meter approved for hazardous area locations. The LI25-1001 is a general-purpose loop-powered meter for safe area applications. The four front panel buttons make the setup and programming an easy task. Five digits, bar graph, engineering units, and trend arrows provide a clear and attractive presentation of the process. The square root and programmable exponent functions allow for conditioning of signals from non-linear transmitters without adding external components to the system and the convenience of scaling without a calibrated signal source make the LI25 Series the ideal choice for process display applications.

## ORDERING INFORMATION

Model	Description
LI25-1001	Loop-Powered Panel Meter for Safe Area
LI25-2001	FM & CSA Approved Loop-Powered Panel Meter

## Enclosures and Accessories

Model	# of Meters	Description	Mounting
LM91-1001	1	Plastic NEMA 4X Enclosure	Through Cover
LM91-2001	2	Plastic NEMA 4X Enclosure	Through Cover
LM92-1001	1	Plastic NEMA 4X Enclosure	Inside Cover
LM93-1001	2	Plastic NEMA 4X Enclosure	Inside Cover

## REGISTERED TRADEMARKS

NORYL® and LEXAN® are registered trademarks of General Electric Company. All other trademarks mentioned in this document are the property of their respective owners.

© 2013 Flowline, Inc. All rights reserved.

**Visit our Web Site**  
<http://www.flowline.com>

## TABLE OF CONTENTS

INTRODUCTION .....	2
ORDERING INFORMATION .....	2
SPECIFICATIONS .....	5
General .....	5
Input .....	6
LI25 SERIES COMPLIANCE INFORMATION .....	7
Ratings and Approvals .....	7
SAFETY INFORMATION .....	7
INSTALLATION .....	8
Unpacking .....	8
Panel Mounting .....	8
Connections .....	10
4-20 mA Input Connections .....	11
SETUP AND PROGRAMMING .....	12
Front Panel Buttons & Status Indicators .....	13
Main Menu Display Functions & Messages .....	14
Main Menu .....	15
Setting Numeric Values .....	15
Setting Up the Meter (SETUP) .....	16
Setting the Decimal Point (deCpt) .....	16
Setting the Units Display (units) .....	17
Programming the Meter (PROG) .....	18
Scaling the Meter (sCAIE) .....	19
Calibrating the Meter (CAL) .....	20
Recalibrating the internal Calibration Reference (ICAL) .....	20
Setting Up the Bargraph (GrApH) .....	21
Setting Up the Password (PASS) .....	22
Locking the Meter .....	22
Unlocking the Meter .....	23
Advanced Features Menu .....	24
Advanced Features Menu & Display Message .....	25
Math Functions (LnEAR, SQUAr, PROGE, CUTOF) .....	26
Contrast (cOntr) .....	27
Noise Filter (FLtEr) .....	27
Noise Filter Bypass (bYPAS) .....	27
Internal Calibration (ICAL) .....	28

---

Information Menu (InFO).....	29
Operation .....	30
Front Panel Buttons Operation .....	30
Maximum & Minimum (MAX & MIN) .....	31
MOUNTING DIMENSIONS.....	32
Reset Meter to Factory Defaults.....	33
Factory Defaults & User Settings .....	34
TROUBLESHOOTING .....	35
Troubleshooting Tips .....	35
QUICK USER INTERFACE REFERENCE GUIDE .....	36

### TABLE OF FIGURES

Figure 1. Panel Cutout and Mounting.....	9
Figure 2. LI25 Series Rear View .....	10
Figure 3. Input Connections with Backlight .....	11
Figure 4. Input Connections without Backlight .....	11
Figure 5. Meter Dimensions – Side View.....	33
Figure 6. Case Dimensions – Top View.....	33

## SPECIFICATIONS

Except where noted all specifications apply to operation at +25°C.

## General

<b>DISPLAY</b>	Five digits (-99999 to 99999)	0.60" (15.2 mm) high, 7-segment, automatic lead zero blanking.
	Four characters (Engineering Units)	0.25" (6.4 mm) high, 14 segment.
	Bar graph	20-segment, 0% to 100% indication.
	Trend arrows	Up and down trend indication.
	Backlight	Orange (intensity varies with signal)
<b>DISPLAY UPDATE RATE</b>	2.5/second	
<b>OVERRANGE</b>	Display flashes 99999	
<b>UNDERRANGE</b>	Display flashes -99999	
<b>PROGRAMMING METHOD</b>	Four front panel buttons	
<b>NOISE FILTER</b>	Programmable from 1 to 199	
<b>RECALIBRATION</b>	Recalibration is recommended at least every 12 months.	
<b>MAX/MIN DISPLAY</b>	Max/min readings reached by the process are stored until reset by the user or until power to the meter is turned off.	
<b>PASSWORD</b>	Programmable password restricts modification of programmed settings.	
<b>NON-VOLATILE MEMORY</b>	All programmed settings are stored in non-volatile memory for a minimum of ten years if power is lost.	
<b>NORMAL MODE REJECTION</b>	64 dB at 50/60 Hz	
<b>ENVIRONMENTAL</b>	Operating temperature range: -30 to 65°C (-40°C allowed)* Storage temperature range: -40 to 65°C Relative humidity: 0 to 90% non-condensing *Below -30°C, the LCD becomes less readable.	
<b>CONNECTIONS</b>	Removable screw terminals accept 12 to 22 AWG wire	
<b>ENCLOSURE &amp; MATERIALS</b>	1/8 DIN, high impact plastic, UL 94V-0, color: gray GE Plastics NORYL® N190X Polyphenylene Ether & Polystyrene blend (PPE PS) Resin GE Plastics LEXAN® HP92W Polycarbonate (PC) Film	
<b>MOUNTING</b>	1/8 DIN panel cutout required. Two panel mounting bracket assemblies provided	

<b>TIGHTENING TORQUE</b>	Screw terminal connectors: 4.5 lb-in (0.5 Nm) Mounting screws: 8.0 lb-in max. (0.9 Nm)
<b>OVERALL DIMENSIONS</b>	4.68" x 2.45" x 3.79" (119 mm x 62 mm x 96 mm) (W x H x D)
<b>WEIGHT</b>	5.7 oz (162 g)
<b>WARRANTY</b>	See Warranty

### Input

<b>ACCURACY</b>	±0.03% of span ±1 count, square root and programmable exponent: 10-100% FS	
<b>FUNCTION</b>	Linear, square root, or programmable exponent	
<b>LOW-FLOW CUTOFF</b>	-99999 to 99999 (-99999 disables cutoff function)	
<b>TEMPERATURE DRIFT</b>	50 PPM/°C from -40 to 65°C ambient	
<b>DECIMAL POINT</b>	Up to four decimal places: d.dddd, dd.ddd, ddd.dd, dddd.d, or ddddd	
<b>CALIBRATION RANGE</b>	An <i>Error</i> message will appear if input 1 and input 2 signals are too close together.	
	<b>Input Range</b>	<b>Minimum Span Input 1 &amp; Input 2</b>
	4-20 mA	0.40 mA
<b>VOLTAGE DROP</b>	<b>Without Backlight</b>	<b>With Backlight</b>
	2.0 V maximum	5.7 V maximum
<b>EQUIVALENT RESISTANCE</b>	100 Ω @ 20 mA	285 Ω @ 20 mA
<b>INPUT OVERLOAD</b>	Over current protection to 2 A max.	

## LI25 SERIES COMPLIANCE INFORMATION

## Ratings and Approvals

<b>FM</b>	Class I, Div 1, 2, Groups ABCD Class II, Div 1, Groups EFG Class II, Div 2, Groups FG Class III, Div 1, 2 Class 1, Zone 0, Group IIC
<b>CSA</b>	Class I, Div 1, 2, Groups ABCD Class II, Div 1, Groups EFG Class II, Div 2, Groups FG Class III, Div 1, 2 Class 1, Zone 0, Group IIC

LI25-2001 installation must be performed in accordance with Control Drawing **QS301034-1**

## SAFETY INFORMATION



**CAUTION:** Read complete instructions prior to installation and operation of the meter.

Installation and service should be performed only by trained service personnel. Service requiring replacement of internal components must be performed at the factory.

## INSTALLATION

There is no need to remove the meter from its case to complete the installation, wiring, and setup of the meter.

### Unpacking

Remove the meter from box. Inspect the packaging and contents for damage. Report damages, if any, to the carrier.

If any part is missing or the meter malfunctions, please contact your supplier or the factory for assistance.

### Panel Mounting

- Prepare a standard 1/8 DIN panel cutout – 3.622" x 1.772" (92 mm x 45 mm). Refer to *Mounting Dimensions*, page 23 for more details.
- Clearance: allow at least 4" (102 mm) behind the panel for wiring.
- Panel thickness: 0.04" - 0.25" (1.0 mm - 6.4 mm).  
Minimum steel/stainless steel panel thickness to maintain watertight rating: 0.06" (1.5 mm).

**Note: A steel or stainless steel panel rather than plastic is recommended in cases where a watertight or dust-tight seal is required between the meter and the panel.**

- Remove the two mounting brackets provided with the meter (back-off the two screws so that there is ¼" (6.4 mm) or less through the bracket. Slide the bracket toward the front of the case and remove).
- Insert meter into the panel cutout.
- Install mounting brackets and tighten the screws against the panel. To achieve a proper seal, tighten the mounting bracket screws evenly until meter is snug to the panel along its short side. DO NOT OVER TIGHTEN, as the rear of the panel may be damaged.



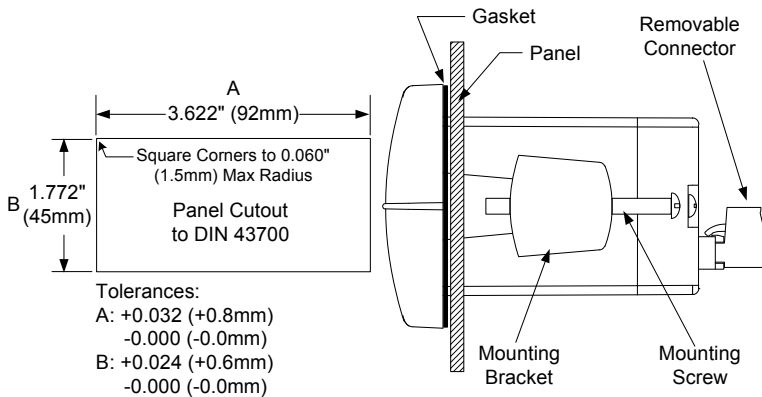

**Figure 1. Panel Cutout and Mounting**

Refer to *Mounting Dimensions*, page 23 for more details.

**CONNECTIONS**

Signal connections are made to a four-terminal removable connector. This section is only intended for the LI25-1001.

***LI25-2001 installation must be performed in accordance with Control Drawing QS301034-1 in order to meet agency approval ratings.***



Observe all safety regulations. Electrical wiring should be performed in accordance with all agency requirements and applicable national, state, and local codes to prevent damage to the meter and ensure personnel safety.

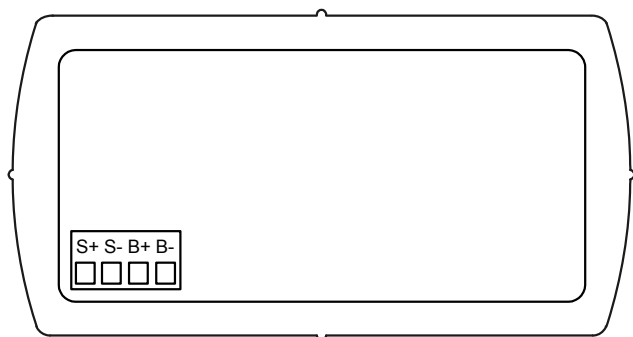

**Figure 2. LI25 Series Rear View**

**4-20 mA INPUT CONNECTIONS**

Input connections are made to a four-terminal connector labeled S+|S-|B+|B-. The loop-powered backlight is an optional configuration and requires a total maximum voltage drop of 5.7 V. The backlight is recommended for dim lighting conditions and is enabled when wired as shown in Figure 3. It may be bypassed if installed in bright lighting conditions to reduce the maximum voltage drop to 2.0 V as shown in Figure 4.

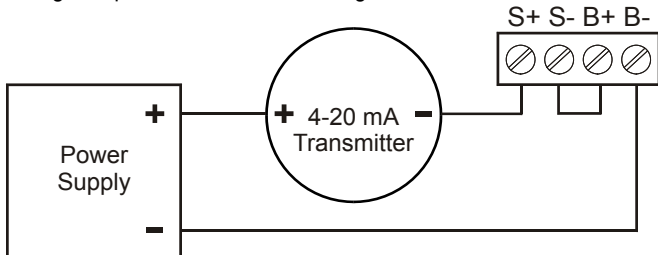

Figure 3. Input Connections with Backlight

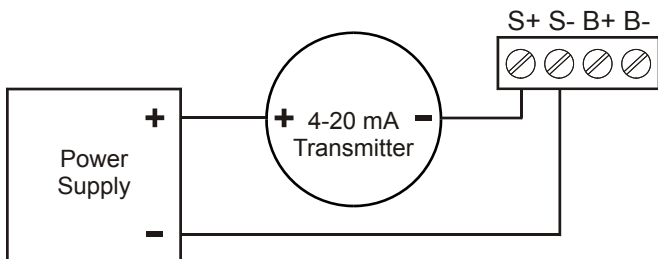

Figure 4. Input Connections without Backlight

**SETUP AND PROGRAMMING**

- There is no need to recalibrate the meter for milliamps when first received from the factory.
- The meter is factory calibrated for milliamps prior to shipment. The calibration equipment is certified to NIST standards.

**Overview**





There are no jumpers involved in the setup process of the meter. Setup and programming is done through the front panel buttons.

After all connections have been completed and verified, apply power to the loop.

For  
Quick User Interface Reference Guide go to  
page 37

## FRONT PANEL BUTTONS &amp; STATUS INDICATORS



Button Symbol	Description
	Menu
	Right arrow/Reset
	Up arrow/Max
	Enter/Ack

Symbol	Status
0%	Bar graph minimum
100%	Bar graph maximum
▲	Increasing trend
▼	Decreasing trend

- Press the **Menu** button to enter or exit the Programming Mode at any time.
- Press the **Right** arrow button to move to the next digit or decimal position during programming.
- Press the **Up** arrow button to scroll through the menus, decimal point, or to increment the value of a digit.
- Press the **Enter/Ack** button to access a menu or to accept a setting.
- Press and hold the **Menu** button for five seconds to access the *Advanced* features of the meter.

## MAIN MENU DISPLAY FUNCTIONS &amp; MESSAGES

The meter displays various functions and messages during setup, programming, and operation. The following table shows the main menu functions and messages in the order they appear in the menu.

Display	Parameter	Action/Setting
uNITS	<i>Units</i>	Enter the <i>Units</i> menu
dECPt	<i>Decimal point</i>	Set decimal point
SCALE	<i>Scale</i>	Enter the <i>Scale</i> menu
INPt 1	<i>Input 1</i>	Calibrate input 1 signal or program input 1 value
dSPt 1	<i>Display 1</i>	Program display 1 value
INPt 2	<i>Input 2</i>	Calibrate input 2 signal or program input 2 value
dSPt 2	<i>Display 2</i>	Program display 2 value
ErRor	<i>Error</i>	Error, calibration not successful, check signal
GrAPh	<i>Graph</i>	Enter the <i>Graph</i> menu
PASS	<i>Password</i>	Enter the <i>Password</i> menu
uNLoc	<i>Unlocked</i>	Program password to lock meter
Locd	<i>Locked</i>	Enter password to unlock meter
99999 -99999	<i>Flashing display</i>	Overrange condition Underrange condition

## Main Menu

The main menu consists of the most commonly used functions: *Setup*, *Program*, and *Password*.

- Press **Menu** button to enter Programming Mode then press **Up** arrow button to scroll main menu.

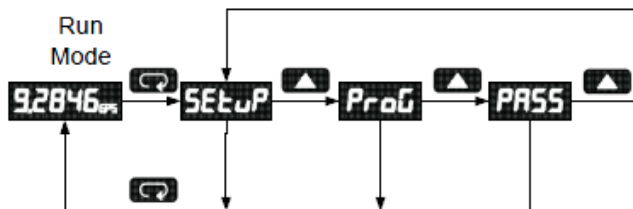

- Press **Menu**, at any time, to exit and return to Run Mode. Changes made to settings prior to pressing **Enter/Ack** are not saved.
- Changes to the settings are saved to memory only after pressing **Enter/Ack**.

The display moves to the next menu every time a setting is accepted by pressing **Enter/Ack**.

## Setting Numeric Values

The numeric values are set using the **Right** and **Up** arrow buttons. Press **Right** arrow to select next digit and **Up** arrow to increment digit.

The digit being changed blinks.

Press the **Enter/Ack** button, at any time, to accept a setting or **Menu** button to exit without saving changes.

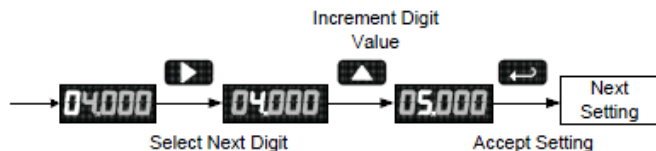

The decimal point is set using the **Right** or **Up** arrow button in the *Setup-decimal point* menu.

### Setting Up the Meter (SETuP)

The Setup menu is used to select:

1. Decimal point position
2. Engineering units display

Press the **Enter/Ack** button to access any menu or press **Up** arrow button to scroll through choices. Press the **Menu** button to exit at any time.

### Setting the Decimal Point (dECPt)

Decimal point may be set with up to four decimal places or with no decimal point at all.

Pressing the **Right** or **Up** arrow moves the decimal point one place to the right until no decimal point is displayed, then it moves to the left most position.

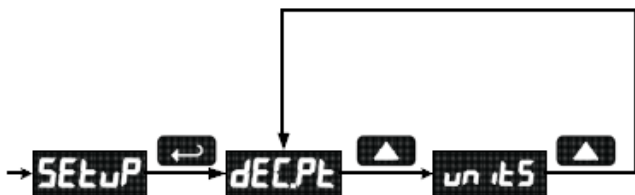

### Setting the Decimal Point (dECPt)

Decimal point may be set with up to four decimal places or with no decimal point at all.



Pressing the **Right** or **Up** arrow moves the decimal point one place to the right until no decimal point is displayed, then it moves to the left most position.

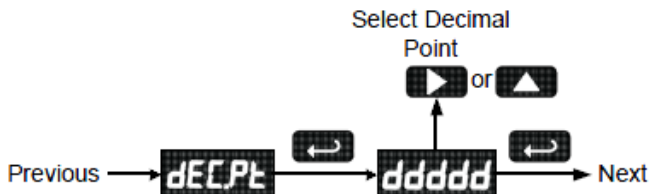

### Setting the Units Display (units)

The meter can be set to display a combination of three alphanumeric characters for engineering units or for identification (eg. FT, IN, M, CM, GAL, L). There is also a fourth alphanumeric character located above this row, which supports a degrees symbol and “x10” symbol (eg. °C, °F, **x103**, **x106**, **x109**).

Preconfigured units are available for feet (FT), inches (IN), meters (M), centimeters (CM), gallons (GAL), liters (L), percent (%), and percent (PCT).

A custom unit or tag may be entered as well, by selecting *cust*.

Press the **Up** arrow to scroll through unit options. Press **Enter/Ack** to select a preconfigured unit or the custom unit or tag.

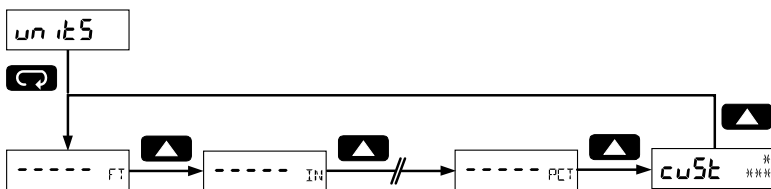

### Entering a Custom Unit or Tag

Select *Custom* (*cust*) from the *Units* menu by pressing the **Enter/Ack** button. The cursor will then show up in the left-most digit of the bottom three alphanumeric tag characters.

Press **Right** arrow to select the next digit, and the **Up** arrow to cycle through the alphanumeric characters available.

The upper right alphanumeric character may also be selected. This character includes degree symbols and a degrees symbol and “x10” symbol (eg. °C, °F, x103, x106, x109).

Press the **Enter/Ack** button, at any time, to accept the programmed unit or tag.  
Press the **Menu** button to exit without saving changes.

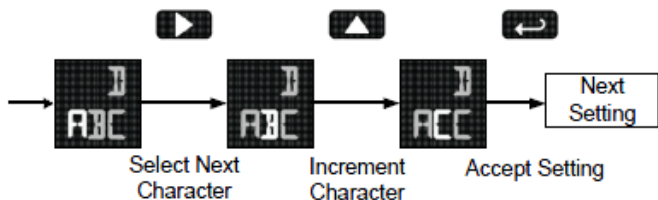

### Programming the Meter (Prog)

It is **very important** to read the following information, before proceeding to program the meter:

- There is **no need to recalibrate** the meter for milliamps when first received from the factory.
- The meter is **factory calibrated** for milliamps prior to shipment. The calibration equipment is certified to NIST standards.
- Use the *Scale* menu to enter scale parameters without applying a live signal.
- Alternatively, use the *Calibrate* menu to apply a signal from a calibrator or a 4-20 mA transmitter to calibrate the meter.

The *Program* menu contains the *Calibrate* and the *Scale* menus. Inputs may be calibrated or scaled to any display within the range of the meter.

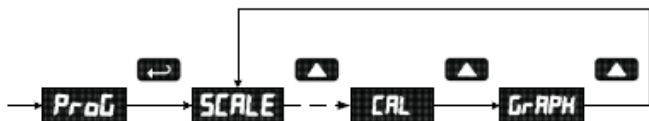

Additional parameters, not needed for most applications, are programmed with the *Advanced features* menu, see *Advanced Features Menu*, page 25.

### Error Message (Error)

An error message indicates that the calibration or scaling process was not successful.

After the error message is displayed, the meter reverts to input 1, allowing the appropriate input signals to be applied.

The error message might be caused by one of the following conditions:

1. Minimum input span requirements not maintained.
2. Input 1 signal inadvertently applied to calibrate input 2.

### Minimum Input Span

The minimum input span is the minimum difference between input 1 and input 2 signals required to complete the calibration or scaling of the meter. The minimum span is 0.40 mA.

### Scaling the Meter (SCALE)

The 4-20 mA input can be scaled to display the process in engineering units.

A signal source is not needed to scale the meter; simply program the inputs and corresponding display values.

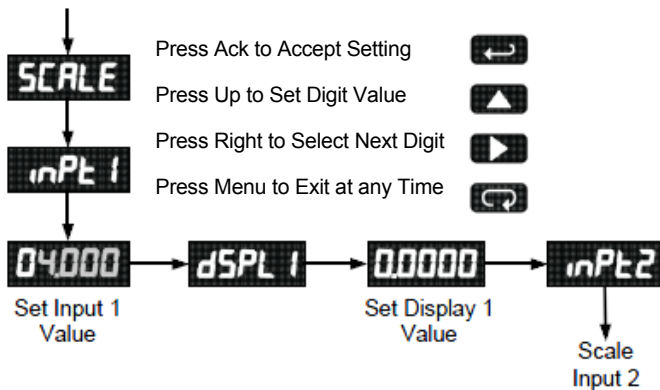

For instructions on how to program numeric values see *Setting Numeric Values*, page 17.

## Calibrating the Meter (Cal)

To scale the meter without a signal source refer to *Scaling the Meter (SCALE)*, page 21.

The meter can be calibrated to display the process in engineering units by applying the appropriate input signal and following the calibration procedure.

The use of a calibrated signal source is strongly recommended.

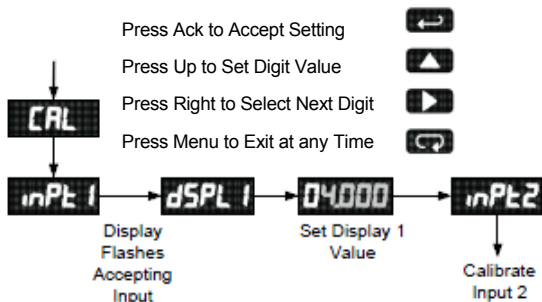

1. Press the **Up** arrow button to scroll to the *Calibration* menu (CAL) and press **Enter/Ack**.
2. The meter displays inpt1. Apply a known signal and press **Enter/Ack**. Trend arrows are displayed while accepting the signal.
3. After the signal is accepted, the meter displays dsp1. Press **Enter/Ack**, enter a corresponding display value for the signal input, and press **Enter/Ack** to accept.
4. The meter displays inpt1. Apply a known signal and press **Enter/Ack**. Trend arrows are displayed while accepting the signal.
5. After the signal is accepted, the meter displays dsp2. Press **Enter/Ack**, enter a corresponding display value for the signal input, and press **Enter/Ack** to accept.

## Recalibrating the Internal Calibration Reference (iCAL)

The *Internal Calibration* (iCAL) menu, located in the *Advanced* features menu, is used to recalibrate the internal calibration reference. Recalibration is recommended at least every twelve months. Refer to *Internal Calibration* (iCAL), page 30 for instructions.

### Setting Up the Bargraph (GRAPH)

The meter can be set to display a bargraph proportional to the percentage process reading within a user-defined span.

The span is determined by values entered for 0% and 100%.

If the 0% and 100% values are the same as the values that were entered for display 1 and display 2, respectively, from the scale or calibrate steps, then it is not necessary to modify them.

The bargraph may be disabled by selecting *OFF* from the bargraph menu.

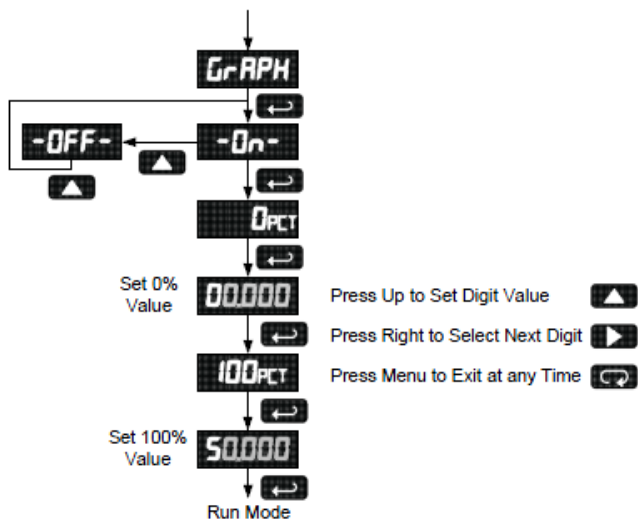

### Setting Up the Password (PASS)

The *Password* menu is used to program a five-digit password to prevent unauthorized changes to the programmed parameter settings.

### Locking the Meter

Enter the *Password* menu and program a five-digit password.

For instructions on how to program numeric values see *Setting Numeric Values*, page 16.

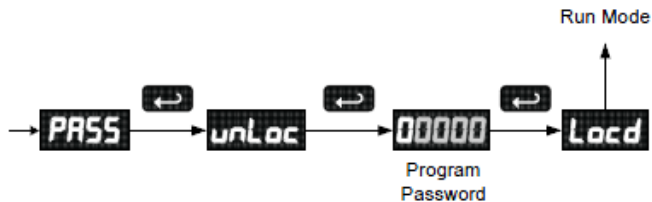

Record the password for future reference. If appropriate, it may be recorded in the space provided.

Model:	
Serial Number:	
Password:	

### Unlocking the Meter

If the meter is password protected, the correct password must be entered in order to make changes to the parameter settings.

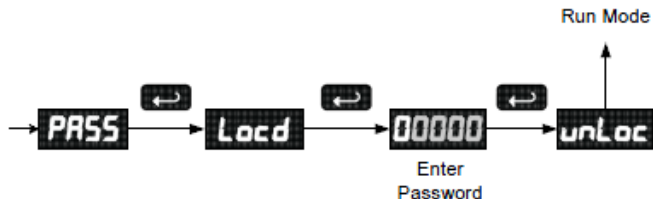

Entering the correct five-digit number sets the password to 00000, disabling the protection. The meter remains unlocked until a new password is programmed or the former password is re-programmed using the *Password* menu.

Changes to the programmed parameter settings are allowed only with the password set to 00000.

If the password entered is incorrect, the meter displays *Locd* (Locked) for about three seconds, then it returns to *Run Mode*. To try again, press **Enter/Ack** while the *Locked* message is displayed.

#### Forgot the Password?

The password may be disabled by the following procedure:

1. Note display reading prior to pressing the Menu button. Ignore decimal point and sign.
2. Access the *Password* menu, add 2 to the noted reading and enter that number as the password (e.g. display reading = -1.23, password = 00125).



### Advanced Features Menu

To simplify the setup process, functions not needed for most applications are located in the *Advanced* features menu.

Press and hold the **Menu** button for five **seconds** to access the Advanced features of the meter.

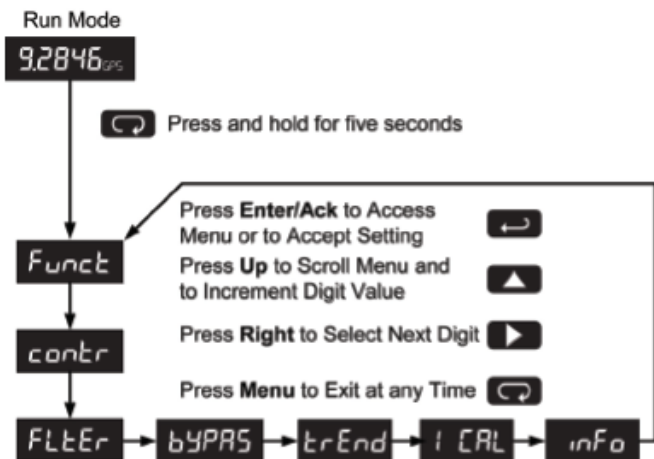

### Advanced Features Menu & Display Messages

The following table shows the *Advanced* features menu functions and messages in the order they appear in the menu.

Display	Parameter	Action/Setting
FuncT	<i>Function</i>	Enter Function menu
LnERr	<i>Linear</i>	Set linear scaling
SqURr	<i>Square Root</i>	Set square root extraction
PrOUE	<i>Programmable Exponent</i>	Set programmable exponent
CuTOF	<i>Low-Flow Cutoff</i>	Set low-flow cutoff
CONtr	<i>Contrast</i>	Enter contrast adjustment menu
FLtEr	<i>Filter</i>	Set noise filter value
bYPR5	<i>Bypass</i>	Set filter bypass value
tREnd	<i>Trend Arrows</i>	Enable or disable trend arrows
-ON-	<i>On</i>	Enable trend arrow display
-OFF-	<i>Off</i>	Disable trend arrow display
ICBL	<i>Initial calibration</i>	Enter initial calibration for process inputs
INFo	<i>Meter information</i>	Show software number and version, or reset to defaults
rESEt	<i>Reset Defaults</i>	Restore factory default parameter settings

For instructions on how to program numeric values see *Setting Numeric Values*, page 17.

## Math Functions (LnEAR, SqURr, PRoGE, CUTOF)

The LI25 SERIES provides a number of math functions to condition outputs from linear and non-linear transmitters.

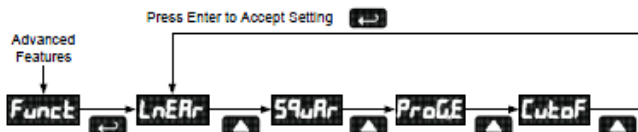

### Linear (LnEAR)

Meters are set up at the factory for linear function. The linear function provides a display that is linear with respect to the input signal.

### Square Root (SqURr)

The square root function is used to linearize the signal from a differential pressure transmitter and display flow rate in engineering units.

### Programmable Exponent (PRoGE)

The programmable exponent function is used to linearize the level signal in applications using weirs and flumes and display flow rate in engineering units. Upon selecting programmable exponent (Prog.E), the meter prompts entry of a 5-digit value between 0.5000 and 3.0000 as the exponent.

### Low-Flow Cutoff (CUTOF)

The low-flow cutoff feature allows the meter to be programmed so that the often-unsteady output from a differential pressure transmitter, at low flow rates, always displays zero on the meter. The cutoff value may be programmed from -99999 to 99999. Below the cutoff value, the meter will display zero. Selecting either square root or programmable exponent will set the cutoff value to 0. Program the cutoff value to -99999 to disable.

### Contrast (CONTR)

LCD contrast is adjustable through the front panel buttons. Select **contr** and increase level using Up Arrow/Max button. Settings 1 through 9 will be displayed on the screen as 11111 to 99999. Settings 1 through 4 are usually best when viewing from below the angle perpendicular to the display. Settings 5 through 9 are usually best when viewing straight on (meter is at eye level) or when viewing from above.

### Noise Filter (FLTER)

Most applications do not require changing this parameter. It is intended to help attain a steady display with an unsteady (noisy) input signal.

The field selectable noise filter averages any minor or quick changes in the input signal and displays the reading with greater stability.

Increasing the filter value will help stabilize the display, however this will reduce the display response to changes on the input signal.

The filter level may be set anywhere from 1 to 199.

### Noise Filter Bypass (bYPAS)

The meter can be programmed to filter small input changes, but allow larger input changes to be displayed immediately, by setting the bypass value accordingly.

If the input signal goes beyond the bypass value, it will be displayed immediately with no averaging done on it.

The noise filter bypass value may be set anywhere from 0.2 to 99.9. It corresponds to percentage of full scale.

Increasing the bypass value may slow down the display response to changes on the input signal.

Pressing the **Right Arrow/Reset** button will also bypass the filter and provide an instant update.

### Internal Calibration (ICal)

- There is **no need to recalibrate** the meter for milliamps when first received from the factory.
- The meter is **factory calibrated** for milliamps prior to shipment. The calibration equipment is certified to NIST standards.

The internal calibration allows the user to scale the meter without applying a signal. The use of a calibrated signal source is necessary to perform the internal calibration of the meter. Check calibration of the meter at least every 12 months.

#### Notes:

- The signal source must have a full-scale accuracy of 0.01% or better between 4 and 20 mA in order to maintain the specified accuracy of the LI25 Series.
- Allow the meter to warm up for at least 15 minutes before performing the internal calibration procedure.

The *Internal calibration* menu is part of the *Advanced* features menu.

1. Press and hold the **Menu** button for five **seconds** to access the Advanced features of the meter.
2. Press the **Up** arrow button to scroll to the *Internal calibration* menu (ICAL) and press **Enter/Ack**.
3. The meter displays 4.000 mA. Apply a 4.000 mA signal and press **Enter/Ack**. The display shows both trend arrows for a moment while the meter is accepting the signal.
4. After the signal is accepted, the meter displays 8.000 mA. Apply an 8.000 mA signal and press **Enter/Ack**. The display shows both trend arrows for a moment while the meter is accepting the signal.
5. Continue, as in the previous step, for the remaining signals: 12.000 mA, 16.000 mA, and 20.000 mA.

#### Error Message (Error)

An error message indicates that the calibration or scaling process was not successful. After the error message is displayed, the meter reverts to the previous signal prompt, allowing the appropriate input signal to be applied. The error message might be caused by inadvertently leaving the signal at the previous level.

**Information Menu** (info)





The *Information* menu is located in the *Advanced* features menu, to access *Information* menu see *Advanced Features Menu*, page 25.

It shows software and version number. To determine the software version of a meter:

1. Go to the *Information* menu (info) and press **Enter/Ack** button. The number shown is the software number.
2. Press **Enter/Ack** again to display the release version.

## Operation

### Front Panel Buttons Operation

Button Symbol	Description
	Press to enter or exit Programming Mode, view settings, or exit Max/Min readings
	Press to reset Max/Min readings Press to manually bypass filtering
	Press to display Max/Min readings alternately
	Press to display Max/Min reading indefinitely while displaying Max/Min Press ACK to acknowledge trend arrows

### Maximum & Minimum Readings (Max & Min)

The maximum and minimum (peak & valley) readings reached by the process are stored in the meter since the last reset or power-up. The meter shows MIN or MAX to differentiate between run mode and max/min display.

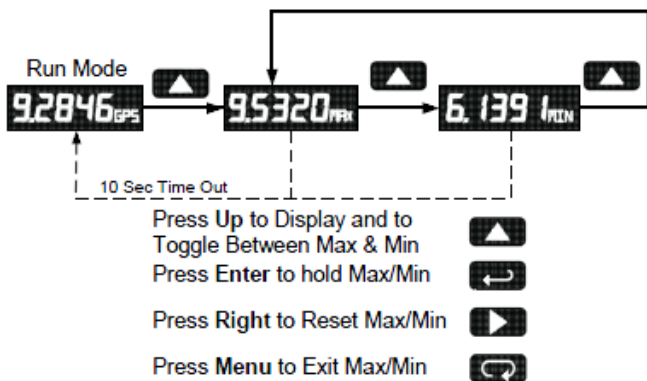

1. Press **Up** arrow/**Max** button to display maximum reading since the last reset/power-up.
2. Press **Up** arrow/**Max** again to display the minimum reading since the last reset/power-up.
3. Press **Enter/Ack** to hold Max/Min display reading, the meter will continue to track new Max/Min readings.
4. If **Enter/Ack** is not pressed, the Max/Min display reading will time out after ten seconds and the meter will return to display the actual reading.
5. Press **Right** arrow/**Reset** button to reset Max/Min while reading is being displayed. Max/Min display readings are reset to actual reading.



## MOUNTING DIMENSIONS

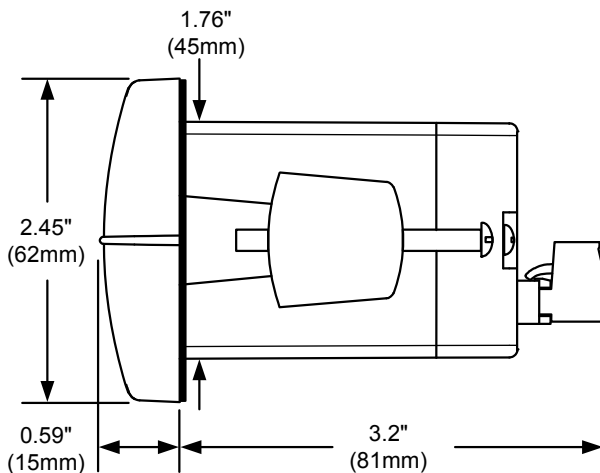

Figure 5. Meter Dimensions – Side View

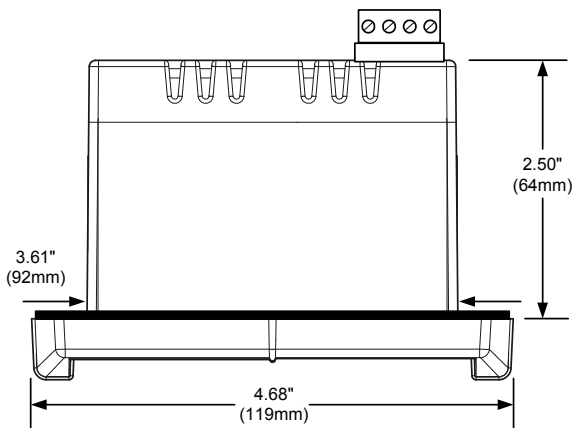

Figure 6. Case Dimensions – Top View

**RESET METER TO FACTORY DEFAULTS**

When the parameters have been changed in a way that is difficult to determine what's happening, it might be better to start the setup process from the factory defaults.

**Instructions to load factory defaults:**

1. Enter the *Advanced* features menu by holding the **Menu** button for 5 seconds. Press **Up** arrow until info is shown.
2. Press and hold **Right** arrow/Reset for five seconds, press **Enter/Ack** when display flashes reset.  
Note: If **Enter/Ack** is not pressed within three seconds, display returns to *Information* menu.
3. The meter goes through an initialization sequence (same as on power-up), and loads the factory default settings.

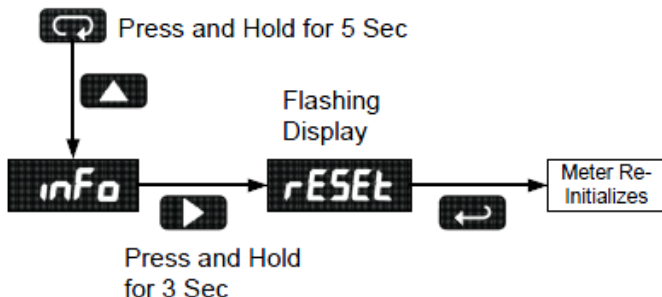

## FACTORY DEFAULTS &amp; USER SETTINGS

The following table shows the factory setting for most of the programmable parameters on the meter. Next to the factory setting, the user may record the new setting for the particular application.

Model: \_\_\_\_\_ S/N: \_\_\_\_\_ Date: \_\_\_\_\_

Parameter	Display	Default Setting	User Setting
Units	r rA	mA	
Decimal point	dd .ddd	3 places	
Scaling	SCALE		
Input 1	INPt 1	4.000 mA	
Display 1	dSPt 1	4.000	
Input 2	INPt 2	20.00 mA	
Display 2	dSPt 2	20.000	
Bargraph	GrAPH	On (enabled)	
Bargraph 0%	0 Pct	4.000	
Bargraph 100%	100 Pct	20.000	
Password	PASS	00000 (unlocked)	
<b>Advanced Features</b>			
Function	Funct	Linear	
Contrast	contr	5 (55555)	
Cutoff	CutoF	-99999 (disabled)	
Filter	FLtER	1	
Bypass	bYPAS	0.2	
Trend Arrows	tREnd	On (enabled)	

## TROUBLESHOOTING

The rugged design and the user-friendly interface of the meter should make it unusual for the installer or operator to refer to this section of the manual.

If the meter is not working as expected, refer to the recommendations below.

## Troubleshooting Tips

Symptom	Check/Action
No display or faint display	<ol style="list-style-type: none"> <li>1. Check connections.</li> <li>2. Increase contrast setting in <i>Advanced</i> menu.</li> <li>3. Perform hard reset by temporarily shorting S+ and S- terminals for a few seconds.</li> </ol>
Rate display unsteady	Increase filter setting in <i>Advanced</i> menu.
Not able to change setup or programming, Locd is displayed	Meter is locked, enter correct five-digit password to unlock.
Meter displays error message during calibration (error)	Check: <ol style="list-style-type: none"> <li>1. Signal connections</li> <li>2. Minimum input span requirements</li> </ol>
Meter displays <ol style="list-style-type: none"> <li>1. 99999</li> <li>2. -99999</li> </ol>	Check: <ol style="list-style-type: none"> <li>1. Input signal within range.</li> <li>2. When using square root or programmable exponent, cutoff must be zero or greater.</li> </ol>
Display stuck showing a number and MAX or MIN	Press <b>Menu</b> to exit Max/Min display readings.
Display response is too slow	Check filter and bypass values to see if they can be lowered.
If the display locks up or the meter does not respond at all	Perform hard reset by temporarily shorting S+ and S- terminals for a few seconds and then removing short.
Display shows blurry, hard-to-read digits in below freezing temperatures (less than -18°C or 0°F).	Increase the filter setting to 10 or greater and the bypass setting to 50 or greater. This will slow the display response rate, but digits will be steady and appear more clearly.
Other symptoms not described above	Call Technical Support for assistance.

## QUICK USER INTERFACE REFERENCE GUIDE

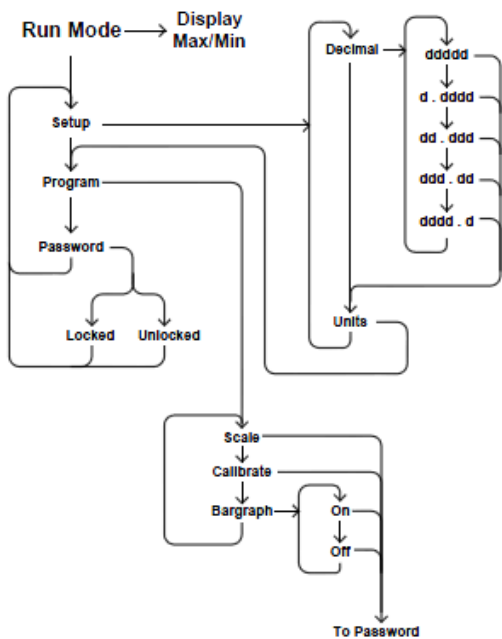

**Push button Function****Menu**

Go to Programming Mode or leave Programming, AdvancedFeatures, and Max/Min Modes.

**Right**

ArrowMove to next digit or decimal point position. Reset Total.

**Up Arrow**

Move to next selection or increment digit. Go to Max/Min Mode.

**Enter/Ack**

Accept selection/value and move to next selection. Toggle Rate/Total.

Hold to Acknowledge Alarm.

**Menu** held for 5 seconds enters Advanced Features

**Max/Min Mode**

While in Run Mode, pressing **Up Arrow** will initiate Max/Min Mode. **Up Arrow** toggles between Max & Min displays, and **Right Arrow** resets the Max/Min to the current value. Press **Menu** or wait 10 seconds to return to Run Mode. Pressing **Enter/Ack** will disable the 10 second timeout and continuously display Max or Min.

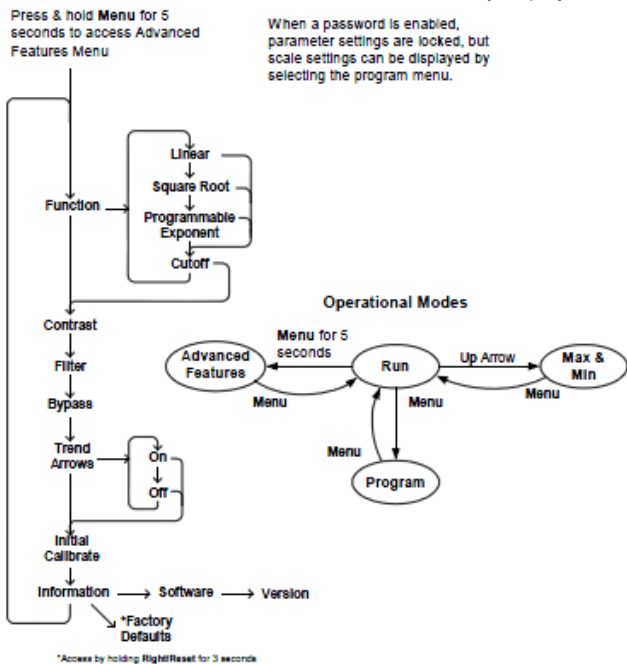

## WARRANTY

Flowline warrants to the original purchaser of its products that such products will be free from defects in material and workmanship under normal use and service in accordance with instructions furnished by Flowline for a period of two years from the date of manufacture of such products. Flowline's obligation under this warranty is solely and exclusively limited to the repair or replacement, at Flowline's option, of the products or components, which Flowline's examination determines to its satisfaction to be defective in material or workmanship within the warranty period. Flowline must be notified pursuant to the instructions below of any claim under this warranty within thirty (30) days of any claimed lack of conformity of the product. Any product repaired under this warranty will be warranted only for the remainder of the original warranty period. Any product provided as a replacement under this warranty will be warranted for the full two years from the date of manufacture.

## RETURNS

Products cannot be returned to Flowline without Flowline's prior authorization. To return a product that is thought to be defective, go to [flowline.com](http://flowline.com), and submit a customer return (MRA) request form and follow the instructions therein. All warranty and non-warranty product returns to Flowline must be shipped prepaid and insured. Flowline will not be responsible for any products lost or damaged in shipment.

## LIMITATIONS

This warranty does not apply to products which: 1) are beyond the warranty period or are products for which the original purchaser does not follow the warranty procedures outlined above; 2) have been subjected to electrical, mechanical or chemical damage due to improper, accidental or negligent use; 3) have been modified or altered; 4) anyone other than service personnel authorized by Flowline have attempted to repair; 5) have been involved in accidents or natural disasters; or 6) are damaged during return shipment to Flowline. Flowline reserves the right to unilaterally waive this warranty and dispose of any product returned to Flowline where: 1) there is evidence of a potentially hazardous material present with the product; or 2) the product has remained unclaimed at Flowline for more than 30 days after Flowline has dutifully requested disposition. This warranty contains the sole express warranty made by Flowline in connection with its products. **ALL IMPLIED WARRANTIES, INCLUDING WITHOUT LIMITATION, THE WARRANTIES OF MERCHANTABILITY AND FITNESS FOR A PARTICULAR PURPOSE, ARE EXPRESSLY DISCLAIMED.** The remedies of repair or replacement as stated above are the exclusive remedies for the breach of this warranty. **IN NO EVENT SHALL FLOWLINE BE LIABLE FOR ANY INCIDENTAL OR CONSEQUENTIAL**

DAMAGES OF ANY KIND INCLUDING PERSONAL OR REAL PROPERTY OR FOR INJURY TO ANY PERSON. THIS WARRANTY CONSTITUTES THE FINAL, COMPLETE AND EXCLUSIVE STATEMENT OF WARRANTY TERMS AND NO PERSON IS AUTHORIZED TO MAKE ANY OTHER WARRANTIES OR REPRESENTATIONS ON BEHALF OF FLOWLINE. This warranty will be interpreted pursuant to the laws of the State of California. If any portion of this warranty is held to be invalid or unenforceable for any reason, such finding will not invalidate any other provision of this warranty.

For complete product documentation, video training, and technical support, go to [flowline.com](http://flowline.com).

For phone support, call 562-598-3015 from 8am to 5pm PST, Mon - Fri.

(Please make sure you have the Part and Serial number available.)