

---

**User's  
Manual**

**UTAdvanced.**

**UP55A  
Program Controller  
User's Manual**

IM 05P02C41-01EN

---

**vigilantplant.®**

# Product Registration

Thank you for purchasing YOKOGAWA products.

YOKOGAWA provides registered users with a variety of information and services. Please allow us to serve you best by completing the product registration form accessible from our homepage.

***<http://www.yokogawa.com/ns/reg/>***



## Introduction

Thank you for purchasing the UP55A program controller (hereinafter referred to as UP55A).

This manual describes how to use UP55A functions other than UP55A's communication function and ladder sequence function. Please read through this user's manual carefully before using the product.

Note that the manuals for the UP55A comprise the following seven documents:

- **Printed manual**

Manual Name	Manual Number	Description
UP55A Operation Guide (For Standard model)	IM 05P02C41-11EN	This manual describes the basic operation method. It is also contained in the provided CD-ROM.
UP55A Operation Guide (For Detailed model)	IM 05P02C41-15EN	This manual describes the basic operation method. It is also contained in the provided CD-ROM.

- **Electronic manuals contained in the provided CD-ROM**

Manual Name	Manual Number	Description
UP55A Operation Guide (For Standard model)	IM 05P02C41-11EN	This is identical to the printed manual.
UP55A Operation Guide (For Detailed model)	IM 05P02C41-15EN	This is identical to the printed manual.
UP55A User's Manual	IM 05P02C41-01EN	This manual. It describes the usage of all functions except the ladder sequence and communication functions.
UTAdvanced Series Communication Interface (RS-485, Ethernet) User's Manual	IM 05P07A01-01EN	This manual describes how to use UTAdvanced in Ethernet and serial communications. For communication wiring, see the Operation Guide or User's Manual.
UTAdvanced Series Communication Interface (Open Network) User's Manual	IM 05P07A01-02EN	This manual describes how to use UTAdvanced in PROFIBUS-DP/DeviceNet/CC-Link communications. For communication wiring, see the Operation Guide or User's Manual.
LL50A Parameter Setting Software Installation Manual	IM 05P05A01-01EN	This manual describes how to install and uninstall the LL50A.
LL50A Parameter Setting Software User's Manual	IM 05P05A01-02EN	This manual describes how to use the LL50A, ladder sequence function, peer-to-peer communication, and network profile creating function.

\* User's Manual can be downloaded from a website.

## Target Readers

This guide is intended for the following personnel;

- Engineers responsible for installation, wiring, and maintenance of the equipment.
- Personnel responsible for normal daily operation of the equipment.

## Notice

- The contents of this manual are subject to change without notice as a result of continuing improvements to the instrument's performance and functions.
- Every effort has been made to ensure accuracy in the preparation of this manual. Should any errors or omissions come to your attention, however, please inform Yokogawa Electric's sales office or sales representative.
- Under no circumstances may the contents of this manual, in part or in whole, be transcribed or copied without our permission.

---

## Trademarks

- Our product names or brand names mentioned in this manual are the trademarks or registered trademarks of Yokogawa Electric Corporation (hereinafter referred to as YOKOGAWA).
- Microsoft, MS-DOS, Windows, Windows XP, Windows Vista, and Windows 7 are either registered trademarks or trademarks of Microsoft Corporation in the United States and/or other countries.
- Adobe, Acrobat, and Postscript are either registered trademarks or trademarks of Adobe Systems Incorporated.
- Ethernet is a registered trademark of XEROX Corporation in the United States.
- Modbus is a registered trademark of Schneider Electric.
- PROFIBUS-DP is a registered trademark of PROFIBUS User Organization.
- DeviceNet is a registered trademark of Open DeviceNet Vender Association, Inc.
- CC-Link is a registered trademark of CC-Link Partner Association (CLPA.)
- We do not use the TM or ® mark to indicate these trademarks or registered trademarks in this user's manual.
- All other product names mentioned in this user's manual are trademarks or registered trademarks of their respective companies.

## Safety Precautions

This instrument is a product of Installation Category II of IEC/EN/CSA/UL61010-1 Safety Standards and Class A of EN61326-1, EN55011 (EMC Standards).



---

### CAUTION

---

This instrument is an EMC class A product. In a domestic environment, this product may cause radio interference in which case the user needs to take adequate measures.

---

The instrument is a product rated Measurement Category I (CAT.I).

\* Measurement Category I (CAT.I)

This category applies to electric equipment that measures a circuit connected to a low-voltage facility and receives power from stationary equipment such as electric switchboards.

To use the instrument properly and safely, observe the safety precautions described in this user's manual when operating it. Use of the instrument in a manner not prescribed herein may compromise protection features inherent in the device. We assume no liability for or warranty on a fault caused by users' failure to observe these instructions.

This instrument is designed to be used within the scope of Measurement Category I (CAT. I) and is dedicated for indoor use.

#### Notes on the User's Manual

- This user's manual should be readily accessible to the end users so it can be referred to easily. It should be kept in a safe place.
- Read the information contained in this manual thoroughly before operating the product.
- The purpose of this user's manual is not to warrant that the product is well suited to any particular purpose, but rather to describe the functional details of the product.

---

## Safety, Protection, and Modification of the Product

The following symbols are used in the product and user's manuals to indicate safety precautions:



"Handle with Care" (This symbol is attached to the part(s) of the product to indicate that the user's manual should be referred to in order to protect the operator and the instrument from harm.)



AC



AC/DC



The equipment wholly protected by double insulation or reinforced insulation.



Functional grounding terminal (Do not use this terminal as a protective grounding terminal.)

- In order to protect the system controlled by this product and the product itself, and to ensure safe operation, observe the safety precautions described in this user's manual. Use of the instrument in a manner not prescribed herein may compromise the product's functions and the protection features inherent in the device. We assume no liability for safety, or responsibility for the product's quality, performance or functionality should users fail to observe these instructions when operating the product.
- Installation of protection and/or safety circuits with respect to a lightning protector; protective equipment for the system controlled by the product and the product itself; foolproof or failsafe design of a process or line using the system controlled by the product or the product itself; and/or the design and installation of other protective and safety circuits are to be appropriately implemented as the customer deems necessary.
- Be sure to use the spare parts approved by YOKOGAWA when replacing parts or consumables.
- This product is not designed or manufactured to be used in critical applications that directly affect or threaten human lives. Such applications include nuclear power equipment, devices using radioactivity, railway facilities, aviation equipment, air navigation facilities, aviation facilities, and medical equipment. If so used, it is the user's responsibility to include in the system additional equipment and devices that ensure personnel safety.
- Modification of the product is strictly prohibited.
- This product is intended to be handled by skilled/trained personnel for electric devices.
- This product is UL Recognized Component. In order to comply with UL standards, end-products are necessary to be designed by those who have knowledge of the requirements.



## WARNING

- **Power Supply**  
Ensure that the instrument's supply voltage matches the voltage of the power supply before turning ON the power.
  - **Do Not Use in an Explosive Atmosphere**  
Do not operate the instrument in locations with combustible or explosive gases or steam. Operation in such environments constitutes an extreme safety hazard. Use of the instrument in environments with high concentrations of corrosive gas (H<sub>2</sub>S, SO<sub>x</sub>, etc.) for extended periods of time may cause a failure.
  - **Do Not Remove Internal Unit**  
The internal unit should not be removed by anyone other than YOKOGAWA's service personnel. There are dangerous high voltage parts inside. Additionally, do not replace the fuse by yourself.
  - **Damage to the Protective Construction**  
Operation of the instrument in a manner not specified in this user's manual may damage its protective construction.
-

---

### Warning and Disclaimer

- YOKOGAWA makes no warranties regarding the product except those stated in the WARRANTY that is provided separately.
- The product is provided on an “as is” basis. YOKOGAWA assumes no liability to any person or entity for any loss or damage, direct or indirect, arising from the use of the product or from any unpredictable defect of the product.

### Notes on Software

- YOKOGAWA makes no warranties, either expressed or implied, with respect to the software’s merchantability or suitability for any particular purpose, except as specified in the terms of the separately provided warranty.
- This software may be used on one specific machine only.
- To use the software on another machine, the software must be purchased again separately.
- It is strictly prohibited to reproduce the product except for backup purposes.
- Store the software CD-ROM (the original medium) in a safe place.
- All reverse-engineering operations, such as reverse compilation or the reverse assembly of the product are strictly prohibited.
- No part of the product’s software may be transferred, converted, or sublet for use by any third party, without prior written consent from YOKOGAWA.

### Handling Precautions for the Main Unit

- The instrument comprises many plastic components. To clean it, wipe it with a soft, dry cloth. Do not use organic solvents such as benzene or thinner for cleaning, as discoloration or deformation may result.
- Keep electrically charged objects away from the signal terminals. Not doing so may cause the instrument to fail.
- Do not apply volatile chemicals to the display area, operation keys, etc. Do not leave the instrument in contact with rubber or PVC products for extended periods. Doing so may result in failure.
- If the equipment emits smoke or abnormal smells or makes unusual noises, turn OFF the instrument’s power immediately and unplug the device. In such an event, contact your sales representative.

### Waste Electrical and Electronic Equipment (WEEE), Directive 2002/96/EC

This is an explanation of how to dispose of this product based on Waste Electrical and Electronic Equipment (WEEE), Directive 2002/96/EC. This directive is only valid in the EU.



#### Marking

This product complies with the WEEE Directive (2002/96/EC) marking requirement. This marking indicates that you must not discard this electrical/electronic product in domestic household waste.

#### Product Category

With reference to the equipment types in the WEEE directive Annex 1, this product is classified as a “Monitoring and Control instrumentation” product. Do not dispose in domestic household waste. When disposing products in the EU, contact your local Yokogawa Europe B.V. office.

---

## Checking the Contents of the Package

Unpack the box and check the contents before using the product. If the product is different from that which you have ordered, if any parts or accessories are missing, or if the product appears to be damaged, contact your sales representative.

### **UP55A Main Unit**

The UP55A main units have nameplates affixed to the side of the case. Check the model and suffix codes inscribed on the nameplate to confirm that the product received is that which was ordered.

### **No. (Instrument number)**

When contacting your sales representative, inform them of this number, too.



## Model and Suffix Codes of UP55A (for Standard model)

[Style:S2]

Model	Suffix code	Optional suffix code	Description
<b>UP55A</b>			Program Controller (provided with retransmission output or 15 V DC loop power supply, 8 DIs, and 8 DOs) (Power supply: 100-240 V AC) 30 program patterns / 300 program segments (Max. 99 segments per pattern)
Type 1: Basic control	-0		Standard type
	-1		Position proportional type
	-2		Heating/cooling type
Type 2: Functions (*1)	0		None
	1		Remote (1 additional aux. analog) input, 1 additional DI
	2		RS-485 communication (Max.19.2 kpbs, 2-wire/4-wire)
	3		10 additional DOs
	4		3 additional aux. analog inputs, 2 DIs and 5 DOs to be deleted
Type 3: Open networks	0		None
	1		RS-485 communication (Max.38.4 kpbs, 2-wire/4-wire)
	2		Ethernet communication (with serial gateway function)
	3		CC-Link communication (with Modbus master function)
	4		PROFIBUS-DP communication (with Modbus master function)
	5		DeviceNet communication (with Modbus master function)
Display language (*2)	-1		English
	-2		German
	-3		French
	-4		Spanish
Case color	0		White (Light gray)
	1		Black (Light charcoal gray)
Fixed code		-00	Always "-00"
Optional suffix codes		/DR	Additional direct input (TC and 3-wire/4-wire RTD) and current input to Remote (1 additional aux. analog) input, 1 DI to be deleted (*3)
		/HA	Heater break alarm (*4)
		/DC	Power supply 24 V AC/DC
		/CT	Coating (*5)

\*1: When "3" is specified for the Type 2 code, only "0" can be specified for the Type 3 code.

\*2: English, German, French, and Spanish can be displayed as the guide display.

\*3: When any of "1" or "4" is specified for the Type 2 code, the /DR option can be specified.

\*4: When "-0" is specified for the Type 1 code, the /HA option can be specified.

\*5: When the /CT option is specified, the UP55A does not conform to the safety standards (UL and CSA) and CE marking.

## Model and Suffix Codes of UP55A (for Detailed model)

[Style:S2]

Model	Suffix code	Optional suffix code	Description
<b>UP55A</b>			Program Controller (provided with 3 DIs, and 3 DOs) (Power supply: 100-240 V AC) 30 program patterns/300 program segments (Max. 99 segments per pattern)
Fixed code	<b>-NNN</b>		Always "-NNN"
Display language (*1)	<b>-1</b>		English
	<b>-2</b>		German
	<b>-3</b>		French
	<b>-4</b>		Spanish
Case color	<b>0</b>		White (Light gray)
	<b>1</b>		Black (Light charcoal gray)
Output 1 (*2) (*3)	<b>-A</b>		Analog output (current/voltage pulse)
	<b>-R</b>		Relay output (c-contact)
	<b>-U</b>		Universal output (current/voltage pulse/relay)
	<b>-T</b>		Triac output
	<b>-P</b>		Position proportional output
Output 2 (*2) (*3)	<b>A</b>		Analog output (current/voltage pulse)
	<b>R</b>		Relay output (c-contact)
	<b>U</b>		Universal output (current/voltage pulse/relay)
	<b>T</b>		Triac output
	<b>N</b>		None
Retransmission output		<b>/RT</b>	Retransmission output or 15 V DC power supply
Heater break alarm (*3)		<b>/HA</b>	Heater break alarm
E1 terminal area (*4)		<b>/R1</b>	Remote (1 additional aux. analog) input and 1 additional DI
		<b>/U1</b>	1 additional universal input (TC/RTD/DCV/mA)
		<b>/X1</b>	5 additional DIs
		<b>/Y1</b>	5 additional DOs
		<b>/W1</b>	2 additional DIs and 2 additional DOs
E2 terminal area (*4)		<b>/A2</b>	1 additional aux. analog input and 1 additional DI
		<b>/X2</b>	5 additional DIs
		<b>/Y2</b>	5 additional DOs
		<b>/W2</b>	2 additional DIs and 2 additional DOs
E3 terminal area (*4) (*5)		<b>/CH3</b>	RS485 communication (Max. 38.4 kbps, 2-wire/4-wire)
		<b>/CC3</b>	CC-Link communication (with Modbus master function)
		<b>/PD3</b>	PROFIBUS-DP communication (with Modbus master function)
		<b>/DN3</b>	DeviceNet communication (with Modbus master function)
		<b>/ET3</b>	Ethernet communication (with serial gateway function)
		<b>/X3</b>	5 additional DIs
		<b>/Y3</b>	5 additional DOs
		<b>/W3</b>	2 additional DIs and 2 additional DOs
E4 terminal area (*4) (*5)		<b>/A4</b>	1 additional aux. analog input and 1 additional DI
		<b>/C4</b>	RS485 communication (Max. 19.2 kbps, 2-wire/4-wire)
		<b>/L4</b>	24 V DC loop power supply
		<b>/AC4</b>	1 additional aux. analog input, 1 additional DI, and RS485 communication (Max.19.2 kbps, 2-wire)
		<b>/LC4</b>	24 V DC loop power supply and RS485 communication (Max.19.2 kbps, 2-wire)
		<b>/X4</b>	5 additional DIs
		<b>/Y4</b>	5 additional DOs
		<b>/W4</b>	2 additional DIs and 2 additional DOs
Power supply		<b>/DC</b>	Power supply 24 V AC/DC
Additional treatment (*6)		<b>/CT</b>	Coating

\*1: English, German, French, and Spanish can be displayed as the guide display.

\*2: For heating/cooling output, both Output 1 and Output 2 should be specified. Not available when Output 2 is "N." For position proportional output, specify "-P" for Output 1 and "N" for Output 2.

\*3: The /HA option can be specified only when the code for Output 1 and 2 is "-AN", "-RN", "-UN" or "-TN."

\*4: Only one option is available for each terminal area of E1 to E4.

\*5: The /L4 and /LC4 options for E4 terminal area can be specified only when the E3 terminal area option is not specified or specified any of /CH3, /X3, /Y3 or /W3.

\*6: When the /CT option is specified, the UP55A does not conform to the safety standards (UL and CSA) and CE marking.

## Coating Treatment

### (1)HumiSeal coating treatment

Apply HumiSeal coating to the printed circuit board assembly.

Do not apply HumiSeal coating to the following parts: connector, gold-plated contact area, relay part, RJC device, and in the vicinity of the push switch/LED lamp.

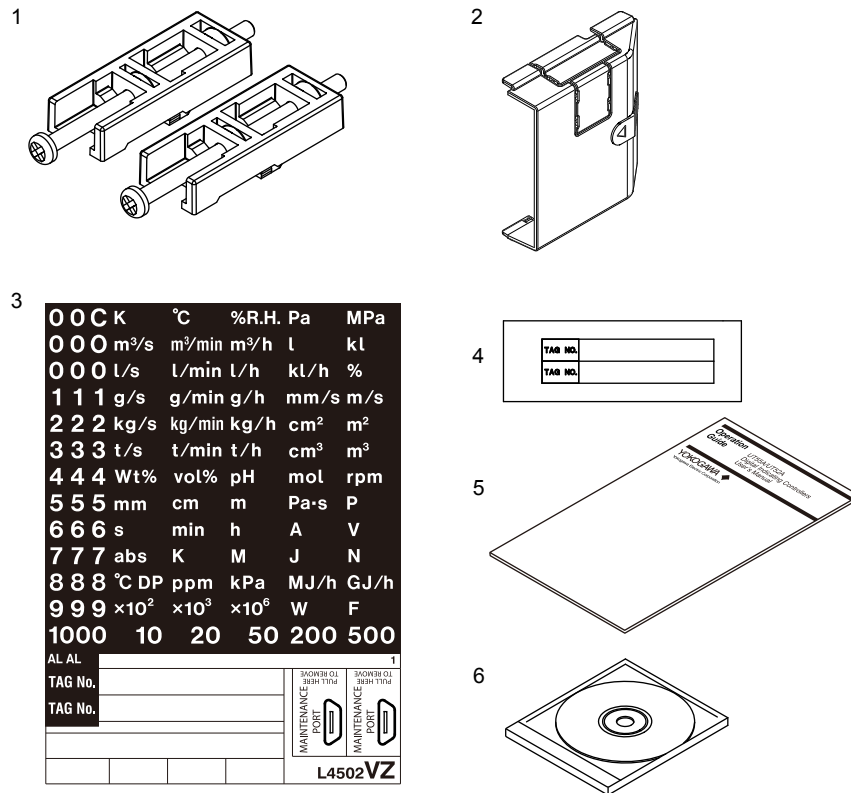
### (2)Apply terminal coating to the gold-plated contact area on the printed circuit board.

### Notes

- There are two treatments as described above, but we do not guarantee their effectiveness.  
We do not supply any test data on these treatments.
- Do not apply any treatment to the screw terminal area on the back side of the instrument.

## Accessories

The product is provided with the following accessories according to the model and suffix codes. Check that none of them are missing or damaged.



No.	Product Name	Quantity	Remark
1	Brackets	2	Part number: L4502TP (For fixing the upper and lower parts)
2	Terminal cover	1	For UP55A: L4502XP
3	Unit label	1	Part number: L4502VZ
4	Tag label	1	Part number: L4502VE (Only when ordered.)
5	Operation Guide	1	Single-loop control (A3 size, x7) (Standard model only)
6	User's Manual (CD-ROM)	1	Contains all manuals (Standard model only)

---

### Accessory (sold separately)

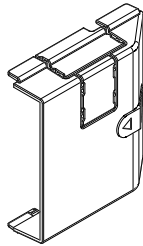
The following lists an accessory sold separately.

- LL50A Parameter Setting Software

Model	Suffix code	Description
LL50A	-00	Parameter Setting Software

- Terminal cover

For model UP55A: UTAP001



For UP55A

- Brackets

Part number L4502TP (2 pieces for fixing the upper and lower parts)

- User's Manual (A4 size)

\* User's Manual can be downloaded from a website.

- User's Manual (CD-ROM), Model: UTAP003

\* Contains all manuals.

---

## Symbols Used in This Manual



This symbol is used on the instrument. It indicates the possibility of injury to the user or damage to the instrument, and signifies that the user must refer to the user's manual for special instructions. The same symbol is used in the user's manual on pages that the user needs to refer to, together with the term "WARNING" or "CAUTION."

### **WARNING**

Calls attention to actions or conditions that could cause serious or fatal injury to the user, and indicates precautions that should be taken to prevent such occurrences.

### **CAUTION**

Calls attention to actions or conditions that could cause injury to the user or damage to the instrument or property and indicates precautions that should be taken to prevent such occurrences.

### **Note**

Identifies important information required to operate the instrument.



Indicates related operations or explanations for the user's reference.



Indicates a character string displayed on the display.

### **Setting Display**

Indicates a setting display and describes the keystrokes required to display the relevant setting display.

### **Setting Details**

Provides the descriptions of settings.

### **Description**

Describes restrictions etc. regarding a relevant operation.

### **How to Open an Electronic Manual**

The provided CD-ROM contains PDF files of the manuals. Place this CD-ROM in the PC's CD-ROM drive; the Startup Window appears. Click on the relevant manual name to open the selected manual.

If the Startup Window does not appear, select My Computer and double click on UT\_manual to open the manual concerned in the English directory.

---

## How to Use This Manual

For the ladder sequence and communication functions, see the respective manuals. This user's manual is organized into Chapters 1 to 19 as shown below.

Chapter	Title and Description
1	<b>Introduction to Functions</b> Describes the main functions of the UP55A.
2	<b>UP55A Operating Procedures</b> Describes the flow from unpacking to regular operations.
3	<b>Part Names</b> Describes part names and functions on the front panel.
4	<b>Basic Operation</b> Describes basic operation of the UP55A.
5	<b>Quick Setting Function</b> Describes the minimum necessary settings for operation.
6	<b>Monitoring and Control of Regular Operations</b> Describes monitoring displays of regular operations and operation.
7	<b>Input (PV, Remote, and Auxiliary Analog) Functions</b> Describes PV input, remote input, and advanced secondary control input.
8	<b>Control Functions</b> Describes basic control and advanced control.
9	<b>Program Pattern Functions</b> Describes program pattern functions
10	<b>Output (Control and Retransmission) Functions</b> Describes output functions.
11	<b>Alarm Functions</b> Describes alarm output and status output.
12	<b>Contact Input/Output Functions</b> Describes contact input/output functions.
13	<b>Display, Key, and Security Functions</b> Describes display, user function key and security functions.
14	<b>Parameter Initialization</b> Describes the initialization to factory default values and to user default values.
15	<b>Power Failure Recovery Processing/Power Frequency Setting/Other Settings</b> Describes operations performed after momentary power interruption and power failures.
16	<b>Troubleshooting, Maintenance, and Inspections</b> Describes troubleshooting, maintenance, periodic inspections, and disposal.
17	<b>Installation and Wiring</b> Describes installation and wiring.
18	<b>Parameters</b> Provides parameter maps.
19	<b>Specifications</b> Provides the UP55A specifications.



# Contents

Introduction.....	i
Target Readers.....	i
Notice .....	i
Trademarks .....	ii
Safety Precautions .....	ii
Handling Precautions for the Main Unit.....	iv
Waste Electrical and Electronic Equipment (WEEE), Directive 2002/96/EC.....	iv
Checking the Contents of the Package.....	v
Model and Suffix Codes of UP55A (for Standard model).....	vi
Model and Suffix Codes of UP55A (for Detailed model) .....	vii
Symbols Used in This Manual.....	x
How to Use This Manual .....	xi
<b>Chapter 1 Introduction to Functions</b>	
1.1 Quick Setting Function .....	1-1
1.2 Input/Output Function.....	1-2
1.3 Control Functions .....	1-4
1.4 Program Pattern Functions .....	1-7
1.5 Display and Key Functions.....	1-8
1.6 Ladder Sequence Function .....	1-9
1.7 Communication Functions.....	1-10
1.8 Definition of Main Symbols and Terms .....	1-14
<b>Chapter 2 UP55A Operating Procedures</b>	
2.1 UP55A Operating Procedures.....	2-1
<b>Chapter 3 Part Names</b>	
3.1 Names and Functions of Display Parts .....	3-1
3.2 Names and Functions of Keys .....	3-4
3.3 List of Display Symbols .....	3-7
3.4 Brief Description of Setting Details (Parameters).....	3-9
<b>Chapter 4 Basic Operation</b>	
4.1 Overview of Display Switch and Operation Keys .....	4-1
4.2 How to Set Parameters .....	4-5
<b>Chapter 5 Quick Setting Function</b>	
5.1 Setting Using Quick Setting Function.....	5-1
5.2 Restarting Quick Setting Function.....	5-6
<b>Chapter 6 Monitoring and Control of Regular Operations</b>	
6.1 Monitoring and Control of Operation Displays.....	6-1
6.1.1 Operation Display Transitions in Single-loop Control, Cascade Primary-loop Control, Loop Control with PV switching, and Loop Control with PV auto-selector.....	6-1
Standard Type .....	6-2
Position Proportional Type.....	6-4
Heating/cooling Type .....	6-6
6.1.2 Operation Display Transitions in Cascade Control .....	6-8
Standard Type .....	6-8
Position Proportional Type.....	6-12
Heating/cooling Type .....	6-16



6.1.3	Details of the Operation Display .....	6-20
6.2	Performing and Canceling Auto-tuning.....	6-26
6.3	Adjusting PID Manually .....	6-29
6.4	Setting Alarm Setpoint.....	6-34
6.5	Selecting Program Pattern Number (PTNO.) .....	6-35
	Selecting by PTN Key.....	6-35
	Selecting by Operation Mode Parameter.....	6-35
6.6	Switching Operation Modes .....	6-36
6.6.1	Operation Display Switching Diagram .....	6-36
6.6.2	Switching to PROG Operation .....	6-37
	Selecting by RUN Key .....	6-37
	Selecting by Operation Mode Parameter.....	6-37
6.6.3	Switching to RESET Operation.....	6-38
	Selecting by RST Key.....	6-38
	Selecting by Operation Mode Parameter.....	6-38
6.6.4	Enabling/Disabling Hold Mode of Program Operation .....	6-40
	Selecting by MODE Key .....	6-40
	Selecting by Operation Mode Parameter.....	6-40
	Hold Operation in Soak Segment .....	6-41
	Hold Operation in Ramp Segment.....	6-41
6.6.5	Executing Advance .....	6-42
	Selecting by MODE Key .....	6-42
	Selecting by Operation Mode Parameter.....	6-42
6.6.6	Switching between AUTO and MAN .....	6-44
	Selecting by MODE Key .....	6-44
	Selecting by Operation Mode Parameter.....	6-44
6.6.7	Switching to Local Operation .....	6-46
	Selecting by MODE Key .....	6-46
	Selecting by Operation Mode Parameter.....	6-46
6.6.8	Switching to Remote Operation .....	6-47
	Selecting by MODE Key .....	6-47
	Selecting by Operation Mode Parameter.....	6-47
6.6.9	Switching between Local (LSP) and Cascade.....	6-48
	Selecting by MODE Key .....	6-48
	Selecting by Operation Mode Parameter.....	6-48
6.7	Selecting Start-of-program Pattern Number.....	6-49
	Selecting by MODE Key .....	6-49
	Selecting by Operation Mode Parameter.....	6-49
6.8	Fast-forwarding Program Pattern .....	6-51
	Performing by MODE Key .....	6-51
	Performing by Operation Mode Parameter.....	6-51
6.9	Changing SP, TSP, or Remaining Segment-time (R.TIM) in HOLD-mode .....	6-52
	Changing SP in HOLD Operation .....	6-52
	Changing TSP in HOLD Operation.....	6-53
	Changing R.TIM in HOLD Operation.....	6-53
	Modifying Target Setpoint in Soak Segment.....	6-55
	Modifying Target Setpoint in Ramp Segment .....	6-55
	Modifying Final Target Setpoint (TSP) in Soak Segment.....	6-56
	Modifying Final Target Setpoint (TSP) in Ramp Segment .....	6-56
	Decreasing Segment-time in Soak Segment.....	6-57
	Increasing Segment-time in Soak Segment .....	6-58
	Decreasing Segment-time in Ramp Segment .....	6-59
	Increasing Segment-time in Ramp Segment.....	6-59
6.10	Changing Program Pattern during Program Operation .....	6-60
6.11	Manipulating Control Output during Manual Operation .....	6-61

6.12 Releasing On-State (Latch) of Alarm Output ..... 6-62

**Chapter 7 Input (PV, Remote, and Auxiliary Analog) Functions**

7.1 Setting Functions of PV Input, Remote Input, and Auxiliary Analog Input ..... 7-1

7.1.1 Setting Input Type, Unit, Range, Scale, and Decimal Point Position ..... 7-1

7.1.2 Setting Burnout Detection for Input ..... 7-5

7.1.3 Setting Reference Junction Compensation (RJC) or External Reference Junction Compensation (ERJC) ..... 7-6

7.1.4 Correcting Input Value ..... 7-7

(1) Setting Bias and Filter ..... 7-7

(2) Setting Square Root Extraction and Low Signal Cutoff Point ..... 7-9

(3) Setting 10-segment Linearizer ..... 7-10

7.1.5 Setting Ratio bias/filter ..... 7-12

7.2 Setting Input Sampling Period (Control Period) ..... 7-13

7.3 Using 4-wire RTD as PV Input ..... 7-14

7.4 Using Larger, Smaller, Average, or Difference of Two to Four Inputs as PV ..... 7-15

7.5 Setting Remote Input Method ..... 7-16

7.6 Adjusting PV Range for Loop Control with PV Switching or Loop Control with PV Auto-selector ..... 7-17

7.7 Setting PV Switching Methods of Loop Control with PV Switching ..... 7-18

**Chapter 8 Control Functions**

8.1 Setting Control Mode (CTLM) ..... 8-1

8.1.1 Single-loop Control, Single-loop Heating/cooling Control, and Single-loop Position Proportional Control ..... 8-1

■ Single-loop Control Function Block Diagram ..... 8-2

■ Single-loop Heating/cooling Control Function Block Diagram ..... 8-4

■ Single-loop Position Proportional Control Function Block Diagram ..... 8-6

8.1.2 Cascade Primary-loop Control ..... 8-9

■ Cascade Primary-loop Control Function Block Diagram ..... 8-10

8.1.3 Cascade Control, Cascade Heating/cooling Control, and Cascade Position Proportional Control ..... 8-13

■ Cascade Control Function Block Diagram ..... 8-15

■ Cascade Heating/cooling Control Function Block Diagram ..... 8-16

■ Cascade Position Proportional Control Function Block Diagram ..... 8-19

8.1.4 Loop Control with PV Switching, Heating/cooling Loop Control with PV Switching, and Position Proportional Loop Control with PV Switching ..... 8-21

■ Loop Control with PV Switching Function Block Diagram ..... 8-22

■ Heating/cooling Loop Control with PV Switching Function Block Diagram ..... 8-25

■ Position Proportional Loop Control with PV Switching Function Block Diagram ..... 8-27

8.1.5 Loop Control with PV Auto-selector, Heating/cooling Loop Control with PV Auto-selector, and Position Proportional Loop Control with PV Auto-selector .... 8-29

■ Loop Control with PV Auto-selector (2 inputs) Function Block Diagram ..... 8-31

■ Heating/cooling Loop Control with PV Auto-selector (2 inputs) Function Block Diagram ..... 8-33

■ Position Proportional Loop Control with PV Auto-selector (2 inputs) Function Block Diagram ..... 8-35

■ Loop Control with PV Auto-selector (4 inputs) Function Block Diagram ..... 8-36

■ Heating/cooling Loop Control with PV Auto-selector (4 inputs) Function Block Diagram ..... 8-39

■ Position Proportional Loop Control with PV Auto-selector (4 inputs) Function Block Diagram ..... 8-41

8.2 Setting Control Type (CNT) ..... 8-42

8.2.1 PID Control ..... 8-43

8.2.2 ON/OFF Control (1 point of hysteresis / 2 points of hysteresis) ..... 8-44

8.2.3 Heating/cooling Control ..... 8-46

8.2.4 PD Control (Stable Control in Which a Setpoint is not Exceeded) ..... 8-51

8.3 Setting PID Control Mode (ALG) ..... 8-52

1

2

3

4

5

6

7

8

9

10

11

12

13

14

15

16

17

18

19

App

8.4	Switching PID .....	8-54
8.4.1	Switching PID According to Target Setpoint Number (SPNO) .....	8-54
8.4.2	Switching PID According to PV .....	8-55
8.4.3	Switching PID According to SP .....	8-56
8.4.4	Switching PID According to Target SP .....	8-58
8.4.5	Switching PID According to Deviation (Reference Deviation).....	8-60
8.4.6	Setting Hysteresis at Time of PID Switch .....	8-61
8.4.7	Switching PID Irrespective of Operation Mode .....	8-61
8.4.8	Switching PID by Contact Input .....	8-61
8.5	Suppressing Overshoot (Super Function) .....	8-62
8.6	Suppressing Hunting (Super2 Function) .....	8-64
8.7	Suppressing Integral Action (Anti-reset Wind-up) .....	8-66
8.8	Performing Non-linear PID Control.....	8-67
8.9	Adjusting Auto-tuning Operation .....	8-68
8.10	Setting SP Limiter.....	8-69
8.11	Setting Program Time Unit .....	8-70
8.12	Forcing Local Setpoint (LSP) to Track Program Setpoint or Remote Setpoint (SP Tracking) ...	8-71
8.13	Setting Controller Action at Power ON (Restart Mode) .....	8-72
8.14	Setting Time between Powering on Controller and Starting Control (Restart Timer) .....	8-73

## Chapter 9 Program Pattern Functions

9.1	Setting the Setting Method of Program Pattern.....	9-1
9.1.1	Setting the Program Pattern Using the Segment Time .....	9-2
9.1.2	Setting the Program Pattern using the Ramp-rate and Segment Time .....	9-3
9.1.3	Setting the Program Time Unit.....	9-5
9.2	PID Selection Method.....	9-6
9.2.1	Segment PID Selection.....	9-6
9.2.2	Zone PID Selection .....	9-7
9.2.3	Local PID Selection .....	9-7
9.3	Setting the Program Starting Conditions (STC) .....	9-8
9.3.1	Starting operation at starting target setpoint (SSP) (STC=SSP) .....	9-8
9.3.2	Ramp-prioritized PV start (STC=RAMP).....	9-9
9.3.3	Time-prioritized PV start (STC=TIME) .....	9-13
9.3.4	Starting operation at local target setpoint (STC=LSP).....	9-15
9.3.5	Starting operation at remote setpoint (STC=RSP).....	9-17
9.4	Setting the Wait Functions.....	9-18
9.4.1	Program Wait at Segment End .....	9-18
9.4.2	Program Wait in the Middle of a Segment .....	9-21
9.5	Setting the Segment Repetition.....	9-22
9.6	Operation with Linked Program Patterns .....	9-23
9.7	Setting Event Functions .....	9-26
9.7.1	PV Event.....	9-27
9.7.2	Time Event.....	9-28
9.7.3	Local Event .....	9-30
9.8	Setting the Operation in Segment Switching .....	9-31
9.8.1	Switching for continuation (JC=CONT).....	9-31
9.8.2	Hold-on switching (JC=HOLD).....	9-33
9.8.3	Local-mode switching (JC=LOCAL).....	9-35
9.8.4	Remote-mode switching (JC=REM) .....	9-37
9.8.5	Segment switching (the controller switches to a local setpoint when the segment is completed after release) (JC=W.SL1 to W.SL5) .....	9-39

9.8.6	Segment switching (the controller switches to a remote setpoint when the segment is completed after release) (JC=W.SR1 to W.SR5) .....	9-40
9.9	Setting Program Pattern-2 Retransmission .....	9-41
9.10	Setting Starting time of program operation .....	9-42
9.11	Setting the Program Pattern Number Clearance .....	9-43
9.12	Program Pattern End Signal .....	9-44
9.13	Editing the Program Pattern .....	9-45
9.13.1	Checking the Number of Remaining Segments .....	9-45
9.13.2	Checking the Number of Segments in specified pattern .....	9-45
9.13.3	Copying a Program Pattern .....	9-46
9.13.4	Adding and Deleting Segment in Program Patterns .....	9-46
9.13.5	Deleting the Program Pattern .....	9-47
9.13.6	List of the Error Code .....	9-47
9.14	Synchronized Program Pattern Operation .....	9-48
9.14.1	Synchronized Operation During Switching Between Segments .....	9-48
9.14.2	Synchronized Operation of Program Pattern Progression .....	9-51

## Chapter 10 Output (Control and Retransmission) Functions

10.1	Setting Control Output Type .....	10-1
10.2	Setting Control Output Cycle Time .....	10-5
10.3	Setting Limiter to Control Output .....	10-6
10.4	Disabling Output Limiter in MAN mode .....	10-7
10.5	Setting Velocity Limiter to Control Output .....	10-8
10.6	Reducing 4-20 mA Current Output to 0 mA (Tight Shut Function) .....	10-9
10.7	Setting ON/OFF Control Hysteresis .....	10-10
10.8	Canceling Offset of PV and SP (Manual Reset) .....	10-12
10.9	Setting Hysteresis and Dead Band for Heating/cooling Control Output .....	10-13
10.10	Setting Hysteresis and Dead Band for Position Proportional Control Output .....	10-15
10.11	Setting Retransmission Output Terminal, Type, and Scales .....	10-16
10.12	Setting Preset Output Value .....	10-19
10.12.1	Setting Output Value in RESET Mode (Preset Output) .....	10-19
10.12.2	Setting Output Value When Switched to MAN Mode (Manual Preset Output) ....	10-20
10.12.3	Setting Output Value When Error Occurs (Input Error Preset Output) .....	10-21
10.13	Setting 10-segment Linearizer for Output .....	10-22
10.14	Changing Current Output Range .....	10-24
10.15	Setting Split Computation Output Function .....	10-25
10.16	Adjusting Motor-operated Valve Position (Position Proportional Output) .....	10-27
10.16.1	Setting Valve Operation Mode .....	10-28
10.16.2	Adjusting Valve Position Automatically .....	10-28
10.16.3	Adjusting Valve Position Manually .....	10-29
10.16.4	Setting Valve Traveling Time (Estimating Type) .....	10-30
10.16.5	Selecting Feedback Input (Resistor/Current) .....	10-30
10.17	Using 15 V DC Loop Power Supply .....	10-31

## Chapter 11 Alarm Functions

11.1	Setting Alarm Type .....	11-1
11.2	Setting Number of Alarm Groups to Use .....	11-15
11.3	Setting Hysteresis to Alarm Operation .....	11-16
11.4	Delaying Alarm Output (Alarm Delay Timer) .....	11-17
11.5	Setting Alarm Output to Control Relay Terminal .....	11-18
11.6	Setting Alarm Action According to Operation Mode .....	11-19
11.7	Setting Heater Break Alarm .....	11-20



## Chapter 12 Contact Input/Output Functions

12.1	Setting Contact Input Function .....	12-1
12.1.1	Setting Contact Input Function .....	12-1
12.1.2	Changing Contact Type of Contact Input .....	12-11
12.2	Setting Contact Output Function .....	12-12
12.2.1	Setting Function of Contact Output.....	12-12
12.2.2	Changing Contact Type of Contact Output .....	12-19

## Chapter 13 Display, Key, and Security Functions

13.1	Setting Display Functions.....	13-1
13.1.1	Setting Active Color PV Display Function .....	13-1
13.1.2	Masking Arbitrary Display Value in Operation Display .....	13-4
13.1.3	Registering SELECT Display (Up to 5 Displays) .....	13-5
13.1.4	Changing Event Display .....	13-6
13.1.5	Registering SELECT Parameter Display (Up to 10 Displays).....	13-7
13.1.6	Setting Bar-graph Display Function .....	13-8
13.1.7	Masking Least Significant Digit of PV Display .....	13-10
13.1.8	Setting Economy Mode.....	13-11
13.1.9	Selecting the Initial Operation Display that Appears at Power ON .....	13-12
13.1.10	Setting Message Function .....	13-13
13.1.11	Switching Guide Display Language .....	13-13
13.1.12	Changing Guide Scroll Speed .....	13-14
13.1.13	Turning Guide Display ON/OFF.....	13-14
13.1.14	Setting Automatic Return to Operation Display .....	13-14
13.1.15	Setting Brightness and Contrast Adjustment of LCD and Display Update Cycle ....	13-15
13.2	Assigning Function to User Function.....	13-16
13.3	Setting Security Functions.....	13-19
13.3.1	Setting a Password.....	13-19
13.3.2	Setting Parameter Display Level .....	13-19
13.3.3	Locking (Hiding) Parameter Menu Display .....	13-20
13.3.4	Key Lock .....	13-22
13.3.5	Setting Display/Non-display of Operation Display .....	13-22
13.3.6	Prohibiting Writing via Communication .....	13-23
13.4	Confirmation of Key and I/O Condition and Version.....	13-24
13.4.1	Confirmation of Key and I/O Condition .....	13-24
13.4.2	Confirmation of Version .....	13-29

## Chapter 14 Parameter Initialization

14.1	Initializing Parameter Settings to Factory Default Values.....	14-1
14.2	Registering and Initializing User Default Values.....	14-2
14.2.1	Registering as User Setting (Default) Values.....	14-2
14.2.2	Initializing to User Setting (Default) Values.....	14-2

## Chapter 15 Power Failure Recovery Processing / Power Frequency Setting / Other Settings

15.1	Remedies if Power Failure Occurs during Operations .....	15-1
15.2	Power Frequency Setting .....	15-2

## Chapter 16 Troubleshooting, Maintenance, and Inspections

16.1	Troubleshooting.....	16-1
16.1.1	Troubleshooting Flowchart.....	16-1
16.1.2	Errors at Power On .....	16-2

16.1.3	Errors during Operation .....	16-4
16.2	Maintenance .....	16-15
16.2.1	Cleaning.....	16-15
16.2.2	Packaging when Shipping the Product for Repair .....	16-15
16.2.3	Replacing Parts .....	16-15
16.3	Periodic Maintenance .....	16-16
16.4	Disposal.....	16-17

## Chapter 17 Installation and Wiring

17.1	Installation Location.....	17-1
17.2	Mounting Method.....	17-3
17.3	External Dimensions and Panel Cutout Dimensions .....	17-4
17.4	Wiring .....	17-5
17.4.1	Important Information on Wiring .....	17-5
17.4.2	PV Input Wiring.....	17-7
17.4.3	Remote (Auxiliary Analog) Input Wiring .....	17-8
17.4.4	Control Output (Relay, Triac, Current, and Voltage Pulse) Wiring .....	17-10
17.4.5	Valve Position Output and Feedback Input Wiring .....	17-12
17.4.6	Contact Input Wiring .....	17-13
17.4.7	Contact Output Wiring .....	17-17
17.4.8	Retransmission Output Wiring .....	17-20
17.4.9	15 V DC Loop Power Supply Wiring.....	17-20
17.4.10	24 V DC Loop Power Supply Wiring (for Detailed model) .....	17-20
17.4.11	Heater Break Alarm Wiring .....	17-21
17.4.12	RS-485 Communication Interface Wiring .....	17-22
17.4.13	Coordinated Operation Wiring .....	17-24
17.4.14	Peer-to peer Communication Wiring.....	17-26
17.4.15	Ethernet Communication Interface Wiring.....	17-28
17.4.16	PROFIBUS-DP Communication Interface Wiring .....	17-30
17.4.17	DeviceNet Communication Interface Wiring .....	17-32
17.4.18	CC-Link Communication Interface Wiring.....	17-34
17.4.19	Power Supply Wiring .....	17-36
17.5	Attaching and Detaching Terminal Cover .....	17-37

## Chapter 18 Parameters

18.1	Parameter Map.....	18-1
18.2	List of Parameters .....	18-8
18.2.1	Operation Parameters .....	18-8
18.2.2	Setup Parameters.....	18-21

## Chapter 19 Specifications

19.1	Hardware Specifications.....	19-1
19.1.1	Input Specifications.....	19-2
19.1.2	Analog Output Specifications.....	19-4
19.1.3	Step Response Time Specifications .....	19-4
19.1.4	Relay Contact Output Specifications .....	19-4
19.1.5	Triac Output Specifications (for Detailed model) .....	19-5
19.1.6	Position Proportional Output Specifications.....	19-5
19.1.7	Retransmission Output Specifications .....	19-5
19.1.8	15 V DC Loop Power Supply Specifications.....	19-5
19.1.9	Contact Input Specifications .....	19-5
19.1.10	Transistor Contact Output Specifications.....	19-6
19.1.11	Heater Break Alarm Specifications .....	19-6



## Contents

---

19.1.12 24 V DC Loop Power Supply Specifications (for Detailed model) .....	19-6
19.1.13 Safety and EMC Standards .....	19-7
19.1.14 Construction, Installation, and Wiring .....	19-7
19.1.15 Power Supply Specifications and Isolation .....	19-8
19.1.16 Environmental Conditions.....	19-9

### Appendix Input and Output Table

Appendix 1	Input and Output Table (for Standard model).....	App-1
Appendix 2	Input and Output Table (for Detailed model) .....	App-4

### Revision Information

## 1.1 Quick Setting Function

The Quick setting function is a function to easily set the basic function of the controller.

Buy and  
Unpacking



Check the contents.



Installation  
and Wiring

Installation and Wiring: Chapter 17  
Install and wire a controller, and then turn on the power.



Setup



Q: What should I do to perform control immediately?  
First, I want to set the input, output and program pattern.

A: Use the Quick setting function to perform the setup easily.

Quick setting function: Chapter 5

For creating program pattern, see chapter 9, or Operation Guide.



Operation

Q: How do I determine the PID?

A: Use Auto-tuning to perform the tuning easily.  
Auto-tuning: Section 6.2

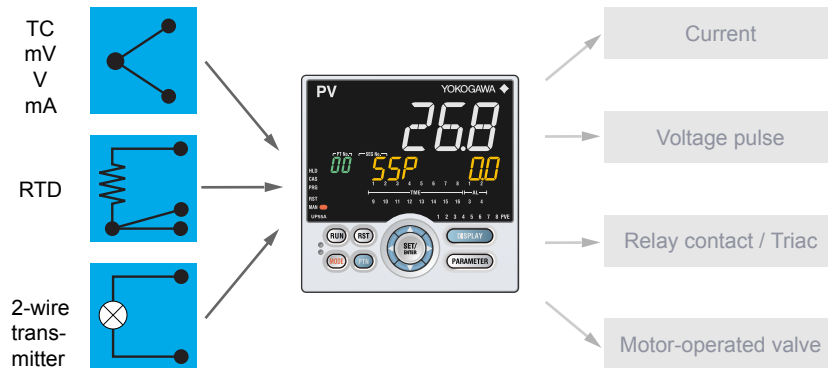


## 1.2 Input/Output Function

### PV Input

PV input is a universal input to arbitrarily set the type and range for the thermocouple (TC), resistance-temperature detector (RTD), and DC voltage/current.

▶ [Chapter 7 Input \(PV, Remote, and Auxiliary Analog\) Functions](#)



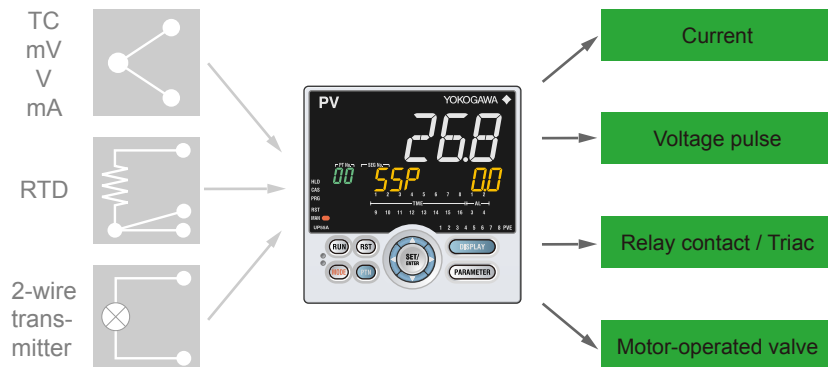
### Control Output

Control output (OUT) is a universal output to arbitrarily set the type for the current, voltage pulse, and relay/triac. Heating/cooling control and Position proportional control are possible by specifying the suffix code for the control.

Position proportional control is used exclusively for the motor-operated valve.

Heating/cooling control is for two output type of heat and cool.

▶ [Chapter 10 Output \(Control and Retransmission\) Functions](#)

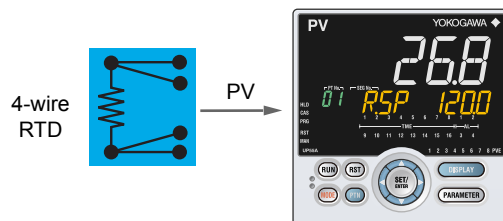


### Remote Input

Remote input (RSP) is external analog signal used for remote setpoint.

▶ [Chapter 7 Input \(PV, Remote, and Auxiliary Analog\) Functions](#)

Add direct input (optional suffix code /DR or /U1) to the remote input to use the 4-wire RTD as PV input. The LL50A Parameter Setting Software is required.



**Auxiliary Analog Input**

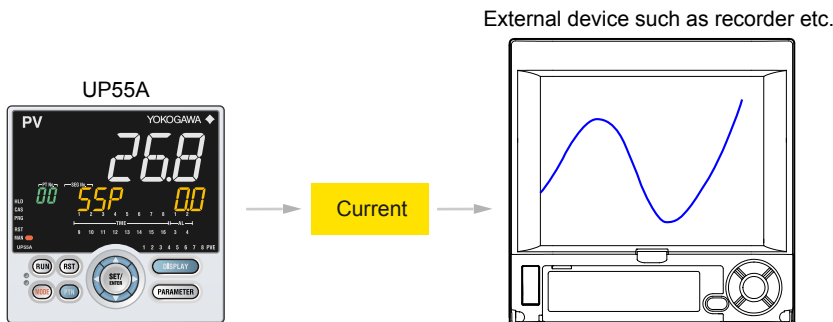
Two auxiliary analog inputs can be used separately from PV input (PV) and remote input (RSP).

▶ Chapter 7 Input (PV, Remote, and Auxiliary Analog) Functions

**Retransmission Output**

Retransmission output outputs a PV input value (PV), target setpoint (SP), control output value (OUT) and the like as an analog signal to, for example, the recorder.

▶ Chapter 10 Output (Control and Retransmission) Functions



**Contact Input**

Up to 23 contact inputs can be incorporated. The operation modes can be switched. PID control and sequence control can be performed simultaneously using the ladder sequence function.

The contact input can be specified with other suffix codes. For details, see the table of Model and Suffix Codes.

▶ Chapter 12 Contact Input/Output Functions

**Contact Output**

Up to 23 contact outputs can be incorporated. Contact output can output events such as alarms.

PID control and sequence control can be performed simultaneously using the ladder sequence function.

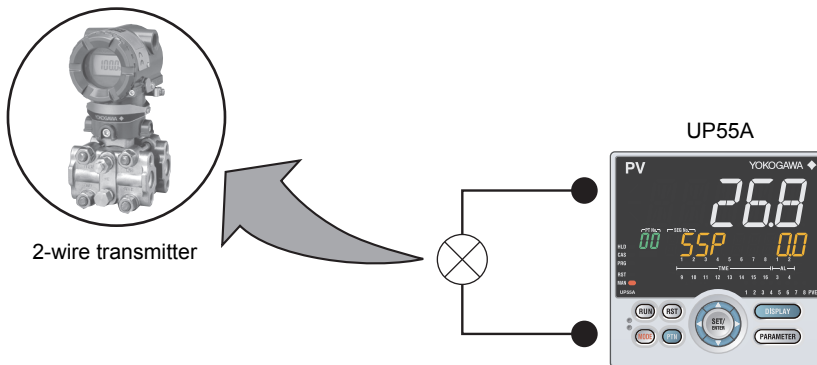
The contact output can be specified with other suffix codes. For details, see the table of Model and Suffix Codes.

▶ Chapter 9 Program Pattern Functions, Chapter 11 Alarm Functions

**24 V DC Loop Power Supply**

24 V DC loop power supply can be supplied to 2-wire transmitter.

▶ 17.4.10 24 V DC Loop Power Supply Wiring

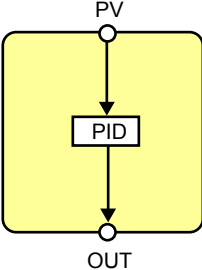
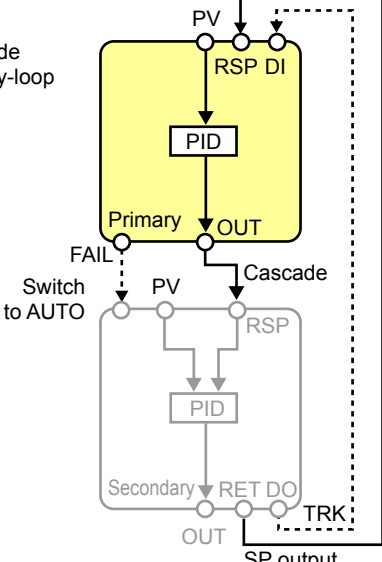
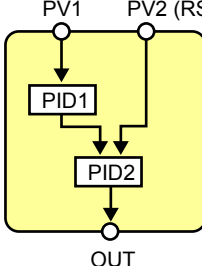
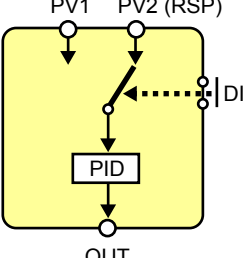


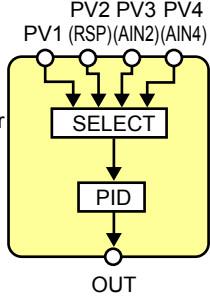
# 1.3 Control Functions

## Control Mode

The UP55A are controllers equipped with 5 control modes. Some control modes require a remote input (RSP) terminal.

For the auxiliary functions of control modes, see the respective sections.

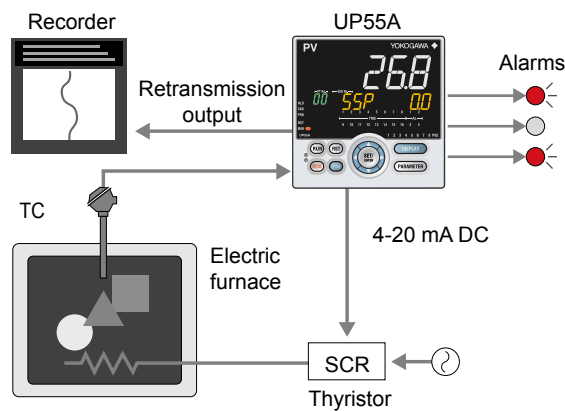
Control mode schematic diagram	Description
<p>Single-loop control</p> 	<p>“Single-loop control” provides the basic control function having one control computation unit.</p> <ul style="list-style-type: none"> <li>▶ <a href="#">8.1.1 Single-loop Control, Single-loop Heating/cooling Control, and Single-loop Position Proportional Control</a></li> </ul>
<p>Cascade primary-loop control</p> 	<p>“Cascade primary-loop control” sets up a controller as the primary-loop controller when two controllers are used for Cascade control. It is used in connection with “Cascade secondary-loop control.” It provides the output tracking function and FAIL output to the secondary-loop controller.</p> <p>Remote input (RSP) terminal is required for output tracking input</p> <ul style="list-style-type: none"> <li>▶ <a href="#">8.1.2 Cascade Primary-loop Control</a></li> </ul>
<p>Cascade control</p> 	<p>“Cascade control” uses two control computation units and permits Cascade control using just a single controller.</p> <p>Remote input (RSP) terminal is required for Loop-2 PV input.</p> <ul style="list-style-type: none"> <li>▶ <a href="#">8.1.3 Cascade Control, Cascade Heating/cooling Control, and Cascade Position Proportional Control</a></li> </ul>
<p>Loop control with PV switching</p> 	<p>“Loop control with PV switching” uses two PV inputs, which are switched according to input contact signals or measurement ranges.</p> <p>Remote input (RSP) terminal is required for Loop-2 PV input.</p> <ul style="list-style-type: none"> <li>▶ <a href="#">8.1.4 Loop Control with PV Switching, Heating/cooling Loop Control with PV Switching, and Position Proportional Loop Control with PV Switching</a></li> </ul>

Control mode schematic diagram	Description
<p>Loop control with PV auto-selector</p> 	<p>“Loop control with PV auto-selector” automatically selects or calculates the max. value, the min. value, the average, or difference (of PV1 and PV2) of two to four PV inputs. Remote input (RSP) terminal and auxiliary analog input terminal are required for the inputs 2, 3, and 4.</p> <p>▶ 8.1.5 Loop Control with PV Auto-selector, Heating/cooling Loop Control with PV Auto-selector, and Position Proportional Loop Control with PV Auto-selector</p>

### PID Control

PID control is a general control using the PID control-related parameters.

▶ 8.2.1 PID Control

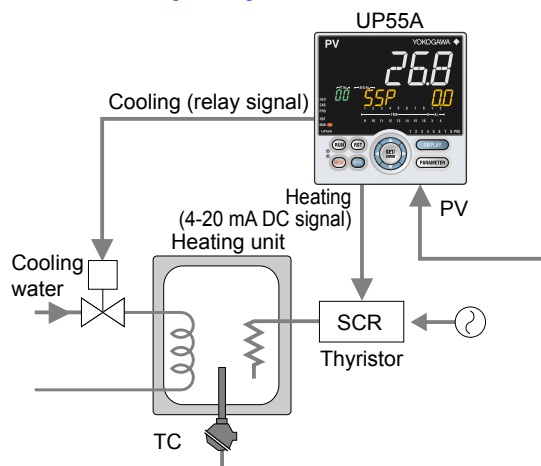


### Heating/cooling Control

Heating/cooling control is available only for Heating/cooling type.

In Heating/cooling control, the controller outputs the result of control computation after splitting it into heating-purpose and cooling-purpose signals.

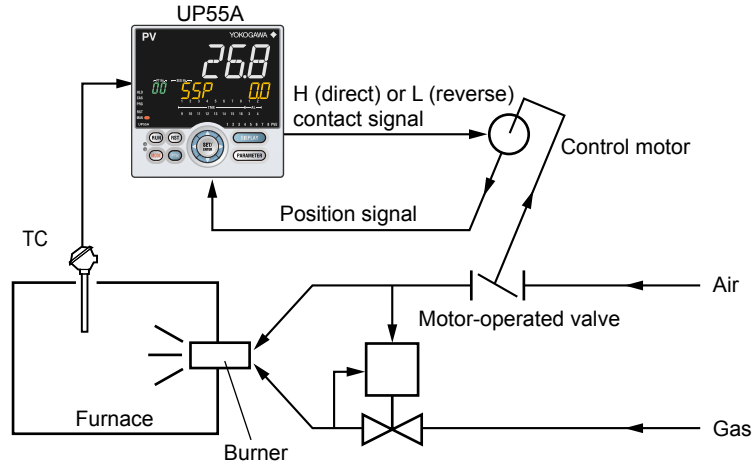
▶ 8.2.3 Heating/cooling Control



### Position Proportional Control

Position proportional control is available only for Position proportional type. It is used exclusively for the motor-operated valve.

- ▶ 10.16 Adjusting Motor-operated Valve Position (Position Proportional Output)



## 1.4 Program Pattern Functions

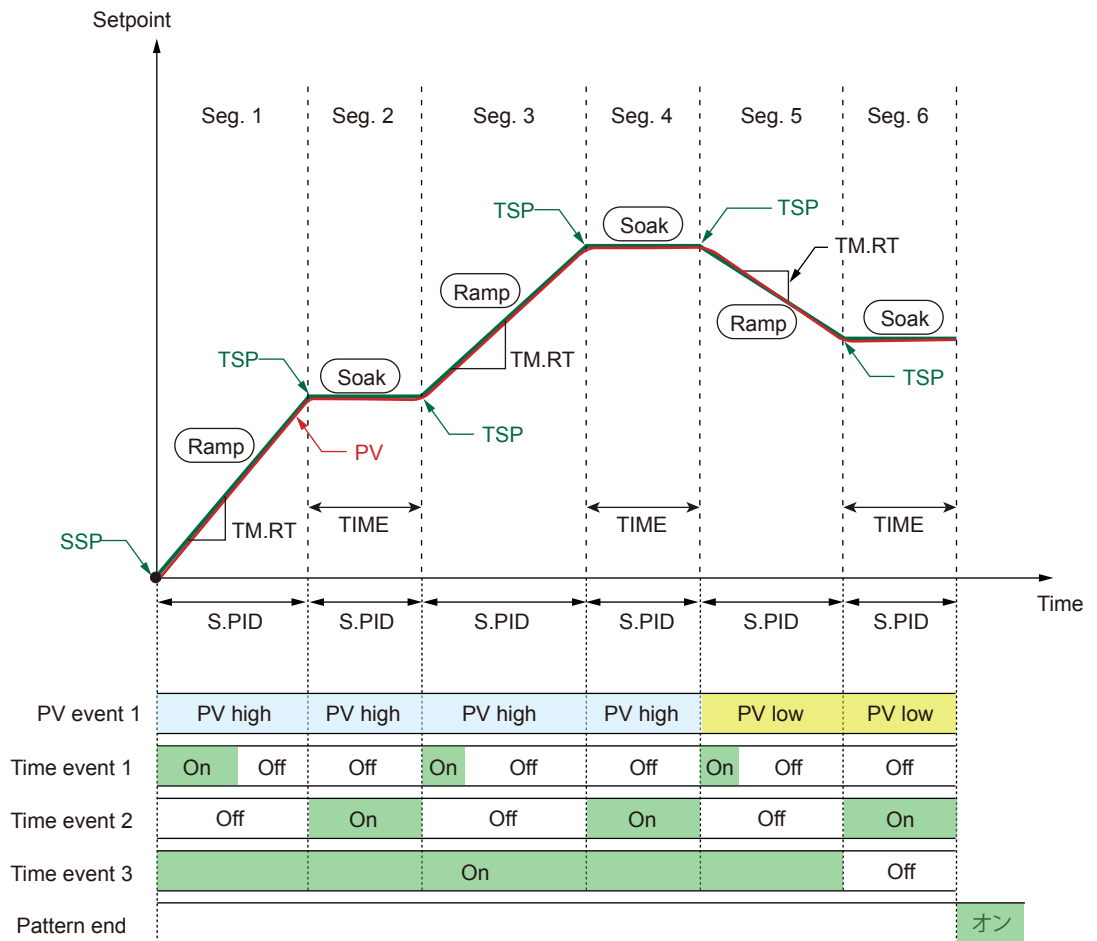
The program pattern function allows performing a program operation by changing the setpoint in conjunction with the time according to the preset program pattern.

A program pattern consists of multiple segments.

A program pattern can be created by setting the final target setpoint, segment time, PV event, time event, and the like.

The use of the program pattern-2 retransmission function allows creating a program pattern for retransmission.

▶ [Chapter 9 Program Pattern Functions](#)



The display symbols of the parameters, TSP (Final target setpoint), TIME (Segment time setting), and S.PID (Segment PID number selection) are the same in each segment. However, the segment can be recognized by the number displayed on the Symbol display.

Symbol (parameter)	Description
SSP (Starting target setpoint)	SP at the time when the program pattern starts
TSP (Final target setpoint)	Final target setpoint for the segment
TIME (Segment time setting)	Determines whether to set the segment by TIME or TM.RT
TM.RT (Segment ramp-rate setting)	Time to reach TSP
SEG.T (Segment setting method)	Time or ramp-rate to reach TSP

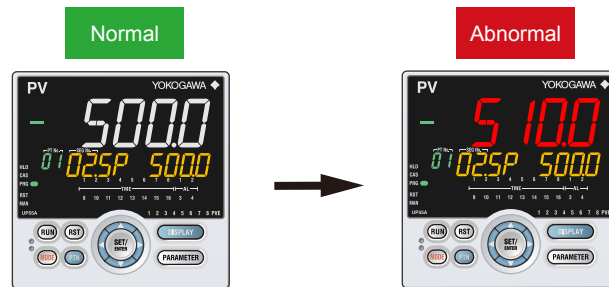
## 1.5 Display and Key Functions

Employing a 14-segment, active color LCD greatly increases the monitoring and operating capabilities.

### Active Color PV Display (display color change)

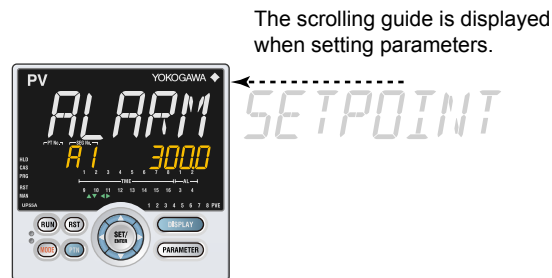
The active color PV display function changes the PV display color (red or white) when abnormality occurs in PV etc.

▶ [13.1.1 Setting Active Color PV Display Function](#)



### Guide Display

The guide is displayed on PV display when setting parameters. This guide can be turned on/off with the MODE key.



### Multilingual Guide Display

English, German, French, or Spanish can be displayed in Guide display.

▶ [13.1.11 Switching Guide Display Language](#)

### Parameter Display Level

To intended use of the operator, the display level of the parameter can be set.

▶ [Chapter 18 Parameters](#)

### User Function Keys

The UP55A has user function keys (RUN, RST, MODE, and PTN).

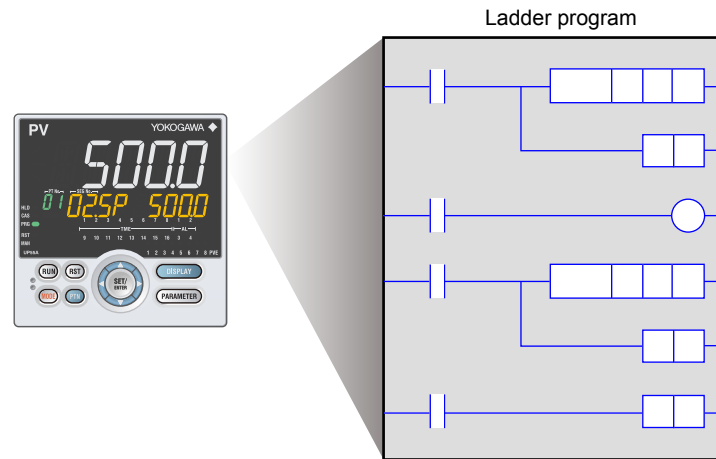
Assign a function to a user function key to use it as an exclusive key.

▶ [13.2 Assigning Function to User Function Key](#)

## 1.6 Ladder Sequence Function

To use the ladder sequence function, it is necessary to create a ladder program using LL50A Parameter Setting Software and download it to a controller.

- ▶ [Ladder sequence function: LL50A Parameter Setting Software User's Manual](#)





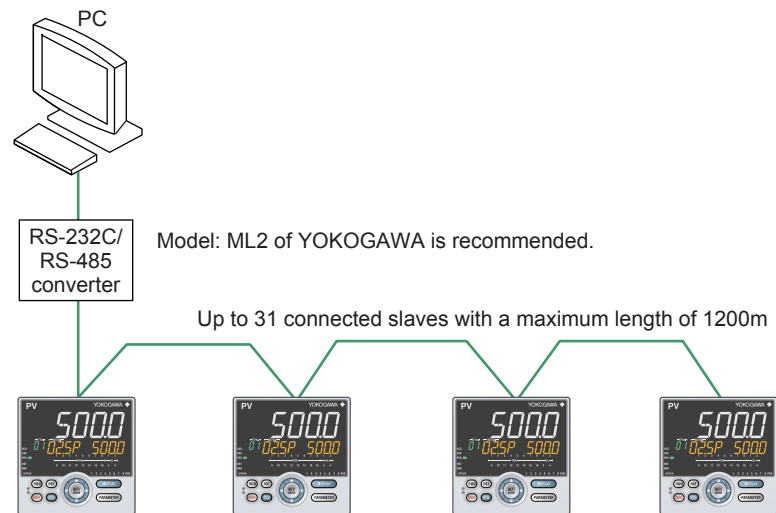
## 1.7 Communication Functions

The UP55A can use RS-485 communication, Ethernet communication, PROFIBUS-DP communication, DeviceNet communication, and CC-Link communication by specifying the suffix code and optional suffix code for each communication.

- ▶ [UTAdvanced Series Communication Interface \(RS-485, Ethernet\) User's Manual](#)
- ▶ [UTAdvanced Series Communication Interface \(Open Network\) User's Manual](#)

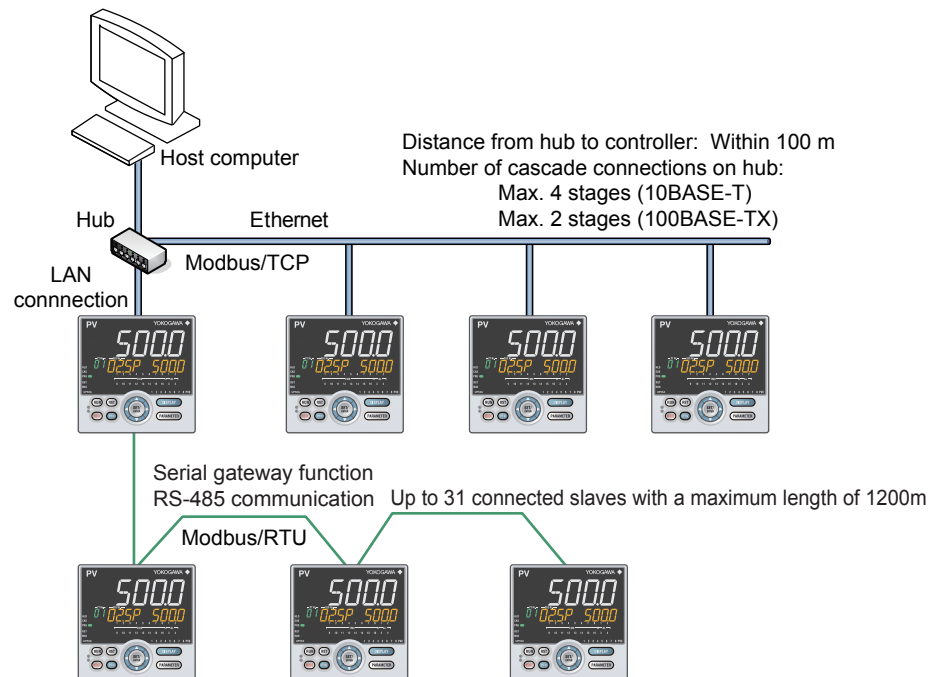
### RS-485 Communication (Modbus communication, PC link communication, and Ladder communication)

The UP55A can communicate with PCs, PLCs, touch panels, and other devices.



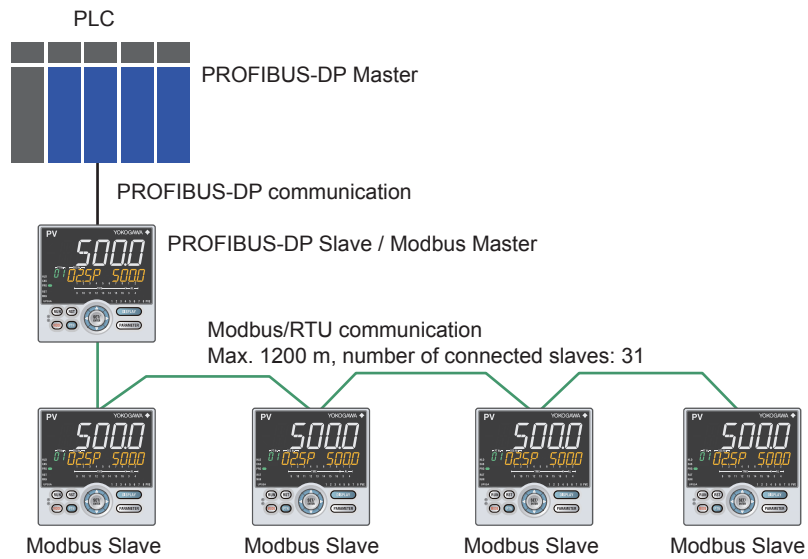
### Ethernet Communication (Modbus/TCP)

The UP55A can be connected to IEEE802.3-compliant network (10BASE-T/100BASE-TX). A serial gateway function can increase the number of connected controllers.



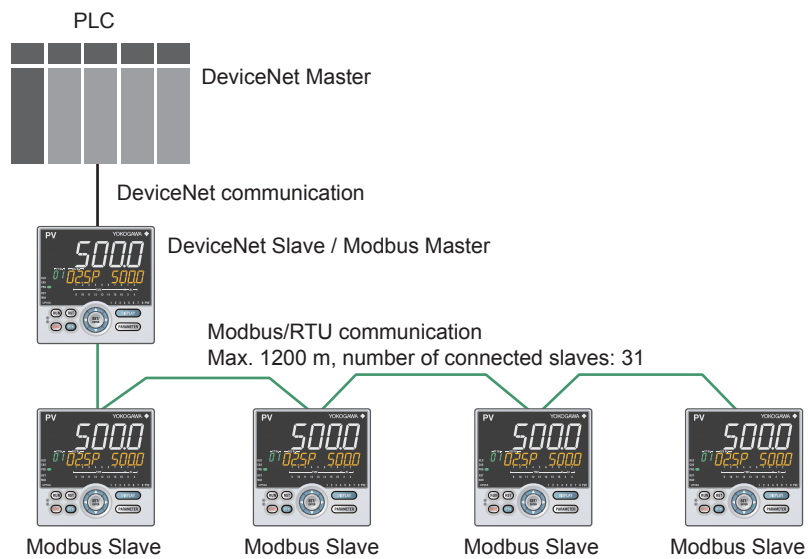
### PROFIBUS-DP Communication

The UP55A can be used as the slave devices for PROFIBUS-DP communication. Read-out of PV, operation or alarm status, and SP setting can be done by accessing the remote I/O on the master unit of PROFIBUS-DP.



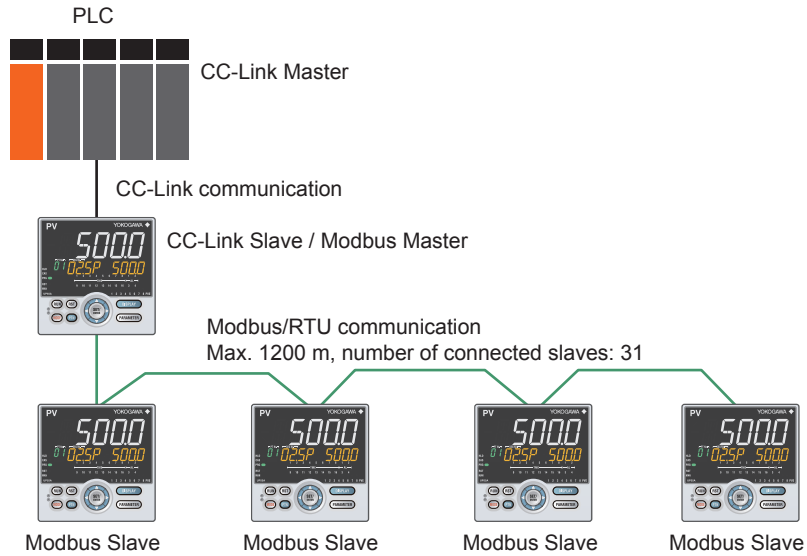
### DeviceNet Communication

The UP55A can be used as the slave devices for DeviceNet communication. Read-out of PV, operation or alarm status, and SP setting can be done by accessing the remote I/O on the master unit of DeviceNet.



### CC-Link Communication

The UP55A can be used as the slave devices for CC-Link communication. Read-out of PV, operation or alarm status, and SP setting can be done by accessing the remote I/O on the master unit of CC-Link.

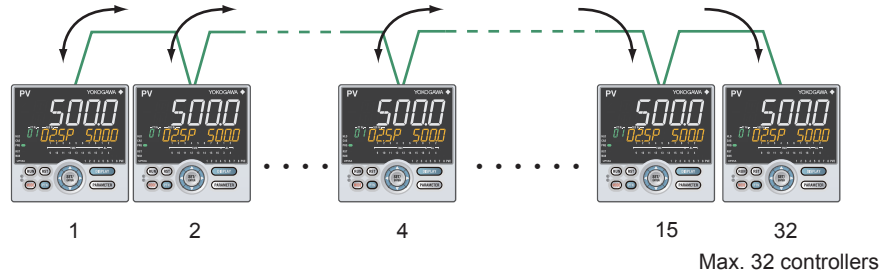


### Peer-to-peer Communication

In Peer-to-peer communication, controllers send and receive process data each other and share data. However, ladder program creation using LL50A Parameter Setting Software is necessary.

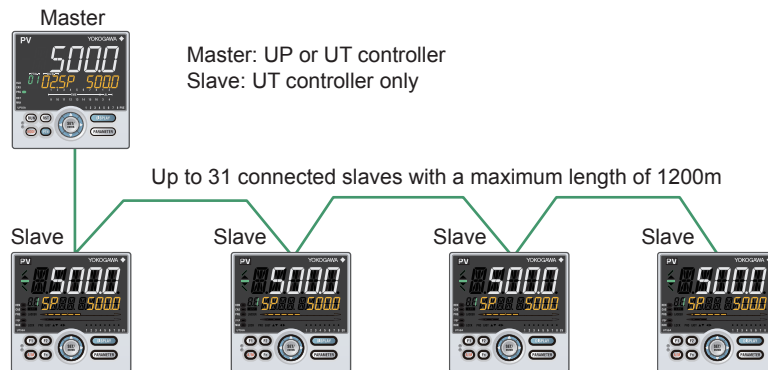
▶ [Ladder program: LL50A Parameter Setting Software User's Manual](#)

Controller No. 1 to 4 can transmit and receive data. Controller No. 5 to 32 can only receive data.



### Coordinated Operation

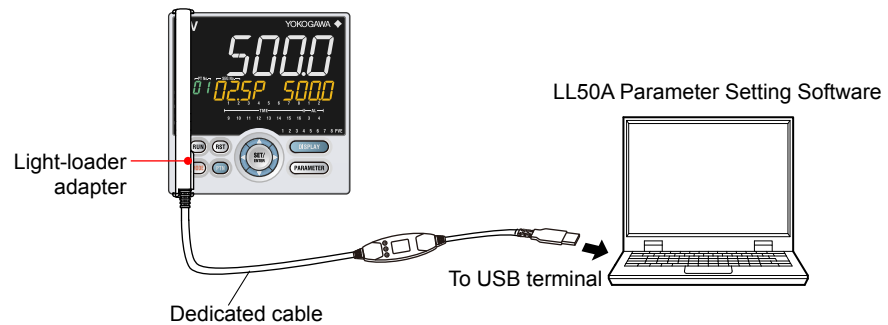
A system of coordinated operation is configured with a master controller and a number of slave controllers. The slave controllers are set to operate in the same way as the master controller. Therefore you do not have to create a communication program.



## Light-loader Communication

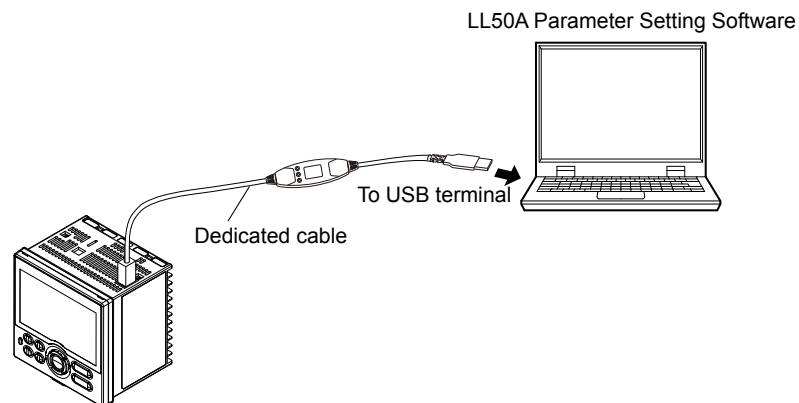
Use the LL50A to set parameters and create ladder programs. Attach the adapter to the front of the controller to communicate.

- ▶ [Light-loader function: LL50A Parameter Setting Software User's Manual](#)



## Maintenance Port Communication (Power supply is not required for the UP55A)

Maintenance port is used to connect with the dedicated cable when using LL50A Parameter Setting Software (sold separately). The parameters can be set without supplying power to the UP55A. Likewise, the ladder program and the program pattern can also be downloaded.



### CAUTION

When using the maintenance port, do not supply power to the controller. Otherwise, the controller does not work normally.

If power is supplied to the controller while the cable is connected, or the cable is connected to the controller already turned on, unplug the cable and turn on the controller again. The controller returns to the normal condition.

## 1.8 Definition of Main Symbols and Terms

### Main Symbol

PV: Measured input value  
SP: Target setpoint  
OUT: Control output value  
RSP: Remote setpoint

PRG, PROGRAM: Start of Program operation  
RST, RESET: Stop of Program operation  
LOC, LOCAL: Start of Local operation  
REM, REMOTE: Start of Remote operation  
HLD, HOLD: Pause of program operation  
ADV, ADVANCE: Advance of segment  
A/M: AUTO/MAN  
AUTO: Automatic  
MAN: Manual  
LSP/CAS: Local(LSP)/cascade in Cascade control  
CAS, CASCADE: Cascade operation

E1, E2, E3, and E4: Terminal areas

▶ [17.4 Wiring](#)

### Engineering Units

Input range (scale): the PV range low limit is set to 0%, and the high limit is set to 100% for conversion.

Input range (scale) span: the PV range span is set to 100% for conversion.

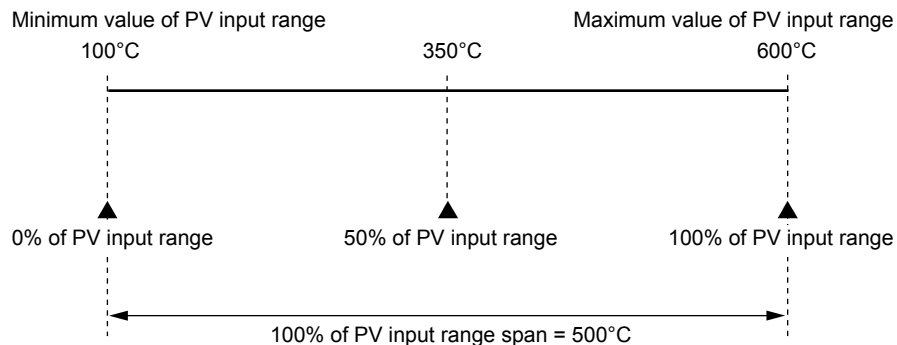
In this manual, the parameter setting range is described as the “input range” and “input range span.” This means that engineering units are required to be set. Set a temperature for temperature input.

The following describes a conversion example.

When the PV input range is 100 to 600°C, 0% of the PV range is equivalent to 100°C, 50% of the PV range is equivalent to 350°C, and 100% of the PV range is equivalent to 600°C.

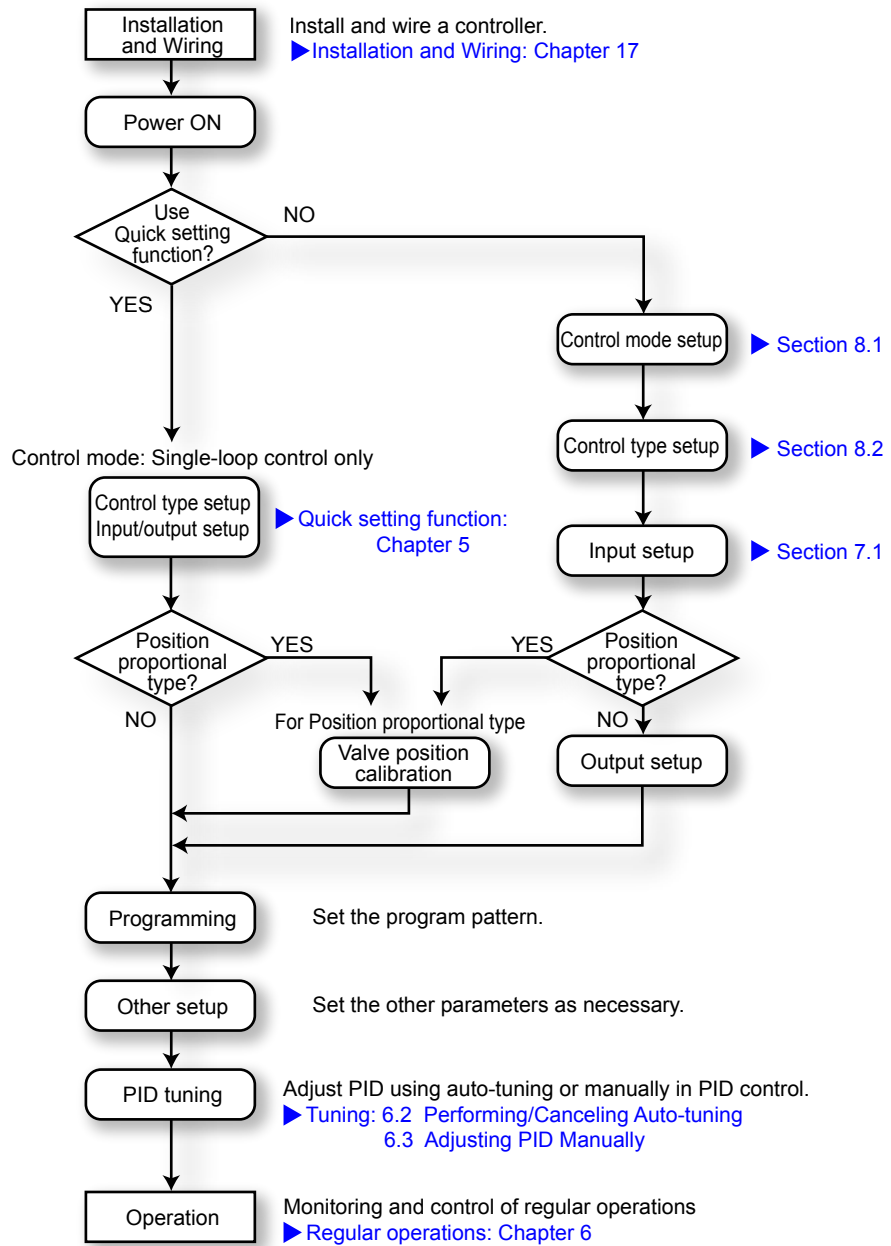
100% of the PV range span is equivalent to 500°C.

20% of the PV range span is equivalent to 100°C.



The above applies to the scale for voltage and current input.

# 2.1 UP55A Operating Procedures





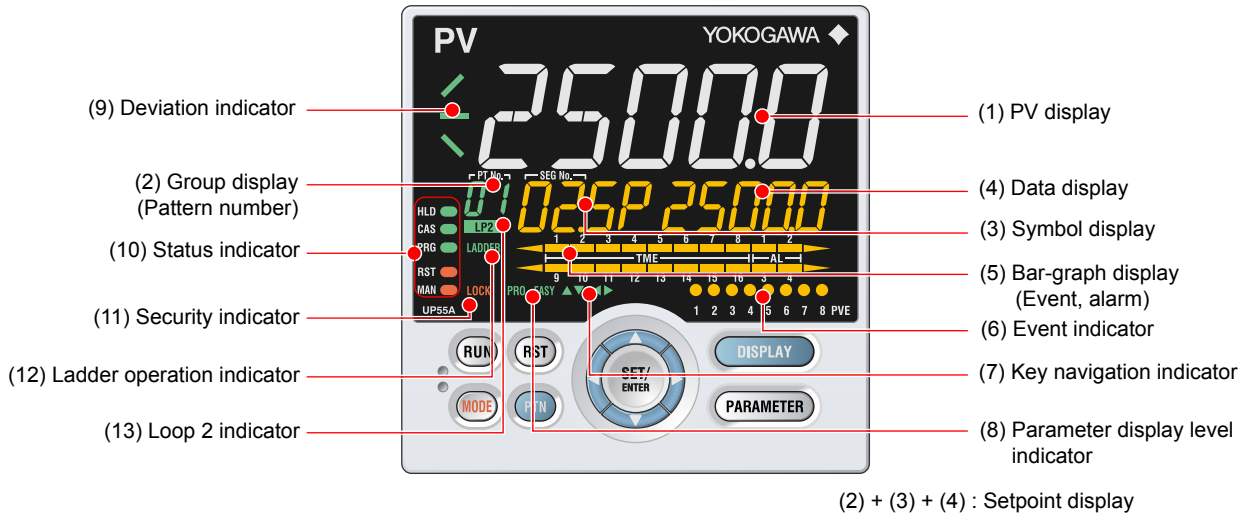
## 3.1 Names and Functions of Display Parts

See the next page.






### 3.1 Names and Functions of Display Parts

#### UP55A

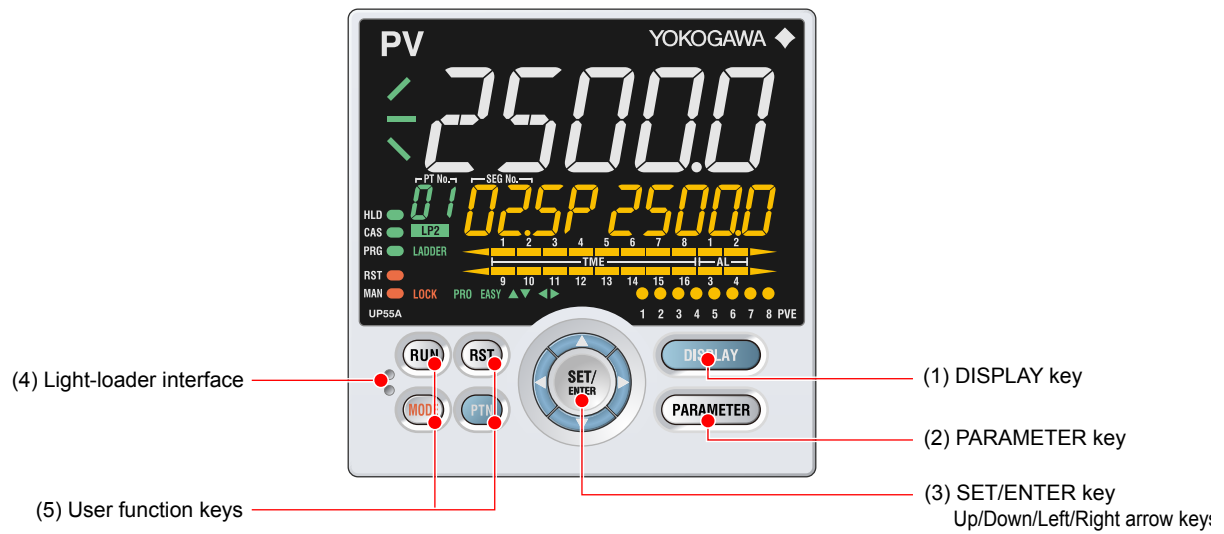


### 3.1 Names and Functions of Display Parts

No. in figure	Name	Description												
(1)	<b>PV display (white or red)</b>	Displays PV. Displays an error code if an error occurs. Displays the scrolling guide in the Menu Display and Parameter Setting Display when the guide display ON/OFF is set to ON.												
(2)	<b>Group display (pattern number) (green)</b>	1 to 30 represent pattern numbers in the Operation Display. Displays a group number (1 to 8 or R) and terminal area (E1 to E4) in the Parameter Setting Display.												
(3)	<b>Symbol display (orange)</b>	Displays a parameter symbol.												
(4)	<b>Data display (orange)</b>	Displays a parameter setpoint and menu symbol.												
(5)	<b>Bar-graph display (event, alarm) (orange)</b>	Displays the event status and the segment position in the Operation Display. (Default values: Time event status, Alarm status) Displays control output value (OUT) and measured input value (PV). The data to be displayed can be set by the parameter.												
(6)	<b>Event indicator (orange)</b>	Lit when the PV events occur. Event displays can be set by the parameter.												
(7)	<b>Key navigation indicator (green)</b>	Lit or blinks when the Up/Down or Left/Right arrow key operation is possible.												
(8)	<b>Parameter display level indicator (green)</b>	Displays the setting conditions of the parameter display level function. <table border="1"> <thead> <tr> <th>Parameter display level</th> <th>EASY</th> <th>PRO</th> </tr> </thead> <tbody> <tr> <td>Easy setting mode</td> <td>Lit</td> <td>Unlit</td> </tr> <tr> <td>Standard setting mode</td> <td>Unlit</td> <td>Unlit</td> </tr> <tr> <td>Professional setting mode</td> <td>Unlit</td> <td>Lit</td> </tr> </tbody> </table>	Parameter display level	EASY	PRO	Easy setting mode	Lit	Unlit	Standard setting mode	Unlit	Unlit	Professional setting mode	Unlit	Lit
Parameter display level	EASY	PRO												
Easy setting mode	Lit	Unlit												
Standard setting mode	Unlit	Unlit												
Professional setting mode	Unlit	Lit												
(9)	<b>Program monitor (green)</b>	Displays the status of increment, constancy, and decrement of the program setpoint.  : Lit when a program setpoint is increasing.  : Lit when a program setpoint is constant.  : Lit when a program setpoint is decreasing.												
(10)	<b>Status indicator (green and red)</b>	Displays the operating conditions and control status. <table border="1"> <thead> <tr> <th>Display</th> <th>Description</th> </tr> </thead> <tbody> <tr> <td>HLD</td> <td>Lit when in remote mode (HOLD).</td> </tr> <tr> <td>CAS</td> <td>Lit when in cascade mode (CAS).</td> </tr> <tr> <td>PRG</td> <td>Lit when in program operation mode (PRG). Lit while the Starting time of program operation (S.TM) is available.</td> </tr> <tr> <td>RST</td> <td>Lit when in reset mode (RST).</td> </tr> <tr> <td>MAN</td> <td>Lit when in manual mode (MAN). Blinks during auto-tuning.</td> </tr> </tbody> </table>	Display	Description	HLD	Lit when in remote mode (HOLD).	CAS	Lit when in cascade mode (CAS).	PRG	Lit when in program operation mode (PRG). Lit while the Starting time of program operation (S.TM) is available.	RST	Lit when in reset mode (RST).	MAN	Lit when in manual mode (MAN). Blinks during auto-tuning.
Display	Description													
HLD	Lit when in remote mode (HOLD).													
CAS	Lit when in cascade mode (CAS).													
PRG	Lit when in program operation mode (PRG). Lit while the Starting time of program operation (S.TM) is available.													
RST	Lit when in reset mode (RST).													
MAN	Lit when in manual mode (MAN). Blinks during auto-tuning.													
(11)	<b>Security indicator (red)</b>	Lit if a password is set. The setup parameter settings are locked.												
(12)	<b>Ladder operation indicator (green)</b>	Lit while the ladder program operation is executed.												
(13)	<b>Loop 2 indicator (LP2 lamp) (green)</b>	Lit when the control mode is Cascade control. In the Operation Display, the LP2 lamp is lit while the Loop-2 data is displayed on Setpoint display. In the Parameter Setting Display, the LP2 lamp indicates the loop of displayed menu symbol or parameter symbol. The LP2 lamp is lit while the Loop-2 menu symbol or parameter symbol is displayed.												

## 3.2 Names and Functions of Keys

UP55A



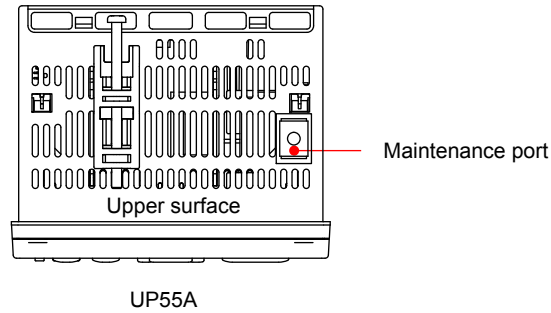
No. in figure	Name	Description
(1)	<b>DISPLAY key</b>	Used to switch the Operation Displays. Press the key in the Operation Display to switch the provided Operation Displays. Press the key in the Menu Display or Parameter Setting Display to return to the Operation Display.
(2)	<b>PARAMETER key</b>	Hold down the key for 3 seconds to move to the Operation Parameter Setting Display. Hold down the key and the Left arrow key simultaneously for 3 seconds to move to the Setup Parameter Setting Display. Press the key in the Parameter Setting Display to return to the Menu Display. Press the key once to cancel the parameter setting (setpoint is blinking).
(3)	<b>SET/ENTER key Up/Down/ Left/Right arrow keys</b>	<b>SET/ENTER key</b> Press the key in the Menu Display to move to the Parameter Setting Display of the Menu. Press the key in the Parameter Setting Display to transfer to the parameter setting mode (setpoint is blinking), and the parameter can be changed. Press the key during parameter setting mode to register the setpoint. <b>Up/Down/Left/Right arrow keys</b> Press the Left/Right arrow keys in the Menu Display to switch the Displays. Press the Up/Down/Left/Right arrow keys in the Parameter Setting Display to switch the Displays. Press the Up/Down arrow keys during parameter setting mode (setpoint is blinking) to change a setpoint. Press the Left/Right arrow keys during parameter setting mode (setpoint is blinking) to move between digits according to the parameter.
(4)	<b>Light-loader interface</b>	It is the communication interface to the adapter cable when setting and storing parameters via PC. The LL50A Parameter Setting Software (sold separately) is required.
(5)	<b>RUN key RST key MODE key PTN</b>	PTN key: Press the RUN key for 1 second while an operation display is shown starts the controller. RST key: Press the RST key for 1 second while an operation display is shown stops the controller. MODE key: Presents a display for switching between the HOLD, ADVANCE, PROG, RESET, LOCAL, REMOTE and AUTO/MAN. In order to change the operation mode, press the SET/ENTER key while the setpoint is blinking. PTN key: A program pattern number can be selected during the operation except the program pattern operation. (The program pattern number displayed on the Group display blinks.) When the PTN key is pressed while the program pattern number is blinking, the blinking stops. Users can assign functions to the key using parameters.

### 3.2 Names and Functions of Keys

---

#### **Maintenance Port (Power supply is not required for the UP55A).**

The maintenance port is used to connect with the dedicated cable when using LL50A Parameter Setting Software (sold separately). The parameters can be set without supplying power to the UP55A.



---

### **CAUTION**

---

When using the maintenance port, do not supply power to the controller. Otherwise, the controller does not work normally.

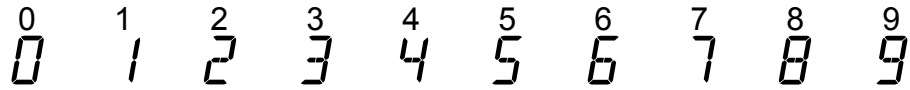
If power is supplied to the controller while the cable is connected, or the cable is connected to the controller already turned on, unplug the cable and turn on the controller again. The controller returns to the normal condition.

---

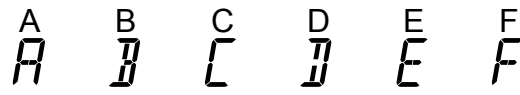
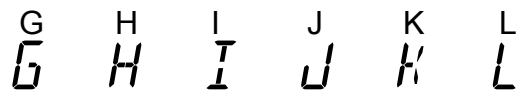
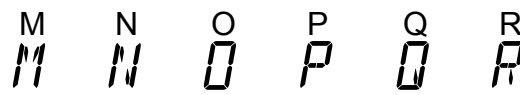


### 3.3 List of Display Symbols

The following shows the parameter symbols, menu symbols, alphanumeric of guide, and symbols which are displayed on the UP55A.

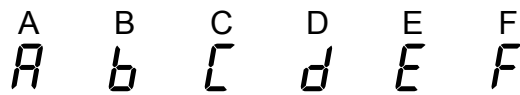

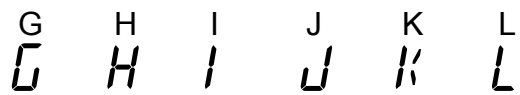
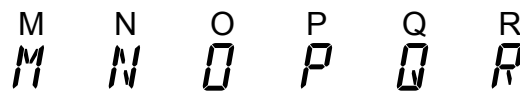
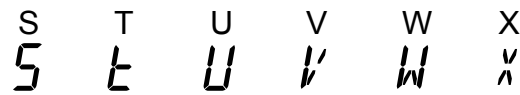

Figure (common to all display area)

0 1 2 3 4 5 6 7 8 9  


PV display (14 segments): Alphabet

A B C D E F  
  
 G H I J K L  
  
 M N O P Q R  
  
 S T U V W X  
  
 Y Z  


Symbol display and Data display (11 segments): Alphabet

A B C D E F  
  
 C (lower-case)  
  
 G H I J K L  
  
 M N O P Q R  
  
 S T U V W X  
  
 Y Z  


### 3.3 List of Display Symbols

---

Group display (7 segments): Alphabet

A	B	C	D	E	F	
G	H	I	J	K	L	
M	N	O	P	Q	R	
S	T	U	V	W	X	
						None
Y	Z					

PV display (14 segments): Symbol

Space	-	/	'	,

## 3.4 Brief Description of Setting Details (Parameters)

This manual describes the Setting Details as follows in addition to the functional Description.

### Setting Details

#### (Display Example)

Parameter symbol	Name	Display level	Setting range	Menu symbol
A1 to A8	Alarm-1 to -8 setpoint	EASY	Set a display value of setpoint of PV alarm, SP alarm, deviation alarm, output alarm, or velocity alarm. -19999 to 30000 (Set a value within the input range.) Decimal point position depends on the input type	AL <b>Ope</b>

(1) Parameter symbol: Symbol displayed on Symbol display on the front panel.

(2) Name: Parameter name

(3) Display level: Indicates the parameter display level.

(4) Setting range: Parameter setting range

(5) Menu symbol: Indicates the menu to which the parameter belongs.

**Ope**: Operation parameter

**Set**: Setup parameter

#### Parameter Display Level

Display level	Description
<b>EASY</b>	Easy setting mode: The minimum necessary parameters are displayed. Corresponding parameters are displayed in all modes.
<b>STD</b>	Standard setting mode: The wider range of parameters than those shown in Easy setting mode are displayed. Corresponding parameters are displayed only in Standard setting mode and Professional setting mode. Parameter display level indicators "EASY" and "PRO" are unlit in Standard setting mode. *: "STD" is the symbol used in this manual only.
<b>PRO</b>	Professional setting mode: All parameters are displayed. Corresponding parameters are displayed only in Professional setting mode.

#### Note

For more intelligible display operation of parameters and the references, see Chapter 18, "Parameter Map."

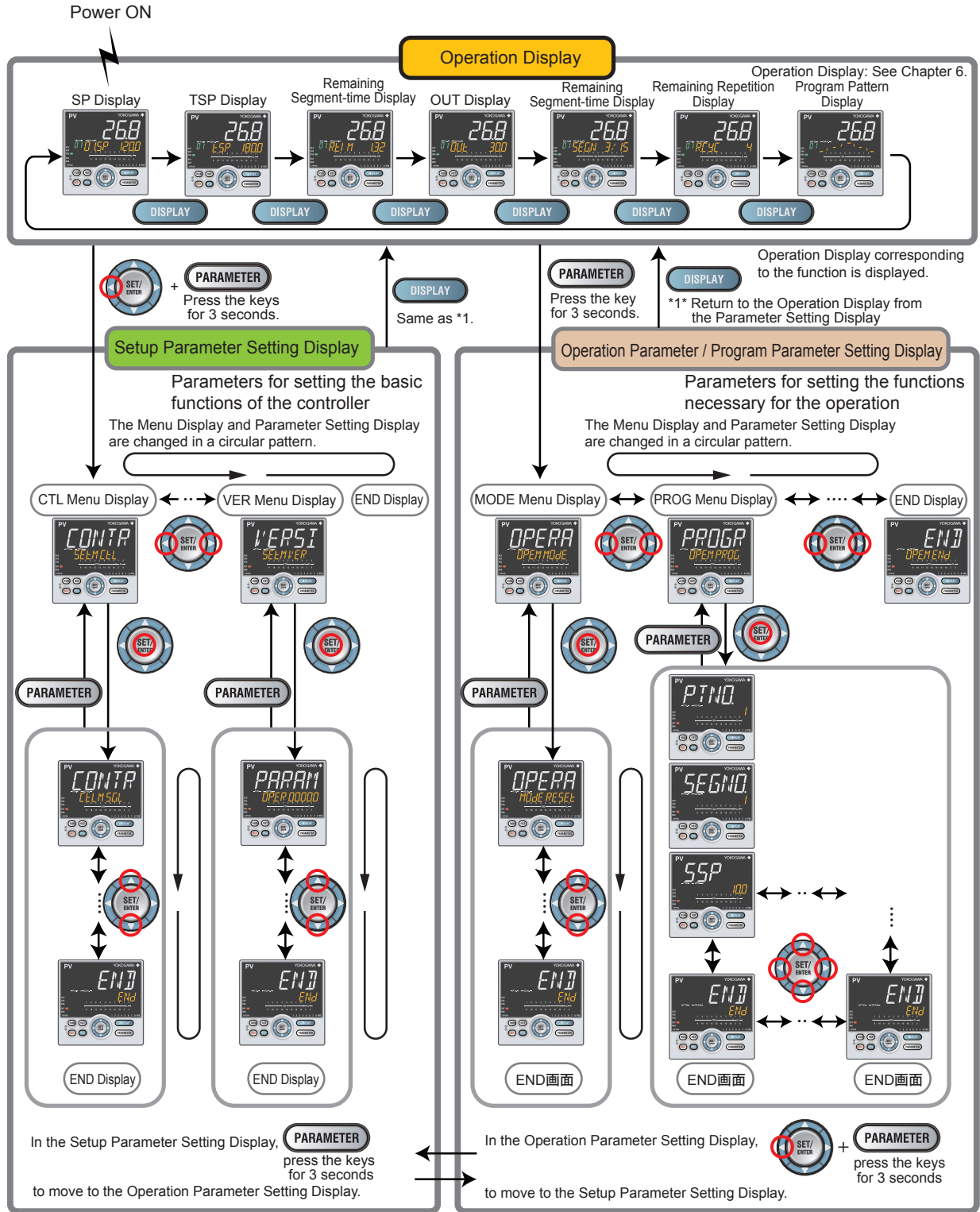


---

Blank Page

# 4.1 Overview of Display Switch and Operation Keys



The following shows the transition of Operation Display, Operation Parameter Setting Display, and Setup Parameter Setting Display. The "Operation Parameter Setting Display" has the parameters for setting the functions necessary for the operation. The "Setup Parameter Setting Display" has the parameters for setting the basic functions of the controller.


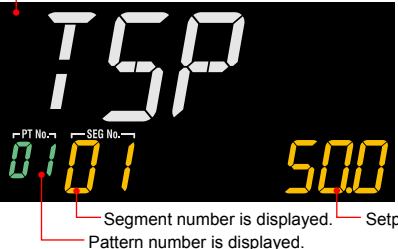


#### 4.1 Overview of Display Switch and Operation Keys

The display pattern of the UP55A is as follows; the Menu Display and Parameter Setting Display.

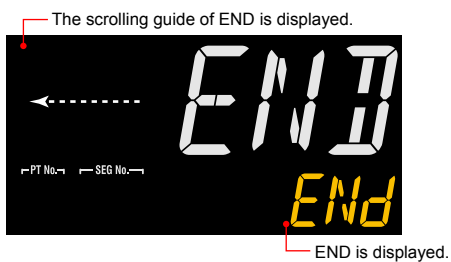
For the Operation Display, see Chapter 6, "Monitoring and Control of Regular Operations."

Display	Description
<p><b>Menu Display</b></p>	<p>The Menu Display is segmented by the function and optional terminal position. The scrolling guide for the menu is displayed on PV display. The guide display can be turned on/off with the MODE key.</p> <p>Menu Display of Operation Parameter</p> <p>The scrolling guide for the menu is displayed.</p>  <p>← OPE.M is displayed.      Menu symbol is displayed.      ← Group number or Terminal area is displayed.      ← Lit while Loop-2 parameter is displayed.</p> <p>Menu Display of Setup Parameter</p> <p>The scrolling guide for the menu is displayed.</p>  <p>← SET.M is displayed.      Menu symbol is displayed.      ← Group number or Terminal area is displayed.</p>

Display	Description
<p><b>Parameter Setting Display</b></p>	<p>The following is the Display for displaying and setting a parameter. The parameters have three types of display levels; Easy setting mode, Standard setting mode, and Professional setting mode. The parameters to be displayed can be limited according to the setting of the parameter display level. The scrolling guide for the parameter is displayed on PV display. The guide display can be turned on/off with the MODE key.</p> <p>Parameter Setting Display (Example of Operation Parameter Setting Display) The scrolling guide for the parameter is displayed.</p>  <p>Parameter Setting Display (Example of Program Parameter Setting Display) Parameter symbol is displayed. This guide can be turned on/off with the MODE key.</p> 

**Display Shown at the End (the Lowest Level) of the Parameter Setting Display**

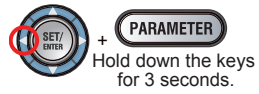
As shown in the figure below, the END Display is shown to indicate the end of the Menu Display and Parameter Setting Display. There are no setting items.



### Basic Key Operation Sequence

- **To move to the Setup Parameter Setting Display**

Hold down the PARAMETER key and the Left arrow key simultaneously for 3 seconds.



- **To move to the Operation Parameter Setting Display**

Hold down the PARAMETER key for 3 seconds.



Hold down the key for 3 seconds.

- **To move to the Operation Display**

Press the DISPLAY key once.

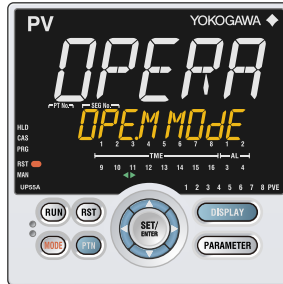


## 4.2 How to Set Parameters

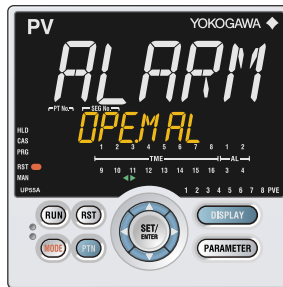
The following operating procedure describes an example of setting alarm setpoint (A1).

### Operation

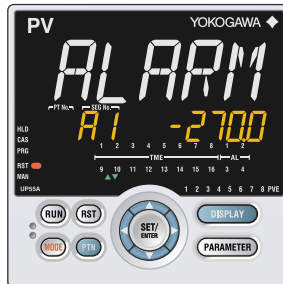
1. Hold down the **PARAMETER** key for 3 seconds in the Operation Display to call up the **[MODE]** Menu Display.



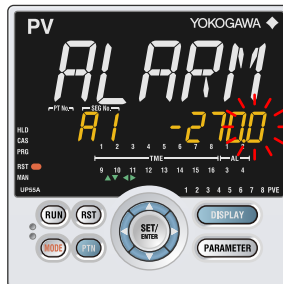
2. Press the **Right arrow** key to display the **[AL]** Menu Display.



3. Press the **SET/ENTER** key to display the **[A1]** Parameter Setting Display.



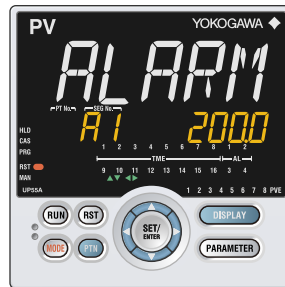
4. Press the **SET/ENTER** key to blink the setpoint.



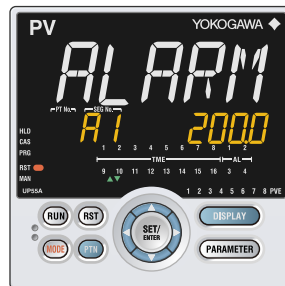
## 4.2 How to Set Parameters

---

5. Press the **Up** or **Down arrow** key to change the setpoint.  
(Change the setpoint using the Up/Down arrow keys to increase and decrease the value and the Left/Right arrow keys to move between digits.)



6. Press the **SET/ENTER** key to register the setpoint (the setpoint stops blinking).



7. Press the **PARAMETER** key once to return to the Menu Display. Press the **DISPLAY** key once to return to the Operation Display.

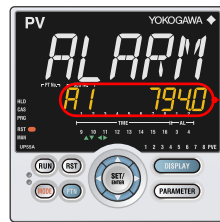
This completes the setting procedure.

### How to Cancel Parameter Setting

To cancel parameter setting when a parameter is being set (setpoint is blinking), press the **PARAMETER** key once.

## How to Set Parameter Setpoint

### Numeric Value Setting



A1 7940

1. Display the Parameter Setting Display.

A1 7940

2. Press the SET/ENTER key to move to the setting mode (the setpoint blinks).

A1 7940

3. Press the Left arrow key to move one digit to the left. (Press the Right arrow key to move one digit to the right.)

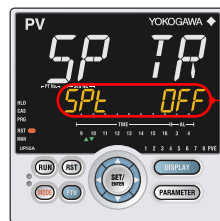
A1 8040

4. Press the Up or Down arrow key to change the setpoint. Press the Up arrow key when 9 is displayed to move one digit to the left. Press the Down arrow key when 0 is displayed to move one digit to the right.

A1 8040

5. Press the SET/ENTER key to register the setpoint.

### Selection Data Setting



SPt OFF

1. Display the Parameter Setting Display.

SPt OFF

2. Press the SET/ENTER key to move to the setting mode (the setpoint blinks).

SPt ON

3. Press the Up arrow key to change the setpoint (press the Down arrow key to change the setpoint).

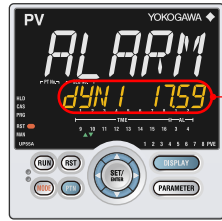
SPt ON

4. Press the SET/ENTER key to register the setpoint.








## 4.2 How to Set Parameters

### Time (minute.second) Setting



Example of 17 minutes 59 seconds

-  1. Display the Parameter Setting Display.
-  2. Press the SET/ENTER key to move to the setting mode (the setpoint blinks).
-  3. Press the Left arrow key to move one digit to the left. (press the Right arrow key to move one digit to the right.)
-  4. Press the Up or Down arrow key to change the setpoint. Press the Up arrow key when 5 is displayed to move one digit to the left. Press the Down arrow key when 0 is displayed to move one digit to the right.
-  5. Press the SET/ENTER key to register the setpoint.

## 5.1 Setting Using Quick Setting Function

### Description

The Quick setting function is a function to easily set the basic function of the controller. The Quick setting function starts when the power is turned on after wiring.

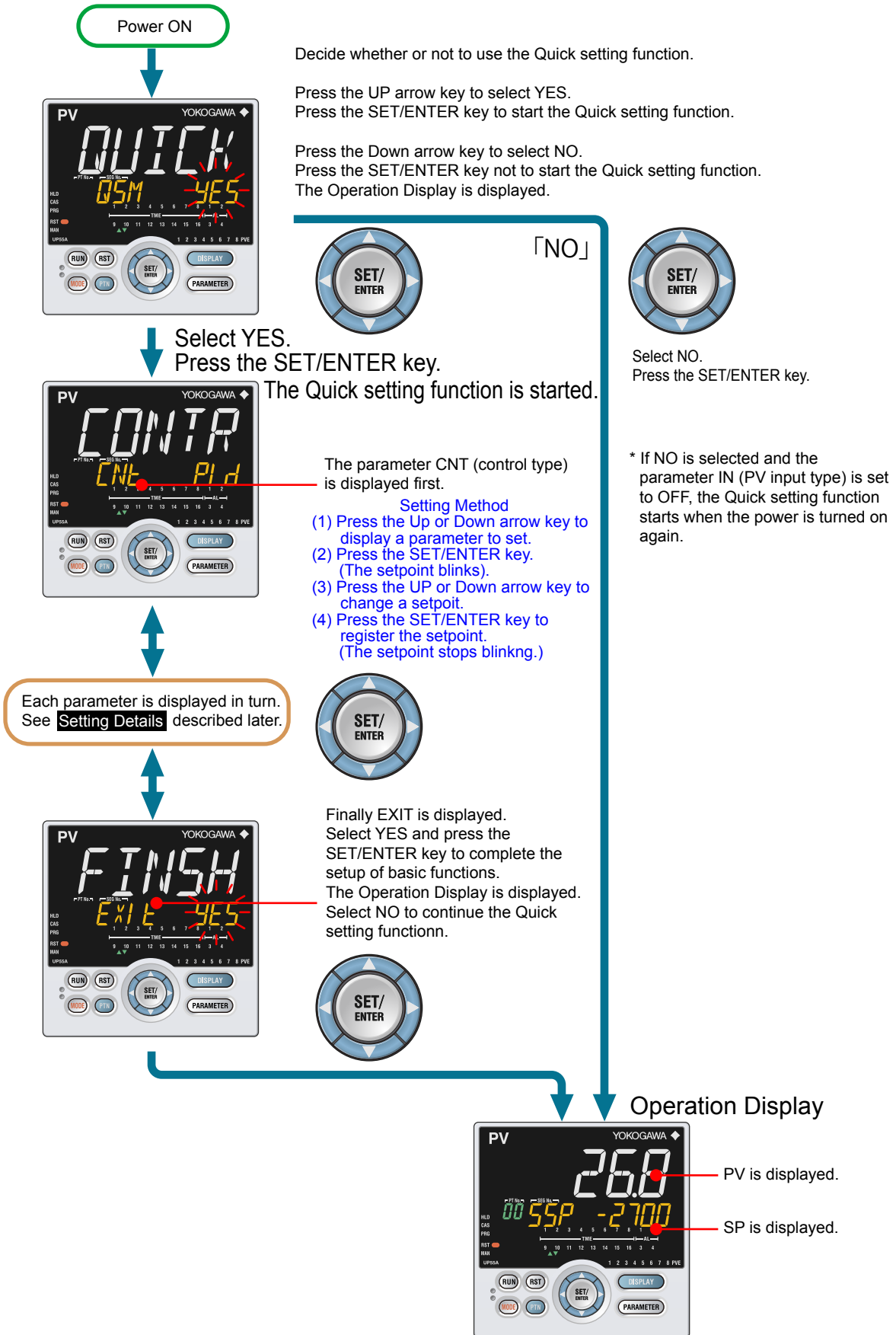
The Quick setting function can be used only when the control mode is Single-loop control. In other control modes, set the functions without using the Quick setting function.

The following lists the items to set using the Quick setting function.

- (1) Control type (PID control, Heating/cooling control, etc.)
- (2) Input function (PV input, range, scale (at voltage/current input), etc.)
- (3) Output function (control output type and cycle time)

## 5.1 Setting Using Quick Setting Function

### Flowchart of Quick Setting Function



**Setting Example**

Set the following parameters to set to PID control, thermocouple Type K (range: 0.0 to 500.0°C), and current control output. No need to change the parameters other than the following parameters.

Set QSM = YES to enter the quick setting mode.

- (1) Set CNT = PID.
- (2) Set IN = K1.
- (3) Set UNIT = C (initial value).
- (4) Set RH = 500.0.
- (5) Set RL = 0.0.
- (6) Set OT = 00.02

Set EXIT = YES to quit the quick setting mode.  
The Operation Display is shown.

**Setting Details****Control Type**

Parameter symbol	Name	Display level	Setting range	Menu symbol
CNT	Control type	EASY	PID: PID control ONOF: ON/OFF control (1 point of hysteresis) ONOF2: ON/OFF control (2 points of hysteresis) H/C: Heating/cooling control	CTL <b>Set</b>

Note1: In Cascade control, the LP2 lamp is lit while the Loop-2 parameter is displayed.

▶ [Control type: 8.2 Setting Control Type \(CNT\)](#)

## 5.1 Setting Using Quick Setting Function

### Input Function

Parameter symbol	Name	Display level	Setting range	Menu symbol
IN	PV input type	EASY	OFF: Disable K1: -270.0 to 1370.0 °C / -450.0 to 2500.0 °F K2: -270.0 to 1000.0 °C / -450.0 to 2300.0 °F K3: -200.0 to 500.0 °C / -200.0 to 1000.0 °F J: -200.0 to 1200.0 °C / -300.0 to 2300.0 °F T1: -270.0 to 400.0 °C / -450.0 to 750.0 °F T2: 0.0 to 400.0 °C / -200.0 to 750.0 °F B: 0.0 to 1800.0 °C / 32 to 3300 °F S: 0.0 to 1700.0 °C / 32 to 3100 °F R: 0.0 to 1700.0 °C / 32 to 3100 °F N: -200.0 to 1300.0 °C / -300.0 to 2400.0 °F E: -270.0 to 1000.0 °C / -450.0 to 1800.0 °F L: -200.0 to 900.0 °C / -300.0 to 1600.0 °F U1: -200.0 to 400.0 °C / -300.0 to 750.0 °F U2: 0.0 to 400.0 °C / -200.0 to 1000.0 °F W: 0.0 to 2300.0 °C / 32 to 4200 °F PL2: 0.0 to 1390.0 °C / 32.0 to 2500.0 °F P2040: 0.0 to 1900.0 °C / 32 to 3400 °F WRE: 0.0 to 2000.0 °C / 32 to 3600 °F JPT1: -200.0 to 500.0 °C / -300.0 to 1000.0 °F JPT2: -150.0 to 150.0 °C / -200.0 to 300.0 °F PT1: -200.0 to 850.0 °C / -300.0 to 1560.0 °F PT2: -200.0 to 500.0 °C / -300.0 to 1000.0 °F PT3: -150.0 to 150.0 °C / -200.0 to 300.0 °F 0.4-2V: 0.400 to 2.000 V 1-5V: 1.000 to 5.000 V 4-20: 4.00 to 20.00 mA 0-2V: 0.000 to 2.000 V 0-10V: 0.00 to 10.00 V 0-20 : 0.00 to 20.00 mA -1020: -10.00 to 20.00 mV 0-100: 0.0 to 100.0 mV	PV <b>Set</b>
UNIT	PV input unit	EASY	-: No unit C: Degree Celsius -: No unit - -: No unit - - -: No unit F: Degree Fahrenheit	
RH	Maximum value of PV input range	EASY	Depends on the input type. - For temperature input - Set the temperature range that is actually controlled. (RL<RH)	
RL	Minimum value of PV input range	EASY	- For voltage / current input - Set the range of a voltage / current signal that is applied. The scale across which the voltage / current signal is actually controlled should be set using the maximum value of input scale (SH) and minimum value of input scale (SL). (Input is always 0% when RL=RH.)	

Note1: W:W-5% Re/W-26% Re(Hoskins Mfg. Co.). ASTM E988  
 WRE: W97Re3-W75Re25

## Input Function (Continued)

Parameter symbol	Name	Display level	Setting range	Menu symbol
<b>SDP</b>	PV input scale decimal point position	EASY	0: No decimal place 1: One decimal place 2: Two decimal places 3: Three decimal places 4: Four decimal places	PV <b>Set</b>
<b>SH</b>	Maximum value of PV input scale	EASY	-19999 to 30000, (SL<SH),  SH - SL  ≤ 30000	
<b>SL</b>	Minimum value of PV input scale	EASY		

▶ Input setting: 7.1 Setting Functions of PV Input, Remote Input, and Auxiliary Analog Input

## Output Function

Parameter symbol	Name	Display level	Setting range	Menu symbol
<b>OT</b>	Output type selection	EASY	Control output or Heating-side control output (Lower two digits) 00: OFF 01: OUT terminals (voltage pulse) 02: OUT terminals (current) 03: OUT terminals (relay/triac) 04: OUT2 terminals (voltage pulse) 05: OUT2 terminals (current) 06: OUT2 terminals (relay/triac)  Cooling-side control output (Upper two digits) 00: OFF 01: OUT terminals (voltage pulse) 02: OUT terminals (current) 03: OUT terminals (relay/triac) 04: OUT2 terminals (voltage pulse) 05: OUT2 terminals (current) 06: OUT2 terminals (relay/triac)	OUT <b>Set</b>
<b>CT</b>	Control output cycle time Heating-side control output cycle time (in Heating/cooling control)	EASY	0.5 to 1000.0 s	
<b>CTc</b>	Cooling-side control output cycle time	EASY		

▶ Output type: 10.1 Setting Control Output Type

▶ Cycle time: 10.2 Setting Control Output Cycle Time

## 5.2 Restarting Quick Setting Function

Once functions have been built using the Quick setting function, the Quick setting function does not start even when the power is turned on. The following methods can be used to restart the Quick setting function.

- Set the parameter QSM (Quick setting mode) to ON and turn on the power again.
- Set the parameter IN (PV input type) to OFF and turn on the power again.

### CAUTION

The parameters related to the range or scale are initialized if the input type is changed.

Changing the control mode (CTLM) allows you to restart the Quick setting function. However, be careful because some parameters will be initialized.

#### Setting Details

Parameter symbol	Name	Display level	Setting range	Menu symbol
IN	PV input type	EASY	OFF: Disable	PV <b>Set</b>
QSM	Quick setting mode	EASY	OFF: Disable ON: Enable	SYS <b>Set</b>

## 6.1 Monitoring and Control of Operation Displays

### 6.1.1 Operation Display Transitions in Single-loop Control, Cascade Primary-loop Control, Loop Control with PV switching, and Loop Control with PV auto-selector

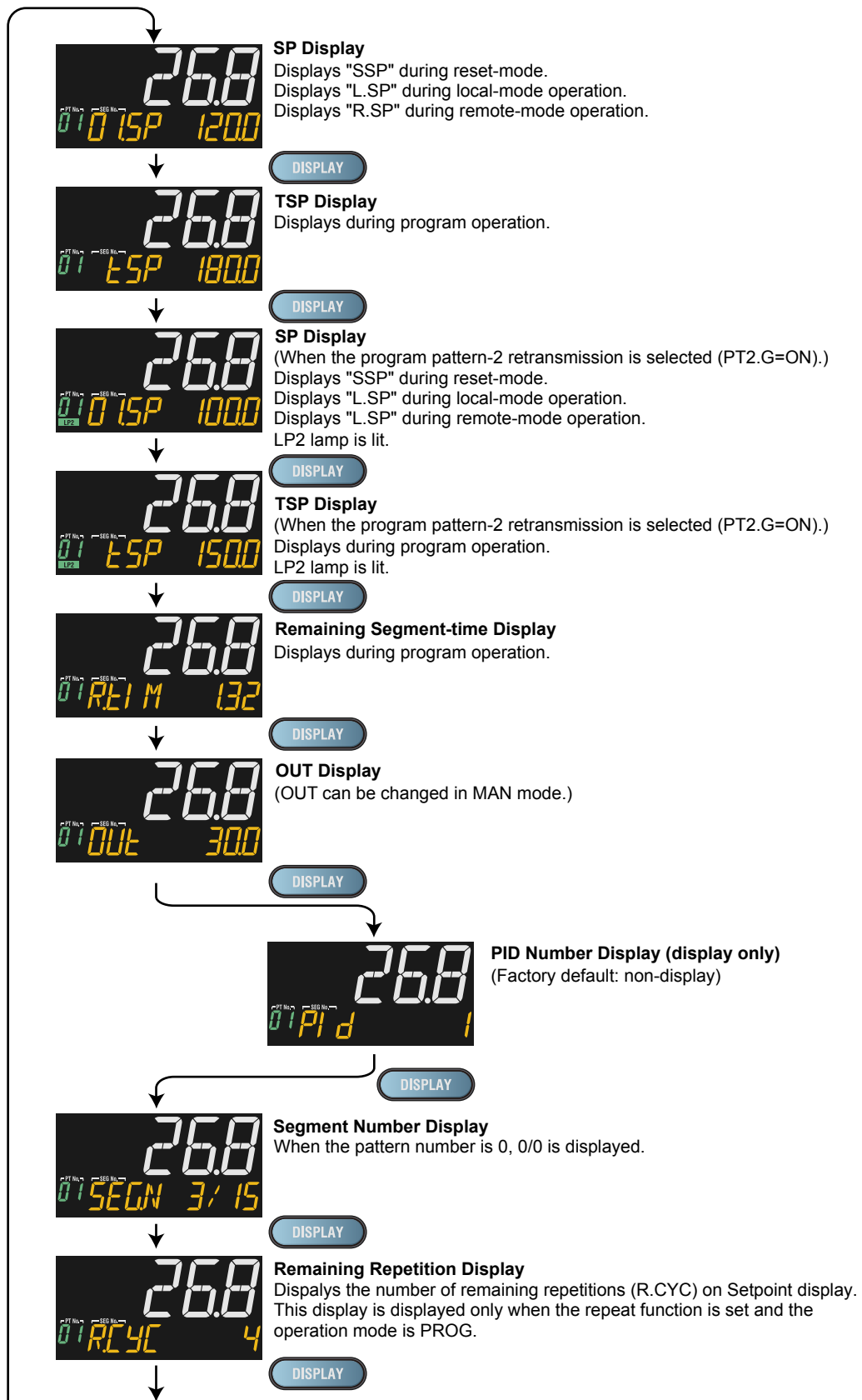
- ▶ [Display/Non-display of Operation Display: 13.3.5 Setting Display/Non-display of Operation Display](#)
- ▶ [Registration of SELECT Display: 13.1.3 Registering SELECT Display \(Up to 5 displays\)](#)

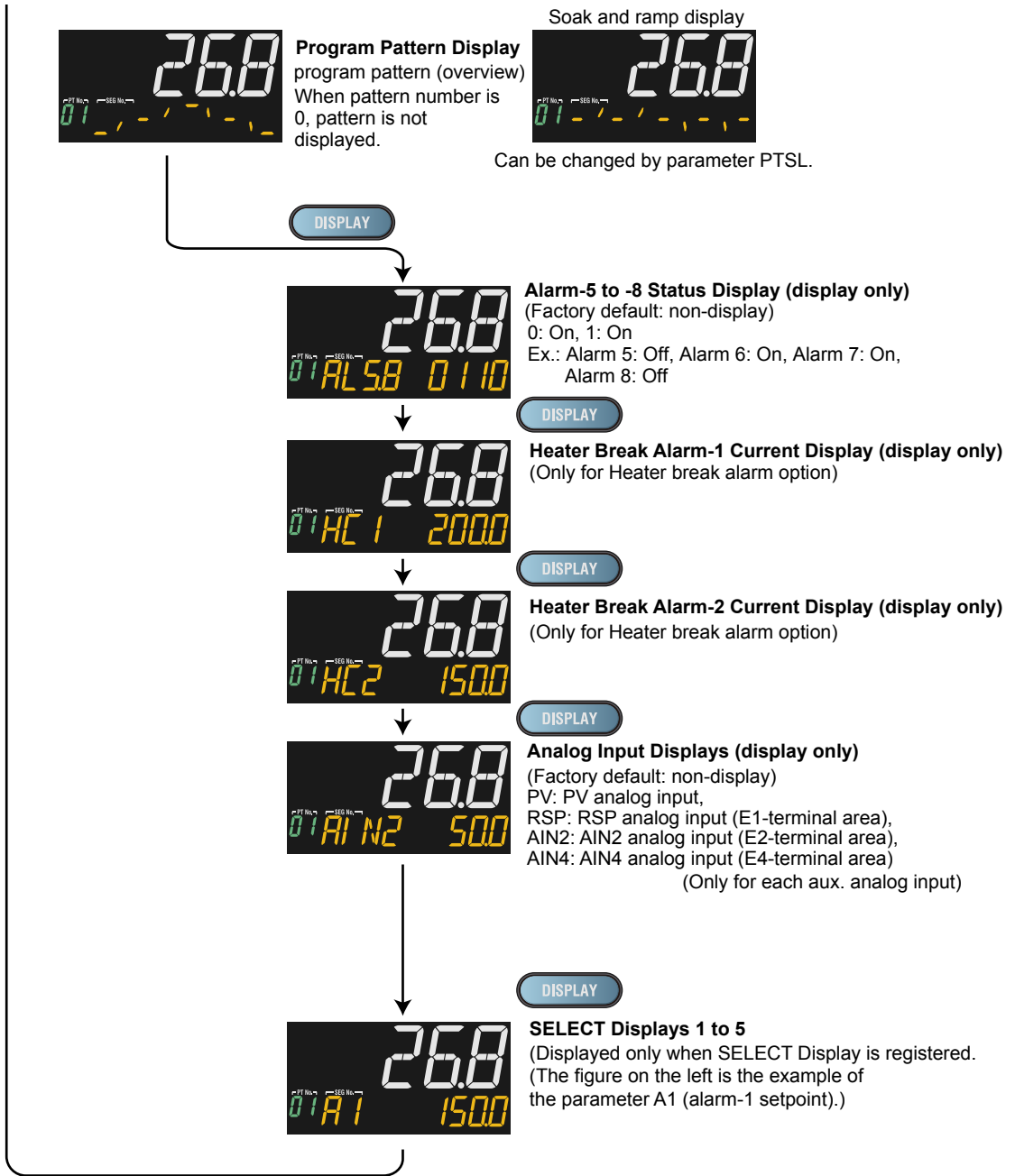
See the next page.



## 6.1 Monitoring and Control of Operation Displays

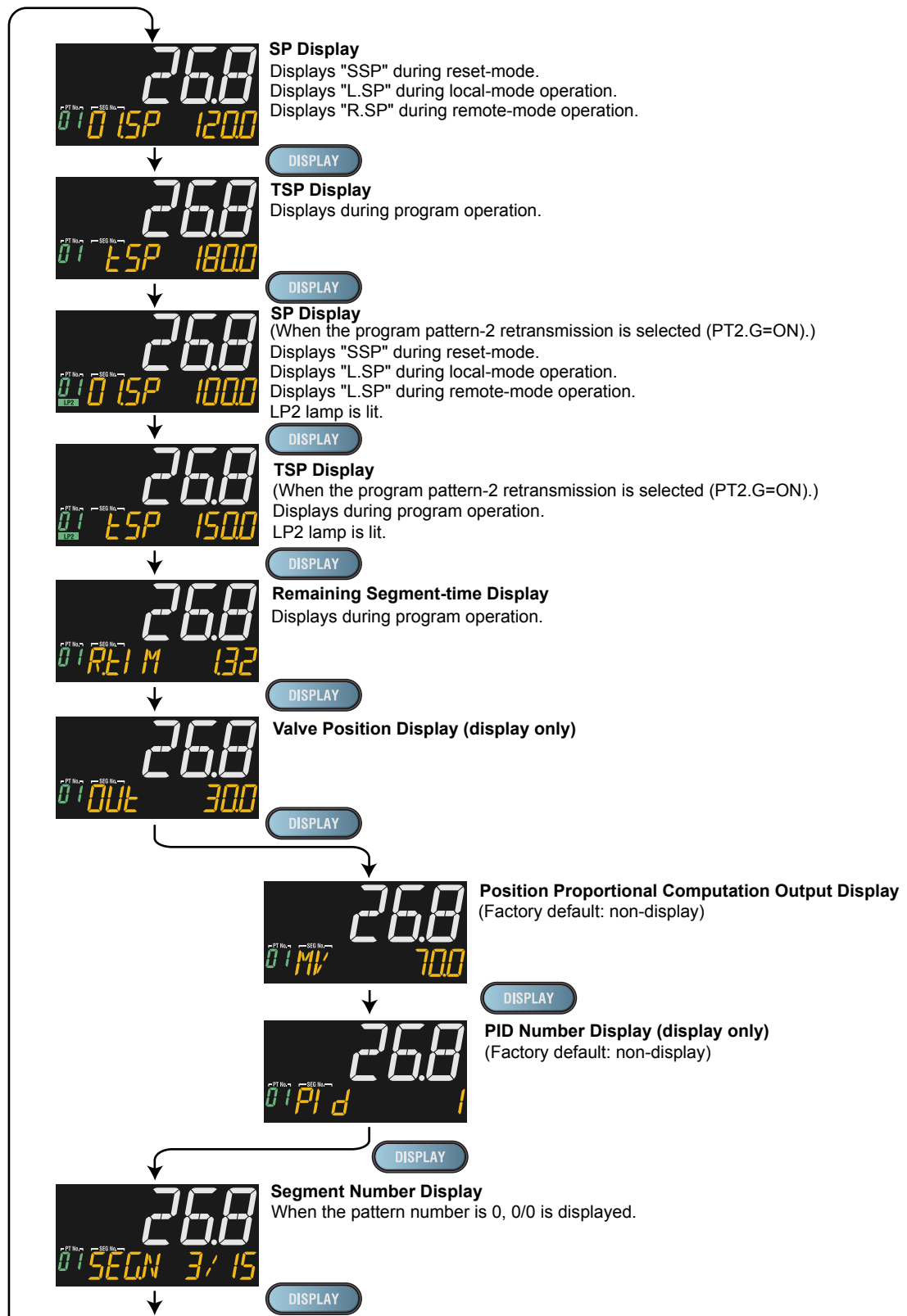
### Standard Type

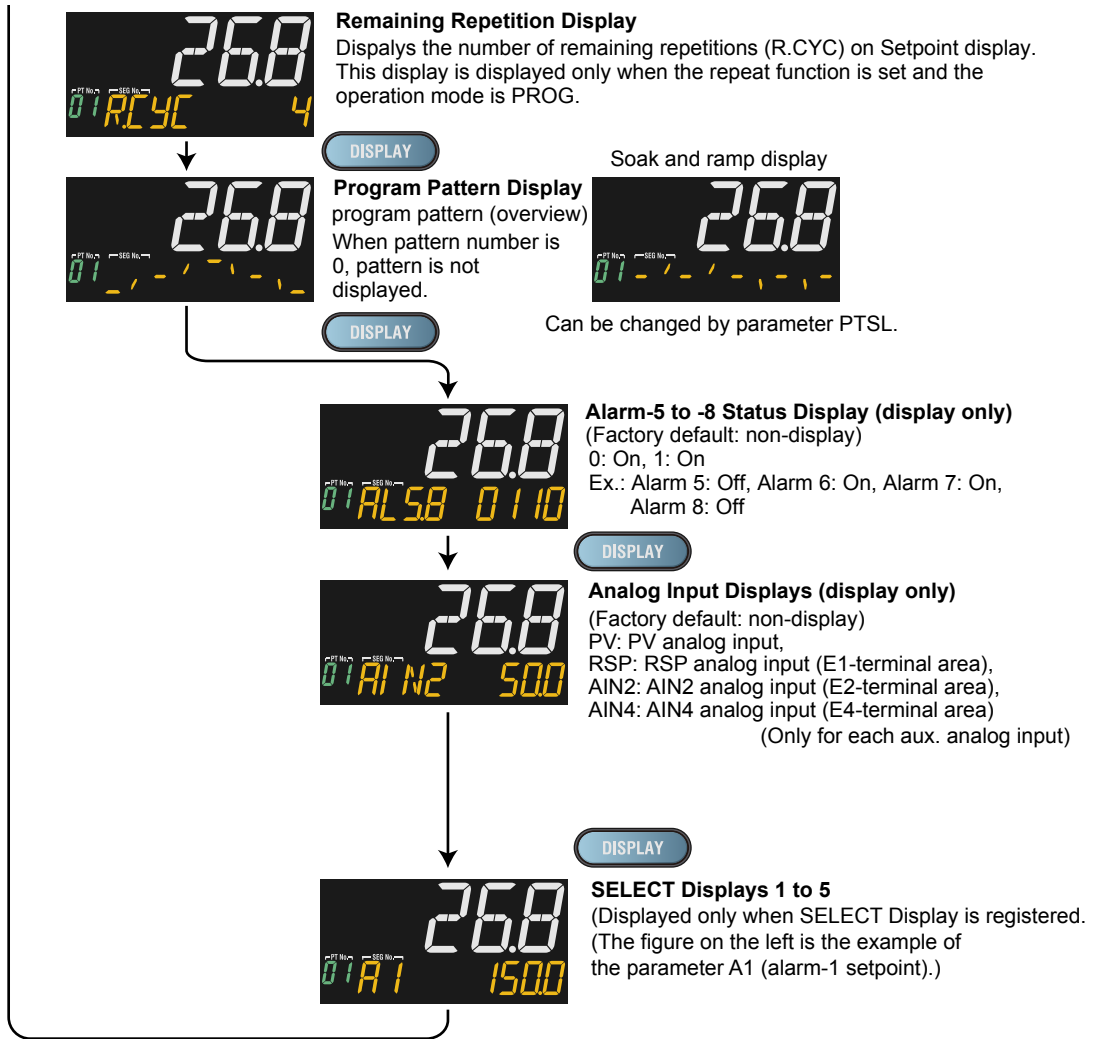




## 6.1 Monitoring and Control of Operation Displays

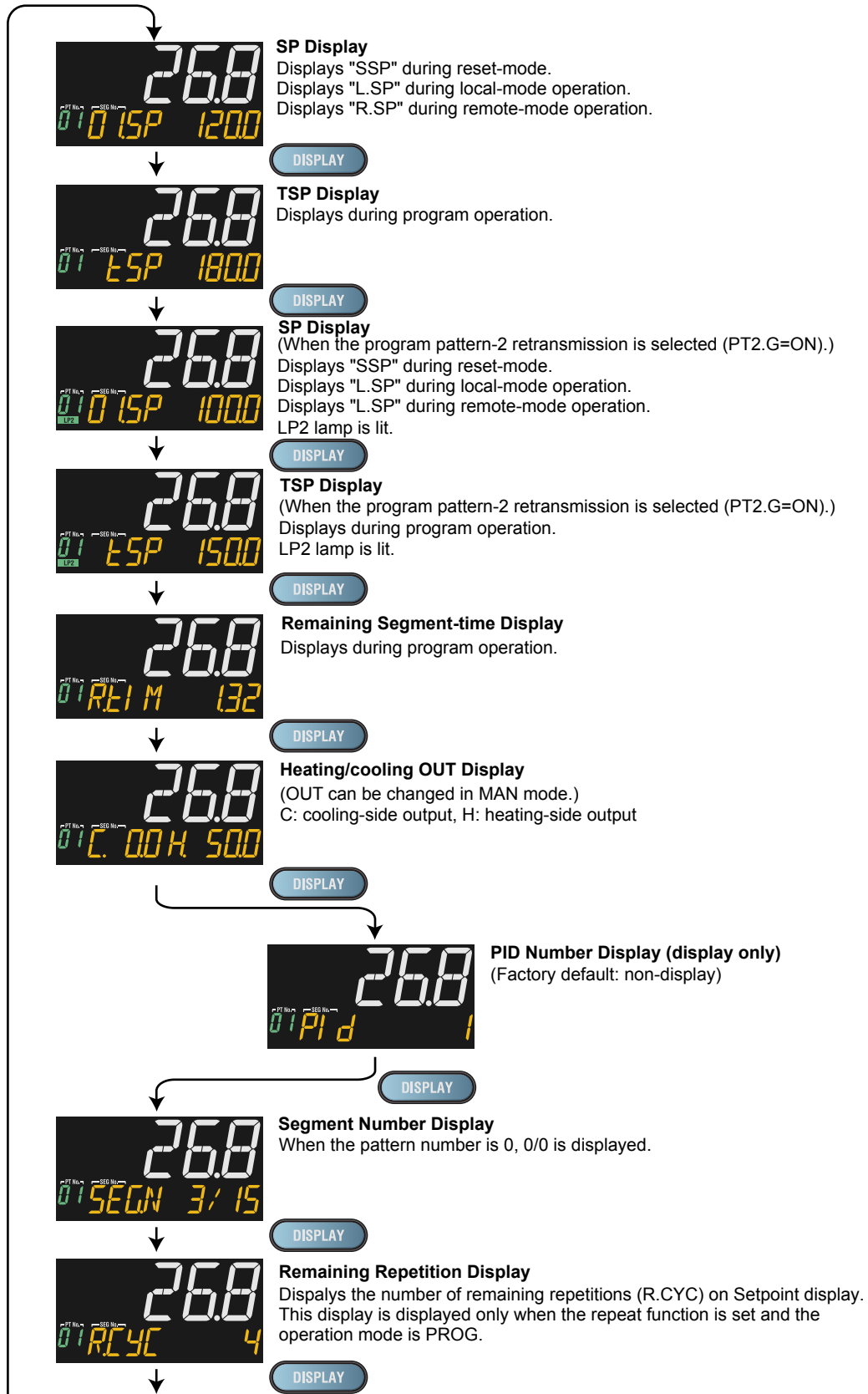
### Position Proportional Type

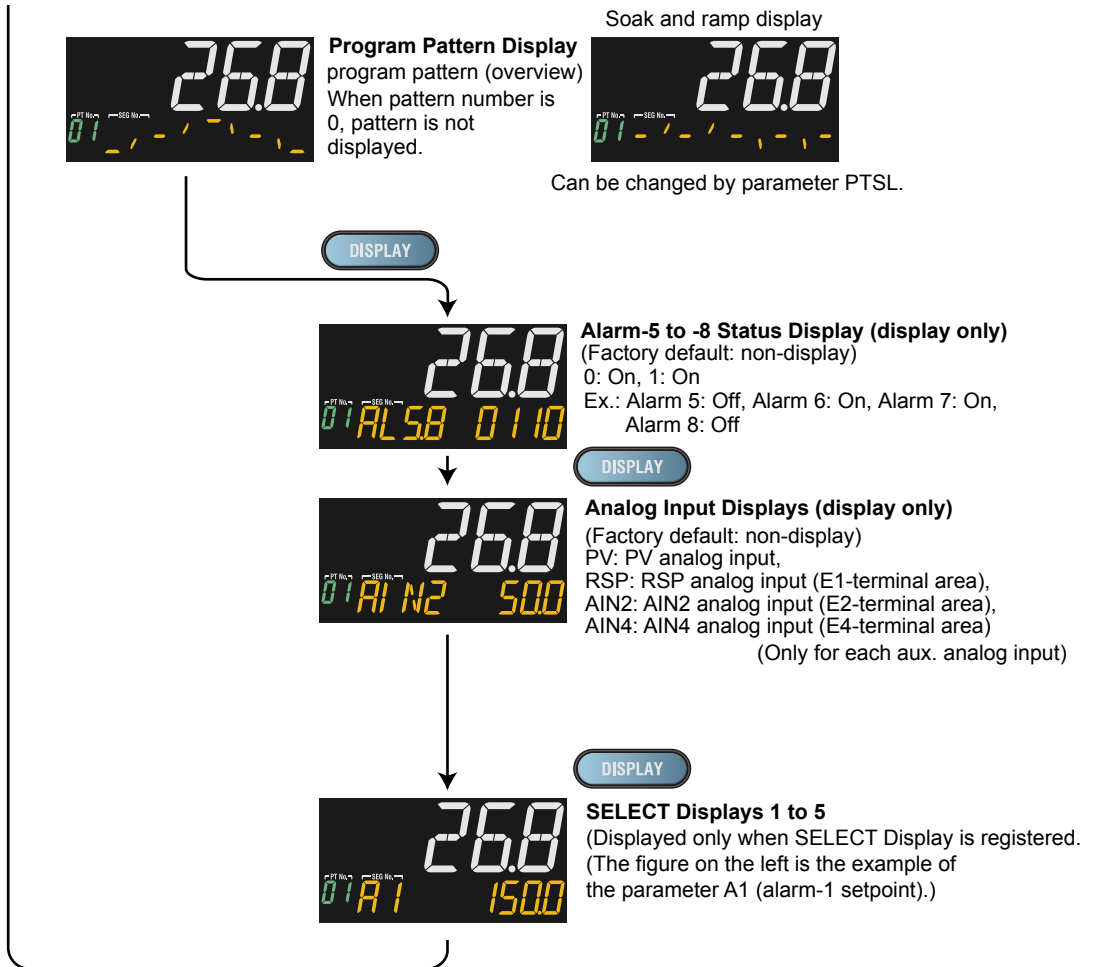




## 6.1 Monitoring and Control of Operation Displays

### Heating/cooling Type





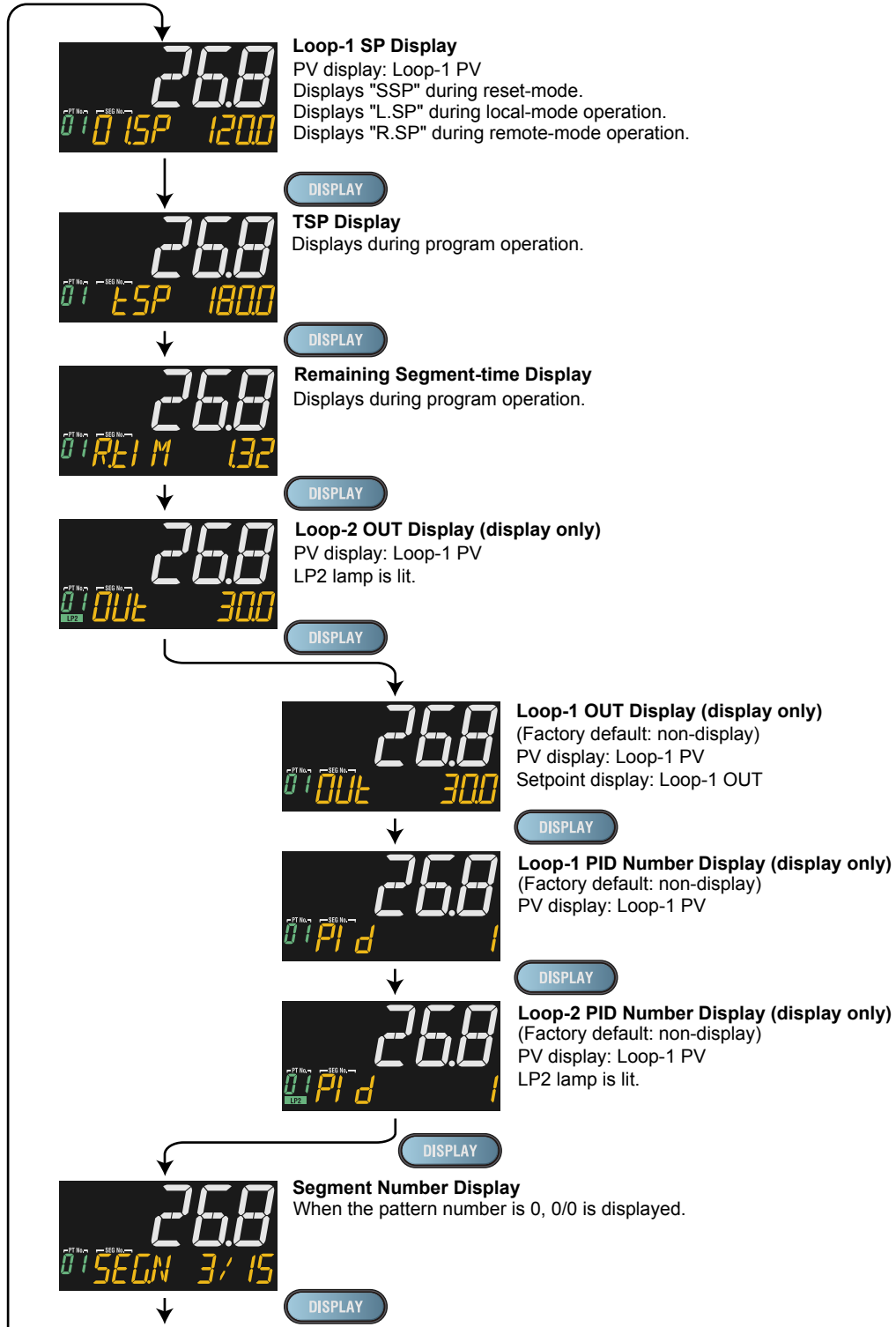
6.1 Monitoring and Control of Operation Displays

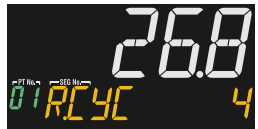
6.1.2 Operation Display Transitions in Cascade Control

- ▶ Display/non-display of Operation Display: 13.3.5 Setting Display/Non-Display of Operation Display
- ▶ Registration of SELECT Display: 13.1.3 Registering SELECT Display (Up to 5 Displays)

Standard Type

When the operation mode is Cascade (CAS):





**Remaining Repetition Display**  
 Displays the number of remaining repetitions (R.CYC) on Setpoint display. This display is displayed only when the repeat function is set and the operation mode is PROG.



**Program Pattern Display**  
 program pattern (overview)  
 When pattern number is 0, pattern is not displayed.

Soak and ramp display



Can be changed by parameter PTSL.



**Loop-1 Alarm-5 to -8 Status Display (display only)**  
 (Factory default: non-display)  
 0: On, 1: On  
 Ex.: Alarm 5: Off, Alarm 6: On, Alarm 7: On, Alarm 8: Off



**Loop-2 Alarm-5 to -8 Status Display (display only)**  
 (Factory default: non-display) LP2 lamp is lit.  
 0: On, 1: On  
 Ex.: Alarm 5: Off, Alarm 6: On, Alarm 7: On, Alarm 8: On



**Heater Break Alarm-1 Current Display (display only)**  
 (Only for Heater break alarm option)  
 PV display: Loop-1 PV



**Heater Break Alarm-2 Current Display (display only)**  
 (Only for Heater break alarm option)  
 PV display: Loop-1 PV



**Loop-1/Loop-2 PV Display (display only)**  
 PV display: Loop-1 PV  
 Setpoint display: Loop-2 PV  
 LP2 lamp is lit.



**Analog Input Displays (display only)**  
 (Factory default: non-display)  
 PV: PV analog input,  
 RSP: RSP analog input (E1-terminal area),  
 AIN2: AIN2 analog input (E2-terminal area),  
 AIN4: AIN4 analog input (E4-terminal area)  
 (Only for each aux. analog input)

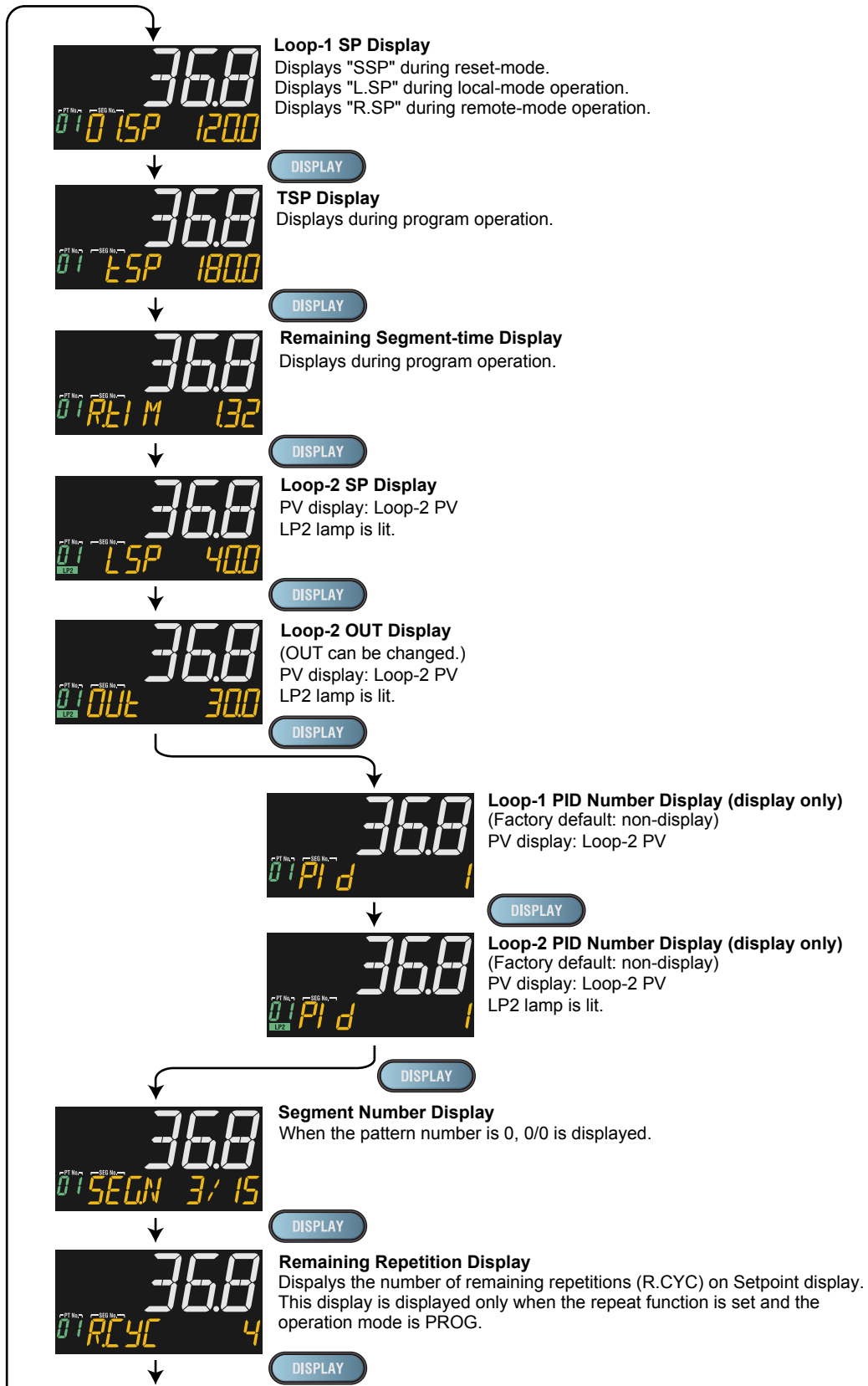


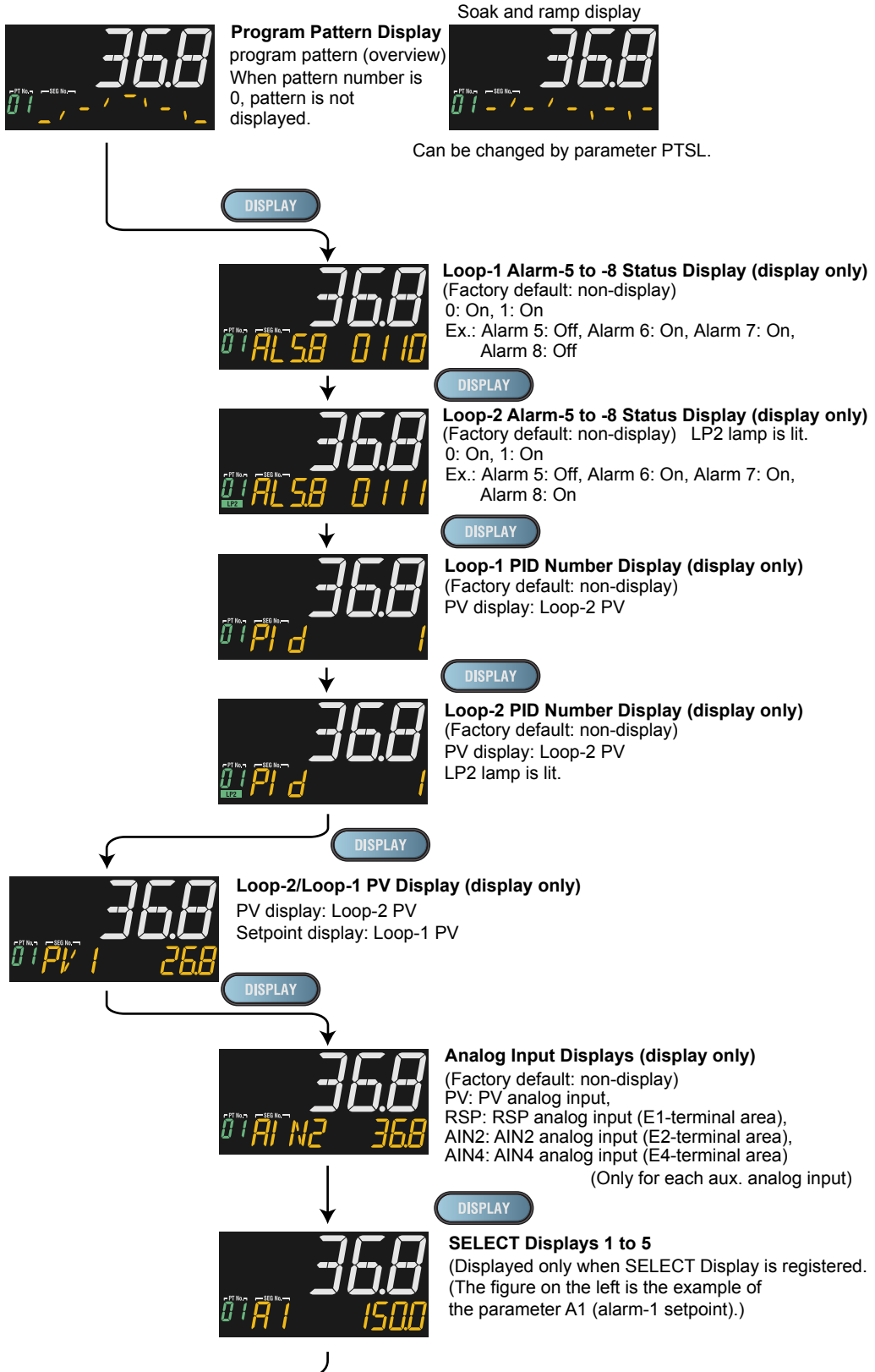
**SELECT Displays 1 to 5**  
 (Displayed only when SELECT Display is registered. (The figure on the left is the example of the parameter A1 (alarm-1 setpoint).)



## 6.1 Monitoring and Control of Operation Displays

When the operation mode is LOC(LSP):

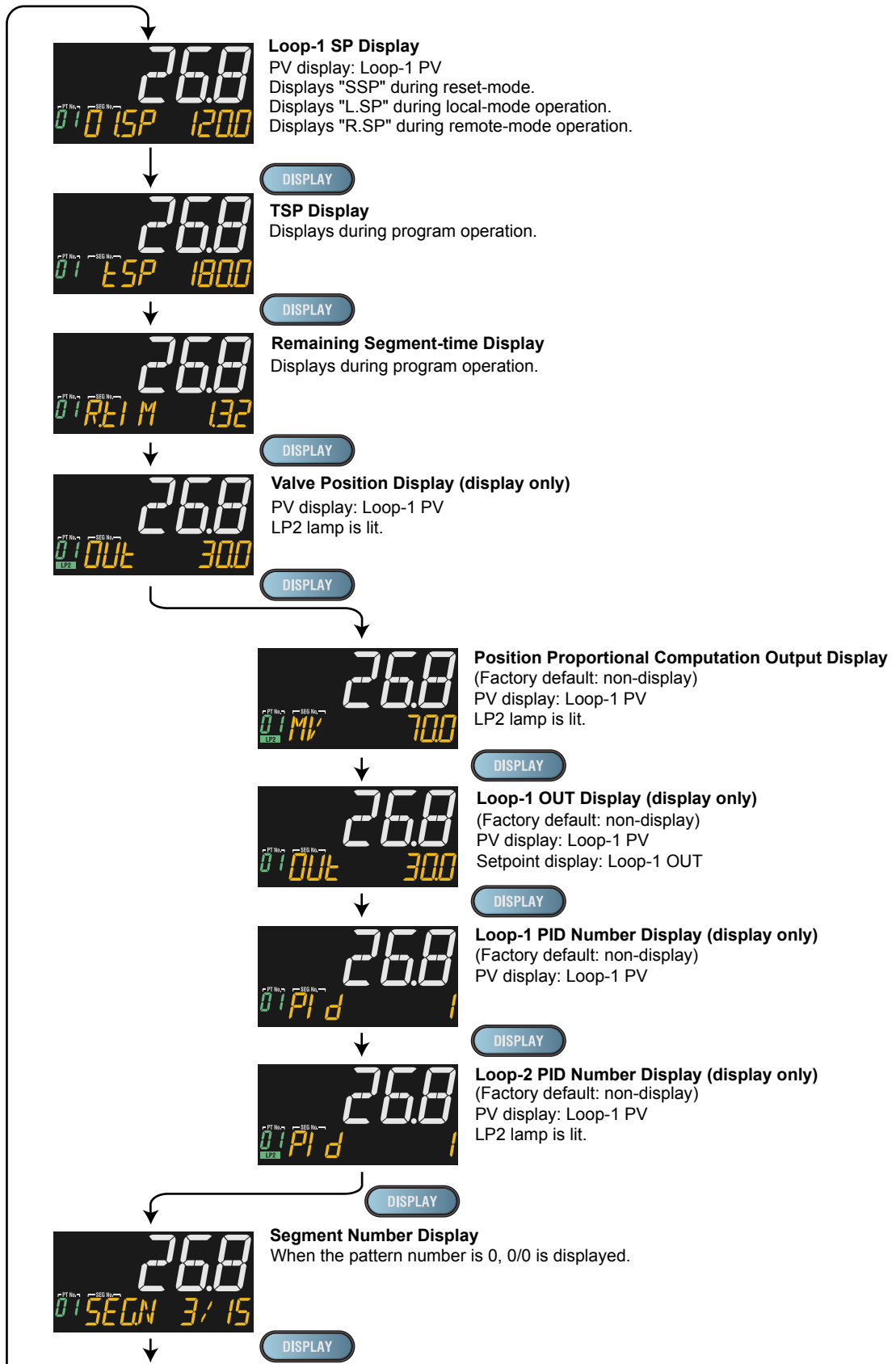


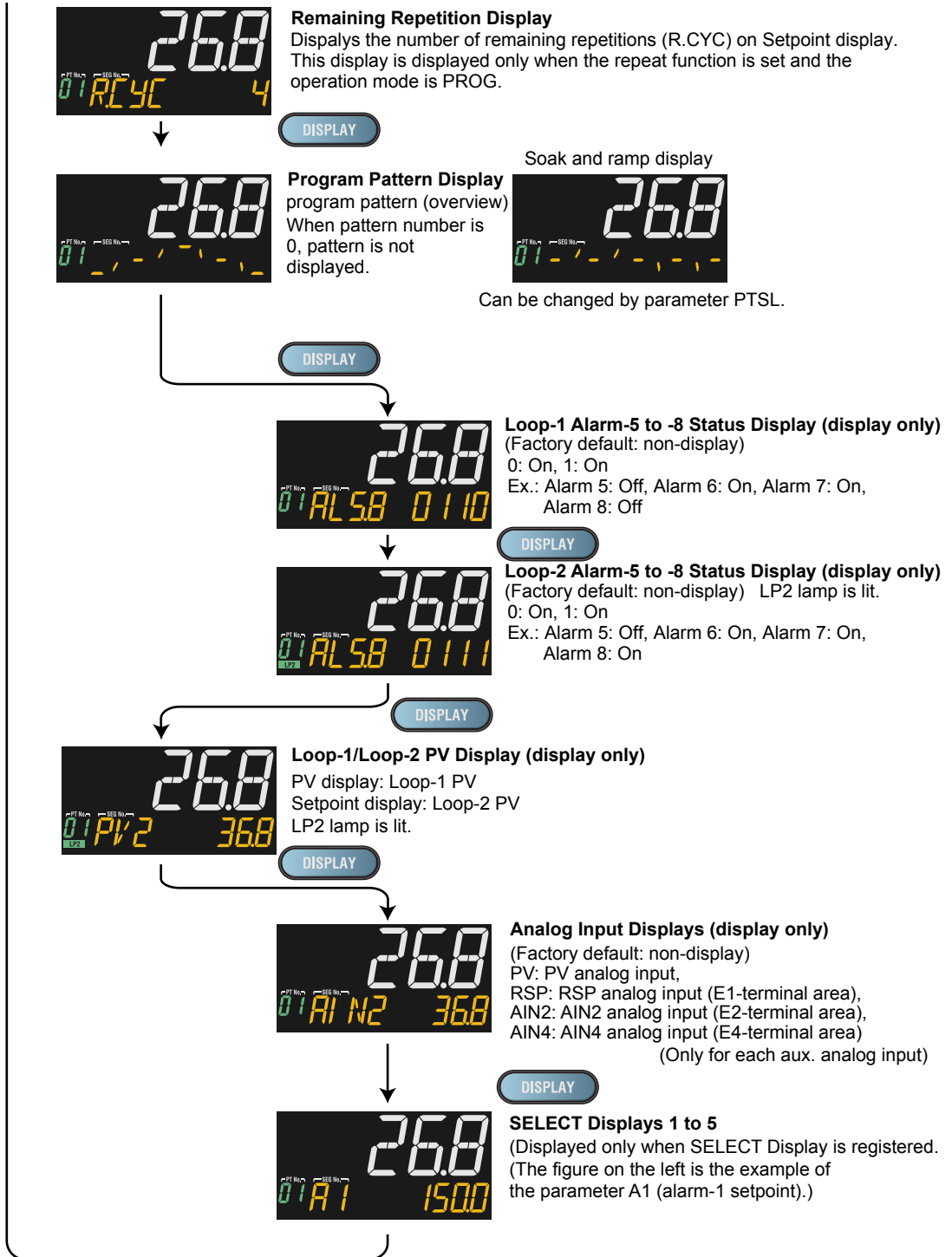


## 6.1 Monitoring and Control of Operation Displays

### Position Proportional Type

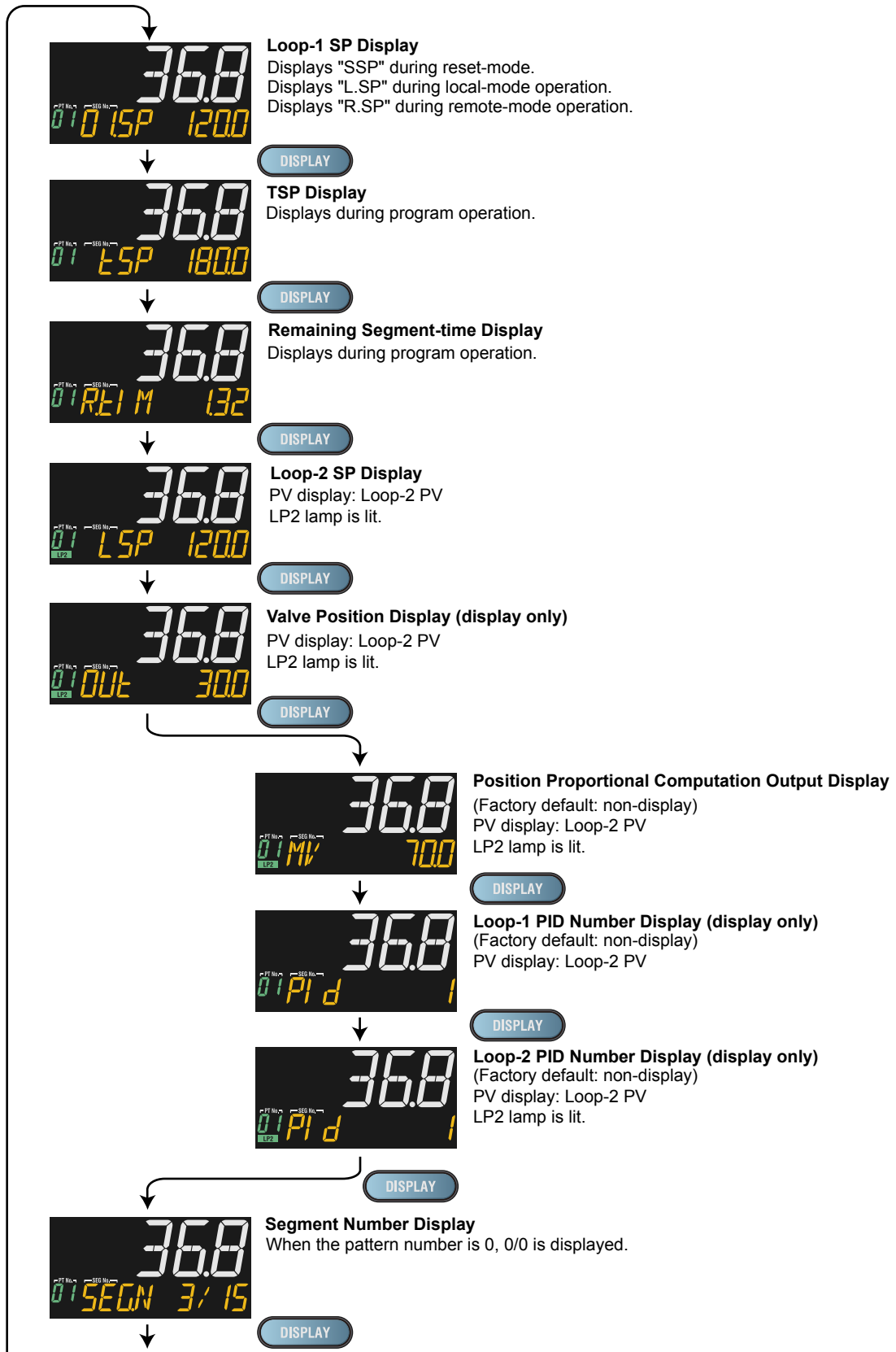
When the operation mode is Cascade (CAS):

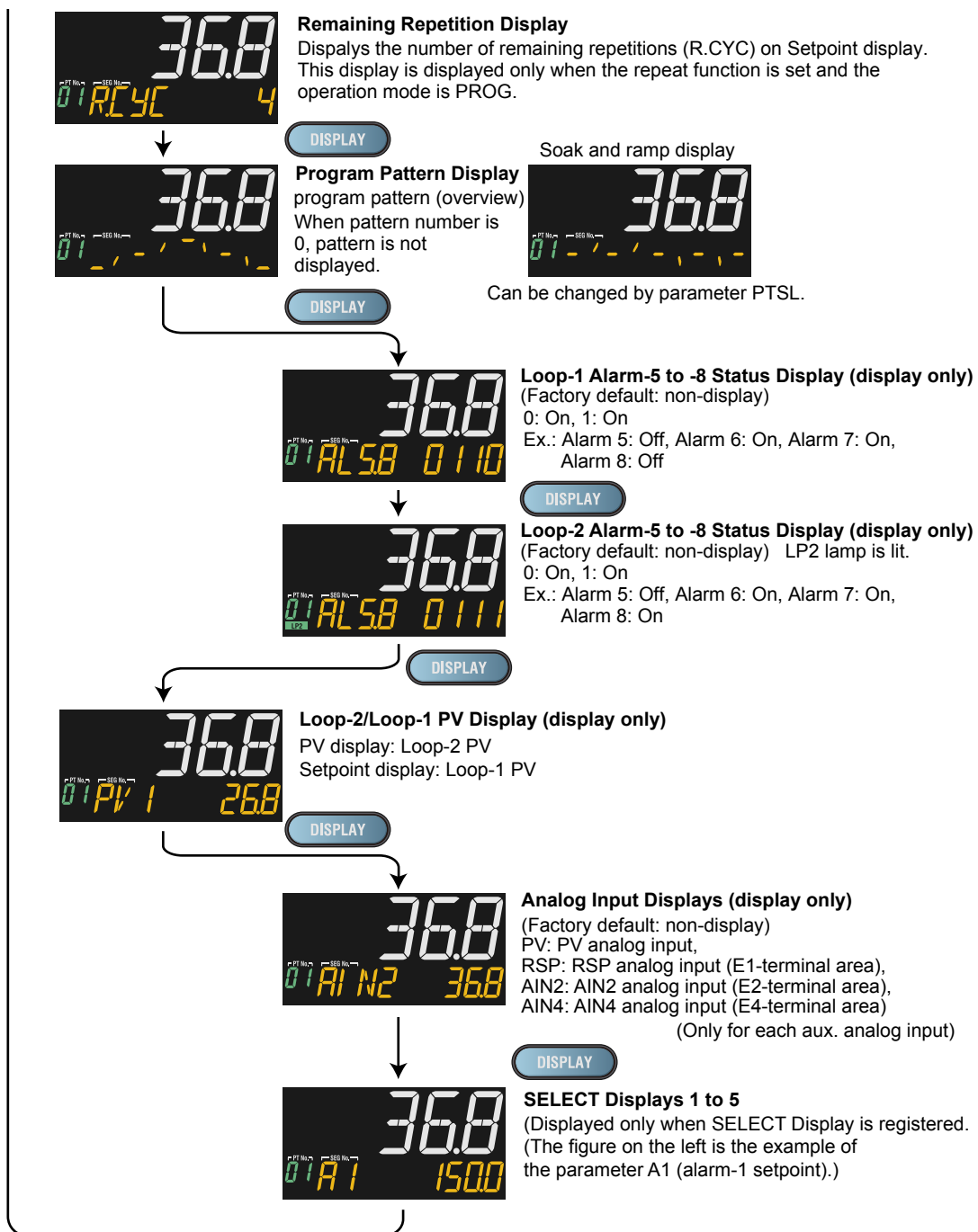




## 6.1 Monitoring and Control of Operation Displays

When the operation mode is LOC(LSP):

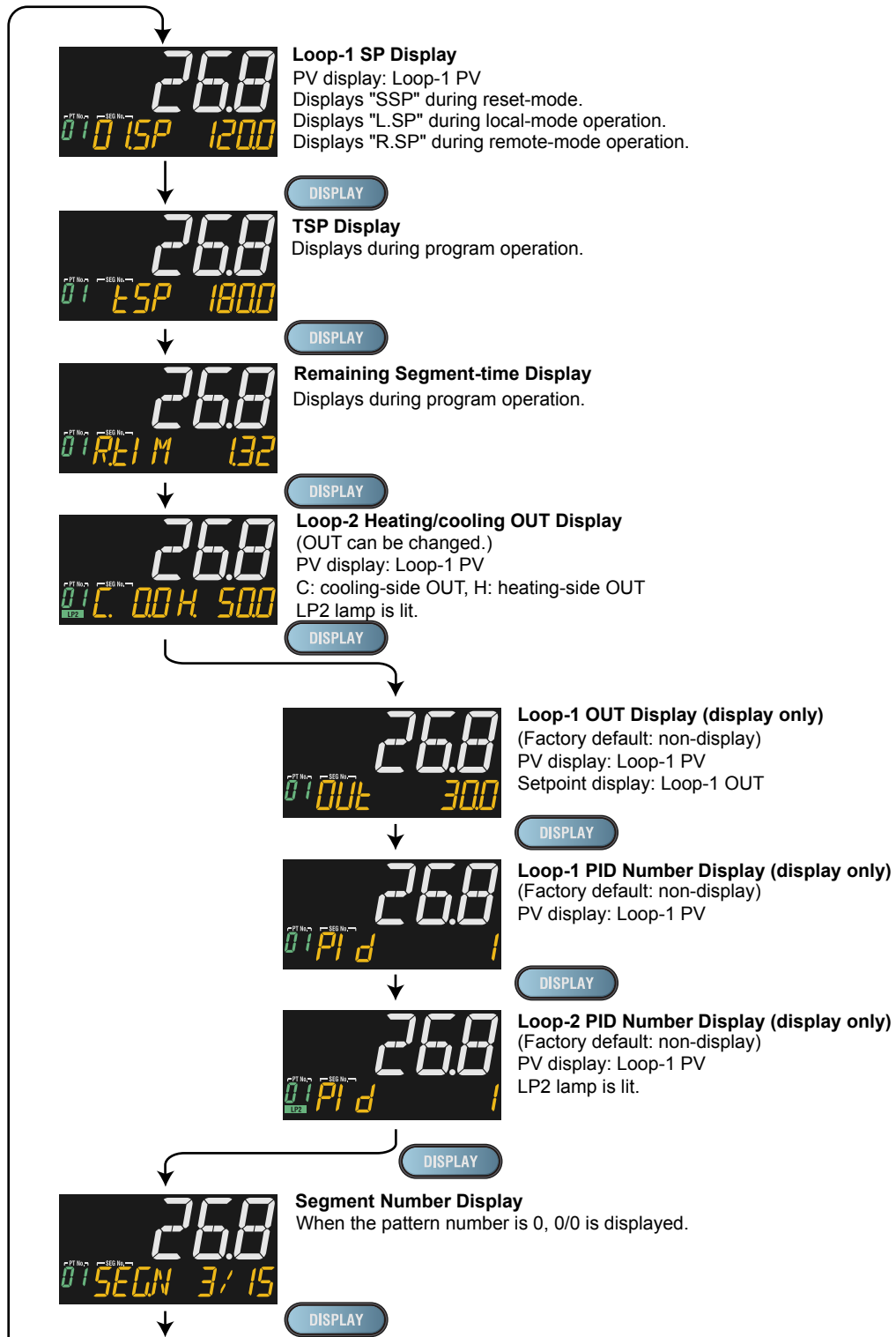


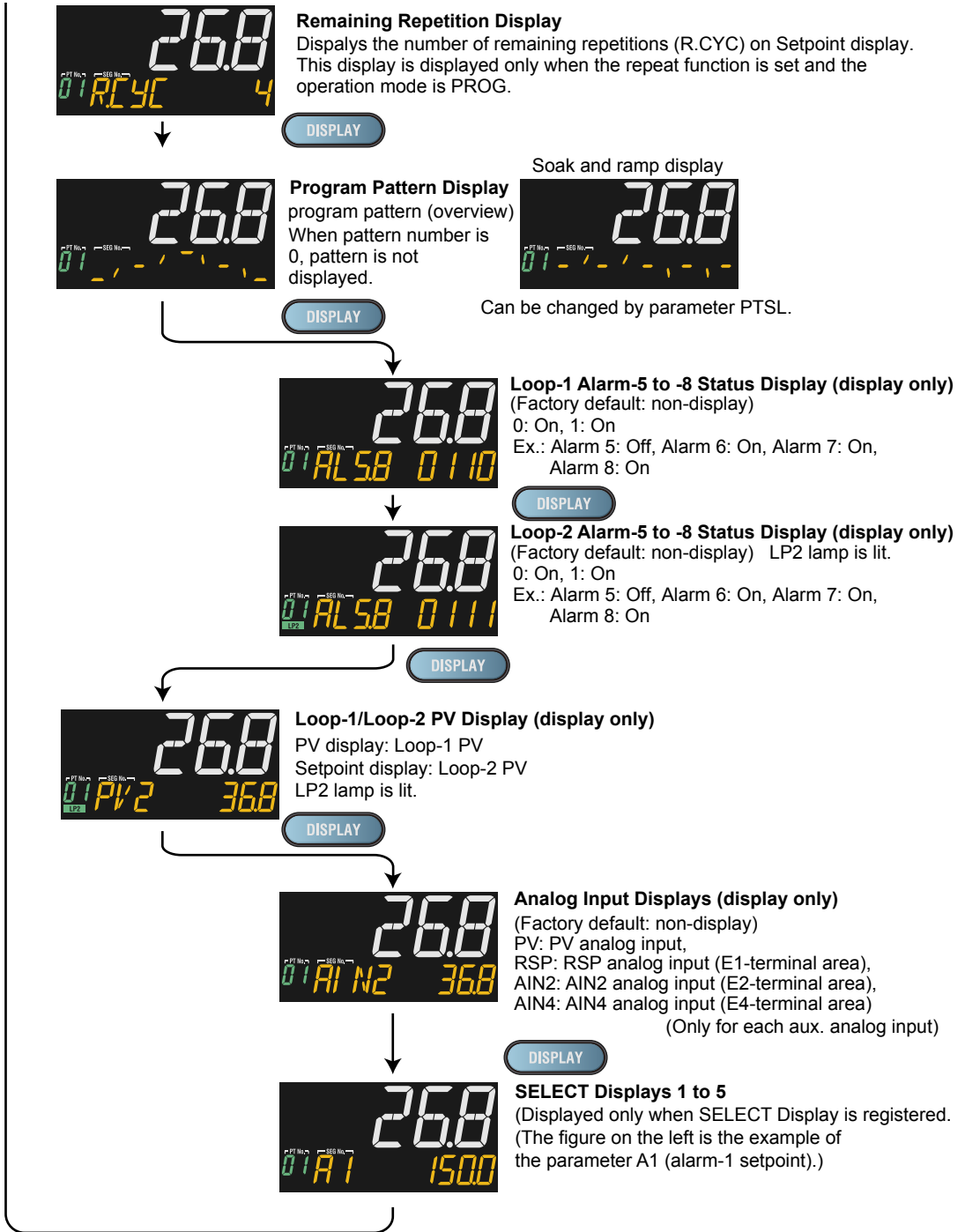


## 6.1 Monitoring and Control of Operation Displays

### Heating/cooling Type

When the operation mode is Cascade (CAS):

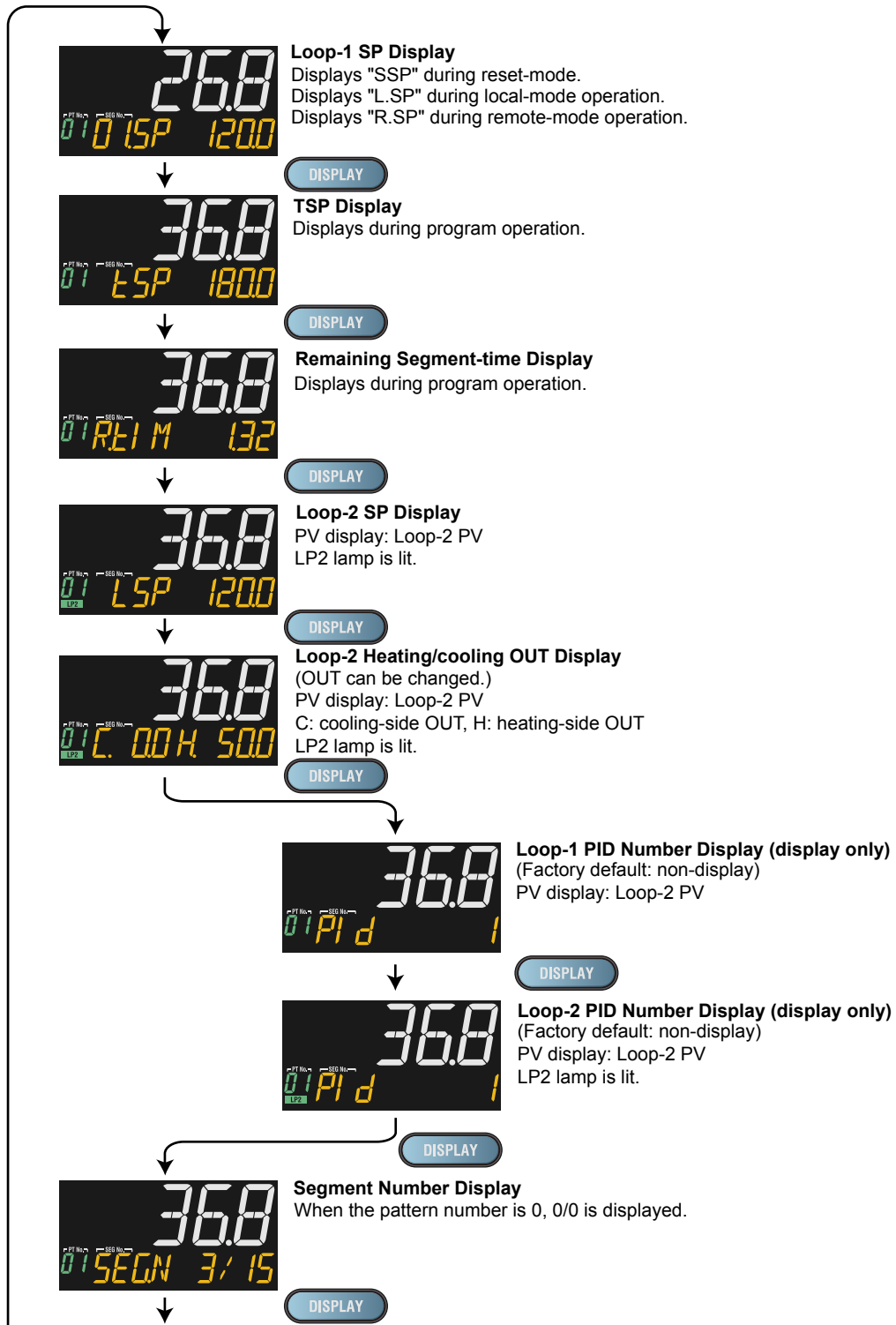


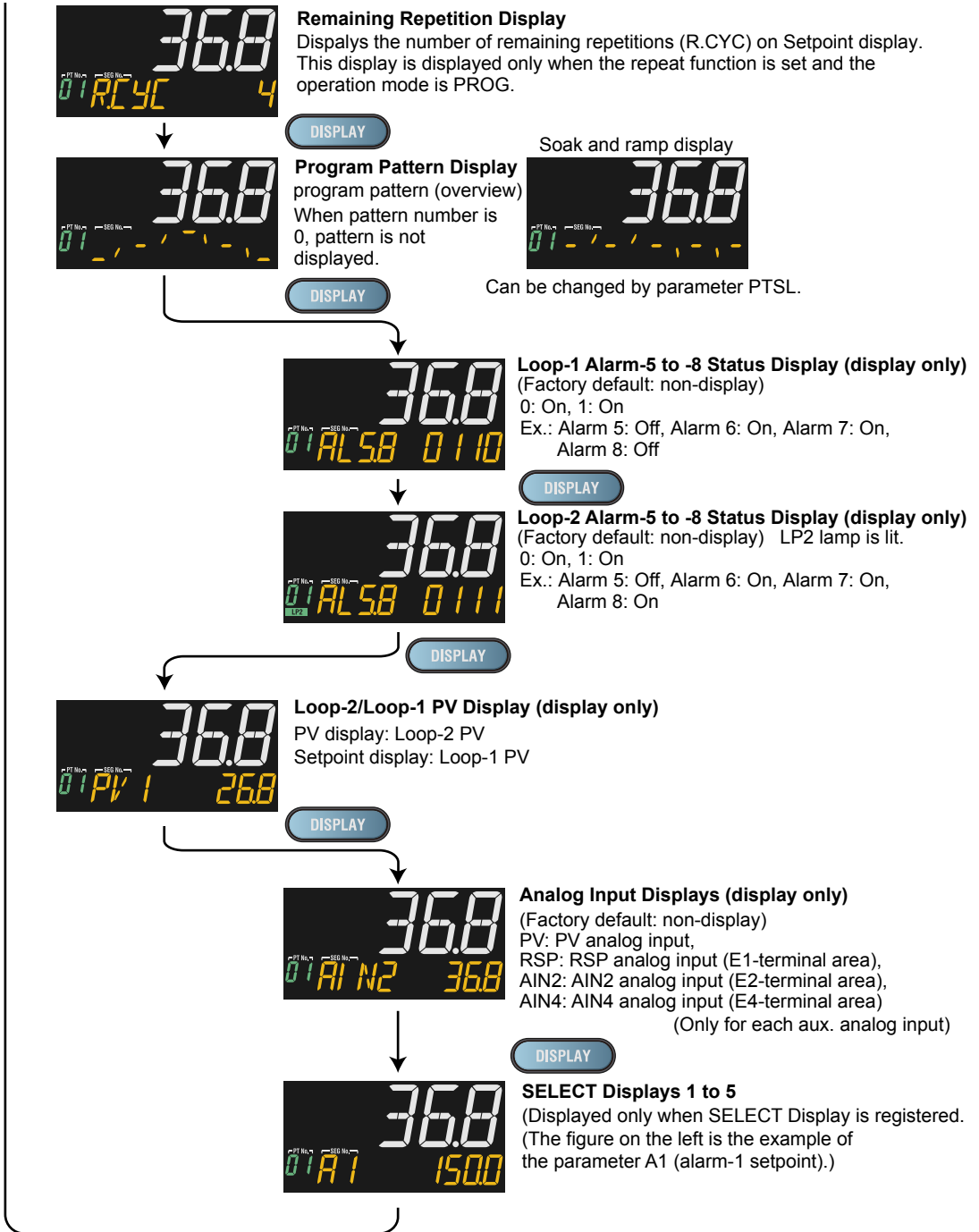




## 6.1 Monitoring and Control of Operation Displays

When the operation mode is LOC(LSP):

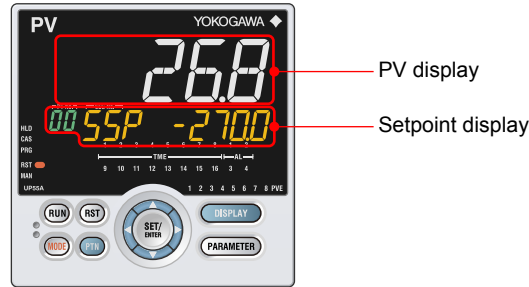









6.1 Monitoring and Control of Operation Displays

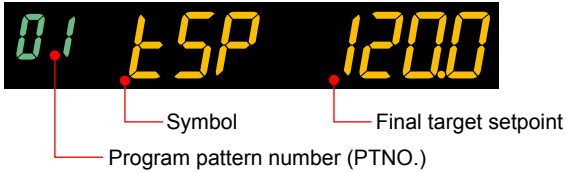
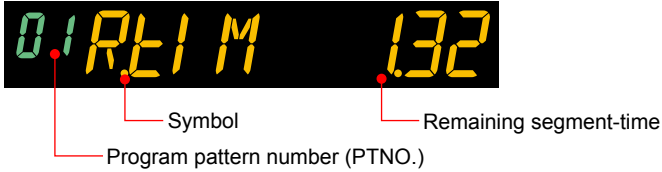
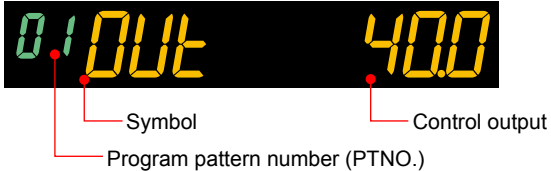
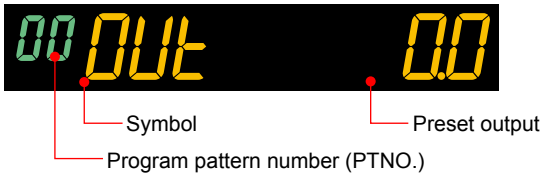
6.1.3 Details of the Operation Display

The following is the Operation Display types and each display and operation description.



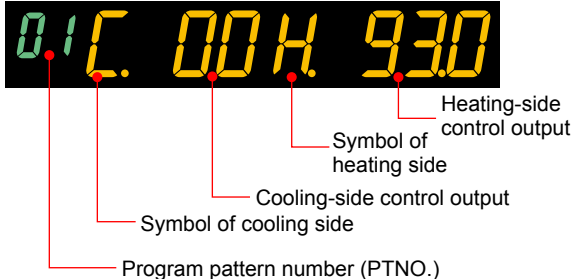
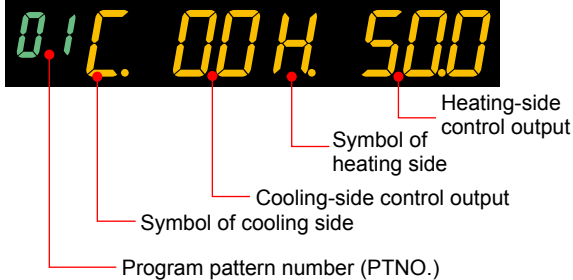
Operation Display	Display and operation description
<b>SP Display</b>	<p>PV display: Displays measured input value (PV).                      Setpoint display: Displays and changes target setpoint (SP).</p>  <p style="text-align: center;"> <span style="margin-right: 100px;">Program pattern number (PTNO.)</span> <span>Program setpoint</span> </p> <p>The Display is switched to the SP Display if the operation mode is switched to AUTO, CAS, LOC, or REM when other Operation Display is shown.</p> <p>When the operation mode is reset:</p>  <p style="text-align: center;"> <span style="margin-right: 100px;">Program pattern number (PTNO.)</span> <span>Starting target setpoint</span> </p> <p>When the operation mode is local:</p>  <p style="text-align: center;"> <span style="margin-right: 100px;">Program pattern number (PTNO.)</span> <span>Local setpoint</span> </p> <p>When the operation mode is remote (REM lamp is lit):</p>  <p style="text-align: center;"> <span style="margin-right: 100px;">Program pattern number (PTNO.)</span> <span>Remote setpoint</span> </p> <p>The figure below is displayed while the right arrow key is held down on SP Display.</p>  <p style="text-align: center;"> <span style="margin-right: 100px;">Program pattern number (PTNO.)</span> <span style="margin-right: 50px;">Program setpoint</span> <span>The number of segments included in the selected program pattern.</span> </p> <p style="text-align: center;"> <span style="margin-right: 100px;">Program pattern number (PTNO.)</span> <span>The segment number for which operation is in progress.</span> </p>

(Continued)






Operation Display	Display and operation description
<p><b>TSP Display</b></p>	<p>PV display: Displays measured input value (PV). Setpoint display: Displays final target setpoint (TSP).</p>  <p>Symbol Final target setpoint Program pattern number (PTNO.)</p>
<p><b>Remaining Segment-time Display</b></p>	<p>PV display: Displays measured input value (PV). Setpoint display: Displays remaining segment-time.</p>  <p>Symbol Remaining segment-time Program pattern number (PTNO.)</p>
<p><b>OUT Display (Valve Position Display)</b></p>	<p>PV display: Displays measured input value (PV). Setpoint display: Displays control output value and changes control output value in MAN mode.</p>  <p>Symbol Control output Program pattern number (PTNO.)</p> <p>Displays the valve's feedback input value (at 0 to 100% valve opening) in Position proportional control. The Display is switched to the OUT Display if the operation mode is switched to MAN when other Operation Display is shown. The Display is switched to the OUT Display while auto-tuning is performed.</p> <p><b>[OUT Change Operation]</b> The control output value can be changed with the Up or Down arrow key in MAN mode (MAN lamp is lit). The control output value is changed by direct operation (without pressing the SET/ENTER key), and cannot be changed by moving between digits using the Left and Right arrow keys. In Position proportional control and in MAN mode, the valve opens as long as the Up arrow key is being pressed, and closes as long as the Down arrow key is being pressed. In Two-position two-level control, main setting-side output and sub-setting-side output can be manipulated individually.</p> <p>When in RESET mode (RST lamp is lit):</p>  <p>Symbol Preset output Program pattern number (PTNO.)</p> <p>Preset output value is displayed in RESET mode. Preset output values cannot be changed by OUT change operation.</p>

## 6.1 Monitoring and Control of Operation Displays

(Continued)

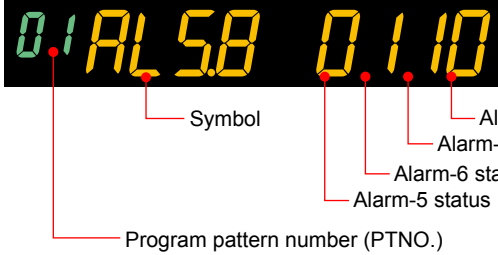

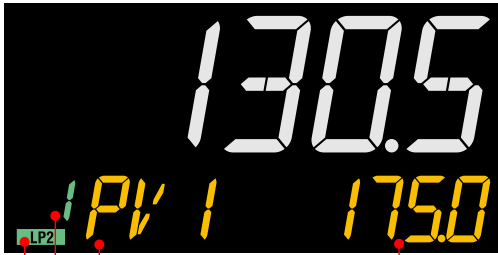
Operation Display	Display and operation description
<p><b>Heating/cooling OUT Display</b></p>	<p>PV display: Displays measured input value (PV).            Setpoint display: Displays heating-side and cooling-side control output value and changes control output value in MAN mode.</p>  <p>When the control output value is less than 100%, one digit is displayed to the right of the decimal point. When the control output value is equal to or more than 100%, no digits are displayed to the right of the decimal point.            The display is switched to the Heating/cooling OUT Display if the operation mode is switched to MAN when other Operation Display is shown.            An interruption is displayed while auto-tuning is performed.</p> <p><b>[OUT Change Operation]</b>            In MAN mode (MAN lamp is lit) pressing the Up arrow key causes the cooling-side output to decrease, and the heating-side output to increase. Pressing the Down arrow key causes the cooling-side output to increase, and the heating-side output to decrease.            The control output value is changed by direct operation (without pressing the SET/ENTER key), and cannot be changed by moving between digits using the Left and Right arrow keys.</p> <p>When in RESET mode (RST lamp is lit):</p>  <p>Heating-side or cooling-side preset output value is displayed in RESET mode.            Preset output values cannot be changed by OUT change operation.            Loop-2 output value is always displayed in Cascade control.</p>

(Continued)






Operation Display	Display and operation description
<p><b>PID Number Display</b></p>	<p>PV display: Displays measured input value (PV). Setpoint display: Displays PID number currently being used.</p>  <p>Symbol Program pattern number (PTNO.) PID number</p>
<p><b>Segment Number Display</b></p>	<p>PV display: Displays measured input value (PV). Setpoint display: Displays the segment number for which operation is in progress / the number of segments included in the selected program pattern.</p>  <p>Symbol Program pattern number (PTNO.) The segment number for which operation is in progress / the number of segments included in the selected program pattern.</p>
<p><b>Remaining Repetition Display</b></p>	<p>PV display: Displays measured input value (PV). Setpoint display: Displays the remaining repetition.</p>  <p>Symbol Program pattern number (PTNO.) Remaining repetition</p>
<p><b>Program Pattern Display</b></p>	<p>PV display: Displays measured input value (PV). Setpoint display: Displays program pattern</p>  <p>Program pattern (overview) Program pattern number (PTNO.) Period (.) This symbol is displayed after the final segment.</p> <p>The Soak and ramp display can be displayed by parameter PTSL.</p>  <p>Soak and ramp display Program pattern number (PTNO.) Period (.) This symbol is displayed after the final segment.</p> <p>Program pattern display can be scrolled using Up/Down/Left/Right arrow key. When the SET/ENTER key is pressed, the Program Pattern Display returns to the former position.</p>

6.1 Monitoring and Control of Operation Displays

(Continued)

Operation Display	Display and operation description
<p><b>Alarm-5 to -8 Status Display</b></p>	<p>PV display: Displays measured input value (PV).                      Setpoint display: Displays alarm-5 to -8 status.</p>  <p>Symbol                      Program pattern number (PTNO.)                      Alarm-5 status                      Alarm-6 status                      Alarm-7 status                      Alarm-8 status</p>
<p><b>PV1/PV2 Display</b></p>	<p>The following is the Display shown when the control mode is cascade.                      PV display: Displays Loop-1 PV input.                      Setpoint display: Displays Loop-2 PV input.</p> <p>When the control mode is Cascade control and the operation mode is cascade (CAS lamp is lit):</p>  <p>Loop-1 PV input                      Symbol of PV2                      Program pattern number (PTNO.)                      Loop-2 PV input</p> <p>PV display: Displays Loop-2 PV input.                      Setpoint display: Displays Loop-1 PV input.</p> <p>When the control mode is Cascade control and the operation mode is Local (LSP):</p>  <p>Loop-2 PV input                      Symbol of PV1                      Program pattern number (PTNO.)                      LP2 lamp is lit (indicates the loop shown on PV display).                      Loop-1 PV input</p>

(Continued)

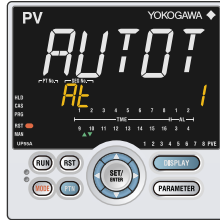
Operation Display	Display and operation description
<p><b>Analog Input Display</b></p>	<p>PV display: Displays measured input value (PV). Setpoint display: Displays PV, RSP, AIN2, or AIN4 analog input value.</p> <p>AIN2 auxiliary analog input value</p>  <p>AIN4 auxiliary analog input value</p> 
<p><b>Position Proportional Computation Output Display</b></p>	<p>PV display: Displays measured input value (PV). Setpoint display: Displays position proportional computation output value (internal computed value).</p>  <p>Can be changed in MAN mode. The valve opens or closes so that the valve's feedback input value reaches the setpoint.</p>
<p><b>Heater Break Alarm Current Display</b></p>	<p>PV display: Displays measured input value (PV). Setpoint display: Displays measured heater current.</p> 
<p><b>SELECT Display</b></p>	<p>SELECT Display is for registering frequently-used parameters from Parameter Setting Display, and for displaying them on Operation Display so that the parameter settings can be easily changed in normal operation.</p> <p>PV display: Displays measured input value (PV). Setpoint display: Displays and changes the registered parameter.</p> <p>The following is the display example when the parameter A1 (alarm-1 setpoint) is registered.</p> 



## 6.2 Performing and Canceling Auto-tuning

### Setting Display

Operation Mode Setting Display Operation Display > **PARAMETER** key for **3 seconds** (to [MODE] Menu Display) > **SET/ENTER** key (The operation mode is displayed.) > **Down arrow** key (The operation mode is displayed.)



The parameter AT is displayed when the operation mode is AUTO.

### Setting Details

Parameter symbol	Name	Display level	Setting range	Menu symbol
AT	AUTO-tuning switch	EASY	OFF: Disable 1: Perform auto-tuning. Tuning result is stored in the PID of group 1. 2: Perform auto-tuning. Tuning result is stored in the PID of group 2. 3: Perform auto-tuning. Tuning result is stored in the PID of group 3. 4: Perform auto-tuning. Tuning result is stored in the PID of group 4. 5: Perform auto-tuning. Tuning result is stored in the PID of group 5. 6: Perform auto-tuning. Tuning result is stored in the PID of group 6. 7: Perform auto-tuning. Tuning result is stored in the PID of group 7. 8: Perform auto-tuning. Tuning result is stored in the PID of group 8. R: Tuning result is stored in the PID for reference deviation.	MODE <b>Ope</b>
AT.BS	SP bias in auto-tuning	PRO	-100.0 to 100.0% of PV input range span (EUS)	TUNE <b>Ope</b>

Note1: In Cascade control, the LP2 lamp is lit while the Loop-2 parameter is displayed.

### CAUTION

Set the operation mode to AUTO and PRG/LOC/REM to perform auto-tuning.

### Lamp Status

Status	STOP lamp	CAS lamp	MAN lamp
During auto-tuning	Unlit	Unlit	Blinking

In Cascade control, perform Loop-2 auto-tuning in AUTO and RUN modes, then Loop-1 auto-tuning in Cascade and RUN modes.

**Lamp Status**

Status	STOP lamp	CAS lamp	MAN lamp
During auto-tuning of Loop-2	Unlit	Unlit	Blinking
During auto-tuning of Loop-1	Unlit	Lit	Blinking

**Description**

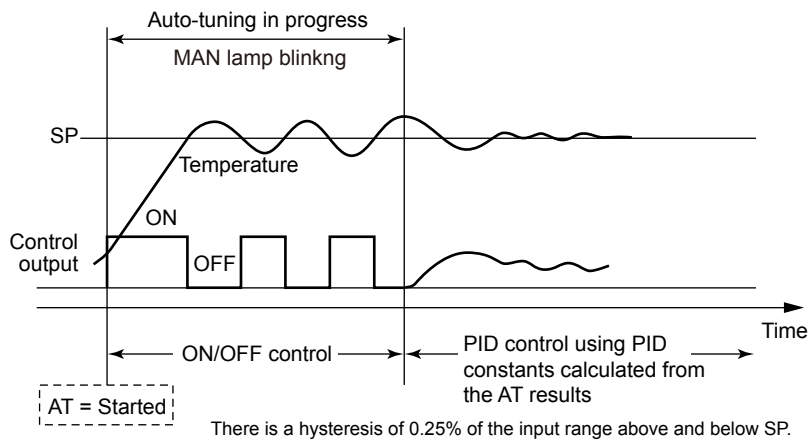
Auto-tuning is a function with which the controller automatically measures the process characteristics and sets PID constants, which are control-related parameters, to optimum values for the setpoint. Auto-tuning temporarily executes ON/OFF control, calculates appropriate PID constants from response data obtained, and sets these constants.

**CAUTION**

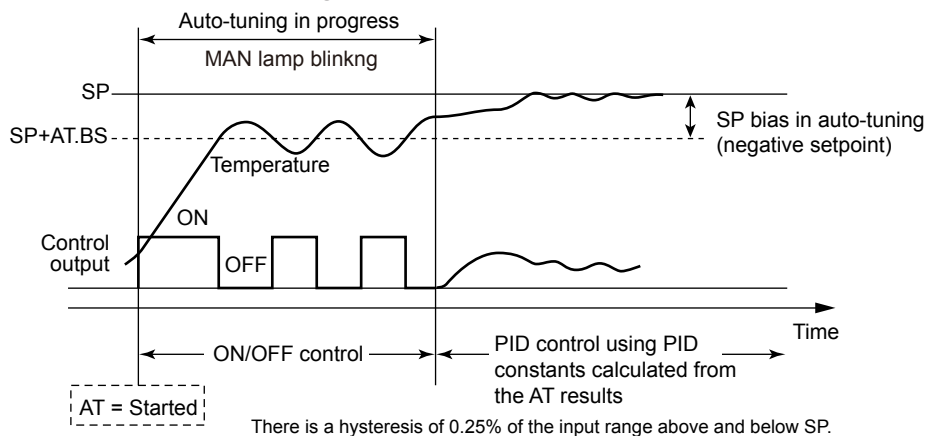
Do not perform auto-tuning for the following processes.

Tune PID manually.

- Processes with fast response such as flow rate control and pressure control.
- Processes which do not allow the output to be turned on and off even temporarily.
- Processes which prohibit output changes at control valves (or other actuators).
- Processes in which product quality can be adversely affected if PV values fluctuate beyond their allowable ranges.



**When SP bias in auto-tuning is set**



## 6.2 Performing and Canceling Auto-tuning

### Tuning Point and Storage Location of Tuning Results

The tuning point when performing auto-tuning is the target setpoint that is currently used for control computation.

PID constants after the tuning are stored in the PID group that is specified when performing auto-tuning.

Operation mode	AT setpoint	Tuning point	Storage location
Program / Local	1 to 8, R	Setpoint that is currently used	P, I, and D of the PID group specified in AT. In Heating/cooling control: P, I, D, Pc, Ic, and Dc
Remote	1 to 8, R	Remote setpoint	P, I, and D of the PID group specified in AT. In Heating/cooling control: P, I, D, Pc, Ic, and Dc

When the setpoint of AT is "R," the AT result is stored in the PID group for reference deviation.

When performing auto-tuning in AT setpoint "R", set the parameter ZON to other than 0, and set the parameter RDV to other than 0.

Auto-tuning cannot be performed when the control type (CNT) is as follows.

- ON/OFF control (1 point of hysteresis)
- ON/OFF control (2 points of hysteresis)

In addition, auto-tuning cannot be performed in the following cases (no error indication).

- Input error occurs. (Input burnout, ADC error, etc.)
- The operation mode is RESET.
- The operation mode is MAN.
- Output limiter setpoint at auto-tuning:  $AT.OL \geq AT.OH$

### Start and Stop of Auto-tuning

Start and stop of auto-tuning can be set by parameter setting, communication, or contact input.

Auto-tuning is stopped in the following cases.

- Switch to MAN
- Switch to RESET
- The parameter AT is set to OFF.
- Power failure
- Auto-tuning is not finished even after the time-out detection time is elapsed.

The time-out detection time is about 24 hours.

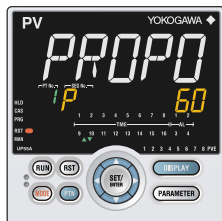
When the auto-tuning error occurs, the error code is shown in the Operation Display. Press any key to erase it.

- ▶ [Auto-tuning time output limiter: 8.9 Adjusting Auto-tuning Operation](#)

## 6.3 Adjusting PID Manually

### Setting Display

Parameter Setting Display Operation Display > **PARAMETER** key for **3 seconds** (to [MODE] Menu Display) > **Right arrow** key (to [PID] Menu Display) > **SET/ENTER** key (The setting parameter is displayed.) > **Down arrow** key (The setting parameter is displayed.)



In the Setting Display for the PID parameters, Displays can be arbitrarily switched using the Up, Down, Left or Right arrow key. Pressing the Left or Right arrow key changes the group. (The group number is displayed on Group display.)

### Setting Details

Parameter symbol	Name	Display level	Setting range	Menu symbol
<b>P</b>	Proportional band Heating-side proportional band (in Heating/cooling control)	EASY	0.0 to 999.9% When 0.0% is set, it operates as 0.1%. Heating-side ON/OFF control applies when 0.0% in Heating/ cooling control	PID <b>Ope</b>
<b>I</b>	Integral time Heating-side integral time (in Heating/cooling control)	EASY	OFF: Disable 1 to 6000 s	
<b>D</b>	Derivative time Heating-side derivative time (in Heating/cooling control)	EASY	OFF: Disable 1 to 6000 s	
<b>Pc</b>	Cooling-side proportional band	EASY	0.0 to 999.9% Cooling-side ON/OFF control applies when 0.0% in Heating/ cooling control	
<b>Ic</b>	Cooling-side integral time	EASY	OFF: Disable 1 to 6000 s	
<b>Dc</b>	Cooling-side derivative time	EASY	OFF: Disable 1 to 6000 s	

Note1: In Cascade control, the LP2 lamp is lit while the Loop-2 parameter is displayed.

There are eight groups of PID parameters.

In Cascade control, both Loop 1 and Loop 2 have eight groups.

The PID parameters can be selected by using the following two methods:

**(1) Segment PID number selection**

**(2) Zone PID selection**

**(3) Local PID selection**

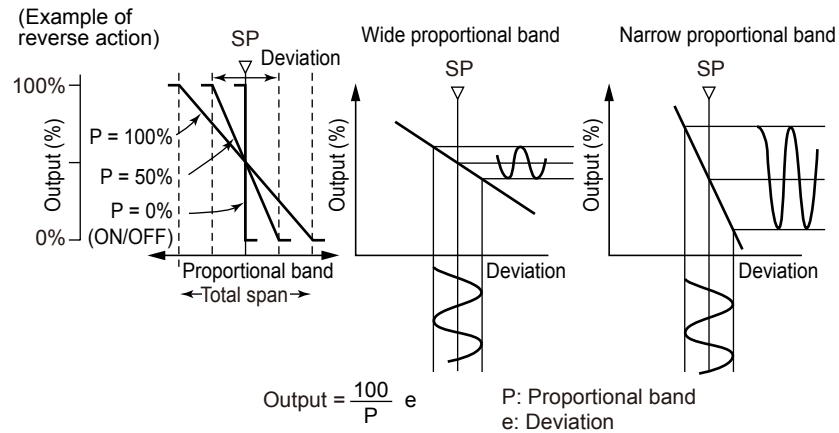
▶ Selection by contact input: [12.1 Setting Contact Input Function](#)

▶ Selection by each Zone: [8.4 Switching PID](#)

**Description**

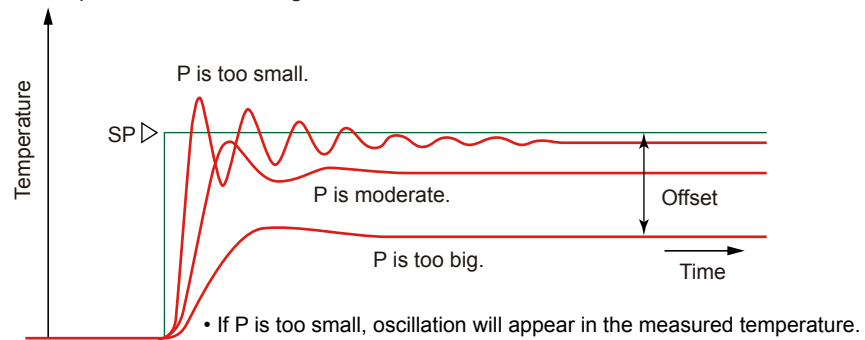
**Description and Tuning of Proportional Band**

The proportional band is defined as the amount of change in input (or deviation), as a percent of span, required to cause the control output to change from 0% to 100%. Because a narrower proportional band gives greater output change for any given deviation, it therefore also makes the control performance more susceptible to oscillation. At the same time, a narrower proportional band reduces the offset. Reducing the proportional band to its smallest limit (proportional band = 0%) results in ON/OFF control.



To fine-tune a proportional band obtained using auto-tuning, or to manually tune the proportional band:

- Work from larger to smaller numbers (wider to narrower).
- If cycling appears, that means that the proportional band is too narrow.
- Proportional band tuning cannot cancel an offset.



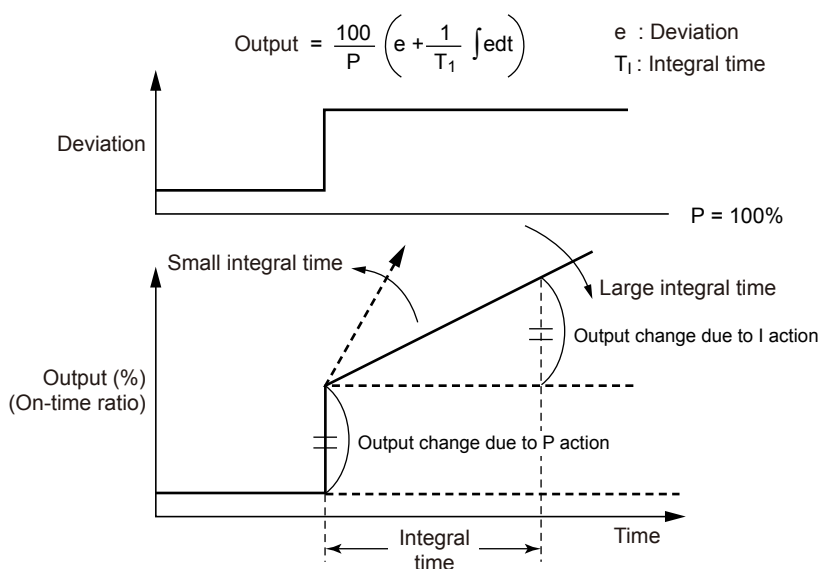
► [Offset: 10.8 Canceling Offset of PV and SP \(Manual Reset\)](#)

## Description and Tuning of Integral Time

The integral action (I action) is a function that will automatically diminish the offset (steady-state deviation) that is inherently unavoidable with proportional action alone. The integral action continuously increases or decreases the output in proportion to the time integral of the deviation (the product of the deviation and the time that the deviation continues.)

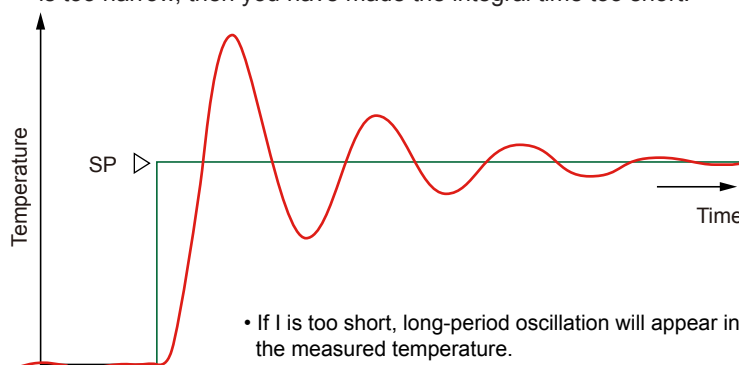
The integral action is normally used together with proportional action as proportional-plus-integral action (PI action).

The integral time (I) is defined as the time required to develop, when a stepwise change in deviation is imposed, an output change due to integral action that is exactly equal to the change due to proportional action. The longer the integral time set, the slower the change in output; the smaller the time, the faster the output changes.



To manually tune the integral time

- The main goal is to reduce the offset.
- Adjust from longer time to shorter time.
- If you see an oscillation at a longer period than that seen when the proportional band is too narrow, then you have made the integral time too short.



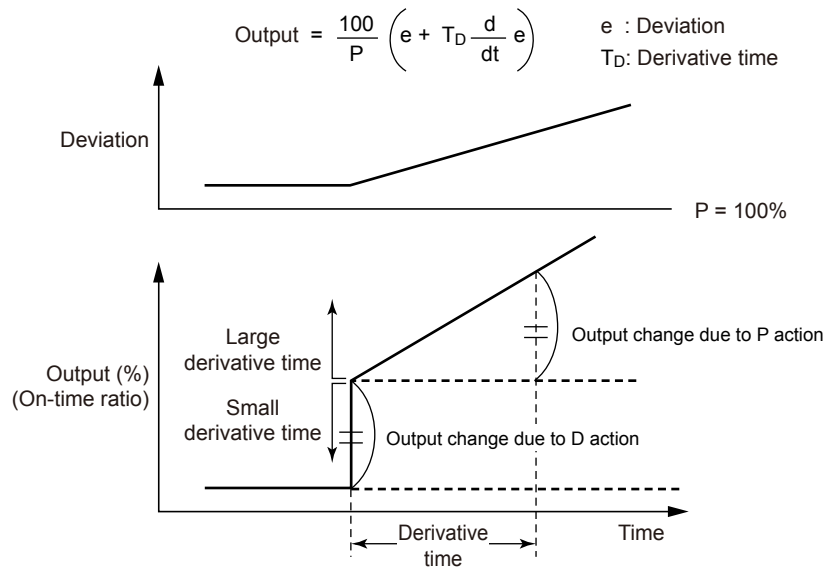
Use the manual reset (MR) to cancel an offset when the integral action is disabled.

- ▶ [Manual reset: 10.8 Canceling Offset of PV and SP \(Manual Reset\)](#)

### Description and Tuning of Derivative Time

If the control object has a large time constant or dead time, the corrective action will be too slow with proportional action or proportional-plus-integral action alone, causing overshoot. However, even just sensing whether the deviation is on an increasing or a decreasing trend and adding some early corrective action can improve the controllability. Thus the derivative action (D action) is action that changes the output in proportion to the deviation derivative value (rate-of-change).

The derivative time is defined as the time required with PD action to develop, when a constant-slope change in deviation is imposed, an output change due to derivative action that is exactly equal to the change due to proportional action.

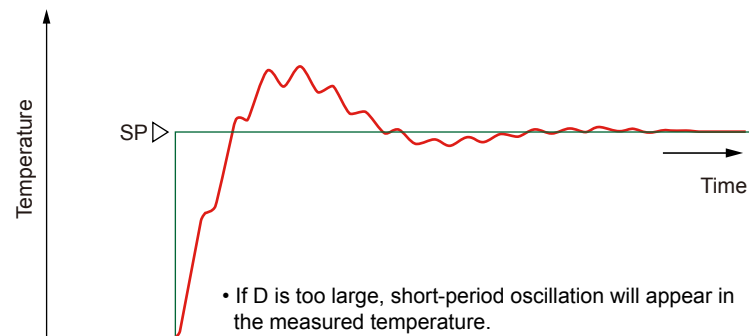


To manually tune the derivative time

- Adjust from shorter time to longer time.
- If you see a short-period oscillation, the time is too long.

The longer the derivative time set, the stronger the corrective action, and the more likely the output will become oscillatory. Oscillations due to derivative action are characterized by a short period.

D = OFF should always be used when controlling fast-responding inputs such as pressure and flow rate, or inputs characterized by rapid fluctuation, such as optical sensors.



### Manual PID Tuning Procedure

- (1) In principle, auto-tuning must be used.
- (2) Tune PID parameters in the order of P, I, and D. Adjust a numeric slowly by observing the result, and keep notes of what the progress is.
- (3) Gradually reduce P from a larger value. When the PV value begins to oscillate, stop tuning and increase the value somewhat.
- (4) Also gradually reduce I from a larger value. When the PV value begins to oscillate (with long period), stop tuning and increase the value somewhat.
- (5) Gradually increase D from a smaller value. When the PV value begins to oscillate (with short period), stop tuning and lower the value slightly.

### Reference Values for Manual Tuning of Temperature, Pressure, and Flow Rate

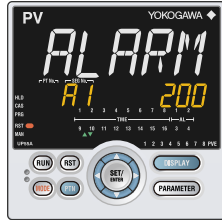
		Setting range (reference)	Initial value for tuning (reference)
Pressure	P	100 to 300%	200%
	I	5 to 30 s	15 s
	D	OFF	OFF
Flow rate	P	100 to 240%	150%
	I	8 to 30 s	20 s
	D	OFF	OFF
Temperature (electric furnace)	P	1 to 20%	5%
	I	180 to 600 s	240 s
	D	1/4 to 1/6 of I	60 s



## 6.4 Setting Alarm Setpoint

### Setting Display

Parameter Setting Display Operation Display > **PARAMETER** key for **3 seconds** (to [MODE] Menu Display) > **Right arrow** key (to [SP] Menu Display) > **SET/ENTER** key (The setting parameter is displayed.) > **Down arrow** key (The setting parameter is displayed.)



### Setting Details

Parameter symbol	Name	Display level	Setting range	Menu symbol
<b>A1 to A8</b>	Alarm-1 to -8 setpoint	EASY	Set a display value of setpoint of PV alarm, SP alarm, deviation alarm, output alarm, or velocity alarm. -19999 to 30000 (Set a value within the input range.) Decimal point position depends on the input type	SP <b>Ope</b>
<b>ALNO.</b>	Number of alarms	PRO	1 to 8	CTL <b>Set</b>

Note 1: The initial value of the parameter ALNO. is "4." Four alarm setpoint parameters are displayed for each SP group.

Note 2: In Cascade control, the LP2 lamp is lit while the Loop-2 parameter is displayed.

### Description

These alarms work irrespective of the operation mode.

Each alarm type has eight alarm setpoints.

In Cascade control, each alarm type has eight setpoints for Loop 1 and Loop 2, respectively.

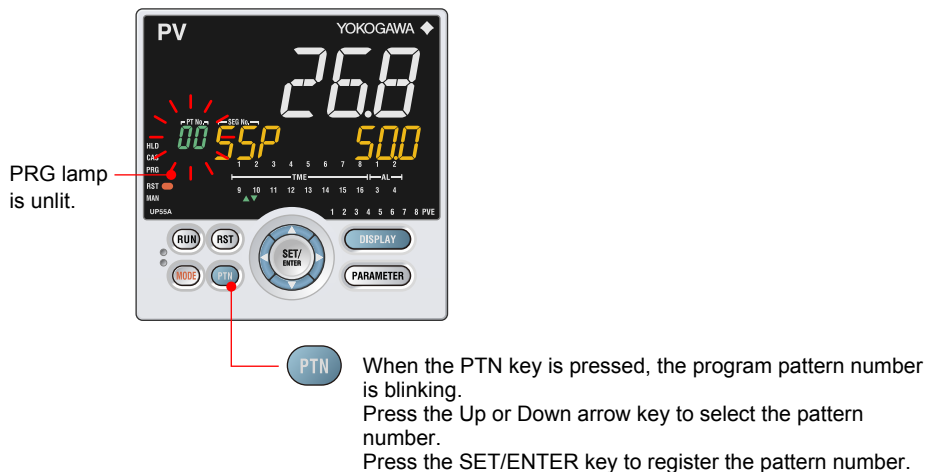
Alarm-related parameter	Number of settings
Alarm type	8 (number of settings) x 2 (number of loops)
PV velocity alarm time setpoint	8 (number of settings) x 2 (number of loops)
Alarm hysteresis	8 (number of settings) x 2 (number of loops)
Alarm delay timer	8 (number of settings) x 2 (number of loops)
Alarm setpoint	8 (number of settings) x 2 (number of loops)

▶ Alarm type: [Chapter 11 Alarm Functions](#)

## 6.5 Selecting Program Pattern Number (PTNO.)

### Selecting by PTN Key

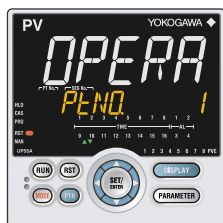
#### Setting Display



### Selecting by Operation Mode Parameter

#### Setting Display

Parameter Setting Display Operation Display > **PARAMETER** key for **3 seconds** (to [MODE] Menu Display) > **SET/ENTER** key (The setting parameter is displayed.) > **Down arrow** key (The setting parameter is displayed.)



#### Setting Details

Parameter symbol	Name	Display level	Setting range	Menu symbol
PTNO.	Program pattern number selection	EASY	0: Not select program pattern 1 to 30	MODE <b>Ope</b>

#### Description

Before starting program operation, select the program pattern number to execute. When a program pattern is not created, or when program operation is being performed, the program pattern number cannot be selected.

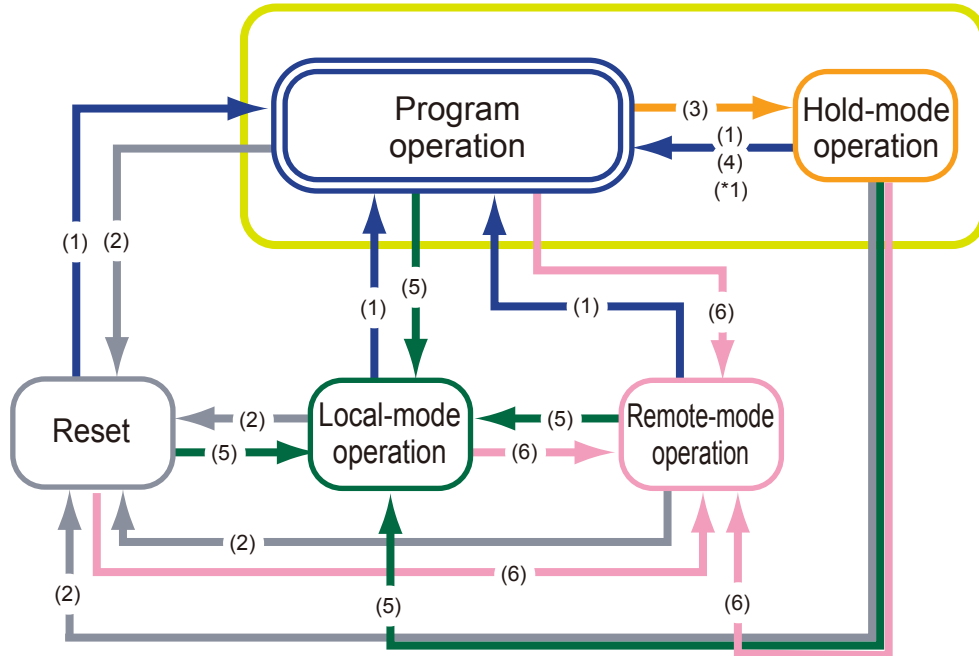
Selecting the program pattern number can be performed by any of the following:

- (1) PTN key (The PTN key action can be changed by a parameter)
- (2) Operation mode parameter
- (3) Contact input
- (4) Communication

▶ Selection by contact input: [12.1 Setting Contact Input Function](#)

## 6.6 Switching Operation Modes

### 6.6.1 Operation Display Switching Diagram



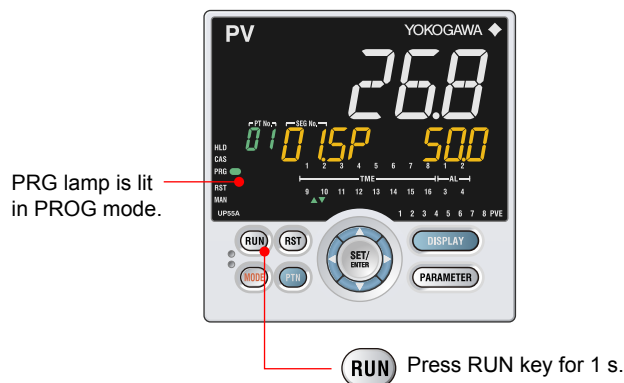
- (1) Press RUN key for 1 s.
- (2) Press RST key for 1 s.
- (3) Press MODE key, select HOLD=ON and press SET/ENT key.
- (4) Press MODE key, select HOLD=OFF and SET/ENT key.
- (5) Press MODE key, select LOC=ON and press SET/ENT key.
- (6) Press MODE key, select REM=ON and press SET/ENT key.

\*1: For another operation, when select ADV=ON and starts program operation. In this case, the segment is advanced.

## 6.6.2 Switching to PROG Operation

### Selecting by RUN Key

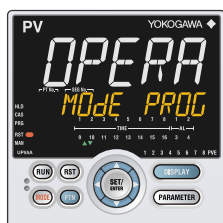
#### Setting Display



### Selecting by Operation Mode Parameter

#### Setting Display

Parameter Setting Display > Operation Display > **PARAMETER** key for **3 seconds** (to [MODE] Menu Display) > **SET/ENTER** key (The setting parameter is displayed.) > **Down arrow** key (The setting parameter is displayed.)



#### Setting Details

Parameter symbol	Name	Display level	Setting range	Menu symbol
<b>MODE</b>	Operation mode	EASY	RESET: Stop of program operation PROG: Start of program operation LOCAL: Start of local-mode operation REM: Start of remote-mode operation	MODE <b>Ope</b>

#### Description

Program pattern operation can be performed after selecting the program pattern number (except for 00).

Switching to PROG Operation can be performed by any of the following:

- (1) RUN key (Factory default: PROG)
- (2) Operation mode parameter
- (3) Contact input
- (4) Communication
- (5) MODE key (Can be used when the user function key is not set to "PROG".)

After switching is performed by the above (2) or (5), the display is switched to SP Display.

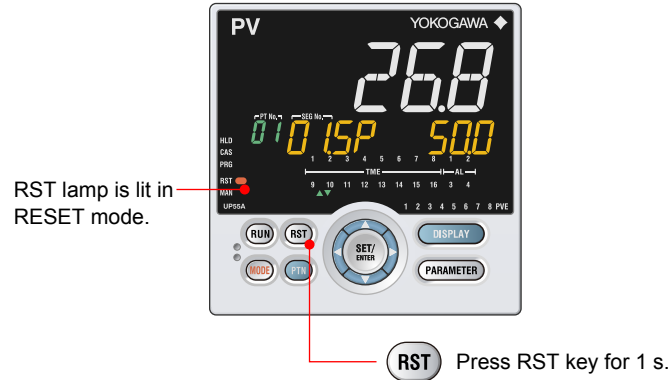
▶ [Switch by contact input: 12.1 Setting Contact Input Function](#)

## 6.6 Switching Operation Modes

### 6.6.3 Switching to RESET Operation

#### Selecting by RST Key

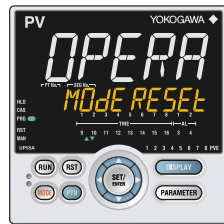
##### Setting Display



#### Selecting by Operation Mode Parameter

##### Setting Display

Parameter Setting Display Operation Display > **PARAMETER** key for **3 seconds** (to [MODE] Menu Display) > **SET/ENTER** key (The setting parameter is displayed.) > **Down arrow** key (The setting parameter is displayed.)



##### Setting Details

Parameter symbol	Name	Display level	Setting range	Menu symbol
<b>MODE</b>	Operation mode	EASY	RESET: Stop of program operation PROG: Start of program operation LOCAL: Start of local-mode operation REM: Start of remote-mode operation	MODE <b>Ope</b>

##### Description

Local operation and Remote operation are also stopped.

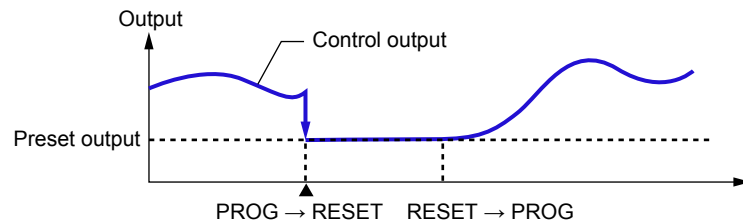
Switching to RESET can be performed by any of the following:

- (1) RST key
- (2) Operation mode parameter
- (3) Contact input
- (4) Communication
- (5) MODE key (Can be used when the user function key is not set to "RESET".)

After switching is performed by the above (2) or (5), the display is switched to SP Display.

- ▶ Switch by contact input: [12.1 Setting Contact Input Function](#)
- ▶ Switch by user function key: [13.2 Assigning Function to User Function Key](#)

Switch	Output action
PROG→RESET	The control output bumps.
RESET→PROG RESET→LOCAL RESET→REM	The control output does not bump (bumpless).



- ▶ Preset output value: 10.12.1 Setting Output Value in STOP Mode (Preset Output)

The PV event and time event are disabled in RESET mode (OFF).

#### Operation Display in RESET and RUN Modes

The preset output value is displayed in RESET mode.

When the zone PID selection parameter (ZON) is set to segment PID selection, the preset output value for the PID group number 1 is output. When the zone PID selection parameter (ZON) is set to other than segment PID selection, the preset output value for the PID group number for which zone control is performed is output. And when the zone PID selection parameter (ZON) is set to the PID number selection for local-mode operation, the PID parameter is selected by the PID number which is specified in the parameter L.PID (Local PID number selection).

#### Operation Display in RESET and PROG Modes in Heating/cooling Control

In RESET mode in Heating/cooling control, the display is as follows. The cooling-side preset output is displayed on the left and heating-side preset output is displayed on the right.

01C. 00H. 930

#### Lamp Status

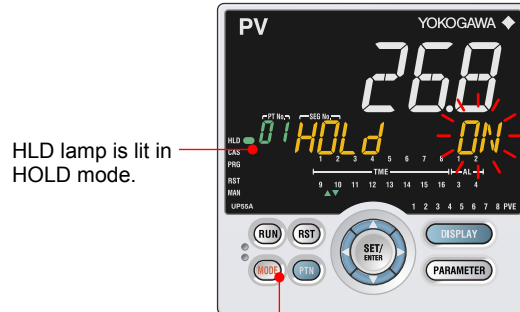
Status	RST lamp
Operation start (PROG)	Unlit
Operation Stop (RESET)	Lit

## 6.6 Switching Operation Modes

### 6.6.4 Enabling/Disabling Hold Mode of Program Operation

#### Selecting by MODE Key

##### Setting Display



HLD lamp is lit in HOLD mode.

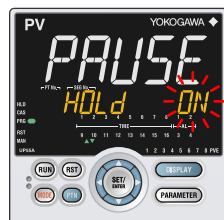
Each time you press the **MODE** key, Operation modes is switched.

- Display HOLD ON (blinking), and press the SET/ENTER key. HLD lamp is lit.
- Display HOLD OFF (blinking), and press the SET/ENTER key. HLD lamp is unlit.

#### Selecting by Operation Mode Parameter

##### Setting Display

Parameter Setting Display Operation Display > **PARAMETER** key for **3 seconds** (to [MODE] Menu Display) > **SET/ENTER** key (The setting parameter is displayed.) > **Down arrow** key (The setting parameter is displayed.)



##### Setting Details

Parameter symbol	Name	Display level	Setting range	Menu symbol
<b>HOLD</b>	Pause/cancel release of program operation	EASY	Display during program operation. ON: Pause OFF: Cancel release (Program operation restart)	MODE <b>Ope</b>

##### Description

HOLD switching can be performed during program operation.  
HOLD switching can be performed by any of the following:

- (1) MODE key
- (2) Operation mode parameter
- (3) Contact input
- (4) Communication

After switching is performed by the above (1) or (2), the display is switched to SP Display.

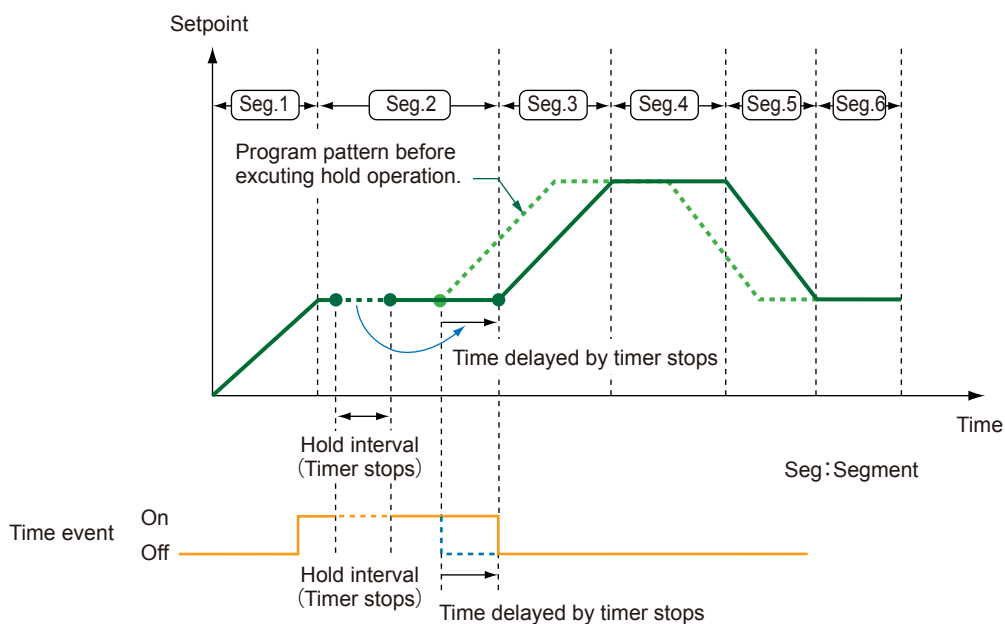
▶ [Switch by contact input: 12.1 Setting Contact Input Function](#)

The hold operation function allows pausing the progress of the program pattern. The hold operation stops the segment time and the time of the time event. As a result, the segment time and the time of the time event are extended by the amount of the holding time.

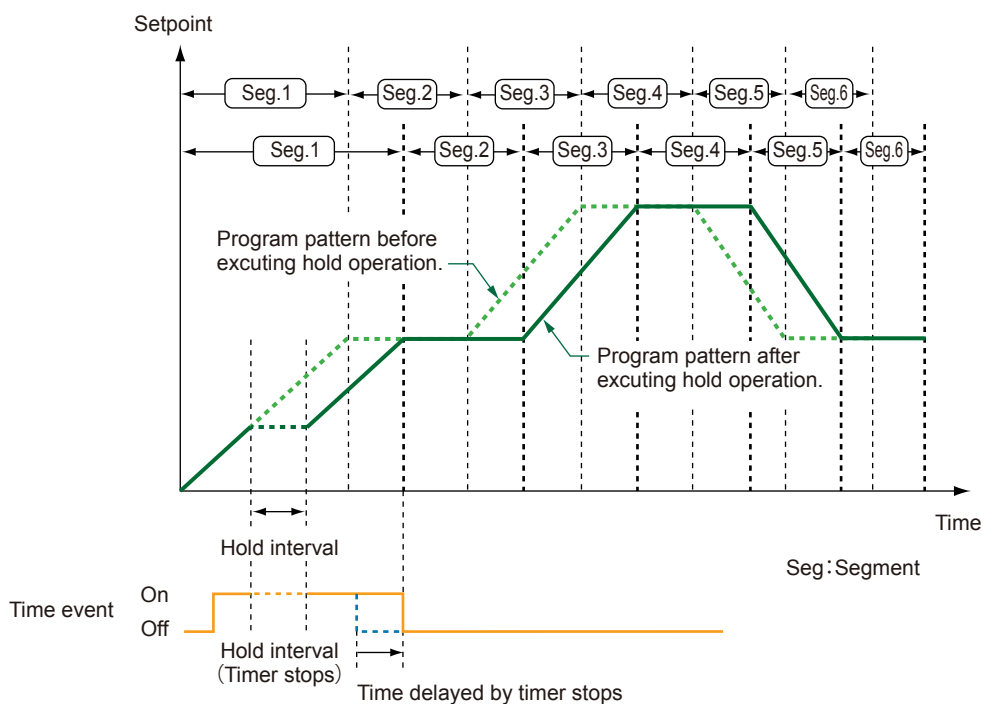
Releasing the hold state restarts the segment time and the time of the time event from the time when they were stopped. When the hold state is released, the action can be checked in the Deviation indicator (Program monitor display) on the front panel. Control during the hold operation is performed using the setpoint at the time when the hold operation starts. The time event keeps the state and the PV event continues the action at the time when the hold operation starts.

► 6.9 Changing SP, TSP, or Remaining Segment-time (R.TIM) in HOLD-mode

**Hold Operation in Soak Segment**



**Hold Operation in Ramp Segment**



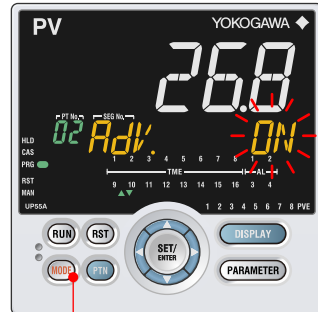


## 6.6 Switching Operation Modes

### 6.6.5 Executing Advance

#### Selecting by MODE Key

##### Setting Display

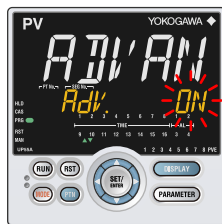


Each time you press the **MODE** key, Operation modes is switched. Display ADV ON (blinking), and press the SET/ENTER key.

#### Selecting by Operation Mode Parameter

##### Setting Display

Parameter Setting Display > Operation Display > **PARAMETER** key for **3 seconds** (to [MODE] Menu Display) > **SET/ENTER** key (The setting parameter is displayed.) > **Down arrow** key (The setting parameter is displayed.)



##### Setting Details

Parameter symbol	Name	Display level	Setting range	Menu symbol
<b>ADV.</b>	Advance of segment	EASY	OFF: - Display during program operation. Set as "ADV = ON" to advance from the current segment to the next segment.	MODE <b>Ope</b>

##### Description

Advance switching can be performed during program operation.

Advance switching can be performed by any of the following:

- (1) MODE key
- (2) Operation mode parameter
- (3) Contact input
- (4) Communication

After switching is performed by the above (1) or (2), the display is switched to SP Display.

► [Switch by contact input: 12.1 Setting Contact Input Function](#)

Executing Advance advances the program to the next segment, irrespective of the junction code (JC).

Advance is performed as follows depending on the segment to execute and the operating state.

- When executing Advance in the last segment:  
The program switches to Reset operation (when JC=CONT), Local operation, or Remote operation depending on the junction code (JC).
- When executing Advance in the repeat cycle end segment:  
The program performs a repeat operation.
- When executing Advance during the hold operation:  
The program releases the hold state and restarts program pattern operation from the next segment.

Executing Advance shortens the segment time of the segment for which operation is in progress and the time of the event.

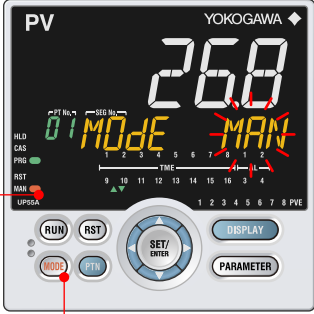
## 6.6 Switching Operation Modes

### 6.6.6 Switching between AUTO and MAN

#### Selecting by MODE Key

##### Setting Display

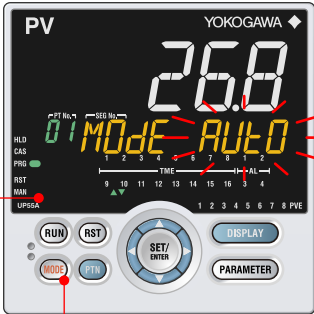
From Auto to Man



MAN lamp is lit in MAN mode. (The lamp is lit after the switching operation is completed.)

Each time you press the **MODE** key, Operation modes is switched. Display MODE MAN (blinking), and press the SET/ENTER key.

From Man to Auto



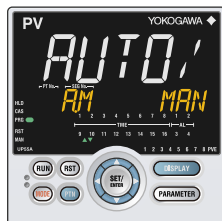
MAN lamp is unlit in MAN mode. (The lamp is unlit after the switching operation is completed.)

Each time you press the **MODE** key, Operation modes is switched. Display MODE AUTO (blinking), and press the SET/ENTER key.

#### Selecting by Operation Mode Parameter

##### Setting Display

Parameter Setting Display Operation Display > **PARAMETER** key for **3 seconds** (to [MODE] Menu Display) > **SET/ENTER** key (The setting parameter is displayed.) > **Down arrow** key (The setting parameter is displayed.)



##### Setting Details

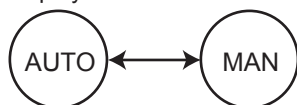
Parameter symbol	Name	Display level	Setting range	Menu symbol
<b>A.M</b>	AUTO/MAN switch	EASY	AUTO: Automatic mode MAN: Manual mode	MODE <b>Ope</b>

**Description**

AUTO/MAN switching can be performed by any of the following:

- (1) MODE key
- (2) Operation mode parameter
- (3) Contact input
- (4) Communication

When the above (1) or (2) is used to switch AUTO to MAN and MAN to AUTO, the display is switched to OUT Display and SP Display, respectively.



When the contact input (status) is ON, operation cannot be performed by keystroke or communication.

When the contact input is OFF, and the setting is switched by keystroke or communication, the last switching operation is performed.

- ▶ Switch by contact input: 12.1 Setting Contact Input Function
- ▶ Switch by user function key: 13.2 Assigning Function to User Function Key

Switch	Output action
AUTO→MAN	Holds the control output value from AUTO mode. The control output value can be bump to the manual preset output value by the setting of parameter MPO. The output value can be changed in manual mode.
MAN→AUTO	The control output value does not bump (bumpless). Does not work when Integral time (I) = OFF.

- ▶ Switch from AUTO to MAN, and MPON: 10.12.2 Setting Output Value When Switched to MAN Mode (Manual Preset Output)

**Operation Display in AUTO and MAN Modes**

“OUT” is displayed on Symbol display and “Output value” is displayed on Data display in MAN mode. (The OUT Display is shown.)

SP Display is shown in AUTO mode.

**Operation Display in AUTO and MAN Modes in Heating/cooling Control**

In MAN mode, the Display is as follows. Symbol “C” represents the cooling side and “H” represents the heating side. The value on the right of each symbol is the output value.

**Lamp Status**

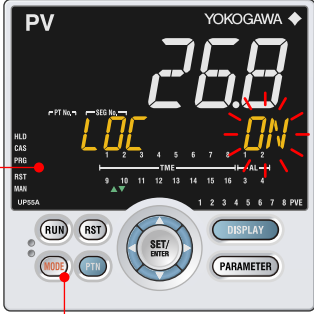
Status	MAN lamp
Automatic operation (AUTO)	Unlit
Manual operation (MAN)	Lit

## 6.6 Switching Operation Modes

### 6.6.7 Switching to Local Operation

#### Selecting by MODE Key

##### Setting Display



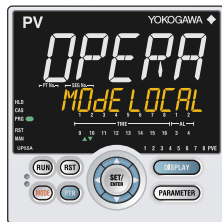
HLD, CAS, PRG, or RST lamp is unlit in LOC mode.  
(The lamp is unlit after the switching operation is completed.)

Each time you press the **MODE** key, Operation modes is switched.  
Display MODE LOC (blinking), and press the SET/ENTER key.

#### Selecting by Operation Mode Parameter

##### Setting Display

Parameter Setting Display > Operation Display > **PARAMETER** key for **3 seconds** (to [MODE] Menu Display) > **SET/ENTER** key (The setting parameter is displayed.) > **Down arrow** key (The setting parameter is displayed.)



##### Setting Details

Parameter symbol	Name	Display level	Setting range	Menu symbol
<b>MODE</b>	Operation mode	EASY	RESET: Stop of program operation PROG: Start of program operation LOCAL: Start of local-mode operation REM: Start of remote-mode operation	MODE <b>Ope</b>

##### Description

Local operation is controlled by the local target setpoint (LSP). The local event can be enabled, while the time event is disabled.

Switching to Local can be performed by any of the following:

- (1) MODE key
- (2) Operation mode parameter
- (3) Contact input
- (4) Communication

After switching is performed by the above (1) or (2), the display is switched to SP Display.

▶ [Switch by contact input: 12.1 Setting Contact Input Function](#)

### 6.6.8 Switching to Remote Operation

Selecting by MODE Key

Setting Display

HLD, CAS, PRG, or RST lamp is unlit in REM mode. (The lamp is unlit after the switching operation is completed.)

Each time you press the **MODE** key, Operation modes is switched. Display MODE REM (blinking), and press the SET/ENTER key.

Selecting by Operation Mode Parameter

Setting Display

Parameter Setting Display Operation Display > **PARAMETER** key for **3 seconds** (to [MODE] Menu Display) > **SET/ENTER** key (The setting parameter is displayed.) > **Down arrow** key (The setting parameter is displayed.)

Setting Details

Parameter symbol	Name	Display level	Setting range	Menu symbol
<b>MODE</b>	Operation mode	EASY	PROG: Start of program operation RESET: Stop of program operation LOCAL: Start of local-mode operation REM: Start of remote-mode operation	MODE <b>Ope</b>

Description

Remote operation is controlled by the remote setpoint (RSP). The local event can be enabled, while the time event is disabled.

Switching to Local can be performed by any of the following:

- (1) MODE key
- (2) Operation mode parameter
- (3) Contact input
- (4) Communication

After switching is performed by the above (1) or (2), the display is switched to SP Display.

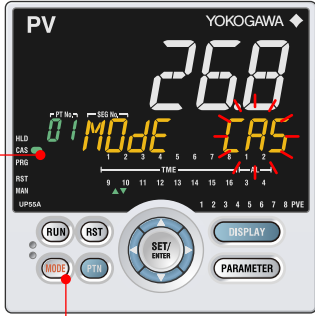
▶ Switch by contact input: 12.1 Setting Contact Input Function

6.6 Switching Operation Modes

6.6.9 Switching between Local (LSP) and Cascade

Selecting by MODE Key

Setting Display

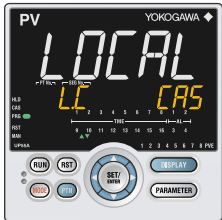


CAS lamp is lit in CAS mode. (The lamp is lit after operation right.)

Each time you press the **MODE** key, Operation modes is switched. Display MODE CAS (blinking), and press the SET/ENTER key.

Selecting by Operation Mode Parameter

Setting Display



Parameter Setting Display Operation Display > **PARAMETER** key for **3 seconds** (to [MODE] Menu Display) > **SET/ENTER** key (The setting parameter is displayed.) > **Down arrow** key (The setting parameter is displayed.)

Setting Details

Parameter symbol	Name	Display level	Setting range	Menu symbol
<b>L.C</b>	Local (LSP) / cascade switch	EASY	LSP: Local (LSP) CAS: Cascade	MODE <b>Ope</b>

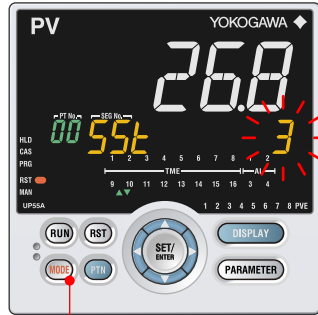
Description

Local (LSP) and Cascade can be switched when the control mode is set to cascade control.  
When the switching is completed using the above method, the screen is switched to SP Display.

## 6.7 Selecting Start-of-program Pattern Number

### Selecting by MODE Key

#### Setting Display



Every time you press the MODE key, the operation mode is switched.  
Display SST (start-of-program segment number), and press the SET/ENTER key.

### Selecting by Operation Mode Parameter

#### Setting Display

Parameter Setting Display > Operation Display > **PARAMETER** key for **3 seconds** (to [MODE] Menu Display) > **SET/ENTER** key (The setting parameter is displayed.) > **Down arrow** key (The setting parameter is displayed.)



#### Setting Details

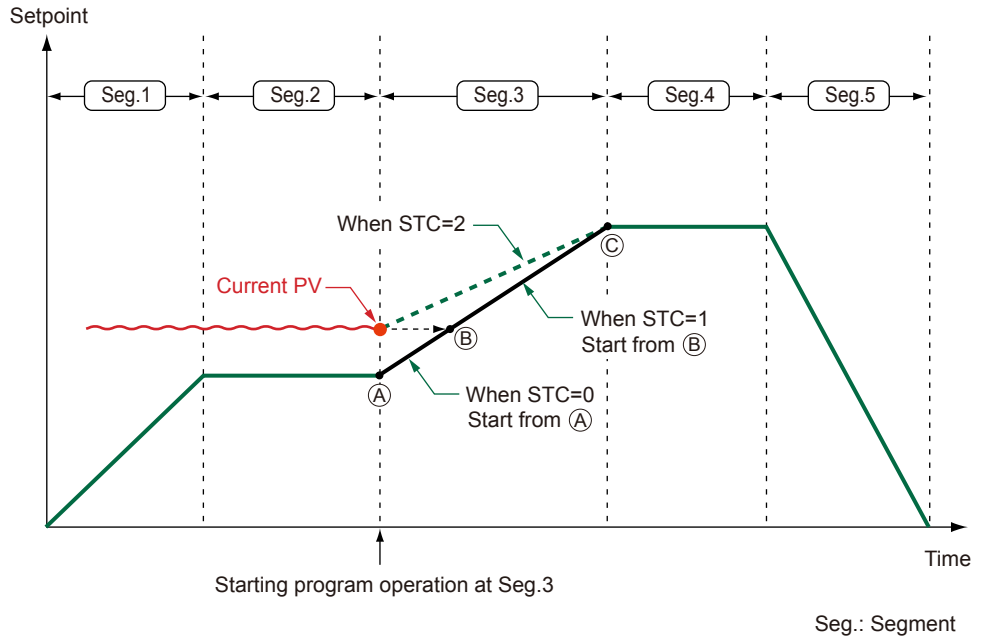
Parameter symbol	Name	Display level	Setting range	Menu symbol
SST	Start-of-program segment number	EASY	1 to 99	MODE <b>Ope</b>



## 6.7 Selecting Program Pattern Number

### Description

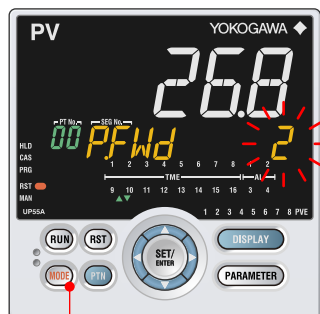
Program operation starts from the set segment number.  
When the operation mode is switched to reset (RST), local (LOC), or remote (REM) operation, or when power is turned on, the segment number automatically returns to 1.



## 6.8 Fast-forwarding Program Pattern

### Performing by MODE Key

#### Setting Display

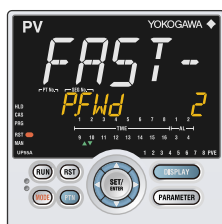


Every time you press the MODE key, the operation mode is switched. Display P.FWD (fast-forwarding), and press the SET/ENTER key.


### Performing by Operation Mode Parameter

#### Setting Display

Parameter Setting Display > Operation Display > **PARAMETER** key for **3 seconds** (to [MODE] Menu Display) > **SET/ENTER** key (The setting parameter is displayed.) > **Down arrow** key (The setting parameter is displayed.)



#### Setting Details

Parameter symbol	Name	Display level	Setting range	Menu symbol
P.FWD	Fast-forwarding of program operation	EASY	1: Normal, 2: Twice, 5: Five times, 10: Ten times	MODE 

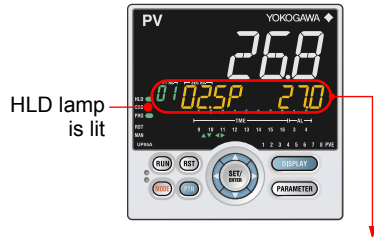
#### Description

This function is used to make sure that the program pattern is set correctly. It fast forwards only the segment time and the time of the time event. When the fast-forwarding function is executed, when the operation mode is switched to local, remote, or reset operation, or when power is turned on, P.FWD returns to 1 (normal). Other functions (alarm delay timer, PV velocity alarm, output velocity limiter, and ladder program time) work at normal speed.

## 6.9 Changing SP, TSP, or Remaining Segment-time (R.TIM) in HOLD-mode

### Changing SP in HOLD Operation

#### Operation



0102SP 270

1. Display the SP Display, switch to HOLD mode. See "6.6.4 Enabling/Disabling Hold Mode of Program Operation."

0102SP 270

2. Press the SET/ENTER key to move to the setting mode (the setpoint blinks).

0102SP 270

3. Press the Left arrow key to move one digit to the left. (Press the Right arrow key to move one digit to the right.)

0102SP 280

4. Press the Up or Down arrow key to change the setpoint. Press the Up arrow key when 9 is displayed to move one digit to the left. Press the Down arrow key when 0 is displayed to move one digit to the right.

0102SP 280

5. Press the SET/ENTER key to register the setpoint.

The figure right is displayed while the right arrow key is held down on SP Display.

(1) The number of segments included in the selected program pattern.

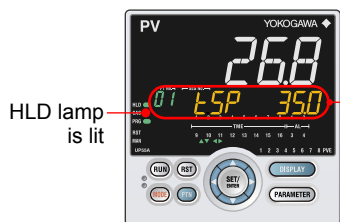
(2) The segment number for which operation is in progress.

0102.15 270

(2) (1)

Changing TSP in HOLD Operation

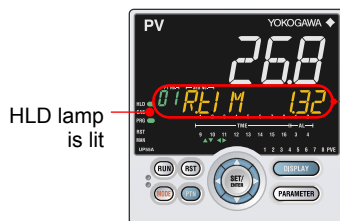
**Operation**



1. Display the TSP Display, switch to HOLD mode. See “6.6.4 Enabling/Disabling Hold Mode of Program Operation.”
2. Press the SET/ENTER key to move to the setting mode (the setpoint blinks).
3. Press the Left arrow key to move one digit to the left. (Press the Right arrow key to move one digit to the right.)
4. Press the Up or Down arrow key to change the setpoint. Press the Up arrow key when 9 is displayed to move one digit to the left. Press the Down arrow key when 0 is displayed to move one digit to the right.
5. Press the SET/ENTER key to register the setpoint.

Changing R.TIM in HOLD Operation

**Operation**



1. Display the Remaining Segment-time Display, switch to HOLD mode. See “6.6.4 Enabling/Disabling Hold Mode of Program Operation.”
2. Press the SET/ENTER key to move to the setting mode (the setpoint blinks).
3. Press the Left arrow key to move one digit to the left. (Press the Right arrow key to move one digit to the right.)
4. Press the Up or Down arrow key to change the setpoint. Press the Up arrow key when 9 is displayed to move one digit to the left. Press the Down arrow key when 0 is displayed to move one digit to the right.
5. Press the SET/ENTER key to register the setpoint.

## 6.9 Changing SP, TSP, or Remaining Segment-time (R.TIM) in HOLD-mode

---

### Description

The current setpoint (hold SP), final target setpoint (TSP), and remaining segment time can be changed during the hold operation.

The value changed during the hold operation is temporary. When the program is operated again, it is operated according to the original program pattern. To operate the program using the changed value, the original program pattern needs to be changed.

The following shows conditions that can be changed during the hold operation.

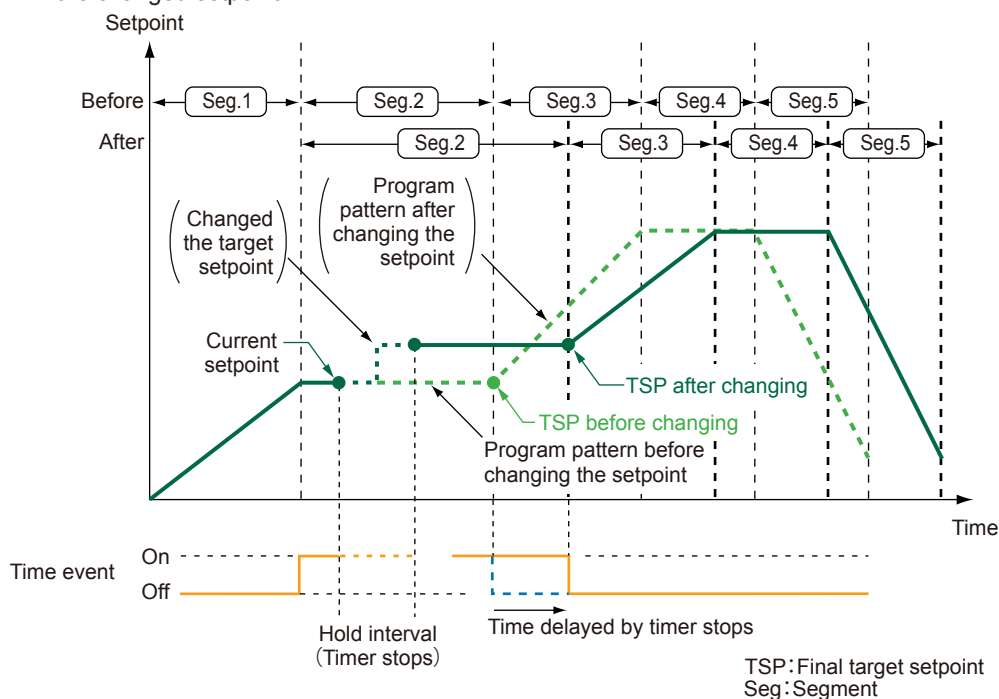
Segment setting method (SEG.T)	Segment time setting		Segment ramp-rate setting	
	Soak	Ramp	Soak	Ramp
Hold SP	√	√	N/A	N/A
Final target setpoint	√	√	N/A	N/A
Remaining segment-time	√	√	√	N/A

√: Available, N/A: Not available

When the segment ramp-rate setting is selected in the segment setting method (SEG.T), the hold operation is enabled, while the hold SP and final target setpoint (TSP) cannot be changed.

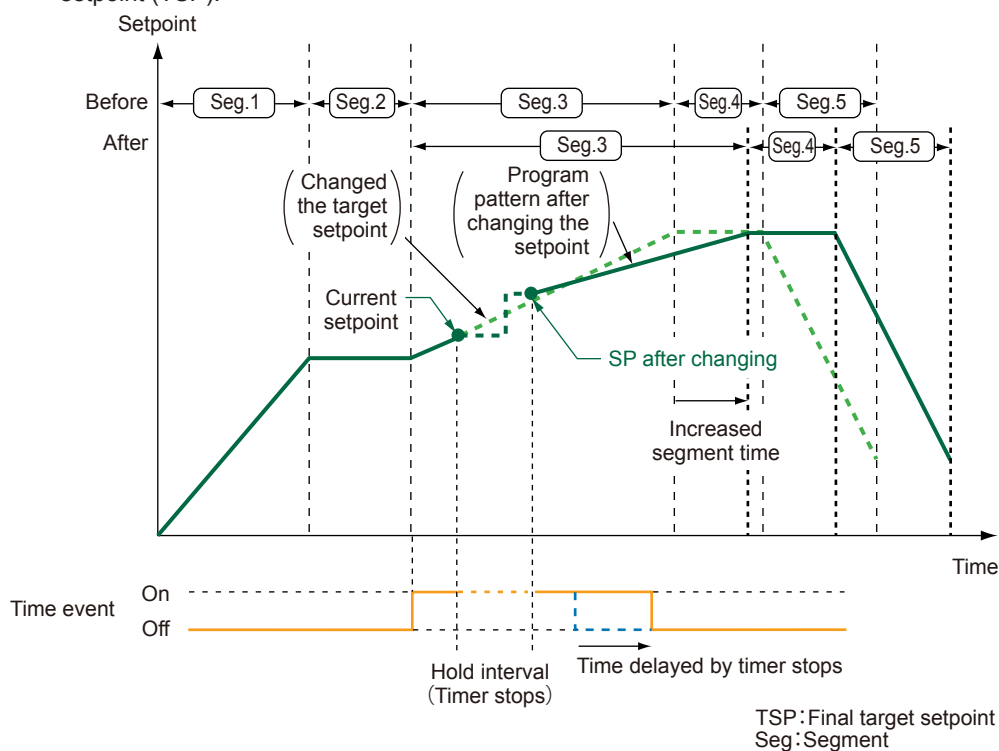
**Modifying Target Setpoint in Soak Segment**

When the hold SP is changed in the soak segment, the final target setpoint (TSP) is also changed. When the hold state is released, the program pattern operation restarts from the changed setpoint.



**Modifying Target Setpoint in Ramp Segment**

When the hold SP is changed in the ramp segment and the hold state is released, the program pattern operation restarts from the changed setpoint towards the final target setpoint (TSP).

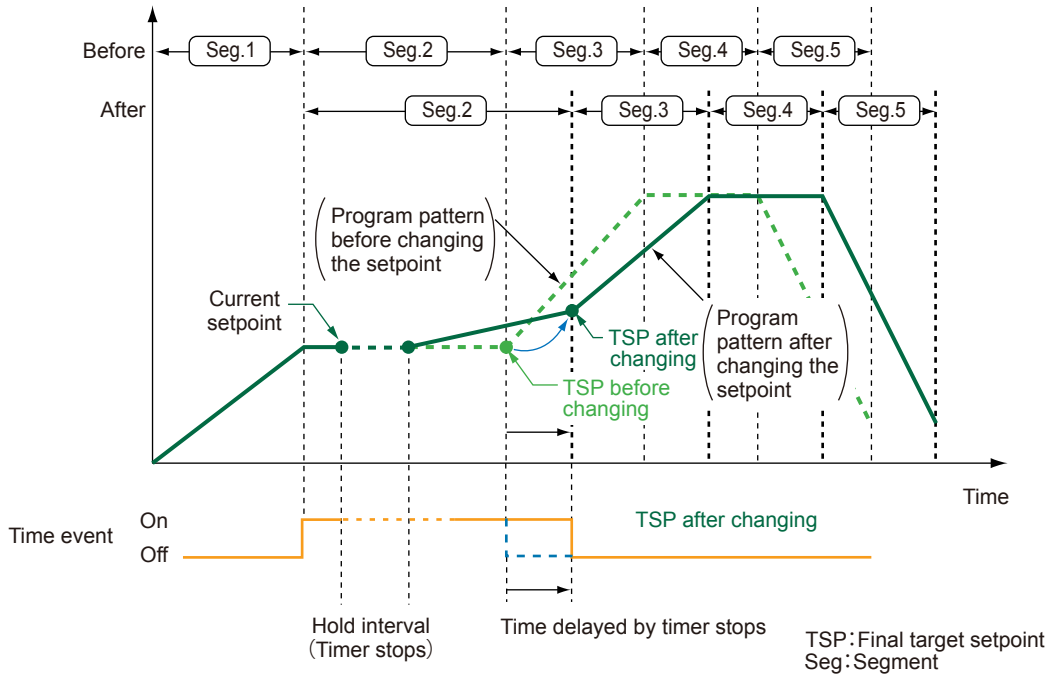


The hold SP is set to the same value as TSP by SET/ENTER key, and when the hold SP is changed again, TSP is changed. (Same as Modifying Target Setpoint in Soak Segment)

**6.9 Changing SP, TSP, or Remaining Segment-time (R.TIM) in HOLD-mode**

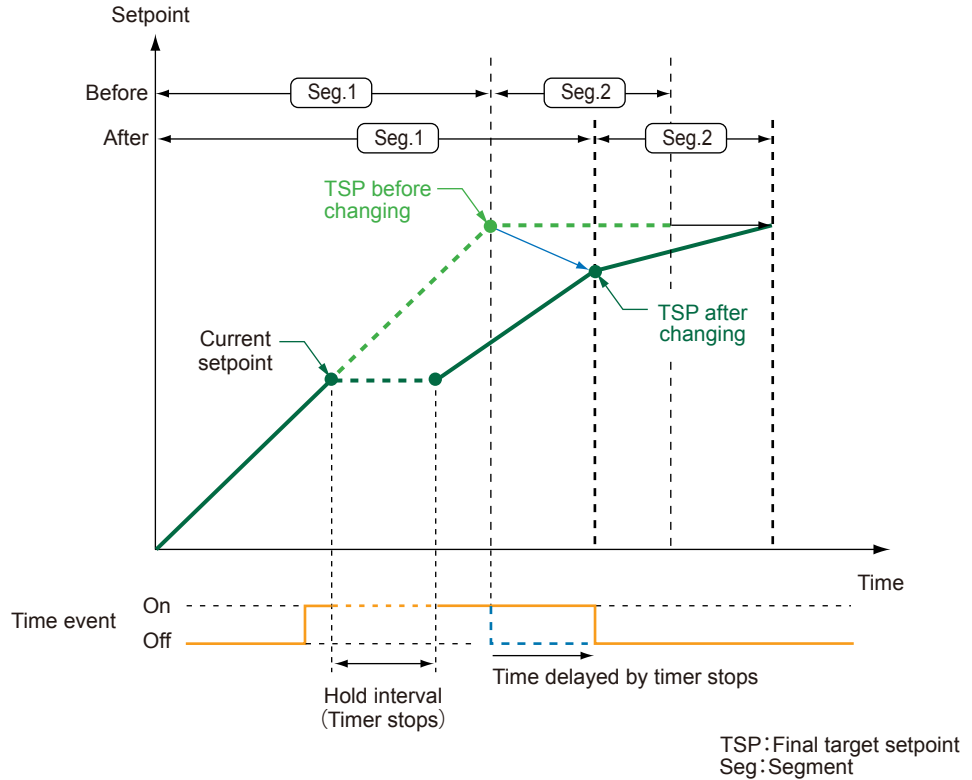
**Modifying Final Target Setpoint (TSP) in Soak Segment**

The final target setpoint (TSP) can be changed in the soak segment. When the hold state is released, the program pattern operation restarts towards the changed final target setpoint (TSP).  
Setpoint



**Modifying Final Target Setpoint (TSP) in Ramp Segment**

When the final target setpoint (TSP) is changed in the ramp segment and the hold state is released, the program pattern operation restarts towards the changed final target setpoint (TSP).  
Setpoint

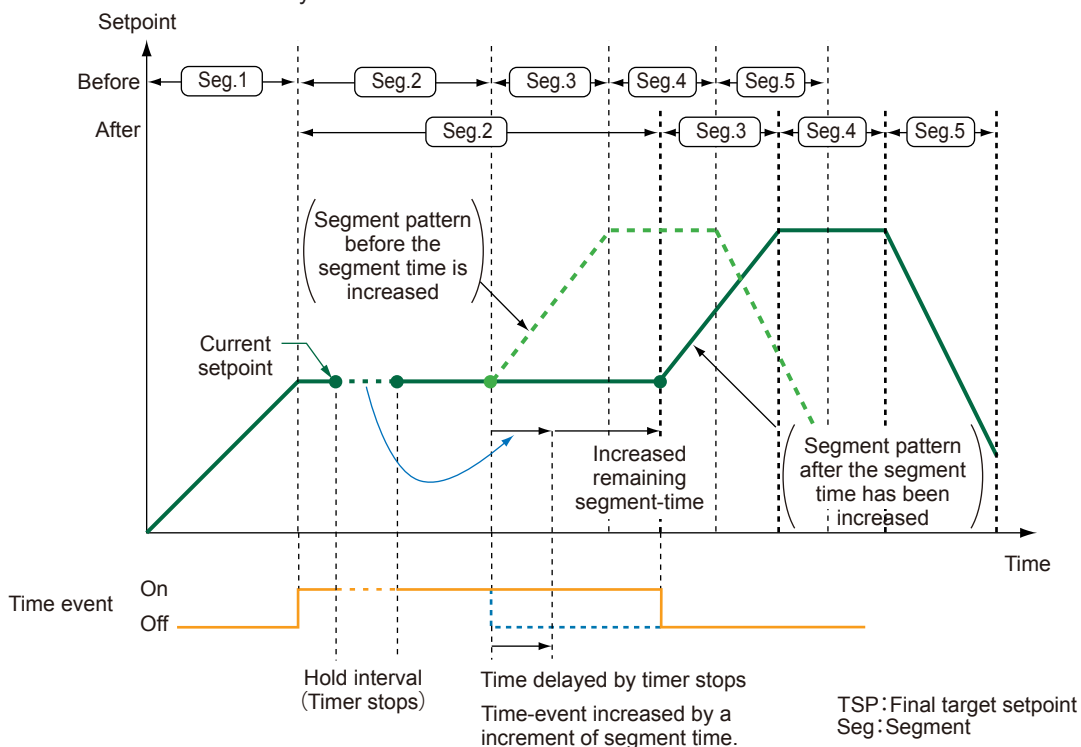


**Decreasing Segment-time in Soak Segment**

The remaining segment time from the time when the hold state is released can be changed during the hold operation.

When the remaining segment time is changed in the soak segment and the hold state is released, the program pattern operation restarts from the changed segment time.

When the segment time is increased, the segment time and the time of the time event are extended by the increased amount of time.





## 6.9 Changing SP, TSP, or Remaining Segment-time (R.TIM) in HOLD-mode

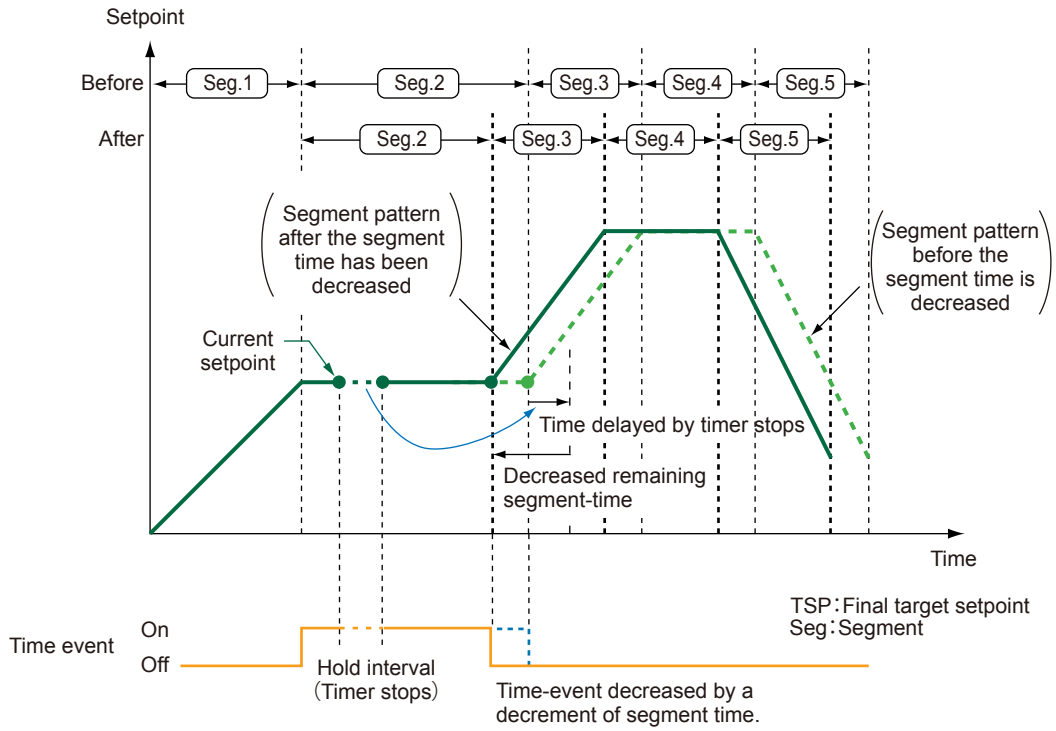
### Increasing Segment-time in Soak Segment

The remaining segment time from the time when the hold state is released can be changed during the hold operation.

When the remaining segment time is changed in the soak segment and the hold state is released, the program pattern operation restarts from the changed segment time.

When the segment time is decreased, the segment time and the time of the time event are shortened by the decreased amount of time.

When the on time or off time of the time event is larger than the changed remaining segment time, the program works according to the changed remaining segment time.



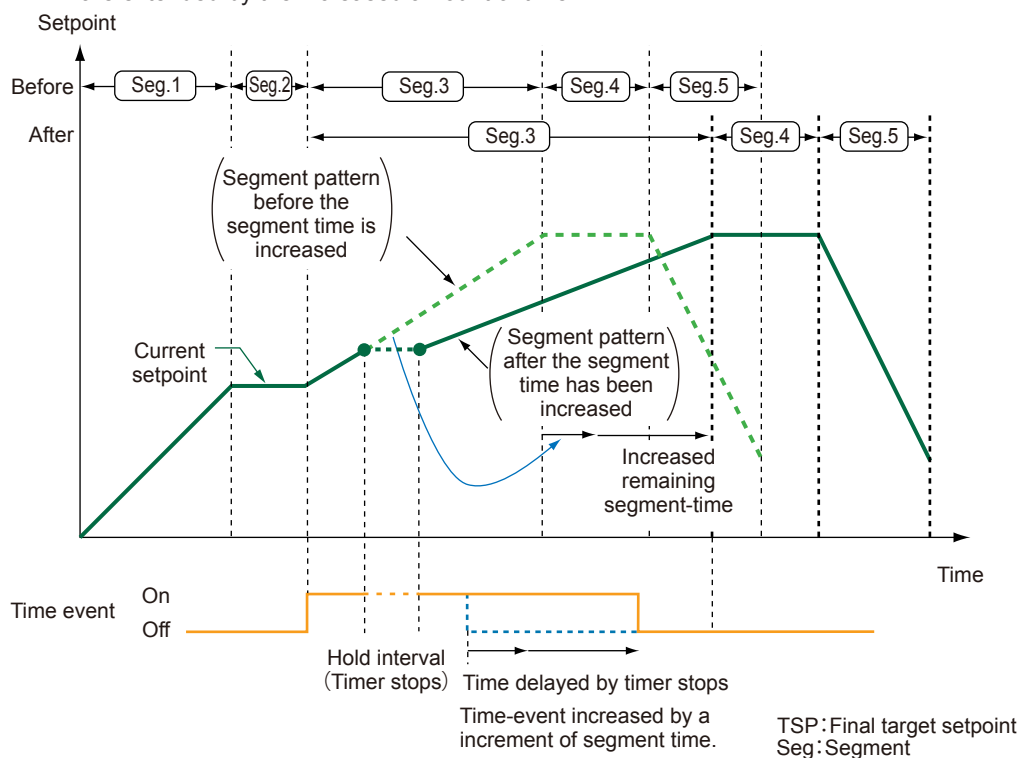
**Decreasing Segment-time in Ramp Segment**

The remaining segment time from the time when the hold state is released can be changed during the hold operation.

However, the ramp-rate for the changed program setpoint changes.

When the remaining segment time is changed in the ramp segment and the hold state is released, the program pattern operation restarts from the changed segment time.

When the segment time is increased, the segment time and the time of the time event are extended by the increased amount of time.



**Increasing Segment-time in Ramp Segment**

The remaining segment time from the time when the hold state is released can be changed during the hold operation.

However, the ramp-rate for the changed program setpoint changes.

When the remaining segment time is changed in the ramp segment and the hold state is released, the program pattern operation restarts from the changed segment time.

When the segment time is decreased, the segment time and the time of the time event are shortened by the decreased amount of time.

---

## 6.10 Changing Program Pattern during Program Operation

### Description

The program pattern can be changed during the program operation in Program Parameter Setting Display.

Unlike changing during the hold operation, changing the program pattern in Program Parameter Setting Display saves the changed setpoint. However, even if the parameter of the segment in process is changed, it is not reflected in operation. It is reflected from the next operation.

In hold mode operation, it is reflected when TSP of segment is changed.

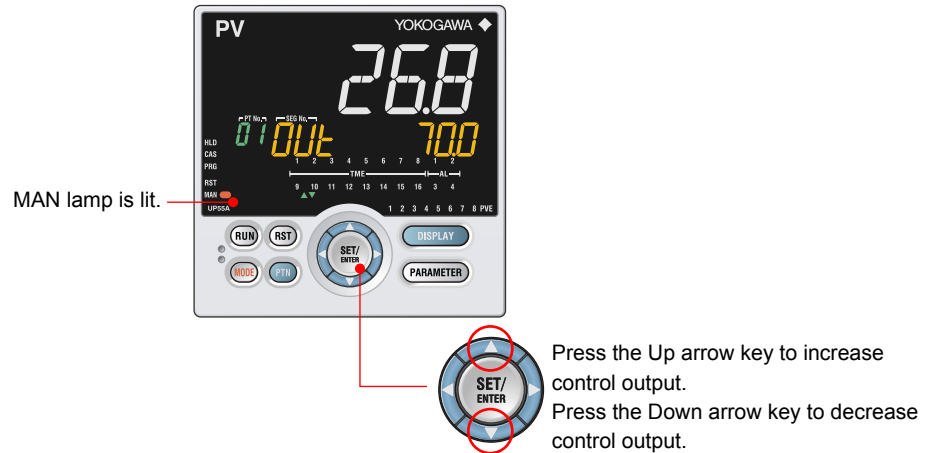
The change of the Hold-SP is reflected after release of the HOLD-mode.

▶ [Changing Hold SP: 6.9 Changing SP, TSP, or Remaining Segment-time \(R.TIM\) in HOLD-mode](#)

The program pattern cannot be changed via communication during the program operation.

## 6.11 Manipulating Control Output during Manual Operation

### Operation



In Heating/cooling control, press the Up arrow key to decrease cooling-side control output and to increase heating-side control output; press the Down arrow key to increase cooling-side control output and to decrease heating-side control output.

### Description

In MAN mode, the control output is manipulated by direct key operation. (The value changed using the Up or Down arrow key is output as is.) Manipulation of the control output is not possible in RESET mode (the RST lamp is lit). Output manipulation differs depending on the ON or OFF setting of the control output limiter (OH, OL).

▶ [10.4 Disabling Output Limiter in MAN mode](#)

#### OUT Display



Feedback input value is displayed in Position proportional control.

#### Heating/cooling OUT Display

The heating/cooling control output is manipulated simultaneously on both the heating and cooling sides.

In MAN mode, the display is as follows. The symbol "C" represents the cooling side, and "H" the heating side. The value on the right of each symbol is the output value.



When the control output low limit is set to "SD" while the control output type is 4 to 20 mA, the control output value can be lowered down to 0 mA.

▶ [10.6 Reducing 4-20 mA Current Output to 0 mA \(Tight Shut Function\)](#)

---

## 6.12 Releasing On-State (Latch) of Alarm Output

### Description

Alarm latch can be released by any of the following.

- (1) User function key (RUN, RST, PTN, MODE)
- (2) Communication
- (3) Contact input

For the switching operation by using the above, the last switching operation is performed.

Releasing the alarm latch function releases all of the latched alarm outputs.

By factory default, the function is not assigned to the user function key and contact input.

Assign and use the function in accordance with the reference sections below.

- ▶ [Release by user function key: 13.2 Assigning Function to User Function Key](#)
- ▶ [Release by contact input: 12.1 Setting Contact Input Function](#)
- ▶ [Release via communication: UTAdvanced Series Communication Interface User's Manual](#)

# 7.1 Setting Functions of PV Input, Remote Input, and Auxiliary Analog Input

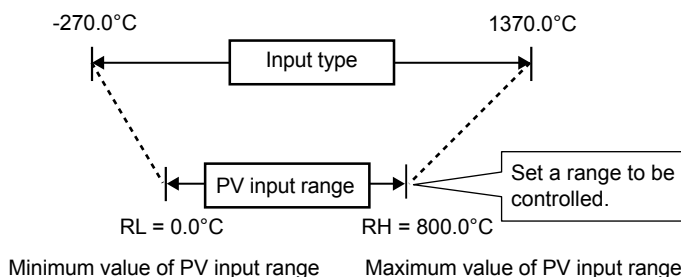
## 7.1.1 Setting Input Type, Unit, Range, Scale, and Decimal Point Position

### Description

The figure below describes the case of PV input. The remote input and auxiliary analog input can be set in the same way.

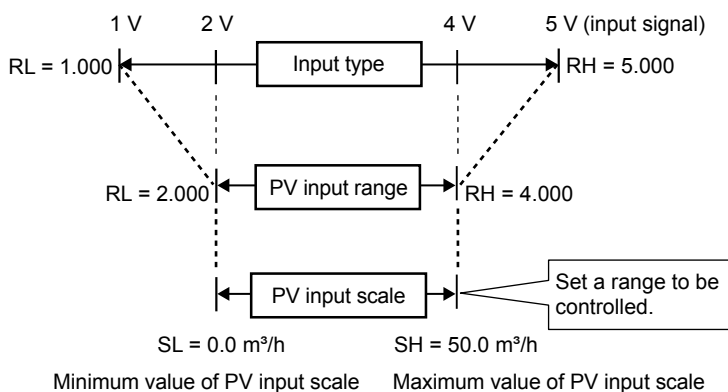
#### Example of Temperature Input

The figure below is an example of setting Type K thermocouple and a measurement range of 0.0 to 800.0 °C.



#### Example of Voltage and Current Inputs

The figure below is an example of setting 2-4 V DC and a scale of 0.0 to 50.0 m³/h.



When using 1-5 V DC signal as is, set RH = 5.000 V, RL = 1.000 V, SDP=1, and SH = 50.0, and SL=0.0.

## 7.1 Setting Functions of PV Input, Remote Input, and Auxiliary Analog Input

### Setting Details

Parameter symbol	Name	Display level	Setting range	Menu symbol
IN	PV input type	EASY	OFF: Disable K1: -270.0 to 1370.0 °C / -450.0 to 2500.0 °F K2: -270.0 to 1000.0 °C / -450.0 to 2300.0 °F K3: -200.0 to 500.0 °C / -200.0 to 1000.0 °F J: -200.0 to 1200.0 °C / -300.0 to 2300.0 °F T1: -270.0 to 400.0 °C / -450.0 to 750.0 °F T2: 0.0 to 400.0 °C / -200.0 to 750.0 °F B: 0.0 to 1800.0 °C / 32 to 3300 °F S: 0.0 to 1700.0 °C / 32 to 3100 °F R: 0.0 to 1700.0 °C / 32 to 3100 °F N: -200.0 to 1300.0 °C / -300.0 to 2400.0 °F E: -270.0 to 1000.0 °C / -450.0 to 1800.0 °F L: -200.0 to 900.0 °C / -300.0 to 1600.0 °F U1: -200.0 to 400.0 °C / -300.0 to 750.0 °F U2: 0.0 to 400.0 °C / -200.0 to 1000.0 °F W: 0.0 to 2300.0 °C / 32 to 4200 °F (Note1) PL2: 0.0 to 1390.0 °C / 32.0 to 2500.0 °F P2040: 0.0 to 1900.0 °C / 32 to 3400 °F WRE: 0.0 to 2000.0 °C / 32 to 3600 °F JPT1: -200.0 to 500.0 °C / -300.0 to 1000.0 °F JPT2: -150.0 to 150.0 °C / -200.0 to 300.0 °F PT1: -200.0 to 850.0 °C / -300.0 to 1560.0 °F PT2: -200.0 to 500.0 °C / -300.0 to 1000.0 °F PT3: -150.0 to 150.0 °C / -200.0 to 300.0 °F 0.4-2V: 0.400 to 2.000 V 1-5V: 1.000 to 5.000 V 4-20: 4.00 to 20.00 mA 0-2V: 0.000 to 2.000 V 0-10V: 0.00 to 10.00 V 0-20 : 0.00 to 20.00 mA -1020: -10.00 to 20.00 mV 0-100: 0.0 to 100.0 mV	PV <b>Set</b>
	RSP remote input type (Note2)	EASY	0.4-2V: 0.400 to 2.000 V	RSP <b>Set</b>
	AIN2 aux. analog input type	EASY	1-5V: 1.000 to 5.000 V 0-2V: 0.000 to 2.000 V	AIN2 <b>Set</b>
	AIN4 aux. analog input type	EASY	0-10V: 0.00 to 10.00 V 0-125: 0.000 to 1.250 V	AIN4 <b>Set</b>
UNIT	PV input unit	EASY	-: No unit	PV <b>Set</b>
	RSP remote input unit	EASY	C: Degree Celsius	RSP <b>Set</b>
	AIN2 aux. analog input unit	EASY	-: No unit --: No unit	AIN2 <b>Set</b>
	AIN4 aux. analog input unit	EASY	---: No unit F: Degree Fahrenheit	AIN4 <b>Set</b>

Note1: W: W-5% Re/W-26% Re(Hoskins Mfg. Co.). ASTM E988  
WRE: W97Re3-W75Re25

Note2: Standart model: For remote input with the optional suffix code /DR, RSP remote input type is same as PV input type.

Detailed model: When the optional suffix code /U1 is specified, RSP remote input type is same as PV input type.

## 7.1 Setting Functions of PV Input, Remote Input, and Auxiliary Analog Input

(Continued)

Parameter symbol	Name	Display level	Setting range	Menu symbol
<b>RH</b> (Physical quantity)	Maximum value of PV input range	EASY	Depends on the input type. - For temperature input - Set the temperature range that is actually controlled. (RL<RH) - For voltage / current input - Set the range of a voltage / current signal that is applied. The scale across which the voltage / current signal is actually controlled should be set using the maximum value of input scale (SH) and minimum value of input scale (SL). (Input is always 0% when RL = RH.)	PV <b>Set</b>
	Maximum value of RSP remote input range	EASY		RSP <b>Set</b>
	Maximum value of AIN2 aux. analog input range	EASY		AIN2 <b>Set</b>
	Maximum value of AIN4 aux. analog input range	EASY		AIN4 <b>Set</b>
<b>RL</b> (Physical quantity)	Minimum value of PV input range	EASY	Same as RH	PV <b>Set</b>
	Minimum value of RSP remote input range	EASY		RSP <b>Set</b>
	Minimum value of AIN2 aux. analog input range	EASY		AIN2 <b>Set</b>
	Minimum value of AIN4 aux. analog input range	EASY		AIN4 <b>Set</b>
<b>SDP</b> (Scaling)	PV input scale decimal point position	EASY	0: No decimal place 1: One decimal place 2: Two decimal places 3: Three decimal places 4: Four decimal places	PV <b>Set</b>
	RSP remote input scale decimal point position	EASY		RSP <b>Set</b>
	AIN2 aux. analog input scale decimal point position	EASY		AIN2 <b>Set</b>
	AIN4 aux. analog input scale decimal point position	EASY		AIN4 <b>Set</b>
<b>SH</b> (Scaling)	Maximum value of PV input scale	EASY	-19999 to 30000, (SL<SH),   SH - SL   ≤ 30000	PV <b>Set</b>
	Maximum value of RSP remote input scale	EASY		RSP <b>Set</b>
	Maximum value of AIN2 aux. analog input scale	EASY		AIN2 <b>Set</b>
	Maximum value of AIN4 aux. analog input scale	EASY		AIN4 <b>Set</b>



## 7.1 Setting Functions of PV Input, Remote Input, and Auxiliary Analog Input

Parameter symbol	Name	Display level	Setting range	Menu symbol
<b>SL</b> (Scaling)	Minimum value of PV input scale	EASY	-19999 to 30000, (SL<SH),   SH - SL   ≤ 30000	PV <b>Set</b>
	Minimum value of RSP remote input range	EASY		RSP <b>Set</b>
	Minimum value of AIN2 aux. analog input scale	EASY		AIN2 <b>Set</b>
	Minimum value of AIN4 aux. analog input scale	EASY		AIN4 <b>Set</b>

Note 1: For remote input with the optional suffix code /DR, setting range for RSP remote input type is same as that for PV input type.

When the optional suffix code /U1 is specified, RSP remote input type is same as PV input type.

Note 2: When each parameter is displayed, the terminal area (E1 to E4) is displayed on Group display according to the suffix code and optional suffix code.

IN, UNIT, RH, and RL described above are the parameters to be used for processing before the input ladder calculation program.

The following parameters are used for processing after the input ladder calculation program.

Parameter symbol	Name	Display level	Setting range	Menu symbol
<b>P.UNI</b>	Control PV input unit	STD	-: No unit C: Degree Celsius -: No unit - -: No unit - - -: No unit F: Degree Fahrenheit	MPV <b>Set</b>
<b>P.DP</b>	Control PV input decimal point position		0: No decimal place 1: One decimal place 2: Two decimal places 3: Three decimal places 4: Four decimal places	
<b>P.RH</b>	Maximum value of control PV input range		-19999 to 30000, (P.RL<P.RH),   P.RH - P.RL   ≤ 30000	
<b>P.RL</b>	Minimum value of control PV input range			

Note1: In Cascade control, the LP2 lamp is lit while the Loop-2 parameter is displayed.

## 7.1.2 Setting Burnout Detection for Input

**Description**

The input value when input burnout occurs can be determined.

The input value is 105.0% of the input range when the upscale is set, and -5.0% of the input range when the downscale is set.

Burnout detection is activated for TC, RTD, and standard signal (0.4–2 V or 1–5 V).

For standard signal, burnout is determined to have occurred if it is 0.1 V or less for the range of 0.4–2 V and 1–5V, or if it is 0.4 mA or less for the range of 4–20 mA.

When input burnout occurs, the error preset output (EPO) is output as control output.

- ▶ [Input error preset output: 10.12.3 Setting Output Value When Error Occurs \(Input Error Preset Output\)](#)

**Setting Details**

Parameter symbol	Name	Display level	Setting range	Menu symbol
BSL	PV input burnout action	STD	OFF: Disable UP: Upscale DOWN: Downscale	PV <b>Set</b>
	RSP remote input burnout action	STD		RSP <b>Set</b>
	AIN2 aux. analog input burnout action	STD		AIN2 <b>Set</b>
	AIN4 aux. analog input burnout action	STD		AIN4 <b>Set</b>

Note 1: When each parameter is displayed, the terminal area (E1 to E4) is displayed on Group display according to the suffix code and optional suffix code.

### 7.1.3 Setting Reference Junction Compensation (RJC) or External Reference Junction Compensation (ERJC)

**Description**

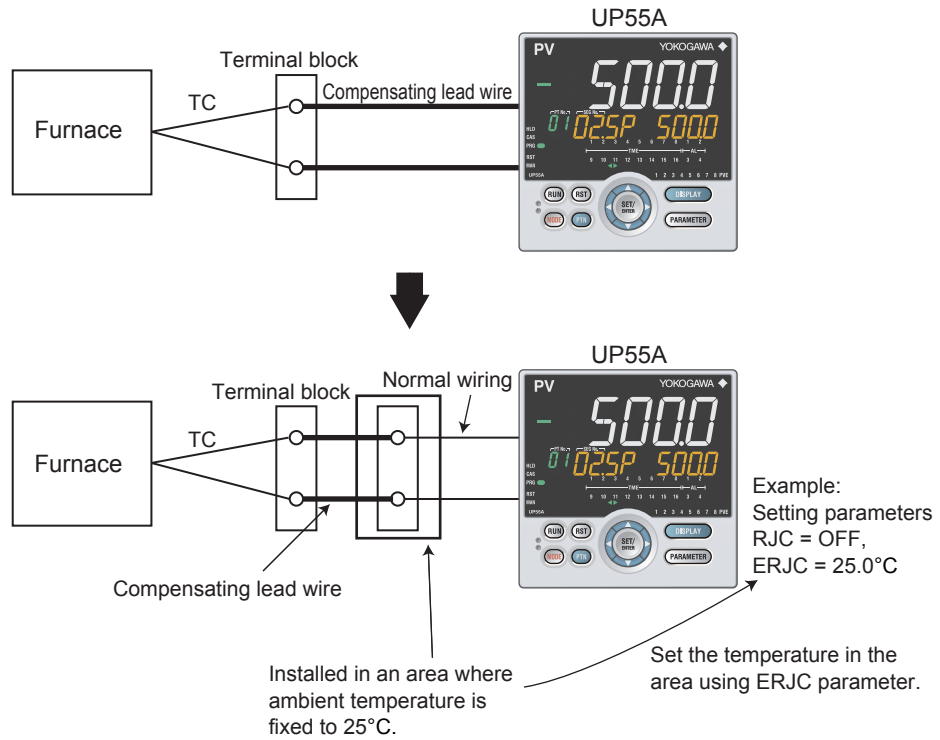
**Reference Junction Compensation (RJC)**

When TC input is selected, presence/absence of input reference junction compensation can be set.

Usually input values are compensated with the RJC function provided for the controller. However, if it is necessary to rigorously compensate the values with a device other than the function of the controller, for example with a zero-compensator, the RJC function of the controller can be turned off.

**External Reference Junction Compensation (ERJC)**

For TC input, a temperature compensation value for external device can be set. The external RJC can be used only when RJC = OFF.



**Setting Details**

Parameter symbol	Name	Display level	Setting range	Menu symbol
RJC	PV input reference junction compensation	PRO	OFF: RJC OFF ON: RJC ON	PV <b>Set</b>
	RSP remote input reference junction compensation	PRO		RSP <b>Set</b>
ERJC	PV input external RJC setpoint	PRO	-10.0 to 60.0°C	PV <b>Set</b>
	RSP remote input external RJC setpoint	PRO		RSP <b>Set</b>

Note 1: When each parameter is displayed, the terminal area (E1 to E4) is displayed on Group display according to the suffix code and optional suffix code.

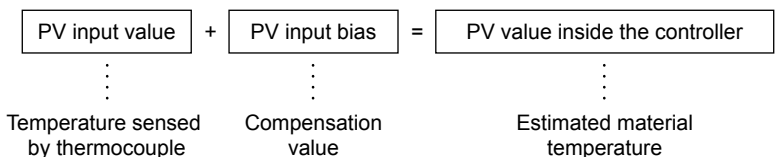
### 7.1.4 Correcting Input Value

#### (1) Setting Bias and Filter

**Description**

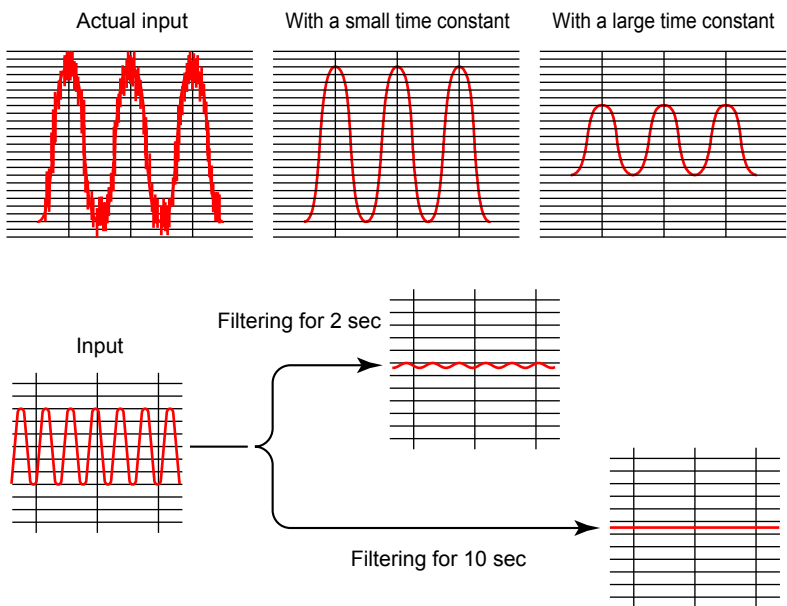
**PV Input Bias**

The PV input bias allows bias to be summed with input to develop a measured value for display and control use inside the controller. This function can also be used for fine adjustment to compensate for small inter-instrument differences in measurement reading that can occur even if all are within the specified instrument accuracies. PV input bias is used for normal operation.



**PV Input Filter**

If input noise or variations cause the low-order display digits to fluctuate so that the displayed value is difficult to read, a digital filter can be inserted to smooth operation. This filter provides a first-order lag calculation, which can remove more noise the larger the time constant becomes. However, an excessively large time constant will distort the waveform. PV input filter is used for normal operation.



**Analog Input Bias**


Analog input bias is used to correct sensor-input characteristics, compensating lead wire errors, and so on.









**Analog Input Filter**

The analog input filter is used to remove noise from an input signal. This filter provides a first-order lag calculation, which can remove more noise the larger the time constant becomes. However, an excessively large time constant will distort the waveform.

## 7.1 Setting Functions of PV Input, Remote Input, and Auxiliary Analog Input

### Setting Details

Parameter symbol	Name	Display level	Setting range	Menu symbol
<b>BS</b>	PV input bias	EASY	-100.0 to 100.0% of PV input range span (EUS)	PVS 
<b>FL</b>	PV input filter	EASY	OFF, 1 to 120 s	

Parameter symbol	Name	Display level	Setting range	Menu symbol
<b>A.BS</b>	PV analog input bias	STD	-100.0 to 100.0% of each input range span (EUS)	PV 
	RSP analog input bias	PRO		RSP 
	AIN2 aux. analog input bias	PRO		AIN2 
	AIN4 aux. analog input bias	PRO		AIN4 
<b>A.FL</b>	PV analog input filter	STD	OFF, 1 to 120 s	PV 
	RSP analog input filter	PRO		RSP 
	AIN2 aux. analog input filter	PRO		AIN2 
	AIN4 aux. analog input filter	PRO		AIN4 

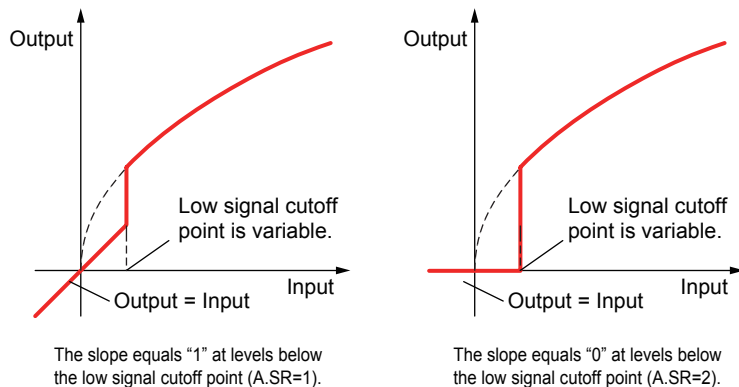
Note 1: BS, FL; In Cascade control, PV input terminal is for Loop 1 and RSP remote input terminal is for Loop 2. The LP2 lamp is lit while the Loop-2 parameter is displayed.

Note 2: When each parameter is displayed, the terminal area (E1 to E4) is displayed on Group display according to the suffix code and optional suffix code.

## (2) Setting Square Root Extraction and Low Signal Cutoff Point

## Description

This calculation is used to convert, for example, a differential pressure signal from a throttling flow meter such as an orifice and nozzle into a flow-rate signal. There is no hysteresis for low signal cutoff point.



## Setting Details

Parameter symbol	Name	Display level	Setting range	Menu symbol
A.SR	PV analog input square root extraction	PRO	OFF: No square root extraction. 1: Compute the square root. (The slope equals "1.") 2: Compute the square root. (The slope equals "0.")	PV <b>Set</b>
	RSP analog input square root extraction	PRO		RSP <b>Set</b>
	AIN2 aux. analog input square root extraction	PRO		AIN2 <b>Set</b>
	AIN4 aux. analog input square root extraction	PRO		AIN4 <b>Set</b>
A.LC	PV analog input low signal cutoff	PRO	0.0 to 5.0%	PV <b>Set</b>
	RSP analog input low signal cutoff	PRO		RSP <b>Set</b>
	AIN2 aux. analog input low signal cutoff	PRO		AIN2 <b>Set</b>
	AIN4 aux. analog input low signal cutoff	PRO		AIN4 <b>Set</b>

Note 1: When each parameter is displayed, the terminal area (E1 to E4) is displayed on Group display according to the suffix code and optional suffix code.

Note 2: Each parameter is displayed when the input type is voltage or current.

(3) Setting 10-segment Linearizer

**Description**

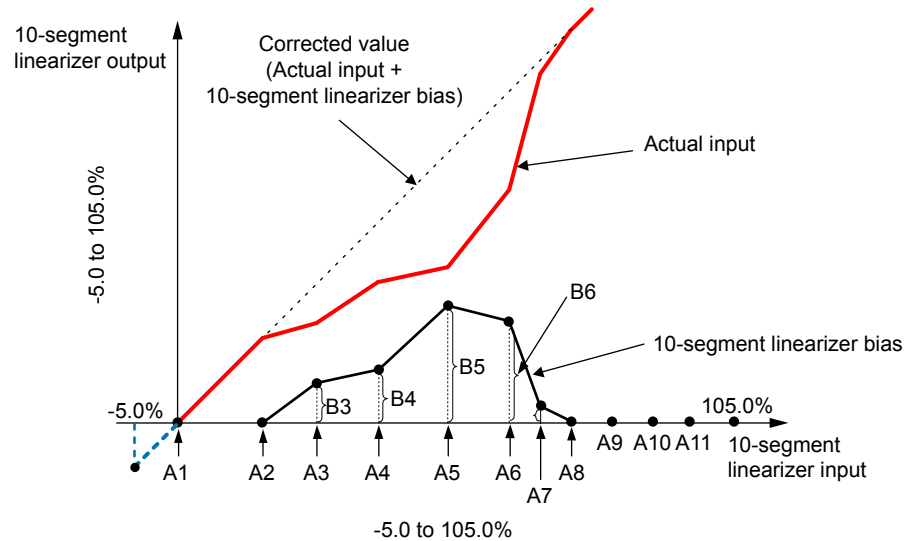
A total of up to four 10-segment linearizers can be used for the input unit and output unit. For the position used by a ten-segment linearizer, see the function block diagram.

- ▶ Function block diagram: 8.1 Setting Control Mode (CTLM)
- ▶ Output Linearizer: 10.13 Setting 10-segment Linearizer for Output

**10-segment Linearizer Bias**

This function is used to correct an input signal affected by sensor deterioration. The corrected values are obtained by adding the corresponding bias values to each of the 11 points of optionally set input values.

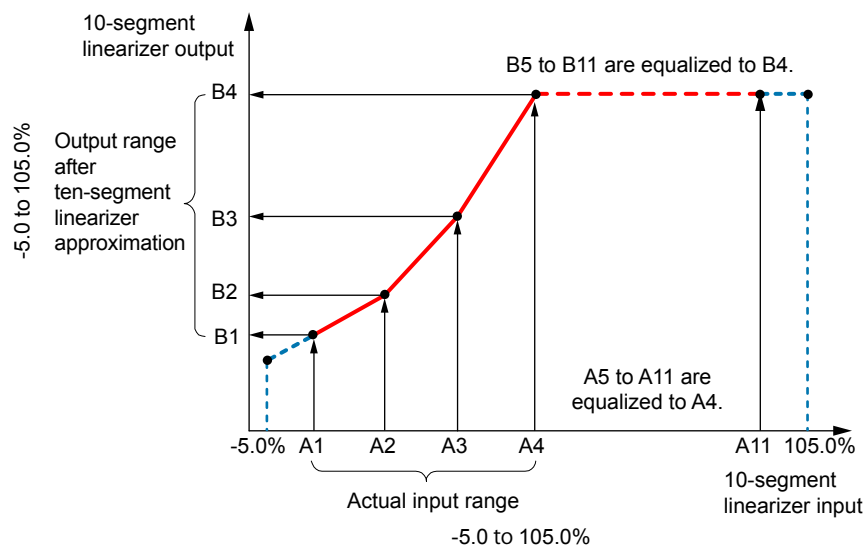
When 10-segment linearizer input is A1 or less, B1 is to be added. When 10-segment linearizer input is A11 or more, B11 is to be added.



**10-segment Linearizer Approximation**

This function is used when the input signal and the required measurement signal have a non-linear relationship, for example, when trying to obtain the volume from a sphere tank level. As shown in the figure below, the output values can be optionally set to 11 points of the optionally set input values.

When the 10-segment linearizer input is A1 or less, the value of extended line between B1 and B2 is output. Moreover, when the input is A11 or more, the value of extended line between B10 and B11 is output.



## Setting Details

Parameter symbol	Name	Display level	Setting range	Menu symbol
<b>PYS</b>	10-segment linearizer selection	Group 1, 2: STD Group 3, 4: PRO	OFF: Disable PV: PV analog input RSP: RSP analog input AIN2: AIN2 analog input AIN4: AIN4 analog input PVIN: PV input OUT: OUT analog output OUT2: OUT2 analog output RET: RET analog output	PYS1 PYS2 PYS3 PYS4 <b>Ope</b>
<b>A1 to A11</b>	10-segment linearizer input	Group 1, 2: STD Group 3, 4: PRO	-66.7 to 105.0% of input range (EU) Output linearizer: -5.0 to 105.0%	
<b>B1 to B11</b>	10-segment linearizer output	Group 1, 2: STD Group 3, 4: PRO	10-segment linearizer bias: -66.7 to 105.0% of input range span (EUS) 10-segment linearizer approximation: -66.7 to 105.0% of input range (EU) Output linearizer: -5.0 to 105.0%	
<b>PMD</b>	10-segment linearizer mode	Group 1, 2: STD Group 3, 4: PRO	0: 10-segment linearizer bias 1: 10-segment linearizer approximation	

Note1: When each parameter is displayed, the group number (1 to 4) is displayed on Group display.

Parameters are set in the following order.

- (1) PYS: Specifies where the 10-segment linearizer function is used.
  - Setpoints PV, RSP, AIN2, and AIN4 function before the input ladder calculation section.
  - Setpoint PVIN functions after the input ladder calculation section.
  - ▶ Where the 10-segment linearizer function is used; Function block diagrams in 8.1 Setting Control Mode (CTLM)
- (2) PMD: Specifies whether to use it as a 10-segment linearizer bias or a 10-segment linearizer approximation.
- (3) A1 to A11, B1 to B11: Sets the 10-segment linearizer input and 10-segment linearizer output.
  - For the input range and input range span, the range varies depending on where the 10-segment linearizer is used.
  - PV input and PV analog input: PV input range or PV input range span
  - RSP analog input: RSP remote input range or RSP remote input range span
  - AIN2 auxiliary analog input: AIN2 auxiliary analog input range or AIN2 auxiliary analog input range span
  - AIN4 auxiliary analog input: AIN4 auxiliary analog input range or AIN4 auxiliary analog input range span

**Note**

- Set the 10-segment linearizer so that it increases monotonically.
- If the same setpoint is set for the two or more parameters of 10-segment linearizer selection (PYS), a smaller group number is used.



## 7.1 Setting Functions of PV Input, Remote Input, and Auxiliary Analog Input

### Initial value of each control mode

Control mode	Group-1 PYS	Group-2 PYS	Group-3 and -4 PYS
Single-loop control	PV	OFF	OFF
Cascade primary-loop control	PV	OFF	OFF
Cascade control	PV	RSP	OFF
Loop control with PV switching	PV	OFF	OFF
Loop control with PV auto-selector	PVIN	OFF	OFF


### 7.1.5 Setting Ratio bias/filter

#### Description

Ratio bias computing performs ratio computation and bias addition for remote setpoints.

$$SP = \text{Remote input} \times \text{Remote input ratio (RT)} + \text{Remote input bias (RBS)}$$

#### Setting Details

Parameter symbol	Name	Display level	Setting range	Menu symbol
<b>RT</b>	Remote input ratio	STD	0.001 to 9.999	SPS 
<b>RBS</b>	Remote input bias	STD	100.0 to 100.0% of PV input range span (EUS)	
<b>RFL</b>	Remote input filter	STD	OFF, 1 to 120 s	

Note 1: In Cascade control, PV input terminal is for Loop 1 and RSP remote input terminal is for Loop 2. The LP2 lamp is lit while the Loop-2 parameter is displayed.

## 7.2 Setting Input Sampling Period (Control Period)

### Setting Details

Parameter symbol	Name	Display level	Setting range	Menu symbol
<b>SMP</b>	Input sampling period (control period)	STD	100: 100 ms 200: 200 ms	CTL <b>Set</b>

## 7.3 Using 4-wire RTD as PV Input

### Description

To use the 4-wire RTD, the optional suffix code /DR is required for remote input. Or the optional suffix code /U1 is required.

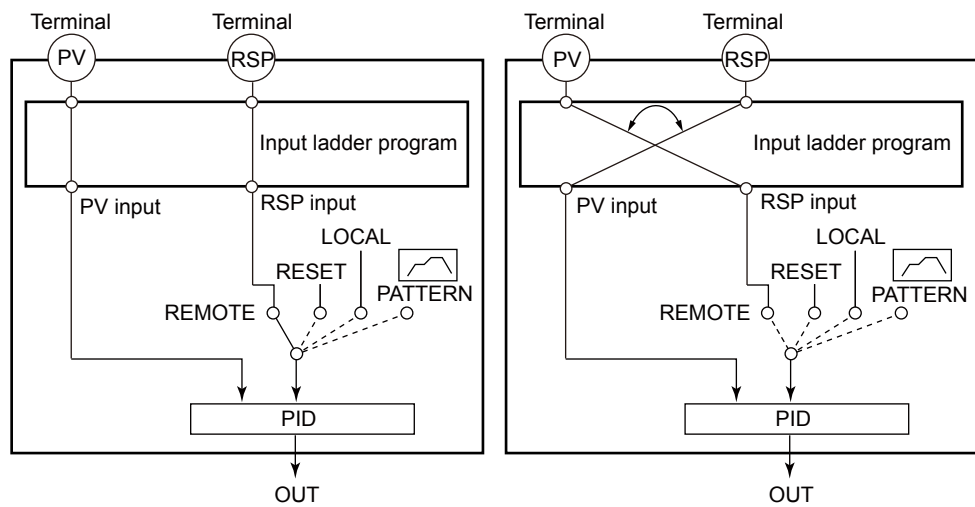
Normally, PV terminal input is used as PV.

When RSP terminal is used as PV, use the ladder program of LL50A Parameter Setting Software (sold separately) to switch the functions of the PV terminal and RSP terminal.

▶ [LL50A Parameter Setting Software: LL50A Parameter Setting Software User's Manual](#)

PV terminal input is used as PV.  
RSP terminal input is used as RSP.

PV terminal input is used as RSP.  
RSP terminal input is used as PV.



### Setting Details

Parameter symbol	Name	Display level	Setting range	Menu symbol
<b>RTD.S</b>	RTD wiring system	STD	3-W: 3-wire system 4-W: 4-wire system	RSP <b>Set</b>

## 7.4 Using Larger, Smaller, Average, or Difference of Two to Four Inputs as PV

### Description

Loop control with PV auto-selector function automatically selects or calculates the larger, smaller, average, or difference of multiple (two to four) inputs and uses the result as PV.

The larger, smaller, and average are automatically computed based on the specified number of inputs.

For the input difference, the difference between input 1 and input 2 is computed.

Input 1: PV terminal input

Input 2: RSP terminal input

Input 3: AIN2 auxiliary analog input

Input 4: AIN4 auxiliary analog input

- ▶ [Function block diagram for Loop control with PV auto-selector](#); [8.1.5 Loop Control with PV Auto-selector](#), [Heating/cooling Loop Control with PV Auto-selector](#), and [Position Proportional Loop Control with PV Auto-selector](#)

### Setting Details

Parameter symbol	Name	Display level	Setting range	Menu symbol
PV.AS	Input computation selection	STD	0: Max. value 1: Min. value 2: Ave. value 3: Input 1 - Input 2 4: Input 2 - Input 1	MPV <b>Set</b>
PV.NU	Number of inputs	STD	2: Use Input 1 and Input 2 3: Use Input 1, Input 2, and Input 3 4: Use 4 inputs	

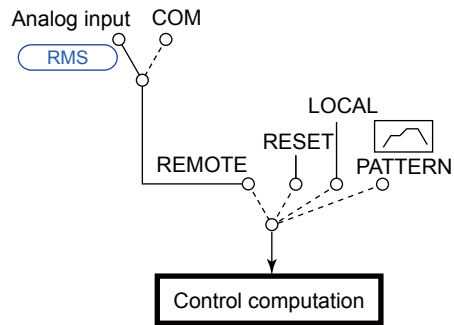
## 7.5 Setting Remote Input Method

### Description

There are two methods for remote input: analog input and communication. Decide which to use among two methods in advance.

Analog input: Remote setting using external analog signal (RSP terminal)

Communication: Remote setting via external communication.



### Setting Details

Parameter symbol	Name	Display level	Setting range	Menu symbol
<b>RMS</b>	Remote input method	STD	RSP: Via remote (auxiliary analog) input COM: Via communication	SPS <b>Ope</b>

Note1: In Cascade control, the LP2 lamp is lit while the Loop-2 parameter is displayed.

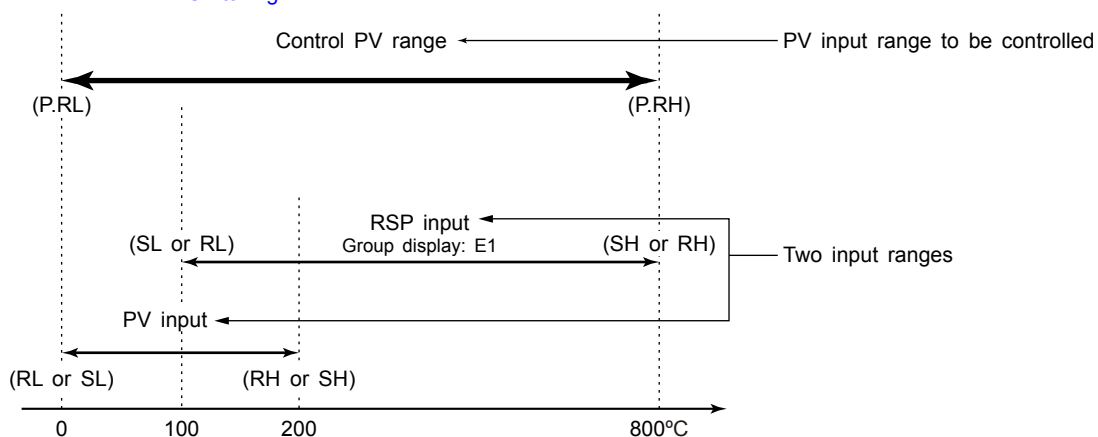
## 7.6 Adjusting PV Range for Loop Control with PV Switching or Loop Control with PV Auto-selector

### Description

Loop control with PV switching and Loop control with PV auto-selector need to determine the PV range for control if the measurement ranges of two input signals are different.

The figure below is an example of setting PV input range of 0 to 200°C, RSP terminal input of 100 to 800°C, and control PV range of 0 to 800°C.

- ▶ [Block diagram of Loop control with PV switching: 8.1.4 Loop Control with PV Switching, Heating/cooling Loop Control with PV Switching, and Position Proportional Loop Control with PV Switching](#)



### Setting Details

Parameter symbol	Name	Display level	Setting range	Menu symbol
<b>P.UNI</b>	Control PV input unit	STD	-: No unit C: Degree Celsius - -: No unit - - -: No unit F: Degree Fahrenheit	MPV <b>Set</b>
<b>P.DP</b>	Control PV input decimal point position	STD	0: No decimal place 1: One decimal place 2: Two decimal places 3: Three decimal places 4: Four decimal places	
<b>P.RH</b>	Maximum value of control PV input range	STD	-19999 to 30000, (P.RL < P.RH),	
<b>P.RL</b>	Minimum value of control PV input range	STD	$ P.RH - P.RL  \leq 30000$	

Note1: Set the input ranges for two inputs consecutively. Set the control PV ranges (P.RL, P.RH) within the actual input range.

## 7.7 Setting PV Switching Methods of Loop Control with PV Switching

### Description

PV switching method of Loop control with PV switching can be set when the control mode is Loop control with PV switching.

- ▶ Block diagram of Loop control with PV switching: 8.1.4 Loop Control with PV Switching, Heating/cooling Loop Control with PV Switching, and Position Proportional Loop Control with PV Switching

Input 1: PV terminal input

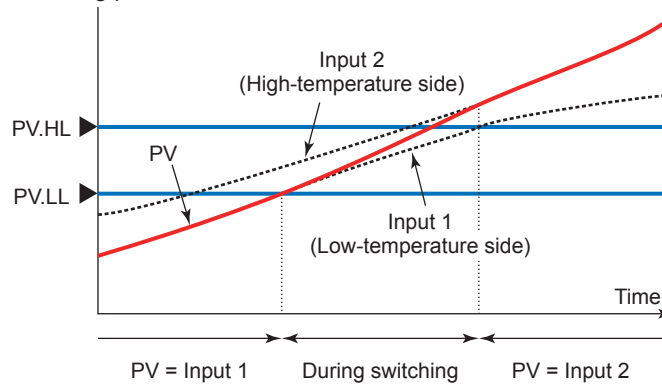
Input 2: RSP terminal input

#### Switching within the Temperature Range (Low-temperature side) (Parameter PV.2C=0)

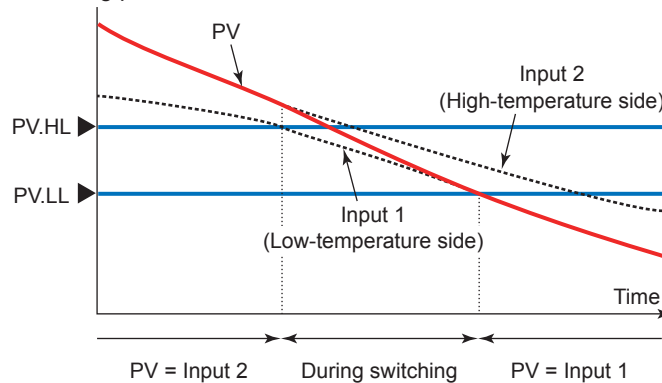
This method automatically switches PV within the range of input switching PV high limit and low limit.

It should be selected in case where a sudden change in PV must be avoided.

PV rising process



PV falling process



When  $\text{input 1} \leq \text{PV.LL}$ , **PV=Input 1**.

When  $\text{PV.LL} < \text{Input 1} < \text{PV.HL}$

$$\text{PV} = \left(1 - \frac{\text{Input 1} - \text{PV.LL}}{\text{PV.HL} - \text{PV.LL}}\right) \cdot \text{Input 1} + \left(\frac{\text{Input 1} - \text{PV.LL}}{\text{PV.HL} - \text{PV.LL}}\right) \cdot \text{Input 2}$$

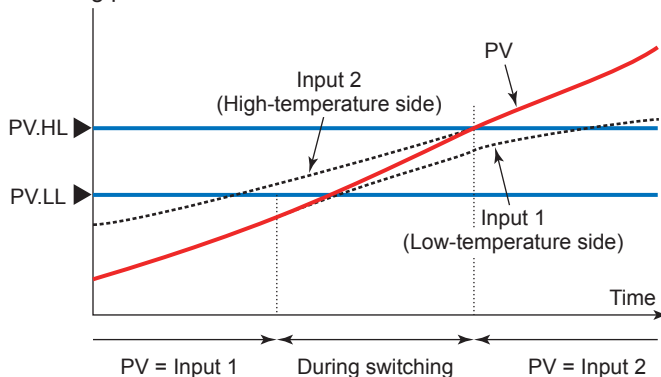
When  $\text{PV.HL} \leq \text{Input 1}$ , **PV=Input 2**.

**Switching within the Temperature Range (High-temperature side) (Parameter PV.2C=3)**

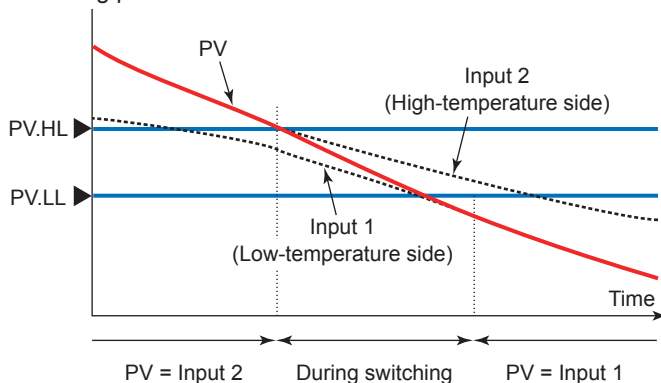
This method automatically switches PV within the range of input switching PV high limit and low limit.

It should be selected in case where a sudden change in PV must be avoided.

PV rising process



PV falling process



When  $\text{input 2} \leq \text{PV.LL}$ , **PV=Input 1**.

When  $\text{PV.LL} < \text{Input 2} < \text{PV.HL}$

$$\text{PV} = \left( 1 - \frac{\text{Input 2} - \text{PV.LL}}{\text{PV.HL} - \text{PV.LL}} \right) \cdot \text{Input 1} + \left( \frac{\text{Input 2} - \text{PV.LL}}{\text{PV.HL} - \text{PV.LL}} \right) \cdot \text{Input 2}$$

When  $\text{PV.HL} \leq \text{Input 2}$ , **PV=Input 2**.



## 7.7 Setting PV Switching Methods of Loop Control with PV Switching

### Switching at the Input Switching PV High Limit (Parameter PV.2C=1)

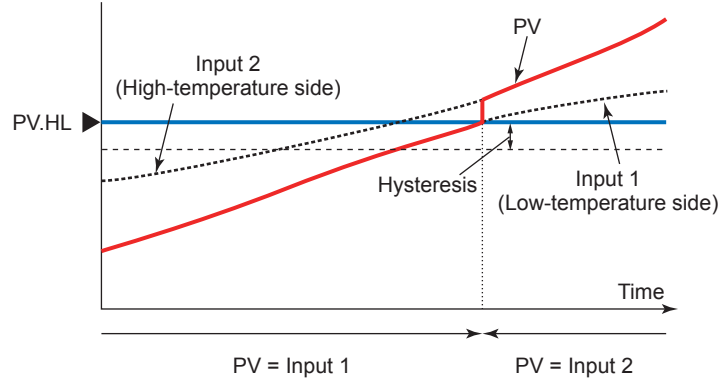
This method automatically switches two inputs at switching point (input switching PV high limit)

It should be selected in case where a sudden change in PV is allowed.

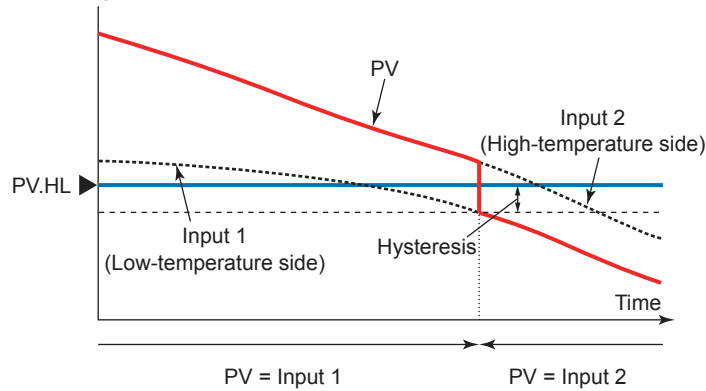
Control output will change smoothly (i.e., without any bumps) when PV switches.

Hysteresis (0.5% of PV range span) is provided around the switching point.

PV rising process



PV falling process



When  $\text{input 1} < \text{PV.HL} - 0.5\% \text{ of PV input range span}$ , **PV=Input 1**.

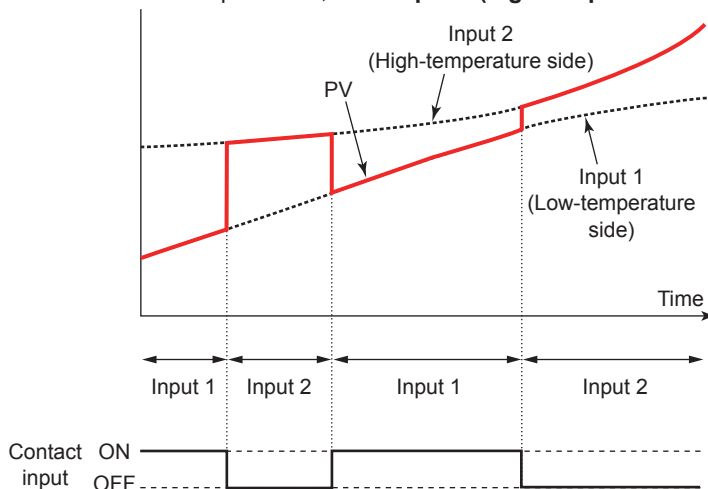
When  $\text{PV.HL} \leq \text{Input 1}$ , **PV=Input 2**.

**Switching by Contact Input (Parameter PV.2C=2)**

This method switches two inputs by contact input ON/OFF.

When the contact input is OFF, PV = **Input 1 (low-temperature side)**.

When the contact input is ON, PV = **Input 2 (high-temperature side)**.



The function is assigned to DI16 for the factory default when switched by DI. Control output will change smoothly (i.e., without any bumps) when PV switches.

**Setting Details**

Parameter symbol	Name	Display level	Setting range	Menu symbol
PV.2C	Input switching action (in Loop control with PV switching)	STD	0: Switch based on low limit of temperature range 1: Switch using the parameter PV.HL 2: Switch using DI 3: Switch based on high limit of temperature range	MPV <b>Set</b>
PV.HL	Input switching PV high limit (in Loop control with PV switching)	STD	0.0 to 100.0% of control PV input range (EU), (PV.HL>PV.LL)	
PV.LL	Input switching PV low limit (in Loop control with PV switching)	STD		



## 8.1 Setting Control Mode (CTLM)

### 8.1.1 Single-loop Control, Single-loop Heating/cooling Control, and Single-loop Position Proportional Control

#### Setting Details

Parameter symbol	Name	Display level	Setting range	Menu symbol
CTLM	Control mode	STD	SGL: Single-loop control CAS1: Cascade primary-loop control CAS: Cascade control PVSW: Loop control with PV switching PVSEL: Loop control with PV auto-selector	CTL <b>Set</b>

#### CAUTION

- Some parameters will be initialized if the control mode (CTLM) is changed.
- When using the ladder program, the control mode cannot be changed.

#### Description

These control modes provide the basic control function having one control computation unit.

Single-loop control can be used for Standard type or Heating/cooling type controller. Single-loop heating/cooling control can be used for Heating/cooling type controller. Single-loop position proportional control can be used for Position proportional type controller.

▶ PID control: [8.2 Setting Control Type \(CNT\)](#)

Up to four 10-segment linearizer approximation/10-segment linearizer biases can be used for the input unit or output unit.

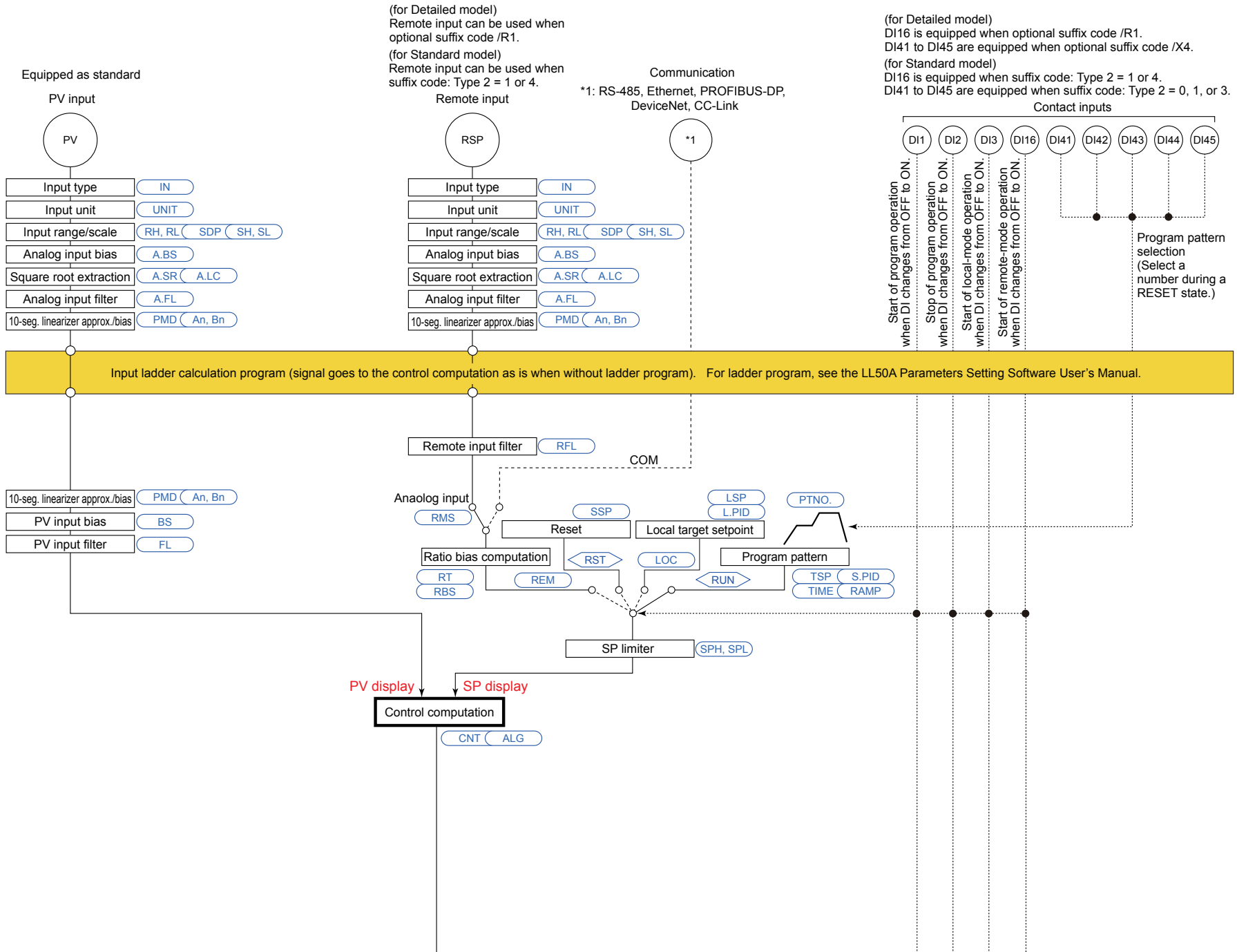
The Function block diagram describes only the basic functions.

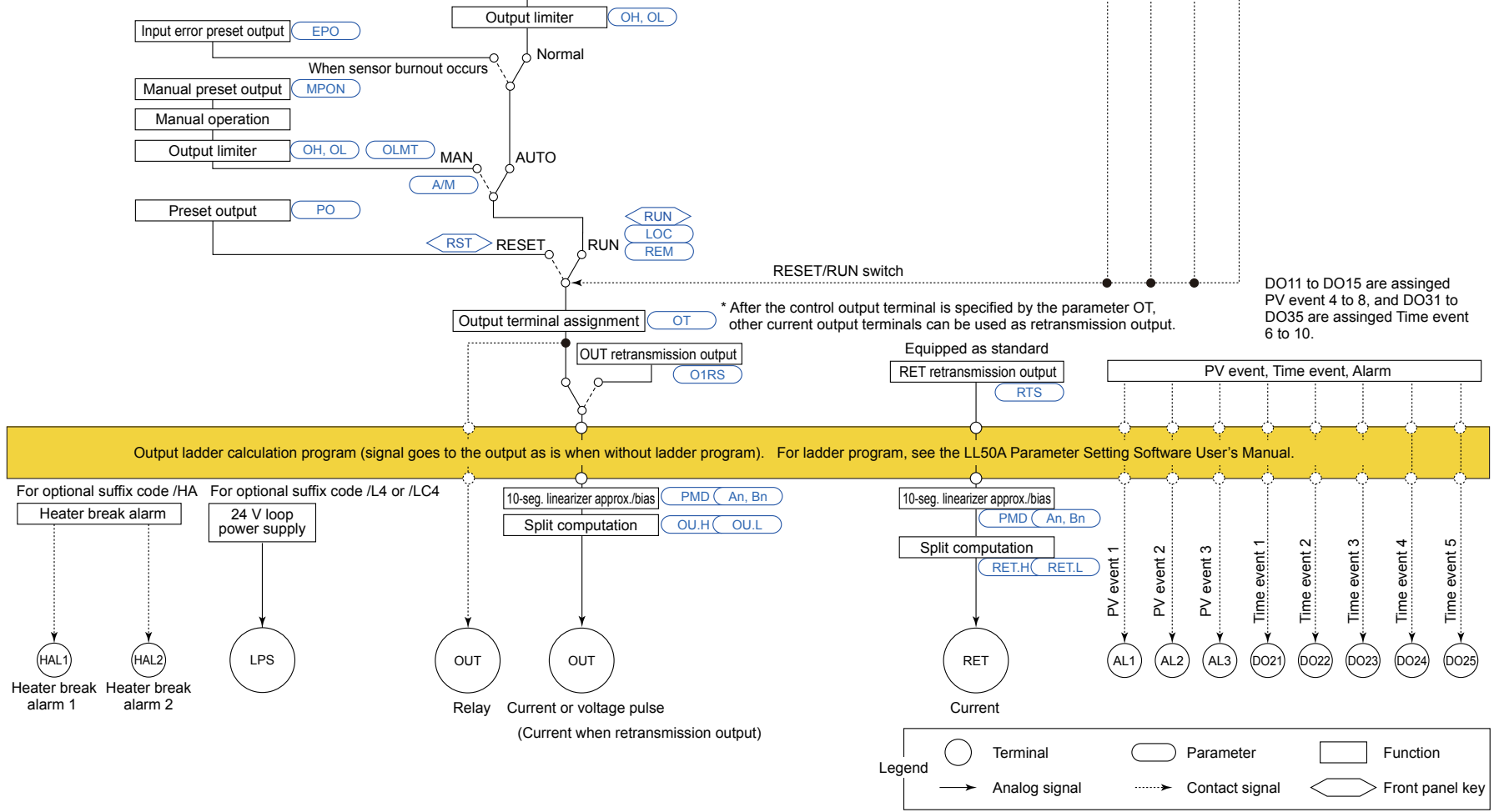
Parameter symbols in the Function block diagram describe representative parameters.

For the functions and parameters which are not described in Function block diagram, see the following.

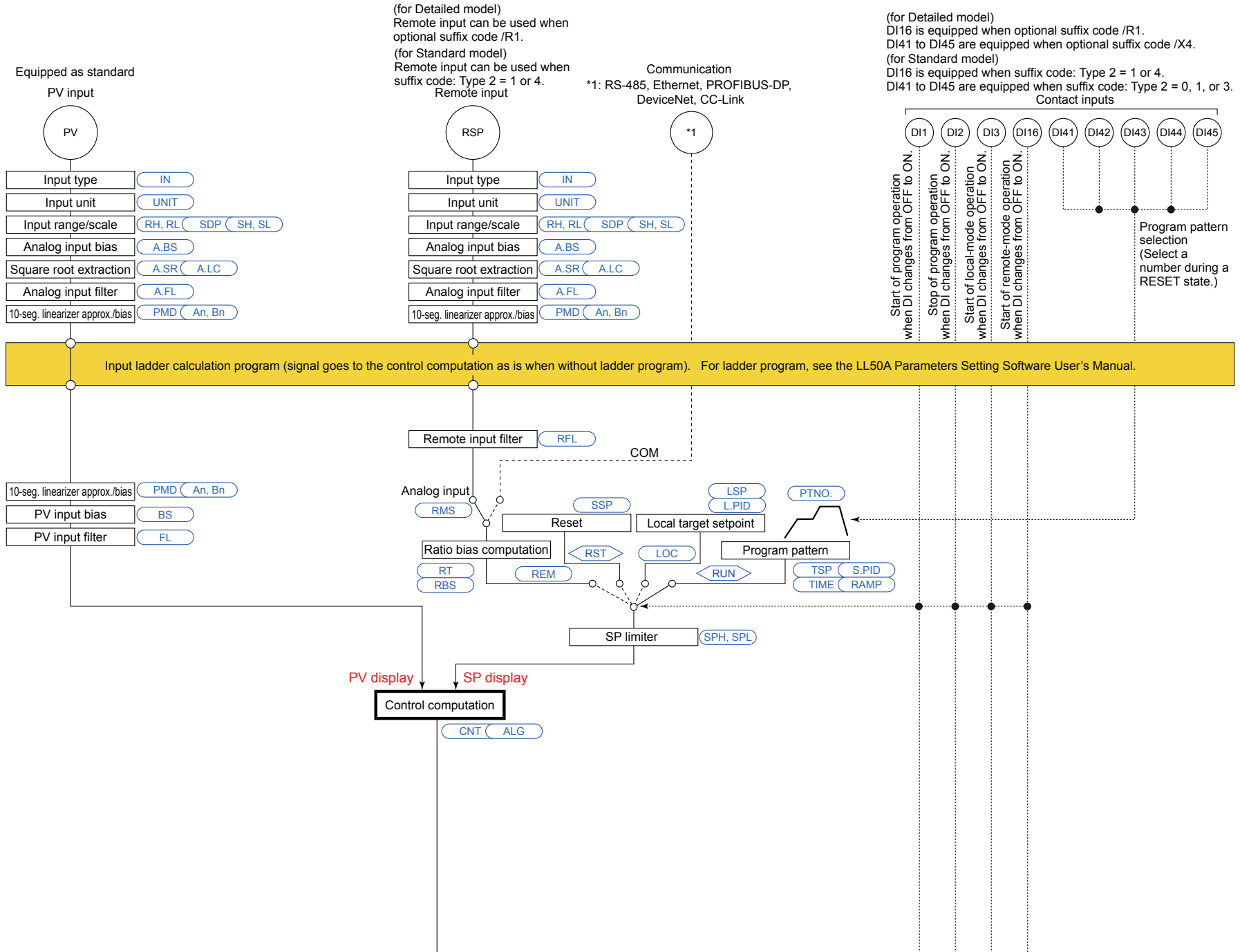
- ▶ Contact input assignment: [12.1 Setting Contact Input Function](#)
- ▶ Contact output assignment: [12.2 Setting Contact Output Function](#)
- ▶ Contact output assignment to retransmission output terminal: [10.1 Setting Control Output Type](#)
- ▶ Analog output range change: [10.14 Changing Current Output Range](#)

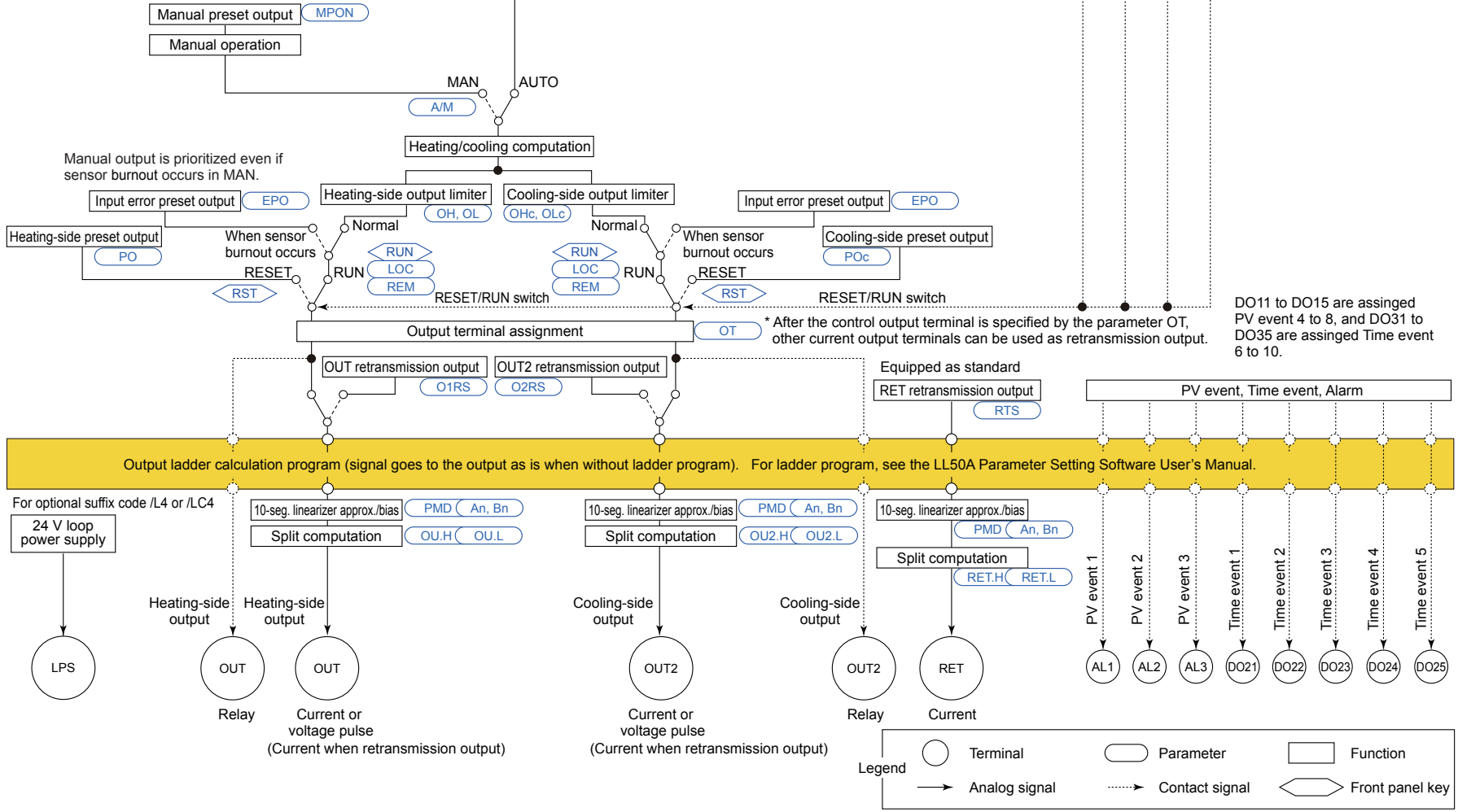
### Single-loop Control Function Block Diagram





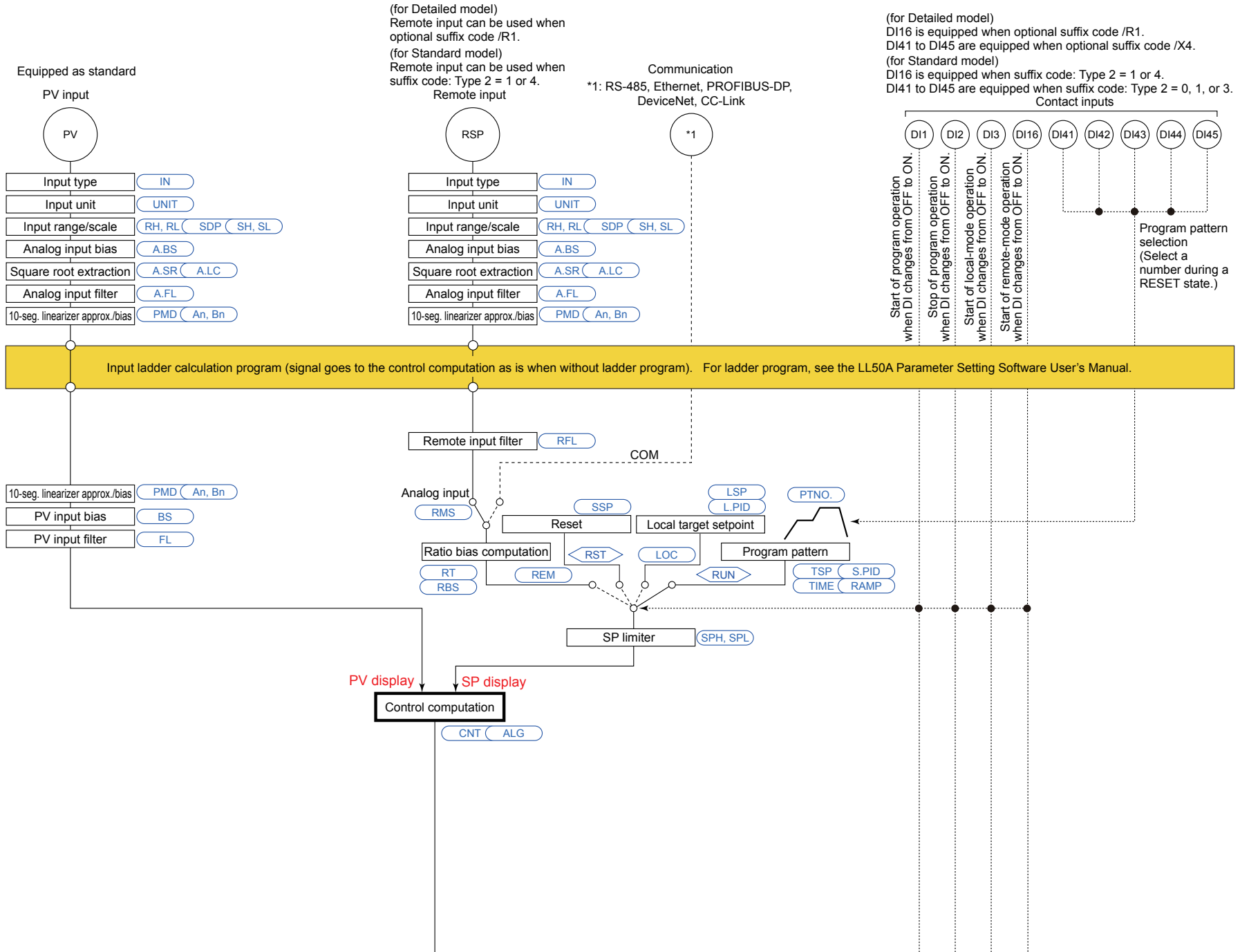
### Single-loop Heating/cooling Control Function Block Diagram

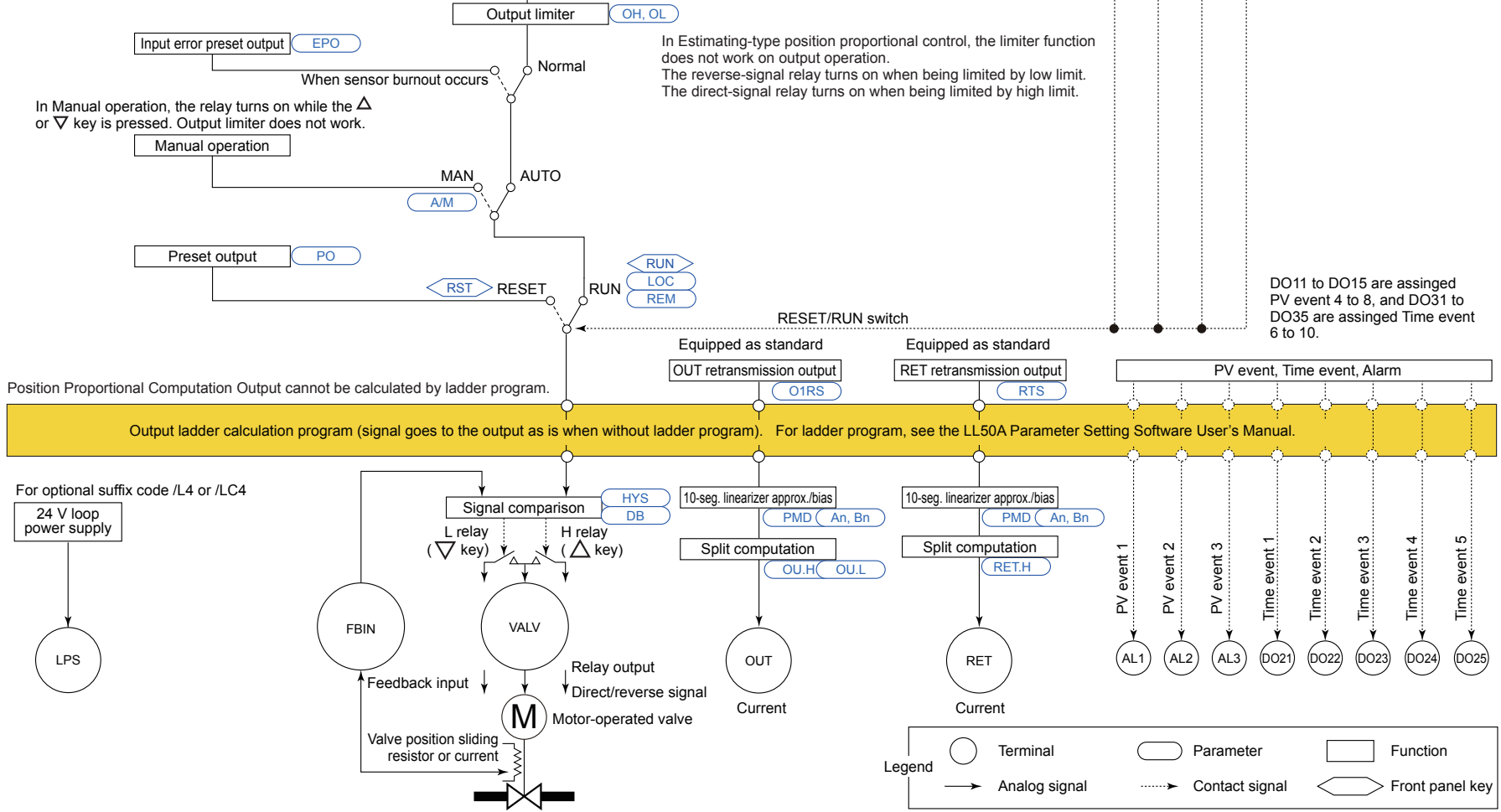






### Single-loop Position Proportional Control Function Block Diagram





## 8.1 Setting Control Mode (CTLM)

---

Intentionally blank

## 8.1.2 Cascade Primary-loop Control

### Setting Details

Parameter symbol	Name	Display level	Setting range	Menu symbol
CTLM	Control mode	STD	SGL: Single-loop control CAS1: Cascade primary-loop control CAS: Cascade control PVSW: Loop control with PV switching PVSEL: Loop control with PV auto-selector	CTL <b>Set</b>

### CAUTION

- Some parameters will be initialized if the control mode (CTLM) is changed.
- When using the ladder program, the control mode cannot be changed.

### Description

Cascade primary-loop control sets up a controller as the primary-loop controller when two controllers are used for Cascade control. It provides the output tracking function and FAIL output to the secondary-loop controller.

Cascade primary-loop control can be used for Standard type or Heating/cooling type controller.

▶ PID control: [8.2 Setting Control Type \(CNT\)](#)

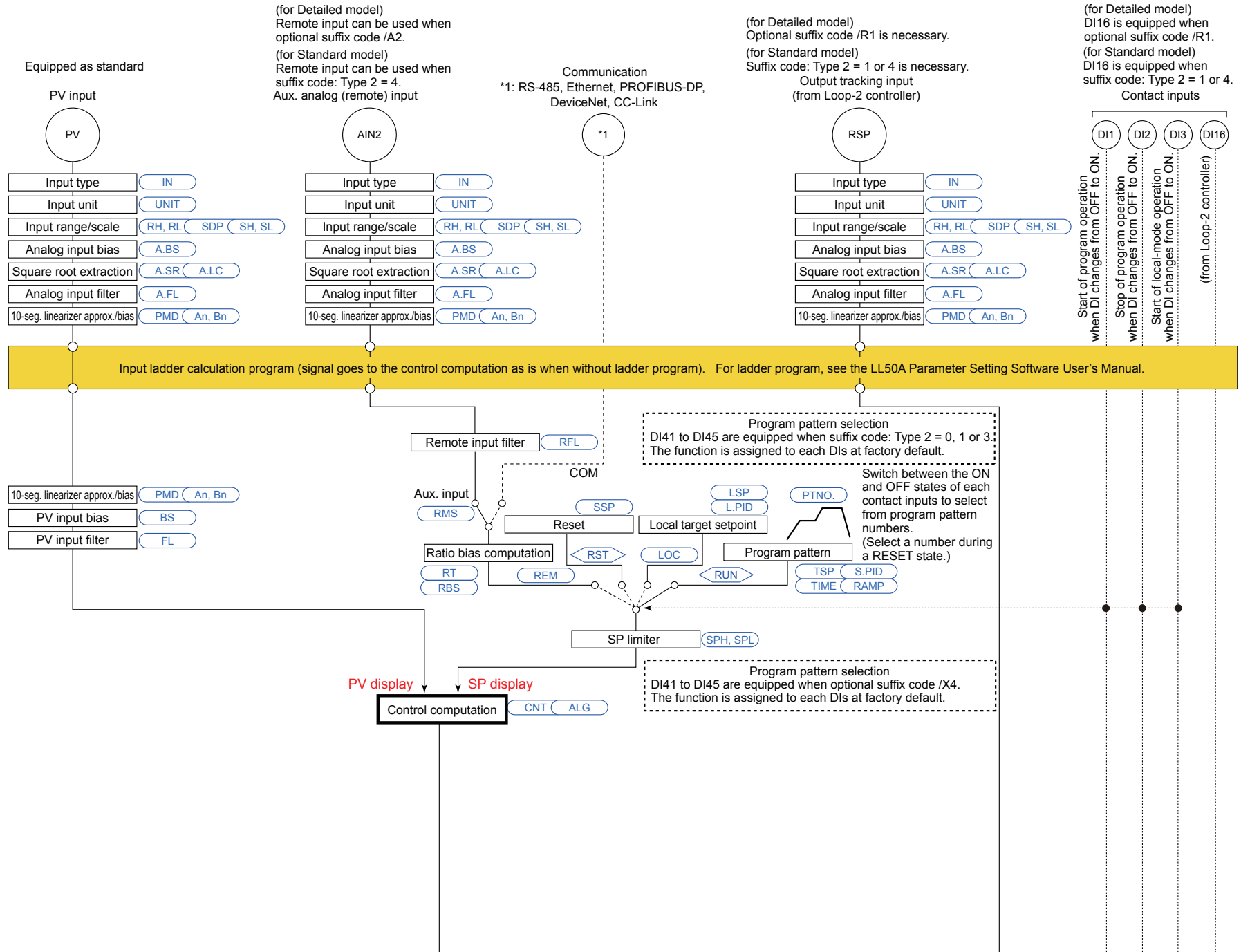
Up to four 10-segment linearizer approximation/10-segment linearizer biases can be used for the input unit or output unit.

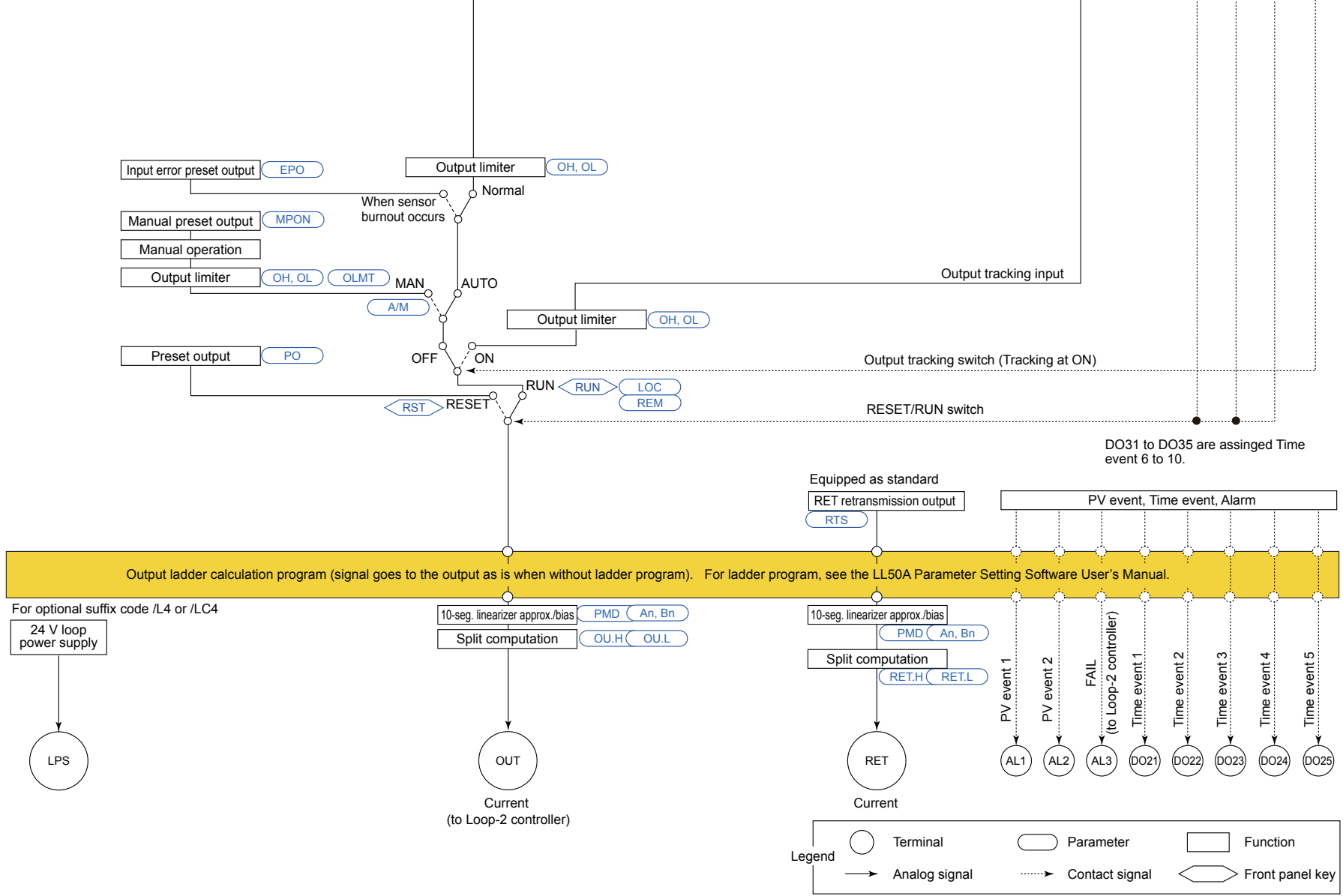
The Function block diagram describes only the basic functions. Parameter symbols in the Function block diagram describe representative parameters.

For the functions and parameters which are not described in Function block diagram, see the following.

- ▶ Contact input assignment: [12.1 Setting Contact Input Function](#)
- ▶ Contact output assignment: [12.2 Setting Contact Output Function](#)
- ▶ Contact output assignment to retransmission output terminal: [10.1 Setting Control Output Type](#)
- ▶ Analog output range change: [10.14 Changing Current Output Range](#)

### ■ Cascade Primary-loop Control Function Block Diagram





## 8.1 Setting Control Mode (CTLM)

---

Intentionally blank

### 8.1.3 Cascade Control, Cascade Heating/cooling Control, and Cascade Position Proportional Control

#### Setting Details

Parameter symbol	Name	Display level	Setting range	Menu symbol
CTLM	Control mode	STD	SGL: Single-loop control CAS1: Cascade primary-loop control CAS: Cascade control PVSW: Loop control with PV switching PVSEL: Loop control with PV auto-selector	CTL <b>Set</b>

#### CAUTION

- Some parameters will be initialized if the control mode (CTLM) is changed.
- When using the ladder program, the control mode cannot be changed.

#### Description

These control modes use two control computation units and permits Cascade control using just a single controller.

Cascade control can be used for Standard type or Heating/cooling type controller. Cascade heating/cooling control can be used for Heating/cooling type controller. Cascade position proportional control can be used for Position proportional type controller.

▶ [PID control and Heating/cooling control: 8.2 Setting Control Type \(CNT\)](#)

Up to four 10-segment linearizer approximation/10-segment linearizer biases can be used for the input unit or output unit.

The Function block diagram describes only the basic functions.

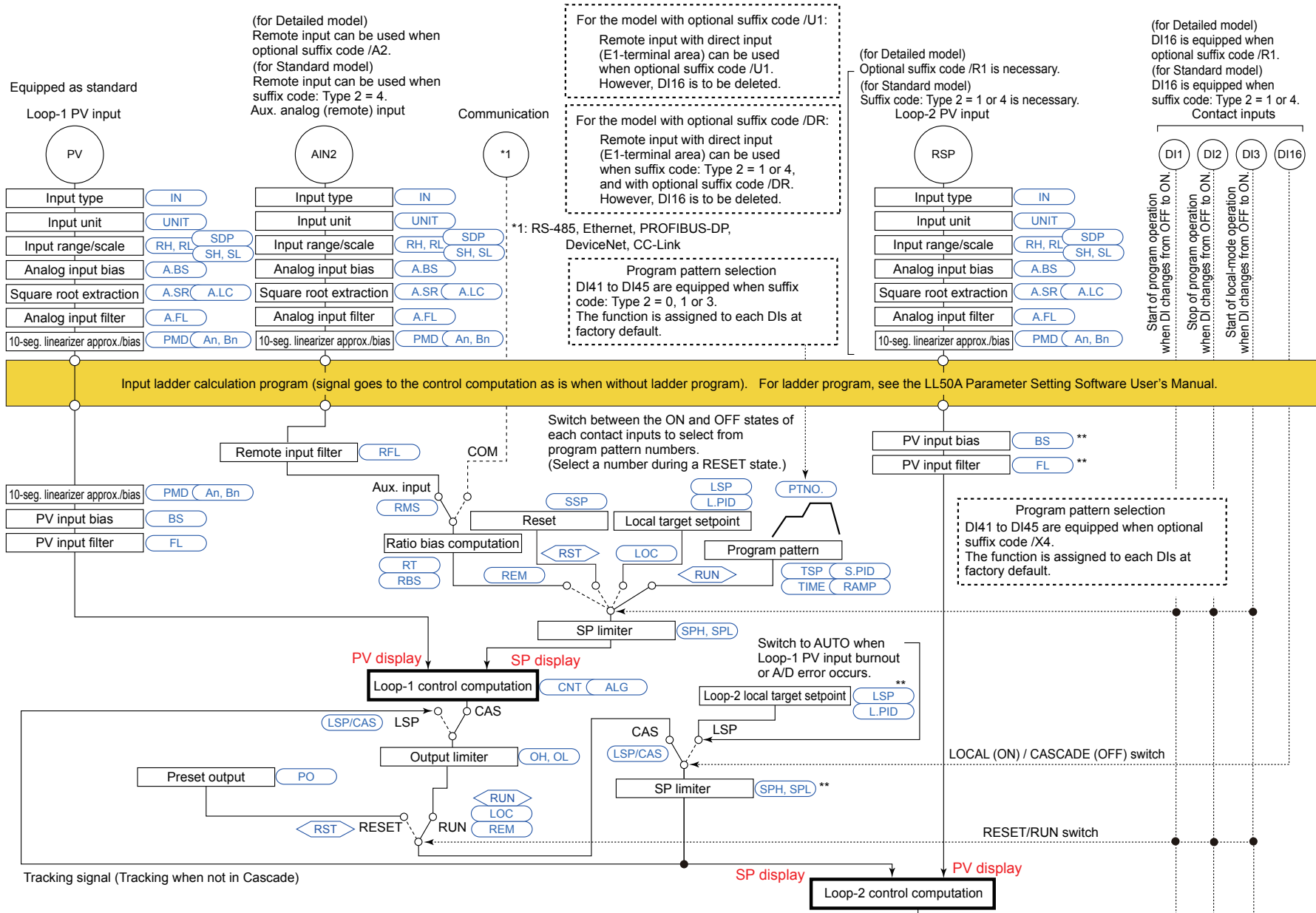
Parameter symbols in the Function block diagram describe representative parameters.

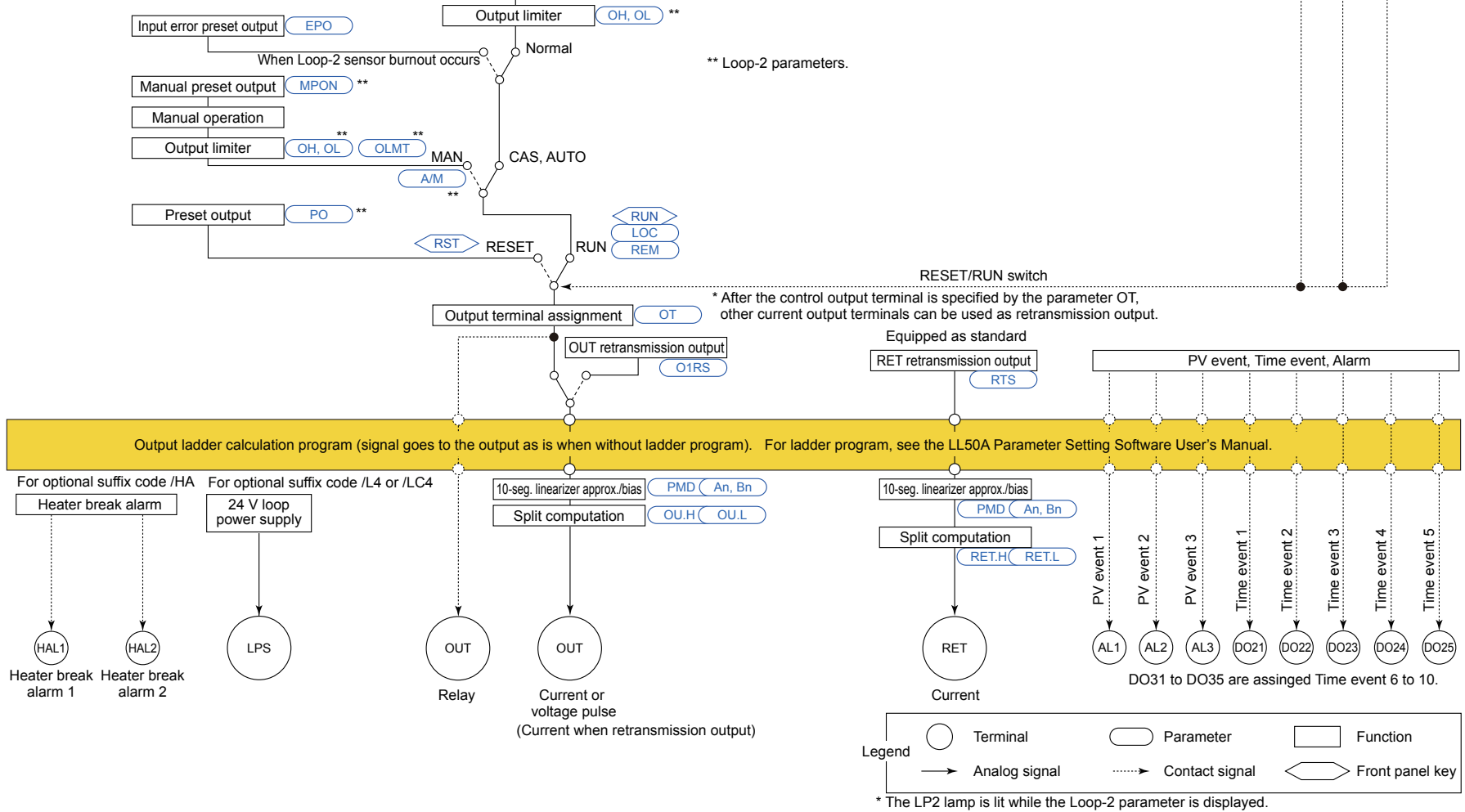
For the functions and parameters which are not described in Function block diagram, see the following.

- ▶ [Contact input assignment: 12.1 Setting Contact Input Function](#)
- ▶ [Contact output assignment: 12.2 Setting Contact Output Function](#)
- ▶ [Contact output assignment to retransmission output terminal: 10.1 Setting Control Output Type](#)
- ▶ [Analog output range change: 10.14 Changing Current Output Range](#)

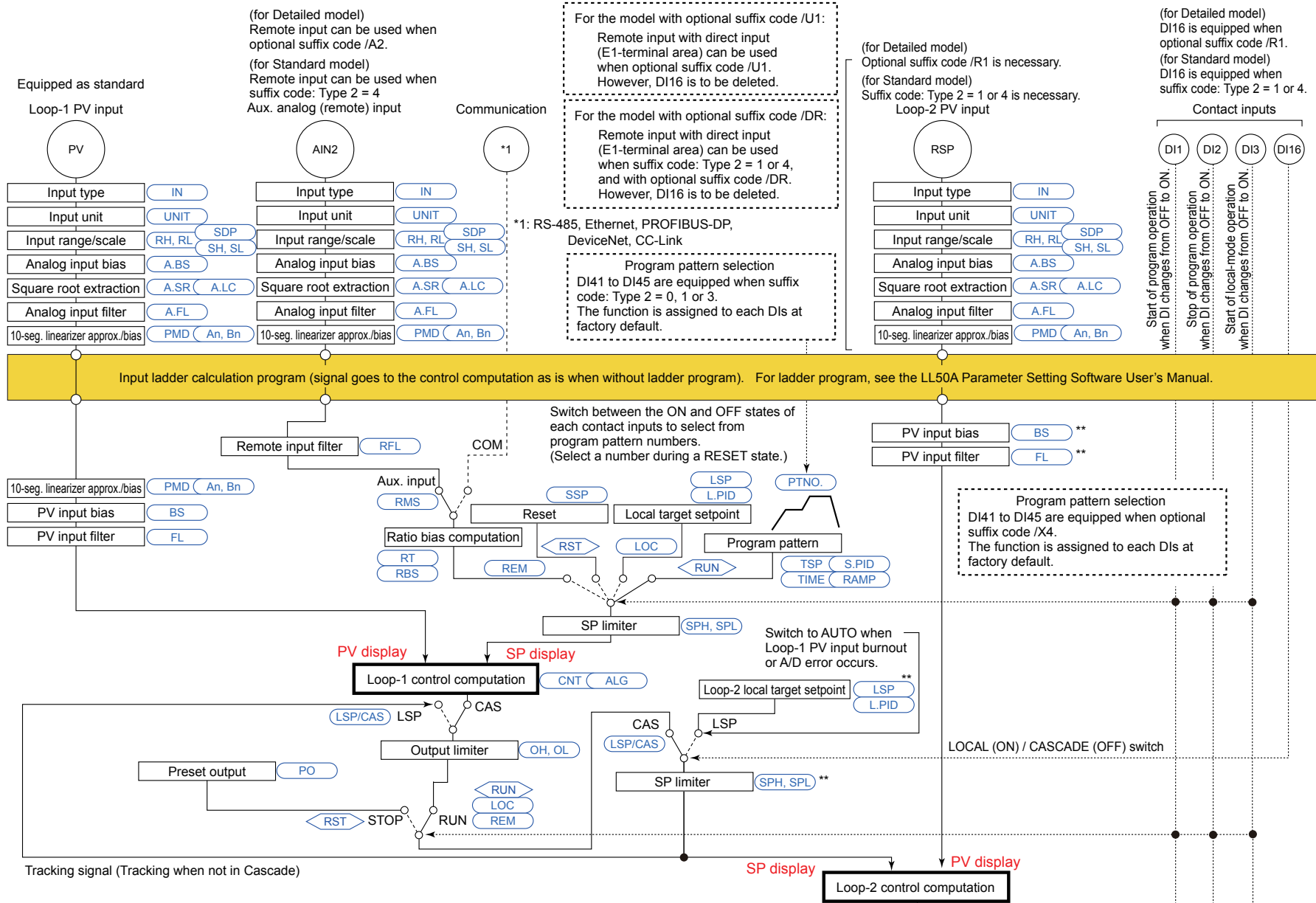


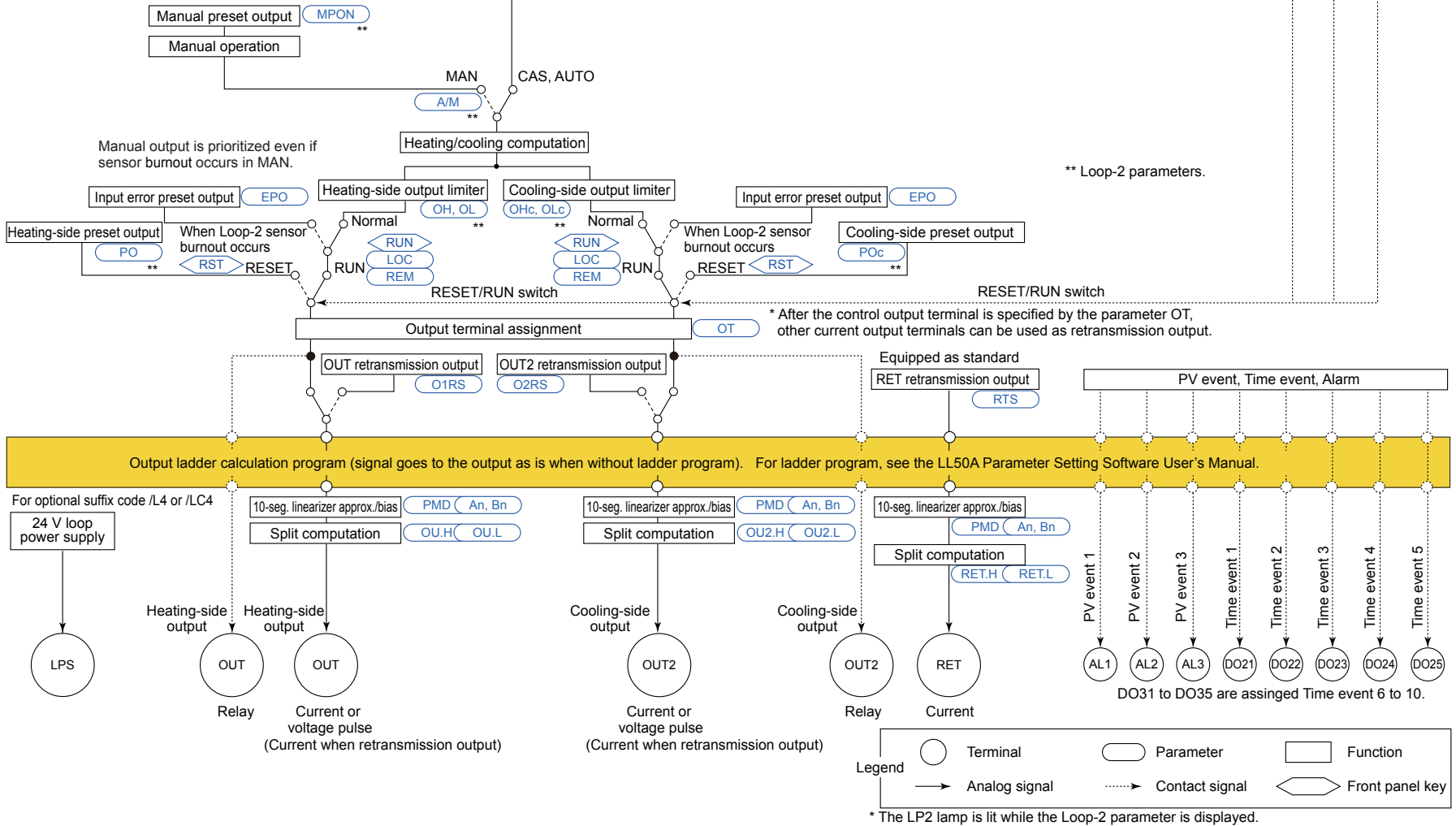
### ■ Cascade Control Function Block Diagram





### ■ Cascade Heating/cooling Control Function Block Diagram





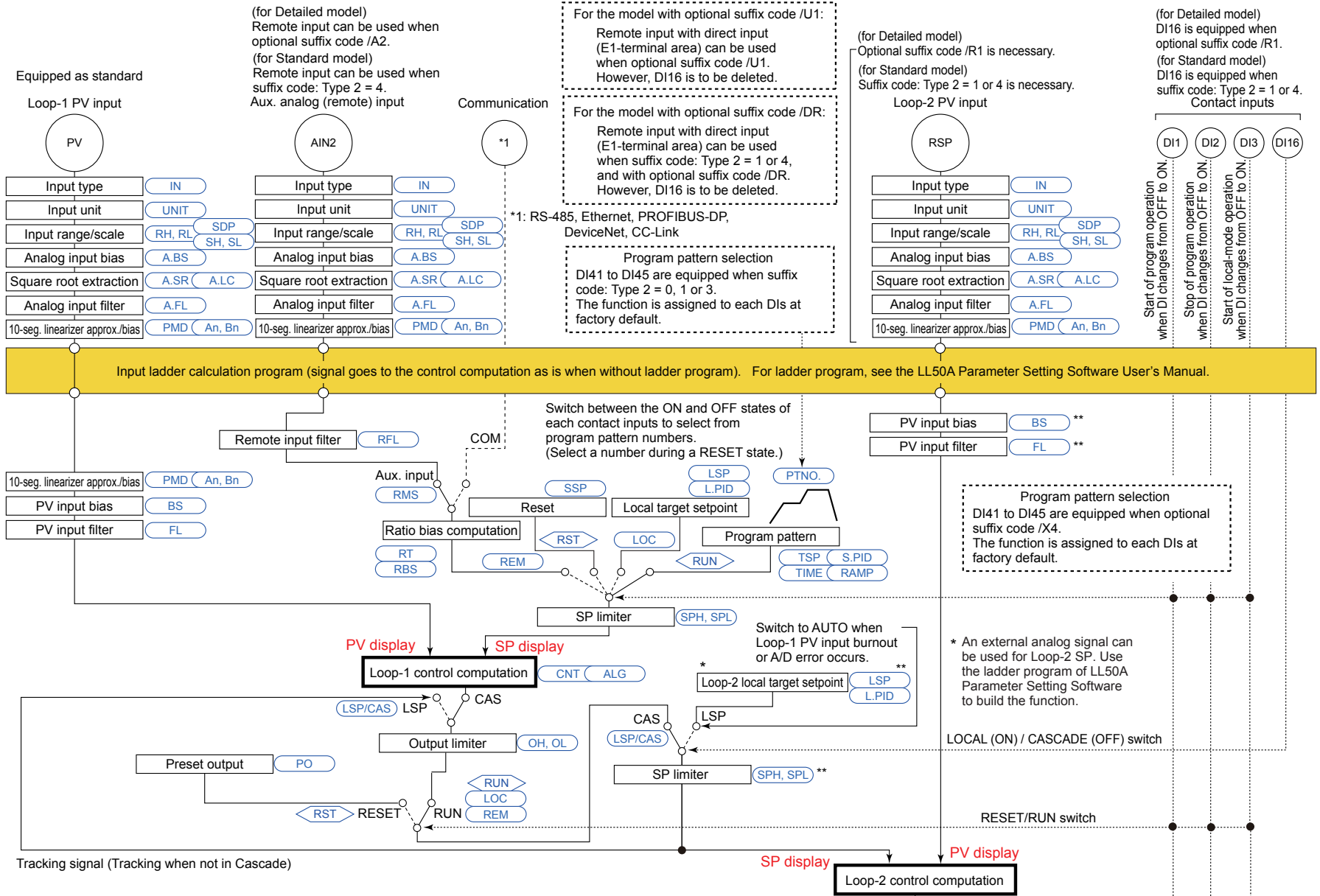
\*\* Loop-2 parameters.

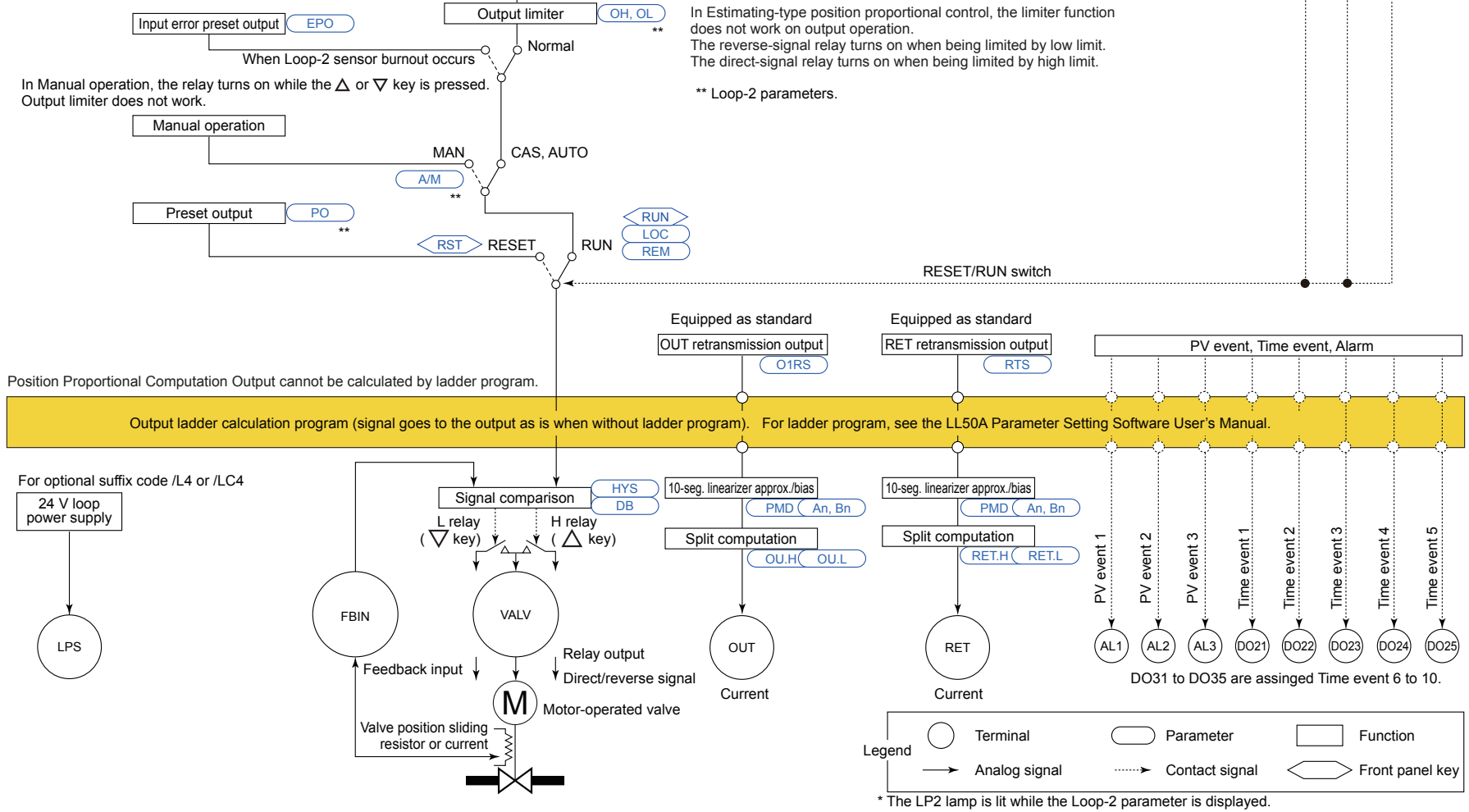
\* After the control output terminal is specified by the parameter OT, other current output terminals can be used as retransmission output.

Manual output is prioritized even if sensor burnout occurs in MAN.

For optional suffix code /L4 or /LC4

### ■ Cascade Position Proportional Control Function Block Diagram





## 8.1 Setting Control Mode (CTLM)

---

Intentionally blank

## 8.1.4 Loop Control with PV Switching, Heating/cooling Loop Control with PV Switching, and Position Proportional Loop Control with PV Switching

### Setting Details

Parameter symbol	Name	Display level	Setting range	Menu symbol
CTLM	Control mode	STD	SGL: Single-loop control CAS1: Cascade primary-loop control CAS: Cascade control PVSW: Loop control with PV switching PVSEL: Loop control with PV auto-selector	CTL <b>Set</b>

### CAUTION

- Some parameters will be initialized if the control mode (CTLM) is changed.
- When using the ladder program, the control mode cannot be changed.

### Description

These control modes use two PV inputs, which are switched according to input contact signals or measurement ranges.

Loop control with PV switching can be used for Standard type or Heating/cooling type controller.

Heating/cooling loop control with PV switching can be used for Heating/cooling type controller.

Position proportional loop control with PV switching can be used for Position proportional type controller.

▶ [PID control and Heating/cooling control: 8.2 Setting Control Type \(CNT\)](#)

Description about Loop control with PV switching

▶ [PV range: 7.6 Adjusting PV Range for Loop Control with PV Switching](#)

▶ [Switching action: 7.7 Setting PV Switching Methods of Loop Control with PV Switching](#)

Up to four 10-segment linearizer approximation/10-segment linearizer biases can be used for the input unit or output unit.

The Function block diagram describes only the basic functions.

Parameter symbols in the Function block diagram describe representative parameters.

For the functions and parameters which are not described in Function block diagram, see the following.

▶ [Contact input assignment: 12.1 Setting Contact Input Function](#)

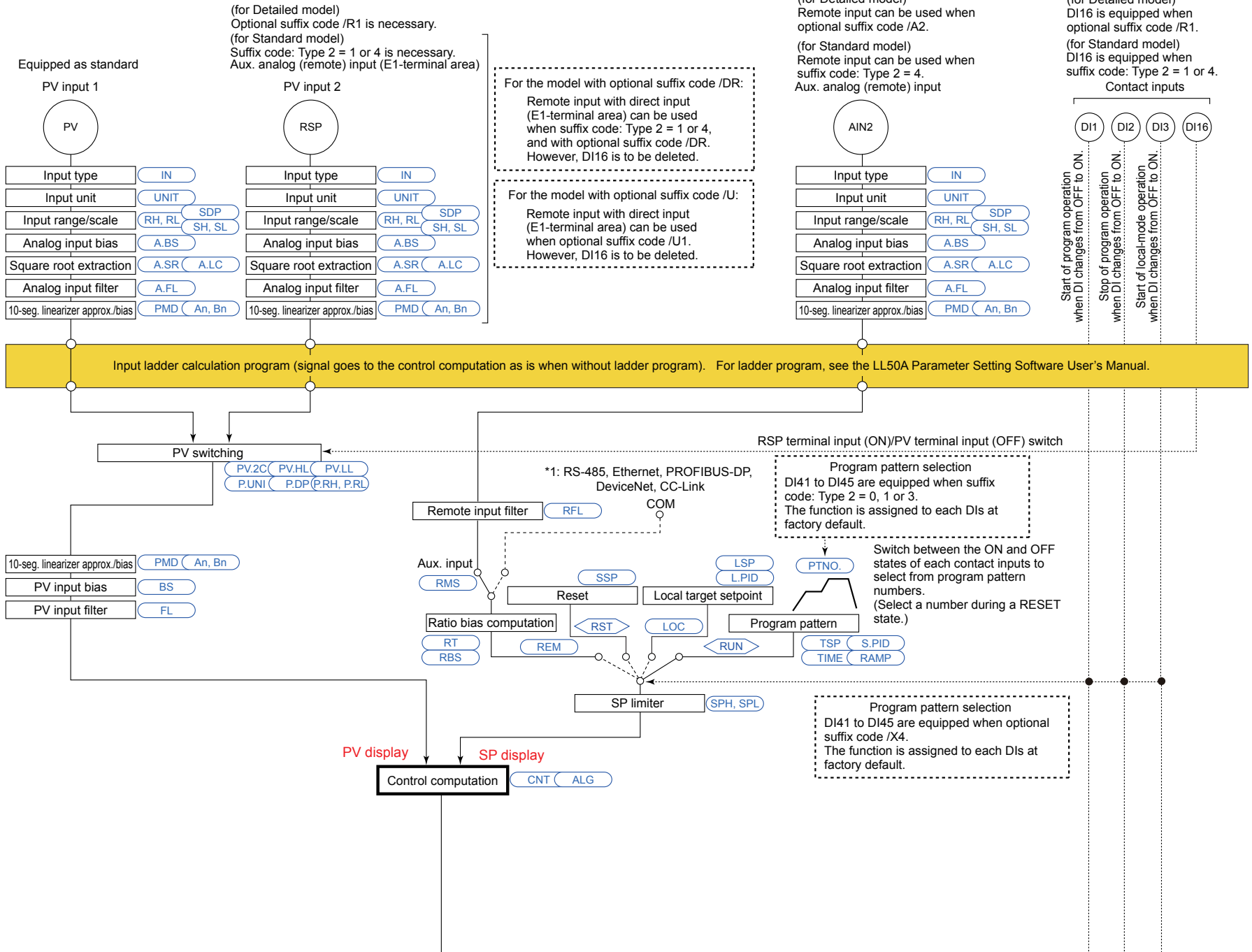
▶ [Contact output assignment: 12.2 Setting Contact Output Function](#)

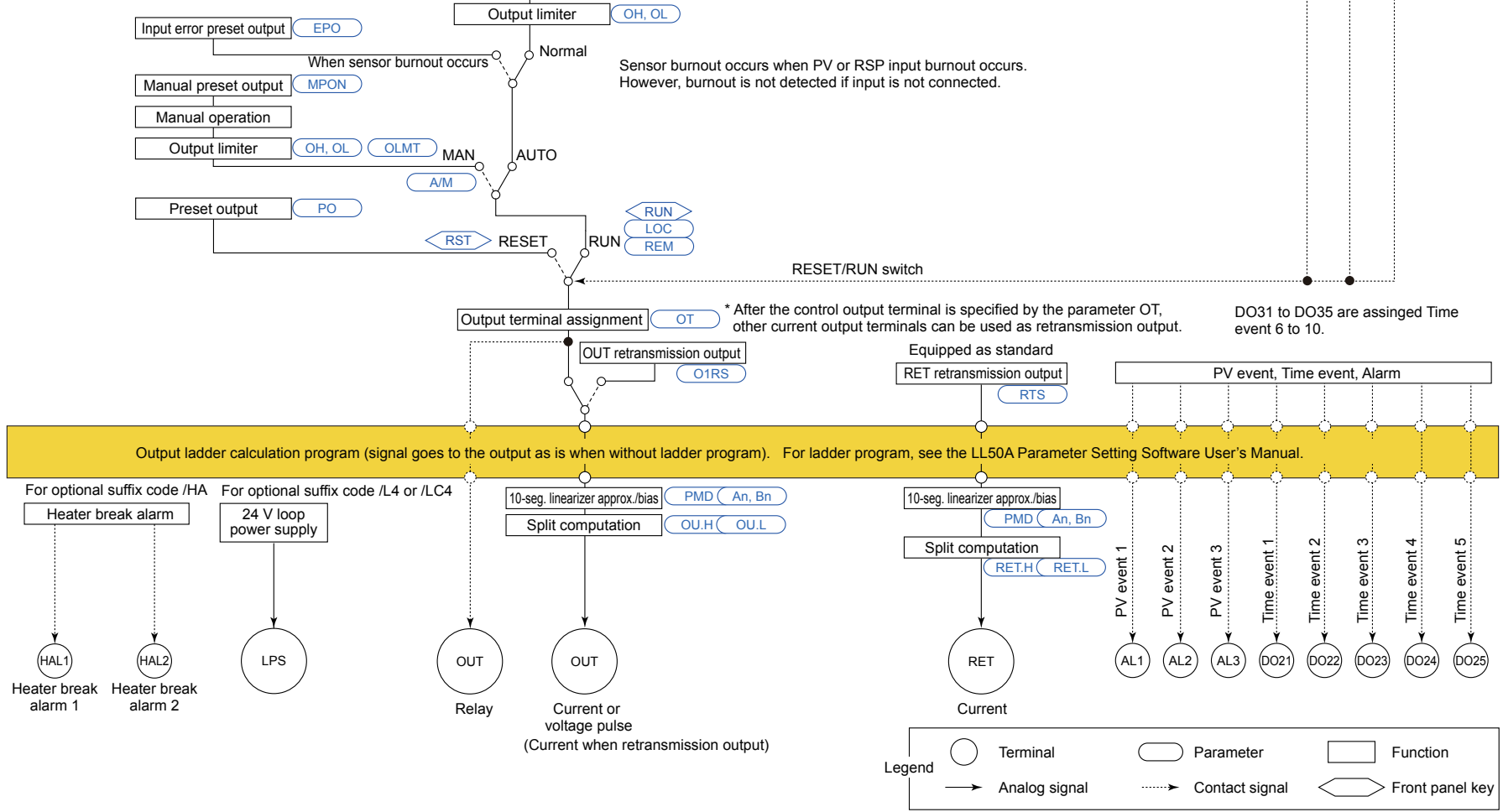
▶ [Contact output assignment to retransmission output terminal: 10.1 Setting Control Output Type](#)

▶ [Analog output range change: 10.14 Changing Current Output Range](#)

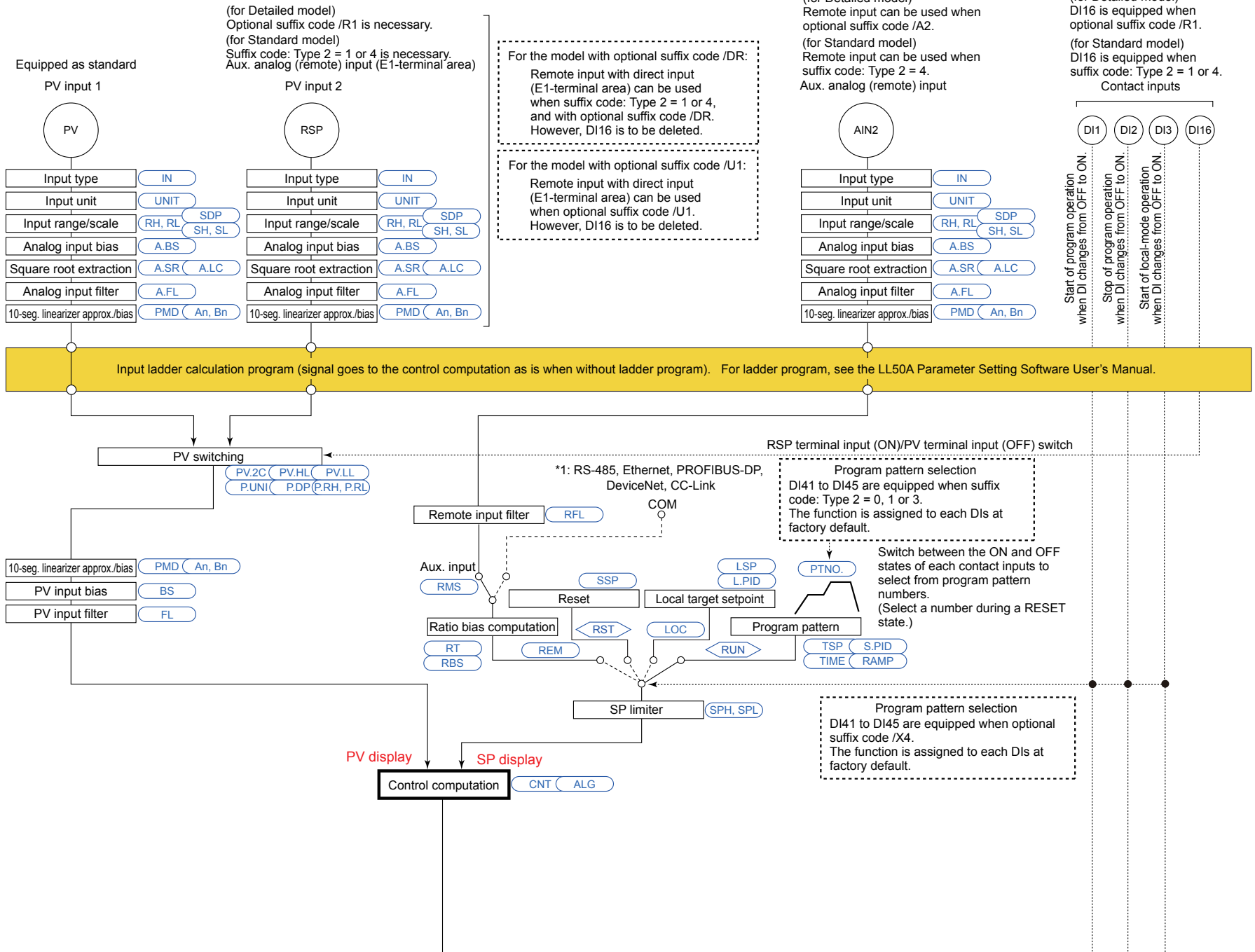


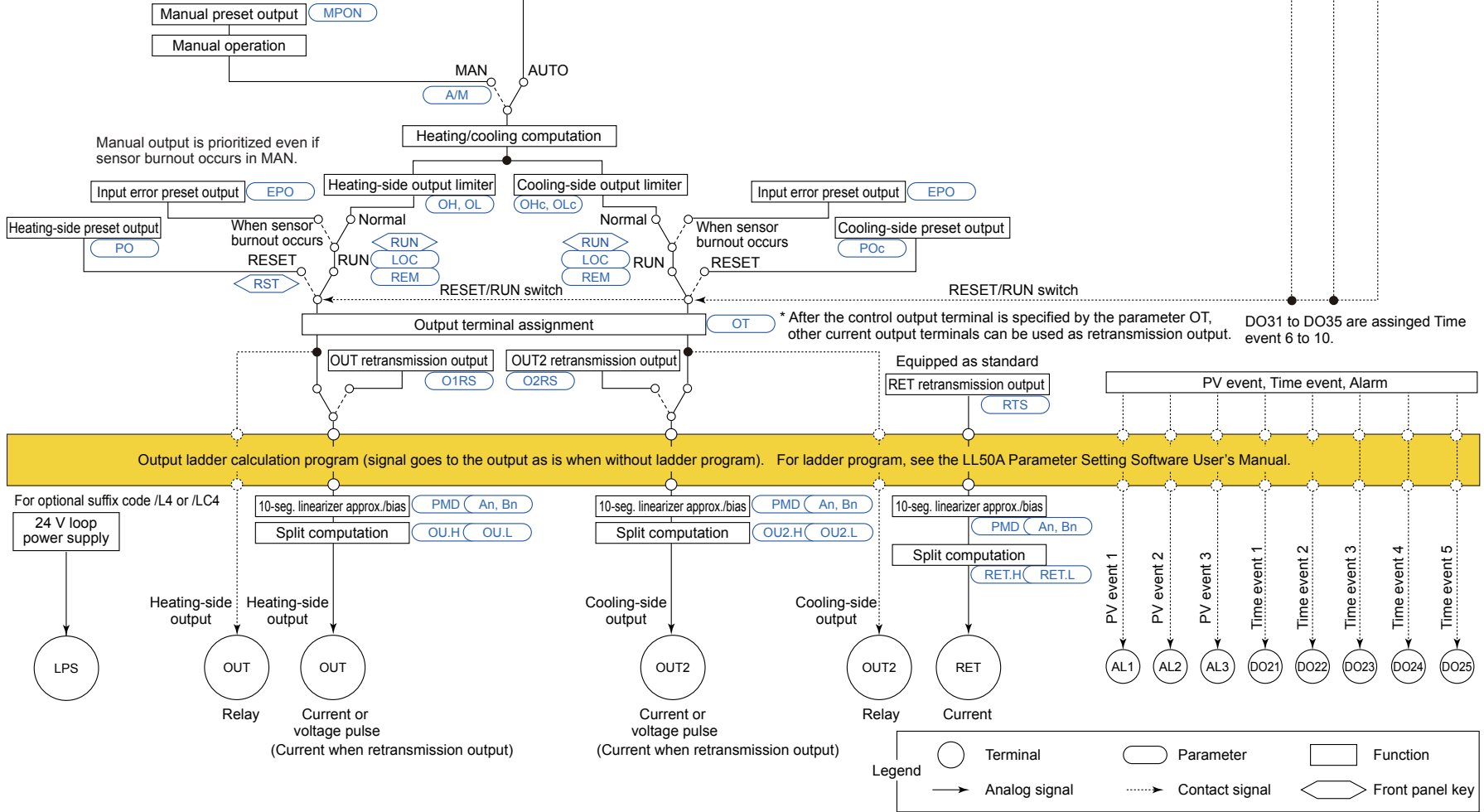
### Loop Control with PV Switching Function Block Diagram



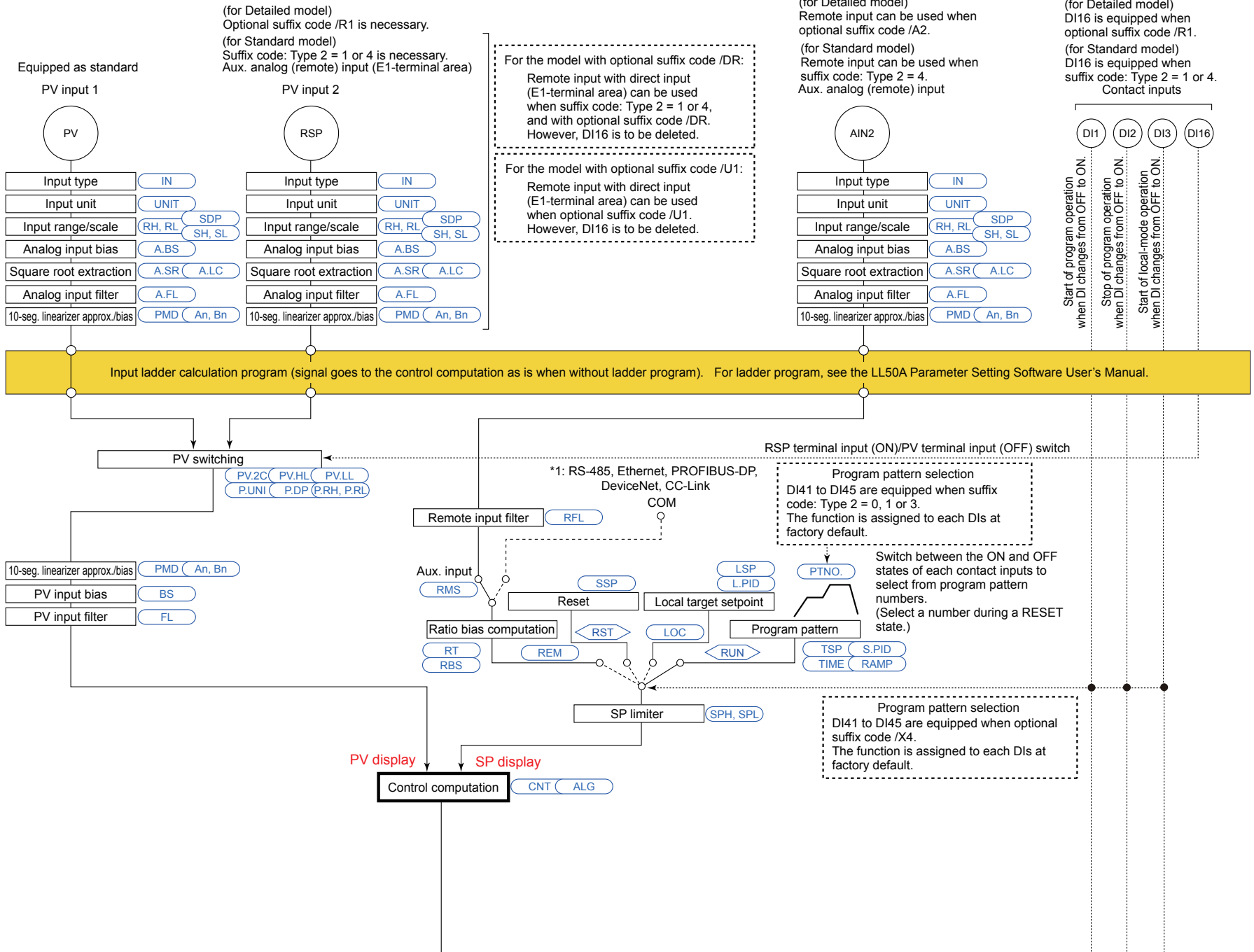


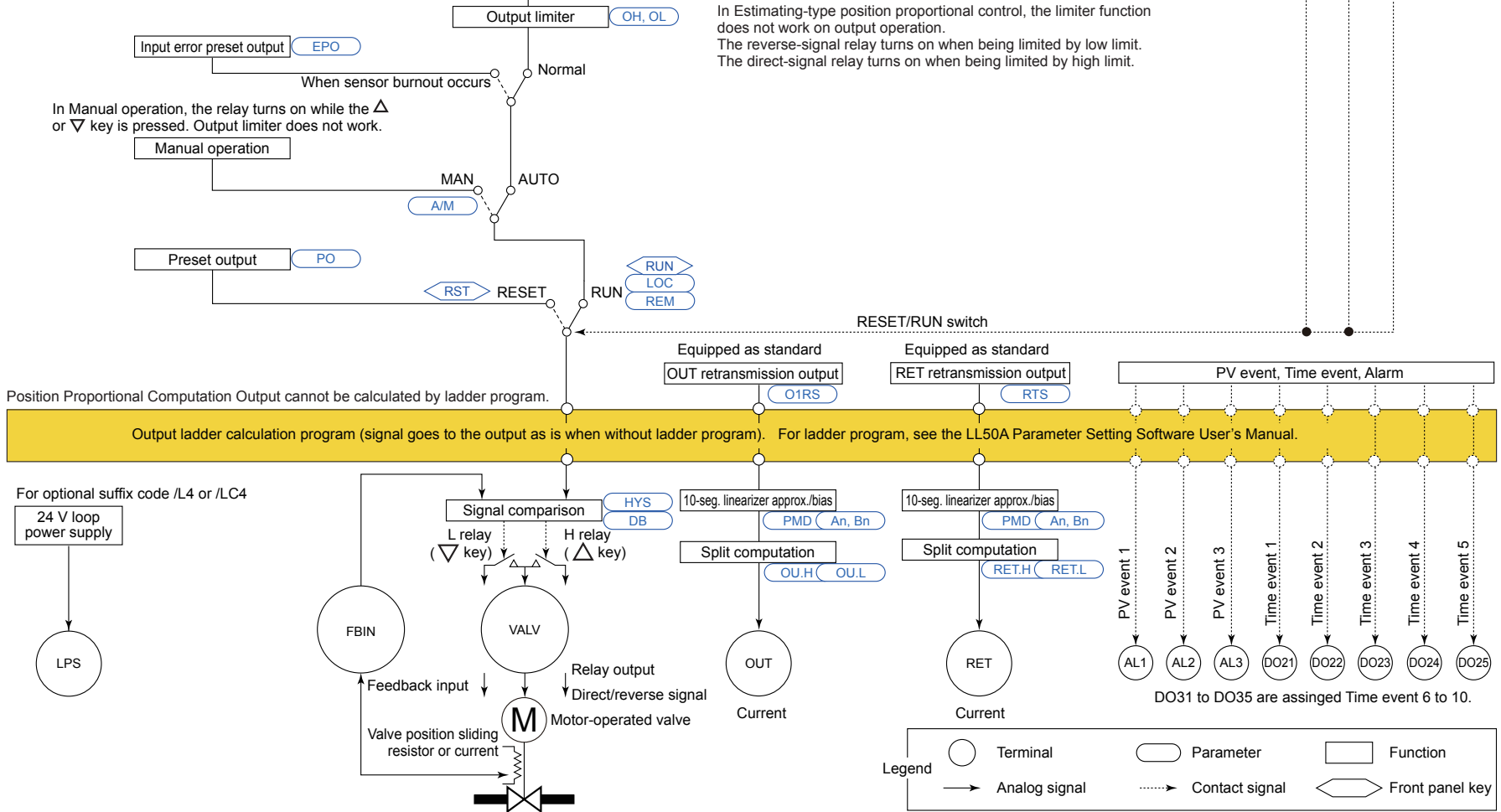
### ■ Heating/cooling Loop Control with PV Switching Function Block Diagram





### ■ Position Proportional Loop Control with PV Switching Function Block Diagram





In Estimating-type position proportional control, the limiter function does not work on output operation.  
The reverse-signal relay turns on when being limited by low limit.  
The direct-signal relay turns on when being limited by high limit.

## 8.1 Setting Control Mode (CTLM)

---

Intentionally blank

### 8.1.5 Loop Control with PV Auto-selector, Heating/cooling Loop Control with PV Auto-selector, and Position Proportional Loop Control with PV Auto-selector

#### Setting Details

Parameter symbol	Name	Display level	Setting range	Menu symbol
CTLM	Control mode	STD	SGL: Single-loop control CAS1: Cascade primary-loop control CAS: Cascade control PVSW: Loop control with PV switching PVSEL: Loop control with PV auto-selector	CTL <b>Set</b>

#### CAUTION

- Some parameters will be initialized if the control mode (CTLM) is changed.
- When using the ladder program, the control mode cannot be changed.

#### Description

These control modes automatically select or calculate the larger, the smaller, the average, or difference of multiple (two to four) PV inputs for control.

Loop control with PV auto-selector can be used for Standard type or Heating/cooling type controller.

Heating/cooling loop control with auto-selector can be used for Heating/cooling type controller.

Position proportional loop control with auto-selector can be used for Position proportional type controller.

▶ [PID control and Heating/cooling control: 8.2 Setting Control Type \(CNT\)](#)

Description about Loop control with PV auto-selector

▶ [Input selection: 7.4 Using Larger, Smaller, Average, or Difference of Two to Four Inputs as PV](#)

Up to four 10-segment linearizer approximation/10-segment linearizer biases can be used for the input unit or output unit.

The Function block diagram describes only the basic functions.

Parameter symbols in the Function block diagram describe representative parameters.

For the functions and parameters which are not described in Function block diagram, see the following.

▶ [Contact input assignment: 12.1 Setting Contact Input Function](#)

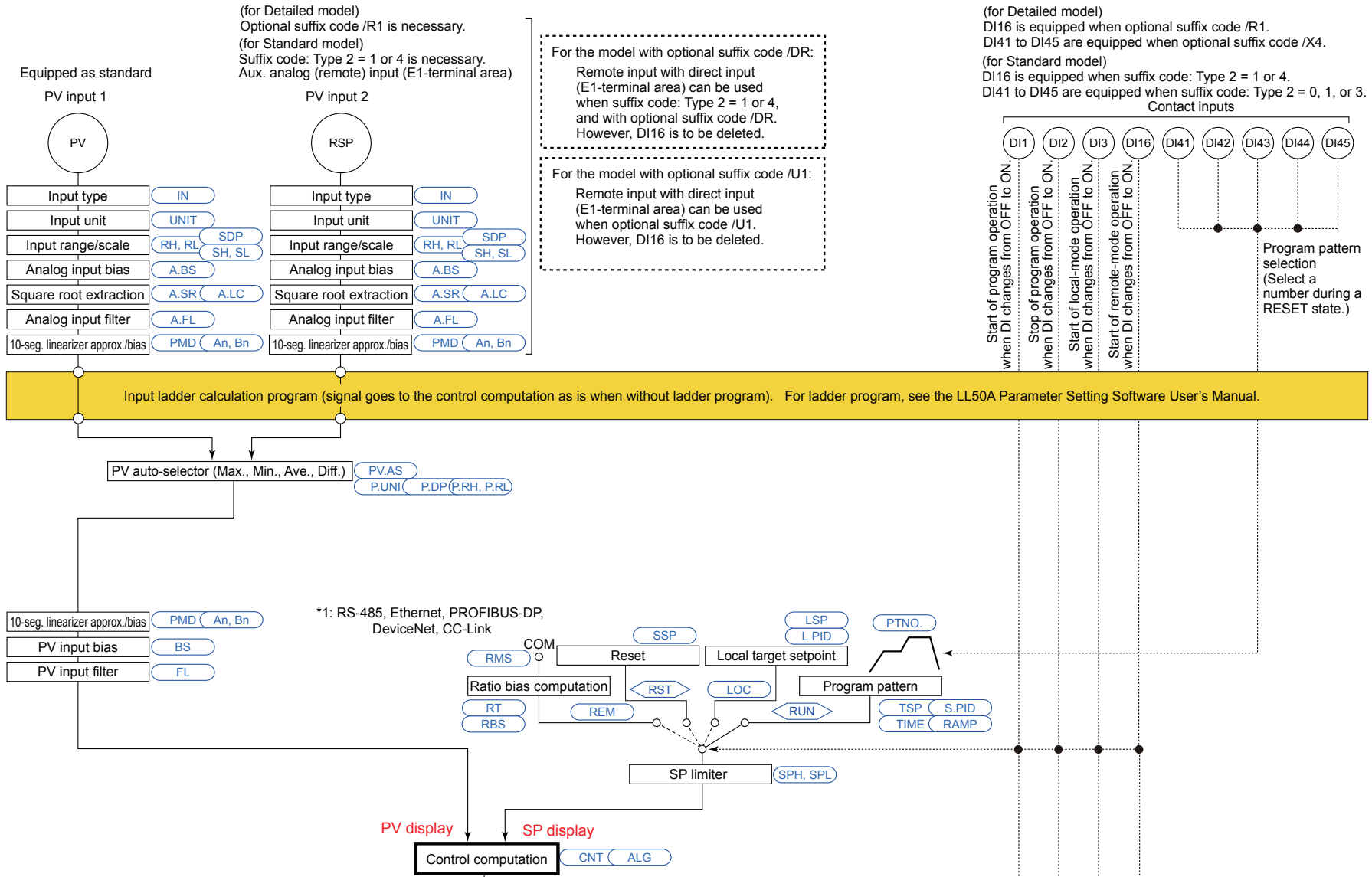
▶ [Contact output assignment: 12.2 Setting Contact Output Function](#)

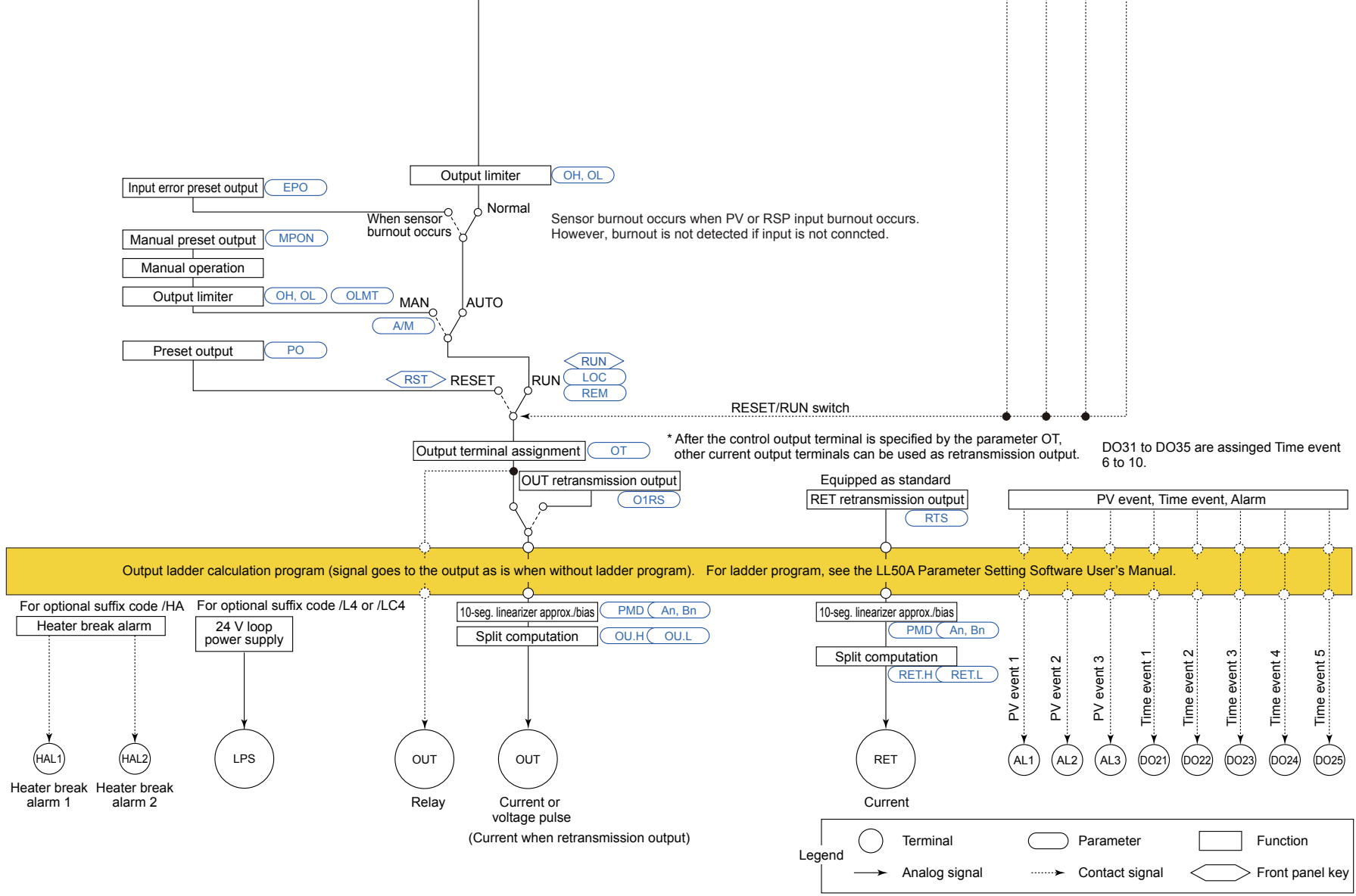
▶ [Contact output assignment to retransmission output terminal: 10.1 Setting Control Output Type](#)

▶ [Analog output range change: 10.14 Changing Current Output Range](#)

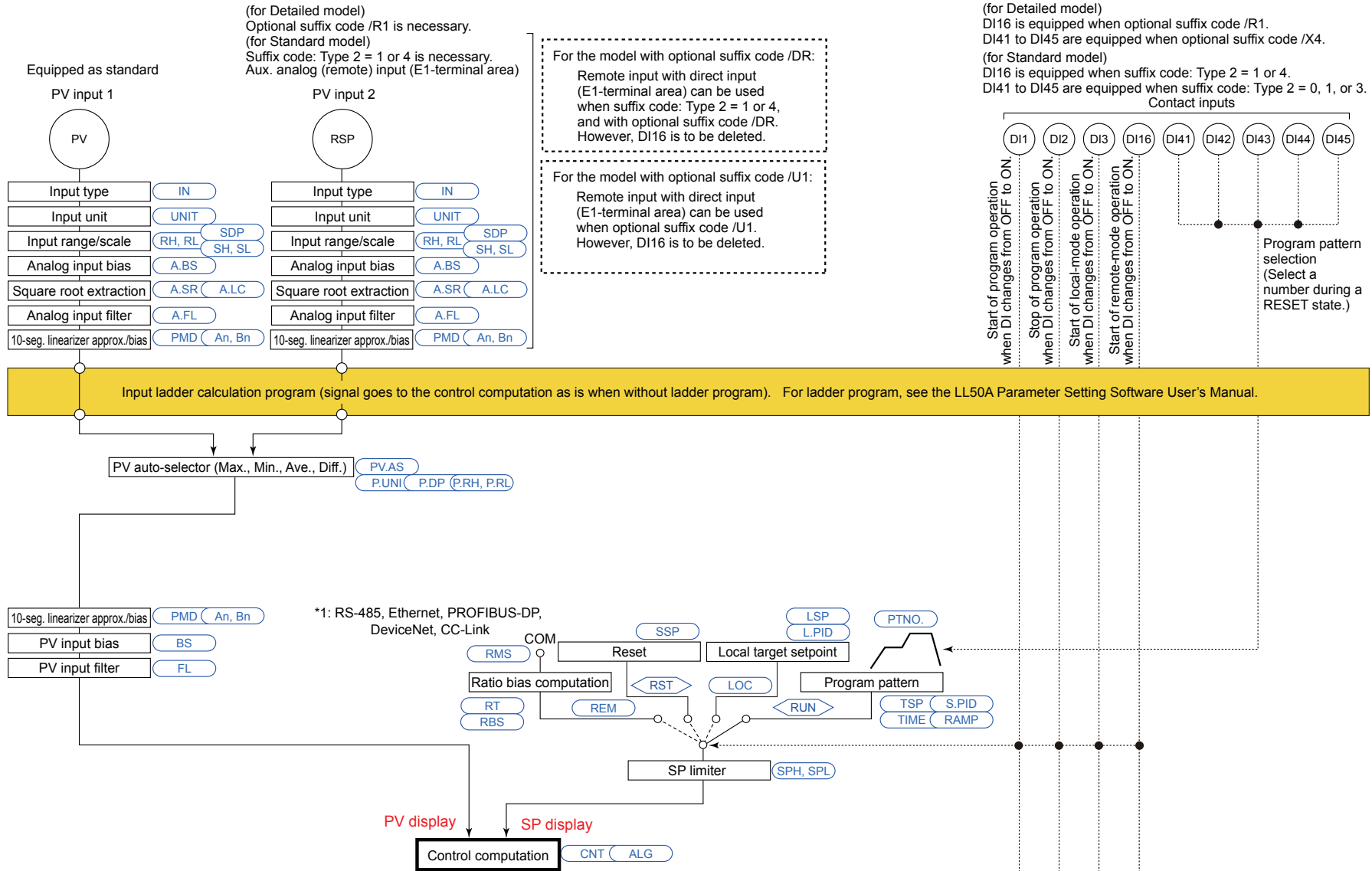


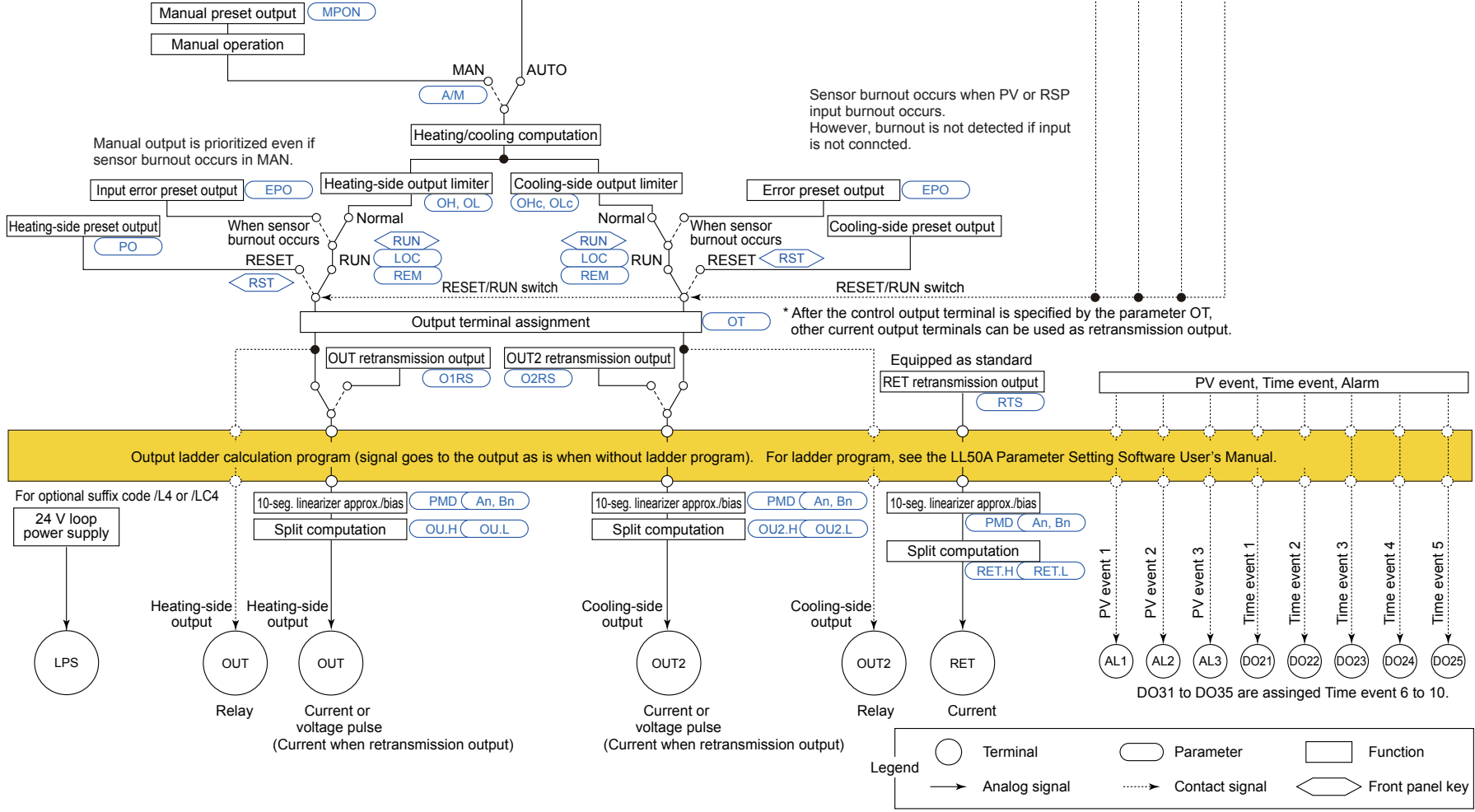
### Loop Control with PV Auto-selector (2 inputs) Function Block Diagram



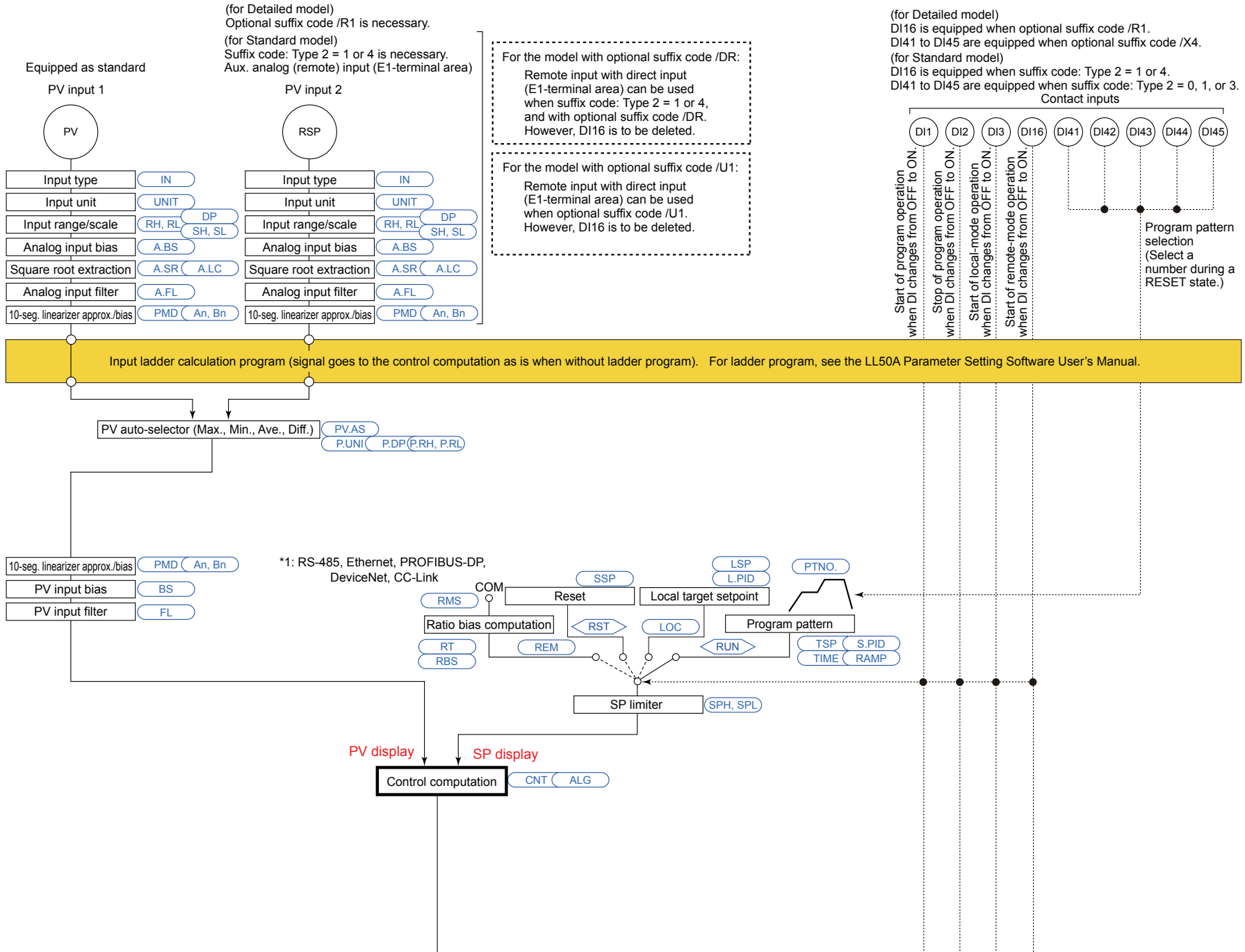


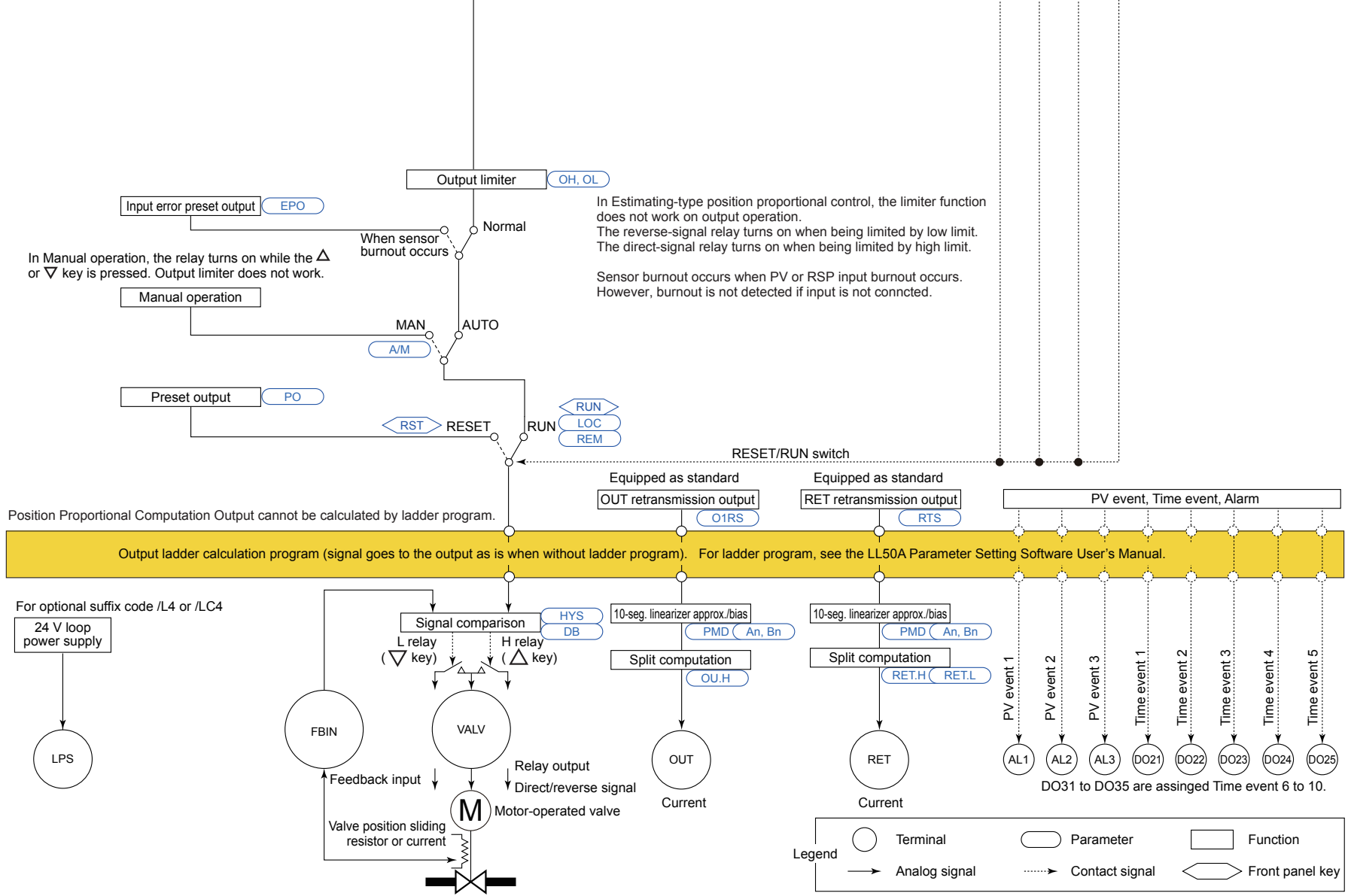
### ■ Heating/cooling Loop Control with PV Auto-selector (2 inputs) Function Block Diagram





### Position Proportional Loop Control with PV Auto-selector (2 inputs) Function Block Diagram





### ■ Loop Control with PV Auto-selector (4 inputs) Function Block Diagram

(for Detailed model) Optional suffix code /R1 is necessary.

For the model with optional suffix code /U1:  
Refer to the function block diagram of  
Loop control with PV auto-selector (2 inputs).

(for Standard model) Suffix code: Type 2 = 1 or 4 is necessary.

For the model with optional suffix code /DR:  
Refer to the function block diagram of  
Loop control with PV auto-selector (2 inputs).

Necessary for Loop control with PV auto-selector for 3 inputs or 4 inputs

(for Detailed model)  
When optional suffix code /A2

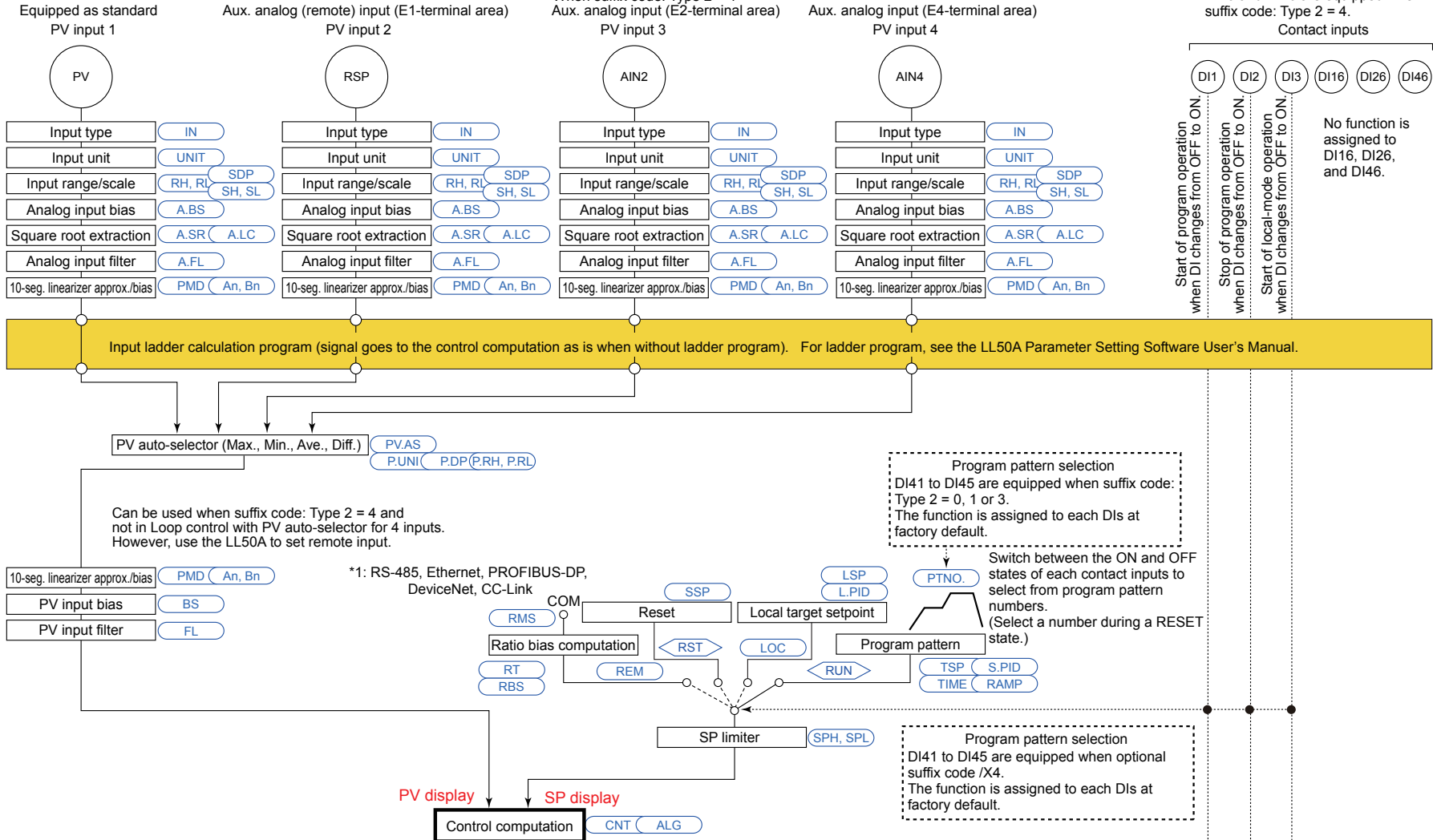
(for Standard model)  
When suffix code: Type 2 = 4  
Aux. analog input (E2-terminal area)

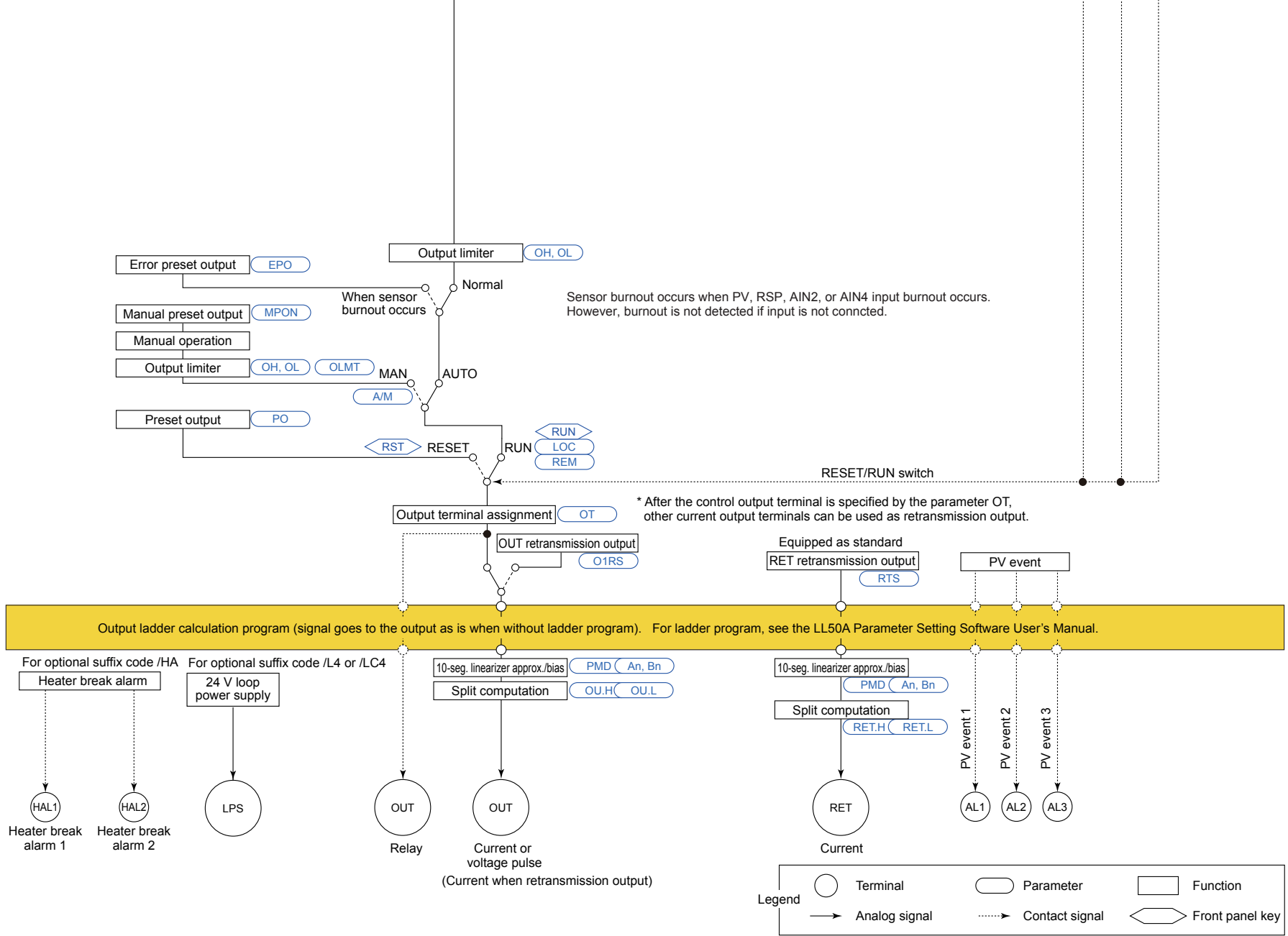
(for Detailed model)  
When optional suffix code /A4

(for Standard model)  
When suffix code: Type 2 = 4  
Aux. analog input (E4-terminal area)

(for Detailed model)  
DI16 is equipped when  
optional suffix code /R1.  
DI26 and DI46 are equipped when  
optional suffix code /A2 and /A4.

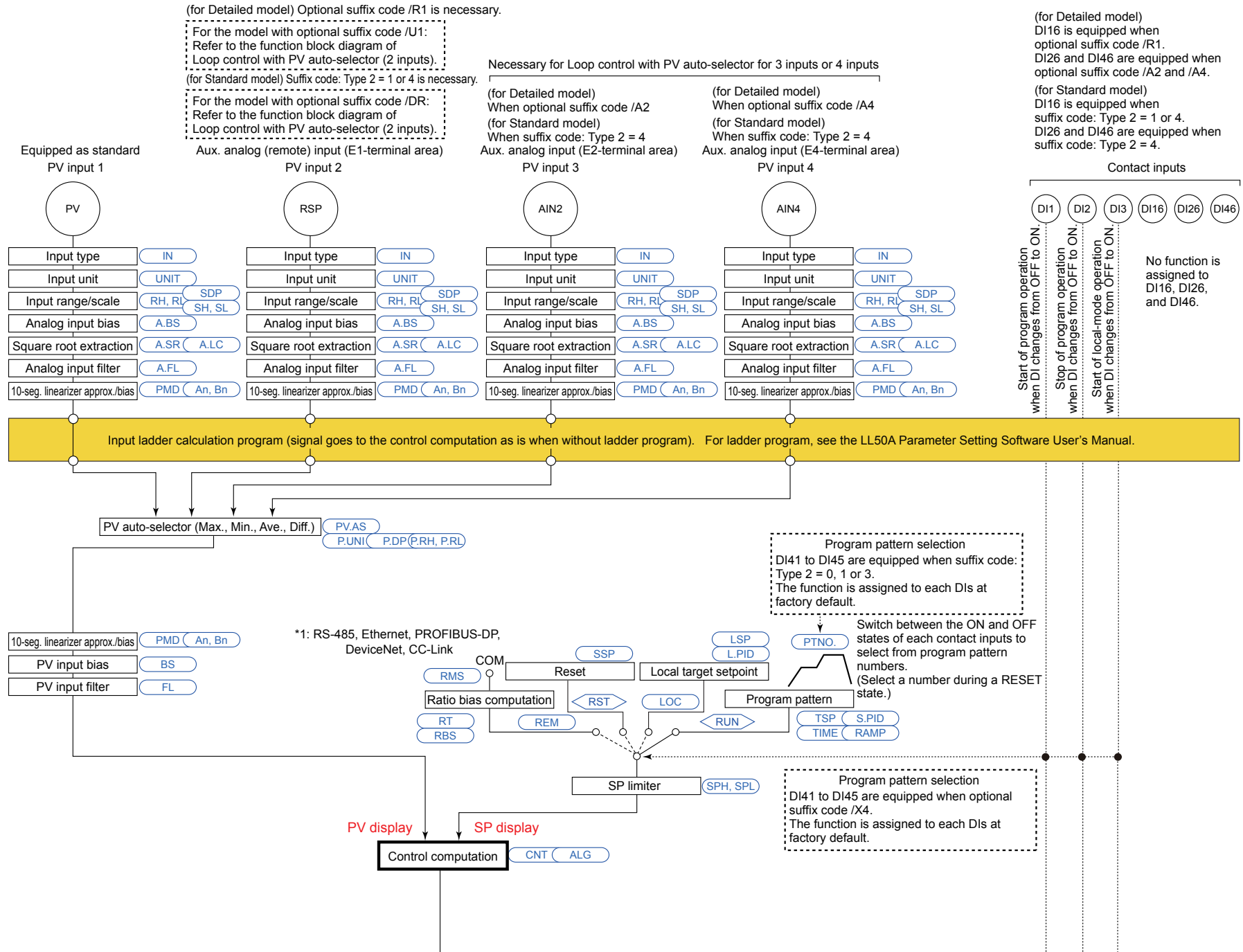
(for Standard model)  
DI16 is equipped when  
suffix code: Type 2 = 1 or 4.  
DI26 and DI46 are equipped when  
suffix code: Type 2 = 4.

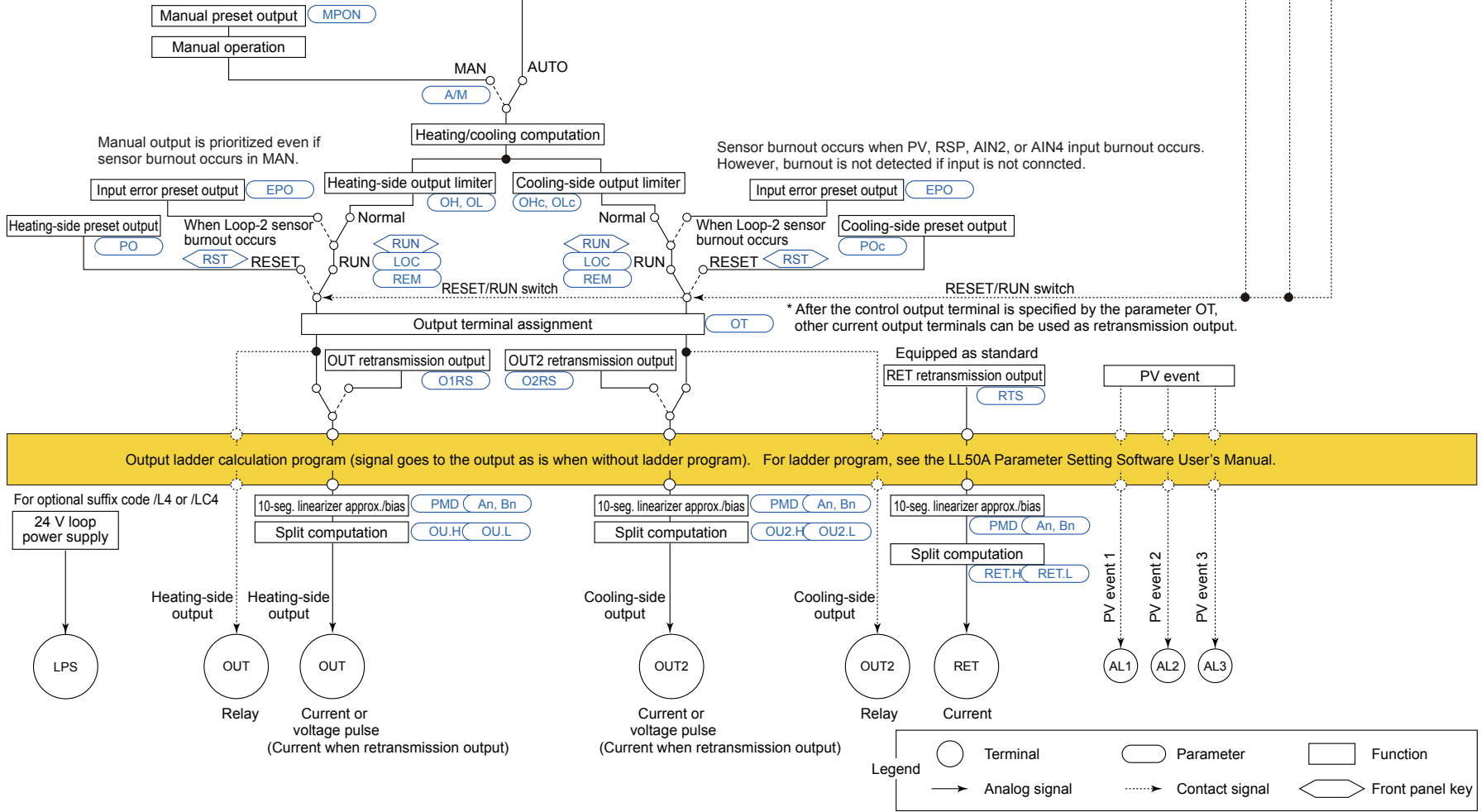




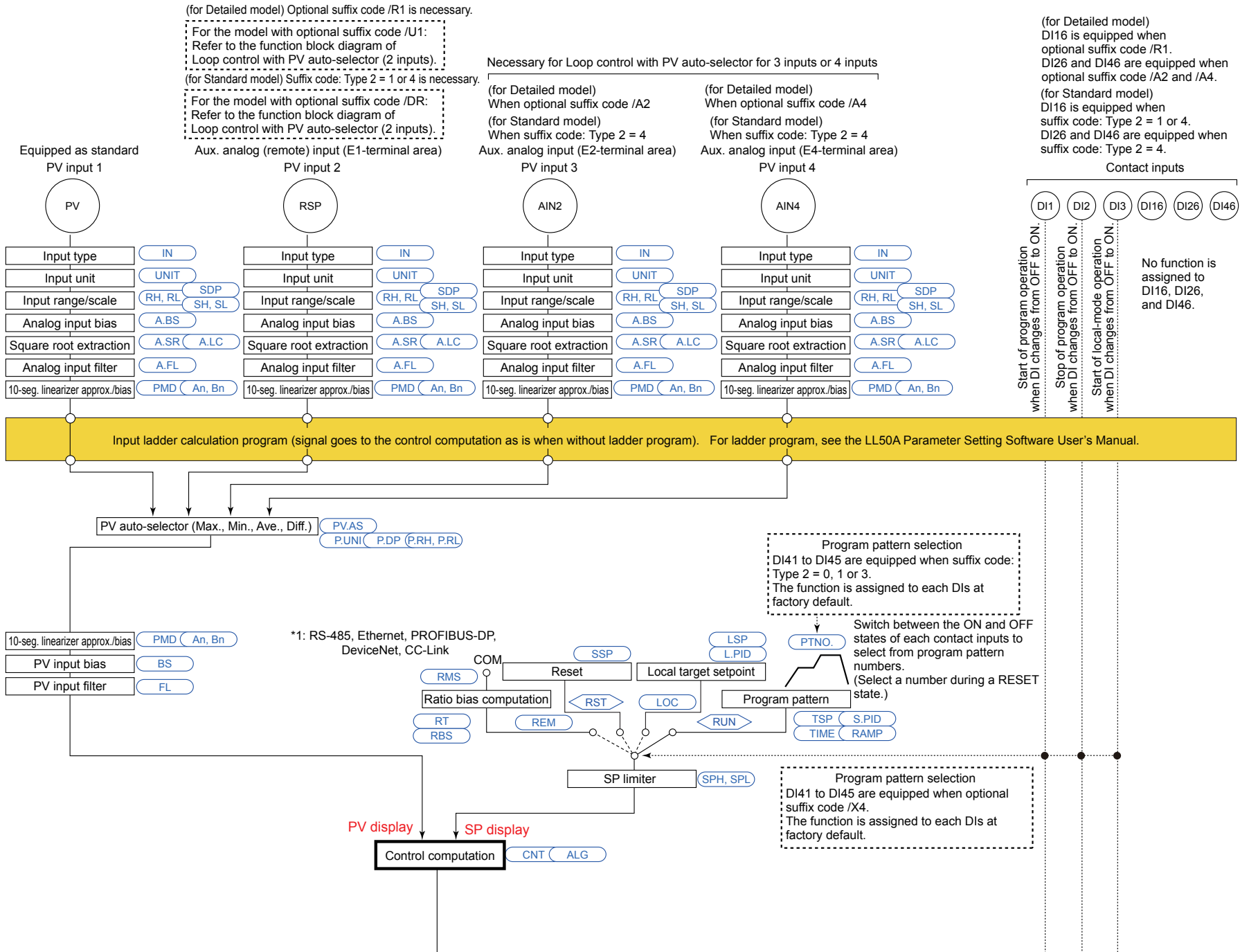


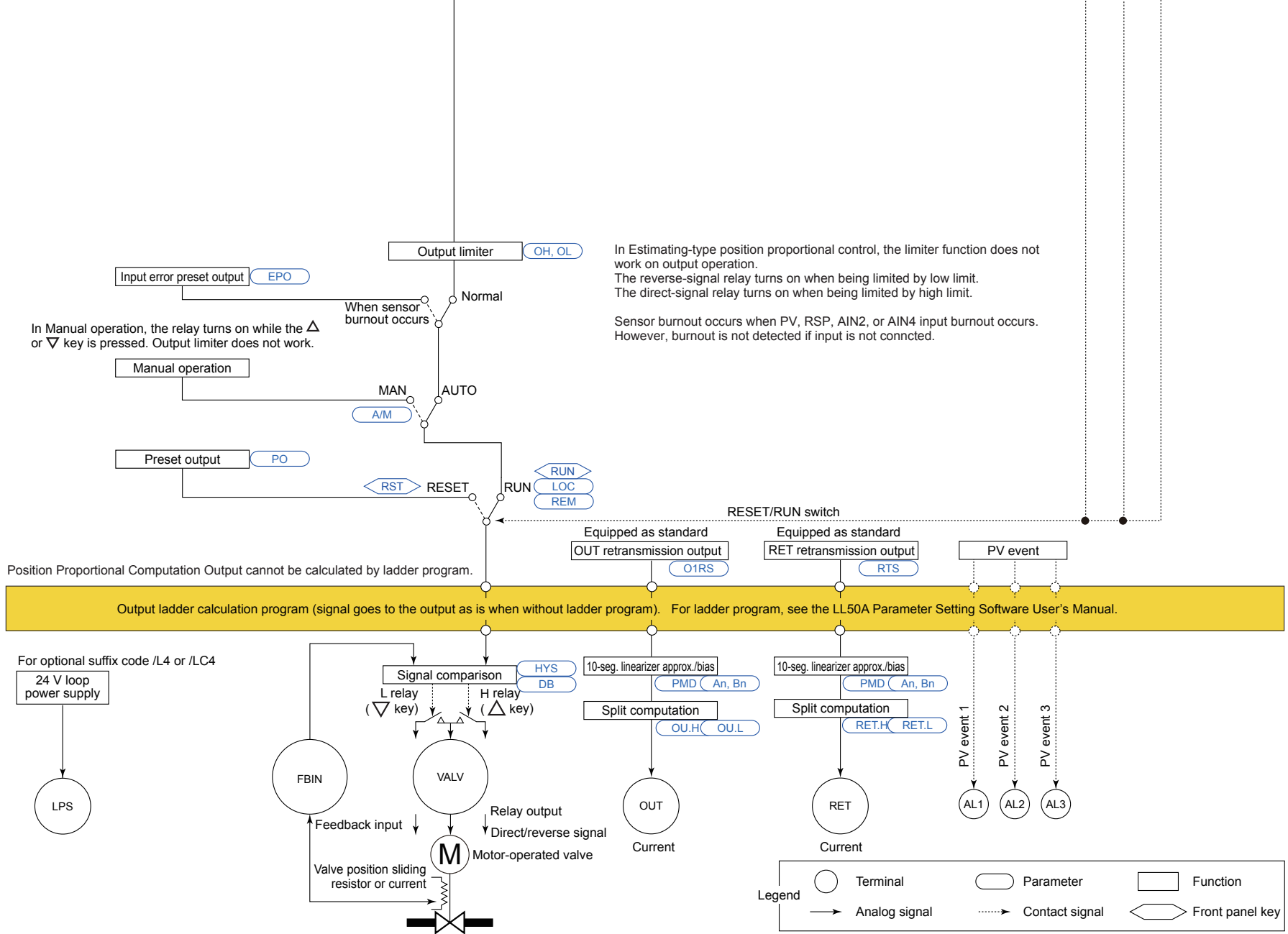
### ■ Heating/cooling Loop Control with PV Auto-selector (4 inputs) Function Block Diagram





### Position Proportional Loop Control with PV Auto-selector (4 inputs) Function Block Diagram





## 8.2 Setting Control Type (CNT)

The following table shows combination of Standard type, Heating/cooling type, Position proportional type and control type (CNT).

Control type	Suffix code: Type 1		
	Standard type	Heating/cooling type	Position proportional type
PID control	√	√	√
ON/OFF control (1 point of hysteresis)	√	√	N/A
ON/OFF control (2 points of hysteresis)	√	√	N/A
Heating/cooling control	N/A	√	N/A

√: Available, N/A: Not available

The following table shows combination of control type (CNT) and control mode (CTLM).

Control type	Control mode (CTLM)				
	SGL	CAS1	CAS	PVSW	PVSEL
PID control	√	√*1	√	√	√
ON/OFF control (1 point of hysteresis)	√*1	N/A	N/A	N/A	N/A
ON/OFF control (2 points of hysteresis)	√*1	N/A	N/A	N/A	N/A
Heating/cooling control	√*2	N/A	√*2	√*2	√*2

√: Available, N/A: Not available

\*1: Cannot be selected for Position proportional type.

\*2: Can be selected only for Heating/cooling type.

The following table shows combination of control type (CNT) and output type.

Control type	Output type			
	Current output	Time proportional output	ON/OFF output	Position proportional output
PID control	√	√	N/A	√
ON/OFF control (1 point of hysteresis)	√	N/A	√	N/A
ON/OFF control (2 points of hysteresis)	√	N/A	√	N/A
Heating/cooling control	√	√	√	N/A

√: Available, N/A: Not available

▶ [Output type: 10.1 Setting Control Output Type](#)

## 8.2.1 PID Control

## Description

PID control is a general control using control-related parameters PID.  
 PID should be obtained by adjusting manually or by auto-tunings at SP during program pattern operation, local target setpoint, or remote setpoint.

## Setting Details

Parameter symbol	Name	Display level	Setting range	Menu symbol
<b>CNT</b>	Control type	EASY	PID: PID control ONOF: ON/OFF control (1 point of hysteresis) ONOF2: ON/OFF control (2 points of hysteresis) H/C: Heating/cooling control	CTL <b>Set</b>
<b>P</b>	Proportional band Heating-side proportional band (in Heating/cooling control)	EASY	0.0 to 999.9% When 0.0% is set, it operates as 0.1%. Heating-side ON/OFF control applies when 0.0% in Heating/cooling control.	PID <b>Ope</b>
<b>I</b>	Integral time Heating-side integral time (in Heating/cooling control)	EASY	OFF: Disable 1 to 6000 s	
<b>D</b>	Derivative time Heating-side derivative time (in Heating/cooling control)	EASY	OFF: Disable 1 to 6000 s	
<b>Pc</b>	Cooling-side proportional band	EASY	0.0 to 999.9% Cooling-side ON/OFF control applies when 0.0% in Heating/cooling control.	
<b>Ic</b>	Cooling-side integral time	EASY	OFF: Disable 1 to 6000 s	
<b>Dc</b>	Cooling-side derivative time	EASY	OFF: Disable 1 to 6000 s	
<b>MR</b>	Manual reset	EASY	-5.0 to 105.0%	

Note 1: The PID number (1 to 8, or R) is displayed on Group display while the parameter P, I, D, Pc, Ic, Dc, or MR is displayed.

Note 2: In Cascade control, the LP2 lamp is lit while the Loop-2 parameter is displayed.

Note 3: The parameter CNT of Loop 2 displays PID and H/C.

8.2.2 ON/OFF Control (1 point of hysteresis / 2 points of hysteresis)

**Description**

ON/OFF control compares the SP and PV and outputs an on or off signal according to the positive or negative deviation (PV – SP). Hysteresis can be set in the vicinity of the on/off output operating point.

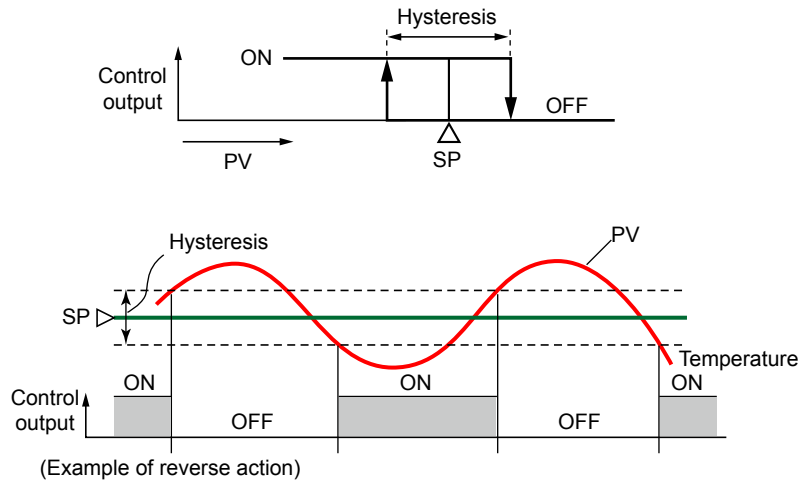
If the SP and PV become close and the polarity of the deviation reverses frequently, the on/off output will cycle repeatedly. The life of the output relay will therefore be dramatically shortened.

In such a case, set a wider hysteresis so that the relay’s frequent on/off output (chattering) will not occur.

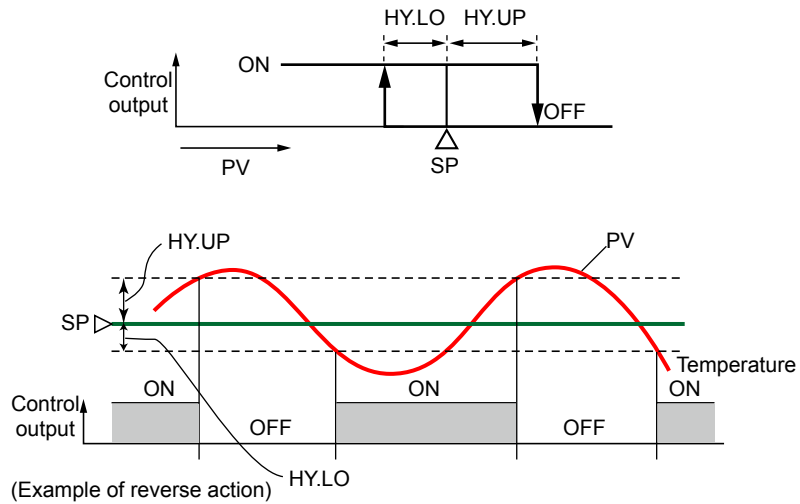
When the control type (CNT) is set to “ONOF,” one point of hysteresis can be set to the operating point.

When the control type (CNT) is set to “ONOF2,” two points of hysteresis (deviation positive hysteresis and deviation negative hysteresis) can be set to the operating point.

**1 point of hysteresis**



**2 points of hysteresis**



## Setting Details

Parameter symbol	Name	Display level	Setting range	Menu symbol
<b>CNT</b>	Control type	EASY	PID: PID control ONOF: ON/OFF control (1 point of hysteresis) ONOF2: ON/OFF control (2 points of hysteresis) H/C: Heating/cooling control	CTL <b>Set</b>
<b>HYS</b>	Hysteresis (in ON/OFF control, or Position proportional control) Heating-side ON/OFF control hysteresis (in Heating/cooling control)	EASY	In ON/OFF control: 0.0 to 100.0% of PV input range span (EUS) In Heating/cooling control or Position proportional control: 0.0 to 100.0%	PID <b>Ope</b>
<b>HY.UP</b>	Upper-side hysteresis (in ON/OFF control)	EASY	0.0 to 100.0% of PV input range span (EUS)	
<b>HY.LO</b>	Lower-side hysteresis (in ON/OFF control)	EASY		

Note1: The PID number (1 to 8, or R) is displayed on Group display while the parameter HYS, HY.UP or HY.LO is displayed.

Note2: In Cascade control, the LP2 lamp is lit while the Loop-2 parameter is displayed.



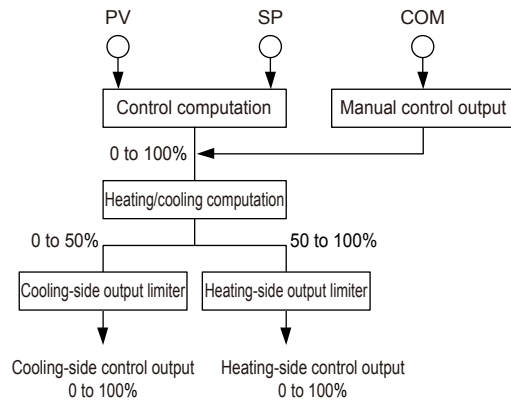
### 8.2.3 Heating/cooling Control

#### Description

Heating/cooling control can be used only for Heating/cooling type.

In Heating/cooling control, the controller outputs the result of computation after splitting it into heating-purpose and cooling-purpose signals. PID control or ON/OFF control can be selected for each of the heating side and the cooling side.

Set the heating-side proportional band to "0" to perform ON/OFF control on the heating side. Set the cooling-side proportional band to "0" to perform ON/OFF control on the cooling side.



#### Details of Heating/cooling Control

In Heating/cooling control, PID control or ON/OFF control can be selected for each of the heating side and the cooling side.

Set the proportional band to "0" to perform ON/OFF control.

The following describes the combination of heating side and cooling side.

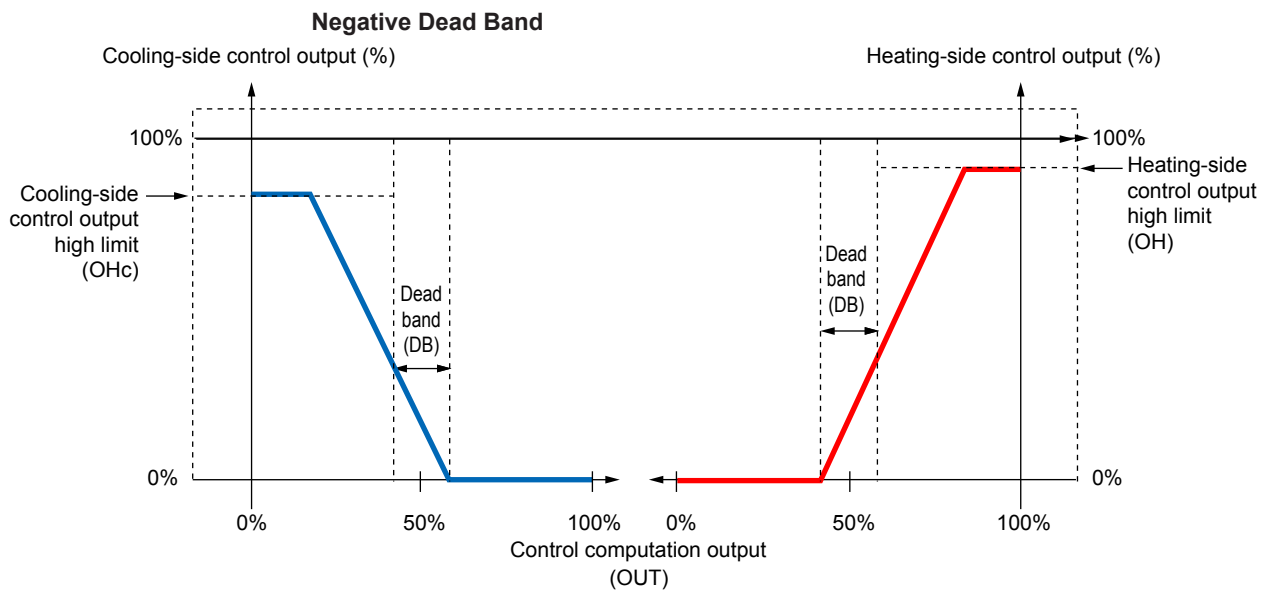
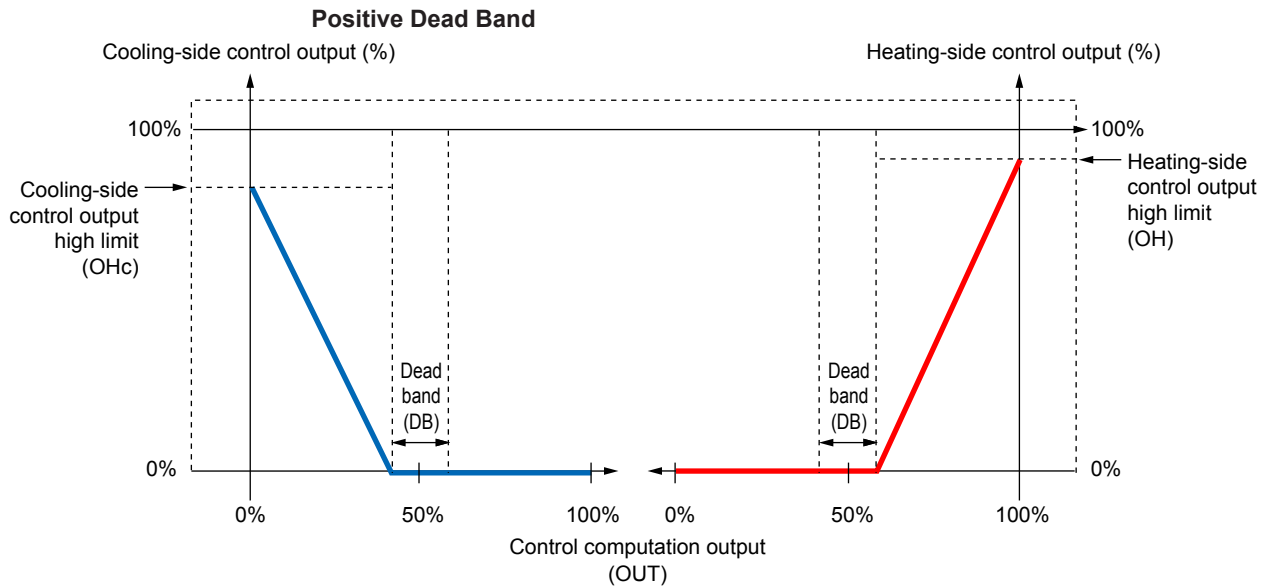
#### When Both the Heating Side and Cooling Side are in PID Control

The following shows the formula and operation example.

$$HOUT = ( OUT - \frac{DB}{2} - 50\% ) \times 2$$

$$COUT = ( 50\% - OUT - \frac{DB}{2} ) \times 2 \times \frac{P}{Pc}$$

\*: OUT: control output, HOUT: heating-side control output,  
COUT: cooling-side control output, P: heating-side proportional band,  
Pc: cooling-side proportional band, and DB: dead band



### CAUTION

- Set the ratio of the heating-side proportional band (P) to the cooling-side proportional band ( $P_c$ ) to within 1 to 5.
- Setting the heating-side or cooling-side integral time (I or  $I_c$ ) to "OFF" results in the integral time of both sides being set to "OFF."

## 8.2 Setting Control Type (CNT)

**When the Heating Side is in ON/OFF Control and the Cooling Side is in PID Control:**

The following shows the formula and operation example.

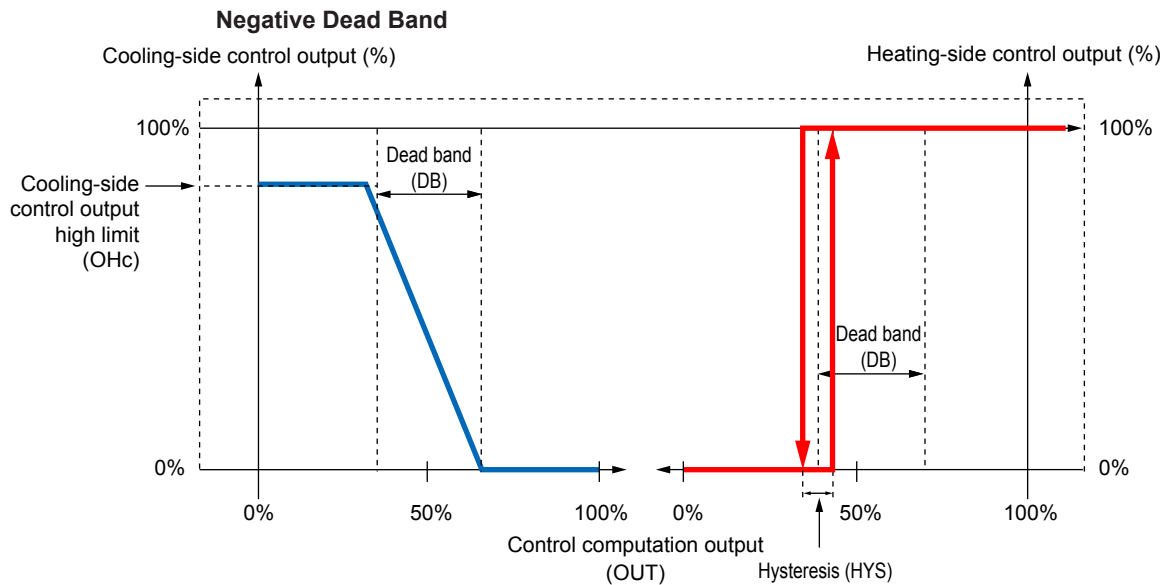
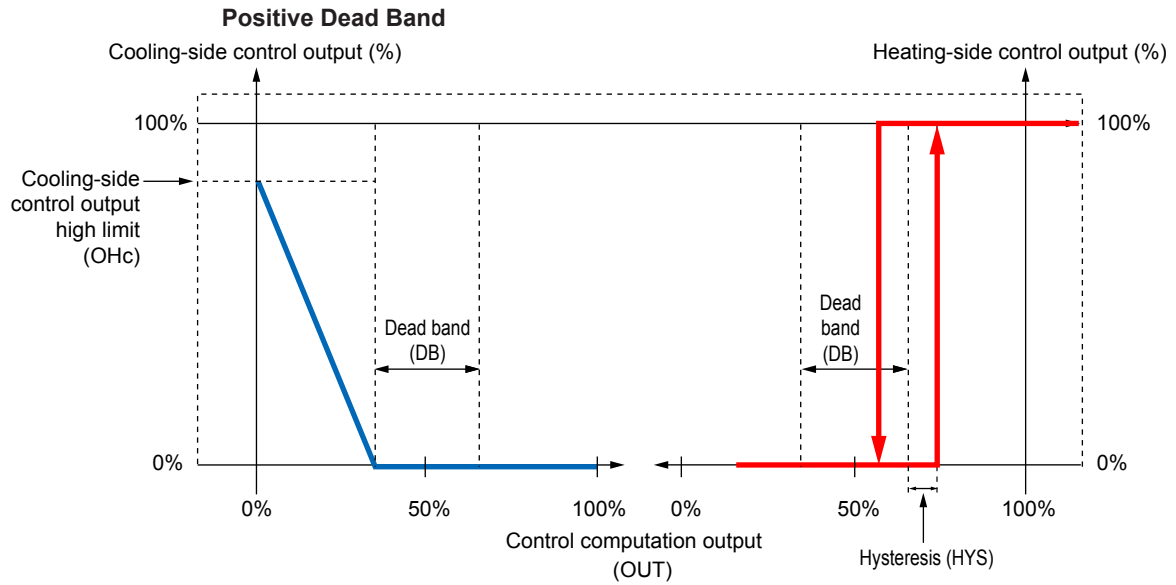
Output turns on when

$$HOUT = OUT > \left( 50\% + \frac{DB}{2} + \frac{HYS}{2} \right)$$

Other than this case, maintain current state.

$$COUT = \left( 50\% - OUT - \frac{DB}{2} \right) \times 2$$

\*: OUT: control output, HOUT: heating-side control output, COUT: cooling-side control output, DB: dead band, and HYS: heating-side hysteresis



**When the Heating Side is in PID Control and the Cooling Side is in ON/OFF Control:**

The following shows the formula and operation example.

$$HOUT = ( OUT - \frac{DB}{2} - 50\% ) \times 2$$

Output turns on when

$$COUT = OUT < ( 50\% - \frac{DB}{2} - \frac{HYSc}{2} )$$

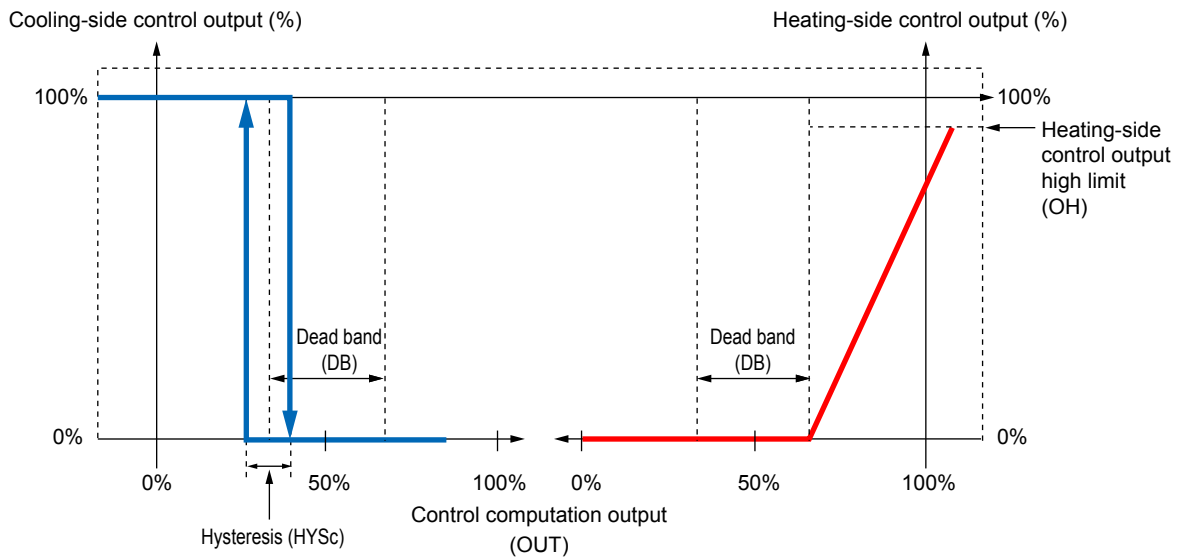
Output turns off when

$$OUT > ( 50\% + \frac{DB}{2} + \frac{HYSc}{2} )$$

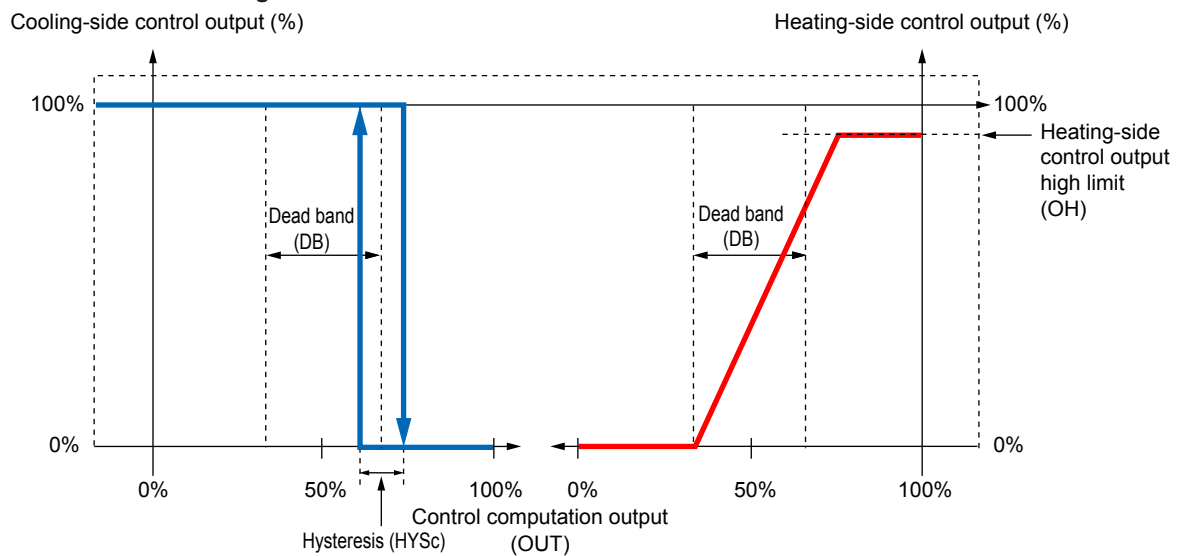
Other than these cases, maintain current state.

\*: OUT: control output, HOUT: heating-side control output, COUT: cooling-side control output, DB: dead band, and HYSc: cooling-side hysteresis

**Positive Dead Band**



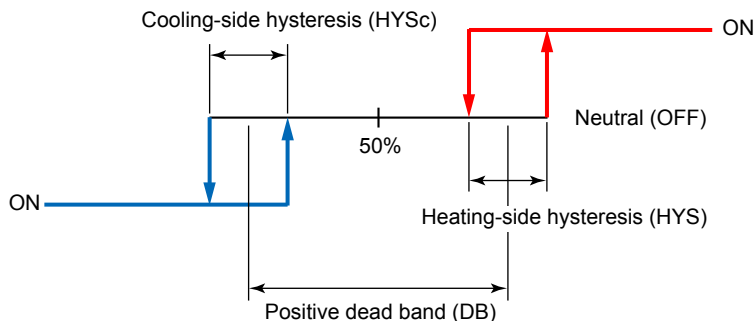
**Negative Dead Band**



## 8.2 Setting Control Type (CNT)

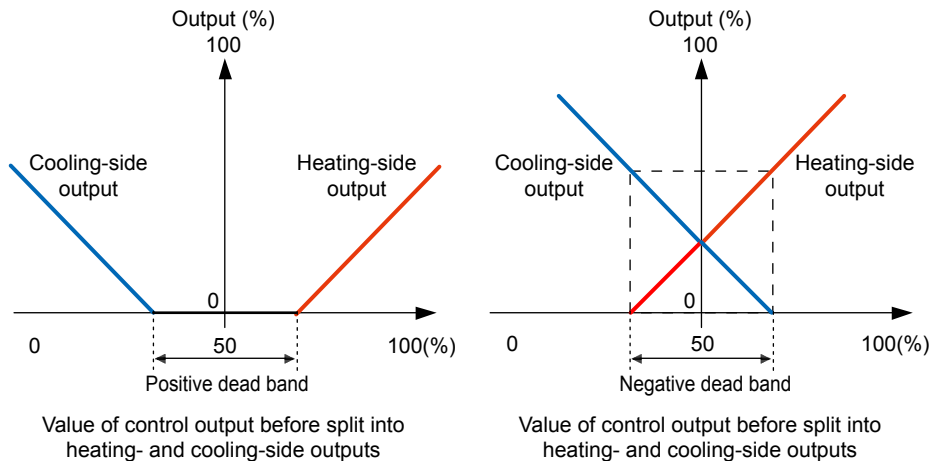
### When both the Heating Side and Cooling Side are in ON/OFF Control:

The following shows the operation example.



### Dead Band (DB)

In Heating/cooling control, the positive dead band denotes the zone where none of the heating-side and cooling-side outputs are presented. The negative dead band denotes the zone where both of the heating-side and cooling-side outputs are presented.



### Setting Details

Parameter symbol	Name	Display level	Setting range	Menu symbol
<b>CNT</b>	Control type	EASY	PID: PID control ONOF: ON/OFF control (1 point of hysteresis) ONOF2: ON/OFF control (2 points of hysteresis) H/C: Heating/cooling control	CTL <b>Set</b>
<b>HYS</b>	Hysteresis (in ON/OFF control, or Position proportional control) Heating-side ON/OFF control hysteresis (in Heating/cooling control)	EASY	In ON/OFF control: 0.0 to 100.0% of PV input range span (EUS) In Heating/cooling control or Position proportional control: 0.0 to 100.0%	PID <b>Ope</b>
<b>HYSc</b>	Cooling-side ON/OFF control hysteresis	EASY	0.0 to 100.0%	
<b>DB</b>	Output dead band (in Heating/cooling control or Position proportional control)	EASY	In Heating/cooling control: -100.0 to 50.0% In Position proportional control: 1.0 to 10.0%	

Note1: The PID number (1 to 8, or R) is displayed on Group display while the parameter HYS, HYSc, or DB is displayed.

Note2: In Cascade control, the LP2 lamp is lit while the Loop-2 parameter is displayed.

## 8.2.4 PD Control (Stable Control in Which a Setpoint is not Exceeded)

### Description

This control type performs control in which integral action (I action) is excluded from PID action.

Set the integral time (I or I<sub>c</sub>) to OFF.

It is useful when stable control in which a setpoint is not exceeded is desired for integral processes in which constant flows are delivered.

The following shows the PID control computation formula.

$$\text{OUT} = \frac{100}{P} \left( e + T_d \frac{d}{dt} \cdot \Delta PV \right) + \text{MR}$$

where OUT: control output, e: deviation (PV-SP), P: proportional band, T<sub>d</sub>: derivative time, ΔPV: PV<sub>n</sub>-PV<sub>n-1</sub> (n-1: value before one control period), and MR: manual reset

The following table shows combination of PD control and control mode (CTLM).

	Control mode (CTLM)				
	SGL	CAS1	CAS	PVSW	PVSEL
PD control	√	N/A	√	√	√

√: Available, N/A: Not available

The following table shows combination of PD control and output method.

	Output method			
	Current output	Time proportional output	ON/OFF output	Position proportional output
PD control	√	√	N/A	√

√: Available, N/A: Not available

### Setting Details

Parameter symbol	Name	Display level	Setting range	Menu symbol
<b>P</b>	Proportional band	EASY	0.0 to 999.9% When 0.0% is set, it operates as 0.1%.	PID <b>Ope</b>
<b>D</b>	Derivative time	EASY	OFF: Disable 1 to 6000 s	
<b>MR</b>	Manual reset	EASY	-5.0 to 105.0%	

Note1: The PID number (1 to 8, or R) is displayed on Group display while the parameter P, D, or MR is displayed.

## 8.3 Setting PID Control Mode (ALG)

### Description

There are two PID control modes: standard PID control mode and fixed-point control mode.

Select a PID control computation formula shown in the following table according to the control mode or operation mode.

Single-loop Control, Cascade Primary-loop Control, Loop Control with PV Switching, Loop Control with PV Auto-selector

	Operation mode			
	Program operation PRG+AUTO	Program operation (when in hold operation) PRG+AUTO	Local operation LOC+AUTO	Remote operation REM+AUTO
Standard PID control mode	Deviation derivative type	PV derivative type (output bump at SP change)	PV derivative type (output bump at SP change)	Deviation derivative type
Fixed-point control mode	PV derivative type (output bump at SP change)	PV derivative type (output bumpless at SP change)	PV derivative type (output bumpless at SP change)	PV derivative type (output bump at SP change)

Cascade Control

	Operation mode			
	Primary-loop			
	Program operation PRG+CAS	Program operation (when in hold operation) PRG+CAS	Local operation LOC+CAS	Remote operation REM+CAS
Standard PID control mode	Deviation derivative type	PV derivative type (output bump at SP change)	PV derivative type (output bump at SP change)	Deviation derivative type
Fixed-point control mode	PV derivative type (output bump at SP change)	PV derivative type (output bumpless at SP change)	PV derivative type (output bump at SP change)	PV derivative type (output bump at SP change)

	Operation mode	
	Secondary-loop	
	Local operation LSP+AUTO	Cascade operation CAS+AUTO
Standard PID control mode	PV derivative type (output bump at SP change)	Deviation derivative type
Fixed-point control mode	PV derivative type (output bumpless at SP change)	PV derivative type (output bump at SP change)

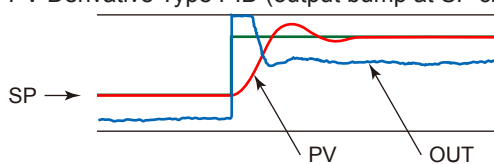
### PV Derivative Type PID

This is a PID control method in which the derivative action works only on the PV. It can also eliminate output bump due to SP changing operation in Local mode. The following shows the PV derivative type PID control computation formula.

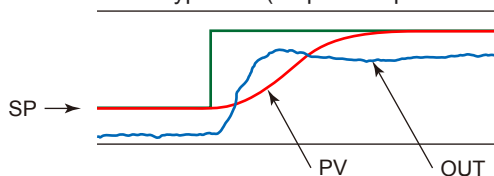
$$OUT = \frac{100}{P} \left( e + \frac{1}{T_i} \int e \cdot dt + T_d \frac{d}{dt} \cdot \Delta PV \right)$$

where OUT: control output, e: deviation (PV-SP), P: proportional band, Ti: integral time, Td: derivative time, and  $\Delta PV$ :  $PV_n - PV_{n-1}$  (n-1: value before one control period)

PV Derivative Type PID (output bump at SP change)



PV Derivative Type PID (output bumpless at SP change)



**Deviation Derivative Type PID**

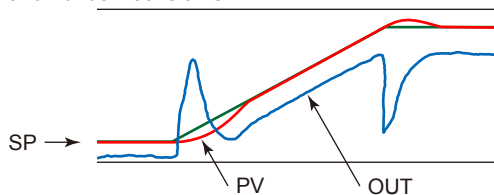
The PID control method in which derivative action works for the deviation value = PV – SP.

The derivative action works for a SP change, so this method is useful for cases like Cascade secondary-loop control where the SP-following capability is important.

The following shows the deviation derivative type PID control computation formula.

$$OUT = \frac{100}{P} \left( e + \frac{1}{Ti} \int e \cdot dt + Td \frac{d}{dt} \cdot e \right)$$

where OUT: control output, e: deviation (PV-SP), P: proportional band, Ti: integral time, and Td: derivative time



**Setting Details**

Parameter symbol	Name	Display level	Setting range	Menu symbol
ALG	PID control mode	PRO	0: Standard PID control mode 1: Fixed-point control mode.	CTL <b>Set</b>



## 8.4 Switching PID

### 8.4.1 Switching PID According to Target Setpoint Number (SPNO)

#### Description

The segment PID selection selects a group of PID parameters according to switching segment of the program pattern.

The segment PID number selection (S.PID) can be set for each segment.

For the operation except the program pattern operation, the PID parameter is selected by the PID number which is specified in the parameter L.PID (Local PID number selection).

#### Setting Details

Parameter symbol	Name	Display level	Setting range	Menu symbol
<b>ZON</b>	Zone PID selection	STD	0: Segment PID selection 1: Zone PID selection (selection by PV) 2: Zone PID selection (selection by target SP) 4: Zone PID selection (selection by SP) 5: Local PID selection	CTL <b>Set</b>
<b>S.PID</b>	Segment PID number selection	EASY	1 to 8	PROG <b>Prog</b>
<b>L.PID</b>	Local PID number selection	EASY	1 to 8	LOC <b>Ope</b>
<b>PID</b>	PID number (display only)	EASY	1 to 8	MODE <b>Ope</b>

Note 1: A currently-used PID number is displayed for the parameter PID.

## 8.4.2 Switching PID According to PV

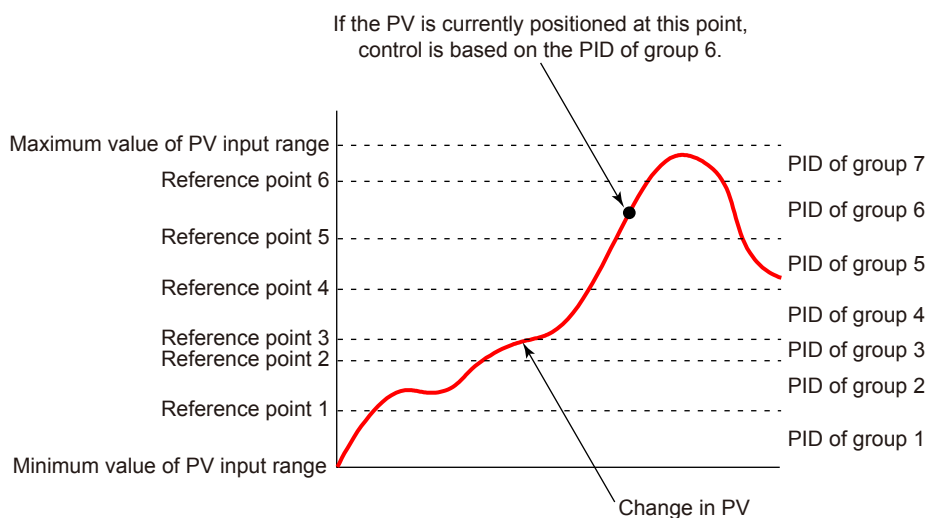
### Description

The PID switching according to PV is a function that switches between the groups of PID parameters according to the PV.

The maximum number of PID groups to be switched is 8. (Set RP1 to RP7.)

This function is useful for reactors in which the chemical reaction gain changes depending on the temperature.

The figure below shows an example of dividing the PV input range from the maximum value to the minimum value into seven zones by reference points 1 to 6. (Set RP1 to RP6.)



The PV input range can be divided into the number of zones that is set in the reference point.

Hysteresis at the time of zone switch can be set.

► [Setpoint PD: 8.4.6 Setting Hysteresis at Time of Zone Switch](#)

Reference deviation can be set at the same time.

► [Reference deviation: 8.4.5 Switching PID according to Deviation \(Reference Deviation\)](#)

### Setting Details

Parameter symbol	Name	Display level	Setting range	Menu symbol
<b>ZON</b>	Zone PID selection	STD	0: Segment PID selection 1: Zone PID selection (selection by PV) 2: Zone PID selection (selection by target SP) 4: Zone PID selection (selection by SP) 5: Local PID selection	CTL <b>Set</b>
<b>RP1 to RP7</b>	Reference point 1 to 7	STD	0.0 to 100.0% of PV input range (EU) ( $RP1 \leq RP2 \leq RP3 \leq RP4 \leq RP5 \leq RP6 \leq RP7$ )	ZONE <b>Ope</b>
<b>PID</b>	PID number (display only)	EASY	1 to 8, R: PID group for reference deviation	MODE <b>Ope</b>

Note1: In Cascade control, the LP2 lamp is lit while the Loop-2 parameter is displayed.

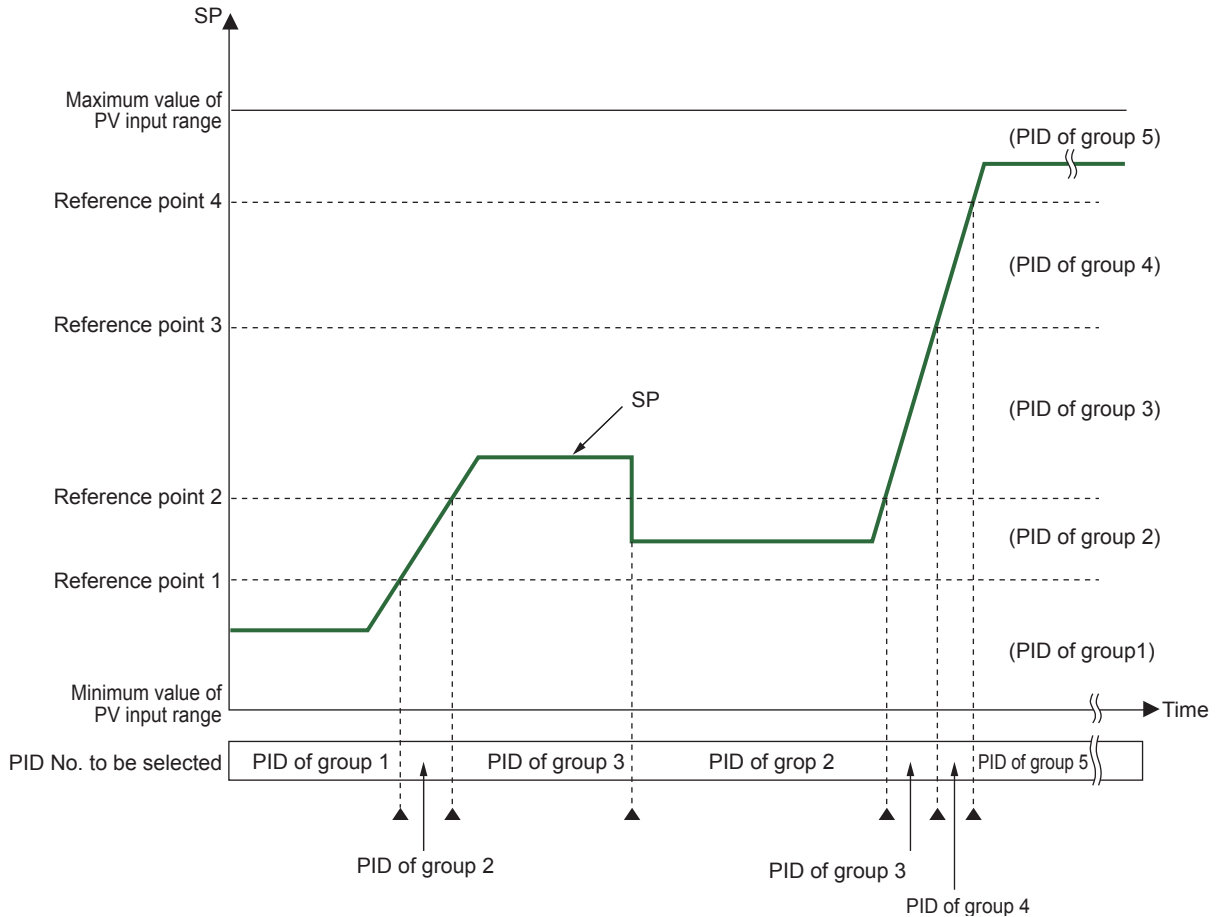
Note2: A currently-used PID number is displayed for the parameter PID.

8.4.3 Switching PID According to SP

**Description**

The zone PID selection by SP switches between the groups of PID parameters according to the SP. The maximum number of PID groups to be switched is 8. (Set RP1 to RP7)

The figure below shows the example of switching the group of PID parameters according to the SP. It shows an example of dividing the PV input range from the maximum value to the minimum value into five zones by reference points 1 to 4. (Set RP1 to RP4.)



The PV input range can be divided into the number of zones that is set in the reference point.

Reference deviation can be set at the same time.

▶ [Reference deviation: 8.4.5 Switching PID according to Deviation \(Reference Deviation\)](#)

## Setting Details

Parameter symbol	Name	Display level	Setting range	Menu symbol
<b>ZON</b>	Zone PID selection	STD	0: Segment PID selection 1: Zone PID selection (selection by PV) 2: Zone PID selection (selection by target SP) 4: Zone PID selection (selection by SP) 5: Local PID selection	CTL <b>Set</b>
<b>RP1 to RP7</b>	Reference point 1 to 7	STD	0.0 to 100.0% of PV input range (EU) ( $RP1 \leq RP2 \leq RP3 \leq RP4 \leq RP5 \leq RP6 \leq RP7$ )	ZONE <b>Ope</b>
<b>PID</b>	PID number (display only)	EASY	1 to 8, R: PID group for reference deviation	MODE <b>Ope</b>

Note1: In Cascade control, the LP2 lamp is lit while the Loop-2 parameter is displayed.

Note2: A currently-used PID number is displayed for the parameter PID.

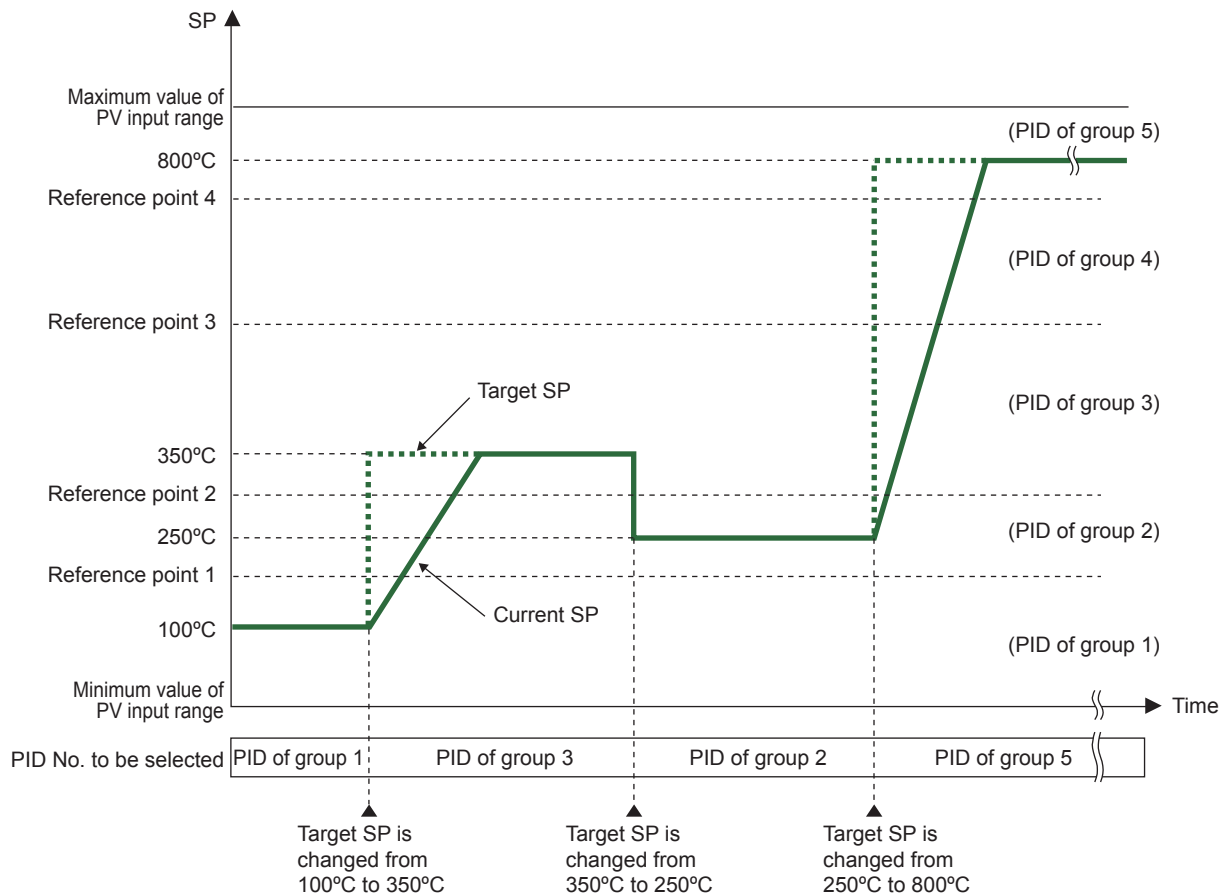
## 8.4 Switching PID

### 8.4.4 Switching PID According to Target SP

#### Description

The zone PID selection by target SP switches between the groups of PID parameters according to the target SP.

The figure below shows the example of switching the group of PID parameters according to the target SP. It shows an example of dividing the PV input range from the maximum value to the minimum value into five zones by reference points 1 to 4. (Set RP1 to RP4.)



The PV input range can be divided into the number of zones that is set in the reference point.

Reference deviation can be set at the same time.

► [Reference deviation: 8.4.5 Switching PID according to Deviation \(Reference Deviation\)](#)

## Setting Details

Parameter symbol	Name	Display level	Setting range	Menu symbol
<b>ZON</b>	Zone PID selection	STD	0: Segment PID selection 1: Zone PID selection (selection by PV) 2: Zone PID selection (selection by target SP) 4: Zone PID selection (selection by SP) 5: Local PID selection	CTL <b>Set</b>
<b>RP1 to RP7</b>	Reference point 1 to 7	STD	0.0 to 100.0% of PV input range (EU) ( $RP1 \leq RP2 \leq RP3 \leq RP4 \leq RP5 \leq RP6 \leq RP7$ )	ZONE <b>Ope</b>
<b>PID</b>	PID number (display number)	EASY	1 to 8, R: PID group for reference deviation	MODE <b>Ope</b>

Note1: In Cascade control, the LP2 lamp is lit while the Loop-2 parameter is displayed.

Note2: A currently-used PID number is displayed for the parameter PID.

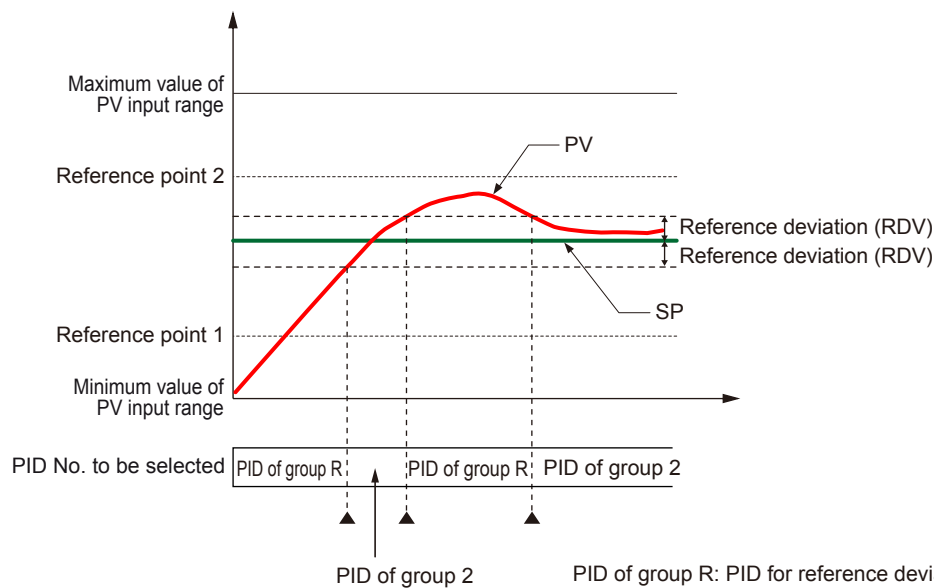
### 8.4.5 Switching PID According to Deviation (Reference Deviation)

**Description**

The zone PID selection by deviation switches between the groups of PID parameters according to the amount of deviation. This function is called “reference deviation.”

In the fixed point control, if the actual amount of deviation exceeds the setpoint of the reference deviation, the controller automatically changes to the PID parameter group (PID of group R) set for the zone. If the actual amount of deviation becomes smaller than the setpoint of reference deviation, the controller changes to the PID parameter group appropriate for the zone.

For example, if the deviation is large, PV can be reached more rapidly to SP by increasing the proportional gain (i.e., narrowing the proportional band). Switching PID according to deviation is effective when ZON is set to 1, 2, 4. The zone PID selection by reference deviation has priority over other zone PID selections.



**Setting Details**

Parameter symbol	Name	Display level	Setting range	Menu symbol
ZON	Zone PID selection	STD	0: Segment PID selection 1: Zone PID selection (selection by PV) 2: Zone PID selection (selection by target SP) 4: Zone PID selection (selection by SP) 5: Local PID selection	CTL <b>Set</b>
RDV	Reference deviation	STD	OFF: Disable 0.0 + 1 digit to 100.0% of PV input range span (EUS)	ZONE <b>Ope</b>
PID	PID number (display only)	EASY	1 to 8, R: PID group for reference deviation	MODE <b>Ope</b>

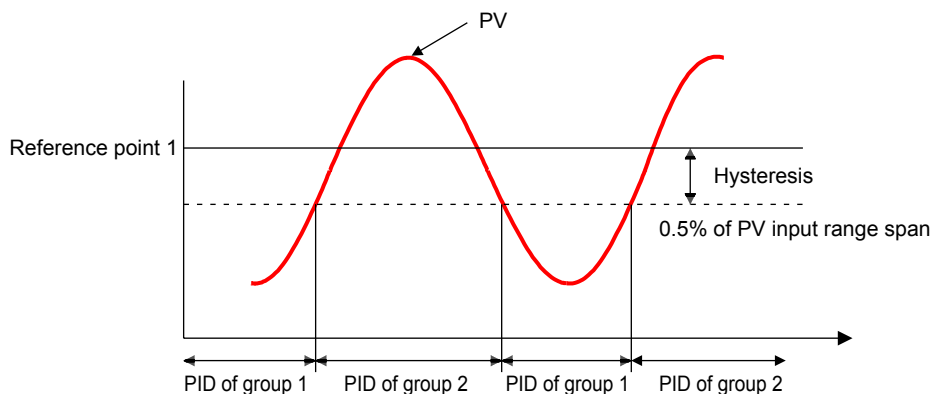
Note1: In Cascade control, the LP2 lamp is lit while the Loop-2 parameter is displayed.  
 Note2: A currently-used PID number is displayed for the parameter PID.

### 8.4.6 Setting Hysteresis at Time of PID Switch

#### Description

When the zone PID selection is selected, hysteresis at time of each zone switch can be set.

The following shows the operation example of hysteresis at time of zone switch.



#### Setting Details

Parameter symbol	Name	Display level	Setting range	Menu symbol
RHY	Zone PID switching hysteresis	STD	0.0 to 10.0% of PV input range span (EUS)	ZONE <b>Ope</b>

Note1: In Cascade control, the LP2 lamp is lit while the Loop-2 parameter is displayed.

### 8.4.7 Switching PID Irrespective of Operation Mode

#### Description

When the local PID selection is selected (ZON = 5), the PID group set in the local PID number selection (L.PID) is used, irrespective of the operation mode.

#### Setting Details

Parameter symbol	Name	Display level	Setting range	Menu symbol
ZON	Zone PID selection	STD	0: Segment PID selection 1: Zone PID selection (selection by PV) 2: Zone PID selection (selection by target SP) 4: Zone PID selection (selection by SP) 5: Local PID selection	CTL <b>Set</b>
L.PID	Local PID number selection	EASY	1 to 8	LOC <b>Ope</b>
PID	PID number (display only)	EASY	1 to 8	MODE <b>Ope</b>

Note 1: A currently-used PID number is displayed for the parameter PID.

### 8.4.8 Switching PID by Contact Input

#### Description

When the local PID selection is selected (ZON = 5), PID can be switching by contact input.

#### Setting Details

► [Contact input assignment: 12.1 Setting Contact Input Function](#)



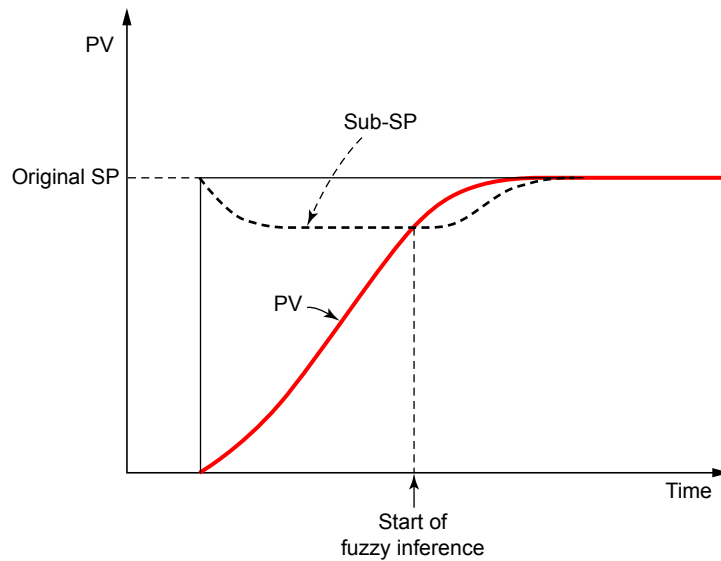
## 8.5 Suppressing Overshoot (Super Function)

### Description

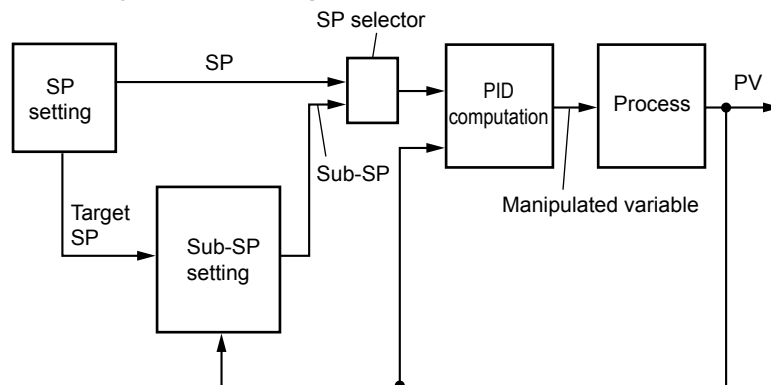
The Super function monitors the deviation for evidence that there is a danger of overshoot, and on sensing such danger automatically changes the setpoint temporarily to a somewhat lower value (sub-SP).

Once the danger of overshoot appears diminished, the function returns the effective SP gradually to the true SP. "Fuzzy ratiocination" techniques are employed in the algorithms used to change the SP to the lower temporary value, and to return it gradually to the true SP.

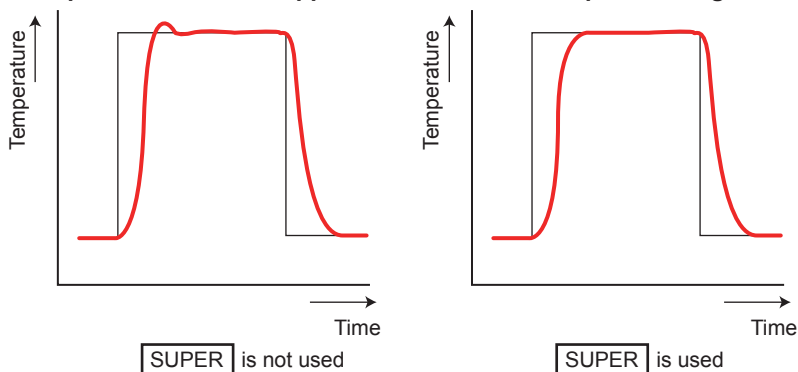
### Operation Diagram



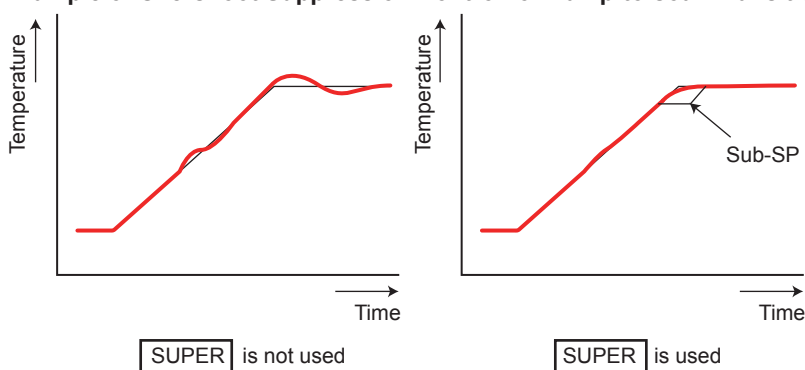
### Control System Block Diagram



Example of Overshoot Suppression Control for Setpoint Changes



Example of Overshoot Suppression Control for Ramp-to-soak Transition



Setting Details

Parameter symbol	Name	Display level	Setting range	Menu symbol
SC	Super function	EASY	OFF: Disable 1: Overshoot suppressing function (normal mode) 2: Hunting suppressing function (stable mode) 3: Hunting suppressing function (response mode) 4: Overshoot suppressing function (strong suppressing mode)	TUNE <b>Ope</b>

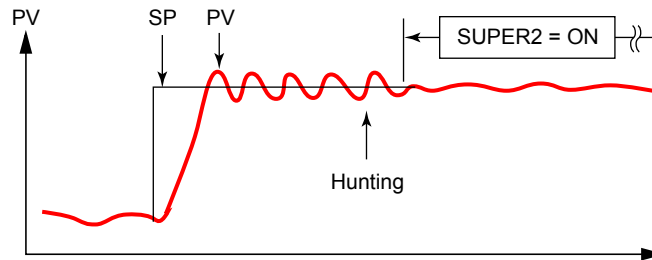
Note1: In Cascade control, the LP2 lamp is lit while the Loop-2 parameter is displayed.

The setting SC=4 is effective compared with SC=1. However, the hunting may occur until the PV reaches SP. Use it as usage.

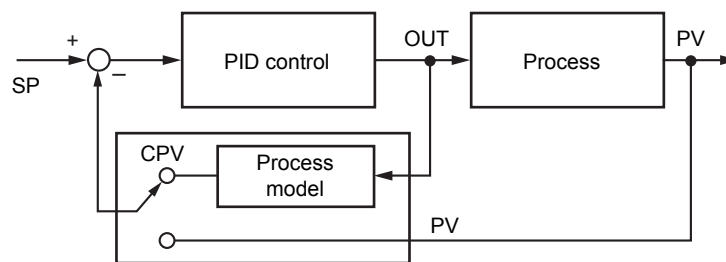
## 8.6 Suppressing Hunting (Super2 Function)

### Description

The Super2 function suppresses the hunting effect of the controller without re-tuning the PID parameters.  
Hunting means the PV becomes unstable and oscillates around SP.

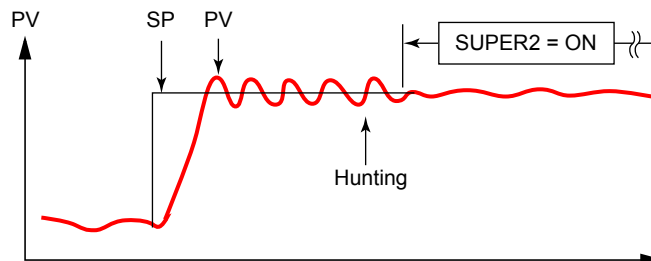


- In hunting condition, the Super2 function selects the output from process model as PV signal.
- The process model removes a factor of dead time from the actual process.
- The real process is under the open-loop condition.
- After hunting is suppressed, the Super2 function selects real PV signal, and carry out the standard feedback control.

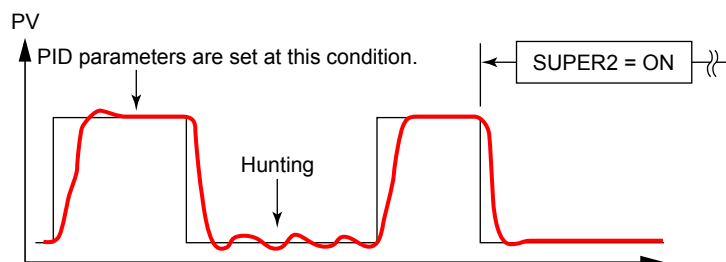


### Effects of Super2

Load change



Temperature change



## Setting Details

Parameter symbol	Name	Display level	Setting range	Menu symbol
SC	Super function	EASY	OFF: Disable 1: Overshoot suppressing function (normal mode) 2: Hunting suppressing function (stable mode) 3: Hunting suppressing function (response mode) 4: Overshoot suppressing function (strong suppressing mode).	TUNE <b>Ope</b>

Note1: In Cascade control, the LP2 lamp is lit while the Loop-2 parameter is displayed.

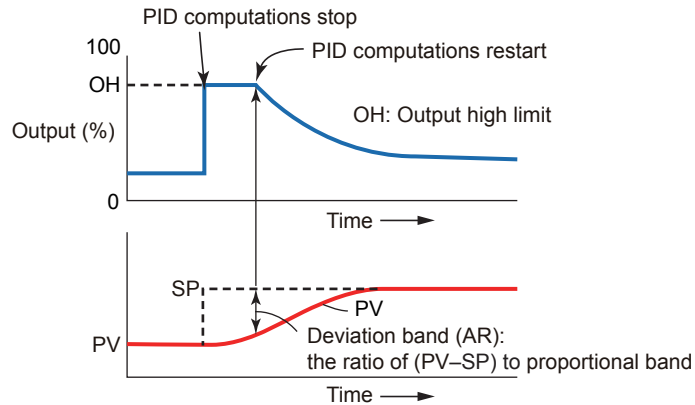
Set SC=2 when there are a lot of disturbances, and much hunting occurs.  
 Set SC=3 when SP is changed frequently. Hunting suppressing effect is smaller than that of SC=2, however, responsiveness is good.

The Super function (SC=2 and 3) does not work in direct action.

## 8.7 Suppressing Integral Action (Anti-reset Wind-up)

### Description

Where there is a large deviation at the start of the control operation, for example, integral outputs are accumulated and the PV exceeds the SP, thereby causing the output to overshoot. To avoid this, the controller provides an anti-reset wind-up function for suppressing an extreme integral output by stopping PID computations. Same applies to the case of undershoot.



The parameter AR sets the point (by deviation band (%)) to restart the PID computation that is suspended by the controller's anti-reset windup function. PID computation restarts when the deviation band has decreased to the AR setpoint. When the parameter AR is set to AUTO, the controller automatically determines the point at which to restart the PID computation.

$$\text{Deviation band (= Setpoint of AR)} = \frac{|PV - SP|}{\text{Proportional band}} \times 100 (\%)$$

### Setting Details

Parameter symbol	Name	Display level	Setting range	Menu symbol
AR	Anti-reset windup	STD	AUTO, 50.0 to 200.0%	TUNE <b>Ope</b>

Note1: In Cascade control, the LP2 lamp is lit while the Loop-2 parameter is displayed.

## 8.8 Performing Non-linear PID Control

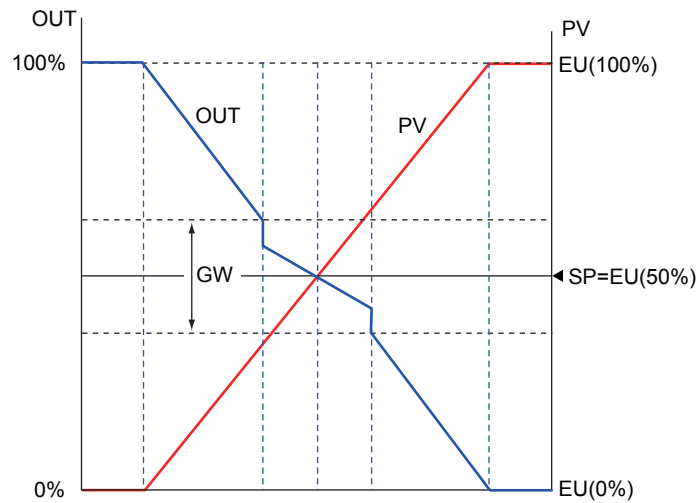
### Description

If a deviation (E) is smaller than the non-linear control gap width (GW), it is computed as a proportional added the non-linear control gain (GG).

Proportional Band (CPB) = Proportional Band (P) / GG

\*  $|E| \leq GW / 2$

However, CPB is limited by 0.1 to 999.9%.



Control output will change smoothly (i.e., without any bumps) when CPB switches.

### Setting Details

Parameter symbol	Name	Display level	Setting range	Menu symbol
<b>GW</b>	Non-linear control gap width	PRO	OFF, 0.0%+1digit to 50.0% of PV input range span (EUS)	TUNE <b>Ope</b>
<b>GG</b>	Non-linear control gain	PRO	0.001 to 1.000	

Note1: In Cascade control, the LP2 lamp is lit while the Loop-2 parameter is displayed.

## 8.9 Adjusting Auto-tuning Operation

### Description

#### Auto-tuning Type

“Normal” of auto-tuning type requires a rapidly rising PID constant. This type is useful for processes that allow some overshooting.

On the other hand, “stable” of auto-tuning type requires a slowly rising PID constant.

#### Auto-tuning Output Limiter

When executing auto-tuning, the control output high and low limits can be set.


When the control output low limit > AT.OL, or AT.OH < control output high limit, auto-tuning is limited by the control output low or high limit.

In Heating/cooling control, AT.OH and AT.OL do not work.

#### Note

In time proportional output, the output is turned on and off irrespective of the upper/lower limit.

### Setting Details

Parameter symbol	Name	Display level	Setting range	Menu symbol
AT.TY	Auto-tuning type	STD	0: Normal 1: Stability	TUNE 
AT.OH	Output high limit in auto-tuning	PRO	-5.0 to 105.0% (Disabled in Heating/cooling control)	
AT.OL	Output low limit in auto-tuning	PRO		

Note1: In Cascade control, the LP2 lamp is lit while the Loop-2 parameter is displayed.

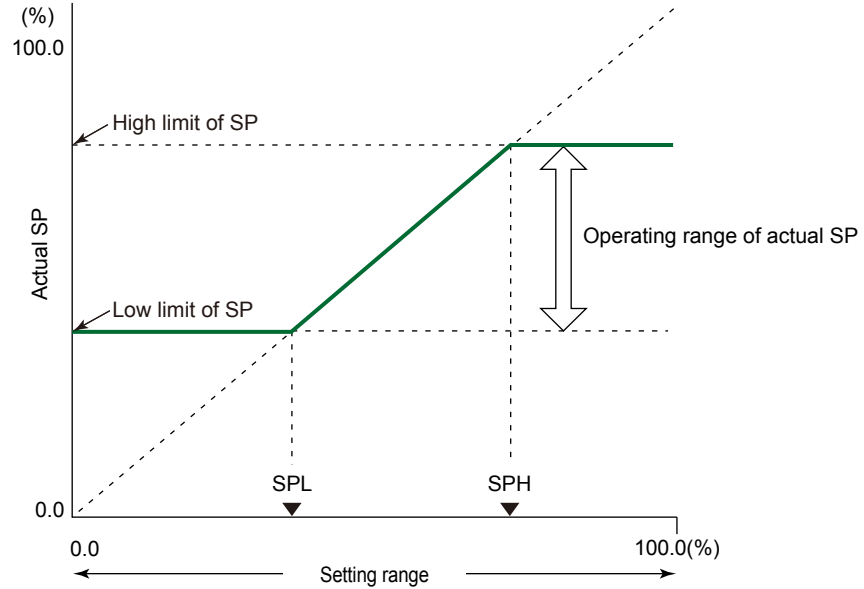
▶ [SP bias in auto-tuning: 6.2 Performing and Canceling Auto-tuning](#)

## 8.10 Setting SP Limiter

### Description

The SP high and low limits can be set to restrict the SP to the operating range between those limits whether in PROG (program), LOC (local), or REM (remote) mode. They work to the SP of all SP groups.

In Cascade control, the SP high and low limits can be set for both Loop1 and Loop 2.



▶ SP group: 6.2 Setting Target Setpoint

### Setting Details

Parameter symbol	Name	Display level	Setting range	Menu symbol
<b>SPH</b>	SP high limit	STD	0.0 to 100.0% of PV input range	MPV <b>Set</b>
<b>SPL</b>	SP low limit	STD	(EU), (SPL<SPH)	

Note1: In Cascade control, the LP2 lamp is lit while the Loop-2 parameter is displayed.



## 8.11 Setting Program Time Unit

### Description

The program time unit is applied to the segment time (TIME), segment ramp-rate (TM.RT), wait time (WT.TM1 to WT.TM5), time event (T.ON1 to T.ON16 and T.OF1 to T.OF16), and starting time of program operation (S.TM).

### Setting Details

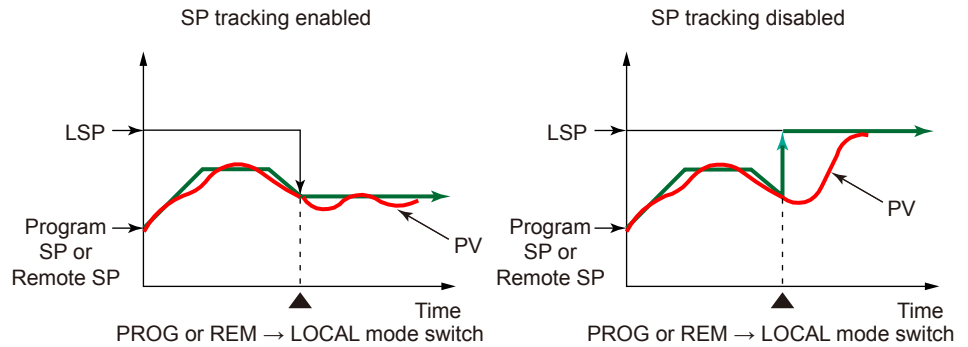
Parameter symbol	Name	Display level	Setting range	Menu symbol
TMU	Program time unit	EASY	HH.MM: hour.minute (when the segment ramp-rate setting is selected in the segment setting method (SEG.T), HH.SS means "per 1 hour.") MM.SS: minute.second (when the segment ramp-rate setting is selected in the segment setting method (SEG.T), HH.SS means "per 1 minute.")	CTL <b>Set</b>

## 8.12 Forcing Local Setpoint (LSP) to Track Program Setpoint or Remote Setpoint (SP Tracking)

### Description

SP tracking function is the function to force the local setpoint (LSP) to track the program setpoint or remote setpoint when the operation mode is switched from program (PROG) or remote (REM) to local (LOC) mode.

The function is effective to prevent abrupt PV changes.



### Setting Details

Parameter symbol	Name	Display level	Setting range	Menu symbol
SPT	SP tracking selection	STD	OFF, ON	SPS <b>Ope</b>

Note1: In Cascade control, the LP2 lamp is lit while the Loop-2 parameter is displayed.

## 8.13 Setting Controller Action at Power ON (Restart Mode)

### Description

For details, see Chapter 15, "Power Failure Recovery Processing."

### Setting Details

Parameter symbol	Name	Display level	Setting range	Menu symbol
R.MD	Restart Mode	STD	CONT: Continue action set before power failure. (Continue operation mode.) MAN: Start from MAN. (Continue operation mode.) RESET: Start from AUTO and RESET. Outputs the preset output value. Set how the controller should recover from a power failure of 5 seconds or more.	SYS <b>Set</b>

Operation mode: PROG, RESET, LOCAL, REMOTE

The preset output (PO) is output in MAN or RESET mode.

## 8.14 Setting Time between Powering on Controller and Starting Control (Restart Timer)

### Description

The time between power on and the instant where controller starts control computation can be set.

Operation start time = Operating time of controller initialization after power on.

### Setting Details

Parameter symbol	Name	Display level	Setting range	Menu symbol
R.TM	Restart Timer	STD	0 to 10 s	SYS <b>Set</b>



## 9.1 Setting the Setting Method of Program Pattern

The segment setting method refers to an action control method within a segment. The segment setting method is common to all program patterns.

Segment time can be selected between the two criteria below.

- Segment time setting
- Segment ramp-rate setting

### CAUTION

If the Segment Setting Method (SEG.T) parameter is changed, the program patterns created and stored so far will be all cleared (initialized) !! Be careful.

#### Setting Details

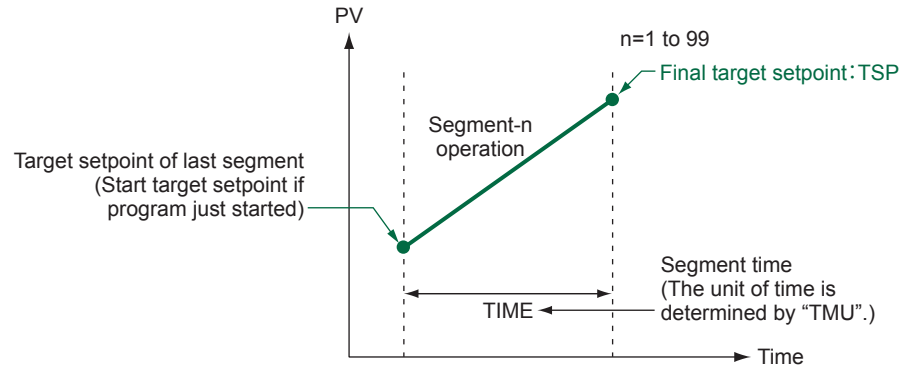
Parameter symbol	Name	Display level	Setting range	Menu symbol
SEG.T	Segment setting method	EASY	TIME: Segment time setting TM.RT: Segment ramp-rate setting	CTL <b>Set</b>

9.1.1 Setting the Program Pattern Using the Segment Time

**Description**

The segment time criterion bases segment operation on the target setpoint (TSP) and the segment time (TIME.)

The target setpoint is the control target to be attained at segment end, whereas the segment time is the time duration from the start of that segment to the end.



**Setting Details**

Parameter symbol	Name	Display level	Setting range	Menu symbol
<b>TSP</b>	Final target setpoint	EASY	0.0 to 100.0% of PV input range (EU) (Setting range: P.RL to P.RH)	PROG <b>Prog</b>
<b>TIME</b>	Segment time setting	EASY	-: Unregistered 0.00 to 999.59 ("hour.minute" or "minute.second")	

Note 1: When the program pattern-2 retransmission is selected (PT2.G=ON), the second loop is also displayed for the parameter SSP. (LP2 lamp is lit.)

If the setting is 0.00, the program advances to the next segment after one control period. Use the parameter TMU to set the time unit. (Common in the instrument.)

When setting the program pattern via communication, set the time in minutes when the time unit is set to hour.minute and set the time in seconds when the time unit is set to minute.second.

### 9.1.2 Setting the Program Pattern using the Ramp-rate and Segment Time

**Description**

The segment ramp time criterion bases segment operation on the target setpoint (TSP) and the segment ramp-rate (TM.RT.)

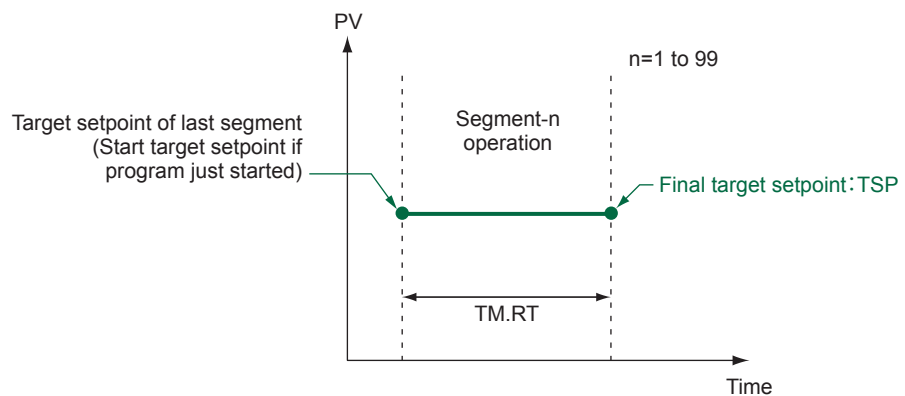
Ramp time in segment ramp-up or ramp-down is expressed as an amount of change (between target setpoints) per hour or per minute.

The unit of time is selected with parameter TMU. When segment is set for soaking at a constant target setpoint, ramp time expresses the time duration of the segment.

**Segment time during soak operations**

When the target setpoint of the current segment is the same as that of the last segment, soak operations are performed for the current segment.

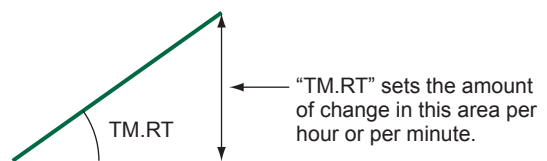
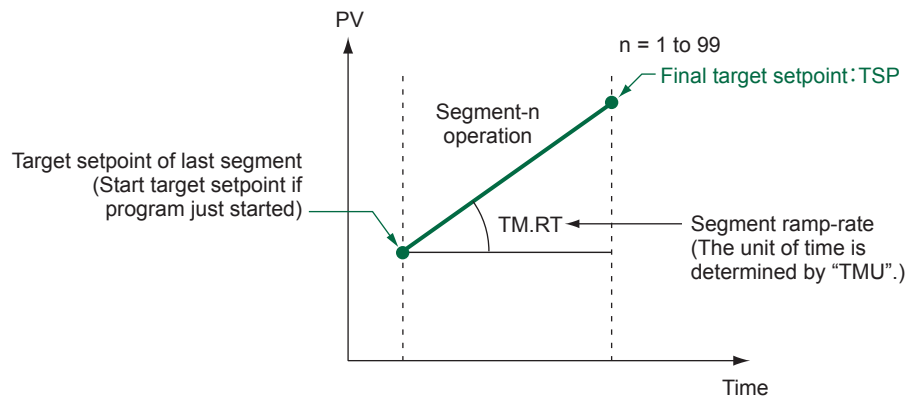
The time duration of the soak segment is set with the ramp time parameter TM.RM.



**Segment time during ramp-up operations**

When the target setpoint of the current segment is higher than that of the last segment, ramp-up operations are performed for the current segment.

During ramp-up, the amount of change (between target setpoints) per hour or per minute is set with the ramp time parameter TM.RM.



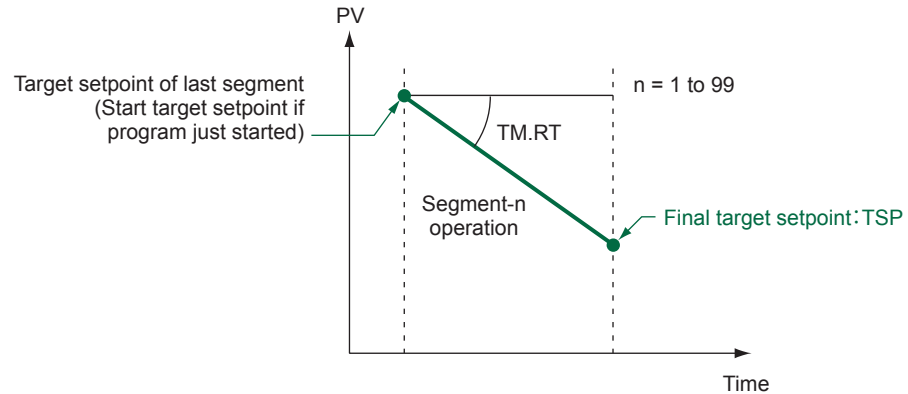


## 9.1 Setting the Setting Method of Program Pattern

### Segment time during ramp-down operations

When the target setpoint of the current segment is lower than that of the last segment, ramp-down operations are performed for the current segment.

During ramp-down, the amount of change (between target setpoints) per hour or per minute is set with the ramp time parameter TM.RM.



### Setting Details

Parameter symbol	Name	Display level	Setting range	Menu symbol
<b>TSP</b>	Final target setpoint	EASY	0.0 to 100.0% of PV input range (EU) (Setting range: P.RL to P.RH)	PROG <b>Prog</b>
<b>TM.RT</b>	Segment ramp-rate setting	EASY	-: Unregistered Ramp: 0.0 to 100.0% of PV input range span (EUS) / 1 hour or 1 minute Soak: 0.00 to 999.59 ("hour.minute" or "minute.second")	

Note 1: When the program pattern-2 retransmission is selected (PT2.G=ON), the second loop is also displayed for the parameter SSP. (LP2 lamp is lit.)

If it is set to 0.0% of the input range span, or the segment time 0.00, the program moves to the next segment after one control period.

Use the parameter TMU to set the time unit. (Common in the instrument.)

When setting the program pattern via communication, set the time in minutes when the time unit is set to hour.minute and set the time in seconds when the time unit is set to minute.second.

When program pattern-2 retransmission is selected, priority is given to the conditions for the program pattern for control.

When the control program pattern is set to ramp and the retransmission program pattern is set to soak, the program pattern is set by the ramp. When the control program pattern is set to soak and the retransmission program pattern is set to ramp, the program pattern is set by the time.

Segment for control	Segment for retransmission	Segment time (TM.RT)	TSP action for retransmission
Ramp	Ramp	Ramp setting	-
Ramp	Soak	Ramp setting	Soak action during the time to reach the control TSP
Soak	Ramp	Time setting	Ramp action according to the time setting
Soak	Soak	Time setting	-

### 9.1.3 Setting the Program Time Unit

#### Description

The program time unit is applied to the segment time (TIME), segment ramp-rate (TM.RT), wait time (WT.TM1 to WT.TM5), time event (T.ON1 to T.ON16 and T.OF1 to T.OF16), and starting time of program operation (S.TM).

#### Setting Details

Parameter symbol	Name	Display level	Setting range	Menu symbol
TMU	Program time unit	EASY	HH.MM: hour.minute (when the segment ramp-rate setting is selected in the segment setting method (SEG.T), HH.SS means "per 1 hour.") MM.SS: minute.second (when the segment ramp-rate setting is selected in the segment setting method (SEG.T), HH.SS means "per 1 minute.")	CTL <b>Set</b>

## 9.2 PID Selection Method

There are two PID selection methods. One is segment PID number selection and the other is zone PID selection. When segment PID number selection is selected, the PID number is set for each segment, and when zone PID selection is selected, the zone is set and the PID constant is selected. The factory default is zone PID selection.

### 9.2.1 Segment PID Selection

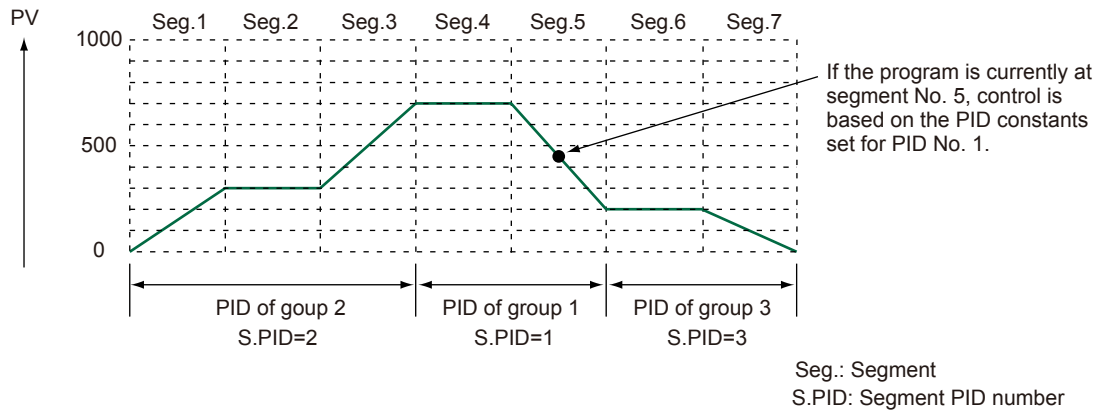
#### Description

Segment PID control automatically switches PID settings to those set for each segment of the program pattern (in programmed operations.)

The PID number is set for each segment at the same time as when the program pattern is set.

during ramp-up and rampdown.

The following example shows how PID settings change in segment PID control.



► Segment PID Selection: 8.4 Switching PID

#### Setting Details

Parameter symbol	Name	Display level	Setting range	Menu symbol
<b>ZON</b>	Zone PID selection	EASY	0: Segment PID selection 1: Zone PID selection (selection by PV) 2: Zone PID selection (selection by target SP) 4: Zone PID selection (selection by SP) 5: Local PID selection	CTL <b>Set</b>
<b>S.PID</b>	Segment PID number selection	EASY	1 to 8	PROG <b>Prog</b>

## 9.2.2 Zone PID Selection

### Description

Zone PID control automatically switches PID settings according to PV.  
 Zone PID control is used with reactors that change chemical reaction gain according to temperature.  
 For the function and setting ranges, see “8.4 Switching PID.”

▶ Segment PID Selection: 8.4 Switching PID

## 9.2.3 Local PID Selection

### Description

When local PID selection is selected, the program works according to the PID group number set in the local PID number selection (L.PID).  
 Available only for the L.PID when ZON = 0 or 5. If set to “Local PID selection,” local PID is selected irrespective of the operation modes.

### Setting Details

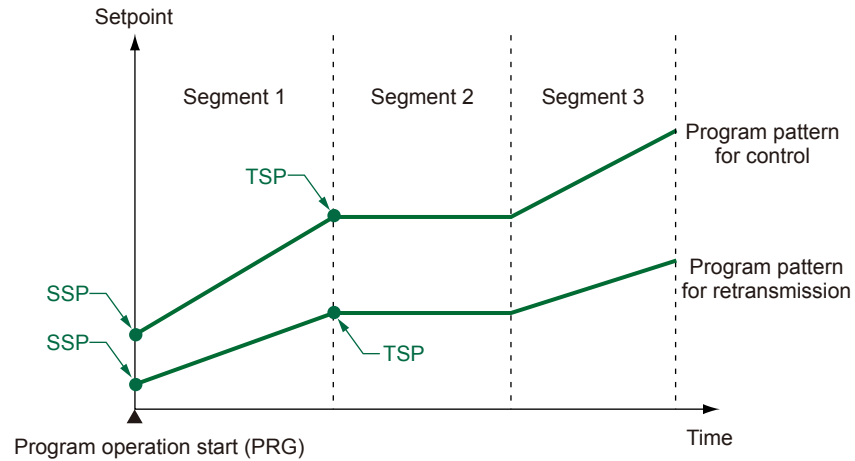
Parameter symbol	Name	Display level	Setting range	Menu symbol
ZON	Zone PID selection	EASY	0: Segment PID selection 1: Zone PID selection (selection by PV) 2: Zone PID selection (selection by target SP) 4: Zone PID selection (selection by SP) 5: Local PID selection	CTL <b>Set</b>
L.PID	Local PID PID number selection	EASY	Set a PID group number to use. 1 to 8 * Available only for the L.PID when ZON = 0 or 5. * If set to “Local PID selection,” local PID is selected irrespective of the operation modes.	LOC <b>Ope</b>

## 9.3 Setting the Program Starting Conditions (STC)

### 9.3.1 Starting operation at starting target setpoint (SSP) (STC=SSP)

#### Description

The start target setpoint is the target setpoint at which programmed operation starts. When selected as the start condition, the target setpoint can be changed from the starting target setpoint (SSP) to the target setpoint (TSP.) This change is made totally independent of PV, using the (TSP - SSP)/TIME ramp.



#### Setting Details

Parameter symbol	Name	Display level	Setting range	Menu symbol
<b>SSP</b>	Starting target setpoint	EASY	0.0 to 100.0% of PV input range (EU) (Setting range: P.RL to P.RH)	PROG <b>Prog</b>
<b>STC</b>	Start code	EASY	SSP: Program operation begins with the starting target setpoint. RAMP: Ramp-prioritized PV start TIME: Time-prioritized PV start LSP: Local-mode start RSP: Remote-mode start	

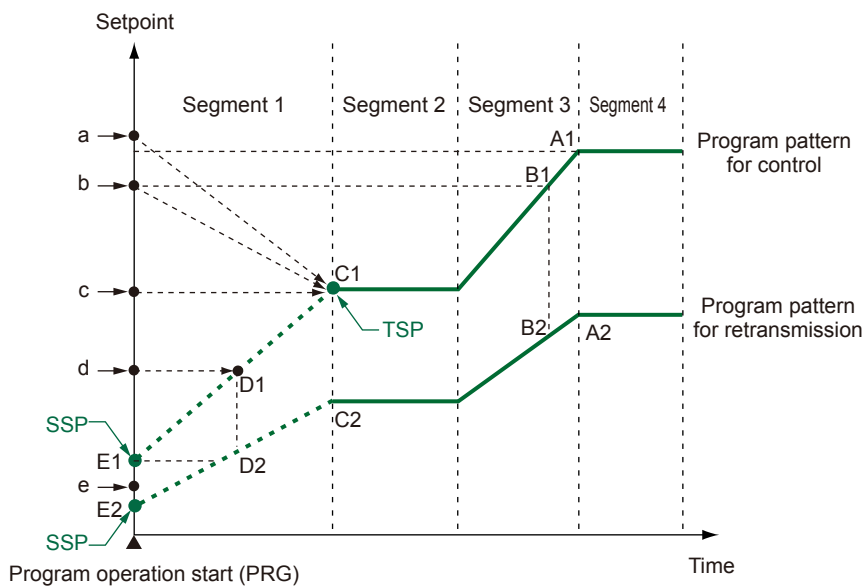
Note 1: When the program pattern-2 retransmission is selected (PT2.G=ON), the second loop is also displayed for the parameter SSP. (LP2 lamp is lit.)

### 9.3.2 Ramp-prioritized PV start (STC=RAMP)

**Description**

**Example of a soak segment for segment No. 2 of the control program pattern**

When ramp-prioritized PV start is the selected start condition, the control program pattern ramp is the start trigger. The control program pattern contains points C1, D1 and E1. The retransmission program pattern will start at the same time as the control program pattern does. For example, if C1 is the selected start point for the control program pattern, C2 will be that for the retransmission program pattern.



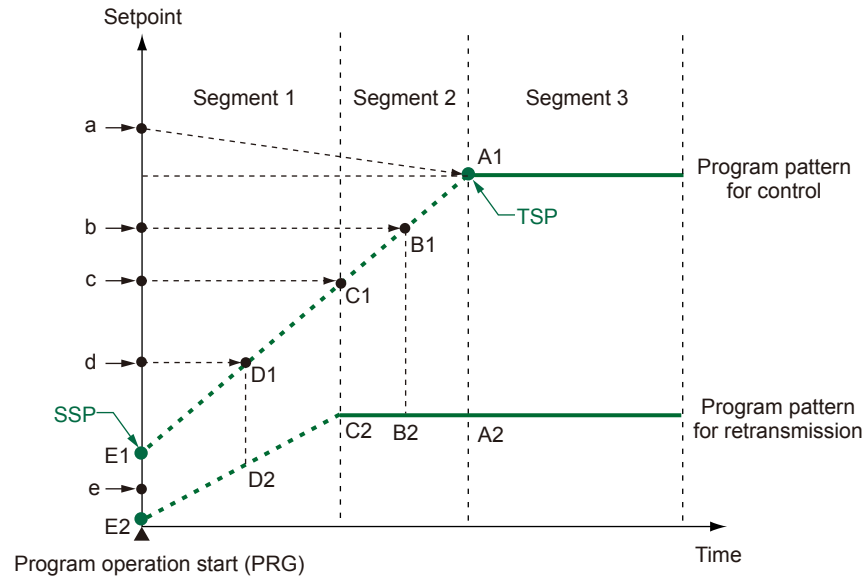
Program start point is determined by the control PV as follows.

PV at start	Operation-starting point for control	Operation-starting point for retransmission
a	C1	C2
b	C1	C2
c	C1	C2
d	D1	D2
e	E1 (SSP)	E2 (SSP)

### 9.3 Setting the Program Starting Conditions (STC)

#### Example of a soak segment for segment No. 3 of the control program pattern

When ramp-prioritized PV start is the selected start condition, the control program pattern ramp is the start trigger. The control program pattern contains points A1 to E1. The retransmission program pattern will start at the same time as the control program pattern does. For example, if A1 is the selected start point for the control program pattern, A2 will be that for the retransmission program pattern.

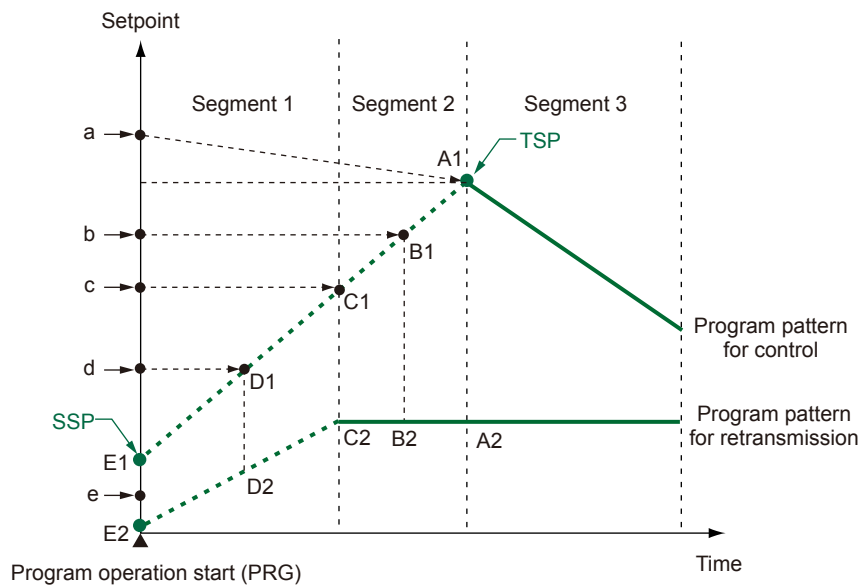


Program start point is determined by the control PV as follows.

PV at start	Operation-starting point for control	Operation-starting point for retransmission
a	A1	A2
b	B1	B2
c	C1	C2
d	D1	D2
e	E1 (SSP)	E2 (SSP)

**Example of no soak segment in control program pattern**

When ramp-prioritized PV start is the selected start condition, the control program pattern ramp is the start trigger. The control program pattern contains points A1 to E1. For some PV, the program advances through the segments up to the point at which the ramp is reversed. When PV is set to point a, the program advances through the segments up to the point A1 at which the ramp is reversed.



PV at start	Operation-starting point for control	Operation-starting point for retransmission
a	A1	A2
b	B1	B2
c	C1	C2
d	D1	D2
e	E1 (SSP)	E2 (SSP)



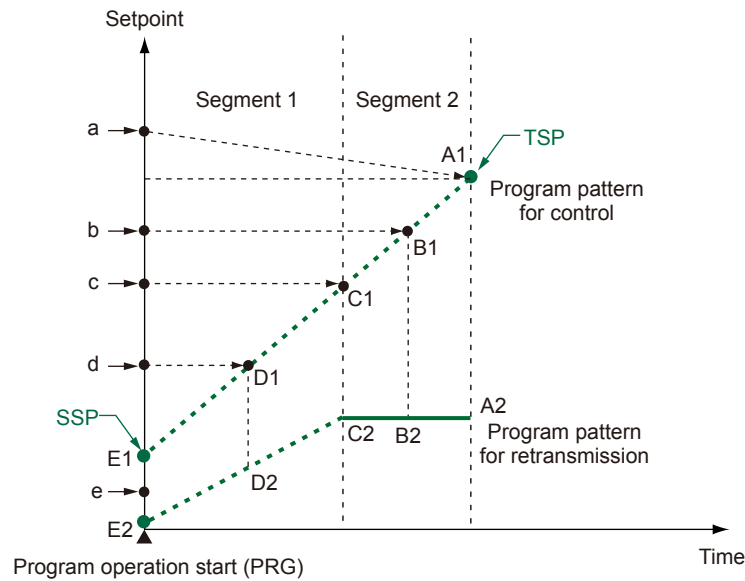
### 9.3 Setting the Program Starting Conditions (STC)

#### Example of programs with only ramp-up segments

When Ramp-prioritized PV start is the selected start condition, the control program pattern ramp is the start trigger. The control program pattern contains points A1 to E1. For some PV, the program advances through the segments up to the point at which the ramp is reversed.

The retransmission program pattern will start at the same time as the control program pattern does. For example, if B1 is the selected start point for the control program pattern, B2 will be that for the retransmission program pattern.

When the program operation starting point is set to A1, program operation is performed for one control period, and program operation ends according to the junction code (JC) for segment 2.



PV at start	Operation-starting point for control	Operation-starting point for retransmission
a	A1	A2
b	B1	B2
c	C1	C2
d	D1	D2
e	E1 (SSP)	E2 (SSP)

#### Setting Details

Parameter symbol	Name	Display level	Setting range	Menu symbol
<b>SSP</b>	Starting target setpoint	EASY	0.0 to 100.0% of PV input range (EU) (Setting range: P.RL to P.RH)	PROG <b>Prog</b>
<b>STC</b>	Start code	EASY	SSP: Program operation begins with the starting target setpoint. RAMP: Ramp-prioritized PV start TIME: Time-prioritized PV start LSP: Local-mode start RSP: Remote-mode start	

Note 1: When the program pattern-2 retransmission is selected (PT2.G=ON), the second loop is also displayed for the parameter SSP. (LP2 lamp is lit.)

### 9.3.3 Time-prioritized PV start (STC=TIME)

**Description**

With Time-prioritized PV starts, operation start is triggered by segment time, which sets the time from the PV at program start to the target setpoint (TSP) of segment 1.

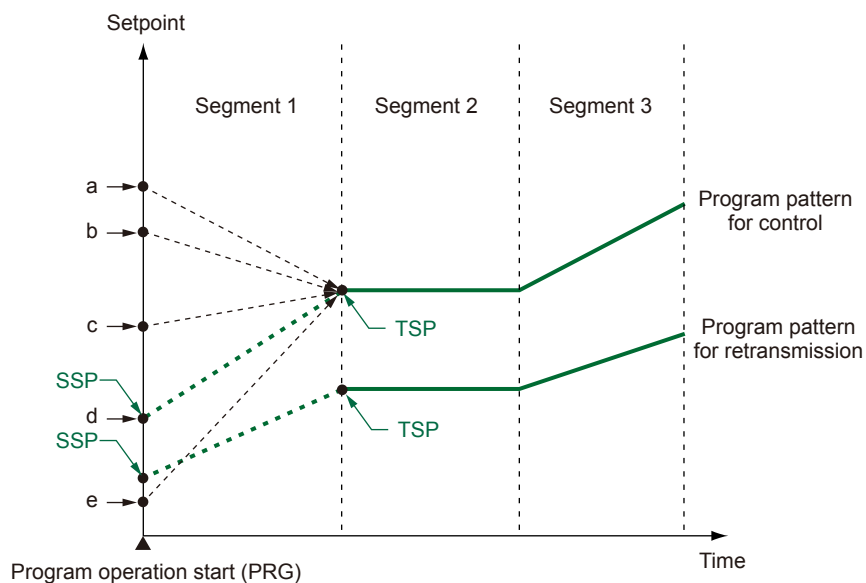
**CAUTION**

Time-prioritized PV start (STC=TIME) cannot be selected when the segment setting method (SEG.T) is Segment ramp-rate (TM.RT.)

The segment ramps are determined by the segment time (TIME.)  
 The control program pattern will start at PV.  
 The retransmission program pattern will start at the SSP.

$$\text{Ramp rate} = (\text{Target setpoint (TSP)} - \text{PV}) / \text{Segment time}$$

The start point of control program pattern will be a point a - e. Because the retransmission program pattern will start at the same point as the control program pattern does, it will start at SSP. Even though segment 2 is set to ramp, program operation starts from segment 1.



PV at start	Operation-starting point for control	Operation-starting point for retransmission
a	a	SSP for retransmission
b	b	SSP for retransmission
c	c	SSP for retransmission
d	d	SSP for retransmission
e	e	SSP for retransmission

### 9.3 Setting the Program Starting Conditions (STC)

#### Setting Details

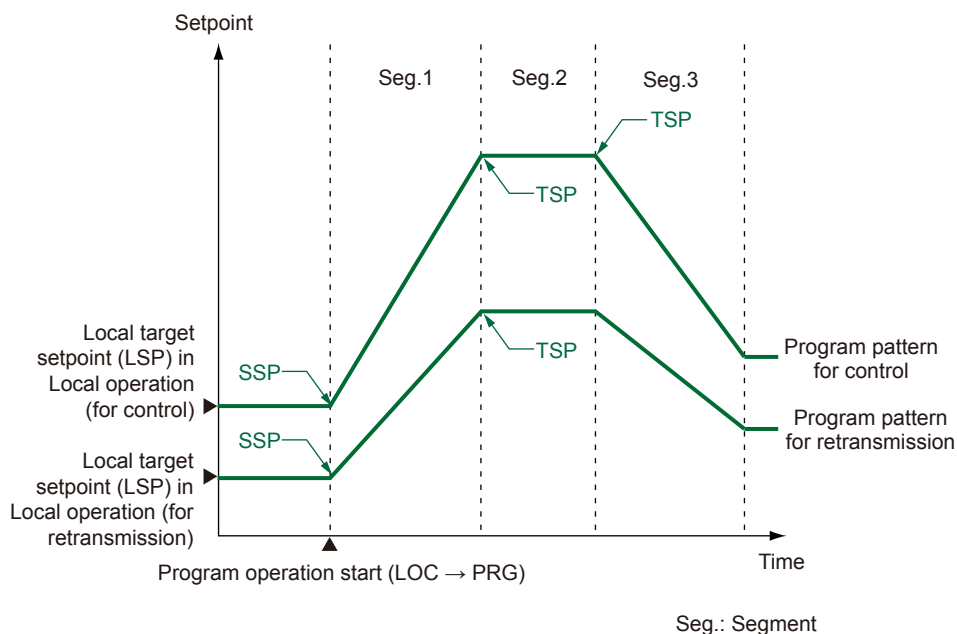
Parameter symbol	Name	Display level	Setting range	Menu symbol
<b>SSP</b>	Starting target setpoint	EASY	0.0 to 100.0% of PV input range (EU) (Setting range: P.RL to P.RH)	PROG <b>Prog</b>
<b>STC</b>	Start code	EASY	SSP: Program operation begins with the starting target setpoint. RAMP: Ramp-prioritized PV start TIME: Time-prioritized PV start LSP: Local-mode start RSP: Remote-mode start	

Note 1: When the program pattern-2 retransmission is selected (PT2.G=ON), the second loop is also displayed for the parameter SSP. (LP2 lamp is lit.)

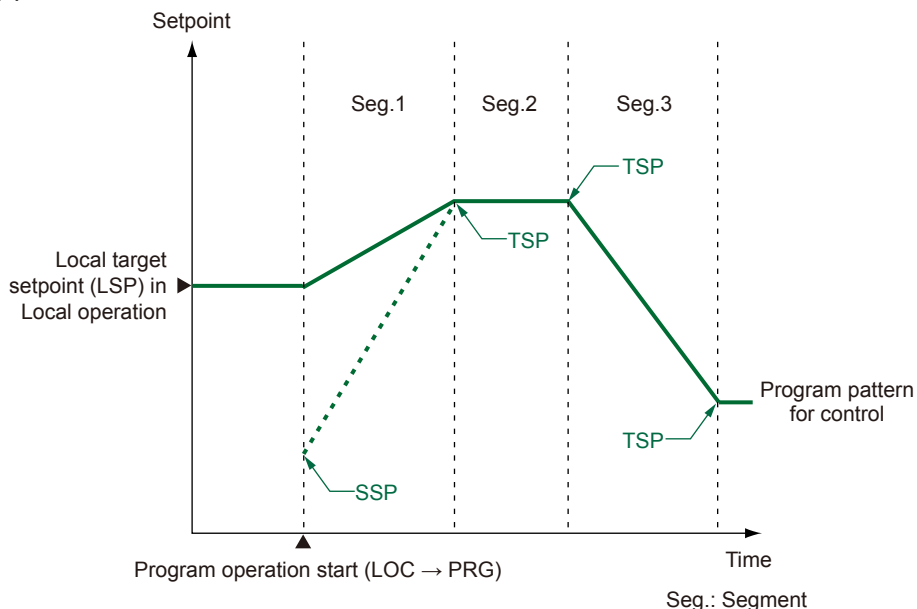
### 9.3.4 Starting operation at local target setpoint (STC=LSP)

**Description**

When selected as the start condition, the target setpoint can be changed from the local target setpoint (LSP) to the target setpoint (TSP). This change is made totally independent of PV, using the (TSP - LSP)/TIME ramp. Local-mode start (STC=LSP) cannot be selected when the segment setting method (SEG. T) is Segment ramp-rate (TM.RT.)

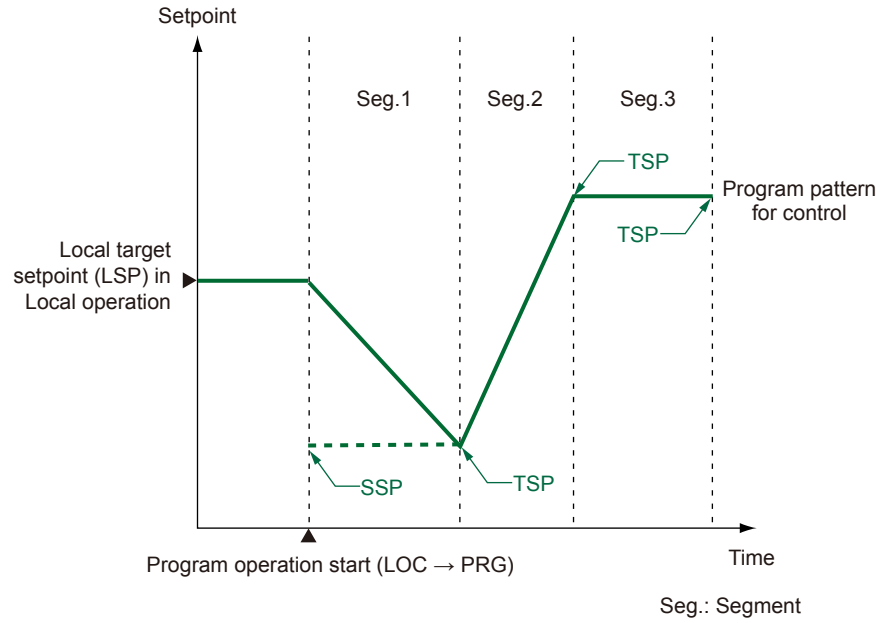


**(1) When LSP and SSP are different**



### 9.3 Setting the Program Starting Conditions (STC)

#### (2) When LSP and SSP are different



#### Setting Details

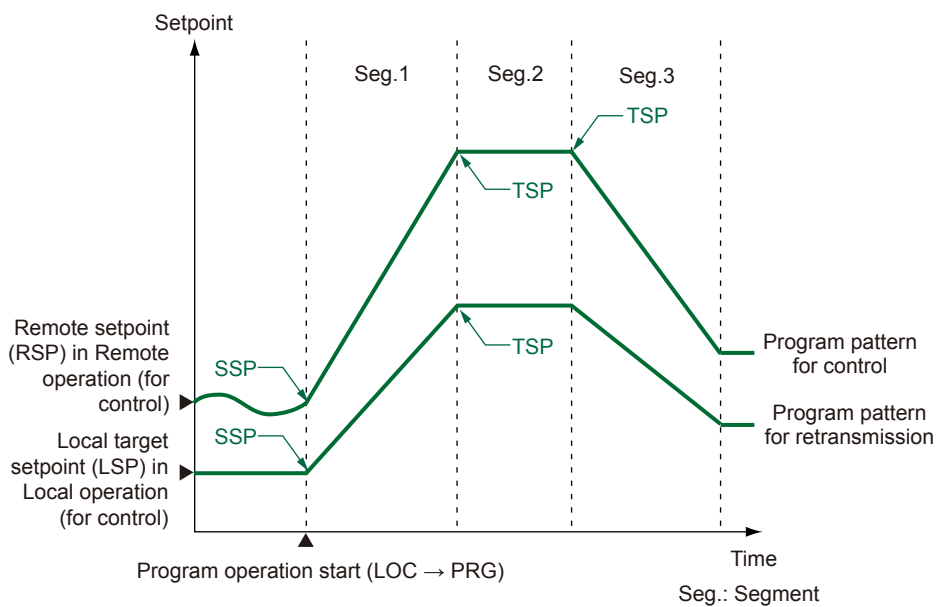
Parameter symbol	Name	Display level	Setting range	Menu symbol
<b>SSP</b>	Starting target setpoint	EASY	0.0 to 100.0% of PV input range (EU) (Setting range: P.RL to P.RH)	PROG <b>Prog</b>
<b>STC</b>	Start code	EASY	SSP: Program operation begins with the starting target setpoint. RAMP: Ramp-prioritized PV start TIME: Time-prioritized PV start LSP: Local-mode start RSP: Remote-mode start	
<b>LSP</b>	Local target setpoint	EASY	0.0 to 100.0% of PV input range (EU) (Setting range: P.RL to P.RH)	LOC <b>Ope</b>

Note 1: When the program pattern-2 retransmission is selected (PT2.G=ON), the second loop is also displayed for the parameter SSP. (LP2 lamp is lit.)

### 9.3.5 Starting operation at remote setpoint (STC=RSP)

#### Description

When selected as the start condition, the target setpoint can be changed from the local target setpoint (LSP) to the target setpoint (TSP). This change is made totally independent of PV, using the (TSP - RSP)/TIME ramp.  
 Remote-mode start (STC=RSP) cannot be selected when the segment setting method (SEG.T) is Segment ramp-rate (TM.RT.)



#### Setting Details

Parameter symbol	Name	Display level	Setting range	Menu symbol
SSP	Starting target setpoint	EASY	0.0 to 100.0% of PV input range (EU) (Setting range: P.RL to P.RH)	PROG <b>Prog</b>
STC	Start code	EASY	SSP: Program operation begins with the starting target setpoint. RAMP: Ramp-prioritized PV start TIME: Time-prioritized PV start LSP: Local-mode start RSP: Remote-mode start	

Note 1: When the program pattern-2 retransmission is selected (PT2.G=ON), the second loop is also displayed for the parameter SSP. (LP2 lamp is lit.)

## 9.4 Setting the Wait Functions

### 9.4.1 Program Wait at Segment End

#### Description

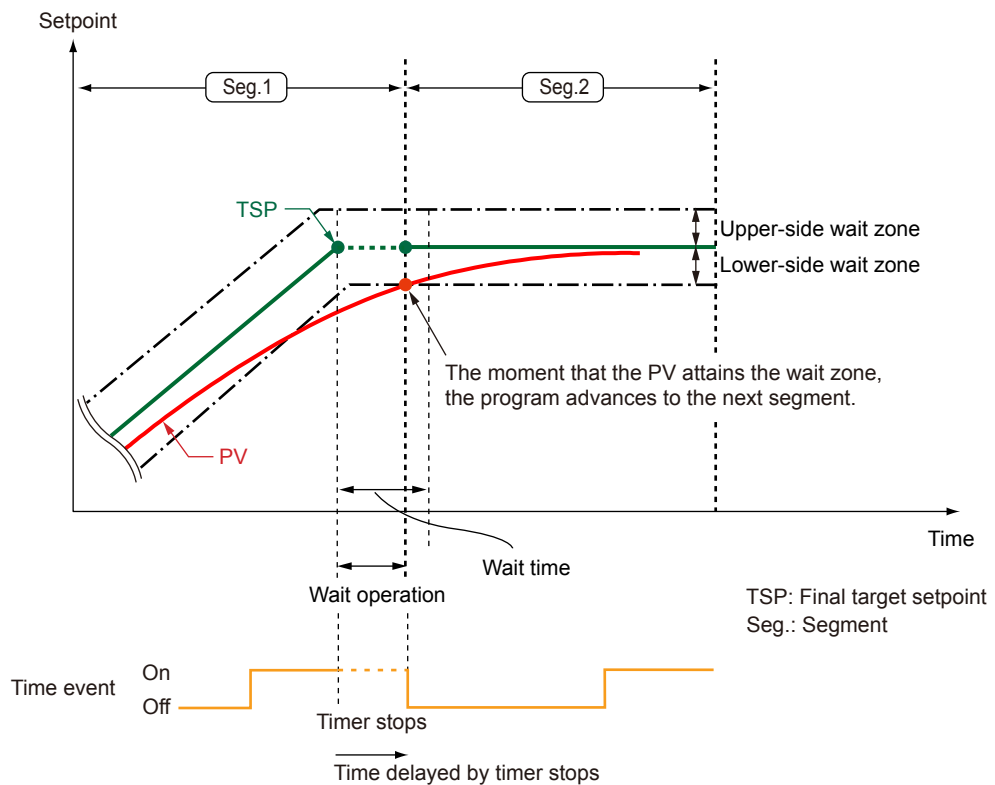
Program wait at segment end makes the program wait at segment end if PV has not attained the target setpoint.

The program will advance to the next segment the moment that the measured input attains the wait zone.

If the measured input does not attain the wait zone within the wait time, the program will advance to the next segment the moment the wait time elapses.

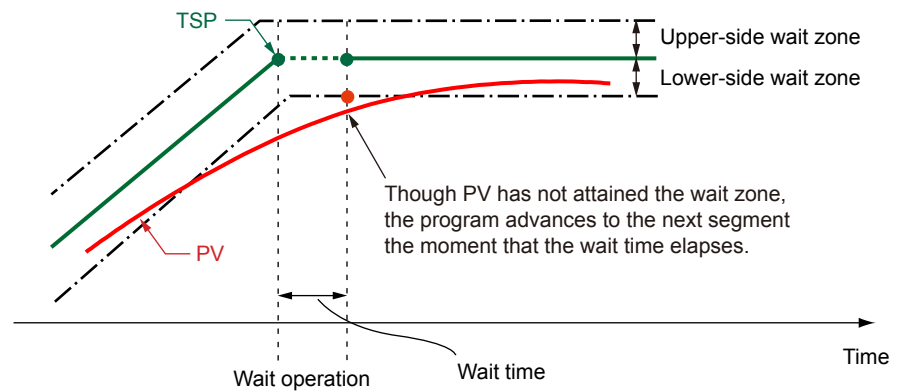
- **Operation when the measured input attains the wait zone before the wait time elapses**

From when the wait operation starts, if the measured input attains the wait zone, the wait state is changed to the operating state and the program advances to the next segment. During the wait state, the program timer is stopped, therefore the time event value is held.



- **Operation when the measured input does not attain the wait zone within the wait time**

If the wait time elapses before the measured input attains the wait zone, the wait state is changed to the operating state and the program advances to the next segment the moment that the wait time elapses. This happens even if the measured input has not attained the wait zone.



If the wait time is OFF (No function), the controller keeps the wait status until PV has attained the wait zone.



## 9.4 Setting the Wait Functions

### Setting Details

Parameter symbol	Name	Display level	Setting range	Menu symbol
<b>JC</b>	Junction code	STD	CONT: Switching for continuation HOLD: Hold-on switching (the controller holds the end-of-segment setpoint when the segment is completed, to perform control). LOC: Local-mode switching (the controller switches to a local setpoint when the segment is completed). REM: Remote-mode switching (the controller switches to a remote setpoint when the segment is completed). W.SW1 to W.SW5: Wait during switching between segments. W.IV1 to W.IV5: Wait within a segment interval. W.SL1 to W.SL5: Segment switching (the controller switches to a local setpoint when the segment is completed after release.) (5 groups) W.SR1 to W.SR5: Segment switching (the controller switches to a remote setpoint when the segment is completed after release.) (5 groups) PLK.1 to PLK.30: Linked to patterns 1 to 30. INS.: Allows a segment to be added to the end of a specified segment. DEL.: Allows a specified segment to be deleted.	PROG <b>Prog</b>
<b>WT.SW1 to WT.SW5</b>	Wait function ON/OFF 1 to 5	STD	OFF: Disable ON: Enable	
<b>WT.UP1 to WT.UP5</b>	Upper-side wait zone 1 to 5	STD	0.0 to 10.0% of PV input range (EU)	
<b>WT.LO1 to WT.LO5</b>	Lower-side wait zone 1 to 5	STD		
<b>WT.TM1 to WT.TM5</b>	Wait time 1 to 5	STD	OFF: No function 0.00 to 999.59 ("hour.minute" or "minute.second") * Available only for the wait time at the segment switching. * Use the parameter TMU to set the time unit. (Common in the instrument.)	
<b>TMU</b>	Program time unit	EASY	HH.MM: hour.minute MM.SS: minute.second	CTL <b>Set</b>

The table below shows which JC parameter settings correspond to which set of the wait zone parameter (WZ.UP1 to WZ.UP5, WZ.LO1 to WZ.LO5) and wait time parameter (WT.TM1 to WT.TM5.)

Setting value of JC				
W.SW1	W.SW2	W.SW3	W.SW4	W.SW5
WT.TM1	WT.TM2	WT.TM3	WT.TM4	WT.TM5
WZ.UP1	WZ.UP2	WZ.UP3	WZ.UP4	WZ.UP5
WZ.LO1	WZ.LO2	WZ.LO3	WZ.LO4	WZ.LO5

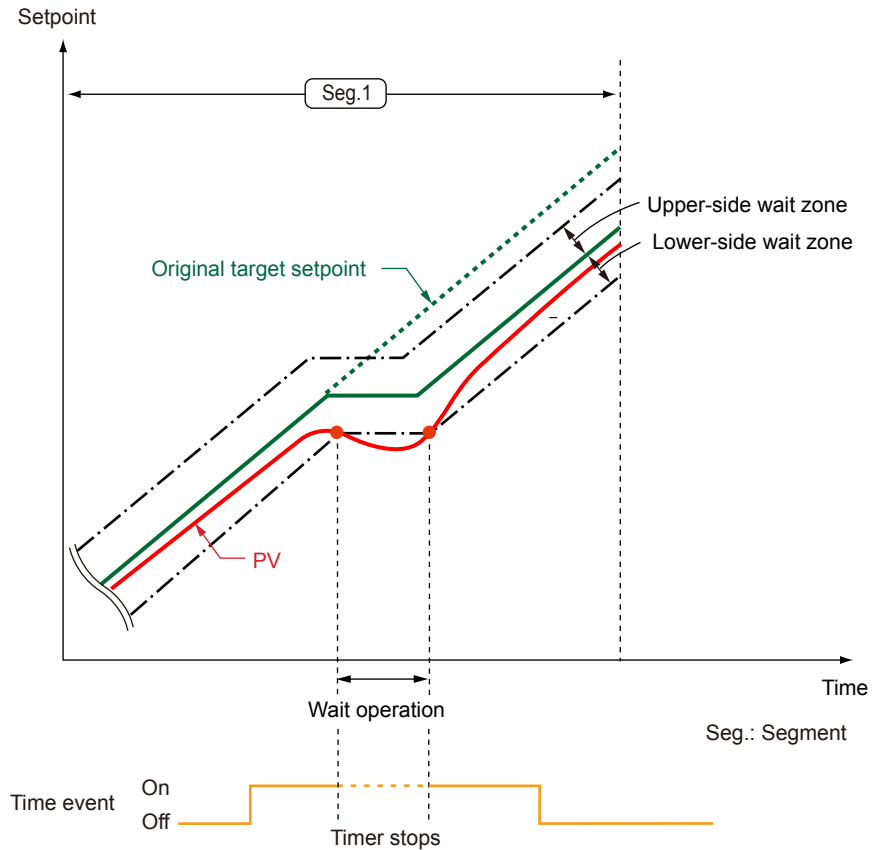
Setting value of JC				
W.IV1	W.IV2	W.IV3	W.IV4	W.IV5
WZ.UP1	WZ.UP2	WZ.UP3	WZ.UP4	WZ.UP5
WZ.LO1	WZ.LO2	WZ.LO3	WZ.LO4	WZ.LO5

### 9.4.2 Program Wait in the Middle of a Segment

**Description**

When the wait operation is set so that the program waits in the middle of the segment, the wait state is automatically engaged and the program is delayed if PV drifts outside of a preset wait zone. This wait zone is set with respect to the current target setpoint. If PV returns within the wait zone, the wait state is changed to the operating state and the program resumes running.

Wait time (WT.TM1 to WT.TM5) is disabled in the middle of a segment.



**Setting Details**

- ▶ [9.4.1 Wait during switching between segments](#)

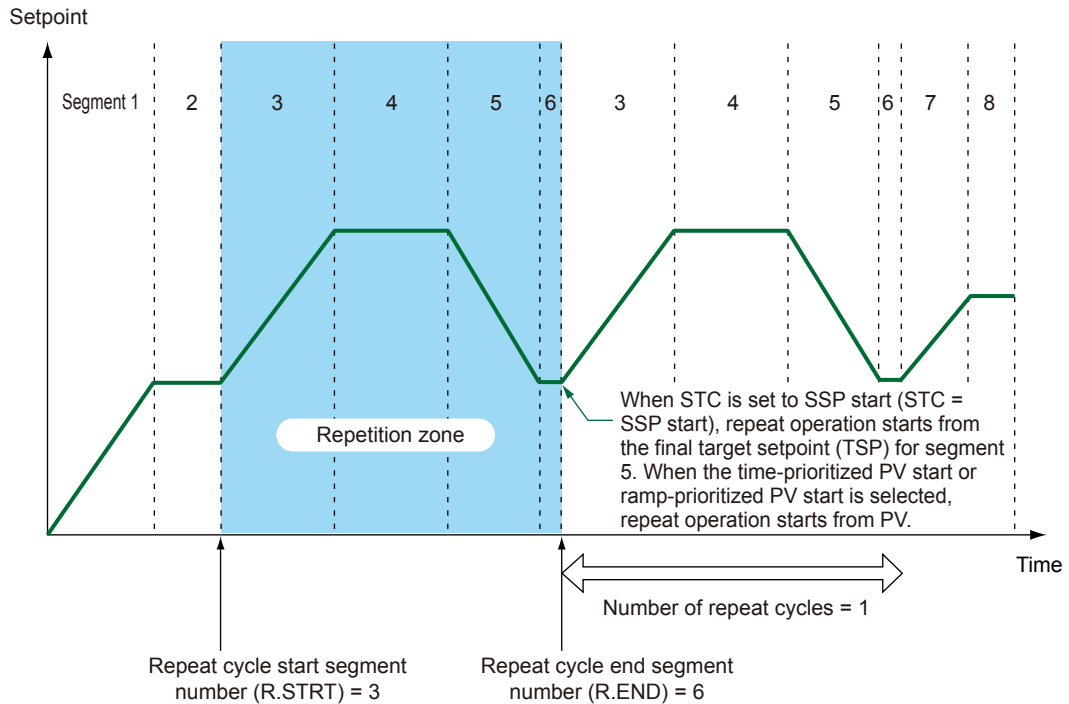
## 9.5 Setting the Segment Repetition

### Description

Repeat functions enable you to repeat successive segments in a program pattern a multiple number of times.

To use the repeat operation, set the repeat cycle start segment number, repeat cycle end segment number and number of repeat cycles.

One set of repeat operation can be set for each program pattern.



When the ramp-prioritized PV start is selected, the start code (STC) setting for the repeat cycle start segment becomes enabled.

When time-prioritized PV start or ramp-prioritized PV start is set in the start code (STC), the start code (STC) setting applies to the repeat operation start.

### Setting Details

Parameter symbol	Name	Display level	Setting range	Menu symbol
<b>R.CYCL</b>	Number of repeat cycles	STD	0 to 999, CONT (The controller indefinitely repeats the segment specified by the R.STRT and R.END parameters.)	PROG <b>Prog</b>
<b>R.STRT</b>	Repeat cycle start segment number	STD	1 to 99	
<b>R.END</b>	Repeat cycle end segment number	STD	$1 \leq R.STRT \leq R.END \leq 99$	

## 9.6 Operation with Linked Program Patterns

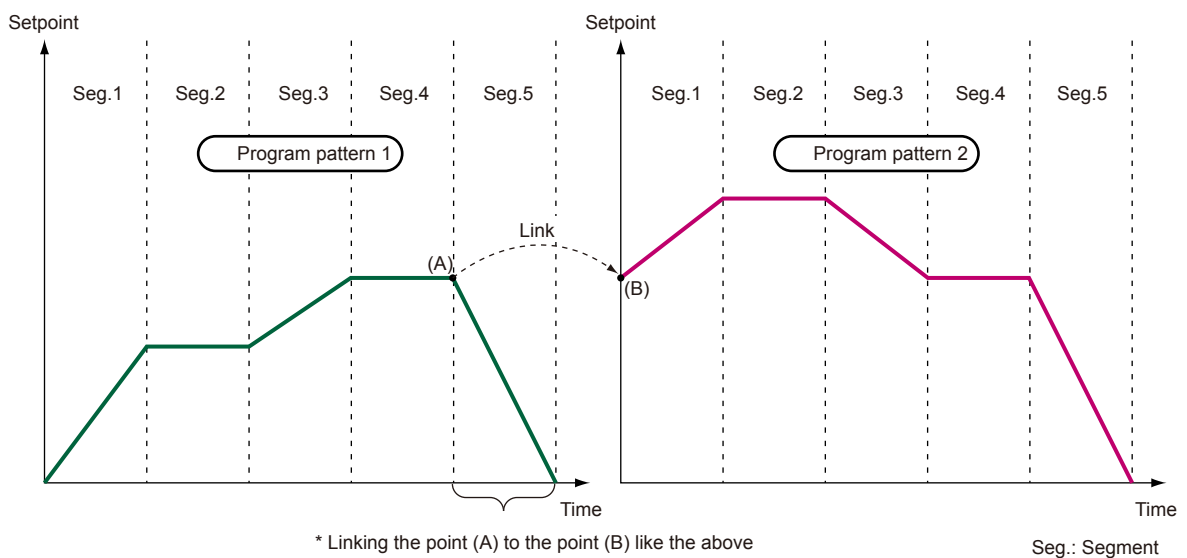
### Description

The pattern-link function allows linking multiple patterns and running them as one program pattern. The start code (STC) setting for the link destination applies to the starting target setpoint (SST) for the link destination.

When the program starts at the link destination, the start-of-program segment number (SST) becomes disabled.

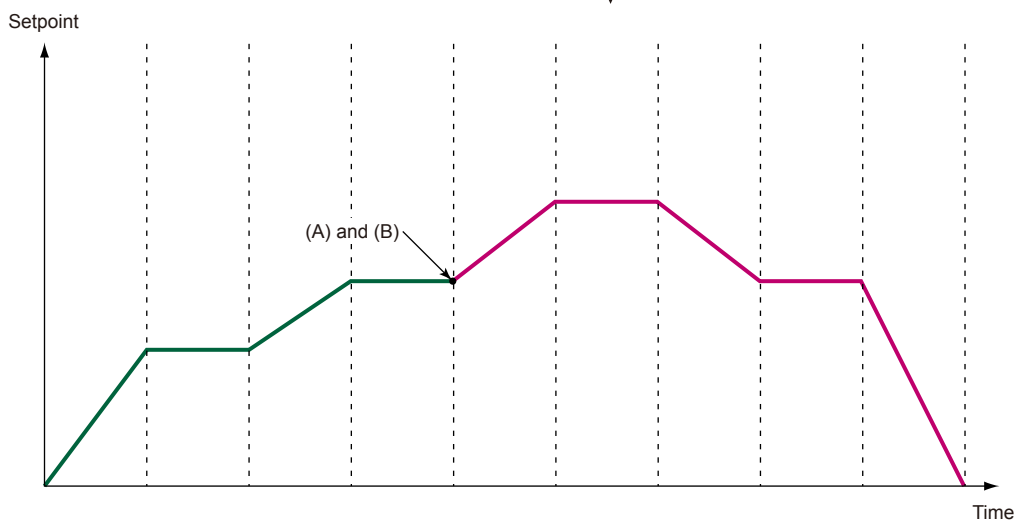
Do not specify the nonexistent program pattern for the link. When pattern-link is set for the segment in the middle of the program pattern, a link to the specified pattern is established after the set segment.

The following shows an example of linking the program patterns 2 and 5 (pattern-link). However, the start code (STC) is set to SSP start.



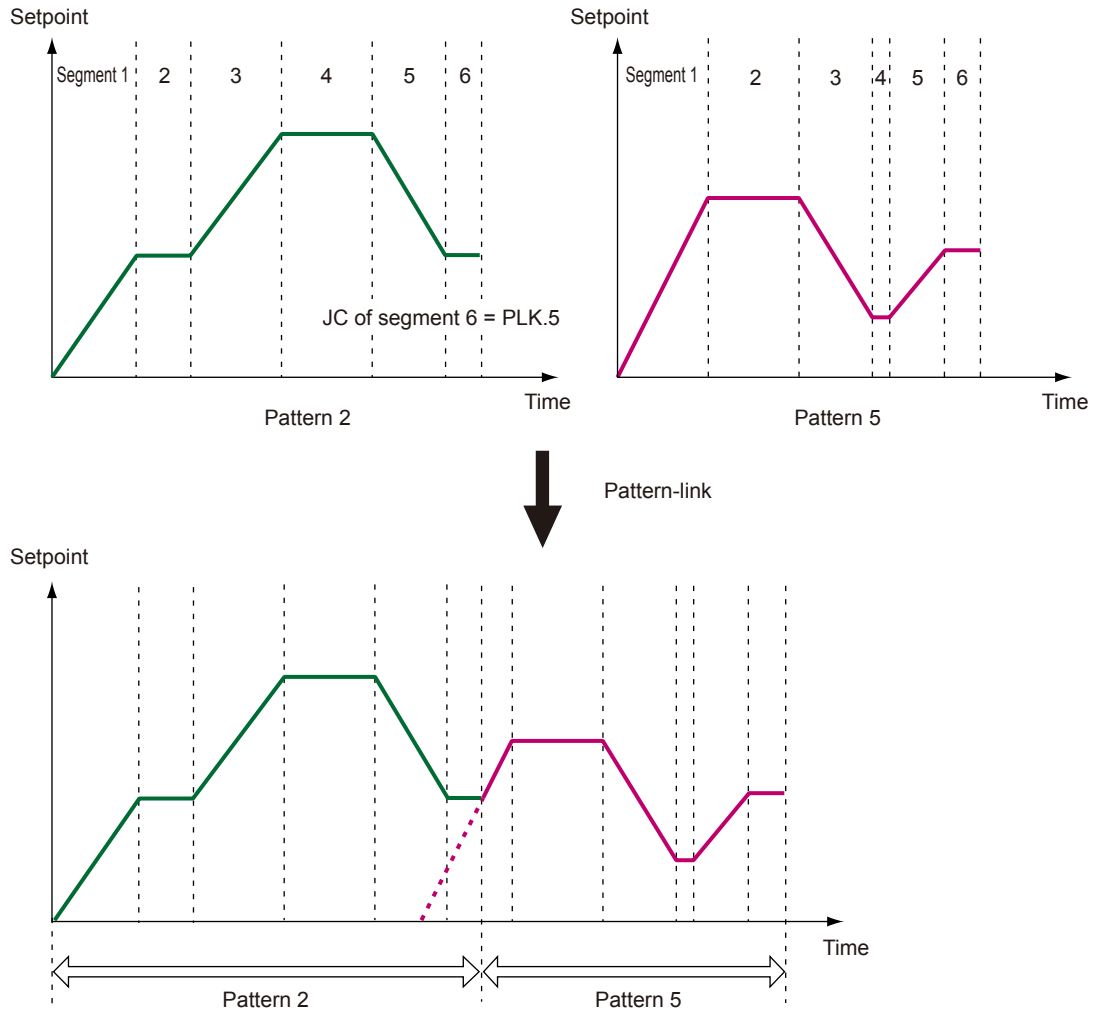
\* Linking the point (A) to the point (B) like the above example disables the operation for Seg. 5 of the program pattern 1.

Link the point (A) of the program pattern 1 to the point (B) of the program pattern 2 (pattern-link).




## 9.6 Operation with Linked Program Patterns

The following shows an example of linking the program patterns 2 and 5 (pattern-link). However, the start code (STC) is set to RAMP (Ramp-prioritized PV start.)



When ramp-prioritized PV start is selected, the start code (STC) setting for pattern 5 becomes enabled at the time when pattern 5 starts.

## Setting Details

Parameter symbol	Name	Display level	Setting range	Menu symbol
JC	Junction code	STD	<p>CONT: Switching for continuation</p> <p>HOLD: Hold-on switching (the controller holds the end-of-segment setpoint when the segment is completed, to perform control).</p> <p>LOC: Local-mode switching (the controller switches to a local setpoint when the segment is completed).</p> <p>REM: Remote-mode switching (the controller switches to a remote setpoint when the segment is completed).</p> <p>W.SW1 to W.SW5: Wait during switching between segments.</p> <p>W.IV1 to W.IV5: Wait within a segment interval.</p> <p>W.SL1 to W.SL5: Segment switching (the controller switches to a local setpoint when the segment is completed after release.) (5 groups)</p> <p>W.SR1 to W.SR5: Segment switching (the controller switches to a remote setpoint when the segment is completed after release.) (5 groups)</p> <p>PLK.1 to PLK.30: Linked to patterns 1 to 30.</p> <p>INS.: Allows a segment to be added to the end of a specified segment.</p> <p>DEL.: Allows a specified segment to be deleted.</p>	PROG 

---

## 9.7 Setting Event Functions

The event functions allow outputting an alarm at a preset time under the process of program operation, or turning on the contact output after a specified time elapses. There are two types of event action. One is PV event and the other is time event.

Two types of event action, PV event and time event, can be registered with the program operation, and one type of event action, local event, can be registered with the local operation.

Up to 8 PV events and up to 16 time events can be set for one program pattern, and up to 8 local events can be set for local operation.

The event action for program operation starts at the time when the segment for which the event action is set starts.

## 9.7.1 PV Event

**Description**

The PV event is a function to output defined PV alarms, deviation alarms and others which are related to the program.

If SP tracking is enabled when the program operation is completed, the registered PV event together with the target setpoint will be tracked for local event and the event function will be continued. If SP tracking is disabled, the PV event and the target setpoint will be switched to the preset local event.

The PV event is set for each segment.

The PV event does not have a stand-by action and latch action.

The PV event action and hysteresis action are the same as the alarm action.

▶ PV Event, Hysteresis: 11.1 Setting Alarm Type

**Setting Details**

Parameter symbol	Name	Display level	Setting range	Menu symbol
<b>PV.TY1 to PV.TY8</b>	PV event-1 to -8 type	STD	OFF: Disable (Energized) 1: PV high limit, 2: PV low limit, 3: SP high limit, 4: SP low limit, 5: Deviation high limit, 6: Deviation low limit, 7: Deviation high and low limits, 8: Deviation within high and low limits, 9: Target SP high limit, 10: Target SP low limit, 11: Target SP deviation high limit, 12: Target SP deviation low limit, 13: Target SP deviation high and low limits, 14: Target SP deviation within high and low limits, 15: OUT high limit, 16: OUT low limit, 17: Cooling-side OUT high limit, 18: Cooling-side OUT low limit * Add 100 for "de-energized". For example, when the PV high limit is de-energized, the setting is 101.	PROG <b>Prog</b>
<b>PV.EV1 to PV.EV8</b>	PV event-1 to -8 setpoint	STD	Set a display value of setpoint of PV alarm, SP alarm, deviation alarm, or output alarm. -19999 to 30000 (Set a value within the input range.) Decimal point position depends on the input type.	
<b>EHY1 to EHY8</b>	Event-1 to -8 hysteresis	STD	The hysteresis setpoint of PV event or Local event is set to the percentage of 0.0 to 100.0%. The setting value (%) is for the PV input range span or output span.	ALRM <b>Ope</b>



### 9.7.2 Time Event

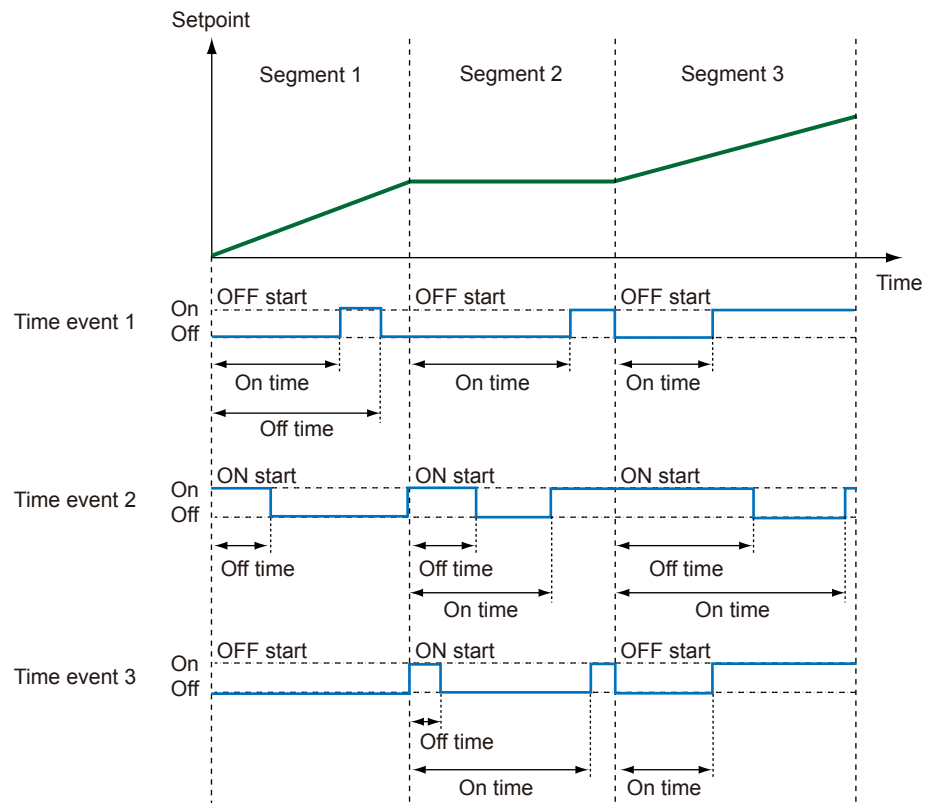
**Description**

The time event function allows starting the timer at the time when segment operation starts and turning on the contact output at the time when the set time has elapsed. The on time and off time for the time event are set within the segment time. When the set time is outside the range of the segment time, the event action at the set time is not performed.

The event information at the time when the segment ends varies depending on the time event starting condition setting for the next segment.

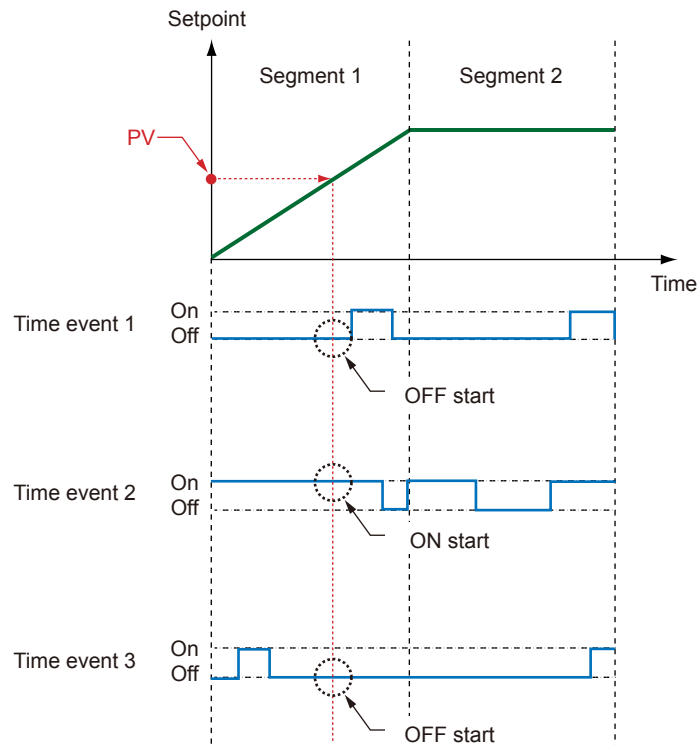
The time event is set for each segment.

The time event turns off at the time when the program operation ends, the local operation starts, the remote operation starts, and during the reset operation.



**Time event action when start code (STC) is set to ramp-prioritized PV start**

When operation is started in the middle of the segment by the start code (STC), the event action starts in the event setting state at the time when operation should have started, on the assumption that the set event action has been performed by that time.



**Setting Details**

Parameter symbol	Name	Display level	Setting range	Menu symbol
<b>TME1 to TME16</b>	Start condition of time event 1 to 16	STD	ON: Start ON state OFF: Start OFF state	PROG <b>Prog</b>
<b>T.ON1 to T.ON16</b>	On time of time event 1 to 16	STD	-: Unregistered 0.01 to 999.59 ("hour.minute" or "minute.second") * Available only within the segment time.	
<b>T.OF1 to T.OF16</b>	Off time of time event 1 to 16	STD	* OFF when the operation mode is changed to the mode except the program operation. * Use the parameter TMU to set the time unit. (Common in the instrument.)	
<b>TMU</b>	Program time unit	EASY	HH.MM: hour.minute MM.SS: minute.second	CTL <b>Set</b>

When the off time and on time for the time event coincide in the same segment, priority is given to the off state.

## 9.7 Setting Event Functions



### 9.7.3 Local Event

#### Description

The local event is enabled during local operation.  
 The local event does not have a stand-by action and latch action.  
 The local event action and hysteresis action are the same as the alarm action.

► [PV Event, Hysteresis: 11.1 Setting Alarm Type](#)

#### Setting Details

Parameter symbol	Name	Display level	Setting range	Menu symbol
<a href="#">L.TY1 to L.TY8</a>	Local event-1 to -8 type	STD	OFF: Disable (Energized) 1: PV high limit, 2: PV low limit, 3: SP high limit, 4: SP low limit, 5: Deviation high limit, 6: Deviation low limit, 7: Deviation high and low limits, 8: Deviation within high and low limits, 9: Target SP high limit, 10: Target SP low limit, 11: Target SP deviation high limit, 12: Target SP deviation low limit, 13: Target SP deviation high and low limits, 14: Target SP deviation within high and low limits, 15: OUT high limit, 16: OUT low limit, 17: Cooling-side OUT high limit, 18: Cooling-side OUT low limit * Add 100 for "de-energized". For example, when the PV high limit is de-energized, the setting is 101.	LOC 
<a href="#">L.EV1 to L.EV8</a>	Local event-1 to -8 setpoint	STD	Set a display value of setpoint of PV alarm, SP alarm, deviation alarm, or output alarm. -19999 to 30000 (Set a value within the input range.) Decimal point position depends on the input type	
<a href="#">EHY1 to EHY8</a>	Event-1 to -8 hysteresis	STD	The hysteresis setpoint of PV event or Local event is set to the percentage of 0.0 to 100.0%. The setting value (%) is for the PV input range span or output span.	ALRM 

## 9.8 Setting the Operation in Segment Switching

Segment end condition can be set for each segment. End condition can be set so that the program advances automatically to the next segment.

Use the program parameter "JC" to specify the program segment-end conditions.

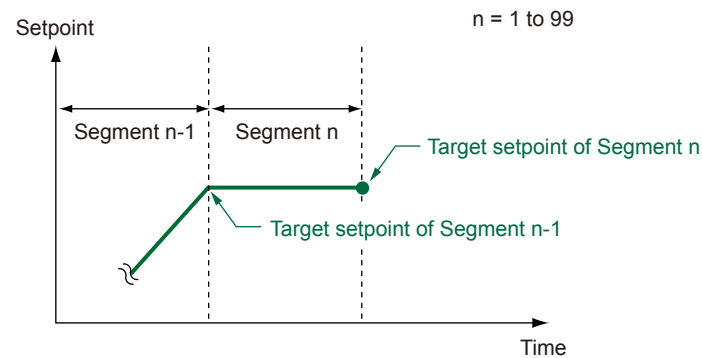
► [Wait operation: 9.4 Setting the Wait Functions](#)

### 9.8.1 Switching for continuation (JC=CONT)

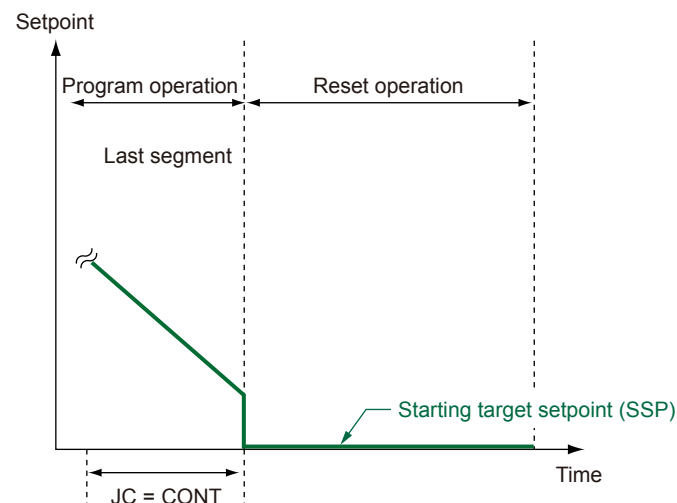
#### Description

If program continue (JC=CONT) is selected as the segment end condition, the program advances to the next segment and operation continues when the current segment ends. If it is set for the last segment in the program, the program stops (resets) at the end of that segment. At the end of the last segment, the start setpoint is taken as the target setpoint.

#### Example of program continue as the segment end condition




#### Example of the last segment



## 9.8 Setting the Operation in Segment Switching

### Setting Details

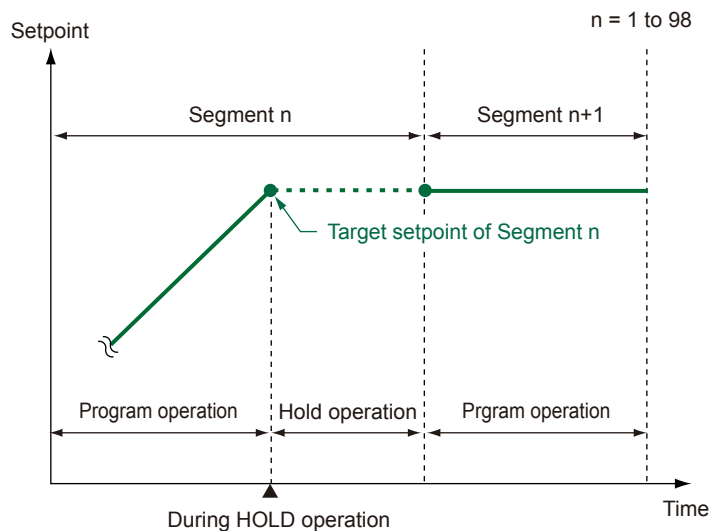
Parameter symbol	Name	Display level	Setting range	Menu symbol
JC	Junction code	STD	<p>CONT: Switching for continuation</p> <p>HOLD: Hold-on switching (the controller holds the end-of-segment setpoint when the segment is completed, to perform control).</p> <p>LOC: Local-mode switching (the controller switches to a local setpoint when the segment is completed).</p> <p>REM: Remote-mode switching (the controller switches to a remote setpoint when the segment is completed).</p> <p>W.SW1 to W.SW5: Wait during switching between segments.</p> <p>W.IV1 to W.IV5: Wait within a segment interval.</p> <p>W.SL1 to W.SL5: Segment switching (the controller switches to a local setpoint when the segment is completed after release.) (5 groups)</p> <p>W.SR1 to W.SR5: Segment switching (the controller switches to a remote setpoint when the segment is completed after release.) (5 groups)</p> <p>PLK.1 to PLK.30: Linked to patterns 1 to 30.</p> <p>INS.: Allows a segment to be added to the end of a specified segment.</p> <p>DEL.: Allows a specified segment to be deleted.</p>	PROG 

### 9.8.2 Hold-on switching (JC=HOLD)

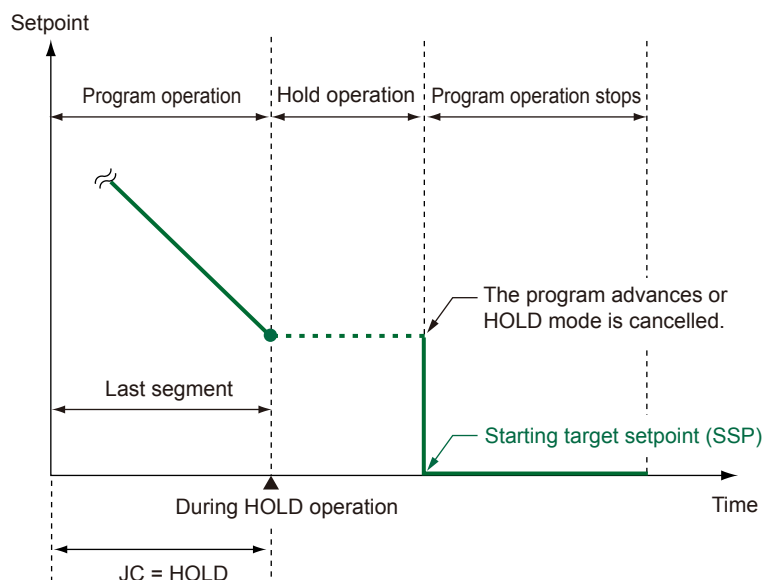
**Description**

When segment hold (JC=HOLD) is selected as the segment end condition, the program pauses (is placed on hold) at the end of the current segment. While the program is on hold, the HOLD lamp is lit. The program is kept on hold until the hold state is released either by key input or external contact input. When the hold state is released for the last segment in the program, the program stops (resets). Executing the advance function while the program is on hold releases the hold state.

**An example of segment hold being used as the segment end condition is as follows:**



**Example of the last segment**



## 9.8 Setting the Operation in Segment Switching

### Setting Details

Parameter symbol	Name	Display level	Setting range	Menu symbol
JC	Junction code	STD	<p>CONT: Switching for continuation</p> <p>HOLD: Hold-on switching (the controller holds the end-of-segment setpoint when the segment is completed, to perform control).</p> <p>LOC: Local-mode switching (the controller switches to a local setpoint when the segment is completed).</p> <p>REM: Remote-mode switching (the controller switches to a remote setpoint when the segment is completed).</p> <p>W.SW1 to W.SW5: Wait during switching between segments.</p> <p>W.IV1 to W.IV5: Wait within a segment interval.</p> <p>W.SL1 to W.SL5: Segment switching (the controller switches to a local setpoint when the segment is completed after release.) (5 groups)</p> <p>W.SR1 to W.SR5: Segment switching (the controller switches to a remote setpoint when the segment is completed after release.) (5 groups)</p> <p>PLK.1 to PLK.30: Linked to patterns 1 to 30.</p> <p>INS.: Allows a segment to be added to the end of a specified segment.</p> <p>DEL.: Allows a specified segment to be deleted.</p>	PROG <b>Prog</b>

### 9.8.3 Local-mode switching (JC=LOCAL)

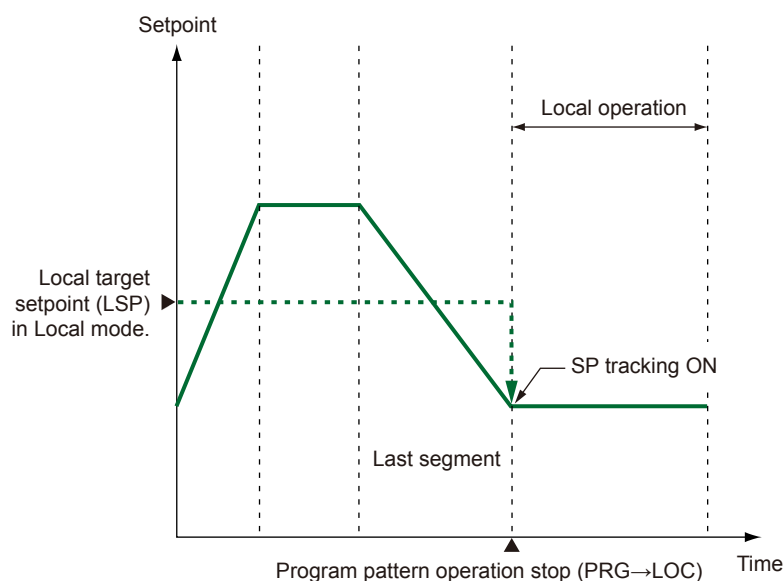
#### Description

When the last segment of program operation ends, the state becomes the local operation state. After the program operation ends, the action is performed by the on/off operation of SP tracking (SPT) and junction code (JC) as follows. When zone PID selection is selected, the action is controlled according to zone selection, and when segment PID selection is selected, the action is controlled according to local PID number selection (L.PID).

Local control (JC=LOCAL) can be set only for the last segment in the program pattern. If set for a segment in the middle of the program, the program will act as if program continue (JC=CONT) were set as the segment end condition.

#### When setpoint tracking is ON

At the end of the last segment in the program, the local (constant setpoint) mode is engaged. In this case, the target setpoint of the last segment is used as the target setpoint of the local mode. The local setpoint can be set in advance, but when setpoint tracking is ON, the target setpoint of the last segment in the program will be tracked and used regardless of the local target setpoint. Even in the local mode, the current PV event continues to operate (but the time event is off). The contents that are set in advance as local events are changed to PV events when in local mode. If no PV events are set in the program, events set as local events in advance are all off.

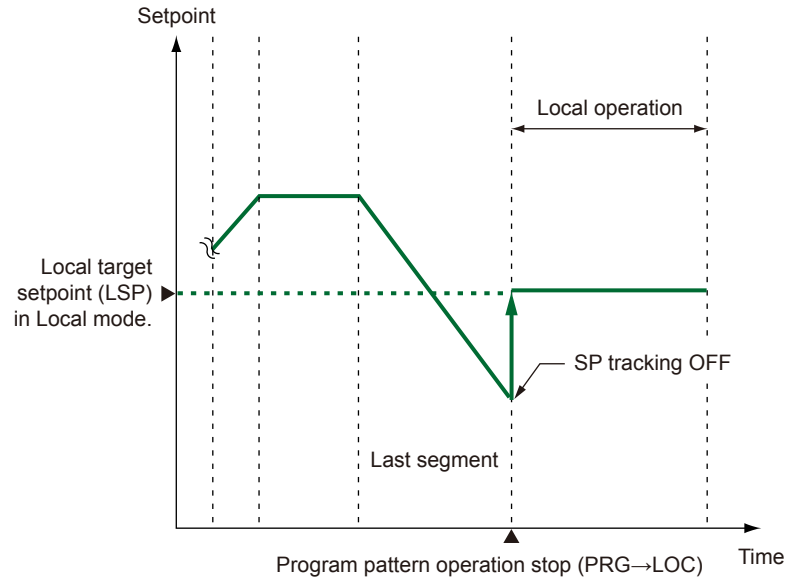




## 9.8 Setting the Operation in Segment Switching

### When setpoint tracking is OFF

At the end of the last segment in the program, the local (constant setpoint) mode is engaged. In this case, a local setpoint that is set in advance is used as the target setpoint. In the local mode, PV events will operate according to the contents of the preset local events. The time events remain off.



### Setting Details

Parameter symbol	Name	Display level	Setting range	Menu symbol
JC	Junction code	STD	CONT: Switching for continuation HOLD: Hold-on switching (the controller holds the end-of-segment setpoint when the segment is completed, to perform control). LOC: Local-mode switching (the controller switches to a local setpoint when the segment is completed). REM: Remote-mode switching (the controller switches to a remote setpoint when the segment is completed). W.SW1 to W.SW5: Wait during switching between segments. W.IV1 to W.IV5: Wait within a segment interval. W.SL1 to W.SL5: Segment switching (the controller switches to a local setpoint when the segment is completed after release.) (5 groups) W.SR1 to W.SR5: Segment switching (the controller switches to a remote setpoint when the segment is completed after release.) (5 groups) PLK.1 to PLK.30: Linked to patterns 1 to 30. INS.: Allows a segment to be added to the end of a specified segment. DEL.: Allows a specified segment to be deleted.	PROG <b>Prog</b>
SPT	SP tracking selection	STD	Tracking is performed when the mode changes from Program or Remote to Local. (The local setpoint keeps track of the program or remote setpoint.) OFF, ON	SPS <b>Ope</b>

## 9.8.4 Remote-mode switching (JC=REM)

**Description**

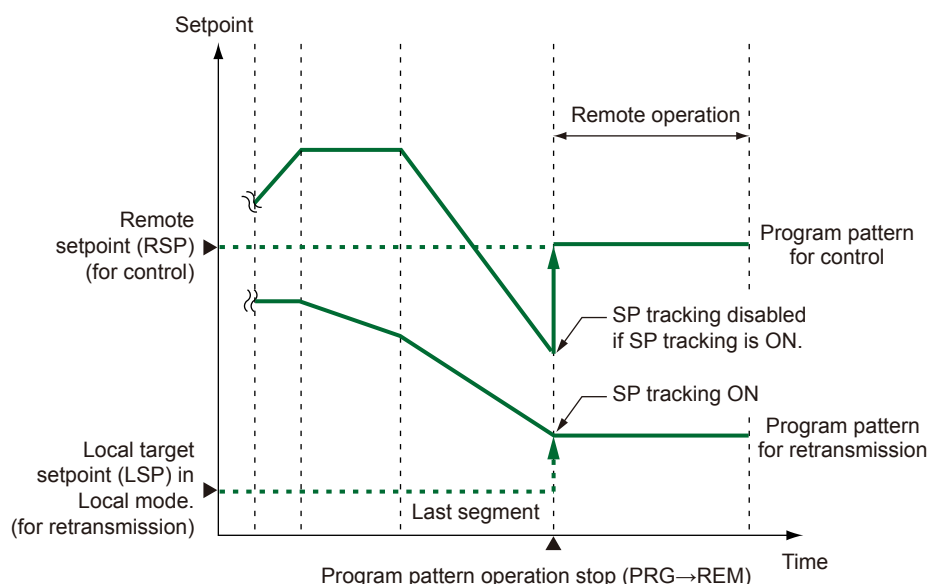
When the last segment of program operation ends, the state becomes the remote operation state. After the program operation ends, the action is performed by the on/off operation of SP tracking (SPT) and junction code (JC) as follows. When zone PID selection is selected, the action is controlled according to zone selection, and when segment PID selection is selected, the action is controlled according to local PID number selection (L.PID).

Remote-mode switching (JC = REM) can be enabled only for the last segment. When remote-mode switching is used for the segment in the middle of the program pattern, the action is the same as that when the junction code (JC) is set to CONT.

**When setpoint tracking is ON**

The remote setpoint (RSP) is the target setpoint at the time when the program ends. The PV event information at the time when the program ends is set in the local event type and setpoint (L.TY1 to L.TY8 and L.EV1 to L.EV8) and the PV event is enabled. The time event is turned off.

With the retransmission program pattern, the final target setpoint is the target setpoint at the time when program operation ends.

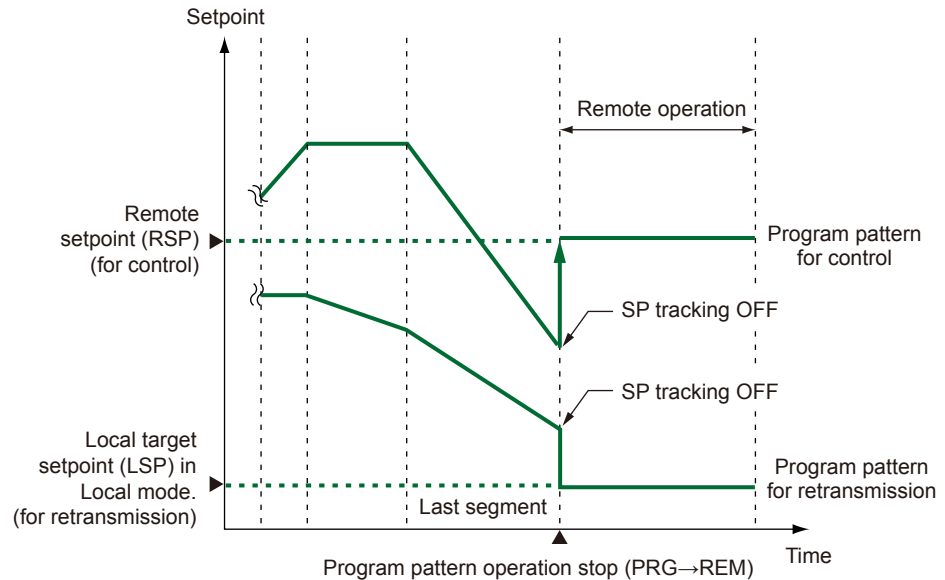


## 9.8 Setting the Operation in Segment Switching

### When setpoint tracking is OFF

The remote setpoint (RSP) is the target setpoint at the time when the program ends. The PV event is enabled according to the local event type and setpoint (L.TY1 to L.TY8 and L.EV1 to L.EV8). The time event turns off.

With the retransmission program pattern, the local setpoint (LSP) is the target setpoint at the time when program operation ends.



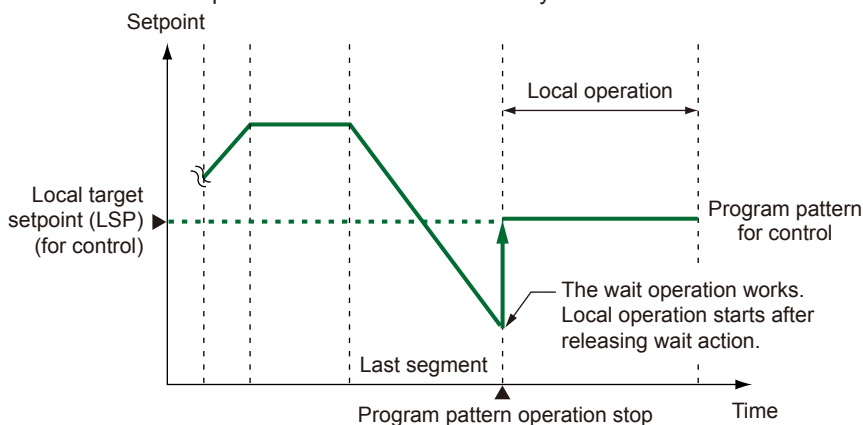
### Setting Details

Parameter symbol	Name	Display level	Setting range	Menu symbol
JC	Junction code	STD	CONT: Switching for continuation HOLD: Hold-on switching (the controller holds the end-of-segment setpoint when the segment is completed, to perform control). LOC: Local-mode switching (the controller switches to a local setpoint when the segment is completed). REM: Remote-mode switching (the controller switches to a remote setpoint when the segment is completed). W.SW1 to W.SW5: Wait during switching between segments. W.IV1 to W.IV5: Wait within a segment interval. W.SL1 to W.SL5: Segment switching (the controller switches to a local setpoint when the segment is completed after release.) (5 groups) W.SR1 to W.SR5: Segment switching (the controller switches to a remote setpoint when the segment is completed after release.) (5 groups) PLK.1 to PLK.30: Linked to patterns 1 to 30. INS.: Allows a segment to be added to the end of a specified segment. DEL.: Allows a specified segment to be deleted.	PROG <b>Prog</b>

### 9.8.5 Segment switching (the controller switches to a local setpoint when the segment is completed after release) (JC=W.SL1 to W.SL5)

**Description**

The stand-by action is performed in the last segment of program operation and the state becomes the local operation state after the stand-by state is released.



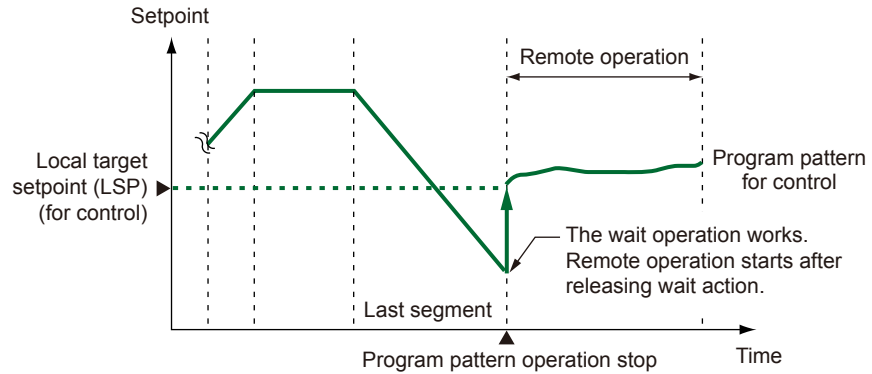
**Setting Details**

Parameter symbol	Name	Display level	Setting range	Menu symbol
<b>JC</b>	Junction code	STD	CONT: Switching for continuation HOLD: Hold-on switching (the controller holds the end-of-segment setpoint when the segment is completed, to perform control). LOC: Local-mode switching (the controller switches to a local setpoint when the segment is completed). REM: Remote-mode switching (the controller switches to a remote setpoint when the segment is completed). W.SW1 to W.SW5: Wait during switching between segments. W.IV1 to W.IV5: Wait within a segment interval. W.SL1 to W.SL5: Segment switching (the controller switches to a local setpoint when the segment is completed after release.) (5 groups) W.SR1 to W.SR5: Segment switching (the controller switches to a remote setpoint when the segment is completed after release.) (5 groups) PLK.1 to PLK.30: Linked to patterns 1 to 30. INS.: Allows a segment to be added to the end of a specified segment. DEL.: Allows a specified segment to be deleted.	PROG Prog
<b>WT.SW1 to WT.SW5</b>	Wait function ON/OFF 1 to 5	STD	OFF: Disable ON: Enable	
<b>WT.UP1 to WT.UP5</b>	Upper-side wait zone 1 to 5	STD	0.0 to 10.0% of PV input range (EU)	
<b>WT.LO1 to WT.LO5</b>	Lower-side wait zone 1 to 5	STD		
<b>WT.TM1 to WT.TM5</b>	Wait time 1 to 5	STD	OFF: No function 0.00 to 999.59 ("hour.minute" or "minute.second") * Available only for the wait time at the segment switching. * Use the parameter TMU to set the time unit. (Common in the instrument.)	
<b>TMU</b>	Program time unit	EASY	HH.MM: hour.minute MM.SS: minute.second	CTL Set

### 9.8.6 Segment switching (the controller switches to a remote setpoint when the segment is completed after release) (JC=W.SR1 to W.SR5)

**Description**

The stand-by action is performed in the last segment of program operation and the state becomes the remote operation state after the stand-by state is released. However, the controller is in local-mode when burnout occurs.



**Setting Details**

Parameter symbol	Name	Display level	Setting range	Menu symbol
<b>JC</b>	Junction code	STD	CONT: Switching for continuation HOLD: Hold-on switching (the controller holds the end-of-segment setpoint when the segment is completed, to perform control). LOC: Local-mode switching (the controller switches to a local setpoint when the segment is completed). REM: Remote-mode switching (the controller switches to a remote setpoint when the segment is completed). W.SW1 to W.SW5: Wait during switching between segments. W.IV1 to W.IV5: Wait within a segment interval. W.SL1 to W.SL5: Segment switching (the controller switches to a local setpoint when the segment is completed after release.) (5 groups) W.SR1 to W.SR5: Segment switching (the controller switches to a remote setpoint when the segment is completed after release.) (5 groups) PLK.1 to PLK.30: Linked to patterns 1 to 30. INS.: Allows a segment to be added to the end of a specified segment. DEL.: Allows a specified segment to be deleted.	PROG <span style="background-color: #e91e63; color: white; border-radius: 5px; padding: 2px;">Prog</span>
<b>WT.SW1 to WT.SW5</b>	Wait function ON/OFF 1 to 5	STD	OFF: Disable ON: Enable	
<b>WT.UP1 to WT.UP5</b>	Upper-side wait zone 1 to 5	STD	0.0 to 10.0% of PV input range (EU)	
<b>WT.LO1 to WT.LO5</b>	Lower-side wait zone 1 to 5	STD		
<b>WT.TM1 to WT.TM5</b>	Wait time 1 to 5	STD	OFF: No function 0.00 to 999.59 ("hour.minute" or "minute.second") * Available only for the wait time at the segment switching. * Use the parameter TMU to set the time unit. (Common in the instrument.)	
<b>TMU</b>	Program time unit	EASY	HH.MM: hour.minute MM.SS: minute.second	CTL <span style="background-color: #333; color: white; border-radius: 5px; padding: 2px;">Set</span>

## 9.9 Setting Program Pattern-2 Retransmission

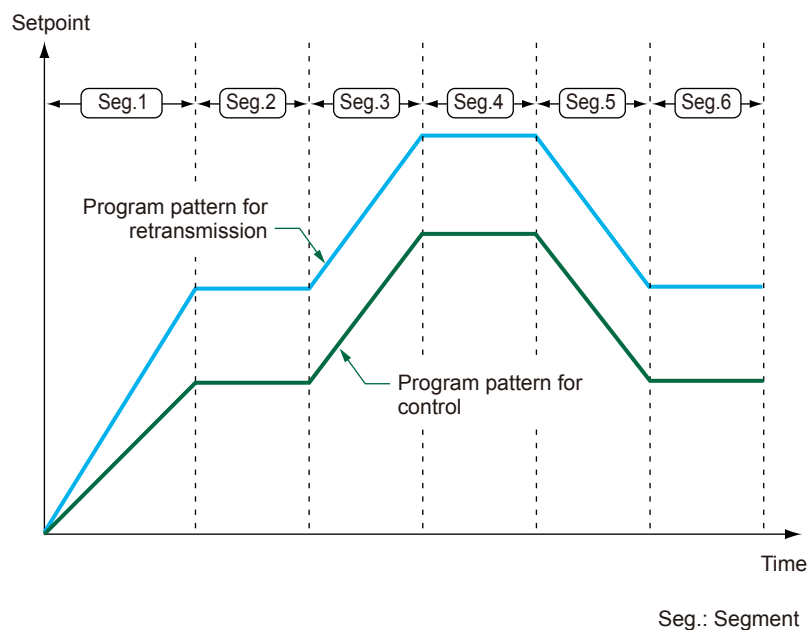
### Description

The program pattern-2 retransmission function allows creating a program pattern other than the program pattern used for control on the same timeline and retransmitting it. With program pattern-2, the starting target setpoint (SSP) and the final target setpoint (TSP) for each segment can be set and created in the same segment time as that for the control program.

When coordinated operation is used, the program pattern can be retransmitted to the slave controller.

The retransmission output types (RTS, O1RS, or O2RS) need to be set to SP2.

The program pattern-2 retransmission function cannot be used when the control mode is set to cascade control.



### Setting Details

Parameter symbol	Name	Display level	Setting range	Menu symbol
<b>PT2.G</b>	Program pattern-2 retransmission	STD	OFF: Not used. ON: used.	CTL <b>Set</b>

Using Terminal	Setting Parameter
RET terminals	RTS, RTH, RTL
OUT terminals	O1RS, O1RH, O1RL
OUT2 terminals	O2RS, O2RH, O2RL

The retransmission output type should be set to SP2, irrespective to the terminal used.

- ▶ [10.11 Setting Retransmission Output Terminal, Type, and Scales](#)

## 9.10 Setting Starting time of program operation

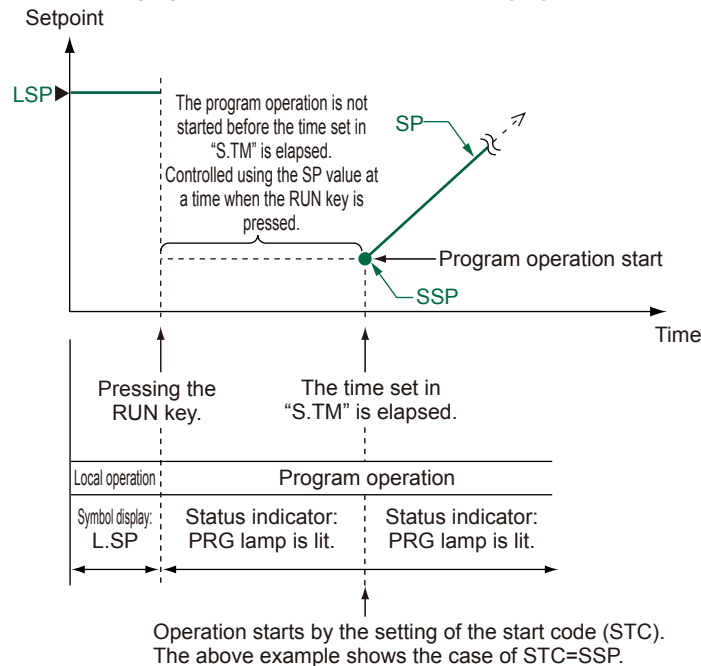
### Description

The starting time of program operation refers to the time from the start of the program operation (RUN) to the start of the program pattern. The starting time of the program operation (S.TM) can be delayed by the set amount of time. The time that is counted is the time from the time when the operation mode is changed from non-program operation to program operation up to the start of operation. The count-down time can be checked in Remaining Segment-time Display (Operation Display).

State until program operation starts	
Target setpoint	Action according to the final target setpoint before the operation mode is changed
PV event	Off
Time event	Off
Status lamp	PRG lamp is lit

When the delay action up until program operations starts is cancelled, the operation mode is changed to other than program operation. For example, when local operation is switched to program operation and then the operation mode is switched to local operation during the delay action, the state returns to the local operation state.

The following figure shows an example of changing local operation to program operation.



### Setting Details

Parameter symbol	Name	Display level	Setting range	Menu symbol
<b>S.TM</b>	Starting time of program operation	STD	0.00 to 999.59 ("hour.minute" or "minute.second" (common use of instrument))	SPS <b>Ope</b>
<b>TMU</b>	Program time unit	EASY	HH.MM: hour.minute MM.SS: minute.second	CTL <b>Set</b>

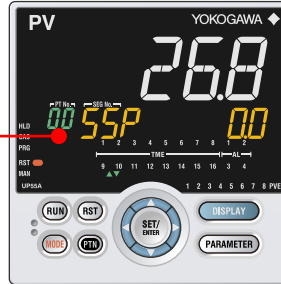
Parameter TMU is used commonly for all controllers.

## 9.11 Setting the Program Pattern Number Clearance

### Description

This function allows resetting the program pattern number in Operation Display to 0 when the program operation ends.

The controller resets (clears) the program pattern number on the operating display to "0" at the end of program operation.



### Setting Details

Parameter symbol	Name	Display level	Setting range	Menu symbol
PNC	Program pattern number clearance	STD	OFF: Not cleared. ON: Cleared. (Set the program No. before restart program operation)	SPS <b>Ope</b>



---

## 9.12 Program Pattern End Signal

### Description

A pattern end signal notifies the outside of the end of a program pattern when the execution of the program pattern ends.

The pattern end signal can be output by contact output or via communication.

There are one-second, three-second, and five-second pattern end signals.

When the program is also forcibly terminated by key operation, contact input, or via communication, the pattern end signal is output. When the pattern-link function is used, the pattern end signal is output when the link destination program pattern ends.

Even if program operation starts while the pattern end signal is on, the pattern end signal is not turned off.

### Setting Details

- ▶ [Pattern End Signal: 12.2 Setting Contact Output Function](#)


## 9.13 Editing the Program Pattern

### 9.13.1 Checking the Number of Remaining Segments

#### Description

This allows checking the number of the segments unused in the controller.

#### Setting Details

Parameter symbol	Name	Display level	Setting range	Menu symbol
ALL.S	Number of remaining unused segments	PRO	0 to 300 (Display only)	EDIT 


### 9.13.2 Checking the Number of Segments in specified pattern

#### Description

This allows specifying the program pattern number to be displayed in the parameter USE.S.

The parameter PTN.S is displayed when a program pattern number is specified in the parameter USE.S. The number of segments for the specified program pattern is displayed in USE.S.

#### Setting Details

Parameter symbol	Name	Display level	Setting range	Menu symbol
PTN.S	Pattern number designation for confirming number of segments	PRO	0 to 300 (Display only)	EDIT 
USE.S	Number of segments within a pattern	PRO	0: disable 1 to 99 (Display only)	


### 9.13.3 Copying a Program Pattern

**Description**

This function allows copying a created program pattern and editing it as a new program pattern.

Specify the source-of-copying pattern number in the parameter CPY.S and then press the SET/ENTER key. Next, specify the destination-of-copying pattern number in the parameter CPY.D and then press the SET/ETNTER key to perform copying. At this point, an error may occur. Check the details of the error.

**Setting Details**

Parameter symbol	Name	Display level	Setting range	Menu symbol
CPY.S	Source-of-copying pattern number designation	PRO	1 to 30	EDIT 
CPY.D	Target-of-copying pattern number designation	PRO	1 to 30	

### 9.13.4 Adding and Deleting Segment in Program Patterns

**Description**


This function allows adding or deleting a segment while or after a program pattern is created.

When the junction code for a segment is set to INS. or DEL., the next segment is editable. When INS. is set, the segment is added, and when DEL. is set, the segment is deleted.

Addition and deletion of a segment cannot be done during program pattern operation.

▶ [Clearing all program pattern data: 12.2 Initializing Parameter Settings to Factory Default Values](#)

**Setting Details**

Parameter symbol	Name	Display level	Setting range	Menu symbol
JC	Junction code	STD	CONT: Switching for continuation HOLD: Hold-on switching (the controller holds the end-of-segment setpoint when the segment is completed, to perform control). LOC: Local-mode switching (the controller switches to a local setpoint when the segment is completed). REM: Remote-mode switching (the controller switches to a remote setpoint when the segment is completed). W.SW1 to W.SW5: Wait during switching between segments. W.IV1 to W.IV5: Wait within a segment interval. W.SL1 to W.SL5: Segment switching (the controller switches to a local setpoint when the segment is completed after release.) (5 groups) W.SR1 to W.SR5: Segment switching (the controller switches to a remote setpoint when the segment is completed after release.) (5 groups) PLK.1 to PLK.30: Linked to patterns 1 to 30. INS.: Allows a segment to be added to the end of a specified segment. DEL.: Allows a specified segment to be deleted.	PROG 

### 9.13.5 Deleting the Program Pattern


#### Description

This allows specifying the program pattern number to delete.

This allows deleting all programs in the controller.

► [Clearing all program pattern data: 12.2 Initializing Parameter Settings to Factory Default Values](#)

#### Setting Details

Parameter symbol	Name	Display level	Setting range	Menu symbol
CLR.P	Program pattern clearance	PRO	1 to 30	EDIT 

### 9.13.6 List of the Error Code

#### Description

#### Error Indication at Program Pattern Creation and Editing

Error code	Error information	Cause of error
ERR01	Pattern creation or editing is disabled during program operation.	Deleting or copying of the program pattern, or inserting or deleting of the segment was executed during program operation.
ERR22	Segment write error	The total number of segments exceeded 300.
ERR23	Segment insert error	New segment cannot be inserted because the number of segments in a pattern exceeded 99.
ERR32	Pattern source specification error	No pattern exists in the source.
ERR33	Pattern destination specification error	Patterns already exist in the destination.
ERR41	Pattern delete error	The pattern to be deleted does not exist.

#### Error Codes in Communication

Error code	Error information	Cause of error
0	No error	Normal end.
1	Pattern creation or editing is disabled during program operation.	Deleting or copying of the program pattern, or inserting or deleting of the segment was executed during program operation.
2	Pattern number error	The specified pattern number does not exist. 1 to 30
3	Segment number error	The specified segment number does not exist. 1 to 99
22	Segment write error	The total number of segments exceeded 300.
31	Pattern copy error	No pattern exists in the source, or patterns already exist in the destination.
41	Pattern delete error	The pattern to be deleted does not exist.

## 9.14 Synchronized Program Pattern Operation

### 9.14.1 Synchronized Operation During Switching Between Segments

#### Description

A synchronized operation during switching between segments can be performed using a wait during switching between segments and a contact I/O.

This function can be implemented by registering a wait due to a contact input (parameter WAIT) and a control flag for segment transition (I relay: 4261) in the contact output and using the respective contact I/Os.

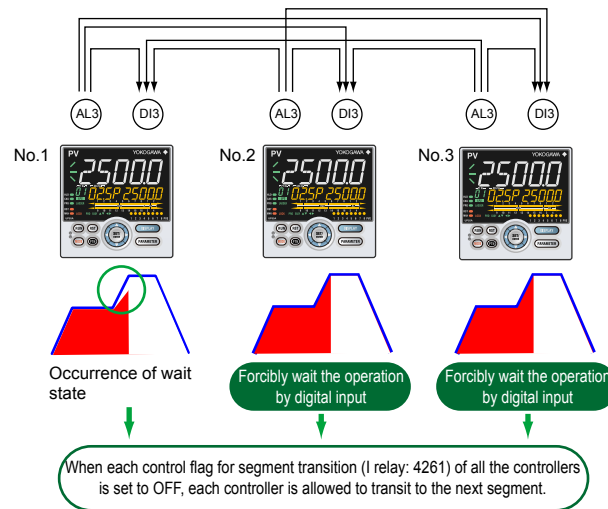
The following parameters are available in wait operations using this function.

First group of wait parameters: [WT.SW1](#), [WZ.UP1](#), [WZ.LO1](#)

The following shows an example of synchronized operation during switching between segments.

Wire each contact I/O of controllers 1 to 3 as shown in the following figure.

When setting parameters, set “5027” in the Wait ON/OFF switch parameter “WAIT” of each controller (DI function registration menu: DI.SL) and set “4261” in the AL3 function selection parameter “AL3.S” of each controller (AL1-AL3 function registration menu: ALM). Once controller 1 is put in the wait state, none of the controllers are allowed to transition to the next segment and are forcibly put in the wait state. They are allowed to transit to the next segment only when each control flag for segment transition (I relay: 4261) of all the controllers is set to OFF.



#### Control flag for segment transition (I relay: 4261)

When the control flag for segment transition is ON:

- The controller is in the wait state at segment transition (out of the first group of wait zone) or the remaining segment time is not zero.

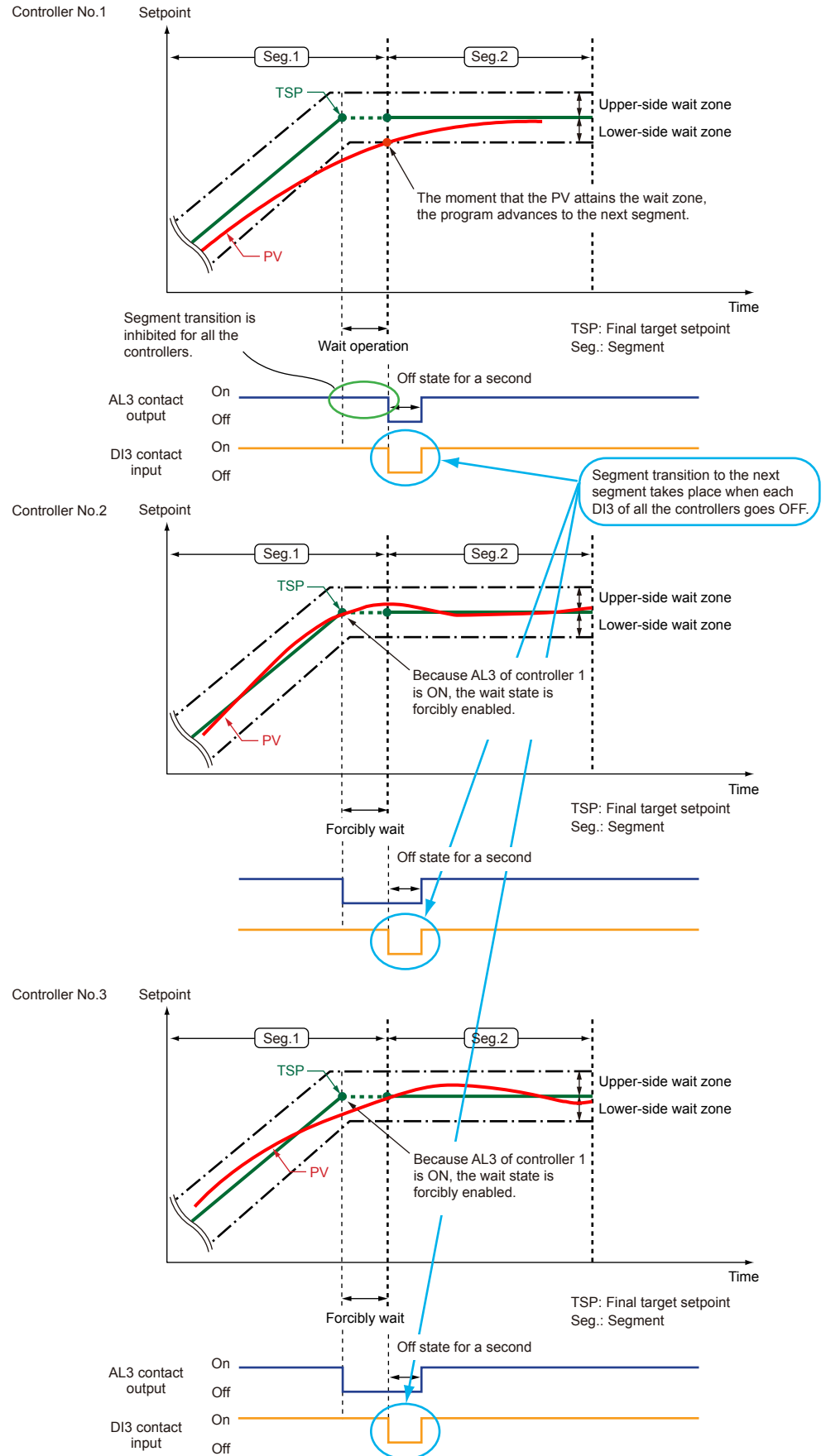
When the control flag for segment transition is OFF:

- The controller is not in the wait state and the remaining segment time is zero.
- Each control flag for segment transition (I relay: 4261) of all the controllers is set to OFF and a one-second off state is caused immediately after segment transition takes place.
- The operation concerned is not program pattern operation.(Reset, Local, Remote)
- The wait function ON/OFF switch (WT.SW1) is OFF.

#### Note

- Turn on the power switches of all the controllers at the same time.
- Set each segment time to five seconds or more.
- Set JC=CONT usually because transition to the next segment may not take place depending on the setting contents (wait switching or hold switching) of the junction code (JC).

## 9.14 Synchronized Program Pattern Operation



## 9.14 Synchronized Program Pattern Operation

### Setting Details

Parameter symbol	Name	Display level	Setting range	Menu symbol
<b>WAIT</b>	Wait ON/OFF switch	STD	Set an I relay number of contact input. Set "OFF" to disable the function.  Standard terminals DI1: 5025, DI2: 5026, DI3: 5027 E1-terminal area DI11: 5041, DI12: 5042, DI13: 5043, DI14: 5044, DI15: 5045, DI16: 5046 E2-terminal area DI21: 5057, DI22: 5058, DI23: 5059, DI24: 5060, DI25: 5061, DI26: 5062 E3-terminal area DI31: 5073, DI32: 5074, DI33: 5075, DI34: 5076, DI35: 5077 E4-terminal area DI41: 5089, DI42: 5090, DI43: 5091, DI44: 5092, DI45: 5093, DI46: 5094	DI.SL <b>Set</b>
<b>AL1.S</b>	AL1 function selection	STD	Control flag for segment transition: 4261	ALM <b>Set</b>
<b>AL2.S</b>	AL2 function selection			
<b>AL3.S</b>	AL3 function selection			
<b>OR.S</b>	OUT relay function selection			
<b>OR2.S</b>	OUT2 relay function selection			
<b>DO1.S</b>	DOn1 function selection	STD	Control flag for segment transition: 4261	DO <b>Set</b>
<b>DO2.S</b>	DOn2 function selection			
<b>DO3.S</b>	DOn3 function selection			
<b>DO4.S</b>	DOn4 function selection			
<b>DO5.S</b>	DOn5 function selection			

n: Terminal area number (1 to 4)

## 9.14.2 Synchronized Operation of Program Pattern Progression

## Description

The synchronized operation of program pattern progression can be performed using a wait within segment interval and a contact I/O.

This function can be implemented by registering a switch to HOLD for synchronized program operation (parameter S.HLD) and a wait flag (I flag: 4190) in the contact output and using the respective contact I/Os.

The following parameters are available in the wait operation using this function.

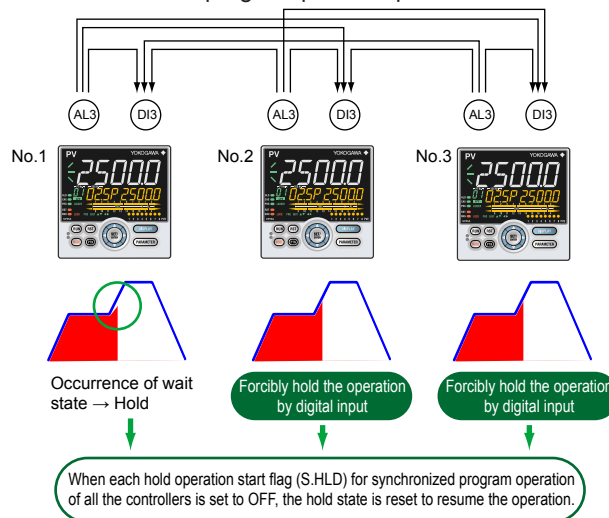
First group of wait parameters: WT.SW1, WZ.UP1, WZ.LO1

The following figure shows an example of synchronized operation of program pattern progression.

Wire each contact I/O of controllers 1 to 3 as shown in the following figure.

When setting parameters, set "5027" in the switch to HOLD for synchronized program operation parameter "S.HLD (DI function registration menu: DI.SL) and set "4190" in the AL3 function selection parameter "AL3.S" (AL1-AL3 function registration menu: ALM) of each controller.

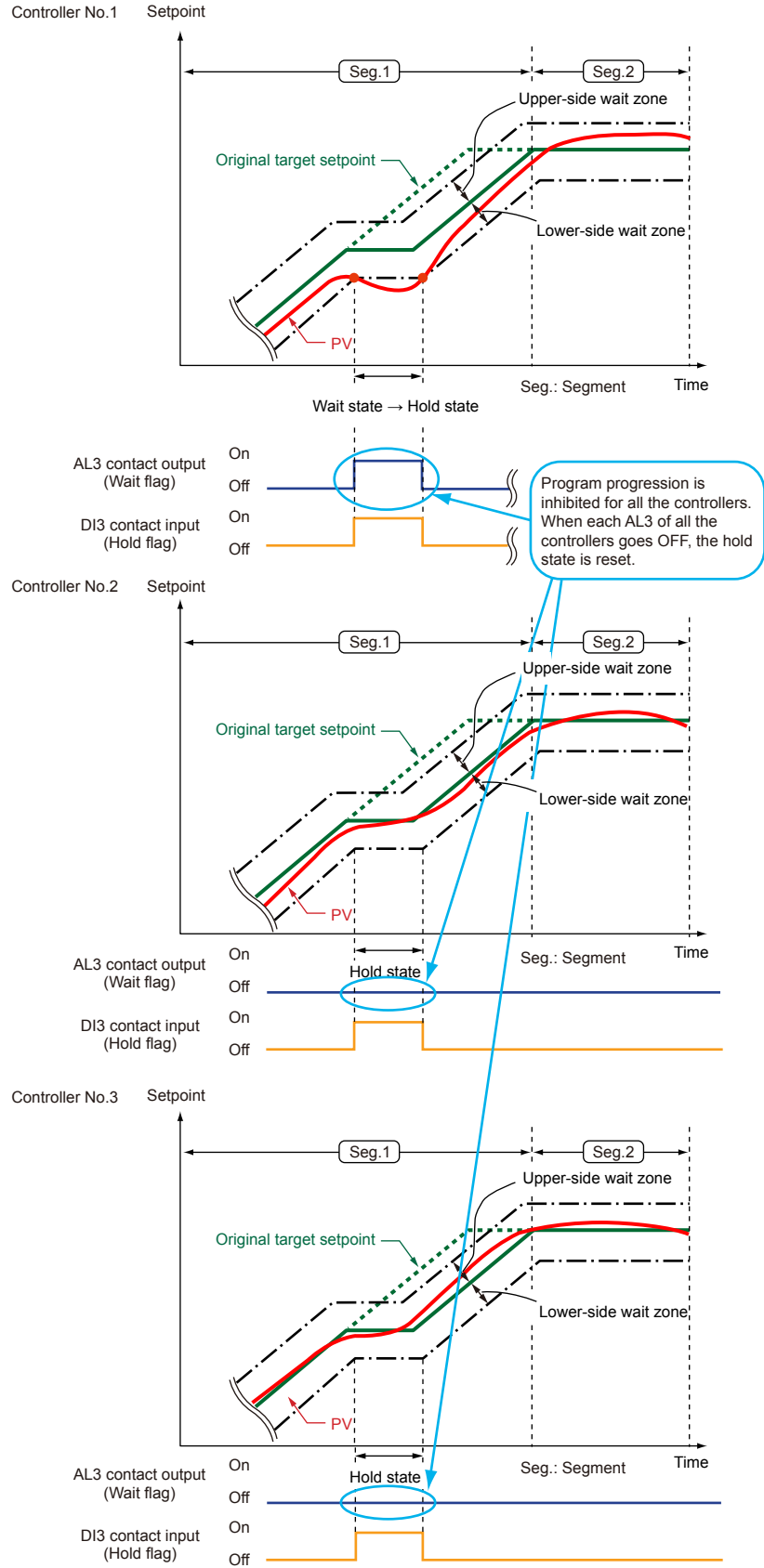
Once controller 1 is put in the wait state, all the controllers are forcibly put in the hold state. When each wait flag (WAIT) of all the controllers is set to OFF, the hold state is reset to resume a program pattern operation.

**Note**

- Turn on the power switches of all the controllers at the same time.
- Set each segment time to five seconds or more.
- When the power switches are turned on at the same time, a time difference in the start of operation occurs, depending on whether each controller uses this function. Specifically, the controller using this function starts operation with a lag of about five seconds.



## 9.14 Synchronized Program Pattern Operation



## Setting Details

Parameter symbol	Name	Display level	Setting range	Menu symbol
<b>S.HLD</b>	Switch to HOLD for synchronized program operation	PRO	Set an I relay number of contact input. Set "OFF" to disable the function.  Standard terminals DI1: 5025, DI2: 5026, DI3: 5027 E1-terminal area DI11: 5041, DI12: 5042, DI13: 5043, DI14: 5044, DI15: 5045, DI16: 5046 E2-terminal area DI21: 5057, DI22: 5058, DI23: 5059, DI24: 5060, DI25: 5061, DI26: 5062 E3-terminal area DI31: 5073, DI32: 5074, DI33: 5075, DI34: 5076, DI35: 5077 E4-terminal area DI41: 5089, DI42: 5090, DI43: 5091, DI44: 5092, DI45: 5093, DI46: 5094	DI.SL <b>Set</b>
<b>AL1.S</b>	AL1 function selection	STD	Wait flag: 4190	ALM <b>Set</b>
<b>AL2.S</b>	AL2 function selection			
<b>AL3.S</b>	AL3 function selection			
<b>OR.S</b>	OUT relay function selection			
<b>OR2.S</b>	OUT2 relay function selection			
<b>DO1.S</b>	DOn1 function selection	STD	Wait flag: 4190	DO <b>Set</b>
<b>DO2.S</b>	DOn2 function selection			
<b>DO3.S</b>	DOn3 function selection			
<b>DO4.S</b>	DOn4 function selection			
<b>DO5.S</b>	DOn5 function selection			

n: Terminal area number (1 to 4)

---

Blank Page

# 10.1 Setting Control Output Type

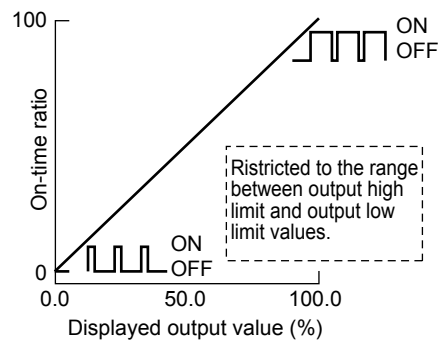
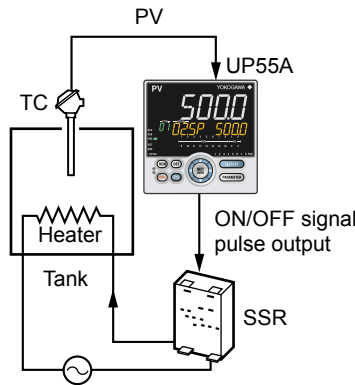
## Description

### Time Proportional Relay Output / Triac Output / Time Proportional Voltage Pulse Output

In time proportional output, the control computation result is output in the form of an on/off signal pulse width proportional to the time. The pulse width is calculated as follows with the cycle time (control output cycle) at 100%.

$$\text{Control output pulse width} = \text{Control output (\%)} \times \text{Cycle time}$$

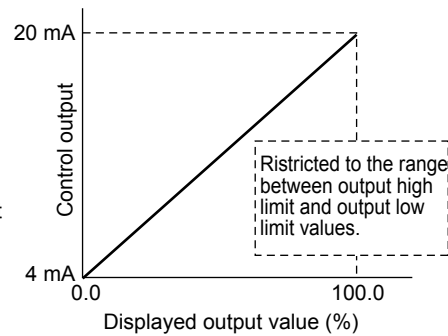
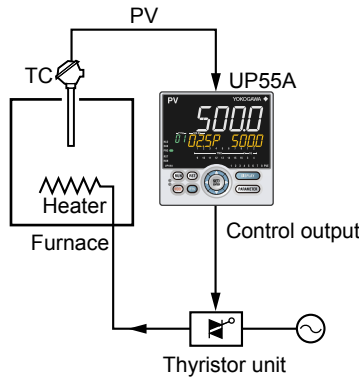
The output type is selected as either the relay/triac output or the voltage pulse output.



► Cycle time: 10.2 Setting Control Output Cycle Time

### Current Output

In current output, the control computation result is output as a current signal. (Example of 4 to 20 mA)

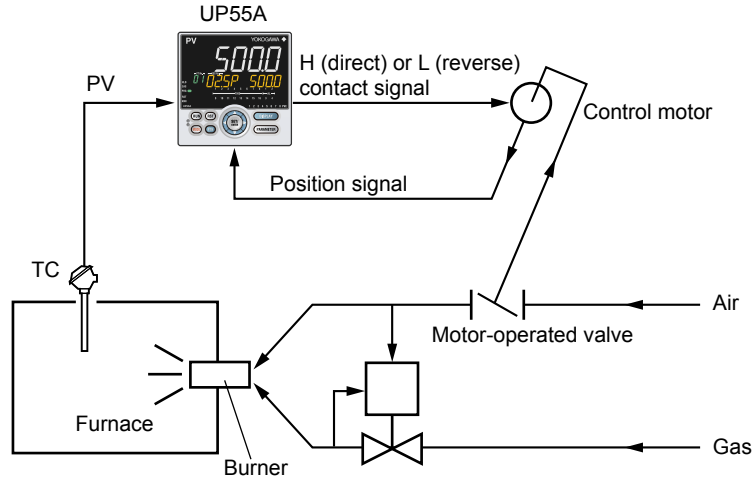


### ON/OFF Output

ON/OFF control compares the SP and PV and outputs an on or off signal according to the positive or negative deviation (PV – SP).

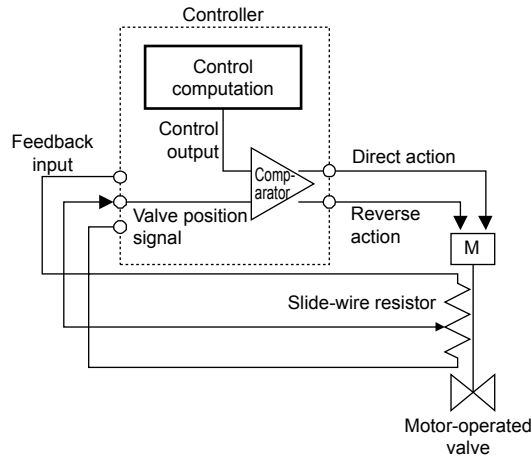
**Position Proportional Output**

Position proportional output is equipped only with Position proportional type. In position proportional output, valve opening is made proportional to the control computation results. The controller outputs direct and reverse signals (relay) to control motor movement and valve opening.



**Feedback-type Position Proportional Output**

In feedback-type position proportional output, the controller obtains a valve position signal from a feedback slide-wire resistor (overall resistance: 100 Ω to 2.5 kΩ) attached to a valve or feedback current input (4 to 20 mA). The following shows an example using feedback slide-wire resistor.



When current is used for feedback input, only wiring is different

- ▶ [Wiring for current: 17.4.5 Valve Position Output and Feedback Input Wiring](#)

**Estimating-type Position Proportional Output**

In estimating-type position proportional output, set the operating time required for a valve to change from the fully-closed position to the fully-open position beforehand. With the preset operating time, the controller controls the valve by estimating its position. Estimating-type position proportional output is used when feedback input signal cannot be obtained. (Feedback input wiring is not necessary.)

Note: When the control output is: upper limit=direct signal, lower limit=reverse signal.

**Heating/cooling Output**

Heating/cooling output is equipped only with Heating/cooling type.

- ▶ [Heating/cooling output: 8.2.3 Heating/cooling Control](#)

**Setting Details**

Parameter symbol	Name	Display level	Setting range	Menu symbol
OT	Output type selection	EASY	Control output or Heating-side control output (Lower two digits) 00: OFF 01: OUT terminals (voltage pulse) 02: OUT terminals (current) 03: OUT terminals (relay/triac) 04: OUT2 terminals (voltage pulse) 05: OUT2 terminals (current) 06: OUT2 terminals (relay/triac)  Cooling-side control output (Upper two digits) 00: OFF 01: OUT terminals (voltage pulse) 02: OUT terminals (current) 03: OUT terminals (relay/triac) 04: OUT2 terminals (voltage pulse) 05: OUT2 terminals (current) 06: OUT2 terminals (relay/triac)	OUT <b>Set</b>

**CAUTION**

No output is generated even if the terminal which is not provided is selected. Confirm that the terminal to be selected is provided.

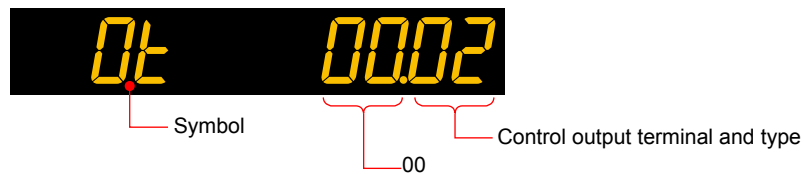
For each output terminal number, see 17.4, "Wiring."

Set a control mode, control type, and an input type before setting an output type.

- ▶ Control mode: 8.1 Setting Control Mode (CTLM)
- ▶ Control type: 8.2 Setting Control Type (CNT)
- ▶ Input type: 7.1.1 Setting Input Type, Unit, Range, Scale, and Decimal Point Position

**Control Output (PID Control, ON/OFF Control) of Standard type**

The figure below shows an example of setting the current output of the OUT terminal to the control output terminal and type. Set "02" to lower two digits and "00" to upper two digits.



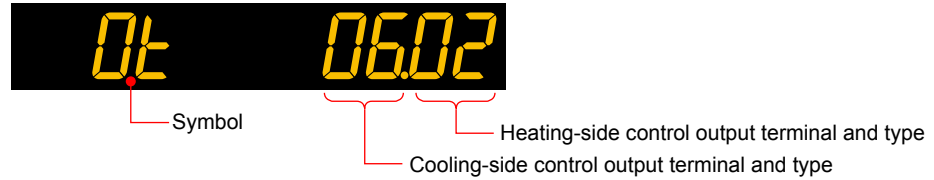
## 10.1 Setting Control Output Type

---

### Heating/cooling Control Output of Heating/cooling Type

The figure below shows an example of setting the current output of the OUT terminal to the heating-side control output terminal and type, and setting the relay output of the OUT2 terminal to the cooling-side control output terminal and type.

Heating side: Set "02" to lower two digits. Cooling side: Set "06" to upper two digits.



### Position Proportional Output (for Position Proportional Type Only)

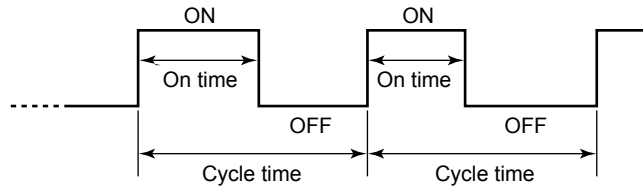
When Position proportional type is specified, the output form is fixed to the position proportional output and setting is not necessary. Adjustment of the valve position is necessary.

- ▶ Valve position adjustment: [10.16 Adjusting Motor-operated Valve Position \(Position Proportional Output\)](#)

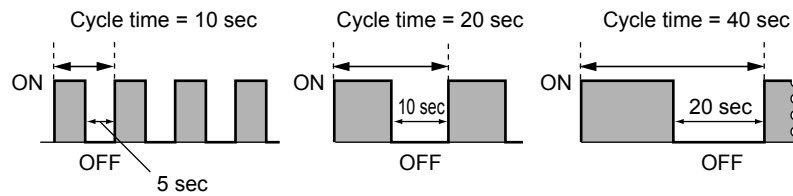
## 10.2 Setting Control Output Cycle Time

### Description

Cycle time is the basic cycle period for a signal full cycle of ON/OFF operation for a relay/triac or voltage pulse output. Reducing cycle time results in faster cycling and finer control. In contrast, reducing the ON/OFF period also reduces relay life. For relay output, set the control output cycle time to 30 to 200 seconds according to the process speed.



Comparison of operations for the same control output (50%)



### Setting Details

Parameter symbol	Name	Display level	Setting range	Menu symbol
CT	Control output cycle time	EASY	0.5 to 1000.0 s	OUT <b>Set</b>
	Heating-side control output cycle time (in Heating/cooling control)			
CTc	Cooling-side control output cycle time	EASY		



## 10.3 Setting Limiter to Control Output

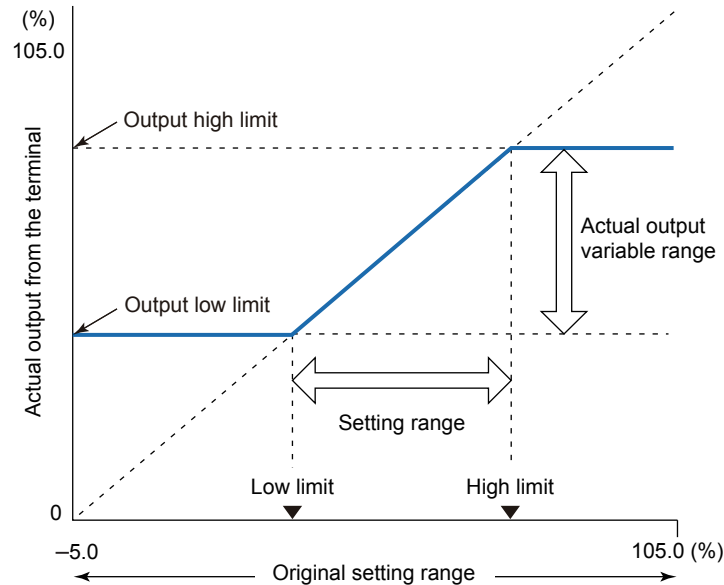
### Description

Control output high and low limits can be set to restrict the control output to the operation range between those limits.

The output limiter is prepared for each PID group, and works according to the selected PID group.

This, however, excludes preset output in RESET mode.

▶ [PID group: 6.3 Adjusting PID Manually](#)



### Setting Details

Parameter symbol	Name	Display level	Setting range	Menu symbol
<b>OH</b>	Control output high limit Heating-side control output high limit (in Heating/cooling control)	EASY	-4.9 to 105.0%, (OL<OH) In Heating/cooling control: 0.1 to 105.0% (OL<OH)	PID <b>Ope</b>
<b>OL</b>	Control output low limit Heating-side control output low limit (in Heating/cooling control)	EASY	-5.0 to 104.9%, (OL<OH), SD: Tight shut In Heating/cooling control: 0.0 to 104.9% (OL<OH)	
<b>OHc</b>	Cooling-side control output high limit	EASY	0.1 to 105.0%, (OLc<OHc)	
<b>OLc</b>	Cooling-side control output low limit	EASY	0.0 to 104.9%, (OLc<OHc)	

Note1: The PID number (1 to 8, R) is displayed on Group display while each parameter is displayed.

Note2: In Cascade control, the LP2 lamp is lit while the Loop-2 parameter is displayed.

Note3: When the setting is low limit  $\geq$  high limit, the controller operates as low limit = high limit -1 digit.

## 10.4 Disabling Output Limiter in MAN mode

### Description

Output limiter can be released when in MAN mode.

However, cannot be released when in Heating/cooling control.

Note that the output bump is caused if the operation mode is changed from MAN to AUTO while the control output is out of the range between the control output high limit (OH) and control output low limit (OL).

Control output bumps to OH in MAN mode when it is larger than OH.

Moreover, it bumps to OL when smaller than OL.

### Setting Details

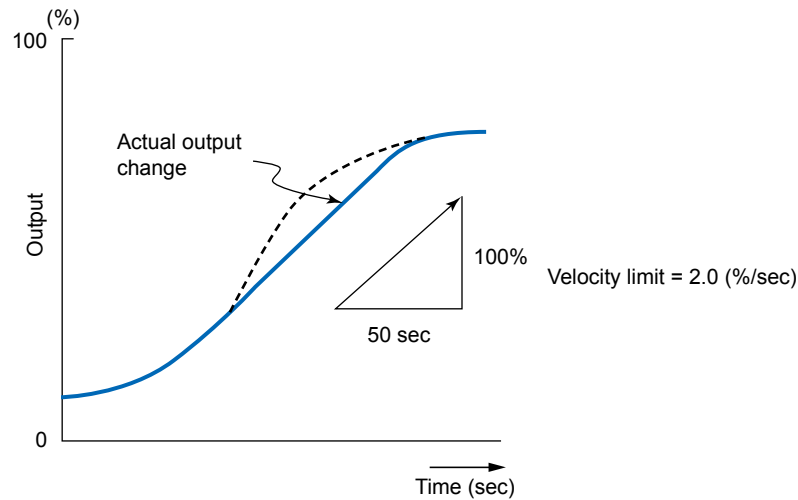
Parameter symbol	Name	Display level	Setting range	Menu symbol
OLMT	Output limiter switch	PRO	OFF: Disable output limiter in MAN mode ON: Enable output limiter in MAN mode	TUNE <b>Ope</b>

Note1: In Cascade control, the LP2 lamp is lit while the Loop-2 parameter is displayed.

## 10.5 Setting Velocity Limiter to Control Output

### Description

Output velocity limiter prevents the control output signal from changing suddenly in order to protect the control valves (or other actuators) and controlled process. The output velocity limiter does not work in MAN or RESET mode or when input burnout or A/D error occurs. Note that setting an output velocity limit may cancel the effects of derivative action. The following shows the operation example of output velocity limiter.



In Heating/cooling control, the output velocity limiter can be set to the control computation result before split into heating-and cooling-side outputs. In ON/OFF control, the setting is invalid even if the output velocity limiter is set.

### Setting Details

Parameter symbol	Name	Display level	Setting range	Menu symbol
OPR	Output velocity limiter	STD	OFF: Disable 0.1 to 100.0%/s	TUNE <b>Ope</b>

Note1: In Cascade control, the LP2 lamp is lit while the Loop-2 parameter is displayed.

## 10.6 Reducing 4-20 mA Current Output to 0 mA (Tight Shut Function)

### Description

Tight shut function fully closes the control valve (or other actuators) (i.e., so that output is zero) beyond its positioner dead band.

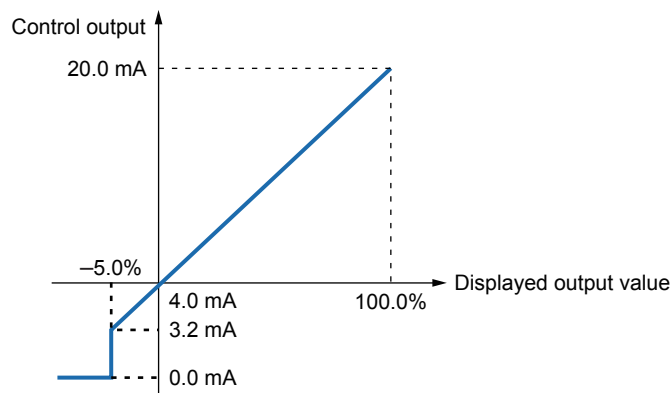
When the output low limit is set to "SD," the output is as follows in MAN or AUTO mode.

- **In MAN mode**

When the output is reduced with the Down arrow key and "SD" is displayed as the output value, the output level reaches tight shut level. The control output delivers a tight shut signal (about 0.0 mA).

- **In AUTO mode**

The output is limited by the output low limit (OL). It does not decrease to 0.0 mA.



### Setting Details

Parameter symbol	Name	Display level	Setting range	Menu symbol
OL	Control output low limit Heating-side control output low limit (in Heating/cooling control)	EASY	-5.0 to 104.9%, (OL<OH), SD: Tight shut (0 mA output in MAN mode) In Heating/cooling control: 0.0 to 104.9% (OL<OH)	PID <b>Ope</b>

Note1: The PID number (1 to 8, R) is displayed on Group display while each parameter is displayed.

Note2: In Cascade control, the LP2 lamp is lit while the Loop-2 parameter is displayed.

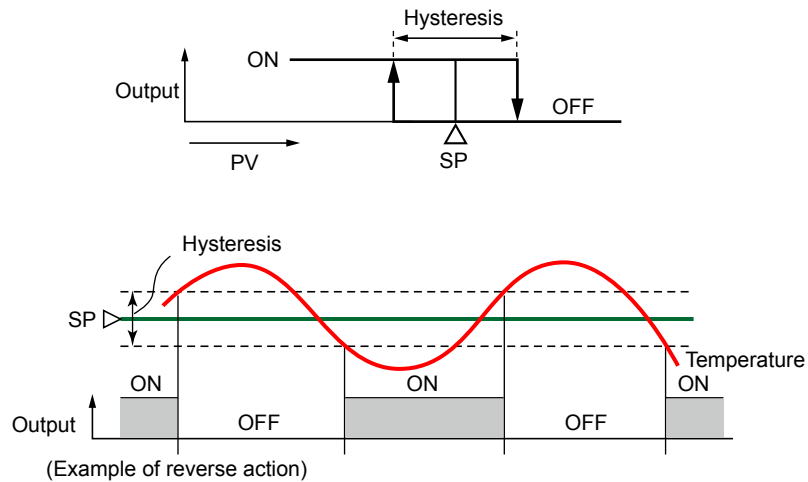
## 10.7 Setting ON/OFF Control Hysteresis

### Description

In ON/OFF control, since the only two possible output states are ON and OFF, the control output cycles are as shown in the figure below. ON/OFF becomes quite narrow, so that if relay output is used, chattering occurs. In this case, the hysteresis should be set wider to prevent relay chattering and for the service life of the relay.

#### One Point of Hysteresis

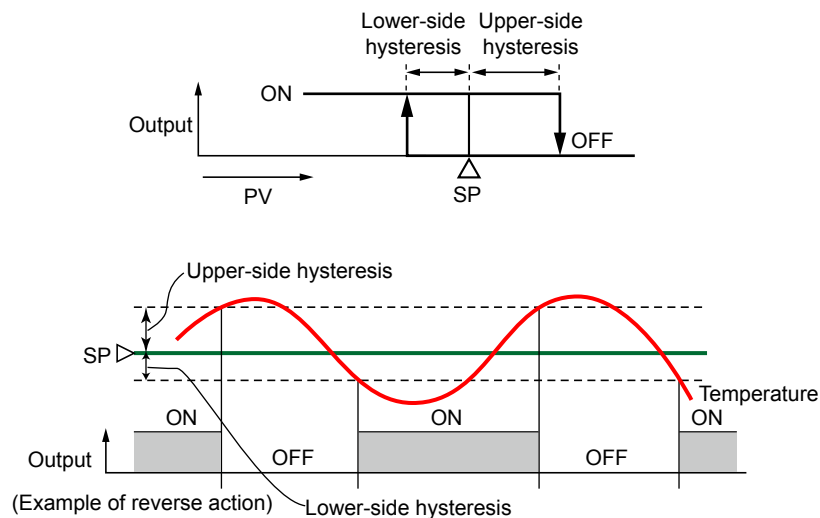
For one point of hysteresis, set one point of hysteresis. In Heating/cooling control, set heating-side ON/OFF control hysteresis and cooling-side ON/OFF control hysteresis.



#### Two Points of Hysteresis

For two points of hysteresis, set two points of hysteresis (upper-side hysteresis and lower-side hysteresis).

Two points of hysteresis cannot be used for Heating/cooling control.



## Setting Details

Parameter symbol	Name	Display level	Setting range	Menu symbol
<b>HYS</b>	Hysteresis (in ON/OFF control, or Position proportional control) Heating-side ON/OFF control hysteresis (in Heating/cooling control)	EASY	In ON/OFF control: 0.0 to 100.0% of PV input range span (EUS) In Heating/cooling control or Position proportional control: 0.0 to 100.0%	PID <b>Ope</b>
<b>HY.UP</b>	Upper-side hysteresis (in ON/OFF control)	EASY	0.0 to 100.0% of PV input range span (EUS)	
<b>HY.LO</b>	Lower-side hysteresis (in ON/OFF control)	EASY		

Note1: The PID number (1 to 8, R) is displayed on Group display while each parameter is displayed.

Note2: In Cascade control, the LP2 lamp is lit while the Loop-2 parameter is displayed.

## 10.8 Canceling Offset of PV and SP (Manual Reset)

### Description

Manual reset can be used when the integral action is disabled.

When the integral action is disabled, there will be an offset of PV and SP. Manual reset cancels this offset.

The manual reset value equals the output value when PV = SP is true.

### Setting Details

Parameter symbol	Name	Display level	Setting range	Menu symbol
MR	Manual reset	EASY	-5.0 to 105.0%	PID <b>Ope</b>

Note1: The PID number (1 to 8, or R) is displayed on Group display while each parameter is displayed.

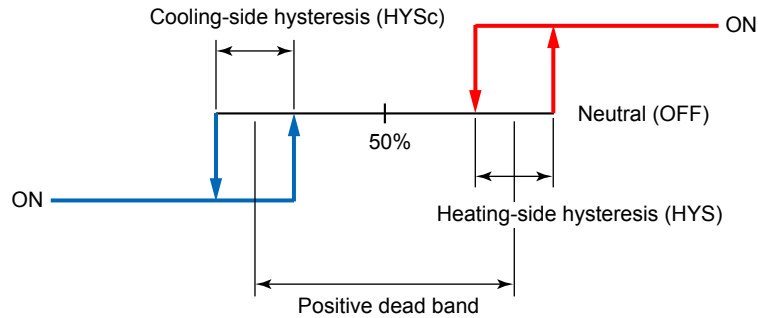
Note2: In Cascade control, the LP2 lamp is lit while the Loop-2 parameter is displayed.

# 10.9 Setting Hysteresis and Dead Band for Heating/cooling Control Output

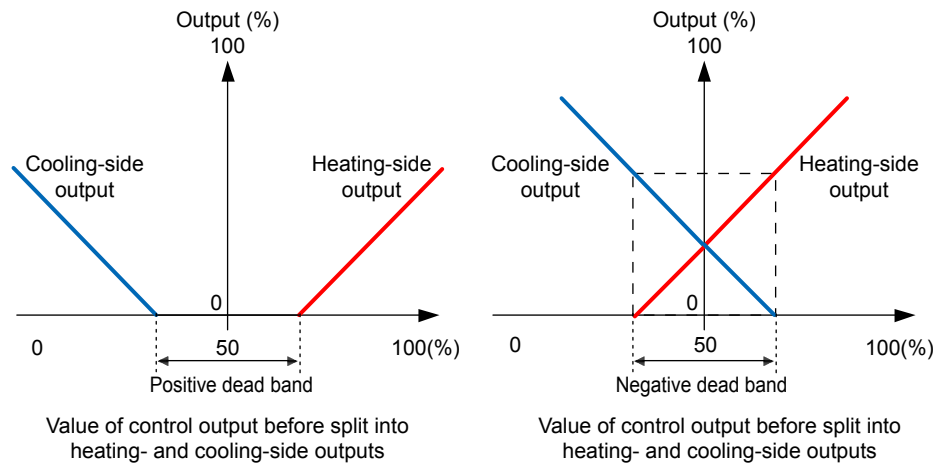
## Description

In Heating/cooling control, the positive dead band denotes the zone where none of the heating-side and cooling-side outputs are presented. The negative dead band denotes the zone where both of the heating-side and cooling-side outputs are presented.

The following shows the case when both the heating side and cooling side are ON/OFF control.



The following shows the case when both the heating side and cooling side are PID control.





## 10.9 Setting Hysteresis and Dead Band for Heating/cooling Control Output

### Setting Details

Parameter symbol	Name	Display level	Setting range	Menu symbol
<b>HYS</b>	Hysteresis (in ON/OFF control, or Position proportional control) Heating-side ON/OFF control hysteresis (in Heating/cooling control)	EASY	In ON/OFF control: 0.0 to 100.0% of PV input range span (EUS) In Heating/cooling control or Position proportional control: 0.0 to 100.0%	PID <b>Ope</b>
<b>HYS<sub>c</sub></b>	Cooling-side ON/OFF control hysteresis	EASY	0.0 to 100.0%	
<b>DB</b>	Output dead band (in Heating/cooling control or Position proportional control)	EASY	In Heating/cooling control: -100.0 to 50.0% In Position proportional control: 1.0 to 10.0%	

Note1: The PID number (1 to 8, or R) is displayed on Group display while each parameter is displayed.

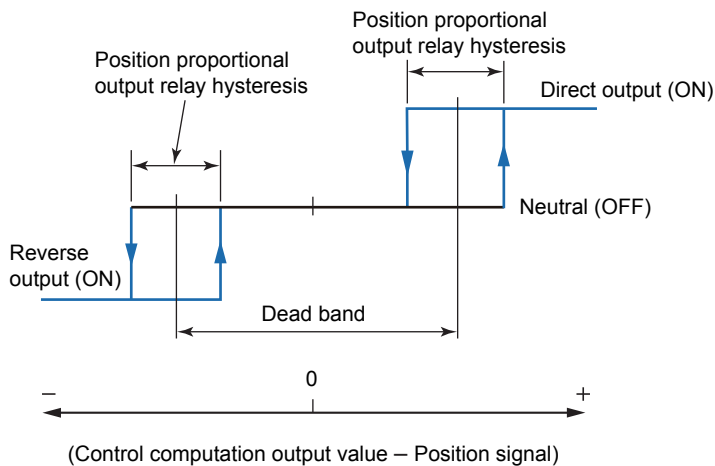
Note2: In Cascade control, the LP2 lamp is lit while the Loop-2 parameter is displayed.

# 10.10 Setting Hysteresis and Dead Band for Position Proportional Control Output

## Description

To prevent excessively frequent operation of the motor and relays, a dead band is provided between two relay output operating points, and hysteresis is provided for each relay output.

If position signal differs from the control computation output by less than the dead band value, neither the “direct” nor “reverse” relay turns ON. If the difference is large enough on the plus side, the direct relay turns ON; if on the minus side, the reverse relay turns ON (in reverse action).



## Setting Details

Parameter symbol	Name	Display level	Setting range	Menu symbol
<b>HYS</b>	Hysteresis (in ON/OFF control, or Position proportional control) Heating-side ON/OFF control hysteresis (in Heating/cooling control)	EASY	In ON/OFF control: 0.0 to 100.0% of PV input range span (EUS) In Heating/cooling control or Position proportional control: 0.0 to 100.0%	PID <b>Ope</b>
<b>DB</b>	Output dead band (in Heating/cooling control or Position proportional control)	EASY	In Heating/cooling control: -100.0 to 50.0% In Position proportional control: 1.0 to 10.0%	

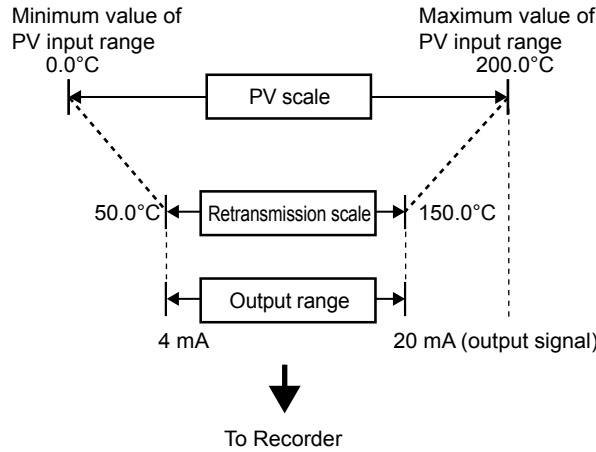
Note1: The PID number (1 to 8, R) is displayed on Group display while each parameter is displayed.  
Note2: In Cascade control, the LP2 lamp is lit while the Loop-2 parameter is displayed.

# 10.11 Setting Retransmission Output Terminal, Type, and Scales

## Description

The retransmission output can be used when the control output is not assigned to the analog output terminal. Confirm the output type selection (OT) before setting the retransmission output. The range can be changed.

- ▶ Control output terminal: 10.1 Setting Control Output Type
- ▶ Current output range: 10.14 Changing Current Output Range



## Setting Details

Parameter symbol	Name	Display level	Setting range	Menu symbol
RTS	Retransmission out type of RET	EASY	OFF: Disable PV1: PV SP1: SP OUT1: OUT (Valve opening: 0 to 100 % in Position proportional control) LPS: 15 V DC loop power supply PV2: Loop-2 PV SP2: Loop-2 SP OUT2: Loop-2 OUT TSP1: Target SP HOUT1: Heating-side OUT COUT1: Cooling-side OUT MV1: Position proportional output (internal computed value) TSP2: Loop-2 target SP HOUT2: Loop-2 heating-side OUT COUT2: Loop-2 cooling-side OUT MV2: Loop-2 position proportional output (internal computed value) PV: PV terminals analog input RSP: RSP terminals analog input AIN2: AIN2 terminals analog input AIN4: AIN4 terminals analog input	OUT <b>Set</b>

## 10.11 Setting Retransmission Output Terminal, Type, and Scales

(Continued)

Parameter symbol	Name	Display level	Setting range	Menu symbol
<b>RTH</b>	Maximum value of retransmission output scale of RET	STD	When RTS = PV1, SP1, PV2, SP2, TSP1, TSP2, PV, RSP, AIN2, or AIN4, RTL + 1 digit to 30000 -19999 to RTH - 1 digit	OUT <b>Set</b>
<b>RTL</b>	Minimum value of retransmission output scale of RET	STD	Decimal point position: When RTS=PV1, SP1, or TSP1, decimal point position is same as that of PV input. When RTS=PV2, SP2, or TSP2, decimal point position is same as that of RSP input. When RTS=PV, decimal point position is same as that of PV input scale. When RTS=RSP, decimal point position is same as that of RSP input scale. When RTS=AIN2, decimal point position is same as that of AIN2 scale. When RTS=AIN4, decimal point position is same as that of AIN4 scale.	
<b>O1RS</b>	Retransmission output type of OUT current output	STD	Same as RTS	
<b>O1RH</b>	Maximum value of retransmission output scale of OUT current output	STD	When O1RS = PV1, SP1, PV2, SP2, TSP1, TSP2, PV, RSP, AIN2, or AIN4, O1RL + 1 digit to 30000 -19999 to O1RH - 1 digit	
<b>O1RL</b>	Minimum value of retransmission output scale of OUT current output	STD	Decimal point position: When O1RS=PV1, SP1, or TSP1, decimal point position is same as that of PV input. When O1RS =PV2, SP2, or TSP2, decimal point position is same as that of RSP input. When O1RS =PV, decimal point position is same as that of PV input scale. When O1RS =RSP, decimal point position is same as that of RSP input scale. When O1RS =AIN2, decimal point position is same as that of AIN2 scale. When O1RS =AIN4, decimal point position is same as that of AIN4 scale	

## 10.11 Setting Retransmission Output Terminal, Type, and Scales

(Continued)

Parameter symbol	Name	Display level	Setting range	Menu symbol
<b>O2RS</b>	Retransmission output type of OUT2 current output	STD	Same as RTS	OUT <b>Set</b>
<b>O2RH</b>	Maximum value of retransmission output scale of OUT2 current output	STD	When O2RS = PV1, SP1, PV2, SP2, TSP1, TSP2, PV, RSP, AIN2, or AIN4, O2RL + 1 digit to 30000 -19999 to O2RH - 1 digit  Decimal point position: When O2RS = PV1, SP1, or TSP1, decimal point position is same as that of PV input. When O2RS = PV2, SP2, or TSP2, decimal point position is same as that of RSP input. When O2RS = PV, decimal point position is same as that of PV input scale. When O2RS = RSP, decimal point position is same as that of RSP input scale. When O2RS = AIN2, decimal point position is same as that of AIN2 scale. When O2RS = AIN4, decimal point position is same as that of AIN4 scale.	
<b>O2RL</b>	Minimum value of retransmission output scale of OUT2 current output	STD		

Setpoints PV2, SP2 and OUT2: Can be used in Cascade control.

Setpoints HOUT1 and COUT1: Can be used in Heating/cooling control.

Setpoint MV1: Can be used in Position proportional control.

(When opening or closing a valve by key operation in manual mode operation, the transmission output becomes -5.0 %.)

Setpoint TSP2: Can be used in Cascade control.

Setpoints HOUT2 and COUT2: Can be used in Cascade control of Heating/cooling type.

Setpoint MV2: Can be used in Cascade control of Position proportional type.

(When opening or closing a valve by key operation in manual mode operation, the transmission output becomes -5.0 %.)

Setpoint RSP: Can be used when equipped with remote input.

Setpoints AIN2 and AIN4: Can be used when the UP55A suffix code: Type 2 = 4.

### Parameters and Corresponding Terminals

RTS, RTH, RTL	RET terminal
O1RS, O1RH, O1RL	OUT terminal
O2RS, O2RH, O2RL	OUT2 terminal

# 10.12 Setting Preset Output Value

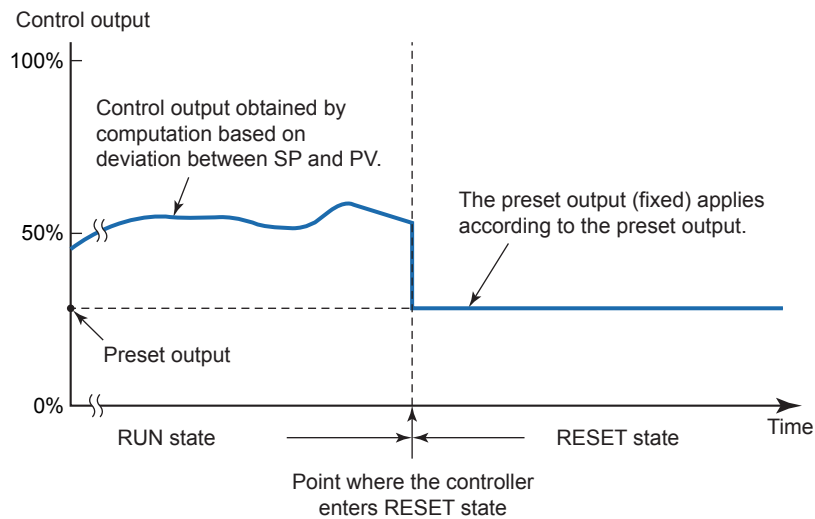
## 10.12.1 Setting Output Value in RESET Mode (Preset Output)

### Description

Preset output becomes the output when the operation mode is switched from RUN to RESET.

The preset output is not limited by the output high and low limits.

The preset output is prepared for each PID parameter group, and works according to the selected PID parameter group.



► [Output limiter: 10.3 Setting Limiter to Control Output](#)

### Preset Output in Heating/cooling Control

The preset output can be set for both of the heating and cooling sides.

The computation starts from the value of 50% of internal computed value (value before split into heating- and cooling-side outputs) when the operation mode is switched from RESET to RUN.

### Setting Details

Parameter symbol	Name	Display level	Setting range	Menu symbol
<b>PO</b>	Preset output Heating-side preset output (in Heating/cooling control)	EASY	In RESET mode, fixed control output can be generated. In Position proportional control, Valve opening can be set; -5.0 to 105.0%	PID <b>Ope</b>
<b>POc</b>	Cooling-side preset output	EASY		

Note1: The PID number (1 to 8, R) is displayed on Group display while each parameter is displayed.

Note2: In Cascade control, the LP2 lamp is lit while the Loop-2 parameter is displayed.

For ON/OFF output (ON/OFF output or ON/OFF output in Heating/cooling control), 0.0% is output when the setting value is 0.0% or less and 100.0% is output when 0.1% or more.

### 10.12.2 Setting Output Value When Switched to MAN Mode (Manual Preset Output)

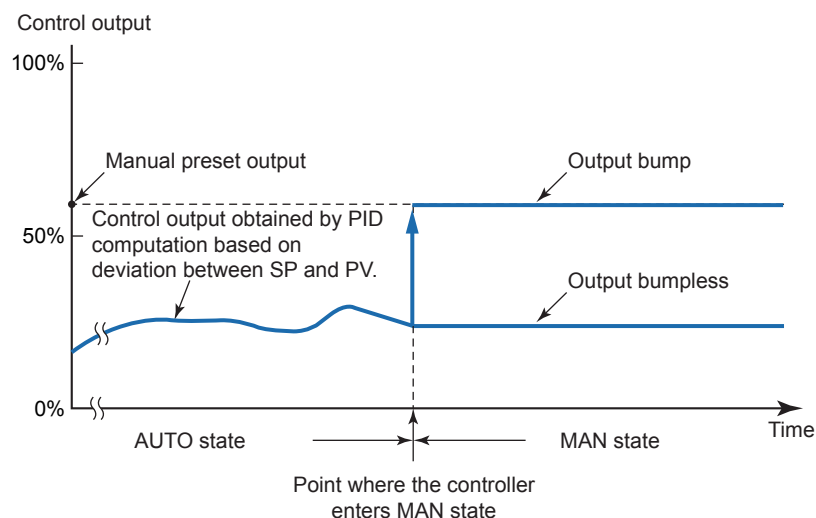
#### Description

When the operation mode is switched from AUTO to MAN, each of the following can be selected.

- The control output takes over the control output as is.
- The control output bumps to the manual preset output.

When the manual preset output is output, the manual operation is possible after the bump.

Manual preset output is limited by the output high and low limits. (when Output limiter switch (OLMT) = ON)



When the operation mode is switched from MAN to AUTO, transferred without bump from the manual output to the control output.

- ▶ [Output limiter: 10.3 Setting Limiter to Control Output](#)
- ▶ [Output limiter switch: 10.4 Disabling Output Limiter in MAN mode](#)

#### Setting Details

Parameter symbol	Name	Display level	Setting range	Menu symbol
<b>MPON</b>	Manual preset output number selection	STD	OFF: Hold the control output in AUTO mode (bumpless) 1: Use manual preset output 1 (output bump) 2: Use manual preset output 2 (output bump) 3: Use manual preset output 3 (output bump) 4: Use manual preset output 4 (output bump) 5: Use manual preset output 5 (output bump)	TUNE <b>Ope</b>
<b>MPO1 to MPO5</b>	Manual preset output 1 to 5	STD	-5.0 to 105.0%	

Note1: In Cascade control, the LP2 lamp is lit while the Loop-2 parameter is displayed.

### 10.12.3 Setting Output Value When Error Occurs (Input Error Preset Output)

#### Description

The 0% control output, 100% control output, or input preset output can be selected and output as input error preset output in the following conditions.

- The input burnout occurs during operation in AUTO or CAS mode and RUN mode.
- The ADC error occurs during operation in AUTO or CAS mode and RUN mode.

However, the manual output becomes the output when the input burnout occurs in MAN mode and RUN mode.

#### Setting Details

Parameter symbol	Name	Display level	Setting range	Menu symbol
EPO	Input error preset output	STD	0: Preset output 1: 0% output 2: 100% output	SYS <b>Set</b>



# 10.13 Setting 10-segment Linearizer for Output

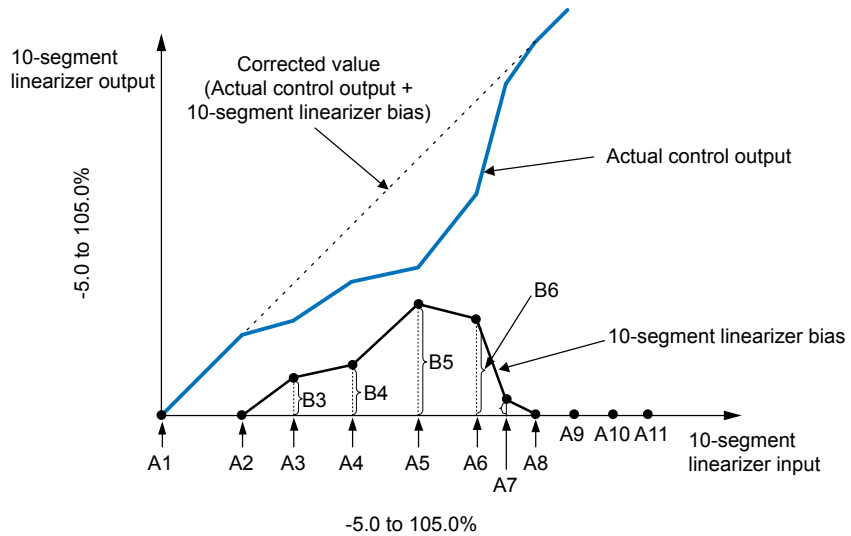
## Description

A total of up to four 10-segment linearizers can be used for the input unit and output unit. For the position used by a 10-segment linearizer, see the function block diagram.

- ▶ [Function block diagram: 8.1 Setting Control Mode \(CTLM\)](#)
- ▶ [10-segment linearizer input: 7.1.4 \(3\) Setting 10-segment Linearizer](#)

### 10-segment Linearizer Biasing

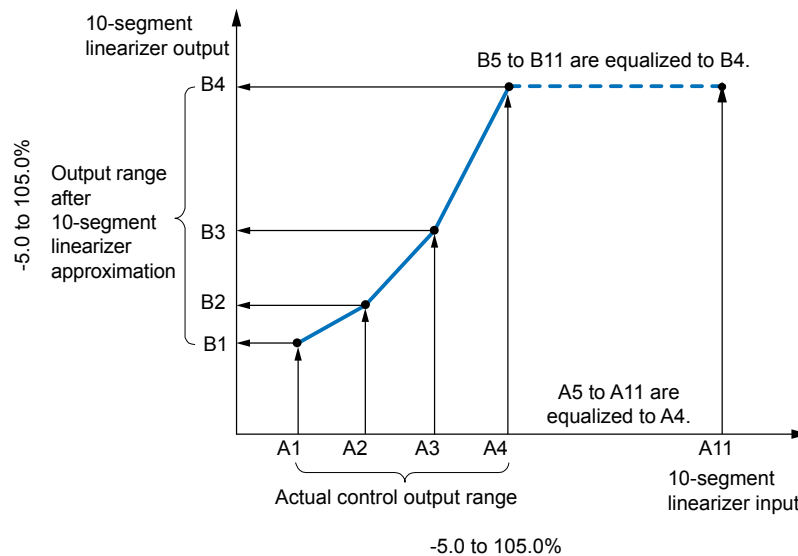
This function is used to correct the control output by adding the corresponding bias values to each of the 11 points of optionally set input values. When the 10-segment linearizer input is A1 or less, B1 is added. Moreover, when the input is A11 or more, B11 is added.



### 10-segment Linearizer Approximation

This function is used to correct the control output.

As shown in the figure below, the output values can be optionally set to 11 points of the optionally set input values. When the 10-segment linearizer input is A1 or less, the value of extended line between B1 and B2 is output. Moreover, when the input is A11 or more, the value of extended line between B10 and B11 is output.



## Setting Details

Parameter symbol	Name	Display level	Setting range	Menu symbol
<b>PYS</b>	10-segment linearizer selection	Group 1, 2: STD Group 3, 4: PRO	OFF: Disable PV: PV analog input RSP: RSP analog input AIN2: AIN2 analog input AIN4: AIN4 analog input PVIN: PV input OUT: OUT analog output OUT2: OUT2 analog output RET: RET analog output	PYS1 PYS2 PYS3 PYS4 <b>Ope</b>
<b>A1 to A11</b>	10-segment linearizer input 1	Group 1, 2: STD Group 3, 4: PRO	-66.7 to 105.0% of input range (EU) Output linearizer: -5.0 to 105.0%	
<b>B1 to B11</b>	10-segment linearizer output 1	Group 1, 2: STD Group 3, 4: PRO	10-segment linearizer bias: -66.7 to 105.0% of input range span (EUS) 10-segment linearizer approximation: -66.7 to 105.0% of input range (EU) Output linearizer: -5.0 to 105.0%	
<b>PMD</b>	10-segment linearizer mode	Group 1, 2: STD Group 3, 4: PRO	0: 10-segment linearizer bias 1: 10-segment linearizer approximation	

Note1: The group number (1 to 4) is displayed on Group display while each parameter is displayed.

Set it in the following orders.

- (1)PYS: Specifies where the 10-segment linearizer function is used.
  - Setpoint OUT functions before output to OUT terminal.
  - Setpoint OUT2 functions before output to OUT2 terminal. (for Heating/cooling type only)
  - Setpoint RET functions before output to RET terminal.
- (2)PMD: Specifies whether to use it as a 10-segment linearizer bias or a 10-segment linearizer approximation.
- (3)A1 to A11, B1 to B11: Sets the 10-segment linearizer input and 10-segment linearizer output.

**Note**

- Set the 10-segment linearizer so that it increases monotonically.
- If the same setpoint is set for the two or more parameters of 10-segment linearizer selection (PYS), a smaller group number is used.

## 10.14 Changing Current Output Range

### Description

The analog output type can be selected from among 4 to 20, 0 to 20, 20 to 4, or 20 to 0 mA.

### Setting Details

Parameter symbol	Name	Display level	Setting range	Menu symbol
<b>OU.A</b>	OUT current output range	STD	4-20: 4 to 20 mA, 0-20: 0 to 20 mA, 20-4: 20 to 4 mA, 20-0: 20 to 0 mA	OUT <b>Set</b>
<b>OU2.A</b>	OUT2 current output range	STD		
<b>RET.A</b>	RET current output range	STD		

### Parameters and Corresponding Terminals

OU.A	OUT terminal
OU2.A	OUT2 terminal
RET.A	RET terminal

# 10.15 Setting Split Computation Output Function

## Description

Split computation output is useful for the case where multiple (up to 3) operating units for switching, for example, hot and cool water are linked for control. There are two characteristics of split computations: V-mode characteristics and Parallel-mode characteristics. The current output range can be changed.

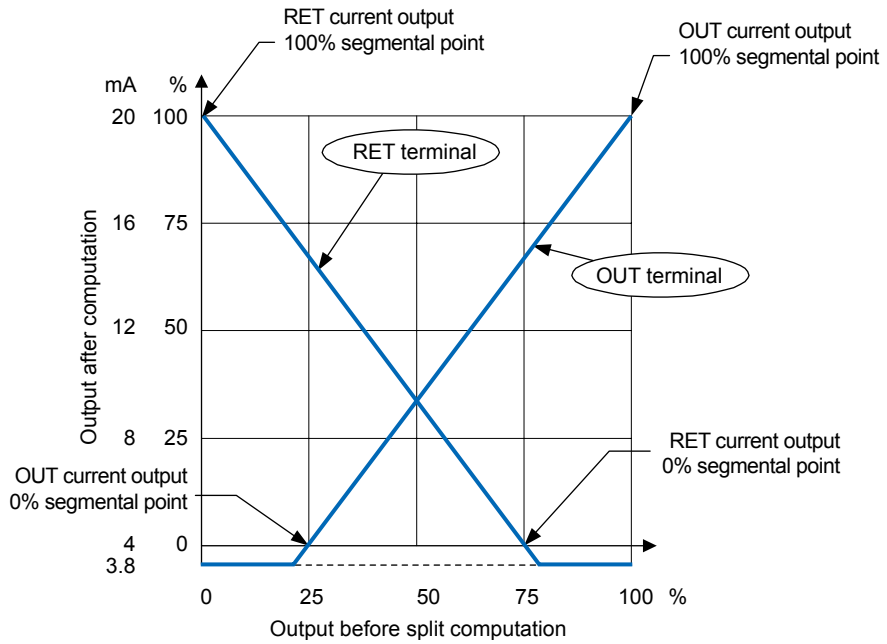
► [Current output range: 10.14 Changing Current Output Range](#)

## V-mode Characteristics

The following explains an example of letting OUT terminal and RET terminal present the V-mode characteristics of split computations.

### Setting Example

	OUT terminal	RET terminal
Control output type/Retransmission output type	OT = 00.02 (current)	RTS=OUT1
Current output 100% segmental point	OU.H=100.0%	RET.H=0.0%
Current output 0% segmental point	OU.L=25.0%	RET.L=75.0%
Current output range	OU.A=4-20	RET.A=4-20



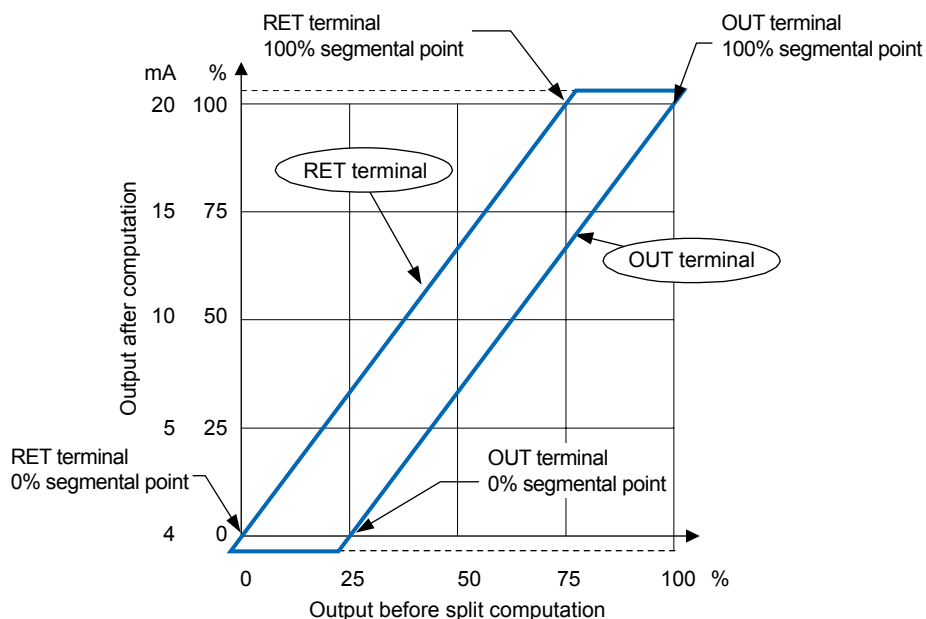
## 10.15 Setting Split Computation Output Function

### Parallel-mode Characteristics

The following explains an example of letting OUT terminal and RET terminal present the Parallel-mode characteristics of split computations.

#### Setting Example

	OUT terminal	RET terminal
Control output type/Retransmission output type	OT = 00.02 (current)	RTS=OUT1
Current output 100% segmental point	OU.H=100.0%	RET.H=75.0%
Current output 0% segmental point	OU.L=25.0%	RET.L=0.0%
Current output range	OU.A=4-20	RET.A=4-20



#### Setting Details

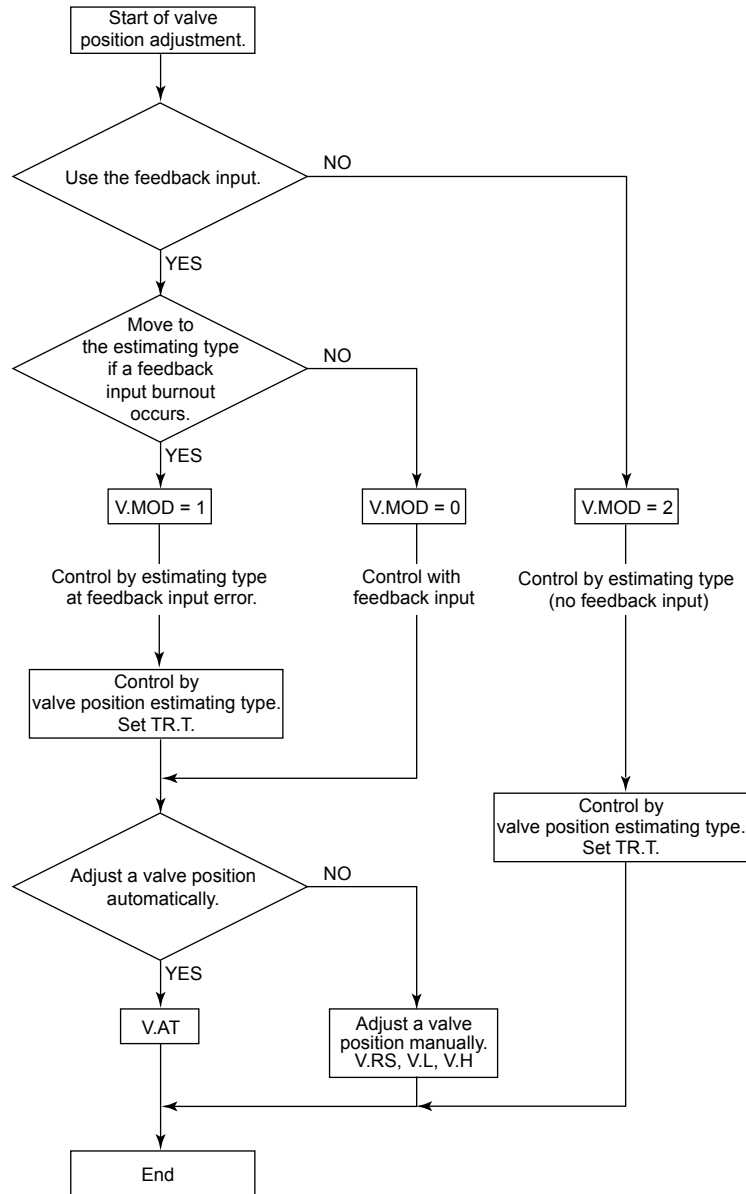
Parameter symbol	Name	Display level	Setting range	Menu symbol
<b>OU.H</b>	100% segmental point of OUT current output	PRO	-100.0 to 200.0%	OUT <b>Set</b>
<b>OU.L</b>	0% segmental point of OUT current output	PRO		
<b>OU2.H</b>	100% segmental point of OUT2 current output	PRO		
<b>OU2.L</b>	0% segmental point of OUT2 current output	PRO		
<b>RET.H</b>	100% segmental point of RET current output	PRO		
<b>RET.L</b>	0% segmental point of RET current output	PRO		

#### Parameters and Corresponding Terminals

OU.H, OU.L	OUT terminal
OU2.H, OU2.L	OUT2 terminal
RET.H, RET.L	RET terminal

## 10.16 Adjusting Motor-operated Valve Position (Position Proportional Output)

When performing control using the motor-operated valve position, adjustment of the valve position is necessary.



When controlling by estimating type, set TR.T corresponding to the valve characteristic.

### 10.16.1 Setting Valve Operation Mode

**Description**

Position proportional control monitors the control output signals and the feedback signals from the control valve and regulates to keep the valve opening and the control output signal in agreement.  
 Position proportional control (output) operation mode has feedback type and estimating type.

**Setting Details**

Parameter symbol	Name	Display level	Setting range	Menu symbol
V.MOD	Valve adjusting mode	STD	0: Valve position feedback type 1: Valve position feedback type (moves to the estimating type if a feedback input error or break occurs.) 2: Valve position estimating type	OUT <b>Set</b>

### 10.16.2 Adjusting Valve Position Automatically

**Description**

The fully-closed and fully-opened positions of a valve can be set automatically by the feedback input signal from a valve.  
 The following describes the procedure of adjusting the valve position automatically.

- (1) Verify that the wirings are correct.
- (2) Set the operation mode to MAN.
- (3) Set the automatic valve position adjustment (V.AT) to ON. (V.AT blinks during the automatic adjustment.)
- (4) When the adjustment is completed, V.AT returns to OFF.  
 When the adjustment fails, VAT.E appears on PV display.

**Setting Details**

Parameter symbol	Name	Display level	Setting range	Menu symbol
V.AT	Automatic valve position adjustment	EASY	OFF: Stop automatic adjustment ON: Start automatic adjustment	OUT <b>Set</b>

### 10.16.3 Adjusting Valve Position Manually

#### Description

The following procedure describes how to adjust valve position manually.

- (1) Verify that the wirings are correct.
- (2) Set the operation mode to MAN.
- (3) Reset the valve position (Set V.RS=ON).
- (4) Display the fully-closed valve position setting (V.L), determine the fully-closed position while holding down the Down arrow ( ▾ ) key, and press the SET/ENTER key.
- (5) Display the fully-opened valve position setting (V.H), determine the fully-opened position while holding down the Up arrow ( ▴ ) key, and press the SET/ENTER key.

#### Setting Details

Parameter symbol	Name	Display level	Setting range	Menu symbol
V.RS	Valve position setting reset	EASY	Setting V.RS to ON resets the valve adjustment settings and causes the indication "V.RS" to blink.	OUT <b>Set</b>
V.L	Fully-closed valve position setting	EASY	Pressing the SET/ENTER key with valve position set to the fully-closed position by Down arrow key causes the adjusted value to be stored. When V.L adjustment is complete, V.L stops blinking.	
V.H	Fully-opened valve position setting	EASY	Pressing the SET/ENTER key with valve position set to the fully-opened position by Up arrow key causes the adjusted value to be stored. When V.H adjustment is complete, V.H stops blinking	



## 10.16 Adjusting Motor-operated Valve Position (Position Proportional Output)

### 10.16.4 Setting Valve Traveling Time (Estimating Type)

#### Description

In the estimating type, a traveling time required to fully open the valve from its fully-closed position is set and valve positions are estimated according to the time consumed for valve operation.

The valve position estimating type is used when the feedback input of valve positions cannot be obtained.

(Wiring for feedback input is not necessary.)

The fully-opened side relay keeps ON-state when the output is 100%, and the fully-closed side relay keeps ON-state when the output is 0%.

#### Operating Principles

In the estimating type, the valve position is obtained by calculating the virtual feedback input based on the valve traveling time.

However, the virtual feedback input starts calculation from 50% at power-on.

#### Setting Details

Parameter symbol	Name	Display level	Setting range	Menu symbol
TR.T	Valve traveling time	STD	5 to 300 s	OUT <b>Set</b>

### 10.16.5 Selecting Feedback Input (Resistor/Current)

#### Description

Only the wiring for resistor or current is necessary for feedback input. There is no setting.

► [Wiring: 17.4.5 Valve Position Output and Feedback Input Wiring](#)

## 10.17 Using 15 V DC Loop Power Supply

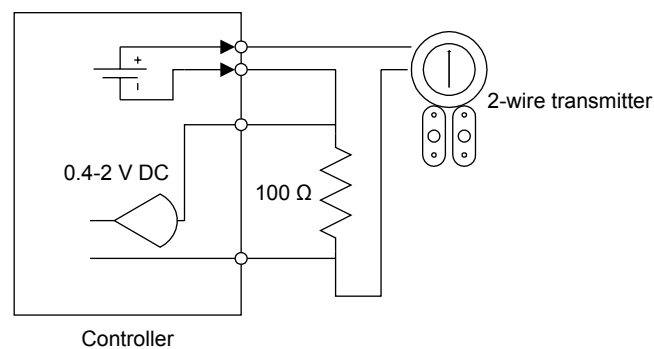
### Description

The 15 V DC loop power supply is a function to supply DC power (14.5 to 18.0 V DC (21 mA DC)) to a 2-wire transmitter.

The loop power supply block is isolated from the controller's internal circuitry. In addition, the block is equipped with a current limiting circuit. Therefore, accidental short-circuits that may occur in the field do not adversely affect the rest of the controller's internal circuitry.

Note that the loop power supply function cannot be used for digital communication where the supply voltage is superposed on the signal line.

The following shows the examples of loop power supply connection to a 2-wire transmitter.



**Setting Details**

Parameter symbol	Name	Display level	Setting range	Menu symbol
<b>RTS</b>	Retransmission output type of RET	EASY	OFF: Disable PV1: PV SP1: SP	OUT <b>Set</b>
<b>O1RS</b>	Retransmission output type of OUT current output	EASY	OUT1: OUT (Valve opening: 0 to 100 % in Position proportional control)	
<b>O2RS</b>	Retransmission output type of OUT2 current output	EASY	LPS: 15 V DC loop power supply PV2: Loop-2 PV SP2: Loop-2 SP OUT2: Loop-2 OUT TSP1: Target SP HOUT1: Heating-side OUT COUT1: Cooling-side OUT MV1: Position proportional output (internal computed value) TSP2: Loop-2 target SP HOUT2: Loop-2 heating-side OUT COUT2: Loop-2 cooling-side OUT MV2: Loop-2 position proportional output (internal computed value) PV: PV terminals analog input RSP: RSP terminals analog input AIN2: AIN2 terminals analog input AIN4: AIN4 terminals analog input	

**Parameters and Corresponding Terminals**

RTS	RET terminal
O1RS	OUT terminal
O2RS	OUT2 terminal

## 11.1 Setting Alarm Type

### Description

These alarms work irrespective of the operation mode.

The alarm-related parameters consist of the alarm type (type, stand-by action, energized/de-energized, and latch function), PV velocity alarm time setpoint, alarm hysteresis, alarm (On-/Off-) delay timer, and alarm setpoint.

In Cascade control, both of Loop 1 and Loop 2 have these parameters.

Alarm-related parameter	Number of settings
Alarm type	8 (number of settings) x 2 (number of loops)
PV velocity alarm time setpoint	8 (number of settings) x 2 (number of loops)
Alarm hysteresis	8 (number of settings) x 2 (number of loops)
Alarm (on-/off-) delay timer	8 (number of settings) x 2 (number of loops)
Alarm setpoint	8 (number of settings) x 2 (number of loops)

- ▶ Alarm hysteresis: [11.3 Setting Hysteresis to Alarm Operation](#)
- ▶ Alarm delay timer: [11.4 Delaying Alarm Output \(Alarm Delay Timer\)](#)
- ▶ Alarm setpoint: [6.4 Setting Alarm Setpoint](#)

Both of Loop-1 and Loop-2 have eight groups of alarms.

Factory default: Only four groups of alarm-related parameters are displayed.

- ▶ Terminal function: [17.4.7 Contact Output Wiring](#)

Alarm output can be assigned to the unused control relay output or contact output.

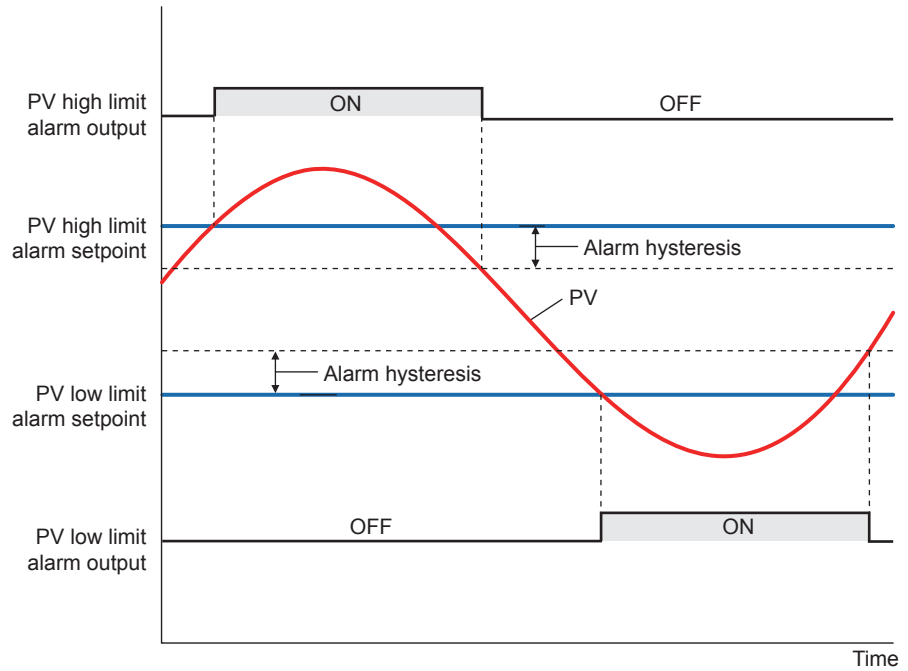
- ▶ Control relay output: [11.5 Setting Alarm Output to Control Relay Terminal](#)
- ▶ Contact output: [12.2.1 Setting Function of Contact Output](#)

Energized/de-energized of alarm output can be changed.

- ▶ Energized/de-energized: [12.2.2 Changing Contact Type of Contact Output](#)

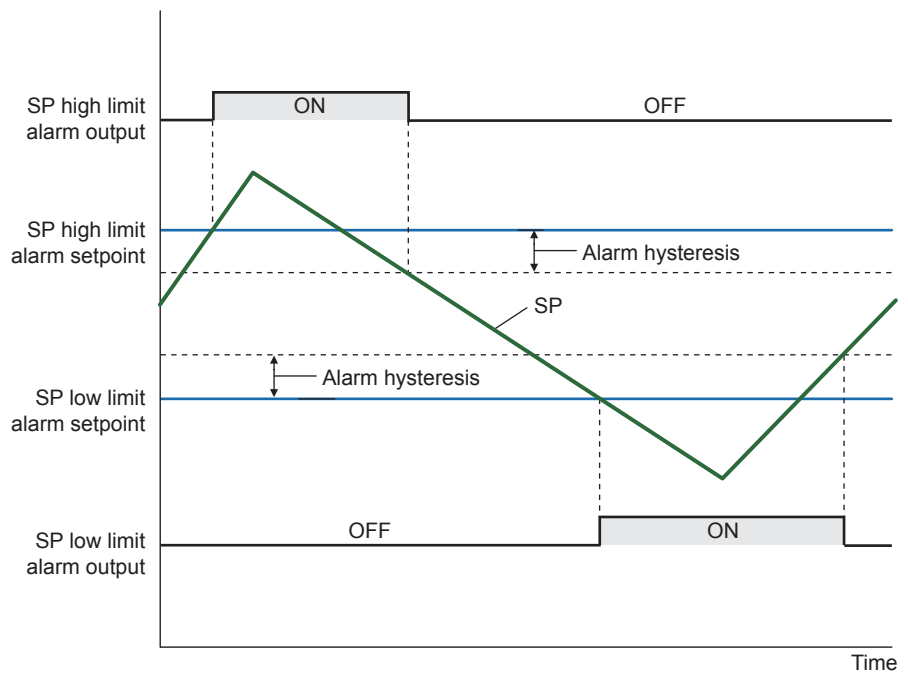
To read the conditions of alarms, outputs, or latches via communication, see Communication Interface User's Manual.

**PV High Limit Alarm and PV Low Limit Alarm**



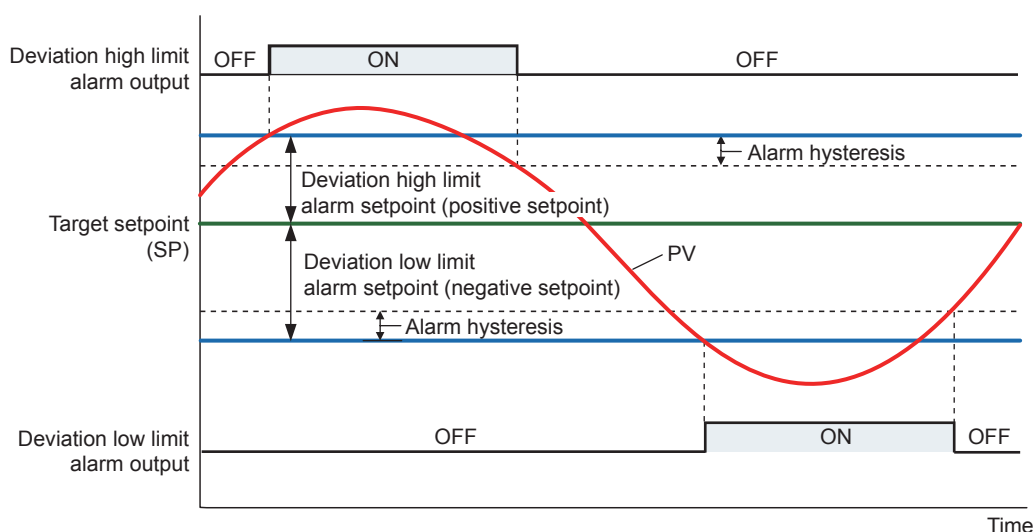
Contact type in the figure above: Energized when an event occurs (factory default).

**SP High Limit Alarm and SP Low Limit Alarm**



Contact type in the figure above: Energized when an event occurs (factory default).

### Deviation High Limit Alarm and Deviation Low Limit Alarm

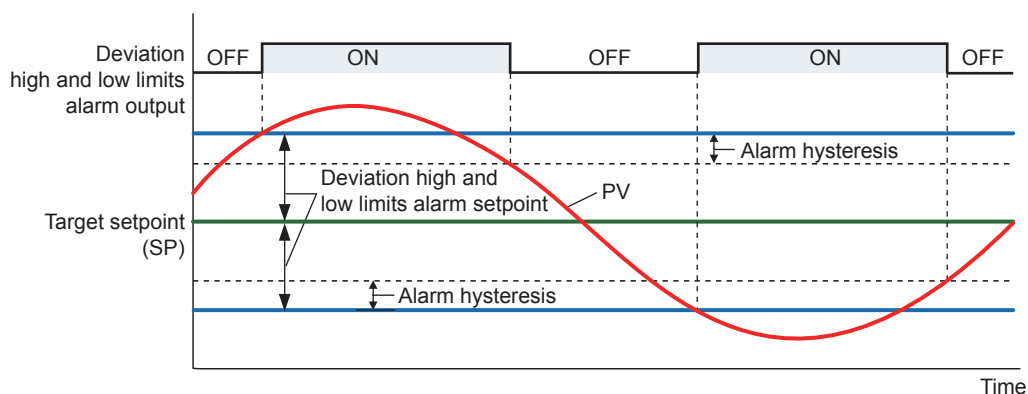


Contact type in the figure above: Energized when an event occurs (factory default).

When a negative setpoint is set for the deviation high limit alarm setpoint, the deviation setpoint will be lower than the SP.

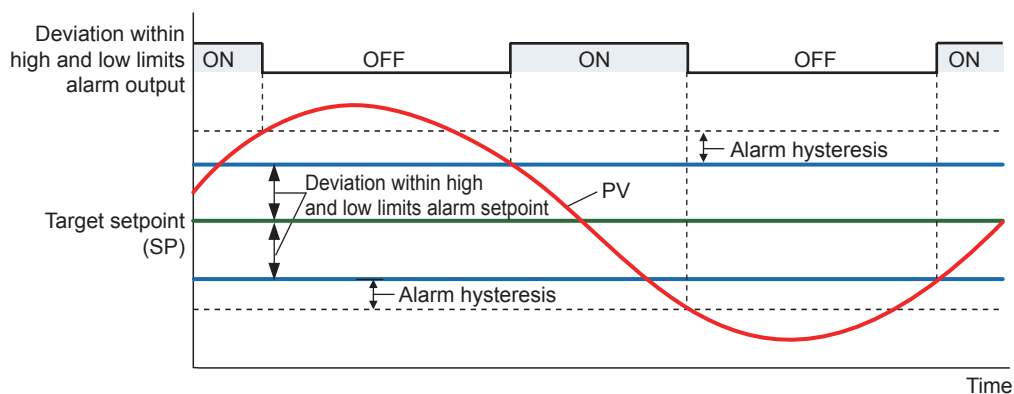
Moreover, when a positive setpoint is set for the deviation low limit alarm setpoint, the deviation setpoint will be higher than the SP.

### Deviation High and Low Limits Alarm



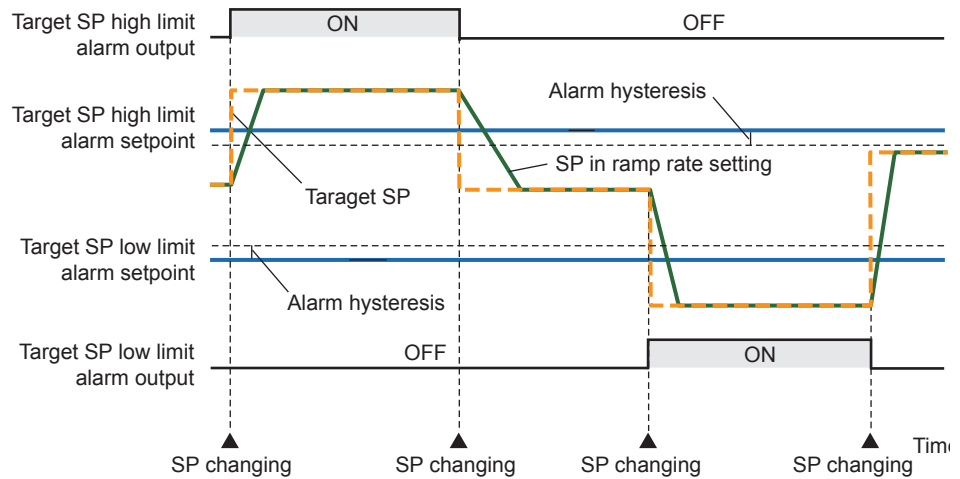
Contact type in the figure above: Energized when an event occurs (factory default).

### Deviation within High and Low Limits Alarm



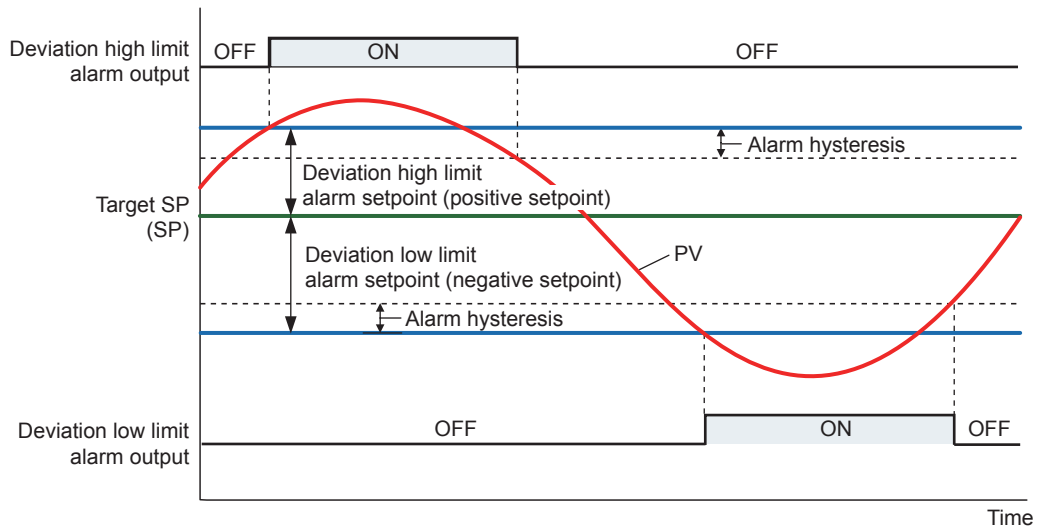
Contact type in the figure above: Energized when an event occurs (factory default).

**Target SP High Limit Alarm and Target SP Low Limit Alarm**



Contact type in the figure above: Energized when an event occurs (factory default).

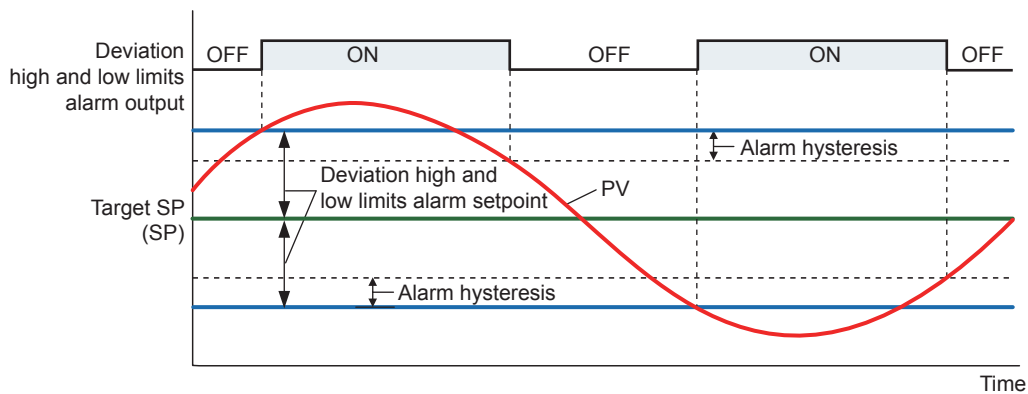
**Target SP Deviation High Limit Alarm and Target SP Deviation Low Limit Alarm**



Contact type in the figure above: Energized when an event occurs (factory default).  
 \* Target SP: a set target setpoint. When the ramp-rate is set, it becomes a final target setpoint.

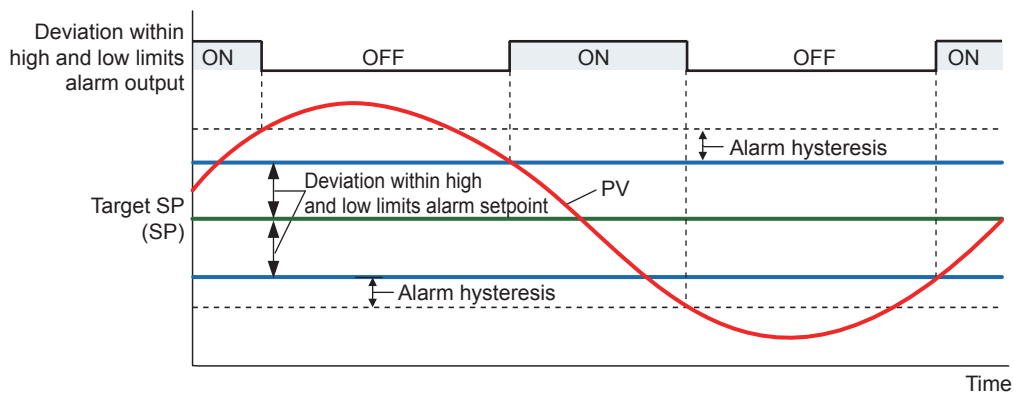
When a negative setpoint is set for the deviation high limit alarm setpoint, the deviation setpoint will be lower than the target SP.  
 Moreover, when a positive setpoint is set for the deviation low limit alarm setpoint, the deviation setpoint will be higher than the target SP.

### Target SP Deviation High and Low Limits Alarm



Contact type in the figure above: Energized when an event occurs (factory default).

### Target SP Deviation within High and Low Limits Alarm



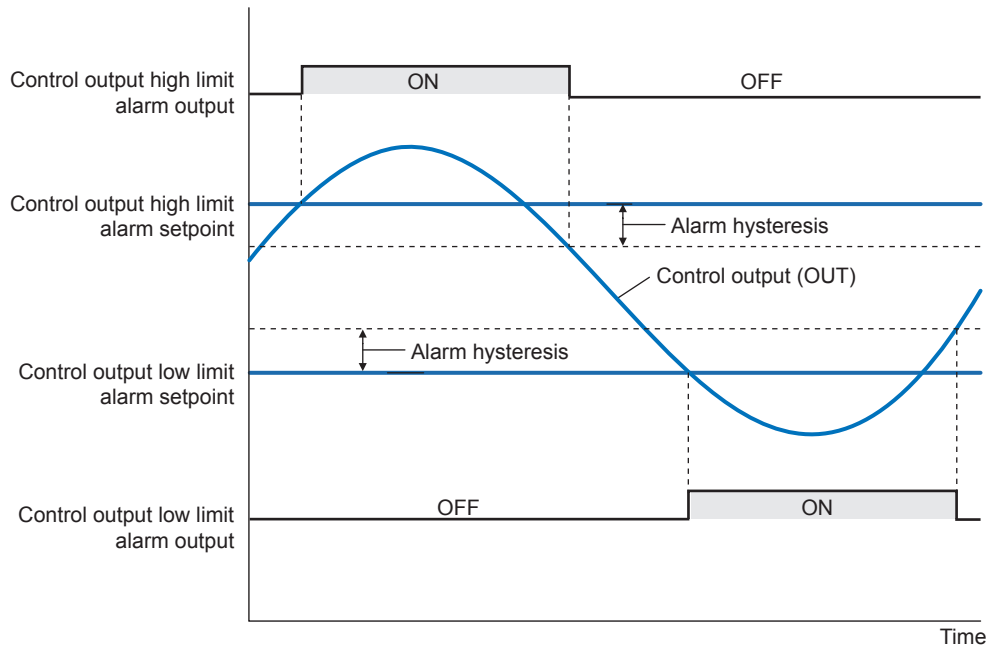
Contact type in the figure above: Energized when an event occurs (factory default).



## 11.1 Setting Alarm Type

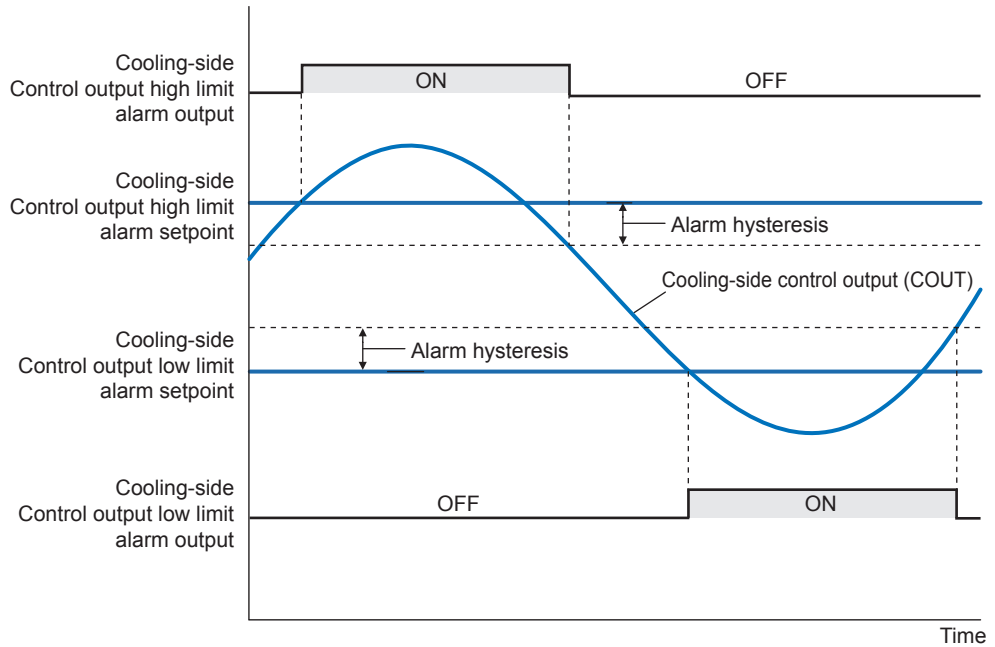
### Control Output High Limit Alarm and Control Output Low Limit Alarm

In Heating/cooling control, alarms are heating-side control output high limit alarm and heating-side control output low limit alarm.



Contact type in the figure above: Energized when an event occurs (factory default).

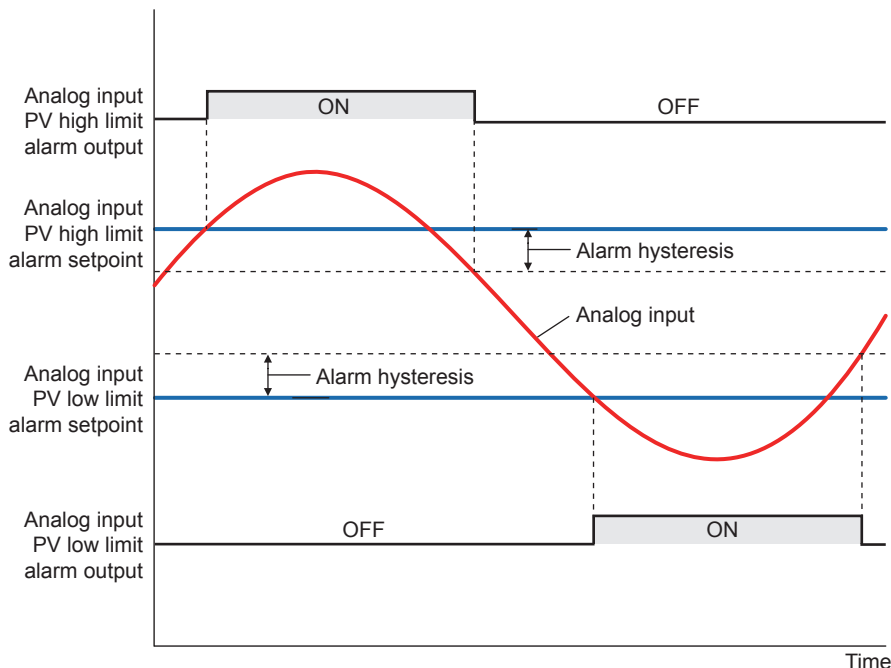
### Cooling-side Control Output High Limit Alarm and Cooling-side Control Output Low Limit Alarm



Contact type in the figure above: Energized when an event occurs (factory default).

### Analog Input PV High Limit Alarm and Analog Input PV Low Limit Alarm

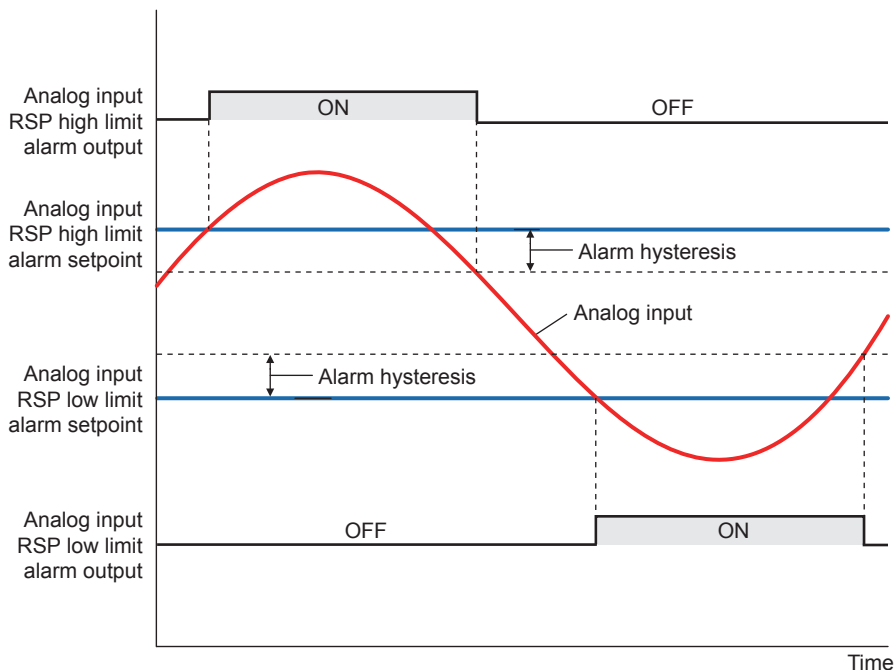
These alarms monitor the input value after the analog input computation process (entrance to the input ladder calculation) is completed.



Contact type in the figure above: Energized when an event occurs (factory default).

### Analog Input RSP High limit Alarm and Analog Input RSP Low Limit Alarm

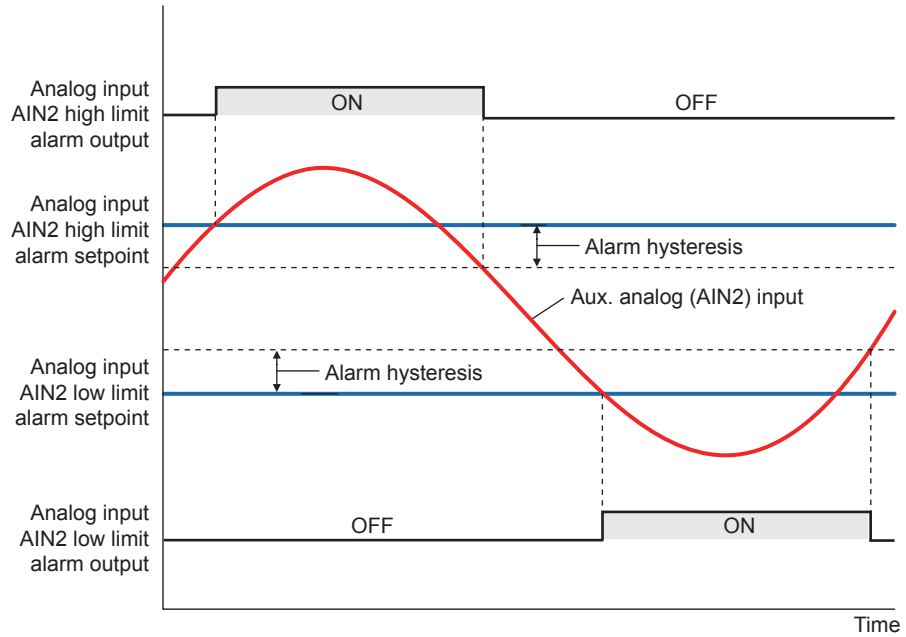
These alarms monitor the input value after the analog input computation process (entrance to the input ladder calculation) is completed.



Contact type in the figure above: Energized when an event occurs (factory default).

**Analog Input AIN2 High Limit Alarm and Analog Input AIN2 Low Limit Alarm**

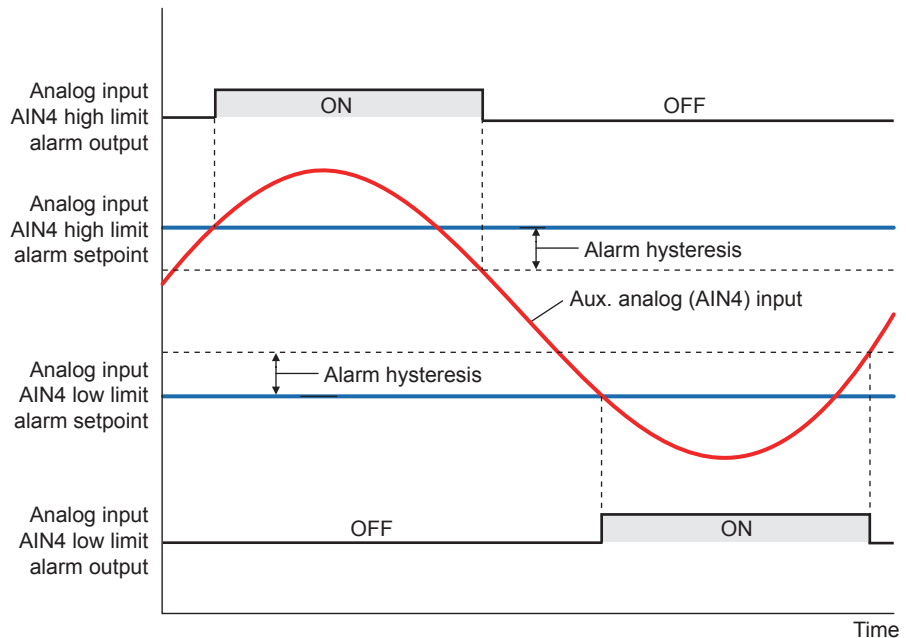
These alarms monitor the input value after the analog input computation process (entrance to the input ladder calculation) is completed.



Contact type in the figure above: Energized when an event occurs (factory default).

**Analog Input AIN4 High Limit Alarm and Analog Input AIN4 Low Limit Alarm**

These alarms monitor the input value after the analog input computation process (entrance to the input ladder calculation) is completed.



Contact type in the figure above: Energized when an event occurs (factory default).

### Feedback Input High Limit Alarm and Feedback Input Low Limit Alarm

These alarms can be used only for Position proportional type..

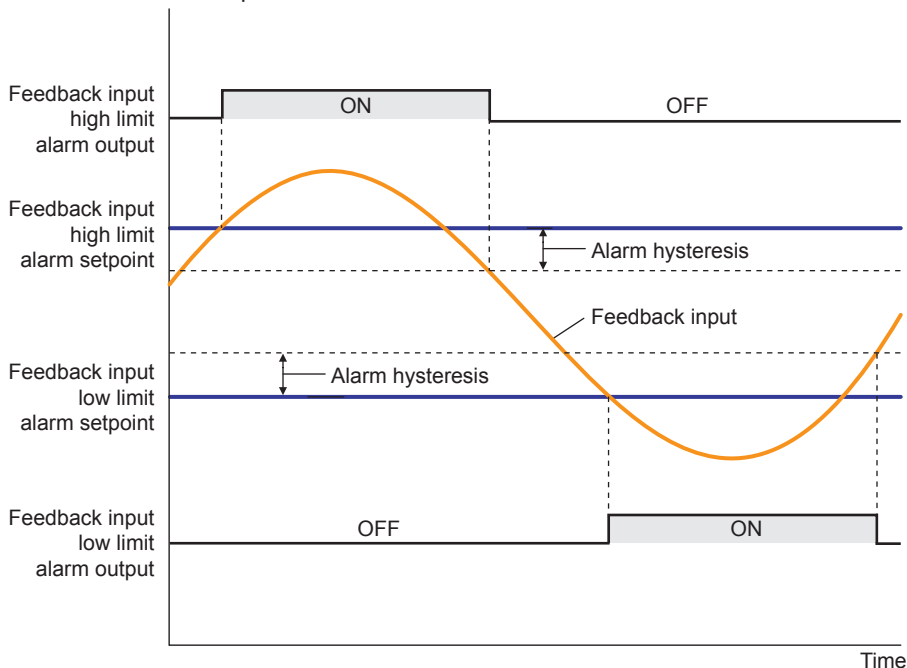
These alarms monitor the feedback input (resistance or current) value.

The setting range for these alarms is 0.0 to 100.0%.

However, the setting range varies depending on whether the feedback input is a current value (4 to 20 mA) or resistance value (100 Ω to 2.5 kΩ).

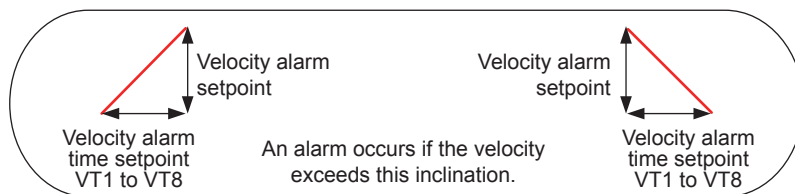
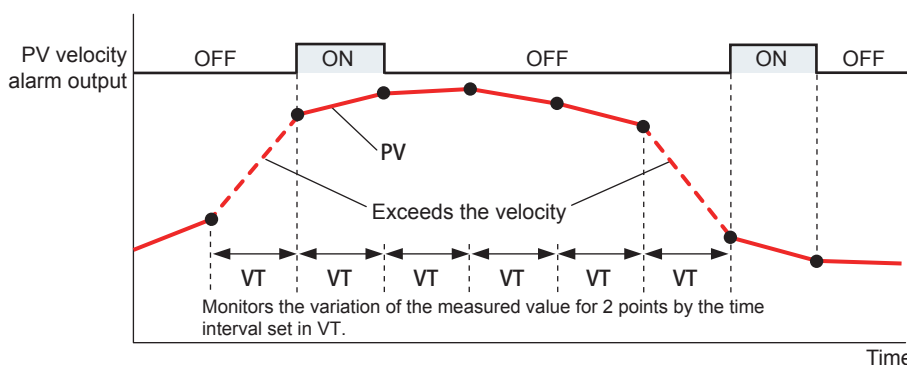
Current value: 4 mA corresponds to 0.0%, and 20 mA to 100.0%.

Resistance value (e.g., 1 kΩ): The resistance value when the valve is fully closed after the valve position adjustment corresponds to 0.0%, and the resistance value when the valve is fully opened corresponds to 100.0%. 0 Ω does not correspond to 0.0%, and 1 kΩ does not correspond to 100.0%.



Contact type in the figure above: Energized when an event occurs (factory default).

### PV Velocity Alarm



Contact type in the figure above: Energized when an event occurs (factory default).

The PV velocity alarm function does not work the alarm hysteresis, the stand-by action and the alarm delay timer functions.

### Fault diagnosis Alarm

The function outputs an alarm signal in the following cases.

The corresponding event (EV) lamp is lit and the contact output turns on (when the contact type is energized).

- Burnout of PV input, RSP remote input, or auxiliary analog input
- ADC failure of PV input, RSP remote input, or auxiliary analog input
- Reference junction compensation (RJC) error of PV input, RSP remote input

The fault diagnosis alarm does not work the stand-by action functions.

### FAIL output

When the FAIL condition is caused (faulty MCU or system data error), DO (alarm output) turned off regardless of contact type.

The FAIL output does not work the alarm latch, the energized/de-energized and the stand-by action functions.

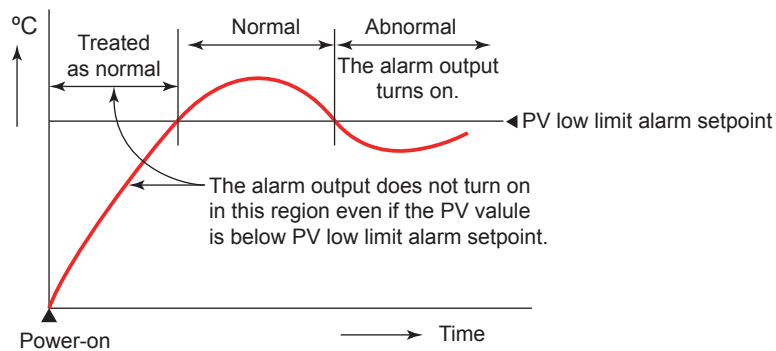
### Stand-by Action

The stand-by action is a function for ignoring the alarm condition and keeps the alarm off until the alarm condition is removed. Once the alarm condition is removed, the stand-by action is cancelled.

It is effective in the following cases where;

- The power is turned on
- The alarm type is changed
- Forced stand-by via communication

The following shows the behavior of an alarm with the stand-by action at power ON.



### Alarm Latch Function

The alarm latch function is a function for keeping the alarm output (keeping the alarm output on) after entering the alarm condition (alarm output is turned on) until an order to release the alarm latch is received.

The alarm latch function has the following four types of action.

#### Latch 1

Cancels the alarm output when an order to release the alarm latch is received. (Alarm output OFF.)

However, an order to release the alarm latch is ignored if the order is received during alarm condition.

#### Latch 2

Always forces cancelling of the alarm output when an order to release the alarm latch is received. (Alarm output OFF)

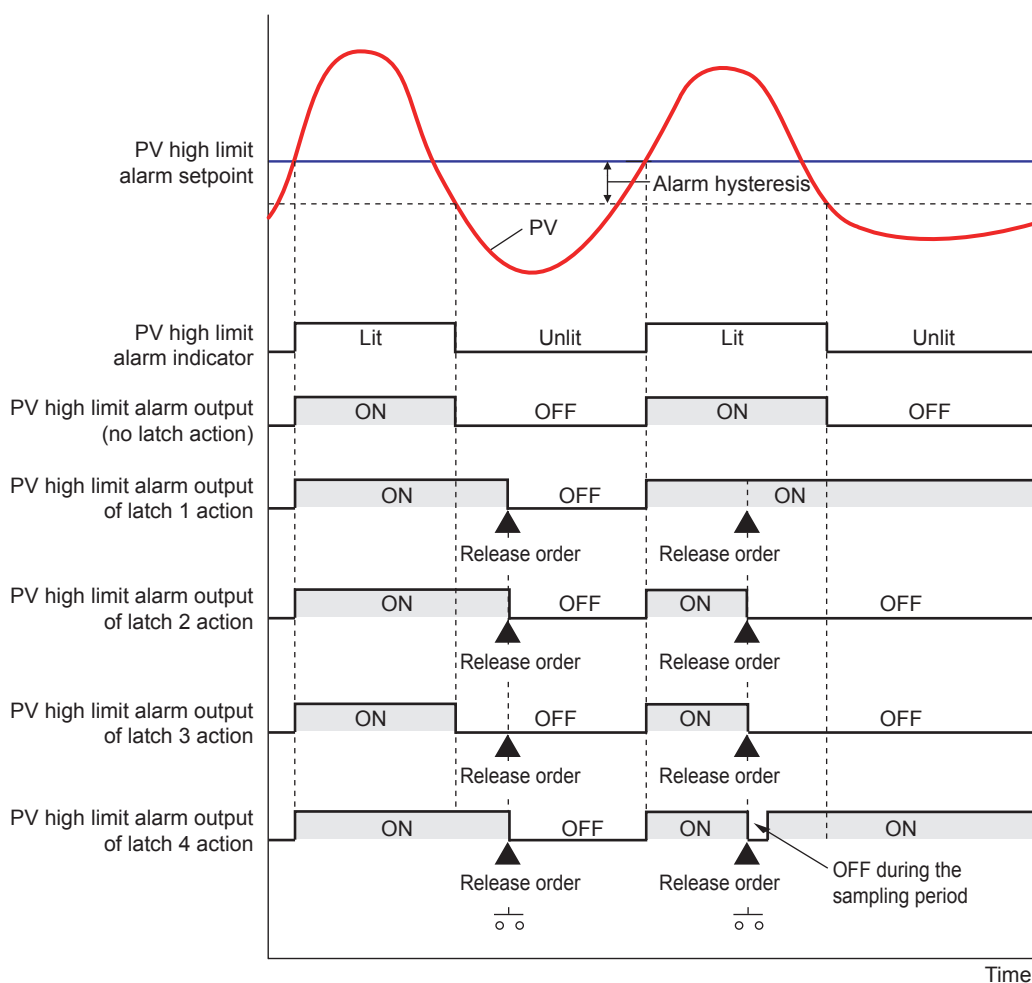
#### Latch 3

Cancels the alarm output when an order to release the alarm latch is received or when the alarm condition is removed. (Alarm output OFF.)

#### Latch 4

Cancels the alarm output when an order to release the alarm latch is received. (Alarm output OFF.)

However, cancels the alarm output for the duration of the sampling period (control period) if an order to release the alarm latch is received during alarm condition. (Alarm output OFF)



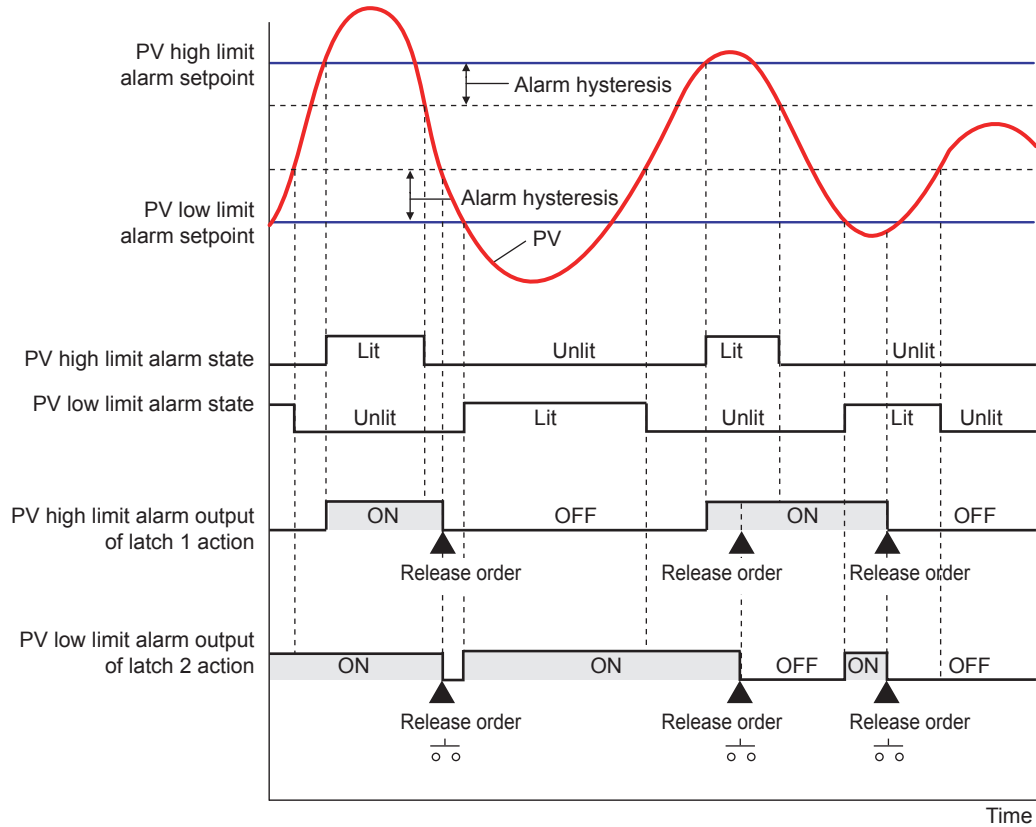
Contact type in the figure above: Energized when an event occurs (factory default).

**Release of Alarm Latch**

The alarm latch function can be cancelled by the user function key, via communication/ ladder program, or by contact input.

Cancelling the alarm latch function cancels all latched alarm outputs.

- ▶ Release by user function key: [13.2 Assigning Function to User Function Key](#)
- ▶ Release by contact input: [12.1.1 Setting Contact Input Function](#)
- ▶ Release via communication: [UTAdvanced Series Communication Interface User's Manual](#)




Contact type in the figure above: Energized when an event occurs (factory default).

**Operation of Alarm Output and Display Lamp (ALM)**

The contact output and display lamp (ALM) are usually output and displayed according to the setpoint of the alarm type. However, the alarm conditions (operations) of the normal action, and latch action can be assigned to the contact output and display lamp (ALM), regardless of the setpoint of the alarm type. (Two operations can be assigned simultaneously.)

- ▶ Display lamp action: [13.1 Setting Display Functions](#)
- ▶ Contact output action: [12.2.1 Setting Function of Contact Output](#)

## Setting Details

Parameter symbol	Name	Display level	Setting range	Menu symbol
<b>AL1 to AL8</b>	Alarm-1 to -8 type	EASY	See the table below.	ALRM 
<b>VT1 to VT8</b>	PV velocity alarm time setpoint 1 to 8	EASY	00.01 to 99.59 (minute.second)	

Note1: The initial values of the parameters AL1 to AL8 and VT1 to VT8 are "4".

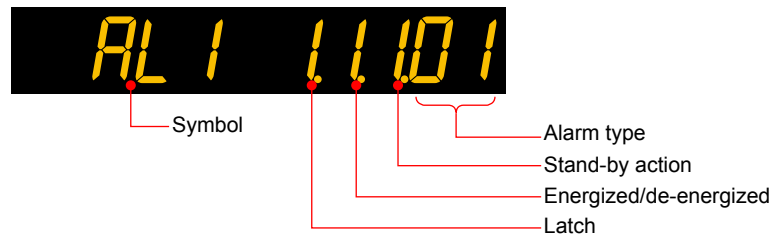
Only AL1 to AL4 and VT1 to VT4 are displayed. The number of alarms can be changed using the parameter ALNO.

Note2: In Cascade control, the LP2 lamp is lit while the Loop-2 parameter is displayed.



## 11.1 Setting Alarm Type

The following shows the example of setting PV high limit (01), With stand-by action (1), De-energized (1), and Latch 1 action (1).



Name	Latch action (Note 1)	Energized (0) / de-energized (1)	Stand-by action Without (0) / with (1)	Alarm type
Disable	0 / 1 / 2 / 3 / 4	0 / 1	0 / 1	00
PV high limit	0 / 1 / 2 / 3 / 4	0 / 1	0 / 1	01
PV low limit	0 / 1 / 2 / 3 / 4	0 / 1	0 / 1	02
SP high limit	0 / 1 / 2 / 3 / 4	0 / 1	0 / 1	03
SP low limit	0 / 1 / 2 / 3 / 4	0 / 1	0 / 1	04
Deviation high limit	0 / 1 / 2 / 3 / 4	0 / 1	0 / 1	05
Deviation low limit	0 / 1 / 2 / 3 / 4	0 / 1	0 / 1	06
Deviation high and low limits	0 / 1 / 2 / 3 / 4	0 / 1	0 / 1	07
Deviation within high and low limits	0 / 1 / 2 / 3 / 4	0 / 1	0 / 1	08
Target SP high limit	0 / 1 / 2 / 3 / 4	0 / 1	0 / 1	09
Target SP low limit	0 / 1 / 2 / 3 / 4	0 / 1	0 / 1	10
Target SP deviation high limit	0 / 1 / 2 / 3 / 4	0 / 1	0 / 1	11
Target SP deviation low limit	0 / 1 / 2 / 3 / 4	0 / 1	0 / 1	12
Target SP deviation high and low limits	0 / 1 / 2 / 3 / 4	0 / 1	0 / 1	13
Target SP deviation within high and low limits	0 / 1 / 2 / 3 / 4	0 / 1	0 / 1	14
Control output high limit	0 / 1 / 2 / 3 / 4	0 / 1	0 / 1	15
Control output low limit	0 / 1 / 2 / 3 / 4	0 / 1	0 / 1	16
Cooling-side Control output high limit	0 / 1 / 2 / 3 / 4	0 / 1	0 / 1	17
Cooling-side Control output low limit	0 / 1 / 2 / 3 / 4	0 / 1	0 / 1	18
Analog input PV high limit	0 / 1 / 2 / 3 / 4	0 / 1	0 / 1	19
Analog input PV low limit	0 / 1 / 2 / 3 / 4	0 / 1	0 / 1	20
Analog input RSP high limit	0 / 1 / 2 / 3 / 4	0 / 1	0 / 1	21
Analog input RSP low limit	0 / 1 / 2 / 3 / 4	0 / 1	0 / 1	22
Analog input AIN2 high limit	0 / 1 / 2 / 3 / 4	0 / 1	0 / 1	23
Analog input AIN2 low limit	0 / 1 / 2 / 3 / 4	0 / 1	0 / 1	24
Analog input AIN4 high limit	0 / 1 / 2 / 3 / 4	0 / 1	0 / 1	25
Analog input AIN4 low limit	0 / 1 / 2 / 3 / 4	0 / 1	0 / 1	26
Feedback input high limit	0 / 1 / 2 / 3 / 4	0 / 1	0 / 1	27
Feedback input low limit	0 / 1 / 2 / 3 / 4	0 / 1	0 / 1	28
PV velocity	0 / 1 / 2 / 3 / 4	0 / 1	- (Note 2)	29
Fault diagnosis	0 / 1 / 2 / 3 / 4	0 / 1	- (Note 2)	30
FAIL	- (Note 2)	- (Note 2)	- (Note 2)	31

Note 1: 0: No latch function, 1: Latch 1, 2: Latch 2, 3: Latch 3, 4: Latch 4

Note 2: -: Alarm function doesn't work even if any value is set.

## 11.2 Setting Number of Alarm Groups to Use

### Description

Up to eight alarm groups of alarm type, alarm hysteresis, alarm (On-/Off-) delay timer, and alarm setpoint are available.

Unused alarm parameters can be hidden and their functions can be turned off.

The initial value of parameter ALNO. is "4."

When ALNO. = 4, for example, only the four groups of alarm type, PV velocity alarm time setpoint, alarm hysteresis, alarm delay timer, and alarm setpoint are displayed.

### Setting Details

Parameter symbol	Name	Display level	Setting range	Menu symbol
ALNO.	Number of alarm groups	PRO	1 to 8	CTL <b>Set</b>

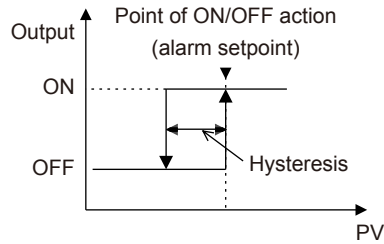
Note1: In Cascade control, the LP2 lamp is lit while the Loop-2 parameter is displayed.

# 11.3 Setting Hysteresis to Alarm Operation

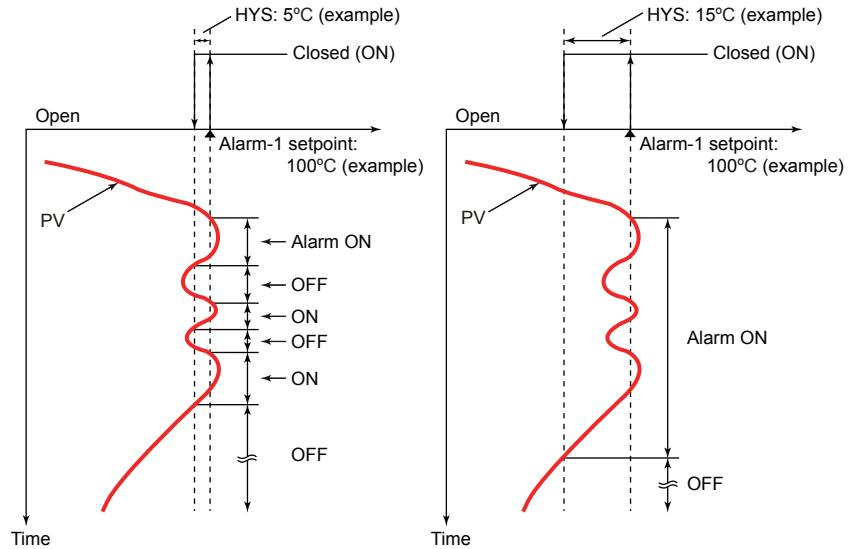
## Description

If the On/Off switch of the alarm output is too busy, you can alleviate the busyness by increasing the alarm hysteresis.

### Hysteresis for PV High Limit Alarm



### When Setting Hysteresis of 5°C and 15°C for PV High Limit Alarm



## Setting Details

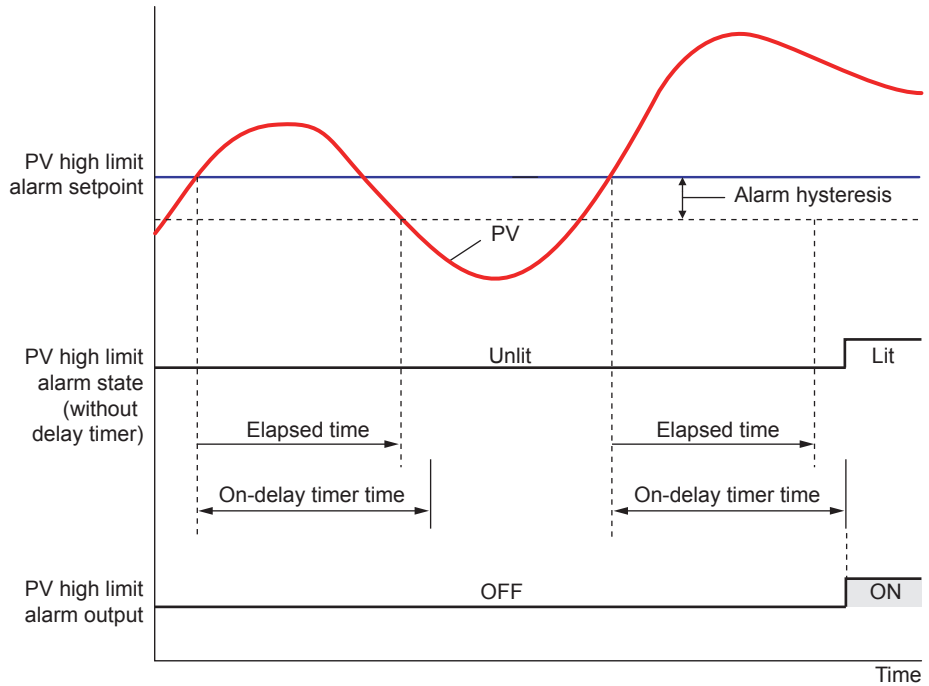
Parameter symbol	Name	Display level	Setting range	Menu symbol
<b>HY1 to HY8</b>	Alarm-1 to -8 hysteresis	EASY	Sets the hysteresis setpoint as a display value. -19999 to 30000 (set it within the input range) The decimal point position depends on the input type.	ALRM <b>Ope</b>

Note1: In Cascade control, the LP2 lamp is lit while the Loop-2 parameter is displayed.

# 11.4 Delaying Alarm Output (Alarm Delay Timer)

## Description

The alarm on-delay timer is a function for turning on the alarm when the alarm condition occurs, and the timer starts and the set time elapses. The timer is reset if the alarm condition is removed while the timer is running. No alarm is generated. The figure below shows the example of the On-delay timer



Contact type in the figure above: Energized when an event occurs (factory default).

The alarm Off-delay timer is a function for turning off the alarm when the alarm condition is removed (normal condition), and the timer starts and the set time elapses. The timer is reset if the alarm condition occurs again while the timer is running. The alarm is not cancelled.

## Setting Details

Parameter symbol	Name	Display level	Setting range	Menu symbol
DYN1 to DYN8	Alarm-1 to -8 On-delay timer	STD	0.00 to 99.59 (minute.second)	ALRM <b>Ope</b>
DYF1 to DYF8	Alarm-1 to -8 Off-delay timer	PRO		

Note1: In Cascade control, the LP2 lamp is lit while the Loop-2 parameter is displayed.

## 11.5 Setting Alarm Output to Control Relay Terminal

### Description

The control relay terminal can be used for alarm output when it is not used for control output.

### Setting Details

Parameter symbol	Name	Display level	Setting range	Menu symbol
OR.S	OUT relay function selection	STD	Same as the setpoint for the contact output function. See 12.2.1, "Setting Function of Contact Output."	ALM <b>Set</b>
OR.D	OUT relay contact type	PRO	0: Closes the contact when an event occurs 1: Opens the contact when an event occurs.	
OR2.S	OUT2 relay function selection	STD	Same as OR.S.	
OR2.D	OUT2 relay contact type	PRO	Same as OR.D	

### Parameters and Corresponding Terminals


OR.S, OR.D	OUT terminal
OR2.S, OR2.D	OUT2 terminal

## 11.6 Setting Alarm Action According to Operation Mode

### Description

The alarm action usually functions regardless of operation modes.  
Setting the alarm mode allows the alarm action to be disabled in RESET or MAN mode.

### Setting Details

Parameter symbol	Name	Display level	Setting range	Menu symbol
AMD	Alarm mode	STD	0: Always active 1: Not active in RESET mode 2: Not active in RESET or MAN mode	ALRM 

Note1: In Cascade control, the LP2 lamp is lit while the Loop-2 parameter is displayed.

## 11.7 Setting Heater Break Alarm

### Description

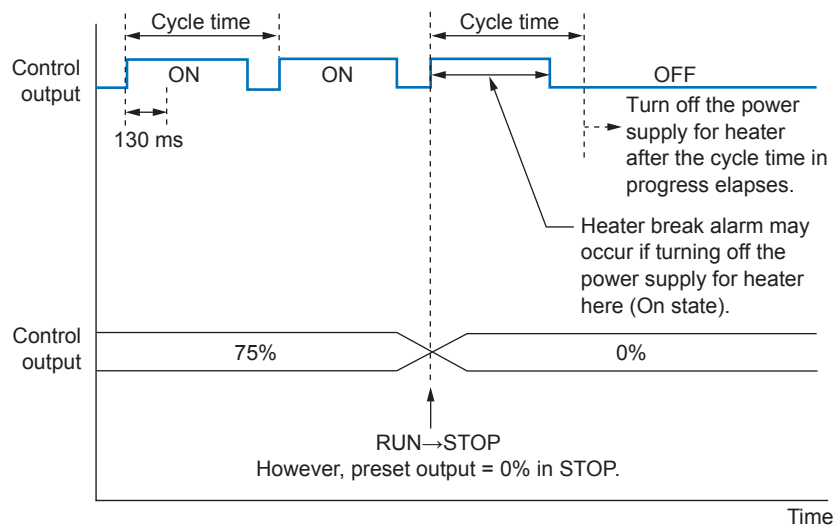
Either of heater break alarm function or heater current measurement function can be selected.

### Heater Break Alarm Function

The heater break alarm function measures the heater current, and outputs the heater break alarm if the current is less than the heater break detecting point.  
The heater break alarm function can be used only for ON/OFF output (relay output) or for time proportional output (relay output, voltage pulse output). It cannot be used for current output.

Timing which detects the heater break alarm is as follows.

- For ON/OFF output:  
Heater break is detected when control output is in On-state. (Heater break is not detected when control output is in Off-state.)
- For time proportional output:  
When On-state time of control output is 130 ms or longer, heater break is detected.  
Heater break is detected between 20 ms and 120 ms after control output turns on.  
Heater current value is detected every 200 ms while control output turns on.



### Heater break detecting point

Set a detecting point (setpoint) of heater break alarm.

The heater break alarm is output if the measured current is less than the detecting point (setpoint).

### Current Transformer Winding Number Ratio

The coil winding number ratio of current transformer (CT ratio) can be set.

Example: Set the CT ratio "800" for the CTL-6-S-H manufactured by U.R.D. Co., Ltd.

Heater Current Measured Value

A measured heater current value can be confirmed by a displayed value on operation display.

▶ [Heater current measured value: 6.1 Monitoring and Control of Operaiotn Displays](#)

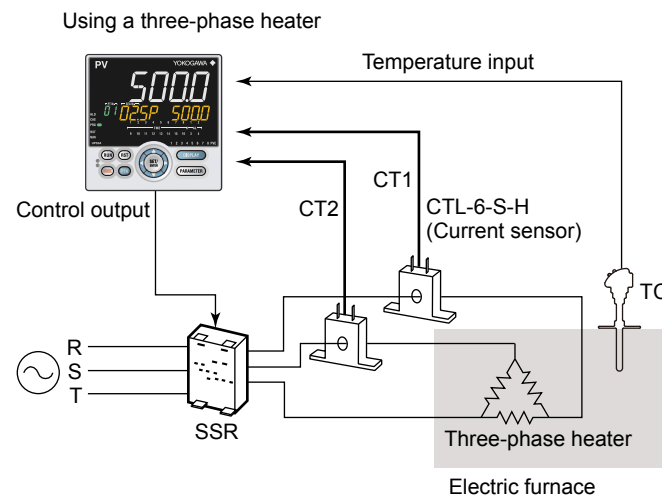
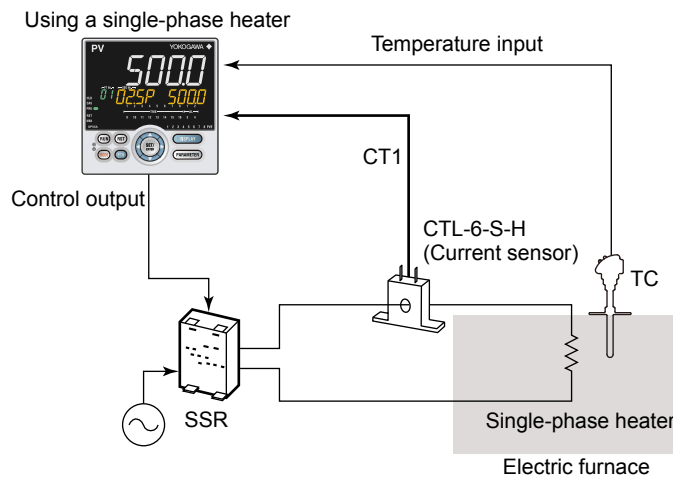
Heater Break Alarm Delay Timer

The delay timer (On-delay timer, Off-delay timer) can be set for the heater break alarm function.

▶ [Delay timer: 11.4 Delaying Alarm Output \(Alarm Delay Timer\)](#)

Heater Break Alarm Output Contact Type

The heater break alarm output contact type sets an action direction of contact output (ON/OFF) when an event occurs.



Release of Heater Break Alarm

To stop or abthe heater break alarm, power on and then power off the main unit.



### Heater Current Measurement Function


The heater current value can be confirmed by a displayed value on operation display.

▶ [Heater current measured value: 6.1 Monitoring and Control of Operaiotn Displays](#)

The heater break alarm function can be used only for ON/OFF output (relay output), for time proportional output (relay output, voltage pulse output) or for current output.

Heater current value is detected every 200 ms.

#### Setting Details

Parameter symbol	Name	Display level	Setting range	Menu symbol
<b>HB1.S,</b> <b>HB2.S</b>	Heater break alarm function selection	EASY	0: Heater current measurement 1: Heater break alarm	HBA 
<b>HB1, HB2</b>	Heater break alarm current setpoint	EASY	OFF, 0.1 to 300.0 Arms	
<b>CT1.T,</b> <b>CT2.T</b>	CT coil winding number ratio	EASY	1 to 3300	
<b>HDN1,</b> <b>HDN2</b>	Heater break alarm On-delay timer	STD	0.00 to 99.59 (minute.second)	
<b>HDF1,</b> <b>HDF2</b>	Heater break alarm Off-delay timer	PRO		
<b>HB1.D,</b> <b>HB2.D</b>	Heater break alarm contact type	PRO	CLS: When the event occurs, the contact is closed. OPN: When the event occurs, the contact is opened.	

Note1: In cases where the current transformer manufactured by U.R.D Co., Ltd. are used, set the following value for the CT coil winding number ratio.  
 CTL-6-S-H: 800  
 CTL-12L-30: 3000

## 12.1 Setting Contact Input Function

### 12.1.1 Setting Contact Input Function

#### Description

The contact input function works by setting the contact input number (I relay) to functions such as the operation mode.

This explanation assumes that the contact type is energized. (The function is executed when the contact is turned on)

#### Switch to PRG (Start of program operation)

The mode can be switched to PROG (start of program operation) using contact input. (Switch by the rising edge)

Contact status	Operation	Remark
OFF→ON	Switch to PROG (start of program operation)	–
ON→OFF	Maintains the current operation status	–

#### Switch to RST (Stop of program operation)

The mode can be switched to RESET (stop of program operation) using contact input. (Switch by the rising edge)

Contact status	Operation	Remark
OFF→ON	Switch to RESET (stop of program operation)	–
ON→OFF	Maintains the current operation status	–

#### Switch to LOC(LSP) (Start of local-mode operation)

The mode can be switched to LOCAL(LSP) (start of local-mode operation) using contact input. (Switch by the rising edge)

Contact status	Operation	Remark
OFF→ON	Switch to LOCAL(LSP) (start of local-mode operation)	–
ON→OFF	Maintains the current operation status	–

#### Switch to REM (Start of remote-mode operation)

The mode can be switched to REMOTE (start of remote-mode operation) using contact input. (Switch by the rising edge)

Contact status	Operation	Remark
OFF→ON	Switch to REMOTE (start of remote-mode operation)	–
ON→OFF	Maintains the current operation status	–

#### PROG/RESET Switch (P/R)

PROG/RESET mode can be switched using contact input. (Switch by the rising edge and the falling edge)

Contact status	Operation	Remark
OFF→ON	PROG	–
ON→OFF	RESET	–

## 12.1 Setting Contact Input Function

### PROG/HOLD Switch (P/H)

PROG/HOLD mode can be switched using contact input. (Switch by the rising edge and the falling edge)

Contact status	Operation	Remark
OFF→ON	PROG	—
ON→OFF	HOLD	—

### PROG/LOCAL(LSP) Switch (P/L)

PROG/LOCAL(LSP) mode can be switched using contact input. (Switch by the rising edge and the falling edge)

Contact status	Operation	Remark
OFF→ON	PROG	—
ON→OFF	LOCAL	—

### Switch to HOLD (Start of hold-mode operation)

The mode can be switched to HOLD (start of hold-mode operation) using contact input. (Switch by the rising edge)

Contact status	Operation	Remark
OFF→ON	Switch to HOLD (start of hold-mode operation)	—
ON→OFF	Maintains the current operation status	—

### Advance of segment (ADV)

The mode can advance from the current segment to the next segment using contact input. (Switch by the rising edge)

Contact status	Operation	Remark
OFF→ON	Advance from the current segment to the next segment	—
ON→OFF	Maintains the current operation status	—

### Wait ON/OFF switch (WAIT)

Wait ON/OFF in the segment switching can be switched using contact input. (Status switch)

Contact status	Operation	Remark
ON	Wait (switching between segments)	—
OFF	Wait release	—

This function is available only for synchronized operation. Set "OFF" to the parameter for operations except synchronized operation.

### Switch to HOLD for synchronized program operation (S.HLD)

HOLD ON/OFF for synchronized program operation can be switched using contact input. (Status switch)

Contact status	Operation	Remark
ON	Wait (wait within a segment interval.)	Switch by keystroke or via communication is disabled.
OFF	Hold release	Switch by keystroke or via communication is enabled.

This function is available only for synchronized operation. Set "OFF" to the parameter for operations except synchronized operation.

**AUTO/MAN Switch (A/M)**

AUTO/MAN mode can be switched using contact input. (Status switch)

Contact status	Operation	Remark
ON	AUTO	Switch by keystroke or via communication is disabled.
OFF	MAN	Switch by keystroke or via communication is enabled.

**LOCAL(LSP)/CAS switch (L/C)**

In cascade control, LSP/CAS mode can be switched using contact input. (Status switch)

Contact status	Operation	Remark
ON	LSP	Switch by keystroke or via communication is disabled.
OFF	CAS	Switch by keystroke or via communication is enabled.

**Auto-tuning START/STOP Switch (AT)**

Auto-tuning START/STOP can be switched using contact input.

Auto-tuning is executed to the PID group currently specified. (Switch by the rising edge and the falling edge)

Contact status	Operation	Remark
OFF→ON	Starts auto-tuning	–
ON→OFF	Stops auto-tuning	–

**Output Tracking Switch (TRK)**

Output tracking can be switched using contact input. (Status switch)

Contact status	Operation	Remark
ON	Turns the output tracking on	–
OFF	Turns the output tracking off	–

Can be used in Cascade primary-loop control.

**PV Switch (SW)**

Two PV inputs can be switched using contact input. (Status switch)

Contact status	Operation	Remark
ON	Switches to input 2	–
OFF	Switches to input 1	–

Can be used in Loop control with PV switching.

**Latch Release (LAT)**

Latch can be released using contact input. (Switch by the rising edge)

Contact status	Operation	Remark
OFF→ON	Releases the latch	–
ON→OFF	Maintains the current operation status	–

Releasing the latch function releases all latched contact (alarm) outputs.

## 12.1 Setting Contact Input Function

### LCD Backlight ON/OFF Switch (LCD)

LCD backlight ON/OFF can be switched using contact input. (Switch by the rising edge and the falling edge)

Contact status	Operation	Remark
OFF→ON	Turns off the LCD backlight	–
ON→OFF	Turns on the LCD backlight	–

### Message Display Interruption 1 to 4 (MG 1 to 4)

The message set using LL50A Parameter Setting Software can be interrupt-displayed on PV display using contact input. The messages are limited to 20 alphanumeric characters. A maximum of four displays can be registered. (Switch by the rising edge)

▶ [Message: LL50A Parameter Setting Software User's Manual](#)

Contact status	Operation	Remark
OFF→ON	Interrupt-displays the message	Pressing the DISPLAY key erases the message.
ON→OFF	Displays the current PV	–

### PV Red/white Switch (PVRW)

PV color can be switched using contact input. (Status switch)

Contact status	Operation	Remark
ON	Red color	–
OFF	White color	–

Set "10" to the parameter PCMD.

### Bit-0 to Bit-5 of Program Pattern Number (PT.B0 to PT.B5)

The program pattern number can be switched using contact input. There are three methods to specify program pattern number.

- Status switch 1 (Operation by keystroke or via communication is enabled depending on the conditions.)

Program pattern number	Contact status				
	PT.B4	PT.B3	PT.B2	PT.B1	PT.B0
1	OFF	OFF	OFF	OFF	ON
2	OFF	OFF	OFF	ON	OFF
3	OFF	OFF	OFF	ON	ON
4	OFF	OFF	ON	OFF	OFF
5	OFF	OFF	ON	OFF	ON
6	OFF	OFF	ON	ON	OFF
7	OFF	OFF	ON	ON	ON
8	OFF	ON	OFF	OFF	OFF
9	OFF	ON	OFF	OFF	ON
10	OFF	ON	OFF	OFF	OFF

A program pattern is selected with the combination of ON and OFF of a contact input. The pattern 11 or later can be selected similarly.

- \*1: "1" when the contact input is turned on and "0" when turned off.
- \*2: Program pattern number can be switched by keystroke or via communication when all contact inputs of PT.B0 to PT.B4 are turned off.
- \*3: Program pattern number cannot be switched by keystroke or via communication when any contact input of PT.B0 to PT.B4 is turned on.
- \*4: The contact input is turned off when the bit of program pattern number is not assigned to the contact input.
- \*5: The immediately preceding program pattern number is held when all contact inputs are turned off.

- Status switch 2 (Operation by keystroke or via communication is disabled.)

Program pattern number	Contact status			
	PT.B3	PT.B2	PT.B1	PT.B0
1	OFF	OFF	OFF	OFF
2	OFF	OFF	OFF	ON
3	OFF	OFF	ON	OFF
4	OFF	OFF	ON	ON
5	OFF	ON	OFF	OFF
6	OFF	ON	OFF	ON
7	OFF	ON	ON	OFF
8	OFF	ON	ON	ON
9	ON	OFF	OFF	OFF
10	ON	OFF	OFF	ON

A program pattern is selected with the combination of ON and OFF of a contact input. The pattern 11 or later can be selected similarly.

\*1: "1" when the contact input is turned on and "0" when turned off.

\*2: Contact input is turned off when the bit of program pattern number is not assigned to the contact input.

- BCD switch (Operation by keystroke or via communication is disabled.)

Program pattern number	Contact status					
	High order digit (0 to 3)		Low order digit (0 to 9)			
	PT.B5	PT.B4	PT.B3	PT.B2	PT.B1	PT.B0
1	OFF	OFF	OFF	OFF	OFF	ON
2	OFF	OFF	OFF	OFF	ON	OFF
3	OFF	OFF	OFF	OFF	ON	ON
4	OFF	OFF	OFF	ON	OFF	OFF
5	OFF	ON	OFF	ON	OFF	ON
6	OFF	ON	OFF	ON	ON	OFF
7	OFF	ON	OFF	ON	ON	ON
8	OFF	ON	ON	OFF	OFF	OFF
9	OFF	OFF	ON	OFF	OFF	ON
10	OFF	ON	OFF	OFF	OFF	OFF
11	OFF	ON	OFF	OFF	OFF	ON
12	OFF	ON	OFF	OFF	ON	OFF

A program pattern is selected with the combination of ON and OFF of a contact input. The pattern 13 or later can be selected similarly.

Example: pattern 23

PT.B5:ON, PT.B4: OFF, PT.B3: OFF, PT.B2: OFF, PT.B1: ON, PT.B0: ON

\*1: "1" when the contact input is turned on and "0" when turned off.

\*2: Contact input is turned off when the bit of program pattern number is not assigned to the contact input.

### Setting Details

Parameter symbol	Name	Display level	Setting range	Menu symbol
PT.BC	Bit changing method of program pattern number	PRO	0: Status switch 1 1: Status switch 2 2: BCD switch	DI.NU <b>Set</b>

## 12.1 Setting Contact Input Function

### Bit-0 to Bit-3 of PID Number (PN.B0 to PN.B3)

The PID number can be switched using contact input. There are two methods to specify a PID number.

Change the local PID number selection (L.PID) using in local or remote operation.

Change the local PID number selection (L.PID) using in local or remote operation, or program operation (when ZON=5.)\*

\*: When the local PID selection is selected (ZON = 5), the PID group set in the local PID number selection (L.PID) is used, irrespective of the operation mode.

- Status switch 1 (Operation by keystroke or via communication is enabled depending on the conditions.)

PID number	Contact status			
	PN.B3	PN.B2	PN.B1	PN.B0
1	OFF	OFF	OFF	ON
2	OFF	OFF	ON	OFF
3	OFF	OFF	ON	ON
4	OFF	ON	OFF	OFF
5	OFF	ON	OFF	ON
6	OFF	ON	ON	OFF
7	OFF	ON	ON	ON
8	ON	OFF	OFF	OFF

\*1: "1" when the contact input is turned on and "0" when turned off.

\*2: PID number can be switched by keystroke or via communication when all contact inputs of PN.B0 to PN.B3 are turned off.

\*3: PID number cannot be switched by keystroke or via communication when any contact input of PN.B0 to PN.B3 is turned on.

\*4: The contact input is turned off when the bit of PID number is not assigned to the contact input.

- Status switch 2 (Operation by keystroke or via communication is disabled.)


PID number	Contact status		
	PN.B2	PN.B1	PN.B0
1	OFF	OFF	OFF
2	OFF	OFF	ON
3	OFF	ON	OFF
4	OFF	ON	ON
5	ON	OFF	OFF
6	ON	OFF	ON
7	ON	ON	OFF
8	ON	ON	ON

\*1: "1" when the contact input is turned on and "0" when turned off.

\*2: Contact input is turned off when the bit of PID number is not assigned to the contact input.

In Cascade control, PID number selection is for Loop 1 and Loop 2.

#### Setting Details

Parameter symbol	Name	Display level	Setting range	Menu symbol
PN.BC	Bit changing method of PID number	PRO	0: Status switch 1 1: Status switch 2	DI.NU 

### Bit-0 to Bit-2 of Manual Preset Output Number (MP.B0 to MP.B2)

The manual preset output number can be switched using contact input. There are two methods to specify a manual preset output number.

- Status switch 1 (Operation by keystroke or via communication is enabled depending on the conditions.)

Manual preset output number	Contact status		
	MP.B2	MP.B1	MP.B0
1	OFF	OFF	ON
2	OFF	ON	OFF
3	OFF	ON	ON
4	ON	OFF	OFF
5	ON	OFF	ON

\*1: "1" when the contact input is turned on and "0" when turned off.

\*2: Manual preset output number can be switched by keystroke via communication when all contact inputs of MP.B0 to MP.B2 are turned off.

\*3: Manual preset output number cannot be switched by keystroke or via communication when any contact input of MP.B0 to MP.B2 is turned on.

\*4: The contact input is turned off when the bit of manual preset output number is not assigned to the contact input.

- Status Switch 2 (Operation by keystroke or via communication is disabled.)


Manual preset output number	Contact status		
	MP.B2	MP.B1	MP.B0
1	OFF	OFF	OFF
2	OFF	OFF	ON
3	OFF	ON	OFF
4	OFF	ON	ON
5	ON	OFF	OFF

\*1: "1" when contact input is turned on and "0" when turned off.

\*2: The contact input is turned off when the bit of manual preset output number is not assigned to the contact input.

In Cascade control, the manual preset output number selection is only for Loop 2.

#### Setting Details

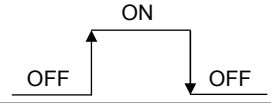
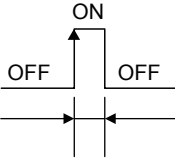
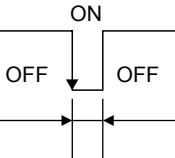
Parameter symbol	Name	Display level	Setting range	Menu symbol
MP.BC	Bit changing method of manual preset output number	PRO	0: Status switch 1 1: Status switch 2	DI.NU 

Note1: In Cascade control, the LP2 lamp is lit while the Loop-2 parameter is displayed.



## 12.1 Setting Contact Input Function

### Contact Action

Type	Operation	Description
Status		Receiving a contact input signal changes the status to the specified operation, and a release changes the status back to the original action.
Rising edge	<p>Rising edge</p>  <p>Detection time: Control period + 50 ms</p>	<p>Receiving an OFF-to-ON contact input signal changes the status to the specified operation. The minimum detection time is the control period + 50 ms.</p> <p>Pulse width is 50 ms or more.</p>
Falling edge	<p>Falling edge</p>  <p>Detection time: Control period + 50 ms</p>	<p>Receiving an ON-to-OFF contact input signal changes the status to the specified operation. The minimum detection time is the control period + 50 ms.</p> <p>Pulse width is 50 ms or more.</p>

## Setting Details

Parameter symbol	Name	Display level	Setting range	Menu symbol
<b>PRG</b>	Switch to PROG (Start of program operation)	STD	See the following section, "UP55A DI and Setpoint".	DI.SL <b>Set</b>
<b>RST</b>	Switch to RESET (Stop of program operation)	STD		
<b>LOC</b>	Switch to LOCAL(LSP) (Start of local-mode operation)	STD		
<b>REM</b>	Switch to REMOTE	STD		
<b>P/R</b>	PROG/RESET Switch	STD		
<b>P/H</b>	PROG/HOLD Switch	STD		
<b>P/L</b>	PROG/LOCAL(LSP) Switch	STD		
<b>HOLD</b>	Switch to HOLD (Start of hold-mode operation)	STD		
<b>ADV</b>	Advance of segment	STD		
<b>WAIT</b>	Wait ON/OFF switch	STD		
<b>S.HLD</b>	Switch to HOLD for synchronized program operation	PRO		
<b>A/M</b>	AUTO/MAN switch	STD		
<b>L/C</b>	LOCAL(LSP)/CAS switch	STD		
<b>AT</b>	Auto-tuning START/STOP switch	STD		
<b>TRK</b>	Output tracking switch	PRO		
<b>SW</b>	PV switch	PRO		
<b>LAT</b>	Latch release	STD		
<b>LCD</b>	LCD backlight ON/OFF switch	STD		
<b>PVRW</b>	PV red/white switch	STD		
<b>MG1</b>	Message display interruption 1	PRO		
<b>MG2</b>	Message display interruption 2	PRO		
<b>MG3</b>	Message display interruption 3	PRO		
<b>MG4</b>	Message display interruption 4	PRO		
<b>PT.B0</b>	Bit-0 of program pattern number	EASY		DI.NU <b>Set</b>
<b>PT.B1</b>	Bit-1 of program pattern number	EASY		
<b>PT.B2</b>	Bit-2 of program pattern number	EASY		
<b>PT.B3</b>	Bit-3 of program pattern number	EASY		
<b>PT.B4</b>	Bit-4 of program pattern number	EASY		
<b>PT.B5</b>	Bit-5 of program pattern number	EASY		
<b>PN.B0</b>	Bit-0 of PID number	STD		
<b>PN.B1</b>	Bit-1 of PID number	STD		
<b>PN.B2</b>	Bit-2 of PID number	STD		
<b>PN.B3</b>	Bit-3 of PID number	STD		
<b>MP.B0</b>	Bit-0 of manual preset output number	STD		
<b>MP.B1</b>	Bit-1 of manual preset output number	STD		
<b>MP.B2</b>	Bit-2 of manual preset output number	STD		

## 12.1 Setting Contact Input Function

### UP55A (Standard model) DI and Setpoint (I relay number)

DI equipped as standard

DI symbol	Setpoint
DI1	5025
DI2	5026
DI3	5027

Additional DI

DI symbol	Setpoint	DI symbol	Setpoint	DI symbol	Setpoint
DI11	5041	–	–	DI41	5089
DI12	5042	–	–	DI42	5090
DI13	5043	–	–	DI43	5091
DI14	5044	–	–	DI44	5092
DI15	5045	–	–	DI45	5093
DI16	5046	DI26	5062	DI46	5094

### UP55A (Detailed model) DI and Setpoint (I relay number)

DI equipped as standard

DI symbol	Setpoint
DI1	5025
DI2	5026
DI3	5027

Additional DI

Optional suffix code /X1		Optional suffix code /X2		Optional suffix code /X3		Optional suffix code /X4	
DI symbol	Setpoint	DI symbol	Setpoint	DI symbol	Setpoint	DI symbol	Setpoint
DI11	5041	DI21	5057	DI31	5073	DI41	5089
DI12	5042	DI22	5058	DI32	5074	DI42	5090
DI13	5043	DI23	5059	DI33	5075	DI43	5091
DI14	5044	DI24	5060	DI34	5076	DI44	5092
DI15	5045	DI25	5061	DI35	5077	DI45	5093

Additional DI

Optional suffix code /R1		Optional suffix code /A2		Optional suffix code /A4 or /AC4	
DI symbol	Setpoint	DI symbol	Setpoint	DI symbol	Setpoint
DI16	5046	DI26	5062	DI46	5094

## 12.1.2 Changing Contact Type of Contact Input

### Description

The contact type can set the action direction of contact input assigned to the function.

### Setting Details

#### Contact Input Equipped as Standard

Parameter symbol	Name	Display level	Setting range	Menu symbol
<b>DI1.D</b>	DI1 contact type	PRO	0: The assigned function is enabled when the contact input is closed. 1: The assigned function is enabled when the contact input is opened.	DI.D <b>Set</b>
<b>DI2.D</b>	DI2 contact type	PRO		
<b>DI3.D</b>	DI3 contact type	PRO		

Note1: Nothing is displayed on Group display when each parameter is displayed.

#### Additional Contact Input

Parameter symbol	Name	Display level	Setting range	Menu symbol
<b>DI1.D</b>	DIn1 contact type	PRO	0: The assigned function is enabled when the contact input is closed. 1: The assigned function is enabled when the contact input is opened.	DI.D <b>Set</b>
<b>DI2.D</b>	DIn2 contact type	PRO		
<b>DI3.D</b>	DIn3 contact type	PRO		
<b>DI4.D</b>	DIn4 contact type	PRO		
<b>DI5.D</b>	DIn5 contact type	PRO		
<b>DI6.D</b>	DIn6 contact type	PRO		RSP, AIN2, or AIN4 <b>Set</b>

Note1: When each parameter is displayed, the terminal area (E1 to E4) is displayed on Group display according to the suffix code and optional suffix code. "n" denotes the position of the terminal area. (n = 1 to 4)

## 12.2 Setting Contact Output Function

### 12.2.1 Setting Function of Contact Output

#### Description

The contact output function works by setting a status such as an alarm to the contact output.

This explanation assumes that the contact type is energized. (The contact is turned on when an event occurs.)

#### Setting Details

##### Contact Output Equipped as Standard

Parameter symbol	Name	Display level	Setting range	Menu symbol
<b>AL1.S</b>	AL1 function selection	STD	See the following section.	ALM <b>Set</b>
<b>AL2.S</b>	AL2 function selection	STD		
<b>AL3.S</b>	AL3 function selection	STD		

Note1: Nothing is displayed on Group display when each parameter is displayed.

##### Additional Contact Output

Parameter symbol	Name	Display level	Setting range	Menu symbol
<b>DO1.S</b>	DOn1 function selection	STD	See the following section.	DO <b>Set</b>
<b>DO2.S</b>	DOn2 function selection	STD		
<b>DO3.S</b>	DOn3 function selection	STD		
<b>DO4.S</b>	DOn4 function selection	STD		
<b>DO5.S</b>	DOn5 function selection	STD		

Note1: When each parameter is displayed, the terminal area (E1 to E4) is displayed on Group display according to the suffix code and optional suffix code. "n" denotes the position of the terminal area. (n = 1 to 4)

##### Contact Output for Control

Parameter symbol	Name	Display level	Setting range	Menu symbol
<b>OR.S</b>	OUT relay function selection	STD	See the following section.	ALM <b>Set</b>
<b>OR2.S</b>	OUT2 relay function selection	STD		

Note1: Nothing is displayed on Group display when each parameter is displayed.

Note2: OR.S and OR2.S can be used as status output when they are not used as control output.  
OR2.S can be used for Heating/cooling type.

**PV Event Status**

PV event status can be output to the contact output. (The setpoints below are I relay numbers.)

▶ [I relay: UTAdvanced Series Communication Interface \(RS-485, Ethernet\) User's Manual](#)

Setpoint		Function
PV event status	PV event output status	
4785	4801	PV event 1
4786	4802	PV event 2
4787	4803	PV event 3
4789	4805	PV event 4
4790	4806	PV event 5
4791	4807	PV event 6
4793	4809	PV event 7
4794	4810	PV event 8

- PV event status: The internal alarm status is turned on when an alarm occurs and turned off in normal condition
- PV event output status: Contact output status when an alarm occurs (ON in alarm condition and OFF in normal condition)

**Time Event Status**

Time event status can be output to the contact output. (The setpoints below are I relay numbers.)

▶ [I relay: UTAdvanced Series Communication Interface \(RS-485, Ethernet\) User's Manual](#)

PV event status	Function
4817	Time event 1
4818	Time event 2
4819	Time event 3
4821	Time event 4
4822	Time event 5
4823	Time event 6
4825	Time event 7
4826	Time event 8
4833	Time event 9
4834	Time event 10
4835	Time event 11
4837	Time event 12
4838	Time event 13
4839	Time event 14
4841	Time event 15
4842	Time event 16

## 12.2 Setting Contact Output Function

### Alarm Status

The alarm status can be output to the contact output. (The setpoints below are I relay numbers.)

▶ [I relay: UTAdvanced Series Communication Interface \(RS-485, Ethernet\) User's Manual](#)

Setpoint		Function
Alarm status	Alarm output status	
4321	4353	Alarm 1
4322	4354	Alarm 2
4323	4355	Alarm 3
4325	4357	Alarm 4
4326	4358	Alarm 5
4327	4359	Alarm 6
4329	4361	Alarm 7
4330	4362	Alarm 8
4337	4369	Loop-2 alarm 1 (in Cascade control)
4338	4370	Loop-2 alarm 2 (in Cascade control)
4339	4371	Loop-2 alarm 3 (in Cascade control)
4341	4373	Loop-2 alarm 4 (in Cascade control)
4342	4374	Loop-2 alarm 5 (in Cascade control)
4343	4375	Loop-2 alarm 6 (in Cascade control)
4345	4377	Loop-2 alarm 7 (in Cascade control)
4346	4378	Loop-2 alarm 8 (in Cascade control)

- Alarm status: The internal alarm status is turned on when an alarm occurs and turned off in normal condition
- Alarm output status: Contact output status when an alarm occurs (ON in alarm condition and OFF in normal condition)

However, the output status depends on the settings of energized/de-energized of alarm, latch action, and contact type.

The above assumes that the contact type is energized. (Then contact is turned on when an event occurs.)

To output the normal alarm to the contact output, assign the alarm output status.

▶ [Alarm action: 11.1 Setting Alarm Type](#)

**Alarm Latch Status**

The alarm latch status can be output to another contact output irrespective of the setting of alarm-1 to -8 type (AL1 to AL8). (The setpoints below are I relay numbers.)

► [I relay: UTAdvanced Series Communication Interface \(RS-485, Ethernet\) User's Manual](#)

Setpoint				Function
Alarm output latch 1 status	Alarm output latch 2 status	Alarm output latch 3 status	Alarm output latch 4 status	
4385	4417	4449	4481	Alarm 1
4386	4418	4450	4482	Alarm 2
4387	4419	4451	4483	Alarm 3
4389	4421	4453	4485	Alarm 4
4390	4422	4454	4486	Alarm 5
4391	4423	4455	4487	Alarm 6
4393	4425	4457	4489	Alarm 7
4394	4426	4458	4490	Alarm 8
4401	4433	4465	4497	Loop-2 alarm 1 (in Cascade control)
4402	4434	4466	4498	Loop-2 alarm 2 (in Cascade control)
4403	4435	4467	4499	Loop-2 alarm 3 (in Cascade control)
4405	4437	4469	4501	Loop-2 alarm 4 (in Cascade control)
4406	4438	4470	4502	Loop-2 alarm 5 (in Cascade control)
4407	4439	4471	4503	Loop-2 alarm 6 (in Cascade control)
4409	4441	4473	4505	Loop-2 alarm 7 (in Cascade control)
4410	4442	4474	4506	Loop-2 alarm 8 (in Cascade control)

- Alarm output latch 1, 2, 3, and 4 status: ON in the latch status of the contact output when an alarm occurs and OFF in the latch release status of the contact output in normal condition

However, the output status depends on the settings of contact type.

► [Alarm latch action: 11.1 Setting Alarm Type](#)



## 12.2 Setting Contact Output Function

### Key and Display Status

The key and display status can be output to the contact output. (The setpoints below are I relay numbers.)

Setpoint	Function	Contact status	
		ON	OFF
4705	PARAMETER key	Key is pressed	Key is not pressed
4706	DISPLAY key		
4707	Right arrow key		
4708	Down arrow key		
4709	SET/ENTER key		
4710	Up arrow key		
4711	Left key		
4716	PTN key		
4717	RST key		
4718	MODE key		
4719	RUN key		

### Operation Mode and Status

Setpoint	Function	Contact status	
		ON	OFF
4177	AUTO/MAN (Loop 1)	MAN	AUTO
4225	AUTO/MAN (Loop 2)	MAN	AUTO
4233	LOCAL(LSP)/CASCADE	LOCAL	CASCADE
4181	Stop of program operation	RESET (OFF→ON)	–
4182	Start of program operation	PROG (OFF→ON)	–
4183	Start of local operation	LOCAL (OFF→ON)	–
4185	Start of remote operation	REMOTE (OFF→ON)	–
4189	Start of hold operation	HOLD (OFF→ON)	–
4186	Output tracking status	Tracking ON	Tracking OFF
4190	Wait flag	Wait command (ON)	Wait release command (OFF)
4191	During auto-tuning	During AT	–
4239	During auto-tuning (Loop 2)	During AT	–
4265	Pattern end signal (1 s.)	Pattern end	–
4266	Pattern end signal (3 s.)	Pattern end	–
4267	Pattern end signal (5 s.)	Pattern end	–
4257	Wait end signal (1 s.)	Wait end	–
4258	Wait end signal (3 s.)	Wait end	–
4259	Wait end signal (5 s.)	Wait end	–
4261	Control flag for segment transition	Wait command (ON)	Wait release command (OFF)
4209	During automatic valve adjustment	During adjustment	–
4210	During operation by the valve position estimating type	During operation by estimating type	During operation by feedback input
4213	Valve is open	Open	–
4214	Valve is closed	Closed	–
4256	FAIL output	Normal status	FAIL status

## System Error Status

Setpoint	Function	Contact status	
		ON	OFF
4529	Heater break alarm 1 status	Alarm occurs	Normal
4530	Heater break alarm 2 status	Alarm occurs	Normal
4769	Message display interruption 1 status	With interruption	Without interruption
4770	Message display interruption 2 status	With interruption	Without interruption
4771	Message display interruption 3 status	With interruption	Without interruption
4773	Message display interruption 4 status	With interruption	Without interruption

## Error Status

Setpoint	Function	Contact status	
		ON	OFF
4065	PV input ADC error	Error occurs	Normal
4066	RSP input (E1-terminal area) ADC error		
4067	AIN2 input (E2-terminal area) ADC error		
4069	AIN4 input (E4-terminal area) ADC error		
4073	PV input burnout error		
4074	RSP input (E1-terminal area) burnout error		
4075	AIN2 input (E2-terminal area) burnout error		
4077	AIN4 input (E4-terminal area) burnout error		
4070	PV input RJC error		
4071	RSP input RJC error		
4081	Feedback resistance/current burnout		
4082	Automatic valve position adjustment error		
4097	PV input burnout error (Loop 1)		
4098	RSP input burnout error (Loop 1)		
4101	PV input over-scale (Loop 1)		
4102	PV input under-scale (Loop 1)		
4111	Auto-tuning time out (Loop 1)		
4113	PV input burnout (Loop 2)		
4117	PV input over-scale (Loop 2)		
4118	PV input under-scale (Loop 2)		
4127	Auto-tuning time out (Loop 2)		

## 12.2 Setting Contact Output Function

---

### System Error Status

Setpoint	Function	Contact status	
		ON	OFF
4001	System data error	Error occurs	Normal
4002	Calibration value error		
4003	User (parameter) default value error		
4005	Setup parameter error		
4006	Operation parameter error		
4017	Corrupted ladder program		
4018	Ladder calculation overflow		
4019	Ladder program error		
4021	Load factor over 100%		
4022	Load factor over 200%		
4009	Faulty FRAM		


## 12.2.2 Changing Contact Type of Contact Output

### Description

The contact type can set the action direction of contact output assigned to the function.


### Setting Details

#### Contact Output Equipped as Standard

Parameter symbol	Name	Display level	Setting range	Menu symbol
AL1.D	AL1 contact type	PRO	0: When the event of assigned function occurs, the contact output is closed. 1: When the event of assigned function occurs, the contact output is opened.	ALM 
AL2.D	AL2 contact type	PRO		
AL3.D	AL3 contact type	PRO		


Note1: Nothing is displayed on Group display when each parameter is displayed.

#### Additional Contact Output

Parameter symbol	Name	Display level	Setting range	Menu symbol
DO1.D	DOn1 contact type	PRO	0: When the event of assigned function occurs, the contact output is closed. 1: When the event of assigned function occurs, the contact output is opened.	DO 
DO2.D	DOn2 contact type	PRO		
DO3.D	DOn3 contact type	PRO		
DO4.D	DOn4 contact type	PRO		
DO5.D	DOn5 contact type	PRO		

Note1: When each parameter is displayed, the terminal area (E1 to E4) is displayed on Group display according to the suffix code and optional suffix code. "n" denotes the position of the terminal area. (n = 1 to 4)

#### Contact Output for Control

Parameter symbol	Name	Display level	Setting range	Menu symbol
OR.D	OUT relay contact type	PRO	0: When the event of assigned function occurs, the contact output is closed. 1: When the event of assigned function occurs, the contact output is opened.	ALM 
OR2.D	OUT2 relay contact type	PRO		

Note1: Nothing is displayed on Group display when each parameter is displayed.

Note2: OR.D and OR2.D can be used as status output when they are not used as control output.  
OR2.D can be used for Heating/cooling type.

- ▶ Terminal arrangement: 17.4 Wiring
- ▶ Contact type of Heater break alarm output: 11.7 Setting Heater Break Alarm



# 13.1 Setting Display Functions

## 13.1.1 Setting Active Color PV Display Function

The active color PV display function changes the PV display color when an event occurs.

**Description**

**Link to Alarm**

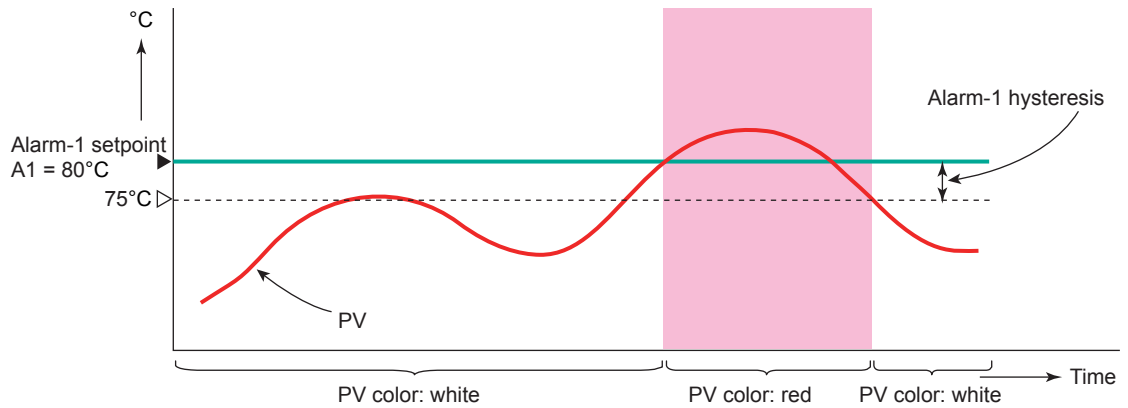
The PV display color changes by linking to the alarm 1 or alarm 2.

The following is an example of operation linking to alarm 1.

Set the alarm-1 type to "PV high limit alarm" and alarm-1 setpoint to "80°C."

When the active color PV display switch is set to "2," PV display color changes from white to red if PV exceeds the alarm-1 setpoint.

The red-to-white switching action can be set.

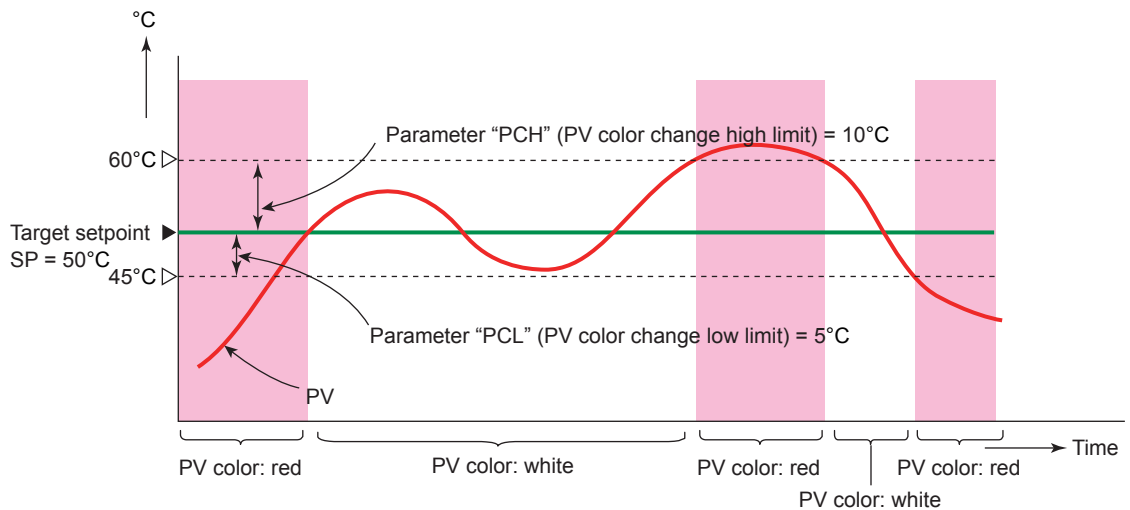


**Change by Deviation**

The PV display color changes by deviation (PV – SP).

Set the PV color change high limit to "10°C" and the PV color change low limit to "5°C" as deviation band for the current target setpoint "50°C." PV display color changes from white to red if PV is out of the deviation.

The red-to-white switching action can be set. There is no hysteresis.

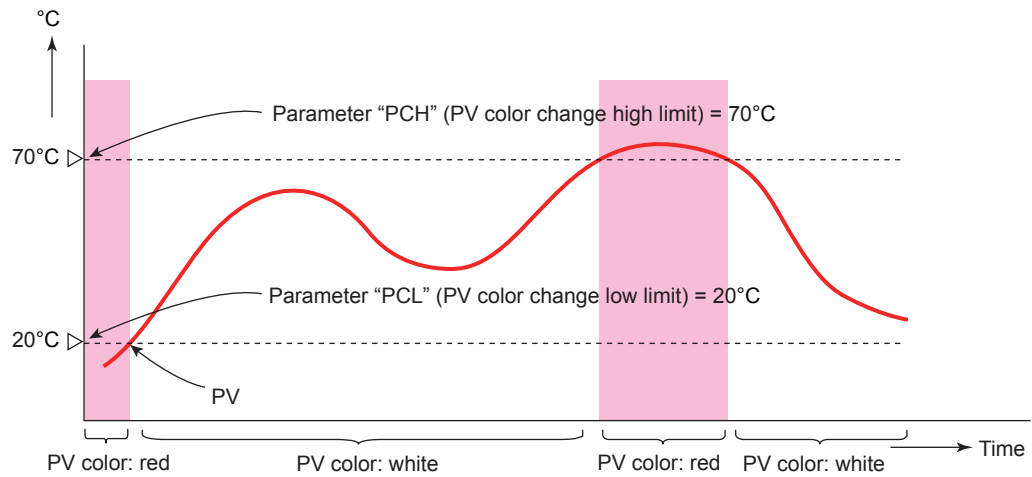


## 13.1 Setting Display Functions

### Link to PV

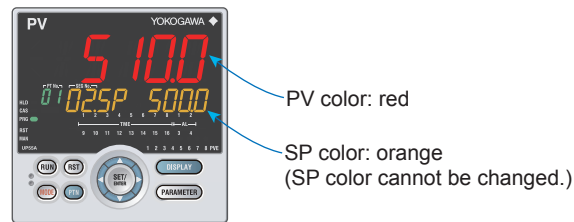
The PV display color changes by linking to PV.

Set the PV color change high limit to "70°C" and the PV color change low limit to "20°C."  
PV display color changes from white to red if PV is out of the range.  
The red-to-white switching action can be set. There is no hysteresis.



### Use in Fixed Color

PV display color can be fixed in red. It can also be fixed in white.



### Link to DI

The PV display color changes by linking to DI (ON/OFF).

The following is an example for changing the display color by a state of DI1.  
Set the parameter PCMD=10, and PVRW=5025.  
PV display color is red when DI1=ON, and is white when DI1=OFF.

PVRW: PV red/white switch (Menu: DI.SL)

## Setting Details

Parameter symbol	Name	Display level	Setting range	Menu symbol
<b>PCMD</b>	Active color PV display switch	EASY	0: Fixed in white 1: Fixed in red 2: Link to alarm 1 (Alarm OFF: white, Alarm ON: red) 3: Link to alarm 1 (Alarm OFF: red, Alarm ON: white) 4: Link to alarm 1 or 2 (Alarm OFF: white, Alarm ON: red) 5: Link to alarm 1 or 2 (Alarm OFF: red, Alarm ON: white) 6: PV limit (Within range: white, Out of range: red) 7: PV limit (Within range: red, Out of range: white) 8: SP deviation (Within deviation: white, Out of deviation: red) 9: SP deviation (Within deviation: red, Out of deviation: white) 10: Link to DI (ON: red, OFF: white)	DISP <b>Set</b>
<b>PCH</b>	PV color change high limit	EASY	Set a display value when in PV limit or SP deviation.	
<b>PCL</b>	PV color change low limit	EASY	-19999 to 30000 (Set a value within the input range.) Decimal point position depends on the input type.	

Note1: In Cascade control, the LP2 lamp is lit while the Loop-2 parameter is displayed.



## 13.1 Setting Display Functions

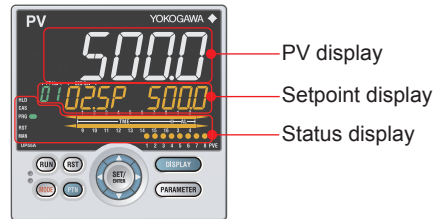
### 13.1.2 Masking Arbitrary Display Value in Operation Display

#### Description

Display/non-display of the PV display, Setpoint display, and Status display in the Operation Display can be set.

Items that you do not want to display can be set to non-display. For example, when the Setpoint display is set to non-display, SP of the SP Display and OUT of the OUT Display are not displayed.

When an error at power-on or hardware malfunction error occurs, Operation display cannot be set to non-display.



#### Setting Details

Parameter symbol	Name	Display level	Setting range	Menu symbol
PV.D	PV display area ON/OFF	PRO	OFF: Nondisplay ON: Display	DISP <b>Set</b>
SP.D	Setpoint display area ON/OFF	PRO		
STS.D	Status display area ON/OFF	PRO		

### 13.1.3 Registering SELECT Display (Up to 5 Displays)

#### Description

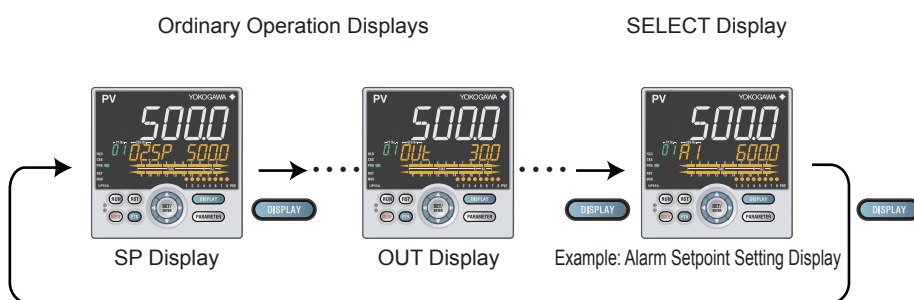
Registering frequently changed-operation parameters in the SELECT Display of the Operation Displays will allow you to change parameter settings easily. A maximum of five Displays can be registered.

Set the D register number of the parameter you wish to register for the registration to the SELECT Display.

However, the parameters in the following menu cannot be set:

CTL, PV, RSP, AIN2, AIN4, MPV, OUT, HBA, R485, ETHR, PROF, DNET, CC-L, KEY, DISP, CSEL, KLOC, MLOC, DI.SL, DI.NU, DI.D, ALM, DO, I/O, SYS, INIT, VER, and LVL.

When each parameter is displayed, the terminal area (E1 to E4) is displayed on Group display according to the suffix code and optional suffix code.



#### Setting Details

Parameter symbol	Name	Display level	Setting range	Menu symbol
CS1 to CS5	SELECT Display-1 to -5 registration	STD	OFF: No registration D register number (2201 to 5000)	CSEL <b>Set</b>

For D register numbers, see the UTAdvanced Series Communication Interface User's Manual.

## 13.1 Setting Display Functions

### 13.1.4 Changing Event Display

#### Description

The UP55A has eight event (EV) lamps.  
 PV events are assigned to EV1 to EV8 lamps on the front of the controller.

#### Setting Details

Parameter symbol	Name	Display level	Setting range	Menu symbol
<b>EV1 to EV8</b>	EV1 to EV8 display condition registration	PRO	Setting range: 4001 to 6304 OFF: Disable 4785: Link to PV event 1 (Lit when the PV event-1 occurs) 4786: Link to PV event 2 (Lit when the PV event-2 occurs) 4787: Link to PV event 3 (Lit when the PV event-3 occurs) 4789: Link to PV event 4 (Lit when the PV event-4 occurs) 4790: Link to PV event 5 (Lit when the PV event-5 occurs) 4791: Link to PV event 6 (Lit when the PV event-6 occurs) 4793: Link to PV event 7 (Lit when the PV event-7 occurs) 4794: Link to PV event 8 (Lit when the PV event-8 occurs)  4529: Heater break alarm 1 (Lit when the alarm occurs) 4530: Heater break alarm 2 (Lit when the alarm occurs)  5025 to 5027: Link to DI1-DI3 (Lit when the contact is closed) 5041 to 5046: Link to DI11-DI16 (E1-terminal area) (Lit when the contact is closed) 5057 to 5062: Link to DI21-DI26 (E2-terminal area) (Lit when the contact is closed) 5073 to 5077: Link to DI31-DI35 (E3-terminal area) (Lit when the contact is closed) 5089 to 5094: Link to DI41-DI46 (E4-terminal area) (Lit when the contact is closed)  5153 to 5155: Link to AL1-AL3 (Lit when the contact is closed) 5169 to 5173: Link to DO11-DO15 (E1-terminal area) (Lit when the contact is closed) 5185 to 5189: Link to DO21-DO25 (E2-terminal area) (Lit when the contact is closed) 5201 to 5205: Link to DO31-DO35 (E3-terminal area) (Lit when the contact is closed) 5217 to 5221: Link to DO41-DO45 (E4-terminal area) (Lit when the contact is closed)  For other functions, see the UTAdvanced Series Communication Interface User's Manual.	<b>DISP Set</b>

Note1: In Cascade control, the LP2 lamp is lit while the Loop-2 parameter is displayed.

### 13.1.5 Registering SELECT Parameter Display (Up to 10 Displays)

#### Description

Registering frequently changed operation parameters (change frequency is lower than SELECT Display) in the SELECT Parameter Display will allow you to change parameter settings easily. A maximum of ten Displays can be registered.

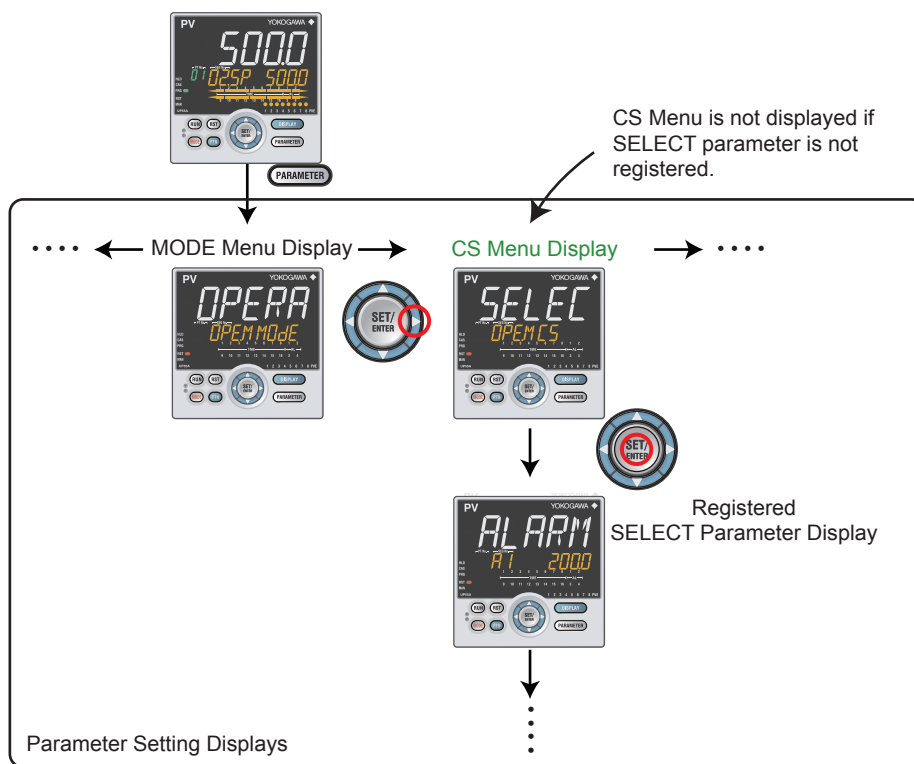
Set the D register number of the parameter you wish to register for the registration to the SELECT Parameter Display.

However, the parameters in the following menus cannot be set:

CTL, PV, RSP, AIN2, AIN4, MPV, OUT, HBA, R485, ETHR, PROF, DNET, CC-L, KEY, DISP, CSEL, KLOC, MLOC, DI.SL, DI.NU, DI.D, ALM, DO, I/O, SYS, INIT, VER, and LVL.

When each parameter is displayed, the terminal area (E1 to E4) is displayed on Group display according to the suffix code and optional suffix code.

Ordinary Operation Display



#### Setting Details

Parameter symbol	Name	Display level	Setting range	Menu symbol
CS10 to CS19	SELECT parameter-10 to -19 registration	PRO	OFF: No registration D register number (2201 to 5000)	CSEL <b>Set</b>

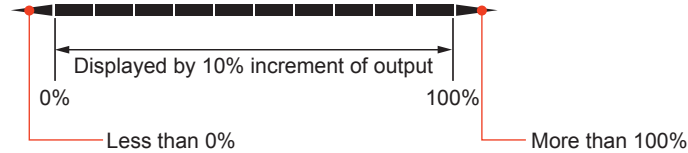
For D register numbers, see the UTAdvanced Series Communication Interface User's Manual.

### 13.1.6 Setting Bar-graph Display Function

**Description**

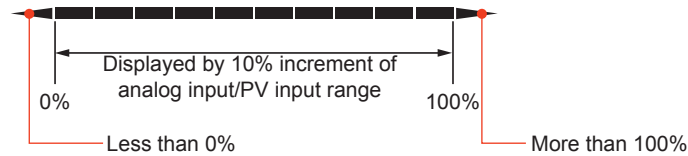
The upper and lower bar-graph displays are provided on the front of the controller. PV or OUT can be displayed. Data which can be displayed on Bar-graph display are as follows.

**OUT, Output**



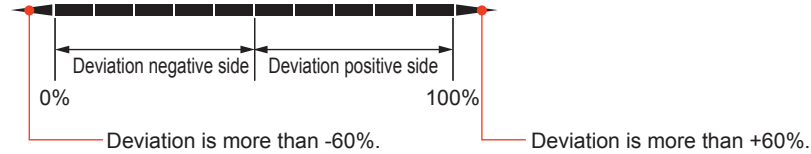
For relay, OFF is equivalent to 0% and ON is equivalent to 100%.

**PV, SP, and Analog Input**



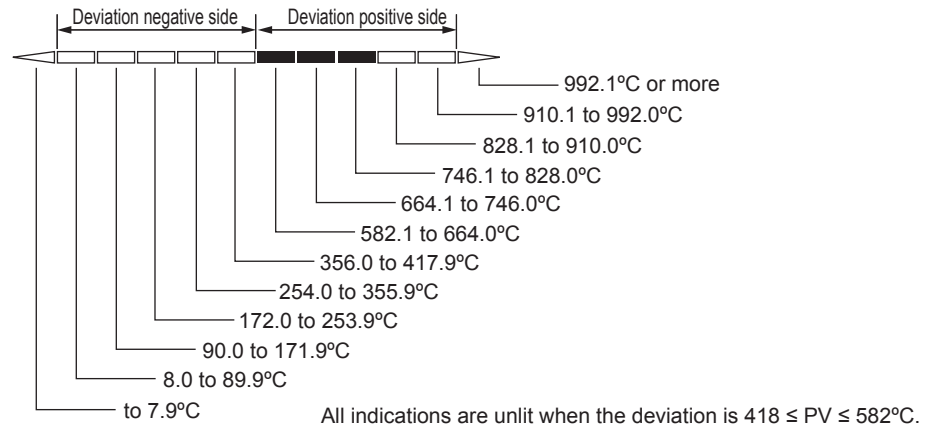
**Deviation**

When the deviation display band (BDV) is 10%:

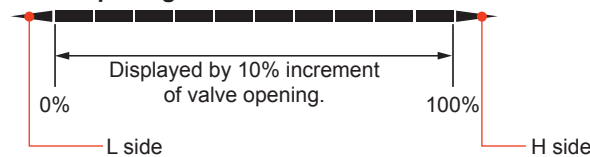


Deviation negative side and deviation positive side are displayed by 10% increment of deviation. Indication is unlit when  $SP - (\text{deviation display band (BDV)}) \leq PV \leq SP + (\text{deviation display band (BDV)})$ .

IN = TC Type K -270.0 to 1370.0°C  
 BDV = 82°C (5%), SP = 500.0°C, PV = 800.0°C

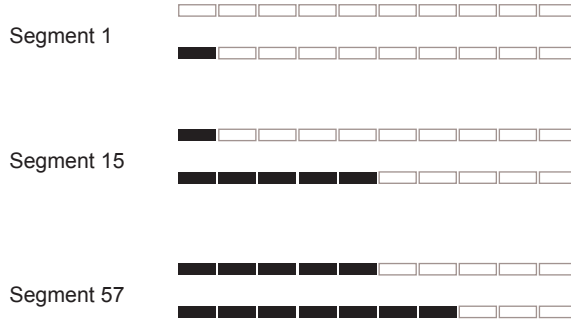


**Valve Opening**

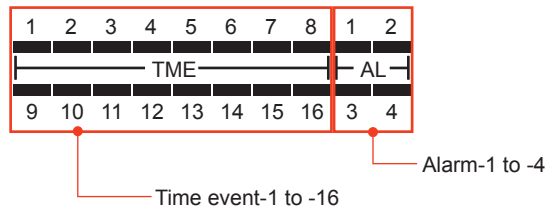


**Degree of Segment**

Upper bargraph: tenths place digit, lower bargraph: ones place digit



**Time Event and Alarm Status**



**Setting Details**

Parameter symbol	Name	Display level	Setting range	Menu symbol
<b>BAR1</b>	Upper bar-graph display registration	STD	0: Disable 1:OUT, Heating-side OUT, Internal value in Position proportional control 2: Cooling-side OUT 3: PV 4: SP 5: Deviation 6: Loop-2 OUT, Loop-2 heating-side OUT 7: Loop-2 cooling-side OUT 8: Loop-2 PV 9: Loop-2 SP 10: Loop-2 deviation 11 to 16: Disable 17: Feedback input (valve opening) 18: PV terminals analog input 19: RSP terminals analog input 20: AIN2 terminals analog input 21: AIN4 terminals analog input 22: Degree of segment 23: Time event and alarm status	DISP <b>Set</b>
<b>BAR2</b>	Lower bar-graph display registration	STD		
<b>BDV</b>	Bar-graph deviation display band	STD	0.0 to 100.0% of PV input range span (EUS)	

Note 1: The bar-graph deviation display band (BDV) is enabled when the deviation is set to the BAR1 or BAR2.

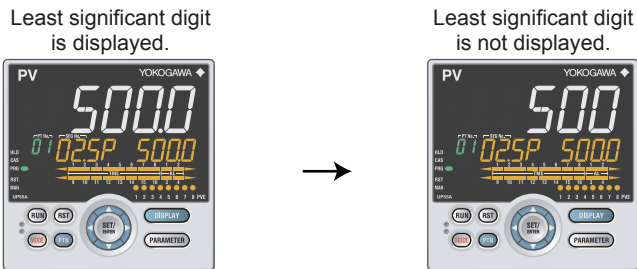
Note 2: In Cascade control, the LP2 lamp is lit while the Loop-2 parameter is displayed.

Note 3: Setting values "22" and "23" can be set to the parameter BAR1 only. If the value of "22" or "23" is set to the parameter BAR1, the setting of BAR2 is disabled. The display of parameter BAR2 depends on the setting value of BAR1.

### 13.1.7 Masking Least Significant Digit of PV Display

**Description**

With and without least significant digit of the PV in the Operation Display can be set. When without least significant digit is set, the value of the least significant digit is truncated and not displayed. The internal value is not changed depending on whether with or without least significant digit (the value is for display only). This parameter does not function for the PV without decimal point.



The following shows the example of with and without least significant digit

PV display	
With least significant digit	Without least significant digit
1.4999	1.499
1.5000	1.500
1.9999	1.999
2.0000	2.000
3000.0	3000
3000.9	3000
3001.0	3001

**Setting Details**

Parameter symbol	Name	Display level	Setting range	Menu symbol
<b>MLSD</b>	Least significant digital mask of PV display	STD	OFF: With least significant digit ON: Without least significant digit	DISP <b>Set</b>

### 13.1.8 Setting Economy Mode

#### Description

The LCD backlight ON/OFF can be set in the following methods.  
Setting the LCD backlight to OFF saves energy.

#### User Function Keys

The LCD backlight ON/OFF switch can be assigned to the user function key.

▶ [User function key: 13.2 Assigning Function to User Function Key](#)

#### Backlight OFF timer

The backlight OFF timer sets the economy mode parameter to ON.

If no keys are pressed for 30 minutes, the LCD backlight goes off automatically.

The backlight OFF can be set to turn off the backlight for the whole display or a display other than the PV display.

To turn on the LCD backlight, press any key.

#### Contact Input


The LCD backlight ON/OFF switch can be assigned to the contact input

▶ [Contact input: 12.1 Setting Contact Input Function](#)

In the following cases, the LCD backlight does not go off.

- when an alarm occurs
- When an error at power-on or a hardware malfunction error occurs

#### Setting Details

Parameter symbol	Name	Display level	Setting range	Menu symbol
ECO	Economy mode	STD	OFF: Disable 1: Economy mode ON (All indications except PV display OFF) 2: Economy mode ON (All indications OFF) 3: Brightness 10 % (all indications)	DISP 




## 13.1 Setting Display Functions

### 13.1.9 Selecting the Initial Operation Display that Appears at Power ON

#### Description

The initial Operation Display that appears when the power is turned on can be set.

#### Setting Details

Parameter symbol	Name	Display level	Setting range	Menu symbol
HOME	Home Operation Display setting	PRO	SP1: SP Display SP2: Loop-2 SP Display OUT1: OUT Display OUT2: Loop-2 OUT Display HCO: Heating/cooling OUT Display VP: Valve Position Display MV: Position Proportional Computation Output Display PID1: PID Number Display PID2: Loop-2 PID Number Display HC1: Heater Break Alarm-1 Current Display HC2: Heater Break Alarm-2 Current Display PV1: PV2/PV1 Display PV2: PV1/PV2 Display PV: PV Analog Input Display RSP: RSP Analog Input Display AIN2: AIN2 Analog Input Display AIN4: AIN4 Analog Input Display CS1 to CS5: SELECT Display 1 to 5 TSP1: TSP Display TSP2: Loop-2 TSP Display R.TIM: Remaining Segment-tim Display SEG.N: Segment Number Display R.CYC: Remaining Repetition Display PTN: Program Pattern Display AL5.8.1: Alarm-5 to -8 Status Display AL5.8.2: Loop-2 Alarm-5 to -8 Status Display	DISP 

### 13.1.10 Setting Message Function

#### Description

Using the message function and turning the contact input on/off, the message registered beforehand can be displayed on PV display by interrupt.

The message is registered using LL50A Parameter Setting Software.

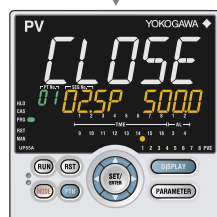
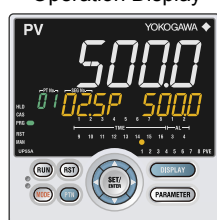
The messages are limited to 20 alphanumeric characters. A maximum of four messages can be registered.

If a number of messages occur simultaneously, the priority is as follows:

(high) MG1>MG2>MG3>MG4 (low)

- ▶ Message registration: [LL50A Parameter Setting Software User's Manual](#)
- ▶ Registration of contact input: [12.1.1 Setting Contact Input Function](#)
- ▶ Registration symbols: [3.3 List of Display Symbols](#)

Operation Display



CLOSE VALVE

When the contact input is turned on, the scrolling message registered beforehand is displayed on PV Display.

### 13.1.11 Switching Guide Display Language

#### Description

The guide display language that appears when the parameter or the menu is displayed can be switched.

#### Setting Details

Parameter symbol	Name	Display level	Setting range	Menu symbol
LANG	Guide display language	EASY	ENG: English FRA: French GER: German SPA: Spanish	SYS <b>Set</b>

## 13.1 Setting Display Functions

### 13.1.12 Changing Guide Scroll Speed

#### Description

The scroll speed can be changed when the guide for the parameter or menu is displayed.

#### Setting Details

Parameter symbol	Name	Display level	Setting range	Menu symbol
SPD	Scroll speed	PRO	(Slow) 1 to 8 (Quick)	DISP <b>Set</b>

### 13.1.13 Turning Guide Display ON/OFF

#### Description

The guide display that appears when the parameter or the menu is displayed can be switched.

The guide display can be turned on and off by the MODE key in the Menu Display and Parameter Setting Display.

#### Setting Details

Parameter symbol	Name	Display level	Setting range	Menu symbol
GUID	Guide display ON/OFF	STD	OFF: Nondisplay ON: Display	DISP <b>Set</b>

### 13.1.14 Setting Automatic Return to Operation Display

#### Description

The Display will automatically revert to the Operation Display if no keys are pressed for 5 minutes in Menu Display or Parameter Setting Display.

#### Setting Details

Parameter symbol	Name	Display level	Setting range	Menu symbol
OP.JP	Automatic return to Operation Display	PRO	ON: Automatically returned to the Operation Display. OFF: Not automatically returned to the Operation Display.	DISP <b>Set</b>

### 13.1.15 Setting Brightness and Contrast Adjustment of LCD and Display Update Cycle

#### Description

The brightness and contrast for PV, Setpoint, Bar-graph, and Status indicator can be adjusted.

Brightness ranges for each display can be set.

The LCD has a characteristic that the display action becomes late at the low temperature.

This can be solved by adjusting the display update cycle (D.CYC).

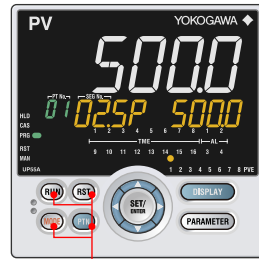
#### Setting Details

Parameter symbol	Name	Display level	Setting range	Menu symbol
<b>BRI</b>	Brightness	EASY	(Dark) 1 to 5 (Bright)	DISP <b>Set</b>
<b>B.PVW</b>	White brightness adjustment of PV display	PRO	Adjusts the white brightness of PV display. (Dark) -4 to 4 (Bright)	
<b>B.PVR</b>	Red brightness adjustment of PV display	PRO	Adjusts the red brightness of PV display. (Dark) -4 to 4 (Bright)	
<b>B.SP</b>	Brightness adjustment of Setpoint display	PRO	Adjusts the brightness of SP display. (Dark) -4 to 4 (Bright)	
<b>B.BAR</b>	Brightness adjustment of Bar-graph display	PRO	Adjusts the brightness of SP display. (Dark) -4 to 4 (Bright)	
<b>B.STS</b>	Brightness adjustment of Status indicator	PRO	Adjusts the brightness of Status indicator. (Dark) -4 to 4 (Bright)	
<b>D.CYC</b>	Display update cycle	PRO	1: 100 ms 2: 200 ms 3: 500 ms 4: 1 s 5: 2 s	

## 13.2 Assigning Function to User Function

### Description

The UP55A has three user function keys on the front panel. Various functions (operation mode switch etc.) can be assigned to the user function key. Press the user function key to perform the assigned function. The User function key is available only on the Operation Display. The assigned function does not work on the Parameter Setting Display. However, the MODE key can be used to turn on/off the guide display.



User function keys

## Setting Details

Parameter symbol	Name	Display level	Setting range	Menu symbol
<b>RUN</b>	RUN key action setting	PRO	See the table below	KEY <b>Set</b>
<b>RST</b>	RST key action setting	PRO		
<b>PTN</b>	PTN key action setting	PRO		
<b>MODE</b>	MODE key action setting	PRO		

Setpoint	Function	Action	Availability			
			RST	RUN	PTN	MODE
OFF	Unassigned	–	√	√	√	√
PROG	Switch to PROG (Start of program operation)	A program pattern starts if the user function key is pressed for one second. If program operation starts in hold-mode, hold-mode operation is disabled.	√	√√	√	√
RESET	Switch to RESET (Stop of program operation)	A program pattern stops if the user function key is pressed for one second.	√√	√	√	√
LOCAL	Switch to LOCAL(LSP) (Start of local-mode operation)	Local-mode operation starts if the user function key is pressed for one second.	√	√	√	√
REM	Switch to REMOTE	Remote-mode operation starts if the user function key is pressed for one second.	√	√	√	√
P/R	PROG/RESET Switch	PROG and RESET switches every time the user function key is pressed for one second.	√	√	√	√
P/H	PROG/HOLD Switch	PROG and HOLD switches every time the user function key is pressed for one second.	√	√	√	√
P/L	PROG/LOCAL(LSP) Switch	PROG and LOCAL switches every time the user function key is pressed for one second.	√	√	√	√
L/C	LOCAL(LSP)/CAS switch	LSP and CASCADE switches every time the user function key is pressed for one second.	√	√	√	√
HLD	Switch to HOLD (Start of hold-mode operation)	Hold-mode operation starts if the user function key is pressed once.	√	√	√	√
ADV	Advance of segment	Program advance if the user function key is pressed for one second.	√	√	√	√
A/M1	AUTO/MAN switch (Loop 1)	AUTO and MAN switches every time the user function key is pressed.	√	√	√	√
A/M2	AUTO/MAN switch (Loop 2)	AUTO and MAN switches every time the user function key is pressed.	√	√	√	√
PRG1	Switch to PROG (Start of program-1 operation)	Starts program pattern-1 if the user function key is pressed for one second.	√	√	√	√
PRG2	Switch to PROG (Start of program-2 operation)	Starts program pattern-2 if the user function key is pressed for one second.	√	√	√	√
AT	Auto-tuning	Pressing the user function key executes auto-tuning	√	√	√	√
LTUP	LCD brightness UP	The current brightness gradually increases every time the function key is pressed.	√	√	√	√
LTDN	LCD brightness DOWN	The current brightness gradually decreases every time the function key is pressed.	√	√	√	√
BRI	Adjust LCD brightness	The current brightness gradually increases every time the function key is pressed. Pressing the function key after reaching the maximum brightness changes to the minimum brightness. Thereafter, minimum brightness→maximum brightness→maximum brightness is repeated.	√	√	√	√
LCD	LCD Backlight ON/OFF switch	The LCD backlight turns on and off every time the user function key is pressed.	√	√	√	√

## 13.2 Assigning Function to User Function Key

(Continued)

Setpoint	Function	Action	Availability			
			RST	RUN	PTN	MODE
LAT	Latch release	Latch 1 to latch 4 are released every time the user function key is pressed.	√	√	√	√
PID	PID Tuning switch	Pressing the function key during operation displays the first parameter (proportional band) of the currently selected PID parameter group and enables the setting to be changed. As with the operation to change the parameter setpoint, the sequence is P→I→D→...→P→.... Pressing the function key again, or pressing the DISPLAY key or DISP key returns to the initial Operation Display. The PARAMETER key or PARA key does not switch to the Menu Display.	√	√	√	√
PTN	Program pattern number selection	Program pattern is selected every time the user function key is pressed.	√	√	√√	√
MODE	Operation mode	The operation mode parameters are displayed every time the user function key is pressed.	√	√	√	√√

Note 1: √ indicates available, – indicates unavailable, and √√ indicates initial value.

▶ [Contact input: 12.1 Setting Contact Input Function](#)

### Status of user function key

The status of the user function key can be identified by communication.

“1” can be read while the user function key is held down, and “0” can be read when the user function key is released. (Initial value: 0)

▶ [Reading via communication: UTAdvanced Series Communication Interface User's Manual](#)

### MODE key operation in the Parameter Setting Display

In the Menu Display and Parameter Setting Display, the guide is displayed on PV display. At this time, use the MODE key to turn on and off the guide display on PV display. A measured input value (PV) is displayed in the ON state.

## 13.3 Setting Security Functions

### 13.3.1 Setting a Password

#### Description

The password function can prevent inadvertent changes to the parameter settings. If a password is set, the checking is required when moving to the Setup Parameter Setting Display. When the password is verified, can be changed to the Setup Parameter Setting Display. The parameters in the following menu can be set only when the password is verified.

CTL, PV, RSP, AIN2, AIN4, MPV, OUT, HBA, R485, ETHR, PROF, DNET, CC-L, KEY, DISP, CSEL, KLOC, MLOC, DI.SL, DI.NU, DI.D, ALM, DO, I/O, SYS, INIT, VER, and LVL.

When each parameter is displayed, the terminal area (E1 to E4) is displayed on Group display according to the suffix code and optional suffix code.

Always remember your password when using the password function.

#### Setting Details

Parameter symbol	Name	Display level	Setting range	Menu symbol
PASS	Password setting	EASY	0 (No password) to 65535	SYS <b>Set</b>

### 13.3.2 Setting Parameter Display Level

#### Description

Parameter display level can be set according to the setting level.

▶ [Parameter display level: Chapter 18 Parameters](#)

#### Setting Details

Parameter symbol	Name	Display level	Setting range	Menu symbol
LEVL	Parameter display level	EASY	EASY: Easy setting mode STD: Standard setting mode PRO: Professional setting mode	LVL <b>Set</b>



### 13.3.3 Locking (Hiding) Parameter Menu Display

**Description**

The parameter menu display lock function hides the following Parameter Menu Displays.

**Setting Details**

Parameter symbol	Name	Display level	Setting range	Menu symbol
<b>CTL</b>	[CTL] menu lock	PRO	OFF: Display ON: Nondisplay	MLOC <b>Set</b>
<b>PV</b>	[PV] menu lock	PRO		
<b>RSP</b>	[RSP] menu lock	PRO		
<b>AIN2</b>	[AIN2] menu lock	PRO		
<b>AIN4</b>	[AIN4] menu lock	PRO		
<b>MPV</b>	[MPV] menu lock	PRO		
<b>OUT</b>	[OUT] menu lock	PRO		
<b>HBA</b>	[HBA] menu lock	PRO		
<b>R485</b>	[R485] menu lock	PRO		
<b>ETHR</b>	[ETHR] menu lock	PRO		
<b>PROF</b>	[PROF] menu lock	PRO		
<b>DNET</b>	[DNET] menu lock	PRO		
<b>CC-L</b>	[CC-L] menu lock	PRO		
<b>KEY</b>	[KEY] menu lock	PRO		
<b>DISP</b>	[DISP] menu lock	PRO		
<b>CSEL</b>	[CSEL] menu lock	PRO		
<b>KLOC</b>	[KLOC] menu lock	PRO		
<b>DI.SL</b>	[DI.SL] menu lock	PRO		
<b>DI.NU</b>	[DI.NU] menu lock	PRO		
<b>DI.D</b>	[DI.D] menu lock	PRO		
<b>ALM</b>	[ALM] menu lock	PRO		
<b>DO</b>	[DO] menu lock	PRO		
<b>I/O</b>	[I/O] menu lock	PRO		
<b>SYS</b>	[SYS] menu lock	PRO		
<b>INIT</b>	[INIT] menu lock	PRO		
<b>VER</b>	[VER] menu lock	PRO		
<b>LVL</b>	[LVL] menu lock	PRO		

Note1: When each parameter is displayed, the terminal area (E1 to E4) is displayed on Group display according to the suffix code and optional suffix code.

(Continued)

Parameter symbol	Name	Display level	Setting range	Menu symbol
<b>MODE</b>	[MODE] menu lock	PRO	OFF: Display ON: Nondisplay	MLOC <b>Set</b>
<b>CS</b>	[CS] menu lock	PRO		
<b>PROG</b>	[PROG] menu lock	PRO		
<b>LOC</b>	[LOC] menu lock	PRO		
<b>EDIT</b>	[EDIT] menu lock	PRO		
<b>AL</b>	[AL] menu lock	PRO		
<b>SPS</b>	[SPS] menu lock	PRO		
<b>ALRM</b>	[ALRM] menu lock	PRO		
<b>PVS</b>	[PVS] menu lock	PRO		
<b>PID</b>	[PID] menu lock	PRO		
<b>TUNE</b>	[TUNE] menu lock	PRO		
<b>ZONE</b>	[ZONE] menu lock	PRO		
<b>PPAR</b>	[PPAR] menu lock	PRO		
<b>PYS1</b>	[PYS1] menu lock	PRO		
<b>PYS2</b>	[PYS2] menu lock	PRO		
<b>PYS3</b>	[PYS3] menu lock	PRO		
<b>PYS4</b>	[PYS4] menu lock	PRO		

Note 1: When each parameter is displayed, the terminal area (E1 to E4) is displayed on Group display according to the suffix code and optional suffix code.

Note 2: In Cascade control, the LP2 lamp is lit while the Loop-2 parameter is displayed.


## 13.3 Setting Security Functions

### 13.3.4 Key Lock

#### Description

The key lock function locks the key on the front panel to prohibit key operation. It can prohibit the operation mode switch or parameter setting change.

#### Setting Details

Parameter symbol	Name	Display level	Setting range	Menu symbol
<b>DATA</b>	Front panel parameter data key lock	STD	OFF: Unlock ON: Lock	KLOCK 
<b>RUN</b>	Front panel RUN key lock	STD		
<b>RST</b>	Front panel RST key lock	STD		
<b>PTN</b>	Front panel PTN key lock	STD		
<b>MODE</b>	Front panel MODE key lock	STD		


### 13.3.5 Setting Display/Non-display of Operation Display

#### Description

Display/non-display of the Operation Display can be set.

► [Operation Display: Chapter 6 Monitoring and Control of Regular Operations](#)

#### Setting Details

Parameter symbol	Name	Display level	Setting range	Menu symbol
<b>U.SP</b>	SP Display lock	PRO	OFF: Display ON: Nondisplay	KLOC 
<b>U.TSP</b>	TSP Display lock	PRO		
<b>U.TM</b>	Remaining Segmen-time Display lock	PRO		
<b>U.OUT</b>	OUT Display lock	PRO		
<b>U.HCO</b>	Heating/cooling OUT Display lock	PRO		
<b>U.VP</b>	Valve Position Display lock	PRO		
<b>U.MV</b>	Position Proportional Computation Output Display lock	PRO		
<b>U.PID</b>	PID Number Display lock	PRO		
<b>U.SEG</b>	Segment Number Display lock	PRO		
<b>U.RCY</b>	Remaining Repetition Display lock	PRO		
<b>U.PTN</b>	Program Pattern Display lock	PRO		
<b>U.AL</b>	Alarm-5 to -8 Status Display lock	PRO		
<b>U.HC</b>	Heater Break Alarm Current Value Display lock	PRO		
<b>U.PV1</b>	PV2/PV1 Display lock	PRO		
<b>U.PV2</b>	PV1/PV2 Display lock	PRO		
<b>U.PV</b>	PV Analog Input Display lock	PRO		
<b>U.RSP</b>	RSP Analog Input Display lock	PRO		
<b>U.AI2</b>	AIN2 Analog Input Display lock	PRO		
<b>U.AI4</b>	AIN4 Analog Input Display lock	PRO		

Note1: In Cascade control or parameter PT2.G=ON, the LP2 lamp is lit while the Loop-2 parameter is displayed.

### 13.3.6 Prohibiting Writing via Communication

#### Description

Writing data to each register via all communication methods can be permitted or prohibited. However, writing data via light-loader (front) or maintenance port (upper) is possible using LL50A Parameter Setting Software.

#### Setting Details

Parameter symbol	Name	Display level	Setting range	Menu symbol
COM.W	Communication write enable/disable	STD	OFF: Enable ON: Disable	KLOC <b>Set</b>

# 13.4 Confirmation of Key and I/O Condition and Version

## 13.4.1 Confirmation of Key and I/O Condition

### Description

Can be confirm the Key and I/O condition.

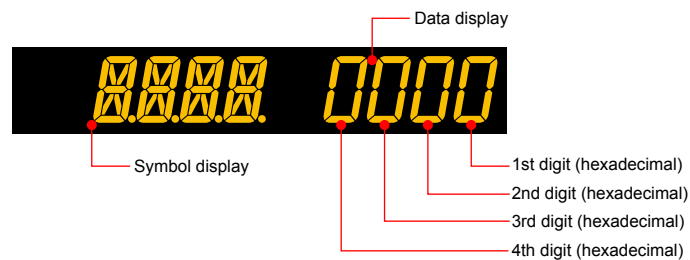
### Setting Details

Parameter symbol	Name	Display level	Setting range	Menu symbol
<b>KEY</b>	Key status	PRO	Read only.	I/O <b>Set</b>
<b>X000</b>	DI1-DI3 status (equipped as standard)	PRO		
<b>X100</b>	DI11-DI16 status (E1-terminal area)	PRO		
<b>X200</b>	DI21-DI26 status (E2-terminal area)	PRO		
<b>X300</b>	DI31-DI35 status (E3-terminal area)	PRO		
<b>X400</b>	DI41-DI46 status (E4-terminal area)	PRO		
<b>Y000</b>	AL1-AL3 status (equipped as standard)	PRO		
<b>Y100</b>	DO11-DO15 status (E1-terminal area)	PRO		
<b>Y200</b>	DO21-DO25 status (E2-terminal area)	PRO		
<b>Y300</b>	DO31-DO35 status (E3-terminal area)	PRO		
<b>Y400</b>	DO41-DO45 status (E4-terminal area)	PRO		

Note: When each parameter is displayed, the terminal area (E1 to E4) is displayed on Group display according to the suffix code and optional suffix code.

Key confirmation parameters are displayed in hexadecimal.

When the error occurs, "1" is set on the bit of corresponding error , and the bit data is displayed in hexadecimal.



## Parameter KEY

Displayed digit	bit	Description
1st digit	0	PARAMETER (or PARA) key (0: OFF, 1: ON)
	1	DISPLAY (or DISP) key (0: OFF, 1: ON)
	2	RIGHT arrow key (0: OFF, 1: ON)
	3	DOWN arrow key (0: OFF, 1: ON)
2nd digit	4	SET/ENTER key (0: OFF, 1: ON)
	5	UP arrow key (0: OFF, 1: ON)
	6	LEFT arrow key (0: OFF, 1: ON)
	7	–
3rd digit	8	–
	9	–
	10	–
	11	PTN key (0: OFF, 1: ON)
4th digit	12	RST key (0: OFF, 1: ON)
	13	MODE key (0: OFF, 1: ON)
	14	RUN key (0: OFF, 1: ON)
	15	–

## Parameter X000

Displayed digit	bit	Description
1st digit	0	DI1 status (0: OFF, 1: ON)
	1	DI2 status (0: OFF, 1: ON)
	2	DI3 status (0: OFF, 1: ON)
	3	–
2nd digit	4	–
	5	–
	6	–
	7	–
3rd digit	8	–
	9	–
	10	–
	11	–
4th digit	12	–
	13	–
	14	–
	15	–

## Parameter X100

Displayed digit	bit	Description
1st digit	0	DI11 status (0: OFF, 1: ON)
	1	DI12 status (0: OFF, 1: ON)
	2	DI13 status (0: OFF, 1: ON)
	3	DI14 status (0: OFF, 1: ON)
2nd digit	4	DI15 status (0: OFF, 1: ON)
	5	DI16 status (0: OFF, 1: ON)
	6	–
	7	–
3rd digit	8	–
	9	–
	10	–
	11	–
4th digit	12	–
	13	–
	14	–
	15	–

### 13.4 Confirmation of Key and I/O Condition and Version

#### Parameter X200

Displayed digit	bit	Description
1st digit	0	DI21 status (0: OFF, 1: ON)
	1	DI22 status (0: OFF, 1: ON)
	2	DI23 status (0: OFF, 1: ON)
	3	DI24 status (0: OFF, 1: ON)
2nd digit	4	DI25 status (0: OFF, 1: ON)
	5	DI26 status (0: OFF, 1: ON)
	6	–
3rd digit	7	–
	8	–
	9	–
4th digit	10	–
	11	–
	12	–
	13	–
	14	–
	15	–

#### Parameter X300

Displayed digit	bit	Description
1st digit	0	DI31 status (0: OFF, 1: ON)
	1	DI32 status (0: OFF, 1: ON)
	2	DI33 status (0: OFF, 1: ON)
	3	DI34 status (0: OFF, 1: ON)
2nd digit	4	DI35 status (0: OFF, 1: ON)
	5	–
	6	–
3rd digit	7	–
	8	–
	9	–
4th digit	10	–
	11	–
	12	–
	13	–
	14	–
	15	–

#### Parameter X400

Displayed digit	bit	Description
1st digit	0	DI41 status (0: OFF, 1: ON)
	1	DI42 status (0: OFF, 1: ON)
	2	DI43 status (0: OFF, 1: ON)
	3	DI44 status (0: OFF, 1: ON)
2nd digit	4	DI45 status (0: OFF, 1: ON)
	5	DI46 status (0: OFF, 1: ON)
	6	–
3rd digit	7	–
	8	–
	9	–
4th digit	10	–
	11	–
	12	–
	13	–
	14	–
	15	–

## Parameter Y000

Displayed digit	bit	Description
1st digit	0	AL1 status (0: OFF, 1: ON)
	1	AL2 status (0: OFF, 1: ON)
	2	AL3 status (0: OFF, 1: ON)
	3	–
2nd digit	4	–
	5	–
	6	–
	7	–
3rd digit	8	–
	9	–
	10	–
	11	–
4th digit	12	–
	13	–
	14	–
	15	–

## Parameter Y100

Displayed digit	bit	Description
1st digit	0	DO11 status (0: OFF, 1: ON)
	1	DO12 status (0: OFF, 1: ON)
	2	DO13 status (0: OFF, 1: ON)
	3	DO14 status (0: OFF, 1: ON)
2nd digit	4	DO15 status (0: OFF, 1: ON)
	5	–
	6	–
	7	–
3rd digit	8	–
	9	–
	10	–
	11	–
4th digit	12	–
	13	–
	14	–
	15	–

## Parameter Y200

Displayed digit	bit	Description
1st digit	0	DO21 status (0: OFF, 1: ON)
	1	DO22 status (0: OFF, 1: ON)
	2	DO23 status (0: OFF, 1: ON)
	3	DO24 status (0: OFF, 1: ON)
2nd digit	4	DO25 status (0: OFF, 1: ON)
	5	–
	6	–
	7	–
3rd digit	8	–
	9	–
	10	–
	11	–
4th digit	12	–
	13	–
	14	–
	15	–



### 13.4 Confirmation of Key and I/O Condition and Version

#### Parameter Y300

Displayed digit	bit	Description
1st digit	0	DO31 status (0: OFF, 1: ON)
	1	DO32 status (0: OFF, 1: ON)
	2	DO33 status (0: OFF, 1: ON)
	3	DO34 status (0: OFF, 1: ON)
2nd digit	4	DO35 status (0: OFF, 1: ON)
	5	–
	6	–
3rd digit	7	–
	8	–
	9	–
	10	–
4th digit	11	–
	12	–
	13	–
	14	–
	15	–

#### Parameter Y400

Displayed digit	bit	Description
1st digit	0	DO41 status (0: OFF, 1: ON)
	1	DO42 status (0: OFF, 1: ON)
	2	DO43 status (0: OFF, 1: ON)
	3	DO44 status (0: OFF, 1: ON)
2nd digit	4	DO45 status (0: OFF, 1: ON)
	5	–
	6	–
3rd digit	7	–
	8	–
	9	–
	10	–
4th digit	11	–
	12	–
	13	–
	14	–
	15	–

## 13.4.2 Confirmation of Version

**Description**

Can be confirm the version of the controller.

**Setting Details**

Parameter symbol	Name	Display level	Setting range	Menu symbol
<b>MCU</b>	MCU version	EASY	Read only.	VER <b>Set</b>
<b>DCU</b>	DCU version	EASY		
<b>ECU1</b>	ECU-1 version	EASY		
<b>ECU2</b>	ECU-2 version	EASY		
<b>ECU3</b>	ECU-3 version	EASY		
<b>ECU4</b>	ECU-4 version	EASY		
<b>PARA</b>	Parameter version	EASY		
<b>H.VER</b>	Product version	EASY		
<b>SER1</b>	Serial number 1	EASY		
<b>SER2</b>	Serial number 2	EASY		
<b>MAC1</b>	MAC address 1	EASY		
<b>MAC2</b>	MAC address 2	EASY		
<b>MAC3</b>	MAC address 3	EASY		



## 14.1 Initializing Parameter Settings to Factory Default Values

### Description

Parameter settings can be initialized to the factory default values.  
 The ladder program is also initialized to the factory default.  
 All program patterns can not be cleared during program pattern operation. Can be cleared in RESET mode.  
 Use the key or LL50A Parameter Setting Software to execute it.

### Note

The user setting values (defaults) are not initialized even if the parameter setting values are initialized to the factory default values.

### Setting Details

Parameter symbol	Name	Display level	Setting range	Menu symbol
<b>F.DEF</b>	Initialization to factory default value	PRO	-12345: Initialization, automatically returned to "0" after initialization.	INIT <b>Set</b>
<b>P.DEF</b>	Clearing all program pattern data	PRO	13579: Initialization, automatically returned to "0" after initialization.	

## 14.2 Registering and Initializing User Default Values

### 14.2.1 Registering as User Setting (Default) Values

#### Description

The user default values can be registered as parameter default values.  
The ladder program, the program pattern, and parameter "SEG.T" can not be registered as user default values.

Use the LL50A Parameter Setting Software to register user setting (default) values.

#### CAUTION

Before registering the user default value, make sure that the user setting value is set to the parameter.

### 14.2.2 Initializing to User Setting (Default) Values

#### Description

Parameter settings can be initialized to the user setting (default) values.  
The ladder program, the program pattern, and parameter "SEG.T" are not initialized to the factory default.

Use the LL50A Parameter Setting Software to execute it.

#### Setting Details

Parameter symbol	Name	Display level	Setting range	Menu symbol
U.DEF	Initialization to user default value	PRO	12345: Initialization, automatically returned to "0" after initialization.	INIT <b>Set</b>

# 15.1 Remedies if Power Failure Occurs during Operations

## Description

The operation status and remedies after a power failure differ with the length of power failure time:

Regardless of the length of power failure time, all functions of the controller cannot be operated for about 10 seconds after recovery. However, the case of instantaneous power failure is excepted.

- 100–240 V AC: Instantaneous power failure of 20 ms or less
- 24 V AC/DC: Instantaneous power failure of 1 ms

A power failure is not detected. Normal operation continues.

- Power failure of about less than 5 seconds

The following shows effects caused in “settings” and “operation status.”

Alarm action	Does not continue. Alarm with stand-by function will enter stand-by status. Alarm latch will be initialized.
Setting parameter	Set contents of each parameter are retained.
Auto-tuning	Cancelled.
Control action	Action before power failure continues.
Timer, counter (ladder program)	Initialized.

- Power failure of about 5 seconds or more

The following shows effects caused in “settings” and “operation status.”

Alarm action	Does not continue. Alarm with stand-by function will enter stand-by status. Alarm latch will be initialized.								
Setting parameter	Set contents of each parameter are retained.								
Auto-tuning	Cancelled.								
Control action	Differs with setting of the parameter “R.MD” (restart mode).								
	<table border="1"> <thead> <tr> <th>R.MD setting</th> <th>Control action after recovery from power failure</th> </tr> </thead> <tbody> <tr> <td><b>CONT</b></td> <td>Continues action (control output and operation mode) before power failure. (Factory default)</td> </tr> <tr> <td><b>MAN (*)</b></td> <td>Outputs the preset output value (PO) of the PID group used as control output and continues action in MAN mode. Continues operation mode (RESET, PROG, LOCAL, or REM)</td> </tr> <tr> <td><b>RESET (*)</b></td> <td>The control computation is executed in RESET mode based on the preset output value (PO) of the PID group used as control output.</td> </tr> </tbody> </table>	R.MD setting	Control action after recovery from power failure	<b>CONT</b>	Continues action (control output and operation mode) before power failure. (Factory default)	<b>MAN (*)</b>	Outputs the preset output value (PO) of the PID group used as control output and continues action in MAN mode. Continues operation mode (RESET, PROG, LOCAL, or REM)	<b>RESET (*)</b>	The control computation is executed in RESET mode based on the preset output value (PO) of the PID group used as control output.
	R.MD setting	Control action after recovery from power failure							
	<b>CONT</b>	Continues action (control output and operation mode) before power failure. (Factory default)							
<b>MAN (*)</b>	Outputs the preset output value (PO) of the PID group used as control output and continues action in MAN mode. Continues operation mode (RESET, PROG, LOCAL, or REM)								
<b>RESET (*)</b>	The control computation is executed in RESET mode based on the preset output value (PO) of the PID group used as control output.								
* In Heating/cooling control, starts action from 50% of control computation output.									
Timer, counter (ladder program)	Initialized.								

## Setting Details

Parameter symbol	Name	Display level	Setting range	Menu symbol
<b>R.MD</b>	Restart mode	STD	CONT: Continue action set before power failure. MAN: Start from MAN. RESET: Start from AUTO and RESET. The preset output value is outputted.	SYS <b>Set</b>

---

## 15.2 Power Frequency Setting

### Description

The power frequency can be set by automatic detection or manually. However, when the /DC option is specified, only manual setting is available. Set the range to the commercial frequency of the installation location.

### Setting Details

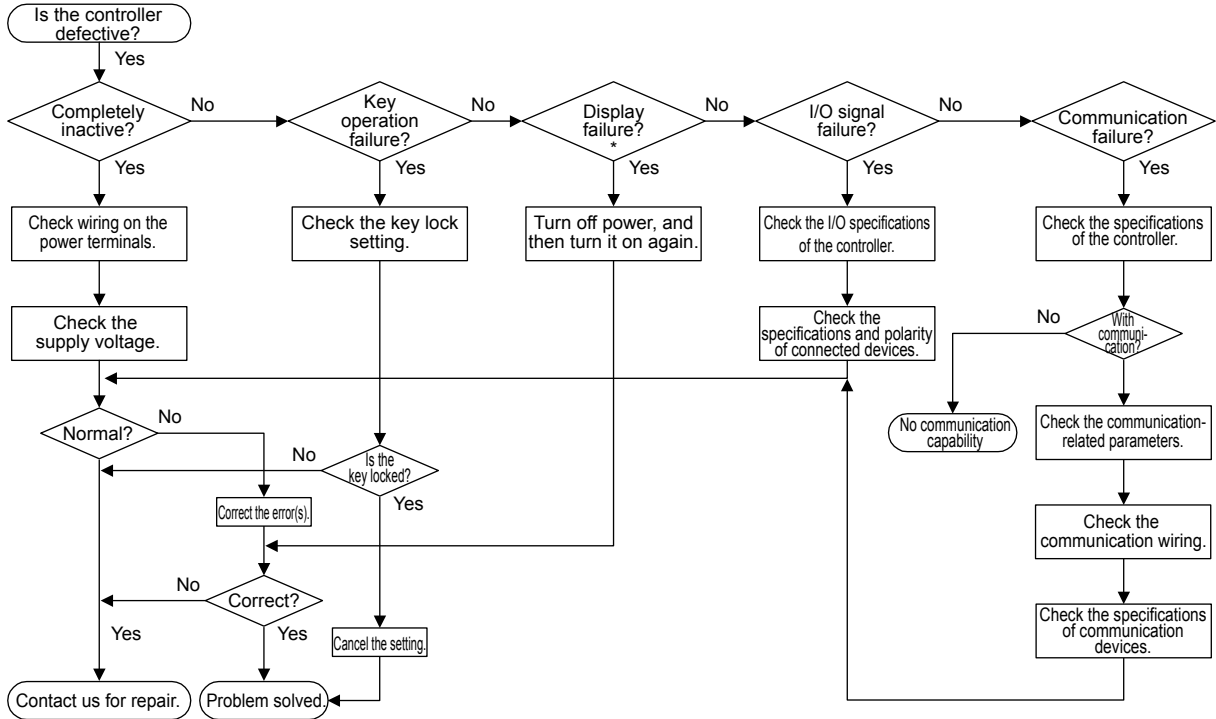
Parameter symbol	Name	Display level	Setting range	Menu symbol
<b>FREQ</b>	Power frequency	EASY	AUTO 60: 60 Hz 50: 50 Hz	SYS <b>Set</b>

# 16.1 Troubleshooting

## 16.1.1 Troubleshooting Flowchart

If the Operation Display does not appear after turning on the controller's power, follow the measures in the procedure below.

If a problem appears complicated, contact our sales representative.



\*: The LCD (a liquid crystal display) is used for a display portion of this product. The LCD has a characteristic that the display action becomes late at the low temperature. Additionally, the luminance and contrast degradation are caused due to aged deterioration. However, the control function is not affected.



## 16.1.2 Errors at Power On

The errors shown below may occur in the fault diagnosis when the power is turned on.

PV display (Operation Display)	Setpoint display (Operation Display)	Status indicator (Operation Display)	Parameter that displays error details	Error description	Cause and diagnosis	Remedy
Indication off	Indication off	–	–	Faulty MCU RAM / MCU ROM	MCU RAM / MCU ROM are failed.	Faulty. Contact us for repair.
ERR	SYS -----	–	Setup parameter (PA.ER)	System data error	System data is corrupted.	Faulty. Contact us for repair.
	PAR 0004 (for user default value error only)			User (parameter) default value error	User parameter is corrupted. Initialized to factory default value.	Check and reconfigure the initialized parameters. Error indication is erased when the power is turned on again.
	PAR 0010 (for setup parameter error only)			Setup parameter error	Setup parameter data is corrupted. Initialized to factory default value.	
	PAR 0020 (for operation parameter error only)			Operation parameter error	Operation parameter data is corrupted. Initialized to user default value.	
	PAR 0040 (for program pattern error only)			Program pattern error	Program pattern data is corrupted. All program patterns are deleted.	
	PAR 0400 (for control parameter error only)			Control parameter (operation mode, output) error	Control parameter data is corrupted. Initialized to user default value.	
	SLOT 0017 (0017: Error occurs to all hardware of E1 to E4-terminal areas.)		Setup parameter (OP.ER)	Non responding hardware of extended function (E1 to E4-terminal areas)	Inconsistence of system data and hardware of extended function. Non responding communication between hardware of extended function (E1 to E4-terminal areas).	Faulty. Contact us for repair.
Normal indication	Normal indication	Rightmost decimal point on PV display blinks.	Setup parameter (PA.ER)	Calibration value error	Initialized to calibrated default value because of corrupted factory default value.	Faulty. Contact us for repair.
		Right most decimal point on Symbol display blinks.		Faulty FRAM	Writing (storing) data to FRAM is impossible.	
Normal indication	Normal indication	LADDER lamp blinks.	Setup parameter (LA.ER)	Corrupted ladder program	Ladder program is corrupted. Operates without ladder program.	Download the ladder program again.
Normal indication	0.000 00000 (Decimal point on the left of the Symbol display blinks)	–	Setup parameter (OP.ER)	User profile error	User profile is corrupted.	Download the user profile again.

## Errors at Power On (Input/output Action)

Error description	PV input, RSP input, and aux. analog input	Ladder calculation	Control computation	Control output	Retransmission output	Alarm action	Analog output (control output, retransmission output)	Voltage pulse output (control output)	Relay output (control output, position proportional output)	Feedback input (for Position proportional type)	Contact input	Contact (alarm) output	Communication	
Faulty MCU RAM Faulty MCU ROM	Undefined	Stopped	Stopped	Undefined	Undefined	Stopped	0% or less	OFF	OFF	Undefined	OFF	OFF	Stopped	
System data error	Undefined	Stopped	Stopped	Undefined	Undefined	Stopped	0% or less	OFF	OFF	Undefined	OFF	OFF	Normal action	
User (parameter) default value error	Normal action	Normal action	Normal action	Normal action	Normal action	Normal action	Normal action	Normal action	Normal action	Normal action	Normal action	Normal action	Normal action	
Setup parameter error														
Operation parameter error														
Program parameter error														
Control parameter error	Undefined	Normal action	Normal action	Normal action	Normal action	Normal action	Normal action	Normal action	Normal action	Normal action	Normal action	Normal action	Normal action	
Non responding hardware of extended function (E1 to E4-terminal areas)														
Calibration value error														
Faulty FRAM														
Corrupted ladder program	Normal action	Normal action (without ladder program)	Normal action	Normal action	Normal action	Normal action	Normal action	Normal action	Normal action	Normal action	Normal action	Normal action	Normal action	
User profile error	Normal action	Normal action	Normal action	Normal action	Normal action	Normal action	Normal action	Normal action	Normal action	Normal action	Normal action	Normal action	Normal action	PROFIBUS-DP/ DeviceNet/CC-Link communication is disabled

## 16.1.3 Errors during Operation

### Errors during Operation (1)

The errors shown below may occur during operation.

PV display (Operation Display)	Setpoint display (Operation Display)	Status indicator (Operation Display)	Parameter that displays error details	Error description	Cause and diagnosis	Remedy
AD.ERR	Normal indication (Note)	–	Setup parameter (AD1.E)	Analog input terminal ADC error • PV input • RSP input (E1-terminal area) • AIN2 input (E2-terminal area) • AIN4 input (E4-terminal area)	Analog input terminal AD value error	Faulty Contact us for repair.
RJC.E (Displays RJC.E and PV alternately.)	Normal indication (Note)	–	Setup parameter (AD1.E)	Universal input terminal RJC error • PV input • RSP input (E1-terminal area)	Universal input terminal RJC error	Faulty Contact us for repair. Set the parameter RJC to OFF to erase error indication.
B.OUT	Normal indication (Note)	–	Setup parameter (AD1.E)	Analog input terminal burnout error • PV input • RSP input (E1-terminal area) • AIN2 input (E2-terminal area) • AIN4 input (E4-terminal area)	Analog input terminal sensor burnout	Check wiring and sensor. Error indication is erased in normal operation.
			Setup parameter (PV1.E/PV2.E)	PV input burnout error (Loop1, Loop2)	Burnout of analog input connected to PV	Check wiring and sensor of connected analog input terminal. Error indication is erased in normal operation.
OVER -OVER	Normal indication	–	Setup parameter (PV1.E/PV2.E)	PV input over-scale PV input under-scale (PV values out of -5 to 105%) (Loop1, Loop 2)	PV input is out of -5 to 105%. Also occurs when the data out of range which is the ladder computation result is input.	Check analog input value or ladder program.
Normal indication	Normal indication	–	Setup parameter (PV1.E)	RSP input burnout error (Loop 1)	Burnout of analog input connected to RSP	Check wiring and sensor. Error indication is erased in normal operation.

Note: When an error occurs in input shown in Analog input display (Operation display).  
Setpoint display shows the same symbol as the PV display.

Errors during Operation (Input/output Action)

Error description	PV input, RSP input, and aux. analog input	Ladder calculation	Control computation	Control output	Retransmission output	Alarm action	Analog output (control output, retransmission output)	Voltage pulse output (control output)	Relay output (control output, position proportional output)	Feedback input (for Position proportional type)	Contact input	Contact (alarm) output	Communication
Analog input terminal ADC error • PV input • RSP input (E1-terminal area) • AIN2 input (E2-terminal area) • AIN4 input (E4-terminal area)	105%	Normal action	Normal action	When in AUTO and RUN modes: Error preset output When in MAN mode: MAN output	Normal action	Normal action	Normal action	Normal action	Normal action	Normal action	Normal action	Normal action	Normal action
Universal input terminal RJC error • PV input • RSP input (E1-terminal area)	Normal action (without reference junction compensation)	Normal action	Normal action	Normal action	Normal action	Normal action	Normal action	Normal action	Normal action	Normal action	Normal action	Normal action	Normal action
Analog input terminal burnout error • PV input • RSP input (E1-terminal area) • AIN2 input (E2-terminal area) • AIN4 input (E4-terminal area)	Depends on the parameter BSL. Upscale: 105% Downscale: -5%			Normal action									
PV input burnout error (Loop1, Loop2)	Depends on the setting of the parameter BSL of the analog terminal connected to the PV where the error occurs. Upscale: 105% Downscale: -5%	Normal action	Normal action	When in AUTO and RUN modes: Error preset output When in MAN mode: MAN output	Normal action	Normal action	Normal action	Normal action	Normal action	Normal action	Normal action	Normal action	Normal action
PV input over-scale PV input under-scale (PV values out of -5 to 105%) (Loop1, Loop 2)	Normal action	Normal action	Normal action	Normal action	Normal action	Normal action	Normal action	Normal action	Normal action	Normal action	Normal action	Normal action	Normal action
RSP input burnout error (Loop 1)	Depends on the setting of the parameter BSL of the analog terminal connected to the RSP where the error occurs. Upscale: 105% Downscale: -5%	Normal action	Normal action	Normal action	Normal action	Normal action	Normal action	Normal action	Normal action	Normal action	Normal action	Normal action	Normal action

## Errors during Operation (2)

The errors shown below may occur during operation.

PV display (Operation Display)	Setpoint display (Operation Display)	Status indicator (Operation Display)	Parameter that displays error details	Error description	Cause and diagnosis	Remedy
Normal indication	RSP B.OUT	–	Setup parameter (PV1.E)	Burnout error when RSP input is used for control (Loop 1)	Burnout error of analog input connected to RSP when RSP is used for control computation	Check wiring and sensor. Error indication is erased in normal operation.
Normal indication	OUT -----	–	Setup parameter (AD2.E)	Feedback input resistor/ current burnout	Feedback input burnout	Check wiring of feedback input resistor/current. Error indication is erased in normal operation.
Normal indication	Normal indication	LADDER lamp blinks	Setup parameter (LA.ER)	Ladder calculation overflow	Floating point computation in ladder calculation is infinite.	Check the ladder program.
				Load factor over 100%	Computation does not end within the control period. (When the load factor is 100% or more, and the computation does not end within the control period.)	Change the control period or reduce the number of steps for the ladder program.
				Load factor over 200%. (Forced end)	Computation does not end within the control period (load factor is 200% or more).	Change the control period or reduce the number of steps for the ladder program.
				Ladder program error	Ladder program is corrupted.	Download the ladder program again. If the error indication is still not erased, there is a fault. Contact us for repair.

## Errors during operation (Input/output Action)

Error description	PV input, RSP input, and aux. analog input	Ladder calculation	Control computation	Control output	Retransmission output	Alarm action	Analog output (control output, retransmission output)	Voltage pulse output (control output)	Relay output (control output, position proportional output)	Feedback input (for Position proportional type)	Contact input	Contact (alarm) output	Communication
Burnout error when RSP input is used for control (Loop 1)	Depends on the setting of the parameter BSL of the analog terminal connected to the RSP where the error occurs. Upscale: 105% Downscale: -5%	Normal action	Normal action	When in AUTO and RUN modes: Error preset output When in MAN mode: MAN output	Normal action	Normal action	Normal action	Normal action	Normal action	Normal action	Normal action	Normal action	Normal action
Feedback input resistor/current burnout	Normal action	Normal action	Normal action	Normal action	Normal action	Normal action	Normal action	-	Position proportional output: OFF	105%	Normal action	Normal action	Normal action
Ladder calculation overflow	Normal action	Undefined (calculation with max. value)	Normal action	Normal action	Normal action	Normal action	Normal action	Normal action	Normal action	Normal action	Normal action	Normal action	Normal action
Load factor is over 100%	Normal action	Does not work according to the control period.	Does not work according to the control period.	Does not work according to the control period.	Does not work according to the control period.	Does not work according to the control period.	Normal action	Normal action	Normal action	Normal action	Normal action	Normal action	The response from the main unit slows.
Load factor is over 200%. (Forced termination)	Normal action	Forced end at 200%	Does not work according to the control period.	Does not work according to the control period.	Does not work according to the control period.	Does not work according to the control period.	Normal action	Normal action	Normal action	Normal action	Normal action	Normal action	
Ladder program error	Normal action	Undefined (Stopped at the error detection)	Normal action	Normal action	Normal action	Normal action	Normal action	Normal action	Normal action	Normal action	Normal action	Normal action	Normal action

### Errors during Operation (3)

The errors shown below may occur during operation.

PV display (Operation Display)	Setpoint display (Operation Display)	Status indicator (Operation Display)	Parameter that displays error details	Error description	Cause and diagnosis	Remedy
Normal indication	0.000 00000 (Decimal point on the left of the Symbol display blinks)	–	Setup parameter (OP.ER)	Peer-to-peer communication error	Peer-to-peer communication error	Check that the target devices are connected correctly. Recovery at normal receipt.
AT,E	Normal indication	–	Setup parameter (PV1.E/PV2.E)	Auto-tuning time-out (Loop 1, Loop 2)	Auto-tuning does not end even when 24 hours have elapsed after the start of tuning.	Check the process. Hold down any key to erase the error indication
VAT,E	Normal indication	–	Setup parameter (AD2.E)	Automatic valve position adjustment error	Fully-closed valve position is equal to or larger than the fully-open valve position after automatic valve position adjustment is performed.	Check wiring and valve. Hold down any key to erase the error indication.
Normal indication	0.000 00000 (Decimal point on the left of the Symbol display blinks)	–	Setup parameter (OP.ER)	Communication error (RS-485 communication)	Framing parity error Buffer overflow Inter-character time-out Checksum error (PC link communication with checksum) CRC check error (Modbus/RTU) LRC check error (Modbus/ASCII)	Check the communication parameters. Recovery at normal receipt. Hold down any key to stop blinking.
Normal indication	0.000 00000 (Decimal point on the left of the Symbol display blinks)	–	Setup parameter (OP.ER)	User profile error	User profile is corrupted.	Download the user profile again.
Normal indication	Normal indication	Rightmost decimal point on Symbol display blinks.	Setup parameter (PA.ER)	Faulty FRAM	Writing (storing) data to FRAM is impossible.	Faulty. Contact us for repair.

Errors during Operation (Input/output Action)

Error description	PV input, RSP input, and aux. analog input	Ladder calculation	Control computation	Control output	Retransmission output	Alarm action	Analog output (control output, retransmission output)	Voltage pulse output (control output)	Relay output (control output, position proportional output)	Feedback input (for Position proportional type)	Contact input	Contact (alarm) output	Communication
Peer-to-peer communication error	Normal action	Normal action (However, the peer-to-peer communication register is not updated.)	Normal action	Normal action	Normal action	Normal action	Normal action	Normal action	Normal action	Normal action	Normal action	Normal action	Normal action
Auto-tuning time-out (Loop 1, Loop 2)	Normal action	Normal action	Auto-tuning stopped, normal action	Auto-tuning stopped, Normal action	Normal action	Normal action	Normal action	Normal action	Normal action	Normal action	Normal action	Normal action	Normal action
Automatic valve position adjustment error	Normal action	Normal action	Normal action	Normal action	Normal action	Normal action	Normal action	–	Normal action	105%	Normal action	Normal action	Normal action
Communication error (RS485 communication)	Normal action	Normal action	Normal action	Normal action	Normal action	Normal action	Normal action	Normal action	Normal action	Normal action	Normal action	Normal action	Normal action
User profile error	Normal action	Normal action	Normal action	Normal action	Normal action	Normal action	Normal action	Normal action	Normal action	Normal action	Normal action	Normal action	PROFIBUS-DP/DeviceNet/CC-Link communication is disabled
Faulty FRAM	Normal action	Normal action	Normal action	Normal action	Normal action	Normal action	Normal action	Normal action	Normal action	Normal action	Normal action	Normal action	Normal action



### Errors during Operation (4)

The errors shown below may occur during operation.

PV display (Operation Display)	Data display (Operation Display)	Status indicator (Operation Display)	Parameter that displays error details	Error description	Cause and diagnosis	Remedy
Undefined	Undefined	–	–	Faulty MCU	MCU is corrupted.	Faulty Contact us for repair.
Undefined	Undefined	–	–	Faulty DCU (ROM/RAM error, corrupted)	DCU is corrupted.	Faulty Contact us for repair.

### Errors during Operation On (Input/output Action)

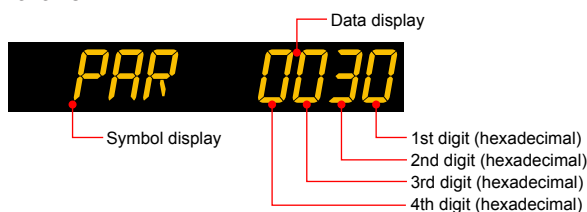
Error description	PV input, RSP input, and aux. analog input	Ladder calculation	Control computation	Control output	Retransmission output	Alarm action	Analog output (control output, retransmission output)	Voltage pulse output (control output)	Relay output (control output, position proportional output)	Feedback input (for Position proportional type)	Contact input	Contact (alarm) output	Communication
Faulty MCU	Undefined	Stopped	Stopped	Undefined	Undefined	Stopped	0% or less	OFF	OFF	Undefined	OFF	OFF	Stopped
Faulty DCU (ROM/RAM error, corrupted)	Undefined	Stopped	Stopped	Undefined	Undefined	Stopped	0% or less	OFF	OFF	Undefined	OFF	OFF	Stopped

## Hexadecimal Display on Setpoint Display (Operation Display)

Some error codes are displayed in hexadecimal.

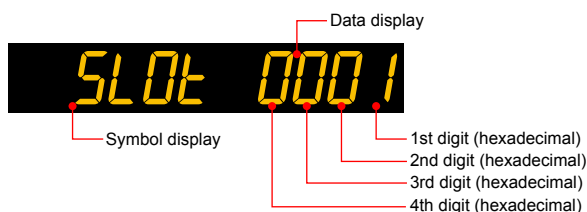
When the error occurs, "1" is set on the bit of corresponding error, and the bit data is displayed in hexadecimal.

If the setup parameter error or the operation parameter errors occur, it is displayed as follows:



Displayed digit	bit	Description
1st digit	0	System data error
	1	Calibration value error
	2	User (parameter) default value error
	3	–
2nd digit	4	Setup parameter error
	5	Operation parameter error
	6	Program parameter error
	7	–
3rd digit	8	Faulty FRAM
	9	–
	10	Control parameter error
	11	–
4th digit	12	–
	13	–
	14	–
	15	–

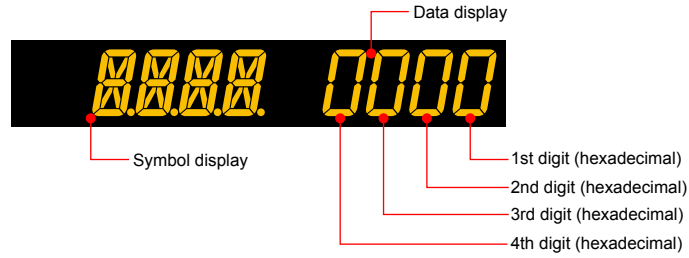
If the hardware in E1-terminal area does not respond, it is displayed as follows:



Displayed digit	bit	Description
1st digit	0	Non responding hardware in E1-terminal area
	1	Non responding hardware in E2-terminal area
	2	Non responding hardware in E3-terminal area
	3	–
2nd digit	4	Non responding hardware in E4-terminal area
	5	–
	6	–
	7	–
3rd digit	8	–
	9	–
	10	–
	11	–
4th digit	12	–
	13	–
	14	–
	15	–

### Hexadecimal Display of the Parameter which Shows the Error Details

Error confirmation parameters are displayed in hexadecimal.  
 When the error occurs, "1" is set on the bit of corresponding error.



Parameter PA.ER

Displayed digit	bit	Description
1st digit	0	System data error
	1	Calibration value error
	2	User (parameter) default value error
	3	–
2nd digit	4	Setup parameter error
	5	Operation parameter error
	6	Program parameter error
	7	–
3rd digit	8	Faulty FRAM
	9	–
	10	Control parameter error
	11	–
4th digit	12	–
	13	–
	14	–
	15	–

Parameter LA.ER

Displayed digit	bit	Description
1st digit	0	Ladder program corruption
	1	Ladder calculation overflow
	2	Ladder program error
	3	–
2nd digit	4	Load factor over 100%
	5	Load factor over 200%
	6	–
	7	–
3rd digit	8	–
	9	–
	10	–
	11	–
4th digit	12	–
	13	–
	14	–
	15	–

## Parameter OP.ER

Displayed digit	bit	Description
1st digit	0	Non responding hardware in E1-terminal area
	1	Non responding hardware in E2-terminal area
	2	Non responding hardware in E3-terminal area
	3	–
2nd digit	4	Non responding hardware in E4-terminal area
	5	–
	6	–
	7	–
3rd digit	8	–
	9	–
	10	Communication error in E3-terminal area
	11	–
4th digit	12	Communication error in E4-terminal area
	13	–
	14	–
	15	–

## Parameter AD1.E

Displayed digit	bit	Description
1st digit	0	ADC error of PV input
	1	ADC error of RSP input (E1-terminal area)
	2	ADC error of AIN2 input (E2-terminal area)
	3	–
2nd digit	4	ADC error of AIN4 input (E4-terminal area)
	5	RJC error of PV input
	6	RJC error of RSP input
	7	–
3rd digit	8	PV input burnout error
	9	RSP input (E1-terminal area) burnout error
	10	AIN2 input (E2-terminal area) burnout error
	11	–
4th digit	12	AIN4 input (E4-terminal area) burnout error
	13	–
	14	–
	15	–

## Parameter AD2.E

Displayed digit	bit	Description
1st digit	0	Feedback input resistor/current burnout
	1	Automatic valve position adjustment error
	2	–
	3	–
2nd digit	4	–
	5	–
	6	–
	7	–
3rd digit	8	–
	9	–
	10	–
	11	–
4th digit	12	–
	13	–
	14	–
	15	–

## 16.1 Troubleshooting

### Parameter PV1.E

Displayed digit	bit	Description
1st digit	0	Loop-1 PV input burnout error
	1	Loop-1 RSP input burnout error
	2	Burnout error when Loop-1 RSP input is used for control
	3	–
2nd digit	4	Loop-1 PV input over-scale
	5	Loop-1 PV input under-scale
	6	–
	7	–
3rd digit	8	–
	9	–
	10	–
	11	–
4th digit	12	–
	13	–
	14	Loop-1 auto-tuning time-out
	15	–

### Parameter PV2.E

Displayed digit	bit	Description
1st digit	0	Loop-2 PV input burnout error
	1	–
	2	–
	3	–
2nd digit	4	Loop-2 PV input over-scale
	5	Loop-2 PV input under-scale
	6	–
	7	–
3rd digit	8	–
	9	–
	10	–
	11	–
4th digit	12	–
	13	–
	14	Loop-2 auto-tuning time-out
	15	–

---

## 16.2 Maintenance

### 16.2.1 Cleaning

The front panel and operation keys should be gently wiped with a cloth soaked with water and squeezed firmly.

---

#### **CAUTION**

In order to prevent LCD from static electricity damage, do not wipe with dry cloth. (When LCD is electrified, it returns to normal in several minutes.)  
Do not use alcohol, benzene, or any other solvents.

---

### 16.2.2 Packaging when Shipping the Product for Repair

Should the instrument break down and need to be shipped to our sales representative for repair, handle it as noted below:

---

#### **CAUTION**

Write down the settings of parameters for a repair request.

---

---

#### **WARNING**

Prior to shipping the instrument, put it into an antistatic bag and repackage it using the original internal packaging materials and packaging container.

---

### 16.2.3 Replacing Parts

Do not replace any parts inside the unit.

---

## **16.3 Periodic Maintenance**

Check the operating condition periodically to use this instrument with good condition.

---

## 16.4 Disposal

When disposing of this instrument, arrange for appropriate disposal as industrial waste according to the rules of a country, the area, or a local government.

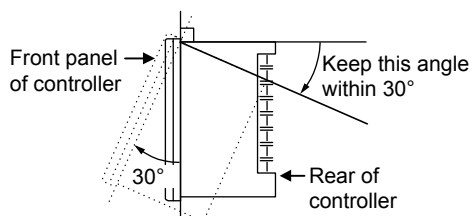




## 17.1 Installation Location

The instrument should be installed in indoor locations meeting the following conditions:

- Instrumented panel  
This instrument is designed to be mounted in an instrumented panel. Mount the instrument in a location where its terminals will not inadvertently be touched.
- Well ventilated locations  
Mount the instrument in well ventilated locations to prevent the instrument's internal temperature from rising. However, make sure that the terminal portions are not exposed to wind. Exposure to wind may cause the temperature sensor accuracy to deteriorate. To mount multiple indicating controllers, see the external dimensions/ panel cutout dimensions which follow. If mounting other instruments adjacent to the instrument, comply with these panel cutout dimensions to provide sufficient clearance between the instruments.
- Locations with little mechanical vibration  
Install the instrument in a location subject to little mechanical vibration.
- Horizontal location  
Mount the instrument horizontally and ensure that it is level, with no inclination to the right or left.



### Note

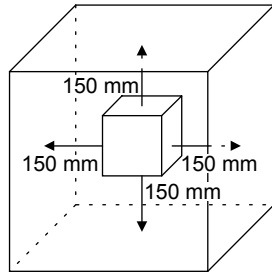
If the instrument is moved from a location with low temperature and low humidity to a place with high temperature and high humidity, or if the temperature changes rapidly, condensation will result. Moreover, in the case of thermocouple inputs, measurement errors will result. To avoid such a situation, leave the instrument in the new environment under ambient conditions for more than 1 hour prior to using it.

## 17.1 Installation Location

---

Do not mount the instrument in the following locations:

- Outdoors
- Locations subject to direct sunlight, ultrared rays, ultraviolet rays, or close to a heater  
Install the instrument in a location with stable temperatures that remain close to an average temperature of 23°C. Do not mount it in locations subject to direct sunlight or close to a heater. Doing so adversely affects the instrument and LCD.
- Locations with substantial amounts of oily fumes, steam, moisture, dust, or corrosive gases  
The presence of oily fumes, steam, moisture, dust, or corrosive gases adversely affects the instrument. Do not mount the instrument in locations subject to any of these substances.
- Areas near electromagnetic field generating sources  
Do not place magnets or tools that generate magnetism near the instrument. If the instrument is used in locations close to a strong electromagnetic field generating source, the magnetic field may cause measurement errors.
- Locations where the display is difficult to see  
The instrument uses an LCD for the display unit, and this can be difficult to see from extremely oblique angles. Mount the instrument in a location where it can be seen as much as possible from the front.
- Areas close to flammable articles  
Absolutely do not place the instrument directly on flammable surfaces. If such a circumstance is unavoidable and the instrument must be placed close to a flammable item, provide a shield for it made of 1.43 mm thick plated steel or 1.6 mm thick unplated steel with a space of at least 150 mm between it and the instrument on the top, bottom and sides.



- Areas subject to being splashed with water

## 17.2 Mounting Method



### WARNING

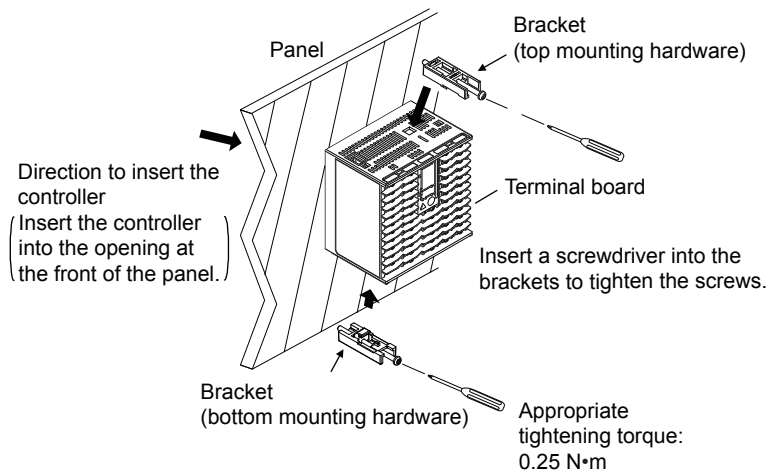
Be sure to turn OFF the power supply to the controller before installing it on the panel to avoid an electric shock.

#### Mounting the Instrument Main Unit

Provide an instrumented panel steel sheet of 1 to 10 mm thickness.

After opening the mounting hole on the panel, follow the procedures below to install the controller:

1. Insert the controller into the opening from the front of the panel so that the terminal board on the rear is at the far side.
2. Set the brackets in place on the top and bottom of the controller as shown in the figure below, then tighten the screws of the brackets. Take care not to overtighten them.



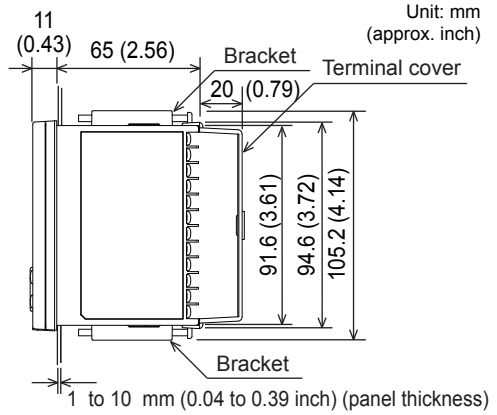
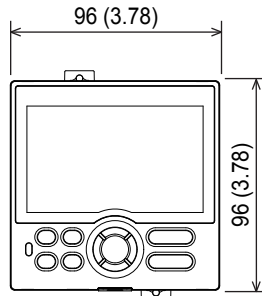
To uninstall the controller, perform the procedure in the reverse order.

### CAUTION

- 1) Tighten the screws with appropriate tightening torque within 0.25 N·m. Otherwise it may cause the case deformation or the bracket damage.
- 2) Make sure that foreign materials do not enter the inside of the instrument through the case's slit holes.

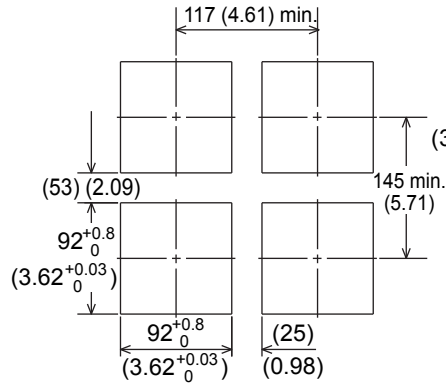
# 17.3 External Dimensions and Panel Cutout Dimensions

UP55A

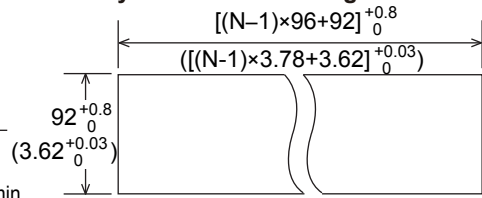


Unit: mm  
(approx. inch)

### General mounting



### Side-by-side close mounting



"N" stands for the number of controllers to be installed. However, the measured value applies if N ≥ 5.

Normal tolerance:  
±(value of JIS B 0401-1998 tolerance class IT18)/2

## 17.4 Wiring

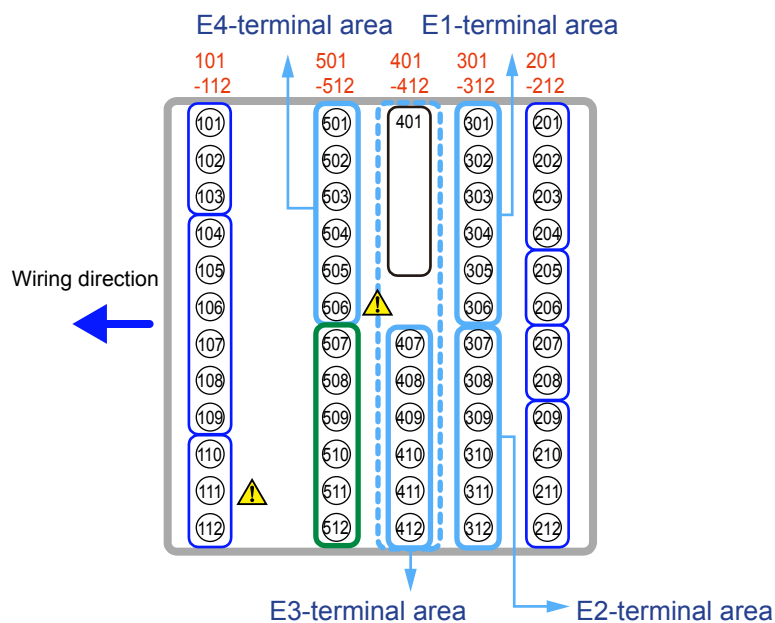
### 17.4.1 Important Information on Wiring



#### WARNING

- 1) Be sure to turn OFF the power supply to the controller before wiring to avoid an electric shock. Use a tester or similar device to ensure that no power is being supplied to a cable to be connected.
- 2) Wiring work must be carried out by a person with basic electrical knowledge and practical experience.

UP55A Terminal Block Diagram



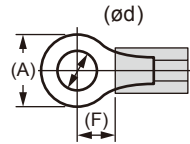
#### CAUTION

- When connecting two or more crimp-on terminal lugs to the single terminal block, bend the crimp-on terminal lugs before tightening the screw.
- Note that the wiring of two or more crimp-on terminal lugs to the single high-voltage terminal of the power supply and relay, etc. does not comply with the safety standard.

## CAUTION

Do not use an unassigned terminal as the relay terminal.

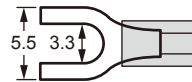
### Recommended Crimp-on Terminal Lugs



Recommended tightening torque: 0.6 N·m

Applicable wire size: Power supply wiring 1.25 mm<sup>2</sup> or more

Applicable terminal lug	Applicable wire size mm <sup>2</sup> (AWG#)	(ød)	(A)	(F)
M3	0.25 to 1.65 (22 to 16)	3.3	5.5	4.2



### Cable Specifications

Purpose	Name and Manufacturer
Power supply, relay contact output	600 V Grade heat-resistant PVC insulated wires, JIS C 3317(HIV), 0.9 to 2.0 mm <sup>2</sup>
Thermocouple	Shielded compensating lead wire JISC1610
RTD	Shielded wire (three/four conductors) UL2482 (Hitachi Cable)
Other signals (other than contact input/output)	Shielded wires
Other signals (contact input/output)	Non shielded wires
RS485 communication	Shielded wires
Ethernet communication	100 BASE-TX (CAT-5) / 10 BASE-T
PROFIBUS-DP communication	Dedicated cable for PROFIBUS-DP (Shielded two-wires)
DeviceNet communication	Dedicated cable for DeviceNet (Shielded five-wires)
CC-Link communication	Dedicated cable for CC-Link (Shielded three-wires)

#### PROFIBUS-DP/CC-Link Connector (wiring side) (Part number: A1987JT)

#### DeviceNet Connector (wiring side) (Part number: L4502BW)

Recommended tightening torque: 0.5 to 0.6 N·m

#### Note

Communication wires of cross-sectional area less than or equal to 0.34 mm<sup>2</sup> may not be secured firmly to the terminals.

Check that the wire is firmly connected to the terminal by folding the conductor of the wire connected to the crimp-on lug.

Recommended length of the stripped wire: 7 mm

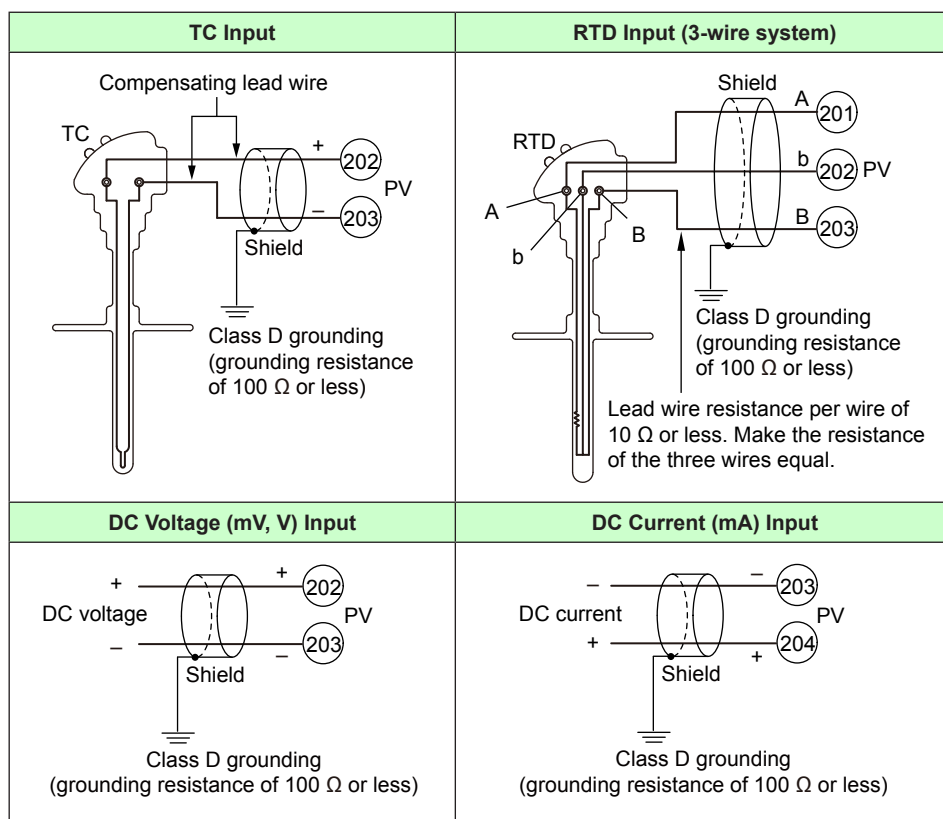
#### Note

If the UP is located at the end of a segment for the PROFIBUS communication wiring, terminating resistors are separately needed. These are to be prepared by users. (390 Ω: 2 pcs. 220 Ω: 1 pc., or an active terminator.)

## 17.4.2 PV Input Wiring

**CAUTION**

- 1) Be careful of polarity when wiring inputs. Reversed polarity can damage the UP.
- 2) Keep the PV input signal line as far away as possible from the power supply circuit and ground circuit.
- 3) For TC input, use shielded compensating lead wires for wiring. For RTD input, use shielded wires that have low conductor resistance and cause no significant differences in resistance between the three wires.
- 4) If there is a risk of external lightning surges, use a lightning arrester etc.

**Use**

In Single-loop control or Cascade primary-loop control, PV input is used for PV input. In Loop control with PV switching or Loop control with PV auto-selector, PV input is used for PV input 1. Remote input (E1-terminal area) is used for PV input 2. In Loop control with PV auto-selector for 3 inputs or 4 inputs, auxiliary analog inputs are used for PV input 3 and PV input 4.

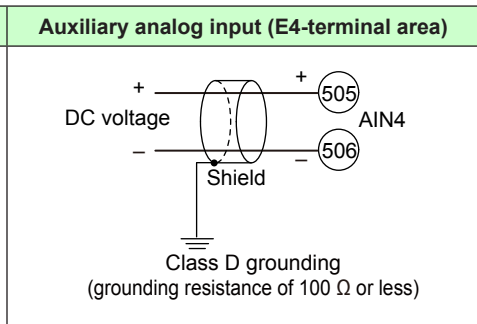
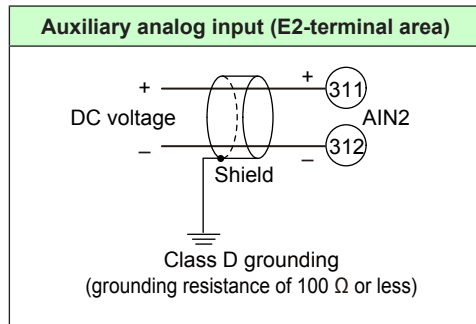
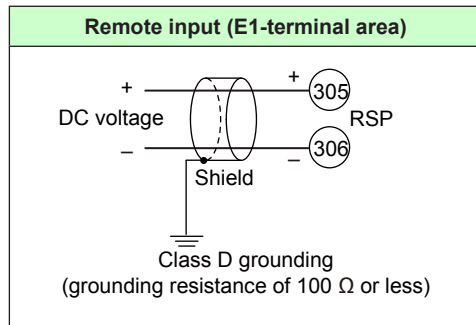
In Cascade control, PV input is used for Loop-1 PV input. Remote input (E1-terminal area) is used for Loop-2 PV input.



17.4.3 Remote (Auxiliary Analog) Input Wiring

**CAUTION**

- 1) Be careful of polarity when wiring inputs. Reversed polarity can damage the UP.
- 2) Keep the remote (auxiliary analog) input signal line as far away as possible from the power supply circuit and ground circuit.
- 3) For TC input (remote input with direct input), use shielded compensating lead wires for wiring. For RTD input, use shielded wires that have low conductor resistance and cause no significant differences in resistance between the three wires.
- 4) If there is a risk of external lightning surges, use a lightning arrester etc.



**Use**

**RSP Remote Input (E1-terminal area)**

In Single-loop control, used for remote input.  
 In Cascade primary-loop control, remote input is used for output tracking input.  
 In Cascade control, remote input is used for Loop-2 PV input.  
 In Loop control with PV switching or Loop control with PV auto-selector, remote input is used for PV input 2.

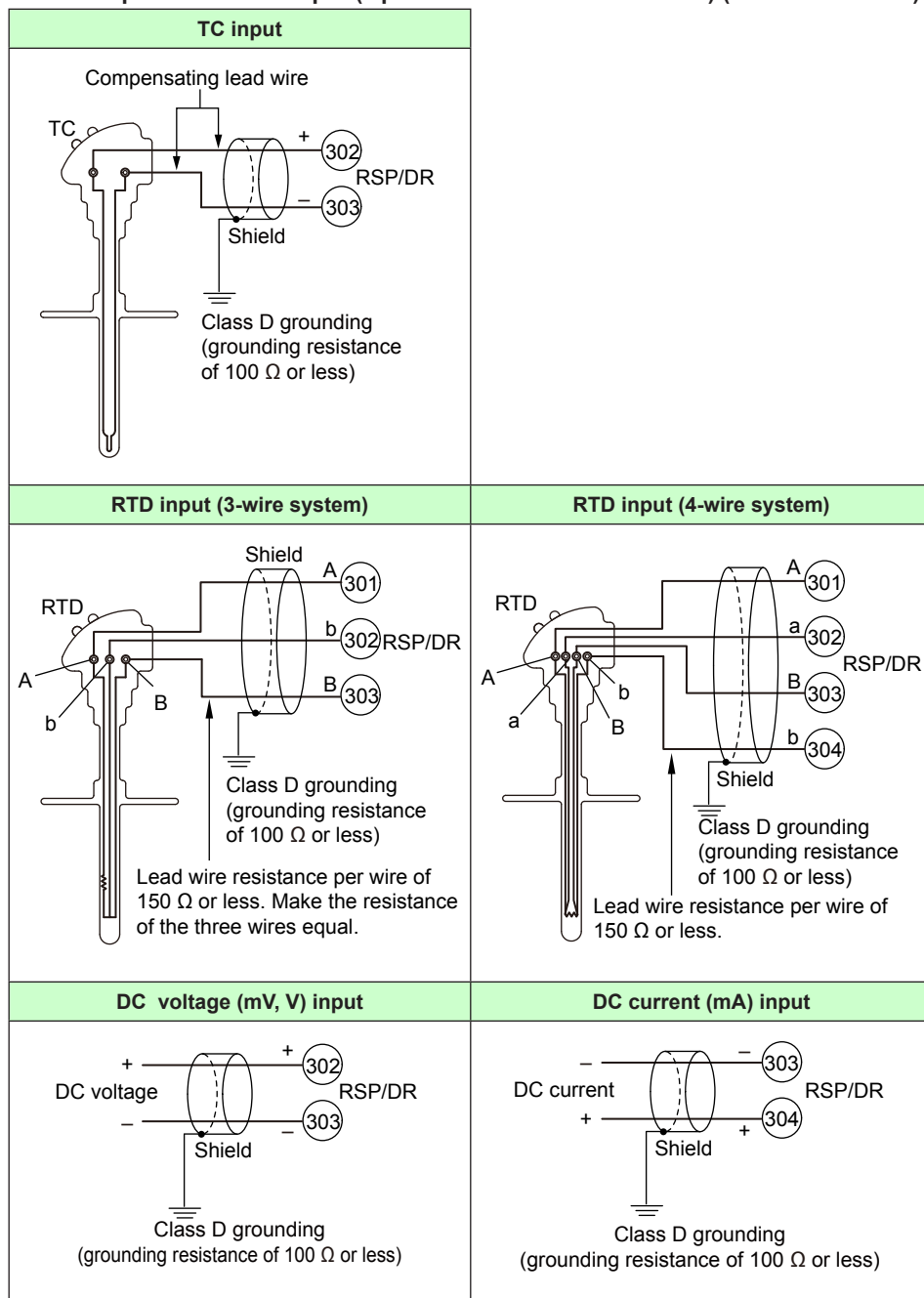
**AIN2 Auxiliary Analog Input (E2-terminal area)**

In Loop control with PV auto-selector for 3 inputs or 4 inputs, auxiliary analog input (E-2 terminal area) is used for PV input 3.

**AIN4 Auxiliary Analog Input (E4-terminal area)**

In Loop control with PV auto-selector for 4 inputs, auxiliary analog input (E4-terminal area) is used for PV input 4.

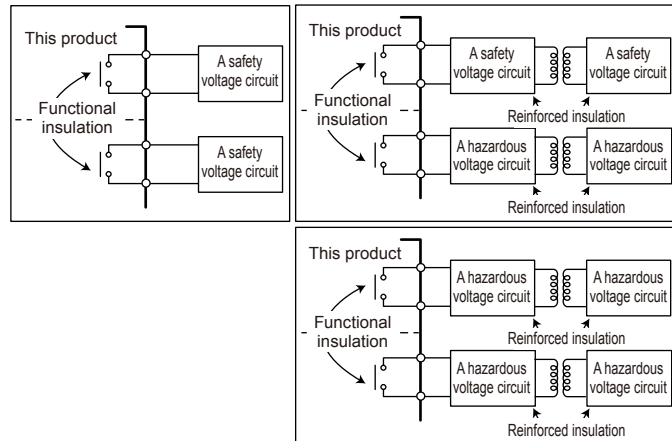
Remote Input with Direct Input (Optional suffix code /DR or /U1) (E1-terminal area)



17.4.4 Control Output (Relay, Triac, Current, and Voltage Pulse) Wiring

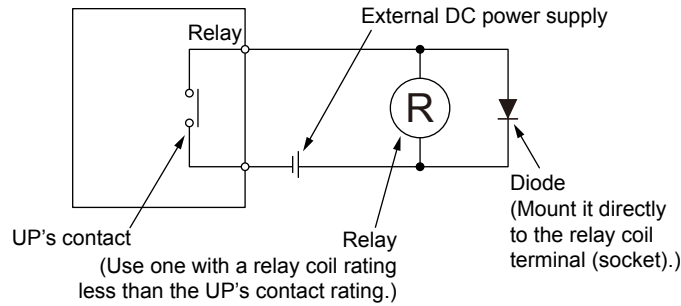
**CAUTION**

- 1) The use of inductance (L) loads such as auxiliary relays, motors and solenoid valves causes malfunction or relay failure; always insert a CR filter for use with alternating current or a diode for use with direct current, as a spark-removal surge suppression circuit, into the line in parallel with the load.
- 2) If there is a risk of external lightning surges, use a lightning arrester etc.
- 3) Relays cannot be used for a small load of 10 mA or less.
- 4) Since the insulation provided to each relay output terminal is Functional insulation, provide Reinforced insulation to the external of the device as necessary. (Refer to the drawing below.)



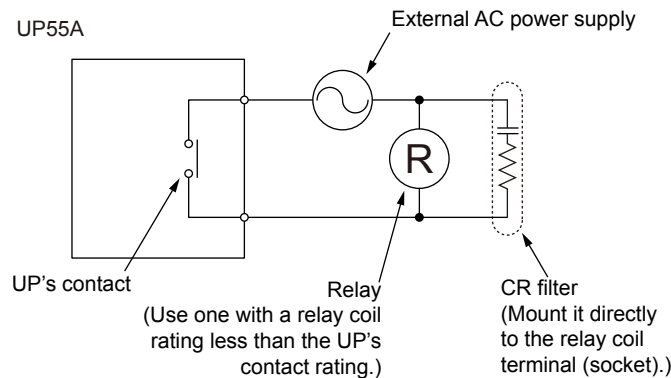
**DC Relay Wiring**

UP55A



**AC Relay Wiring**

UP55A



**Relay Output**

(For Standard model) Standard type output or Heating/cooling type heating-side output (For Detailed model) Suffix code of Output 1 = "R" or "U"	(For Standard model) Heating/cooling type cooling-side output (For Detailed model) Suffix code of Output 2 = "R" or "U"
<p>Contact rating: 250 V AC, 3 A 30 V DC, 3 A (resistance load)</p>	<p>Contact rating: 250 V AC, 3 A 30 V DC, 3 A (resistance load)</p>

Note: Cannot be used for a small load of 10 mA or less.

**Triac Output (for Detailed model)**

Suffix code of Output 1 = "T"	Suffix code of Output 2 = "T"
<p>Contact rating: 75-250 V AC Allowable load current: 0.8 A</p>	<p>Contact rating: 75-250 V AC Allowable load current: 0.8 A</p>

**Current and Voltage Pulse Output**

(For Standard model) Standard type or Heating/cooling type heating-side output (For Detailed model) Suffix code of Output 1 = "A" or "U"	(For Standard model) Heating/cooling type cooling-side output (For Detailed model) Suffix code of Output 2 = "A" or "U"
<p>Control valves (or other actuators) Class D grounding (grounding resistance of 100 Ω or less)</p> <p>Current: 4 to 20 mA DC or 0 to 20 mA DC (resistance load: 600 Ω or less)</p> <p>Voltage pulse: On-voltage: 12 V DC or more (load resistance: 600 Ω or more) Off-voltage: 0.1 V DC or less</p>	<p>Control valves (or other actuators) Class D grounding (grounding resistance of 100 Ω or less)</p> <p>Current: 4 to 20 mA DC or 0 to 20 mA DC (resistance load: 600 Ω or less)</p> <p>Voltage pulse: On-voltage: 12 V DC or more (load resistance: 600 Ω or more) Off-voltage: 0.1 V DC or less</p>

**Use**

When current/voltage pulse output is not used for control output, it can be used for retransmission output.

When retransmission output terminal is not used for retransmission output, it can be used for optional control output. The current output range can be changed.

For control output setting, set the control mode (CTLM) and the control type (CNT), then set the output terminal and output type in the output type selection (OT).

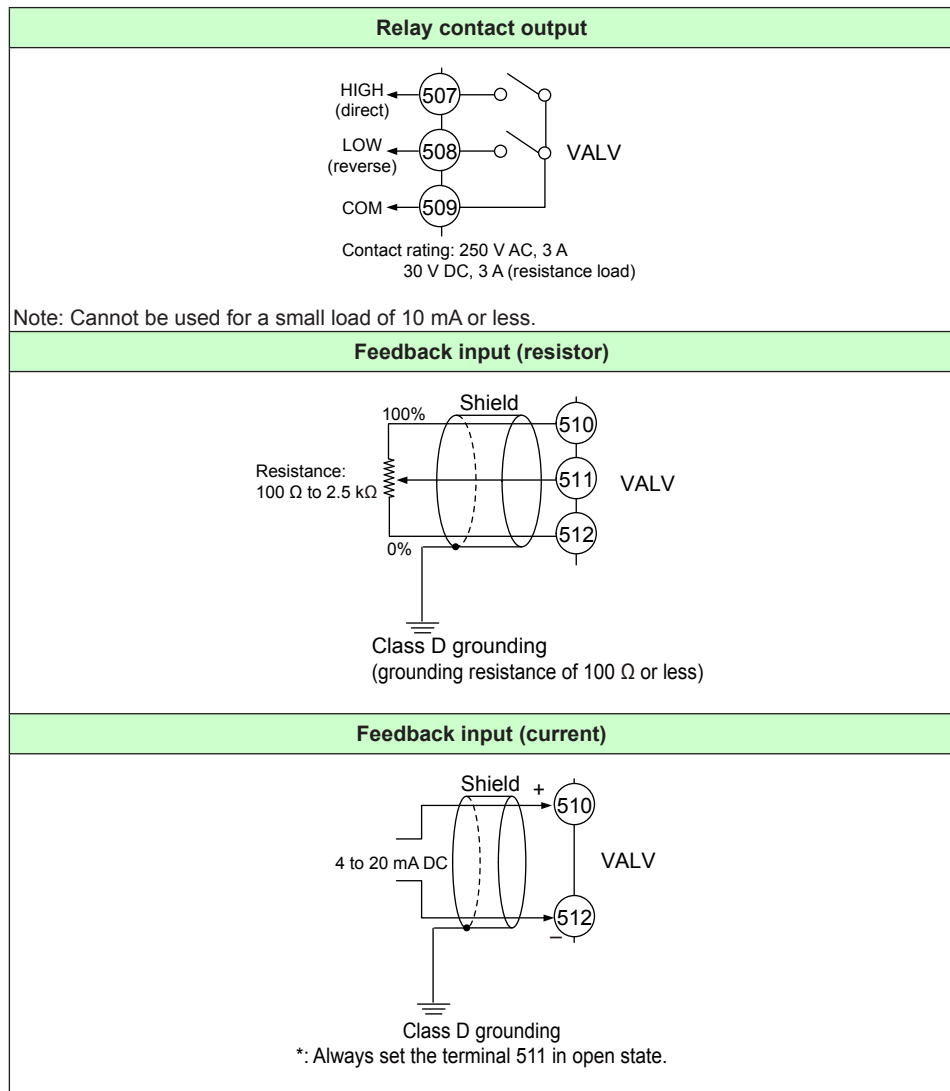
▶ [Control output type: 10.1 Setting Control Output Type](#)

17.4.5 Valve Position Output and Feedback Input Wiring

**CAUTION**

- 1) Use an auxiliary relay for load-switching if the contact rating is exceeded.
- 2) Keep the relay output wires and the feedback input wires at least 30 cm apart.
- 3) The output relay has a limited service life. Be sure to connect a CR filter (for AC) or diode (for DC) to the load.
- 4) If there is a risk of external lightning surges, use a lightning arrester etc.
- 5) Relays cannot be used for a small load of 10 mA or less.

► When using auxiliary relay: 17.4.4 Control Output (Relay, Current, and Voltage Pulse) Wiring

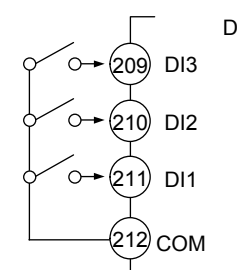
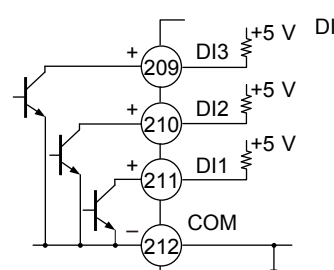


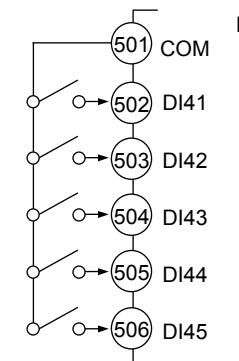
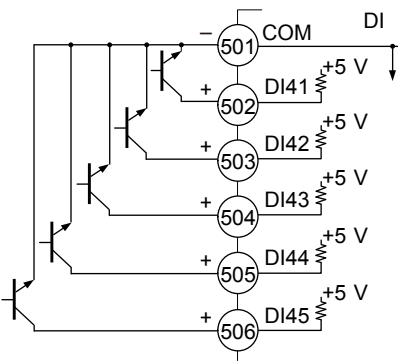
### 17.4.6 Contact Input Wiring

#### CAUTION

- 1) Use a no-voltage contact (relay contact etc.) for external contacts.
- 2) Use a no-voltage contact which has ample switching capacity for the terminal's OFF voltage (approx. 5V) and ON current (approx 1mA).
- 3) When using a transistor contact, the voltage at both terminals must be 2 V or less when the contact is ON and the leakage current must be 100  $\mu$ A or less when it is OFF.
- 4) If there is a risk of external lightning surges, use a lightning arrester etc.

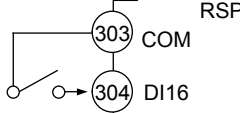
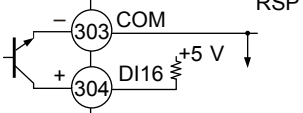
#### Contact Input Equipped as Standard

No-voltage contact	Transistor contact
 <p style="text-align: center;">Contact rating: 12 V DC, 10 mA or more</p>	 <p style="text-align: center;">Contact rating: 12 V DC, 10 mA or more</p>

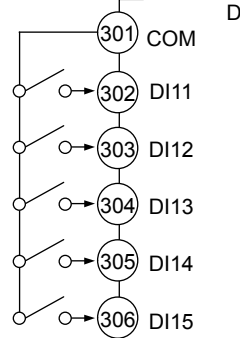
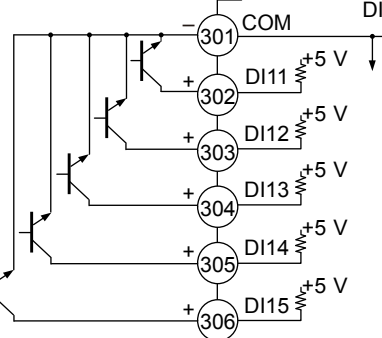
Suffix code (for Standard model): Type 2#2 or 4 Optional suffix code (for Detailed model):/X4	
No-voltage contact	Transistor contact
 <p style="text-align: center;">Contact rating: 12 V DC, 10 mA or more</p>	 <p style="text-align: center;">Contact rating: 12 V DC, 10 mA or more</p>

**Additional Contact Input According to the UP55A Suffix Codes**

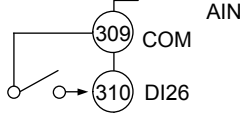
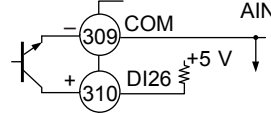
**Suffix codes (for Standard model): Type 2=1 or 4; however, without optional suffix code /DR  
Optional suffix code (for Detailed model): /R1**

Non-voltage contact	Transistor contact
 <p>RSP COM DI16</p> <p>Contact rating: 12 V DC, 10 mA or more</p>	 <p>RSP COM DI16 +5 V</p> <p>Contact rating: 12 V DC, 10 mA or more</p>

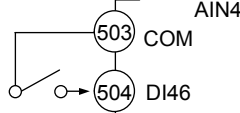
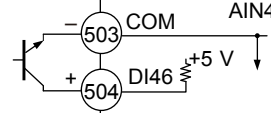
**Suffix code (for Standard model): Type 2=2  
Optional suffix code (for Detailed model): /X1**

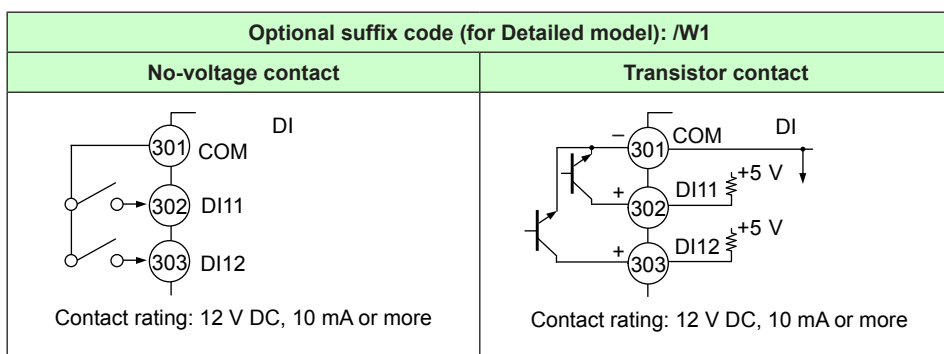
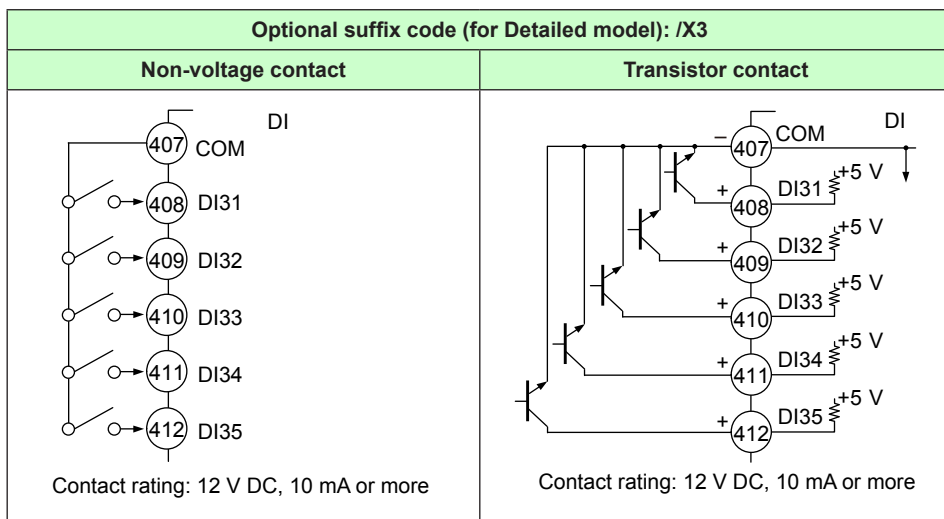
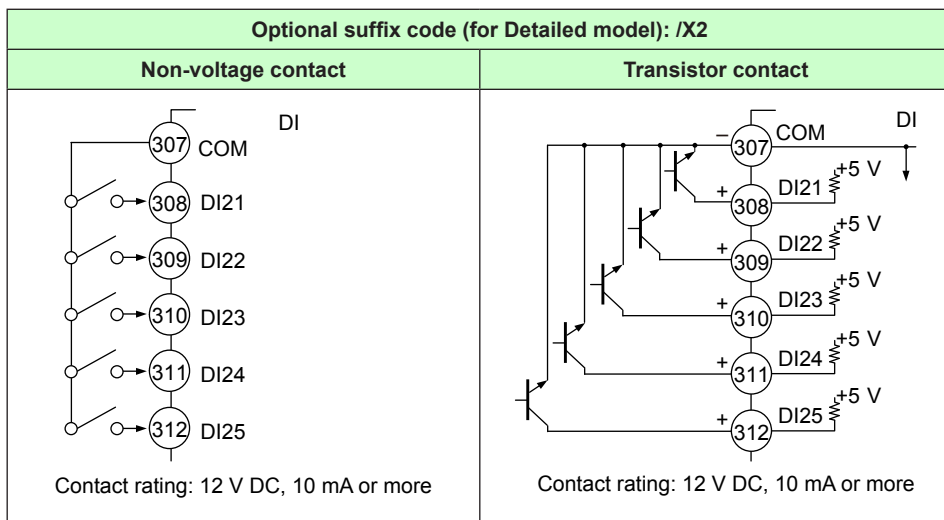
Non-voltage contact	Transistor contact
 <p>DI COM DI11 DI12 DI13 DI14 DI15</p> <p>Contact rating: 12 V DC, 10 mA or more</p>	 <p>DI COM DI11 DI12 DI13 DI14 DI15 +5 V +5 V +5 V +5 V +5 V</p> <p>Contact rating: 12 V DC, 10 mA or more</p>

**Suffix code (for Standard model): Type 2=4  
Optional suffix code (for Detailed model): /A2**

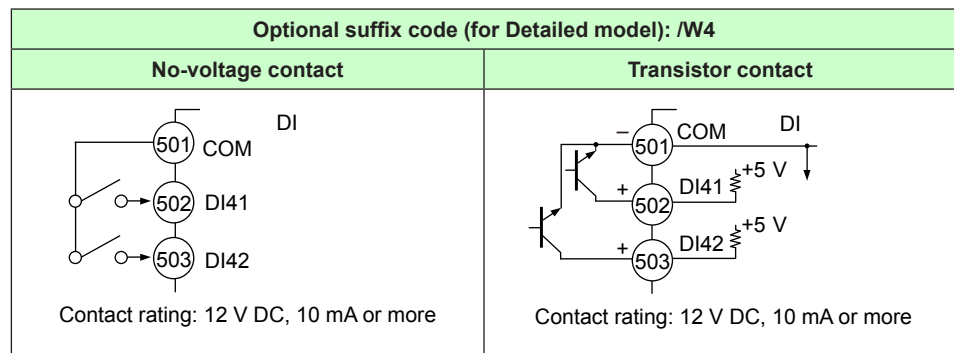
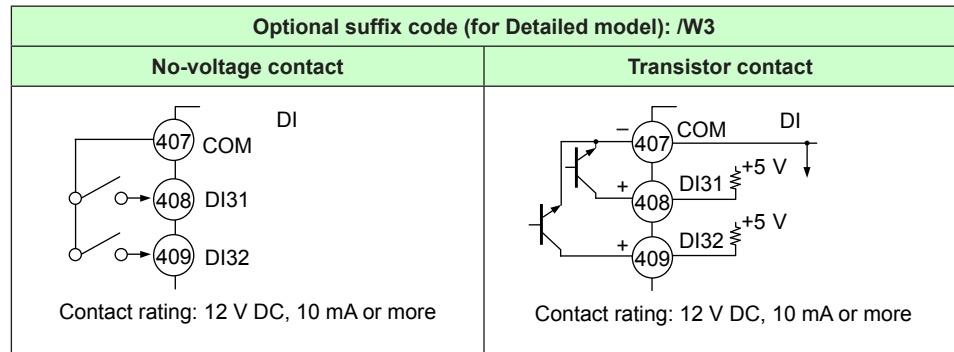
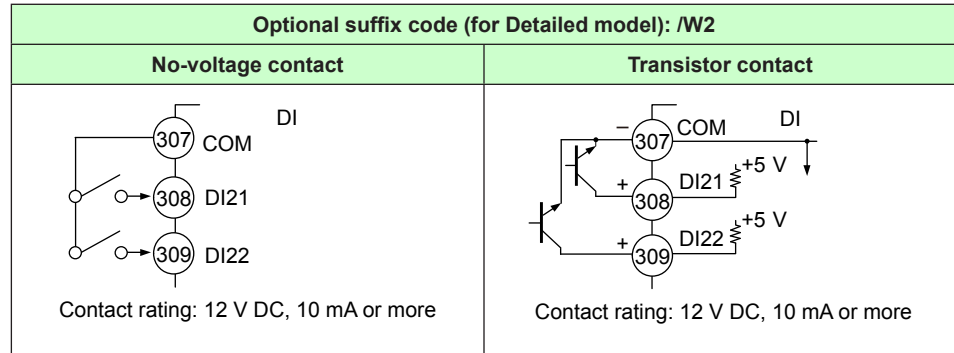
Non-voltage contact	Transistor contact
 <p>AIN2 COM DI26</p> <p>Contact rating: 12 V DC, 10 mA or more</p>	 <p>AIN2 COM DI26 +5 V</p> <p>Contact rating: 12 V DC, 10 mA or more</p>

**Suffix code (for Standard model): Type 2=4  
Optional suffix code (for Detailed model): /A4**

No-voltage contact	Transistor contact
 <p>AIN4 COM DI46</p> <p>Contact rating: 12 V DC, 10 mA or more</p>	 <p>AIN4 COM DI46 +5 V</p> <p>Contact rating: 12 V DC, 10 mA or more</p>







The function is assigned to contact inputs for each control mode and control type.

- ▶ [Initial value of Contact input function: 8.1 Setting Control Mode \(CTLM\)](#)
- ▶ [Contact input function registration: 12.1 Setting Contact Input Function](#)

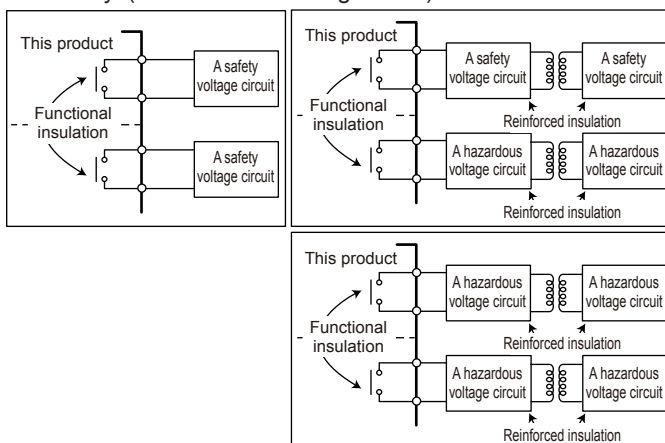
**Note**

If the /DR option is additionally specified to the remote input, the remote Input with direct input can be used as remote input.  
 However, DI16 is to be deleted. (See 17.4.3 Remote (Auxiliary Analog) Input Wiring)

### 17.4.7 Contact Output Wiring

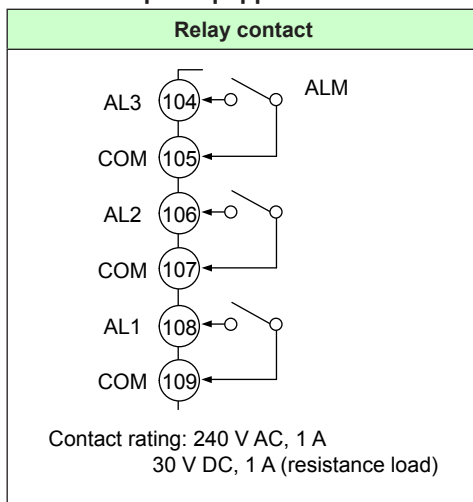
#### CAUTION

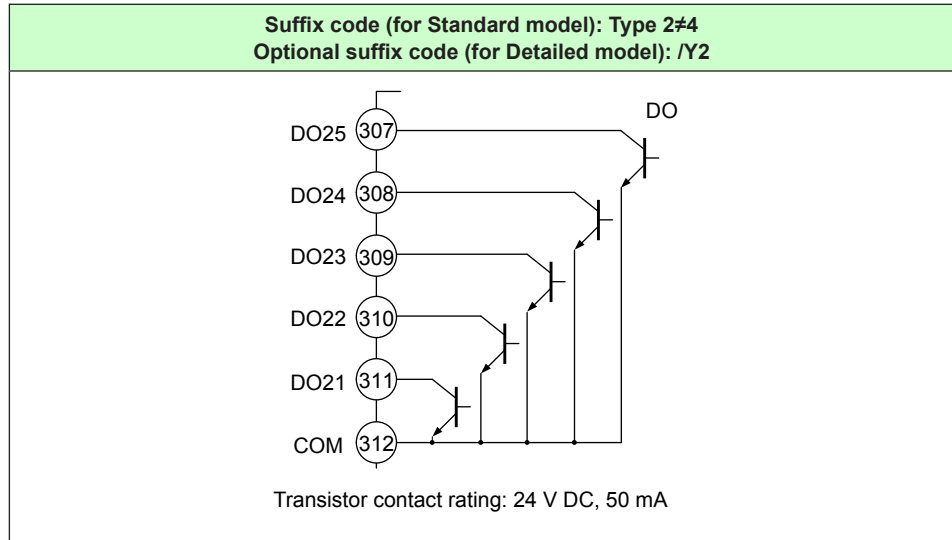
- 1) Use an auxiliary relay for load-switching if the contact rating is exceeded.
- 2) Connect a bleeder resistor when a small current is used, so that a current exceeding 10 mA can be supplied.
- 3) The output relay has a limited service life. Be sure to connect a CR filter (for AC) or diode (for DC) to the load.
- 4) If there is a risk of external lightning surges, use a lightning arrester etc.
- 5) Since the insulation provided to each relay output terminal is Functional insulation, provide Reinforced insulation to the external of the device as necessary. (Refer to the drawing below.)



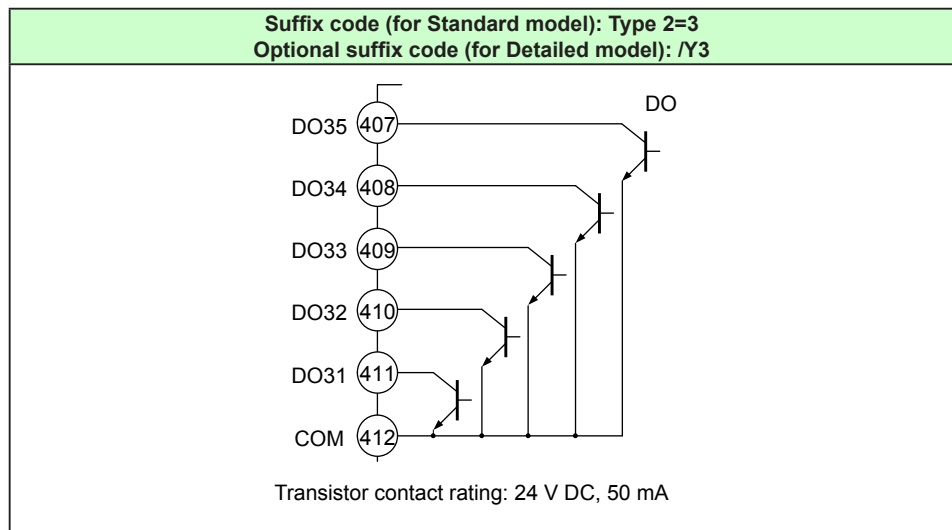
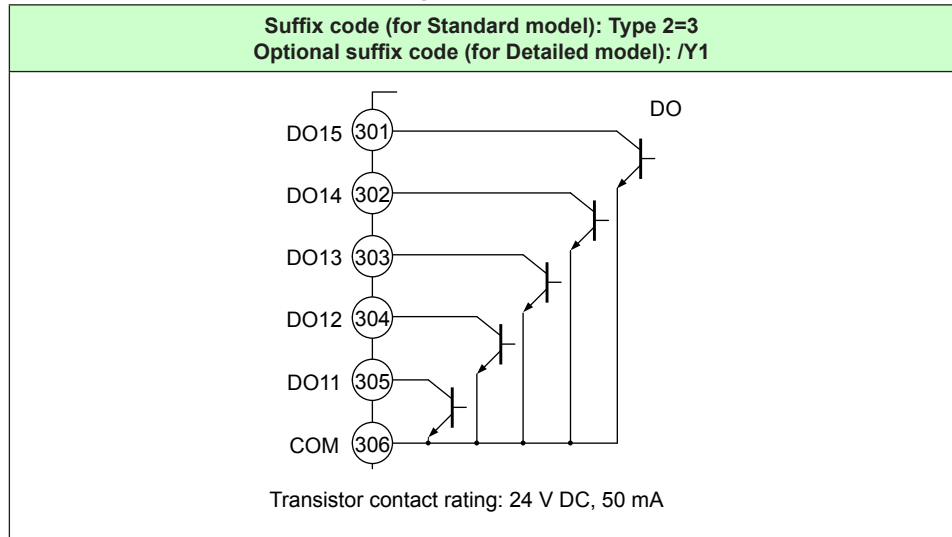
► When using auxiliary relay: 17.4.4 Control Output (Relay, Current, and Voltage Pulse) Wiring

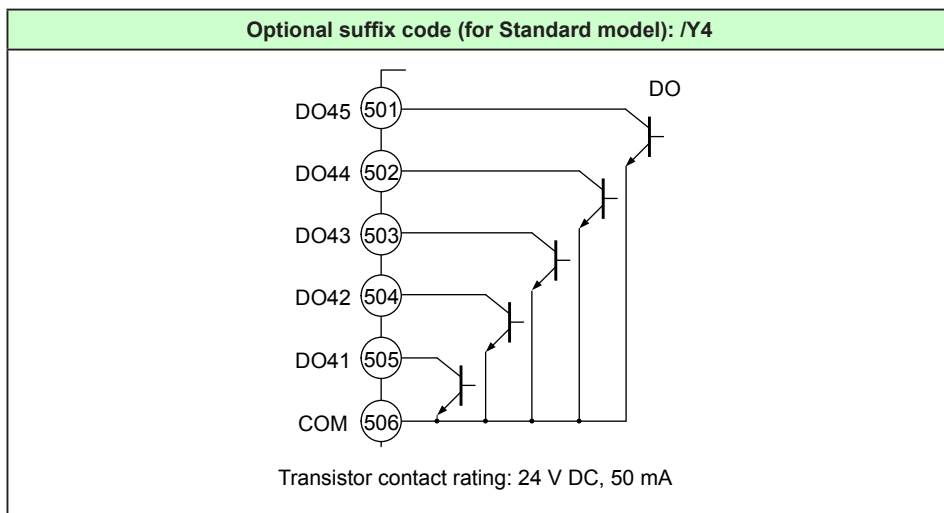
#### Contact Output Equipped as Standard





**Additional Contact Output According to the Suffix Codes**





Optional suffix code (for Detailed model): /W1	Optional suffix code (for Detailed model): /W2
<p style="text-align: center;">Transistor contact rating: 24 V DC, 50 mA</p>	<p style="text-align: center;">Transistor contact rating: 24 V DC, 50 mA</p>
Optional suffix code (for Detailed model): /W3	Optional suffix code (for Detailed model): /W4
<p style="text-align: center;">Transistor contact rating: 24 V DC, 50 mA</p>	<p style="text-align: center;">Transistor contact rating: 24 V DC, 50 mA</p>

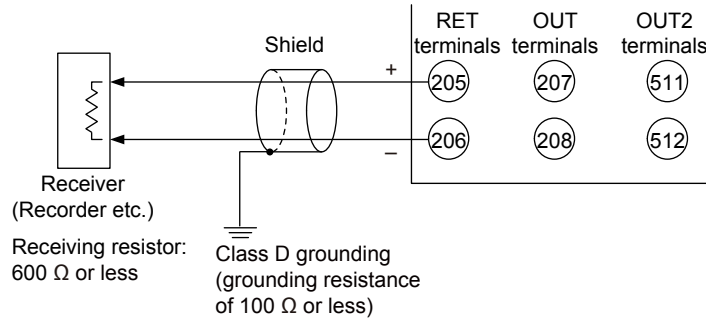
The function is assigned to contact outputs for each control mode and control type.

- ▶ Initial value of Contact output function: 8.1 Setting Control Mode (CTLM)
- ▶ Contact output function registration: 12.2 Setting Contact Output Function

### 17.4.8 Retransmission Output Wiring

When retransmission output is not used for retransmission output, it can be used for 15 V DC loop power supply.

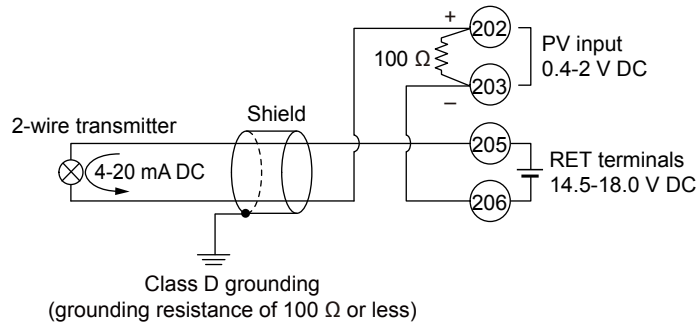
The current output range can be changed.



### 17.4.9 15 V DC Loop Power Supply Wiring

This can be used when it is not used for retransmission output.

The controller is equipped with a non-isolated loop power supply (14.5 to 18.0 V DC) for connecting a 2-wire transmitter.

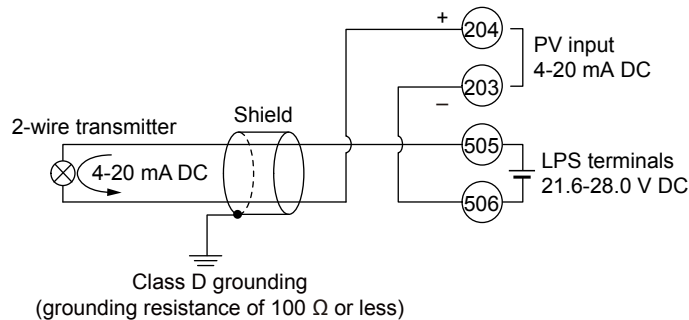


OUT terminal and OUT2 terminal also can be used.

### 17.4.10 24 V DC Loop Power Supply Wiring (for Detailed model)

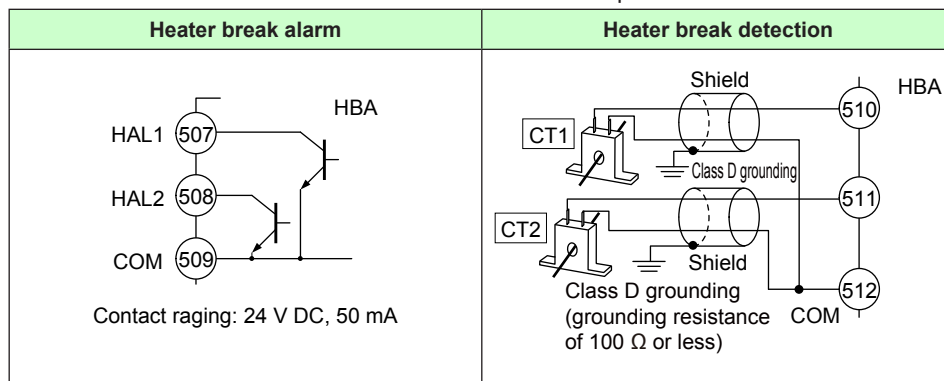
This can be used when the optional suffix code /L4, or /LC4 is specified.

The controller with the optional suffix code above is equipped with an isolated loop power supply (21.6 to 28.0 V DC) for connecting a 2-wire transmitter.



### 17.4.11 Heater Break Alarm Wiring

Heater break alarm can be used for the UP55A with the optional suffix code /HA.



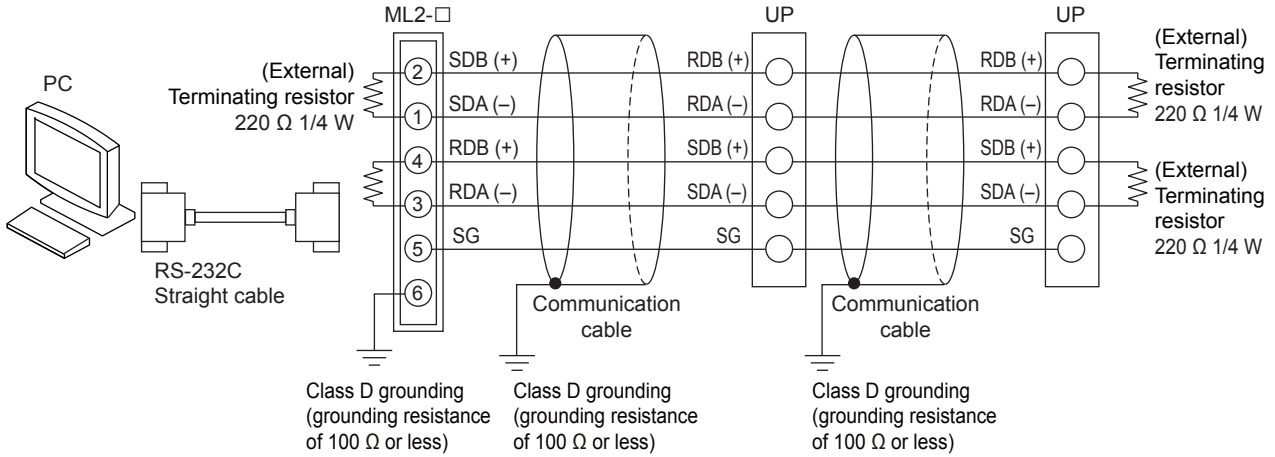
### 17.4.12 RS-485 Communication Interface Wiring

Wire as follows for Modbus communication, PC link communication, or ladder communication.

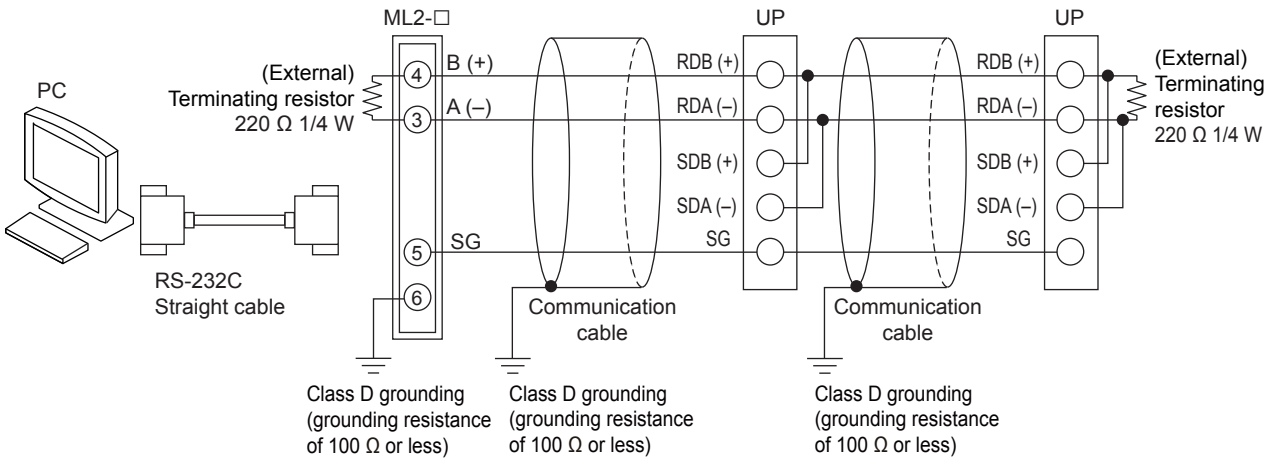
Always connect a terminating resistor to the station at the end of the communication line.

► [Details of communication parameter settings and communication functions: UTAdvanced Series Communication Interface \(RS-485, Ethernet\) User's Manual](#)

#### 4-wire Wiring

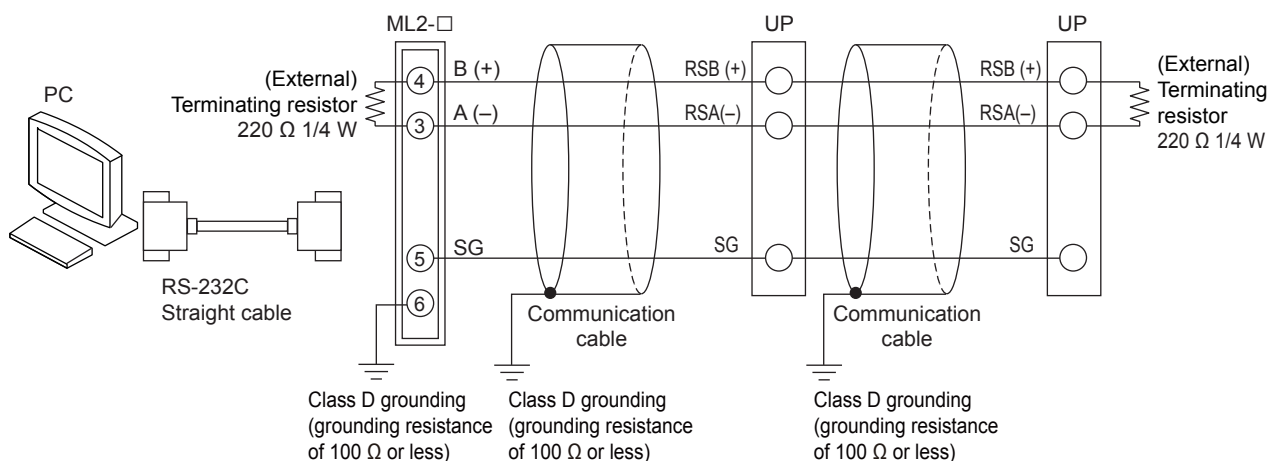


#### 2-wire Wiring of 4-wire Terminal



Terminal symbol above.	Applicable to suffix code (for Standard model): Type 3 = 1; however, Type 2 = 3 excluded Applicable to optional suffix code (for Detailed model): /CH3	Applicable to suffix code (for Standard model): Type 2 = 2 Applicable to optional suffix code (for Detailed model): /C4
RDB (+)	410	504
RDA (-)	411	505
SDB (+)	407	501
SDA (-)	408	502
SG	409	503

2-wire Wiring



Terminal symbol above.	Applicable to optional suffix code (for Detailed model): /LC4 or /AC4
RSB (+)	501
RSA (-)	502
SG	503

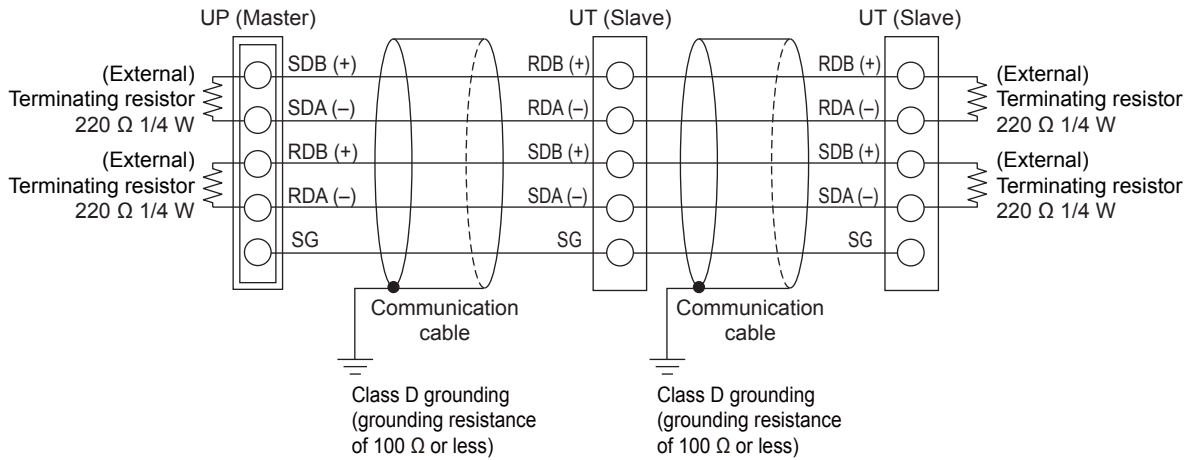
**Note**

ML2-x indicates a converter of YOKOGAWA. Other than this, RS232C/RS485 converters can also be used. If another converter is to be used, check the electrical specifications of the converter before using it.

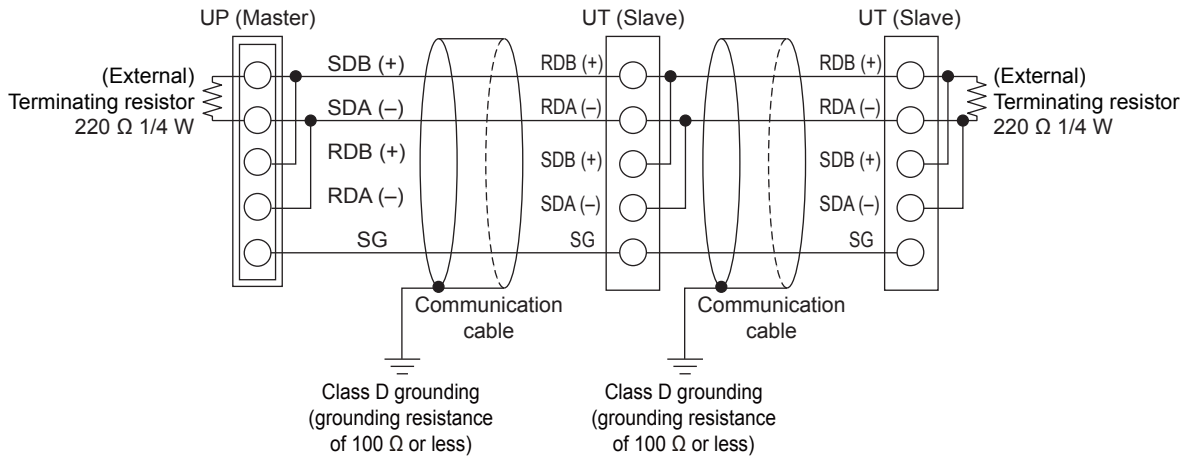


17.4.13 Coordinated Operation Wiring

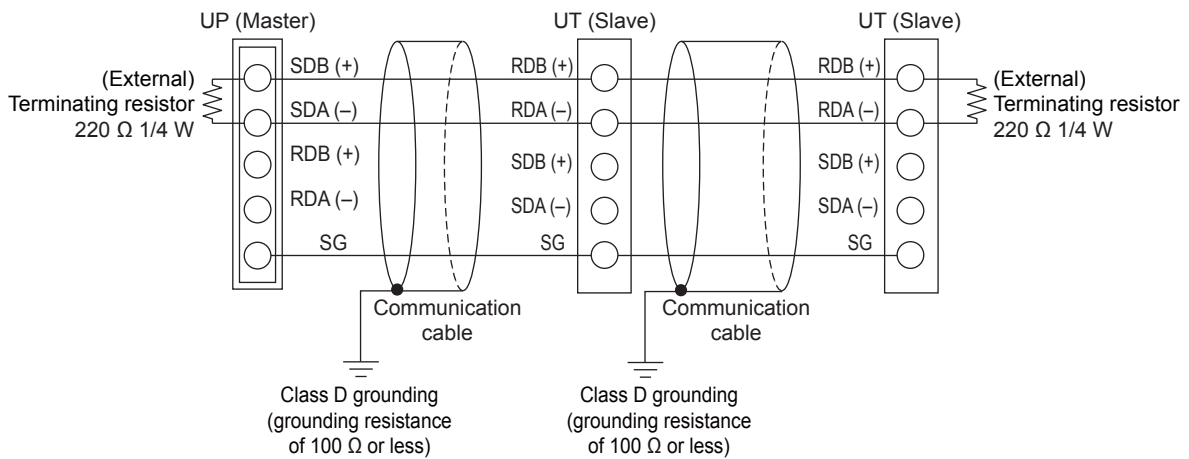
4-wire Wiring



2-wire Wiring of 4-wire Terminal (1)

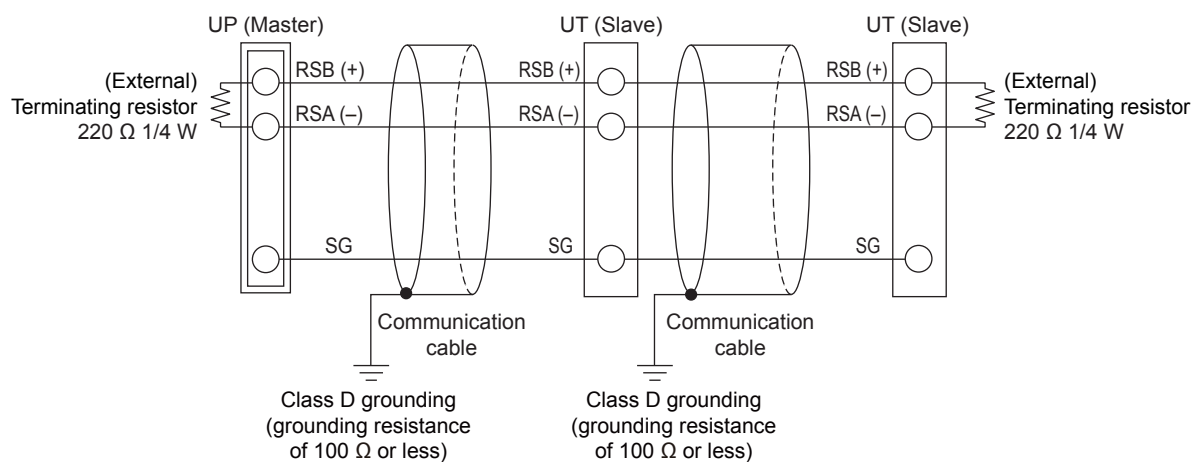


2-wire Wiring of 4-wire Terminal (2)



Terminal symbol above.	Applicable to suffix code (for Standard model): Type 3 = 1; however, Type 2 = 3 excluded Applicable to optional suffix code (for Detailed model): /CH3	Applicable to suffix code (for Standard model): Type 2 = 2 Applicable to optional suffix code (for Detailed model): /C4
RDB (+)	410	504
RDA (-)	411	505
SDB (+)	407	501
SDA (-)	408	502
SG	409	503

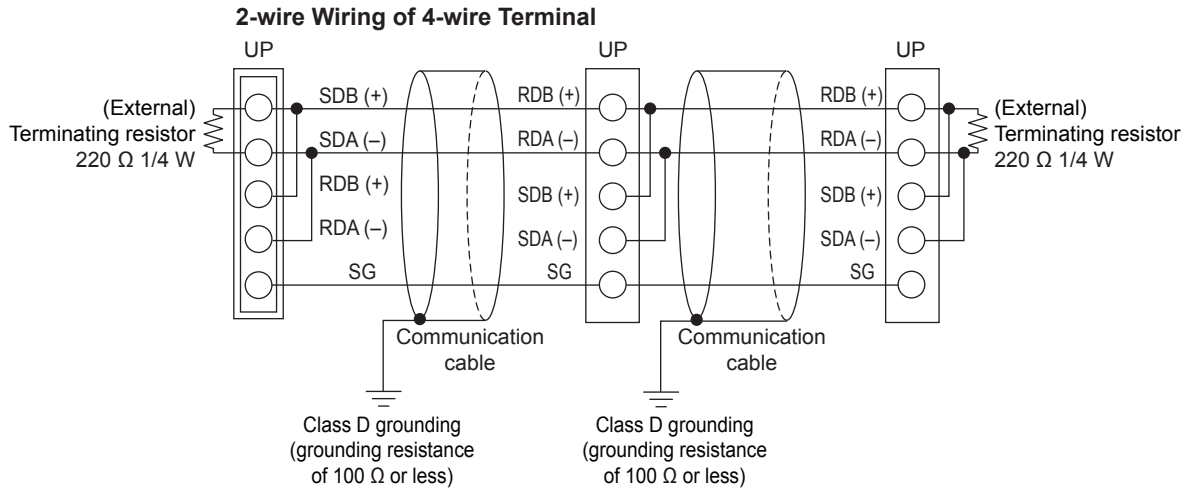
**2-wire Wiring**



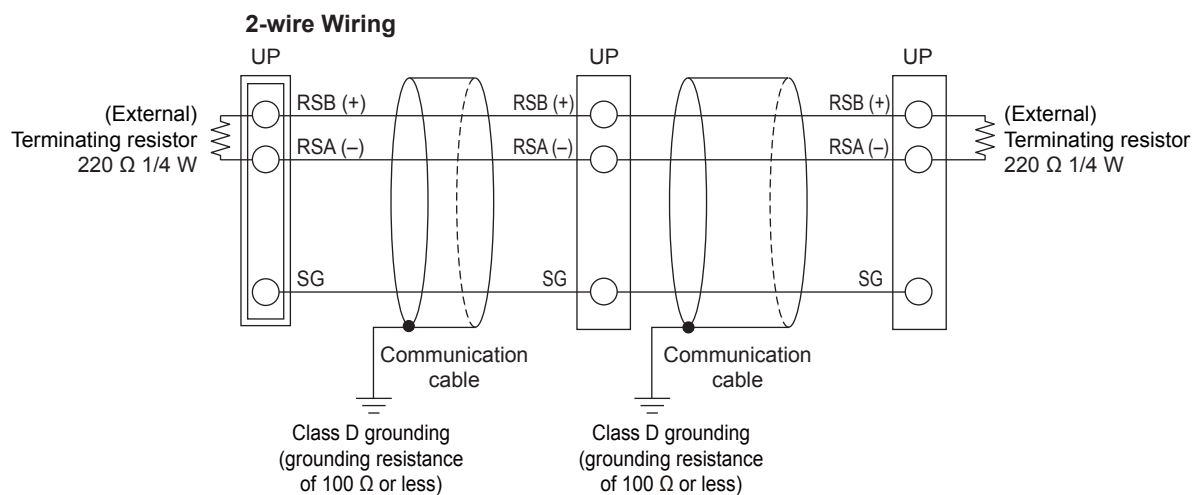
Terminal symbol above.	Applicable to suffix code (for Detailed model): /LC4 or /AC4
RSB (+)	501
RSA (-)	502
SG	503

17.4.14 Peer-to peer Communication Wiring

Peer-to-peer communication can be used on ladder program of UP55A.



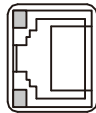
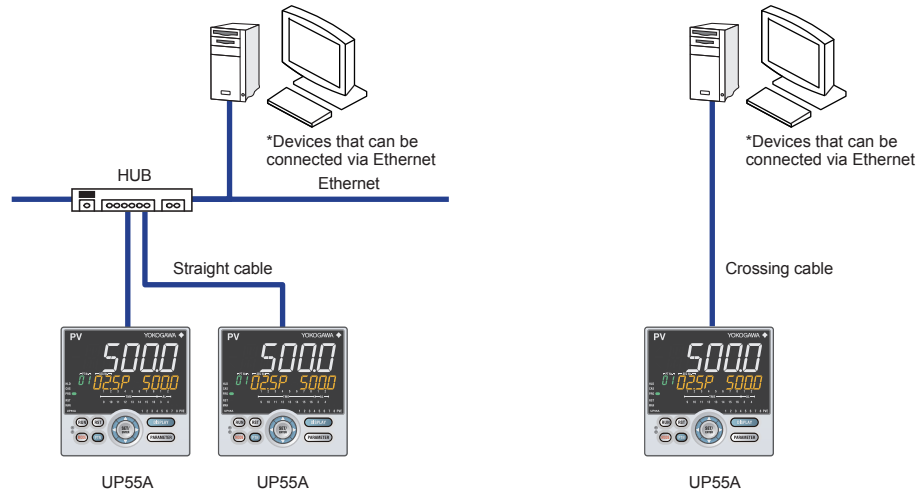
Terminal symbol above.	Applicable to suffix code (for Standard model): Type 3 = 1; however, Type 2 = 3 excluded Applicable to optional suffix code (for Detailed model): /CH3	Applicable to suffix code (for Standard model): Type 2 = 2 Applicable to optional suffix code (for Detailed model): /C4
RDB (+)	410	504
RDA (-)	411	505
SDB (+)	407	501
SDA (-)	408	502
SG	409	503



Terminal symbol above.	Applicable to suffix code (for Detailed model): /LC4 or /AC4
RSB (+)	501
RSA (-)	502
SG	503

- ▶ Details of communication parameter settings and communication functions: UTAdvanced Series Communication Interface (RS-485, Ethernet) User's Manual
- ▶ Details of Peer-to-peer communication: LL50A Parameter Setting Software User's Manual

17.4.15 Ethernet Communication Interface Wiring



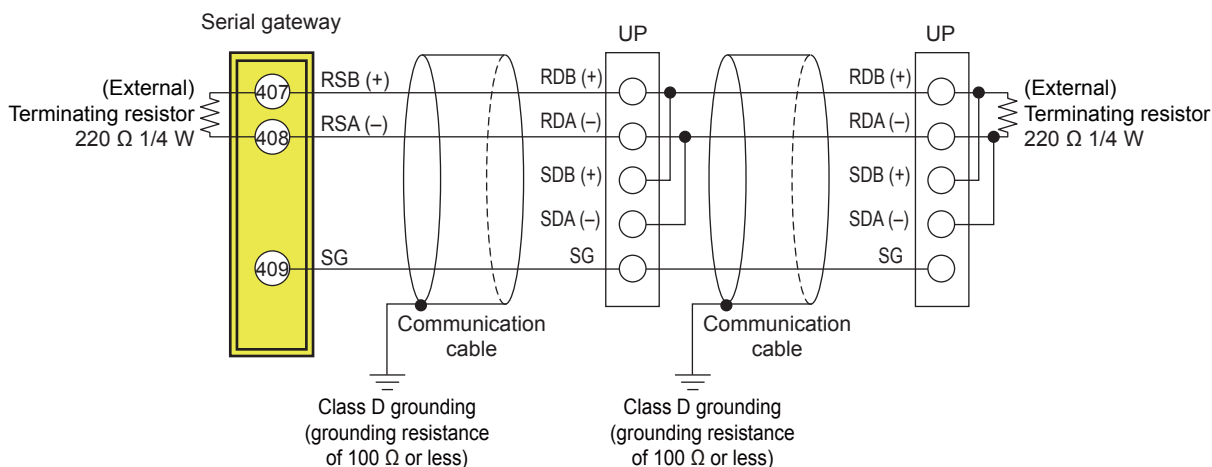
Upper side LED (baud rate)		Lower side LED (link activity)	
Color	Amber	Color	Green
Lit	100M bps	Lit	Linked
Unlit	10M bps	Blink	Active
		Unlit	Link failure

**CAUTION**

Be sure to connect a lightning arrester for Ethernet (100BASE-TX/10BASE-T) in an environment where a surge voltage may be induced by a lightning discharge.

RS-485 communication wiring for the serial gateway function is as follows.

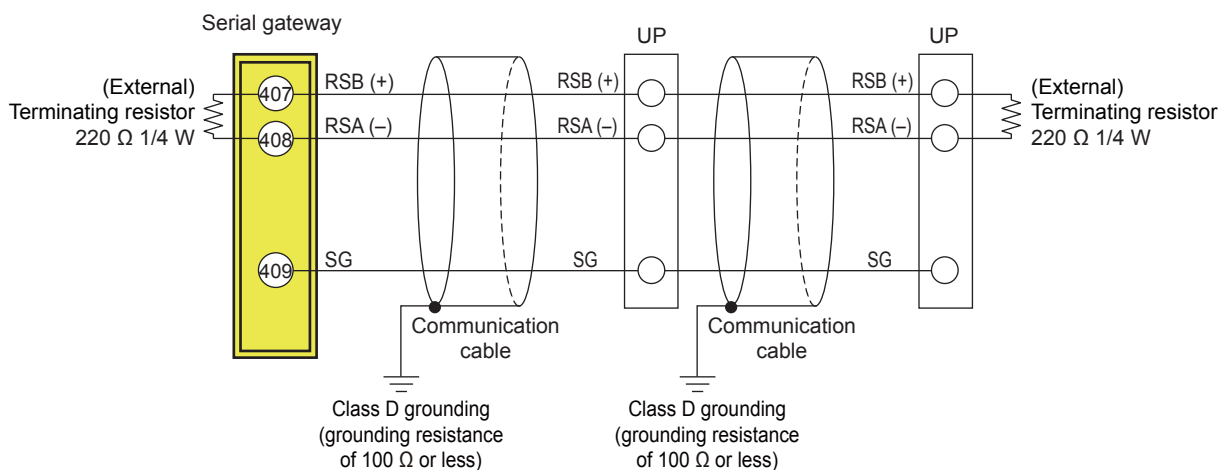
**2-wire Wiring of 4-wire Terminal**



**Slave terminals**

Terminal symbol above.	Applicable to suffix code (for Standard model): Type 3 = 1; however, Type 2 = 3 excluded Applicable to optional suffix code (for Detailed model): /CH3	Applicable to suffix code (for Standard model): Type 2 = 2 Applicable to optional suffix code (for Detailed model): /C4
RDB (+)	410	504
RDA (-)	411	505
SDB (+)	407	501
SDA (-)	408	502
SG	409	503

**2-wire Wiring**

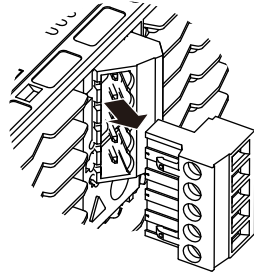


**Slave terminals**

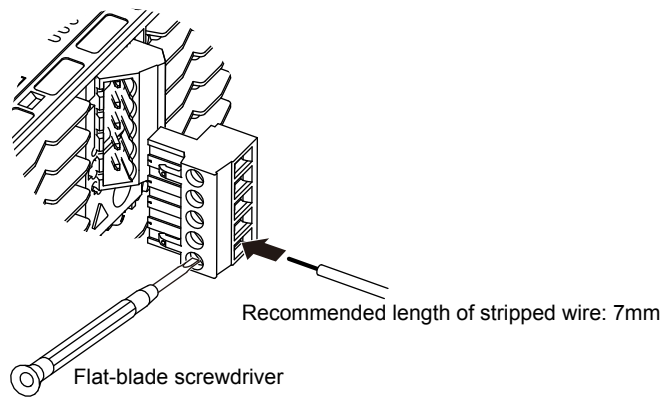
Terminal symbol above.	Applicable to optional suffix code (for Detailed model): /LC4 or /AC4
RSB (+)	501
RSA (-)	502
SG	503

## 17.4.16 PROFIBUS-DP Communication Interface Wiring

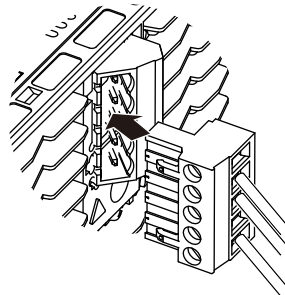
- (1) Remove the terminal block  
Hold both ends of the terminal block and pull straight.



- (2) Connect the wires



- (3) Connect the terminal block  
Hold both ends of the terminal block, align with the connector on the UT side, and push the terminal block into the connector.



### Multiple wiring (multi-drop) of connector

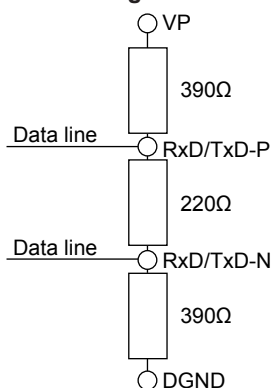
Multiple wiring of the UTAdvanced connector with other devices is possible within the following multi-wire connection capacity range.

Multi-wire connection capacity (Two wires with the same cross-sectional area)

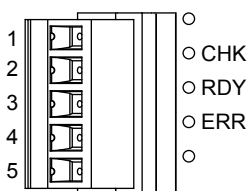
- Single wire 0.2 to 1.0 mm<sup>2</sup>/twisted wire 0.2 to 1.5 mm<sup>2</sup>
- Twisted wire with bar terminal (without plastic sleeve) 0.25 to 1.0 mm<sup>2</sup>
- Twisted wire with twin bar terminals (with plastic sleeve) 0.5 to 1.5 mm<sup>2</sup>

Number of Pin	Singnal name	Description
1	VP	+5V bus power
2	RxD/TxD-P	Data signal (positive data receive/transmit)
3	RxD/TxD-N	Data signal (negative data recive/transmit)
4	DGND	Signal ground
5	SHIELD	Shield ground

**Terminating Resister of Bus**



**PROFIBUS-DP communication connector and LED**



LED	Lit	Unlit
CHK (red)	User profile error	Normal
RDY (green)	Normal. Communicating successfully.	No electricity, or Communication failure
ERR (red)	Not connected, or communication failure (flashing)	Normal

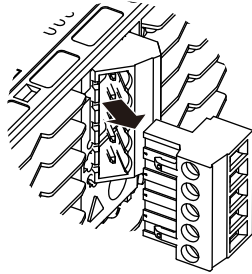
**Modbus master wiring**

Modbus master wiring is same as RS-485 communication wiring for Ethernet-serial gateway function.

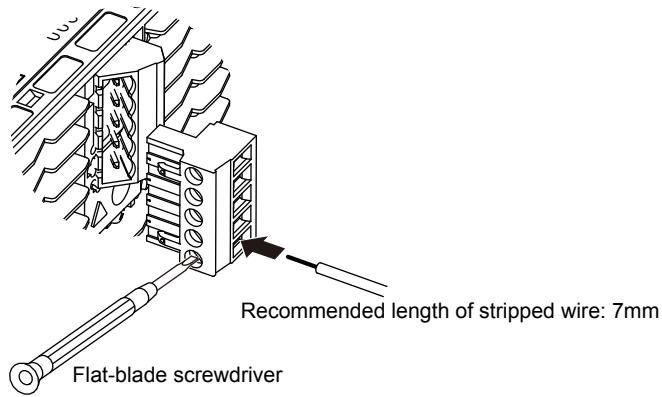


## 17.4.17 DeviceNet Communication Interface Wiring

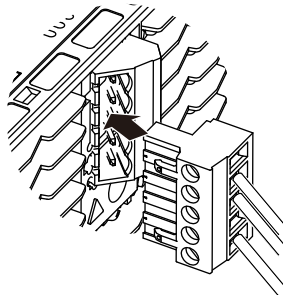
- (1) Remove the terminal block  
Hold both ends of the terminal block and pull straight.



- (2) Connect the wires



- (3) Connect the terminal block  
Hold both ends of the terminal block, align with the connector on the UT side, and push the terminal block into the connector.



### Multiple wiring (multi-drop) of connector

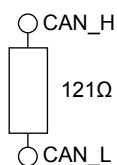
Multiple wiring of the UTAdvanced connector with other devices is possible within the following multi-wire connection capacity range.

Multi-wire connection capacity (Two wires with the same cross-sectional area)

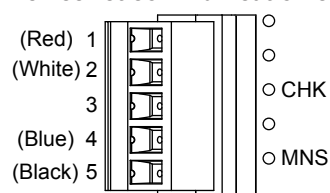
- Single wire 0.2 to 1.0 mm<sup>2</sup>/twisted wire 0.2 to 1.5 mm<sup>2</sup>
- Twisted wire with bar terminal (without plastic sleeve) 0.25 to 1.0 mm<sup>2</sup>
- Twisted wire with twin bar terminals (with plastic sleeve) 0.5 to 1.5 mm<sup>2</sup>

Number of Pin	Singnal name	Description
1	V+	Power supply 24V for DeviceNet
2	CAN_H	RX/TX + signal
3	DRAIN	Shield/drain
4	CAN_L	RX/TX - signal
5	V-	Power supply COM for DeviceNet

**Terminating Resistor of Bus (both ends of the trunk line)**



**DeviceNet communication connector and LED**



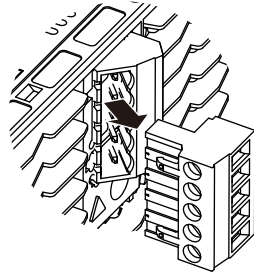
LED	Lit / flashing	Unlit
CHK (red)	User profile error	Normal
MNS (green/red)	Normal. Communicating successfully (green, lit). Not connected (green, flashing).	No electricity,
	Critical link failure (red, lit). Connection timeout (red, flashing)	
	At power-on/Communication faulted (green/red, flashing)	

**Modbus master wiring**

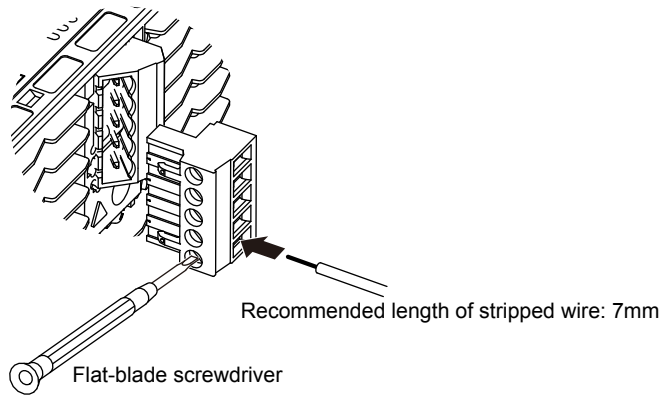
Modbus master wiring is same as RS-485 communication wiring for Ethernet-serial gateway function.

## 17.4.18 CC-Link Communication Interface Wiring

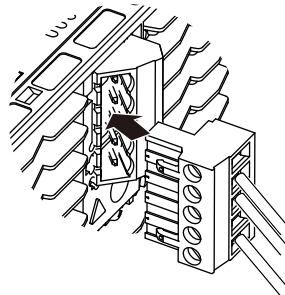
- (1) Remove the terminal block  
Hold both ends of the terminal block and pull straight.



- (2) Connect the wires



- (3) Connect the terminal block  
Hold both ends of the terminal block, align with the connector on the UT side, and push the terminal block into the connector.



### Multiple wiring (multi-drop) of connector

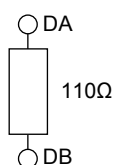
Multiple wiring of the UTAdvanced connector with other devices is possible within the following multi-wire connection capacity range.

Multi-wire connection capacity (Two wires with the same cross-sectional area)

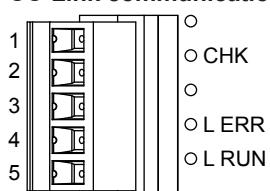
- Single wire 0.2 to 1.0 mm<sup>2</sup>/twisted wire 0.2 to 1.5 mm<sup>2</sup>
- Twisted wire with bar terminal (without plastic sleeve) 0.25 to 1.0 mm<sup>2</sup>
- Twisted wire with twin bar terminals (with plastic sleeve) 0.5 to 1.5 mm<sup>2</sup>

Number of Pin	Singnal name	Description
1	FG	Frame ground
2	SLD	Shield
3	DG	TX/RX signal ground
4	DB	RX/TX - signal
5	DA	RS/TX + signal

#### Terminating Resistor of Bus (both ends of the trunk line)



#### CC-Link communication connector and LED



LED	Lit	Unlit
CHK (red)	User profile error / address error	Normal
L ERR (red)	Communication failure (CRC error)	Normal
L RUN (green)	Normal. Communicating successfully.	No carrier detected. / Connection timeout.

#### Modbus master wiring

Modbus master wiring is same as RS-485 communication wiring for Ethernet-serial gateway function.

### 17.4.19 Power Supply Wiring

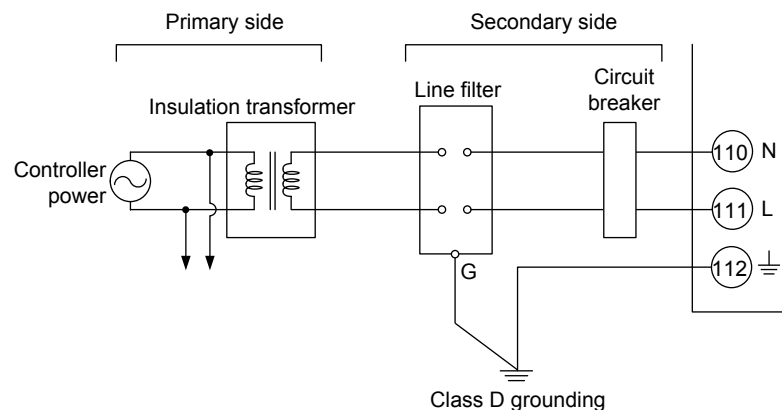


#### WARNING

- 1) Wiring work must be carried out by a person with basic electrical knowledge and practical experience.
- 2) Be sure to turn OFF the power supply to the controller before wiring to avoid an electric shock. Use a tester or similar device to ensure that no power is being supplied to a cable to be connected.
- 3) As a safety measure, always install a circuit breaker (an IEC 60947-compatible product, 5 A, 100 V or 220 V AC) in an easily accessible location near the instrument. Moreover, provide indication that the switch is a device for turning off the power to the instrument.
- 4) Install the power cable keeping a distance of more than 1 cm from other signal wires.
- 5) The power cable is required to meet the IEC standards concerned or the requirements of the area in which the instrument is being installed.
- 6) Wiring should be installed to conform to NEC (National Electrical Code: ANSI/NFPA-70) or the wiring construction standards in countries or regions where wiring will be installed.
- 7) Be sure to use a heat-resistant cable for control output, alarm output, and power wiring.

#### CAUTION

- 1) Provide electricity from a single-phase power supply. If the power is noisy, install an isolation transformer on the primary side, and use a line filter on the secondary side. When measures against noise are taken, do not install the primary and secondary power cables close to each other.
- 2) If there is a risk of external lightning surges, use a lightning arrester etc.



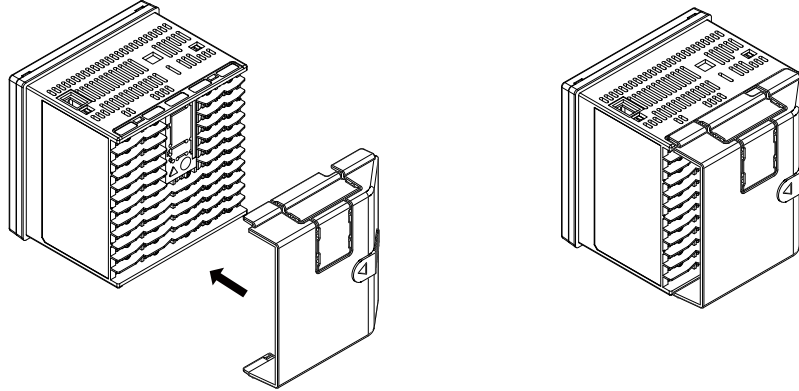
## 17.5 Attaching and Detaching Terminal Cover

After completing the wiring, the terminal cover is recommended to use for the instrument.

### Attaching Method

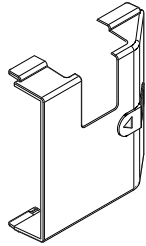
(1) Attach the terminal cover to the rear panel of the main unit horizontally.

(2) The following figure is a mounting image.



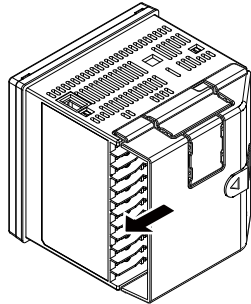
When Ethernet, PROFIBUS-DP, DeviceNet or CC-Link communication is specified, cut and use a terminal cover as follows.

Cut the cover carefully using nippers etc. so that sharp edge does not remain.



### Detaching Method

(1) Slide the terminal cover to the direction of the printed arrow.





# 18.1 Parameter Map

## Brief Description of Parameter Map

### Group Display

"E1 to E4" and "1 to 8, R" appearing in the parameter map are displayed on Group display (7 segments, 2 digits) while the menu or parameter is displayed.

**E1:** indicates the parameter in E1-terminal area

**E2:** indicates the parameter in E2-terminal area

**E3:** indicates the parameter in E3-terminal area

**E4:** indicates the parameter in E4-terminal area

1 to 8, R: indicate the group numbers

► [E1 to E4: Terminal assignments in 17.4 Wiring](#)



### Loop-2 Display

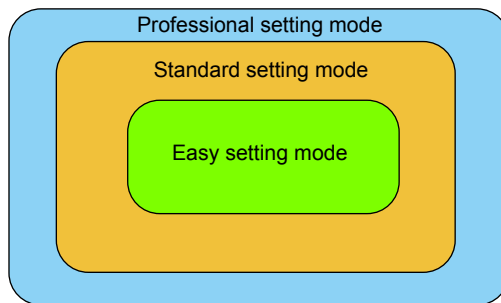
"LP2" appearing in the parameter map indicates that the LP2 lamp (green) is lit.

**LP2:** indicates that the parameter is for Loop 2. Loop 2 is used when the control mode is Cascade control.

### Parameter Display Level

The marks below appearing next to the menu symbol and parameter symbol in the parameter map indicate the display/non-display level.

Mark	Display	Display level	Description
None	EASY	Easy setting mode: Displays the minimum parameters.	Corresponding parameters are displayed in all modes.
	STD	Standard setting mode: Displays a wider range of parameters than displayed in the Easy setting mode.	Corresponding parameters are displayed only in Standard setting mode and Professional setting mode. Parameter display level indicators "EASY" and "PRO" are unlit in Standard setting mode. *: "STD" is the symbol used in this manual only.
	PRO	Professional setting mode: Displays all parameters.	Corresponding parameters are displayed only in Professional setting mode.



► [Display level: 13.3.2 Setting Parameter Display Level](#)



**Function of Each Menu**

Menu symbol	Function
<b>MODE</b>	Operation mode (PROG/RESET/LOCAL/REM switch, Auto-tuning switch, etc.)

The parameters in the menu of the following table indicate the parameters to set the functions necessary for operation. The symbol in parentheses are shown on Group display.

Menu symbol	Function
<b>CS</b>	SELECT parameter
<b>PROG</b>	Program pattern setting function
<b>LOC</b>	Local setting function
<b>EDIT</b>	Editing function
<b>AL</b>	Alarm setpoint
<b>SPS</b>	SP-related function
<b>ALRM</b>	Alarm function
<b>PVS</b>	PV-related function
<b>PID</b>	PID setting
<b>TUNE</b>	Super, Super 2, Sample PI control, non-linear PID control, anti-reset windup, output velocity limiter, and manual preset output
<b>ZONE</b>	Zone control
<b>AL (LP2)</b>	Alarm setpoint (Loop 2)
<b>ALRM (LP2)</b>	Alarm function (Loop 2)
<b>PVS (LP2)</b>	PV-related function (Loop 2)
<b>PID (LP2)</b>	PID setting (Loop 2)
<b>TUNE (LP2)</b>	Super, Super 2, non-linear PID control, anti-reset windup, output velocity limiter, manual preset output (Loop 2)
<b>ZONE (LP2)</b>	Zone control (Loop 2)
<b>PPAR</b>	P parameter (for ladder program)
<b>PYS1 (1)</b>	10-segment linearizer 1
<b>PYS2 (2)</b>	10-segment linearizer 2
<b>PYS3 (3)</b>	10-segment linearizer 3
<b>PYS4 (4)</b>	10-segment linearizer 4

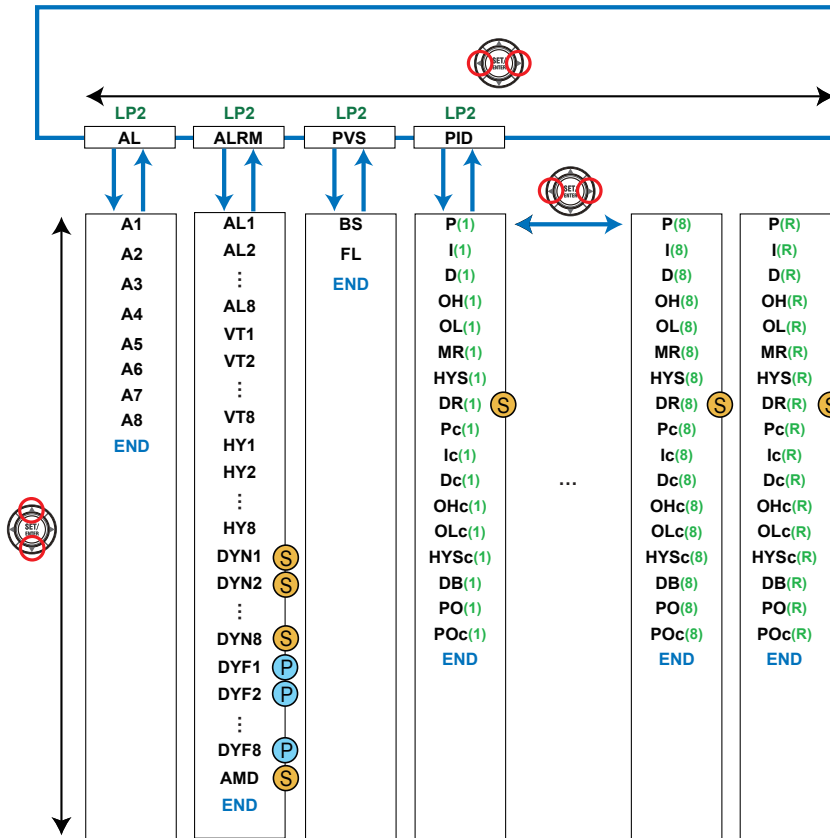
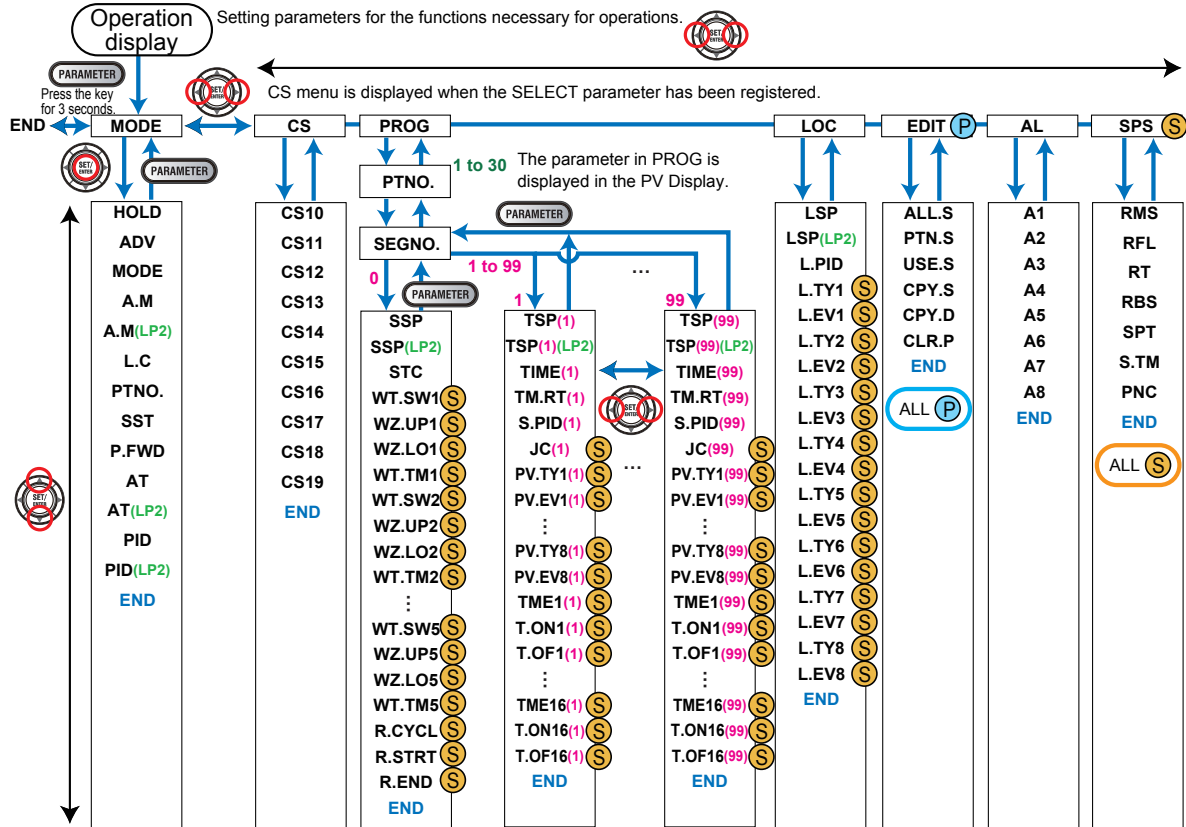
The parameters in the menu of the following table indicate the parameters to set the basic functions of the controller. The symbol in parentheses are shown on Group display.

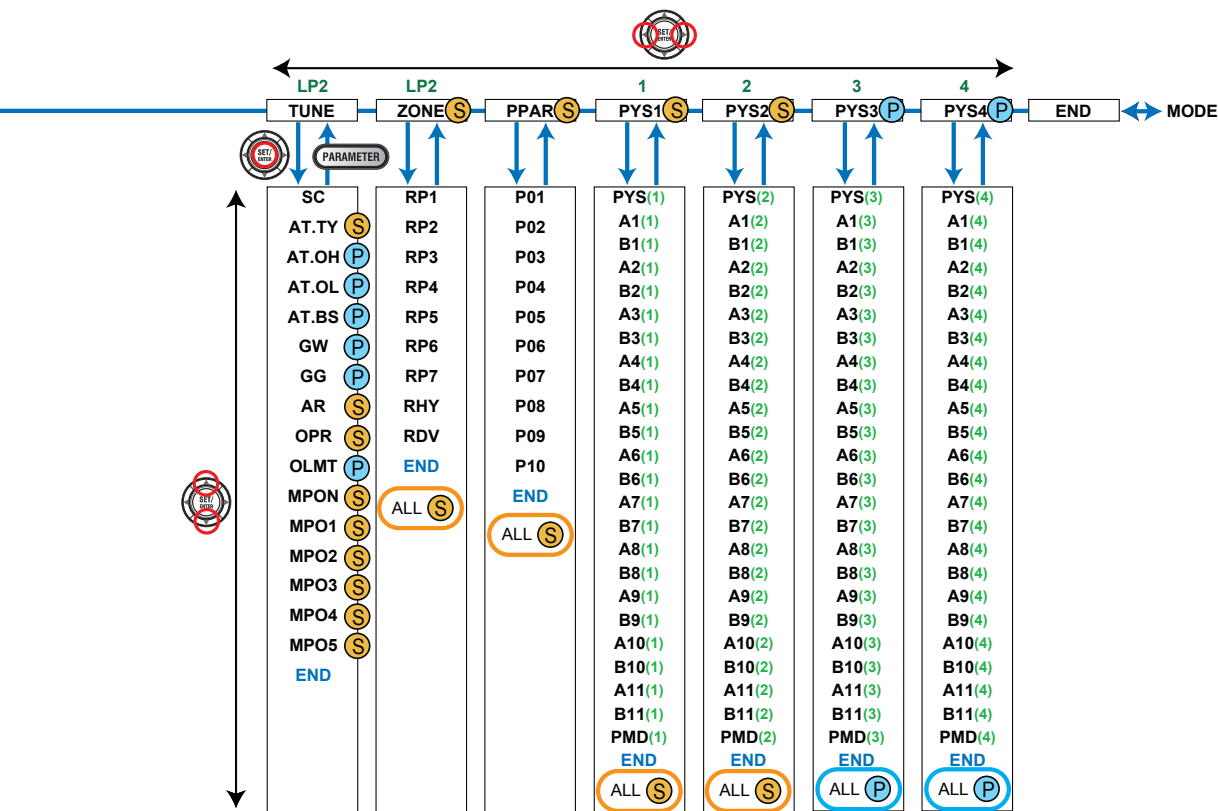
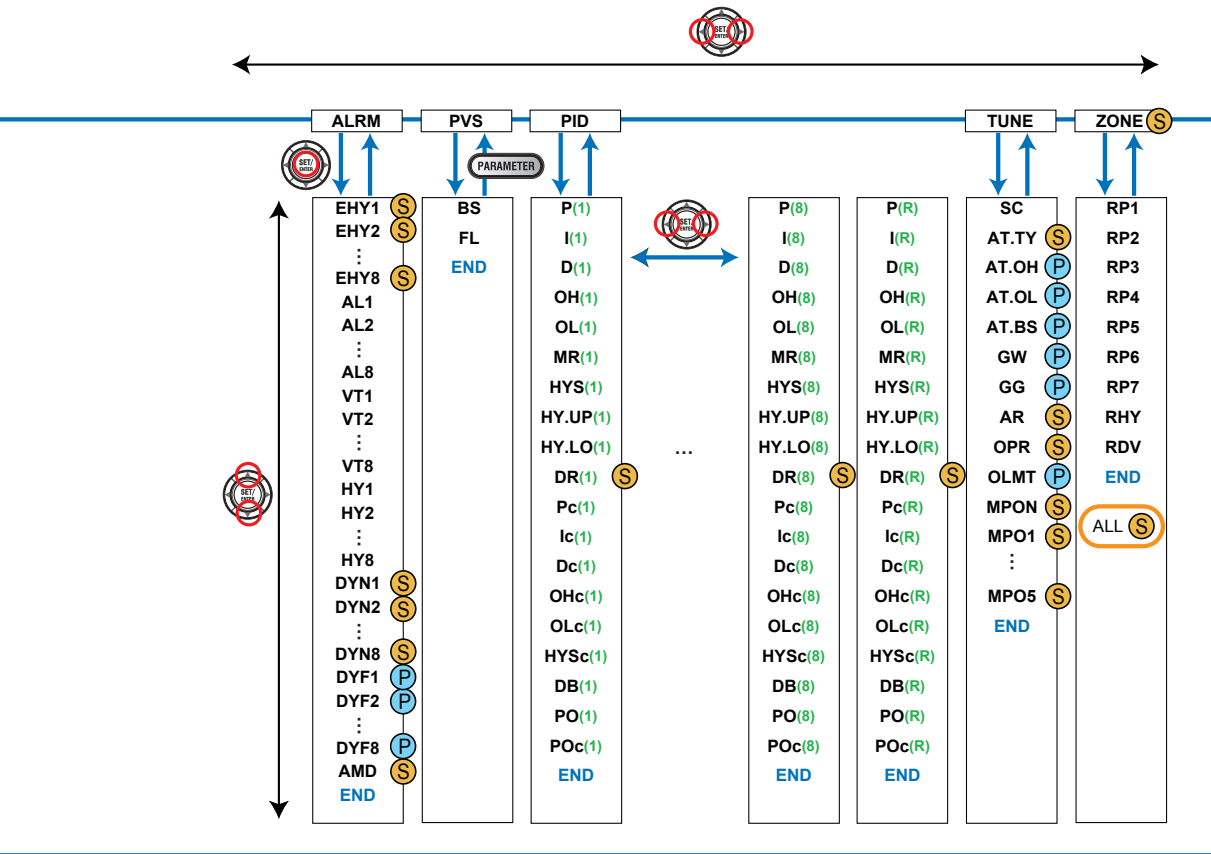
Menu symbol	Functions
PASS	Password setting (Displayed only when the password has been sent.)
Menu symbol	Functions
CTL	Control mode, control type, sampling period, segment setting method, program time unit, etc
PV	PV input type, range, scale, etc
RSP	RSP remote input type, scale, etc
AIN2	AIN2 aux. analog input type, scale, etc
AIN4	AIN4 aux. analog input type, scale, etc
MPV	Input function in Loop control with PV switching and Loop control with PV auto-selector, SP limiters, etc.
MPV (LP2)	Loop-2 input function, SP limiters (Loop 2), etc in Cascade control.
OUT	Control output type, valve position adjustment, retransmission output, etc.
HBA	Heater break alarm
R485 (E3)	RS-485 communication (E3-terminal area)
R485 (E4)	RS-485 communication (E4-terminal area)
ETHR (E3)	Ethernet communication, gateway setting, IP access restriction, etc. (E3-terminal area)
PROF (E3)	PROFIBUS-DP communication (E3-terminal area)
DNET (E3)	DeviceNet communication (E3-terminal area)
CC-L (E3)	CC-Link communication (E3-terminal area)
KEY	Function of User function key
DISP	Display functions
CSEL	SELECT Display, SELECT parameter registration
KLOC	Key lock
MLOC	Parameter menu lock
DI.SL	Contact input function
DI.NU	Contact input function (bit selection)
DI.D	Contact input type (equipped as standard)
DI.D (E1)	Contact input type (E1-terminal area)
DI.D (E2)	Contact input type (E2-terminal area)
DI.D (E3)	Contact input type (E3-terminal area)
DI.D (E4)	Contact input type (E4-terminal area)
ALM	Alarm output function, contact output type (equipped as standard)
DO (E1)	Contact output function, contact output type (E1-terminal area)
DO (E2)	Contact output function, contact output type (E2-terminal area)
DO (E3)	Contact output function, contact output type (E3-terminal area)
DO (E4)	Contact output function, contact output type (E4-terminal area)
I/O	Input / output data display
SYS	Action setting when recovering from a power failure, guide display language, password setting, etc
INIT	Initialization of parameter
VER	Error status, version, MAC address, etc
LVL	Parameter display level

**Note**

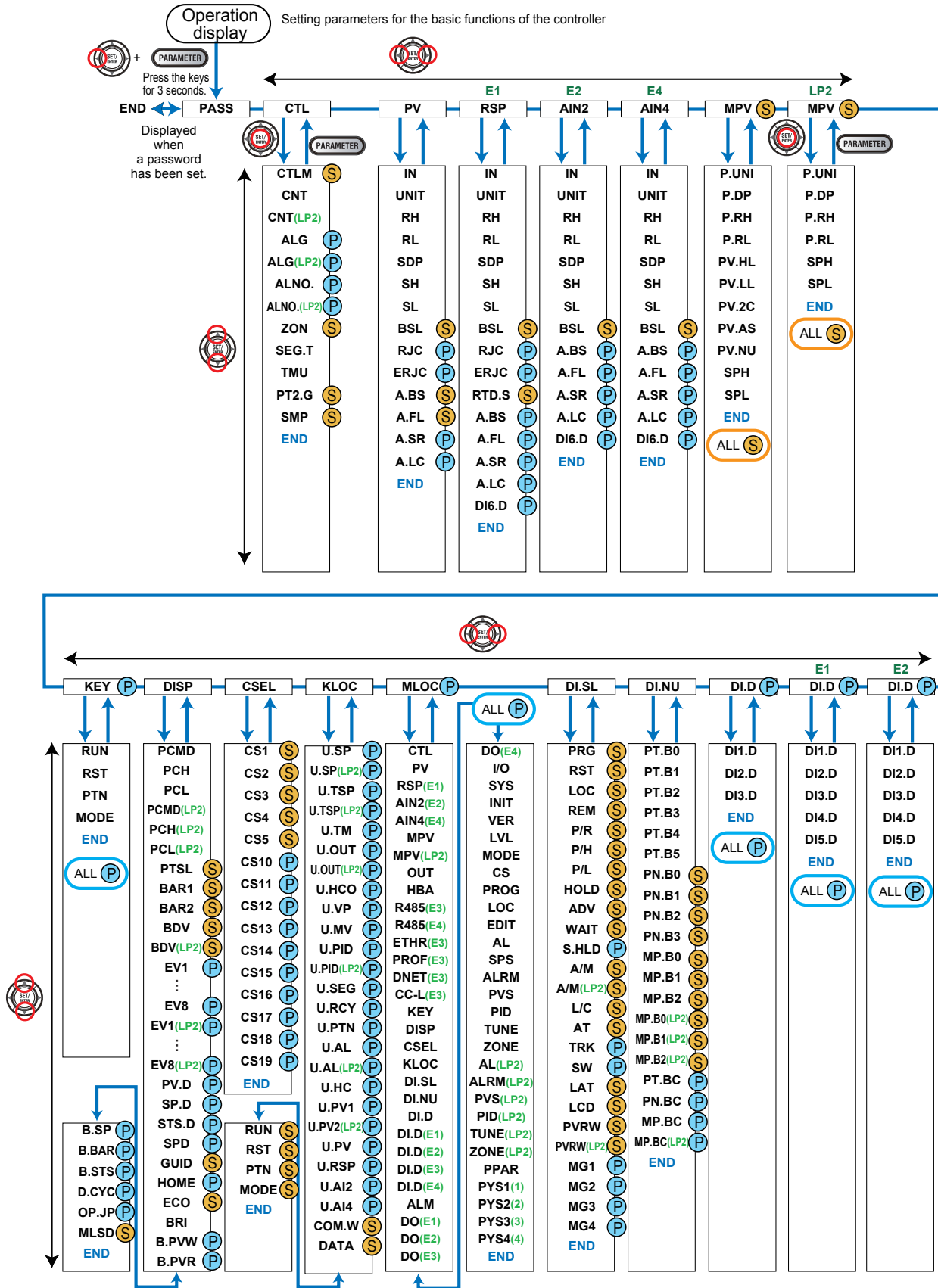
Some parameters are not displayed according to the setting such as control mode, control type, or input and output.

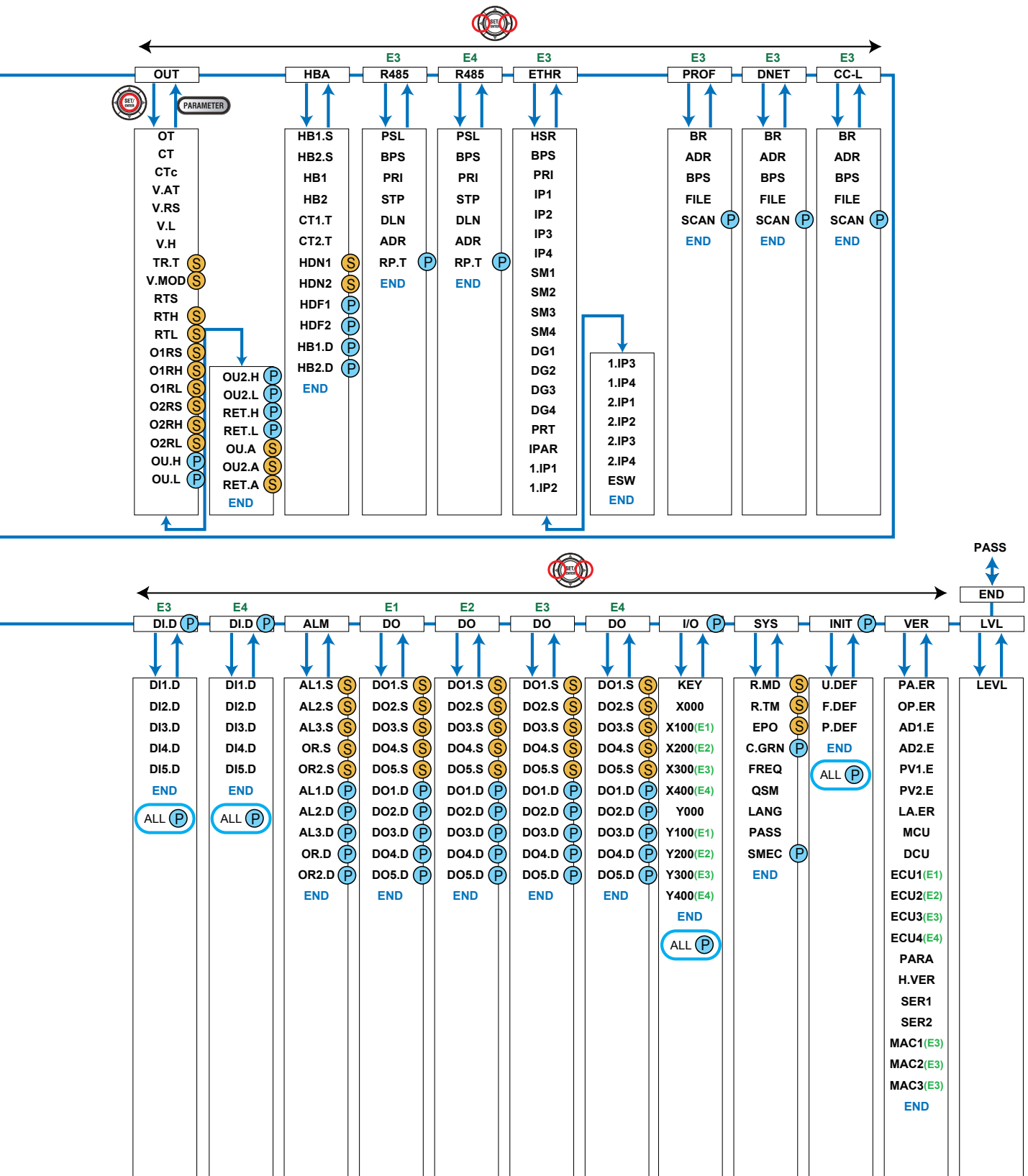
# 18.1 Parameter Map





# 18.1 Parameter Map





## 18.2 List of Parameters

### 18.2.1 Operation Parameters

Operation Mode Menu (Menu: MODE)

Parameter symbol	Name	Display level	Setting range	Initial value
<b>HOLD</b>	Pause/cancel release of program operation	EASY	ON: Pause OFF: Cancel release (Program operation restart) Display during program operation.	OFF
<b>ADV</b>	Advance of segment	EASY	OFF: - Display during program operation. Set as "ADV = ON" to advance from the current segment to the next segment.	OFF
<b>MODE</b>	Operation mode	EASY	RESET: Stop of program operation PROG: Start of program operation LOCAL: Start of local-mode operation REM: Start of remote-mode operation	RESET
<b>A.M</b>	AUTO/MAN switch	EASY	AUTO: Automatic mode MAN: Manual mode	MAN
<b>L.C</b>	LOCAL(LSP)/CAS switch	EASY	LSP: Local (LSP) CAS: Cascade	CAS
<b>PTNO.</b>	Program pattern number selection	EASY	0: Not select program pattern 1 to 30	0
<b>SST</b>	Start-of-program segment number	EASY	1 to 99 The setting value returns to "1" when the program operation (PROG) changes into RESET, LOCAL, or REM.	1
<b>P.FWD</b>	Fast-forwarding of program operation	EASY	1: Normal, 2: Twice, 5: Five times, 10: Ten times, 20: Twenty times * Use this function when checking the program pattern setting. Only Segment time and Time event can be faster. * The operation returns to the normal speed after fast-forwarding.	1
<b>AT</b>	Auto-tuning switch	EASY	OFF: Disable 1 to 8: Perform auto-tuning. Tuning result is stored in the specified numbered PID. R: Tuning result is stored in the PID for reference deviation.	OFF
<b>PID</b>	PID number	EASY	The PID group number being selected is displayed. (display only) 1 to 8, R: PID group for reference deviation	1

In Cascade control, the following operation modes are also displayed for secondary loop. (the LP2 lamp is lit)

- Operation mode: A.M, AT, PID

## SELECT Parameter Menu (Menu: CS)

Parameter symbol	Name	Display level	Setting range	Initial value
<b>CS10 to CS19</b>	SELECT parameter 10 to 19	EASY	Setting range of a registered parameter.	-

## Program Pattern Setting Menu (Menu: PROG&gt;PTNO. (=01 to 30) &gt; SEGNO. (=00))

Parameter symbol	Name	Display level	Setting range	Initial value
<b>SSP</b>	Starting target setpoint	EASY	0.0 to 100.0% of PV input range (EU) (Setting range: P.RL to P.RH)	P.RL
<b>STC</b>	Start code	EASY	SSP: Program operation begins with the starting target setpoint. RAMP: Ramp-prioritized PV start TIME: Time-prioritized PV start LSP: Local-mode start RSP: Remote-mode start * STC=TIME cannot be selected when the parameter SEG.T is TM.RT.	SSP
<b>WT.SW1 to WT.SW5</b>	Wait function ON/OFF 1 to 5	STD	OFF: Disable ON: Enable	OFF
<b>WZ.UP1 to WZ.UP5</b>	Upper-side wait zone 1 to 5	STD	0.0 to 10.0% of PV input range (EU)	0.5% of PV input range
<b>WZ.LO1 to WZ.LO5</b>	Lower-side wait zone 1 to 5	STD		0.5% of PV input range
<b>WT.TM1 to WT.TM5</b>	Wait time 1 to 5	STD	OFF: No function 0.00 to 999.59 ("hour.minute" or "minute.second") * Available only for the wait time at the segment switching. * Use the parameter TMU to set the time unit. (Common in the instrument.)	OFF
<b>R.CYCL</b>	Number of repeat cycles	STD	0 to 999, CONT (The controller indefinitely repeats the segment specified by the R.STRT and R.END parameters.)	0
<b>R.STRT</b>	Repeat cycle start segment number	STD	1 to 99	1
<b>R.END</b>	Repeat cycle end segment number	STD	$1 \leq R.STRT \leq R.END \leq 99$	1

When the program pattern-2 retransmission is selected (PT2.G=ON), the second loop is also displayed for the parameter SSP. (LP2 lamp is lit.)



18.2 List of Parameters

Program Pattern Setting Menu (Menu: PROG>PTNO. (=01 to 30) > SEGNO. (=01 to 99))

Parameter symbol	Name	Display level	Setting range	Initial value
TSP	Final target setpoint	EASY	0.0 to 100.0% of PV input range (EU) (Setting range: P.RL to P.RH)	P.RL
TIME	Segment time setting	EASY	-: Unregistered 0.00 to 999.59 ("hour.minute" or "minute.second") * Setting available for the parameter SEG.T=TIME. * Use the parameter TMU to set the time unit. (Common in the instrument.) * If the setting is 0.00, TSP changes in stepwise after one control period.	-
TM.RT	Segment ramp-rate setting	EASY	-: Unregistered Ramp: 0.0 to 100.0% of PV input range span (EUS) / 1 hour or 1 minute Soak: 0.00 to 999.59 ("hour.minute" or "minute.second") * Setting available for the parameter SEG.T=TM.RT. * Use the parameter TMU to set the time unit. (Common in the instrument.) Per 1 hour: TMU=HH.MM, Per 1 minute: TMU=MM.SS * If it is set to 0.0% of the input range span, or the segment time 0.00, the program moves to the next segment after one control period.	-
S.PID	Segment PID number selection	EASY	1 to 8 * PID number can be set when the parameter "ZON = 0."	1
JC	Junction code	STD	CONT: Switching for continuation HOLD: Hold-on switching (the controller holds the end-of-segment setpoint when the segment is completed, to perform control). LOC: Local-mode switching (the controller switches to a local setpoint when the segment is completed). REM: Remote-mode switching (the controller switches to a remote setpoint when the segment is completed). W.SW1 to W.SW5: Wait during switching between segments. W.IV1 to W.IV5: Wait within a segment interval. W.SL1 to W.SL5: Segment switching (the controller switches to a local setpoint when the segment is completed after release.) (5 groups) W.SR1 to W.SR5: Segment switching (the controller switches to a remote setpoint when the segment is completed after release.) (5 groups) PLK.1 to PLK.30: Linked to patterns 1 to 30. INS.: Allows a segment to be added to the end of a specified segment. DEL.: Allows a specified segment to be deleted.	CONT

When the program pattern-2 retransmission is selected (PT2.G=ON), the second loop is also displayed for the parameter TSP. (LP2 lamp is lit.)

Program Pattern Setting Menu (Menu: PROG>PTNO. (=01 to 30) > SEGNO. (=01 to 99))

Parameter symbol	Name	Display level	Setting range	Initial value
PV.TY1 to PV.TY8	PV event-1 to -8 type	EASY	OFF: Disable (Energized) 1: PV high limit, 2: PV low limit, 3: SP high limit, 4: SP low limit, 5: Deviation high limit, 6: Deviation low limit, 7: Deviation high and low limits, 8: Deviation within high and low limits, 9: Target SP high limit, 10: Target SP low limit, 11: Target SP deviation high limit, 12: Target SP deviation low limit, 13: Target SP deviation high and low limits, 14: Target SP deviation within high and low limits, 15: OUT high limit, 16: OUT low limit, 17: Cooling-side OUT high limit, 18: Cooling-side OUT low limit * Add 100 for "de-energized". For example, when the PV high limit is de-energized, the setting is 101.	OFF
PV.EV1 to PV.EV8	PV event-1 to -8 setpoint	EASY	Set a display value of setpoint of PV alarm, SP alarm, deviation alarm, or output alarm. -19999 to 30000 (Set a value within the input range.) Decimal point position depends on the input type.	0
TME1 to TME16	Start condition of time event 1 to 16	EASY	ON: Start ON state OFF: Start OFF state	OFF
T.ON1 to T.ON16	On time of time event 1 to 16	EASY	-: Unregistered 0.01 to 999.59 ("hour.minute" or "minute.second")	-
T.OF1 to T.OF16	Off time of time event 1 to 16	STD	* Available only within the segment time. * OFF when the operation mode is changed to the mode except the program operation. * Use the parameter TMU to set the time unit. (Common in the instrument.)	-

PV event and Time event are available only during the program operation.

## 18.2 List of Parameters

### Local Setting Menu (Menu: LOC)

Parameter symbol	Name	Display level	Setting range	Initial value
LSP	Local target setpoint	EASY	0.0 to 100.0% of PV input range (EU) (Setting range: P.RL to P.RH)	P.RL
L.PID	PID number selection for local-mode operation	EASY	Set a PID group number to use. 1 to 8 * Available only for the L.PID when ZON = 0 or 5. * If set to "Local PID selection," local PID is selected irrespective of the operation modes.	1
L.TY1 to L.TY8	Local event-1 to -8 type	STD	OFF: Disable (Energized) 1: PV high limit, 2: PV low limit, 3: SP high limit, 4: SP low limit, 5: Deviation high limit, 6: Deviation low limit, 7: Deviation high and low limits, 8: Deviation within high and low limits, 9: Target SP high limit, 10: Target SP low limit, 11: Target SP deviation high limit, 12: Target SP deviation low limit, 13: Target SP deviation high and low limits, 14: Target SP deviation within high and low limits, 15: OUT high limit, 16: OUT low limit, 17: Cooling-side OUT high limit, 18: Cooling-side OUT low limit * Add 100 for "de-energized". For example, when the PV high limit is de-energized, the setting is 101.	OFF
L.EV1 to L.EV8	Local event-1 to -8 setpoint	STD	Set a display value of setpoint of PV alarm, SP alarm, deviation alarm, or output alarm. -19999 to 30000 (Set a value within the input range.) Decimal point position depends on the input type	0

When the program pattern-2 retransmission is selected (PT2.G=ON), the second loop is also displayed for the parameter LSP. (LP2 lamp is lit.)

### Program Editing Menu (Menu: EDIT)

Parameter symbol	Name	Display level	Setting range	Initial value
ALL.S	Number of remaining unused segments	PRO	0 to 300 (Display only)	300
PTN.S	Pattern number designation for confirming number of segments	PRO	Specify the numbers of program pattern to display in parameter USE.S. 1 to 30	0
USE.S	Number of segments within a pattern	PRO	Can be displayed when the parameter number specify in parameter PTN.S. (Display only) 0: disable 1 to 99	-
CPY.S	Source-of-copying pattern number designation	PRO	Specify the number of the source-of-copying program pattern. (1 to 30)	0
CPY.D	Target-of-copying pattern number designation	PRO	Specify the target-of-copying program pattern. (1 to 30)	0
CLR.P	Program pattern clearance	PRO	Specify the number of the program pattern to be cleared. (1 to 30)	0

## Alarm Setpoint Setting Menu (Menu: AL)

Parameter symbol	Name	Display level	Setting range	Initial value
<b>A1 to A8</b>	Alarm-1 to -8 setpoint	EASY	These alarms work irrespective of the operation mode. Set a display value of setpoint of PV alarm, SP alarm, deviation alarm, output alarm, or velocity alarm. -19999 to 30000 (Set a value within the input range.) Decimal point position depends on the input type.	0

In Cascade control, the following parameters are also displayed for secondary loop. (the LP2 lamp is lit)

- Parameter: A1 to A8

## SP-related Setting Menu (Menu: SPS)

Parameter symbol	Name	Display level	Setting range	Initial value
<b>RMS</b>	Remote input method	STD	RSP: Via remote (aux. analog) input COM: Via communication	RSP
<b>RFL</b>	Remote input filter	STD	OFF, 1 to 120 s	OFF
<b>RT</b>	Remote input ratio	STD	0.001 to 9.999	1.000
<b>RBS</b>	Remote input bias	STD	-100.0 to 100.0% of PV input range span (EUS)	0.0 % of PV input range span
<b>SPT</b>	SP tracking selection	STD	OFF, ON Tracking is performed when the mode changes from Program or Remote to Local. (The local setpoint keeps track of the remote setpoint.)	OFF
<b>S.TM</b>	Starting time of program operation	STD	0.00 to 999.59 ("hour.minute" or "minute.second" (common use of instrument)) * Use the parameter TMU to set the time unit.	0.00
<b>PNC</b>	Program pattern number clearance	STD	OFF: Not cleared. ON: Cleared. (Set the program No. before restart program operation) * The controller resets (clears) the program pattern number on the operating display to "0" at the end of program operation.	OFF

18.2 List of Parameters

Alarm Function Setting Menu (Menu: ALRM)

Parameter symbol	Name	Display level	Setting range	Initial value
<b>EHY1 to EHY8</b>	Event-1 to -8 hysteresis	STD	The hysteresis setpoint of PV event or Local event is set to the percentage of 0.0 to 100.0%. The setting value (%) is for the PV input range span or output span.	0
<b>AL1 to AL8</b>	Alarm-1 to -8 type	EASY	<p>These alarms work irrespective of the operation mode. Set a 5-digit value in the following order. [Alarm type: 2 digits (see below)] + [Without (0) or With (1) Stand-by action] + [Energized (0) or De-energized (1)] + [Latch action (0/1/2/3/4)] For latch action, see chapter 11.</p> <p>Alarm type: 2 digits 00: Disable 01: PV high limit 02: PV low limit 03: SP high limit 04: SP low limit 05: Deviation high limit 06: Deviation low limit 07: Deviation high and low limits 08: Deviation within high and low limits 09: Target SP high limit 10: Target SP low limit 11: Target SP deviation high limit 12: Target SP deviation low limit 13: Target SP deviation high and low limits 14: Target SP deviation within high and low limits 15: OUT high limit 16: OUT low limit 17: Cooling-side OUT high limit 18: Cooling-side OUT low limit 19: Analog input PV high limit 20: Analog input PV low limit 21: Analog input RSP high limit 22: Analog input RSP low limit 23: Analog input AIN2 high limit 24: Analog input AIN2 low limit 25: Analog input AIN4 high limit 26: Analog input AIN4 low limit 27: Feedback input high limit 28: Feedback input low limit 29: PV velocity 30: Fault diagnosis 31: FAIL</p>	<p>AL1, AL3: PV high limit (01) Without Stand-by action (0) Energized (0) Latch action (0)</p> <p>AL2, AL4: PV low limit (02) Without Stand-by action (0) Energized (0) Latch action (0)</p> <p>AL5 to AL8: not displayed for factory default</p>

In Cascade control, the following parameters are also displayed for secondary loop. (the LP2 lamp is lit)

- Parameter: AL1 to AL8

## Alarm Function Setting Menu (Menu: ALRM) (Continued from previous page)

Parameter symbol	Name	Display level	Setting range	Initial value
<b>VT1 to VT8</b>	PV velocity alarm time setpoint 1 to 8	EASY	0.01 to 99.59 (minute.second)	1.00
<b>HY1 to HY8</b>	Alarm-1 to -8 hysteresis	EASY	Set a display value of setpoint of hysteresis. -19999 to 30000 (Set a value within the input range.) Decimal point position depends on the input type. When the decimal point position for the input type is set to "1", the initial value of the hysteresis is "1.0".	10
<b>DYN1 to DYN8</b>	Alarm-1 to -8 On-delay timer	STD	0.00 to 99.59 (minute.second)	0.00
<b>DYF1 to DYF8</b>	Alarm-1 to -8 Off-delay timer	PRO		0.00
<b>AMD</b>	Alarm mode	STD	0: Always active 1: Not active in RESET mode 2: Not active in RESET or MAN mode	0

In Cascade control, the following parameters are also displayed for secondary loop. (the LP2 lamp is lit)

- Parameter: VT1 to VT8 HY1 to HY8, DYN1 to DYN8, DYF1 to DYF8, AMD

## 18.2 List of Parameters

### PV-related Setting Menu (Menu: PVS)

Parameter symbol	Name	Display level	Setting range	Initial value
<b>BS</b>	PV input bias	EASY	-100.0 to 100.0% of PV input range span (EUS)	0.0 % of PV input range span
<b>FL</b>	PV input filter	EASY	OFF, 1 to 120 s	OFF

In Cascade control, the following parameters are also displayed for secondary loop. (the LP2 lamp is lit)

Parameter: BS, FL

### PID Setting Menu (Menu: PID)

Parameter symbol	Name	Display level	Setting range	Initial value
<b>P</b>	Proportional band Heating-side proportional band (in Heating/cooling control)	EASY	0.0 to 999.9% When 0.0% is set, it operates as 0.1%. Heating-side ON/OFF control applies when 0.0% in Heating/cooling control	5.0%
<b>I</b>	Integral time Heating-side integral time (in Heating/cooling control)	EASY	OFF: Disable 1 to 6000 s	240 s
<b>D</b>	Derivative time Heating-side derivative time (in Heating/cooling control)	EASY	OFF: Disable 1 to 6000 s	60 s
<b>OH</b>	Control output high limit Heating-side control output high limit (in Heating/cooling control)	EASY	-4.9 to 105.0%, (OL<OH) In Heating/cooling control: 0.1 to 105.0% (OL<OH)	100.0%
<b>OL</b>	Control output low limit Heating-side control output low limit (in Heating/cooling control)	EASY	-5.0 to 104.9%, (OL<OH), SD: Tight shut In Heating/cooling control: 0.0 to 104.9% (OL<OH)	0.0%
<b>MR</b>	Manual reset	EASY	Enabled when integral time is OFF. The manual reset value equals the output value when PV = SP. -5.0 to 105.0%	50.0%
<b>HYS</b>	Hysteresis (in ON/OFF control, or Position proportional control) Heating-side ON/OFF control hysteresis (in Heating/cooling control)	EASY	In ON/OFF control: 0.0 to 100.0% of PV input range span (EUS) In Heating/cooling control or Position proportional control: 0.0 to 100.0%	In ON/OFF control: 0.5 % of PV input range span In Heating/cooling control or Position proportional control: 0.5 %
<b>HY.UP</b>	Upper-side hysteresis (in ON/OFF control)	EASY	0.0 to 100.0% of PV input range span (EUS)	0.5 % of PV input range span
<b>HY.LO</b>	Lower-side hysteresis (in ON/OFF control)	EASY		0.5 % of PV input range span
<b>DR</b>	Direct/reverse action switch	STD	RVS: Reverse action, DIR: Direct action	RVS

In Cascade control, the following parameters are also displayed for secondary loop. (the LP2 lamp is lit)

• Parameter: P, I, D, OH, OL, MR, HYS, DR

## PID Setting Menu (Menu: PID) (Continued from previous page)

Parameter symbol	Name	Display level	Setting range	Initial value
<b>Pc</b>	Cooling-side proportional band	EASY	0.0 to 999.9% (Cooling-side ON/OFF control applies when 0.0% in Heating/cooling control)	5.0%
<b>Ic</b>	Cooling-side integral time	EASY	OFF: Disable 1 to 6000 s	240 s
<b>Dc</b>	Cooling-side derivative time	EASY	OFF: Disable 1 to 6000 s	60 s
<b>OHc</b>	Cooling-side control output high limit	EASY	0.1 to 105.0%, (OLc<OHc)	100.0%
<b>OLc</b>	Cooling-side control output low limit	EASY	0.0 to 104.9%, (OLc<OHc)	0.0%
<b>HYS</b>	Cooling-side ON/OFF control hysteresis	EASY	0.0 to 100.0%	0.5%
<b>DB</b>	Output dead band (in Heating/cooling control or Position proportional control)	EASY	In Heating/cooling control: -100.0 to 50.0% In Position proportional control: 1.0 to 10.0%	3.0%
<b>PO</b>	Preset output Heating-side preset output (in Heating/cooling control)	EASY	-5.0 to 105.0% In RESET mode, fixed control output can be generated. In Position proportional control, Valve opening can be set	0.0%
<b>POc</b>	Cooling-side preset output	EASY	-5.0 to 105.0% In RESET mode, cooling-side fixed control output can be generated.	0.0%

In Cascade control, the following parameters are also displayed for secondary loop. (the LP2 lamp is lit)

- Parameter: Pc, Ic, Dc, OHc, OLc, HYS, DB, PO, POc



## 18.2 List of Parameters

### Tuning Menu (Menu: TUNE)

Parameter symbol	Name	Display level	Setting range	Initial value
<b>SC</b>	Super function	EASY	OFF: Disable 1: Overshoot suppressing function (normal mode) 2: Hunting suppressing function (stable mode) Enables to answer the wider characteristic changes compared with response mode. 3: Hunting suppressing function (response mode) Enables quick follow-up and short converging time of PV for the changed SP. 4: Overshoot suppressing function (strong suppressing mode)	OFF
<b>AT.TY</b>	Auto-tuning type	STD	0: Normal 1: Stability	0
<b>AT.OH</b>	Output high limit in auto-tuning	PRO	-5.0 to 105.0% (Disabled in Heating/cooling control)	100.0%
<b>AT.OL</b>	Output low limit in auto-tuning	PRO		0.0%
<b>AT.BS</b>	SP bias in auto-tuning	PRO	-100.0 to 100.0% of PV input range span (EUS)	0.0 % of PV input range span
<b>GW</b>	Non-linear control gap width	PRO	OFF, 0.0%+1digit to 50.0% of PV input range span (EUS)	OFF
<b>GG</b>	Non-linear control gain	PRO	0.001 to 1.000	1.000
<b>AR</b>	Anti-reset windup (excess integration prevention)	STD	AUTO, 50.0 to 200.0%	AUTO
<b>OPR</b>	Output velocity limiter	STD	OFF: Disable 0.1 to 100.0%/s	OFF
<b>OLMT</b>	Output limiter switch	PRO	OFF: Disable output limiter in MAN mode ON: Enable output limiter in MAN mode	ON
<b>MPON</b>	Manual preset output number selection	STD	OFF: Hold the control output in AUTO mode (bumpless) 1: Use manual preset output 1 (output bump) 2: Use manual preset output 2 (output bump) 3: Use manual preset output 3 (output bump) 4: Use manual preset output 4 (output bump) 5: Use manual preset output 5 (output bump)	OFF
<b>MPO1 to MPO5</b>	Manual preset output 1 to 5	STD	-5.0 to 105.0% * However, output is limited to the output high limit and low limit.	0.0%

In Cascade control, the following parameters are also displayed for secondary loop. (the LP2 lamp is lit)

• Parameter: SC, AT.TY, AT.OH, AT.OL, AT.BS, GW, GG, AR, OPR, OLMT, MPON, MPO1 to MPO5

## Zone Control Menu (Menu: ZONE)

Parameter symbol	Name	Display level	Setting range	Initial value
<b>RP1 to RP7</b>	Reference point 1 to 7	STD	0.0 to 100.0% of PV input range (EU) ( $RP1 \leq RP2 \leq RP3 \leq RP4 \leq RP5 \leq RP6 \leq RP7$ ) * Set reference points at which switching is carried out between groups of PID constants according to the given temperature zone.	100.0 % of PV input range
<b>RHY</b>	Zone PID switching hysteresis	STD	0.0 to 10.0% of PV input range span (EUS) * Hysteresis can be set for switching at a reference point.	0.5 % of PV input range span
<b>RDV</b>	Reference deviation	STD	OFF: Disable 0.0 + 1 digit to 100.0% of PV input range span (EUS) * Set a deviation from SP. The PID for reference deviation is used if there is a larger deviation than the preset reference deviation.	OFF

In Cascade control, the following parameters are also displayed for secondary loop. (the LP2 lamp is lit)

- Parameter: RP1 to RP7, RHY, RDV

## P Parameter Menu (Menu: PPAR)

Parameter symbol	Name	Display level	Setting range	Initial value
<b>P01 to P10</b>	P01 to P10 parameter	STD	-19999 to 30000 (Set a decimal point position using LL50A Parameter Setting Software.)	0

## 18.2 List of Parameters

### 10-segment Linearizer Setting Menu (Menu: PYS1 to PYS4)

Parameter symbol	Name	Display level	Setting range	Initial value
<b>PYS</b>	10-segment linearizer selection	Group 1, 2: STD Group 3, 4: PRO	OFF: Disable PV: PV analog input RSP: RSP analog input AIN2: AIN2 analog input AIN4: AIN4 analog input PVIN: PV input OUT: OUT analog output OUT2: OUT2 analog output RET: RET analog output	PV (CTLM: SGL)
<b>A1 to A11</b>	10-segment linearizer input 1 to 11	Group 1, 2: STD Group 3, 4: PRO	-66.7 to 105.0% of input range (EU) Output linearizer: -5.0 to 105.0%	0.0%
<b>B1 to B11</b>	10-segment linearizer output 1 to 11	Group 1, 2: STD Group 3, 4: PRO	10-segment linearizer bias: -66.7 to 105.0% of input range span (EUS) 10-segment linearizer approximation: -66.7 to 105.0% of input range (EU) Output linearizer: -5.0 to 105.0%	0.0%
<b>PMD</b>	10-segment linearizer mode	Group 1, 2: STD Group 3, 4: PRO	0: 10-segment linearizer bias 1: 10-segment linearizer approximation	0

10-segment linearizer parameters are four groups, the group number (1 to 4) is displayed on Group display.

#### Initial value of each control mode

Control mode	Group-1 PYS	Group-2 PYS	Group-3 and -4 PYS
Single-loop control	PV	OFF	OFF
Cascade primary-loop control	PV	OFF	OFF
Cascade control	PV	RSP	OFF
Loop control with PV switching	PV	OFF	OFF
Loop control with PV auto-selector	PVIN	OFF	OFF

## 18.2.2 Setup Parameters

Control Function Setting Menu (Menu: CTL)

Parameter symbol	Name	Display level	Setting range	Initial value
<b>CTLM</b>	Control mode	STD	SGL: Single-loop control CAS1: Cascade primary-loop control CAS: Cascade control PVSU: Loop control with PV switching PVSEL: Loop control with PV auto-selector  * When using the ladder program, the control mode cannot be changed.	SGL
<b>CNT</b>	Control type	EASY	PID: PID control ONOF: ON/OFF control (1 point of hysteresis) ONOF2: ON/OFF control (2 points of hysteresis) H/C: Heating/cooling control	Standard type: PID Heating/cooling type: H/C
<b>ALG</b>	PID control mode	PRO	0: Standard PID control mode 1: Fixed-point control mode	0
<b>ALNO.</b>	Number of alarms	PRO	1 to 8	4
<b>ZON</b>	Zone PID selection	STD	0: Segment PID selection 1: Zone PID selection (selection by PV) 2: Zone PID selection (selection by target SP) 4: Zone PID selection (selection by SP) 5: Local PID selection * If set to "Segment PID selection," allows PID constants to be selected for each segments. * If set to "Zone PID selection," automatically selects PID constants according to the range set in the Reference point. * If set to "Local PID selection," local PID is selected irrespective of the operation modes.	1
<b>SEG.T</b>	Segment setting method	EASY	TIME: Segment time setting TM.RT: Segment ramp-rate setting Note: A change of setting deletes a program pattern.	TIME
<b>TMU</b>	Program time unit	EASY	HH.MM: hour.minute MM.SS: minute.second	HH.MM
<b>PT2.G</b>	Program pattern-2 retransmission	STD	OFF: Not used. ON: used. * The controller can serve as a program pattern generator. * Retransmission output types (RTS, O1RS, or O2RS) need to be set to SP2.	OFF
<b>SMP</b>	Input sampling period (control period)	STD	100: 100 ms 200: 200 ms	200

In Cascade control, the following parameters are also displayed for secondary loop. (the LP2 lamp is lit)

• Parameter: CNT, ALG, ALNO.

The parameter CNT of Loop 2 displays PID and H/C.

18.2 List of Parameters

PV Input Setting Menu (Menu: PV)

Parameter symbol	Name	Display level	Setting range	Initial value
IN	PV input type	EASY	OFF: Disable K1: -270.0 to 1370.0 (°C) / -450.0 to 2500.0 (°F) K2: -270.0 to 1000.0 (°C) / -450.0 to 2300.0 (°F) K3: -200.0 to 500.0 (°C) / -200.0 to 1000.0 (°F) J: -200.0 to 1200.0 (°C) / -300.0 to 2300.0 (°F) T1: -270.0 to 400.0 (°C) / -450.0 to 750.0 (°F) T2: 0.0 to 400.0 (°C) / -200.0 to 750.0 (°F) B: 0.0 to 1800.0 (°C) / 32 to 3300 (°F) S: 0.0 to 1700.0 (°C) / 32 to 3100 (°F) R: 0.0 to 1700.0 (°C) / 32 to 3100 (°F) N: -200.0 to 1300.0 (°C) / -300.0 to 2400.0 (°F) E: -270.0 to 1000.0 (°C) / -450.0 to 1800.0 (°F) L: -200.0 to 900.0 (°C) / -300.0 to 1600.0 (°F) U1: -200.0 to 400.0 (°C) / -300.0 to 750.0 (°F) U2: 0.0 to 400.0 (°C) / -200.0 to 1000.0 (°F) W: 0.0 to 2300.0 (°C) / 32 to 4200 (°F) PL2: 0.0 to 1390.0 (°C) / 32.0 to 2500.0 (°F) P2040: 0.0 to 1900.0 (°C) / 32 to 3400 (°F) WRE: 0.0 to 2000.0 (°C) / 32 to 3600 (°F) JPT1: -200.0 to 500.0 (°C) / -300.0 to 1000.0 (°F) JPT2: -150.00 to 150.00 (°C) / -200.0 to 300.0 (°F) PT1: -200.0 to 850.0 (°C) / -300.0 to 1560.0 (°F) PT2: -200.0 to 500.0 (°C) / -300.0 to 1000.0 (°F) PT3: -150.00 to 150.00 (°C) / -200.0 to 300.0 (°F) 0.4-2V: 0.400 to 2.000 V 1-5V: 1.000 to 5.000 V 4-20: 4.00 to 20.00 mA 0-2V: 0.000 to 2.000 V 0-10V: 0.00 to 10.00 V 0-20: 0.00 to 20.00 mA -1020: -10.00 to 20.00 mV 0-100: 0.0 to 100.0 mV  Note: W: W-5% Re/W-26% Re (Hoskins Mfg. Co.), ASTM E988 WRE: W97Re3-W75Re25	OFF
UNIT	PV input unit	EASY	-: No unit C: Degree Celsius -: No unit --: No unit ---: No unit F: Degree Fahrenheit	C
RH	Maximum value of PV input range	EASY	Depends on the input type. - For temperature input - Set the temperature range that is actually controlled. (RL<RH)	Depends on the input type
RL	Minimum value of PV input range	EASY	- For voltage / current input - Set the range of a voltage / current signal that is applied. The scale across which the voltage / current signal is actually controlled should be set using the maximum value of input scale (SH) and minimum value of input scale (SL). (Input is always 0% when RL = RH.)	Depends on the input type

## PV Input Setting Menu (Menu: PV) (Continued from previous page)

Parameter symbol	Name	Display level	Setting range	Initial value
<b>SDP</b>	PV input scale decimal point position	EASY	0: No decimal place 1: One decimal place 2: Two decimal places 3: Three decimal places 4: Four decimal places	Depends on the input type
<b>SH</b>	Maximum value of PV input scale	EASY	-19999 to 30000, (SL<SH),   SH - SL   ≤ 30000	Depends on the input type
<b>SL</b>	Minimum value of PV input scale	EASY		Depends on the input type
<b>BSL</b>	PV input burnout action	STD	OFF: Disable UP: Upscale DOWN: Downscale	Depends on the input type
<b>RJC</b>	PV input reference junction compensation	PRO	OFF: RJC OFF ON: RJC ON	ON
<b>ERJC</b>	PV input external RJC setpoint	PRO	-10.0 to 60.0 (°C)	0.0
<b>A.BS</b>	PV analog input bias	STD	-100.0 to 100.0% of PV input range span (EUS)	0.0 % of PV input range span
<b>A.FL</b>	PV analog input filter	STD	OFF, 1 to 120 s	OFF
<b>A.SR</b>	PV analog input square root extraction	PRO	OFF: No square root extraction. 1: Compute the square root. (The slope equals "1.") 2: Compute the square root. (The slope equals "0.")	OFF
<b>A.LC</b>	PV analog input low signal cutoff	PRO	0.0 to 5.0%	1.0%

## 18.2 List of Parameters

**RSP Setting Menu (Menu: RSP) (E1 terminal area)**

Parameter symbol	Name	Display level	Setting range	Initial value
<b>IN</b>	RSP remote input type	EASY	0.4-2V: 0.400 to 2.000 V 1-5V: 1.000 to 5.000 V 0-2V: 0.000 to 2.000 V 0-10V: 0.00 to 10.00 V 0-125: 0.000 to 1.250 V For option /DR, RSP remote input type is same as PV input type.	1-5V
<b>UNIT</b>	RSP remote input unit	EASY	-: No unit C: Degree Celsius -: No unit --: No unit ---: No unit F: Degree Fahrenheit	C
<b>RH</b>	Maximum value of RSP remote input range	EASY	Depends on the input type. - For temperature input (with /DR option) - Set the temperature range that is actually controlled. (RL<RH)	Depends on the input type
<b>RL</b>	Minimum value of RSP remote input range	EASY	- For voltage / current (with /DR option) input - Set the range of a voltage / current signal that is applied. The scale across which the voltage / current signal is actually controlled should be set using the maximum value of input scale (SH) and minimum value of input scale (SL). (Input is always 0% when RL = RH.)	Depends on the input type
<b>SDP</b>	RSP remote input scale decimal point position	EASY	0: No decimal place 1: One decimal place 2: Two decimal places 3: Three decimal places 4: Four decimal places	Depends on the input type
<b>SH</b>	Maximum value of RSP remote input scale	EASY	-19999 to 30000, (SL<SH),   SH - SL   ≤ 30000	Depends on the input type
<b>SL</b>	Minimum value of RSP remote input scale	EASY		Depends on the input type
<b>BSL</b>	RSP remote input burnout action	STD	OFF: Disable UP: Upscale DOWN: Downscale	Depends on the input type
<b>RJC</b>	RSP remote input reference junction compensation (for /DR option)	PRO	OFF: RJC OFF ON: RJC ON	ON
<b>ERJC</b>	RSP remote input external RJC setpoint (for /DR option)	PRO	-10.0 to 60.0 (°C)	0.0
<b>RTD.S</b>	RTD wiring system	STD	3-W: 3-wire system 4-W: 4-wire system	3-W

When each parameter is displayed, the terminal area (E1) is displayed on Group display.

## RSP Input Setting Menu (Menu: RSP) (Continued from previous page)

Parameter symbol	Name	Display level	Setting range	Initial value
<b>A.BS</b>	RSP aux. analog input bias	PRO	-100.0 to 100.0% of RSP input range span (EUS)	0.0 % of RSP input range span
<b>A.FL</b>	RSP aux. analog input filter	PRO	OFF, 1 to 120 s	OFF
<b>A.SR</b>	RSP aux. analog input square root extraction	PRO	OFF: No square root extraction. 1: Compute the square root. (The slope equals "1.") 2: Compute the square root. (The slope equals "0.")	OFF
<b>A.LC</b>	RSP aux. analog input low signal cutoff	PRO	0.0 to 5.0%	1.0%
<b>DI6.D</b>	DI16 contact type	PRO	0: The assigned function is enabled when the contact is closed. 1: The assigned function is enabled when the contact is opened.	0

When each parameter is displayed, the terminal area (E1) is displayed on Group display.



## 18.2 List of Parameters

**AIN2 Aux. Analog Input Setting Menu (Menu: AIN2) (E2 terminal area)**

Parameter symbol	Name	Display level	Setting range	Initial value
<b>IN</b>	AIN2 aux. analog input type	EASY	0.4-2V: 0.400 to 2.000 V 1-5V: 1.000 to 5.000 V 0-2V: 0.000 to 2.000 V 0-10V: 0.00 to 10.00 V 0-125: 0.000 to 1.250 V	1-5V
<b>UNIT</b>	AIN2 aux. analog input unit	EASY	-: No unit C: Degree Celsius -: No unit --: No unit ---: No unit F: Degree Fahrenheit	C
<b>RH</b>	Maximum value of AIN2 aux. analog input range	EASY	Depends on the input type. Set the range of a voltage signal that is applied.	Depends on the input type
<b>RL</b>	Minimum value of AIN2 aux. analog input range	EASY	The scale across which the voltage signal is actually controlled should be set using the maximum value of input scale (SH) and minimum value of input scale (SL). (Input is always 0% when RL = RH.)	Depends on the input type
<b>SDP</b>	AIN2 aux. analog input scale decimal point position	EASY	0: No decimal place 1: One decimal place 2: Two decimal places 3: Three decimal places 4: Four decimal places	Depends on the input type
<b>SH</b>	Maximum value of AIN2 aux. analog input scale	EASY	-19999 to 30000, (SL<SH),   SH - SL   ≤ 30000	Depends on the input type
<b>SL</b>	Minimum value of AIN2 aux. analog input scale	EASY		Depends on the input type
<b>BSL</b>	AIN2 aux. analog input burnout action	STD	OFF: Disable UP: Upscale DOWN: Downscale	Depends on the input type
<b>A.BS</b>	AIN2 aux. analog input bias	PRO	-100.0 to 100.0% of AIN2 input range span (EUS)	0.0 % of AIN2 input range span
<b>A.FL</b>	AIN2 aux. analog input filter	PRO	OFF, 1 to 120 s	OFF
<b>A.SR</b>	AIN2 aux. analog input square root extraction	PRO	OFF: No square root extraction. 1: Compute the square root. (The slope equals "1.") 2: Compute the square root. (The slope equals "0.")	OFF
<b>A.LC</b>	AIN2 aux. analog input low signal cutoff	PRO	0.0 to 5.0%	1.0%
<b>DI6.D</b>	DI26 contact type	PRO	0: The assigned function is enabled when the contact is closed. 1: The assigned function is enabled when the contact is opened.	0

When each parameter is displayed, the terminal area (E2) is displayed on Group display.

## AIN4 Aux. Analog Input Setting Menu (Menu: AIN4) (E4 terminal area)

Parameter symbol	Name	Display level	Setting range	Initial value
<b>IN</b>	AIN4 aux. analog input type	EASY	0.4-2V: 0.400 to 2.000 V 1-5V: 1.000 to 5.000 V 0-2V: 0.000 to 2.000 V 0-10V: 0.00 to 10.00 V 0-125: 0.000 to 1.250 V	1-5V
<b>UNIT</b>	AIN4 aux. analog input unit	EASY	-: No unit C: Degree Celsius -: No unit --: No unit ---: No unit F: Degree Fahrenheit	C
<b>RH</b>	Maximum value of AIN4 aux. analog input range	EASY	Depends on the input type. Set the range of a voltage signal that is applied.	Depends on the input type
<b>RL</b>	Minimum value of AIN4 aux. analog input range	EASY	The scale across which the voltage signal is actually controlled should be set using the maximum value of input scale (SH) and minimum value of input scale (SL). (Input is always 0% when RL = RH.)	Depends on the input type
<b>SDP</b>	AIN4 aux. analog input scale decimal point position	EASY	0: No decimal place 1: One decimal place 2: Two decimal places 3: Three decimal places 4: Four decimal places	Depends on the input type
<b>SH</b>	Maximum value of AIN4 aux. analog input scale	EASY	-19999 to 30000, (SL<SH),   SH - SL   ≤ 30000	Depends on the input type
<b>SL</b>	Minimum value of AIN4 aux. analog input scale	EASY		Depends on the input type
<b>BSL</b>	AIN4 aux. analog input burnout action	STD	OFF: Disable UP: Upscale DOWN: Downscale	Depends on the input type
<b>A.BS</b>	AIN4 aux. analog input bias	PRO	-100.0 to 100.0% of AIN4 input range span (EUS)	0.0 % of AIN4 input range span
<b>A.FL</b>	AIN4 aux. analog input filter	PRO	OFF, 1 to 120 s	OFF
<b>A.SR</b>	AIN4 aux. analog input square root extraction	PRO	OFF: No square root extraction. 1: Compute the square root. (The slope equals "1.") 2: Compute the square root. (The slope equals "0.")	OFF
<b>A.LC</b>	AIN4 aux. analog input low signal cutoff	PRO	0.0 to 5.0%	1.0%
<b>DI6.D</b>	DI46 contact type	PRO	0: The assigned function is enabled when the contact is closed. 1: The assigned function is enabled when the contact is opened.	0

When each parameter is displayed, the terminal area (E4) is displayed on Group display.

## 18.2 List of Parameters

**Input Range/SP Limiter/Input Switch/Input Auto-selector Setting Menu (Menu: MPV)**

Parameter symbol	Name	Display level	Setting range	Initial value
<b>P.UNI</b>	Control PV input unit	STD	-: No unit C: Degree Celsius -: No unit --: No unit ---: No unit F: Degree Fahrenheit	Same as PV input unit
<b>P.DP</b>	Control PV input decimal point position	STD	0: No decimal place 1: One decimal place 2: Two decimal places 3: Three decimal places 4: Four decimal places	1
<b>P.RH</b>	Maximum value of control PV input range	STD	-19999 to 30000, (P.RL<P.RH),   P.RH - P.RL   ≤ 30000	Depends on the input type
<b>P.RL</b>	Minimum value of control PV input range	STD		Depends on the input type
<b>PV.HL</b>	Input switching PV high limit (in Loop control with PV switching)	STD	0.0 to 100.0% of control PV input range (EU), (PV.HL>PV.LL)	100.0 % of control PV input range
<b>PV.LL</b>	Input switching PV low limit (in Loop control with PV switching)	STD		0.0 % of control PV input range
<b>PV.2C</b>	Input switching action (in Loop control with PV switching)	STD	0: Switch based on low limit of temperature range 1: Switch using the parameter PV.HL 2: Switch using DI 3: Switch based on high limit of temperature range	0
<b>PV.AS</b>	Input computation selection (in Loop control with PV auto-selector)	STD	0: Max. value 1: Min. value 2: Ave. value 3: Input 1 - Input 2 4: Input 2 - Input 1	0
<b>PV.NU</b>	Number of inputs (in Loop control with PV auto-selector)	STD	2: Use Input 1 and Input 2 3: Use Input 1, Input 2, and Input 3 4: Use 4 inputs	2
<b>SPH</b>	SP high limit	STD	0.0 to 100.0% of PV input range (EU), (SPL<SPH)	100.0 % of PV input range
<b>SPL</b>	SP low limit	STD	Place limits on the program setpoints or the local setpoints when the controller is in program operation. * Places the limit on the program setpoint, local setpoint, or remote setpoint during program operation. * When LP2 lamp is on, SPH and SPL limit the program setpoint for program pattern 2 retransmission.	0.0 % of PV input range

In Cascade control, the following parameters are also displayed for secondary loop. (the LP2 lamp is lit)

- Parameter: P.UNI, P.DP, P.RH, P.RL, SPH, SPL

## Output Setting Menu (Menu: OUT)

Parameter symbol	Name	Display level	Setting range	Initial value
<b>OT</b>	Output type selection	EASY	Control output or Heating-side control output (Lower two digits) 00: OFF 01: OUT terminals (voltage pulse) 02: OUT terminals (current) 03: OUT terminals (relay/triac) 04: OUT2 terminals (voltage pulse) 05: OUT2 terminals (current) 06: OUT2 terminals (relay/triac)  Cooling-side control output (Upper two digits) 00: OFF 01: OUT terminals (voltage pulse) 02: OUT terminals (current) 03: OUT terminals (relay/triac) 04: OUT2 terminals (voltage pulse) 05: OUT2 terminals (current) 06: OUT2 terminals (relay/triac)	Standard type: 00.03  Heating/ cooling type: 06.03
<b>CT</b>	Control output cycle time Heating-side control output cycle time (in Heating/cooling control)	EASY	0.5 to 1000.0 s	30.0 s
<b>CTc</b>	Cooling-side control output cycle time	EASY		30.0 s
<b>V.AT</b>	Automatic valve position adjustment	EASY	OFF: Stop automatic adjustment ON: Start automatic adjustment	OFF
<b>V.RS</b>	Valve position setting reset	EASY	Setting V.RS to ON resets the valve adjustment settings and causes the indication "V.RS" to blink.	OFF
<b>V.L</b>	Fully-closed valve position setting	EASY	Pressing the SET/ENTER key with valve position set to the fully-closed position by Down arrow key causes the adjusted value to be stored. When V.L adjustment is complete, V.L stops blinking.	-
<b>V.H</b>	Fully-open valve position setting	EASY	Pressing the SET/ENTER key with valve position set to the fully-opened position by Up arrow key causes the adjusted value to be stored. When V.H adjustment is complete, V.H stops blinking.	-
<b>TR.T</b>	Valve traveling time	STD	5 to 300 s	60 s
<b>V.MOD</b>	Valve adjusting mode	STD	0: Valve position feedback type 1: Valve position feedback type (moves to the estimating type if a feedback input error or break occurs.) 2: Valve position estimating type	0

18.2 List of Parameters

Output Setting Menu (Menu: OUT) (Continued from previous page)

Parameter symbol	Name	Display level	Setting range	Initial value
<b>RTS</b>	Retransmission output type of RET	EASY	OFF: Disable PV1: PV SP1: SP OUT1: OUT (Valve opening: 0 to 100 % in Position proportional control) LPS: 15 V DC loop power supply PV2: Loop-2 PV SP2: Loop-2 SP OUT2: Loop-2 OUT TSP1: Target SP HOUT1: Heating-side OUT COUT1: Cooling-side OUT MV1: Position proportional output (internal computed value) TSP2: Loop-2 target SP HOUT2: Loop-2 heating-side OUT COUT2: Loop-2 cooling-side OUT MV2: Loop-2 position proportional output (internal computed value) PV: PV terminals analog input RSP: RSP terminals analog input AIN2: AIN2 terminals analog input AIN4: AIN4 terminals analog input	PV1
<b>RTH</b>	Maximum value of retransmission output scale of RET	STD	When RTS = PV1, SP1, PV2, SP2, TSP1, TSP2, PV, RSP, AIN2, or AIN4,	100 % of PV input range
<b>RTL</b>	Minimum value of retransmission output scale of RET	STD	RTL + 1 digit to 30000 -19999 to RTH - 1 digit  Decimal point position: When RTS=PV1, SP1, or TSP1, decimal point position is same as that of PV input. When RTS=PV2, SP2, or TSP2, decimal point position is same as that of RSP input. When RTS=PV, decimal point position is same as that of PV input scale. When RTS=RSP, decimal point position is same as that of RSP input scale. When RTS=AIN2, decimal point position is same as that of AIN2 scale. When RTS=AIN4, decimal point position is same as that of AIN4 scale.	0 % of PV input range

## Output Setting Menu (Menu: OUT) (Continued from previous page)

Parameter symbol	Name	Display level	Setting range	Initial value
<b>O1RS</b>	Retransmission output type of OUT current output	STD	Same as RTS	OFF
<b>O1RH</b>	Maximum value of retransmission output scale of OUT current output	STD	When O1RS = PV1, SP1, PV2, SP2, TSP1, TSP2, PV, RSP, AIN2, or AIN4, O1RL + 1 digit to 30000 -19999 to O1RH - 1 digit	-
<b>O1RL</b>	Minimum value of retransmission output scale of OUT current output	STD	Decimal point position: When O1RS = PV1, SP1, or TSP1, decimal point position is same as that of PV input. When O1RS = PV2, SP2, or TSP2, decimal point position is same as that of RSP input. When O1RS = PV, decimal point position is same as that of PV input scale. When O1RS = RSP, decimal point position is same as that of RSP input scale. When O1RS = AIN2, decimal point position is same as that of AIN2 scale. When O1RS = AIN4, decimal point position is same as that of AIN4 scale.	-
<b>O2RS</b>	Retransmission output type of OUT2 current output	STD	Same as RTS	OFF
<b>O2RH</b>	Maximum value of retransmission output scale of OUT2 current output	STD	When O2RS = PV1, SP1, PV2, SP2, TSP1, TSP2, PV, RSP, AIN2, or AIN4, O2RL + 1 digit to 30000 -19999 to O2RH - 1 digit	-
<b>O2RL</b>	Minimum value of retransmission output scale of OUT2 current output	STD	Decimal point position: When O2RS = PV1, SP1, or TSP1, decimal point position is same as that of PV input. When O2RS = PV2, SP2, or TSP2, decimal point position is same as that of RSP input. When O2RS = PV, decimal point position is same as that of PV input scale. When O2RS = RSP, decimal point position is same as that of RSP input scale. When O2RS = AIN2, decimal point position is same as that of AIN2 scale. When O2RS = AIN4, decimal point position is same as that of AIN4 scale.	-

18.2 List of Parameters

Output Setting Menu (Menu: OUT) (Continued from previous page)

Parameter symbol	Name	Display level	Setting range	Initial value
OU.H	100% segmental point of OUT current output	PRO	-100.0 to 200.0%	100.0%
OU.L	0% segmental point of OUT current output	PRO		0.0%
OU2.H	100% segmental point of OUT2 current output	PRO		100.0%
OU2.L	0% segmental point of OUT2 current output	PRO		0.0%
RET.H	100% segmental point of RET current output	PRO		100.0%
RET.L	0% segmental point of RET current output	PRO		0.0%
OU.A	OUT current output range	PRO	4-20: 4 to 20 mA	4-20
OU2.A	OUT2 current output range	PRO	0-20: 0 to 20 mA 20-4: 20 to 4 mA	4-20
RET.A	RET current output range	PRO	20-0: 20 to 0 mA	4-20

Heater Break Alarm Setting Menu (Menu: HBA)

Parameter symbol	Name	Display level	Setting range	Initial value
HB1.S, HB2.S	Heater break alarm-1, -2 function selection	EASY	0: Heater current measurement 1: Heater break alarm	1
HB1, HB2	Heater break alarm-1, -2 current setpoint	EASY	OFF, 0.1 to 300.0 Arms	OFF
CT1.T, CT2.T	CT1, CT2 coil winding number ratio	EASY	1 to 3300	800
HDN1, HDN2	Heater break alarm-1, -2 On-delay timer	STD	0.00 to 99.59 (minute.second)	0.00
HDF1, HDF2	Heater break alarm-1, -2 Off-delay timer	PRO		0.00
HB1.D, HB2.D	Heater break alarm-1, -2 contact type	PRO	CLS: When the event occurs, the contact is closed. OPN: When the event occurs, the contact is opened.	CLS

## RS-485 Communication Setting Menu (Menu: R485) (E3 and E4 terminal area)

Parameter symbol	Name	Display level	Setting range	Initial value
<b>PSL</b>	Protocol selection	EASY	PCL: PC link communication PCLSM: PC link communication (with checksum) LADR: Ladder communication CO-M: Coordinated master station MBASC: Modbus (ASCII) MBRTU: Modbus (RTU) CO-M2: Coordinated master station (2-loop mode) P-P: Peer-to-peer communication	MBRTU
<b>BPS</b>	Baud rate	EASY	600: 600 bps 1200: 1200 bps 2400: 2400 bps 4800: 4800 bps 9600: 9600 bps 19200: 19.2k bps 38400: 38.4k bps (except for communication of E4 terminal area)	19200
<b>PRI</b>	Parity	EASY	NONE: None EVEN: Even ODD: Odd	EVEN
<b>STP</b>	Stop bit	EASY	1: 1 bit, 2: 2 bits	1
<b>DLN</b>	Data length	EASY	7: 7 bits, 8: 8 bits	8
<b>ADR</b>	Address	EASY	1 to 99	1
<b>RP.T</b>	Minimum response time	PRO	0 to 10 (x10ms)	0

When each parameter is displayed, the terminal area (E3 or E4) is displayed on Group display.

• Parameter: PSL, BPS, STP, DLN, ADR, RP.T



## 18.2 List of Parameters

### Ethernet Communication Setting Menu (Menu: ETHR) (E3 terminal area)

Parameter symbol	Name	Display level	Setting range	Initial value
<b>HSR</b>	High-speed response mode	EASY	OFF, 1 to 8	1
<b>BPS</b>	Baud rate	EASY	9600: 9600 bps 19200: 19.2k bps 38400: 38.4k bps	38400
<b>PRI</b>	Parity	EASY	NONE: None EVEN: Even ODD: Odd	EVEN
<b>IP1 to IP4</b>	IP address 1 to 4	EASY	0 to 255 Initial value: 192.168.1.1	See left
<b>SM1 to SM4</b>	Subnet mask 1 to 4	EASY	0 to 255 Initial value: 255.255.255.0	See left
<b>DG1 to DG4</b>	Default gateway 1 to 4	EASY	0 to 255 Initial value: 0.0.0.0	See left
<b>PRT</b>	Port number	EASY	502, 1024 to 65535	502
<b>IPAR</b>	IP access restriction	EASY	OFF: Disable, ON: Enable	OFF
<b>1.IP1 to 1.IP4</b>	Permitted IP address 1-1 to 1-4	EASY	0 to 255 Initial value: 255.255.255.255	See left
<b>2.IP1 to 2.IP4</b>	Permitted IP address 2-1 to 2-4	EASY	0 to 255 Initial value: 255.255.255.255	See left
<b>ESW</b>	Ethernet setting switch	EASY	OFF, ON Setting this parameter to "ON" enables the Ethernet communication parameter settings. * The parameter ESW automatically returns to "OFF" after "ON" is set.	OFF

When each parameter is displayed, the terminal area (E3) is displayed on Group display.

### PROFIBUS-DP Communication Setting Menu (Menu: PROF) (E3 terminal area)

Parameter symbol	Name	Display level	Setting range	Initial value
<b>BR</b>	Baud rate	EASY	9.6K: 9.6k bps 19.2K: 19.2k bps 93.75K: 93.75k bps 187.5K: 187.5k bps 0.5M: 0.5M bps 1.5M: 1.5M bps 3M: 3M bps 6M: 6M bps 12M: 12M bps AUTO 45.45K: 45.45k bps	AUTO
<b>ADR</b>	Address	EASY	0 to 125	3
<b>BPS</b>	Baud rate	EASY	9600: 9600 bps 19200: 19.2k bps 38400: 38.4k bps	38400
<b>FILE</b>	Profile number	EASY	0, 11 to 15	0
<b>SCAN</b>	Automatic rescan time	PRO	OFF 1M: 1 minute 10M: 10 minutes 30M: 30 minutes 60M: 60 minutes	OFF

When each parameter is displayed, the terminal area (E3) is displayed on Group display.

## DeviceNet Communication Setting Menu (Menu: DNET) (E3 terminal area)

Parameter symbol	Name	Display level	Setting range	Initial value
<b>BR</b>	Baud rate	EASY	125K: 125k bps 250K: 250k bps 500K: 500k bps	125K
<b>ADR</b>	Address	EASY	0 to 63	63
<b>BPS</b>	Baud rate	EASY	9600: 9600 bps 19200: 19.2k bps 38400: 38.4k bps	38400
<b>FILE</b>	Profile number	EASY	0, 11 to 15	0
<b>SCAN</b>	Automatic rescan time	PRO	OFF 1M: 1 minute 10M: 10 minutes 30M: 30 minutes 60M: 60 minutes	OFF

When each parameter is displayed, the terminal area (E3) is displayed on Group display.

## CC-Link Communication Setting Menu (Menu: CC-L) (E3 terminal area)

Parameter symbol	Name	Display level	Setting range	Initial value
<b>BR</b>	Baud rate	EASY	156K: 156k bps 625K: 625k bps 2.5M: 2.5M bps 5M: 5M bps 10M: 10M bps	10M
<b>ADR</b>	Address	EASY	1 to 64	1
<b>BPS</b>	Baud rate	EASY	9600: 9600 bps 19200: 19.2k bps 38400: 38.4k bps	38400
<b>FILE</b>	Profile number	EASY	0, 11 to 15 (0, 11: Ver.1.10) (12 to 15: Ver.2.00)	0
<b>SCAN</b>	Automatic rescan time	PRO	OFF 1M: 1 minute 10M: 10 minutes 30M: 30 minutes 60M: 60 minutes	OFF

When each parameter is displayed, the terminal area (E3) is displayed on Group display.

## 18.2 List of Parameters

### Key Action Setting Menu (Menu: KEY)

Parameter symbol	Name	Display level	Setting range	Initial value
<b>RUN</b>	RUN key action setting	PRO	OFF: Disable PROG: Switch to PROG (Start of program operation)	PROG
<b>RST</b>	RST key action setting	PRO	RESET: Switch to RESET (Stop of program operation)	RESET
<b>PTN</b>	PTN key action setting	PRO	LOCAL: Switch to LOCAL(LSP) (Start of local-mode operation)	PTN
<b>MODE</b>	MODE key action setting	PRO	REM: Switch to REMOTE P/R: PROG/RESET Switch P/H: PROG/HOLD Switch P/L: PROG/LOCAL(LSP) Switch L/C: LOCAL(LSP)/CAS switch HLD: Switch to HOLD (Start of hold-mode operation) ADV: Advance of segment A/M1: Loop-1 AUTO/MAN switch A/M2: Loop-2 AUTO/MAN switch PRG1: Switch to PROG1 (Start of program-1 operation) PRG2: Switch to PROG2 (Start of program-2 operation) AT: Auto-tuning LTUP: LCD brightness UP LTDN: LCD brightness DOWN BRI: Adjust LCD brightness LCD: LCD backlight ON/OFF switch LAT: Latch release PID: PID tuning switch PTN: Program pattern number switch MODE: Operation mode	MODE

## Display Function Setting Menu (Menu: DISP)

Parameter symbol	Name	Display level	Setting range	Initial value
<b>PCMD</b>	Active color PV display switch	EASY	0: Fixed in white 1: Fixed in red 2: Link to alarm 1 (Alarm OFF: white, Alarm ON: red) 3: Link to alarm 1 (Alarm OFF: red, Alarm ON: white) 4: Link to alarm 1 or 2 (Alarm OFF: white, Alarm ON: red) 5: Link to alarm 1 or 2 (Alarm OFF: red, Alarm ON: white) 6: PV limit (Within range: white, Out of range: red) 7: PV limit (Within range: red, Out of range: white) 8: SP deviation (Within deviation: white, Out of deviation: red) 9: SP deviation (Within deviation: red, Out of deviation: white) 10: Link to DI (ON: red, OFF: white)	0
<b>PCH</b>	PV color change high limit	EASY	Set a display value when in PV limit or SP deviation.	0
<b>PCL</b>	PV color change low limit	EASY	-19999 to 30000 (Set a value within the input range.) Decimal point position depends on the input type.	0
<b>PTSL</b>	Program display pattern selection	STD	PTN: Pattern display SK.RP: Ramp and soak display	PTN
<b>BAR1</b>	Upper bar-graph display registration	STD	0: Disable 1:OUT, Heating-side OUT, Internal value in Position proportional control	23
<b>BAR2</b>	Lower bar-graph display registration	STD	2: Cooling-side OUT 3: PV 4: SP 5: Deviation 6: Loop-2 OUT, Loop-2 heating-side OUT 7: Loop-2 cooling-side OUT 8: Loop-2 PV 9: Loop-2 SP 10: Loop-2 deviation 11 to 16: Disable 17: Feedback input (valve opening) 18: PV terminals analog input 19: RSP terminals analog input 20: AIN2 terminals analog input 21: AIN4 terminals analog input 22: Segment progress 23: Time event and alarm status	0

In Cascade control, the following parameters are also displayed for secondary loop. (the LP2 lamp is lit)

- Parameter: PCMD, PCH, PCL

## 18.2 List of Parameters

Display Function Setting Menu (Menu: DISP) (Continued from previous page)

Parameter symbol	Name	Display level	Setting range	Initial value
<b>BDV</b>	Bar-graph deviation display band	STD	0.0 to 100.0% of PV input range span (EUS)	10.0 % of PV input range span
<b>EV1 to EV8</b>	EV1 to EV8 display condition registration	PRO	Setting range: 4001 to 6304 OFF: Disable 4785: Link to PV event-1/local event-1 (Lit when the event occurs) 4786: Link to PV event-2/local event-2 (Lit when the event occurs) 4787: Link to PV event-3/local event-3 (Lit when the event occurs) 4789: Link to PV event-4/local event-4 (Lit when the event occurs) 4790: Link to PV event-5/local event-5 (Lit when the event occurs) 4791: Link to PV event-6/local event-6 (Lit when the event occurs) 4793: Link to PV event-7/local event-7 (Lit when the event occurs) 4794: Link to PV event-8/local event-8 (Lit when the event occurs) 4817: Link to time event-1 (Lit when the event occurs) 4818: Link to time event-2 (Lit when the event occurs) 4819: Link to time event-3 (Lit when the event occurs) 4821: Link to time event-4 (Lit when the event occurs) 4822: Link to time event-5 (Lit when the event occurs) 4823: Link to time event-6 (Lit when the event occurs) 4825: Link to time event-7 (Lit when the event occurs) 4826: Link to time event-8 (Lit when the event occurs) 4833: Link to time event-9 (Lit when the event occurs) 4834: Link to time event-10 (Lit when the event occurs) 4835: Link to time event-11 (Lit when the event occurs) 4837: Link to time event-12 (Lit when the event occurs) 4838: Link to time event-13 (Lit when the event occurs) 4839: Link to time event-14 (Lit when the event occurs) 4841: Link to time event-15 (Lit when the event occurs) 4842: Link to time event-16 (Lit when the event occurs) 4321: Link to alarm-1 (Lit when the alarm occurs) 4322: Link to alarm-2 (Lit when the alarm occurs) 4323: Link to alarm-3 (Lit when the alarm occurs) 4325: Link to alarm-4 (Lit when the alarm occurs) 4326: Link to alarm-5 (Lit when the alarm occurs) 4327: Link to alarm-6 (Lit when the alarm occurs) 4329: Link to alarm-7 (Lit when the alarm occurs) 4330: Link to alarm-8 (Lit when the alarm occurs) 4529: Heater break alarm 1 (Lit when the alarm occurs) 4530: Heater break alarm 2 (Lit when the alarm occurs) * For other functions, see the UTAdvanced Series Communication Interface User's Manual.	EV1: 4785 EV2: 4786 EV3: 4787 EV4: 4789 EV5: 4790 EV6: 4791 EV7: 4793 EV8: 4794

In Cascade control, the following parameters are also displayed for secondary loop. (the LP2 lamp is lit)

- Parameter: BDV, EV1 to EV8

## Display Function Setting Menu (Menu: DISP) (Continued from previous page)

Parameter symbol	Name	Display level	Setting range	Initial value
<b>EV1 to EV8</b>	EV1 to EV8 display condition registration	PRO	Setting range: 4001 to 6304 OFF: Disable  5025 to 5027: Link to DI1-DI3 (Lit when the contact is closed) 5041 to 5046: Link to DI11-DI16 (E1-terminal area) (Lit when the contact is closed) 5057 to 5062: Link to DI21-DI26 (E2-terminal area) (Lit when the contact is closed) 5073 to 5077: Link to DI31-DI35 (E3-terminal area) (Lit when the contact is closed) 5089 to 5094: Link to DI41-DI46 (E4-terminal area) (Lit when the contact is closed)  5153 to 5155: Link to AL1-AL3 (Lit when the contact is closed) 5169 to 5173: Link to DO11-DO15 (E1-terminal area) (Lit when the contact is closed) 5185 to 5189: Link to DO21-DO25 (E2-terminal area) (Lit when the contact is closed) 5201 to 5205: Link to DO31-DO35 (E3-terminal area) (Lit when the contact is closed) 5217 to 5221: Link to DO41-DO45 (E4-terminal area) (Lit when the contact is closed)  * For other functions, see the UTAdvanced Series Communication Interface User's Manual.	EV1: 4785 EV2: 4786 EV3: 4787 EV4: 4789 EV5: 4790 EV6: 4791 EV7: 4793 EV8: 4794

In Cascade control, the following parameters are also displayed for secondary loop. (the LP2 lamp is lit)

- Parameter: EV1 to EV8

## 18.2 List of Parameters

**Display Function Setting Menu (Menu: DISP) (Continued from previous page)**

Parameter symbol	Name	Display level	Setting range	Initial value
<b>PV.D</b>	PV display area ON/OFF	PRO	OFF: Nondisplay, ON: Display	ON
<b>SP.D</b>	Setpoint display area ON/OFF	PRO		ON
<b>STS.D</b>	Status display area ON/OFF	PRO		ON
<b>SPD</b>	Scroll speed	PRO	(Slow) 1 to 8 (Quick)	4
<b>GUID</b>	Guide display ON/OFF	STD	OFF: Nondisplay ON: Display	ON
<b>HOME</b>	Home Operation Display setting	PRO	SP1: SP Display SP2: Loop-2 SP Display OUT1: OUT Display OUT2: Loop-2 OUT Display HCO: Heating/cooling OUT Display VP: Valve Position Display MV: Position Proportional Computation Output Display PID1: PID Number Display PID2: Loop-2 PID Number Display HC1: Heater Break Alarm-1 Current Display HC2: Heater Break Alarm-2 Current Display PV1: PV2/PV1 Display PV2: PV1/PV2 Display PV: PV Analog Input Display RSP: RSP Analog Input Display AIN2: AIN2 Analog Input Display AIN4: AIN4 Analog Input Display CS1 to CS5: SELECT Display 1 to 5 TSP1: TSP Display TSP2: Loop-2 TSP Display R.TIM: Remaining Segment-tim Display SEG.N: Segment Number Display R.CYC: Remaining Repetition Display PTN: Program Pattern Display AL5.8.1: Alarm-5 to -8 Status Display AL5.8.2: Loop-2 Alarm-5 to -8 Status Display	SP1
<b>ECO</b>	Economy mode	STD	OFF: Disable 1: Economy mode ON (All indications except PV display OFF) 2: Economy mode ON (All indications OFF) 3: Brightness 10 % (All indications)	OFF
<b>BRI</b>	Brightness	EASY	(Dark) 1 to 5 (Bright)	3
<b>B.PVW</b>	White brightness adjustment of PV display	PRO	Adjusts the white brightness of PV display. (Dark) -4 to 4 (Bright)	0
<b>B.PVR</b>	Red brightness adjustment of PV display	PRO	Adjusts the red brightness of PV display. (Dark) -4 to 4 (Bright)	0
<b>B.SP</b>	Brightness adjustment of Setpoint display	PRO	Adjusts the brightness of SP display. (Dark) -4 to 4 (Bright)	0
<b>B.BAR</b>	Brightness adjustment of Bar-graph display	PRO	Adjusts the brightness of SP display. (Dark) -4 to 4 (Bright)	0
<b>B.STS</b>	Brightness adjustment of Status indicator	PRO	Adjusts the brightness of Status indicator. (Dark) -4 to 4 (Bright)	0
<b>D.CYC</b>	Display update cycle	PRO	1: 100 ms 2: 200 ms 3: 500 ms 4: 1 s 5: 2 s	2

## Display Function Setting Menu (Menu: DISP) (Continued from previous page)

Parameter symbol	Name	Display level	Setting range	Initial value
<b>OP.JP</b>	Autoreturn to operation display	PRO	Automatically returned to the Operation Display when there has been no keystroke operation for 5 minutes. OFF, ON	ON
<b>MLSD</b>	Least significant digital mask of PV display	STD	OFF: With least significant digit ON: Without least significant digit	OFF

## SELECT Display Setting Menu (Menu: CSEL)

Parameter symbol	Name	Display level	Setting range	Initial value
<b>CS1 to CS5</b>	SELECT Display-1 to -5registration	STD	OFF, 2201 to 5000	OFF
<b>CS10 to CS19</b>	SELECT parameter-10 to -19 registration	PRO		OFF



## 18.2 List of Parameters

### Key Lock Setting Menu (Menu: KLOC)

Parameter symbol	Name	Display level	Setting range	Initial value
U.SP	SP Display lock	PRO	OFF: Display ON: Nondisplay	OFF
U.TSP	TSP Display lock	PRO		OFF
U.TM	Remaining Segment-tim Display lock	PRO		OFF
U.OUT	OUT Display lock	PRO		OFF (Cascade control: ON)
U.HCO	Heating/cooling OUT Display lock	PRO		OFF
U.VP	Valve Position Display lock	PRO		OFF
U.MV	Position Proportional Computation Output Display lock	PRO		ON
U.PID	PID Number Display lock	PRO		ON
U.SEG	Segment Number Display lock	PRO		OFF
U.RCY	Remaining Repetition Display lock	PRO		OFF
U.PTN	Program Pattern Display lock	PRO		OFF
U.AL	Alarm-5 to -8 Status Display lock	PRO		OFF
U.HC	Heater Break Alarm Current Value Display lock	PRO		OFF
U.PV1	PV2/PV1 Display lock	PRO		OFF
U.PV2	PV1/PV2 Display lock	PRO		OFF
U.PV	PV Analog Input Display lock	PRO		ON (Loop control with PV switching and Loop control with PV auto-selector: OFF)
U.RSP	RSP Analog Input Display lock	PRO		ON (Loop control with PV auto-selector: OFF)
U.AI2	AIN2 Analog Input Display lock	PRO		
U.AI4	AIN4 Analog Input Display lock	PRO		
COM.W	Communication write enable/disable	STD	OFF: Enable, ON: Disable	OFF
DATA	Front panel parameter data key lock	STD	OFF: Unlock ON: Lock	OFF
RUN	Front panel RUN key lock	STD		OFF
RST	Front panel RST key lock	STD		OFF
PTN	Front panel PTN key lock	STD		OFF
MODE	Front panel MODE key lock	STD		OFF

The following parameters are also displayed for secondary loop. (the LP2 lamp is lit)

• Parameter: U.SP, U.OUT, U.PID, U.AL, U.PV2

When the program pattern-2 retransmission is selected (PT2.G=ON), the second loop is also displayed for the parameters UT.SP, U.TSP. (LP2 lamp is lit.)

## Menu Lock Setting Menu (Menu: MLOC)

Parameter symbol	Name	Display level	Setting range	Initial value
CTL	[CTL] menu lock	PRO	OFF: Display ON: Nondisplay	OFF
PV	[PV] menu lock	PRO		
RSP	[RSP] menu lock	PRO		
AIN2	[AIN2] menu lock	PRO		
AIN4	[AIN4] menu lock	PRO		
MPV	[MPV] menu lock	PRO		
OUT	[OUT] menu lock	PRO		
HBA	[HBA] menu lock	PRO		
R485	[R485] menu lock	PRO		
ETHR	[ETHR] menu lock	PRO		
PROF	[PROF] menu lock	PRO		
DNET	[DNET] menu lock	PRO		
CC-L	[CC-L] menu lock	PRO		
KEY	[KEY] menu lock	PRO		
DISP	[DISP] menu lock	PRO		
CSEL	[CSEL] menu lock	PRO		
KLOC	[KLOC] menu lock	PRO		
DI.SL	[DI.SL] menu lock	PRO		
DI.NU	[DI.NU] menu lock	PRO		
DI.D	[DI.D] menu lock	PRO		
ALM	[ALM] menu lock	PRO		
DO	[DO] menu lock	PRO		
I/O	[I/O] menu lock	PRO		
SYS	[SYS] menu lock	PRO		
INIT	[INIT] menu lock	PRO		
VER	[VER] menu lock	PRO		
LVL	[LVL] menu lock	PRO		

When each parameter is displayed, the terminal area (E1 to E4) is displayed on Group display.

- Parameter: RSP, AIN2, AIN4, R485, ETHR, PROF, DNET, CC-L, DI.D, DO

In Cascade control, the following parameters are also displayed for secondary loop. (the LP2 lamp is lit)

- Parameter: MPV

## 18.2 List of Parameters

### Menu Lock Setting Menu (Menu: MLOC)

Parameter symbol	Name	Display level	Setting range	Initial value
<b>MODE</b>	[MODE] menu lock	PRO	OFF: Display ON: Nondisplay	OFF
<b>CS</b>	[CS] menu lock	PRO		
<b>PROG</b>	[PROG] menu lock	PRO		
<b>LOC</b>	[LOC] menu lock	PRO		
<b>EDIT</b>	[EDIT] menu lock	PRO		
<b>AL</b>	[AL] menu lock	PRO		
<b>SPS</b>	[SPS] menu lock	PRO		
<b>ALRM</b>	[ALRM] menu lock	PRO		
<b>PVS</b>	[PVS] menu lock	PRO		
<b>PID</b>	[PID] menu lock	PRO		
<b>TUNE</b>	[TUNE] menu lock	PRO		
<b>ZONE</b>	[ZONE] menu lock	PRO		
<b>PPAR</b>	[PPAR] menu lock	PRO		
<b>PYS1</b>	[PYS1] menu lock	PRO		
<b>PYS2</b>	[PYS2] menu lock	PRO		
<b>PYS3</b>	[PYS3] menu lock	PRO		
<b>PYS4</b>	[PYS4] menu lock	PRO		

In Cascade control, the following parameters are also displayed for secondary loop. (the LP2 lamp is lit)

- Parameter: AL, SPS, ALRM, PVS, PID, TUNE, ZONE

## DI Function Registration Menu (Menu: DI.SL)

Parameter symbol	Name	Display level	Setting range	Initial value
<b>PRG</b>	Switch to PROG (Start of program operation)	STD	Set an I relay number of contact input. Set "OFF" to disable the function.  Standard terminals DI1: 5025, DI2: 5026, DI3: 5027 E1-terminal area DI11: 5041, DI12: 5042, DI13: 5043, DI14: 5044, DI15: 5045, DI16: 5046 E2-terminal area DI21: 5057, DI22: 5058, DI23: 5059, DI24: 5060, DI25: 5061, DI26: 5062 E3-terminal area DI31: 5073, DI32: 5074, DI33: 5075, DI34: 5076, DI35: 5077 E4-terminal area DI41: 5089, DI42: 5090, DI43: 5091, DI44: 5092, DI45: 5093, DI46: 5094	5025
<b>RST</b>	Switch to RESET (Stop of program operation)	STD		5026
<b>LOC</b>	Switch to LOCAL(LSP) (Start of local-mode operation)	STD		5027
<b>REM</b>	Switch to REMOTE	STD		5046
<b>P/R</b>	PROG/RESET Switch	STD		OFF
<b>P/H</b>	PROG/HOLD Switch	STD		OFF
<b>P/L</b>	PROG/LOCAL(LSP) Switch	STD		OFF
<b>HOLD</b>	Switch to HOLD (Start of hold-mode operation)	STD		OFF
<b>ADV</b>	Advance of segment	STD		OFF
<b>WAIT</b>	Wait ON/OFF switch	STD		OFF
<b>S.HLD</b>	Switch to HOLD for synchronized program operation	PRO		OFF
<b>A/M</b>	AUTO/MAN switch	STD		OFF
<b>L/C</b>	LOCAL(LSP)/CAS switch	STD		OFF
<b>AT</b>	Auto-tuning START/STOP switch	STD		OFF
<b>TRK</b>	Output tracking switch	PRO		OFF
<b>SW</b>	PV switch	PRO		OFF
<b>LAT</b>	Latch release	STD		OFF
<b>LCD</b>	LCD backlight ON/OFF switch	STD		OFF
<b>PVRW</b>	PV red/white switch	STD		OFF
<b>MG1</b>	Message display interruption 1	PRO		OFF
<b>MG2</b>	Message display interruption 2	PRO	OFF	
<b>MG3</b>	Message display interruption 3	PRO	OFF	
<b>MG4</b>	Message display interruption 4	PRO	OFF	

In Cascade control, the following parameters are also displayed for secondary loop. (the LP2 lamp is lit)

- Parameter: A/M, PVRW

## 18.2 List of Parameters

### DI Function Numbering Menu (Menu: DI.NU)

Parameter symbol	Name	Display level	Setting range	Initial value
PT.B0	Bit-0 of Program pattern number	EASY	Set an I relay number of contact input. Set "OFF" to disable the function.  Standard terminals DI1: 5025, DI2: 5026, DI3: 5027 E1-terminal area DI11: 5041, DI12: 5042, DI13: 5043, DI14: 5044, DI15: 5045, DI16: 5046 E2-terminal area DI21: 5057, DI22: 5058, DI23: 5059, DI24: 5060, DI25: 5061, DI26: 5062 E3-terminal area DI31: 5073, DI32: 5074, DI33: 5075, DI34: 5076, DI35: 5077 E4-terminal area DI41: 5089, DI42: 5090, DI43: 5091, DI44: 5092, DI45: 5093, DI46: 5094	5089
PT.B1	Bit-1 of Program pattern number	EASY		5090
PT.B2	Bit-2 of Program pattern number	EASY		5091
PT.B3	Bit-3 of Program pattern number	EASY		5092
PT.B4	Bit-4 of Program pattern number	EASY		5093
PT.B5	Bit-5 of Program pattern number	EASY		OFF
PN.B0	Bit-0 of PID number	STD		OFF
PN.B1	Bit-1 of PID number	STD		OFF
PN.B2	Bit-2 of PID number	STD		OFF
PN.B3	Bit-3 of PID number	STD		OFF
MP.B0	Bit-0 of manual preset output number	STD		OFF
MP.B1	Bit-1 of manual preset output number	STD		OFF
MP.B2	Bit-2 of manual preset output number	STD		OFF
PT.BC	Bit changing method of program pattern number	PRO	0: Status switch 1 1: Status switch 2 2: BCD switch	0
PN.BC	Bit changing method of PID number	PRO	0: Status switch 1 1: Status switch 2	0
MP.BC	Bit changing method of manual preset output number	PRO	0: Status switch 1 1: Status switch 2	0

In Cascade control, the following parameters are also displayed for secondary loop. (the LP2 lamp is lit)

- Parameter MP.B0, MP.B1, MP.B2, MP.BC

### DI1-DI3 Contact Type Setting Menu (Menu: DI.D)

Parameter symbol	Name	Display level	Setting range	Initial value
DI1.D	DI1 contact type	PRO	0: The assigned function is enabled when the contact input is closed. 1: The assigned function is enabled when the contact input is opened.	0
DI2.D	DI2 contact type	PRO		0
DI3.D	DI3 contact type	PRO		0

### DI Setting Menu (Menu: DI.D) (E1 and E4 terminal area)

Parameter symbol	Name	Display level	Setting range	Initial value
DI1.D	DIn1 contact type	PRO	0: The assigned function is enabled when the contact input is closed. 1: The assigned function is enabled when the contact input is opened.	0
DI2.D	DIn2 contact type	PRO		0
DI3.D	DIn3 contact type	PRO		0
DI4.D	DIn4 contact type	PRO		0
DI5.D	DIn5 contact type	PRO		0

n: Terminal area number (1, 3 or 4)

## AL1-AL3 Function Registration Menu (Menu: ALM)

Parameter symbol	Name	Display level	Setting range	Initial value
AL1.S	AL1 function selection	STD	Set an I relay number. Setting range: 4001 to 6304	4801
AL2.S	AL2 function selection	STD	No function: OFF	4802
AL3.S	AL3 function selection	STD	PV event 1: 4801, PV event 2: 4802, PV event 3: 4803, PV event 4: 4805, PV event 5: 4806, PV event 6: 4807, PV event 7: 4809, PV event 8: 4810,	4803
OR.S	OUT relay function selection	STD	Time event 1: 4817, Time event 2: 4818, Time event 3: 4819, Time event 4: 4821, Time event 5: 4822, Time event 6: 4823, Time event 7: 4825, Time event 8: 4826, Time event 9: 4833, Time event 10: 4834, Time event 11: 4835, Time event 12: 4837, Time event 13: 4838, Time event 14: 4839, Time event 15: 4841, Time event 16: 4842, Alarm 1: 4353, Alarm 2: 4354, Alarm 3: 4355, Alarm 4: 4357, Alarm 5: 4358, Alarm 6: 4359, Alarm 7: 4361, Alarm 8: 4362, AUTO (ON) / MAN (OFF) status: 4177, Program RESET status: 4181, Program RUN status: 4182, Local operation status: 4183, Remote operation status: 4185, HOLD mode status: 4189, Program advance status: 4187, Pattern end signal (1 second): 4265, Pattern end signal (3 seconds): 4266, Pattern end signal (5 seconds): 4267, Wait end signal (1 second) : 4257, Wait end signal (3 seconds) : 4258, Wait end signal (5 seconds) : 4259, Output tracking (ON) switching signal: 4186, FAIL (Normally ON) output: 4256	OFF
OR2.S	OUT2 relay function selection	STD		OFF
AL1.D	AL1 contact type	PRO	0: When the event of assigned function occurs, the contact output is closed. 1: When the event of assigned function occurs, the contact output is opened.	0
AL2.D	AL2 contact type	PRO		0
AL3.D	AL3 contact type	PRO		0
OR.D	OUT relay contact type	PRO		0
OR2.D	OUT2 relay contact type	PRO		0

## 18.2 List of Parameters

### DO Setting Menu (Menu: DO) (E1 to E4 terminal area)

Parameter symbol	Name	Display level	Setting range	Initial value
<b>DO1.S</b>	DOn1 function selection	STD	Same as AL1.S.	See left
<b>DO2.S</b>	DOn2 function selection	STD	DO11=4805, DO12=4806, DO13=4807, DO14=4809, DO15=4810, DO21=4817, DO22=4818, DO23=4819, DO24=4821, DO25=4822, DO31=4823, DO32=4825, DO33=4826, DO34=4833, DO35=4834, DO41=OFF, DO42=OFF, DO43=OFF, DO44=OFF, DO45=OFF	See left
<b>DO3.S</b>	DOn3 function selection	STD		See left
<b>DO4.S</b>	DOn4 function selection	STD		See left
<b>DO5.S</b>	DOn5 function selection	STD		See left
<b>DO1.D</b>	DOn1 contact type	PRO		0: When the event of assigned function occurs, the contact output is closed. 1: When the event of assigned function occurs, the contact output is opened.
<b>DO2.D</b>	DOn2 contact type	PRO	0	
<b>DO3.D</b>	DOn3 contact type	PRO	0	
<b>DO4.D</b>	DOn4 contact type	PRO	0	
<b>DO5.D</b>	DOn5 contact type	PRO	0	

n: Terminal area number (1 to 4)

### I/O Display Menu (Menu: I/O)

Parameter symbol	Name	Display level	Read only
<b>KEY</b>	Key status	PRO	See Chapter 13.
<b>X000</b>	DI1-DI3 status (equipped as standard)	PRO	
<b>X100</b>	DI11-DI16 status (E1-terminal area)	PRO	
<b>X200</b>	DI21-DI26 status (E2-terminal area)	PRO	
<b>X300</b>	DI31-DI35 status (E3-terminal area)	PRO	
<b>X400</b>	DI41-DI46 status (E4-terminal area)	PRO	
<b>Y000</b>	AL1-AL3 status (equipped as standard)	PRO	
<b>Y100</b>	DO11-DO15 status (E1-terminal area)	PRO	
<b>Y200</b>	DO21-DO25 status (E2-terminal area)	PRO	
<b>Y300</b>	DO31-DO35 status (E3-terminal area)	PRO	
<b>Y400</b>	DO41-DO45 status (E4-terminal area)	PRO	

## System Setting Menu (Menu: SYS)

Parameter symbol	Name	Display level	Setting range	Initial value
<b>R.MD</b>	Restart mode	STD	CONT: Continue action set before power failure. MAN: Start from MAN. RESET: Start from AUTO and RESET. The preset output value is outputted. * Set how the controller should recover from a power failure of 5 seconds or more.	CONT
<b>R.TM</b>	Restart timer	STD	0 to 10 s * Set time between power on and the instant where controller starts computation.	0
<b>EPO</b>	Input error preset output	STD	0: Preset output 1: 0% output 2: 100% output * Set preset output value when the input burnout or ADC error occurs. Manual output is prioritized when the input burnout occurs in MAN.	0
<b>C.GRN</b>	Response as GREEN Series	PRO	OFF: Works as UP55A in communication of device information response or broadcasting. ON: Works as GREEN Series in communication of device information response or broadcasting.	OFF
<b>FREQ</b>	Power frequency	EASY	AUTO, 60: 60 Hz, 50: 50 Hz	AUTO
<b>QSM</b>	Quick setting mode	EASY	OFF: Disable ON: Enable	ON
<b>LANG</b>	Guide display language	EASY	ENG: English FRA: French GER: German SPA: Spanish	Depends on the Model and Suffix Codes
<b>PASS</b>	Password setting	EASY	0 (No password) to 65535	0
<b>SMEC</b>	Sampling period error counter	PRO	0 to 65535 (display only)	0 when power is turned on.



## 18.2 List of Parameters

### Initialization Menu (Menu: INIT)

Parameter symbol	Name	Display level	Setting range	Initial value
U.DEF	Initialization to user default value	PRO	12345: Initialization, automatically returned to "0" after initialization.	0
F.DEF	Initialization to factory default value	PRO	-12345: Initialization, automatically returned to "0" after initialization.	0
P.DEF	Clearing all program pattern data	PRO	13579: Initialization, automatically returned to "0" after initialization. * Data all deletions in menu [PROG]	0

### Error and Version Confirmation Menu (Menu: VER)

Parameter symbol	Name	Display level	Read only
PA.ER	Parameter error status	EASY	See Chapter 16.
OP.ER	Option error status	EASY	
AD1.E	A/D converter error status 1	EASY	
AD2.E	A/D converter error status 2	EASY	
PV1.E	Loop-1 PV input error status	EASY	
PV2.E	Loop-2 PV input error status	EASY	
LA.ER	Ladder error status	EASY	
MCU	MCU version	EASY	See Chapter 13.
DCU	DCU version	EASY	
ECU1	ECU-1 version	EASY	
ECU2	ECU-2 version	EASY	
ECU3	ECU-3 version	EASY	
ECU4	ECU-4 version	EASY	
PARA	Parameter version	EASY	
H.VER	Product version	EASY	
SER1	Serial number 1	EASY	
SER2	Serial number 2	EASY	
MAC1	MAC address 1	EASY	
MAC2	MAC address 2	EASY	
MAC3	MAC address 3	EASY	

When the following parameters are displayed, the terminal area (E1 to E4) is displayed on Group display.

- Parameter: ECU1, ECU2, ECU3, ECU4, MAC1, MAC2 and MAC3

### Parameter Display Level Menu (Menu: LVL)

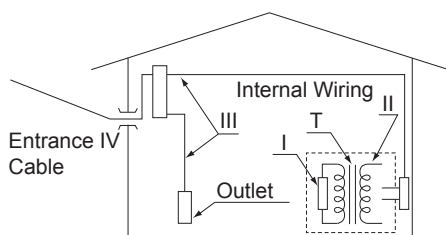
Parameter symbol	Name	Display level	Setting range	Initial value
LEVL	Parameter display level	EASY	EASY: Easy setting mode STD: Standard setting mode PRO: Professional setting mode	STD

# 19.1 Hardware Specifications



## WARNING

This instrument is for Measurement Category I (CAT.I). Do not use it for measurements in locations falling under Measurement Categories II, III, and IV.



Category	Measurement category	Description	Remarks
I	CAT.I	For measurements performed on circuits not directly connected to MAINS.	-
II	CAT.II	For measurements performed on circuits directly connected to the low-voltage installation.	Appliances, portable equipments, etc.
III	CAT.III	For measurements performed in the building installation.	Distribution board, circuit breaker, etc.
IV	CAT.IV	For measurements performed at the source of the low-voltage installation.	Overhead wire, cable systems, etc.

## 19.1 Hardware Specifications

### 19.1.1 Input Specifications

#### Universal Input

- Number of inputs: 1
- Input type, instrument range, and measurement accuracy: See the table below.

Input Type		Instrument Range (°C)	Instrument Range (°F)	Accuracy
Thermo-couple	K	-270.0 to 1370.0°C	-450.0 to 2500.0°F	±0.1% of instrument range ±1 digit for 0°C or more ±0.2% of instrument range ±1 digit for less than 0°C ±2% of instrument range ±1 digit for less than -200.0°C of thermocouple K ±1% of instrument range ±1 digit for less than -200.0°C of thermocouple T  ±0.15% of instrument range ±1 digit for 400°C or more ±5% of instrument range ±1 digit for less than 400°C  ±0.15% of instrument range ±1 digit  ±0.1% of instrument range ±1 digit ±0.25% of instrument range ±1 digit for less than 0°C  ±0.1% of instrument range ±1 digit for 0°C or more ±0.2% of instrument range ±1 digit for less than 0°C ±1.5% of instrument range ±1 digit for less than -200.0°C of thermocouple E.  ±0.2% of instrument range ±1 digit (Note 2)  ±0.1% of instrument range ±1 digit  ±0.5% of instrument range ±1 digit for 800°C or more Accuracy is not guaranteed for less than 800°C.  ±0.2% of instrument range ±1 digit
		-270.0 to 1000.0°C	-450.0 to 2300.0°F	
		-270.0 to 500.0°C	-200.0 to 1000.0°F	
	J	-200.0 to 1200.0°C	-300.0 to 2300.0°F	
	T	-270.0 to 400.0°C	-450.0 to 750.0°F	
		0.0 to 400.0°C	-200.0 to 750.0°F	
	B	0.0 to 1800.0°C	32 to 3300°F	
	S	0.0 to 1700.0°C	32 to 3100°F	
	R	0.0 to 1700.0°C	32 to 3100°F	
	N	-200.0 to 1300.0°C	-300.0 to 2400.0°F	
	E	-270.0 to 1000.0°C	-450.0 to 1800.0°F	
	L	-200.0 to 900.0°C	-300.0 to 1600.0°F	
	U	-200.0 to 400.0°C	-300.0 to 750.0°F	
		0.0 to 400.0°C	-200.0 to 1000.0°F	
	W	0.0 to 2300.0°C	32 to 4200°F	
Platinel 2	0.0 to 1390.0°C	32.0 to 2500.0°F		
PR20-40	0.0 to 1900.0°C	32 to 3400°F		
W97Re3-W75Re25	0.0 to 2000.0°C	32 to 3600°F		
RTD	JPt100	-200.0 to 500.0°C	-300.0 to 1000.0°F	
		-150.00 to 150.00°C	-200.0 to 300.0°F	
	Pt100	-200.0 to 850.0°C	-300.0 to 1560.0°F	
		-200.0 to 500.0°C	-300.0 to 1000.0°F	
		-150.00 to 150.00°C	-200.0 to 300.0°F	
Standard signal	0.400 to 2.000 V		±0.1% of instrument range ±1 digit	
	1.000 to 5.000 V			
	4.00 to 20.00 mA			
DC voltage/current	0.000 to 2.000 V			
	0.00 to 10.00 V			
	0.00 to 20.00 mA			
	-10.00 to 20.00 mV			
	0.0 to 100.0 mV			

The accuracy is that in the standard operating conditions: 23±2°C, 55±10%RH, and power frequency at 50/60 Hz.

Note 1: ±0.3°C ±1 digit in the range between 0 and 100°C, ±0.5°C ±1 digit in the range between -100 and 200°C.

Note 2: W: W-5% Re/W-26% Re(Hoskins Mfg.Co.). ASTM E988

- Input sampling (control) period: Select from among 100 and 200 ms
- Burnout detection:
  - Functions at TC, RTD, and standard signal
  - Upscale, downscale, and off can be specified.
  - For standard signal, burnout is determined to have occurred if it is 0.1 V or 0.4 mA or less.
- Input bias current: 0.05  $\mu$ A (for TC or RTD)
- Measurement current (RTD): About 0.16 mA
- Input resistance:
  - TC or mV input: 1 M $\Omega$  or more
  - V input: About 1 M $\Omega$
  - mA input: About 250  $\Omega$
- Allowable signal source resistance:
  - TC or mV input: 250  $\Omega$  or less
  - Effects of signal source resistance: 0.1  $\mu$ V/ $\Omega$  or less
  - DC voltage input: 2 k $\Omega$  or less
  - Effects of signal source resistance: About 0.01%/100  $\Omega$
- Allowable wiring resistance:
  - RTD input: Max. 150  $\Omega$ /wire (The conductor resistance between the three wires shall be equal.)
  - Wiring resistance effect:  $\pm 0.1^{\circ}\text{C}/10 \Omega$
- Allowable input voltage/current:
  - TC, mV, mA or RTD input:  $\pm 10$  V DC
  - V input:  $\pm 20$  V DC
  - mA input:  $\pm 40$  mA
- Noise rejection ratio:
  - Normal mode: 40 dB or more (50/60 Hz)
  - Common mode: 120 dB or more (50/60 Hz)
  - For 100-240 V AC, the power frequency can be set manually. Automatic detection is also available.
  - For 24 V AC/DC, the power frequency can be set manually.
- Reference junction compensation error:
  - $\pm 1.0^{\circ}\text{C}$  (15 to 35 $^{\circ}\text{C}$ )
  - $\pm 1.5^{\circ}\text{C}$  (-10 to 15 $^{\circ}\text{C}$ , 35 to 50 $^{\circ}\text{C}$ )
- Applicable standards: JIS/IEC/DIN (ITS-90) for TC and RTD

### Auxiliary Analog Input

- Use: Remote setpoint setting, external compensating input, auxiliary input for computation, etc.
- Number of inputs: See the table of Model and Suffix Codes
- Input type, instrument range, and measurement accuracy: See the table below.

Input Type	Instrument Range	Accuracy
Standard Signal	0.400 to 2.000 V	$\pm 0.2\%$ of instrument range $\pm 1$ digit
	1.000 to 5.000 V	$\pm 0.1\%$ of instrument range $\pm 1$ digit
DC Voltage	0.000 to 2.000 V	$\pm 0.2\%$ of instrument range $\pm 1$ digit
	0.00 to 10.00 V	$\pm 0.1\%$ of instrument range $\pm 1$ digit
DC voltage for high-input impedance	0.000 to 1.250 V	$\pm 0.1\%$ of instrument range $\pm 1$ digit

- Input sampling (control) period: Same as universal input
- Input resistance: About 1 M $\Omega$ 
  - However, 10 M $\Omega$  or more for DC voltage for high-input impedance range
- Burnout detection: Functions at standard signal
  - Burnout is determined to have occurred if it is 0.1 V or less.

## 19.1 Hardware Specifications

### Remote Input with Direct Input

- Number of inputs: See the table of Model and Suffix Codes.
- Input type, instrument range, and measurement accuracy: Same as universal input except the table below.

Input Type		Instrument Range (°C)	Instrument Range (°F)	Accuracy
4-wire RTD	JPt100	-200.0 to 500.0°C	-300.0 to 1000.0°F	±0.5°C of instrument range ±1 digit
		-150.00 to 150.00°C	-200.0 to 300.0°F	±0.2°C of instrument range ±1 digit
	Pt100	-200.0 to 850.0°C	-300.0 to 1560.0°F	±0.1% of instrument range ±1 digit (Note 1)
		-200.0 to 500.0°C	-300.0 to 1000.0°F	±0.5°C of instrument range ±1 digit
		-150.00 to 150.00°C	-200.0 to 300.0°F	±0.2°C of instrument range ±1 digit

Note 1: ±0.5°C ±1 digit in the range between -200.0 and 500.0°C/-300.0 and 1000.0°F.

- Input sampling (control) period: Same as universal input
- Burnout detection: Same as universal input

### 19.1.2 Analog Output Specifications

- Number of outputs:
  - Control output: 1
  - Cooling-side control output of Heating/cooling type: 1
- Output type: Current output or voltage pulse output
- Current output: 4 to 20 mA DC or 0 to 20 mA DC/load resistance of 600 Ω or less
- Current output accuracy: ±0.1% of span (±5% of span for 1 mA or less.)
  - The accuracy is that in the standard operating conditions: 23±2°C, 55±10%RH, and power frequency at 50/60 Hz.
- Voltage pulse output:
  - Use: Time proportional output
  - On-voltage: 12 V or more/load resistance of 600 Ω or more
  - Off-voltage: 0.1 V DC or less
  - Time resolution: 10 ms or 0.1% of output, whichever is larger

### 19.1.3 Step Response Time Specifications

Within 500 ms (when the control period is 100 ms)

Within 1 s (when the control period is 200 ms)

(63% of analog output response time when a step change of 10 to 90% of input span is applied)

### 19.1.4 Relay Contact Output Specifications

- Contact type and number of outputs:
    - Control output: contact point 1c; 1 point
    - Cooling-side control output of Heating/cooling type: contact point 1c; 1 point
    - Event output: contact point 1a; 3 points (common is independent)
  - Contact rating:
    - Contact point 1c (control output): 250 V AC, 3 A or 30 V DC, 3A (resistance load)
    - Contact point 1a (event output): 240 V AC, 1A or 30 V DC, 1 A (resistance load)
  - Use: Time proportional output, event output, alarm output, FAIL output, etc.
  - Time resolution of control output: 10 ms or 0.1% of output, whichever is larger
- Note: Cannot be used for a small load of 10 mA or less.

### 19.1.5 Triac Output Specifications (for Detailed model)

- Contact type and number of output: zero cross; 1 point  
Load voltage: 75 to 250 V AC  
Allowable load current: 0.8 A when the ambient temperature is 20°C, 0.3 A when the ambient temperature is 50°C.
- Minimum load current: 20 mA (\*)  
\*: Unusable for a small load of 10 mA or less.  
\*: If there is a risk of surge current, connect a current-limiting reactor, a current-limiting fuse or a breaker in series to the load power supply.
- Use: Time proportional output, Alarm output
- Time resolution of control output: 1/commercial frequency (s) or 0.1% of output, whichever is larger.

### 19.1.6 Position Proportional Output Specifications

- Position signal input:  
Slide resistance: 100  $\Omega$  to 2.5 k $\Omega$  of total resistance  
100% side and slide line: with disconnection detection  
0% side: without disconnection detection  
Current input: 4 to 20 mA (with disconnection detection)
- Sampling period: 50 ms
- Measurement resolution: 0.1% of input span
- Position proportional relay output:  
contact point 1a; 2 points, 250 V AC, 3 A or 30 V DC, 3 A (resistance load)  
Note: Cannot be used for a small load of 10 mA or less.

### 19.1.7 Retransmission Output Specifications

- Number of outputs: Retransmission output; 1, shared with 15 V DC loop power supply
- Current output: 4 to 20 mA DC or 0 to 20 mA DC/ load resistance of 600  $\Omega$  or less
- Current output accuracy:  $\pm 0.1\%$  of span ( $\pm 5\%$  of span for 1 mA or less.)  
The accuracy is that in the standard operating conditions: 23 $\pm$ 2°C, 55 $\pm$ 10%RH, and power frequency at 50/60 Hz.

### 19.1.8 15 V DC Loop Power Supply Specifications

(Shared with retransmission output)

- Power supply: 14.5 to 18.0 V DC
- Maximum power supply: About 21 mA (with short-circuit current limiting circuit)

### 19.1.9 Contact Input Specifications

- Number of inputs: See the table of Model and Suffix Codes.
- Input type: No-voltage contact input or transistor contact input
- Input contact rating: 12 V DC, 10 mA or more  
Use a contact of a minimum on-current of 1 mA or more
- ON/OFF detection:  
No-voltage contact input:  
Contact resistance of 1 k $\Omega$  or less is determined as "ON" and contact resistance of 50 k $\Omega$  or more as "OFF."  
Transistor contact input:  
Input voltage of 2 V or less is determined as "ON" and leakage current must not exceed 100  $\mu$ A when "OFF."
- Minimum status detection hold time: Control period +50 ms
- Use: PTNO. switch, operation mode switch, and event input

### 19.1.10 Transistor Contact Output Specifications

- Number of outputs: See the table of Model and Suffix Codes.
- Output type: Open collector (SINK current)
- Output contact rating: Max. 24 V DC, 50 mA
- Output time resolution: Min. 100 ms

### 19.1.11 Heater Break Alarm Specifications

- Number of inputs: 2
- Number of outputs: 2 (transistor contact output)
- Use: Measures the heater current using an external current transformer (CT) and generates a heater break alarm when the measured value is less than the break detection value.
- Current transformer input resistance: About 9.4  $\Omega$
- Current transformer input range: 0.0 to 0.1 Arms (0.12 Arms or more cannot be applied.)
- Heater current setting range: OFF, 0.1 to 300.0 Arms  
Heater current measured value display range: 0.0 to 360.0 Arms  
Note: The CT ratio can be set. CT ratio setting range: 1 to 3300
- Recommended CT: CT from U.R.D., Ltd.  
CTL-6-S-H: CT ratio 800, measurable current range: 0.1 to 80.0 Arms  
CTL-12L-30: CT ratio 3000, measurable current range: 0.1 to 180.0 Arms
- Heater current measurement period: 200 ms
- Heater current measurement accuracy:  $\pm 5\%$  of current transformer input range span  $\pm 1$  digit (CT error is not included.)  
Ex.: CTL-12L-30  
 $0.1 \text{ (Max. of current transformer input range)} \times 3000 \text{ (CT ratio)} \times \pm 0.05 \text{ (}\pm 5\%) \pm 1 \text{ digit} = \pm 15 \text{ Arms} \pm 1 \text{ digit}$
- Heater current detection resolution: Within 1/250 of current transformer input range span  
Ex.: CTL-12L-30  
 $0.1 \text{ (Max. of current transformer input range)} \times 3000 \text{ (CT ratio)} / 250 = 1.2 \text{ Arms}$
- Break detection On-time: Min. 0.2 second. (for time proportional output)

### 19.1.12 24 V DC Loop Power Supply Specifications (for Detailed model)

- Use: Power is supplied to a 2-wire transmitter.
- Power supply: 21.6 to 28.0 V DC
- Rated current: 4 to 20 mA DC
- Maximum power supply: About 30 mA (with short circuit current limiting circuit)

### 19.1.13 Safety and EMC Standards

- Safety: Compliant with IEC/EN61010-1 (CE), approved by CAN/CSA C22.2 No.61010-1 (CSA), approved by UL61010-1.

Installation category: CAT. II Pollution degree: 2

Measurement category: I (CAT. I)

Rated measurement input voltage: Max. 10 V DC

Rated transient overvoltage: 1500 V (Note)

Note: This is a reference safety standard value for Measurement Category I of IEC/EN/CSA/UL61010-1. This value is not necessarily a guarantee of instrument performance.

- EMC Conformity standards:

CE marking

EN61326-1 Class A, Table 2 (For use in industrial locations)

EN61326-2-3

EN 55011 Class A, Group1

EN 61000-3-2 Class A

EN 61000-3-3

C-tick mark

EN 55011 Class A, Group1

The instrument continues to operate at a measurement accuracy of within  $\pm 20\%$  of the range during testing

### 19.1.14 Construction, Installation, and Wiring

- Dust-proof and drip-proof: IP56 (for front panel) (Not available for side-by-side close mounting.)
- Material: Polycarbonate (Flame retardancy: UL94V-0)
- Case color: White (Light gray) or black (Light charcoal gray)
- Weight: 0.5 kg or less
- External dimensions (mm): 96 (W) × 96 (H) × 65 (depth from the panel face)  
(Depth except the projection on the rear panel)
- Installation: Direct panel mounting; mounting bracket, one each for upper and lower mounting
- Panel cutout dimensions (mm):  $92^{+0.8/0}$  (W) ×  $92^{+0.8/0}$  (H)
- Mounting attitude: Up to 30 degrees above the horizontal. No downward titling allowed.
- Wiring: M3 screw terminal with square washer (for signal wiring and power wiring)



**19.1.15 Power Supply Specifications and Isolation**

- Power supply:
  - Rated voltage: 100 – 240 V AC (+10%/-15%), 50/60 Hz  
24 V AC/DC (+10%/-15%) (for /DC option)
- Power consumption: 18 VA (DC:9 VA, AC: 14 VA if /DC option is specified)
- Data backup: Nonvolatile memory
- Power holdup time: 20 ms (for 100 V AC drive)
- Withstanding voltage
  - Between primary terminals and secondary terminals: 2300 V AC for 1 minute
  - Between primary terminals: 1500 V AC for 1 minute
  - Between secondary terminals: 500 V AC for 1 minute  
(Primary terminals: Power (\*) and relay output terminals; Secondary terminals: Analog I/O signal terminals, contact input terminals, communication terminals, and functional grounding terminals.)
- (\*) : Power terminals for 24V AC/DC models are the secondary terminals.
- Insulation resistance
  - Between power supply terminals and a grounding terminal: 20 MΩ or more at 500 V DC
- Isolation specifications

PV (universal ) input terminals	Internal circuits	Power supply
Remote (universal) input terminals with direct input / Remote input terminals		
Aux. analog (AIN2) input terminals		
Aux. analog (AIN4) input terminals		
Control, retransmission (analog) output terminals (not isolated between the analog output terminals) Valve position (feedback) input terminals		
Control relay (contact point c) / triac output terminals		
PV event-1 relay (contact point a) output terminals		
PV event-2 relay (contact point a) output terminals		
PV event-3 relay (contact point a) output terminals		
Position proportional relay output terminals		
Contact input terminals (All) RS-485 communication terminals (2 ports)		
24 V DC loop power supply terminals		
Contact output (transistor) terminals		
Ethernet communication terminal		
PROFIBUS-DP/DeviceNet/CC-Link communication terminals		
Current transformer input terminals		

The circuits divided by lines are insulated mutually.

## 19.1.16 Environmental Conditions

### Normal Operating Conditions

- Ambient temperature: -10 to 50°C (-10 to 40°C for side-by-side close mounting)  
For the CC-Link option, 0 to 50 °C (0 to 40 °C for side-by-side close mounting)
  - Ambient humidity: 20 to 90% RH (no condensation allowed)
  - Magnetic field: 400 A/m or less
  - Continuous vibration at 5 to 9 Hz: Half amplitude of 1.5 mm or less, 1oct/min for 90 minutes each in the three axis directions  
Continuous vibration at 9 to 150 Hz: 4.9 m/s<sup>2</sup> or less, 1oct/min for 90 minutes each in the three axis directions
  - Short-period vibration: 14.7 m/s<sup>2</sup>, 15 seconds or less
  - Shock: 98 m/s<sup>2</sup> or less, 11 ms
  - Altitude: 2000 m or less above sea level
  - Warm-up time: 30 minutes or more after the power is turned on
  - Startup time: Within 10 seconds
- \*: The LCD (a liquid crystal display) is used for a display portion of this product.  
The LCD has a characteristic that the display action becomes late at the low temperature.  
However, the control function is not affected.

### Transportation and Storage Conditions

- Temperature: -25 to 70°C
- Temperature change rate: 20°C/h or less
- Humidity: 5 to 95% RH (no condensation allowed)

### Effects of Operating Conditions

- Effect of ambient temperature:
  - Voltage or TC input:  $\pm 1 \mu\text{V}/^\circ\text{C}$  or  $\pm 0.01\%$  of F.S./ $^\circ\text{C}$ , whichever is larger
  - Current input:  $\pm 0.01\%$  of F.S./ $^\circ\text{C}$
  - RTD input:  $\pm 0.05^\circ\text{C}/^\circ\text{C}$  (ambient temperature) or less
  - Analog output:  $\pm 0.02\%$  of F.S./ $^\circ\text{C}$  or less
- Effect of power supply voltage fluctuation
  - Analog input:  $\pm 0.05\%$  of F.S. or less
  - Analog output:  $\pm 0.05\%$  of F.S. or less
  - (Each within rated voltage range)



# Appendix 1 Input and Output Table (for Standard model)

See the next page.

### UP55A Model and Suffix Codes

Model	Suffix code					Optional suffix code	INPUT				OUTPUT					
	-x	x	x	-xx	-00		/x	PV	RSP	AIN2	AIN4	OUT	OUT2	VALV	RET	
UP55A	-x	x	x	-xx	-00	/x	●								●	
Type 1: Basic control	-0										●					
	-1													●		
	-2										●	●				
Type 2: Functions	0															
	1							●								
	2															
	3															
	4							●	●	●						
Type 3: Open networks	x															
Display language/Case color	-xx															
Fixed code	-00															
Optional suffix codes	/DR							◆1								
	/HA															

- : Equipped
- ◆1: If the /DR option is additionally specified to the remote input, RSP terminal can be used as universal input. However, DI16 is deleted.
- ◆2: If the suffix code type 2 = 2, DI41 to DI45 are deleted.
- ◆3: If the suffix code type 2 = 4, DI41 to DI45 and DO21 to DO25 are deleted.

Appendix 1 Input and Output Table (for Standard model)

UP55A (Continued)

DI																				
DI1	DI2	DI3	DI11	DI12	DI13	DI14	DI15	DI16	DI26	DI31	DI32	DI33	DI34	DI35	DI41	DI42	DI43	DI44	DI45	DI46
•	•	•													•	•	•	•	•	
										♦1										
			•	•	•	•	•								♦2	♦2	♦2	♦2	♦2	
															♦3	♦3	♦3	♦3	♦3	

UP55A (Continued)

DO																				
AL1	AL2	AL3	DO11	DO12	DO13	DO14	DO15	DO21	DO22	DO23	DO24	DO25	DO31	DO32	DO33	DO34	DO35	HAL1	HAL2	
•	•	•						•	•	•	•	•								
			•	•	•	•	•							•	•	•	•	•		
								♦3	♦3	♦3	♦3	♦3								
																			•	•

# Appendix 2 Input and Output Table (for Detailed model)

## UP55A Model and Suffix Codes

Model	Suffix code				Optional suffix code	INPUT				OUTPUT					RET		
						PV	RSP	AIN2	AIN4	OUT (mA/pulse)	OUT (relay)	OUT (triac)	VALV	OUT2 (mA/pulse)	OUT2 (relay)	OUT2 (triac)	RET
UP55A	-xxx	-xx	-x	x	/x	●											
Fixed code	-NNN																
Display language/ Case color	-xx																
Output 1	-A								●								
	-R									●							
	-U								●	●							
	-T										●						
	-P											●					
Output 2	A											●					
	R												●				
	U											●	●				
	T														●		
	N																
Retransmission output					/RT												●
Heater break alarm					/HA												
E1 terminal area					/R1		●										
					/U1		●										
					/X1												
					/Y1												
					/W1												
E2 terminal area					/A2			●									
					/X2												
					/Y2												
					/W2												
E3 terminal area					/CH3												
					/CC3												
					/PD3												
					/DN3												
					/ET3												
					/X3												
					/Y3												
E4 terminal area					/A4				●								
					/C4												
					/L4												
					/AC4				●								
					/LC4												
					/X4												
					/Y4												
Power supply					/DC												
Additional treatment					/CT												

●: Equipped





Appendix 2 Input and Output Table (for Detailed model)

UP55A (Continued)

Model	Suffix code			Optional suffix code	
UP55A	-NNN	-xx	-x	x	/x
Fixed code	-NNN				
Display language/ Case color	-xx				
Output 1				-A	
				-R	
				-U	
				-T	
				-P	
Output 2				A	
				R	
				U	
				T	
				N	
Retransmission output				/RT	
Heater break alarm				/HA	
E1 terminal area				/R1	
				/U1	
				/X1	
				/Y1	
				/W1	
E2 terminal area				/A2	
				/X2	
				/Y2	
				/W2	
E3 terminal area				/CH3	
				/CC3	
				/PD3	
				/DN3	
				/ET3	
				/X3	
				/Y3	
				/W3	
E4 terminal area				/A4	
				/C4	
				/L4	
				/AC4	
				/LC4	
				/X4	
				/Y4	
Power supply				/DC	
Additional treatment				/CT	





---

# Revision Information

- Title : UP55A Program Controller User's Manual
- Manual No. : IM 05P02C41-01EN

**Aug. 2010/1st Edition**

Newly published

**Sep. 2010/2nd Edition**

Error correction

**Jan. 2011/3rd Edition**

UL approved and error correction

- Written by Yokogawa Electric Corporation
  - Published by Yokogawa Electric Corporation  
2-9-32 Nakacho, Musashino-shi, Tokyo 180-8750, JAPAN
-





---

**YOKOGAWA ELECTRIC CORPORATION****Headquarters**

2-9-32, Nakacho, Musashino-shi, Tokyo, 180-8750 JAPAN

**Branch Sales Offices**

Nagoya, Osaka, Hiroshima, Fukuoka, Sendai, Ichihara, Toyota, Kanazawa, and Kitakyusyu.

---

**YOKOGAWA CORPORATION OF AMERICA**

2 Dart Road, Newnan, Georgia 30265-1094, U.S.A.

Phone : 1-800-888-6400

Fax : 1-770-254-0928

**YOKOGAWA EUROPE B. V.**

Euroweg 2, 3825 HD Amersfoort, THE NETHERLANDS

Phone : 31-88-4641000 Fax : 31-88-4641111

**Branch Sales Offices** / Wien (Austria), Zaventem (Belgium), Ratingen (Germany), Madrid (Spain), Runcorn (United Kingdom), Milano (Italy), Velizy-Villacoublay (France), Budapest (Hungary), Stockholm (Sweden), Sola (Norway), Warszawa (Poland), Vila Nova de Gaia (Portugal), Bucharest (Romania), Dublin (Ireland)

**YOKOGAWA AMERICA DO SUL LTDA.**

Praca Acapulco, 31 - Santo Amaro. Sao Paulo/SP - BRAZIL

Phone : 55-11-5681-2400 Fax : 55-11-5681-4434

**YOKOGAWA ENGINEERING ASIA PTE. LTD.**

5 Bedok South Road, 469270 SINGAPORE

Phone : 65-6241-9933 Fax : 65-6241-2606

**YOKOGAWA ELECTRIC KOREA CO., LTD.**

14-1, Yangpyongdong-4Ga, Youngdeungpo-Gu, Seoul, 150-866 KOREA

Phone : 82-2-2628-6000 Fax : 82-2-2628-6400

**YOKOGAWA AUSTRALIA PTY. LTD.**

Tower A, 112-118 Talavera Road, Macquarie Park, N.S.W.2113, AUSTRALIA

Phone : 61-2-8870-1100 Fax : 61-2-8870-1111

**YOKOGAWA INDIA LTD.**

Plot No.96 Electronic City Complex, Hosur Road, Bangalore 560100, INDIA

Phone : 91-80-4158-6000 Fax : 91-80-2852-1442

**YOKOGAWA CHINA CO., LTD.**

3F TowerD Cartelo Crocodile Building

No.568 West Tianshan Road, Shanghai 200335, CHINA

Phone : 86-21-62396262 Fax : 86-21-62387866