

# Operation Guide

UP55A  
Program Controller  
Operation Guide for Single-loop Control



IM 05P02C41-11EN **Installation and Wiring**

**YOKOGAWA**  
Yokogawa Electric Corporation

2nd Edition : Jan. 2011

This operation guide describes installation, wiring, and other tasks required to make the controller ready for operation.

## Contents

1. Safety Precautions
2. Model and Suffix Codes
3. How to Install
4. Hardware Specifications
5. How to Connect Wires
6. Terminal Wiring Diagrams

## Introduction

Thank you for purchasing the UP55A Program Controller. This operation guide describes the basic operations related to the single-loop control function of the UP55A. The guide should be provided to the end user of this product. Be sure to read this operation guide before using the product in order to ensure correct operation. For details of each function, refer to the electronic manual contained in the provided CD-ROM. Before using the product, refer to the table of Model and Suffix Codes to make sure that the delivered product is consistent with the model and suffix codes you ordered. Also make sure that the following items are included in the package.

- Program Controller (the model you ordered) .....x1
- Set of Brackets .....x1
- Unit Label (L4502VZ) .....x1
- Tag Label (L4502VE) .....x1 (Only when ordered.)
- Terminal Cover (L4502XP) .....x1
- Operation Guide for Single-loop Control (this document) .....x7 (A3 size) (Installation and Wiring, Initial Settings, Programming, Operations, and Parameters)
- User's Manual (CD-ROM) .....x1

- Target Readers  
This guide is intended for the following personnel:
  - Engineers responsible for installation, wiring, and maintenance of the equipment.
  - Personnel responsible for normal daily operation of the equipment.

## 1. Safety Precautions

The following symbol is used on the instrument. It indicates the possibility of injury to the user or damage to the instrument, and signifies that the user must refer to the user's manual for special instructions. The same symbol is used in the user's manual on pages that the user needs to refer to, together with the term "WARNING" or "CAUTION."

**WARNING**  
Calls attention to actions or conditions that could cause serious or fatal injury to the user, and indicates precautions that should be taken to prevent such occurrences.

**CAUTION**  
Calls attention to actions or conditions that could cause injury to the user or damage to the instrument or property and indicates precautions that should be taken to prevent such occurrences.

- AC**  
The equipment wholly protected by double insulation or reinforced insulation.
- AC/DC**  
Functional grounding terminals  
(Do not use this terminal as a protective grounding terminal).

### Note

Identifies important information required to operate the instrument.

### Warning and Disclaimer

- (1) YOKOGAWA makes no warranties regarding the product except those stated in the WARRANTY that is provided separately.
- (2) The product is provided on an "as is" basis. YOKOGAWA assumes no liability to any person or entity for any loss or damage, direct or indirect, arising from the use of the product or from any unpredictable defect of the product.

## Safety, Protection, and Modification of the Product

- (1) In order to protect the system controlled by this product and the product itself, and to ensure safe operation, observe the safety precautions described in the user's manual. Use of the instrument in a manner not prescribed herein may compromise the product's functions and the protection features inherent in the device. We assume no liability for safety, or responsibility for the product's quality, performance or functionality should users fail to observe these instructions when operating the product.
- (2) Installation of protection and/or safety circuits with respect to a lightning protector; protective equipment for the system controlled by the product and the product itself; foolproof or failsafe design of a process or line using the system controlled by the product or the product itself; and/or the design and installation of other protective and safety circuits are to be appropriately implemented as the customer deems necessary.
- (3) Be sure to use the spare parts approved by YOKOGAWA when replacing parts or consumables.
- (4) This product is not designed or manufactured to be used in critical applications that directly affect or threaten human lives. Such applications include nuclear power equipment, devices using radioactivity, railway facilities, aviation equipment, air navigation facilities, aviation facilities, and medical equipment. If so used, it is the user's responsibility to include in the system additional equipment and devices that ensure personnel safety.
- (5) Modification of the product is strictly prohibited.
- (6) This product is intended to be handled by skilled/trained personnel for electric devices.
- (7) This product is UL Recognized Component. In order to comply with UL standards, end-products are necessary to be designed by those who have knowledge of the requirements.



- **Power Supply**  
Ensure that the instrument's supply voltage matches the voltage of the power supply before turning ON the power.
- **Do Not Use in an Explosive Atmosphere**  
Do not operate the instrument in locations with combustible or explosive gases or steam. Operation in such environments constitutes an extreme safety hazard. Use of the instrument in environments with high concentrations of corrosive gas (H<sub>2</sub>S, SO<sub>x</sub>, etc.) for extended periods of time may cause a failure.
- **Do Not Remove Internal Unit**  
The internal unit should not be removed by anyone other than YOKOGAWA's service personnel. There are dangerous high voltage parts inside. Additionally, do not replace the fuse by yourself.
- **Damage to the Protective Construction**  
Operation of the instrument in a manner not specified in the user's manual may damage its protective construction.



This instrument is an EMC class A product. In a domestic environment this product may cause radio interference in which case the user needs to take adequate measures.

## 2. Model and Suffix Codes

### UP55A

[Style:S2]

Model	Suffix code	Optional suffix code	Description	
UP55A			Program Controller (provided with retransmission output or 15 V DC loop power supply, 8 Dis, and 8 DOs) (Power supply: 100-240 V AC) 30 program patterns / 300 program segments (Max. 99 segments per pattern)	
	Type 1: Basic control	-0 -1 -2	Standard type Position proportional type Heating/cooling type	
	Type 2: Functions (*1)	0 1 2 3 4	None Remote (1 additional aux. analog) input, 1 additional DI RS-485 communication (Max.19.2 kbps, 2-wire/4-wire) 10 additional DOs 3 additional aux. analog inputs, 2 Dis and 5 DOs to be deleted	
Type 3: Open networks		0 1 2 3 4 5	None RS-485 communication (Max.38.4 kbps, 2-wire/4-wire) Ethernet communication (with serial gateway function) CC-Link communication (with Modbus master function) PROFIBUS-DP communication (with Modbus master function) DeviceNet communication (with Modbus master function)	
	Display language (*2)	-1 -2 -3 -4	English German French Spanish	
		Case color	0 1	White (Light gray) Black (Light charcoal gray)
			Fixed code	-00
		Optional suffix codes	/DR	Additional direct input (TC, 3-wire/4-wire RTD) and current input to Remote (1 additional aux. analog) input, 1 DI to be deleted (*3)
/HA /DC	Heater break alarm (*4) Power supply 24 V AC/DC			
/CT	Coating (*5)			

- \*1: When "3" is specified for the Type 2 code, only "0" can be specified for the Type 3 code.
- \*2: English, German, French, and Spanish can be displayed as the guide display.
- \*3: When any of "1" or "4" is specified for the Type 2 code, the /DR option can be specified.
- \*4: When "-0" is specified for the Type 1 code, the /HA option can be specified.
- \*5: When the /CT option is specified, the UP55A does not conform to the safety standards (UL and CSA) and CE marking.

### Accessories (sold separately)

The following is an accessory sold separately.  
• LL50A Parameter Setting Software

Model	Suffix code	Description
LL50A	-00	Parameter Setting Software

- Brackets  
Part number: L4502TP (2 pcs for upper and lower sides)

## Waste Electrical and Electronic Equipment (WEEE), Directive 2002/96/EC

This is an explanation of how to dispose of this product based on Waste Electrical and Electronic Equipment (WEEE), Directive 2002/96/EC. This directive is only valid in the EU.

### Marking

This product complies with the WEEE Directive (2002/96/EC) marking requirement. This marking indicates that you must not discard this electrical/electronic product in domestic household waste.



### Product Category

With reference to the equipment types in the WEEE directive Annex 1, this product is classified as a "Monitoring and Control instrumentation" product. Do not dispose in domestic household waste. When disposing products in the EU, contact your local Yokogawa Europe B.V. office.

## 3. How to Install

### Installation Location

The instrument should be installed in indoor locations meeting the following conditions:

- **Instrumented panel**  
This instrument is designed to be mounted in an instrumented panel. Mount the instrument in a location where its terminals will not inadvertently be touched.
- **Well ventilated locations**  
Mount the instrument in well ventilated locations to prevent the instrument's internal temperature from rising. However, make sure that the terminal portions are not exposed to wind. Exposure to wind may cause the temperature sensor accuracy to deteriorate. To mount multiple indicating controllers, see the external dimensions/panel cutout dimensions which follow. If mounting other instruments adjacent to the instrument, comply with these panel cutout dimensions to provide sufficient clearance between the instruments.
- **Locations with little mechanical vibration**  
Install the instrument in a location subject to little mechanical vibration.
- **Horizontal location**  
Mount the instrument horizontally and ensure that it is level, with no inclination to the right or left.

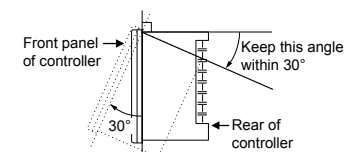

### Note

If the instrument is moved from a location with low temperature and low humidity to a place with high temperature and high humidity, or if the temperature changes rapidly, condensation will result. Moreover, in the case of thermocouple inputs, measurement errors will result. To avoid such a situation, leave the instrument in the new environment under ambient conditions for more than 1 hour prior to using it.

Do not mount the instrument in the following locations:

- **Outdoors**
- **Locations subject to direct sunlight or close to a heater**  
Install the instrument in a location with stable temperatures that remain close to an average temperature of 23°C. Do not mount it in locations subject to direct sunlight or close to a heater. Doing so adversely affects the instrument.
- **Locations with substantial amounts of oily fumes, steam, moisture, dust, or corrosive gases**  
The presence of oily fumes, steam, moisture, dust, or corrosive gases adversely affects the instrument. Do not mount the instrument in locations subject to any of these substances.
- **Areas near electromagnetic field generating sources**  
Do not place magnets or tools that generate magnetism near the instrument. If the instrument is used in locations close to a strong electromagnetic field generating source, the magnetic field may cause measurement errors.
- **Locations where the display is difficult to see**  
The instrument uses an LCD for the display unit, and this can be difficult to see from extremely oblique angles. Mount the instrument in a location where it can be seen as much as possible from the front.
- **Areas close to flammable articles**  
Absolutely do not place the instrument directly on flammable surfaces. If such a circumstance is unavoidable and the instrument must be placed close to a flammable item, provide a shield for it made of 1.43 mm thick plated steel or 1.6 mm thick unplated steel with a space of at least 150 mm between it and the instrument on the top, bottom, and sides.
- **Areas subject to being splashed with water**

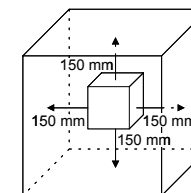

Be sure to turn OFF the power supply to the controller before installing it on the panel to avoid an electric shock.

**YOKOGAWA**

YOKOGAWA ELECTRIC CORPORATION  
Network Solutions Business Division  
2-9-32, Naka-cho Musashino-shi, Tokyo 180-8750 JAPAN  
YOKOGAWA CORPORATION OF AMERICA  
Head office and for product sales  
2 Dart Road, Newnan, Georgia 30265, USA  
YOKOGAWA EUROPE B.V.  
Headquarters  
Euroweg 2, 3825 HD Amersfoort, THE NETHERLANDS  
[www.yokogawa.com/ns](http://www.yokogawa.com/ns)

All Rights Reserved, Copyright © 2010 Yokogawa Electric Corporation

## ■ Mounting the Instrument Main Unit

Provide an instrumented panel steel sheet of 1 to 10 mm thickness. After opening the mounting hole on the panel, follow the procedures below to install the controller:

- 1) Insert the controller into the opening from the front of the panel so that the terminal board on the rear is at the far side.
- 2) Set the brackets in place on the top and bottom of the controller as shown in the figure below, then tighten the screws of the brackets. Take care not to overtighten them.

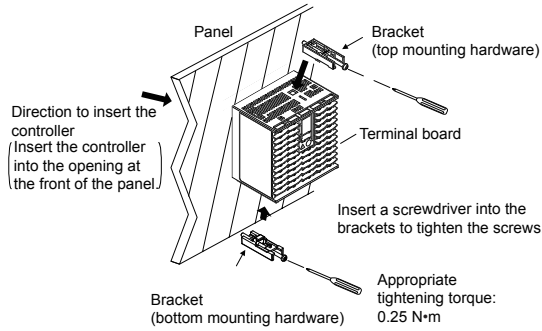

**CAUTION**

- Tighten the screws with appropriate tightening torque within 0.25 N·m. Otherwise it may cause the case deformation or the bracket damage.
- Make sure that foreign materials do not enter the inside of the instrument through the case's slit holes.

## ■ External Dimensions and Panel Cutout Dimensions

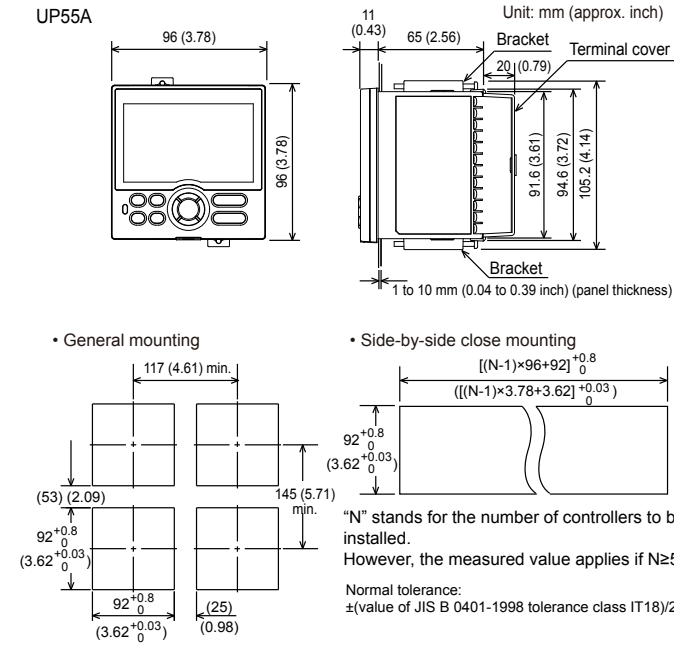

## 4. Hardware Specifications



**This instrument is for Measurement Category I (CAT.I). Do not use it for measurements in locations falling under Measurement Categories II, III, and IV.**

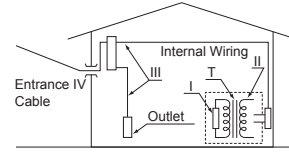

Category	Measurement category	Description	Remarks
I	CAT.I	For measurements performed on circuits not directly connected to MAINS.	-
II	CAT.II	For measurements performed on circuits directly connected to the low-voltage installation.	Appliances, portable equipment, etc.
III	CAT.III	For measurements performed in the building installation.	Distribution board, circuit breaker, etc.
IV	CAT.IV	For measurements performed at the source of the low-voltage installation.	Overhead wire, cable systems, etc.

## ■ Input Specifications

### ● Universal Input (Equipped as standard)

- Number of inputs: 1
- Input type, instrument range, and measurement accuracy: See the table below.

Input Type	Instrument Range		Accuracy	
	°C	°F		
Thermocouple	K	-270.0 to 1370.0°C	-450.0 to 2500.0°F	±0.1% of instrument range ±1 digit for 0°C or more
		-270.0 to 1000.0°C	-450.0 to 2300.0°F	±0.2% of instrument range ±1 digit for less than 0°C
		-200.0 to 500.0°C	-200.0 to 1000.0°F	±2% of instrument range ±1 digit for less than -200.0°C of thermocouple K
	J	-200.0 to 1200.0°C	-300.0 to 2300.0°F	±1% of instrument range ±1 digit for less than -200.0°C of thermocouple J
		-270.0 to 400.0°C	-450.0 to 750.0°F	±1% of instrument range ±1 digit for less than -200.0°C of thermocouple T
	T	0.0 to 400.0°C	-200.0 to 750.0°F	±1% of instrument range ±1 digit for less than -200.0°C of thermocouple T
RTD	B	0.0 to 1800.0°C	32 to 3300°F	±0.15% of instrument range ±1 digit for 400°C or more
		0.0 to 1700.0°C	32 to 3100°F	±5% of instrument range ±1 digit for less than 400°C
	S	0.0 to 1700.0°C	32 to 3100°F	±0.15% of instrument range ±1 digit
	R	0.0 to 1700.0°C	32 to 3100°F	±0.15% of instrument range ±1 digit
	N	-200.0 to 1300.0°C	-300.0 to 2400.0°F	±0.1% of instrument range ±1 digit ±0.25% of instrument range ±1 digit for less than 0°C
		-270.0 to 1000.0°C	-450.0 to 1800.0°F	±0.1% of instrument range ±1 digit for 0°C or more
	L	-200.0 to 900.0°C	-300.0 to 1600.0°F	±0.2% of instrument range ±1 digit for less than 0°C
	U	-200.0 to 400.0°C	-300.0 to 750.0°F	±1.5% of instrument range ±1 digit for less than -200.0°C of thermocouple E.
	E	0.0 to 400.0°C	-200.0 to 1000.0°F	±0.2% of instrument range ±1 digit (Note 2)
	W	0.0 to 2300.0°C	32 to 4200°F	±0.2% of instrument range ±1 digit
	Platinel 2	0.0 to 1390.0°C	32.0 to 2500.0°F	±0.1% of instrument range ±1 digit
	PR20-40	0.0 to 1900.0°C	32 to 3400°F	±0.5% of instrument range ±1 digit for 800°C or more
	W97Re3-W75Re25	0.0 to 2000.0°C	32 to 3600°F	±0.2% of instrument range ±1 digit
	Standard signal	0.400 to 2.000 V		±0.1% of instrument range ±1 digit
1.000 to 5.000 V				
4.00 to 20.00 mA				
0.000 to 2.000 V				
DC voltage/current	0.00 to 10.00 V		±0.1% of instrument range ±1 digit	
	0.00 to 20.00 mA			
	-10.00 to 20.00 mV			
	0.0 to 100.0 mV			

The accuracy is that in the standard operating conditions: 23±2°C, 55±10%RH, and power frequency at 50/60 Hz.

Note 1: ±0.3°C ±1 digit in the range between 0 and 100°C, ±0.5°C ±1 digit in the range between -100 and 200°C.

Note 2: W: W-5% Re/W-26% Re(Hoskins Mfg.Co.), ASTM E988

- Input sampling (control) period: Select from 100 and 200 ms
- Burnout detection:
  - Functions at TC, RTD, and standard signal.
  - Upscale, downscale, and off can be specified.
  - For standard signal, burnout is determined to have occurred if it is 0.1 V or 0.4 mA or less.
- Input bias current: 0.05 µA (for TC or RTD)
- Measured current (RTD): About 0.16 mA
- Input resistance:
  - TC or mV input: 1 MΩ or more
  - V input: About 1 MΩ
  - mA input: About 250 Ω

- Allowable signal source resistance:
  - TC or mV input: 250 Ω or less
  - Effects of signal source resistance: 0.1 µV/Ω or less
  - DC voltage input: 2 kΩ or less
  - Effects of signal source resistance: About 0.01%/100 Ω
- Allowable wiring resistance:
  - RTD input: Max. 150 Ω/wire (The conductor resistance between the three wires shall be equal.)
  - Wiring resistance effect: ±0.1°C/10 Ω
- Allowable input voltage/current:
  - TC, mV, mA and RTD input: ±10 V DC
  - V input: ±20 V DC
  - mA input: ±40 mA
- Noise rejection ratio:
  - Normal mode: 40 dB or more (at 50/60 Hz)
  - Common mode: 120 dB or more (at 50/60 Hz)
  - For 100-240 V AC, the power frequency can be set manually.
  - Automatic detection is also available.
  - For 24 V AC/DC, the power frequency can be set manually.
- Reference junction compensation error:
  - ±1.0°C (15 to 35°C)
  - ±1.5°C (-10 to 15°C and 35 to 50°C)
- Applicable standards: JIS/IEC/DIN (ITS-90) for TC and RTD

### ● Auxiliary Analog Input

- Use: Remote setpoint setting, external compensating input, auxiliary input for computation, etc.
- Number of inputs: See the table of Model and Suffix Codes.
- Input type, instrument range, and measurement accuracy: See the table below.

Input Type	Instrument Range	Accuracy
Standard signal	0.400 to 2.000 V	±0.2% of instrument range ±1 digit
	1.000 to 5.000 V	±0.1% of instrument range ±1 digit
DC voltage	0.000 to 2.000 V	±0.2% of instrument range ±1 digit
	0.00 to 10.00 V	±0.1% of instrument range ±1 digit
DC voltage for high-input impedance	0.000 to 1.250 V	±0.1% of instrument range ±1 digit

- Input sampling (control) period: Same as universal input
- Input resistance: About 1 MΩ
- However, 10 MΩ or more for DC voltage for high-input impedance range
- Burnout detection: Functions at standard signal
- Burnout is determined to have occurred if it is 0.1 V or less.

### ● Remote Input with Direct Input

- Number of inputs: See the table of Model and Suffix Codes.
- Input type, instrument range, and measurement accuracy: Same as universal input except the table below.

Input Type	Instrument Range		Accuracy	
	°C	°F		
4-wire RTD	JPt100	-200.0 to 500.0°C	-300.0 to 1000.0°F	±0.5°C of instrument range ±1 digit
		-150.00 to 150.00°C	-200.0 to 300.0°F	±0.2°C of instrument range ±1 digit
	Pt100	-200.0 to 850.0°C	-300.0 to 1560.0°F	±0.1% of instrument range ±1 digit (Note 1)
		-200.0 to 500.0°C	-300.0 to 1000.0°F	±0.5°C of instrument range ±1 digit
		-150.00 to 150.00°C	-200.0 to 300.0°F	±0.2°C of instrument range ±1 digit

Note 1: ±0.5°C ±1 digit in the range between -200.0 and 500.0°C/-300.0 and 1000.0°F.

- Input sampling (control) period: Same as universal input
- Burnout detection: Same as universal input

## ■ Analog Output Specifications

- Number of outputs:
  - Control output: 1
  - Cooling-side control output of Heating/cooling type: 1
- Output type: Current output or voltage pulse output
- Current output: 4 to 20 mA DC or 0 to 20 mA DC/load resistance of 600 Ω or less
- Current output accuracy: ±0.1% of span (±5% of span for 1 mA or less)
  - The accuracy is that in the standard operating conditions: 23±2°C, 55±10%RH, and power frequency at 50/60 Hz.
- Voltage pulse output:
  - Use: Time proportional output
  - On-voltage: 12 V or more/load resistance of 600 Ω or more
  - Off-voltage: 0.1 V DC or less
  - Time resolution: 10 ms or 0.1% of output, whichever is larger

## ■ Step Response Time Specifications

Within 500 ms (when the control period is 100 ms)  
 Within 1 s (when the control period is 200 ms)  
 (63% of analog output response time when a step change of 10 to 90% of input span is applied)

## ■ Relay Contact Output Specifications

- Contact type and number of outputs:
    - Control output: contact point 1c; 1 point
    - Cooling-side control output of Heating/cooling type: contact point 1c; 1 point
    - Event output: contact point 1a; 3 points (common is independent)
  - Contact rating:
    - Contact point 1c (control output): 250 V AC, 3 A or 30 V DC, 3 A (resistance load)
    - Contact point 1a (event output): 240 V AC, 1 A or 30 V DC, 1 A (resistance load)
  - Use: Time proportional output, event output, alarm output, FAIL output, etc.
  - Time resolution of control output: 10 ms or 0.1% of output, whichever is larger
- Note: This cannot be used for a small load of 10 mA or less.

## ■ Position Proportional Output Specifications

- Position signal input:
    - Slide resistance: 100 Ω to 2.5 kΩ of total resistance
    - 100% side and slide line: with disconnection detection
    - 0% side: without disconnection detection
    - Current input: 4 to 20 mA (with disconnection detection)
  - Sampling period: 50 ms
  - Measurement resolution: 0.1% of input span
  - Position proportional relay output:
    - Contact point 1a; 2 points, 250 V AC, 3 A or 30 V DC, 3 A (resistance load)
- Note: This cannot be used for a small load of 10 mA or less.

## ■ Retransmission Output Specifications

- Number of outputs: Retransmission output; 1, shared with 15 V DC loop power supply
- Current output: 4 to 20 mA DC or 0 to 20 mA DC/ load resistance of 600 Ω or less
- Current output accuracy: ±0.1% of span (±5% of span for 1 mA or less)
  - The accuracy is that in the standard operating conditions: 23±2°C, 55±10%RH, and power frequency at 50/60 Hz.

## ■ 15 V DC Loop Power Supply Specifications

- (Shared with retransmission output)
- Power supply: 14.5 to 18.0 V DC
- Maximum supply current: About 21 mA (with short-circuit current limiting circuit)

## ■ Contact Input Specifications

- Number of inputs: See the table of Model and Suffix Codes.
- Input type: No-voltage contact input or transistor contact input
- Input contact rating: 12 V DC, 10 mA or more
  - Use a contact with a minimum on-current of 1 mA or more.
- ON/OFF detection:
  - No-voltage contact input:
    - Contact resistance of 1 kΩ or less is determined as "ON" and contact resistance of 50 kΩ or more as "OFF."
  - Transistor contact input:
    - Input voltage of 2 V or less is determined as "ON" and leakage current must not exceed 100 µA when "OFF."
- Minimum status detection hold time: Control period +50 ms
- Use: PTNO. switch, operation mode switch, and event input

## ■ Transistor Contact Output Specifications

- Number of outputs: See the table of Model and Suffix Codes.
- Output type: Open collector (SINK current)
- Output contact rating: Max. 24 V DC, 50 mA
- Output time resolution: Min. 100 ms

## ■ Heater Break Alarm Specifications

- Number of inputs: 2
- Number of outputs: 2 (transistor contact output)
- Use: Measures the heater current using an external current transformer (CT) and generates a heater break alarm when the measured value is less than the break detection value.
- Current transformer input resistance: About 9.4 Ω
- Current transformer input range: 0.0 to 0.1 Arms (0.12 Arms or more cannot be applied.)
- Heater current setting range: OFF, 0.1 to 300.0 Arms
  - Heater current measured value display range: 0.0 to 360.0 Arms
  - Note: The CT ratio can be set. CT ratio setting range: 1 to 3300
- Recommended CT: CT from U.R.D., Ltd.
  - CTL-6-S-H: CT ratio 800, measurable current range: 0.1 to 80.0 Arms
  - CTL-12L-30: CT ratio 3000, measurable current range: 0.1 to 180.0 Arms
- Heater current measurement period: 200 ms
- Heater current measurement accuracy: ±5% of current transformer input range span ± 1 digit (CT error is not included.)
- Heater current detection resolution: Within 1/250 of current transformer input range span
- Break detection On-time: Min. 0.2 second (for time proportional output)



## ■ Safety and EMC Standards

- Safety: Compliant with IEC/EN61010-1 (CE), approved by CAN/CSA C22.2 No.61010-1 (CSA), approved by UL61010-1.  
Installation category: CAT. II Pollution degree: 2  
Measurement category: I (CAT. I)  
Rated measurement input voltage: Max. 10 V DC  
Rated transient overvoltage: 1500 V (Note)  
Note: This is a reference safety standard value for Measurement Category I of IEC/EN/CSA/UL61010-1. This value is not necessarily a guarantee of instrument performance.

- EMC Conformity standards:  
CE marking  
EN61326-1 Class A, Table 2 (For use in industrial locations)  
EN61326-2-3  
EN 55011 Class A, Group 1  
EN 61000-3-2 Class A  
EN 61000-3-3  
C-tick mark  
EN 55011 Class A, Group 1  
The instrument continues to operate at a measurement accuracy of within ±20% of the range during testing.

## ■ Construction, Installation, and Wiring

- Dust-proof and drip-proof: IP56 (for front panel) (Not available for side-by-side close mounting.)
- Material: Polycarbonate (Flame retardancy: UL94V-0)
- Case color: White (Light gray) or Black (Charcoal gray light)
- Weight: 0.5 kg or less
- External dimensions (mm): 96 (W) × 96 (H) × 65 (depth from the panel face) (Depth except the projection on the rear panel)
- Installation: Direct panel mounting; mounting bracket, one each for upper and lower mounting
- Panel cutout dimensions (mm): 92<sup>+0.8/0</sup> (W) × 92<sup>+0.8/0</sup> (H)
- Mounting attitude: Up to 30 degrees above the horizontal. No downward tilting allowed.
- Wiring: M3 screw terminal with square washer (for signal wiring and power wiring)

## ■ Power Supply Specifications and Isolation

- Power supply:  
Rated voltage: 100-240 V AC (+10%/-15%), 50/60 Hz  
24 V AC/DC (+10%/-15%) (for /DC option)
- Power consumption: 18 VA (DC:9 VA, AC: 14 VA if /DC option is specified)
- Data backup: Nonvolatile memory
- Power holdup time: 20 ms (for 100 V AC drive)
- Withstanding voltage  
Between primary terminals and secondary terminals: 2300 V AC for 1 minute  
Between primary terminals: 1500 V AC for 1 minute  
Between secondary terminals: 500 V AC for 1 minute  
(Primary terminals: Power\* and relay output terminals; Secondary terminals: Analog I/O signal terminals, contact input terminals, communication terminals and functional grounding terminals.)  
\*: Power terminals for 24V AC/DC models are the secondary terminals.
- Insulation resistance: Between power supply terminals and a grounding terminal 20 MΩ or more at 500 V DC
- Isolation specifications

PV (universal) input terminals	Internal circuits	Power supply
Remote (universal) input terminals with direct input / Remote input terminals		
Aux. analog (AIN2) input terminals		
Aux. analog (AIN4) input terminals		
Control, retransmission (analog) output terminals (not isolated between the analog output terminals)		
Valve position (feedback) input terminals		
Control relay (contact point c) output terminals		
PV event-1 relay (contact point a) output terminals		
PV event-2 relay (contact point a) output terminals		
PV event-3 relay (contact point a) output terminals		
Position proportional relay output terminals		
Contact input terminals (all)		
RS-485 communication terminals (2 ports)		
Contact output (transistor) terminals		
Ethernet communication terminal		
PROFIBUS-DP/DeviceNet/CC-Link communication terminals		
Current transformer input terminals		

The circuits divided by lines are insulated mutually.

## ■ Environmental Conditions

### Normal Operating Conditions:

- Ambient temperature: -10 to 50°C (-10 to 40°C for side-by-side close mounting)  
For the CC-Link option, 0 to 50 °C (0 to 40 °C for side-by-side close mounting)
- Ambient humidity: 20 to 90% RH (no condensation allowed)
- Magnetic field: 400 A/m or less
- Continuous vibration at 5 to 9 Hz: Half amplitude of 1.5 mm or less, 1oct/min for 90 minutes each in the three axis directions  
Continuous vibration at 9 to 150 Hz: 4.9 m/s<sup>2</sup> or less, 1oct/min for 90 minutes each in the three axis directions
- Short-period vibration: 14.7 m/s<sup>2</sup>, 15 seconds or less
- Shock: 98 m/s<sup>2</sup> or less, 11 ms
- Altitude: 2000 m or less above sea level
- Warm-up time: 30 minutes or more after the power is turned on
- Startup time: Within 10 seconds  
\*: The LCD (a liquid crystal display) is used for a display portion of this product. The LCD has a characteristic that the display action becomes late at the low temperature. However, the control function is not affected.

### Transportation and Storage Conditions:

- Temperature: -25 to 70°C
- Temperature change rate: 20°C/h or less
- Humidity: 5 to 95% RH (no condensation allowed)

### Effects of Operating Conditions

- Effect of ambient temperature:  
Voltage or TC input: ±1 μV/°C or ±0.01% of F.S./°C, whichever is larger  
Current input: ±0.01% of F.S./°C  
RTD input: ±0.05°C/°C (ambient temperature) or less  
Analog output: ±0.02% of F.S./°C or less
- Effect of power supply voltage fluctuation  
Analog input: ±0.05% of F.S. or less  
Analog output: ±0.05% of F.S. or less (Each within rated voltage range)

## 5. How to Connect Wires



- Wiring work must be carried out by a person with basic electrical knowledge and practical experience.
- Be sure to turn OFF the power supply to the controller before wiring to avoid an electric shock. Use a tester or similar device to ensure that no power is being supplied to a cable to be connected.
- As a safety measure, always install a circuit breaker (an IEC 60947-compatible product, 5 A, 100 V or 220 V AC) in an easily accessible location near the instrument. Moreover, provide indication that the switch is a device for turning off the power to the instrument.
- Install the power cable keeping a distance of more than 1 cm from other signal wires.
- The power cable is required to meet the IEC standards concerned or the requirements of the area in which the instrument is being installed.
- Wiring should be installed to conform to NEC (National Electrical Code: ANSI/NFPA-70) or the wiring construction standards in countries or regions where wiring will be installed.
- For control relay output, alarm relay output, and power terminal connections, use heat-resistant cables.
- Since the insulation provided to each relay output terminal is functional insulation, provide Reinforced insulation to the external of the device as necessary. (Refer to the drawing below.)

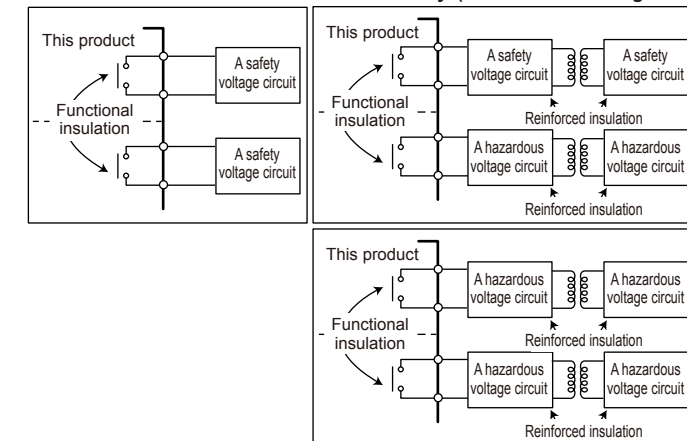

- When connecting two or more crimp-on terminal lugs to the single terminal block, bend the crimp-on terminal lugs before tightening the screw.
- Note that the wiring of two or more crimp-on terminal lugs to the single high-voltage terminal of the power supply and relay, etc. does not comply with the safety standard.



- Provide electricity from a single-phase power supply. If the power is noisy, install an isolation transformer on the primary side, and use a line filter on the secondary side. When measures against noise are taken, do not install the primary and secondary power cables close to each other.
- If there is a risk of external lightning surges, use a lightning arrester etc.
- For TC input, use shielded compensating lead wires for wiring. For RTD input, use shielded wires that have low conductor resistance and cause no significant differences in resistance between the three wires.
- Since the control output relay has a life span (resistance load of 100,000 times), use the auxiliary relay to perform ON/OFF control.
- The use of inductance (L) loads such as auxiliary relays, motors and solenoid valves causes malfunction or relay failure; always insert a CR filter for use with alternating current or a diode for use with direct current, as a spark-removal surge suppression circuit, into the line in parallel with the load.
- After completing the wiring, the terminal cover is recommended to use for the instrument.

## ● Recommended Crimp-on Terminal Lugs

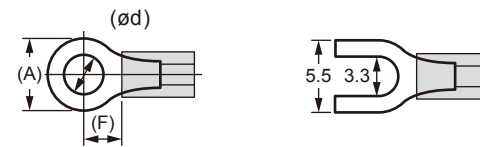

Recommended tightening torque: 0.6 N-m  
Applicable wire size: Power supply wiring 1.25 mm<sup>2</sup> or more

## 6. Terminal Wiring Diagrams



- Do not use an unassigned terminal as the relay terminal.
- Do not use a 100-240 V AC power supply for the 24 V AC/DC model; otherwise, the instrument will malfunction.

### ■ UP55A

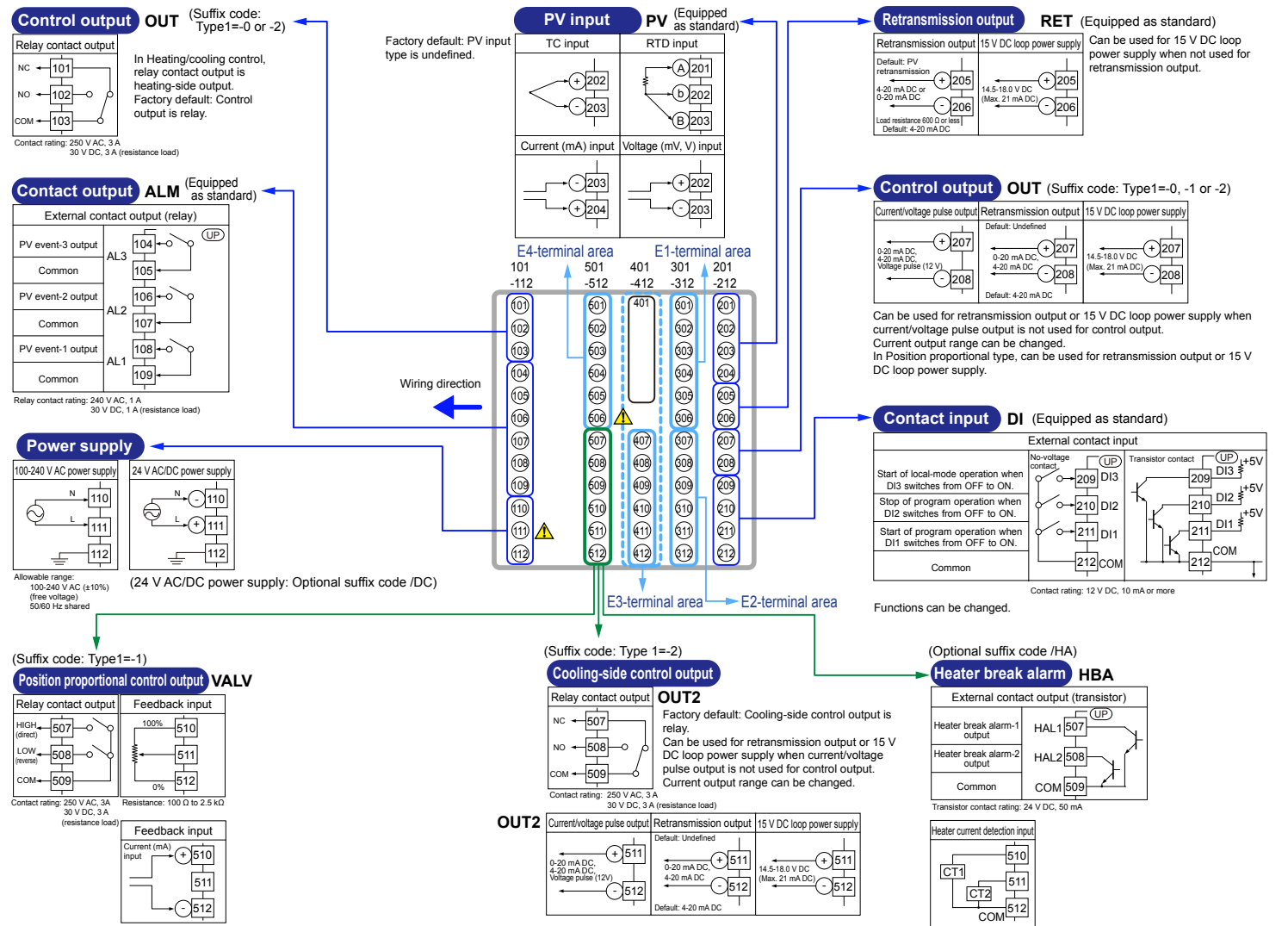

Applicable terminal lug	Applicable wire size mm <sup>2</sup> (AWG#)	(φ d)	(A)	(F)
M3	0.25 to 1.65 (22 to 16)	3.3	5.5	4.2

## ● Cable Specifications and Recommended Cables

Purpose	Name and Manufacturer
Power supply, relay contact outputs	600 V Grade heat-resistant PVC insulated wires, JIS C 3317(HIV), 0.9 to 2.0 mm <sup>2</sup>
Thermocouple	Shielded compensating lead wires, JIS C 1610
RTD	Shielded wires (three/four conductors), UL2482 (Hitachi Cable)
Other signals (other than contact input/output)	Shielded wires
Other signals (contact input/output)	Unshielded wires
RS-485 communication	Shielded wires
Ethernet communication	100 BASE-TX (CAT-5)/10 BASE-T
PROFIBUS-DP communication	Dedicated cable for PROFIBUS-DP (Shielded two-wires)
DeviceNet communication	Dedicated cable for DeviceNet (Shielded five-wires)
CC-Link communication	Dedicated cable for CC-Link (Shielded three-wires)

PROFIBUS-DP/CC-Link Connector (wiring side) (Part number: A1987JT)

DeviceNet Connector (wiring side) (Part number: L4502BW)

Recommended tightening torque: 0.5 to 0.6 N-m

### DC Relay Wiring

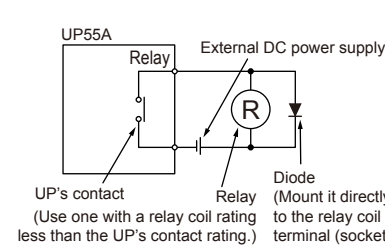

### AC Relay Wiring

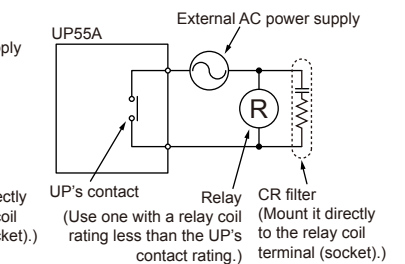

■ UP55A (Continued from page 3)

E4-terminal area E1-terminal area

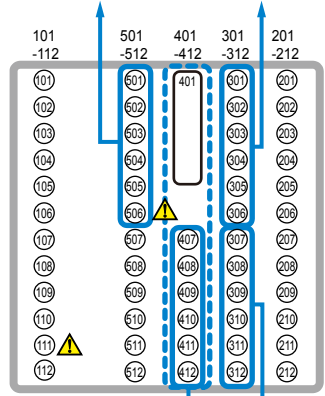

E3-terminal area E2-terminal area



301-306 E1-Terminal Area

(Suffix code: Type 2=1 or 4 and without optional suffix code /DR)

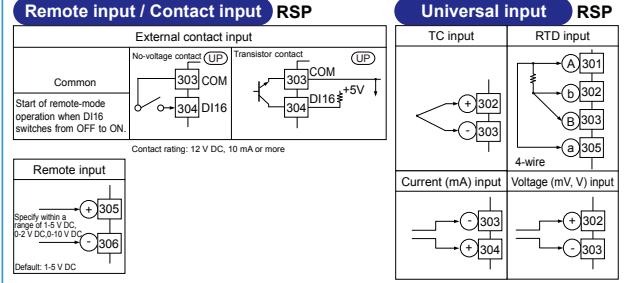

(Suffix code: Type 2=2) Contact input DI

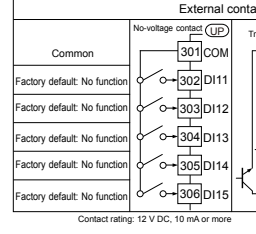

(Suffix code: Type 2=3) Contact output DO

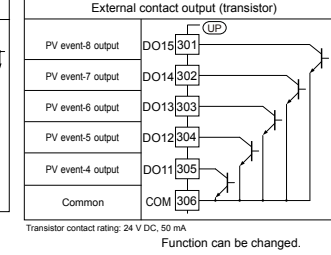

307-312 E2-Terminal Area

(Equipped as standard, however suffix code: Type 2= except 4)

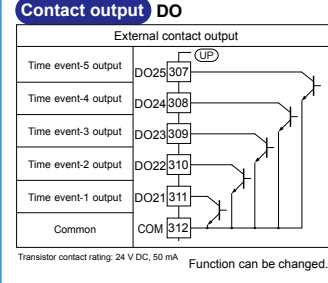

(Suffix code: Type 2=4) Aux. analog input / Contact input AIN2

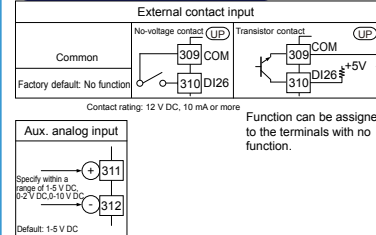

401-412 E3-Terminal Area

Contact output DO (Suffix code: Type 2=3)

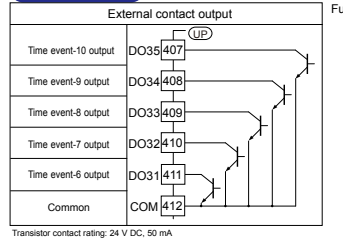

RS-485 communication RS485

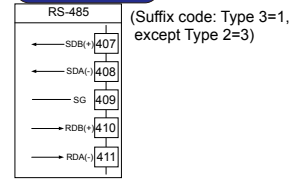

PROFIBUS-DP communication (with Modbus master)

PROF (Suffix code: Type 3=4, except Type 2=3)

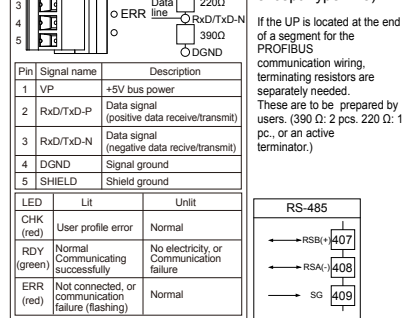

Ethernet communication (with gateway function)

ETHR (Suffix code: Type 3=2, except Type 2=3)

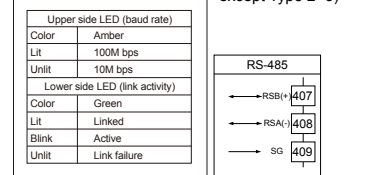

DeviceNet communication (with Modbus master)

DNET (Suffix code: Type 3=5, except Type 2=3)

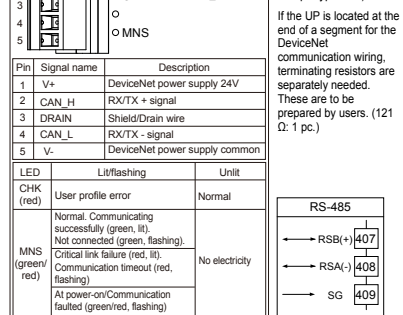

CC-Link communication (with Modbus master)

CC-L (Suffix code: Type 3=3, except Type 2=3)

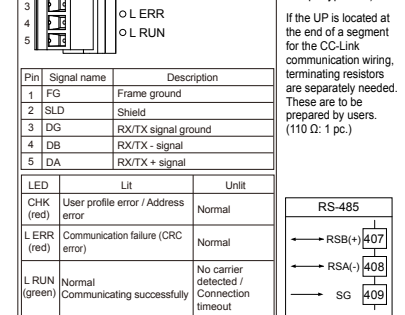

501-506 E4-Terminal Area

(Equipped as standard, however suffix code: Type 2= except 2 and 4)

Contact input DI

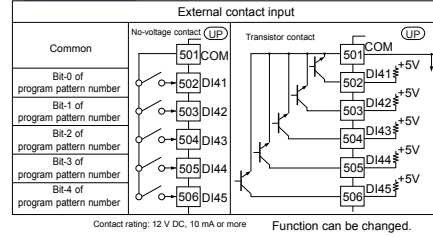

A program pattern is selected with the combination of ON and OFF of a contact input. In the case of a pattern 5, ON (1) of "DI45 to DI41" and OFF (0) is represented as a binary number "00101". It is "5" decimally. The pattern 13 or later can be selected similarly.

Program pattern number	1	2	3	4	5	6	7	8	9	10	11	12
DI41	ON	OFF	ON	OFF	ON	OFF	ON	OFF	ON	OFF	ON	OFF
DI42	OFF	ON	ON	OFF	OFF	ON	ON	OFF	OFF	ON	ON	OFF
DI43	OFF	OFF	OFF	ON	ON	ON	ON	OFF	OFF	OFF	OFF	ON
DI44	OFF	OFF	OFF	OFF	OFF	OFF	OFF	ON	ON	ON	ON	ON
DI45	OFF	OFF	OFF	OFF	OFF	OFF	OFF	OFF	OFF	OFF	OFF	OFF

RS-485 communication RS485

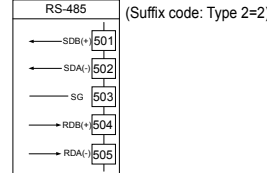

(Suffix code: Type 2=4)

Aux. analog input/Contact input AIN4

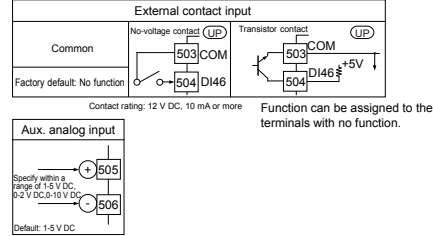

[ Operations 13. Troubleshooting ] ■ Errors at Power On

The errors shown below may occur in the fault diagnosis when the power is turned on. (For details of Setpoint display and input/output action when each error occurs, see User's Manual (CD-ROM).)

PV display (Operation Display)	Setpoint display (Operation Display)	Status indicator (Operation Display)	Parameter that displays error details	Error description	Cause and diagnosis	Remedy
Indication off	Indication off	—	—	Faulty MCU RAM / MCU ROM	MCU RAM / MCU ROM are failed.	Faulty. Contact us for repair.
ERR	SYS - - - -	—	—	System data error	System data is corrupted.	Faulty. Contact us for repair.
	PAR 0004 (for user default value error only)			User parameter is corrupted. Initialized to factory default value.	—	
	PAR 0010 (for setup parameter error only)			Setup parameter data is corrupted. Initialized to user default value.	Check and reconfigure the initialized setting parameters. Error indication is erased when the power is turned on again.	
	PAR 0020 (for operation parameter error only)			Operation parameter data is corrupted. Initialized to user default value.	—	
	PAR 0040 (for program pattern error only)			Program pattern data is corrupted. All program patterns are deleted.	—	
Normal indication	Normal indication	Rightmost decimal point on PV display blinks.	Setup parameter (PA.ER)	Nonresponding hardware of extended function (E1 to E4-terminal areas)	Inconsistency of system data and hardware of extended function. Nonresponding communication between hardware of extended function (E1 to E4-terminal areas).	Faulty. Contact us for repair.
		Rightmost decimal point on Symbol display blinks.	Setup parameter (OP.ER)	Calibration value error	Initialized to calibrated default value because of corrupted factory default value.	Faulty. Contact us for repair.
Normal indication	Normal indication	LADDER lamp blinks	Setup parameter (LA.ER)	Corrupted ladder program	Ladder program is corrupted. Operates without ladder program.	Download the ladder program again.
Normal indication	0.000 00000 (Decimal point on the left of the Symbol display blinks)	—	Setup parameter (OP.ER)	User profile error	User profile is corrupted.	Download the user profile again.

[ Operations 13. Troubleshooting ] ■ Errors during Operation

The errors shown below may occur during operation. (For input/output action when each error occurs, see User's Manual (CD-ROM).)

PV display (Operation Display)	Setpoint display (Operation Display)	Status indicator (Operation Display)	Parameter that displays error details	Error description	Cause and diagnosis	Remedy
AD.ERR	Normal indication (Note)	—	Setup parameter (AD1.E)	Analog input terminal ADC error •PV input •RSP input (E1-terminal area) •AIN2 input (E2-terminal area) •AIN4 input (E4-terminal area)	Analog input terminal AD value error	Faulty. Contact us for repair.
RJC.E (Displays RJC, E and PV alternately.)	Normal indication (Note)	—	Setup parameter (AD1.E)	Universal input terminal RJC error •PV input •RSP input (E1-terminal area)	Universal input terminal RJC error	Faulty. Contact us for repair. Set the parameter RJC to OFF to erase error indication.
B.OUT	Normal indication (Note)	—	Setup parameter (AD1.E)	Analog input terminal burnout error •PV input •RSP input (E1-terminal area) •AIN2 input (E2-terminal area) •AIN4 input (E4-terminal area)	Analog input terminal sensor burnout	Check wiring and sensor. Error indication is erased in normal operation.
				PV input burnout error (Loop 1, Loop 2)	Burnout of analog input connected to PV	Check wiring and sensor of connected analog input terminals. Error indication is erased in normal operation.
OVER-OVER	Normal indication	—	Setup parameter (PV1.E / PV2.E)	PV input over-scale PV input under-scale (PV values out of -5 to 105%) (Loop 1, Loop 2)	PV input is out of -5 to 105%. Also occurs when the data out of range which is the ladder calculation result is input.	Check analog input value or ladder program.
Normal indication	Normal indication	—	Setup parameter (PV1.E)	RSP input burnout error (Loop 1)	Burnout of analog input connected to RSP	Check wiring and sensor. Error indication is erased in normal operation.
Normal indication	RSP B.OUT	—	Setup parameter (PV1.E)	Burnout error when RSP input is used for control (Loop 1)	Burnout of analog input connected to RSP when RSP is used for control computation	Check wiring and sensor. Error indication is erased in normal operation.
Normal indication	OUT - - - -	—	Setup parameter (AD2.E)	Feedback input resistor/current burnout	Feedback input burnout	Check wiring of feedback input resistor/current. Error indication is erased in normal operation.
Normal indication	Normal indication	LADDER lamp blinks	Setup parameter (LA.ER)	Ladder calculation overflow	Floating point computation for ladder calculation is infinite.	Check the ladder program.
				Load factor over 100%	Computation does not end within the control period. (When the load factor is 100% or more, and the computation does not end within the control period.)	Change the control period or reduce the number of steps for the ladder program.
				Load factor over 200% (Forced end)	Computation does not end within the control period (load factor is 200% or more).	Change the control period or reduce the number of steps for the ladder program.
				Ladder program error	Ladder program is corrupted.	Download the ladder program again. If the error indication is still not erased, there is a fault. Contact us for repair.
Normal indication	0.000 00000 (Decimal point on the left of the Symbol display blinks)	—	Setup parameter (OP.ER)	Peer-to-peer communication error	Peer-to-peer communication error	Check that the target devices are connected correctly. Recovery at normal receipt.
AT.E	Normal indication	—	Setup parameter (PV1.E/PV2.E)	Auto-tuning time-out (Loop 1, Loop 2)	Auto-tuning does not end even when 24 hours have elapsed after the start of tuning.	Check the process. Hold down any key to erase the error indication.
VAT.E	Normal indication	—	Setup parameter (AD2.E)	Valve position automatic adjustment error	Fully-closed valve position is equal to or larger than the fully-open valve position after automatic valve position adjustment is performed.	Check wiring and valve. Hold down any key to erase the error indication.
Normal indication	0.000 00000 (Decimal point on the left of the Symbol display blinks)	—	Setup parameter (OP.ER)	Framing parity error Buffer overflow Inter-character time-out Checksum error (PC link communication with checksum) CRC check error (Modbus/RTU) LRC check error (Modbus/ASCII)	Communication error (RS-485 communication)	Check the communication parameters. Recovery at normal receipt. Hold down any key to stop blinking.
				User profile error	User profile is corrupted.	Download the user profile again.
Normal indication	Normal indication	Rightmost decimal point on Symbol display blinks.	Setup parameter (PA.ER)	Faulty FRAM	Writing (storing) data to FRAM is impossible.	Faulty. Contact us for repair.
Undefined	Undefined	—	—	Faulty MCU / DCU (ROM / RAM error, corrupted)	MCU / DCU is corrupted.	Faulty. Contact us for repair.

Note: When an error occurs in input shown in Analog input display (Operation display), Setpoint display shows the same symbol as the PV display.



This operation guide describes basic settings and operations of the UP55A. For details of each function, see the electronic manual contained in the provided CD-ROM. The scrolling guide is displayed on PV display in the Parameter Setting Display. This guide can be turned on/off with the MODE key.

**Contents**

- Names and Functions of Display Parts
- Setup Procedure
- Quick Setting Function (Setting of Input and Output)
- Adjusting Valve Position Automatically (for a Position Proportional Type Controller Only)
- Setting Alarm Type
- Setting Alarm Setpoint

**1. Names and Functions of Display Parts**

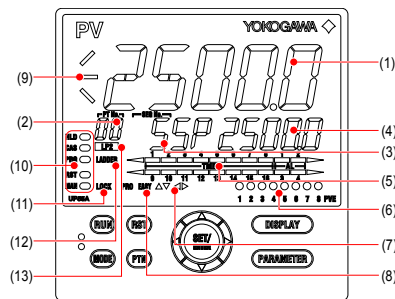

(2) + (3) + (4) : Setpoint display

No. in figure	Name	Description												
(1)	PV display (white or red)	Displays PV. Displays an error code if an error occurs. Displays the scrolling guide in the Menu Display and Parameter Setting Display when the guide display ON/OFF is set to ON.												
(2)	Group display (pattern number) (green)	1 to 30 represent pattern numbers in the Operation Display. Displays a group number (1 to 8 or R) and terminal area (E1 to E4) in the Parameter Setting Display.												
(3)	Symbol display (orange)	Displays a parameter symbol.												
(4)	Data display (orange)	Displays a parameter setpoint and menu symbol.												
(5)	Bar-graph display (event, alarm) (orange)	Displays the event status and the segment position in the Operation Display. (Default values: Time event status, Alarm status) Displays control output value (OUT) and measured input value (PV). The data to be displayed can be set by the parameter.												
(6)	Event indicator (orange)	Lit when the PV events occur. Event displays can be set by the parameter.												
(7)	Key navigation indicator (green)	Lit or blinks when the Up/Down or Left/Right arrow key operation is possible.												
(8)	Parameter display level indicator (green)	Displays the setting conditions of the parameter display level function. <table border="1"> <thead> <tr> <th>Parameter display level</th> <th>EASY</th> <th>PRO</th> </tr> </thead> <tbody> <tr> <td>Easy setting mode</td> <td>Lit</td> <td>Unlit</td> </tr> <tr> <td>Standard setting mode</td> <td>Unlit</td> <td>Unlit</td> </tr> <tr> <td>Professional setting mode</td> <td>Unlit</td> <td>Lit</td> </tr> </tbody> </table>	Parameter display level	EASY	PRO	Easy setting mode	Lit	Unlit	Standard setting mode	Unlit	Unlit	Professional setting mode	Unlit	Lit
Parameter display level	EASY	PRO												
Easy setting mode	Lit	Unlit												
Standard setting mode	Unlit	Unlit												
Professional setting mode	Unlit	Lit												
(9)	Program monitor (green)	Displays the status of increment, constancy, and decrement of the program setpoint. <ul style="list-style-type: none"> <li>↗ : Lit when a program setpoint is increasing.</li> <li>↔ : Lit when a program setpoint is constant.</li> <li>↘ : Lit when a program setpoint is decreasing.</li> </ul>												
(10)	Status indicator (green and red)	Displays the operating conditions and control status. <table border="1"> <thead> <tr> <th>Indicator</th> <th>Description</th> </tr> </thead> <tbody> <tr> <td>HLD</td> <td>Lit when in hold mode (HLD).</td> </tr> <tr> <td>CAS</td> <td>Lit when in cascade mode (CAS).</td> </tr> <tr> <td>PRG</td> <td>Lit when in program operation mode (PRG). Lit while the Starting time of program operation (S.TM) is available.</td> </tr> <tr> <td>RST</td> <td>Lit when in reset mode (RST).</td> </tr> <tr> <td>MAN</td> <td>Lit when in manual mode (MAN). Blinks during auto-tuning.</td> </tr> </tbody> </table>	Indicator	Description	HLD	Lit when in hold mode (HLD).	CAS	Lit when in cascade mode (CAS).	PRG	Lit when in program operation mode (PRG). Lit while the Starting time of program operation (S.TM) is available.	RST	Lit when in reset mode (RST).	MAN	Lit when in manual mode (MAN). Blinks during auto-tuning.
Indicator	Description													
HLD	Lit when in hold mode (HLD).													
CAS	Lit when in cascade mode (CAS).													
PRG	Lit when in program operation mode (PRG). Lit while the Starting time of program operation (S.TM) is available.													
RST	Lit when in reset mode (RST).													
MAN	Lit when in manual mode (MAN). Blinks during auto-tuning.													
(11)	Security indicator (red)	Lit if a password is set. The setup parameter settings are locked.												
(12)	Ladder operation indicator (green)	Lit while the ladder program operation is executed.												
(13)	Loop 2 indicator (LP2 lamp) (green)	Lit when the control mode is Cascade control. In the Operation Display, the LP2 lamp is lit while the Loop-2 data is displayed on Setpoint display. In the Parameter Setting Display, the LP2 lamp indicates the loop of displayed menu symbol or parameter symbol. The LP2 lamp is lit while the Loop-2 menu symbol or parameter symbol is displayed.												

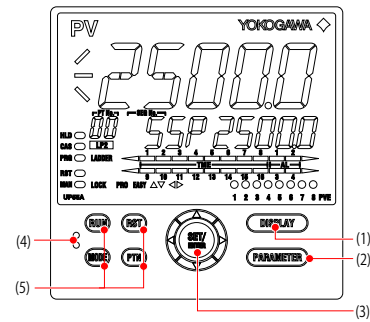

No. in figure	Name	Description
(1)	DISPLAY key	Used to switch the Operation Displays. Press the key in the Operation Display to switch the provided Operation Displays. Press the key in the Menu Display or Parameter Setting Display to return to the Operation Display.
(2)	PARAMETER key	Hold down the key for 3 seconds to move to the Operation Parameter Setting Display. Hold down the key and the Left arrow key simultaneously for 3 seconds to move to the Setup Parameter Setting Display. Press the key in the Parameter Setting Display to return to the Menu Display. Press the key once to cancel the parameter setting (setpoint is blinking).
(3)	SET/ENTER key Up/Down/Left/Right arrow keys	SET/ENTER key Press the key in the Menu Display to move to the Parameter Setting Display of the Menu. Press the key in the Parameter Setting Display to transfer to the parameter setting mode (setpoint is blinking), and the parameter can be changed. Press the key during parameter setting mode to register the setpoint. Up/Down/Left/Right arrow keys Press the Left/Right arrow keys in the Menu Display to switch the Displays. Press the Up/Down/Left/Right arrow keys in the Parameter Setting Display to switch the Displays. Press the Up/Down arrow keys during parameter setting mode (setpoint is blinking) to change a setpoint. Press the Left/Right arrow keys during parameter setting mode (setpoint is blinking) to move between digits according to the parameter.
(4)	Light-loader interface	It is the communication interface for the adapter cable used when setting and storing parameters from a PC. The LL50A Parameter Setting Software (sold separately) is required.
(5)	RUN key RST key MODE key PTN key	RUN key: Press the RUN key for 1 second while an operation display is shown starts the program pattern operation. RST key: Press the RST key for 1 second while an operation display is shown stops the program pattern operation. MODE key: Presents a display for switching between the HOLD, ADVANCE, PROG, RESET, LOCAL, REMOTE and AUTO/MAN. In order to change the operation mode, press the SET/ENTER key while the setpoint is blinking. PTN key: A program pattern number can be selected during the operation except the program pattern operation. (The program pattern number displayed on the Group display blinks.) When the PTN key is pressed while the program pattern number is blinking, the blinking stops. Users can assign functions to the key using parameters.

Note: The communication connector (maintenance port) for LL50A Parameter Setting Software is on the top of the unit.

**2. Setup Procedure**

The following flowchart shows the setup procedure for UP55A.

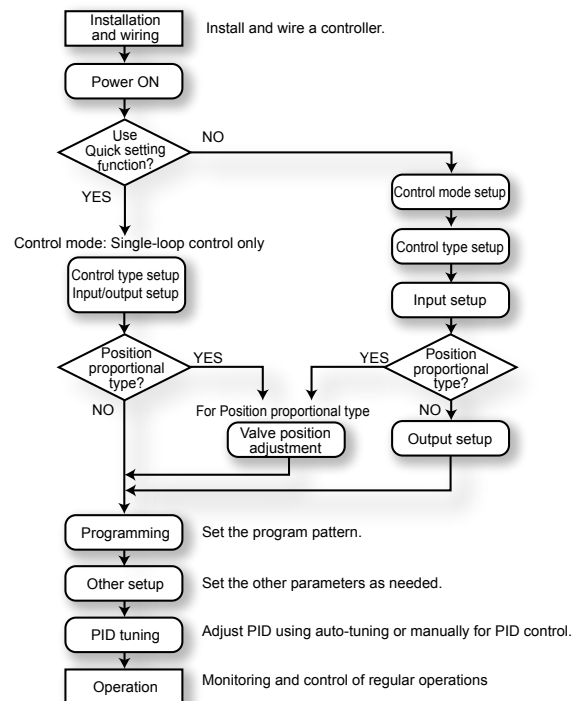

**3. Quick Setting Function (Setting of Input and Output)**

The Quick setting function is a function to easily set the basic function of the controller. Turn on the controller to start the Quick setting function. This function allows you to easily set the control type, input, and output, and quickly start the control action. The items (parameters) to be set by Quick setting function are as follows.  
 (1) Control type (PID control, Heating/cooling control, etc.)  
 (2) Input function (PV input type, range, scale (at voltage input), etc.)  
 (3) Output function (control output type and cycle time)

After turning on the controller, first decide whether or not to use the Quick setting function. The Quick setting function can be used only when the control mode is Single-loop control. For other control modes, set the functions without using the Quick setting function.

**Operation in Initial Display**

- Press the SET/ENTER key while YES is displayed to start the Quick setting function.
- If you change YES to NO and press the SET/ENTER key, Operation Display will appear without starting the Quick setting function.

**Flow of Quick Setting Function**

In Quick setting mode, the parameter guide appears on PV display. This guide can be turned on/off with the MODE key.

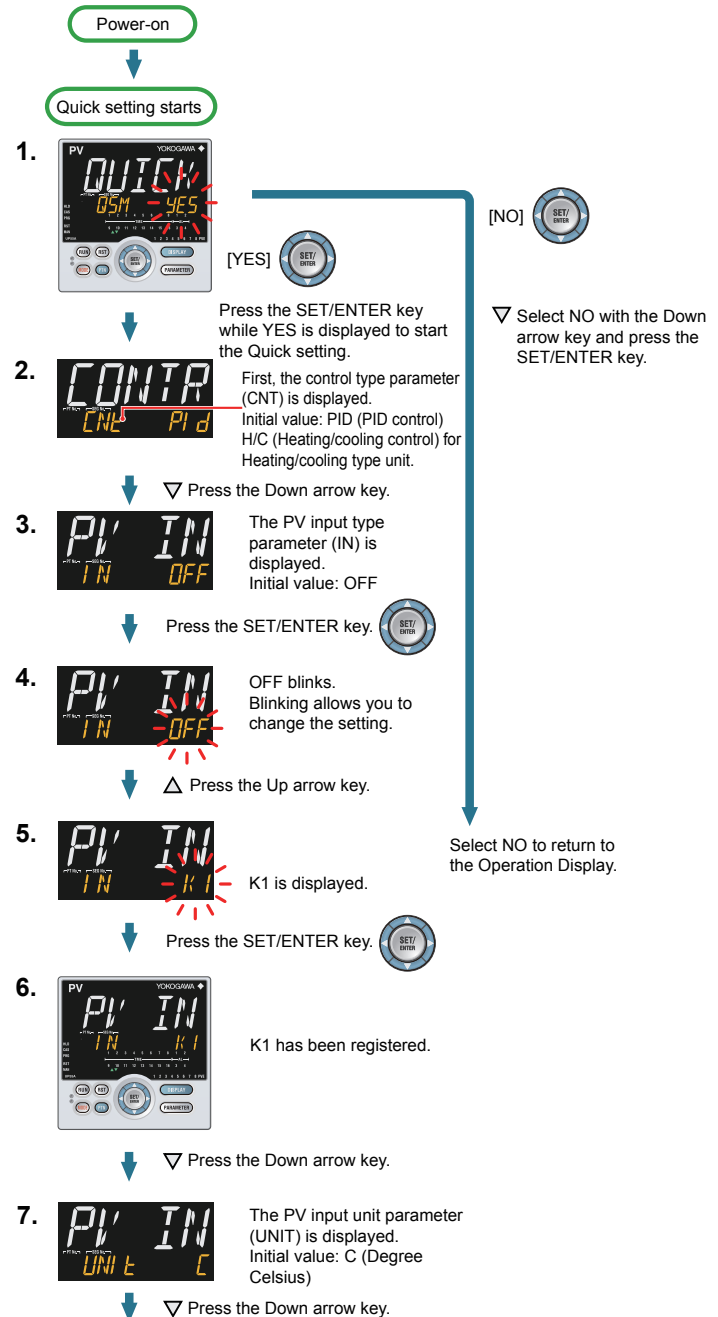

**Operation for Setting**

- To select the parameter setting displayed as the initial value, press the Down arrow key to move to the next parameter.
- To change and set the parameter setting, press the SET/ENTER key to start the setpoint blinking. The blinking state allows you to make changes (setting mode). Use the Up/Down/Left/Right arrow keys to change the setpoint. Press the SET/ENTER key to register the setting.

**Making Settings Using Quick Setting Function**

**Example: Setting to PID control, thermocouple type K (range of 0.0 to 500.0°C), and current control output**

For the detailed procedure and switching of displays, see "Flow of Quick Setting Function" below. For the parameters to set, see the next page.

- Press the SET/ENTER key while YES for QSM (Quick setting mode) is displayed.
- Set the control type parameter (CNT) to PID (PID control).
- Set the PV input type parameter (IN) to K1 (-270.0 to 1370.0 °C).
- Set the PV input unit parameter (UNIT) to C (Degree Celsius).
- Set the maximum value of PV input range parameter (RH) to 500.0.
- Set the minimum value of PV input range parameter (RL) to 0.0.
- Set the output type selection parameter (OT) to OUT terminals (current).
- Finally, EXIT is displayed. Change NO to YES and press the SET/ENTER key to complete the setup. Operation Display appears.



## Parameters to be set

### Control Type

Parameter Symbol	Name of Parameter	Setting Range
CNT	Control type	PID: PID control ONOF: ON/OFF control (1 point of hysteresis) ONOF2: ON/OFF control (2 points of hysteresis) H/C: Heating/cooling control

Note: Some setpoints may not be displayed depending on the model and suffix codes.

### Input Function

Parameter Symbol	Name of Parameter	Setting Range
IN	PV input type	OFF: Disable K1: -270.0 to 1370.0 °C / -450.0 to 2500.0 °F K2: -270.0 to 1000.0 °C / -450.0 to 2300.0 °F K3: -200.0 to 500.0 °C / -200.0 to 1000.0 °F J: -200.0 to 1200.0 °C / -300.0 to 2300.0 °F T1: -270.0 to 400.0 °C / -450.0 to 750.0 °F T2: 0.0 to 400.0 °C / -200.0 to 750.0 °F B: 0.0 to 1800.0 °C / 32 to 3300 °F S: 0.0 to 1700.0 °C / 32 to 3100 °F R: 0.0 to 1700.0 °C / 32 to 3100 °F N: -200.0 to 1300.0 °C / -300.0 to 2400.0 °F E: -270.0 to 1000.0 °C / -450.0 to 1800.0 °F L: -200.0 to 900.0 °C / -300.0 to 1600.0 °F U1: -200.0 to 400.0 °C / -300.0 to 750.0 °F U2: 0.0 to 400.0 °C / -200.0 to 1000.0 °F W: 0.0 to 2300.0 °C / 32 to 4200 °F PL2: 0.0 to 1390.0 °C / 32.0 to 2500.0 °F P2040: 0.0 to 1900.0 °C / 32 to 3400 °F WRE: 0.0 to 2000.0 °C / 32 to 3600 °F JPT1: -200.0 to 500.0 °C / -300.0 to 1000.0 °F JPT2: -150.00 to 150.00 °C / -200.0 to 300.0 °F PT1: -200.0 to 850.0 °C / -300.0 to 1560.0 °F PT2: -200.0 to 500.0 °C / -300.0 to 1000.0 °F PT3: -150.00 to 150.00 °C / -200.0 to 300.0 °F 0.4-2V: 0.400 to 2.000 V 1-5V: 1.000 to 5.000 V 4-20: 4.00 to 20.00 mA 0-2V: 0.000 to 2.000 V 0-10V: 0.00 to 10.00 V 0-20: 0.00 to 20.00 mA -1020: -10.00 to 20.00 mV 0-100: 0.0 to 100.0 mV
UNIT	PV input unit	-: No unit, C: Degree Celsius -: No unit, -: No unit, - -: No unit, F: Degree Fahrenheit
RH	Maximum value of PV input range	Depends on the input type. - For temperature input - Set the temperature range that is actually controlled. (RL<RH)
RL	Minimum value of PV input range	- For voltage / current input - Set the range of a voltage / current signal that is applied. The scale across which the voltage / current signal is actually controlled should be set using the maximum value of input scale (SH) and minimum value of input scale (SL). (Input is always 0% when RL = RHL)
SDP	PV input scale decimal point position	0: No decimal place 1: One decimal place 2: Two decimal places 3: Three decimal places 4: Four decimal places
SH	Maximum value of PV input scale	-19999 to 30000, (SL<SH),  SH - SL  ≤ 30000
SL	Minimum value of PV input scale	

Note 1: SDP, SH, and SL are displayed only for voltage/current input.  
Note 2: W: W-5%Re/W-26%Re (Hoskins Mfg. Co.), ASTM E988

### Output Function

Parameter Symbol	Name of Parameter	Setting Range
OT	Output type selection	Control output or Heating-side control output (Lower two digits) 00: OFF 01: OUT terminals (voltage pulse) 02: OUT terminals (current) 03: OUT terminals (relay) 04: OUT2 terminals (voltage pulse) 05: OUT2 terminals (current) 06: OUT2 terminals (relay)
CT	Control output cycle time	Heating-side control output cycle time (in Heating/cooling control) 0.5 to 1000.0 s
CTc	Cooling-side control output cycle time	

## 4. Adjusting Valve Position Automatically (for a Position Proportional Type Controller Only)

The following operating procedure describes how to input feedback signals from the control valve and adjust the fully-open and fully-closed positions of the control valve automatically. The fully-open and fully-closed positions of the valve can be adjusted automatically by inputting feedback signals from the valve. To adjust the valve position, you need to carry out the connection and bring the controller into manual mode. For the connection, see "6. Terminal Wiring Diagrams" in "Installation and Wiring", and for the manual mode, see "5. Switching between AUTO and MAN" in "Operations." The automatic adjustment can be done in program pattern operation, local operation, and remote operation.

1. Show the Operation Display.  
MAN is lit
2. Hold down the keys for 3 seconds.  
\* When a password is set, PASS is displayed. If the correct password is not entered, setup parameters cannot be changed. CTL menu is displayed.
3. Press the Right arrow key until OUT menu appears.  
OUT menu is displayed.
4. Press the SET/ENTER key.  
The parameter V.AT (automatic valve position adjustment) is displayed.
5. Press the SET/ENTER key.  
OFF blinks.
6. Press the Up arrow key.  
ON is displayed. Blinks during the change.
7. Press the SET/ENTER key.  
ON has been registered and the automatic adjustment of the valve position starts. V.AT blinks during the automatic adjustment. After the adjustment is completed, press the DISPLAY key or DISP key once to return to the Operation Display.

- When the adjustment is completed normally, the indication automatically returns to OFF.
- When VAT.E appears on PV display, it indicates an error. Check the wiring for feedback input and perform the automatic adjustment again. To perform a valve adjustment manually, see User's Manual.

## 5. Setting Alarm Type

The following operating procedure shows an example of changing the alarm-1 type (factory default: PV high limit alarm) to PV low limit alarm (setpoint: 02). (These alarms work irrespective of the operation mode.)

1. Show the Operation Display.
2. Hold down the key for 3 seconds.  
MODE menu is displayed.
3. Press the Right arrow key until ALRM menu appears.  
ALRM menu is displayed.
4. Press the SET/ENTER key.  
Press the Up/Down arrow keys to display the parameter needs to be changed.  
The parameter AL1 (alarm-1 type) is displayed.

5. The last digit of the setpoint blinks.  
Change the setpoint using the Up/Down arrow keys to increase and decrease the value and the Left/Right arrow keys to move between digits.  
Press the SET/ENTER key.
6. The alarm-1 type setpoint 02 (PV low limit) is registered. After the setup is completed, press the DISPLAY key once to return to the Operation Display.

- To change the alarm type, change the last 2 digits of the 5-digit value.
- Stand-by action and excitation are turned on or off by selecting 1 or 0. (See "Setting Display of Alarm Type.")
- For the latch action, see User's Manual (CD-ROM).

Alarm Type (Alarm Setpoint)	Alarm Action (Energized)	Alarm Action (De-energized)
No alarm (00)	-	-
PV high limit (01) Analog input PV high limit (19) Analog input RSP high limit (21) Analog input AIN2 high limit (23) Analog input AIN4 high limit (25)	Hysteresis Open (unit) / Closed (lit) PV, RSP, AIN2 Alarm setpoint or AIN4	Hysteresis Closed (unit) / Open (lit) PV, RSP, AIN2 Alarm setpoint or AIN4
PV low limit (02) Analog input PV low limit (20) Analog input RSP low limit (22) Analog input AIN2 low limit (24) Analog input AIN4 low limit (26)	Hysteresis Closed (lit) / Open (unit) Alarm setpoint PV, RSP, AIN2 or AIN4	Hysteresis Open (lit) / Closed (unit) Alarm setpoint PV, RSP, AIN2 or AIN4
SP high limit (03) Target SP high limit (09)	Hysteresis Open (unit) / Closed (lit) SP or Target SP Alarm setpoint	Hysteresis Closed (unit) / Open (lit) SP or Target SP Alarm setpoint
SP low limit (04) Target SP low limit (10)	Hysteresis Closed (lit) / Open (unit) Alarm setpoint SP or Target SP	Hysteresis Open (lit) / Closed (unit) Alarm setpoint SP or Target SP
Deviation high limit (05) Target SP deviation high limit (11)	Hysteresis Open (unit) / Closed (lit) PV / Deviation setpoint SP or Target SP ⊕	Hysteresis Closed (unit) / Open (lit) PV / Deviation setpoint SP or Target SP ⊕
Deviation low limit (06) Target SP deviation low limit (12)	Hysteresis Closed (lit) / Open (unit) Deviation setpoint / PV SP or Target SP ⊖	Hysteresis Open (unit) / Closed (lit) Deviation setpoint / PV SP or Target SP ⊖
Deviation high and low limits (07) Target SP deviation high and low limits (13)	Hysteresis Hysteresis Closed (lit) / Open (unit) / Closed (lit) Deviation setpoint / PV SP or Target SP	Hysteresis Hysteresis Open (lit) / Closed (unit) / Open (lit) Deviation setpoint / PV SP or Target SP
Deviation within high and low limits (08) Target SP deviation within high and low limits (14)	Hysteresis Hysteresis Open (unit) / Closed (lit) / Open (unit) Deviation setpoint / PV SP or Target SP	Hysteresis Hysteresis Closed (unit) / Open (lit) / Closed (unit) Deviation setpoint / PV SP or Target SP
Control output high limit (15) Cooling-side control output high limit (17)	Hysteresis Open (unit) / Closed (lit) Output Alarm setpoint	Hysteresis Closed (unit) / Open (lit) Output Alarm setpoint
Control output low limit (16) Cooling-side control output low limit (18)	Hysteresis Closed (lit) / Open (unit) Alarm setpoint Output	Hysteresis Open (lit) / Closed (unit) Alarm setpoint Output
Feedback input high limit (27)	Fault diagnosis alarm (30) Burnout of PV input, RSP remote input, or AIN2/AIN4 auxiliary analog input. ADC failure, RJC error.	
Feedback input low limit (28)	FAIL (31)	
PV velocity (29)	For the factory default, the contact output is turned ON in normal operation, OFF at the time of FAIL. Control output: OFF or 0%, Alarm output: OFF	

Note 1: "Open/closed" shows status of relay contact, and "lit/unlit" shows status of EV (event) lamp.  
Note 2: ⊕ Positive setpoint, ⊖ Negative setpoint

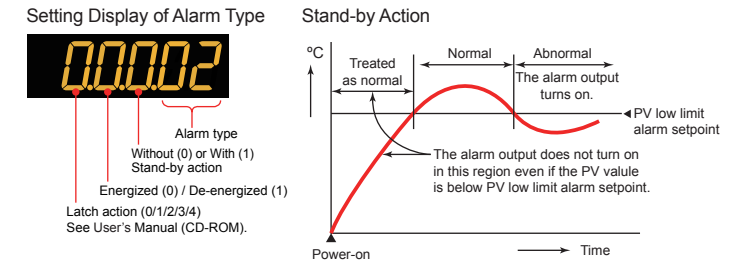

Note that the SP in reset-mode is SSP (Starting target setpoint).

## 6. Setting Alarm Setpoint

The following operating procedure shows an example of setting the alarm-1 setpoint to 180.0. (These alarms work irrespective of the operation mode.) Before setting the alarm setpoint, check the alarm type. To change the alarm type, see "5. Setting Alarm Type."

1. Show the Operation Display.
2. Display MODE menu with the same procedure as described in Setting Alarm Type.  
Press the Right arrow key.
3. AL menu is displayed.
4. Press the SET/ENTER key.  
The parameter A1 is displayed. A1 to A8 represent the alarm-1 to -8 setpoints.

- Each parameter can be changed in the Parameter Setting Displays of alarms using arrow keys.
- △▽ Up/Down arrow keys: changing parameters

5. Display the parameter that need to be changed.  
Press the SET/ENTER key.
6. Blinks during the change.  
Change the setpoint using the Up/Down arrow keys to increase and decrease the value and the Left/Right arrow keys to move between digits.  
Press the SET/ENTER key.
7. The setpoint has been registered. After the setup is completed, press the DISPLAY key once to return to the Operation Display.



This operation guide describes basic program settings of the UP55A. For details of each function, see the electronic manual contained in the provided CD-ROM. The scrolling guide is displayed on PV display in the Parameter Setting Display. This guide can be turned on/off with the MODE key. (The scrolling guide is OFF when displaying the Program parameter setting display first.)

**Contents**

1. Overview of Program Patterns
2. Creating Program Patterns
3. Program Pattern Setup Charts

**1. Overview of Program Patterns**

The programming example given here demonstrates how to do the tasks outlined below.

- 1) Program the controller to start program operation at 50.0°C and raise the temperature up to 100.0°C in 50 minutes.
- 2) When the temperature reaches 100.0°C, keep it at this level for 30 minutes.
- 3) Raise the temperature up to 200.0°C in 60 minutes.
- 4) When the temperature reaches 200.0°C, keep it at this level for 30 minutes.
- 5) Lower the temperature to 50.0°C in 50 minutes.
- 6) When the temperature reaches 50.0°C, keep it at this level for 30 minutes.

PV input ranges are following:  
Maximum value of PV input range: 250.0°C  
Minimum value of PV input range: 0.0°C  
PV input unit: C

Zone PID selection (ZON): Segment PID selection (0)  
Segment setting method (SEG.T): Segment time setting (TIME)  
Program time unit (TMU): hour.minute (HH.MM)

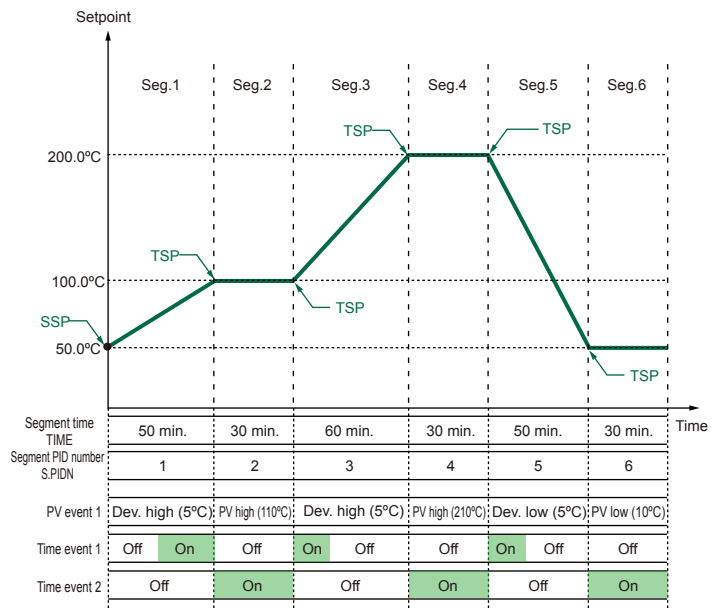

The display symbols of the parameters, TSP (Final target setpoint), TIME (Segment time setting), and S.PID (Segment PID number selection) are the same in each segment. However, the segment can be recognized by the number displayed on the Symbol display.

See User's Manual for the Wait and Repeat actions, Zone PID, Start of program operation (Start code), Changing operation mode at segment switching (Junction code), Local mode, and Remote mode.

**2. Creating Program Patterns**

The following operating procedure describes an example of creating the program discussed in "1. Overview of Program Patterns."

**CAUTION** Note that the program patterns are all deleted if the settings change after creating program patterns. Be sure to check the PV input range, Program time unit (TMU), and Segment setting method (SEG.T) before creating.

1. Show the Operation Display. RST lamp is lit. Hold down the keys for 3 seconds.
2. MODE menu is displayed. Press the Right arrow key.
3. PROG menu is displayed. Press the SET/ENTER key.
4. PTNO.=1 Change the setpoint using the Up/Down arrow keys to increase and decrease the value and the Left/Right arrow keys to move between digits. Press the SET/ENTER key.
5. SEGNO=0 Press the SET/ENTER key. When SEGNO.=0, set the common parameter for the pattern specified. When SEGNO.=1 to 99, set the parameter for the segment specified.
6. SSP=50.00 Press the SET/ENTER key. (Blinks during the change.) Change the setpoint using the Up/Down arrow keys to increase and decrease the value and the Left/Right arrow keys to move between digits.
7. Starting target setpoint=50.0°C Press the Down arrow key (until TSP appears.)
8. STC=SSP Press the Down arrow key. STC=SSP (Starting target setpoint) Keep the initial value.
9. TSP=50.00 Press the SET/ENTER key. (Blinks during the change.) Change the setpoint using the Up/Down arrow keys to increase and decrease the value and the Left/Right arrow keys to move between digits.
10. Final target setpoint=100.0°C Press the SET/ENTER key. Press the Down arrow key.
11. TIME=01:00 Press the SET/ENTER key. (Blinks during the change.) Change the setpoint using the Up/Down arrow keys to increase and decrease the value and the Left/Right arrow keys to move between digits.

12. Segment time=50 minutes Press the SET/ENTER key. Press the Down arrow key.
13. SPID=01 Press the Down arrow key. Set the segment PID number. Keep the initial value.
14. JC=CONE Press the Down arrow key. Set the junction code. Keep the initial value.
15. PVTY1=OFF Press the SET/ENTER key. (Blinks during the change.) Change the setpoint using the Up/Down arrow keys to increase and decrease the value and the Left/Right arrow keys to move between digits.
16. PVTY1=5 Press the SET/ENTER key. PV event-1 type=Deviation high limit Press the Down arrow key.
17. PVEV1=00 Press the SET/ENTER key. (Blinks during the change.) Change the setpoint using the Up/Down arrow keys to increase and decrease the value and the Left/Right arrow keys to move between digits.
18. PVEV1=50 Press the SET/ENTER key. PV event-1 setpoint=5.0°C Press the Down arrow key (until TIM1 appears.)
19. TIME1=OFF Press the Down arrow key. Time event-1 starts from the Off state.
20. TON1=00:25 Press the SET/ENTER key. (Blinks during the change.) Change the setpoint using the Up/Down arrow keys to increase and decrease the value and the Left/Right arrow keys to move between digits.
21. TON1=00:25 Press the SET/ENTER key. On time=25 minutes Press the Down arrow key.
22. TOF1=OFF Press the Down arrow key. There is no the Off time.
23. TME2=OFF Press the Down arrow key (until TSP appears.) Time event-2 starts from the Off state.
24. TSP=100.00 Change the Up/Down arrow keys to move the parameters for segment-1 and the Left/Right arrow keys to move between each segments. Press the SET/ENTER key. (Blinks during the change.) Press the Down arrow key. Set the final target setpoint. Continues the TSP of segment 1.
25. TIME=02:00 Press the SET/ENTER key. (Blinks during the change.) Change the setpoint using the Up/Down arrow keys to increase and decrease the value and the Left/Right arrow keys to move between digits.

26. Segment time=30 minutes Press the SET/ENTER key. Press the Down arrow key.
  27. SPID=02 Press the SET/ENTER key. (Blinks during the change.) Change the setpoint using the Up/Down arrow keys to increase and decrease the value.
  28. SPID=02 Press the SET/ENTER key. Segment PID number=2 Press the Down arrow key.
  29. JC=CONE Press the Down arrow key. Set the junction code. In this case, the former segment is left unchanged.
  30. PVTY1=5 Press the SET/ENTER key. (Blinks during the change.) Change the setpoint using the Up/Down arrow keys to increase and decrease the value and the Left/Right arrow keys to move between digits.
  31. PVEV1=1 Press the SET/ENTER key. PV event-1 type=PV high limit Press the Down arrow key.
  32. PVEV1=50 Press the SET/ENTER key. (Blinks during the change.) Change the setpoint using the Up/Down arrow keys to increase and decrease the value and the Left/Right arrow keys to move between digits.
  33. PVEV1=110.00 Press the SET/ENTER key. PV event-1 setpoint=110.0°C Press the Down arrow key (until TIM1 appears.)
  34. TIME1=OFF Press the Down arrow key. (until TIM2 appears.) Time event-1 starts from the Off state.
  35. TME2=OFF Press the SET/ENTER key. (Blinks during the change.) Change the setpoint using the Up/Down arrow keys to increase and decrease the value.
  36. TME2=ON Press the SET/ENTER key. Start condition of time event 2=ON start Change the Up/Down arrow keys to move the parameters for segment-1 and the Left/Right arrow keys to move between each segments.
- Settings for the segment 3 to 6 can be done similarly.
  - For programming and the settings for Wait and Repeat actions, see User's Manual.
37. Press the DISPLAY key once to return to the Operation Display.

### 3. Program Pattern Setup Charts

You can register max. 99 program segments with the UP55A controller. Create as many copies of the chart as necessary.

System name	
Program No.	
Program name	
Model	
Serial No.	

The following parameters are necessary to be set before programming.  
 Note that the program is deleted if TMU or SEG.T is changed after creating programs.  
 For the setting range, see "Parameters."

#### < Setup Parameters >

Parameter symbol	Parameter name	User settings
TMU	Program time unit	
SEG.T	Segment setting method	
ZON	Zone PID selection	
PT2.G	Program pattern-2 retransmission	

The following parameters are common parameters for the program pattern specified.  
 For the setting range, see "Parameters."

#### < Program Pattern Data (common parameter) >

Parameter symbol	Parameter name	User settings
SSP	Starting target setpoint	
SSP	Starting target setpoint (for program pattern-2 retransmission)	
STC	Start code	
WT.SW1	Wait function ON/OFF 1	
WZ.UP1	Upper-side wait zone 1	
WZ.LO1	Lower-side wait zone 1	
WT.TM1	Wait time 1	
WT.SW2	Wait function ON/OFF 2	
WZ.UP2	Upper-side wait zone 2	
WZ.LO2	Lower-side wait zone 2	
WT.TM2	Wait time 2	
WT.SW3	Wait function ON/OFF 3	
WZ.UP3	Upper-side wait zone 3	
WZ.LO3	Lower-side wait zone 3	
WT.TM3	Wait time 3	
WT.SW4	Wait function ON/OFF 4	
WZ.UP4	Upper-side wait zone 4	
WZ.LO4	Lower-side wait zone 4	
WT.TM4	Wait time 4	
WT.SW5	Wait function ON/OFF 5	
WZ.UP5	Upper-side wait zone 5	
WZ.LO5	Lower-side wait zone 5	
WT.TM5	Wait time 5	
R.CYCL	Number of repeat cycles	
R.STRT	Repeat cycle start segment number	
R.END	Repeat cycle end segment number	

#### Error Indication at Program Pattern Creation and Editing

Error code	Error information	Cause of error
ERR01	Pattern creation or editing is disable during program operation.	Deleting or copying of the program pattern, or inserting or deleting of the segment was executed during program operation.
ERR22	Segment write error	The total number of segments exceeded 300.
ERR23	Segment insert error	New segment cannot be inserted because the number of segments in a pattern exceeded 99.
ERR32	Pattern source specification error	No pattern exists in the source.
ERR33	Pattern destination specification error	Patterns already exist in the destination.
ERR41	Pattern delete error	The pattern to be deleted does not exist.

Except the above errors, there are some error codes in communication. For details, see User's Manual.

#### < Program Pattern Data (parameters for segments) >

Maximum value of PV input range / Maximum value of PV input scale ( )  
 Unit ( )

A program pattern can be drawn in the right table.

Minimum value of PV input range / Minimum value of PV input scale ( )

Parameter symbol	Parameter name	Segments																				
		1	2	3	4	5	6	7	8	9	10	11	12	13	14	15	16	17	18	19	20	
TSP	Final target setpoint																					
TSP	Final target setpoint for Program pattern-2 retransmission																					
TIME	Segment time setting																					
TM.RT	Segment ramp-rate setting																					
S.PID	Segment PID number selection																					
JC	Junction code																					
PV.TY1	PV event-1 type																					
PV.EV1	PV event-1 setpoint																					
PV.TY2	PV event-2 type																					
PV.EV2	PV event-2 setpoint																					
PV.TY3	PV event-3 type																					
PV.EV3	PV event-3 setpoint																					
PV.TY4	PV event-4 type																					
PV.EV4	PV event-4 setpoint																					
PV.TY5	PV event-5 type																					
PV.EV5	PV event-5 setpoint																					
PV.TY6	PV event-6 type																					
PV.EV6	PV event-6 setpoint																					
PV.TY7	PV event-7 type																					
PV.EV7	PV event-7 setpoint																					
PV.TY8	PV event-8 type																					
PV.EV8	PV event-8 setpoint																					
TME1	Start condition of time event 1																					
T.ON1	On time of time event 1																					
T.OF1	Off time of time event 1																					
TME2	Start condition of time event 2																					
T.ON2	On time of time event 2																					
T.OF2	Off time of time event 2																					
TME3	Start condition of time event 3																					
T.ON3	On time of time event 3																					
T.OF3	Off time of time event 3																					
TME4	Start condition of time event 4																					
T.ON4	On time of time event 4																					
T.OF4	Off time of time event 4																					
TME5	Start condition of time event 5																					
T.ON5	On time of time event 5																					
T.OF5	Off time of time event 5																					
TME6	Start condition of time event 6																					
T.ON6	On time of time event 6																					
T.OF6	Off time of time event 6																					
TME7	Start condition of time event 7																					
T.ON7	On time of time event 7																					
T.OF7	Off time of time event 7																					
TME8	Start condition of time event 8																					
T.ON8	On time of time event 8																					
T.OF8	Off time of time event 8																					
TME9	Start condition of time event 9																					
T.ON9	On time of time event 9																					
T.OF9	Off time of time event 9																					
TME10	Start condition of time event 10																					
T.ON10	On time of time event 10																					
T.OF10	Off time of time event 10																					
TME11	Start condition of time event 11																					
T.ON11	On time of time event 11																					
T.OF11	Off time of time event 11																					
TME12	Start condition of time event 12																					
T.ON12	On time of time event 12																					
T.OF12	Off time of time event 12																					
TME13	Start condition of time event 13																					
T.ON13	On time of time event 13																					
T.OF13	Off time of time event 13																					
TME14	Start condition of time event 14																					
T.ON14	On time of time event 14																					
T.OF14	Off time of time event 14																					
TME15	Start condition of time event 15																					
T.ON15	On time of time event 15																					
T.OF15	Off time of time event 15																					
TME16	Start condition of time event 16																					
T.ON16	On time of time event 16																					
T.OF16	Off time of time event 16																					



This operation guide describes key entries for operating the UP55A. For operations using external contact inputs, see "DI" of "6. Terminal Wiring Diagrams" in "Installation and Wiring."  
 If you cannot remember how to carry out an operation during setting, press the DISPLAY key once. This brings you to the display (Operation Display) that appears at power-on.  
 The scrolling guide is displayed on PV display in the Parameter Setting Display. This guide can be turned on/off with the MODE key.

**Contents**

1. Monitoring-purpose Operation Displays Available during Operation
2. Performing/Canceling Auto-tuning
3. Selecting Program Pattern Number (PT.No)
4. Switching between RUN and RESET
5. Switching between AUTO and MAN
6. Manipulating Control Output in Manual Mode
7. Enabling/Disabling Hold-mode (HOLD) of Program Operation
8. Changing Program Setpoints when in Hold-mode (HOLD)
9. Executing "Advance" (ADV) Function
10. Switching to Local-mode (LOCAL) Operation
11. Changing Setpoints during Local-mode (LOCAL) Operation
12. Switching to Remote-mode (REMOTE) Operation
13. Troubleshooting

**1. Monitoring-purpose Operation Displays Available during Operation**

**■ Operation Display Switching Diagram**

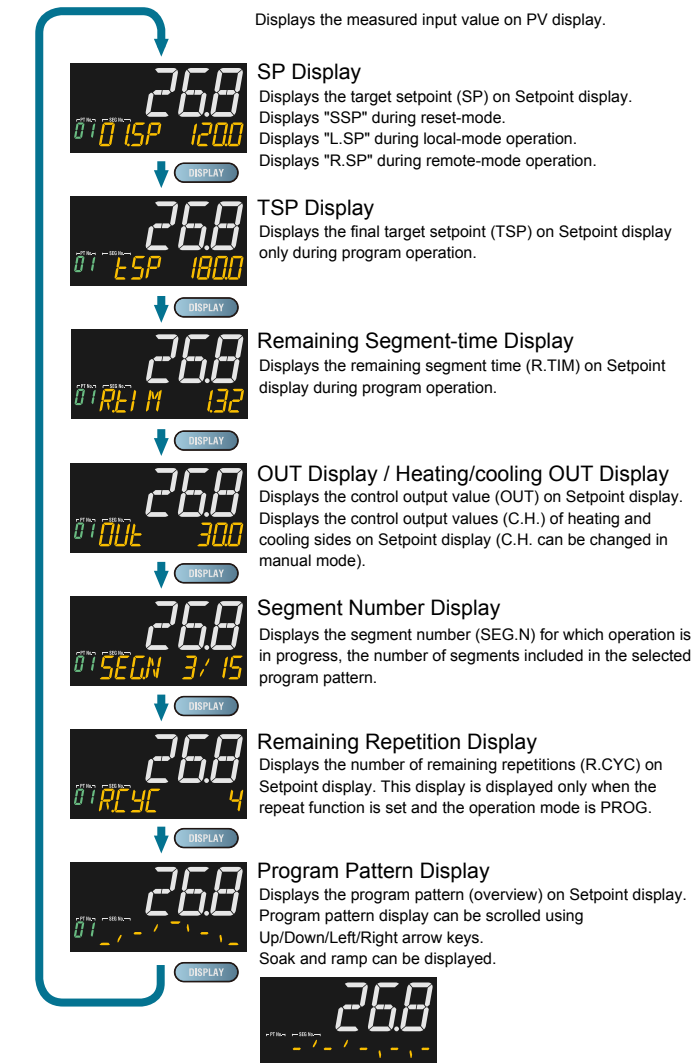

After showing the Program Pattern Display, press the DISPLAY key to show the following displays conditionally. For details, see User's Manual (CD-ROM).

**Standard, Position Proportional, and Heating/Cooling Types**

- SELECT Displays 1 to 5 (which appear when registered)
- Analog Input Display (display only) (factory default: non-display)
- Position Proportional Computation Output Display (display only) (factory default: non-display)
- PID Number Display (display only) (factory default: non-display)
- Alarm-5 to -8 Status Display (which appear when registered)
- Heater Break Alarm-1 Current Display (display only) (for heater break alarm option only)
- Heater Break Alarm-2 Current Display (display only) (for heater break alarm option only)

**■ Event Display**

Time event (TME), PV event (PVE) and alarm (AL) are displayed on the Bar-graph display and the Event Indicator. (factory default setting)

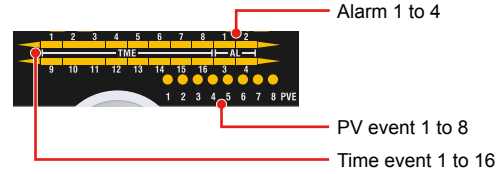

**■ Operation Display Switching Diagram**

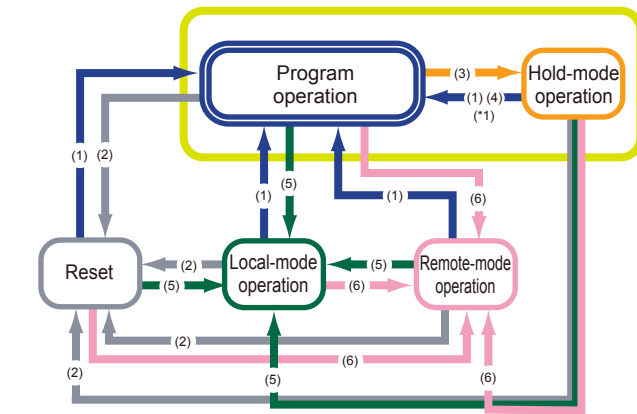

- (1) Press RUN key for 1 s.
  - (2) Press RST key for 1 s.
  - (3) Press MODE key, select HOLD=ON and press SET/ENT key.
  - (4) Press MODE key, select HOLD=OFF and SET/ENT key.
  - (5) Press MODE key, select LOC=ON and press SET/ENT key.
  - (6) Press MODE key, select REM=ON and press SET/ENT key.
- \*1: For another operation, when select ADV=ON and starts program operation. In this case, the segment is advanced.

**2. Performing/Canceling Auto-tuning**

Auto-tuning should be performed after setting a program pattern. Make sure that the controller is in automatic mode (AUTO) and in run mode (RUN) before auto-tuning. For setting to AUTO, see "5. Switching between AUTO and MAN," and for setting to RUN, see "4. Switching between RUN and RESET." If the setpoint is known in advance or auto-tuning does not find any appropriate PID constants, set the PID manually. For setting the PID manually, see User's Manual (CD-ROM).



**Do not perform auto-tuning for the following processes. Tune PID manually.**

- Processes with fast response such as flow rate control and pressure control.
- Processes which do not allow the output to be turned on and off even temporarily.
- Processes which prohibit severe output changes at control valves (or other actuators).
- Processes in which product quality can be adversely affected if PV values fluctuate beyond their allowable ranges.

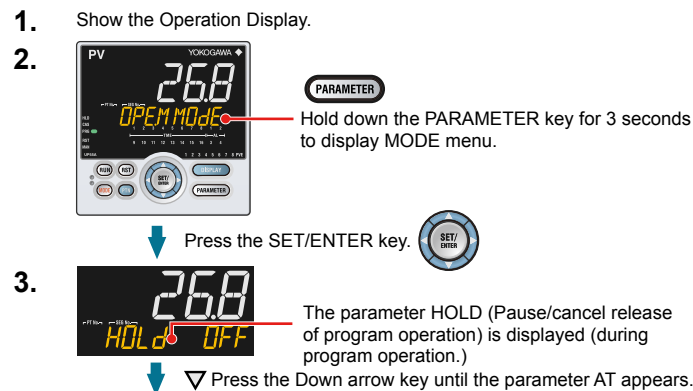

Press the Down arrow key until the parameter AT appears.

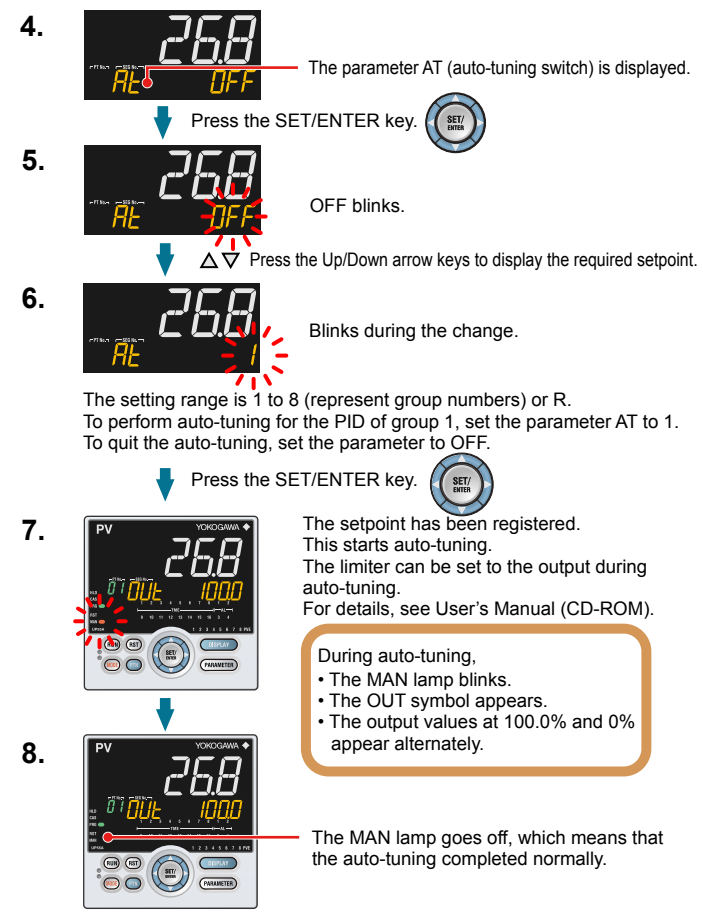

**3. Selecting Program Pattern Number (PT.No)**

Program pattern number selection can be performed using any of the following: (1) key, (2) Parameter, (3) Contact input, and (4) Communication. The following shows an example of changing the program pattern number (PTNO.) to 1 using the key.

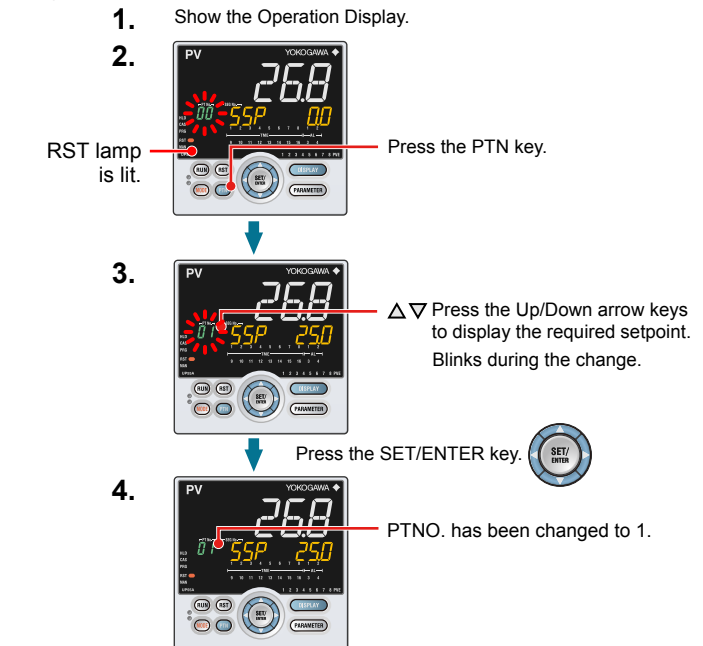

**4. Switching between RUN and RESET**

RUN and RESET switching can be performed using any of the following: (1) key, (2) Contact input, (3) Parameter, and (4) Communication. The following shows an example of switching using the key. For details of other switching methods and the display appearing when the operation is started, see User's Manual (CD-ROM).

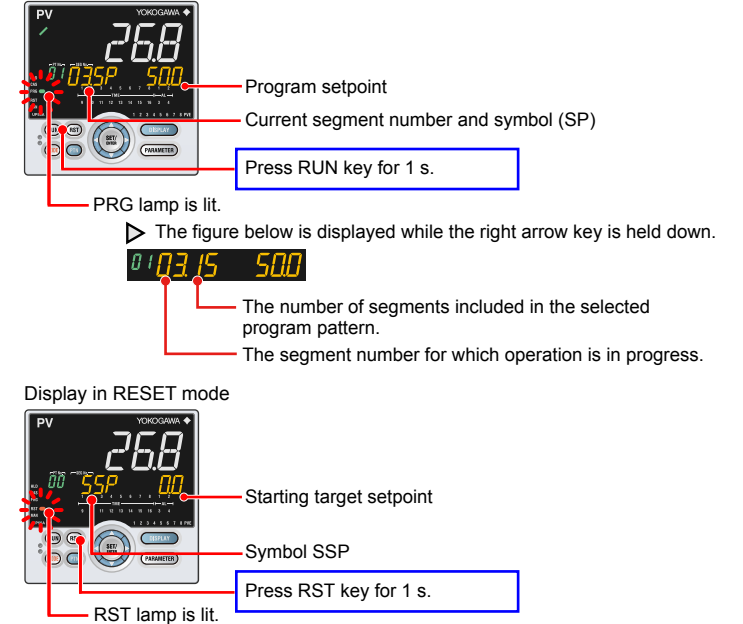

When the controller is stopped, input and outputs are as follows:

PV input	Displays the PV value.
Control output	When the zone PID selection parameter (ZON) is set to segment PID selection, the preset output value for the PID group number 1 is output. When the zone PID selection parameter (ZON) is set to other than segment PID selection, the preset output value for the PID group number for which zone control is performed is output.
Event output	Turns the output off in case of an event.
Alarm output	Turns the output on in case of an alarm.

**5. Switching between AUTO and MAN**

AUTO and MAN switching can be performed using any of the following: (1) MODE key, (2) Contact input, (3) Contact input, and (4) Communication. The following shows an example of switching using the MODE key. When AUTO and MAN switching function is assigned to the contact input, and the contact input is ON, the switching by key operation cannot be performed. For details, see User's Manual (CD-ROM).

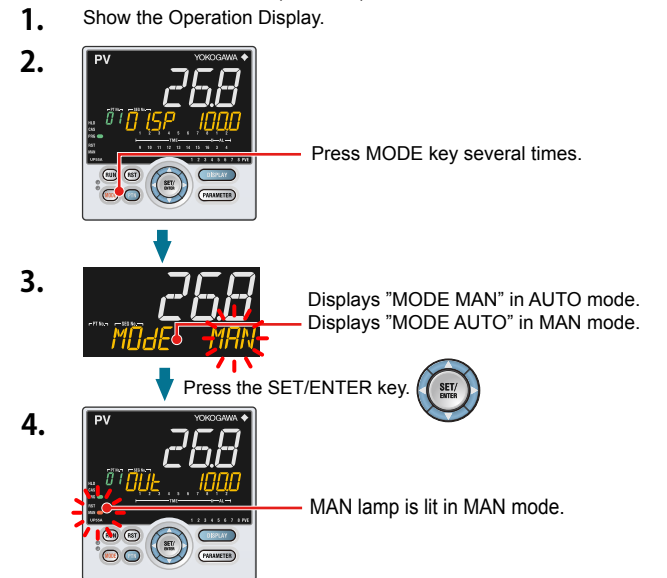

When AUTO is switched into MAN, the control output value in AUTO mode is held. The controller can be operated manually from the hold value. If the manual preset output is set (MPON parameter ≠ OFF), the controller can be operated manually from the arbitrary output value (MPO1 to MPO5 parameters).

## 6. Manipulating Control Output in Manual Mode

### NOTE

In manual mode, control output is manipulated by operating the keys (the value is changed using the Up/Down arrow keys, then outputted as it is). Even if the SET/ENTER key is not pressed, the control output value changes according to the displayed value. In stop mode (when the RST lamp is lit), control output cannot be manipulated.

Up arrow key: increases control output.  
Down arrow key: decreases control output.

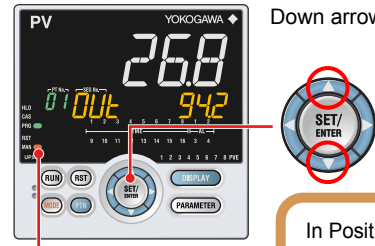

MAN lamp is lit.

In Position proportional control:  
Up arrow key; opens the valve.  
Down arrow key; closes the valve.  
Output; only while pressing a key.  
OUT; valve opening (0-100%)

Output manipulation in Position proportional control is not restricted from output limiters (OH, OL).

### Manual operation in Heating/cooling control



Heating-side control output

Symbol of heating side

Cooling-side control output

Symbol of cooling side

Program pattern (PTNO.) number

Up arrow key: concurrently decreases cooling-side control output and increases heating-side control output.

Down arrow key: concurrently increases cooling-side control output and decreases heating-side control output.

(Either none of the heating-side and cooling-side outputs are presented, or both of them are presented according to the dead band setting.)

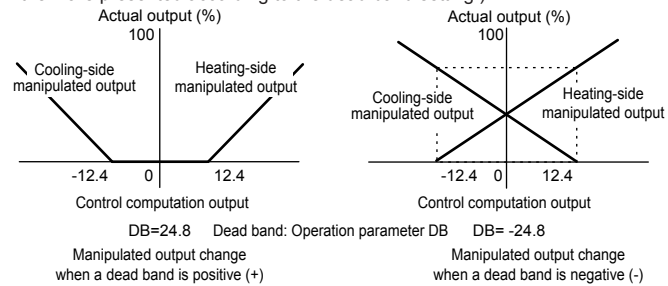

## 7. Enabling/Disabling Hold Mode of Program Operation

Enabling/disabling hold mode of program operation can be performed during program operation using any of the following: (1) MODE key, (2) Parameter, (3) Contact input, and (4) Communication.

The following shows an example of switching using the MODE key.

1. Show the Operation Display.

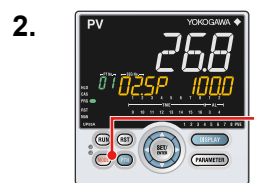

Press the MODE key.

The parameter HOLD (Pause/cancel release of program operation) is displayed (during program operation.)

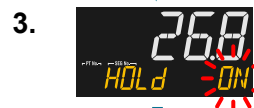

Displays "HOLD ON" in PROG mode.  
Displays "HOLD OFF" in HOLD mode.

Press the SET/ENTER key.

4.

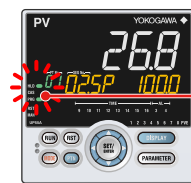

HLD lamp is lit in HOLD mode.

The figure below is displayed while the right arrow key hold down.



The number of segments included in the selected program pattern.  
The segment number for which operation is in progress.

Other operating procedures for disabling the hold mode:

(1) Press the RUN key for 1 second during hold-mode operation. In this case, the controller resumes program operation.

(2) Execute the "Advance" function during hold-mode operation. In this case, the segment is advanced.

## 8. Changing Program Setpoints when in Hold Mode

The following operating procedures changes a program setpoint of soak segment during Hold-mode operation. The program operation is started when releasing the Hold after changing the program setpoint.

1.

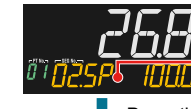

Set program operation in hold mode.

Press the SET/ENTER key.

2.



Blinks during the change.

Press the Up/Down arrow keys to display the required setpoint.

3.



Blinks during the change.

Press the SET/ENTER key.

4.

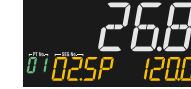

## 9. Executing "Advance" Function

"Advance" can be performed during program operation using any of the following: (1) MODE key, (2) Parameter, (3) Contact input, and (4) Communication.

The following shows an example of switching using the MODE key.

When executing the "Advance" function during hold-mode operation, the hold mode is disabled.

1. Show the Operation Display.

2.

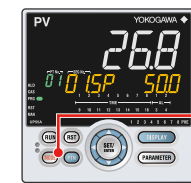

Press the MODE key.

3.



The ADV (Advance of segment) is displayed (during program operation.)

Press the SET/ENTER key.

4.

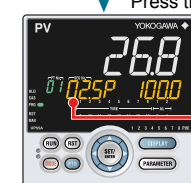

The segment is advanced.

## 10. Switching to Local-mode (LOCAL) Operation

Switching to local-mode can be performed using any of the following:

(1) MODE key (user function key), (2) Parameter, (3) Contact input, and (4) Communication.

The following shows an example of switching using the MODE key.

1. Show the Operation Display.

2.



Press the MODE key several times.

3.



The LOC (local operation) is displayed.

Press the SET/ENTER key.

4.

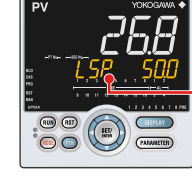

"LSP" is displayed when in local-mode operation.

## 11. Changing Setpoints during Local-mode Operation

The following operating procedures changes setpoints during local-mode operation.

1.



"LSP" is displayed when in local-mode operation

Press the SET/ENTER key.

2.



Blinks during the change.

Press the Up/Down arrow keys to display the required setpoint.

3.



Blinks during the change.

Press the SET/ENTER key.

4.



## 13. Troubleshooting

### Troubleshooting Flow

If the Operation Display does not appear after turning on the controller's power, check the procedures in the following flowchart. If a problem appears to be complicated, contact our sales representatives.

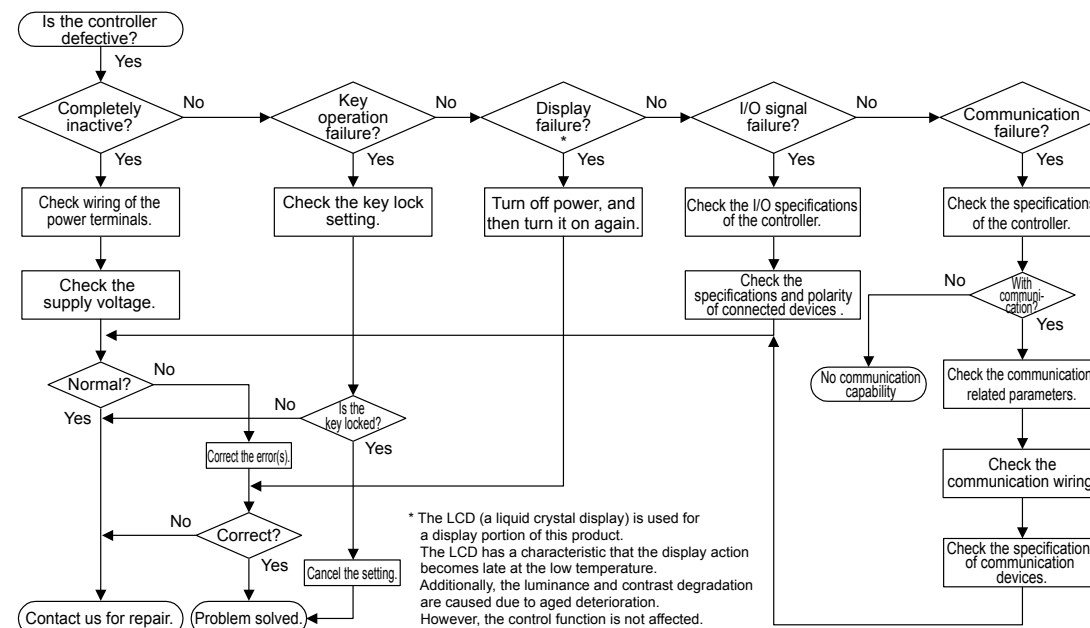

### Remedies if Power Failure Occurs during Operations

- Instantaneous power failure within 20 ms. A power failure is not detected. Normal operation continues.
- Power failure for less than about 5 seconds, or for about 5 seconds or more. Affects the "settings" and "operation status." For details, see User's Manual (CD-ROM).

### NOTE

Write down the settings of parameters for a repair request.

### For the Errors at Power On and the Errors during Operation, see "Installation" in this manual.



**Parameters**

This operation guide describes the functions of parameters briefly. The parameter symbols listed are in the order shown on the display in each group of menu symbols. In addition, each parameter table has a "User Setting" column, where you can record your setpoints when setting them in the controller. The scrolling guide is displayed on PV display in the Parameter Setting Display. This guide can be turned on/off with the MODE key.

**Operation Parameters / Program Parameters**

Hold down the PARAMETER key for 3 seconds to move from the Operation Display to the Operation Parameter Setting Display. Press the DISPLAY key once to return to the Operation Display.

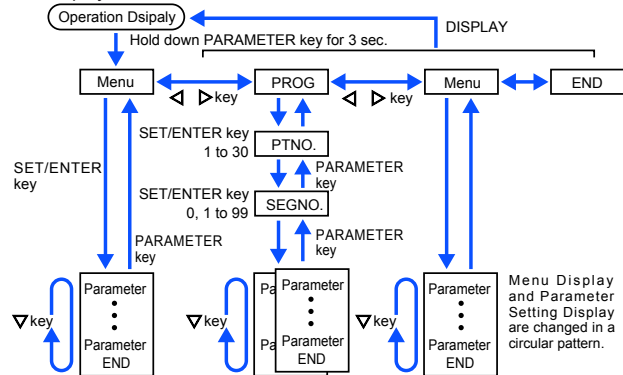

The parameter groups can be switched using ◀ ▶ keys. Move to the Setup Parameter Setting Display: Hold down the PARAMETER key and the Left arrow key simultaneously for 3 sec.

**Operation for Setting**

- To select the parameter setting displayed as the initial value, press the Down arrow key to move to the next parameter.
- To change and set the parameter setting, press the SET/ENTER key to start the setpoint blinking. The blinking state allows you to make changes (setting mode). Use the Up/Down/Left/Right arrow keys to change the setpoint. Press the SET/ENTER key to register the setting.

Note that there are some parameters which are not displayed depending on the Model and Suffix codes, control mode (CTLM), control type (CNT), etc. The parameters for professional setting mode (LEVL: PRO) are not described in this manual. See User's Manual.

**Operation Mode**

Parameter symbol	Name of Parameter	Setting Range	Initial value	User setting	Display level
<i>HOLD</i> (HOLD)	Pause/cancel release of program operation	Display during program operation. ON: Pause OFF: Cancel release (Program operation restart)	OFF		
<i>ADV</i> (ADV)	Advance of segment	Display during program operation. Set as "ADV = ON" to advance from the current segment to the next segment.	OFF		
<i>MODE</i> (MODE)	Operation mode	RESET: Stop of program operation PROG: Start of program operation LOCAL: Start of local-mode operation REM: Start of remote-mode operation	RESET		
<i>AM</i> (A.M)	AUTO/MAN switch	AUTO: Automatic mode MAN: Manual mode	MAN		
<i>PTNO.</i> (PTNO.)	Program pattern number selection	0: Not select program pattern 1 to 30	0		
<i>SST</i> (SST)	Start-of-program segment number	1 to 99 The setting value returns to "1" when the program operation (PROG) changes into RESET, LOCAL, or REM.	1		EASY
<i>PFWd</i> (P.FWD)	Fast-forwarding of program operation	1: Normal, 2: Twice, 5: Five times, 10: Ten times * Use this function when checking the program pattern setting. Only Segment time and Time event can be faster. * The operation returns to the normal speed after fast-forwarding.	1		
<i>AT</i> (AT)	AUTO-tuning switch	OFF: Disable 1 to 8: Perform auto-tuning. Tuning result is stored in the specified numbered PID. R: Tuning result is stored in the PID for reference deviation.	OFF		
<i>PI d</i> (PID)	PID number	The PID group number being selected is displayed. 1 to 8, R: PID group for reference deviation	1		

**SELECT Parameter**

Parameter symbol	Name of Parameter	Setting Range	Initial value	User setting	Display level
Registered parameter symbol	SELECT parameter 10 to 19	Setting range of a registered parameter. For details, see User's Manual (CD-ROM).	—	Table below	EASY
Parameter CSn	n=10 n=11 n=12 n=13 n=14 n=15 n=16 n=17 n=18 n=19				

For the registration of SELECT parameters, see User's Manual (CD-ROM).

**Program Setting Parameter**

Parameter symbol	Name of Parameter	Setting Range	Initial value	User setting	Display level
<i>SSP</i> (SSP)	Starting target setpoint	0.0 to 100.0% of PV input range (EU) (Setting range: P.RL to P.RH)	P.RL		EASY
<i>STC</i> (STC)	Start code	SSP: Program operation begins with the starting target setpoint. RAMP: Ramp-prioritized PV start TIME: Time-prioritized PV start LSP: Local-mode start RSP: Remote-mode start * STC=TIME cannot be selected when the parameter SEG.T is TM.RT.	SSP		
<i>WT.SW1</i> to <i>WT.SW5</i> (WT.SW1 to WT.SW5)	Wait function ON/OFF 1 to 5	OFF: Disable ON: Enable	OFF		
<i>WZ.UP1</i> to <i>WZ.UP5</i> (WZ.UP1 to WZ.UP5)	Upper-side wait zone 1 to 5	0.0 to 10.0% of PV input range (EU)	0.5% of PV input range		
<i>WZ.LO1</i> to <i>WZ.LO5</i> (WZ.LO1 to WZ.LO5)	Lower-side wait zone 1 to 5	0.0 to 10.0% of PV input range (EU)	0.5% of PV input range		
<i>WT.TM1</i> to <i>WT.TM5</i> (WT.TM1 to WT.TM5)	Wait time 1 to 5	OFF: No function 0.00 to 999.59 ("hour.minute" or "minute.second") * Available only for the wait time at the segment switching. * Use the parameter TMU to set the time unit. (Common in the instrument.)	OFF		STD
<i>RCYCL</i> (R.CYCL)	Number of repeat cycles	0 to 999, CONT (limitless number of times)	0		
<i>RSTRT</i> (R.STRT)	Repeat cycle start segment number	1 to 99 1 ≤ R.STRT ≤ R.END ≤ 99	1		
<i>REND</i> (R.END)	Repeat cycle end segment number	1 to 99 1 ≤ R.END ≤ 99	1		

When the program pattern-2 retransmission is selected (PT2.G=ON), the second loop is also displayed for the parameter SSP. (LP2 lamp is lit.) Wait-function-related parameters are displayed in order of the 1st group (WT.SW1, WT.TM1, WZ.UP1, Z.LO1), the 2nd group, the 3rd group, and so on.

**Program Setting Parameter**

Parameter symbol	Name of Parameter	Setting Range	Initial value	User setting	Display level
<i>TSP</i> (TSP)	Final target setpoint	0.0 to 100.0% of PV input range (EU) (Setting range: P.RL to P.RH)	P.RL		
<i>TIME</i> (TIME)	Segment time setting	--: Unregistered 0.00 to 999.59 ("hour.minute" or "minute.second") * Setting available for the parameter SEG.T=TIME. * Use the parameter TMU to set the time unit. (Common in the instrument.) * If the setting is 0.00, TSP changes in stepwise after one control period.	-		
<i>TMRT</i> (TM.RT)	Segment ramp-rate setting	--: Unregistered Ramp: 0.0 to 100.0% of PV input range span (EUS) / 1 hour or 1 minute Soak: 0.00 to 999.59 ("hour.minute" or "minute.second") * Setting available for the parameter SEG.T=TM.RT * Use the parameter TMU to set the time unit. (Common in the instrument.) Per 1 hour: TMU=HH.MM, Per 1 minute: TMU=MM.SS * If it is set to 0.0% of the input range span, or the segment time 0.00, the program moves to the next segment after one control period.	-		EASY
<i>SPI d</i> (S.PID)	Segment PID number selection	1 to 8 * PID number can be set when the parameter "ZON = 0."	1		
<i>JC</i> (JC)	Junction code	CONT: Switching for continuation HOLD: Hold-on switching (the controller holds the end-of-segment setpoint when the segment is completed, to perform control). LOCAL: Local-mode switching (the controller switches to a local setpoint when the segment is completed). REM: Remote-mode switching (the controller switches to a remote setpoint when the segment is completed). W.SW1 to W.SW5: Wait during switching between segments. W.V1 to W.V5: Wait within a segment interval. W.SL1 to W.SL5: Segment switching (the controller switches to a local setpoint when the segment is completed after release.) (5 groups) W.SR1 to W.SR5: Segment switching (the controller switches to a remote setpoint when the segment is completed after release.) (5 groups) PLK.1 to PLK.30: Linked to patterns 1 to 30. INS.: Allows a segment to be added to the end of a specified segment. DEL.: Allows a specified segment to be deleted.	CONT		STD

When the program pattern-2 retransmission is selected (PT2.G=ON), the second loop is also displayed for the parameter SSP. (LP2 lamp is lit.)

**Program Setting Parameter**

Parameter symbol	Name of Parameter	Setting Range	Initial value	User setting	Display level
<i>PV.TY1</i> to <i>PV.TY8</i> (PV.TY1 to PV.TY8)	PV event-1 to -8 type	OFF: Disable (Energized) 1: PV high limit, 2: PV low limit, 3: SP high limit, 4: SP low limit, 5: Deviation high limit, 6: Deviation low limit, 7: Deviation high and low limits, 8: Deviation within high and low limits, 9: Target SP high limit, 10: Target SP low limit, 11: Target SP deviation high limit, 12: Target SP deviation low limit, 13: Target SP deviation high and low limits, 14: Target SP deviation within high and low limits, 15: OUT high limit, 16: OUT low limit, 17: Cooling-side OUT high limit, 18: Cooling-side OUT low limit * Add 100 for "de-energized". For example, when the PV high limit is de-energized, the setting is 101.	OFF		See "Programming" in this manual.
<i>PV.EV1</i> to <i>PV.EV8</i> (PV.EV1 to PV.EV8)	PV event-1 to -8 setpoint	Set a display value of setpoint of PV alarm, SP alarm, deviation alarm, or output alarm. -19999 to 30000 (Set a value within the input range.) Decimal point position depends on the input type.	0		STD
<i>TME1</i> to <i>TME16</i> (TME1 to TME16)	Start condition of time event 1 to 16	ON: Start ON state OFF: Start OFF state	OFF		
<i>T.ON1</i> to <i>T.OF16</i> (T.ON1 to T.OF16)	On time of time event 1 to 16	--: Unregistered 0.01 to 999.59 ("hour.minute" or "minute.second") * Available only within the segment time. * OFF when the operation mode is changed to the mode except the program operation. * Use the parameter TMU to set the time unit. (Common in the instrument.)	-		
<i>T.OF1</i> to <i>T.OF16</i> (T.OF1 to T.OF16)	Off time of time event 1 to 16	0.01 to 999.59 ("hour.minute" or "minute.second") * Available only within the segment time. * OFF when the operation mode is changed to the mode except the program operation. * Use the parameter TMU to set the time unit. (Common in the instrument.)	-		

PV event and Time event are available only during the program operation. PV event parameters are displayed in order of PV event 1 (PV.TY1, PV.EV1), PV event 2, PV event 3, and so on. Time event parameters are displayed in order of Time event 1 (TME1, T.ON1, T.OF1), Time event 2, Time event 3, and so on.

**Local Setting Parameter**

Parameter symbol	Name of Parameter	Setting Range	Initial value	User setting	Display level
<i>LSP</i> (LSP)	Local target setpoint	0.0 to 100.0% of PV input range (EU) (Setting range: P.RL to P.RH)	P.RL		
<i>L.PID</i> (L.PID)	PID number selection for local-mode operation	Set a PID group number to use. 1 to 8 * Available only for the L.PID when ZON = 0 or 5. * If set to "Local PID selection," local PID is selected irrespective of the operation modes.	1		EASY
<i>L.TY1</i> to <i>L.TY8</i> (L.TY1 to L.TY8)	Local event-1 to -8 type	OFF: Disable (Energized) 1: PV high limit, 2: PV low limit, 3: SP high limit, 4: SP low limit, 5: Deviation high limit, 6: Deviation low limit, 7: Deviation high and low limits, 8: Deviation within high and low limits, 9: Target SP high limit, 10: Target SP low limit, 11: Target SP deviation high limit, 12: Target SP deviation low limit, 13: Target SP deviation high and low limits, 14: Target SP deviation within high and low limits, 15: OUT high limit, 16: OUT low limit, 17: Cooling-side OUT high limit, 18: Cooling-side OUT low limit * Add 100 for "de-energized". For example, when the PV high limit is de-energized, the setting is 101.	OFF		STD
<i>LEV1</i> to <i>LEV8</i> (L.EV1 to L.EV8)	Local event-1 to -8 setpoint	Set a display value of setpoint of PV alarm, SP alarm, deviation alarm, or output alarm. -19999 to 30000 (Set a value within the input range.) Decimal point position depends on the input type	0		

When the program pattern-2 retransmission is selected (PT2.G=ON), the second loop is also displayed for the parameter LSP. (LP2 lamp is lit.) Local event parameters are displayed in order of Local event 1 (L.TY1, L.EV1), Local event 2, Local event 3, and so on. The parameters for professional setting mode (LEVL: PRO) is not described in this manual. See User's Manual.

**Alarm Setpoint Setting Parameter**

Parameter symbol	Name of Parameter	Setting Range	Initial value	User setting	Display level
<i>AL1</i> to <i>AL8</i> (A1 to A8)	Alarm-1 to -8 setpoint	These alarms work irrespective of the operation mode. Set a display value of setpoint of PV alarm, SP alarm, deviation alarm, output alarm, or velocity alarm. -19999 to 30000 (Set a value within the input range.) Decimal point position depends on the input type	0	Table below	EASY

Use the following table to record SP and alarm setpoints.

Parameter	n=1	n=2	n=3	n=4	n=5	n=6	n=7	n=8
An								

**SP-related Setting Parameter**

Parameter symbol	Name of Parameter	Setting Range	Initial value	User setting	Display level
<i>RMS</i> (RMS)	Remote input method	RSP: Via remote (auxiliary analog) input COM: Via communication	RSP		
<i>RFL</i> (RFL)	Remote input filter	OFF, 1 to 120 s	OFF		
<i>RT</i> (RT)	Remote input ratio	SP = Remote input x RT + Remote input bias 0.001 to 9.999	1.000		
<i>RBS</i> (RBS)	Remote input bias	-100.0 to 100.0% of PV input range span (EUS)	0.0 % of PV input range span		
<i>SPT</i> (SPT)	SP tracking selection	Tracking is performed when the mode changes from Program or Remote to Local. (The local setpoint keeps track of the program or remote setpoint.) OFF, ON	OFF		STD
<i>S.TM</i> (S.TM)	Starting time of program operation	0.00 to 999.59 ("hour.minute" or "minute.second" (common use of instrument)) * Use the parameter TMU to set the time unit.	0.00		
<i>PNC</i> (PNC)	Program pattern number clearance	OFF: Not cleared. ON: Cleared. (Set the program No. before restart program operation) * The controller resets (clears) the program pattern number on the operating display to "0" at the end of program operation.	OFF		

**Alarm Function Setting Parameter**

Parameter symbol	Name of Parameter	Setting Range	Initial value	User setting	Display level
<i>EHY1</i> to <i>EHY8</i> (EHY1 to EHY8)	Event-1 to -8 hysteresis	The hysteresis setpoint of PV event or Local event is set to the percentage of 0.0 to 100.0%. The setting value (%) is for the PV input range span or output span.	0.5		STD
<i>AL1</i> to <i>AL8</i> (AL1 to AL8)	Alarm-1 to -8 type	These alarms work irrespective of the operation mode. Set a 5-digit value in the following order. [Alarm type: 2 digits (see below)] + [Without (0) or With (1) Stand-by action] + [Energized (0) or De-energized (1)] + [Latch action (0/1/2/3/4)] For latch action, see User's Manual (CD-ROM). Alarm type: 2 digits 00: Disable 01: PV high limit 02: PV low limit 03: SP high limit 04: SP low limit 05: Deviation high limit 06: Deviation low limit 07: Deviation high and low limits 08: Deviation within high and low limits 09: Target SP high limit 10: Target SP low limit 11: Target SP deviation high limit 12: Target SP deviation low limit 13: Target SP deviation high and low limits 14: Target SP deviation within high and low limits 15: OUT high limit 16: OUT low limit 17: Cooling-side OUT high limit 18: Cooling-side OUT low limit 19: Analog input PV high limit 20: Analog input PV low limit 21: Analog input RSP high limit 22: Analog input RSP low limit 23: Analog input AIN2 high limit 24: Analog input AIN2 low limit 25: Analog input AIN4 high limit 26: Analog input AIN4 low limit 27: Feedback input high limit 28: Feedback input low limit 29: PV velocity 30: Fault diagnosis 31: FAIL	00000		EASY
<i>VT1</i> to <i>VT8</i> (VT1 to VT8)	PV velocity alarm time setpoint 1 to 8	0.01 to 99.59 (minute.second)	1.00		
<i>HY1</i> to <i>HY8</i> (HY1 to HY8)	Alarm-1 to -8 hysteresis	Set a display value of setpoint of hysteresis. -19999 to 30000 (Set a value within the input range.) Decimal point position depends on the input type. When the decimal point position for the input type is set to "1", the initial value of the hysteresis is "1.0".	10		
<i>DYN1</i> to <i>DYN8</i> (DYN1 to DYN8)	Alarm-1 to -8 On-delay timer	An alarm output is ON when the delay timer expires after the alarm setpoint is reached. 0.00 to 99.59 (minute.second)	0.00		STD
<i>AMD</i> (AMD)	Alarm mode	0: Always active 1: Not active in RESET mode 2: Not active in RESET or MAN mode	0		

For the alarm function setting parameter, 4 alarms are displayed for the factory default. The number of alarms can be changed by the setup parameter ALNO. (number of alarms). To change the number of alarms, see User's Manual (CD-ROM).

Parameter	n=1	n=2	n=3	n=4	n=5	n=6	n=7	n=8
EHyN								
ALn								
VTn								
HYn								
DYNn								

n: alarm number

## PV-related Setting Parameter

Menu symbol: *PVS* (PVS)

Parameter symbol	Name of Parameter	Setting Range	Initial value	User setting	Display level
<i>bS</i> (BS)	PV input bias	-100.0 to 100.0% of PV input range span (EUS)	0.0 % of PV input range span		EASY
<i>FL</i> (FL)	PV input filter	OFF, 1 to 120 s	OFF		

## PID Setting Parameter

Menu symbol: *PI d* (PID)

Parameter symbol	Name of Parameter	Setting Range	Initial value	User setting	Display level
<i>P</i> (P)	Proportional band Heating-side proportional band (in Heating/cooling control)	0.0 to 999.9% When 0.0% is set, it operates as 0.1%. Heating-side ON/OFF control applies when 0.0% in Heating/cooling control	5.0%		
<i>I</i> (I)	Integral time Heating-side integral time (in Heating/cooling control)	OFF: Disable 1 to 6000 s	240 s		
<i>d</i> (D)	Derivative time Heating-side derivative time (in Heating/cooling control)	OFF: Disable 1 to 6000 s	60 s		
<i>OH</i> (OH)	Control output high limit Heating-side control output high limit (in Heating/cooling control)	-4.9 to 105.0%, (OL<OH) In Heating/cooling control: 0.1 to 105.0% (OL<OH)	100.0%		
<i>OL</i> (OL)	Control output low limit Heating-side control output low limit (in Heating/cooling control)	-5.0 to 104.9%, (OL<OH), SD: Tight shut In Heating/cooling control: 0.0 to 104.9% (OL<OH)	0.0%		
<i>MR</i> (MR)	Manual reset	Enabled when integral time is OFF. The manual reset value equals the output value when PV = SP. -5.0 to 105.0%	50.0%		
<i>HYS</i> (HYS)	Hysteresis (in ON/OFF control or Position proportional control) Heating-side ON/OFF control hysteresis (in Heating/cooling control)	In ON/OFF control: 0.0 to 100.0% of PV input range span (EUS) In Heating/cooling control or Position proportional control: 0.0 to 100.0%	In ON/OFF control: 0.5 % of PV input range span In Heating/cooling control or Position proportional control: 0.5 %		EASY
<i>HYUP</i> (HYUP)	Upper-side hysteresis (in ON/OFF control)	0.0 to 100.0% of PV input range span (EUS)	0.5 % of PV input range span		
<i>HYLO</i> (HYLO)	Lower-side hysteresis (in ON/OFF control)		0.5 % of PV input range span		
<i>dR</i> (DR)	Direct/reverse action switch	RVS: Reverse action DIR: Direct action	RVS		STD
<i>Pc</i> (Pc)	Cooling-side proportional band	0.0 to 999.9% (Cooling-side ON/OFF control applies when 0.0% in Heating/cooling control)	5.0%		
<i>Ic</i> (Ic)	Cooling-side integral time	OFF: Disable 1 to 6000 s	240 s		
<i>dc</i> (Dc)	Cooling-side derivative time	OFF: Disable 1 to 6000 s	60 s		
<i>OHc</i> (OHc)	Cooling-side control output high limit	0.1 to 105.0%, (OLc<OHc)	100.0%		EASY
<i>OLc</i> (OLc)	Cooling-side control output low limit	0.0 to 104.9%, (OLc<OHc)	0.0%		
<i>HYSc</i> (HYSc)	Cooling-side ON/OFF control hysteresis	0.0 to 100.0%	0.5%		
<i>db</i> (DB)	Output dead band (in Heating/cooling control or Position proportional control)	In Heating/cooling control: -100.0 to 50.0% In Position proportional control: 1.0 to 10.0%	3.0%		

<i>PO</i> (PO)	Preset output Heating-side preset output (in Heating/cooling control)	In RESET mode, fixed control output can be generated. In Position proportional control, Valve opening can be set: -5.0 to 105.0%	0.0%		EASY
<i>POc</i> (POc)	Cooling-side preset output	In RESET mode, cooling-side fixed control output can be generated. -5.0 to 105.0%	0.0%		

If you are using two or more groups of PID parameters, use the following table to record their setting values.

Parameter	n=2	n=3	n=4	n=5	n=6	n=7	n=8	R
P								
I								
D								
OH								
OL								
MR								
HYS								
HYUP								
HYLO								
DR								
Pc								
Ic								
Dc								
OHc								
OLc								
HYSc								
DB								
PO								
POc								

n: group number

## Tuning Parameter

Menu symbol: *TUNE* (TUNE)

Parameter symbol	Name of Parameter	Setting Range	Initial value	User setting	Display level
<i>SC</i> (SC)	Super function	OFF: Disable 1: Overshoot suppressing function (normal mode) 2: Hunting suppressing function (stable mode) Enables to answer the wider characteristic changes compared with response mode. 3: Hunting suppressing function (response mode) Enables quick follow-up and short converging time of PV for the changed SP. 4: Overshoot suppressing function (strong suppressing mode) Note: Setpoints 2 and 3 must be used in PID control or PI control. Disabled in the following controls: 1) ON/OFF control, 2) PD control, 3) P control, 4) Heating/cooling control. Do not use the function for the control processes with response such as flow or pressure control.		OFF	EASY
<i>ALTY</i> (AT.TY)	Auto-tuning type	0: Normal 1: Stability	0		STD
<i>AR</i> (AR)	Anti-reset windup (excess integration prevention)	AUTO, 50.0 to 200.0%	AUTO		
<i>OPR</i> (OPR)	Output velocity limiter	OFF: Disable 0.1 to 100.0%/s	OFF		
<i>MPOn</i> (MPOn)	Manual preset output number selection	Select the output used in MAN mode when switched from AUTO to MAN mode. OFF: Hold the control output in AUTO mode (bumpless) 1: Use manual preset output 1 (output bump) 2: Use manual preset output 2 (output bump) 3: Use manual preset output 3 (output bump) 4: Use manual preset output 4 (output bump) 5: Use manual preset output 5 (output bump)	OFF		STD
<i>MPO1</i> to <i>MPO5</i> (MPO1 to MPO5)	Manual preset output 1 to 5	-5.0 to 105.0% However, output is limited to the output high limit and low limit.	0.0%	Table below	

Use the following table to record the manual preset output setting value.

Parameter	n=1	n=2	n=3	n=4	n=5
MPOn					

## Zone Control Parameter

Menu symbol: *ZONE* (ZONE)

Parameter symbol	Name of Parameter	Setting Range	Initial value	User setting	Display level
<i>RP1</i> to <i>RP7</i> (RP1 to RP7)	Reference point 1 to 7	Set reference points at which switching is carried out between groups of PID constants according to the given temperature zone. 0.0 to 100.0% of PV input range (EU) (RP1 ≤ RP2 ≤ RP3 ≤ RP4 ≤ RP5 ≤ RP6 ≤ RP7)	100.0% of PV input range	Table below	STD
<i>RHY</i> (RHY)	Zone PID switching hysteresis	Hysteresis can be set for switching at a reference point. 0.0 to 10.0% of PV input range span (EUS)	0.5 % of PV input range span		STD

<i>RDV</i> (RDV)	Reference deviation	Set a deviation from SP. The PID for reference deviation is used if there is a larger deviation than the preset reference deviation. OFF: Disable 0.0 + 1 digit to 100.0% of PV input range span (EUS)	OFF		STD
------------------	---------------------	--	-----	--	-----

For Zone control, set the setup parameter ZON (zone PID selection) to Zone PID selection. Use the following table to record the reference point setting value.

Parameter	n=1	n=2	n=3	n=4	n=5	n=6	n=7
RPn							

## P Parameter (for Ladder Program)

Menu symbol: *PPAR* (PPAR)

Parameter symbol	Name of Parameter	Setting Range	Initial value	User setting	Display level					
<i>PO1</i> to <i>PI0</i> (PO1 to PI0)	P01 to P10 parameter	-19999 to 30000 (Set a decimal point position using LL50A Parameter Setting Software.)	0	Table below	STD					
Parameter	n=01	n=02	n=03	n=04	n=05	n=06	n=07	n=08	n=09	n=10
Pn										

## 10-segment Linearizer-1, -2 Setting Parameter

Menu symbol: *PYS1* (PYS1) *PYS2* (PYS2)

Parameter symbol	Name of Parameter	Setting Range	Initial value	User setting	Display level
<i>PYS</i> (PYS)	10-segment linearizer selection	OFF: Disable PV: PV analog input RSP: RSP analog input AIN2: AIN2 analog input AIN4: AIN4 analog input PVIN: PV input OUT: OUT analog output OUT2: OUT2 analog output RET: RET analog output	PV (CTL: SGL)		
<i>A1</i> (A1)	10-segment linearizer input 1	-66.7 to 105.0% of input range (EU) Output linearizer: -5.0 to 105.0%	0.0%		
<i>b1</i> (B1)	10-segment linearizer output 1	10-segment linearizer bias: -66.7 to 105.0% of input range span (EUS) 10-segment linearizer approximation: -66.7 to 105.0% of input range (EU) Output linearizer: -5.0 to 105.0%	0.0%		STD
<i>A2</i> to <i>A11</i> , <i>b2</i> to <i>b11</i> (A2 to A11, B2 to B11)	10-segment linearizer input 2 to 11 10-segment linearizer output 2 to 11	Same as A1 and B1	Same as A1 and B1		
<i>PMD</i> (PMD)	10-segment linearizer mode	0: 10-segment linearizer bias 1: 10-segment linearizer approximation	0		

Use the following table to record the 10-segment linearizer input and output setting values.

Parameter	n=2	n=3	n=4	n=5	n=6	n=7	n=8	n=9	n=10	n=11
An										
Bn										

## Setup Parameters

Hold down the PARAMETER key and Left arrow key simultaneously for 3 seconds to move from the Operation Display or Operation Parameter Setting Display to the Setup Parameter Setting Display.

Press the DISPLAY key once to return to the Operation Display.

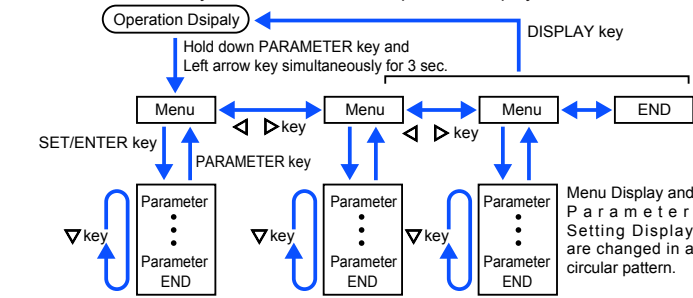

Move to the Operation Parameter Setting Display: Hold down the PARAMETER key for 3 sec.

## Operation for Setting

- To select the parameter setting displayed as the initial value, press the Down arrow key to move to the next parameter.
- To change and set the parameter setting, press the SET/ENTER key to start the set-point blinking. The blinking state allows you to make changes (setting mode). Use the Up/Down/Left/Right arrow keys to change the setpoint. Press the SET/ENTER key to register the setting.

Note that there are some parameters which are not displayed depending on the Model and Suffix codes, control mode (CTL), control type (CNT), etc. The parameters for professional setting mode (LEVL: PRO) are not described in this manual. See User's Manual.

## Control Function Setting Parameter

Menu symbol: *CTL* (CTL)

Parameter symbol	Name of Parameter	Setting Range	Initial value	User setting	Display level
<i>CTLM</i> (CTLM)	Control mode	When using the controls other than Single-loop control, see User's Manual (CD-ROM). SGL: Single-loop control CAS1: Cascade primary-loop control CAS: Cascade control PVS: Loop control with PV switching PVSEL: Loop control with PV auto-selector			STD
<i>CNT</i> (CNT)	Control type	PID: PID control ONOF: ON/OFF control (1 point of hysteresis) ONOFF2: ON/OFF control (2 points of hysteresis) H/C: Heating/cooling control	PID or H/C (for Heating/Cooling type)		EASY
<i>ZON</i> (ZON)	Zone PID selection	0: Segment PID selection 1: Zone PID selection (selection by PV) 2: Zone PID selection (selection by target SP) 3: Local PID selection * If set to "Segment PID selection," allows PID constants to be selected for each segments. * If set to "Zone PID selection," automatically selects PID constants according to the range set in the Reference point. * If set to "Local PID selection," local PID is selected irrespective of the operation modes.	1		STD
<i>SEGL</i> (SEG.T)	Segment setting method	TIME: Segment time setting TM.RT: Segment ramp-rate setting * Note: A change of setting deletes a program pattern.	TIME		EASY
<i>TMU</i> (TMU)	Program time unit	HH.MM: hour.minute MM.SS: minute.second	HH.MM		
<i>PT2.G</i> (PT2.G)	Program pattern-2 retransmission	ON: used. * The controller can serve as a program pattern generator. * Retransmission output types (RTS, O1RS, or O2RS) need to be set to SP2.	OFF		STD
<i>SMP</i> (SMP)	Input sampling period (control period)	100: 100 ms, 200: 200 ms	200		

## PV Input Setting Parameter

Menu symbol: *PV* (PV)

Parameter symbol	Name of Parameter	Setting Range	Initial value	User setting	Display level
<i>IN</i> (IN)	PV input type	OFF: Disable K1: -270.0 to 1370.0 °C / -450.0 to 2500.0 °F K2: -270.0 to 1000.0 °C / -450.0 to 2300.0 °F K3: -200.0 to 500.0 °C / -200.0 to 1000.0 °F J: -200.0 to 1200.0 °C / -300.0 to 2300.0 °F T1: -270.0 to 400.0 °C / -450.0 to 750.0 °F T2: 0.0 to 400.0 °C / -200.0 to 750.0 °F B: 0.0 to 1800.0 °C / 32 to 3300 °F S: 0.0 to 1700.0 °C / 32 to 3100 °F R: 0.0 to 1700.0 °C / 32 to 3100 °F N: -200.0 to 1300.0 °C / -300.0 to 2400.0 °F E: -270.0 to 1000.0 °C / -450.0 to 1800.0 °F L: -200.0 to 900.0 °C / -300.0 to 1600.0 °F U1: -200.0 to 400.0 °C / -300.0 to 750.0 °F U2: 0.0 to 400.0 °C / -200.0 to 1000.0 °F W: 0.0 to 2300.0 °C / 32 to 4200 °F PL2: 0.0 to 1390.0 °C / 32.0 to 2500.0 °F P2040: 0.0 to 1900.0 °C / 32 to 3400 °F WRE: 0.0 to 2000.0 °C / 32 to 3600 °F JPT1: -200.0 to 500.0 °C / -300.0 to 1000.0 °F JPT2: -150.0 to 150.0 °C / -200.0 to 300.0 °F PT1: -200.0 to 850.0 °C / -300.0 to 1560.0 °F PT2: -200.0 to 500.0 °C / -300.0 to 1000.0 °F PT3: -150.0 to 150.0 °C / -200.0 to 300.0 °F 0.4-2V: 0.400 to 2.000 V 1-5V: 1.000 to 5.000 V 4-20: 4.00 to 20.00 mA 0-2V: 0.000 to 2.000 V 0-10V: 0.00 to 10.00 V 0-20: 0.00 to 20.00 mA -1020: -10.00 to 20.00 mV 0-100: 0.0 to 100.0 mV	OFF		EASY
<i>UNIT</i> (UNIT)	PV input unit	-: No unit, C: Degree Celsius, -: No unit, - - -: No unit, F: Degree Fahrenheit	C		
<i>RH</i> (RH)	Maximum value of PV input range	Depends on the input type. - For temperature input - Set the temperature range that is actually controlled. (RL<RH) - For voltage / current input - Set the range of a voltage / current signal that is applied.			Depends on the input type
<i>RL</i> (RL)	Minimum value of PV input range	The scale across which the voltage / current signal is actually controlled should be set using the maximum value of input scale (SH) and minimum value of input scale (SL). (Input is always 0% when RL = RH.)			Depends on the input type
<i>SDP</i> (SDP)	PV input scale decimal point position	0: No decimal place 1: One decimal place 2: Two decimal places 3: Three decimal places 4: Four decimal places			Depends on the input type



■ PV Input Setting Parameter (Continued)

Parameter symbol	Name of Parameter	Setting Range	Initial value	User setting	Display level
SH (SH)	Maximum value of PV input scale	-19999 to 30000, (SL<SH),  SH - SL  ≤ 30000			EASY
SL (SL)	Minimum value of PV input scale				
bSL (BSL)	PV input burnout action	OFF: Disable UP: Upscale DOWN: Downscale			STD
RbS (ABS)	PV analog input bias	-100.0 to 100.0% of PV input range span (EUS)	0.0 % of PV input range span		
RfL (AFL)	PV analog input filter	OFF, 1 to 120 s	OFF		

W: W-5% Re/W-26% Re(Hoskins Mfg.Co.), ASTM E988, WRE: W97Re3-W75Re25

■ RSP Input Setting Parameter (E1-terminal Area)

Parameter symbol	Name of Parameter	Setting Range	Initial value	User setting	Display level
IN (IN)	RSP remote input type	0.4-2V: 0.400 to 2.000 V 1-5V: 1.000 to 5.000 V 0-2V: 0.000 to 2.000 V 0-10V: 0.00 to 10.00 V 0-125: 0.000 to 1.250 V For option /DR, RSP remote input type is same as PV input type	1-5V		
UNIT (UNIT)	RSP remote input unit	--: No unit, C: Degree Celsius, --: No unit, --: No unit, --: No unit, F: Degree Fahrenheit	C		
RH (RH)	Maximum value of RSP remote input range	Depends on the input type. - For temperature (/DR option) input - Set the temperature range that is actually controlled. (RL<RH) - For voltage / current (/DR option) input - Set the range of a voltage / current signal that is applied.	Depends on the input type		EASY
RL (RL)	Minimum value of RSP remote input range	The scale across which the voltage / current signal is actually controlled should be set using the maximum value of input scale (SH) and minimum value of input scale (SL). (Input is always 0% when RL = RH.)	Depends on the input type		
SDP (SDP)	RSP remote input scale decimal point position	0: No decimal place 1: One decimal place 2: Two decimal places 3: Three decimal places 4: Four decimal places	Depends on the input type		
SH (SH)	Maximum value of RSP remote input scale	-19999 to 30000, (SL<SH),  SH - SL  ≤ 30000	Depends on the input type		
SL (SL)	Minimum value of RSP remote input scale		Depends on the input type		
bSL (BSL)	RSP remote input burn-out action	OFF: Disable UP: Upscale DOWN: Downscale	Depends on the input type		STD
RtdS (RTD.S)	RTD wiring system	3-W: 3-wire system 4-W: 4-wire system (The LL50A Parameter Setting Software is required to use RSP terminals input as PV.)	3-W		

■ AIN2/AIN4 Aux. Analog Input Setting Parameter (E2/E4-terminal Area)

Parameter symbol	Name of Parameter	Setting Range	Initial value	User setting	Display level
IN (IN)	AIN2/AIN4 aux. analog input type	0.4-2 V: 0.400 to 2.000 V 1-5 V: 1.000 to 5.000 V 0-2 V: 0.000 to 2.000 V 0-10 V: 0.00 to 10.00 V 0-125: 0.000 to 1.250 V	1-5 V		
UNIT (UNIT)	AIN2/AIN4 aux. analog input unit	--: No unit C: Degree Celsius --: No unit --: No unit --: No unit F: Degree Fahrenheit	C		
RH (RH)	Maximum value of AIN2/AIN4 aux. analog input range	Depends on the input type. Set the range of a voltage signal that is applied.	Depends on the input type		EASY
RL (RL)	Minimum value of AIN2/AIN4 aux. analog input range	The scale across which the voltage signal is actually controlled should be set using the maximum value of input scale (SH) and minimum value of input scale (SL). (Input is always 0% when RL = RH.)	Depends on the input type		
SDP (SDP)	AIN2/AIN4 aux. analog input scale decimal point position	0: No decimal place 1: One decimal place 2: Two decimal places 3: Three decimal places 4: Four decimal places	Depends on the input type		
SH (SH)	Maximum value of AIN2/AIN4 aux. analog input scale	-19999 to 30000, (SL<SH),  SH - SL  ≤ 30000	Depends on the input type		
SL (SL)	Minimum value of AIN2/AIN4 aux. analog input scale		Depends on the input type		
bSL (BSL)	AIN2/AIN4 aux. analog input burnout action	OFF: Disable UP: Upscale DOWN: Downscale	Depends on the input type		STD

■ Input Range, SP Limiter Setting Parameter

Parameter symbol	Name of Parameter	Setting Range	Initial value	User setting	Display level
PUNI (PUNI)	Control PV input unit	--: No unit C: Degree Celsius --: No unit, --: No unit, --: No unit F: Degree Fahrenheit	Same as PV input unit		STD
PdP (PDP)	Control PV input decimal point position	0: No decimal place 1: One decimal place 2: Two decimal places 3: Three decimal places 4: Four decimal places	1		
PRH (PRH)	Maximum value of control PV input range	-19999 to 30000, (PRL<PRH),  PRH - PRL  ≤ 30000	Depends on the input type		
PRL (PRL)	Minimum value of control PV input range		Depends on the input type		
SPH (SPH)	SP high limit	0.0 to 100.0% of PV input range (EU), (SPL<SPH) Place limits on the program setpoints or the local setpoints when the controller is in program operation. * Places the limit on the program setpoint, local setpoint, or remote setpoint during program operation. * When LP2 lamp is on, SPH and SPL limit the program setpoint for program pattern 2 retransmission.	100.0 % of PV input range		
SPL (SPL)	SP low limit		0.0 % of PV input range		

■ Output Setting Parameter

Parameter symbol	Name of Parameter	Setting Range	Initial value	User setting	Display level
OT (OT)	Output type selection	Control output or Heating-side control output (Lower two digits) 00: OFF 01: OUT terminals (voltage pulse) 02: OUT terminals (current) 03: OUT terminals (relay) 04: OUT2 terminals (voltage pulse) 05: OUT2 terminals (current) 06: OUT2 terminals (relay) Cooling-side control output (Upper two digits) 00: OFF 01: OUT terminals (voltage pulse) 02: OUT terminals (current) 03: OUT terminals (relay) 04: OUT2 terminals (voltage pulse) 05: OUT2 terminals (current) 06: OUT2 terminals (relay)	Standard type: 00.03 Heating/cooling type: 06.03		EASY
CT (CT)	Control output cycle time Heating-side control output cycle time (in Heating/cooling control)	0.5 to 1000.0 s	30.0 s		
CTc (CTc)	Cooling-side control output cycle time		30.0 s		
VAT (VAT)	Automatic valve position adjustment	OFF: Stop automatic adjustment ON: Start automatic adjustment	OFF		
VRS (VRS)	Valve position setting reset	Setting V.RS to ON resets the valve adjustment settings and causes the indication "V.RS" to blink.	OFF		
V.L (V.L)	Fully-closed valve position setting	Pressing the SET/ENTER key with valve position set to the fully-closed position by Down arrow key causes the adjusted value to be stored. When V.L adjustment is completed, V.L stops blinking.	-		
V.H (V.H)	Fully-opened valve position setting	Pressing the SET/ENTER key with valve position set to the fully-opened position by Up arrow key causes the adjusted value to be stored. When V.H adjustment is completed, V.H stops blinking.	-		
TRT (TR.T)	Valve traveling time	5 to 300 s	60 s		STD
VMOD (V.MOD)	Valve adjusting mode	0: Valve position feedback type 1: Valve position feedback type (moves to the estimating type if a feedback input error or break occurs.) 2: Valve position estimating type	0		
RTS (RTS)	Retransmission output type of RET	OFF: Disable PV1: PV SP1: SP OUT1: OUT (Valve opening: 0 to 100 % in Position proportional control) LPS: 15 V DC loop power supply PV2: Loop-2 PV SP2: Loop-2 SP OUT2: Loop-2 OUT TSP1: Target SP COUT1: Heating-side OUT HOUT1: Cooling-side OUT MV1: Position proportional output (internal computed value) TSP2: Loop-2 target SP HOUT2: Loop-2 heating-side OUT COUT2: Loop-2 cooling-side OUT MV2: Loop-2 position proportional output (internal computed value) PV: PV terminals analog input RSP: RSP terminals analog input AIN2: AIN2 terminals analog input AIN4: AIN4 terminals analog input * Loop-2 setting values are unavailable in Single-loop control.	PV1		EASY

REH (RTH)	Maximum value of retransmission output scale of RET	When RTS = PV1, SP1, PV2, SP2, TSP1, TSP2, PV, RSP, AIN2, or AIN4, RTL + 1 digit to 30000 -19999 to RTH - 1 digit Decimal point position: When RTS=PV1, SP1, or TSP1, decimal point position is same as that of PV input. When RTS=PV2, SP2, or TSP2, decimal point position is same as that of RSP input.	100 % of PV input range		STD
REL (RTL)	Minimum value of retransmission output scale of RET	When RTS=PV, decimal point position is same as that of PV input scale. When RTS=RSP, decimal point position is same as that of RSP input scale. When RTS=AIN2, decimal point position is same as that of AIN2 scale. When RTS=AIN4, decimal point position is same as that of AIN4 scale.	0 % of PV input range		
OIRS (O1RS)	Retransmission output type of OUT current output	Same as RTS	OFF		
OIRH (O1RH)	Maximum value of retransmission output scale of OUT current output	When O1RS = PV1, SP1, PV2, SP2, TSP1, TSP2, PV, RSP, AIN2, or AIN4, O1RL + 1 digit to 30000 -19999 to O1RH - 1 digit Decimal point position: When O1RS=PV1, SP1, or TSP1, decimal point position is same as that of PV input. When O1RS =PV2, SP2, or TSP2, decimal point position is same as that of RSP input. When O1RS =PV, decimal point position is same as that of PV input scale.	-		STD
OIRL (O1RL)	Minimum value of retransmission output scale of OUT current output	When O1RS =RSP, decimal point position is same as that of RSP input scale. When O1RS =AIN2, decimal point position is same as that of AIN2 scale. When O1RS =AIN4, decimal point position is same as that of AIN4 scale.	-		
O2RS (O2RS)	Retransmission output type of OUT2 current output	Same as RTS	OFF		
O2RH (O2RH)	Maximum value of retransmission output scale of OUT2 current output	When O2RS = PV1, SP1, PV2, SP2, TSP1, TSP2, PV, RSP, AIN2, or AIN4, O2RL + 1 digit to 30000 -19999 to O2RH - 1 digit Decimal point position: When O2RS=PV1, SP1, or TSP1, decimal point position is same as that of PV input. When O2RS =PV2, SP2, or TSP2, decimal point position is same as that of RSP input. When O2RS =PV, decimal point position is same as that of PV input scale.	-		STD
O2RL (O2RL)	Minimum value of retransmission output scale of OUT2 current output	When O2RS =RSP, decimal point position is same as that of RSP input scale. When O2RS =AIN2, decimal point position is same as that of AIN2 scale. When O2RS =AIN4, decimal point position is same as that of AIN4 scale.	-		
OUA (OU.A)	OUT current output range	4-20: 4 to 20 mA 0-20: 0 to 20 mA 20-4: 20 to 4 mA 20-0: 20 to 0 mA	4-20		
OU2A (OU2.A)	OUT2 current output range		4-20		
RETA (RETA)	RET current output range		4-20		

■ Heater Break Alarm Setting Parameter

Parameter symbol	Name of Parameter	Setting Range	Initial value	User setting	Display level
Hb1S (HB1.S)	Heater break alarm-1 function selection	0: Heater current measurement 1: Heater break alarm	1		
Hb2S (HB2.S)	Heater break alarm-2 function selection		1		
Hb1 (HB1)	Heater break alarm-1 current setpoint	OFF, 0.1 to 300.0 Arms	OFF		EASY
Hb2 (HB2)	Heater break alarm-2 current setpoint		OFF		
CT1t (CT1.T)	CT1 coil winding number ratio	1 to 3300	800		
CT2t (CT2.T)	CT2 coil winding number ratio		800		
HdN1 (HDN1)	Heater break alarm-1 On-delay timer	0.00 to 99.59 (m.s)	0.00		STD
HdN2 (HDN2)	Heater break alarm-2 On-delay timer		0.00		

In cases where the current transformers manufactured by U.R.D. Co., Ltd are used, set the following value for the coil winding number ratio.  
CTL-6-S-H: 800, CTL-12L-30: 3000

■ RS-485 Communication Setting Parameter (E1/E3/E4-terminal Area)

Parameter symbol	Name of Parameter	Setting Range	Initial value	User setting	Display level
PSL (PSL)	Protocol selection	PCL: PC link communication PCLSM: PC link communication (with checksum) LADR: Ladder communication CO-M: Coordinated master station MBASC: Modbus (ASCII) MBRTU: Modbus (RTU) CO-M2: Coordinated master station (2-loop mode) P-P: Peer-to-peer communication	MBRTU		
bPS (BPS)	Baud rate	600: 600 bps, 1200: 1200 bps, 2400: 2400 bps, 4800: 4800 bps, 9600: 9600 bps, 19200: 19.2k bps, 38400: 38.4k bps * The baud rate for RS-485 is up to 19.2 k bps in E4-terminal area.	19200		EASY
PRi (PRI)	Parity	NONE: None, EVEN: Even, ODD: Odd	EVEN		
StP (STP)	Stop bit	1: 1 bit, 2: 2 bits	1		
dLN (DLN)	Data length	7: 7 bits, 8: 8 bits	8		
ADR (ADR)	Address	1 to 99	1		

■ Ethernet Communication Setting Parameter (E3-terminal Area)

Parameter symbol	Name of Parameter	Setting Range	Initial value	User setting	Display level
HSP (HSP)	High-speed response mode	OFF, 1 to 8	1		
bPS (BPS)	Baud rate	9600: 9600 bps, 19200: 19.2k bps, 38400: 38.4k bps	38400		
PRi (PRI)	Parity	NONE: None, EVEN: Even, ODD: Odd	EVEN		
IP1 to IP4 (IP1 to IP4)	IP address 1 to 4	0 to 255 Initial value: (IP1),(IP2),(IP3),(IP4) = (192),(168),(1),(1)	See left	Table below	
SM1 to SM4 (SM1 to SM4)	Subnet mask 1 to 4	0 to 255 Initial value: (SM1),(SM2),(SM3),(SM4) = (255),(255),(255),(0)	See left	Table below	
DG1 to DG4 (DG1 to DG4)	Default gateway 1 to 4	0 to 255 Initial value: (DG1),(DG2),(DG3),(DG4) = (0),(0),(0),(0)	See left	Table below	EASY
PRT (PRT)	Port number	502, 1024 to 65535	502		
IPAR (IPAR)	IP access restriction	OFF: Disable, ON: Enable	OFF		
IP1 to IP4 (IP1 to IP4)	Permitted IP address	0 to 255 Initial value: (1.IP1),(1.IP2),(1.IP3),(1.IP4) = (255),(255),(255),(255) 2-1 to 2-4 (2.IP1),(2.IP2),(2.IP3),(2.IP4) = (255),(255),(255),(255)	See left	Table below	
ESW (ESW)	Ethernet setting switch	Setting this parameter to "ON" enables the Ethernet communication parameter settings. OFF, ON	OFF		

Use the following table to record Ethernet communication setting value.

Parameter	n=1	n=2	n=3	n=4
IPn				
SMn				
DGn				
1.IPn				
2.IPn				

■ PROFIBUS-DP Communication Setting Parameter (E3-terminal Area)

Parameter symbol	Name of Parameter	Setting Range	Initial value	User setting	Display level
bR (BR)	Baud rate	9.6K: 9.6k bps 19.2K: 19.2k bps 93.75K: 93.75k bps 187.5K: 187.5k bps 0.5M: 0.5M bps 1.5M: 1.5M bps 3M: 3M bps 6M: 6M bps 12M: 12M bps AUTO 45.45K: 45.45k bps	AUTO		EASY
ADR (ADR)	Address	0 to 125	3		
bPS (BPS)	Baud rate	9600: 9600 bps 19200: 19.2k bps 38400: 38.4k bps	38400		
FILE (FILE)	Profile number	0, 11 to 15	0		

■ DeviceNet Communication Setting Parameter (E3-terminal Area)

Menu symbol: *dNET* (DNET)

Parameter symbol	Name of Parameter	Setting Range	Initial value	User setting	Display level
<i>bR</i> (BR)	Baud rate	125K: 125k bps 250K: 250k bps 500K: 500k bps	125K		EASY
<i>AdR</i> (ADR)	Address	0 to 63	63		
<i>bPS</i> (BPS)	Baud rate	9600: 9600 bps 19200: 19.2k bps 38400: 38.4k bps	38400		
<i>FILE</i> (FILE)	Profile number	0, 11 to 15	0		

■ CC-Link Communication Setting Parameter (E3-terminal Area)

Menu symbol: *CC-L* (CC-L)

Parameter symbol	Name of Parameter	Setting Range	Initial value	User setting	Display level
<i>bR</i> (BR)	Baud rate	156K: 156k bps 625K: 625k bps 2.5K: 2.5k bps 5M: 5M bps 10M: 10M bps	10M		EASY
<i>AdR</i> (ADR)	Address	1 to 64	1		
<i>bPS</i> (BPS)	Baud rate	9600: 9600 bps 19200: 19.2k bps 38400: 38.4k bps	38400		
<i>FILE</i> (FILE)	Profile number	0, 11 to 15 (0, 11: Ver.1.10) (12 to 15: Ver.2.00)	0		

■ Display Function Setting Parameter

Menu symbol: *di SP* (DISP)

Parameter symbol	Name of Parameter	Setting Range	Initial value	User setting	Display level
<i>PCMD</i> (PCMD)	Active color PV display switch	0: Fixed in white 1: Fixed in red 2: Link to alarm 1 (Alarm OFF: white, Alarm ON: red) 3: Link to alarm 1 (Alarm OFF: red, Alarm ON: white) 4: Link to alarm 1 or 2 (Alarm OFF: white, Alarm ON: red) 5: Link to alarm 1 or 2 (Alarm OFF: red, Alarm ON: white) 6: PV limit (Within range: white, Out of range: red) 7: PV limit (Within range: red, Out of range: white) 8: SP deviation (Within deviation: white, Out of deviation: red) 9: SP deviation (Within deviation: red, Out of deviation: white) 10: Link to DI (ON: red, OFF: white)	0		EASY
<i>PCH</i> (PCH)	PV color change high limit	Set a display value when in PV limit or SP deviation. -19999 to 30000 (Set a value within the input range.)	0		STD
<i>PCL</i> (PCL)	PV color change low limit	Decimal point position depends on the input type.	0		
<i>PTSL</i> (PTSL)	Program display pattern selection	PTN: Pattern display SK.RP: Ramp and soak display	PTN		
<i>BAR1</i> (BAR1)	Upper bar-graph display registration	0: Disable 1: OUT, Heating-side OUT, Internal value in Position proportional control 2: Cooling-side OUT 3: PV 4: SP 5: Deviation 6: Loop-2 OUT, Loop-2 heating-side OUT 7: Loop-2 cooling-side OUT 8: Loop-2 PV 9: Loop-2 SP 10: Loop-2 deviation	23		STD
<i>BAR2</i> (BAR2)	Lower bar-graph display registration	11 to 16: Disable 17: Feedback input (valve opening) 18: PV terminals analog input 19: RSP terminals analog input 20: AIN2 terminals analog input 21: AIN4 terminals analog input 22: Segment progress 23: Time event and alarm status	0		
<i>bDV</i> (BDV)	Bar-graph deviation display band	0.0 to 100.0% of PV input range span (EUS)	10.0 % of PV input range span		STD
<i>GUID</i> (GUID)	Guide display ON/OFF	OFF: Nondisplay, ON: Display	ON		
<i>ECO</i> (ECO)	Economy mode	OFF: Disable 1: Economy mode ON (All indications except PV display OFF) 2: Economy mode ON (All indications OFF) 3: Brightness 10 % (whole indication)	OFF		
<i>BR1</i> (BR1)	Brightness	(Dark) 1 to 5 (Bright)	3		
<i>MLSD</i> (MLSD)	Least significant digital mask of PV display	OFF: With least significant digit ON: Without least significant digit	OFF		STD

■ SELECT Display Setting Parameter

Menu symbol: *CSEL* (CSEL)

Parameter symbol	Name of Parameter	Setting Range	Initial value	User setting	Display level
<i>CS1</i> to <i>CS5</i> (CS1 to CS5)	SELECT Display-1 to -5 registration	Register the operation parameter (except the Operation Mode) that is frequently modified to display it in the Operation Display. OFF: 2201 to 5000 For the setting range, see User's Manual (CD-ROM).	OFF		STD

Use the following table to record SELECT Display setting value.

Parameter	n=1	n=2	n=3	n=4	n=5
CSn					

■ Key Lock Setting Parameter

Menu symbol: *KLOC* (KLOC)

Parameter symbol	Name of Parameter	Setting Range	Initial value	User setting	Display level
<i>COMW</i> (COM.W)	Communication write enable/disable	OFF: Enable, ON: Disable	OFF		STD
<i>dPLeR</i> (DATA)	Front panel parameter data (▼,▲) key lock		OFF		
<i>RUN</i> (RUN)	Front panel RUN key lock		OFF		
<i>RSt</i> (RST)	Front panel RST key lock	OFF: Unlock, ON: Lock	OFF		
<i>PTN</i> (PTN)	Front panel PTN key lock		OFF		
<i>MODe</i> (MODE)	Front panel MODE key lock		OFF		

■ DI Function Registration Parameter

Menu symbol: *di SL* (DI.SL)

Parameter symbol	Name of Parameter	Setting Range	Initial value	User setting	Display level
<i>PRG</i> (PRG)	Switch to PROG (Start of program operation)		5025		STD
<i>RSt</i> (RST)	Switch to RESET (Stop of program operation)		5026		
<i>LOC</i> (LOC)	Switch to LOCAL(LSP) (Start of local-mode operation)		5027		
<i>REM</i> (REM)	Switch to REMOTE		5046		
<i>P/R</i> (P/R)	PROG/RESET Switch	Set an I relay number of contact input. Set "OFF" to disable the function.	OFF		
<i>P/H</i> (P/H)	PROG/HOLD Switch		OFF		
<i>P/L</i> (P/L)	PROG/LOCAL(LSP) Switch	Standard terminals DI1: 5025, DI2: 5026, DI3: 5027	OFF		
<i>HOLD</i> (HOLD)	Switch to HOLD (Start of hold-mode operation)	E1-terminal area DI11: 5041, DI12: 5042, DI13: 5043, DI14: 5044, DI15: 5045, DI16: 5046	OFF		
<i>ADV</i> (ADV)	Advance of segment	E2-terminal area DI26: 5062	OFF		
<i>WAIt</i> (WAIt)	Wait ON/OFF switch	E4-terminal area DI41: 5089, DI42: 5090, DI43: 5091, DI44: 5092, DI45: 5093, DI46: 5094	OFF		
<i>A/M</i> (A/M)	AUTO/MAN switch		OFF		
<i>At</i> (AT)	Auto-tuning START/STOP switch		OFF		
<i>LAt</i> (LAt)	Latch release		OFF		
<i>LcD</i> (LcD)	LCD backlight ON/OFF switch		OFF		
<i>PVRW</i> (PVRW)	PV red/white switch		OFF		

■ DI Function Numbering Parameter

Menu symbol: *di NU* ( )

Parameter symbol	Name of Parameter	Setting Range	Initial value	User setting	Display level
<i>PLb0</i> (PT.B0)	Bit-0 of program pattern number	See next table.	5089		EASY
<i>PLb1</i> (PT.B1)	Bit-1 of program pattern number		5090		
<i>PLb2</i> (PT.B2)	Bit-2 of program pattern number		5091		
<i>PLb3</i> (PT.B3)	Bit-3 of program pattern number		5092		
<i>PLb4</i> (PT.B4)	Bit-4 of program pattern number		5093		

<i>PLb5</i> (PT.B5)	Bit-5 of program pattern number		OFF		STD
<i>PNb0</i> (PN.B0)	Bit-0 of PID number	Set an I relay number of contact input. Set "OFF" to disable the function.	OFF		
<i>PNb1</i> (PN.B1)	Bit-1 of PID number	Standard terminals DI1: 5025, DI2: 5026, DI3: 5027	OFF		
<i>PNb2</i> (PN.B2)	Bit-2 of PID number	E1-terminal area DI11: 5041, DI12: 5042, DI13: 5043, DI14: 5044, DI15: 5045, DI16: 5046	OFF		
<i>PNb3</i> (PN.B3)	Bit-3 of PID number	E2-terminal area DI26: 5062	OFF		
<i>MPb0</i> (MP.B0)	Bit-0 of manual preset output number	E4-terminal area DI41: 5089, DI42: 5090, DI43: 5091, DI44: 5092, DI45: 5093, DI46: 5094	OFF		
<i>MPb1</i> (MP.B1)	Bit-1 of manual preset output number		OFF		
<i>MPb2</i> (MP.B2)	Bit-2 of manual preset output number		OFF		

■ AL1-AL3 Function Registration Parameter

Menu symbol: *ALM* (ALM)

Parameter symbol	Name of Parameter	Setting Range	Initial value	User setting	Display level
<i>AL1S</i> (AL1.S)	AL1 function selection	Set an I relay number. For the items other than below, see User's Manual (CD-ROM). Ex.) Set the number 4353 for AL1.S to use the alarm 1. Set "OFF" to disable the function. Setting range: 4001 to 6304 No function: OFF. PV event 1: 4801, PV event 2: 4802, PV event 3: 4803, PV event 4: 4805, PV event 5: 4806, PV event 6: 4807, PV event 7: 4809, PV event 8: 4810, Time event 1: 4817, Time event 2: 4818, Time event 3: 4819, Time event 4: 4821, Time event 5: 4822, Time event 6: 4823, Time event 7: 4825, Time event 8: 4826, Time event 9: 4833, Time event 10: 4834, Time event 11: 4835, Time event 12: 4837, Time event 13: 4838, Time event 14: 4839, Time event 15: 4841, Time event 16: 4842, Alarm 1: 4353, Alarm 2: 4354, Alarm 3: 4355, Alarm 4: 4357, Alarm 5: 4358, Alarm 6: 4359, Alarm 7: 4361, Alarm 8: 4362 AUTO (ON) / MAN (OFF) status: 4177 Program RESET status: 4181 Program RUN status: 4182 Local operation status: 4183 Remote operation status: 4185 HOLD mode status: 4189 Program advance status: 4187 Pattern end signal (1 second): 4265 Pattern end signal (3 seconds): 4266 Pattern end signal (5 seconds): 4267 Wait end signal (1 second) : 4257 Wait end signal (3 seconds) : 4258 Wait end signal (5 seconds) : 4259 Output tracking (ON) switching signal: 4186 FAIL (Normally ON) output: 4256	4801		STD
<i>AL2S</i> (AL2.S)	AL2 function selection		4802		
<i>AL3S</i> (AL3.S)	AL3 function selection		4803		
<i>ORS</i> (OR.S)	OUT relay function selection		OFF		
<i>OR2S</i> (OR2.S)	OUT2 relay function selection		OFF		
<i>DO1S</i> (DO1.S)	DO11/DO21/DO31 function selection	Same as AL1.S Set "OFF" to disable the function. Initial value: DO11=4805, DO12=4806, DO13=4807, DO14=4809, DO15=4810, DO21=4817, DO22=4818, DO23=4819, DO24=4821, DO25=4822, DO31=4823, DO32=4825, DO33=4826, DO34=4833, DO35=4834	See left	Table below	
<i>DO2S</i> (DO2.S)	DO12/DO22/DO32 function selection		See left		
<i>DO3S</i> (DO3.S)	DO13/DO23/DO33 function selection		See left		
<i>DO4S</i> (DO4.S)	DO14/DO24/DO34 function selection		See left		
<i>DO5S</i> (DO5.S)	DO15/DO25/DO35 function selection		See left		

■ DO Setting Parameter (E1/E2/E3-terminal Area)

Menu symbol: *DO* (DO)

Parameter symbol	Name of Parameter	Setting Range	Initial value	User setting	Display level
<i>DO1S</i> (DO1.S)	DO11/DO21/DO31 function selection	Same as AL1.S Set "OFF" to disable the function. Initial value: DO11=4805, DO12=4806, DO13=4807, DO14=4809, DO15=4810, DO21=4817, DO22=4818, DO23=4819, DO24=4821, DO25=4822, DO31=4823, DO32=4825, DO33=4826, DO34=4833, DO35=4834	See left	Table below	
<i>DO2S</i> (DO2.S)	DO12/DO22/DO32 function selection		See left		
<i>DO3S</i> (DO3.S)	DO13/DO23/DO33 function selection		See left		
<i>DO4S</i> (DO4.S)	DO14/DO24/DO34 function selection		See left		
<i>DO5S</i> (DO5.S)	DO15/DO25/DO35 function selection		See left		

Use the following table to record DO setting value.

Parameter	E1-terminal Area	E2-terminal Area	E3-terminal Area
DO1.S			
DO2.S			
DO3.S			
DO4.S			
DO5.S			

■ System Setting Parameter

Menu symbol: *SYS* (SYS)

Parameter symbol	Name of Parameter	Setting Range	Initial value	User setting	Display level
<i>RMd</i> (R.MD)	Restart mode	Set how the controller should recover from a power failure of 5 seconds or more. CONT: Continue action set before power failure. MAN: Start from MAN. RESET: Start from AUTO and RESET. Outputs the preset output value.	CONT		STD
<i>RLM</i> (R.TM)	Restart timer	Set time between power on and the instant where controller starts computation. 0 to 10 s	0		

<i>EPO</i> (EPO)	Input error preset output	Set preset output value when the input burnout or ADC error occurs. Manual output is prioritized when the input burnout occurs in MAN. 0: Preset output 1: 0% output 2: 100% output	0		STD
<i>FREQ</i> (FREQ)	Power frequency	AUTO, 60: 60 Hz, 50: 50 Hz	AUTO		EASY
<i>QSM</i> (QSM)	Quick setting mode	OFF: Disable ON: Enable	ON		
<i>LANG</i> (LANG)	Guide display language	ENG: English FRA: French GER: German SPA: Spanish	Depends on the model and suffix codes		
<i>PASS</i> (PASS)	Password setting	0 (No password) to 65535	0		

■ Error and Version Confirmation Parameter (for display only)

Menu symbol: *VER* (VER)

Parameter symbol	Name of Parameter	Status record	Display level
<i>PAER</i> (PA.ER)	Parameter error status		EASY
<i>OPER</i> (OP.ER)	Option error status		
<i>AD1E</i> (AD1.E)	A/D converter error status 1		
<i>AD2E</i> (AD2.E)	A/D converter error status 2		
<i>PV1E</i> (PV1.E)	Loop-1 PV input error status		
<i>PV2E</i> (PV2.E)	Loop-2 PV input error status		
<i>LAER</i> (LA.ER)	Ladder error status		
<i>MCU</i> (MCU)	MCU version		
<i>DCU</i> (DCU)	DCU version		
<i>ECU1</i> (ECU1)	ECU-1 version (E1-terminal area)		
<i>ECU2</i> (ECU2)	ECU-2 version (E2-terminal area)		
<i>ECU3</i> (ECU3)	ECU-3 version (E3-terminal area)		
<i>ECU4</i> (ECU4)	ECU-4 version (E4-terminal area)		
<i>PARA</i> (PARA)	Parameter version		
<i>HVER</i> (H.VER)	Product version		
<i>SER1</i> (SER1)	Serial number 1		
<i>SER2</i> (SER2)	Serial number 2		
<i>MAC1</i> (MAC1)	MAC address 1 (E3-terminal area)		
<i>MAC2</i> (MAC2)	MAC address 2 (E3-terminal area)		
<i>MAC3</i> (MAC3)	MAC address 3 (E3-terminal area)		

\* The parameters for Loop-2 are unavailable in Single-loop control.

■ Parameter Display Level Parameter

Menu symbol: *LVL* (LVL)

Parameter symbol	Name of Parameter	Setting Range	Initial value	User setting	Display level
<i>LEVl</i> (LEV.L)	Parameter display level	EASY: Easy setting mode STD: Standard setting mode PRO: Professional setting mode	STD		EASY

\* For Professional setting mode, see User's Manual (CD-ROM).

Trademarks

- Our product names or brand names mentioned in this manual are the trademarks or registered trademarks of Yokogawa Electric Corporation.
- Adobe, Acrobat, and Postscript are either registered trademarks or trademarks of Adobe Systems Incorporated.
- Ethernet is a registered trademark of XEROX Corporation in the United States.
- Modbus is a registered trademark of Schneider Electric.
- PROFIBUS-DP is a registered trademark of PROFIBUS User Organization.
- DeviceNet is a registered trademark of Open DeviceNet Vendor Association.
- CC-Link is a registered trademark of CC-Link Partner Association.
- We do not use the TM or ® mark to indicate these trademarks or registered trademarks in this manual.
- All other product names mentioned in this manual are trademarks or registered trademarks of their respective companies.