

# General Specifications

UP55A  
Program Controller

UTAdvanced

Functional Enhancement

GS 05P02C41-01EN

## Overview

The UP55A program controller employs an easy-to-read, 14-segment large color LCD display, along with navigation keys, thus greatly increasing the monitoring and operating capabilities. A ladder sequence function is included as standard. The short depth of the controller helps save instrument panel space. The UP55A also support open networks such as Ethernet communication.



## Features

- Equipped with a large-capacity program setting function that can store 99 program patterns and 600 program segments. It can be used in a wide variety of heating/cooling control applications (on models with the /AP option).
- A 14-segment, active (PV display color changing function) color LCD display is employed. Two five-digit, high-resolution displays are possible. Alphabet letters can be displayed in an easy-to-read manner. The guide display shows parameter names.
- Easy to operate  
Navigation keys (SET/ENTER and Up/Down/Left/Right arrow keys) are employed to facilitate making settings.
- 65 mm depth  
The small depth enables the mounting in a thin and small instrumented panel.
- Ladder sequence function is included as standard. This function allows for creating a simple sequence control. Dedicated LL50A Parameter Setting Software (sold separately) allows for performing programming using a ladder language.
- Various built-in open network functions such as Ethernet are available. Easy connection with various vendors' PLCs is possible.
- Quick setting function  
Setting only the minimum necessary parameters for operation is possible. (For single-loop control only)
- Equipped with a multitude of functions  
Universal I/O and eight control modes (cascade control, etc) are included as standard. PID control, heating/cooling control, feed forward control, etc. are available.
- LL50A Parameter Setting Software (sold separately)  
The parameters and ladder programs of UTAdvanced digital indicating controller can be built from a PC using this software. It makes data management even easier.
- Dust-proof and drip-proof  
IP66 (for front panel) (Not applicable to side-by-side close mounting.)  
NEMA4 (Hose-down test only)

## Functional Specifications

### Program Pattern Functions

The program setting function increases or decreases the value of a target setpoint (SP) according to a given program pattern that varies with time. The controller stores two or more program patterns and the operator can switch between them according to the operating status. Each program pattern consists of multiple line segments (program segments). The operator sets the time interval of each program segment using the segment time or slope. The operator can also set such instructions as the number of repeats, start/stop, and status output (event output) for a given program pattern.

Number of Program pattern	Max. 30 (Max. 99 with /AP option)
Number of program segment per pattern	Max. 99 (Max. 600 with /AP option)
Total number of program segments	Max. 300 (Total of all program patterns)
Segment time	0.00 to 999.59 (hour.minute or minute. second)
Number of PV event	8
PV event type	PV (measured value) high/low limit SP (setpoint) high/low limit Deviation high/low limit Deviation high and low limits Deviation within high and low limits Target SP high/low limit Target SP deviation high/low limit Target SP deviation within high and low limits Control output high/low limit alarm Cooling control output high/low limit alarm
Number of Time event	16
Time of time event	0.01 to 999.59 (hour.minute or minute. second)
Number of repeat cycle	0 to 999, CONT (limitless number of times)
Wait operation	5 groups Can be set the upper-side wait zone and the lower zone for program setpoint.
Fast-forwarding of program operation	1: Normal, 2: Twice, 5: Five times, 10: Ten times, 20: Twenty times Use this function when checking the program pattern setting. Only Time of Segment and Time event can be faster.

Synchronized program operation	If the progress of the operation of one unit is faster, the program operation can be forcibly stopped by digital input when switching between segments.
Program pattern link	Available
Program pattern edit	Addition and deleting of program segment can be available. Copy and deletion of program pattern can also be available.

## ■ Control Computation Function

### Control Specifications

#### (1) Control Mode

Control functions of the controller can be set as control modes.

Control mode	Function
SGL	Single-loop control
CAS1	Cascade primary-loop control
CAS	Cascade control
PVSW	Loop control with PV switching
PVSEL	Loop control with PV auto-selector (Max./Min./Ave./Diff)

\*1: Remote auxiliary analog input is required.

#### (2) Control period

Selectable from 100 ms, and 200 ms

Model and suffix code (See the model code)	Number of analog input points	Number of analog output points <sup>(*)</sup>	Number of contact input points <sup>(**)</sup>	Number of contact output points <sup>(***)</sup>
UP55A				
-x0x	1	1	8	8
-x1x	2	1	9 (8)	8
-x2x	1	1	8	8
-x3x	1	1	8	18
-x4x	4	1	6 (5)	3

\*1: Excluding control output

\*2: The numbers in parentheses show the numbers of points in each model with RSP direct input.(/DR option)

\*3: Excluding control output relays

### Control Computation Specifications

#### (1) Combination of types of control and control modes

Types of control	Control mode				
	SGL	CAS1	CAS	PVSW	PVSEL
PID control	√	√	√	√	√
ON/OFF control <sup>(*)</sup>	√	N/A	N/A	√	√
Heating and cooling control <sup>(**)</sup>	√	N/A	√	√	√

√: Available, N/A: Not Available

\*1: Not selectable for Position proportional type

\*2: Selectable for heating and cooling control

#### (2) Control Computation Function

(a) The number of PID parameter groups

Eight sets of PID parameters can be set. For cascade control, respectively, eight sets can be set for main (primary side) and slave (secondary side).

(b) Selecting the PID parameter group

The following PID parameter groups can be selected.

- Segment PID
- Measured input zone PID
- Target setpoint zone PID
- Reached target setpoint zone PID
- Local PID
- Reference deviation

(c) Auto-tuning

- Tuning results can be selected from two options, Normal or Stable.
- Tuning output limit can be set. (It cannot be used in heating/cooling control.)

(d) "Super" function: Overshoot-suppressing function

(e) "Super 2" function: Hunting-suppressing function

(f) RESET preset output function

(g) Input ERROR preset output function

(h) MANUAL preset output function

#### (3) Operation Mode Switching

Operation mode switching	Start of program operation (PROG) Stop of program operation (RESET) Start of local-mode operation (LOCAL) Start of remote-mode operation (REM) Pause/cancel release of program operation (HOLD) Advance of segment (ADV) Automatic (AUTO)/Manual (MAN) switching Local (LSP)/CAS switching when in cascade control
--------------------------	---

#### (4) Control Parameter Setting Range

Proportional band	0.1 to 999.9%
Integral time	1 to 6000 sec. or OFF (using manual reset)
Derivative time	1 to 6000 sec. or OFF
ON/OFF control hysteresis (one or two hysteresis points)	0.0 to 100.0% of measured input range width
Preset output value	-5.0 to 105.0% (however, 0 mA or less cannot be output)
High/low output limiter	-5.0 to 105.0% Low limit setpoint < high limit setpoint
Tight shut function	When manual control is carried out with 4 to 20 mA output, control output can be reduced to about 0 mA.
Rate-of-change limiter of output	0.1 to 100.0%/sec., OFF
Output dead band	For heating and cooling control: -100.0 to 50.0% For position proportional control: 1.0 to 10.0%

### Alarm Functions

#### • Types of Alarm

Measured value alarm Deviation alarm Rate-of-change alarm	PV (measured value) high/low limit alarm Deviation high/low limit alarm Deviation high and low limits alarm Deviation within high and low limits alarm Analog input PV high/low limit alarm Analog input RSP high/low limit alarm Auxiliary analog input high/low limit alarm Feedback input high/low limit alarm PV rate-of-change alarm
Setpoint alarm	SP (setpoint) high/low limit alarm Target SP high/low limit alarm Target SP deviation high/low limit alarm Target SP deviation high and low limits alarm Target SP deviation within high and low limits alarm
Output alarm	Control output high/low limit alarm Cooling control output high/low limit alarm
Other alarms	Heater disconnection alarm (for /HA option) Self-diagnosis alarm FAIL

#### • Alarm Functions

Alarm output action	Alarm stand-by action Alarm latch (forced reset) function Alarm hysteresis Alarm ON/OFF delay timer
Number of alarm settings	8 (per loop)
Number of alarm output points	Up to 9 (differs by model code)

#### Contact I/O Function

This function allows for allocating the input error condition, operation condition, alarm condition or other conditions to the contact input and contact output.

Contact input	Switch to PROG (Start of program operation)
	Switch to RESET (Stop of program operation)
	Switch to LOCAL (LSP) (Start of local-mode operation)
	Switch to REMOTE
	PROG/RESET Switch
	PROG/LOCAL (LSP) Switch
	PROG/HOLD Switch
	Switch to HOLD (Start of hold-mode operation)
	Advance of segment
	Wait ON/OFF switch
	AUTO/MAN switch
	LOCAL (LSP)/CAS switch
	Auto-tuning START/STOP switch
	Output tracking switching
	Two-input switching
	Latch release
	LCD backlight ON/OFF switch
Contact output	PV red/white switch
	Message interrupt displays 1 through 4
	Program pattern number selection
	PID number selection
	Manual preset output number selection
PV event, Time event, Alarm	
Loop 2 alarm (for cascade control)	
Status output	

#### Ladder Sequence Function

##### (1) Number of I/O Points

Number of digital input points	Up to 9
Number of digital output points	Up to 18

This is limited by the number of contact I/O signal points. (See the model code.)

##### (2) Types of Instruction

	Number of instructions	Remark
Number of basic instruction types	13	Load, AND, OR, Timer, Counter, etc.
Number of application instruction types	73	Comparison, reverse, addition/subtraction/multiplication/division, logic operation, high/low limiter, etc.

##### (3) Sequence Device

	Types of device	Number of points
Digital I/O	Input relay	9 (max.)
	Output relay	18 (max.)
Internal device	M relay (bit data)	256
	DAT register (data)	28
	P register (parameter)	10
	K register (constant)	30
Special device	Special relay (bit data)	12

Process data and process relay can be used besides the above-mentioned.

#### (4) Program capacity

Max. Program capacity: 500 steps \*

\*: Available number of steps differs according to the parameters, using command and control period.

#### (5) Ladder computation period

Ladder computation period is the same as control period.

## Communication Function

	Function	Method	Interface	Targets	Max connection	Communication Data
Modbus/TCP	A standard industry protocol allowing communications between the controller and devices such as PCs, PLCs, and DCSs.	Server	Ethernet	PLC and others	2 connections	PV, ALM etc
		Gateway	Ethernet + RS-485	RS-485: UT75A/UT55A/UT52A/UT35A/UT32A/UP55A/UP35A/UM33A <sup>(*)</sup>	31 units	
Modbus (RTU/ASCII)		Slave	RS-485	PLC and others, UT55A/UT75A/UT52A/UT35A/UT32A/UP55A/UP35A/UP32A/UM33A <sup>(*)</sup>	31 units	
PROFIBUS-DP	Used for communication between PLCs and remote I/O, enabling highspeed data transmission.	Slave	RS-485	PLC and others	Number of nodes: 126	
		Modbus master function	RS-485	UT75A/UT55A/UT52A/UT35A/UT32A/UP55A/UP35A	31 Units (Main Controller is included.)	
CC-Link		Slave	RS-485	PLC and others	Number of nodes: 42 (Remote device)	
		Modbus master function	RS-485	UT75A/UT55A/UT52A/UT35A/UT32A/UP55A/UP35A/UP32A/UM33A	31 Units (Main Controller is included.)	
DeviceNet		Slave	RS-485	PLC and others	Number of nodes: 64	
		Modbus master function	RS-485	UT75A/UT55A/UT52A/UT35A/UT32A/UP55A/UP35A	31 Units (Main Controller is included.)	
Peer to peer	A protocol allowing multiple controllers to send and receive data between one another. The Ladder Program is used.	Multi-drop	RS-485 (2 wire only)	UT75A/UT55A/UT52A/UT35A/UT32A/UP55A/UP35A/UP32A	Read/Write: 4 units Read only : 28 units	
Coordinated Communication	A protocol to coordinate the operation of two or more instruments controlling the same process.	Master/ Slave	RS-485	UT75A/UT55A/UT52A/UT35A/UT32A/UP55A/UP35A/UP32A <sup>(*)</sup>	Master : 1 unit Slave : 31 units	
PC link	The proprietary Yokogawa protocol allowing communications to PCs, PLCs and touch panels.	Slave	RS-485	UT75A/UT55A/UT52A/UT35A/UT32A/UP55A/UP35A/UP32A/UM33A <sup>(*)</sup>	31 units	
Ladder	A protocol to communicate to PLCs.					

\*1: UT digital indicating controller, Signal conditioner JUXTA, Power monitor POWERCERT can be connected.

\*2: UT digital indication controllers can be connected.

## Physical Interface

Ethernet	Standard : IEEE802.3 (10BASE-T, 100BASE-TX) Max segment length : 100 m Max. Connecting Configuration : Cascade Max. 4 level (10BASE-T), Max. 2 level (100BASE-TX)
RS-485	Standard: EIA RS-485 Communication method: Two-wire half-duplex or four-wire half-duplex, start-stop synchronization, and non-procedural Baud rate: 600, 1200, 2400, 4800, 9600, 19200 or 38400 bps <sup>(*)</sup> Peer to peer communication is fixed at 19200 bps Maximum communication distance: 1200 m Terminating resistor: 220Ω (External) *3: "38400 bps" is available only for UP55A (Type 3 code = 1)
PROFIBUS-DP	Standard : Field bus (IEC61158) Corresponding version : DP V0 Baud rate : 9.6k, 19.2k, 45.45k, 93.75k, 187.5k, 0.5M, 1.5M, 3M, 6M, 12M, AUTO <sup>(*)</sup> Communication distance : 1200m (9.6k to 93.75k), 1000m (187.5k), 400m (0.5M), 200m (1.5M), 100m (3M to 12M) *4: AUTO automatically sets the baud rate to that of the host controller (PROFIBUS-DP master).
CC-Link	Supported version : Remote device (Ver. 1.10, Ver.2.00) Baud rate : 156k, 625k, 2.5M, 5M, 10M bps Transmission distance : 1.2km (156k bps), 600m (625k bps), 200m (2.5M bps), 150m (5M bps), 100m (10M bps) When using optical repeater : 7.6 km (156k) to 4.3 km (10M)
DeviceNet	Standard : Field bus (IEC61158) Baud rate 125k, 250k, 500k bps Transmission distance 500m (125k bps), 250m (250k bps), 100m (500k bps)

## Hardware Specifications

### Display Specifications

- PV display: 5-digit, 14-segment active color LCD (white/red)  
Character height: 21.5 mm
- Data display: 5-digit, 11-segment color LCD (orange)
- Bar graph display: 12-segment color LCD (orange)

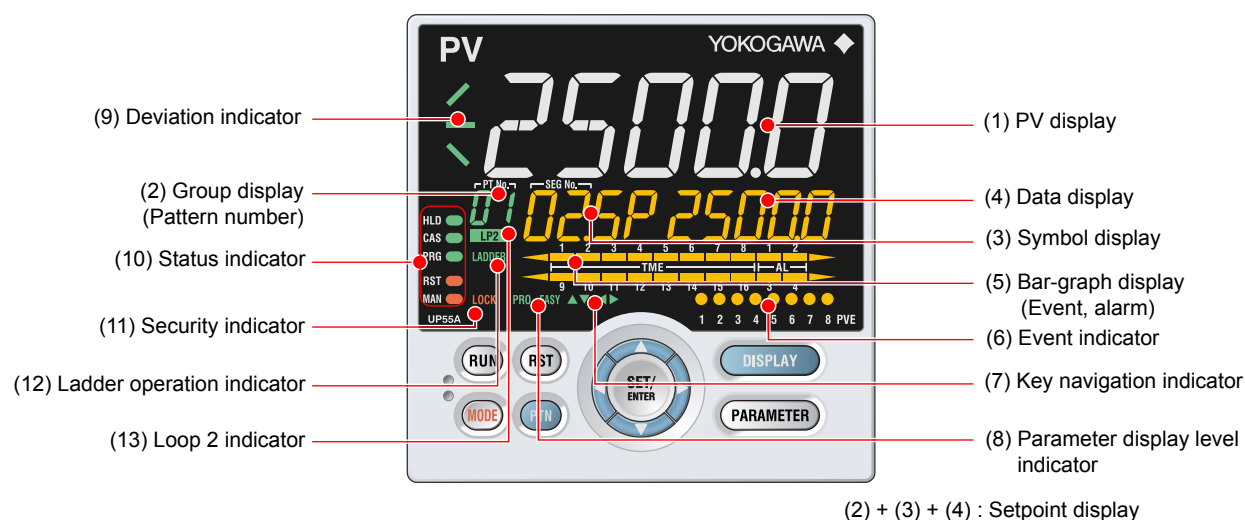

### Names of Display Parts

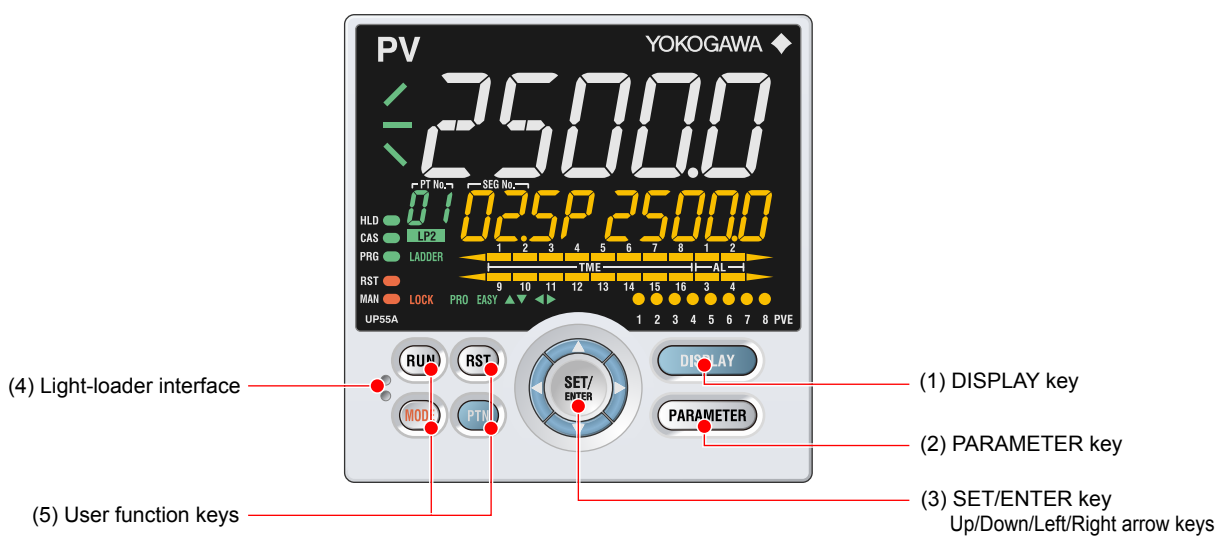



## Universal Input Specifications

- Number of inputs: 1
- Input type, instrument range, and measurement accuracy: See the table below.

Input Type		Instrument Range (°C)		Instrument Range (°F)		Accuracy
Thermo-couple	K	-270.0	to 1370.0°C	-450.0	to 2500.0°F	±0.1% of instrument range ±1 digit for 0°C or more ±0.2% of instrument range ±1 digit for less than 0°C ±2% of instrument range ±1 digit for less than -200.0°C of thermocouple K
		-270.0	to 500.0°C	-200.0	to 1000.0°F	
	J	-200.0	to 1200.0°C	-300.0	to 2300.0°F	±1% of instrument range ±1 digit for less than -200.0°C of thermocouple T
	T	-270.0	to 400.0°C	-450.0	to 750.0°F	
	B	0.0	to 1800.0°C	32	to 3300°F	±0.15% of instrument range ±1 digit for 400°C or more ±5% of instrument range ±1 digit for less than 400°C
	S	0.0	to 1700.0°C	32	to 3100°F	
	R	0.0	to 1700.0°C	32	to 3100°F	±0.15% of instrument range ±1 digit
	N	-200.0	to 1300.0°C	-300.0	to 2400.0°F	±0.1% of instrument range ±1 digit ±0.25% of instrument range ±1 digit for less than 0°C
	E	-270.0	to 1000.0°C	-450.0	to 1800.0°F	
	L	-200.0	to 900.0°C	-300.0	to 1600.0°F	±0.1% of instrument range ±1 digit for 0°C or more ±0.2% of instrument range ±1 digit for less than 0°C
	U	-200.0	to 400.0°C	-300.0	to 750.0°F	
	W	0.0	to 2300.0°C	32	to 4200°F	±0.2% of instrument range ±1 digit (Note 2)
	Platinel 2	0.0	to 1390.0°C	32.0	to 2500.0°F	±0.1% of instrument range ±1 digit
	PR20-40	0.0	to 1900.0°C	32	to 3400°F	±0.5% of instrument range ±1 digit for 800°C or more Accuracy is not guaranteed for less than 800°C.
W97Re3-W75Re25	0.0	to 2000.0°C	32	to 3600°F	±0.2% of instrument range ±1 digit	
RTD	JPt100	-200.0	to 500.0°C	-300.0	to 1000.0°F	±0.1% of instrument range ±1 digit (Note 1) ±0.1% of instrument range ±1 digit
		-150.00	to 150.00°C	-200.0	to 300.0°F	
	Pt100	-200.0	to 850.0°C	-300.0	to 1560.0°F	±0.1% of instrument range ±1 digit (Note 1)
		-200.0	to 500.0°C	-300.0	to 1000.0°F	
Standard signal	0.400 to 2.000 V				±0.1% of instrument range ±1 digit	
	1.000 to 5.000 V					
	4.00 to 20.00 mA					
DC voltage/current	0.000 to 2.000 V					
	0.00 to 10.00 V					
	0.00 to 20.00 mA					
	-10.00 to 20.00 mV					
	0.0 to 100.0 mV					

The accuracy is that in the standard operating conditions: 23±2°C, 55±10%RH, and power frequency at 50/60 Hz.

Note 1: ±0.3°C ±1 digit in the range between 0 and 100°C, ±0.5°C ±1 digit in the range between -100 and 200°C.

Note 2: W: W-5% Re/W-26% Re(Hoskins Mfg.Co.). ASTM E988

- Input sampling (control) period: Select from 100 and 200 ms
- Burnout detection:
  - Functions at TC, RTD, and standard signal.
  - Upscale, downscale, and off can be specified.
  - For standard signal, burnout is determined to have occurred if it is 0.1 V or 0.4 mA or less.
- Input bias current: 0.05 µA (for TC or RTD)
- Measured current (RTD): About 0.16 mA
- Input resistance:
  - TC or mV input: 1 MΩ or more
  - V input: About 1 MΩ
  - mA input: About 250 Ω
- Allowable signal source resistance:
  - TC or mV input: 250 Ω or less
  - Effects of signal source resistance: 0.1 µV/Ω or less
  - DC voltage input: 2 kΩ or less
  - Effects of signal source resistance: About 0.01%/100 Ω
- Allowable wiring resistance:
  - RTD input: Max. 150 Ω/wire (The conductor resistance between the three wires shall be equal.)
  - Wiring resistance effect: ±0.1°C/10 Ω
- Allowable input voltage/current:
  - TC, mV, mA and RTD input: ±10 V DC
  - V input: ±20 V DC
  - mA input: ±40 mA
- Noise rejection ratio:
  - Normal mode: 40 dB or more (at 50/60 Hz)
  - Common mode: 120 dB or more (at 50/60 Hz)

For 100-240 V AC, the power frequency can be set manually. Automatic detection is also available.

For 24 V AC/DC, the power frequency can be set manually.

- Reference junction compensation error:
  - ±1.0°C (15 to 35°C)
  - ±1.5°C (-10 to 15°C and 35 to 50°C)
- Applicable standards: JIS/IEC/DIN (ITS-90) for TC and RTD

### Auxiliary Analog Input

- Use: Remote setpoint setting, external compensating input, auxiliary input for computation, etc.
- Number of inputs: See the table of Model and Suffix Codes.
- Input type, instrument range, and measurement accuracy: See the table below.

Input Type	Instrument Range	Accuracy
Standard signal	0.400 to 2.000 V	±0.2% of instrument range ±1 digit
	1.000 to 5.000 V	±0.1% of instrument range ±1 digit
DC voltage	0.000 to 2.000 V	±0.2% of instrument range ±1 digit
	0.00 to 10.00 V	±0.1% of instrument range ±1 digit
DC voltage for high-input impedance	0.000 to 1.250 V	±0.1% of instrument range ±1 digit

- Input sampling (control) period: Same as universal input
- Input resistance: About 1 MΩ
  - However, 10 MΩ or more for DC voltage for high-input impedance range
- Burnout detection: Functions at standard signal
  - Burnout is determined to have occurred if it is 0.1 V or less.

## Remote Input with Direct Input

- Number of inputs: See the table of Model and Suffix Codes.
- Input type, instrument range, and measurement accuracy: Same as universal input except the table below.

Input Type		Instrument Range		Accuracy
		°C	°F	
4-wire RTD	JPt100	-200.0 to 500.0°C	-300.0 to 1000.0°F	±0.5°C ±1 digit
		-150.00 to 150.00°C	-200.0 to 300.0°F	±0.2°C ±1 digit
	Pt100	-200.0 to 850.0°C	-300.0 to 1560.0°F	±0.1% of instrument range ±1 digit (Note 1)
		-200.0 to 500.0°C	-300.0 to 1000.0°F	±0.5°C ±1 digit
		-150.00 to 150.00°C	-200.0 to 300.0°F	±0.2°C ±1 digit

Note 1: ±0.5°C ±1 digit in the range between -200.0 and 500.0°C/-300.0 and 1000.0°F.

- Input sampling (control) period: Same as universal input
- Burnout detection: Same as universal input

## Contact Input Specifications

- Number of inputs: See the table of Model and Suffix Codes.
- Input type: No-voltage contact input or transistor contact input
- Input contact rating: 12 V DC, 10 mA or more  
Use a contact with a minimum on-current of 1 mA or more.
- ON/OFF detection:  
No-voltage contact input:  
Contact resistance of 1 kΩ or less is determined as "ON" and contact resistance of 50 kΩ or more as "OFF."  
Transistor contact input:  
Input voltage of 2 V or less is determined as "ON" and leakage current must not exceed 100 μA when "OFF."
- Minimum status detection hold time: Control period +50 ms
- Use: PTNO. switch, operation mode switch, and event input

## Analog Output Specifications

- Number of outputs:  
Control output: 1  
Cooling-side control output of Heating/cooling type: 1
- Output type: Current output or voltage pulse output
- Current output: 4 to 20 mA DC or 0 to 20 mA DC/load resistance of 600 Ω or less
- Current output accuracy: ±0.1% of span (±5% of span for 1 mA or less)  
The accuracy is that in the standard operating conditions: 23±2°C, 55±10%RH, and power frequency at 50/60 Hz.
- Voltage pulse output:  
Use: Time proportional output  
On-voltage: 12 V or more/load resistance of 600 Ω or more  
Off-voltage: 0.1 V DC or less  
Time resolution: 10 ms or 0.1% of output, whichever is larger

## Retransmission Output Specifications

- Number of outputs: Retransmission output; 1, shared with 15 V DC loop power supply
- Current output: 4 to 20 mA DC or 0 to 20 mA DC/load resistance of 600 Ω or less
- Current output accuracy (conversion accuracy from PV display on the set scale): ±0.1% of span (±5% of span for 1 mA or less)  
The accuracy is that in the standard operating conditions: 23±2°C, 55±10%RH, and power frequency at 50/60 Hz.  
This is not conversion accuracy through input and output but the performance of transmission output itself.

## 15 V DC Loop Power Supply Specifications

- (Shared with retransmission output)
- Power supply: 14.5 to 18.0 V DC
  - Maximum supply current: About 21 mA (with short-circuit current limiting circuit)

## Step Response Time Specifications

Within 500 ms (when the control period is 100 ms)  
Within 1 s (when the control period is 200 ms)  
(63% of analog output response time when a step change of 10 to 90% of input span is applied)

## Relay Contact Output Specifications

- Contact type and number of outputs:  
Control output: contact point 1c; 1 point  
Cooling-side control output of Heating/cooling type: contact point 1c; 1 point  
Event output: contact point 1a; 3 points (common is independent)
- Contact rating:  
Contact point 1c (control output): 250 V AC, 3 A or 30 V DC, 3A (resistance load)  
Contact point 1a (event output): 240 V AC, 1A or 30 V DC, 1 A (resistance load)
- Use: Time proportional output, event output, alarm output, FAIL output, etc.
- Time resolution of control output: 10 ms or 0.1% of output, whichever is larger  
Note: This cannot be used for a small load of 10 mA or less.  
\*: The control output should always be used with a load of 10 mA or more.  
The event output should always be used with a load of 1 mA or more.

## Transistor Contact Output Specifications

- Number of outputs: See the table of Model and Suffix Codes.
- Output type: Open collector (SINK current)
- Output contact rating: Max. 24 V DC, 50 mA
- Output time resolution: Min. 100 ms
- Use: Event output, alarm output, FAIL output, etc.

## Position Proportional Output Specifications

- Position signal input:  
Slide resistance: 100  $\Omega$  to 2.5 k $\Omega$  of total resistance  
100% side and slide line: with disconnection detection  
0% side: without disconnection detection  
Current input: 4 to 20 mA (with disconnection detection)  
Input resistance: about 330  $\Omega$
- Sampling period: 50 ms
- Measurement resolution: 0.1% of input span
- Position proportional relay output:  
Contact point 1a; 2 points, 250 V AC, 3 A or 30 V DC, 3 A (resistance load)  
\*: This should always be used with a load of 10 mA or more.

## Heater Break Alarm Specifications

- Number of inputs: 2
- Number of outputs: 2 (transistor contact output)
- Use: Measures the heater current using an external current transformer (CT) and generates a heater break alarm when the measured value is less than the break detection value.
- Current transformer input resistance: About 9.4  $\Omega$
- Current transformer input range: 0.0 to 0.1 Arms (0.12 Arms or more cannot be applied.)
- Heater current setting range: OFF, 0.1 to 300.0 Arms  
Heater current measured value display range: 0.0 to 360.0 Arms  
Note: The CT ratio can be set. CT ratio setting range: 1 to 3300
- Recommended CT: CT from U.R.D., Ltd.  
CTL-6-S-H: CT ratio 800, measurable current range: 0.1 to 80.0 Arms  
CTL-12L-30: CT ratio 3000, measurable current range: 0.1 to 180.0 Arms
- Heater current measurement period: 200 ms
- Heater current measurement accuracy:  $\pm 5\%$  of current transformer input range span  $\pm 1$  digit (CT error is not included.)
- Heater current detection resolution: Within 1/250 of current transformer input range span
- Break detection On-time: Min. 0.2 second (for time proportional output)

## Safety and EMC Standards

- Safety:  
Compliant with IEC/EN61010-1 (CE), IEC/EN61010-2-030 (CE), approved by CAN/CSA C22.2 No. 61010-1 (CSA), approved by UL61010-1.  
Installation category: II  
Pollution degree: 2  
Measurement category: I (CAT I) (UL, CSA)  
O (Other) (CE)  
Rated measurement input voltage: Max. 10 V DC  
Rated transient overvoltage: 1500 V (\*)  
\*: This is a reference safety standard value for measurement category I of IEC/EN/CSA/UL61010-1. This value is not necessarily a guarantee of instrument performance.
- EMC standards:  
Compliant with  
CE marking  
EN 61326-1 Class A, Table 2 (For use in industrial locations),  
EN 61326-2-3  
\*: The instrument continues to operate at a measurement accuracy of within  $\pm 20\%$  of the range during testing.  
EN 55011 Class A, Group 1  
EN 61000-3-2 Class A  
EN 61000-3-3  
EMC Regulatory Arrangement in Australia and New Zealand  
EN 55011 Class A, Group 1
- KC marking: Electromagnetic wave interference prevention standard, electromagnetic wave protection standard compliance

## Construction, Installation, and Wiring

- Dust-proof and drip-proof: IP66 (for front panel) (Not available for side-by-side close mounting)/NEMA4 \*  
\*: Hose-down test only
- Material: Polycarbonate (Flame retardancy: UL94V-0)
- Case color: White (Light gray) or Black (Light Charcoal gray)
- Weight: 0.5 kg or less
- External dimensions (mm): 96 (W)  $\times$  96 (H)  $\times$  65 (depth from the panel face)  
(Depth except the projection on the rear panel)
- Installation: Direct panel mounting; mounting bracket, one each for upper and lower mounting
- Panel cutout dimensions (mm): 92<sup>+0.8/0</sup> (W)  $\times$  92<sup>+0.8/0</sup> (H)
- Mounting attitude: Up to 30 degrees above the horizontal. No downward tilting allowed.
- Wiring: M3 screw terminal with square washer (for signal wiring and power wiring)



## Power Supply Specifications and Isolation

- Power supply:  
Rated voltage: 100-240 V AC (+10%/-15%), 50/60 Hz  
24 V AC/DC (+10%/-15%) (for /DC option)
- Power consumption: 18 VA (DC:9 VA, AC: 14 VA if /DC option is specified)
- Data backup: Nonvolatile memory
- Power holdup time: 20 ms (for 100 V AC drive)
- Withstanding voltage  
Between primary terminals and secondary terminals:  
2300 V AC for 1 minute (UL, CSA)  
Between primary terminals and secondary terminals:  
3000 V AC for 1 minute (CE)  
Between primary terminals: 1500 V AC for 1 minute  
Between secondary terminals: 500 V AC for 1 minute  
(Primary terminals: Power\* and relay output terminals; Secondary terminals: Analog I/O signal terminals, contact input terminals, communication terminals and functional grounding terminals.)  
\*: Power terminals for 24V AC/DC models are the secondary terminals.
- Insulation resistance: Between power supply terminals and a grounding terminal 20 MΩ or more at 500 V DC
- Isolation specifications

PV (universal ) input terminals	Internal circuits	Power supply
Remote (universal) input terminals with direct input / Remote input terminals		
Aux. analog (AIN2) input terminals		
Aux. analog (AIN4) input terminals		
Control, retransmission (analog) output terminals (not isolated between the analog output terminals) Valve position (feedback) input terminals		
Control relay (contact point c) output terminals		
PV event-1 relay (contact point a) output terminals		
PV event-2 relay (contact point a) output terminals		
PV event-3 relay (contact point a) output terminals		
Position proportional relay output terminals		
Contact input terminals (all) RS-485 communication terminals (2 ports)		
Contact output (transistor) terminals		
Ethernet communication terminal		
PROFIBUS-DP/DeviceNet/CC-Link communication terminals		
Current transformer input terminals		

The circuits divided by lines are insulated mutually.

## Transportation and Storage Conditions:

- Temperature: -25 to 70°C
- Temperature change rate: 20°C/h or less
- Humidity: 5 to 95% RH (no condensation allowed)

## Effects of Operating Conditions

- Effect of ambient temperature:  
Voltage or TC input:  $\pm 1 \mu\text{V}/^\circ\text{C}$  or  $\pm 0.01\%$  of F.S./ $^\circ\text{C}$ , whichever is larger  
Current input:  $\pm 0.01\%$  of F.S./ $^\circ\text{C}$   
RTD input:  $\pm 0.05^\circ\text{C}/^\circ\text{C}$  (ambient temperature) or less  
Analog output:  $\pm 0.02\%$  of F.S./ $^\circ\text{C}$  or less
- Effect of power supply voltage fluctuation  
Analog input:  $\pm 0.05\%$  of F.S. or less  
Analog output:  $\pm 0.05\%$  of F.S. or less  
(Each within rated voltage range)

## Environmental Conditions

### Normal Operating Conditions:

- Ambient temperature: -10 to 50°C (side-by-side close mounting: -10 to 40 °C)  
0 to 50 °C if the CC-Link option is specified. (side-by-side mounting: 0 to 40 °C)
- Ambient humidity: 20 to 90% RH (no condensation allowed)
- Magnetic field: 400 A/m or less
- Continuous vibration at 5 to 9 Hz: Half amplitude of 1.5 mm or less, 1oct/min for 90 minutes each in the three axis directions  
Continuous vibration at 9 to 150 Hz: 4.9 m/s<sup>2</sup> or less, 1oct/min for 90 minutes each in the three axis directions
- Short-period vibration: 14.7 m/s<sup>2</sup>, 15 seconds or less
- Shock: 98 m/s<sup>2</sup> or less, 11 ms
- Altitude: 2000 m or less above sea level
- Warm-up time: 30 minutes or more after the power is turned on
- Startup time: Within 10 seconds  
\*: The LCD (a liquid crystal display) is used for a display portion of this product. The LCD has a characteristic that the display action becomes late at the low temperature. However, the control function is not affected.

# Block Diagram

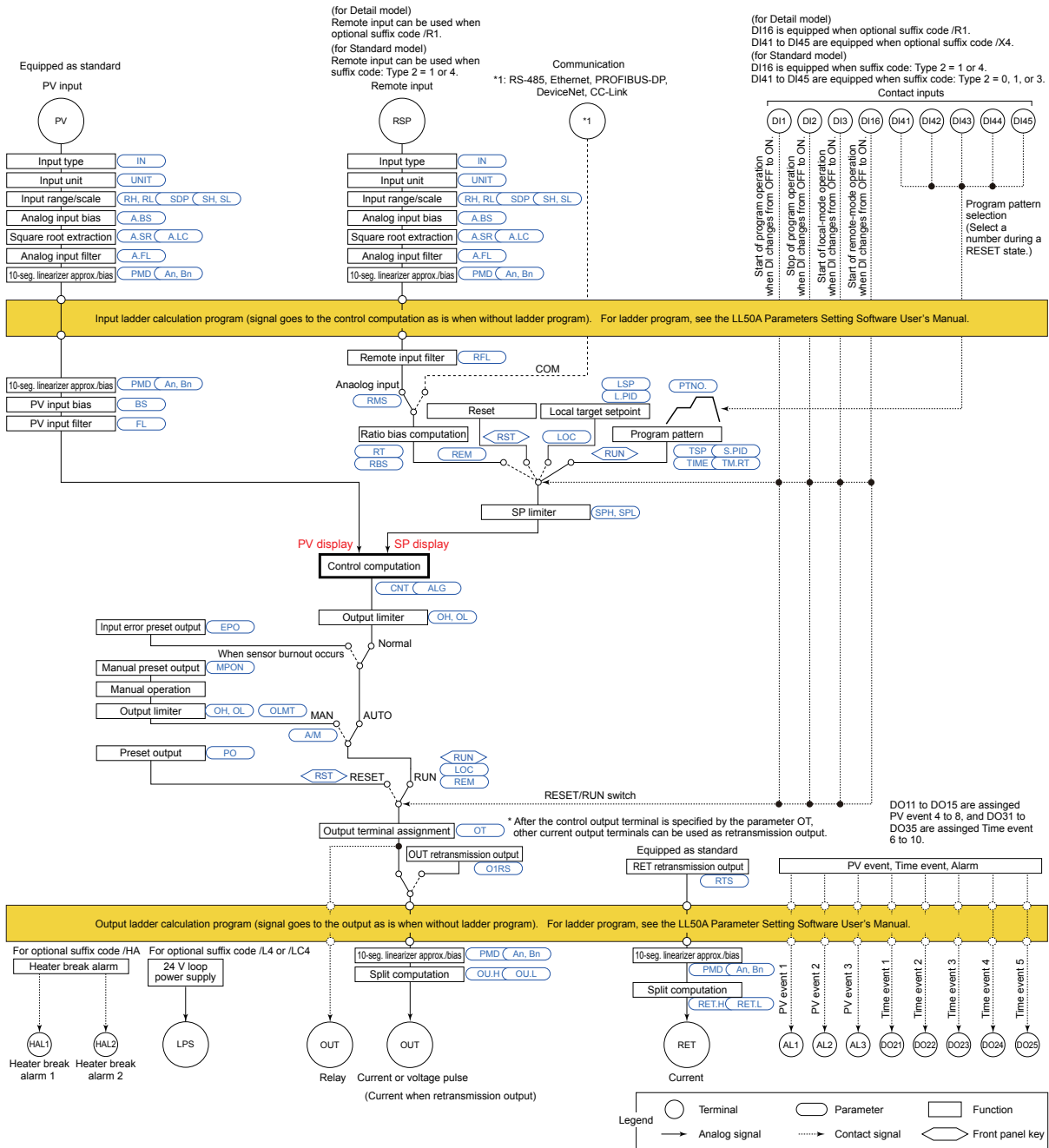

# Terminal Arrangement

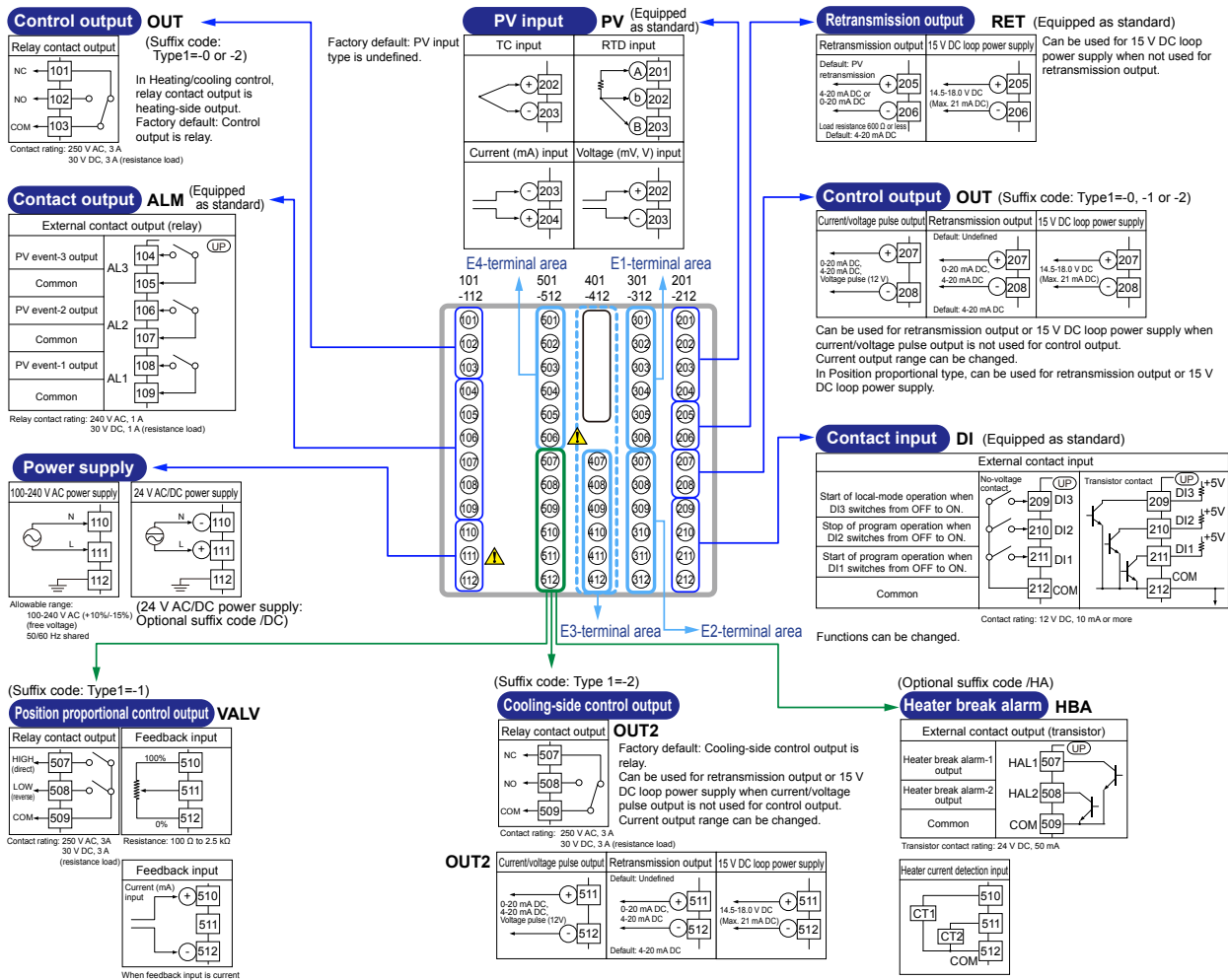

## 301-306 E1-Terminal Area

(Suffix code: Type 2=1 or 4 and without optional suffix code /DR)

### Remote input / Contact input RSP

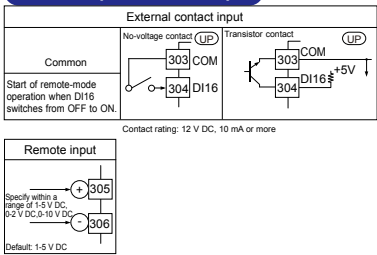

(Suffix code: Type 2=1 or 4 and with optional suffix code /DR)

### Universal input (Remote input) RSP

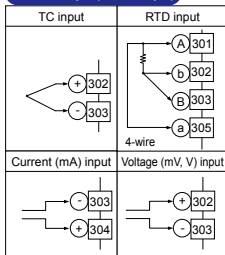

(Suffix code: Type 2=2)

### Contact input DI

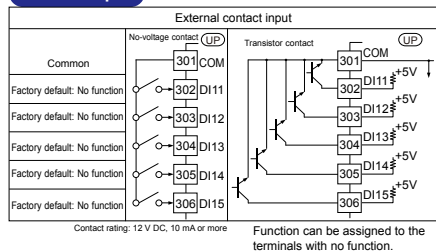

(Suffix code: Type 2=3)

### Contact output DO

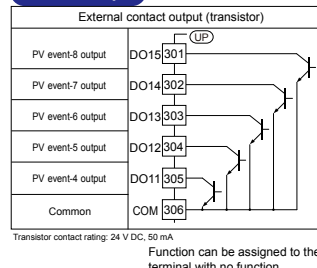

## 307-312 E2-Terminal Area

(Equipped as standard, however suffix code: Type 2= except 4)

### Contact output DO

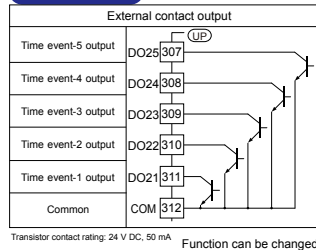

(Suffix code: Type 2=4)

### Aux. analog input / Contact input AIN2

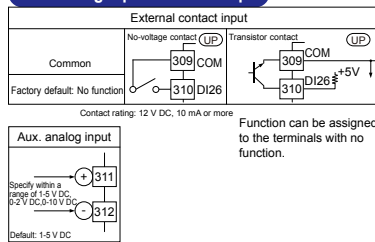

401-412 E3-Terminal Area

**Contact output DO** (Suffix code: Type 2=3)

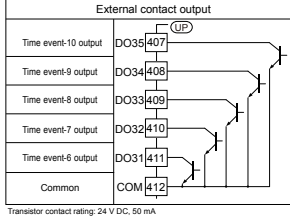

Function can be assigned to the terminals with no function.

Transistor contact rating: 24 V DC, 50 mA

**RS-485 communication RS485**

(Suffix code: Type 3=1, except Type 2=3)

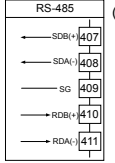

**PROFIBUS-DP communication (with Modbus master)**

**PROF** (Suffix code: Type 3=4, except Type 2=3)

If the UP is located at the end of a segment for the PROFIBUS communication wiring, terminating resistors are separately needed. These are to be prepared by users. (390 Ω; 2 pcs. 220 Ω; 1 pc. or an active terminator.)

Pin	Signal name	Description
1	VP	+5V bus power
2	RxD/TxD-P	Data signal (positive data receive/transmit)
3	RxD/TxD-N	Data signal (negative data receive/transmit)
4	DGND	Signal ground
5	SHIELD	Shield ground

LED	Lit	Unit
CHK (red)	User profile error	Normal
RDY (green)	Normal Communicating successfully	No electricity, or Communication failure
ERR (red)	Not connected, or communication failure (flashing)	Normal

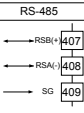

**Ethernet communication (with gateway function)**

**ETHR** (Suffix code: Type 3=2, except Type 2=3)

10BASE-T/100BASE-TX RJ45 connector

Upper side LED (baud rate)	
Color	Amber
Lit	100M bps
Unit	10M bps

Lower side LED (link activity)	
Color	Green
Lit	Linked
Blink	Active
Unit	Link failure

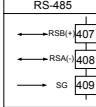

**DeviceNet communication (with Modbus master)**

**DNET** (Suffix code: Type 3=5, except Type 2=3)

If the UP is located at the end of a segment for the DeviceNet communication wiring, terminating resistors are separately needed. These are to be prepared by users. (121 Ω; 1 pc.)

Pin	Signal name	Description
1	V+	DeviceNet power supply 24V
2	CAN_H	RX/TX + signal
3	DRAIN	Shield/Drain wire
4	CAN_L	RX/TX - signal
5	V-	DeviceNet power supply common

LED	Lit/flashing	Unit
CHK (red)	User profile error	Normal
MNS (green/red)	Normal Communicating successfully (green, lit), Not connected (green, flashing), Critical link failure (red, lit), Communication timeout (red, flashing), At power-on/Communication faulted (green/red, flashing)	No electricity

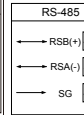

**CC-Link communication (with Modbus master)**

**CC-L** (Suffix code: Type 3=3, except Type 2=3)

If the UP is located at the end of a segment for the CC-Link communication wiring, terminating resistors are separately needed. These are to be prepared by users. (110 Ω; 1 pc.)

Pin	Signal name	Description
1	FG	Frame ground
2	SLD	Shield
3	DG	RX/TX signal ground
4	DB	RX/TX - signal
5	DA	RX/TX + signal

LED	Lit	Unit
CHK (red)	User profile error / Address error	Normal
L.ERR (red)	Communication failure (CRC error)	Normal
L.RUN (green)	Normal Communicating successfully	No carrier detected / Connection timeout

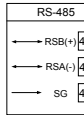

501-506 E4-Terminal Area

(Equipped as standard, however suffix code: Type 2= except 2 and 4)

**Contact input DI**

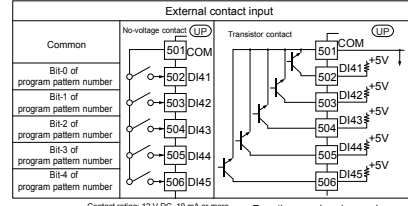

A program pattern is selected with the combination of ON and OFF of a contact input. In the case of a pattern 5, ON (1) of "DI45 to DI41" and OFF (0) is represented as a binary number "00101"; it is "5" decimally. The pattern 13 or later can be selected similarly.

	Program pattern number											
	1	2	3	4	5	6	7	8	9	10	11	12
DI41	ON	OFF	ON	OFF	ON	OFF	ON	OFF	ON	OFF	ON	OFF
DI42	OFF	ON	ON	OFF	OFF	ON	ON	OFF	OFF	ON	ON	OFF
DI43	OFF	OFF	OFF	ON	ON	ON	ON	OFF	OFF	OFF	OFF	ON
DI44	OFF	OFF	OFF	OFF	OFF	OFF	OFF	ON	ON	ON	ON	ON
DI45	OFF	OFF	OFF	OFF	OFF	OFF	OFF	OFF	OFF	OFF	OFF	OFF

**RS-485 communication RS485**

(Suffix code: Type 2=2)

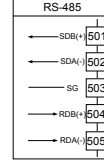

**Aux. analog input/Contact input AIN4**

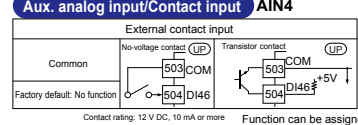

Function can be assigned to the terminals with no function.

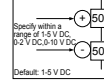

External Dimensions and Panel Cutout Dimensions

UP55A

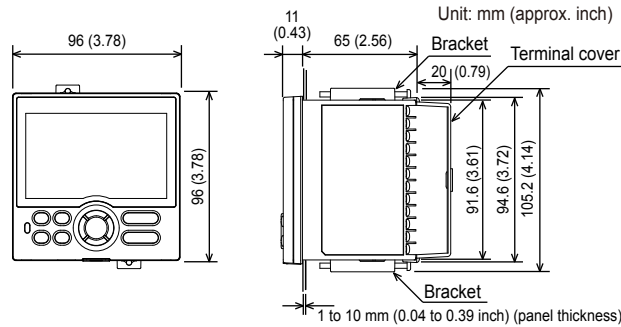

• General mounting

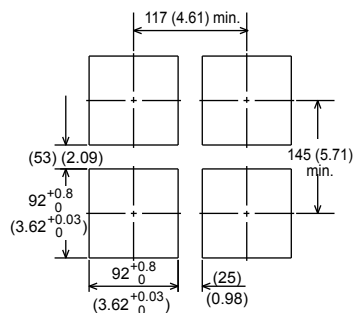

• Side-by-side close mounting

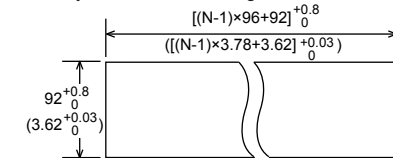

"N" stands for the number of controllers to be installed. However, the measured value applies if N ≥ 5. Normal tolerance: ±(value of JIS B 0401-1998 tolerance class IT18)/2

## ■ Model and Suffix Code

Model	Suffix code	Optional suffix code	Description
<b>UP55A</b>			Program Controller (Power supply: 100-240 V AC) 30 program patterns / 300 program segments (99 program patterns / 600 program segments when the option /AP is specified. Max. 99 segments per pattern) (provided with retransmission output or 15 V DC loop power supply, 8 DIs, and 8 DOs)
Type 1: Basic control	-0		Standard type
	-1		Position proportional type
	-2		Heating/cooling type
Type 2: Functions	0		None
	1		Remote (1 additional aux. analog) input, 1 additional DI
	2		RS-485 communication (Max.19.2 kpbs, 2-wire/4-wire)
	3		10 additional DOs <sup>(1)</sup>
	4		3 additional aux. analog inputs, 2 DIs and 5 DOs to be deleted
Type 3: Open networks	0		None
	1		RS-485 communication (Max.38.4 kbps, 2-wire/4-wire)
	2		Ethernet communication (with serial gateway function)
	3		CC-Link communication (with Modbus master function)
	4		PROFIBUS-DP communication (with Modbus master function)
Display language <sup>(2)</sup>	-1		English (Default. Can be switched to other language by the setting.)
	-2		German (Default. Can be switched to other language by the setting.)
	-3		French (Default. Can be switched to other language by the setting.)
	-4		Spanish (Default. Can be switched to other language by the setting.)
Case color	0		White (Light gray)
	1		Black (Light charcoal gray)
Fixed code		-00	Always "-00"
Optional suffix codes		/AP	69 additional patterns/300 additional segments
		/DR	Additional direct input (TC and 3-wire/4-wire RTD) and current input to Remote (1 additional aux. analog) input, 1 DI to be deleted <sup>(3)</sup>
		/HA	Heater break alarm <sup>(4)</sup>
		/DC	Power supply 24 V AC/DC
		/CT	Coating <sup>(5)</sup>

\*1: When the Type 2 code is "3", only "0" can be specified for the Type 3 code.

\*2: English, German, French, and Spanish are available for the guide display.

\*3: The /DR option can be specified only when the Type 2 code is "1" or "4."

\*4: The /HA option can be specified only when the Type 1 code is "-0."

\*5: When the /CT option is specified, the UP55A does not conform to the safety standards (UL and CSA) and CE marking (Products with /CT option are not intended for EEA-market).

## ■ Items to be specified when ordering

Model and suffix codes, whether User's Manual and QIC required.

## ■ Standard accessories

Terminal cover, Brackets (mounting hardware), Unit label, and Operation Guide for Single-loop Control.

## ■ Special Order Items

Name	Model
Terminal cover	UTAP001
User's Manual (CD)	UTAP003

Model code	Suffix code	Description
LL50A	-00	Parameter Setting Software
X010	See the General Specifications (*)	Resistance Module

\*: Necessary to input the current signal to the voltage input terminal.

## User's Manual

Product user's manuals can be downloaded or viewed at the following URL. To view the user's manual, you need to use Adobe Reader 7 or later by Adobe Systems.

URL: <http://www.yokogawa.com/ns/ut/im/>