

**LL50A**  
**Parameter Setting Software**  
with Ladder Program Building Function and  
Network Profile Creating Function

IM 05P05A01-02EN

---

# Product Registration

Thank you for purchasing YOKOGAWA products.

Please register to the following Partner Portal Member Site.  
You can use various services such as confirmation of purchased product information,  
download of related materials, and newsletter.

***<https://myportal.yokogawa.com/>***



## Introduction

Thank you for purchasing the digital indicating controller UTAdvanced Series and LL50A Parameter Setting Software.

This manual describes how to use LL50A and network profile tool, ladder program function. Please read through this user's manual carefully before using the product.

The following manuals are also available for this software and the main units.

- **Printed manual**

Manual Name	Manual Number	Description
LL50A Parameter Setting Software Installation Manual	IM 05P05A01-01EN	This manual describes how to install and uninstall the LL50A.

- **Electronic manuals**

Manual Name	Manual Number	Description
UT35A/UT32A Operation Guide (for Standard model)	IM 05P01D31-11EN	This manual describes basic operation of the UT35A/UT32A.
UT35A/UT32A Operation Guide (for Detailed model)	IM 05P01D31-15EN	Ditto
UT35A/MDL, UT32A/MDL (Mount on DIN Rail type) Operation Guide	IM 05P01D81-11EN	This manual describes basic operation of the UT35A/MDL and UT32A/MDL.
UT35A/RSP, UT32A/RSP (with non-isolated remote input) Operation Guide	IM 05P01D81-11EN	This manual describes basic operation of the UT35A/RSP and UT32A/RSP.
UT35A/UT32A User's Manual	IM 05P01D31-01EN	This manual describes the usage of all functions except the ladder sequence and communication functions.
UT32A (Entry Model) Operation Guide	IM 05P01F31-11EN	This manual describes basic operation of the UT32A (Entry Model).
UT32A (Entry Model) User's Manual	IM 05P01F31-01EN	This manual describes the usage of all functions except the ladder sequence and communication functions.
UT32A-D (Dual-loop type) Operation Guide	IM 05P08D31-11EN	This manual describes basic operation of the UT32A-D.
UT32A-D/MDL (Dual-loop, Mount on DIN Rail type) Operation Guide	IM 05P08D81-11EN	This manual describes basic operation of the UT32A-D/MDL.
UT32A-D (Dual-loop type) Operation Guide	IM 05P08D31-01EN	This manual describes the usage of all functions except the ladder sequence and communication functions.
UT55A/UT52A Operation Guide (for Standard model)	IM 05P01C31-11EN	This manual describes basic operation of the UT55A/UT52A.
UT55A/UT52A Operation Guide (for Detailed model)	IM 05P01C31-15EN	Ditto
UT55A/MDL, UT52A/MDL (Mount on DIN Rail type) Operation Guide	IM 05P01C81-11EN	This manual describes basic operation of the UT55A/MDL and UT52A/MDL.
UT55A/UT52A User's Manual	IM 05P01C31-01EN	This manual describes the usage of all functions except the ladder sequence and communication functions.
UT75A Operation Guide	IM 05P01B41-11EN	This manual describes basic operation of the UT75A.
UT75A User's Manual	IM 05P01B41-01EN	This manual describes the usage of all functions except the ladder sequence and communication functions.
UP55A Operation Guide (for Standard model)	IM 05P02C41-11EN	This manual describes basic operation of the UP55A.
UP55A Operation Guide (for Detailed model)	IM 05P02C41-15EN	Ditto
UP55A User's Manual	IM 05P02C41-01EN	This manual describes the usage of all functions except the ladder sequence and communication functions.
UP35A/UP32A Operation Guide (for Standard model)	IM 05P02D41-11EN	This manual describes basic operation of the UP35A/UP32A.
UP35A Operation Guide (for Detailed model)	IM 05P02D41-15EN	This manual describes basic operation of the UP35A.
UP35A/UP32A User's Manual	IM 05P02D41-01EN	This manual describes the usage of all functions except the ladder sequence and communication functions.
UM33A Operation Guide	IM 05P03D21-11EN	This manual describes basic operation of the UM33A.
UM33A User's Manual	IM 05P03D21-01EN	This manual describes the usage of all functions except the communication functions.

Manual Name	Manual Number	Description
UT32A-D Operation Guide (for Standard model)	IM 05P08D31-11EN	This manual describes basic operation of the UT32A-D.
UT32A-D User's Manual	IM 05P08D31-01EN	This manual describes the usage of all functions except the ladder sequence and communication functions.
UTAdvanced Series Communication Interface (RS-485, Ethernet) User's Manual	IM 05P07A01-01EN	This manual describes how to use UTAdvanced in Ethernet and serial communications. For communication wiring, see the Operation Guide or User's Manual.
UTAdvanced Series Communication Interface (Open Network) User's Manual	IM 05P07A01-02EN	This manual describes how to use the UTAdvanced in PROFIBUS-DP/DeviceNet/CC-Link communication. For communication wiring, see the Operation Guide or User's Manual.
LL50A Parameter Setting Software Installation Manual	IM 05P05A01-01EN	This manual describes how to install and uninstall the LL50A.
LL50A Parameter Setting Software User's Manual	IM 05P05A01-02EN	This manual. This manual describes how to use the LL50A, ladder sequence function, peer-to-peer communication, and network profile creating function.

## Notice

- The contents of this manual are subject to change without notice as a result of continuing improvements to the instrument's performance and functions.
- Every effort has been made to ensure accuracy in the preparation of this manual. Should any errors or omissions come to your attention, however, please inform Yokogawa Electric's sales office or sales representative.
- Under no circumstances may the contents of this manual, in part or in whole, be transcribed or copied without our permission.

## Trademarks

- Our product names or brand names mentioned in this manual are the trademarks or registered trademarks of Yokogawa Electric Corporation (hereinafter referred to as YOKOGAWA).
- Microsoft, MS-DOS, and Windows are either registered trademarks or trademarks of Microsoft Corporation in the United States and/or other countries.
- Adobe, Acrobat, and Postscript are either registered trademarks or trademarks of Adobe Systems Incorporated.
- Ethernet is a registered trademark of XEROX Corporation in the United States.
- Modbus is a registered trademark of Schneider Electric.
- PROFIBUS-DP is a registered trademark of PROFIBUS User Organization.
- DeviceNet is a registered trademark of Open DeviceNet Vender Association, Inc.
- CC-Link is a registered trademark of CC-Link Partner Association (CLPA.)
- We do not use the TM or ® mark to indicate these trademarks or registered trademarks in this user's manual.
- All other product names mentioned in this user's manual are trademarks or registered trademarks of their respective companies.

# Release Number

The LL50A Parameter Setting Software is a software suite of parameter setting and network profile creating tools.

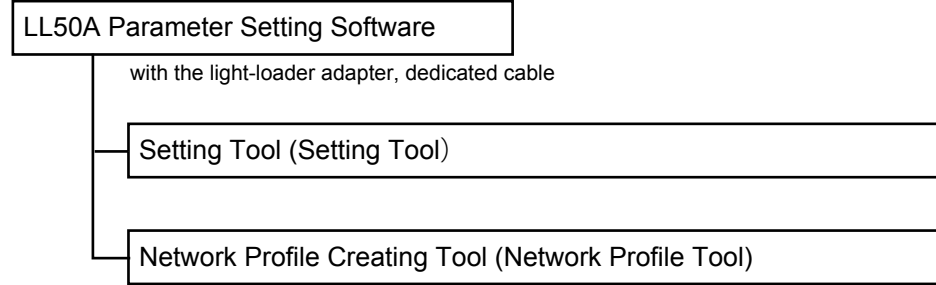

The release numbers of LL50A Parameter Setting Software and each tool are as follows:

LL50A Parameter Setting Software	Setting Tool	Network Profile Creating Tool
R1.01	R1.01.**	None
R1.02	R1.01.**	R1.01.**
R2.01	R2.01.**	R1.01.**
R2.02	R2.02.**	R2.01.**
R3.01	R3.01.**	R3.01.**
R3.01.**	R3.01.**	R3.01.**
R4.01.**	R4.01.**	R3.01.**
R5.01.**	R5.01.**	R4.01.**
R6.01.**	R6.01.**	R5.01.**
R6.02.**	R6.02.**	R5.01.**
R6.03.**	R6.03.**	R5.02.**

The release number of the Setting Tool can be found by the operation in section 2.19. For the Network Profile Tool, the release number can be found by the operation in section 6.13.

# LL50A Parameter Setting Software LICENSE AGREEMENT

## ATTENTION! -

Please read this LICENSE AGREEMENT (hereinafter referred to as the "Agreement") carefully before installing this package software product of Yokogawa Electric Corporation (hereinafter referred to as "Yokogawa") on the computer.

Installing this package software product indicates your acceptance of the terms and conditions of this Agreement. If you are not the end user, transferring this package software product indicates your acceptance of the terms and conditions of this Agreement and you are required to cause the transferee agree to and observe the terms and conditions of this Agreement. If you don't accept the terms and conditions of this Agreement, please kindly return this package software product, without installing it, to the seller or Yokogawa immediately.

### 1. Grant of License

- (1) The terms and conditions of this Agreement shall apply to the following package software of Yokogawa (herein after referred to as "Package Software Product").  
Product: LL50A, Parameter Setting Software and materials related thereto that Yokogawa designates  
Number of license: One (1)
- (2) The Package Software Product herein shall include; without limitation, a software program, font, data base, data put into fill-in-the-form, instruction manual, functional specifications, materials related thereto image, photograph, animation, video image, sound, music, text all of which are incorporated into software component (program) and applet. ("applet" means software component (program) incorporated into text or icon.)

### 2. Terms and Conditions of License

- (1) Yokogawa grants you, for the purpose of your own use, non-exclusive and non-transferable license of the Package Software Product on designated computer agreed by both parties in consideration of the license fee agreed separately by the both parties.
- (2) Unless otherwise agreed or provided by Yokogawa in writing, the following acts are prohibited:
  - a) to reproduce the Package Software Product;
  - b) to sell, lease, distribute, transfer, pledge, sublicense, make available via the network or otherwise convey the Software or the license granted herein to any other person or entity;
  - c) to use the Package Software Product on any unauthorized hardware via the network;
  - d) to cause, permit or attempt to dump, disassemble, decompile, reverse-engineer, or otherwise translate or reproduce the Package Software Product into source code or other human readable format, or to revise or translate the Package Software Product into other language and change it to other formats than that in which Yokogawa provided;
  - e) to cause, permit or attempt to remove any copy protection used or provided in the Package Software Product;
  - f) to remove any copyright notice, trademark notice, logo or other proprietary notices or identification shown in the Package Software Product;
  - g) to develop or have developed derivative software or other computer programs which are based on the Package Software Product unless otherwise permitted by Yokogawa in writing; or
  - h) to use the Package Software Product in the way prohibited by any Instruction Manual, guidelines, or instructions etc. regarding the Package Software Product.
- (3) The Package Software Product including all proprietary technology, algorithm, and know-how such as a factor, invariant or process contained therein shall be the proprietary property or trade secret of Yokogawa or a third party which grants Yokogawa the rights.
- (4) The proprietary property and/or trade secret as defined in the preceding Article 2.(3) shall not be published or disclosed to any third parties except for your limited employees or equivalents thereto who need to have access thereto. You are also required to impose no less stringent confidentiality obligation than herein the on them.
- (5) The Package Software Product and the all copy and duplicates thereof shall be returned to Yokogawa or the party designated by Yokogawa immediately after the expiration or termination of this Agreement. Alternatively, if Yokogawa requires in writing to you that all the Package Software Product is destroyed or disposed, all the information therein shall be deleted completely.
- (6) The Package Software Product may include software program of a third party (hereinafter called "Third Party Software", which may include any software program made and provided by Yokogawa's affiliate) granting Yokogawa the right to sublicense. In the case the different terms and conditions from this Agreement shall apply to Yokogawa's sublicense of such Third Party Software, you shall observe such terms and conditions of which Yokogawa notifies you in writing separately.
- (7) You shall not subject the Package Software Product, in whole or in part, to any license obligations associated with Open Source Software. "Open source Software" means any software that requires as a condition of use, modification or distribution of such software (i) be disclosed or distributed in source code form.; or (ii) be licensed by the user to third parties for the purpose of making or distributing derivative works; or (iii) be distributed at no charge. Open Source Software includes, without limitation, software licensed or distributed under any of the following licenses or distribution models, or licenses or distribution models similar to any of the following: GNU's General Public License (GPL) or Lesser/Library GPL (LGPL), the Artistic license (e.g. PERL), the Mozilla Public License, the Netscape Public License, the Sun Community source License (SCSL), the Sun Industry Source License (SISL), the Apache Software License and the Common Public License (CPL), or the Berkeley Software Development (BSD).

### 3. Limitation for Specific Uses

- (1) Unless otherwise agreed by both parties in writing, the Package Software Product shall not be intended to be specifically designed, manufactured or distributed for the purpose of operation of any aviation, vessel, support of those operations from the ground, or for any design, construction, maintenance, operation and/or use of nuclear products and/or facilities.
- (2) Even if you use the Package Software Product for the purpose of preceding Article 3.(1), Yokogawa disclaims any responsibilities, warranties, liabilities, claims or damages whatsoever similar thereto arising out of the use or operations of the Package Software Product for such purpose and you shall indemnify and hold harmless Yokogawa including without limitation its officers, employees, sales representatives, and their officers and employees, from any claim, suit, demand, damage, and similar thereto (including reasonable attorneys' fees).

### 4. Warranty

- (1) During the warranty period defined in this Article 4.(4) below (hereinafter called "Warranty Period"), Yokogawa warrants that the Package Software Product shall properly function in accordance with the Instruction Manual or Functional Specifications of Yokogawa, on the hardware under the environmental or other conditions designated by the vendor of such hardware or by Yokogawa. However, in no event shall Yokogawa warrant the following under any operating environment and circumstance.  
The Package Software Product ;
  - a) will never be interrupted
  - b) will never be free from defect
  - c) will be completely corrected
  - d) will be free from any cross interference such as cross conflict with other software program
  - e) will satisfy your or your customer's any particular and/or prospective purpose
  - f) will be accurate, correct, reliable or most up-dated
  - g) will be free from vulnerability (including but not limited to vulnerability to intrusion or attack caused by computer virus or unauthorized access or the like).
- (2) During the Warranty Period, if the Package Software Product fails to operate in accordance with the steps of the instruction manual or functional specifications attributable to Yokogawa, or if defect(s) such as damage of a media of the Package Software Product attributable to Yokogawa is found, Yokogawa agrees to either repair or replace, free of charge, any Package Software Product which shall be returned to Yokogawa's nearest authorized service facility immediately at your expense; where delivery point hereunder of the Package Software Product is outside of Japan, re-import tax and other charges shall be also borne by you. Further, in the case that repair or replacement of the Package Software Product requires additional works such as loading of the same at the site by Yokogawa or any person designated by Yokogawa is needed, such cost and expense for the works shall be borne by you and you shall initialize or shut down the system and other related system, products or equipment, if deemed necessary at Yokogawa's sole judgment.

- 
- (3) Notwithstanding the preceding Article 4.(2), Yokogawa's warranty shall not apply if the defect of the Package Software Product is caused by any of the followings;
- where hardware on which the Package Software Product operates becomes out of warranty of the vendor and proper maintenance contract for the hardware is not in place;
  - where, if Yokogawa designates hardware on which the Package Software Product operates, you changed such hardware to other hardware without Yokogawa's consent;
  - where any third party other than entrusted by Yokogawa conducted renovation, or improvement of the Package Software Product;
  - where hardware on which the Package Software Product operates was moved by you or any third party without Yokogawa's consent;
  - where you or a party you designate (including your customer) misused, renovated, up-graded, or used the Package Software Product for any other purpose than set forth in the Instruction Manuals etc.;
  - where the Package Software Product was used or operated under the different operating environment and/or other conditions than the terms designated by Yokogawa or provider of hardware ;
  - where you or your customer does not execute the proper trouble or non-conformity avoiding measures (including repair or replacement) Yokogawa proposed; or other cause of defect not attributable to Yokogawa
- (4) The Warranty Period shall be the twelve (12) month period from the date when Yokogawa complete the delivery at the place designated by you (including your customer) or you or your customer use part or whole of the Package Software Product for the operation, whichever comes first, unless otherwise agreed in writing by Yokogawa.
- (5) Under separate maintenance contract, Yokogawa may conduct maintenance service for the Package Software Product, at the expense of you even after the Warranty period. The maintenance service for the Package Software Product shall be classified into those of standard software, customized software.
- Standard Software**  
Standard Software herein means the standard package software covered by Yokogawa's Catalogue and/or General Specifications. The maintenance service for Standard Software may be available for the latest two versions unless otherwise covered by Yokogawa's Catalogue and/or General Specifications. However, the maintenance service for the Package Software Product which is the earlier version among the latest two versions may be available only for five (5) years after the last up-dated. The maintenance service for the Package Software Product declared by Yokogawa to discontinue order acceptance may be available for five (5) years after such declaration.
  - Customized Software**  
Customized Software herein means the software customized by Yokogawa pursuant to the Quotation or Functional Specifications agreed by both parties. The maintenance service for the Customized Software shall not be available to you including your customer after the Warranty Period unless otherwise separately agreed by both parties. However, such maintenance service may be conducted at your expense as remodeling contract agreed by the both parties.
- (6) Notwithstanding the preceding Article 4.(1), 4.(2), 4.(3), 4.(4) and 4.(5), on the third party's software, warranty, including warranty period, of such third party provider shall apply.

#### **5. Revision-Up Package Software**

When you receive the revision-up of the Package Software Product which is substituted for or is added to the Package Software Product ("Revision-Up"), you can install such Revision-Up in the computer(s) on which you use the Package Software Product. Furthermore, the Revision-Up shall be considered as the Package Software Product and you shall agree to comply with the terms and conditions of this Agreement in order to use the Revision-Up.

#### **6. If You are not the End User**

If you are not the end user of the Package Software Product, you shall present the terms and conditions of this Agreement to your end user and cause your end user to observe such terms and conditions. If Yokogawa incurs damage due to your end user's breach of such terms and conditions as set forth herein, you shall indemnify and hold Yokogawa harmless as set forth herein above. In this case, it is the end user that is granted the license of the Package Software Product by Yokogawa and if you are not the end user, you shall transfer the possession of media and related materials of the Package Software Product to your end user.

#### **7. Intellectual Property Infringement**

- If and when any third party should demand injunction, initiate a law suit, or demand damages against you under patent right, utility model right, design patent right, trademark right, copyright and/or any other right relating to any of the Package Software Product including but not limited to its related materials, you shall notify Yokogawa of that effect in writing without delay.
- In case of preceding Article 7.(1), you shall assign to Yokogawa all of the rights to defend you, to negotiate and to settle with the claiming party. Furthermore, you shall provide Yokogawa with necessary information or any other assistance for Yokogawa's defense and negotiation. If and when such a claim should be attributable to Yokogawa, Yokogawa shall defend you and negotiate with the claiming party at Yokogawa's cost and expense and be responsible for the final settlement or judgment granted to the claiming party in the preceding Article 7.(1).  
Provided, however, that Yokogawa shall have no liability for any claim of infringement in the preceding Article 7.(1) if based on:
  - use of other than the latest version of Package Software Product made available to you, if the infringement would have been avoided by use of such version;
  - addition to Package Software Product of any other software or program not advised or recommended by Yokogawa, if the infringement would have been avoided without such addition;
  - the combination or use of Package Software Product with software or program not furnished by Yokogawa if such infringement would have been avoided by use of Package Software Product with Yokogawa software or program alone; or any other cause not within the control of Yokogawa.
- When any assertion of the infringement of third party's right defined in Article 7. (1) is made or when, at Yokogawa's judgment, there is possibility of such assertion, Yokogawa will, at its discretion and not obligation, take any of the following countermeasures at Yokogawa's cost and expense.
  - To acquire the necessary right from a third party which has lawful ownership of the right so that you will be able to continue to use the Package Software Product;
  - To replace the Package Software Product with the one, which avoids the infringement;
  - To remodel the Package Software Product so that the Package Software Products can avoid the infringement of such third party's right; or
  - If and when Yokogawa fails to take either of the countermeasures set forth in a. through c. above, Yokogawa shall indemnify you only by paying back the price amount of the Package Software Product, which Yokogawa has already received.

#### **8. Limitation of Liability**

If and when you should incur any damage relating to the Package Software Product Yokogawa provided to you under this Agreement, due to the reason attributable to Yokogawa, Yokogawa shall take actions in accordance with this Agreement. HOWEVER, EXCEPT TO THE EXTENT THAT LIABILITY MAY NOT LAWFULLY BE EXCLUDED OR LIMITED BY CONTRACT, YOKOGAWA AND SUPPLIERS SHALL NOT BE LIABLE TO ANY PERSON OR LEGAL ENTITY FOR INDIRECT, SPECIAL, INCIDENTAL, CONSEQUENTIAL OR EXEMPLARY DAMAGES, OR OTHER SIMILAR DAMAGES OF ANY KIND, INCLUDING WITHOUT LIMITATION, DAMAGES FOR LOSS OF BUSINESS PROFITS, BUSINESS INTERRUPTION, LOSS OF MATERIALS OR PRODUCTS, LOSS OF PRODUCTION, LOSS OF CONTRACTS, LOSS OR DESTRUCTION OF DATA, LOSS OF AVAILABILITY AND THE LIKE, ARISING OUT OF THE USE OR INABILITY TO USE OF THE PACKAGE SOFTWARE PRODUCT, OR ARISING OUT OF ITS GENERATED APPLICATIONS OR DATA, EVEN IF ADVISED OF THE POSSIBILITY OF SUCH DAMAGES, WHETHER BASED IN WARRANTY (EXPRESS OR IMPLIED), CONTRACT, STRICT LIABILITY, TORT (INCLUDING NEGLIGENCE), OR ANY OTHER LEGAL OR EQUITABLE GROUNDS. IN NO EVENT YOKOGAWA AND SUPPLIER'S AGGREGATE LIABILITY FOR ANY CAUSE OF ACTION WHATSOEVER SHALL EXCEED THE GREATER OF ONE HUNDRED (100) U.S. DOLLARS.

#### **9. Term**

This Agreement shall become effective from the date when you receive the Package Software Product and continues in effect unless or until early terminated as provided in Article 15 hereof, either party gives thirty (30) days prior written notice to the other party or you cease using the Package Software Product by itself.

#### **10. Injunction for Use**

During the term of this Agreement, Yokogawa may, at its own discretion, demand an injunction against you and your customer in case Yokogawa deems the Package Software Product is used improperly or under severer environments than those Yokogawa first granted or any other condition which Yokogawa may not permit.



---

**11. Confidentiality Obligation**

- (1) You agree that the structure, organization and code of the Package Software Product are the valuable trade secrets of Yokogawa or third party which grants Yokogawa the rights and the Package Software Product contains other proprietary information and know-how of Yokogawa and its third party, which may be disclosed for the purpose of license granted hereunder. You shall not divulge any of such trade secrets, information and know-how to any third party without Yokogawa's consent and shall not use for any purpose other than license use.
- (2) You shall maintain the Package Software Product, its media, any printing material and any copy thereof in strict confidence and with utmost care to comply with the said secrecy obligation and protect the right of Yokogawa and third party which grants Yokogawa the rights.

**12. Assignment**

You shall not assign its rights or obligations under this Agreement without prior written consent of Yokogawa. If you novate or assign this Agreement and the Package Software Product with Yokogawa's consent, you shall transfer all copies and whole part of the Package Software Product to the assignee and shall delete any and all copy of the Package Software Product in possession irretrievably. This Agreement shall inure to the benefit of and shall be binding on the successors of the parties.

**13. Export Control**

You agree to comply with the export control and related laws, regulations and orders of Japan, the United States of America, and any other applicable countries and, if you export or re-export the Package Software Product, to obtain export/import permit and take all necessary procedures under your own responsibility and at your own expense.

**14. Audit; Withholding**

Yokogawa may terminate this Agreement without any notice or demand to you immediately, if you breach any of the terms and conditions of this Agreement. However, Articles 2.(4), 2.(6), 2.(8), 7, 8 and 11 shall survive even after the termination.

- (1) Yokogawa shall have the right to access and audit your facilities and any of your records, including data stored on computers, in relation to the use of the Package Software Product as may be reasonably necessary to verify that the requirements of this Agreement are being met.
- (2) Even after the license being granted under this Agreement, should there be any change in circumstances or environment of use which was not foreseen at the time of delivery and, in Yokogawa's reasonable opinion, is not appropriate for using the Package Software Product, or if Yokogawa otherwise reasonably believes it is inappropriate for you to continue using the Package Software Product, Yokogawa may suspend or withhold the license provided hereunder.

**15. Termination by Cause**

Yokogawa may immediately terminate this Agreement without any notice or demand to you, if you breach any of the terms and conditions of this Agreement. However, Articles 2.(4), 2.(5), 2.(6), 7, 8, 11, 15 and 16 shall survive even after the termination.

**16. Governing Law and Arbitration**

- (1) This Agreement shall be governed by and construed in accordance with the laws of Japan.
- (2) All disputes, controversies or differences which may arise between the parties hereto, out of or in relation to or in connection with this Agreement shall be finally settled by arbitration in Tokyo, Japan in accordance with the Commercial Arbitration Rules of the Japan Commercial Arbitration Association. The arbitration is conducted in the Japanese language. The award rendered by the arbitrator(s) shall be final and binding upon the parties hereto.

**17. Miscellaneous**

- (1) This Agreement supersedes all prior oral and written understandings, representations and discussions between the parties concerning the subject matter hereof to the extent such understandings, representations and discussions should be discrepant or inconsistent with this Agreement.
- (2) If any part of this Agreement is found void or unenforceable, it shall not affect the validity of the balance of the Agreement, which shall remain valid and enforceable according to its terms and conditions. The parties hereby agree to attempt to substitute for such invalid or unenforceable provision a valid or enforceable provision that achieves to the greatest extent possible the economic, legal and commercial objectives of the invalid or unenforceable provision.
- (3) Failure by either party to insist on performance of this Agreement or to exercise a right does not prevent such party from doing so at a later time, either in relation to that default or any subsequent default.

Concluded.

# How to Use This Manual

## Structure of the Manual

This user's manual is organized into Chapters 1 to 6 and appendix as shown below.

Chapter	Title	Description
1	Overview	Describes the main functional overview of the LL50A.
2	LL50A Operation Guide	Describes how to set parameters, set program pattern, and perform upload/download operations, monitoring, file management operations, and printing on the UTAdvanced.
3	A Guide to Building Ladder Programs	Describes how to build ladder programs.
4	Operations of Ladder Program Instructions	Describes details of instructions, input/output registers and special registers used in ladder programs.
5	Using Ladder Program	Describes precautions for ladder program.
6	Profile Creating Guide	Describes how to create an Electronic Device Data Sheet required to connect the UTAdvanced to the open network, and perform profile data download/upload operations, file management operations, and printing.
App	Worksheets / Input/Output Tables	Provides worksheets that are used when designing programs. Input/output tables

## Scope of the Manual

This manual does not explain the basic operations of Windows 7, Windows 8.1 and Windows 10. For information regarding the basic operations of Windows, see the user's guide that came with Windows.

## Symbols Used in the Manual

### Indications of the button:

All of them are enclosed by brackets ([ ]).

### **CAUTION**

Calls attention to actions or conditions that could cause injury to the user or damage to the instrument or property and indicates precautions that should be taken to prevent such occurrences.

### **Note**

Identifies important information required to operate the instrument.



Indicates related operations or explanations for the user's reference.

### **Procedure**

Describes operation procedures.

### **Description**

Describes restrictions, etc. regarding a relevant operation.

---

# Safety Precautions

## Warning and Disclaimer

- YOKOGAWA makes no warranties regarding the product except those stated in the WARRANTY that is provided separately.
- The product is provided on an “as is” basis. YOKOGAWA assumes no liability to any person or entity for any loss or damage, direct or indirect, arising from the use of the product or from any unpredictable defect of the product.

## Notes on Software

- YOKOGAWA makes no warranties, either expressed or implied, with respect to the software’s merchantability or suitability for any particular purpose, except as specified in the terms of the separately provided warranty.
- This software may be used on one specific machine only.
- To use the software on another machine, the software must be purchased again separately.
- It is strictly prohibited to reproduce the product except for backup purposes.
- Store the software CD-ROM (the original medium) in a safe place.
- All reverse-engineering operations, such as reverse compilation or the reverse assembly of the product are strictly prohibited.
- No part of the product’s software may be transferred, converted, or sublet for use by any third party, without prior written consent from YOKOGAWA.
- YOKOGAWA holds the copyright to the software that is on the CD-ROM.

# Contents

Introduction .....	i
Release Number .....	iv
License Agreement for Package Software Product .....	v
How to Use This Manual .....	vii
Safety Precautions .....	viii
<b>Chapter 1 Overview</b>	
1.1 Functional Overview .....	1-1
1.2 Operating Environment .....	1-7
1.3 Connecting the Main Unit to a PC and Setting Parameters .....	1-10
1.4 Model Compatibility of LL50A Functions .....	1-19
<b>Chapter 2 LL50A Operation Guide</b>	
2.1 Setting Flow .....	2-1
2.2 Starting up/Exiting the LL50A .....	2-2
2.3 Part Names of Window and Their Functions .....	2-4
2.4 Creating New Parameters Using the Wizard Function .....	2-12
2.5 Setting the Parameter View Level .....	2-17
2.6 Setting System Data .....	2-18
2.7 Setting Parameters .....	2-21
2.8 Creating a Custom Display (UT75A Only) .....	2-25
2.9 Creating Program Pattern (UP55A/UP35A/UP32A only) .....	2-29
2.9.1 Setting the Operation Setting .....	2-29
2.9.2 Setting the Segments .....	2-31
2.9.3 Inserting and Deleting a Segment .....	2-35
2.9.4 Copying, Adding, and Deleting a Pattern .....	2-36
2.9.5 Hiding Time Event/PV Event .....	2-38
2.9.6 Changing the Display Color of a Program Pattern .....	2-38
2.10 Creating User File Information .....	2-39
2.11 Downloading Data .....	2-40
2.12 Uploading Data .....	2-45
2.13 Comparing Data with Main unit's Data .....	2-50
2.14 Monitoring/Changing Data .....	2-53
2.14.1 Monitoring/Changing Tuning Data .....	2-53
2.14.2 Setting Data Read Cycle .....	2-65
2.15 Managing Files .....	2-66
2.15.1 Creating a New File .....	2-66
2.15.2 Opening a User File .....	2-67
2.15.3 Opening a Program Pattern Data File .....	2-68
2.15.4 Opening User Ladder Program Files .....	2-71
2.15.5 Opening Custom Ladder Instruction Files (UT75A Only) .....	2-72
2.15.6 Setting/Clearing a User File Password .....	2-73
2.15.7 Closing a File .....	2-74
2.15.8 Saving by Overwrite .....	2-74
2.15.9 Saving a File .....	2-74
2.15.10 Saving Program Pattern File .....	2-75
2.15.11 Saving User Ladder Program Files .....	2-77
2.15.12 Saving Custom Ladder Instruction Files (UT75A Only) .....	2-78
2.15.13 Comparing with File Data .....	2-79

2.15.14 Saving Tuning Data.....	2-81
2.15.15 Saving a CSV File.....	2-82
2.15.16 Making Environmental Settings.....	2-85
2.16 Window Operations.....	2-87
2.17 Activating Single-byte Character Entry.....	2-89
2.18 Printing.....	2-90
2.19 Initializing the Main Unit.....	2-91
2.20 Checking Software Version.....	2-94
2.21 Viewing the List of Tables.....	2-95

### Chapter 3 A Guide to Building Ladder Programs

3.1 Flow of Building a New Ladder Program.....	3-1
3.2 Part Names of the Window and Their Functions.....	3-3
3.3 How to Build a Ladder Program.....	3-4
3.3.1 Registering Basic Instructions (Instruction Palette).....	3-4
3.3.2 Registering an Application Instruction (Instruction Palette).....	3-6
3.3.3 Registering Circuit Comments (Instruction Palette).....	3-8
3.3.4 Registering Basic Instructions (Instruction Window).....	3-9
3.3.5 Registering an Application Instruction (Instruction Window).....	3-10
3.3.6 Registering a Register.....	3-11
3.3.7 Setting a K-constant (K-register).....	3-12
3.4 Building a Ladder Program.....	3-13
3.5 Editing Ladder Programs.....	3-28
3.5.1 Overwrite and Insert Modes.....	3-28
3.5.2 Circuit Editing Elements.....	3-28
3.5.3 Inserting a Blank Line.....	3-29
3.5.4 Selecting a Circuit Range.....	3-29
3.5.5 Deleting a Circuit.....	3-31
3.5.6 Copying a Circuit.....	3-33
3.5.7 Moving a Circuit.....	3-35
3.5.8 Finding a Register or Instruction.....	3-37
3.5.9 Replacing a Register or Instruction.....	3-38
3.5.10 Setting a Burnout Connection.....	3-39
3.6 Checking Ladder Programs.....	3-40
3.7 Saving a Ladder Program in a File and Downloading/Uploading It.....	3-42
3.8 Monitoring a Ladder Program.....	3-43
3.9 Monitoring/Changing Register Data.....	3-48
3.10 Default Ladder Programs.....	3-51
3.10.1 UT35A/UT32A/UP35A/UP32A.....	3-51
3.10.2 UT55A/UT52A/UP55A Single-loop Control.....	3-52
3.10.3 UT55A/UT52A/UP55A Cascade Primary-loop Control.....	3-54
3.10.4 UT55A/UT52A Cascade Secondary-loop Control.....	3-54
3.10.5 UT55A/UT52A/UP55A Cascade Control.....	3-55
3.10.6 UT55A/UT52A Loop Control for Backup.....	3-55
3.10.7 UT55A/UT52A/UP55A Loop Control with PV Switching.....	3-56
3.10.8 UT55A/UT52A/UP55A Loop Control with PV Auto-selector.....	3-56
3.10.9 UT55A/UT52A Loop Control with PV-hold Function.....	3-57
3.10.10 UT75A Single-loop Control.....	3-58
3.10.11 UT75A Cascade Primary-loop Control.....	3-59
3.10.12 UT75A Cascade Secondary-loop Control.....	3-59
3.10.13 UT75A Cascade Control.....	3-60
3.10.14 UT75A Loop Control for Backup.....	3-60

3.10.15 UT75A Loop Control with PV Switching .....	3-61
3.10.16 UT75A Loop Control with PV Auto-selector .....	3-61
3.10.17 UT75A Loop Control with PV-hold Function .....	3-62
3.10.18 UT75A Dual-loop Control .....	3-62
3.10.19 UT32A-D Dual-loop Control .....	3-63

## Chapter 4 Operations of Ladder Program Instructions

4.1 Basic Specifications .....	4-1
4.1.1 Control Period (Scan Time) .....	4-1
4.1.2 Number of Inputs/Outputs .....	4-1
4.1.3 Types of Instructions .....	4-2
4.1.4 Sequence Devices .....	4-2
4.1.5 Operation Status .....	4-2
4.1.6 Operation Conditions .....	4-2
4.1.7 Operation in Operation Mode L-RUN/L-STOP on the Monitor Ladder Program .....	4-2
4.2 Registers .....	4-3
4.2.1 Input/Output Ladder Calculation Relays/Registers .....	4-3
4.2.2 Internal Devices (Read/Write) .....	4-14
4.2.3 Parameter Registers and Status Relays (Read/Write) .....	4-17
4.2.4 Special Relays (Read Only) .....	4-18
4.2.5 Registers/Relays for Peer-to-peer Communication (Read/Write) .....	4-18
4.3 Data Format .....	4-19
4.3.1 Relay (Bit) Processing .....	4-19
4.3.2 Data (Register) Processing .....	4-19
4.3.3 Floating Point Processing (Float) .....	4-21
4.3.4 Execution-while-ON Instructions and Input Differential Instructions .....	4-21
4.4 List of Instructions .....	4-22
4.4.1 List of Basic Instructions .....	4-22
4.4.2 List of Application Instructions .....	4-24
4.4.3 Custom Ladder Instructions (UT75A only) .....	4-34
4.5 Details of Basic Instructions .....	4-35
4.5.1 Load, And .....	4-36
4.5.2 Load Not, And Not .....	4-36
4.5.3 Or .....	4-37
4.5.4 Or Not .....	4-37
4.5.5 And Load .....	4-38
4.5.6 Or Load .....	4-38
4.5.7 Out .....	4-39
4.5.8 Set .....	4-40
4.5.9 Reset .....	4-41
4.5.10 Timer .....	4-42
4.5.11 Counter .....	4-45
4.5.12 Differential Up and Differential Down .....	4-47
4.5.13 Push, Stack Read, and Pop .....	4-48
4.5.14 End .....	4-49
4.6 Details of Application Instructions .....	4-50
4.6.1 Comparison .....	4-51
4.6.2 Four Fundamental Arithmetic Operations .....	4-54
4.6.3 Square Root .....	4-56
4.6.4 Square Root Extraction .....	4-57
4.6.5 Absolute Value .....	4-59
4.6.6 Exponential .....	4-60



4.6.7	Power .....	4-61
4.6.8	Natural Logarithm.....	4-62
4.6.9	Common Logarithm.....	4-63
4.6.10	Logical Operation .....	4-64
4.6.11	Rotation.....	4-69
4.6.12	Shift.....	4-71
4.6.13	Move .....	4-74
4.6.14	Binary/BCD Conversion .....	4-78
4.6.15	Ratio.....	4-80
4.6.16	Reciprocal .....	4-81
4.6.17	Selectors .....	4-82
4.6.18	Limiters.....	4-83
4.6.19	Limit.....	4-84
4.6.20	Scaling and Normalization .....	4-85
4.6.21	Maximum, Minimum, and Average Values .....	4-87
4.6.22	Temperature Compensation.....	4-89
4.6.23	Pressure Compensation.....	4-91
4.6.24	Temperature and Humidity Calculation .....	4-93
4.6.25	10-segment Linearizer Approximation.....	4-94
4.6.26	Inverse Conversion of 10-segment Linearizer Approximation.....	4-96
4.6.27	20-segment Linearizer Approximation.....	4-98
4.6.28	Maximum Input Hold .....	4-100
4.6.29	Minimum Value Hold .....	4-101
4.6.30	Filter .....	4-102
4.6.31	Dead Time .....	4-104
4.6.32	Moving Average.....	4-106
4.6.33	Velocity Computation .....	4-108
4.6.34	Velocity Limiter .....	4-110
4.6.35	Totalizer Pulse Output.....	4-112
4.6.36	On-delay Timer.....	4-113
4.6.37	Off-delay Timer.....	4-115
4.6.38	CP Calculation.....	4-117
4.7	Details of Custom Ladder Instructions (UT75A Only) .....	4-119
4.7.1	Registering Custom Ladder Instructions .....	4-119
4.7.2	Creating Custom Ladder Instructions.....	4-121

## Chapter 5 Using Ladder Programs

5.1	Precautions for Using Ladder Program .....	5-1
5.1.1	Relay and Register Values upon Recovery from Power Failure .....	5-6
5.1.2	Circuit Actions upon Recovery from Power Failure .....	5-8
5.2	Functions That Require Parameter Setting.....	5-9
5.2.1	Setting P Parameters .....	5-9
5.2.2	Setting Contact Inputs for Switching Operation Mode from Ladder Program .....	5-10
5.2.3	Assigning Operation Mode Switching Functions to Keys on main unit's Front Panel .....	5-11
5.2.4	Settings for Activating Contact Outputs and Event Lamps.....	5-12
5.2.5	Settings for Interrupt Message Display in PV Display Area .....	5-13
5.3	Examples of Supplementing Instructions and General Specifications in Ladder Programming ..	5-14
5.3.1	Retaining Timers and Counters from Previous Values after Power Failure .....	5-14
5.3.2	Holding Timer and Counter Values.....	5-17
5.3.3	Retaining the Values of Peer-to-Peer Communication Status Input Relays (CIn) during Power Failure of Master or Slave main unit .....	5-20

5.3.4	Retaining the Values of Peer-to-Peer Communication Analog Input Registers (CXn) during Power Failure of Master or Slave main unit.....	5-22
5.3.5	Detecting Communication Failure and Recovery Other Than Using Peer-to-Peer Communication .....	5-23
5.4	Peer-to-peer Communication.....	5-24
5.4.1	Overview of Function Peer-to-peer Communication .....	5-24
5.4.2	Setting Peer-to-peer Communication and Communication Address.....	5-25
5.4.3	Peer-to-peer Communication Relays and Registers .....	5-26
5.4.4	Ladder Programming Example .....	5-28
5.5	Extension Method of Control Input Combination .....	5-38
5.5.1	Using Four-wired RTD as PV (Example of using UT55A).....	5-38
5.5.2	Build the Loop-2 RSP of Cascade Control Using the Ladder Program (Example for UT55A) .....	5-39
5.5.3	Build the Feedforward Control Using the Ladder Program (Example for UT55A) .....	5-40

## Chapter 6 Profile Creating Guide

6.1	Creating Flow.....	6-1
6.2	Starting up/Exiting the Network Profile Tool.....	6-2
6.3	Part Names of Window and Their Functions .....	6-3
6.4	Create the Profile .....	6-18
6.5	Edit the Profile .....	6-23
6.5.1	Inserting a Row .....	6-23
6.5.2	Deleting a Row .....	6-24
6.5.3	Copying a Row.....	6-25
6.5.4	Setting the Word Size.....	6-26
6.5.5	Others .....	6-27
6.6	Window Operations .....	6-28
6.7	Downloading the Profile Data .....	6-31
6.8	Uploading the Profile Data.....	6-33
6.9	Comparing Data with Main Unit's Profile Data.....	6-34
6.10	Managing Files .....	6-35
6.10.1	Creating a New File.....	6-35
6.10.2	Opening a User File .....	6-36
6.10.3	Saving by Overwrite.....	6-37
6.10.4	Saving a File as.....	6-37
6.10.5	Comparing with File Data.....	6-38
6.10.6	Making Environmental Settings.....	6-39
6.11	Printing.....	6-40
6.12	Initializing the Main Unit's Profile Data.....	6-41
6.13	Checking Network Profile Tool Version.....	6-43
6.14	Viewing the List of Tables .....	6-44

## Appendix Worksheet / Input/Output Tables

App.1	Worksheet .....	App-1
-------	-----------------	-------

## Revision Information





# 1.1 Functional Overview

This section describes the main functional overview of the LL50A Parameter Setting Software.

## Parameter setting function

This function is used to set the parameters of the main unit. There are setup parameters for setting the basic functions of a main unit controller and operation parameters used for setting functions necessary to operate the main unit. It is also possible to set them using the Setting wizard.

## Program pattern setting function

This function is used to set the program pattern of the UP55A/UP35A/UP32A. Set the program pattern of the UT75A using the parameter setting function.

## Monitoring function

### Tuning/change

With the PC connected to one controller, the tuning function tunes PID parameters by displaying PV input values (PV), target setpoints (SP), control output values (OUT), etc. on the PC screen. Furthermore, it also enables the PV, SP, and OUT values to be displayed as trend data and acquired together with the loop information and fixed registers in the Tuning window. Acquired trend data can be saved in a file of .csv format.

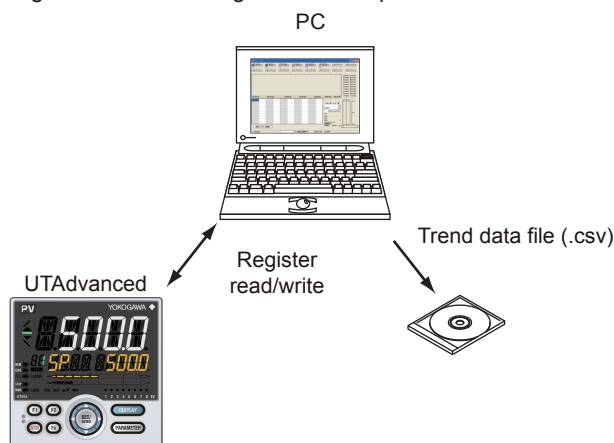

### Monitoring/changing registers

The register monitoring function enables the main unit's registers to be monitored and/or changed during ladder program debugging.

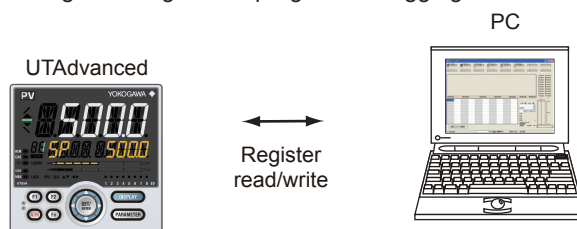

### Ladder program monitoring function

This function is used to check the operation of a ladder program you have built.

### Note

The monitoring function is not available for UM33A.

**Upload/download/comparison function**

This function downloads parameter data, program pattern data and/or ladder program data to the main unit, uploads it from the main unit, and compares it with the main unit data.

You can specify all data, or individual data items, to be uploaded or downloaded.

**File management/print function**

This function enables you to save created parameter data, program pattern data and/or ladder program data in a file. It also allows data to be printed out for submission to the customer.

**Ladder program building function**

In ladder programs, there are various computations for input and output signals, and sequence processing can be built using four fundamental arithmetic operations, logical operation, temperature compensation factor calculation, and pressure compensation factor calculation and between input and output contacts.

**Configuration of ladder program**

A ladder program consists of three parts: the input ladder calculation executed before control computation, and the output ladder calculation and the user ladder calculation performed after control computation. Each calculation section is respectively executed every control period.

The sequence of calculation is: input, input ladder calculation, control computation, output ladder calculation, user ladder calculation, and output.

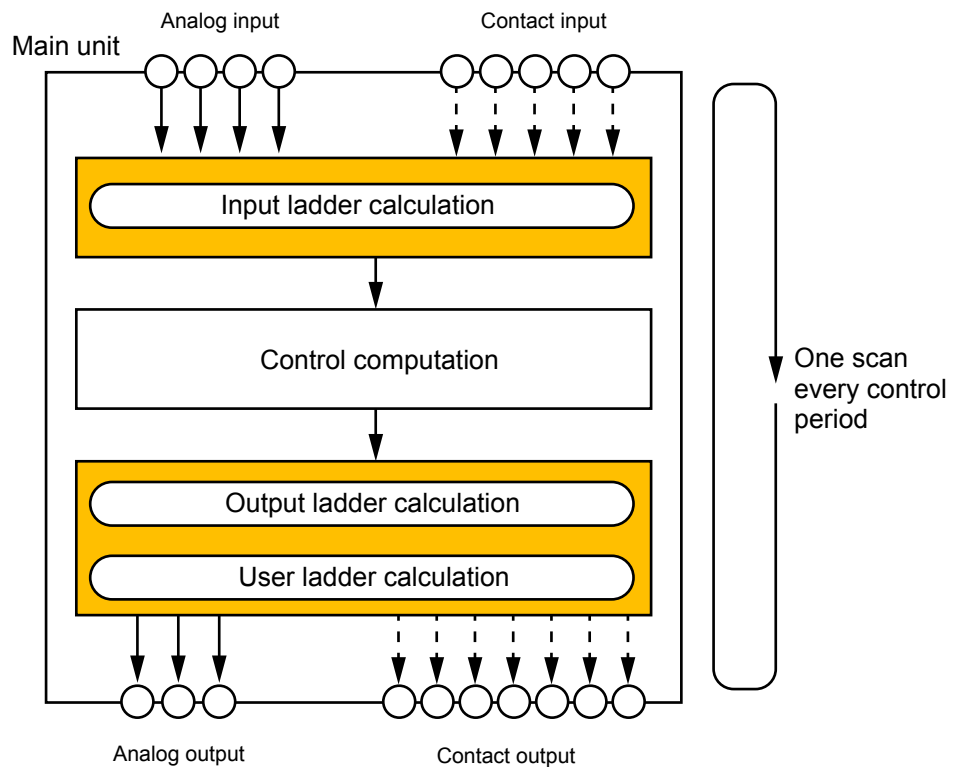

### Building a ladder program

A ladder program is built by editing the default ladder programs provided for each control mode of system data.

It is recommended that the user ladder calculation section be used if a sequence is desired to be configured regardless of controller control computation.

As the initial status, the default ladder programs are described in the input ladder calculation and output ladder calculation sections on a control mode basis. No program is written in the user ladder calculation section. Programs written in the user ladder calculation section can be saved and used regardless of the UTAdvanced model (limitations on a command level exist).

- ▶ System data: Section 2.6, Setting System Data
- ▶ Default ladder programs: Section 3.10, Default Ladder Programs

### CAUTION

If a new ladder program is built or the system data's control mode is changed, the ladder program is initialized to the default ladder program.  
UT35A/UT32A/UP35A/UP32A does not have the parameter CTLM (Control mode.)

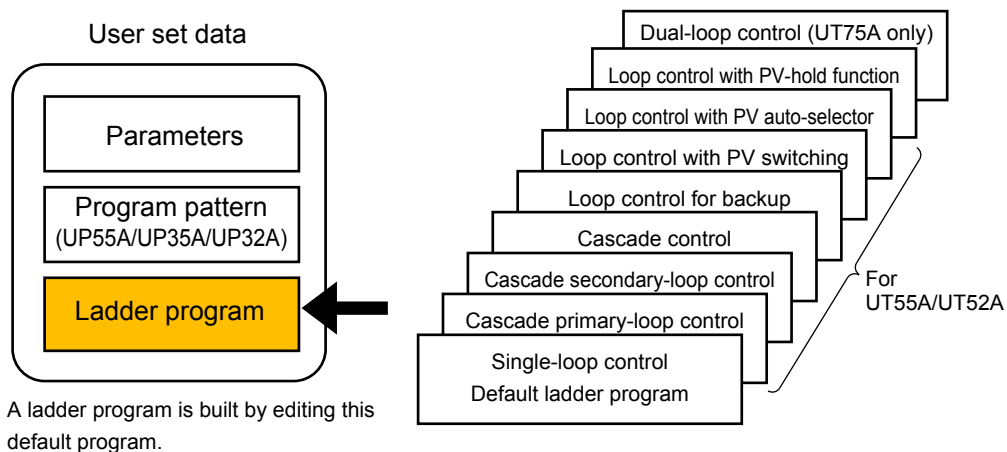

A ladder program is built by editing this default program.

### Note

The building a ladder program function is not available for UM33A.

### Network Profile Creating Function

This function creates an Electronic Device Data Sheet for PROFIBUS-DP communication, DeviceNet communication and CC-Link communication (in UTAdvanced, PROFIBUS-DP, DeviceNet and CC-Link are collectively called Open Network.)

The following figure shows an example of one Open Network slave/Modbus master and 4 Modbus slaves. An arbitrary configuration like this can be created using the LL50A Network Profile Tool and Open Network Configuration tool\*.

When using a fixed profile, a GSD file and EDS file can be downloaded from the YOKOGAWA website. When not using a fixed profile, an Electronic Device Data Sheet can be created as a user profile.

URL: [www.yokogawa.com/ns/utadv/](http://www.yokogawa.com/ns/utadv/)

	File name	Explanation
PROFIBUS-DP	YEC45F2.GSD	
DeviceNet	UTAdvanced_Profile0.eds	Profile number: 0 (for UT55A/UT35A/UP55A/UP35A)
	UTAdvanced_Profile1.eds	Profile number: 1 (for UT55A/UT35A)
	UTAdvanced_Profile2.eds	Profile number: 2 (for UT55A/UT35A)
	UTAdvanced_Profile3.eds	Profile number: 3 (for UT55A/UT35A)
	UTAdvanced_Profile4.eds	Profile number: 4 (for UT55A)
	UTAdvanced_Profile5.eds	Profile number: 5 (for UT55A)
	UTAdvanced_Profile11.eds	Profile number: 11 (for UP55A/UP35A)
	UTAdvanced_Profile12.eds	Profile number: 12 (for UP55A/UP35A)
	UTAdvanced_Profile13.eds	Profile number: 13 (for UP55A/UP35A)
	UTAdvanced_Profile14.eds	Profile number: 14 (for UP55A)
	UTAdvanced_Profile15.eds	Profile number: 15 (for UP55A)
	UTAdvanced_Profile21.eds	Profile number: 21 (for UT75A)
	UTAdvanced_Profile22.eds	Profile number: 22 (for UT75A)
	UTAdvanced_Profile23.eds	Profile number: 23 (for UT75A)
	UTAdvanced_Profile24.eds	Profile number: 24 (for UT75A)
UTAdvanced_Profile25.eds	Profile number: 25 (for UT75A)	

\*: CC-Link profile is created by using CC-Link master tool.

- ▶ [OpenNetwork communication, fixed profile: UTAdvanced Series Communication Interface \(OpenNetwork\) User's Manual](#)

For PROFIBUS-DP/DeviceNet configuration tool, contact PROFIBUS-DP/DeviceNet master vendor.

For CC-Link master tool, contact CC-Link master vendor.

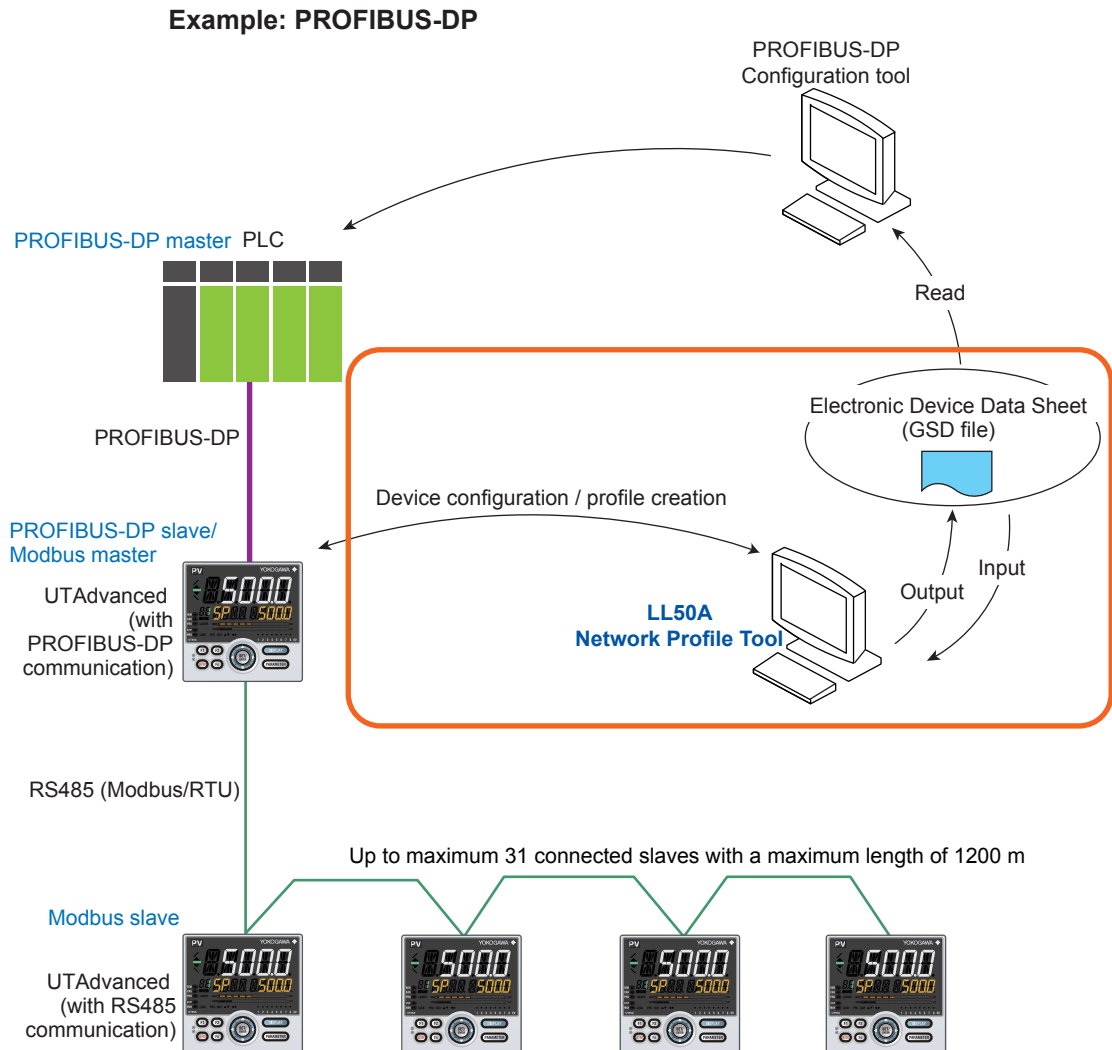

### Note

Network Profile Tool is available only for the light-loader adapter and the dedicated cable.

- Electronic Device Data Sheet (GSD File (PROFIBUS-DP), EDS file (DeviceNet))**  
 This is a file in the format specified by the PROFIBUS-DP/\*DeviceNet communication protocol. It is called a GSD file in PROFIBUS-DP communication. It is called a EDS file in DeviceNet communication. This file is provided to the external connection device via the PLC configurator. Electronic Device Data Sheets created by other than the LL50A cannot be loaded into the LL50A.
- Open network master (PROFIBUS-DP master, DeviceNet master, CC-Link master)**  
 An open network master is a controller which exchanges information with slaves periodically and which is a PLC or PC (which is called a class 1 master in PROFIBUS-DP).  
 An engineering or configuration device is also an open network master which is a PC on which configuration software is installed or software (which is called a class 2 master in PROFIBUS-DP.)

## 1.1 Functional overview

---

- **PROFIBUS-DP slave/Modbus master**

This is an input and output device that is accessed by the master. UTAdvanced (with PROFIBUS-DP communication) runs as a PROFIBUS-DP slave.

Furthermore, UTAdvanced (with PROFIBUS-DP communication), which runs as a PROFIBUS-DP slave, also runs as a Modbus master using the RS-485 terminal.

It reads and writes the parameters of Modbus slaves, which are connected via RS-485 communication, according to the profile definition.

- **Modbus slave**

This is UTAdvanced (with RS-485 terminal). Up to 31 slaves can be connected.

## 1.2 Operating Environment

PC

Item	Windows 11 <sup>*1</sup> Japanese / English	Windows 10 <sup>*1</sup> Japanese / English	Windows 8.1 <sup>*1</sup> Japanese / English
Edition	Pro 64 bit	Pro 32 bit/64 bit	Pro 32 bit/64 bit
Version <sup>*1</sup>	21H2 or later	20H2 or later	Update
CPU	Intel processor that supports 64 bit and 1 GHz or faster with 2 or more cores	Intel processor that supports 32 bit /64 bit and 2 GHz or faster speed (recommended)	2GHz or faster Intel processor (recommended)
Recommended main memory capacity	8 GB or more	8 GB or more	2 GB or more
Recommended storage free capacity	32 GB or more	32 GB or more	16 GB or more
Display	Display compatible with OS	Display compatible with OS	Display compatible with OS
Communication port	Communication with a dedicated cable: USB port (1 channel) RS-485 communication: RS-232C port (1 channel) (RS-232C/485 converter required, YOKOGAWA ML2 recommended) Ethernet communication: 10BASE-T/100BASE-TX		
Peripherals	Printer (paper size for print: A4-size, or letter-size on the English version.) LL50A connection cable (dedicated, included with tool) Ethernet connection cable (necessary for Ethernet communication, compliant with 10BASE-T/100BASE-TX standard)		

\*1: Yokogawa will also stop supporting OSs that Microsoft Corporation no longer supports.



**Dedicated Adapter**

Communication method:

Non-contact, two-way, serial optical communication on the controller side

Compliant with the USB Specification Rev. 1.1 on the PC side

Power supply: Supplied from the USB bus power

Rated input voltage; 4.75 to 5.25 VDC,

100 mA DC (including the dedicated cable)

Ambient temperature: 0 to 50°C

Ambient humidity: 20 to 90%RH (No condensation)

Transport and storage conditions: -20 to 70°C, 5 to 90%RH (No condensation)

Dust-proof and drip-proof: IP3x

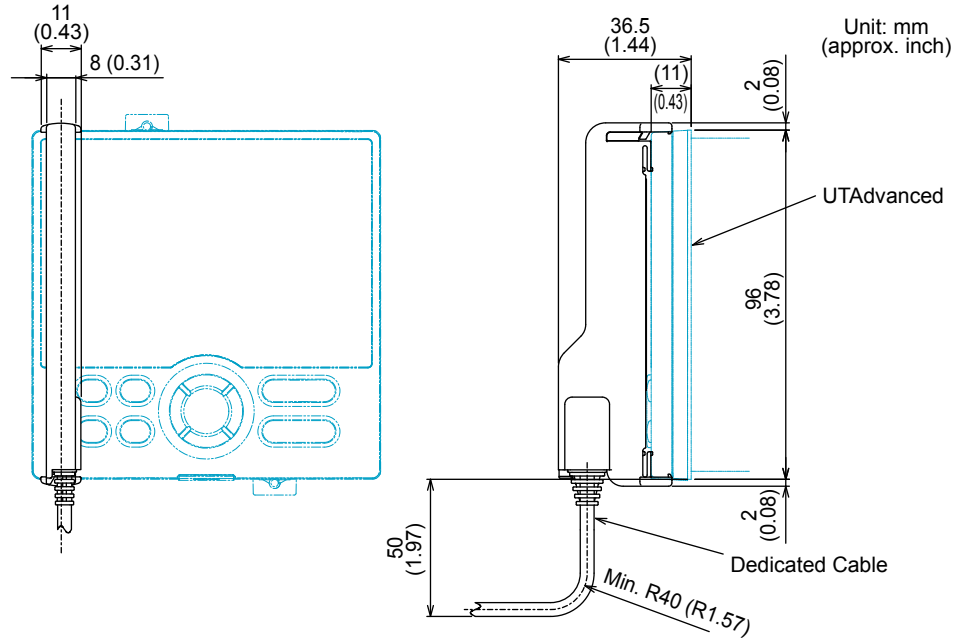

**Dedicated Cable**

USB serial converter is incorporated, Compliant with the USB Specification Rev. 1.1

USB Series "A" plug on the PC side

Dedicated plug (5-pin) on the adapter side

Cable length: About 2.7 m

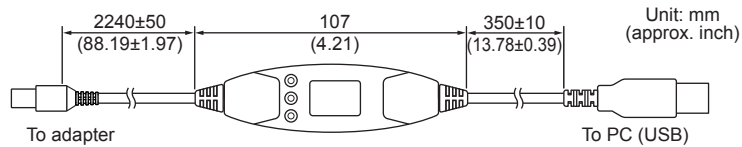

**CAUTION**

- The dedicated cable is not waterproof. Do not use it in locations that are likely to be exposed to splashes of water or other liquids.
- Directly insert the USB plug into a USB port on the PC.

**EMC Standards**

CE marking: EN61326-1 Class A, Table 2 (For use in industrial locations)

RCM: EN55011 Class A Group 1 compliant

KC: Electromagnetic wave interference prevention standard, electromagnetic wave protection standard compliance

---

**CAUTION**

---

This instrument is an EMC class A product. In a domestic environment, this product may cause radio interference in which case the user needs to take adequate measures.

---

**Light-loader communication interface on the controller's front panel**

Dedicated cable (with RS-232C/USB conversion function)

Compliant with the USB Specification Rev. 1.1 on the PC side

**Maintenance port**

Dedicated cable (with RS-232C/USB conversion function)

**Ethernet communication**

Specification: IEEE802.3 compliant, 10BASE-T/100BASE-TX, RJ45 connector

For a connection via a hub: Straight cable

For a direct connection: Cross cable

**RS-485 communication**

Specification: EIA RS-485 compliant

## 1.3 Connecting the Main Unit to a PC and Setting Parameters

### Dedicated cable

#### Light-loader Communication (front panel communication)

Attach the light-loader adapter to the main unit's front panel and connect the dedicated cable between the PC's USB terminal and the light-loader adapter.

Network Profile Tool is available only for the light-loader adapter and the dedicated cable.

#### Attach the light-loader adapter and the dedicated cable

1. Attach the light-loader adapter and the dedicated cable.  
Insert the connector into the adapter until you hear a click.

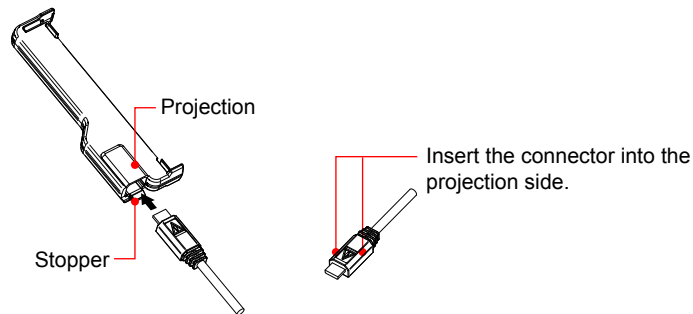

2. Attach the light-loader adapter to the main unit's front panel.  
Hang the dedicated adapter's bracket from the lower side groove.  
Bring the dedicated adapter into contact with the main unit's front panel.

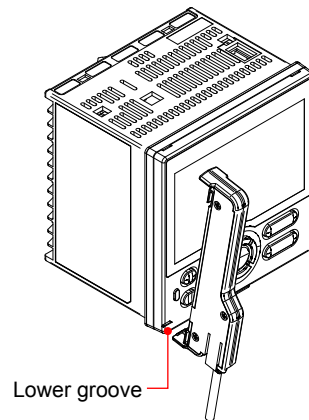

3. Connect the dedicated cable to the USB communication port of a personal computer.

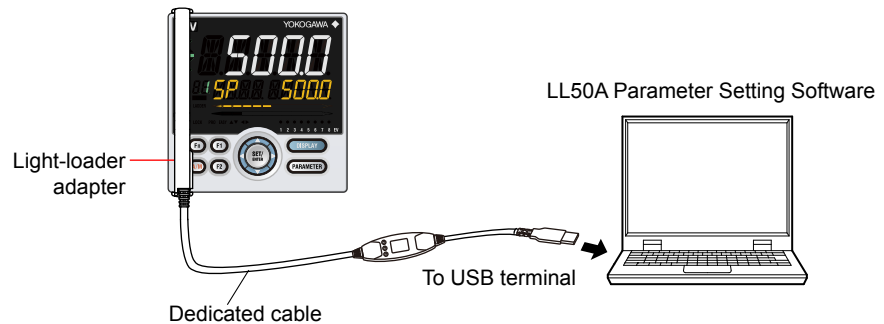

**CAUTION**

- Make sure the light-loader adapter is attached to the controller in a vertical orientation. Communication is not possible if the light-loader adapter is attached in a slanting position.
- The light-loader adapter cannot be used on DIN rail mounting type (/MDL option) UTAdvanced.
- Do not remove the dedicated cable while LL50A communicate, or it may affect the stability of the operation system.
- Do not suspend while LL50A communicate, or the system may fail to recover subsequently from the suspension.
- The dedicated adapter and the dedicated cable are not waterproof. Do not use them in locations that are likely to be exposed to splashes of water or other liquids.
- Do not make dirty the optical communication interface.

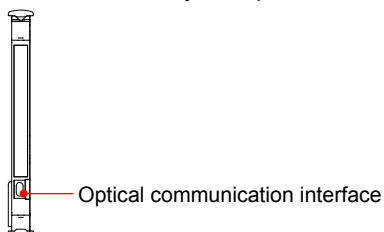
**Detach the light-loader adapter and the dedicated cable**

1. Detach the light-loader adapter from the main unit.

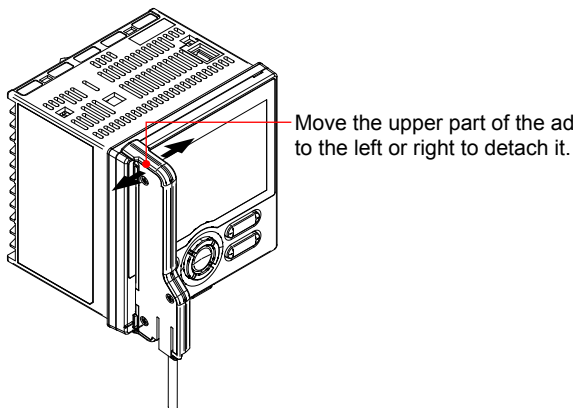

2. Disconnect the dedicated cable from the light-loader adapter.

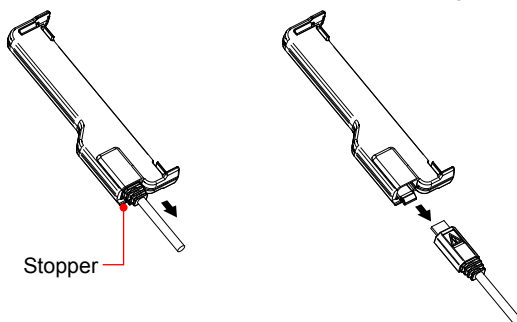

### 1.3 Connecting the Main Unit to a PC and Setup Parameters

#### Maintenance Port Communication (not necessary to supply power to the main unit)

Connect the dedicated cable between the PC's USB terminal and the connection port on top of the main unit.

**Note**

When connecting the PC to a main unit using the maintenance port, do not supply power to the main unit, otherwise the main unit will not function properly. If the dedicated cable is connected to the main unit and the power is turned on or if the main unit's power supply is turned on and the dedicated cable is connected, disconnect the cable and turn the main unit's power supply back on again. This returns the main unit to the normal condition.

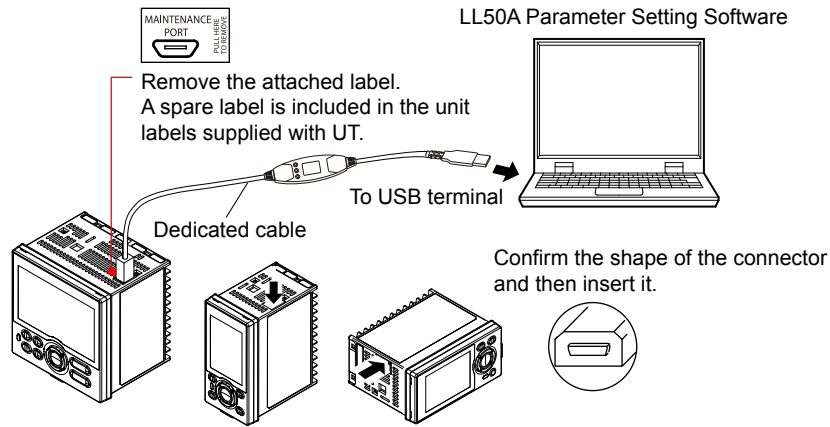

The following table shows the functions available between the main unit and LL50A when the PC is connected using the main unit's maintenance port.

Menu	Function
Communication	Upload all
	Download all
	Upload parameter data
	Download parameter data
	Upload program pattern data
	Download program pattern data
	Upload ladder program
	Download ladder program
	Compare communication
Main unit operation	Factory defaults
	User defaults
	Set User defaults
	Program pattern clearance

**Note**

Network Profile Tool cannot be set via the maintenance port.

### Maintenance Port Communication (the main unit needs power supply)(model of optional specifications /MDL)

Connect the dedicated cable between the PC's USB terminal and the connection port on top of the main unit.

#### **Note**

Use LL50A with the controller turned on. (The dedicated cable must be connected. LL50A Light-loader adapter cannot be used.)

The maintenance port is not isolated from the PV input terminal. Use the port only for maintenance purposes, such as for setting the controller parameters.

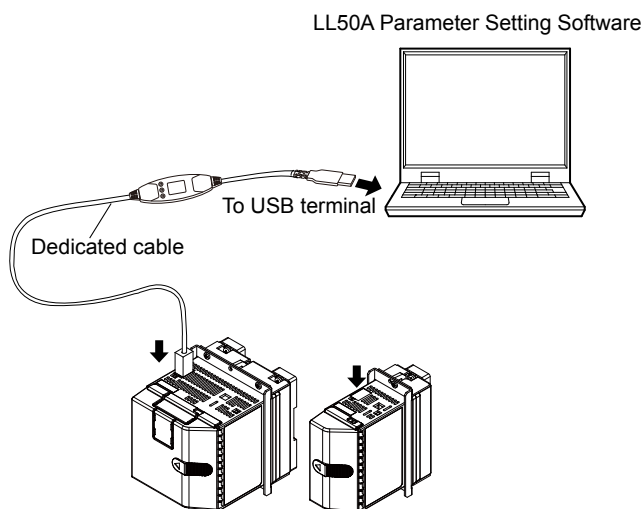

The available function is the same as Light-loader communication.

### Setting parameters

It is not necessary to set communication parameters on the main unit side.

### 1.3 Connecting the Main Unit to a PC and Setup Parameters

#### RS-485 communication terminal

Connect the PC to the main unit via the communication terminal on the main unit's rear face.

This connection requires an RS232C/RS485 converter (recommended model: ML2, Yokogawa Electric).

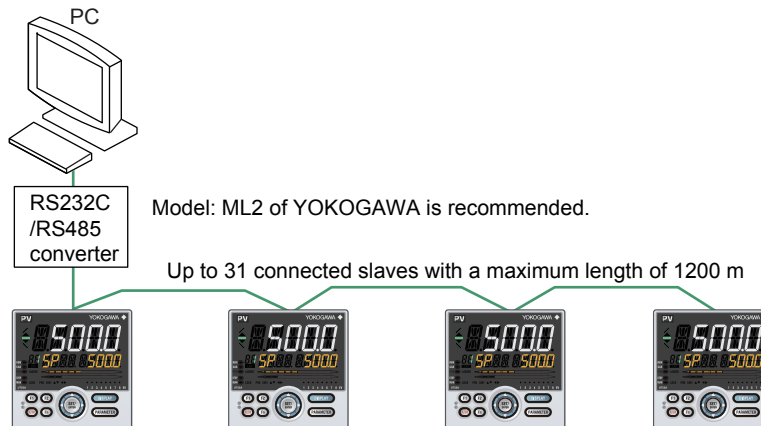

**Note**

Network Profile Tool cannot be set via the RS-485 communication terminal.

#### Setting parameters

Check the position of the RS-485 communication terminal and set the parameters. The terminal area to be used differs depending on the model and suffix codes. Confirm the specification of the main unit.

Parameter symbol	Name	Display level	Setting range	Menu symbol
<b>PSL</b>	Protocol selection		PCL: PC link communication PCLSM: PC link communication (with checksum) LADR: Ladder communication CO-M: Coordinated master station CO-S: Coordinated slave station MBASC: Modbus (ASCII) MBRTU: Modbus (RTU) Coordinated master station (2-loop mode) CO-S1: Coordinated slave station (Loop-1 mode) CO-S2: Coordinated slave station (Loop-2 mode) P-P: Peer-to-peer communication	
<b>BPS</b>	Baud rate	EASY	600: 600 bps 1200: 1200 bps 2400: 2400 bps 4800: 4800 bps 9600: 9600 bps 19200: 19.2k bps 38400: 38.4k bps Up to 19.2k bps for RS-485 in E4-terminal area.	R485 <b>Set</b>
<b>PRI</b>	Parity		NONE: None EVEN: Even ODD: Odd	
<b>STP</b>	Stop bit		1: 1 bit, 2: 2 bits	
<b>DLN</b>	Data length		7: 7 bits, 8: 8 bits	
<b>ADR</b>	Address		1 to 99	

**Set**: Setup parameter

When parameters have been displayed, the terminal areas (E1 to E4) are indicated in the group display area according to the suffix and optional suffix codes.

### Ethernet communication

Use a 10BASE-T/100BASE-TX compatible cable to connect the PC to a network through which the PC can communicate, and then connect to main units on the network.

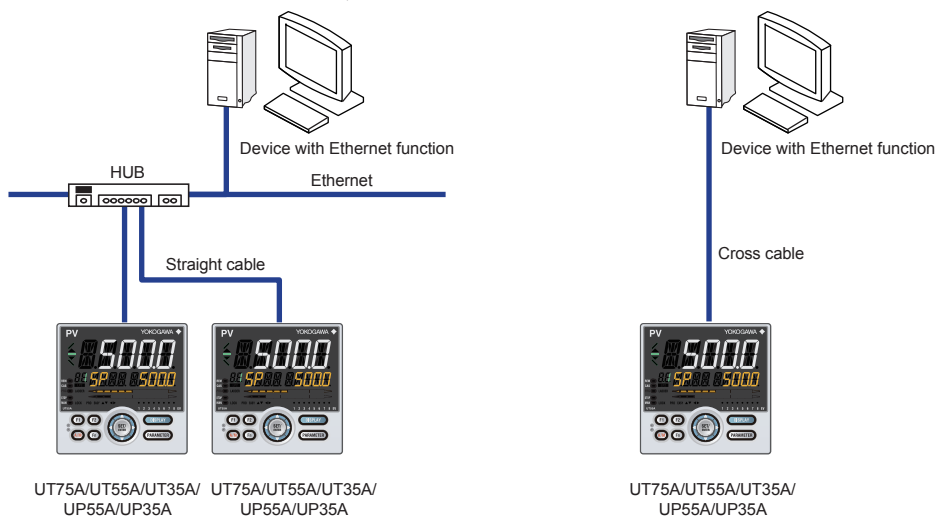

**Note**

When connecting a UT75A/UT55A/UT35A/UP55A/UP35A to a network, the baud rate, connectors, etc. must match. For more information, consult a network administrator who connects UT75A/UT55A/UT35A/UP55A/UP35A devices to networks.

**Note**

Network Profile Tool cannot be set via the Ethernet communication terminal.

### Setting parameters

Parameter symbol	Name	Display level	Setting range	Menu symbol
HSR	High-speed response mode	EASY	OFF, 1 to 8	ETHR Set
IP1 to IP4	IP address 1 to 4		0 to 255 Default: (IP1).(IP2).(IP3).(IP4) =(192).(168).(1).(1)	
SM1 to SM4	Subnet mask 1 to 4		0 to 255 Default: (SM1).(SM2).(SM3).(SM4) =(255).(255).(255).(0)	
DG1 to DG4	Default gateway 1 to 4		0 to 255 Default: (DG1).(DG2).(DG3).(DG4) =(255).(255).(255).(0)	
PRT	Port number		502, 1024 to 65535	
IPAR	IP access restriction		OFF: Disable, ON: Enable	
1.IP1 to 1.IP4	Permitted IP address 1-1 to 1-4		0 to 255 Default: (1.IP1).(1.IP2).(1.IP3).(1.IP4) =(255).(255).(255).(255)	
2.IP1 to 2.IP4	Permitted IP address 2-1 to 2-4		0 to 255 Default: (2.IP1).(2.IP2).(2.IP3).(2.IP4) =(255).(255).(255).(255)	
ESW	Ethernet setting switch		Setting this parameter to "ON" enables the Ethernet parameter settings. OFF, ON	

**Set** : Setup parameter



### Ethernet-serial gateway function

Connect the main unit with RS-485 communication to the main unit with Ethernet-serial gateway function. The PC can access data of main unit with RS-485 communication.

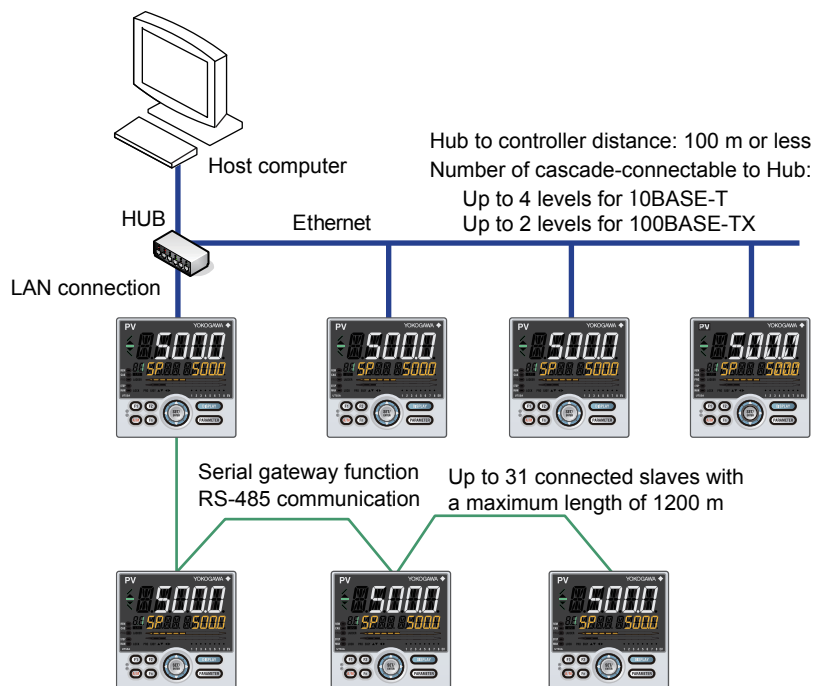

The communication conditions between the main unit with gateway function and the slave main units should be the same settings (parameters PSL, STP, and DLN). ADR should be set so that there are no overlaps between slave units. It is necessary to set the following parameters in addition to the Ethernet parameters.

**Note**

Network Profile Tool cannot be set via the Ethernet-serial gateway function.

### Setting parameters

Parameter symbol	Name	Display level	Setting range	Menu symbol
<b>BPS</b>	Baud rate	EASY	9600: 9600 bps 19200: 19.2k bps 38400: 38.4k bps	ETHR <b>Set</b>
<b>PRI</b>	Parity		NONE: None EVEN: Even ODD: Odd	

**Set**: Setup parameter

### Connection via an Ethernet-RS485 converter

Connect the PC to main units via the Ethernet/RS-485 converter (recommended model: VJET, Yokogawa Electric).

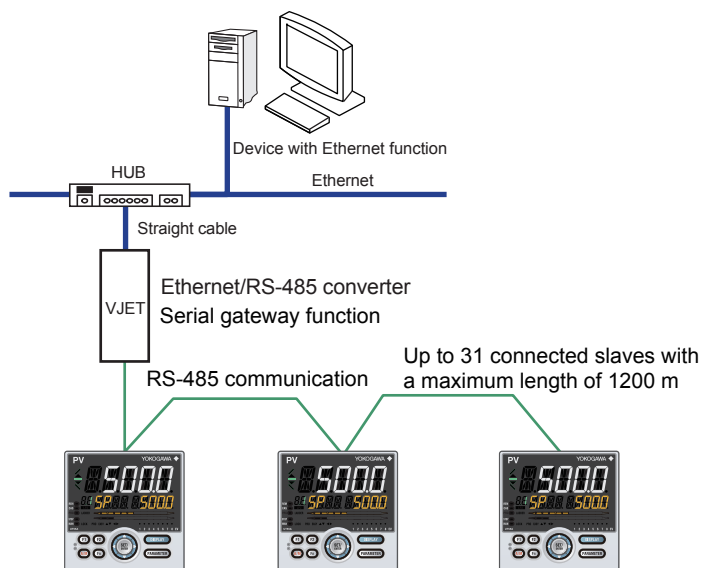

#### Note

Network Profile Tool cannot be set via the Ethernet-RS485 converter.

### 1.3 Connecting the Main Unit to a PC and Setup Parameters

#### Setting parameters

Set the communication conditions of slave main units in the same way as those of the VJET with the gateway function.

The VJET must be set using a VJET setting tool.

The VJET setting tool can be downloaded from:

<https://www.yokogawa.com/library/search/#/t=742>

Check the position of the RS-485 communication terminal and set the parameters. The terminal area to be used differs depending on the model and suffix codes. Confirm the specification of the main unit.

Parameter symbol	Name	Display level	Setting range	Menu symbol
<b>PSL</b>	Protocol selection		PCL: PC link communication PCLSM: PC link communication (with checksum) LADR: Ladder communication CO-M: Coordinated master station CO-S: Coordinated slave station MBASC: Modbus (ASCII) MBRTU: Modbus (RTU) CO-M2: Coordinated master station (2-loop mode) CO-S1: Coordinated slave station (Loop-1 mode) CO-S2: Coordinated slave station (Loop-2 mode) P-P: Peer-to-peer communication	
<b>BPS</b>	Baud rate	EASY	600: 600 bps 1200: 1200 bps 2400: 2400 bps 4800: 4800 bps 9600: 9600 bps 19200: 19.2k bps 38400: 38.4k bps Up to 19.2k bps for RS-485 in E4-terminal area.	R485 <b>Set</b>
<b>PRI</b>	Parity		NONE: None EVEN: Even ODD: Odd	
<b>STP</b>	Stop bit		1: 1 bit 2: 2 bits	
<b>DLN</b>	Data length		7: 7 bits 8: 8 bits	
<b>ADR</b>	Address		1 to 99	

**Set**: Setup parameter

When parameters have been displayed, the terminal areas (E1 to E4) are indicated in the group display area according to the suffix and optional suffix codes.

## 1.4 Model Compatibility of LL50A Functions

The model compatibility of LL50A functions are as follows:

Functions		User File / Model	Release number of the Setting Tool													
			R6.xx.xx													
			R5.xx.xx													
			R4.xx.xx													
			R3.xx.xx													
			R2.xx.xx													
			R1.xx.xx													
			Setting model in the System Data window													
			UT55A or UT52A	UT55A or UT52A	UT35A or UT32A	UT55A or UT52A	UT35A or UT32A	UP55A	UP35A	UM33A	UT35A-L	UT75A	UP32A	UT32A-D	UT32A-V UT32A-C UT32A-R	
User File	Open	UT55A	v	v	N/A	v	N/A	N/A	N/A	N/A	N/A	N/A	N/A	N/A	N/A	
		UT52A	v	v	N/A	v	N/A	N/A	N/A	N/A	N/A	N/A	N/A	N/A	N/A	
		UT35A	N/A	N/A	v	v	v	N/A	N/A	N/A	N/A	N/A	N/A	N/A	N/A	N/A
		UT32A	N/A	N/A	v	v	v	N/A	N/A	N/A	N/A	N/A	N/A	N/A	N/A	N/A
		UP55A	N/A	N/A	N/A	N/A	N/A	v	N/A	N/A	N/A	N/A	N/A	N/A	N/A	N/A
		UP35A	N/A	N/A	N/A	N/A	N/A	N/A	v	N/A	N/A	N/A	N/A	N/A	N/A	N/A
		UP32A	N/A	N/A	N/A	N/A	N/A	N/A	N/A	N/A	N/A	N/A	N/A	v	N/A	N/A
		UM33A	N/A	N/A	N/A	N/A	N/A	N/A	N/A	v	N/A	N/A	N/A	N/A	N/A	N/A
		UT35A-L	N/A	N/A	N/A	N/A	N/A	N/A	N/A	N/A	N/A	v	N/A	N/A	N/A	N/A
		UT75A	N/A	N/A	N/A	N/A	N/A	N/A	N/A	N/A	N/A	N/A	v	N/A	N/A	N/A
	UT32A-D	N/A	N/A	N/A	N/A	N/A	N/A	N/A	N/A	N/A	N/A	N/A	N/A	v	N/A	
	UT32A-V UT32A-C UT32A-R	N/A	N/A	N/A	N/A	N/A	N/A	N/A	N/A	N/A	N/A	N/A	N/A	N/A	v	
	Save	UT55A	v	v	N/A	v	N/A	N/A	N/A	N/A	N/A	N/A	N/A	N/A	N/A	N/A
		UT52A	v	v	N/A	v	N/A	N/A	N/A	N/A	N/A	N/A	N/A	N/A	N/A	N/A
		UT35A	N/A	N/A	v	N/A	v	N/A	N/A	N/A	N/A	N/A	N/A	N/A	N/A	N/A
		UT32A	N/A	N/A	v	N/A	v	N/A	N/A	N/A	N/A	N/A	N/A	N/A	N/A	N/A
		UP55A	N/A	N/A	N/A	N/A	N/A	v	N/A	N/A	N/A	N/A	N/A	N/A	N/A	N/A
		UP35A	N/A	N/A	N/A	N/A	N/A	N/A	v	N/A	N/A	N/A	N/A	N/A	N/A	N/A
		UP32A	N/A	N/A	N/A	N/A	N/A	N/A	N/A	N/A	N/A	N/A	N/A	v	N/A	N/A
		UM33A	N/A	N/A	N/A	N/A	N/A	N/A	N/A	v	N/A	N/A	N/A	N/A	N/A	N/A
UT35A-L		N/A	N/A	N/A	N/A	N/A	N/A	N/A	N/A	N/A	v	N/A	N/A	N/A	N/A	
UT75A		N/A	N/A	N/A	N/A	N/A	N/A	N/A	N/A	N/A	N/A	v	N/A	N/A	N/A	
UT32A-D	N/A	N/A	N/A	N/A	N/A	N/A	N/A	N/A	N/A	N/A	N/A	N/A	v	N/A		
UT32A-V UT32A-C UT32A-R	N/A	N/A	N/A	N/A	N/A	N/A	N/A	N/A	N/A	N/A	N/A	N/A	N/A	v		
Compare Files	Parameter	UT55A	v	v	N/A	v	N/A	N/A	N/A	N/A	N/A	N/A	N/A	N/A	N/A	
		UT52A	v	v	N/A	v	N/A	N/A	N/A	N/A	N/A	N/A	N/A	N/A	N/A	
		UT35A	N/A	N/A	v	N/A	v	N/A	N/A	N/A	N/A	N/A	N/A	N/A	N/A	
		UT32A	N/A	N/A	v	N/A	v	N/A	N/A	N/A	N/A	N/A	N/A	N/A	N/A	
		UP55A	N/A	N/A	N/A	N/A	N/A	v	N/A	N/A	N/A	N/A	N/A	N/A	N/A	
		UP35A	N/A	N/A	N/A	N/A	N/A	N/A	v	N/A	N/A	N/A	N/A	N/A	N/A	
		UP32A	N/A	N/A	N/A	N/A	N/A	N/A	N/A	N/A	N/A	N/A	N/A	v	N/A	
		UM33A	N/A	N/A	N/A	N/A	N/A	N/A	N/A	v	N/A	N/A	N/A	N/A	N/A	
		UT35A-L	N/A	N/A	N/A	N/A	N/A	N/A	N/A	N/A	N/A	v	N/A	N/A	N/A	
		UT75A	N/A	N/A	N/A	N/A	N/A	N/A	N/A	N/A	N/A	N/A	v	N/A	N/A	
UT32A-D	N/A	N/A	N/A	N/A	N/A	N/A	N/A	N/A	N/A	N/A	N/A	N/A	v			
UT32A-V UT32A-C UT32A-R	N/A	N/A	N/A	N/A	N/A	N/A	N/A	N/A	N/A	N/A	N/A	N/A	N/A	v		

v: Available, vv: Available with condition, N/A: Not available

### 1.4 Model Compatibility of LL50A Functions

Functions		User File / Model		Release number of the Setting Tool											
				R6.xx.xx											
				R5.xx.xx											
				R4.xx.xx											
		R2.xx.xx		R3.xx.xx											
		R1.xx.xx													
		Setting model in the System Data window													
		UT55A or UT52A	UT55A or UT52A	UT35A or UT32A	UT55A or UT52A	UT35A or UT32A	UP55A	UP35A	UM33A	UT35A-L	UT75A	UP32A	UT32A-D	UT32A-V UT32A-C UT32A-R	
Compare Files	Ladder Program	UT55A	v	v	vv	v	vv	vv	N/A	N/A	vv	vv	vv	N/A	
		UT52A	v	v	(Note 1)	v	(Note 1)	(Note 1)	(Note 1)	N/A	N/A	(Note 1)	(Note 1)	(Note 1)	N/A
		UT35A	N/A	vv	v	vv	v	vv	vv	N/A	N/A	vv	vv	vv	N/A
		UT32A	N/A	(Note 1)	v	(Note 1)	v	(Note 1)	(Note 1)	N/A	N/A	(Note 1)	(Note 1)	(Note 1)	N/A
		UP55A	N/A	N/A	N/A	vv	vv	v	vv	N/A	N/A	vv	vv	vv	N/A
		UP35A	N/A	N/A	N/A	vv	vv	(Note 1)	v	N/A	N/A	vv	vv	vv	N/A
		UP32A	N/A	N/A	N/A	N/A	N/A	N/A	N/A	N/A	N/A	N/A	v	vv	(Note 1)
		UT75A	vv	vv	vv	vv	vv	vv	vv	vv	N/A	v	vv	vv	N/A
	UT32A-D	N/A	N/A	N/A	N/A	N/A	N/A	N/A	N/A	N/A	N/A	vv	v	N/A	
	Program pattern	UP55A	N/A	N/A	N/A	N/A	N/A	v	N/A	N/A	N/A	N/A	N/A	N/A	
	UP35A	N/A	N/A	N/A	N/A	N/A	N/A	v	N/A	N/A	N/A	v	N/A	N/A	
	UP32A	N/A	N/A	N/A	N/A	N/A	N/A	N/A	N/A	N/A	N/A	v	N/A	N/A	
	Communication	Upload All	UT52A	v	v	N/A	v	N/A	N/A	N/A	N/A	N/A	N/A	N/A	N/A
			UT35A	N/A	N/A	v	N/A	v	N/A	N/A	N/A	N/A	N/A	N/A	N/A
UT32A			N/A	N/A	v	N/A	v	N/A	N/A	N/A	N/A	N/A	N/A	N/A	
UP55A			N/A	N/A	N/A	N/A	N/A	v	N/A	N/A	N/A	N/A	N/A	N/A	
UP35A			N/A	N/A	N/A	N/A	N/A	N/A	v	N/A	N/A	N/A	N/A	N/A	
UP32A			N/A	N/A	N/A	N/A	N/A	N/A	N/A	N/A	N/A	N/A	v	N/A	
UM33A			N/A	N/A	N/A	N/A	N/A	N/A	N/A	v	N/A	N/A	N/A	N/A	
UT35A-L			N/A	N/A	N/A	N/A	N/A	N/A	N/A	N/A	v	N/A	N/A	N/A	
UT75A			N/A	N/A	N/A	N/A	N/A	N/A	N/A	N/A	N/A	v	N/A	N/A	
UT32A-D			N/A	N/A	N/A	N/A	N/A	N/A	N/A	N/A	N/A	N/A	N/A	v	
UT32A-V UT32A-C UT32A-R			N/A	N/A	N/A	N/A	N/A	N/A	N/A	N/A	N/A	N/A	N/A	N/A	v
Download All			UT55A	v	v	N/A	v	N/A	N/A	N/A	N/A	N/A	N/A	N/A	N/A
			UT52A	v	v	N/A	v	N/A	N/A	N/A	N/A	N/A	N/A	N/A	N/A
			UT35A	N/A	N/A	v	N/A	v	N/A	N/A	N/A	N/A	N/A	N/A	N/A
		UT32A	N/A	N/A	v	N/A	v	N/A	N/A	N/A	N/A	N/A	N/A	N/A	
		UP55A	N/A	N/A	N/A	N/A	N/A	v	N/A	N/A	N/A	N/A	N/A	N/A	
		UP35A	N/A	N/A	N/A	N/A	N/A	N/A	v	N/A	N/A	N/A	N/A	N/A	
		UP32A	N/A	N/A	N/A	N/A	N/A	N/A	N/A	N/A	N/A	N/A	v	N/A	
		UM33A	N/A	N/A	N/A	N/A	N/A	N/A	N/A	v	N/A	N/A	N/A	N/A	
		UT35A-L	N/A	N/A	N/A	N/A	N/A	N/A	N/A	N/A	v	N/A	N/A	N/A	
		UT75A	N/A	N/A	N/A	N/A	N/A	N/A	N/A	N/A	N/A	v	N/A	N/A	
		UT32A-D	N/A	N/A	N/A	N/A	N/A	N/A	N/A	N/A	N/A	N/A	N/A	v	
		UT32A-V UT32A-C UT32A-R	N/A	N/A	N/A	N/A	N/A	N/A	N/A	N/A	N/A	N/A	N/A	N/A	v
		Download Parameter Data	UT55A	v	v	N/A	v	N/A	N/A	N/A	N/A	N/A	N/A	N/A	N/A
			UT52A	v	v	N/A	v	N/A	N/A	N/A	N/A	N/A	N/A	N/A	N/A
UT35A			N/A	N/A	v	N/A	v	N/A	N/A	N/A	N/A	N/A	N/A	N/A	
UT32A			N/A	N/A	v	N/A	v	N/A	N/A	N/A	N/A	N/A	N/A	N/A	
UP55A			N/A	N/A	N/A	N/A	N/A	v	N/A	N/A	N/A	N/A	N/A	N/A	
UP35A	N/A		N/A	N/A	N/A	N/A	N/A	v	N/A	N/A	N/A	N/A	N/A		
UP32A	N/A		N/A	N/A	N/A	N/A	N/A	N/A	N/A	N/A	N/A	v	N/A		
UM33A	N/A		N/A	N/A	N/A	N/A	N/A	N/A	v	N/A	N/A	N/A	N/A		
UT35A-L	N/A		N/A	N/A	N/A	N/A	N/A	N/A	N/A	v	N/A	N/A	N/A		
UT75A	N/A		N/A	N/A	N/A	N/A	N/A	N/A	N/A	N/A	v	N/A	N/A		
UT32A-D	N/A	N/A	N/A	N/A	N/A	N/A	N/A	N/A	N/A	N/A	N/A	v			
UT32A-V UT32A-C UT32A-R	N/A	N/A	N/A	N/A	N/A	N/A	N/A	N/A	N/A	N/A	N/A	N/A	v		

v: Available, vv: Available with condition, N/A: Not available

## 1.4 Model Compatibility of LL50A Functions

Functions	User File / Model	Release number of the Setting Tool													
		R6.xx.xx											R5.xx.xx		
		R4.xx.xx									R3.xx.xx		R2.xx.xx		
		R1.xx.xx	R2.xx.xx		R3.xx.xx			R4.xx.xx			R5.xx.xx		R6.xx.xx		
		Setting model in the System Data window													
		UT55A or UT52A	UT55A or UT52A	UT35A or UT32A	UT55A or UT52A	UT35A or UT32A	UP55A	UP35A	UM33A	UT35A-L	UT75A	UP32A	UT32A-D	UT32A-V UT32A-C UT32A-R	
Communication	Download Parameter Data	UT55A	v	v	N/A	v	N/A	N/A	N/A	N/A	N/A	N/A	N/A	N/A	N/A
		UT52A	v	v	N/A	v	N/A	N/A	N/A	N/A	N/A	N/A	N/A	N/A	N/A
		UT35A	N/A	N/A	N/A	v	N/A	v	N/A	N/A	N/A	N/A	N/A	N/A	N/A
		UT32A	N/A	N/A	v	N/A	v	N/A	N/A	N/A	N/A	N/A	N/A	N/A	N/A
		UP55A	N/A	N/A	N/A	N/A	N/A	v	N/A	N/A	N/A	N/A	N/A	N/A	N/A
		UP35A	N/A	N/A	N/A	N/A	N/A	N/A	v	N/A	N/A	N/A	N/A	N/A	N/A
		UM33A	N/A	N/A	N/A	N/A	N/A	N/A	N/A	v	N/A	N/A	N/A	N/A	N/A
		UT35A-L	N/A	N/A	N/A	N/A	N/A	N/A	N/A	N/A	v	N/A	N/A	N/A	N/A
		UT75A	N/A	N/A	N/A	N/A	N/A	N/A	N/A	N/A	N/A	v	N/A	N/A	N/A
		UT32A-D	N/A	N/A	N/A	N/A	N/A	N/A	N/A	N/A	N/A	N/A	N/A	v	N/A
	UT32A-V UT32A-C UT32A-R	N/A	N/A	N/A	N/A	N/A	N/A	N/A	N/A	N/A	N/A	N/A	N/A	v	
	Upload Ladder Program	UT55A	v	v	vv (Note 2) (Note 7)	v	vv (Note 2) (Note 7)	vv (Note 2) (Note 7)	vv (Note 2) (Note 7)	N/A	N/A	vv (Note 2) (Note 7)	vv (Note 2) (Note 7)	vv (Note 2) (Note 7)	N/A
		UT52A	v	v	vv (Note 2) (Note 7)	v	vv (Note 2) (Note 7)	vv (Note 2) (Note 7)	vv (Note 2) (Note 7)	N/A	N/A	vv (Note 2) (Note 7)	vv (Note 2) (Note 7)	vv (Note 2) (Note 7)	N/A
		UT35A	N/A	vv (Note 2) (Note 7)	v	vv (Note 2) (Note 7)	v	vv (Note 2) (Note 7)	vv (Note 2) (Note 7)	N/A	N/A	vv (Note 2) (Note 7)	vv (Note 2) (Note 7)	vv (Note 2) (Note 7)	N/A
		UT32A	N/A	vv (Note 2) (Note 7)	v	vv (Note 2) (Note 7)	v	vv (Note 2) (Note 7)	vv (Note 2) (Note 7)	N/A	N/A	vv (Note 2) (Note 7)	vv (Note 2) (Note 7)	vv (Note 2) (Note 7)	N/A
		UP55A	N/A	N/A	N/A	vv (Note 2) (Note 7)	vv (Note 2) (Note 7)	v	vv (Note 2) (Note 7)	N/A	N/A	vv (Note 2) (Note 7)	vv (Note 2) (Note 7)	vv (Note 2) (Note 7)	N/A
		UP35A	N/A	N/A	N/A	vv (Note 2) (Note 7)	vv (Note 2) (Note 7)	vv (Note 2) (Note 7)	v	N/A	N/A	vv (Note 2) (Note 7)	vv (Note 2) (Note 7)	vv (Note 2) (Note 7)	N/A
		UP32A	N/A	N/A	N/A	N/A	N/A	N/A	N/A	N/A	N/A	N/A	v	vv (Note 2) (Note 7)	N/A
		UT75A	N/A	N/A	N/A	N/A	N/A	N/A	N/A	N/A	N/A	v	vv (Note 2) (Note 7)	vv (Note 2) (Note 7)	N/A
		UT32A-D	N/A	N/A	N/A	N/A	N/A	N/A	N/A	N/A	N/A	N/A	vv (Note 2) (Note 7)	v	N/A
	Download Ladder Program	UT55A	v	v	vv (Note 3)	v	vv (Note 3)	vv (Note 3)	vv (Note 3)	N/A	N/A	vv (Note 3)	vv (Note 3)	vv (Note 3)	N/A
		UT52A	v	v	vv (Note 3)	v	vv (Note 3)	vv (Note 3)	vv (Note 3)	N/A	N/A	vv (Note 3)	vv (Note 3)	vv (Note 3)	N/A
		UT35A	N/A	vv (Note 3)	v	vv (Note 3)	v	vv (Note 3)	vv (Note 3)	N/A	N/A	vv (Note 3)	vv (Note 3)	vv (Note 3)	N/A
		UT32A	N/A	vv (Note 3)	v	vv (Note 3)	v	vv (Note 3)	vv (Note 3)	N/A	N/A	vv (Note 3)	vv (Note 3)	vv (Note 3)	N/A
		UP55A	N/A	N/A	N/A	vv (Note 3)	vv (Note 3)	v	vv (Note 3)	N/A	N/A	vv (Note 3)	vv (Note 3)	vv (Note 3)	N/A
		UP35A	N/A	N/A	N/A	vv (Note 3)	vv (Note 3)	vv (Note 3)	v	N/A	N/A	vv (Note 3)	vv (Note 3)	vv (Note 3)	N/A
		UP32A	N/A	N/A	N/A	N/A	N/A	N/A	N/A	N/A	N/A	N/A	v	vv (Note 3)	N/A
		UT75A	N/A	N/A	N/A	N/A	N/A	N/A	N/A	N/A	N/A	v	vv (Note 3)	vv (Note 3)	N/A
		UT32A-D	N/A	N/A	N/A	N/A	N/A	N/A	N/A	N/A	N/A	N/A	vv (Note 3)	v	N/A

v: Available, vv: Available with condition, N/A: Not available

## 1.4 Model Compatibility of LL50A Functions

Functions		User File / Model	Release number of the Setting Tool													
			R6.xx.xx													
			R5.xx.xx										R4.xx.xx			
			R3.xx.xx					R2.xx.xx		R1.xx.xx						
		Setting model in the System Data window														
		UT55A or UT52A	UT55A or UT52A	UT35A or UT32A	UT55A or UT52A	UT35A or UT32A	UP55A	UP35A	UM33A	UT35A-L	UT75A	UP32A	UT32A-D	UT32A-V	UT32A-C	UT32A-R
Communication	Upload Program Pattern Data	UP55A	N/A	N/A	N/A	N/A	N/A	✓ (Note 4)	N/A	N/A	N/A	N/A	N/A	N/A	N/A	N/A
		UP35A	N/A	N/A	N/A	N/A	N/A	N/A	✓ (Note 4)	N/A	N/A	N/A	N/A	✓ (Note 4)	N/A	N/A
		UP32A	N/A	N/A	N/A	N/A	N/A	N/A	N/A	N/A	N/A	N/A	N/A	✓ (Note 4)	N/A	N/A
	Download Program Pattern Data	UP55A	N/A	N/A	N/A	N/A	N/A	✓ (Note 5)	N/A	N/A	N/A	N/A	N/A	N/A	N/A	N/A
		UP35A	N/A	N/A	N/A	N/A	N/A	N/A	✓ (Note 5)	N/A	N/A	N/A	N/A	✓ (Note 5)	N/A	N/A
		UP32A	N/A	N/A	N/A	N/A	N/A	N/A	N/A	N/A	N/A	N/A	N/A	✓ (Note 5)	N/A	N/A
Parameter Compare	UT55A	✓	✓	N/A	✓	N/A	N/A	N/A	N/A	N/A	N/A	N/A	N/A	N/A	N/A	
	UT52A	✓	✓	N/A	✓	N/A	N/A	N/A	N/A	N/A	N/A	N/A	N/A	N/A	N/A	
	UT35A	N/A	N/A	✓	N/A	✓	N/A	N/A	N/A	N/A	N/A	N/A	N/A	N/A	N/A	
	UT32A	N/A	N/A	✓	N/A	✓	N/A	N/A	N/A	N/A	N/A	N/A	N/A	N/A	N/A	
	UP55A	N/A	N/A	N/A	N/A	N/A	✓	N/A	N/A	N/A	N/A	N/A	N/A	N/A	N/A	
	UP35A	N/A	N/A	N/A	N/A	N/A	N/A	✓	N/A	N/A	N/A	N/A	N/A	N/A	N/A	
	UP32A	N/A	N/A	N/A	N/A	N/A	N/A	N/A	N/A	N/A	N/A	✓	N/A	N/A	N/A	
	UM33A	N/A	N/A	N/A	N/A	N/A	N/A	N/A	✓	N/A	N/A	N/A	N/A	N/A	N/A	
	UT35A-L	N/A	N/A	N/A	N/A	N/A	N/A	N/A	N/A	✓	N/A	N/A	N/A	N/A	N/A	
	UT75A	N/A	N/A	N/A	N/A	N/A	N/A	N/A	N/A	N/A	✓	N/A	N/A	N/A	N/A	
	UT32A-D	N/A	N/A	N/A	N/A	N/A	N/A	N/A	N/A	N/A	N/A	N/A	✓	N/A	N/A	
	UT32A-V	N/A	N/A	N/A	N/A	N/A	N/A	N/A	N/A	N/A	N/A	N/A	N/A	✓	N/A	
	Compare Communication	Ladder Program Compare	UT55A	✓	✓	vv (Note 1)	✓	vv (Note 1)	vv (Note 1)	vv (Note 1)	N/A	N/A	vv (Note 1)	vv (Note 1)	vv (Note 1)	N/A
UT52A			✓	✓	vv (Note 1)	N/A	vv (Note 1)	vv (Note 1)	vv (Note 1)	N/A	N/A	vv (Note 1)	vv (Note 1)	vv (Note 1)	N/A	
UT35A			N/A	vv (Note 1)	✓	vv (Note 1)	✓	vv (Note 1)	vv (Note 1)	N/A	N/A	vv (Note 1)	vv (Note 1)	vv (Note 1)	N/A	
UT32A			N/A	vv (Note 1)	✓	vv (Note 1)	✓	vv (Note 1)	vv (Note 1)	N/A	N/A	vv (Note 1)	vv (Note 1)	vv (Note 1)	N/A	
UP55A			N/A	N/A	N/A	vv (Note 1)	vv (Note 1)	✓	vv (Note 1)	N/A	N/A	vv (Note 1)	vv (Note 1)	vv (Note 1)	N/A	
UP35A			N/A	N/A	N/A	vv (Note 1)	vv (Note 1)	vv (Note 1)	✓	N/A	N/A	vv (Note 1)	vv (Note 1)	vv (Note 1)	N/A	
UP32A			N/A	N/A	N/A	N/A	N/A	N/A	N/A	N/A	N/A	✓	vv (Note 1)	vv (Note 1)	N/A	
UT75A			N/A	N/A	N/A	N/A	N/A	N/A	N/A	N/A	N/A	✓	vv (Note 1)	vv (Note 1)	N/A	
UT32A-D			N/A	N/A	N/A	N/A	N/A	N/A	N/A	N/A	N/A	N/A	vv (Note 1)	✓	N/A	
Program Pattern		UP55A	N/A	N/A	N/A	N/A	N/A	✓	N/A	N/A	N/A	N/A	N/A	N/A	N/A	
Program Pattern File	Open	UP55A	N/A	N/A	N/A	N/A	N/A	✓ (Note 6)	N/A	N/A	N/A	N/A	N/A	N/A	N/A	
		UP35A	N/A	N/A	N/A	N/A	N/A	N/A	✓ (Note 6)	N/A	N/A	N/A	✓ (Note 6)	N/A	N/A	
		UP32A	N/A	N/A	N/A	N/A	N/A	N/A	N/A	N/A	N/A	N/A	✓ (Note 6)	N/A	N/A	
	Save	UP55A	N/A	N/A	N/A	N/A	N/A	✓	N/A	N/A	N/A	N/A	N/A	N/A	N/A	
		UP35A	N/A	N/A	N/A	N/A	N/A	N/A	✓	N/A	N/A	N/A	✓	N/A	N/A	
		UP32A	N/A	N/A	N/A	N/A	N/A	N/A	N/A	N/A	N/A	N/A	✓	N/A	N/A	

✓: Available, vv: Available with condition, N/A: Not available

Note 1: Each ladder program of UT75A, UT55A, UT52A, UT35A, UT32A, UP55A, UP35A and UP32A can be compared mutually.

Note 2: If the models are UT35A/UT32A/UP35A/UP32A and UT75A/UT55A/UT52A/UP55A (when in single-loop control mode), the upload can be performed only when the condition is LL50A (maximum ladder program capacity)  $\geq$  Main unit (the downloaded ladder program capacity).

Note 3: If the models are UT35A/UT32A/UP35A/UP32A and UT75A/UT55A/UT52A/UP55A (when in single-loop control mode), the download can be performed only when the condition is LL50A (maximum ladder program capacity)  $\leq$  Main unit (the downloaded ladder program capacity). The download cannot be performed when the ladder program in LL50A data includes an address that cannot be used in the downloading UT.

Max. ladder program capacity of UT75A: 1000 steps

Max. ladder program capacity of UT55A/UT52A/UP55A: 500 steps

Max. ladder program capacity of UT35A/UT32A/UP35A/UP32A: 300 steps

Note 4: The number of patterns and the number of segments that can be set vary depending on whether or not option code /AP is specified. Only the pattern data that can be downloaded to the main unit can be downloaded.

UP55A/AP can use LL50As with R6.xx.xx or later.

Note 5: The number of patterns and the number of segments that can be set vary depending on whether or not option code /AP is specified. Only the pattern data that can be uploaded can be downloaded.

Note 6: The number of patterns and the number of segments that can be set vary depending on whether or not option code /AP is specified. Only readable pattern data can be read.

Note 7: For uploads from a different model, if the data contains an address that the uploading model cannot use, a blank address will be uploaded.





## 2.1 Setting Flow

The LL50A operation guide describes how to set parameters to the main unit, build program pattern, creating user file information, monitoring, downloading, uploading, file management, printing, etc. For how to build ladder programs, see Chapter 3, A Guide to Building Ladder Programs.

For how to create network profile, see Chapter 6, Profile Creating Guide.

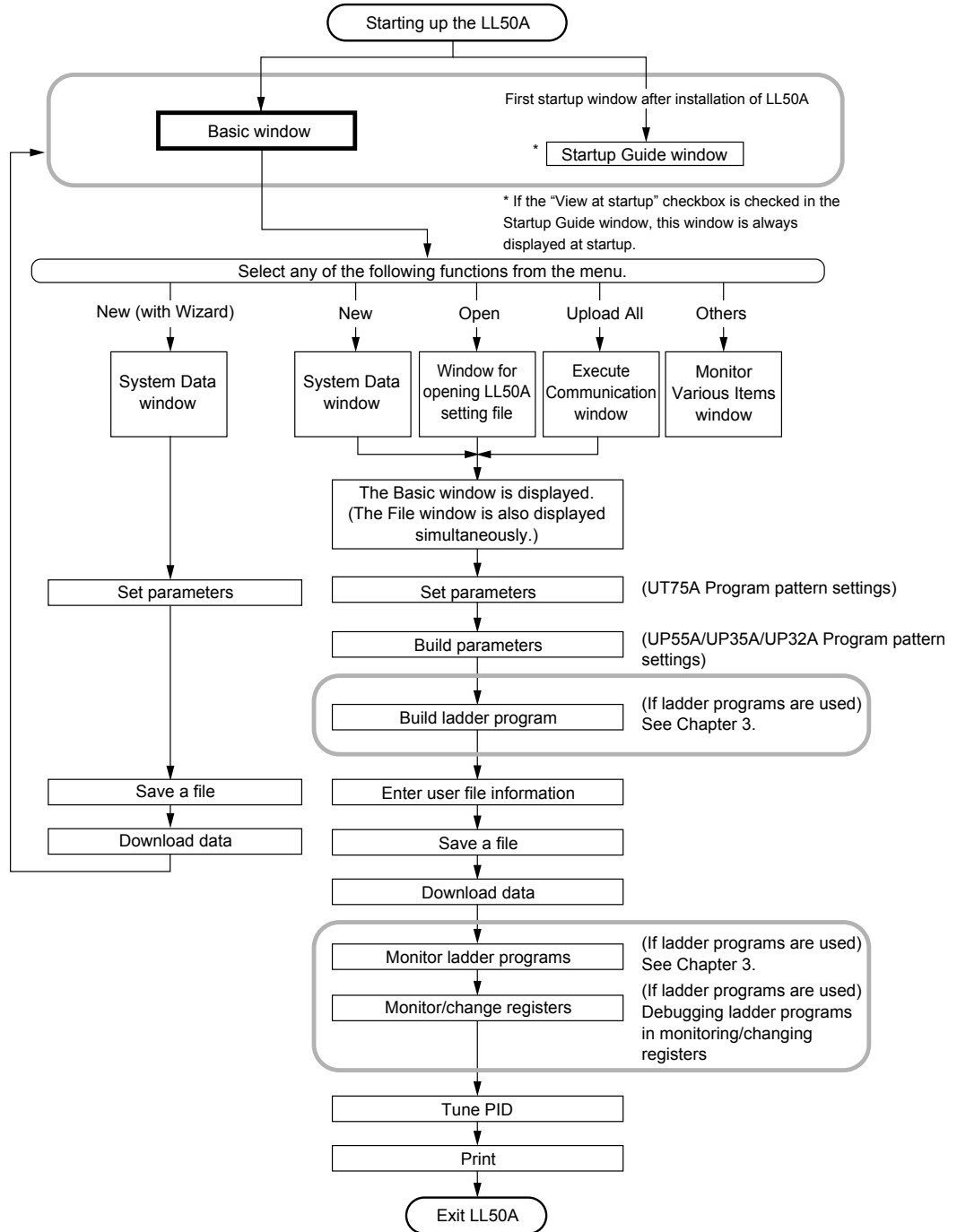

## 2.2 Starting up/Exiting the LL50A

### Starting up the LL50A

#### Procedure

1. For Windows 11  
Click on Windows' [Start] menu, select [All apps] –[UTAdvanced], and then click on [Setting Tool].  
For Windows 10  
Apps in the Windows Start menu - [UTAdvanced], and then click on [Setting Tool].  
For Windows 8.1  
Click on Windows' [Start] menu, select [All Programs] - [UTAdvanced], and then click on [Setting Tool].

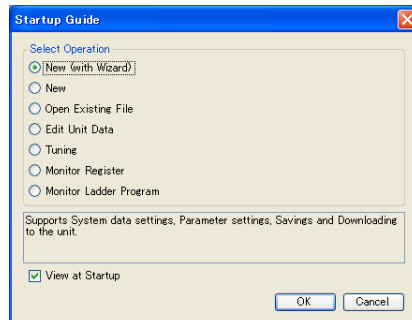

The Startup Guide window is displayed at the first startup after installing the LL50A and if the Use Startup Guide checkbox is checked in the Environmental Setting window.

- **New (with Wizard)**  
Enables you to set system data, set parameters, save a file, and download data to the main unit in sequence.
- **New**  
Creates new parameters.
- **Open Existing File**  
Enables you to open and edit an existing user file.
- **Edit Unit Data**  
Enables you to read out and edit data from the main unit.
- **Tuning**  
Enables you to tune main unit data.
- **Monitor Registers**  
Monitors main unit registers.
- **Monitor Ladder Programs**  
Monitors main unit ladder programs.

- View at Startup  
If this checkbox is checked, the Startup Guide window is displayed at the next startup.
- Guide message  
This section displays the description of a selected function.

2. Select a function and click the [OK] button. Click the [Cancel] button to close the window.

The Startup Guide window can also be started up by double-clicking on the Setting Tool shortcut or a setting file (user file extension: see section 2.15.2) on the Desktop.

If the Startup Guide window is disabled from being displayed at startup, the following Basic window appears.

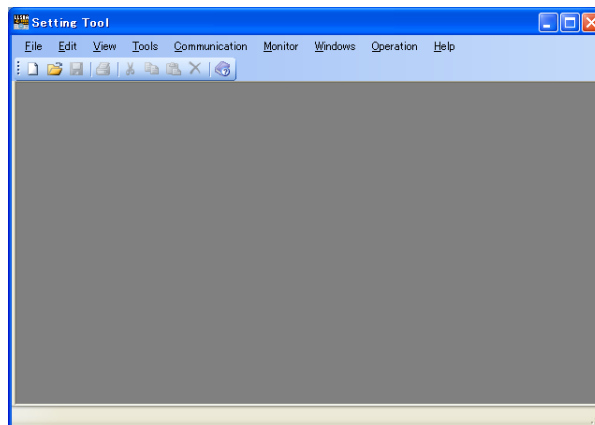

## Exiting the LL50A

### Procedure

1. Click on [File] – [Exit] in the menu or click .

### Note

Save the current editing file as necessary.

## 2.3 Part Names of Window and Their Functions

### Basic window

The Basic window is a background window for setting system data, setting parameters, performing tuning, building ladder programs, etc.

The window below shows an example display of the Parameter Setting window.

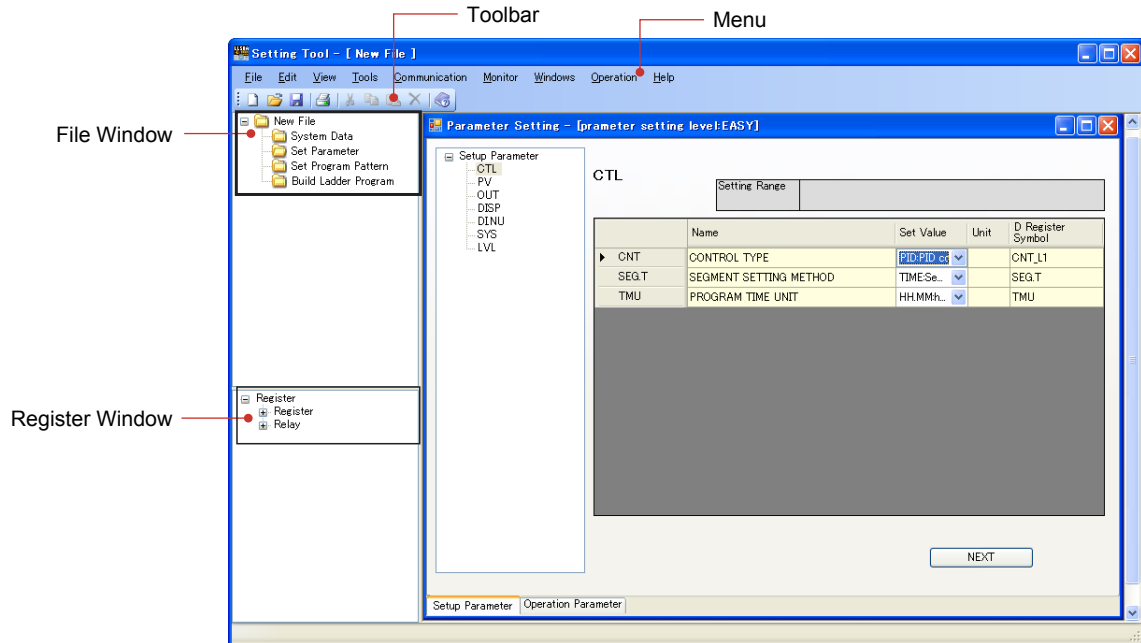

### Note

Clicking Help on Help menu opens a PDF file of this manual.

### File window

The File window is displayed on the left of the Basic window. It can be made visible or invisible. If data is saved in a file, the file name is displayed.

Clicking on a folder on the tree causes the Set System Data, Set Parameter, Set Program pattern or Build Ladder Program window to appear.

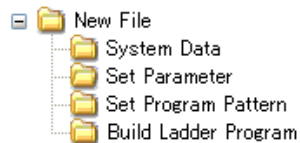

Clicking on "Build Ladder Program" in the File window causes the Build Ladder Program window to appear. In this case, the Instruction window is displayed. See Chapter 3, A Guide to Building Ladder Programs.

## Register window

The Register window is also displayed on the left of the Basic window. It can be made visible or invisible. This window can be used to set parameters, set program pattern perform tuning, monitor registers, or build ladder programs.

Right-clicking in the Register window enables the [Expand] or [Collapse] shortcut menu to be selected. When Expand is selected, a register can be searched by using the keyboard to enter search conditions or something similar.

- [-] Register
  - [+] Register
    - [+] Process monitoring
    - [+] Program pattern
    - [+] Operation mode parameter
    - [+] Loop-1 operation parameter
    - [+] Loop-2 operation parameter
    - [+] P parameter
    - [+] Register for ladder program
  - [-] Relay
    - [+] Function status
    - [+] Status for ladder program

### 2.3 Part Names of Window and Their Functions

Data category of Register tree

Large class.	Middle class.	Small class.	UT75A	UT55A	UT52A	UT35A	UT32A	UP55A	UP35A	UM33A	UT35A-L	UT32A-D		
Register	Process monitoring	Process data	✓	✓	✓	✓	✓	✓	✓	✓	✓	✓		
	Program pattern	Local mode setting	N/A	N/A	N/A	N/A	N/A	✓	✓	N/A	N/A	N/A		
	Operation mode parameters	Loop-1/Loop-2 operation mode	✓	✓	✓	N/A	N/A	✓	N/A	N/A	N/A	N/A	N/A	
		Operation mode	N/A	N/A	N/A	✓	✓	N/A	✓	N/A	N/A	N/A	✓	
	Operation parameter	Loop-1/Loop-2 alarm setpoint setting	N/A	N/A	N/A	N/A	N/A	✓	N/A	N/A	N/A	N/A	N/A	
		Alarm setpoint setting	N/A	N/A	N/A	N/A	N/A	N/A	✓	✓	N/A	N/A	N/A	
	Loop-1 operation parameters	SP and alarm setpoint setting	✓	✓	✓	✓	✓	✓	N/A	N/A	N/A	✓	✓	
		SP-related setting	✓	✓	✓	✓	✓	✓	✓	✓	N/A	✓	✓	
		Alarm function setting	✓	✓	✓	✓	✓	✓	✓	✓	✓	✓	✓	
		PV-related setting	✓	✓	✓	✓	✓	✓	✓	✓	✓	✓	✓	
		PID setting	✓	✓	✓	✓	✓	✓	✓	✓	N/A	N/A	✓	
	Loop-2 operation parameters	Control action-related setting	✓	✓	✓	✓	✓	✓	✓	✓	N/A	N/A	✓	
		SP and alarm setpoint setting	✓	✓	✓	N/A	N/A	N/A	N/A	N/A	N/A	N/A	✓	
		SP-related setting	✓	✓	✓	N/A	N/A	N/A	N/A	N/A	N/A	N/A	✓	
		Alarm function setting	✓	✓	✓	N/A	N/A	✓	N/A	N/A	N/A	N/A	✓	
		PV-related setting	✓	✓	✓	N/A	N/A	✓	N/A	N/A	N/A	N/A	✓	
	P-parameters	PID setting	✓	✓	✓	N/A	N/A	✓	N/A	N/A	N/A	N/A	✓	
		Control action-related setting	✓	✓	✓	N/A	N/A	✓	N/A	N/A	N/A	N/A	✓	
		P-parameter	✓	✓	✓	✓	✓	✓	✓	✓	N/A	N/A	✓	
		Custom display parameters	Custom display setting	✓	N/A	N/A	N/A	N/A	N/A	N/A	N/A	N/A	N/A	N/A
		T-parameters	T-parameter	✓	✓	✓	✓	✓	✓	✓	N/A	✓	✓	
	Registers for ladder program	For input ladder calculation	✓	✓	✓	✓	✓	✓	✓	✓	N/A	N/A	✓	
		For output ladder calculation	✓	✓	✓	✓	✓	✓	✓	✓	N/A	N/A	✓	
		Status register	✓	✓	✓	✓	✓	✓	✓	✓	N/A	N/A	✓	
		Constant register	✓	✓	✓	✓	✓	✓	✓	✓	N/A	N/A	✓	
		Input range / scale	✓	✓	✓	✓	✓	✓	✓	✓	N/A	N/A	✓	
		DAT register	✓	✓	✓	✓	✓	✓	✓	✓	N/A	N/A	✓	
		Special register	✓	✓	✓	✓	✓	✓	✓	✓	N/A	N/A	✓	
	Peer-to-peer communication register	✓	✓	✓	✓	✓	✓	✓	✓	N/A	N/A	✓		
	Program pattern	Program pattern	✓	N/A	N/A	N/A	N/A	N/A	N/A	N/A	N/A	N/A	N/A	

✓: Available  
N/A: Not available

Data category of Register tree (Continued)

Large class.	Middle class.	Small class.	UT75A	UT55A	UT52A	UT35A	UT32A	UP55A	UP35A	UM33A	UT35A-L	UT32A-D	
Relay	Function status	System error	✓	✓	✓	✓	✓	✓	✓	✓	✓	✓	
		Input error	✓	✓	✓	✓	✓	✓	✓	✓	✓	✓	
		Operation mode	✓	✓	✓	✓	✓	✓	✓	✓	✓	✓	
		Program pattern end signal	✓	N/A	N/A	N/A	N/A	N/A	N/A	N/A	N/A	N/A	
		Wait end signal											
		Alarm	✓	✓	✓	✓	✓	✓	✓	✓	✓	✓	
		Alarm latch	✓	✓	✓	✓	✓	✓	✓	✓	✓	✓	
		Heater break alarm	N/A	✓	✓	✓	✓	✓	✓	✓	N/A	N/A	✓
		SP number, PID number	N/A	✓	✓	✓	✓	✓	N/A	N/A	N/A	N/A	✓
		SP number, PID number, Segment number	✓	N/A	N/A	N/A	N/A	N/A	N/A	N/A	N/A	N/A	N/A
		PID number, Pattern number, Segment number	N/A	N/A	N/A	N/A	N/A	N/A	✓	✓	N/A	N/A	N/A
		Key	✓	✓	✓	✓	✓	✓	✓	✓	✓	N/A	✓
		Display	✓	✓	✓	✓	✓	✓	✓	✓	✓	✓	✓
		PV event status	N/A	N/A	N/A	N/A	N/A	N/A	✓	✓	N/A	N/A	N/A
		Time event status	N/A	N/A	N/A	N/A	N/A	N/A	✓	✓	N/A	N/A	N/A
		Pattern number status, Segment number status	N/A	N/A	N/A	N/A	N/A	N/A	✓	✓	N/A	N/A	N/A
	Segment number status	✓	N/A	N/A	N/A	N/A	N/A	N/A	N/A	N/A	N/A	N/A	
	Status for ladder program	Input (status) relay	✓	✓	✓	✓	✓	✓	✓	✓	✓	N/A	✓
		Output (status) relay	✓	✓	✓	✓	✓	✓	✓	✓	✓	N/A	✓
		Control (status) relay	✓	✓	✓	✓	✓	✓	✓	✓	N/A	N/A	✓
		Special relay	✓	✓	✓	✓	✓	✓	✓	✓	N/A	N/A	✓
		Internal relay	✓	✓	✓	✓	✓	✓	✓	✓	✓	N/A	✓
		Peer-to-peer communication	✓	✓	✓	✓	✓	✓	✓	✓	N/A	N/A	✓

✓: Available  
N/A: Not available

**Note**

The registers and relays of Loop-2 are available for UT75A/UT55A/UT52A/UP55A.

\* Only on the UT75A has groups 9 to 20.



## 2.3 Part Names of Window and Their Functions

### Parameter Setting window

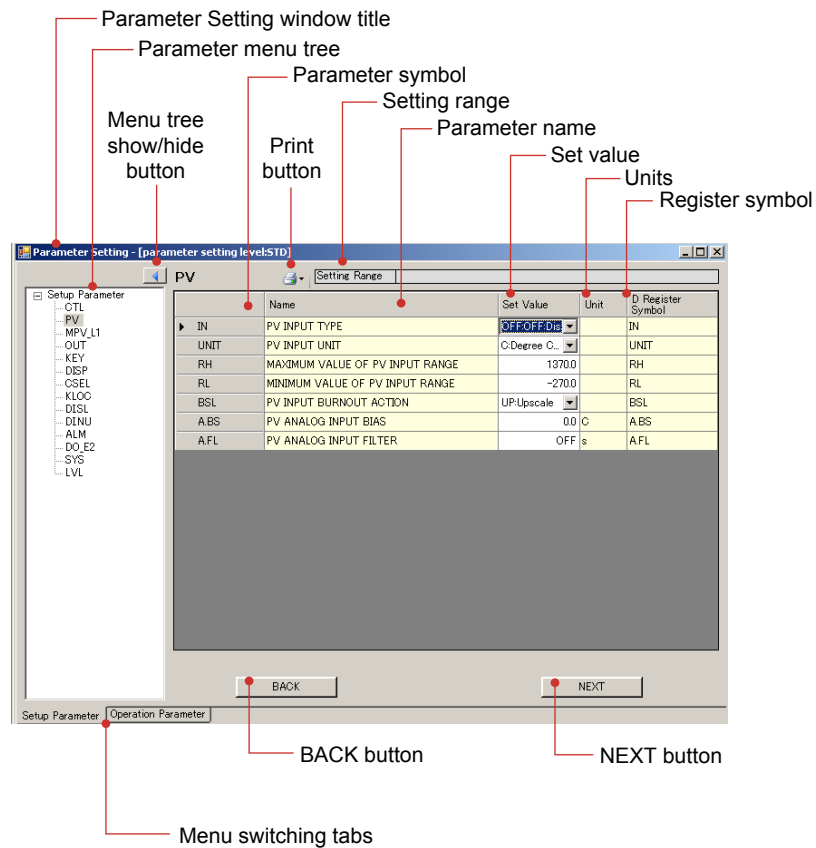

Name	Specifications
Menu switching tabs	Used to switch to the operation parameter or setup parameter windows.
Parameter Setting window title	Parameter Setting – [Parameter display level:***] To set to easy setting mode display or parameter display level (LEVL = EASY): EASY To set to standard setting mode display or parameter display level (LEVL = STD): STD To set to professional setting mode display or parameter display level (LEVL = PRO): PRO
Parameter menu tree	A menu tree of operation parameters and setup parameters
Menu tree show/hide button	Shows/hides a parameter menu tree by clicking.
Print button	Prints parameters.
Setting Range	Shows the setting range of the selected parameter.
Parameter symbol	Shows parameter symbols.
Parameter name	Shows parameter names.
Set value	Shows parameter set values. Enter a set value into a cell directly or select it from a dropdown list. To register a register, enter a register symbol by drag-and-drop from the Register window or input a register symbol into a cell directly.
Units	Shows the unit of a parameter set value.
Register symbol	Shows register symbols. Use these symbols when performing tuning or building ladder programs.

**Program pattern Setting window (UP55A/UP35A/UP32A only)**  
**Action Setting**

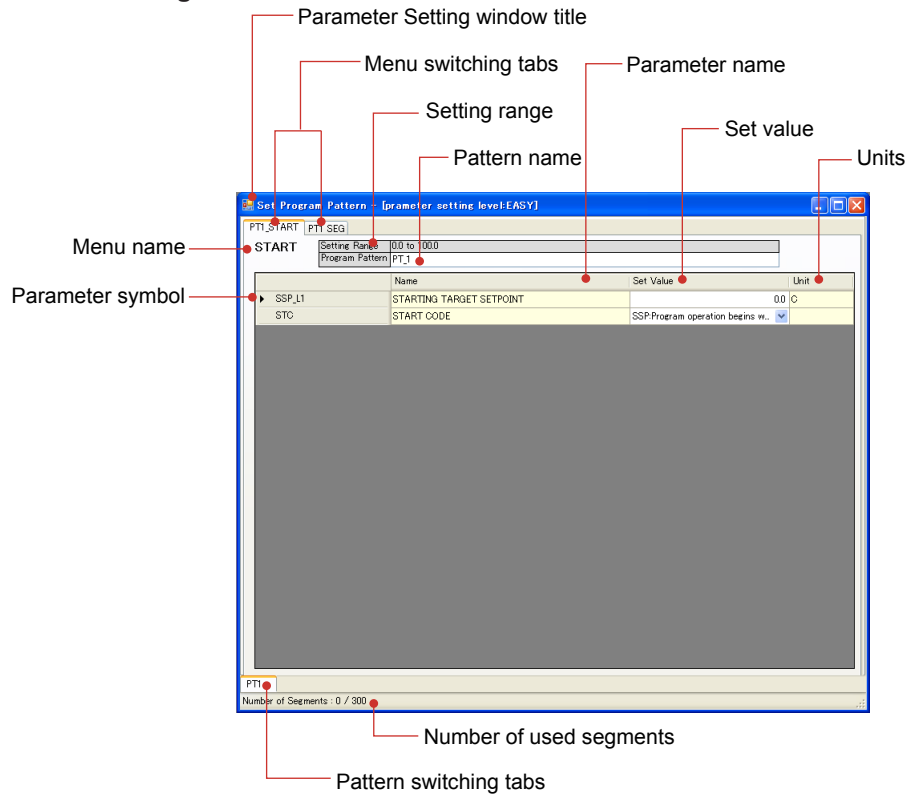

Name	Specifications
Parameter Setting window title	Parameter Setting – [Parameter display level:***] To set to easy setting mode display or parameter display level (LEVL = EASY): EASY To set to standard setting mode display or parameter display level (LEVL = STD): STD To set to professional setting mode display or parameter display level (LEVL = PRO): PRO
Menu switching tabs	Used to switch between the Operation Setting (PTn_START) and Segment Setting (PTn_SEG) windows. n = pattern number
Menu name	START, when the window is the Action Setting (PTn_START) window.
Setting range	This section shows the setting range of a selected parameter.
Pattern name	Sets or shows the specified program pattern name.
Parameter symbol	Parameter symbol (which, however, is followed by _L1 when the pattern is a control program pattern, and by _L2 when the pattern is a retransmission program pattern)
Parameter name	Shows parameter names.
Set value	Shows parameter set values. Enter a set value into a cell directly or select it from a dropdown list. To register a register, enter a register symbol by drag-and-drop from the Register window or input a register symbol into a cell directly.
Units	Shows the unit of a parameter set value.
Pattern switching tabs	Used to switch to the pattern number.
Number of used segments	Number of used segments/max number segments

## 2.3 Part Names of Window and Their Functions

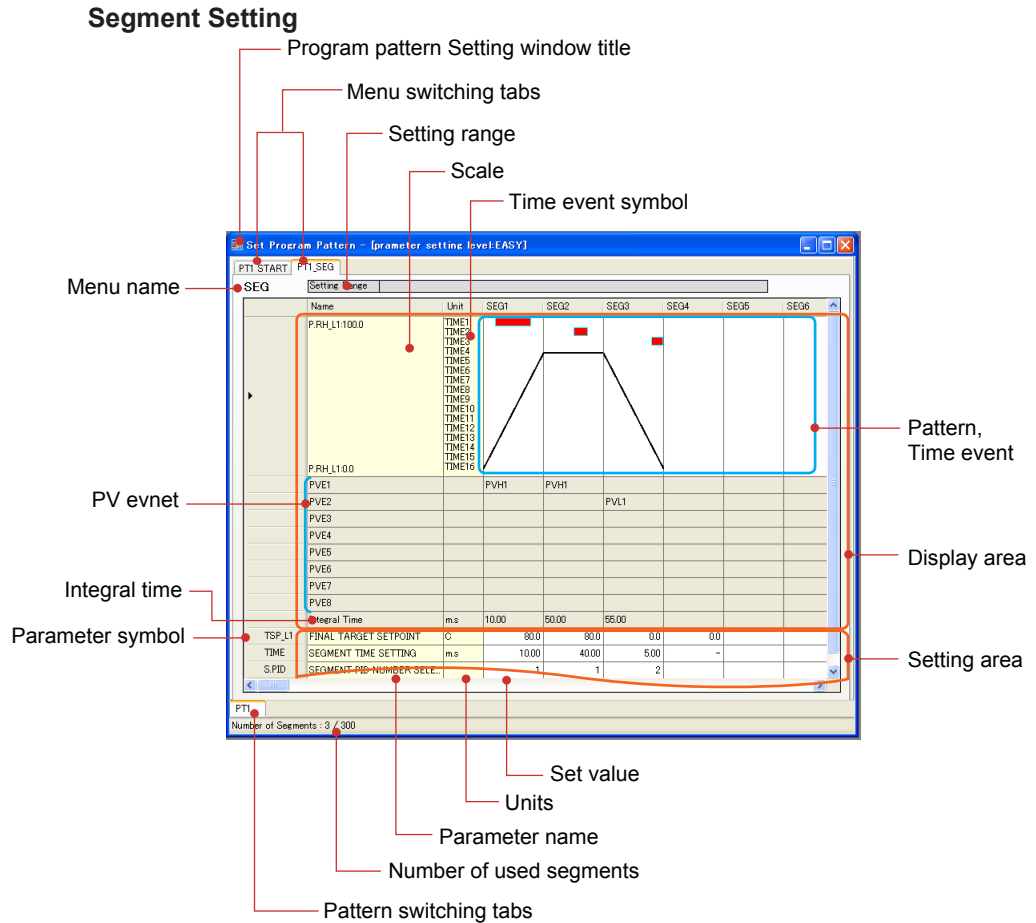

Name	Specifications
Parameter Setting window title	Parameter Setting – [Parameter display level:***] To set to easy setting mode display or parameter display level (LEVL = EASY): EASY To set to standard setting mode display or parameter display level (LEVL = STD): STD To set to professional setting mode display or parameter display level (LEVL = PRO): PRO
Menu switching tabs	Used to switch between the Operation Setting (PTn_START) and Segment Setting (PTn_SEG) windows. n = pattern number
Menu name	SEG, when the window is the Segment Setting (PTn_SEG) window.
Setting range	This section shows the setting range of a selected parameter.
Scale	Control PV input range
Parameter symbol	Parameter symbol (which, however, is followed by _L1 when the pattern is a control program pattern, and by _L2 when the pattern is a retransmission program pattern)
Parameter name	Shows parameter names.
Set value	Shows parameter set values.
Units	Shows the unit of a parameter set value.
Time event symbol	Shows the time event symbol.
Pattern, Time event	The ON/OFF status of the pattern and time events is displayed.
PV event	Shows PV event type.

Name	Specifications
Integral time	<p>Shows integrated value of segment time.</p> <p>Note: With LL50A, the segment time of each of the segments starting with SEG1 is added up and displayed as the integral time. The integral time does not include the wait time and the segment time activated by the settings, such as repeat segment, number of repeat cycles and program start segment number.</p> <p>Furthermore, when the start code (STC) is set to RAMP, the integral time displayed in LL50A may differ from the actual action, since the start segment and segment time are determined by the measurement values at the time when the program operation starts.</p> <p>In ramp segment where the segment setting method (SEG.T) is set to TM.RT, the segment time is calculated from the setting value of the segment ramp-rate time (TM.RT). Therefore, the minimum digit of the segment time may include an error.</p>
Pattern	<p>Shows program pattern.</p> <p>Note: The setpoint in the start target setpoint (SSP_L1 or SSP_L2) is used as the start target value for SEG1 to plot the graph.</p> <p>When the start code (STC) is set to other than SSP, the pattern graph differs from the actual action.</p> <ul style="list-style-type: none"> <li>▶ <a href="#">UP55A Program Controller User's Manual "9.3 Setting the Program Starting Conditions (STC)"</a></li> <li>▶ <a href="#">UP35A/UP32A Program Controller User's Manual "9.3 Setting the Program Starting Conditions (STC)"</a></li> </ul>
Number of used segments	Number of used segments/max number segments

### Ladder Program Building window

See ["Chapter 3 A Guide to Building Ladder Programs"](#)

## 2.4 Creating New Parameters Using the Wizard Function

The Wizard function supports operations from system data setting, parameter setting, and a file save to downloading data to the main unit. When using the Wizard function, parameters to be displayed are those available in the “easy setting mode” of the main unit’s parameter display level (LEVL).

### Procedure

1. Click on Windows’ [Start], select [All Programs] – [UTAdvanced], and then click on [Setting Tool].

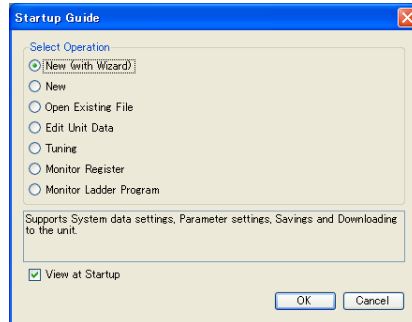

The Startup Guide window appears at the first startup after installing the LL50A and if the Use Startup Guide checkbox is checked in the Environmental Setting window.

2. Click on New (with Wizard) and click the [OK] button to display the System Data window.

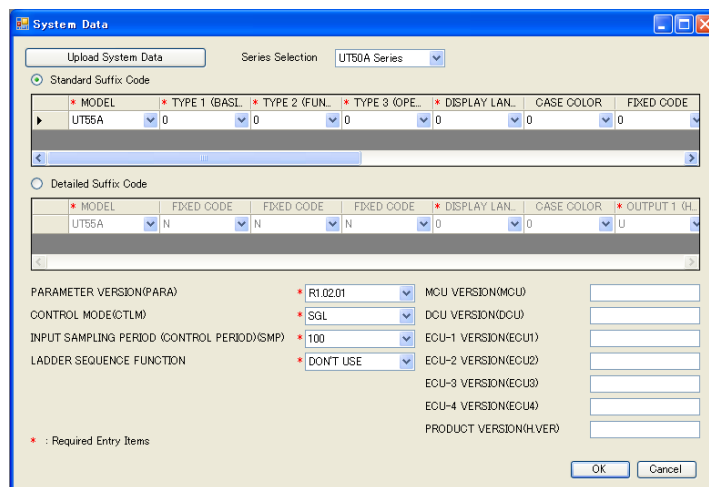

Items marked by an asterisk \* are mandatory input fields.

CONTROL MODE (CTLM) and ECU-2 VERSION (ECU2) are displayed for UT75A/UT55A/UT52A/UP55A only.

INPUT SAMPLING PERIOD (CONTROL PERIOD) (SMP) is displayed for UT75A/UT55A/UT52A/UP55A/UM33A only.

LADDER SEQUENCE FUNCTION, ECU-2 VERSION (ECU2), and ECU-3 VERSION (ECU3) are not available for UM33A.

Clicking the [Upload System Data] button enables the LL50A to communicate with the main unit to load system data into it.

For the model and suffix codes, set them to the model and suffix codes of the main unit to be set.

**Note**

- For Model and Suffix codes, set the code except the hyphen in order.
- The Detailed Suffix Code is available when "Use Detailed Suffix Code" is selected in [File] – [Environmental setting].  
In the factory default setting, it is already selected. However, UT75A and UM33A have no detailed codes.

- Enter system data and click the [OK] button to display the Parameter Setting window. Clicking the [Cancel] button closes the System Data window and cancels the settings that have been made.

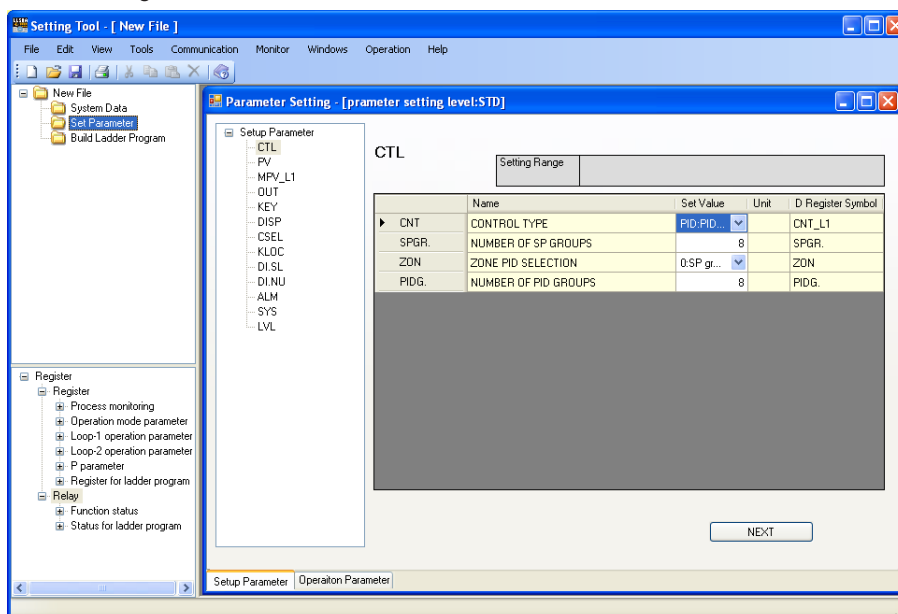
**Setting parameters**

- For entering a set value: Click in a cell to enable entry, enter the desired set value, then press the [Enter] key.
- For selecting a set value: Select it from a dropdown list.
- Entering a register symbol: Drag and drop register symbols from the Register window. When register symbols have been entered, candidates are displayed in a list; select a desired one from the list. It is also possible to register a register symbol by entering a register number. Entering and accepting a register number causes the indication to change to the register symbol.

The cell's background color is different, identifying it as a cell in which a register symbol can be entered. To disable setting, enter "OFF" or "0" (zero).

A cell's column width can be increased or decreased by dragging the boundary line between columns.

- ▶ Register symbol, register number: [UTAdvanced Series Communication Interface User's Manual](#)

Icon	Status
	Status enabling a drop
	Status disabling a drop

Set parameters in turn, starting at the top of the parameter menu tree. Clicking [NEXT] causes a list of parameters to be switched to the next list. Clicking [BACK] causes a list of parameters to be switched to the previous list.

## 2.4 Creating New Parameters Using the Wizard Function

---

### Parameter setting sequence

First set parameters relating to the input/output of setup parameters (menus CTL, PV, RSP (PV2 in case of UT75A), AIN2, AIN4, MPV\_L1, MPV\_L2, and OUT), then set the other setup parameters. After setting most of the setup parameters, set the operation parameters.

### Note

- Parameters to be displayed are the same as those in the “easy setting mode” of the main unit irrespective of the LL50A parameter view level.
  - If setup parameter(s) are set after setting the operation parameters, there may be cases in which the operation parameters are initialized.
- 

### What are register symbols?

Register symbols are the symbols of registers containing data such as main unit parameter, operation status, alarm status, contact input, and error information in 16 bits or 1 bit.

When performing communication, registers are used as D-registers or I-relays.

For more information on them, see the UTAdvanced Communication Interface (RS-485, Ethernet) User’s Manual.

### D-register symbols

For some register symbols, the loop number, terminal area number, and group number are indicated by adding the underscore (\_) to the end of a parameter symbol. If both the loop number and group number are added to a parameter symbol, they are added to it in the order of \_loop number and \_group number.

xxxx\_Ln\_Y

Ln: loop number (L1 or L2)

Y: group number (1 to 8 (20) or 1 to 16, R)

xxxx\_En

En: terminal area number (E1 to E4)

Example:

SP\_L1\_3: This means Loop-1 group-3 target setpoint.

PYS\_2: This means group-2 PYS.

DI1.D\_E1: This means E1-terminal area DI1.D.

### Note

Since the UT35A/UT32A/UP35A/UP32A/UM33A is a single-loop controller, it has no distinction between Loop-1 and Loop-2. However, the register symbol has "L1" which indicates Loop-1.

---

### Menu symbols and parameter symbols different from those in the main unit

For menu symbols and parameter symbols, the loop number and terminal area number are indicated like register symbols. For example, the alarm function menu is indicated as ALRM in the main unit, while it is indicated as ALRM\_L1 in the LL50A.

For the notation, refer to “D-register symbols” above.

- Alarm function setting parameters  
In the main unit, the alarm type, stand-by action, energized/de-energized, and latch settings are made using one parameter. However, they are set using one parameter each in the LL50A.
- Output type parameters  
These parameters are used only for setting during heating/cooling control. The output types are set using one parameter in the main unit, while they are set using the heating- and cooling-side parameters in the LL50A.
- P-parameters (when the ladder is used)  
The decimal point position can be set only in the LL50A.

4. Close the window or click . This causes the confirmation message to appear.

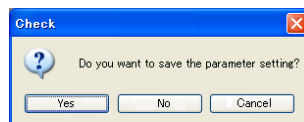

This message dialog is also displayed if the NEXT button is clicked until the end.

5. Click [Yes] to display the Save As window. Enter a name for the file and click the [Save] button.

LL50A User File for UT50A Series (\*.uta)  
 LL50A User File for UT30A Series (\*.utb)  
 LL50A User File for UT70A Series (\*.utc)  
 LL50A User File for UT30L Series (\*.utl)  
 LL50A User File for UP50A Series (\*.upa)  
 LL50A User File for UP30A Series (\*.upb)  
 LL50A User File for UM30A Series (\*.umb)

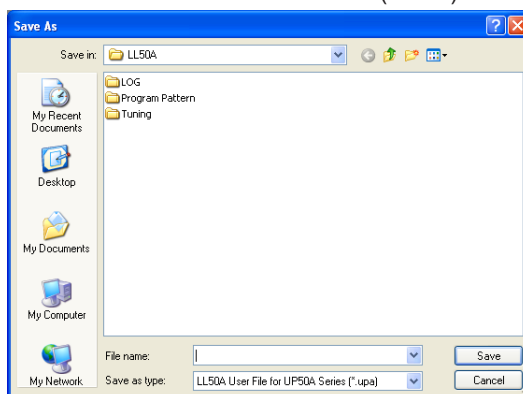

6. Next, the download message is displayed. Click the [Yes] button to proceed with the download, or the [No] button not to download. If you click the [No] button, move to step 9.

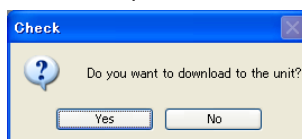

7. When download is selected, the Execute Communication window appears. Set up the communication conditions and click the [Download All] button.

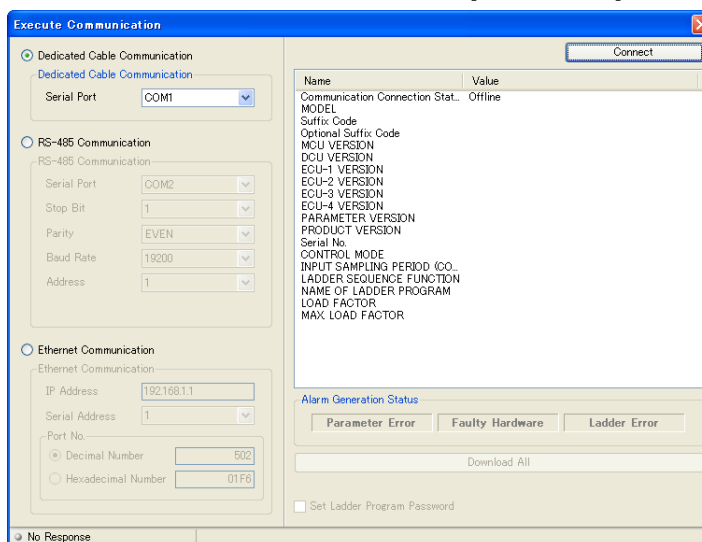



## 2.4 Creating New Parameters Using the Wizard Function

Alarm occurrence status (Lit when the corresponding errors occur.)

The symbols in parentheses indicate the register symbol.

Error display	Description
Parameter Error	System data error (SYSTEM_ERR) Calibration value error (CALB_ERR) User (parameter) default value error (UPARA_ERR) Setup parameter error (SETPA_ERR) Operation parameter error (OPEPA_ERR) Control parameter error (CTLPA_ERR) Faulty FRAM (FRAM_ERR)
Faulty Hardware	PV input A/D converter error (ADERR) RSP input A/D converter error (ADERR_E1) PV2 input A/D converter error (ADERR_E1) (In case of UT75A) AIN2 input A/D converter error (ADERR_E2) AIN4 input A/D converter error (ADERR_E3) PV input RJC error (RJCERR) RSP input RJC error (RJCERR_E1) PV2 input RJC error (RJCERR_E1) (In case of UT75A) Nonresponding hardware of E1 terminal area (E1_ERR) Nonresponding hardware of E2 terminal area (E2_ERR) Nonresponding hardware of E3 terminal area (E3_ERR) Nonresponding hardware of E4 terminal area (E4_ERR)
Ladder Error	Corrupted ladder program (LAD_ERR)

**8.** When download has completed, a download completed message appears. Click [OK] to close the Execute Communication window.

**9.** Next, the message asking if you want to close setting data appears.

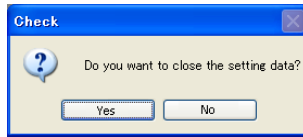

If you click [Yes], the user file is closed, causing the Startup Guide window to appear. If you click [No], the Basic window and File window are displayed.

### Note

If data is downloaded using the Wizard function, the ladder programs in the main unit will be initialized.

### Note

To change languages, close the wizard once and set the language as shown in 2.15.16 Making Environmental Settings.

## 2.5 Setting the Parameter View Level

Aside from the main unit's parameter display level, this section sets the view level of parameters to be displayed in the LL50A. It is different from the main unit's parameter display level (LEVL).

### Procedure

- When the Parameter Setting window or the Set Program Pattern window is being displayed, click on [View], select [Parameter View Level], and click on the following command in the menu. This enables parameters to be set in each view level.
  - View the same Display Level as the main unit: The parameter view level changes to Easy Setting Mode, Standard Setting Mode, and Professional Setting Mode according to the LEVL parameter set value of the parameter setting function.
  - View Easy Setting Mode: Same as the main unit's easy setting mode
  - View Standard Setting Mode: Same as the main unit's standard setting mode
  - View Professional Setting Mode: Same as the main unit's professional setting mode

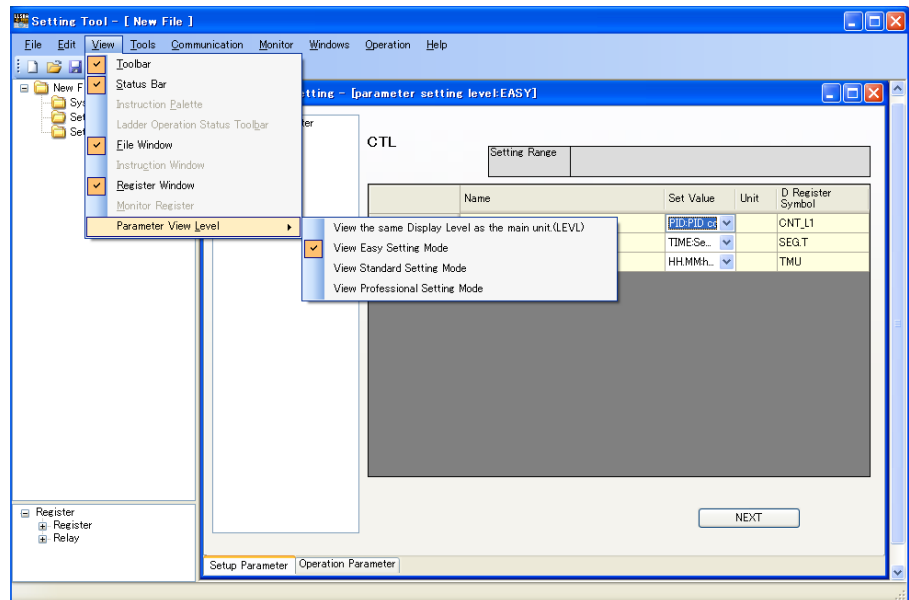

The parameter view level is displayed on the Parameter Setting window's and Program Pattern Setting window's title bar.

Parameter Setting window title: Parameter Setting – [Parameter display level: \*\*\*]

Program Pattern Setting window title: Parameter Setting – [Parameter display level: \*\*\*]

- To set to easy setting mode display or parameter display level (LEVL = EASY): EASY
- To set to standard setting mode display or parameter display level (LEVL = STD): STD
- To set to professional setting mode display or parameter display level (LEVL = PRO): PRO

For the parameter display levels, see the the User's Manual corresponding to your controller.

Parameters menu-locked in the main unit unit can be displayed and set in the LL50A.

## 2.6 Setting System Data

### Procedure

1. Open the System Data window in any of the following ways:
  - Click on (or select) "New (with Wizard)" in the Startup Guide window and click the [OK] button.
  - Click on (or select) "New" in the Startup Guide window and click the [OK] button.
  - Click on "System Data" in the File window.
  - Click on [File] – [New] in the menu.
  - Click on [File] – [New (with Wizard)] in the menu.
  - Click  on the toolbar.

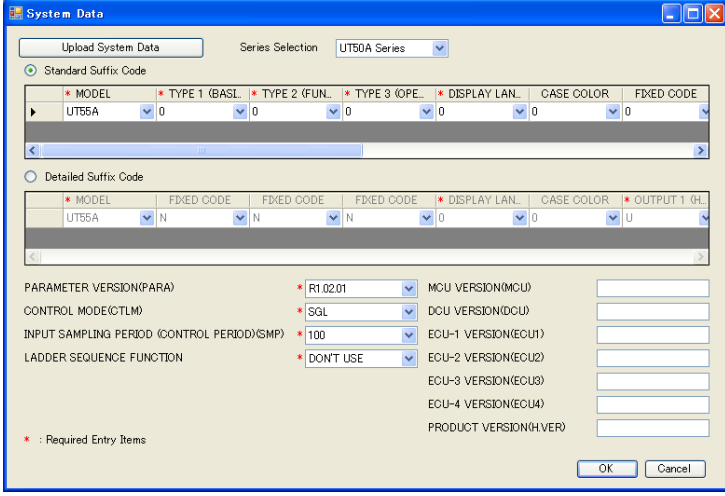

Items marked by an asterisk \* are mandatory input fields.

CONTROL MODE (CTLM) and ECU-2 VERSION (ECU2) are displayed for UT75A/UT55A/UT52A/UP55A only.

INPUT SAMPLING PERIOD (CONTROL PERIOD) (SMP) is displayed for UT75A/UT55A/UT52A/UP55A/UM33A only.

LADDER SEQUENCE FUNCTION, ECU-2 VERSION (ECU2), and ECU-3 VERSION (ECU3) are not available for UM33A.

### Note

- For Model and Suffix codes, set the code except the hyphen in order.
- The Detailed Suffix Code is available when "Use Detailed Suffix Code" is selected in [File] – [Environmental setting].  
In the factory default setting, it is already selected. However, UT75A and UM33A have no detailed codes.

2. Enter system data or upload it from the main unit and click the [OK] button. This causes the Basic window to appear. The File window is also displayed.

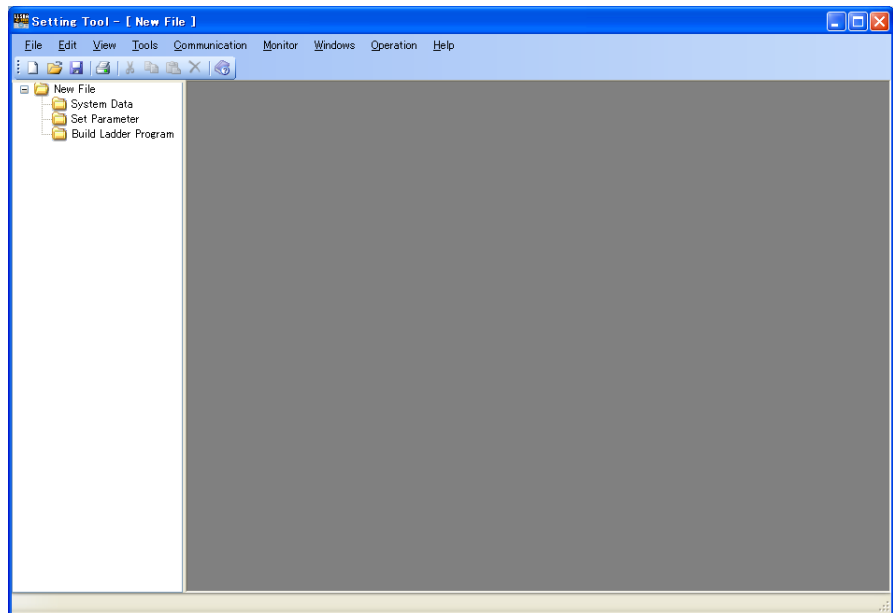

3. See each section for the successive operations.

## 2.6 Setting System Data

### Uploading system data

Connect a PC to the main unit and upload system data from the main unit to the PC. This makes it easy to set system data.

If a PC cannot be connected to the main unit, set up system data manually.

### Example

UT55A-000-00-00

Model: UT55A  
 Type 1 (basic control): 0  
 Type 2 (functions): 0  
 Type 3 (open network): 0  
 Display language: 0  
 Fixed: 0  
 Fixed: 0  
 Fixed: 0  
 RSP direct input option: none  
 LPS option: none  
 Power supply option: none  
 Additional treatment option: none  
 Heater break alarm option: none  
 Custom order: /Sxxx or /SxxxN  
 custom-order information  
 can be displayed or input.

Connect a PC to the main unit and upload system data from the main unit to the PC.

In this case, the following system data need not be set.

Select the series corresponding to the model.

UT55A/UT52A: UT50A series

UT35A/UT32A: UT30A series

UT35A-L: UT30L series

UP55A: UP50A series

UP35A/UP32A: UP30A series

UM33A: UM30A series

UT75A: UT70A series

UT32A-D: UT30D series

UT32A Entry model: UT30 Entry

The Detailed Suffix Code is available when "Use Detailed Suffix Code" is selected in [File] – [Environmental setting]. In the factory default setting, it is already selected. However, UT75A, UT35A-L and UM33A have no detailed codes.

Set the main unit's parameter PARA version.

Set the main unit's control mode (CTLM).

Set the main unit's input sampling period (control period).

Set the ladder sequence function to USE to use it  
 DON'T USE if not using it

## 2.7 Setting Parameters

### Procedure

1. Click on Windows' [Start], select [All Programs] – [UTAdvanced], and then click on [Setting Tool].

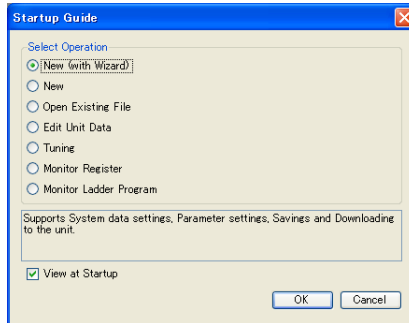

The Startup Guide window appears at the first startup after installing the LL50A and if the "Use the startup guide" checkbox is checked in the Environmental Setting window.

2. Click on "New" and click [OK] in the Startup Guide window, click on [File] – [New] in the menu, or click  on the toolbar to display the System Data window.

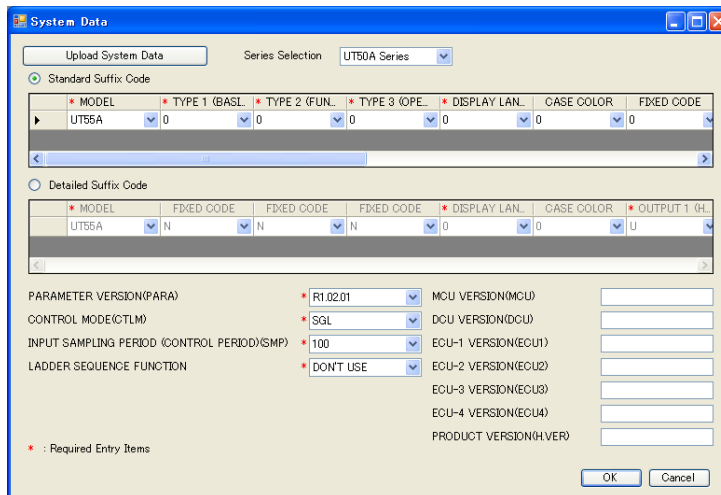

Items marked by an asterisk \* are mandatory input fields.

CONTROL MODE (CTLM) and ECU-2 VERSION (ECU2) are displayed for UT75A/UT55A/UT52A/UP55A only.

INPUT SAMPLING PERIOD (CONTROL PERIOD) (SMP) is displayed for UT75A/UT55A/UT52A/UP55A/UM33A only.

LADDER SEQUENCE FUNCTION, ECU-2 VERSION (ECU2), and ECU-3 VERSION (ECU3) are not available for UM33A.

## 2.7 Setting Parameters

3. Enter system data and click the [OK] button to display the Basic window. The File window is also displayed.

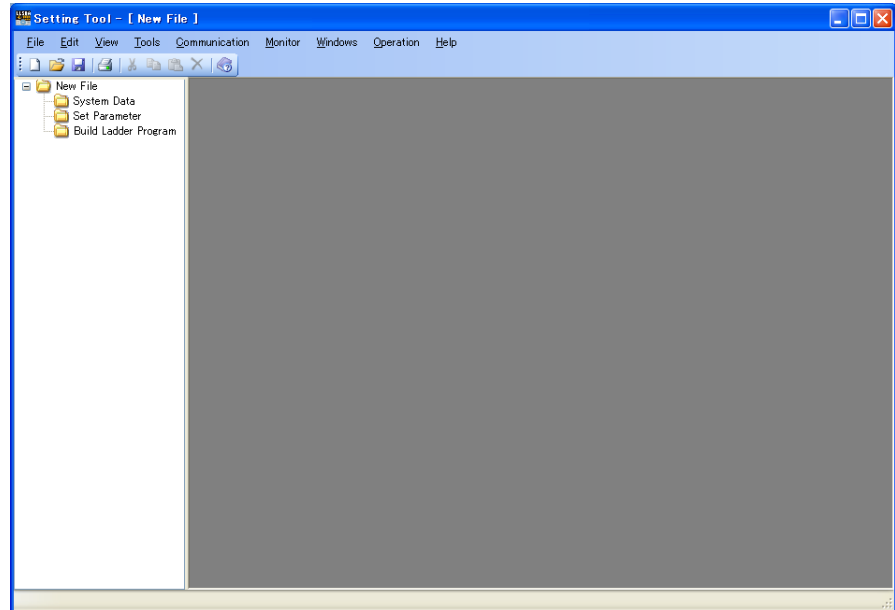

4. Click "Set Parameter" in the File window to display the Parameter Setting window at the right of the Basic window.

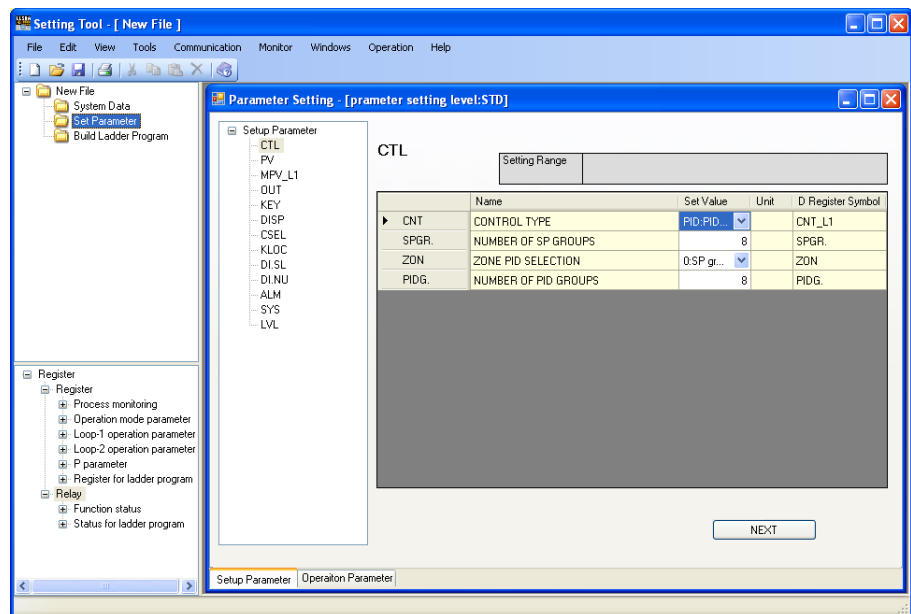

### Parameter setting sequence



First set parameters relating to the input/output of setup parameters (menus CTL, PV, RSP (PV2 in case of UT75A), AIN2, AIN4, MPV\_L1, MPV\_L2, and OUT), then set the other setup parameters. After setting most of the setup parameters, set the operation parameters.

**Note**

- Parameters to be displayed are as given by the setting of the parameter view level.
- If setup parameter(s) are set after setting the operation parameters, there may be cases in which the operation parameters are initialized.

- Click on the menu of a parameter that you want to set, to display a list of parameters in the Parameter Setting window. (Click the [+] button to expand the menu or click the [-] button to collapse it.)
- Click on the parameter that you want to set.
- Enter a value to be set.
  - For entering a value to be set: Click in a cell to enable entry, enter the desired set value, then press the [Enter] key.
  - For selecting a set value: Select it from a dropdown list.
  - Entering a register symbol: Drag and drop register symbols from the Register window. When register symbols have been entered, candidates are displayed in a list; select a desired one from the list. It is also possible to register a register symbol by entering a register number. Entering and accepting a register number causes the indication to change to the corresponding register symbol. The cell's background color is different, identifying it as a cell in which a register symbol can be entered. To disable setting, enter "OFF" or "0" (zero).

- ▶ Register symbols and register numbers: [UTAdvanced Series Communication Interface \(RS-485, Ethernet\) User's Manual](#)

Icon	Status
	Status enabling a drop
	Status disabling a drop

- Repeat steps 5 to 7 to set other parameters.
- To finish parameter setting, click .

**What are register symbols?**

Register symbols are the symbols of registers containing data such as main unit parameter, operation status, alarm status, contact input, or error information in 16 bits or 1 bit.

When performing communication, registers are used as D-registers or I-relays.

For more information on them, see the UTAdvanced Communication Interface (RS-485, Ethernet) User's Manual.

**D-register symbols**

For some register symbols, the loop number, terminal area number, and group number are indicated by adding the underscore (\_) to the end of a parameter symbol. If both the loop number and group number are added to a parameter symbol, they are added to it in the order of \_loop number and \_group number.

xxxx\_Ln\_Y

Ln: loop number (L1 or L2)

Y: group number (1 to 8 (20) or 1 to 16, R)

xxxx\_En

En: terminal area number (E1 to E4)



## 2.7 Setting Parameters

---

Example:

SP\_L1\_3: This means Loop-1 group-3 target setpoint.

PYS\_2: This means group-2 PYS.

DI1.D\_E1: This means E1-terminal area DI1.D.

### **Note**

Since the UT35A/UT32A/UP35A/UP32A/UM33A is a single-loop controller, it has no distinction between Loop-1 and Loop-2. However, the register symbol has "L1" which indicates Loop-1.

---

### **Menu symbols and parameter symbols different from those in the main unit**

For menu symbols and parameter symbols, the loop number and terminal area number are indicated like register symbols. For example, the alarm function menu is indicated as ALRM in the main unit, while it is indicated as ALRM\_L1 in the LL50A.

For the notation, refer to "D-register symbols" above.

- Alarm function setting parameters  
In the main unit, the alarm type, standby operation, energized/non-energized, and latch settings are made using one parameter. However, they are set using one parameter each in the LL50A.
- Output type parameters  
These parameters are used only for setting during heating/cooling control. The output types are set using one parameter in the main unit, while they are set using the heating- and cooling-side parameters in the LL50A.
- P-parameters (when the ladder is used)  
The decimal point position can be set only in the LL50A.

### **Message registration**

Register message to be displayed on the main unit.

Setup parameter menu: DI.SL

Symbol: MSG1 to MSG2

▶ **Message function:**

[Section 13.1.10 Setting Message Function, of UT35A/UT32A Digital Indicating Controllers User's Manual](#)

[Section 13.1.11 Setting Message Function, of UT55A/UT52A Digital Indicating Controllers User's Manual](#)

[Section 13.1.11 Setting Message Function, of UT75A Digital Indicating Controllers User's Manual](#)

[Section 13.1.10 Setting Message Function, of UP35A/UP32A Program Controller User's Manual](#)

[Section 13.1.10 Setting Message Function, of UP55A Program Controller User's Manual](#)

[Section 12.1.8 Setting Message Function, of UM33A Digital Indicator with Alarms User's Manual](#)

▶ **Characters to be registered:**

[Section 3.3 List of Display Symbols, of UT35A/UT32A Digital Indicating Controllers User's Manual](#)

[Section 3.3 List of Display Symbols, of UT55A/UT52A Digital Indicating Controllers User's Manual](#)

[Section 3.3 List of Display Symbols, of UT75A Digital Indicating Controllers User's Manual](#)

[Section 3.3 List of Display Symbols, of UP35A/UP32A Program Controller User's Manual](#)

[Section 3.3 List of Display Symbols, of UP55A Program Controller User's Manual](#)

[Section 3.3 List of Display Symbols, of UM33A Digital Indicator with Alarms User's Manual](#)

### **Group unit copy of parameter setting value**

You can copy the setting values of SP groups (SP\_L1, SP\_L2) and PID groups (PID\_L1, PID\_L2) within each group.

Display the parameter setting window you want to copy the setting value and click the "Copy parameter" button.

Select (group) the copy source (one) and copy destination (s), and click OK.

## 2.8 Creating a Custom Display (UT75A Only)

### Procedure

1. When data is loaded in the LL50A after you create a new file, open a new file, or use the upload all feature, clicking a custom display number under Custom Display Setting in the file selection window opens a Custom Display Setting window.

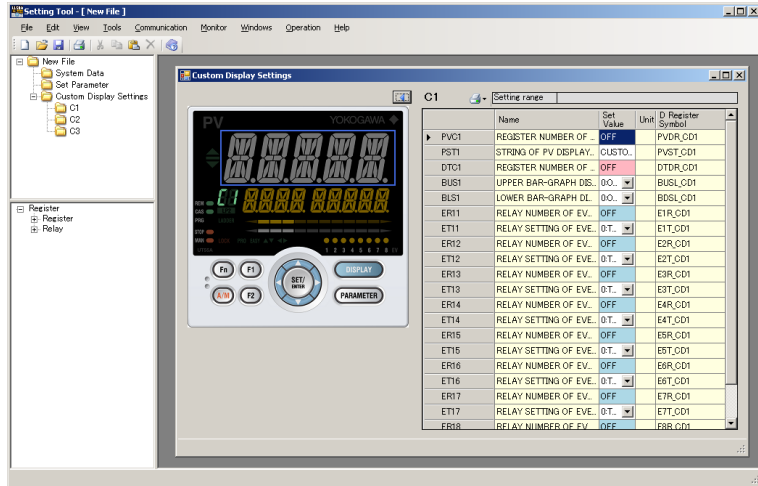

2. Assign registers in the Set Value column, and select the values. For details on each parameter, see the explanation below.

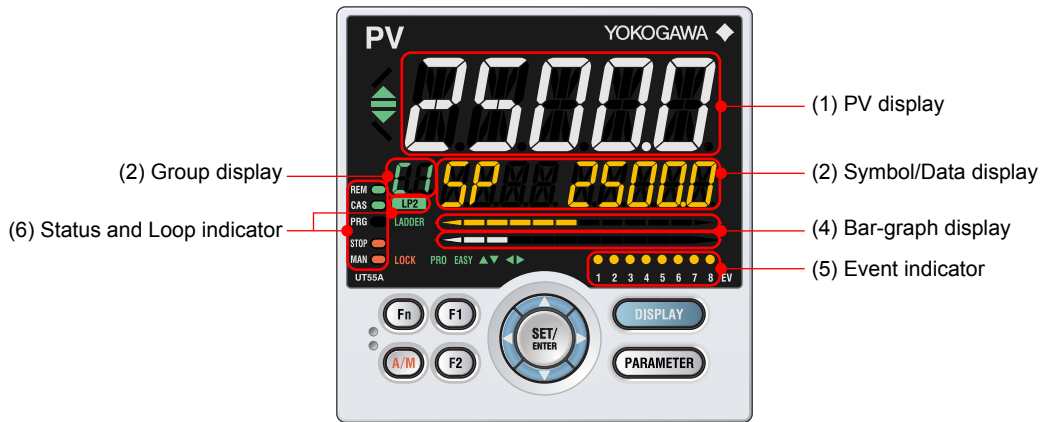

### Customizable Areas

No. in figure	Name	Description
(1)	PV display (white or red)	Can be hidden (OFF) or displays the assigned D-register value
(2)	Group display (green)	Displays the custom display number (C1 to C3)
(3)	Symbol/Data display (orange)	Can be hidden (OFF) or displays the assigned D-register symbol and value.
(4)	Bar-graph display (orange and white)	The data value is displayed as a bar graph depending on whether OFF, Normal, or D-register is selected.
(5)	Event indicator (orange)	Can be hidden (OFF) or displays the assigned I relay status.
(6)	Status and Loop indicator (green and red)	Can be hidden (OFF) or displays the status of the selected loop.

### Custom Display Data

Custom display data is saved to an LL50A user file for the UT70A Series (.utc), which is the same file for storing parameter data.

See “2.15.2 Opening a User File”

Data can be downloaded from and uploaded to the main unit at once or individually.

See “2.11 Downloading Data” and “2.12 Uploading Data”

Only custom display data can be printed.

See “2.17 Printing”

### What are register symbols?

Register symbols are the symbols of registers containing data such as main unit parameter, operation status, alarm status, contact input, or error information in 16 bits or 1 bit.

When performing communication, registers are used as D-registers or I-relays.

For more information on them, see the UTAdvanced Communication Interface (RS-485, Ethernet) User’s Manual.

### Range of use

The usable parameter is an operating parameter listed in Chapter 18 of “the UT75A digital indicating controller user’s manual” (except the parameter in MODE and PROG menu). In addition, the following parameters can be used.

PV\_L1, CSP\_L1, OUT\_L1, H.OUT\_L1, C.OUT\_L1, PID\_L1, PV\_L2, CSP\_L2, OUT\_L2, H.OUT\_L2, C.OUT\_L2, PID\_L2, UT\_SEG.N, T01 to T10

## Description

### Parameters

Parameter symbols		Parameter names		
PVCn		Register number of PV display for Custom display n		
PSTn		String of PV display for Custom display n		
DTCn		Register number of Data display for Custom display n		
BUSn		Upper bar-graph displays type selection for Custom display n		
Normal	BUCn	Upper bar-graph displays registration D for Custom display n		
		UDCn		DVB of upper bar-graph for Custom display n
	D register selection	BUDn	Register number of upper bar-graph for Custom display n	
		BUTn	Display method of upper bar-graph for Custom display n	
		UDSn	Standard value of upper bar-graph for Custom display n	
UDCn		DVB of upper bar-graph for Custom display n		
BLSn		Lower bar-graph displays type selection for Custom display n for Custom display n		
Normal	BDCn	Lower bar-graph displays registration D for Custom display n		
		LDCn		DVB of lower bar-graph for Custom display n
	D register selection	BLDn	Register number of lower bar-graph for Custom display n	
BLTn		Display method of lower bar-graph for Custom display n		
LDSn		Standard value of lower bar-graph for Custom display n		
LDCn		DVB of lower bar-graph for Custom display n		
ERn1 to ERn8		Relay number of Event 1 to 8 for Custom display n		
ETn1 to ETn8		Relay setting of Event 1 to 8 for Custom display n		
LPCn		Status and Loop for Custom display n		

n: 1 to 3 (Custom display number)

## (1) PV display

A data item or character string of your choice can be shown in the PV display. To show a data item, assign (drag-and-drop) a D-register shown in the register tree. To show a character string, set a string up to 31 characters in the String (PSTn) box and set the following register, which appears in the register tree, in the Register number (PVCn) box.

Custom Display 1 "PVST\_CD1 (6611)"

Custom Display 2 "PVST\_CD2 (6641)"

Custom Display 3 "PVST\_CD3 (6671)"

Specify OFF to hide it.

## (2) Symbol/data display area

A symbol or data item of your choice can be shown in the symbol display/data display. To show a symbol and data item, assign (drag-and-drop) a D-register shown in the register tree.

Specify OFF to hide it.

## (3) Upper/lower bar-graph display

A data item of your choice can be shown in the upper or lower bar-graph display.

For Display Type Selection (BUSn), set Normal or D-register.

If Normal is set, the following set values are displayed in the drop-down list (BUCn).

0: No display

1: OUT, Heating side OUT, or internal value in position proportional control.

2: Cooling side OUT

3: PV

4: SP

5: Deviation

6: Loop-2 OUT, Loop-2 heating-side OUT

7: Loop-2 cooling-side OUT

8: Loop-2 PV

9: Loop-2 SP

10: Loop-2 deviation

11 to 16: Disable

17: Feedback input (valve opening)

18: PV terminals analog input

19: PV2 terminals analog input

20: AIN2 terminals analog input

21: AIN4 terminals analog input

22 to 26: Disable

27: TSP

28: TSP deviation

29: Loop-2 TSP

30: Loop-2 TSP deviation

## 2.8 Creating a Custom Display (UT75A Only)

If D-register is set, the register value is displayed using the standard value and deviation band. For D-register (BUDn), set a D-register of your choice.

Display method (BUTn) can be set to Left, Center, Right, Right (Reverse), or Degree of segment.

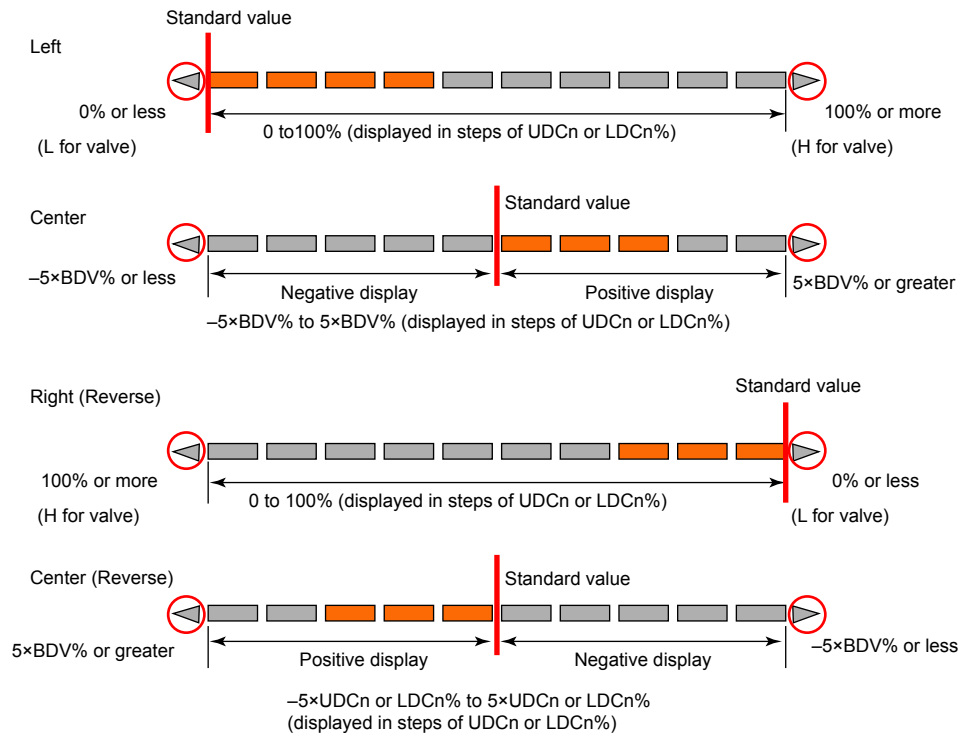

Set Standard value (UDSn) within the data range of the registers to be assigned. For Deviation band (DVB; UDCn), set the band that corresponds to one segment of the bar graph.

Degree of segment shows two segments of a program pattern as one segment on the bar graph.

### Degree of segment

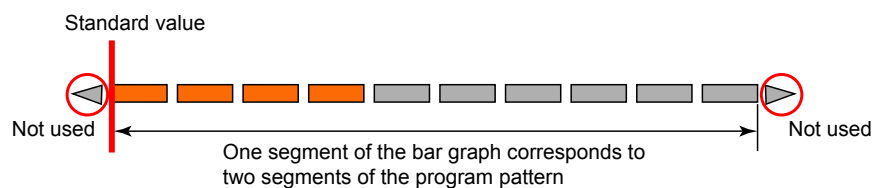

### Note

After you have downloaded the custom display data, if you change the custom display parameters, such as the range and decimal point position on the main unit, check the settings, and download the custom display parameters again if necessary.

## 2.9 Creating Program Pattern (UP55A/UP35A/UP32A only)

### CAUTION

First, set the parameters, and then set the program pattern.  
Changing the setting of the segment setting method (SEG.T) will initialize the setting of all the program patterns.

The numbers of settable pattern and segment depending on the model and suffix codes.

		UP55A		UP35A/UP32A	
			with optin/AP		with optin/AP
Per one user file	Max. number of pattern	30	99	2	4
	Max. number of segment	300	600	20	40
Per one pattern	Max. number of segment	99	99	20	40

### 2.9.1 Setting the Operation Setting

#### Procedure

1. Click "Set Program Pattern" in the File window to display the action setting screen [START] of Program Pattern Setting window.

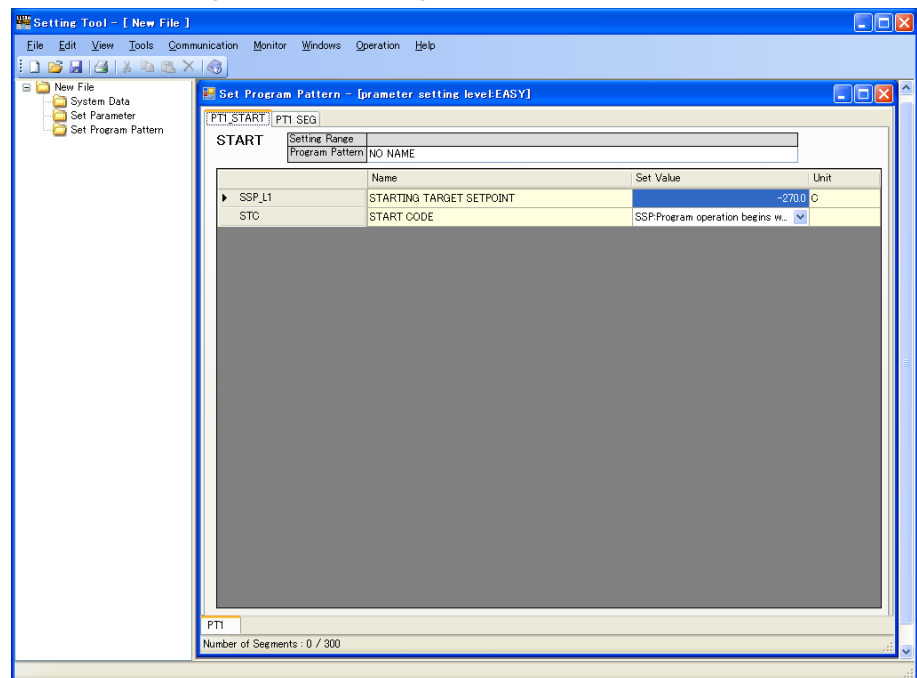

Click on the pattern switching tab in the lower part of the Operation Setting window [START] to switch patterns. The PT1 tab is displayed for factory default.

2. Enter the pattern name.  
Up to 20 single-byte or up to 10 two-byte characters can be entered.

## 2.9 Creating Program Pattern

3. Enter a value to be set.
  - For entering a value to be set: Click in a cell to enable entry, enter the desired set value, then press the [Enter] key.
  - For selecting a set value: Select it from a dropdown list.

### Setting Item

#### UP55A

Parameter symbol	Neme
SSP_L1	Starting target setpoint of control program pattern
SSP_L2 *1	Starting target setpoint of retransmission program pattern
STC	Start code
WT.SW1	Wait function ON/OFF 1
WZ.UP1	Upper-side wait zone 1
WZ.LO1	Lower-side wait zone 1
WT.TM1	Wait time 1
WT.SW2	Wait function ON/OFF 2
WZ.UP2	Upper-side wait zone 2
WZ.LO2	Lower-side wait zone 2
WT.TM2	Wait time 2
WT.SW3	Wait function ON/OFF 3
WZ.UP3	Upper-side wait zone 3
WZ.LO3	Lower-side wait zone 3
WT.TM3	Wait time 3
WT.SW4	Wait function ON/OFF 4
WZ.UP4	Upper-side wait zone 4
WZ.LO4	Lower-side wait zone 4
WT.TM4	Wait time 4
WT.SW5	Wait function ON/OFF 5
WZ.UP5	Upper-side wait zone 5
WZ.LO5	Lower-side wait zone 5
WT.TM5	Wait time 5
R.CYCL	Number of repeat cycles
R.STRT	Repeat cycle start segment number
R.END	Repeat cycle end segment number

\*1: To display the parameters for the retransmission program pattern, it is necessary to configure the following setting.

Parameter Setting window - Setup Parameters (CTL) - Program Pattern 2 Retransmission (PT2.G) = ON (Use)

#### UP35A/UP32A

Parameter symbol	Neme
SSP_L1	Starting target setpoint of program pattern
STC	Start code
WT.SW1	Wait function ON/OFF
WZ.UP1	Upper-side wait zone
WZ.LO1	Lower-side wait zone
WT.TM1	Wait time
R.CYCL	Number of repeat cycles
R.STRT	Repeat cycle start segment number
R.END	Repeat cycle end segment number

## 2.9.2 Setting the Segments

**Note**

First, set the parameters of the Operation Setting window [START], and then set the program pattern of the Segment Setting window [SEG].

**Procedure**

1. Click menu switching tab "PTn\_SEG" in the Set Program Pattern window to display the Segment Setting Display [SEG].

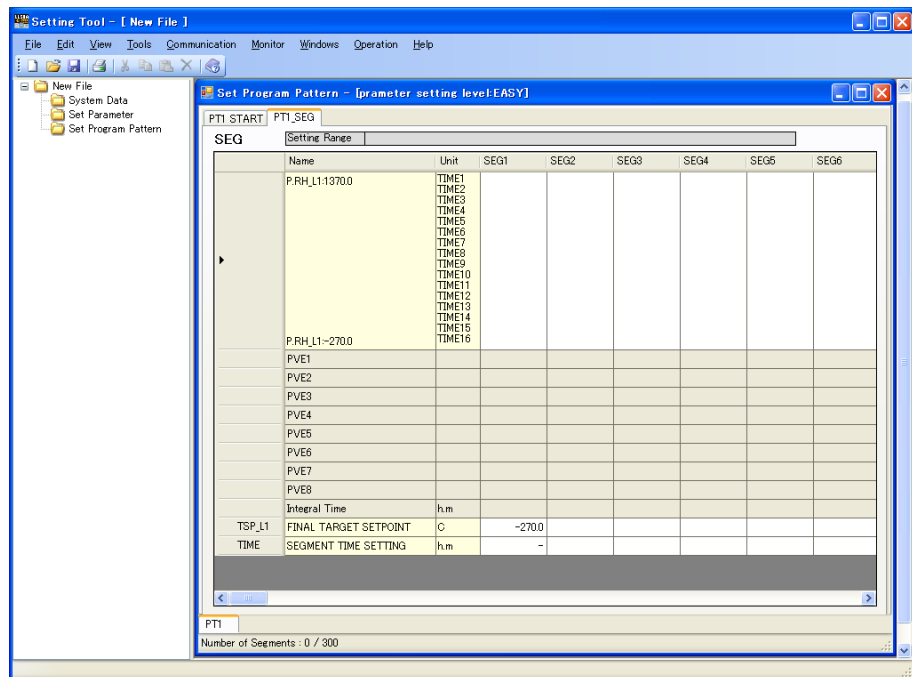

Click on the pattern switching tab in the lower part of the Segment Setting window [SEG] to switch patterns. The PT1 tab is displayed for factory default.

2. Enter the pattern name.
  - For entering a value to be set: Click in a cell to enable entry, enter the desired set value, then press the [Enter] key.
  - For selecting a set value: Select it from a dropdown list.
3. To finish program pattern setting, click .



## 2.9 Creating Program Pattern

### Setting Item

#### UP55A

Parameter symbol	Neme
TSP_L1	Final target setpoint of control program pattern
TSP_L2 *1	Final target setpoint of retransmission program pattern
TIME *2	Segment time setting
TM.RT *3	Segment ramp-rate setting
S.PID *4, *5	Segment PID number selection
JC *5	Junction code
PV.TY1 to PV.TY8 *5	PV evnet-1 to -8 type
PV.EV1 to PV.EV8 *5	PV evnet-1 to -8 setpoint
TME1 to TME16 *5	Start condition of time event 1 to 16
T.ON1 to T.ON16 *5	On time of time event 1 to 16
T.OF1 to T.OF16 *5	Off time of time event 1 to 16

\*1: To display the parameters for the retransmission program pattern, it is necessary to configure the following setting.

Parameter Setting window - Setup Parameters (CTL) - Program Pattern 2 Retransmission (PT2.G) = ON (Use)

\*2: Can be set when Segment setting method selection (SEG.T) is set to TIME.

\*3: Can be set when Segment setting method selection (SEG.T) is set to TM.RT.

\*4: Can be set when Zone PID selection (ZON) is set to 0.

\*5: Can be set when a value is set to the segment time (TIME) or the segment ramp-rate time (TM.RT).

#### UP35A/UP32A

Parameter symbol	Neme
TSP_L1	Final target setpoint of control program pattern
TIME *1	Segment time setting
TM.RT *2	Segment ramp-rate setting
S.PID *3, *4	Segment PID number selection
JC *4	Junction code
PV.TY1 to PV.TY2 *4	PV evnet-1 to -2 type
PV.EV1 to PV.EV2 *4	PV evnet-1 to -2 setpoint
TME1 to TME4 *4	Start condition of time event 1 to 4
T.ON1 to T.ON4 *4	On time of time event 1 to 4
T.OF1 to T.OF4 *4	Off time of time event 1 to 4

\*1: Can be set when Segment setting method selection (SEG.T) is set to TIME.

\*2: Can be set when Segment setting method selection (SEG.T) is set to TM.RT.

\*3: Can be set when Zone PID selection (ZON) is set to 0.

\*4: Can be set when a value is set to the segment time (TIME) or the segment ramp-rate time (TM.RT).

### Note

- With LL50A, the segment time of each of the segments starting with SEG1 is added up and displayed as the integral time. The integral time does not include the wait time and the segment time activated by the settings, such as repeat segment, number of repeat cycles and program start segment number.  
Furthermore, when the start code (STC) is set to RAMP, the integral time displayed in LL50A may differ from the actual action, since the start segment and segment time are determined by the measurement values at the time when the program operation starts.
- In ramp segment where the segment setting method (SEG.T) is set to TM.RT, the segment time is calculated from the setting value of the segment ramp-rate time (TM.RT).  
Therefore, the minimum digit of the segment time may include an error.
- The setpoint in the start target setpoint (SSP\_L1 or SSP\_L2) is used as the start target value for SEG1 to plot the graph.  
When the start code (STC) is set to other than SSP, the pattern graph differs from the actual action.

▶ [Section 9.3 Setting the Program Starting Conditions \(STC\), of UP35A/UP32A Program Controller User's Manual](#)  
▶ [Section 9.3 Setting the Program Starting Conditions \(STC\), of UP55A Program Controller User's Manual](#)

▶ [Register symbol, register number: UTAdvanced Series Communication Interface \(RS-485, Ethernet\) User's Manual](#)

## Displaying PV Events

The set PV event types are displayed in the PV event display area.

Set value	PV event type	PV event setpoint
0	Disable (OFF)	(nondisplay)
1	(Energized) PV high limit	PVH1
2	(Energized) PV low limit	PVL1
3	(Energized) SP high limit	SPH1
4	(Energized) SP low limit	SPL1
5	(Energized) Deviation high limit	DH1
6	(Energized) Deviation low limit	DL1
7	(Energized) Deviation high and low limits	D1
8	(Energized) Deviation within high and low limits	Dw1
9	(Energized) Target SP high limit	TSPH1
10	(Energized) Target SP low limit	TSPL1
11	(Energized) Target SP deviation high limit	TSPDH1
12	(Energized) Target SP deviation low limit	TSPDL1
13	(Energized) Target SP deviation high and low limits	TSPD1
14	(Energized) Target SP deviation within high and low limits	TSPDw1
15	(Energized) OUT high limit	OH1
16	(Energized) OUT low limit	OL1
17	(Energized) Cooling-side OUT high limit	OHc1
18	(Energized) Cooling-side OUT low limit	OLc1
101	(de-energized) PV high limit	dPVH1
102	(de-energized) PV low limit	dPVL1
103	(de-energized) SP high limit	dSPH1
104	(de-energized) SP low limit	dSPL1
105	(de-energized) Deviation high limit	dDH1
106	(de-energized) Deviation low limit	dDL1
107	(de-energized) Deviation high and low limits	dD1
108	(de-energized) Deviation within high and low limits	dDw1
109	(de-energized) Target SP high limit	dTSPH1
110	(de-energized) Target SP low limit	dTSPL1
111	(de-energized) Target SP deviation high limit	dTSPDH1
112	(de-energized) Target SP deviation low limit	dTSPDL1
113	(de-energized) Target SP deviation high and low limits	dTSPD1
114	(de-energized) Target SP deviation within high and low limits	dTSPDw1
115	(de-energized) OUT high limit	dOH1
116	(de-energized) OUT low limit	dOL1
117	(de-energized) Cooling-side OUT high limit	dOHc1
118	(de-energized) Cooling-side OUT low limit	dOLc1

## 2.9 Creating Program Pattern

### Example: Set program pattern (UP55A)

Program pattern 1 (PTNO. = 1)

Segment setting method (SEG.T) = TIME (Segment time setting)

#### Set Segment (menu: SEG)

Parameter symbol	Name	SEG1: set value	SEG2: set value	SEG3: set value
TSP_L1	Final target setpoint	80.0	80.0	0.0
TIME	Segment time setting	10.00	40.00	5.00
S.PID	Segment PID number selection	1	1	2
JC	Junction code	CONT	CONT	LOCAL
PV.TY1	PV evnet-1 type	1	1	OFF
PV.EV1	PV evnet-1 setpoint	80.5	80.5	0.0
PV.TY2	PV evnet-2 type	OFF	OFF	2
PV.EV2	PV evnet-2 setpoint	0.0	0.0	-0.5
PV.TY3	PV evnet-3 type			
PV.EV3	PV evnet-3 setpoint			
.	.			
.	.			
.	.			
PV.TY8	PV evnet-8 type			
PV.EV8	PV evnet-8 setpoint			
TME1	Start condition of time event 1	OFF	OFF	OFF
T.ON1	On time of time event 1	2.00	-	-
T.OF1	Off time of time event 1	8.00	-	-
TME2	Start condition of time event 2	OFF	OFF	OFF
T.ON2	On time of time event 2	-	20.00	-
T.OF2	Off time of time event 2	-	30.00	-
TME3	Start condition of time event 3	OFF	OFF	OFF
T.ON3	On time of time event 3	-	-	4.00
T.OF3	Off time of time event 3	-	-	-
.	.			
.	.			
.	.			
TME16	Start condition of time event 16			
T.ON16	On time of time event 16			
T.OF16	Off time of time event 16			

**SEG1 (Time Event)**

(1) TME1 (Start condition of time event 1):  
OFF: Start (OFF start)  
Set the time event for each segment.  
(Example: ON start

(2) T.ON1 (On time of time event 1): 2.00 minutes after.\*  
(3) T.OF1 (Off time of time event 1): 8.00 minutes after.\*

**SEG2 (Time Event)**

(1) TME2 (Start condition of time event 2):  
OFF: Start (OFF start)  
Set the time event for each segment.  
(2) T.ON2 (On time of time event 2): 20.00 minutes after.\*  
(3) T.OF2 (Off time of time event 2): 30.00 minutes after.\*

\*: TMU (Program time unit) = MM.SS:minute.second

**Set Time Event**

TME1 to TME16 (Start condition of time event 1 to 16):

Set the start condition (ON: start from ON-state, OFF: start from OFF-state) for each segment.

T.ON1 to T.ON16 (On time of time event 1 to 16):

Set the time from each segment start until the time event ON. The time can be set only within the TIME (segment time) of each segment.

T.OF1 to T.OF16 (Off time of time event 1 to 16):

Set the time from each segment start until the time event OFF. The time can be set only within the TIME (segment time) of each segment.

Note: When the set time is outside the range of the segment time, the event action at the set time is not performed.

**2.9.3 Inserting and Deleting a Segment****Inserting a Segment**

1. In the Segment Setting window [SEG] of the Program Pattern Setting window, click on [Edit] – [Insert Segment] in the menu to display the Insert Segment window.

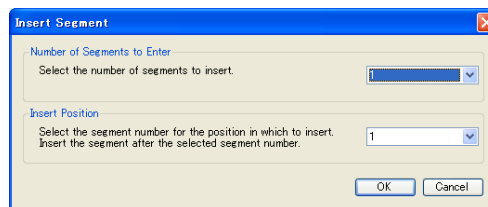

2. Select the number of segments to insert and the insertion position.
3. Click the [OK] button to insert the number of segments you entered in the position after the selected segment number.

**Deleting a Segment**

1. In the Segment Setting window [SEG] of the Program Pattern Setting window, click on [Edit] – [Delete Segment] in the menu to display the Delete Segment window.

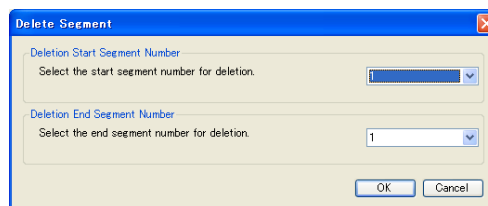

2. Select the deletion start segment number and deletion end segment number.
3. Click the [OK] button to delete the segment(s) for the selected segment number(s).

2.9.4 Copying, Adding, and Deleting a Pattern  
 Copying a Pattern

1. In the Program Pattern Setting window, click on [Edit] – [Copy Program Pattern] in the menu to display the Check and Select Pattern window.

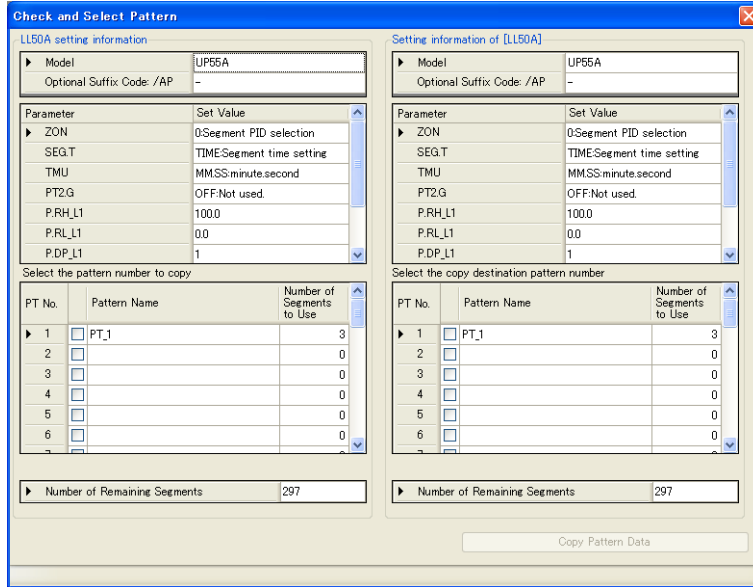

2. Select the copy source pattern number and the copy destination pattern number, and click the [Copy Pattern Data] button.
  - When the copy source pattern number and the copy destination pattern number are the same, a message appears. Click [OK] and select the copy destination pattern number again.

Adding a Pattern

1. In the Program Pattern Setting window, click on [Edit] – [Add Program Pattern] in the menu to display the Check and Select Pattern window.

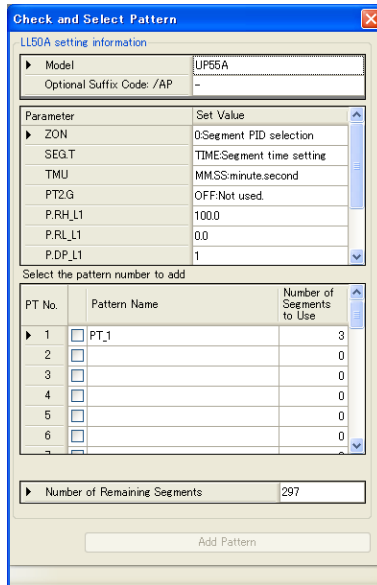

2. Select the pattern number to add, and click the [Add Pattern Data] button.
  - When the selected pattern number is already used, a message appears. Click [OK] and select the pattern number again.

## Deleting a Pattern

1. In the Program Pattern Setting window, click on [Edit] – [Delete Program Pattern] in the menu to display the Check and Select Pattern window.

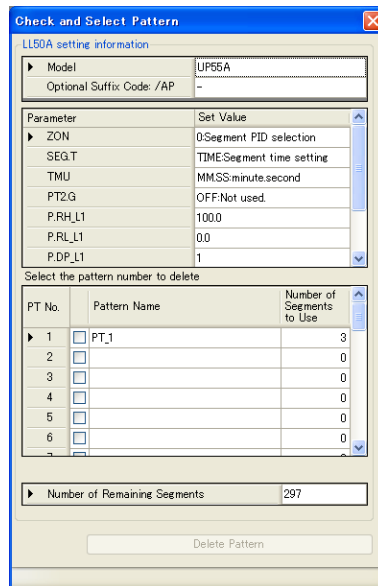

2. Select the pattern number to delete, and click the [Delete Pattern Data] button.
3. The confirmation message appears.  
To delete the pattern number, click the [OK] button.  
To cancel the deletion, click the [Cancel] button.

### 2.9.5 Hiding Time Event/PV Event

#### Time Event View

In the Segment Setting window [SEG] of the Program Pattern Setting window, click on [View] in the menu, and place a check mark in front of [Time Event] to display the time event ON time. (Removing the check mark hides the time event and the number is not displayed)

#### PV Event View

In the Segment Setting window [SEG] of the Program Pattern Setting window, click on [View] in the menu, and place a check in front of [PV Event] to display the PV event display area (line). (Removing the check mark hides the PV event and the display area [line] is not displayed.)

### 2.9.6 Changing the Display Color of a Program Pattern

The following procedure allows changing the color of the time event and pattern that are plotted.

1. In the Segment Setting window [SEG] of the Program Pattern Setting window, click on [Tools] – [Program Pattern Display Color Setting] in the menu to display the Program Pattern Display Color Setting window.

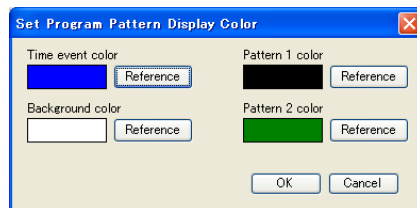

Pattern 1 color: Pattern display color of Loop-1

Pattern 2 color: Pattern display color of Loop-2

2. Click on the [Browse] button and select the color.
3. Click the [OK] button to change the color of the graph to be plotted.

## 2.10 Creating User File Information

User file information is used for creating data sheets that are submitted to the customer. Data sheets can also be printed out. User file information is saved in a user file and will not be downloaded to the main unit.

### Procedure

1. Click on [File] – [Set User File Information] in the menu. Enter user file information in the window displayed.

The screenshot shows a window titled "User File Information" with a form containing the following fields:

- Customer Name
- Delivery Destination
- Device Name
- Model Name
- Order No.
- Serial Number
- Author
- Date Created
- Specification Number
- Revision No.
- Function Overview
- Memo

Annotations on the right side of the window provide character limits:

- Up to 20 two-byte characters or 40 single-byte characters (for Customer Name, Delivery Destination, Device Name, Model Name, Order No., and Serial Number).
- Each item can be up to 20 two-byte characters or 40 single-byte characters. (for Author, Date Created, Specification Number, and Revision No.).
- Up to 16 two-byte characters or 32 single-byte characters (for Function Overview).
- Up to 600 two-byte characters or 1200 single-byte characters (for Memo).

At the bottom, a note states: "These items can be changed. Each item can be up to 16 two-byte characters or 32 single-byte characters." with a red line pointing to the "Function Overview" and "Memo" fields.

2. To close the window, click



## 2.11 Downloading Data

### CAUTION

Do not download data while the controller is being used for control loop. Otherwise, it may cause a sudden change of the control output.

Be sure to disconnect the main unit from the target unit before downloading data.

### Download All

#### Procedure

1. Click on [File] – [Download All] in the menu to display the Execute Communication window.

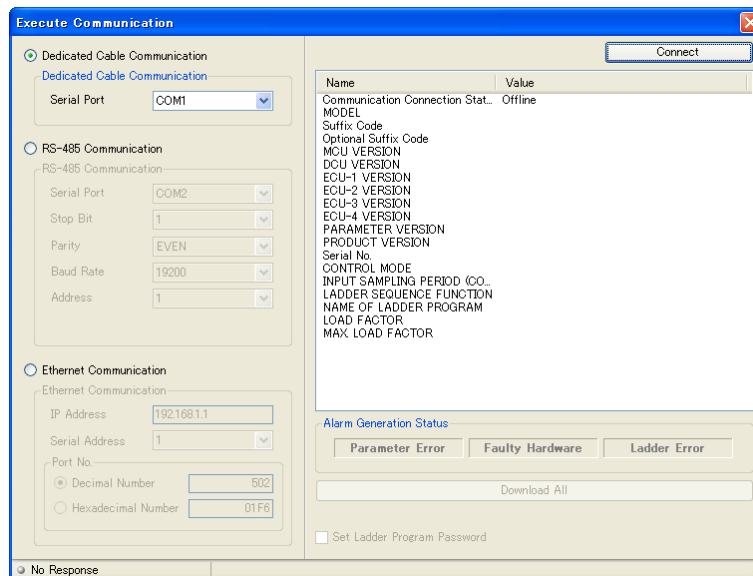

2. Set up the communication conditions and click the [Download All] button. When download is complete, the following message appears.
3. Click [OK] to close the Execute Communication window.

After clicking the [Download All] button, follow the prompts that are displayed.

If the data in use has not yet been saved, a dialog box asking if you want to save data appears.

- To save the data and continue the process, click [Yes].
- To continue the process without saving the data, click [No].
- To stop the process, click [Cancel].

If the “Set a ladder program password” checkbox is checked in the Execute Communication window, a dialog box asking if you want to set a password appears. Set a password using eight single-byte alphanumeric characters. If you do not want to set it, click the [OK] button without entering a password.

To change the password once it has been set to no password, click the [OK] button without entering a password.

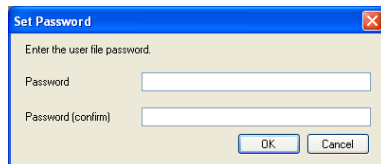

In overwriting the main unit parameters for which a password has been set, entering the set password enables new data to be downloaded.

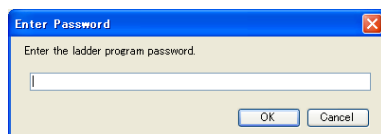

## Description

Data which can be downloaded by one operation are a user file name, system data (only control mode, control period, and ladder program USE/DON'T USE information), parameter data, program pattern data, K-constant (K-register), and ladder program data. Circuit comment of ladder program is not downloaded.

Once a password has been set, it must be entered whenever you upload/download, compare, or monitor the ladder programs.

The password default value is non-setting. The password can be up to eight single-byte alphanumeric characters and is case sensitive.

Individual data can be downloaded as follows.

- Click on [Communication] – [Download Parameter Data] in the menu.
- Click on [Communication] – [Download Ladder Programs] in the menu.  
K-constant can be also downloaded by [Download Ladder Programs].
- Click on [Communication] – [Download Program Pattern Data] > [All Patterns] in the menu.
- Click on [Communication] – [Download Program Pattern Data] > [One Pattern] in the menu.  
\* If the controller is UT75A, the downloaded data includes the data of Custom display.

### <Execute Communication window>

- Serial Port: A port available for a PC is automatically displayed.
- Stop Bit, Parity, Baud Rate, and address: Set these items according to the main unit's communication conditions. Data length: fixed 8 bit
- IP Address: Set this address according to the main unit's IP address (for Ethernet communication).
- Serial Address: Set the main unit's RS-485 communication address if communication is made via an Ethernet/RS-485 converter (e.g., model VJET). (Not allowed to be duplicated)
- Port Number: Set the port number. (Decimal Number or Hexadecimal Number)

If data is downloaded via a maintenance port, nothing is displayed in the Alarm Generation Status in the Execute Communication window. In addition, “-” is displayed for the Load Factor and Max Load Factor when using a ladder program.

### Note

- Do not disconnect a connection cable or turn off the main unit power supply during a download.
- If any ladder program is included in the downloaded data, the program is executed immediately after the download is completed.

## Downloading Program Pattern Data

### Note

The following operations cannot be executed concurrently, otherwise the program pattern data cannot be read/written normally.

- Access to the program pattern via Open Network.
- Upload/download of the program pattern data using the LL50A Parameter Setting Tool.

## All Patterns

### Procedure

1. Click on [Communication] – [Download Program Pattern Data] – [All Patterns] in the menu to display the Execute Communication window.
2. Set the communication conditions and click the [Download All Program Pattern Data] button.
3. The Check and Select Pattern window appears. Confirm the details and click the [Download All Pattern Data] button. When downloading is completed, the message appears.

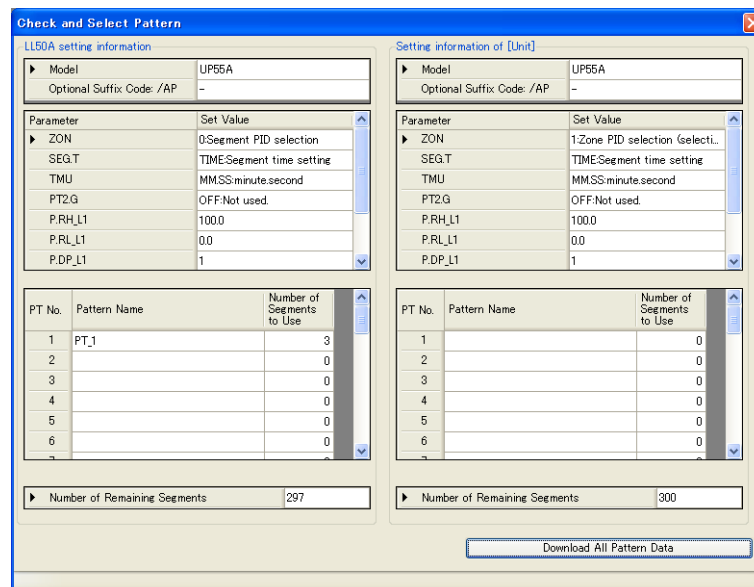

4. Click [OK] to close the Execute Communication window.

First, click the [Download All Pattern Data] button, and then perform the operation in accordance with the instructions in the message.

When the current work data is not saved, a dialog box appears to ask whether or not to save the data.

- To save the data and continue the process, click [Yes].
- To continue the process without saving the data, click [No].
- To stop the process, click [Cancel].

### Note

- Be aware that when the downloading of all the patterns is executed, all the pattern data set in main unit will be cleared.
- The number of patterns that can be set in UP35A/UP32A varies depending on whether or not option code /AP is specified. Only the number of patterns that can be downloaded to the main unit can be downloaded.

## One Pattern

## Procedure

1. Click on [Communication] – [Download Program Pattern Data] – [One Pattern] in the menu to display the Execute Communication window.
2. Set the communication conditions and click the [Download One Program Pattern Data] button.
3. The Check and Select Pattern window appears. Select the download source pattern number and the download destination pattern number, and click [Download One Pattern Data]. When downloading is completed, a message appears.

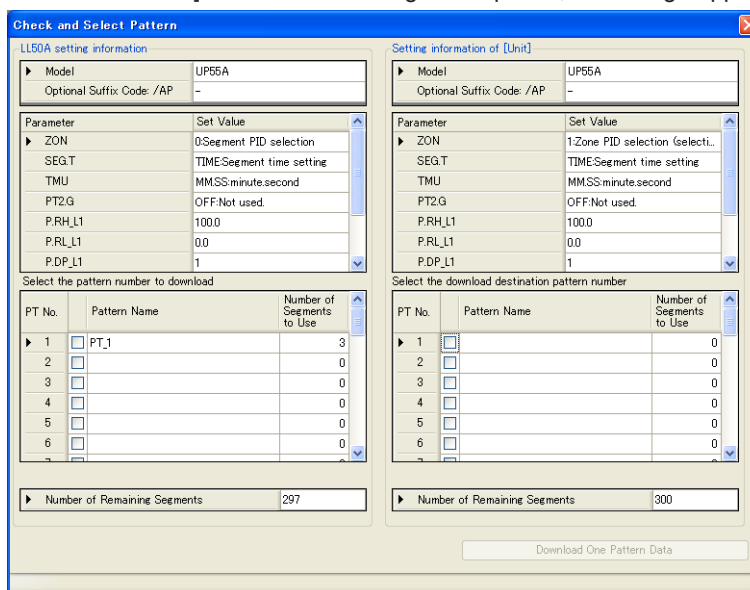

4. Click [OK] to close the Execute Communication window.

If the data in use has not yet been saved, a dialog box asking if you want to save data appears.

- To save the data and continue the process, click [Yes].
- To continue the process without saving the data, click [No].
- To stop the process, click [Cancel].

**Note**

When downloading of one pattern is performed, do a batch upload and save the backup file.

## 2.11 Downloading Data

### Description

When the parameters displayed in the Check and Select Pattern window do not meet the following conditions, the pattern file cannot be read.

Parameter	Checkpoint
SEG.T	Main unit (or file) setting data = LL50A setting data
P.DP_L1	Main unit (or file) setting data = LL50A setting data
P.RH_L1 P.RL_L1	LL50A range ≤ Main unit (or file) range
P.DP_L2 (*1)	Main unit (or file) setting data = LL50A setting data
P.RH_L2 (*1) P.RL_L2 (*1)	LL50A range ≤ Main unit (or file) range
PT2.G	A message appears when both do not match "The setpoint for parameter PT2.G does not match. Do you want to continue the process?" "Yes/No" Clicking [Yes] allows you to continue the process
ZON	A message appears when both do not match "The setpoint for parameter ZON does not match. Do you want to continue the process?" "Yes/No" Clicking [Yes] allows you to continue the process
TMU	A message appears when both do not match "The setpoint for parameter TMU does not match. Do you want to continue the process?" "Yes/No" Clicking [Yes] allows you to continue the process

\*1: To display the retransmission program pattern parameters, it is necessary to configure the following setting.

Parameter Setting window – Setup Parameters (CTL) – Program Pattern 2 Retransmission (PT2.G) = ON (Use)

### Error List Window

When downloading of the program pattern data is performed and the download to the main unit is unsuccessful because of an error, such as the setpoint is over the limit, the Error List window appears.

Example: When the setpoint for the junction code (JC) cannot be downloaded, which may occur because the limit to the junction code (JC) varies depending on whether or not UP35A's option code /AP is specified.

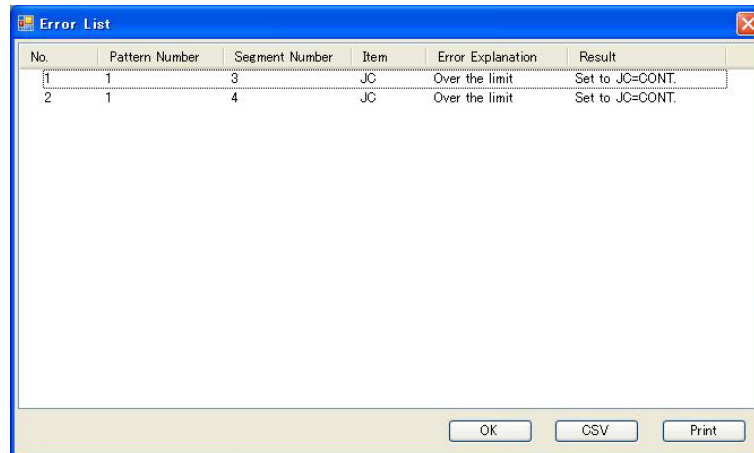

No.	Pattern Number	Segment Number	Item	Error Explanation	Result
1	1	3	JC	Over the limit	Set to JC=CONT.
2	1	4	JC	Over the limit	Set to JC=CONT.

Buttons: OK, CSV, Print

## 2.12 Uploading Data

### Upload All

#### Procedure

1. Click on [Communication] – [Upload All] in the menu to display the Execute Communication window.

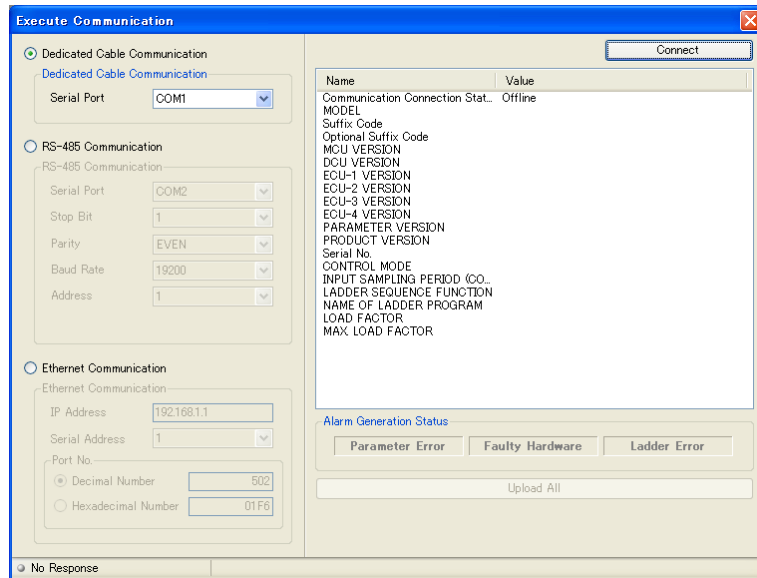

2. Set up the communication conditions and click the [Upload All] button. When an upload is complete, the Execute Communication window.

If the data in use has not yet been saved, a dialog box asking if you want to save data appears.

- To save the data and continue the process, click [Yes].
- To continue the process without saving the data, click [No].
- To stop the process, click [Cancel].

If the following message appears after clicking the [Upload All] button, follow the instructions of the message.

If a ladder program password has been set to data to be uploaded, the Enter Password dialog box appears. Enter the password and click the [OK] button.

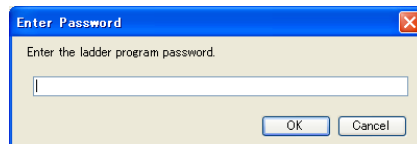

### Description

Data which are uploaded at once are a user file name, system data, parameter data, program pattern data, and ladder program data.

Once a password has been set, it must be entered whenever you upload, download, compare, or monitor the ladder programs.

The password default value is non-setting. The password can be up to eight single-byte alphanumeric characters and is case-sensitive.

Individual data can be uploaded as follows.

- Click on [Communication] – [Upload Parameter Data] in the menu.
- Click on [Communication] – [Upload Ladder Programs] in the menu.
- Click on [Communication] – [Upload Program Pattern Data] > [All Patterns] in the menu.
- Click on [Communication] – [Upload Program Pattern Data] > [One Pattern] in the menu.
  - \* If the controller is UT75A, the uploaded data includes the data of custom display.

#### <Execute Communication window>

- Serial Port: A port available for a PC is automatically displayed.
- Stop Bit, Parity, Baud Rate, and address: Set these items according to the main unit's communication conditions. Data length: fixed 8 bit
- IP Address: Set this address according to the main unit's IP address (for Ethernet communication).
- Serial Address: Set the main unit's RS-485 communication address if communication is made via an Ethernet/RS-485 converter (e.g., model VJET). (Not allowed to be duplicated)
- Port Number: Set the port number. (Decimal Number or Hexadecimal Number)

If data is downloaded via a maintenance port, nothing is displayed in the Alarm Generation Status in the Execute Communication window. In addition, "-" is displayed for the Load Factor and Max Load Factor when using a ladder program.

#### **Note**

---

Do not disconnect a connection cable or turn off the main unit power supply during an upload.

---

## Uploading Program Pattern Data

### Note

The following operations cannot be executed concurrently, otherwise the program pattern data cannot be read/written normally.

- Access to the program pattern via Open Network.
- Upload/download of the program pattern data using the LL50A Parameter Setting Tool.

## All Patterns

### Procedure

1. Click on [Communication] – [Upload Program Pattern Data] – [All Patterns] in the menu to display the Execute Communication window.
2. Set the communication conditions and click the [Upload All Program Pattern Data] button.
3. The Check and Select Pattern window appears. Confirm the details and click the [Upload All Pattern Data] button. When downloading is completed, the message appears.

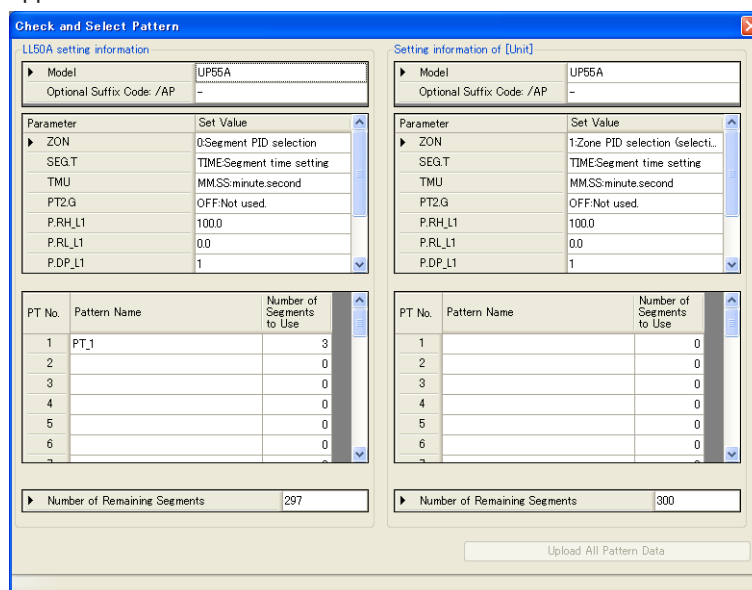

When the current work data is not saved, a dialog box appears to ask whether or not to save the data.

- To save the data and continue the process, click [Yes].
- To continue the process without saving the data, click [No].
- To stop the process, click [Cancel].

### Note

- Be aware that when the uploading of all the patterns is executed, all the pattern data set in LL50A will be cleared.
- The number of patterns that can be set in UP35A/UP32A varies depending on whether or not option code /AP is specified. Only the number of patterns that can be downloaded to the main unit can be downloaded.



One Pattern

**Procedure**

1. Click on [Communication] – [Upload Program Pattern Data] – [One Pattern] in the menu to display the Execute Communication window.
2. Set the communication conditions and click the [Upload One Program Pattern Data] button.
3. The Check and Select Pattern window appears. Select the upload source pattern number and the upload destination pattern number, and click [Upload One Pattern]. When uploading is completed, the Execute Communication window closes.

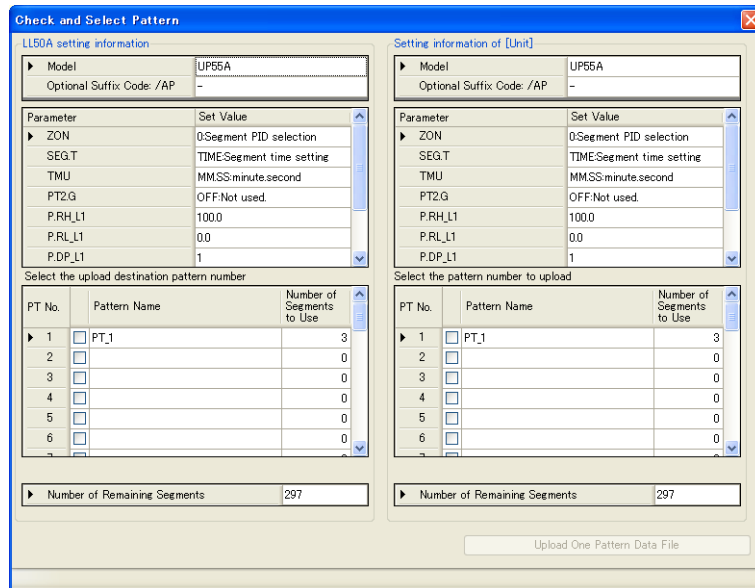

If the data in use has not yet been saved, a dialog box asking if you want to save data appears.

- To save the data and continue the process, click [Yes].
- To continue the process without saving the data, click [No].
- To stop the process, click [Cancel].

**Description**

When the parameters displayed in the Check and Select Pattern window do not meet the following conditions, the pattern file cannot be read.

Parameter	Checkpoint
SEG.T	Main unit (or file) setting data = LL50A setting data
P.DP_L1	Main unit (or file) setting data = LL50A setting data
P.RH_L1 P.RL_L1	LL50A range $\geq$ Main unit (or file) range
P.DP_L2 (*1)	Main unit (or file) setting data = LL50A setting data
P.RH_L2 (*1) P.RL_L2 (*1)	LL50A range $\leq$ Main unit (or file) range
PT2.G	A message appears when both do not match "The setpoint for parameter PT2.G does not match. Do you want to continue the process?" "Yes/No" Clicking [Yes] allows you to continue the process
ZON	A message appears when both do not match "The setpoint for parameter ZON does not match. Do you want to continue the process?" "Yes/No" Clicking [Yes] allows you to continue the process
TMU	A message appears when both do not match "The setpoint for parameter TMU does not match. Do you want to continue the process?" "Yes/No" Clicking [Yes] allows you to continue the process

\*1: To display the retransmission program pattern parameters, it is necessary to configure the following setting.

Parameter Setting window – Setup Parameters (CTL) – Program Pattern 2 Retransmission (PT2.G) = ON (Use)

When uploading of the program pattern data is performed and the upload to the main unit is unsuccessful because of an error, such as the setpoint is over the limit, the Error List window appears.

## 2.13 Comparing Data with Main unit's Data

### Procedure

1. Click on [Communication] – [Compare Communication] in the menu to display the Select Comparison Range window.

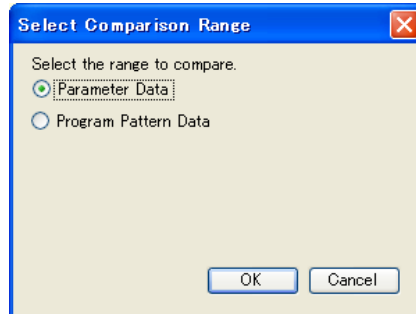

2. Select the comparison range and click the [OK] button to display the Execute Communication window.

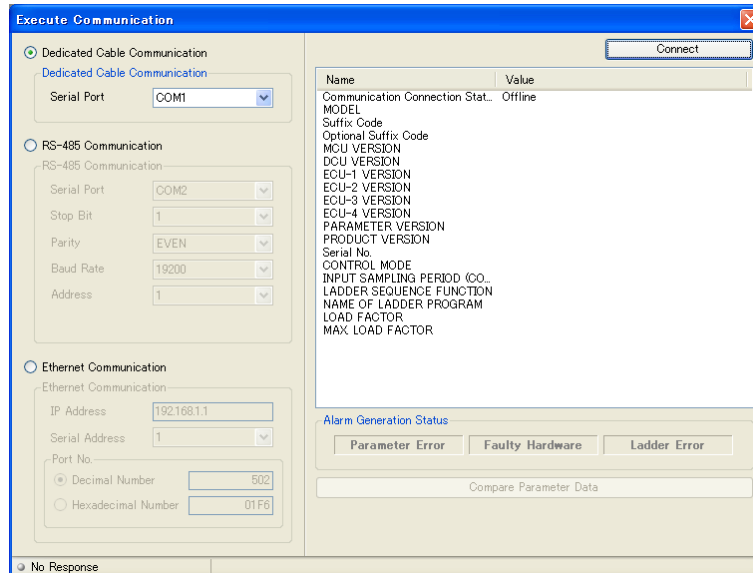

3. Set up the communication conditions and click the [Execute Parameter Comparison] button to start parameter comparison. When parameter data matches the main unit's data, the following message appears. If there is any mismatch, the mismatched data is displayed.

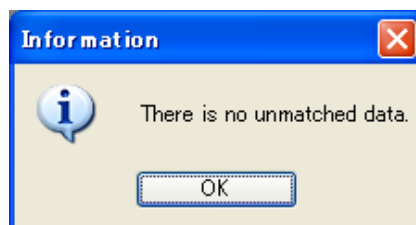

**Note**

When program pattern data is compared with each other, the Check and Select Pattern window appears. Select the program pattern numbers to compare and click the [Compare Pattern Data via Communication] button.

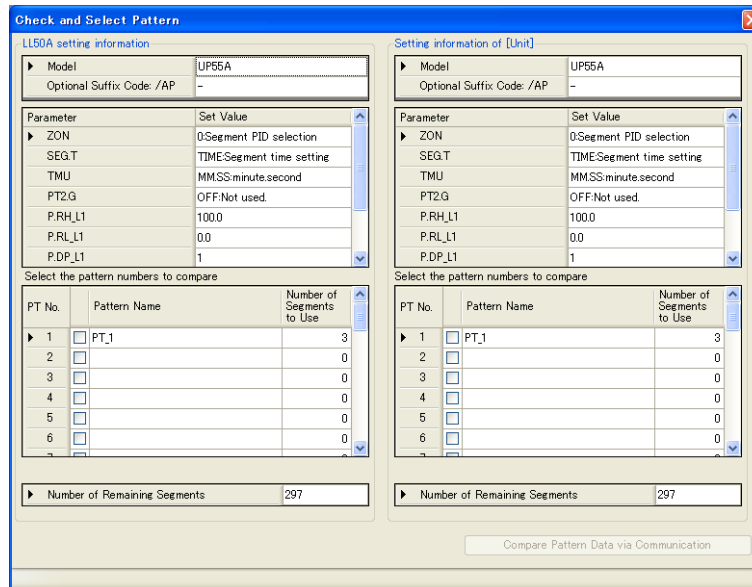

When the number of segments used in the LL50A data and the number of segments used in the comparison data are different in the comparison of the program pattern data, the number of the used segments is output as the unmatched data. The comparison segment range is only the segments common to the LL50A data and the comparison data.

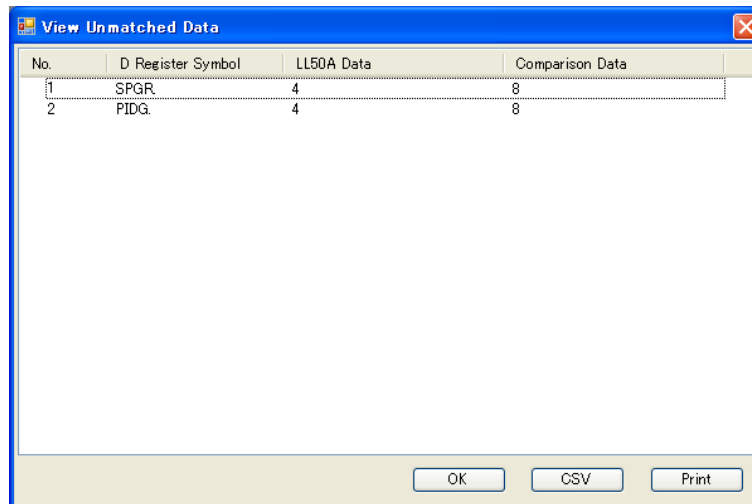
**Window displayed if there is mismatched data**

The contents of mismatch can be output to a .csv format file. If the following message appears during data comparison, follow the instructions of the message.

If the parameter version is different, data may not be properly compared.

- To save the data and continue the process, click [Yes].
- To continue the process without saving the data, click [No].
- To stop the process, click [Cancel].

If a ladder program password has been set to data to be compared, the Enter Password dialog box appears. Enter the password and click the [OK] button.

## 2.13 Comparing Data with Main unit's Data

---

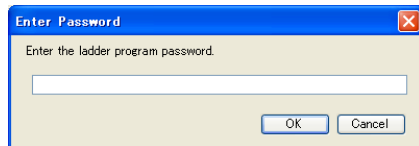

### Description

The password can be up to eight single-byte alphanumeric characters and is case-sensitive.

#### <Execute Communication window>

- Serial Port: A port available for a PC is automatically displayed.
- Stop Bit, Parity, Baud Rate, and address: Set these items according to the main unit's communication conditions. Data length: fixed 8 bit
- IP Address: Set this address according to the main unit's IP address (for Ethernet communication).
- Serial Address: Set the main unit's RS-485 communication address if communication is made via an Ethernet/RS-485 converter (e.g., model VJET). (Not allowed to be duplicated)
- Port Number: Set the port number. (Decimal Number or Hexadecimal Number)

If data is downloaded via a maintenance port, nothing is displayed in the Alarm Generation Status in the Execute Communication window. In addition, "-" is displayed for the Load Factor and Max Load Factor when using a ladder program.

#### **Note**

- Do not disconnect a connection cable or turn off the main unit power supply during data comparison.
-

## 2.14 Monitoring/Changing Data

### 2.14.1 Monitoring/Changing Tuning Data

For details of the tuning function, see the “description” given later.

#### Procedure

1. Display the Basic window.

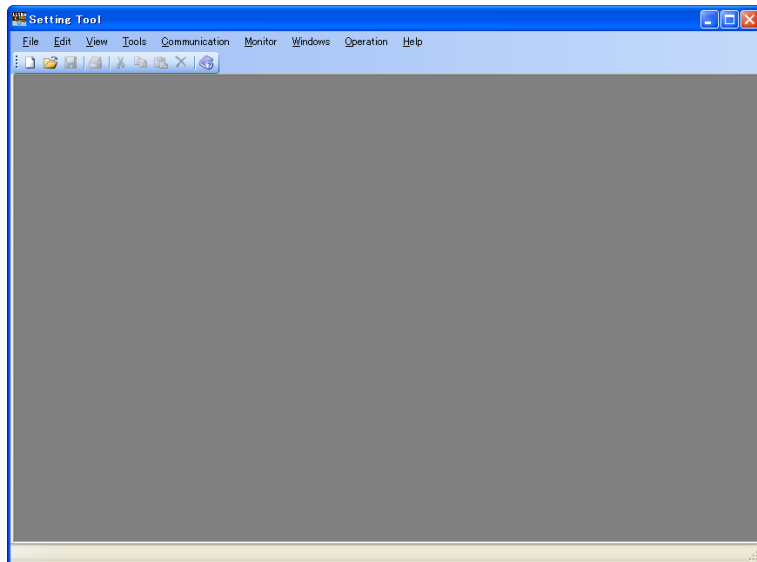

2. Click on [Monitor] – [Tuning] in the menu to display the Execute Communication window.

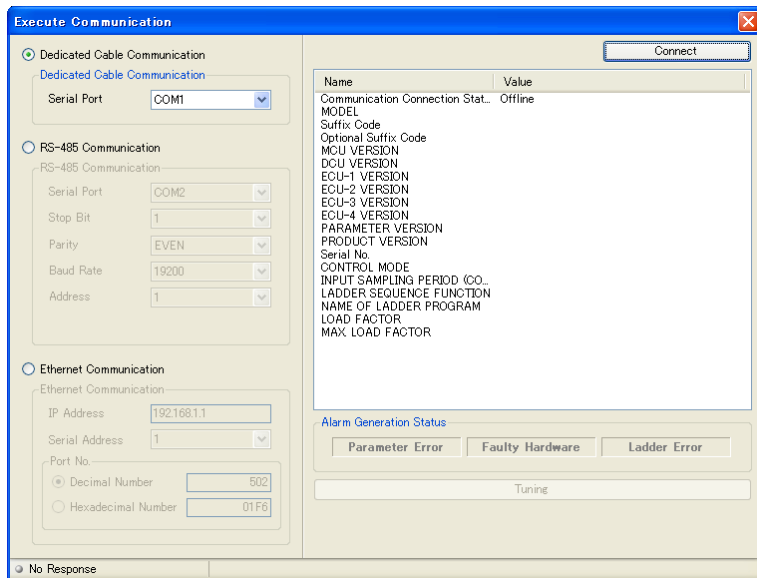

3. Set up the communication conditions and click the [Execute Tuning] button to display the Tuning window.

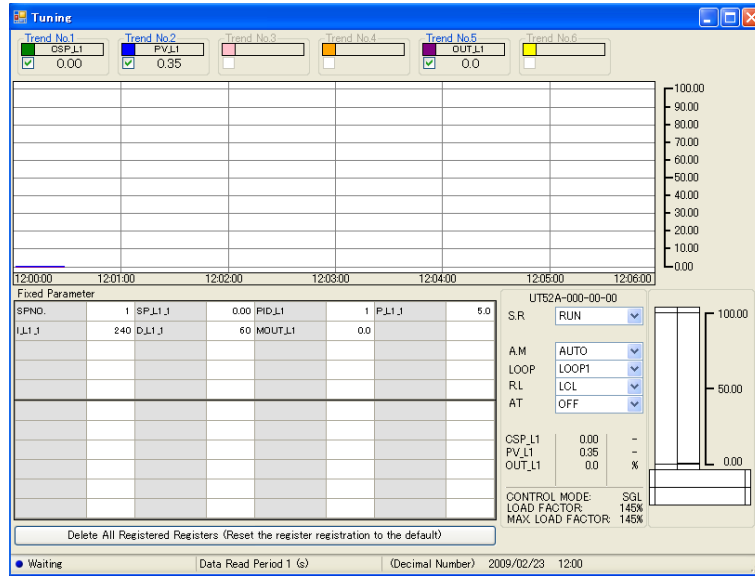

4. By observing PV, SP, and OUT trends, change the proportional band, integral time, and derivative time according to the register values in the register monitor display area.

5. Double-click in the cell of a register value that you want to change to display the Set Value window.

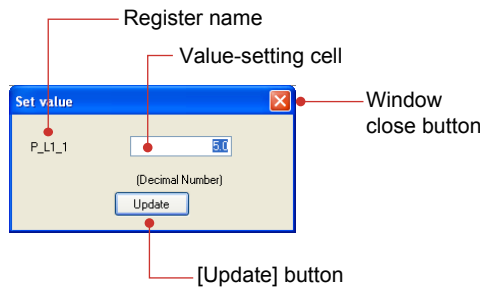

A value is displayed in the data format selected by clicking on [Monitor] – [Display Format] in the menu.

6. Enter a value and click the [Update] button.
7. To close the window, click .

If trend data has not yet been saved during tuning, a dialog box asking if you want to save data appears.

- To save the data, click the [Yes] button.
- To discard the data, click the [No] button.
- To return to tuning, click the [Cancel] button.

## Making register-monitoring display invisible

### Procedure

1. Click on [View] – [Monitor Register] in the menu.

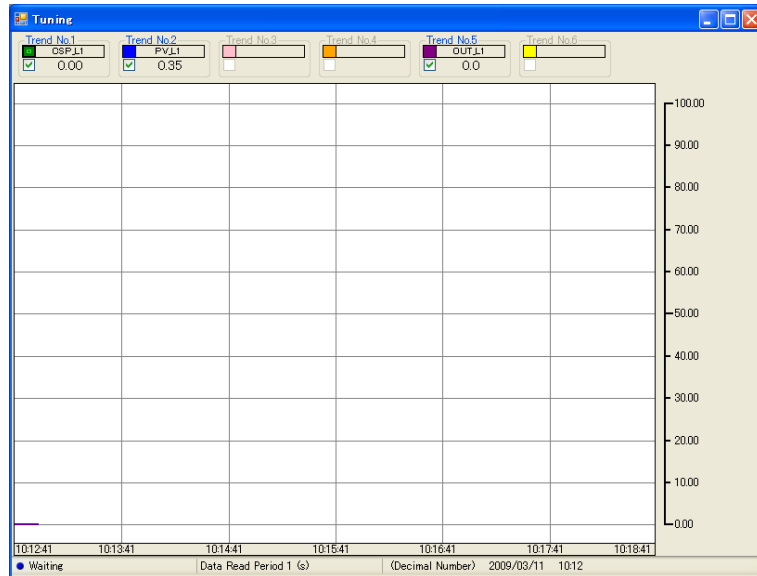



## Clearing tuning trend

### Procedure

1. Click on [Monitor] – [Clear Trend] in the menu.

This function clears only the display; no data will be deleted.

### Description

The tuning function performs tuning by communicating with one main unit. This function is primarily used at system startup. The recommended trend acquisition period is one day. Furthermore, it also enables the PV, SP, and OUT values to be displayed as trend data and acquired together with the loop information and fixed registers in the Tuning window. A maximum of 65,000 acquisition times of trend data can be saved irrespective of the data read cycle. If the number of acquisition times exceeds 65,000, acquired data will automatically be saved in another file. However, the trend data can not be saved for the first one minute when another file has been made. Example: If data acquisition is performed the 65,000st time at 21:30:50 on May 20, 2009, the name of the file containing this data is 2009\_05\_20\_21\_30\_50.csv.

### Note

If the control mode, control type, scale parameter, or another item is changed while the Tuning window is displayed, once close the Tuning window and then re-open it to refresh the displayed values.

If a register value is changed, the change is reflected in the main unit. Multiple Tuning windows cannot be displayed simultaneously.

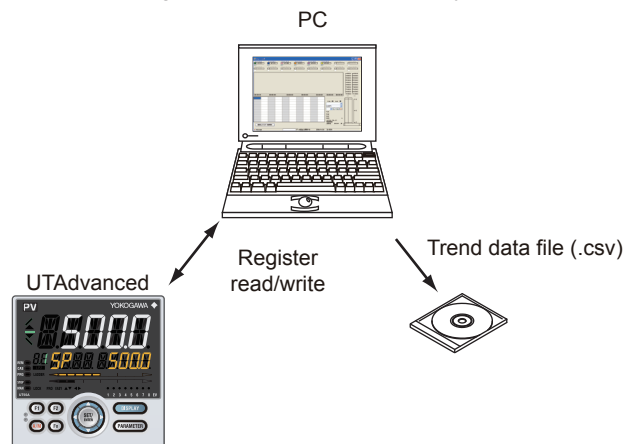

### <Execute Communication window>

- Serial port: A port available for a PC is automatically displayed.
- Stop bit, parity, baud rate, data length, and address: Set these items according to the main unit's communication conditions.
- IP address: Set this address according to the main unit's IP address (for Ethernet communication).
- Serial address: Set the main unit's RS-485 communication address if communication is made via an Ethernet/RS-485 converter (e.g., model VJET). (Not allowed to be duplicated)
- Port number: Set the port number. (Decimal or Hexadecimal)

### Note

Do not disconnect a connection cable or turn off the main unit power supply during trend data tuning.

(1) Trend data digital-value display section

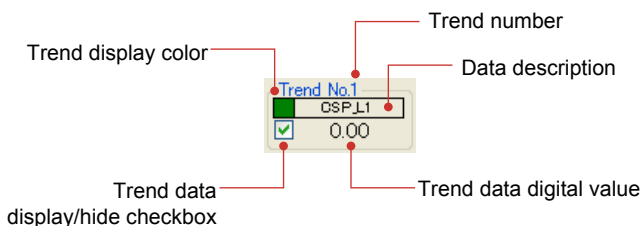

Display	Description
Number of trend data displayed	Up to six data
Trend data display/ hide checkbox	Select whether or not to display trend data on a graph using a check mark. Even if trend data is made invisible, a trend data digital value is displayed and can be output in .csv file format as trend data.
Trend display color	Clicking on the trend display color causes the Color dialog box to appear, enabling you to change the display color.
Data description	<p>&lt;When suffix code type 1 (basic control) is standard type or Position proportional type&gt;                      When the control mode is anything other than Cascade control, and the control type is anything other than Two-position two-level control or Heating/cooling control:                      Trend 1: CSP_L1 (target setpoint)                      Trend 2: PV_L1 (measured input value)                      Trend 3: None *1                      Trend 4: None                      Trend 5: OUT_L1 (control output value)                      Trend 6: None</p> <p>When the Control mode is Cascade control, and the control type is anything other than Two-position two-level control or Heating/cooling control:                      Trend 1: CSP_L1 (Loop-1 target setpoint)                      Trend 2: PV_L1 (Loop-1 measured input value)                      Trend 3: CSP_L2 (Loop-2 target setpoint)                      Trend 4: PV_L2 (Loop-2 measured input value)                      Trend 5: OUT_L2 (control output value)                      Trend 6: None</p> <p>&lt;When suffix code type 1 (basic control) is Heating/cooling type&gt;                      When the control mode is anything other than Cascade control, and the control type is Heating/cooling control or Two-position two-level control:                      Trend 1: CSP_L1 (target setpoint)                      Trend 2: PV_L1 (measured input value)                      Trend 3: None *1                      Trend 4: None                      Trend 5: HOUT_L1 (heating-side or main setting-side control output value)                      Trend 6: COUT_L1 (cooling-side or sub-setting-side control output value)</p> <p>When the control mode is Cascade control, and the control type is Two-position two-level control or Heating/cooling control:                      Trend 1: CSP_L1 (Loop-1 target setpoint)                      Trend 2: PV_L1 (Loop-1 measured input value)                      Trend 3: CSP_L2 (Loop-2 target setpoint)                      Trend 4: PV_L2 (Loop-2 measured input value)                      Trend 5: HOUT_L2 (heating-side or main setting-side control output value)                      Trend 6: COUT_L2 (cooling-side or sub-setting-side control output value)</p>

**Trend data digital-value display section (Continued)**

Display	Description
Data description	<p>&lt;When suffix code type 1 (basic control) is Dual-loop type&gt;                      When the control mode is Dual-loop control, and the control type is anything other than Heating/cooling control:                      Trend 1: CSP_L1 (target setpoint)                      Trend 2: PV_L1 (measured input value)                      Trend 3: OUT_L1 (control output value)                      Trend 4: CSP_L2 (Loop-2 target setpoint)                      Trend 5: PV_L2 (Loop-2 measured input value)                      Trend 6: OUT_L2 (control output value)</p> <p>When the Control mode is Dual-loop control, and the control type is Heating/cooling control:                      Trend 1: CSP_L1 (Loop-1 target setpoint)                      Trend 2: PV_L1 (Loop-1 measured input value)                      Trend 3: HOUT_L1 (Loop-1 heating-side control output value)                      Trend 4: COUT_L1 (Loop-1 cooling-side control output value)                      Trend 5: CSP_L2 (Loop-2 target setpoint)                      Trend 6: PV_L2 (Loop-2 measured input value)                      Trend 7: HOUT_L2 (Loop-2 heating-side control output value)                      Trend 8: COUT_L2 (Loop-2 cooling-side control output value)</p>
Trend data digital value	Data read from the main unit (Max. 7 digits including the sign and decimal point) is displayed.

\*1: Only for UP55A. When the program pattern-2 retransmission (PT2.G) is ON, "CSP\_L2" is displayed in Trend 3.

**Color Setting window**

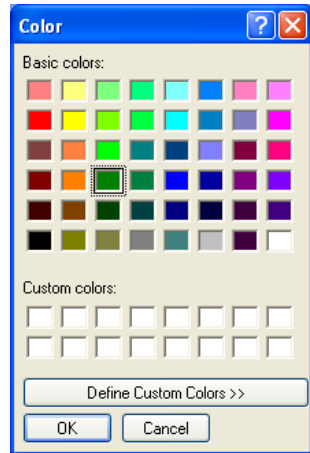

## (2) Trend display area

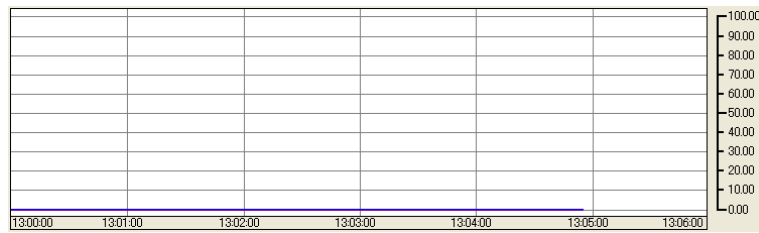

Display	Description
Scale display	Maximum value to minimum value of the input range (Loop 1 and Loop 2) Scale divisions: 11
Trend	Trend data of -5.0 to 105.0% (0 to 100% scale) is displayed. Display update period: Data read cycle Plotting: Plotting from the left When the trend is plotted up to the right end, the display area is scrolled to the left by 2/3 hours on the time-axis scale. If a value exceeds the range, trend display is limited. However, read data is saved as is in a .csv file. Trend data is displayed starting on the left end.
X-axis (time-axis) scale	The time axis is automatically calculated according to the data read cycle.
Background color	Right-clicking on the trend graph and selecting Background Color from the shortcut menu which appears causes the Color dialog box to appear, enabling you to change the trend display color.

**(3) Loop information display area**

This area displays loop information selected by LOOP switching.

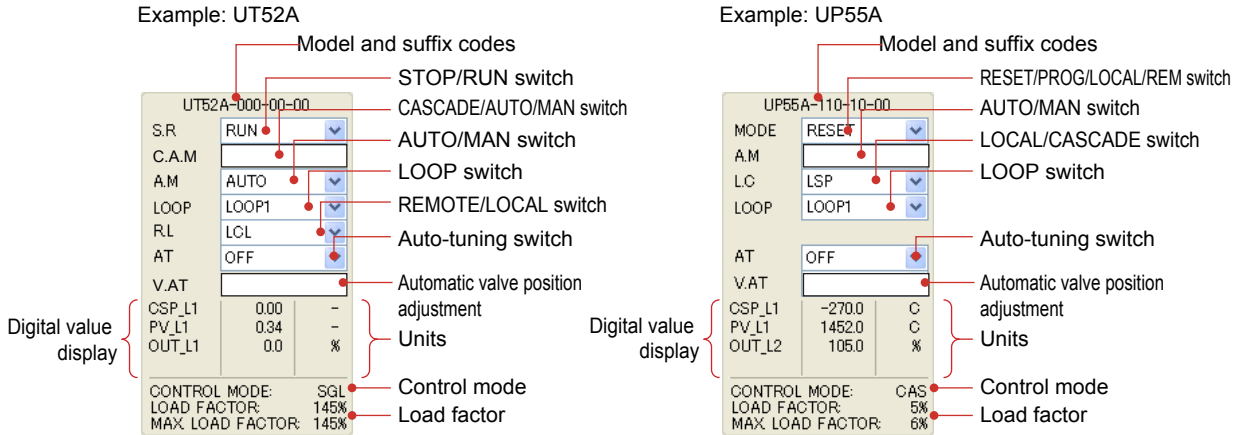

Display	Description
Model and suffix codes	This field displays the model and suffix codes read out when the window is opened.
STOP/RUN switching (only for UT75A/UT55A/ UT52A/UT35A/UT32A)	Displays the operation status, which can be switched. RUN: Starts operation. STOP: Stops operation.
RESET/PROG/LOCAL/REM switching (only for UP55A/UP35A/ UP32A)	RESET: Stop of program operation PROG: Start of program operation LOCAL: Start of local-mode operation REM: Start of remote-mode operation (only for UP55A)
CASCADE/AUTO/MAN switching (only for UT75A/UT55A/ UT52A)	Displays the operation status. It is displayed when the control mode is Cascade control or Secondary-loop cascade control. It can be switched. CAS: Cascade AUTO: Automatic MAN: Manual
LOCAL/CASCADE switching (only for UP55A)	Displays the operation status. It is displayed when the control mode is Cascade control. It can be switched. LCL: Local CAS: Cascade
AUTO/MAN switching	Displays the operation status. It is displayed when the control mode is anything other than Cascade control or Secondary-loop cascade control. It can be switched. AUTO: Automatic MAN: Manual
LOOP switching (only for UT75A/UT55A/ UT52A/UP55A)	The loop can be switched between LOOP1 and LOOP2 when the control mode is Cascade control or Dual-loop control.
REMOTE/LOCAL switching (only for UT35A/UT32A with communication)	Displays the operation status. It is displayed when the control mode is anything other than Secondary-loop cascade control. It can be switched. LCL: Local REM: Remote
Auto-tuning switching	Enables auto-tuning to be activated or deactivated. When auto-tuning is activated, optimized PID values are set to the main unit and are displayed and updated in the register monitor display area at the next data read cycle. When auto-tuning finishes, OFF is displayed at the next read cycle. UT35A/UT32A/UP35A/UP32A: Switchable among OFF, 1 to 4, and R UT55A/UT52A/UP55A: Switchable among OFF, 1 to 8, and R UT75A: Switchable among OFF, 1 to 16, and R
Automatic valve position adjustment	Activates and deactivates automatic valve position adjustment. This is available only in position proportional type. When automatic valve position adjustment finishes, OFF is displayed at the next data read cycle. Switchable between OFF and ON If an automatic valve position adjustment error occurs in the main unit, an error icon is displayed.

Display	Description
SV and PV digital value display	PV and SV digital values are read from the main unit and displayed. The values are max. 7 digits including the sign and decimal point.
OUT digital value display	OUT digital values are read from the main unit and displayed. The values are max. 7 digits including the sign and decimal point.
Unit display	Displays units.
Control mode (only for UT75A/UT55A/ UT52A/UP55A)	Displays control mode.
Load factor and maximum load factor	Displays the load factor and maximum load factor of ladder programs.

The display update period is the data read cycle. Data to be updated are those other than the model and suffix codes, unit display, and control mode.

#### (4) Bar graph display area

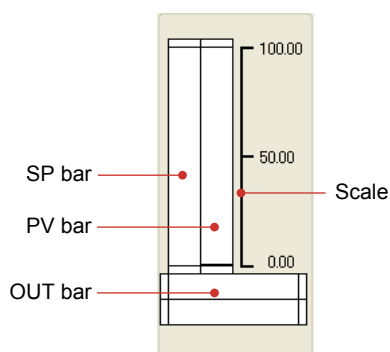

Display	Description
SP and PV bars	Display the SP and PV values of the loop selected by LOOP switching in a bar graph. LOOP1 SP bar: green, PV bar: blue LOOP2 SP bar: pink, PV bar: orange
OUT bar	Displays OUT values in a bar graph. Control output or heating-side control output: purple Cooling-side control output: yellow
Scale	The maximum value to minimum value of the input scale (Loop 1 and Loop 2) Memory: 3 points

The display update period is the data read cycle. Data to be updated are SP bar, PV bar, and OUT bar.



### D-register symbols

For some register symbols, the loop number, terminal area number, and group number are indicated by adding the underscore (\_) to the end of a parameter symbol. If both the loop number and group number are added to a parameter symbol, they are added to it in the order of \_loop number and \_group number.

xxxx\_Ln\_Y

Ln: loop number (L1 or L2)

Y: group number (1 to 8 (20) or 1 to 16, R)

xxxx\_En

En: terminal area number (E1 to E4)

Example:

SP\_L1\_3: This means Loop-1 group-3 target setpoint.

PYS\_2: This means group-2 PYS.

DI1.D\_E1: This means E1-terminal area DI1.D.

#### Note

Since the UT35A/UT32A/UP35A/UP32A is a single-loop controller, it has no distinction between Loop-1 and Loop-2. However, the register symbol has "L1" which indicates Loop-1.

#### Note

When hexadecimal display is selected, the integers of registers are displayed in hexadecimal numbers, except DAT01 to DAT20. (No decimal point position is displayed.)

DAT01 to DATA20 use 32-bit floating-point numbers of the IEEE 754 format in hexadecimal notation.

### Set Value window

When a register set value is registered in the register monitor display area, the following Set Value window appears.

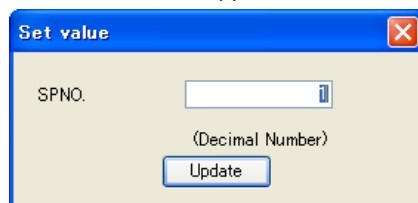

#### Actions to be taken when the Set Value window is closed

The display of the following data will be updated:

- Trend data digital value
- LOOP information display area
- Bar graph display
- Register monitor display area

Even if the Set Value window is opened and then closed without changing a set value, the displays will be updated irrespective of the data read cycle.



(6) Status bar display area

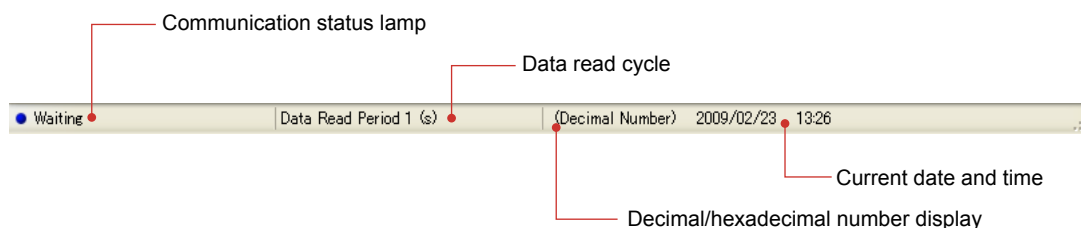

Display	Description
Communication status lamp	Green: Communicating Blinks at the data read cycle. Blue: Waiting (lit) Red: Delay occurring (Lit) Gray: No response
Progress bar display	The progress rate is indicated in a bar display (when Save Tuning Data)
Data read cycle	Double-clicking on this item causes the Set Data Read Cycle window to open.
Decimal/hexadecimal display	Enables you to check if a register value is displayed in whichever data format of decimal or hexadecimal numbers. It can be switched by the command from the menu. Click on [Monitor], select [Display Format], and click on [Decimal] or [Hexadecimal] in the menu.
Current date	PC system date (year/month/day)
Current time	PC system time (hour : minute)

**Note**

When the communication status indicates “Red: Delay occurring (Lit)”, set the data read cycle longer.

## 2.14.2 Setting Data Read Cycle

## Procedure

1. Double-click on the data read cycle display field in the status bar display area.

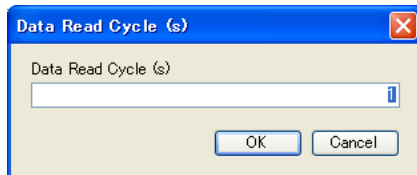

2. Set a data read cycle and click the [OK] button.

## Description

Data is read during tuning, while monitoring registers, and at the set data read cycle.  
Setting range: 1 to 3600 sec

If the data read cycle is changed during tuning, the X-axis (time-axis) span of the trend graph changes as shown in the table below. The trend graph displayed is deleted, and trend data starts to be plotted from the left end of the X axis (time axis).

Data Read Cycle	X-axis (Time-axis) Span
1 sec	6 min
2 sec	12 min
60 sec	6 hr

**Note**

If communication processing is unable to meet the set data read cycle, a communication delay occurs.

## 2.15 Managing Files

### 2.15.1 Creating a New File

#### Procedure

1. Click on [File] – [New] in the menu or click  on the toolbar to display the Set System Data window.

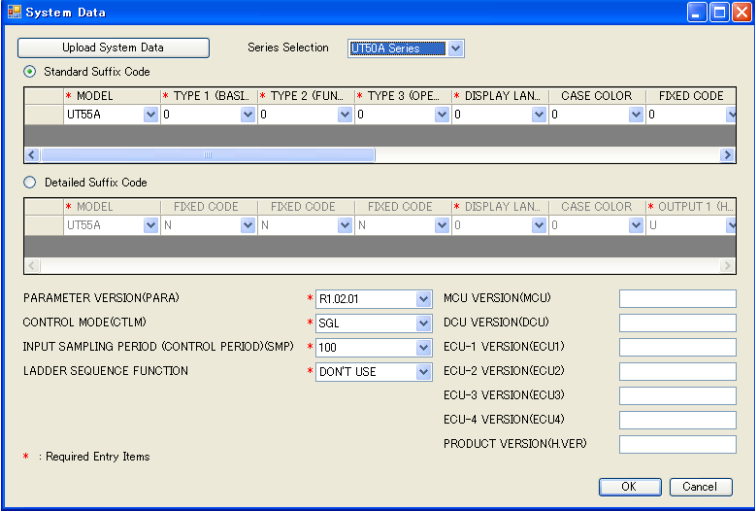

Items marked by an asterisk \* are mandatory input fields.

CONTROL MODE (CTLM) and ECU-2 VERSION (ECU2) are displayed for UT75A/UT55A/UT52A/UP55A only.

INPUT SAMPLING PERIOD (CONTROL PERIOD) (SMP) is displayed for UT75A/UT55A/UT52A/UP55A/UM33A only.

LADDER SEQUENCE FUNCTION, ECU-2 VERSION (ECU2), and ECU-3 VERSION (ECU3) are not available for UM33A.

2. Enter system data or click the [Upload System Data] button and then click the [OK] button.
3. For operations such as setting parameters and creating user file information, see the relevant section.

## 2.15.2 Opening a User File

## Procedure

1. Click on [File] – [Open] in the menu or click  on the toolbar to display the Open File window.

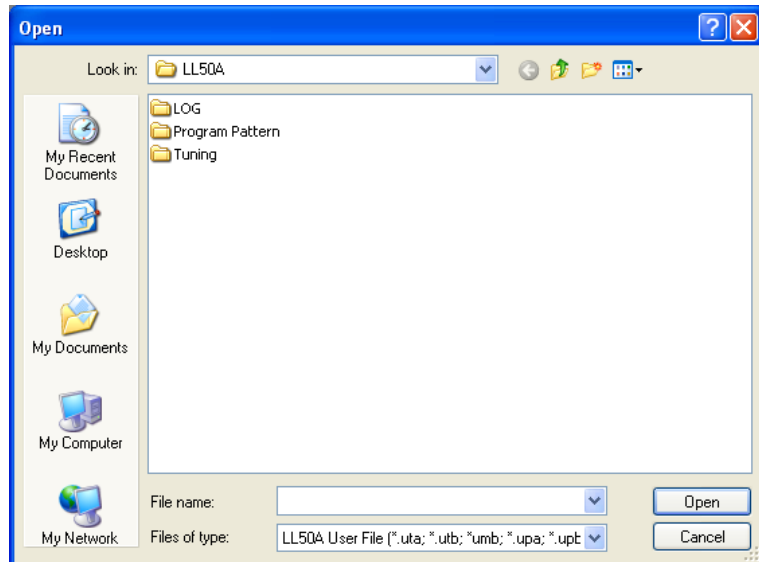

2. See the following table for the user file extension. For operations such as setting parameters and creating user file information, see the relevant section.

If a password has been set to a user file, enter the user file password.

## Extension

Model	Extension
UT55A/UT52A	uta
UT35A/UT32A	utb
UT75A	utc
UT32A-D	utd
UT32A (Entry model)	ute
UT35A-L	utl
UP55A	upa
UP35A/UP32A	upb
UM33A	umb

2.15.3 Opening a Program Pattern Data File

All Pattern Files

**Procedure**

1. Click on [File] – [Open Program Pattern File] – [All Pattern Files] in the menu to display the Browse Folders dialog box.
2. Select the folder and then click [OK].
3. The Check and Select Pattern window appears. Confirm the details and click the [Read All Pattern Data Files] button.

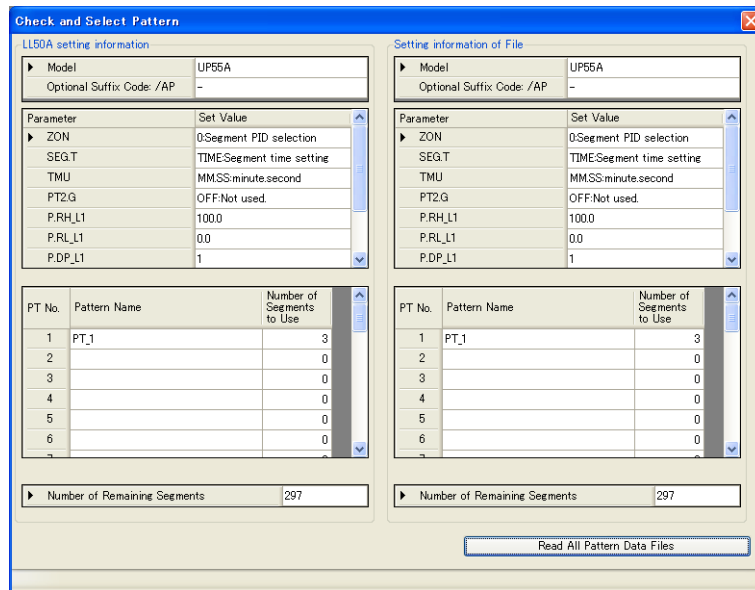

**Note**

- Be aware that when the uploading of all the patterns is executed, all the pattern data set in LL50A will be cleared.
  - Files with file names of PTN001 to PTN030\* can be read.
  - \*: PTN001 and PTN002 for UP35A/UP32A (plus PTN004 when the option code is specified).
- ▶ [File name: Section 2.15.8 Saving Program Pattern File in this Manual](#)

**Extension**

Model	Extension
UP55A	5pt
UP35A/UP32A	3pt

## One Pattern File

## Procedure

1. Click on [File] – [Open Program Pattern File] – [One Pattern File] in the menu to display the Open File window.
2. Select the folder and then click [OK].
3. The Check and Select Pattern window appears. Select the the read destination pattern number, and click [Read One Pattern Data File].

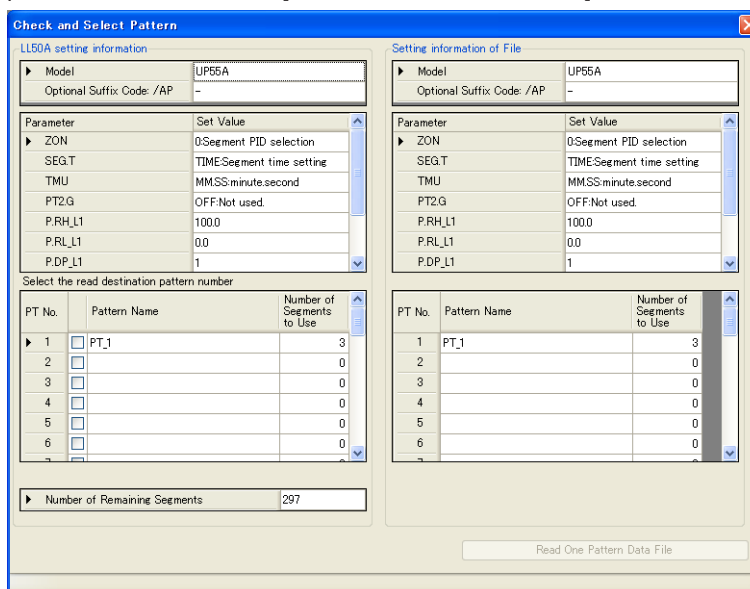

## Extension

Model	Extension
UP55A	5pt
UP35A/UP32A	3pt

## Description

When the parameters displayed in the Check and Select Pattern window do not meet the following conditions, the pattern file cannot be read.

Parameter	Checkpoint
SEG.T	Main unit (or file) setting data = LL50A setting data
P.DP_L1	Main unit (or file) setting data = LL50A setting data
P.RH_L1	LL50A range $\geq$ Main unit (or file) range
P.RL_L1	
P.DP_L2 (*1)	Main unit (or file) setting data = LL50A setting data
P.RH_L2 (*1)	LL50A range $\leq$ Main unit (or file) range
P.RL_L2 (*1)	
PT2.G	A message appears when both do not match "The setpoint for parameter PT2.G does not match. Do you want to continue the process?" "Yes/No" Clicking [Yes] allows you to continue the process
ZON	A message appears when both do not match "The setpoint for parameter ZON does not match. Do you want to continue the process?" "Yes/No" Clicking [Yes] allows you to continue the process
TMU	A message appears when both do not match "The setpoint for parameter TMU does not match. Do you want to continue the process?" "Yes/No" Clicking [Yes] allows you to continue the process

## 2.15 Managing Files

---

\*1: To display the retransmission program pattern parameters, it is necessary to configure the following setting.

Parameter Setting window – Setup Parameters (CTL) – Program Pattern 2 Retransmission (PT2.G) = ON (Use)

When uploading of the program pattern data is performed and the upload to the main unit is unsuccessful because of an error, such as the setpoint is over the limit, the Error List window appears.

## 2.15.4 Opening User Ladder Program Files

## Procedure

1. On the File menu, click Import user ladder program to display the Open window.

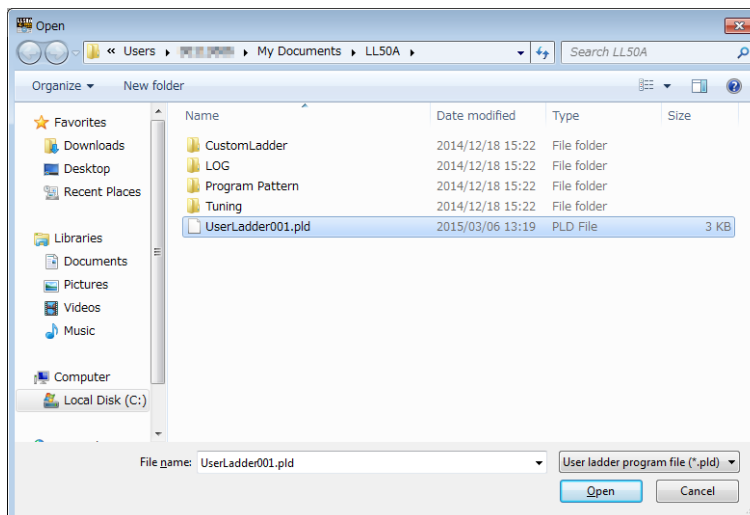

2. Select the file that you want to open, and click Open.

## Extension

Model	Extension
All models	pld

## Description

If the file to be imported contains an instruction that cannot be used on the importing controller, a message is displayed, and the process is canceled.

**Instructions that cannot be imported**

If the controller is UT55A/UT52A/UT35A/UT32A/UP55A/UP35A/UP32A, user ladder programs that include the following instructions cannot be imported.

Timer with back-up (TIM\_B), Counter with back-up (CNT\_B), Comparison (floating point numbers) GTF/LTF/GEF/LEF/NEQ), In range (IRNGF), Out of range (ORNGF), Square Root (floating point numbers) (SQR/E\_SQR), Square Root Extraction (Low cutoff point or less: zero) (SQT/E\_SQT), Square Root Extraction with variable low cutoff (SQTE/E\_SQTE), Exponential (EXP/E\_EXP), Power (PWR/E\_PWR), Natural Logarithm (LN/E\_LN), Common Logarithm (LOG/E\_LOG), Logical XOR (1 bit) (XORB/E\_XORB), Not (1bit) (NOTB/E\_NOTB), Reciprocal (RECIP/E\_RECIP), Limit (LIMIT/E\_LIMIT), Temperature and Humidity Calculation (TMPHM), 10-segment Linearizer Approximation (PLN1/PLN2/PLN3/PLN4), Inverse Conversion of 10-segment Linearizer Approximation (ILN1/ILN2/ILN3/ILN4), 20-segment Linearizer Approximation (PLN21/PLN22), Maximum Input Hold (MXHD1), Minimum Input Hold (MNHD1), Filter (FLTR1/FLTR2/FLTR3/FLTR4), Dead Time (DED1/DED2/DED3), Moving Average (MAV1/MAV2/MAV3), Velocity Computation (VEL1/VEL2/VEL3), Velocity Limiter (CLMT1/CLMT2/CLMT3/CLMT4), Totalizer Pulse Output (CPO1), On-delay Timer (ONDY1/ONDY2/ONDY3/ONDY4/ONDY5/ONDY6/ONDY7/ONDY8), Off-delay Timer (OFDY1/OFDY2/OFDY3/OFDY4/OFDY5/OFDY6/OFDY7/OFDY8), custom ladder instructions, CP calculation instructions\*

\* CP calculation instructions can be imported only into UT75As with the /CP option.

- ▶ Register symbol, register number: [UTAdvanced Series Communication Interface User's Manual](#)



### 2.15.5 Opening Custom Ladder Instruction Files (UT75A Only)

#### File Designation

##### Procedure

1. On the File menu, click Import custom ladder instruction and then File designation to display the Open window.

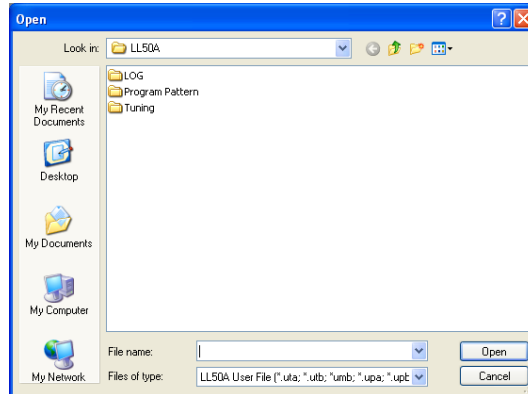

2. Select the file that you want to open, and click Open.
3. The user file extension is shown in the table below.

#### Directory Designation

##### Procedure

1. On the File menu, click Import custom ladder instruction and then Directory designation to display the Browse For Folder window. All the files in the folder that you specify will be imported.
2. Select the folder, and click OK.

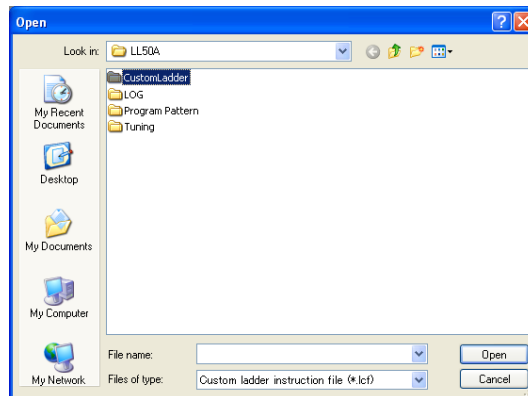

3. The user file extension is shown in the table below.

For the procedure to create custom ladder instructions, see section 4.7.2, “Creating Custom Ladder Instructions (UT75A Only).”

#### Extension

Model	Extension
UT75A	lcf

## 2.15.6 Setting/Clearing a User File Password

### Procedure

1. With the file concerned closed, click on [File] – [Set User File Password] in the menu to display the Open File window.

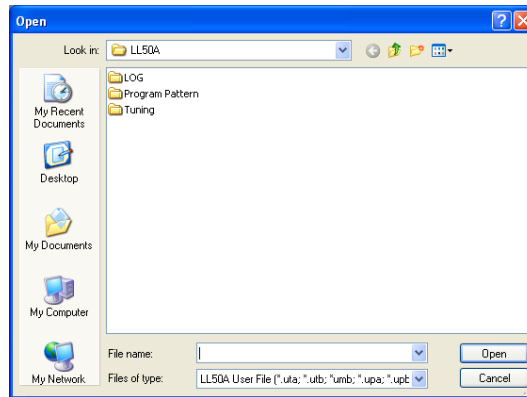

2. Select the user file to which you want to set a password and then click [Open].
3. Enter the password and click the [OK] button. The password can be up to eight single-byte alphanumeric characters.

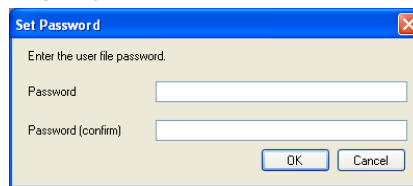

### How to Clear a Password

1. With the file concerned closed, click on [File] – [Set User File Password] in the menu to display the Open File window.
2. Select the user file to which you want to clear a password and then click [Open].
3. Enter the password and click the [OK] button. The password can be up to eight single-byte alphanumeric characters.
4. Click the [OK] button without entering a password in Set Password dialog box.

### Description

If a user file password is set to the user file, it is necessary to enter the password in the opening a user file or comparing with file data.

When setting or clearing a user file password, it is necessary to close the file in use.

### 2.15.7 Closing a File

#### Procedure

1. Click on [File] – [Close] in the menu to close the file in use.  
To save a file in use, save it by entering a file name.

### 2.15.8 Saving by Overwrite

#### Procedure

1. Click on [File] – [Save] in the menu or click  on the toolbar to save data in use.

### 2.15.9 Saving a File

#### Procedure

1. Click on [File] – [Save As] in the menu to display the Save As window. A file name can be up to 40 single-byte characters (20 two-byte characters).

LL50A User File for UT50A Series (\*.uta)  
LL50A User File for UT30A Series (\*.utb)  
LL50A User File for UT70A Series (\*.utc)  
LL50A User File for UT30D Series (\*.utd)  
LL50A User File for UT30Entry (\*.ute)  
LL50A User File for UT30L Series (\*.utl)  
LL50A User File for UP50A Series (\*.upa)  
LL50A User File for UP30A Series (\*.upb)  
LL50A User File for UM30A Series (\*.umb)

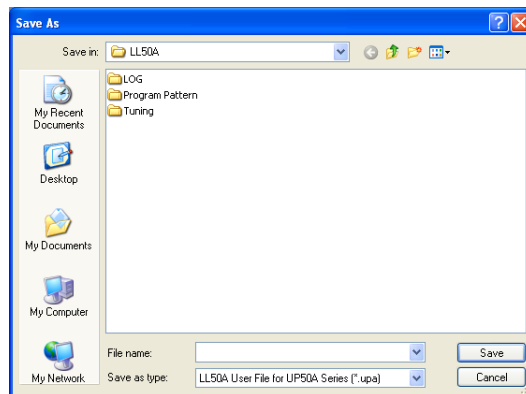

2. Enter a name for the file and click the [Save] button.

## 2.15.10 Saving Program Pattern File

## All Pattern Files

## Procedure

1. Click on [File] – [Save Program Pattern File] – [All Pattern Files] in the menu to display the Check and Select Pattern window.

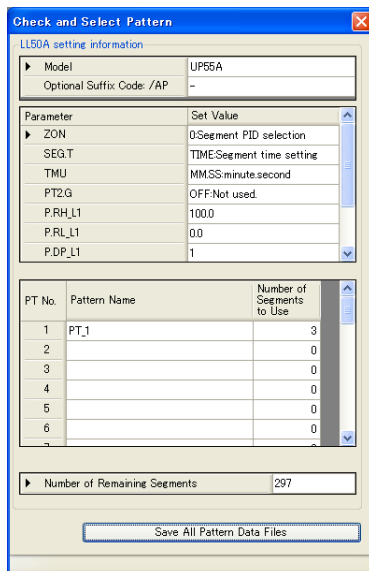

2. Check the details and click the [Save All Pattern Data Files] button.
3. The Browse Folders dialog box appears. Select the save destination folder and click the [OK] button.  
The [Create New Folder] button allows you to create a folder.

**Note**

Program pattern numbers are used as the file names, which are PTN001 to PTN030\*.

\*: PTN001 and PTN002 for UP35A/UP32A (plus PTN004 when the option code is specified).

Example: When the program pattern number is 10, the file name is PTN010.5pt.

**Extension**

Model	Extension
UP55A	5pt
UP35A/UP32A	3pt

One Pattern File

**Procedure**

1. Click on [File] – [Save Program Pattern File] – [One Pattern File] in the menu to display the Check and Select Pattern window.

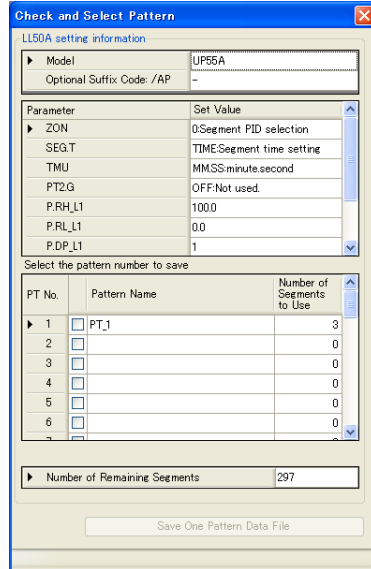

2. Check the details and click the [Save One Pattern Data Files] button.
3. The Save As window appears. Name the file and click the [Save] button.

**Extension**

Model	Extension
UP55A	5pt
UP35A/UP32A	3pt

## 2.15.11 Saving User Ladder Program Files

### Procedure

1. On the File menu, click Export user ladder program to display the Save As window.

LL50A User File for UT50A Series (\*.uta)  
 LL50A User File for UT30A Series (\*.utb)  
 LL50A User File for UT70A Series (\*.utc)  
 LL50A User File for UT30D Series (\*.utd)  
 LL50A User File for UT30Entry (\*.ute)  
 LL50A User File for UT30L Series (\*.utl)  
 LL50A User File for UP50A Series (\*.upa)  
 LL50A User File for UP30A Series (\*.upb)  
 LL50A User File for UM30A Series (\*.umb)

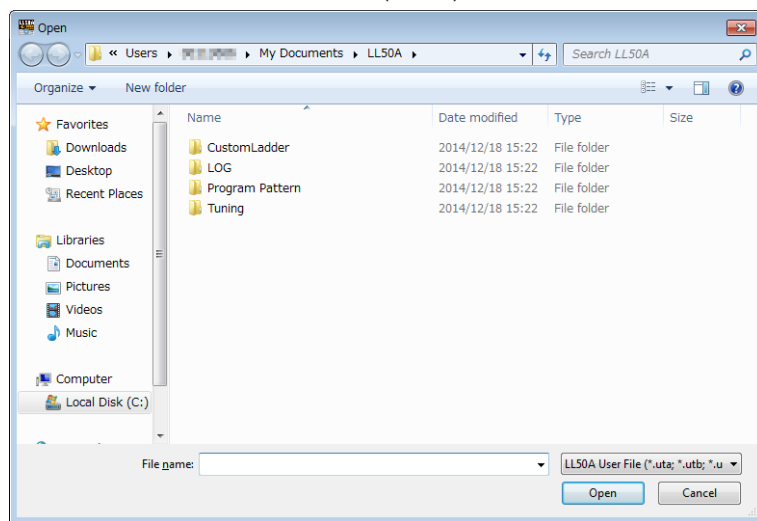

2. Assign a file name, and then click Save.

### 2.15.12 Saving Custom Ladder Instruction Files (UT75A Only)

#### Instruction Selection

##### Procedure

1. On the File menu, click Export custom ladder instruction and then Instruction selection to display the Custom ladder instruction selection window.

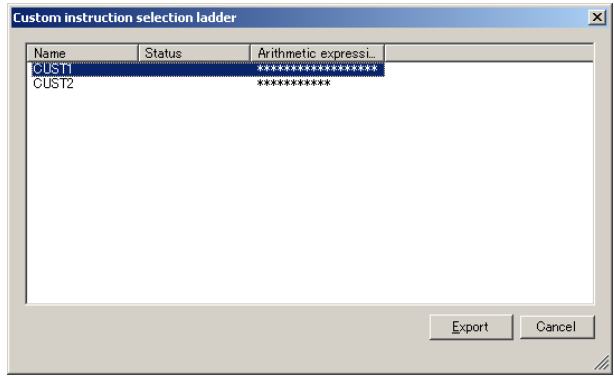

2. Select the instruction to export, and click Export.

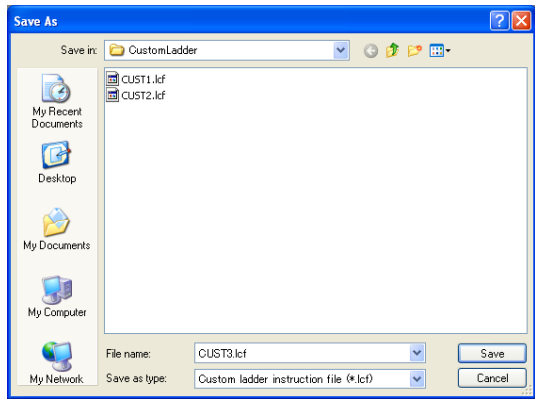

3. Assign a file name, and then click Save.

#### All Instructions

##### Procedure

1. On the File menu, click Export custom ladder instruction and then All instructions to display the Browse For Folder window.
2. Select the folder, and click OK.

The default file name is the instruction name.

For the procedure to create custom ladder instructions, see section 4.7.2, “Creating Custom Ladder Instructions (UT75A Only).”

## 2.15.13 Comparing with File Data

## Procedure

1. Click on [File] – [Compare Files] in the menu to display the Select Compare Range window.

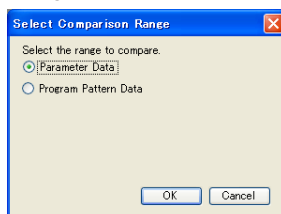

2. Select the comparison range and click the [OK] button.
3. Open a file to be compared and click the [Open] button.

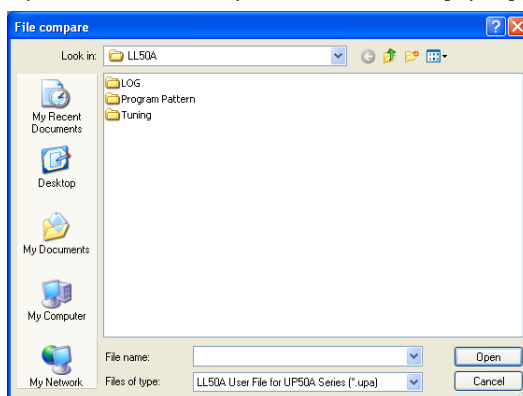
**Note**

When program pattern data is compared with each other, the Check and Select Pattern window appears. Select the program pattern numbers to compare and click the [Compare Pattern Data Files] button.

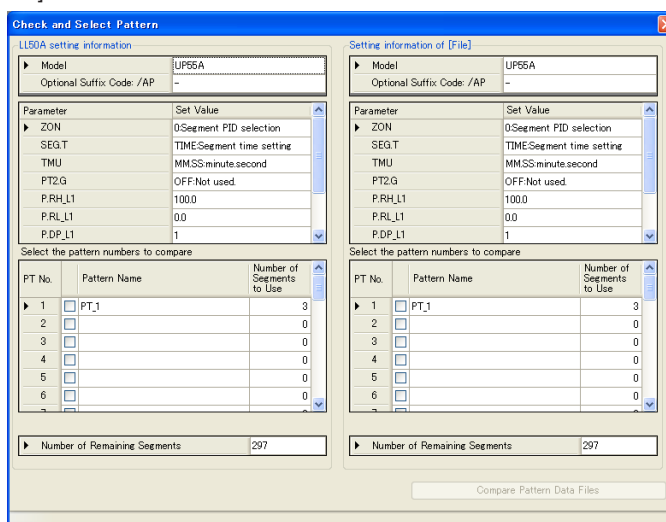

When the number of segments used in the LL50A data and the number of segments used in the comparison data are different in the comparison of the program pattern data, the number of the used segments is output as the unmatched data.

The comparison segment range is only the segments common to the LL50A data and the comparison data.



4. Execute data comparison. When working data matches the file data, the following message appears. If there is any mismatch, the mismatched data is displayed.

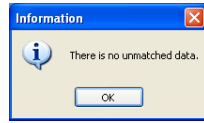

**Window displayed if there is mismatched data**

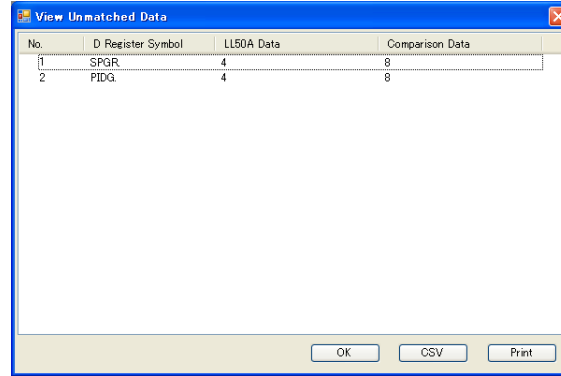

The details of the mismatch can be output to a file in .csv format.

If the following message appears during data comparison, follow the instructions of the message.

If there is a difference in the parameter version, data may not be properly compared.

- To cancel comparison, click the [No] button.
- To continue comparison, click the [Yes] button.

If a password has been set to data to be compared, the Enter Password dialog box appears. Enter the password and click the [OK] button.

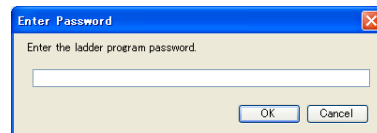

### 2.15.14 Saving Tuning Data

#### Procedure

1. Click on [File] – [Save Trend Data] in the menu during tuning to display the Save Trend Data window.

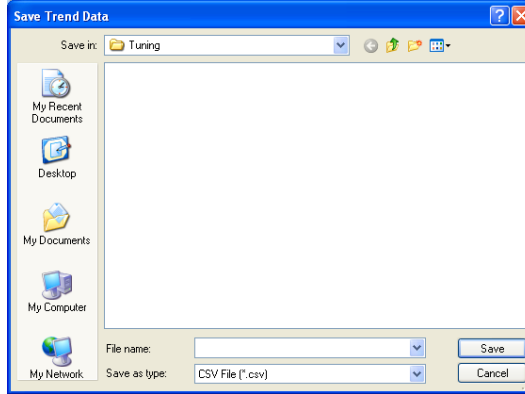

2. Enter a name for the file and click the [Save] button.

#### Description

Trend data can be saved in .csv file format. A maximum of 65,000 acquisition times of trend data can be saved irrespective of the data read cycle. If the number of acquisition times exceeds 65,000, acquired data will automatically be saved in another file.

The save folder cannot be changed.

Example: If data acquisition is performed the 65,000st time at 21:30:50 on May 20, 2009, the name of the file containing this data is 2009\_05\_20\_21\_30\_50.csv.

#### Example of Single-loop control for UT55A/UT52A

Title		Unit data		IP Address		Serial AddressLoop		Control mode		Control type									
UT55A-000-00-00								1 SGL		Standard type									
Trend information		Loop number Data		Decimal point position		Unit		Line color		Min.		Max.							
Trend number1	LOOP1	CSP_L1		1	C	Green	-2700	13700											
Trend number2	LOOP1	PV_L1		1	C	Blue	-2700	13700											
Trend number3																			
Trend number4																			
Trend number5	LOOP1	OUT_L1		1	%	Purple	0	100											
Trend number6																			
Trend data		Date		Time		Trend1		Trend2		Trend3		Trend4		Trends		Trends		S_R_A_M_L1C_A_MR_L_L1R_L_L2AT_L1_AT_L2_V_AT_LOAD_LOAD_M_SPNC	
	2010/7/29	10:38:46	-270	0.1						0	RUN MAN	LCL	OFF	12	14	1	-270		
	2010/7/29	10:38:47	-270	0.1						0	RUN MAN	LCL	OFF	12	14	1	-270		
	2010/7/29	10:38:48	-270	0.1						0	RUN MAN	LCL	OFF	12	14	1	-270		
	2010/7/29	10:38:49	-270	0.1						0	RUN MAN	LCL	OFF	12	14	1	-270		
	2010/7/29	10:38:50	-270	0.1						0	RUN MAN	LCL	OFF	12	14	1	-270		
	2010/7/29	10:38:51	-270	0.1						0	RUN MAN	LCL	OFF	12	14	1	-270		
	2010/7/29	10:38:52	-270	0.1						0	RUN MAN	LCL	OFF	12	14	1	-270		
	2010/7/29	10:38:53	-270	0.1						0	RUN MAN	LCL	OFF	12	14	1	-270		
	2010/7/29	10:38:54	-270	0.1						0	RUN MAN	LCL	OFF	12	14	1	-270		
	2010/7/29	10:38:55	-270	0.1						0	RUN MAN	LCL	OFF	12	14	1	-270		
	2010/7/29	10:38:56	-270	0.1						0	RUN MAN	LCL	OFF	12	14	1	-270		
	2010/7/29	10:38:57	-270	0.1						0	RUN MAN	LCL	OFF	12	14	1	-270		
	2010/7/29	10:38:58	-270	0.1						0	RUN MAN	LCL	OFF	12	14	1	-270		
	2010/7/29	10:38:59	-270	0.1						0	RUN MAN	LCL	OFF	12	14	1	-270		
	2010/7/29	10:39:00	-270	0.1						0	RUN MAN	LCL	OFF	12	14	1	-270		
	2010/7/29	10:39:01	-270	0.1						0	RUN MAN	LCL	OFF	12	14	1	-270		
	2010/7/29	10:39:02	-270	0.1						0	RUN MAN	LCL	OFF	12	14	1	-270		
	2010/7/29	10:39:03	-270	0.1						0	RUN MAN	LCL	OFF	12	14	1	-270		
	2010/7/29	10:39:04	-270	0.1						0	RUN MAN	LCL	OFF	12	14	1	-270		
	2010/7/29	10:39:05	-270	0.1						0	RUN MAN	LCL	OFF	12	14	1	-270		
	2010/7/29	10:39:06	-270	0.1						0	RUN MAN	LCL	OFF	12	14	1	-270		
	2010/7/29	10:39:07	-270	0.1						0	RUN MAN	LCL	OFF	12	14	1	-270		
	2010/7/29	10:39:08	-270	0.1						0	RUN MAN	LCL	OFF	12	14	1	-270		
	2010/7/29	10:39:09	-270	0.1						0	RUN MAN	LCL	OFF	12	14	1	-270		
	2010/7/29	10:39:10	-270	0.1						0	RUN MAN	LCL	OFF	12	14	1	-270		
	2010/7/29	10:39:11	-270	0.1						0	RUN MAN	LCL	OFF	12	14	1	-270		
	2010/7/29	10:39:12	-270	0.1						0	RUN MAN	LCL	OFF	12	14	1	-270		
	2010/7/29	10:39:13	-270	0.1						0	RUN MAN	LCL	OFF	12	14	1	-270		
	2010/7/29	10:39:14	-270	0.1						0	RUN MAN	LCL	OFF	12	14	1	-270		
	2010/7/29	10:39:15	-270	0.1						0	RUN MAN	LCL	OFF	12	14	1	-270		
	2010/7/29	10:39:16	-270	0.1						0	RUN MAN	LCL	OFF	12	14	1	-270		
	2010/7/29	10:39:17	-270	0.1						0	RUN MAN	LCL	OFF	12	14	1	-270		
	2010/7/29	10:39:18	-270	0.1						0	RUN MAN	LCL	OFF	12	14	1	-270		
	2010/7/29	10:39:19	-270	0.1						0	RUN MAN	LCL	OFF	12	14	1	-270		
	2010/7/29	10:39:20	-270	0.1						0	RUN MAN	LCL	OFF	12	14	1	-270		
	2010/7/29	10:39:21	-270	0.1						0	RUN MAN	LCL	OFF	12	14	1	-270		
	2010/7/29	10:39:22	-270	0.1						0	RUN MAN	LCL	OFF	12	14	1	-270		
	2010/7/29	10:39:23	-270	0.1						0	RUN MAN	LCL	OFF	12	14	1	-270		
	2010/7/29	10:39:24	-270	0.1						0	RUN MAN	LCL	OFF	12	14	1	-270		
	2010/7/29	10:39:25	-270	0.1						0	RUN MAN	LCL	OFF	12	14	1	-270		
	2010/7/29	10:39:26	-270	0.1						0	RUN MAN	LCL	OFF	12	14	1	-270		
	2010/7/29	10:39:27	-270	0.1						0	RUN MAN	LCL	OFF	12	14	1	-270		
	2010/7/29	10:39:28	-270	0.1						0	RUN MAN	LCL	OFF	12	14	1	-270		
	2010/7/29	10:39:29	-270	0.1						0	RUN MAN	LCL	OFF	12	14	1	-270		
	2010/7/29	10:39:30	-270	0.1						0	RUN MAN	LCL	OFF	12	14	1	-270		
	2010/7/29	10:39:31	-270	0.1						0	RUN MAN	LCL	OFF	12	14	1	-270		
	2010/7/29	10:39:32	-270	0.1						0	RUN MAN	LCL	OFF	12	14	1	-270		
	2010/7/29	10:39:33	-270	0.1						0	RUN MAN	LCL	OFF	12	14	1	-270		
	2010/7/29	10:39:34	-270	0.1						0	RUN MAN	LCL	OFF	12	14	1	-270		
	2010/7/29	10:39:35	-270	0.1						0	RUN MAN	LCL	OFF	12	14	1	-270		

### 2.15.15 Saving a CSV File

#### Save Parameter Data and File Information

#### Procedure

1. Click on [File] – [Save to CSV File] – [Save Parameter Data and File Information] to display the Save As window.

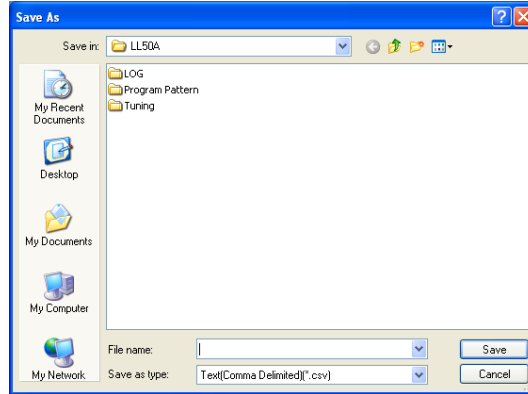

2. Enter a name for the file and click the [Save] button. The user file extension is “uta.”

#### Description

#### Example of CSV format

```

File UT55A.uta
Model UT55A-000-00-00
Control SGL
Product
Parameter R1.02.01

File Information
File Information
Customer Name
Delivery Destination
Device Name
Model Name
Order No.
Serial Number
Author
Date Created
Specification Number
Revision No.
Function Overview
Memo

System Data
Name Set Value
Model and suffix codes : UT55A-000-00-00
PARAMETER VERSION R1.02.01
CONTROL MODE SGL
INPUT SAMPLING PERIOD (CONTROL PERIOD) 100
LADDER SEQUENCE FUNCTION DONT USE
MCU VERSION
DCU VERSION
ECU-1 VERSION
ECU-2 VERSION
ECU-3 VERSION
ECU-4 VERSION
PRODUCT VERSION

Setup Parameter - CTL
D Register Symbol Name Set Value Unit
CNT_L1 CONTROL TYPE PID:PID control
ALG_L1 PID CONTROL MODE 0:Standard PID control mode 8
SPGR. NUMBER OF SP GROUPS 4
ALNO_L1 NUMBER OF ALARMS 0:SP group number selection 1 8
ZON ZONE PID SELECTION
PIDG. NUMBER OF PID GROUPS

Setup Parameter - PV
D Register Symbol Name Set Value Unit
IN PV INPUT TYPE OFF:OFF:Disable
UNIT PV INPUT UNIT C:Degree Celsius
RH MAXIMUM VALUE OF PV INPUT RANGE 1370
RL MINIMUM VALUE OF PV INPUT RANGE -270
BSL PV INPUT BURNOUT ACTION UP:Upscale
RJC PV INPUT REFERENCE JUNCTION COMPENSATION ON:RJC ON
ERJC PV INPUT EXTERNAL RJC SETPOINT 0 C
ABS PV ANALOG INPUT BIAS 0 C
A.FL PV ANALOG INPUT FILTER OFF s
A.SR PV ANALOG INPUT SQUARE ROOT EXTRACTION OFF:No square root extraction.
A.LC PV ANALOG INPUT LOW SIGNAL CUTOFF 1 %
    
```

•  
•  
•  
•

## Save All Program Pattern Data

### Procedure

1. Click on [File] – [Save to CSV File] – [Save All Program Pattern Data].  
The Browse Folders dialog box appears. Select the save destination folder and click the [OK] button.  
The [Create New Folder] button allows you to create a folder.

### Note

Program pattern numbers are used as the file names, which are PTN001 to PTN030\*.

\*: PTN001 and PTN002 for UP35A/UP32A (plus PTN004 when the option code is specified).

Example: When the program pattern number is 10, the file name is PTN010.csv.

## Select Program Pattern Number and Save

### Procedure

1. Click on [File] – [Save to CSV File] – [Select Program Pattern Number and Save] to display the Check and Select Pattern window.

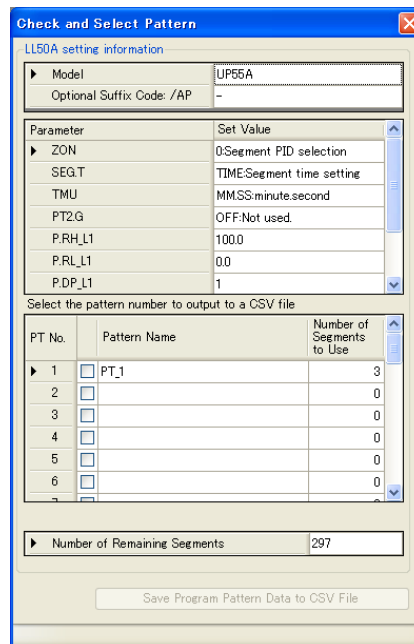

2. Select the pattern number to save to the CSV file and click the [Save Program Pattern Data to CSV File] button to display the Save As window.
3. Name the file and click the [Save] button.

## 2.15 Managing Files

### Description

#### Example of CSV format

START	Pattern Name	PT_1	Set Value	Unit
D Register SymbolName	PT_1			
SSP_L1	STARTING TARGET SETPOINT		"SSP-Program operation begins with the starting target setpoint."	0 C
STC	START CODE			
WT.SW1	WAIT FUNCTION ON/OFF 1		OFF:Disable	
WZ.UP1	UPPER-SIDE WAIT ZONE 1			0 C
WZ.LO1	LOWER-SIDE WAIT ZONE 1			0 C
WT.TM1	WAIT TIME 1			m.s
WT.SW2	WAIT FUNCTION ON/OFF 2		OFF:Disable	
WZ.UP2	UPPER-SIDE WAIT ZONE 2			0 C
WZ.LO2	LOWER-SIDE WAIT ZONE 2			0 C
WT.TM2	WAIT TIME 2		OFF	m.s
WT.SW3	WAIT FUNCTION ON/OFF 3		OFF:Disable	
WZ.UP3	UPPER-SIDE WAIT ZONE 3			0 C
WZ.LO3	LOWER-SIDE WAIT ZONE 3			0 C
WT.TM3	WAIT TIME 3		OFF	m.s
WT.SW4	WAIT FUNCTION ON/OFF 4		OFF:Disable	
WZ.UP4	UPPER-SIDE WAIT ZONE 4			0 C
WZ.LO4	LOWER-SIDE WAIT ZONE 4			0 C
WT.TM4	WAIT TIME 4		OFF	m.s
WT.SW5	WAIT FUNCTION ON/OFF 5		OFF:Disable	
WZ.UP5	UPPER-SIDE WAIT ZONE 5			0 C
WZ.LO5	LOWER-SIDE WAIT ZONE 5			0 C
WT.TM5	WAIT TIME 5		OFF	m.s
R.CYCL	NUMBER OF REPEAT CYCLES			0
R.STRT	REPEAT CYCLE START SEGMENT NUMBER			1
R.END	REPEAT CYCLE END SEGMENT NUMBER			1

  

SEG	D Register SymbolName	Unit	SEG1	SEG2	SEG3	SEG4
TSP_L1	FINAL TARGET SETPOINT	C	80	80	80	0
TIME	SEGMENT TIME SETTING	m.s	10	40	5	2
S.PID	SEGMENT PID NUMBER SELECTION		1	1	1	1
JC	JUNCTION CODE		CONT:Switching for continuation CONT:Switching for continuation LOCAL:Local-mode switching CONT:Switching for continuation			
PV.TY1	PV EVNET-1 TYPE		1	1	1	1
PV.EV1	PV EVNET-1 SETPOINT		80.5	OFF	80.5	0
PV.TY2	PV EVNET-2 TYPE		OFF	OFF	OFF	2
PV.EV2	PV EVNET-2 SETPOINT		0	OFF	0	-0.5
PV.TY3	PV EVNET-3 TYPE		OFF	OFF	OFF	OFF
PV.EV3	PV EVNET-3 SETPOINT		0	OFF	0	0
PV.TY4	PV EVNET-4 TYPE		OFF	OFF	OFF	OFF
PV.EV4	PV EVNET-4 SETPOINT		0	OFF	0	0
PV.TY5	PV EVNET-5 TYPE		OFF	OFF	OFF	OFF
PV.EV5	PV EVNET-5 SETPOINT		0	OFF	0	0
PV.TY6	PV EVNET-6 TYPE		OFF	OFF	OFF	OFF
PV.EV6	PV EVNET-6 SETPOINT		0	OFF	0	0
PV.TY7	PV EVNET-7 TYPE		OFF	OFF	OFF	OFF
PV.EV7	PV EVNET-7 SETPOINT		0	OFF	0	0
PV.TY8	PV EVNET-8 TYPE		OFF	OFF	OFF	OFF
PV.EV8	PV EVNET-8 SETPOINT		0	OFF	0	0
TIME1	START CONDITION OF TIME EVENT 1		OFF:Start OFF state	OFF:Start OFF state	OFF:Start OFF state	OFF:Start OFF state
T.ON1	ON TIME OF TIME EVENT 1	m.s	-	-	-	-
T.OF1	OFF TIME OF TIME EVENT 1	m.s	-	8	-	-
TIME2	START CONDITION OF TIME EVENT 2		OFF:Start OFF state	OFF:Start OFF state	OFF:Start OFF state	OFF:Start OFF state
T.ON2	ON TIME OF TIME EVENT 2	m.s	-	-	20	-
T.OF2	OFF TIME OF TIME EVENT 2	m.s	-	-	30	-
TIME3	START CONDITION OF TIME EVENT 3		OFF:Start OFF state	OFF:Start OFF state	OFF:Start OFF state	OFF:Start OFF state
T.ON3	ON TIME OF TIME EVENT 3	m.s	-	-	-	4
T.OF3	OFF TIME OF TIME EVENT 3	m.s	-	-	-	-
TIME4	START CONDITION OF TIME EVENT 4		OFF:Start OFF state	OFF:Start OFF state	OFF:Start OFF state	OFF:Start OFF state
T.ON4	ON TIME OF TIME EVENT 4	m.s	-	-	-	-
T.OF4	OFF TIME OF TIME EVENT 4	m.s	-	-	-	-
TIME5	START CONDITION OF TIME EVENT 5		OFF:Start OFF state	OFF:Start OFF state	OFF:Start OFF state	OFF:Start OFF state
T.ON5	ON TIME OF TIME EVENT 5	m.s	-	-	-	-
T.OF5	OFF TIME OF TIME EVENT 5	m.s	-	-	-	-
TIME6	START CONDITION OF TIME EVENT 6		OFF:Start OFF state	OFF:Start OFF state	OFF:Start OFF state	OFF:Start OFF state
T.ON6	ON TIME OF TIME EVENT 6	m.s	-	-	-	-
T.OF6	OFF TIME OF TIME EVENT 6	m.s	-	-	-	-
TIME7	START CONDITION OF TIME EVENT 7		OFF:Start OFF state	OFF:Start OFF state	OFF:Start OFF state	OFF:Start OFF state
T.ON7	ON TIME OF TIME EVENT 7	m.s	-	-	-	-
T.OF7	OFF TIME OF TIME EVENT 7	m.s	-	-	-	-
TIME8	START CONDITION OF TIME EVENT 8		OFF:Start OFF state	OFF:Start OFF state	OFF:Start OFF state	OFF:Start OFF state
T.ON8	ON TIME OF TIME EVENT 8	m.s	-	-	-	-
T.OF8	OFF TIME OF TIME EVENT 8	m.s	-	-	-	-
TIME9	START CONDITION OF TIME EVENT 9		OFF:Start OFF state	OFF:Start OFF state	OFF:Start OFF state	OFF:Start OFF state
T.ON9	ON TIME OF TIME EVENT 9	m.s	-	-	-	-
T.OF9	OFF TIME OF TIME EVENT 9	m.s	-	-	-	-
TIME10	START CONDITION OF TIME EVENT 10		OFF:Start OFF state	OFF:Start OFF state	OFF:Start OFF state	OFF:Start OFF state
T.ON10	ON TIME OF TIME EVENT 10	m.s	-	-	-	-
T.OF10	OFF TIME OF TIME EVENT 10	m.s	-	-	-	-
TIME11	START CONDITION OF TIME EVENT 11		OFF:Start OFF state	OFF:Start OFF state	OFF:Start OFF state	OFF:Start OFF state
T.ON11	ON TIME OF TIME EVENT 11	m.s	-	-	-	-
T.OF11	OFF TIME OF TIME EVENT 11	m.s	-	-	-	-
TIME12	START CONDITION OF TIME EVENT 12		OFF:Start OFF state	OFF:Start OFF state	OFF:Start OFF state	OFF:Start OFF state
T.ON12	ON TIME OF TIME EVENT 12	m.s	-	-	-	-
T.OF12	OFF TIME OF TIME EVENT 12	m.s	-	-	-	-
TIME13	START CONDITION OF TIME EVENT 13		OFF:Start OFF state	OFF:Start OFF state	OFF:Start OFF state	OFF:Start OFF state
T.ON13	ON TIME OF TIME EVENT 13	m.s	-	-	-	-
T.OF13	OFF TIME OF TIME EVENT 13	m.s	-	-	-	-
TIME14	START CONDITION OF TIME EVENT 14		OFF:Start OFF state	OFF:Start OFF state	OFF:Start OFF state	OFF:Start OFF state
T.ON14	ON TIME OF TIME EVENT 14	m.s	-	-	-	-
T.OF14	OFF TIME OF TIME EVENT 14	m.s	-	-	-	-
TIME15	START CONDITION OF TIME EVENT 15		OFF:Start OFF state	OFF:Start OFF state	OFF:Start OFF state	OFF:Start OFF state
T.ON15	ON TIME OF TIME EVENT 15	m.s	-	-	-	-
T.OF15	OFF TIME OF TIME EVENT 15	m.s	-	-	-	-
TIME16	START CONDITION OF TIME EVENT 16		OFF:Start OFF state	OFF:Start OFF state	OFF:Start OFF state	OFF:Start OFF state
T.ON16	ON TIME OF TIME EVENT 16	m.s	-	-	-	-
T.OF16	OFF TIME OF TIME EVENT 16	m.s	-	-	-	-

## 2.15.16 Making Environmental Settings

## Procedure

1. Click on [File] – [Environmental Setting] in the menu to display the Environmental Setting window.

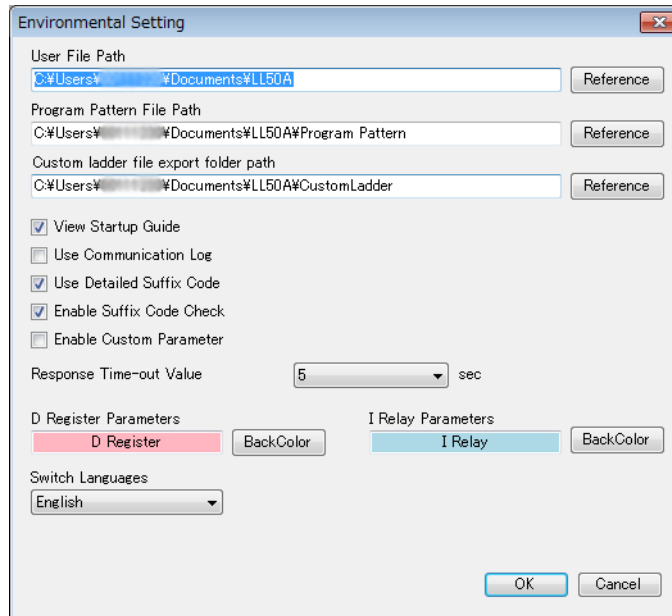

2. Set the path and click the [OK] button.

## Description

- User File Path  
Shows the predetermined LL50A user file storage location.

**Note**

Do not set a path that includes the Program Files folder. Otherwise, the LL50A Parameter Setting Software will not run properly.

- Program Pattern File Path  
Shows the predetermined LL50A user file storage location.

**Note**

Do not set a path that includes the Program Files folder. Otherwise, the LL50A Parameter Setting Software will not run properly.

- View Startup Guide  
If this item is checked, the Startup Guide is displayed at startup.
- Use Communication Log  
If this item is checked, communication logs are output to the specified location.
- Use Detailed Suffix Code  
If this item is checked, the detailed model and suffix codes are available when creating a new file.
- Response time-out value  
Set the response time-out value longer if the response of main unit is late in each monitoring.  
The value can be set for 1 to 10 seconds.

## 2.15 Managing Files

- Enable Suffix Code Check  
If this item is checked, confirm that the model and suffix code is appropriately set in the suffix code of the System Data windows.
- Switch languages  
Can be changed “Japanese” or “English.”

The directories (default values) to which each file is stored are as shown below:

File Type	Storage Directory (Default)
User files for UT55A/UT52A (.uta)	C:\Users\ <username&gt;\documents\ll50a< td=""> </username&gt;\documents\ll50a<>
User files for UT35A/UT32A (.utb)	
User files for UT75A (.utc)	
User files for UT35A-L (.utl)	
User files for UP55A (.upa)	
User files for UP35A/UP32A (.upb)	
User files for UM33A (.umb)	
Trend files (.csv)	C:\Users\ <username&gt;\documents\ll50a\tuning< td=""> </username&gt;\documents\ll50a\tuning<>
Communication log files (.log)	C:\Users\ <username&gt;\documents\ll50a\log </username&gt;\documents\ll50a\log  The directory cannot be changed.
Program pattern files for UP55A (.5pt)	C:\Users\ <username&gt;\documents\ll50a\program </username&gt;\documents\ll50a\program  Pattern
Program pattern files for UP35A/ UP32A (.3pt)	
Custom ladder instruction files for UT75A (.lcf)	C:\Users\ <username&gt;\documents\ll50a\customladder< td=""> </username&gt;\documents\ll50a\customladder<>

## 2.16 Window Operations

### Window operations

#### Procedure

1. Click on [Window] – [following command] in the menu.

The following window operations are available:

- Cascade
- Tile Horizontal
- Tile Vertical
- Arrange Icons
- Close All

### Making the toolbar, palette, or window visible/invisible

#### Procedure

1. Click on [View] – [following command] in the menu.

The following operations are available:

- Making the toolbar visible/invisible



- Making the status bar visible/invisible

Number of steps: 69 / 500 Edit Mode: Overwrite

- Making the Instruction palette visible/invisible



- Making the ladder operation status toolbar visible/invisible

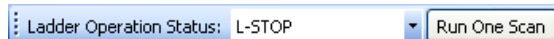

- Making the File window visible/invisible

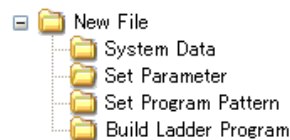



- Making the Instruction window visible/invisible

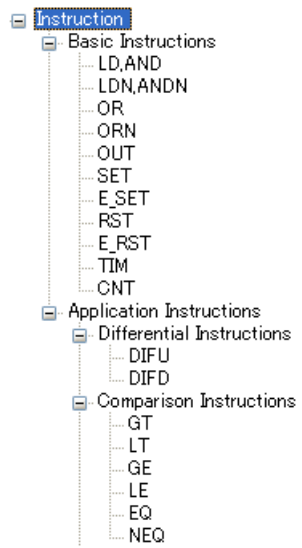

- Making the Register window visible/invisible

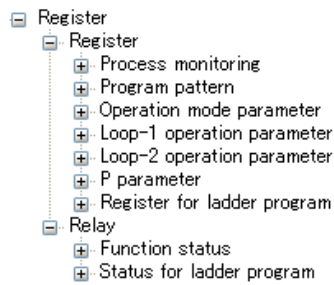

- Making the Monitor Register window visible/invisible  
See 2.14.1, Monitoring/Changing Tuning Data.

## 2.17 Activating Single-byte Character Entry

### Procedure

1. Click on [Tool] and place a checkmark in [Single-byte Input Mode] in the menu to enable single-byte character entry.

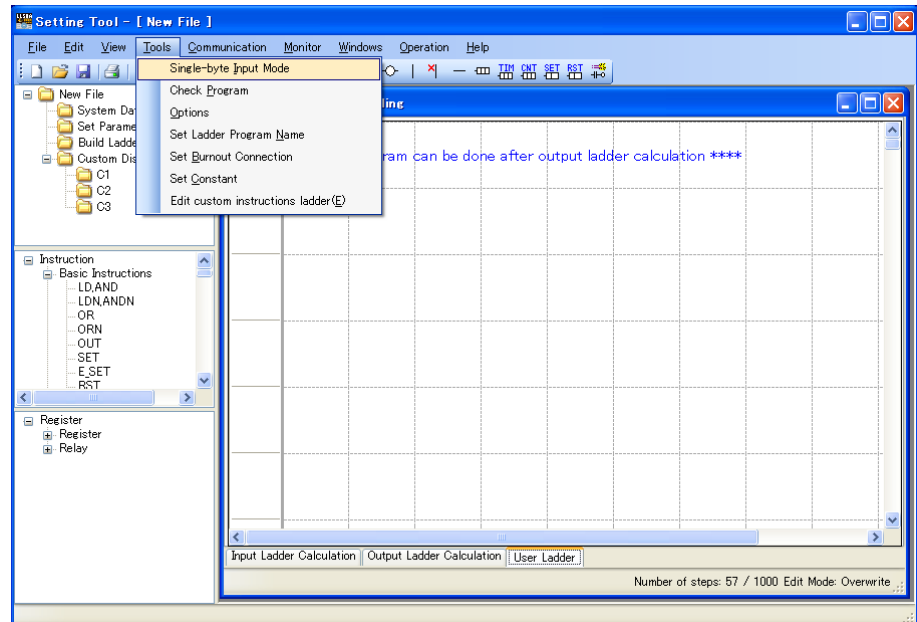

### Description

The Single-byte Input mode is used for entering user file information or program comments and program pattern name. To upload/download data between operating systems (OS) of different languages or to open a file, do so in the Single-byte Input mode to prevent the corruption of characters.

To cancel the Single-byte Input mode, remove the checkmark as described above.

## 2.18 Printing

### Procedure

1. Click on [File] – [Print] in the menu or click  on the toolbar to display the Select Printing Range window.

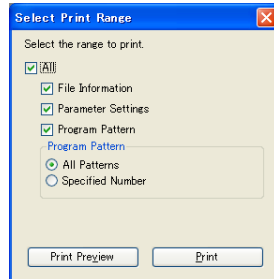

2. Select the data to be printed and click the [Print] button to display the Printing window.

Clicking [Printing Preview] enables a printing image to be displayed as shown below.

Note: Select [Specify Number] for the program pattern and click the [Print Preview] or [Print] button to display the Check and Select Pattern window.

Select the program pattern number to print.

3. Printing window is displayed during printing. To stop printing, click the [Cancel] button.

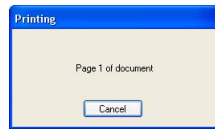

### Description

The following shows a printing image.

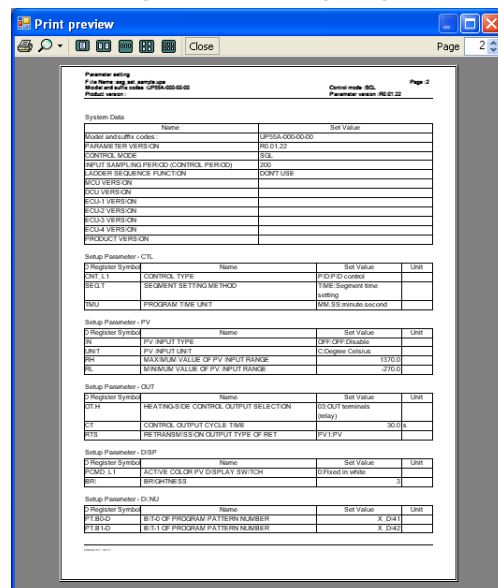

## 2.19 Initializing the Main Unit

### Initializing the Main Unit to Factory Defaults

Use this feature if you have forgotten the password of ladder programs downloaded to the main unit and want to download new ladder programs.

Take care to prevent casual use of the password assigned in this section.

#### Note

- The user setting values are not initialized even if the parameter setting values are initialized to the factory default values.
- UP55A/UP35A cannot be initialized via Ethernet communication. Use Light-loader communication for the initialization.

### Procedure

1. Change to the status that enables communication with the main unit.
2. Click on [Operation] – [Initialize] – [Initialize to Factory Defaults] in the menu. The following confirmation message is displayed; click the [OK] button.

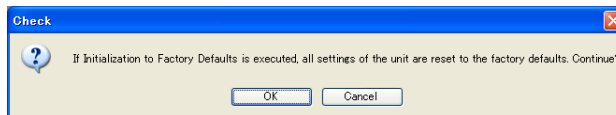

3. Enter the initialization password "UTAdvanced\_INIT" and click the [OK] button. (Single-byte alphanumeric characters)

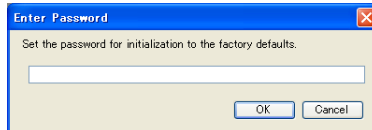

4. The Execute Communication window appears. Click the [Initialize to Factory Defaults] button to start initialization. To cancel initialization, click .

### Setting the User Default Values

Parameter data set to the main unit can be set as the user default values.

#### CAUTION

Before registering the user setting value as the user default value, make sure that the user setting value is set to the parameter. The ladder program can not be registered as user default values.

#### Procedure

1. Change to the status that enables communication with the main unit.
2. Click on [Operation] – [Set User Defaults] in the menu. The following confirmation message is displayed; click the [OK] button.

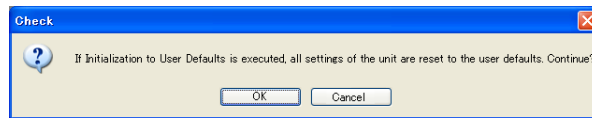

3. Enter the initialization password "UTAdvanced\_INIT\_SET" and click the [OK] button. (Single-byte alphanumeric characters)

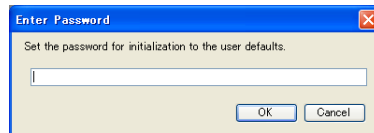

4. The Execute Communication window appears. Click the [Set User Defaults] button to start user default value setting.  
To cancel user default value setting, Click .

### Initializing to the User Default Values

#### Procedure

1. Change to the status that enables communication with the main unit.
2. Click on [Operation] – [Initialize] – [Initialize to User Defaults] in the menu. The following confirmation message is displayed; click the [OK] button.

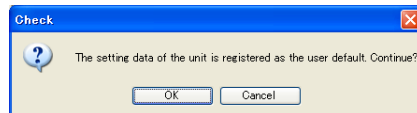

3. Enter the initialization password "UTAdvanced\_USER\_INIT" and click the [OK] button. (Single-byte alphanumeric characters)

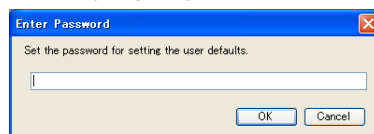

4. The Execute Communication window appears. Click the [Initialize to User Defaults] button to start initialization.  
To cancel initialization, click .

## Deleting Pattern

Program pattern data set to the main unit can be delete.

### All Patterns

#### Procedure

1. Establish communication with main unit.
2. Click on [Operate Main Unit] – [Delete Program Pattern] – [All Patterns] in the menu. The confirmation message appears.

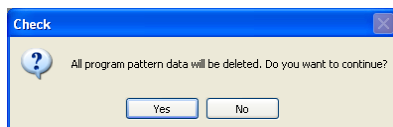

3. Enter the password "UTAdvanced\_PATTERN\_INIT" (single-byte alphanumeric characters) and click the [OK] button.

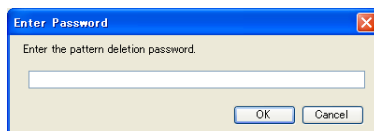

4. The Execute Communication window appears. Click the [Delete Program Pattern] button to start delete program pattern. To cancel delete program pattern, Click .

### One Pattern

#### Procedure

1. Establish communication with main unit.
2. Click on [Operation] – [Delete Program Pattern] – [One Pattern] in the menu to display the Execute Communication window. Click the [Delete Program Pattern].
3. The Check and Select Pattern window appears. Select the pattern number to delete and click [Delete One Pattern in main unit].

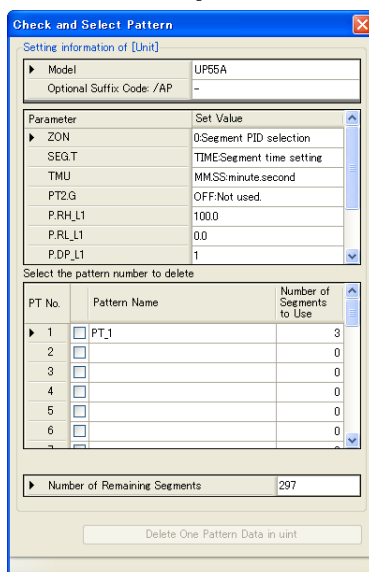

## 2.20 Checking Software Version

### Procedure

1. Click on [Help] – [About...] in the menu to display the Setting Tool Version Information window.

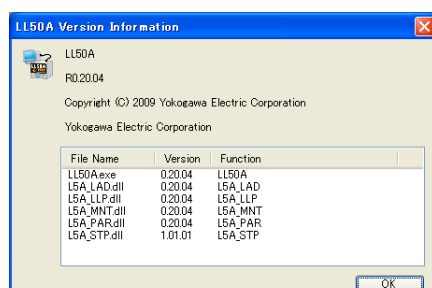

2. To close the window, click the [OK] button or .

## 2.21 Viewing the List of Tables

The list of tables shows the names of .dll and .xml files contained in the Table folder of the LL50A Parameter Setting Software.

### Procedure

1. Click on [Help] – [Table List] in the menu to display the Table List window.

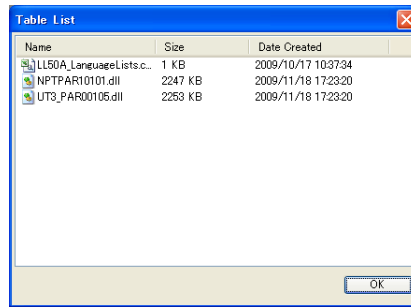

2. To close the window, click the [OK] button or .





# 3.1 Flow of Building a New Ladder Program

The ladder sequence function must be set to "USE" and the control mode must be set in the System Data window beforehand. UT35A/UT32A/UP35A/UP32A does not have the parameter CTLM (Control mode.)

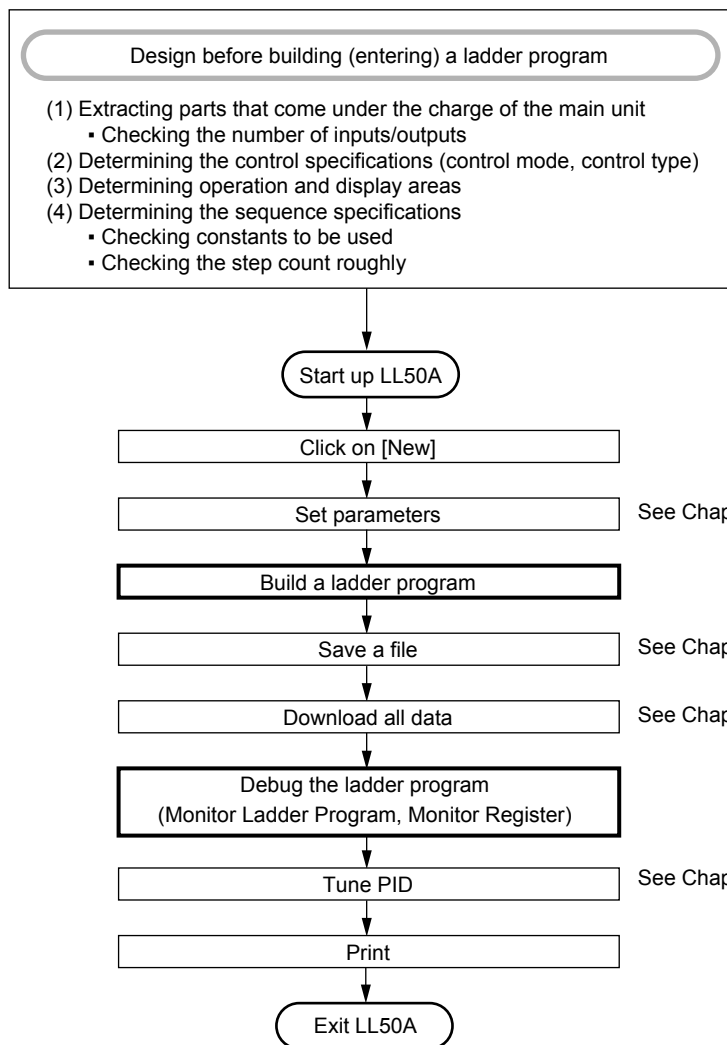

### 3.1 Flow of Building a New Ladder Program

#### Configuration of ladder program

A ladder program consists of three parts: the input ladder calculation executed before control computation, the output ladder calculation performed after control computation, and user ladder calculation. Each calculation section is repetitively executed every control period.

The sequence of calculation/computation is: input, input ladder calculation, control computation, output ladder calculation, user ladder calculation, and output.

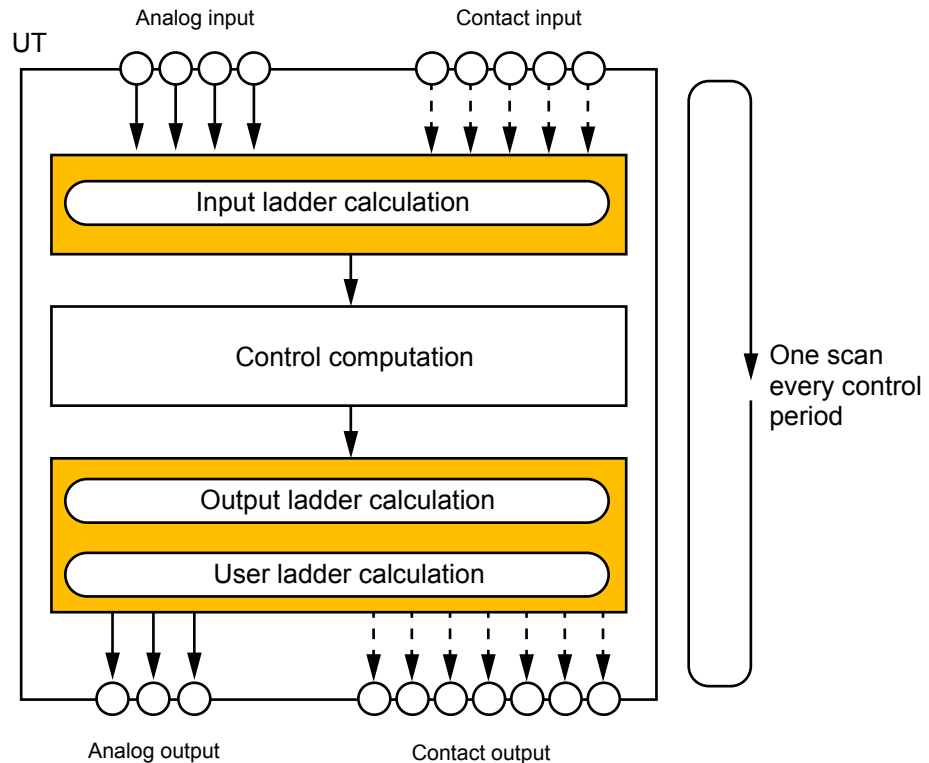

#### Load Factor of Ladder Program

Normally, use the ladder program with the load factor of the range not more than 100%. However, if the control period is set to 50 ms, the maximum load factor should be the value which subtracted the load factor for the following function usage from 100%.

Filter function: 10%

Alarm setpoints more than 5 points (ALNO $\geq$ 5): 10%

Optional suffix code "/DR": 15%

UT55A-x7x (AIN2/AIN4): 10%

10-segment linearizer function: 5%

For Detailed model: Optional suffix code "/U1": 15%

For Detailed model: Same use of optional suffix code "/A2" and "/A4" or "/AC4": 10%

UT75A-5xx: (15%)

UT75A-x2x: (10%)

## 3.2 Part Names of the Window and Their Functions

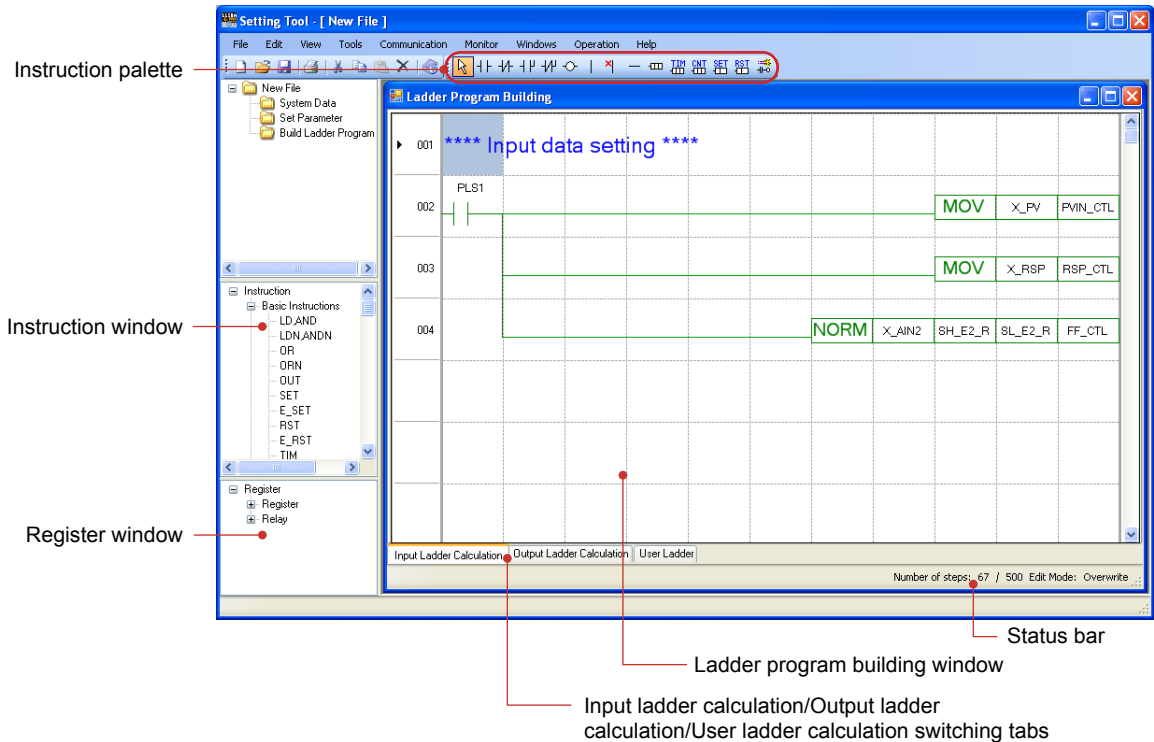

### Ladder program building window

This window is used to edit a circuit. It enables you to edit a ladder program of up to 200 lines x 11 columns.

### Instruction palette

This area displays instruction icons. You select instruction(s) from the instruction palette to build a circuit.

### Instruction window

This window displays a list of ladder instructions. An instruction can be dragged and dropped from the Instruction window to be registered in any column. The instructions in this window are the same as those available in the Input Instruction window displayed by clicking  (application instruction) on the instruction palette.

### Register window

This window displays a list of main unit registers. A register can be dragged and dropped from the Register window to input the address to any instruction.

### Input ladder calculation/output ladder calculation/user ladder window switching tabs

Clicking on a tab below the Build Ladder Program window enables you to switch between the input ladder calculation, output ladder calculation, and user ladder calculation. In the initial status, nothing is described in the user ladder calculation section. These tabs are used to operate only DI and DO regardless of control.

### Status bar

- Step count  
Displays the number of steps of the ladder program being edited and the maximum number of steps.  
Display format: Number of steps being edited/maximum step count
- Edit mode  
Displays whether the build ladder program function is in Overwrite mode or in Insert mode.

## 3.3 How to Build a Ladder Program

### 3.3.1 Registering Basic Instructions (Instruction Palette)

Register a basic instruction from the instruction palette.

#### Procedure

1. Click a basic instruction button on the instruction palette to change the shape of the mouse cursor to the shape of the selected instruction.

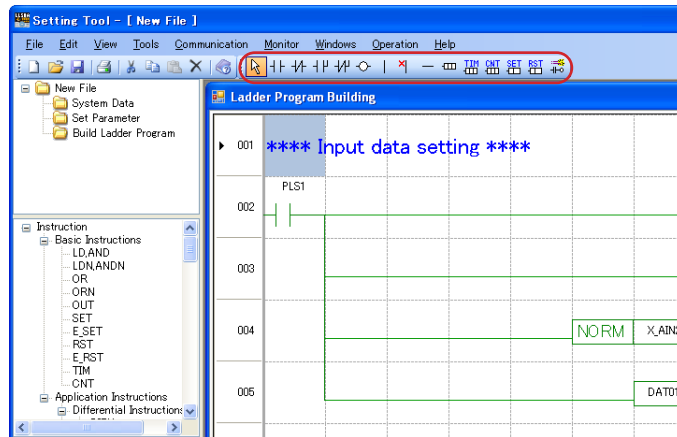

2. Click on the location where you want to enter the instruction. This enables the input field for data entry.  
(If an output instruction is input, it is located at the final column instead of the location where you have clicked. In this case, a horizontal connection line is drawn up to the input instruction existing immediately before the clicked position. It is not possible to locate an output instruction in front of an input instruction.)

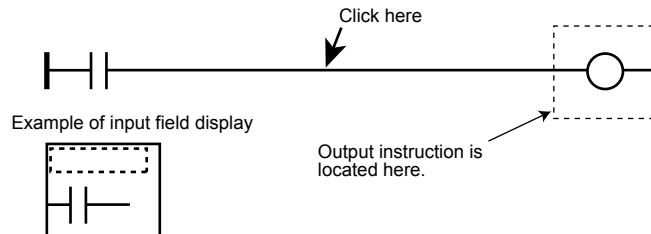















3. Enter a register in the input field directly or input it by drag-and-drop from the Register window.
4. Press the Enter key. This causes a parameter to be input to the field, making the instruction accepted.
5. Selected instructions can be registered in succession.  
To cancel instruction selection, press the ESC key or click the Selector on the instruction palette.

#### Note

- An input field allows only a register to be registered. Constants, etc. cannot be directly entered in an input field. If you want to enter a constant, use K- or P-register.
- Use the following procedure to display the details of the written commands (PDF of this manual).

Click an instruction cell, right-click, and click Help.

## List of instructions on the instruction palette

Icon	Name	Description
	Selector	Returns the mouse cursor shape to the ordinary cursor. Clicking on a circuit element causes it to be selected and double-clicking on it enables functions with respect to each circuit element to be selected.
	"a" contact (LD, AND)	Changes the mouse cursor shape to the "a" contact cursor. This function enters an "a" contact at any clicked position.
	"b" contact (LDN, NDN)	Changes the mouse cursor shape to the "b" contact cursor. This function enters a "b" contact at any clicked position.
	"a" contact OR (LDOR)	Changes the mouse cursor shape to the "a" contact OR cursor. This function enters an "a" contact OR at any clicked position.
	"b" contact OR (LDORN)	Changes the mouse cursor shape to the "b" contact OR cursor. This function enters a "b" contact OR at any clicked position.
	Out	Changes the mouse cursor shape to the Out cursor (output coil cursor). This function enters the Out instruction in the final column at any clicked position.
	OR connection line	Changes the mouse cursor shape to the OR connection-line cursor. This function enters an OR connection line to the right end of the column at any clicked position.
	Delete OR connection line	Changes the mouse cursor shape to the OR connection-line cursor. This function deletes an OR connection line from the right end of the column at any clicked position.
	Connection line	Changes the mouse cursor shape to the connection-line cursor. This function enters a connection line at any clicked position.
	Application instruction	Changes the mouse cursor shape to the application instruction cursor. This function displays the Input Instruction dialog box at any clicked position.
	Timer	Changes the mouse cursor shape to the timer cursor. This function enters a timer in the final column at any clicked position.
	Counter	Changes the mouse cursor shape to the counter cursor. This function enters a counter in the final column at any clicked position.
	Set	Changes the mouse cursor shape to the Set cursor. This function enters the Set instruction in the final column at any clicked position.
	Reset	Changes the mouse cursor shape to the Reset cursor. This function enters the Reset instruction in the final column at any clicked position.
	Circuit comment	Changes the mouse cursor shape to the circuit comment cursor. This function enters a circuit comment line at any clicked position.

### Making the instruction palette visible/invisible

#### Procedure

1. Click on [View] – [Instruction Palette] in the menu to place a check mark (  ) in front of the menu item. This causes the instruction palette to be displayed. Removing the check mark (  ) causes it to be invisible.

### Making the Instruction window visible/invisible

#### Procedure

1. Click on [View] – [Instruction Window] in the menu to place a check mark (  ) in front of the menu item. This causes the Instruction window to be displayed. Removing the check mark (  ) causes it to be invisible.

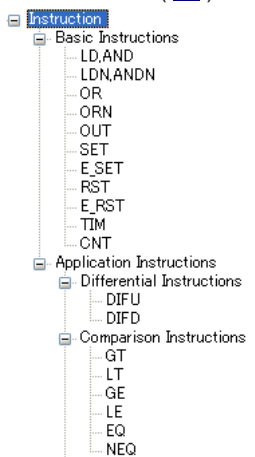

### 3.3.2 Registering an Application Instruction (Instruction Palette)

Register an application instruction from the instruction palette.

#### Procedure

1. Click  (application instruction) on the instruction palette to display the Input Instruction window.

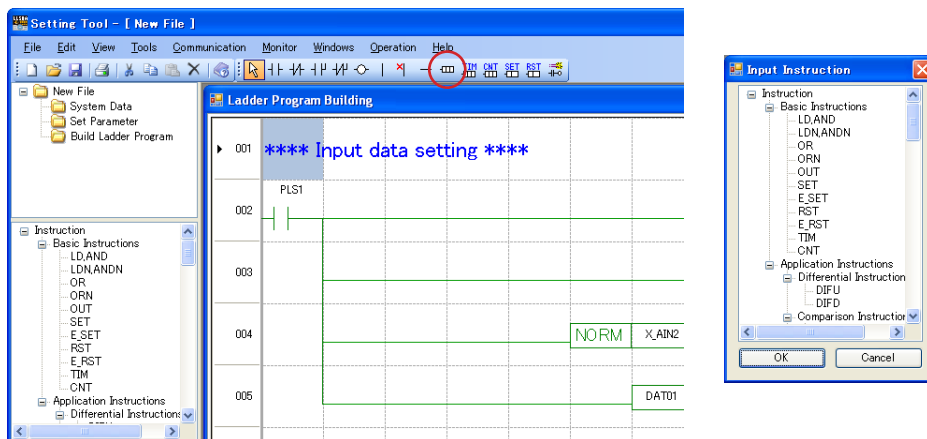

2. Click on an instruction that you want to input from among those in the Input Instruction window.
3. Click the [OK] button.  
This causes the mouse cursor to change to the shape of the selected instruction. To cancel instruction selection, click the [Cancel] button.
4. Click on the location where you want to input the instruction to describe it at the clicked position. This enables the input field for data entry.  
(If an output type instruction is input, it is located at the final column instead of the location where you have clicked. In this case, a horizontal connection line is drawn up to the input instruction immediately before the clicked position. It is not possible to locate an output instruction in front of an input instruction.)

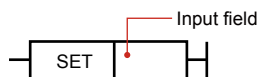

5. Enter a register in the input field directly or input it by drag-and-drop from the Register window.
6. Press the Enter key. This causes a parameter to be input to the field, making the instruction accepted.  
For an instruction with multiple input fields, move to the next field to enter a register, and after entering a register in the last field, press the Enter key to accept the instruction.  
Even if all input fields are not filled with data, clicking on another column causes the instruction to be accepted.
7. Selected instructions can be registered in succession.  
To cancel instruction selection, press the ESC key or click the Selector on the instruction palette.

### Note

An input field allows only a register to be registered. Constants, etc. cannot be directly entered in an input field. If you want to enter a constant, use K- or P-register.

- Use the following procedure to display the details of the written commands (PDF of this manual).

Click an instruction cell, right-click, and click Help.



#### 3.3.3 Registering Circuit Comments (Instruction Palette)

Enter circuit comments from the instruction palette.

#### Procedure

1. Click  (circuit comment) on the instruction palette. This causes the mouse cursor shape to change to the circuit comment cursor.

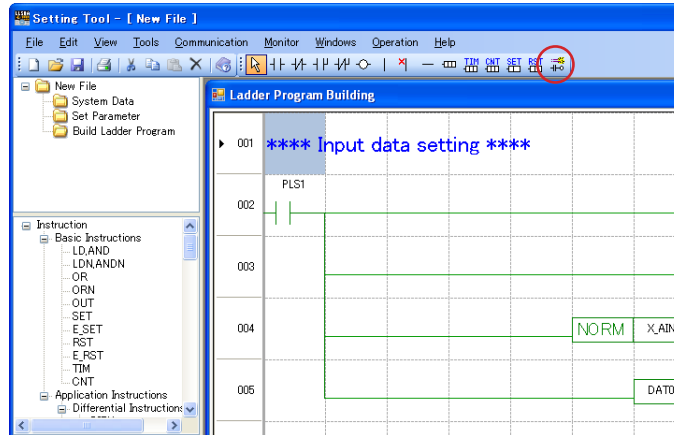

2. Click on the location where you want to input a circuit comment. This causes the circuit comment input field to be displayed at the clicked position.
3. Enter a circuit comment and press the Enter key. This causes the circuit comment to be accepted.

### 3.3.4 Registering Basic Instructions (Instruction Window)

Enter a basic instruction from the Instruction window.

#### Procedure

1. Drag a basic instruction that you want to input from among those in the instruction tree.

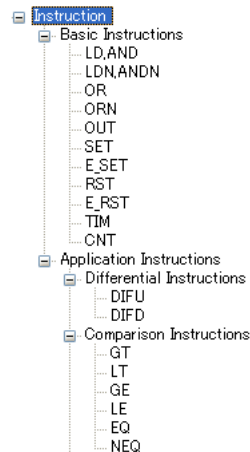

2. Drop the instruction on the location where you want it.

This causes the instruction to be entered at the dropped location, and the input field to appear.

(If an output instruction is input, it is located at the final column instead of the location where you clicked. In this case, a horizontal connection line is drawn up to the input instruction existing immediately before the clicked position. It is not possible to put an output instruction in front of an input instruction.)

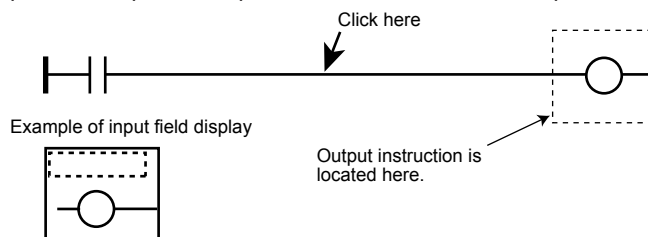

3. Enter a register in the input field directly or input it by drag-and-drop from the Register window.
4. Press the Enter key. This causes a parameter to be input to the field, making the instruction accepted.

#### Note

- An input field allows only a register to be registered. Constants, etc. cannot be directly entered in an input field. If you want to enter a constant, use K- or P-register.
- Use the following procedure to display the details of the written commands (PDF of this manual).

Click an instruction cell, right-click, and click Help.

### 3.3.5 Registering an Application Instruction (Instruction Window)

Enter an application instruction from the Instruction window.

#### Procedure

1. Drag an application instruction that you want to input from among those in the instruction tree.

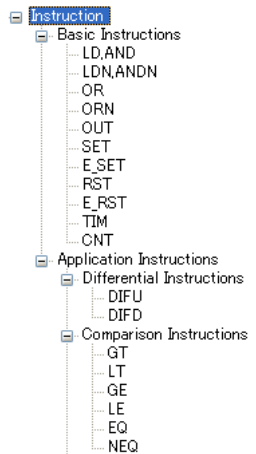

2. Drop the instruction on the location where you want it.  
This causes the instruction to be described at the dropped location, and the input field to be enabled.  
(If an output type instruction is input, it is located at the final column instead of the location where you clicked. In this case, a horizontal connection line is drawn up to the input instruction immediately before the clicked position. It is not possible to put an output instruction in front of an input instruction.)
3. Enter a register in the input field directly or input it by drag-and-drop from the Register window.

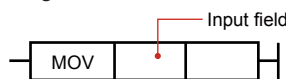

4. Press the Enter key. This causes a parameter to be input to the field, making the instruction accepted.  
For an instruction with multiple input fields, move to the next field to enter a register, and after entering a register in the last field, press the Enter key to accept the instruction.  
Even if all input fields are not filled with data, clicking on another column causes the instruction to be accepted.

#### Note

- An input field allows only a register to be registered. Constants, etc. cannot be directly entered in an input field. If you want to enter a constant, use K- or P-register.
- Use the following procedure to display the details of the written commands (PDF of this manual).

Click an instruction cell, right-click, and click Help.

### 3.3.6 Registering a Register

Register a register by drag-and-drop from the Register window.

#### Procedure

1. Drag a register that you want to register from the Register window.

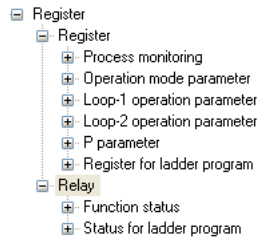

2. Drop it at the input field of an instruction.

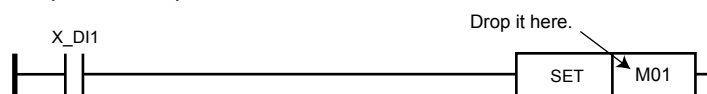

### Making the Register window visible/invisible

#### Procedure

1. Click on [View] – [Register Window] in the menu to place a check mark (  ) in front of the menu item. This causes the Register window to appear. Removing the check mark (  ) causes it to be invisible.

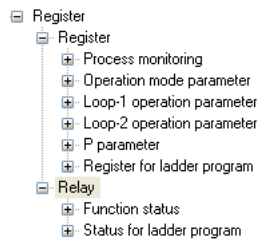

### 3.3.7 Setting a K-constant (K-register)

This section sets a constant to be used in a ladder program.

K-register constants can be set by clicking on [Tools] – [Set Constant] in the menu when the Ladder Program Building window is being displayed.

**Procedure**

1. Click on [Tool] – [Set Constant] in the menu to display the Set Constant window.

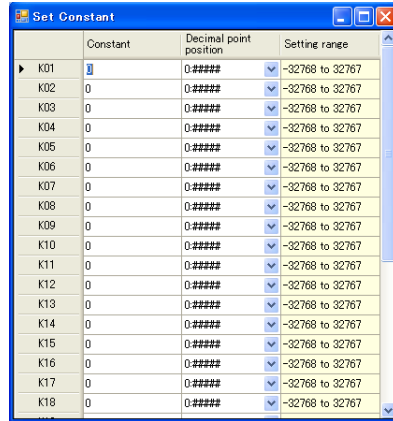

2. Click on the cell where you want to enter a constant.
3. After entering the settings for the constant, click .

**The Set Constant window**

Item	Specification
Constant symbol	The symbol for the constant is displayed in the line header.
Constant	Enter a value for the constant.
Decimal point position	Set the decimal point position.
Range	Indicates the range that can be set.

## 3.4 Building a Ladder Program

The ladder sequence function is used by building a ladder program using the LL50A Parameter Setting Software and then downloading it to a main unit controller. This section describes the examples for UT55A/UT52A. The ladder program for UT75A/UT35A/UT32A/UP55A/UP35A/UP32A can be created in the same way as UT55A/UT52A.

The figure below shows an example of part hardening temperature control.

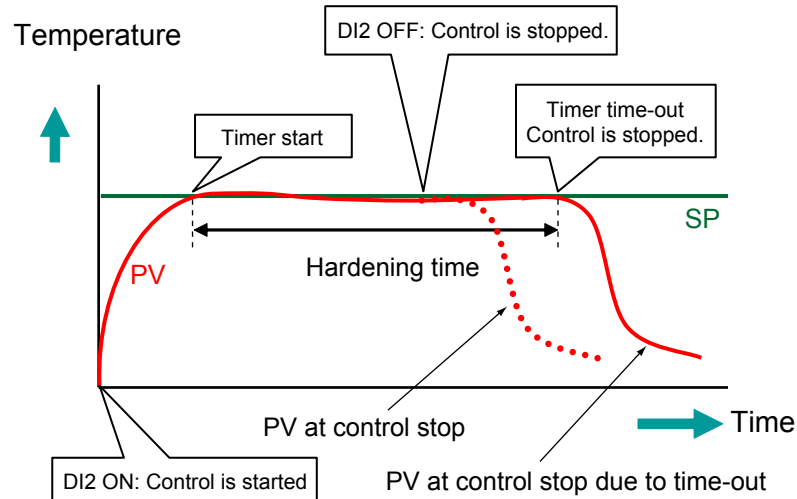

### Specifications

- Control is started when the contact input is ON.
- Timer starts when PV is within 1% of the input scale for SP.
- During the timer operation, if the power supply fails and resumes, control is restarted with the ongoing timer.
- Control stops when the hardening timer is up or when the contact input DI2 is OFF.

### Parameter settings (main unit)

- Control mode (CTLM): Single loop control
- Control period (SMP): 200ms
- STOP/RUN switch (S/R): 0 (disables the contact input-basis switching function)
- P-parameter (P01): Timer current value
- P-parameter (P09): Timer set value
- P-parameter (P10): Condition of timer action

### Devices used

- Internal relay: M01\_B, M128
- DAT register: DAT02, DAT03, DAT20
- Parameter register: S.R, SH\_R, SL\_R, CSP\_L1, PV\_L1, P01, P09, and P10
- Constant register: C100
- Special relay: TIM1

► Details of the instruction: See Chapter 4 , Operations of Ladder Program Instructions.

### 3.4 Building a Ladder Program

Example of a ladder program (input ladder calculation program)

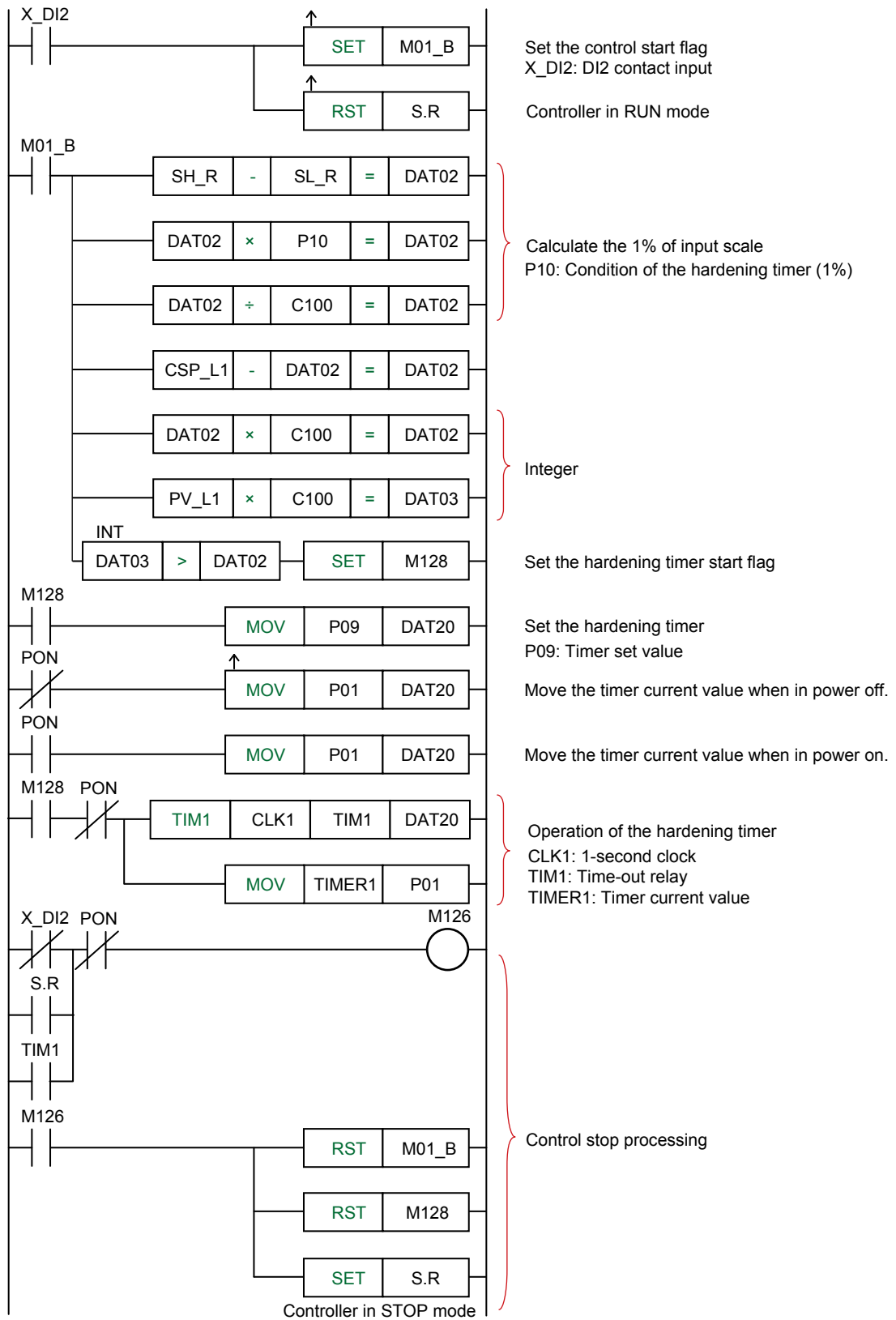

## Procedure

## 1. Display the Basic window.

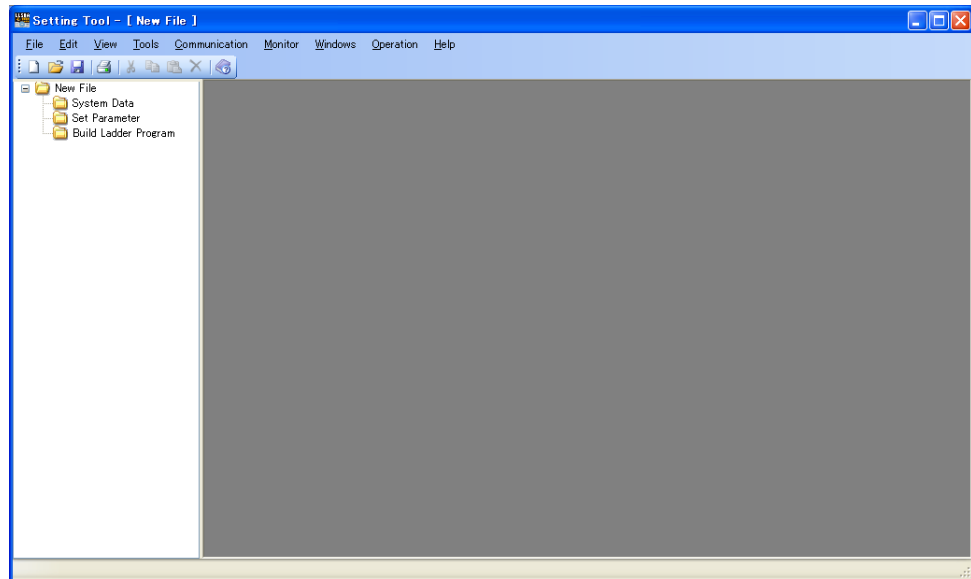

2. Click “Build Ladder Program” in the File window. This causes the control mode confirmation message to appear (when creating a new ladder program for UT75A/UT55A/UT52A/UP55A.)

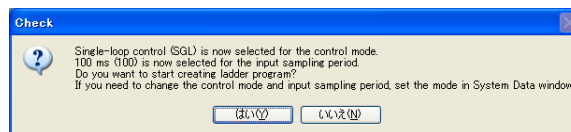

3. Click [Yes] to display the Set Ladder Program Name window. Set a ladder program name of up to eight single-byte alphanumeric characters and click [OK]. If you click [No], the System Data window appears.

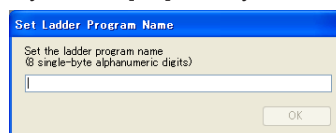

4. The Set Burnout Connection window appears. (LOOP1 PV: PV, LOOP1 RSP: RSP) (only for UT75A/UT55A/UT52A/UP55A)

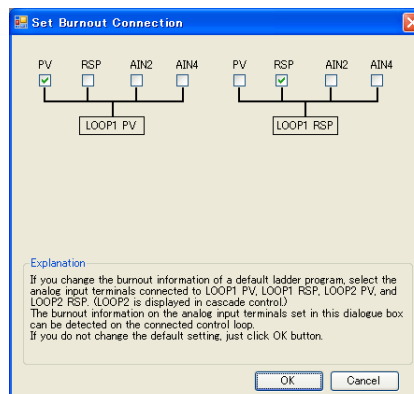

- Burnout connection settings: See 3.5.10, Setting a Burnout Connection.



### 3.4 Building a Ladder Program

5. Set burnout connection information and click the [OK] button. This causes the Ladder Program Building window to appear.

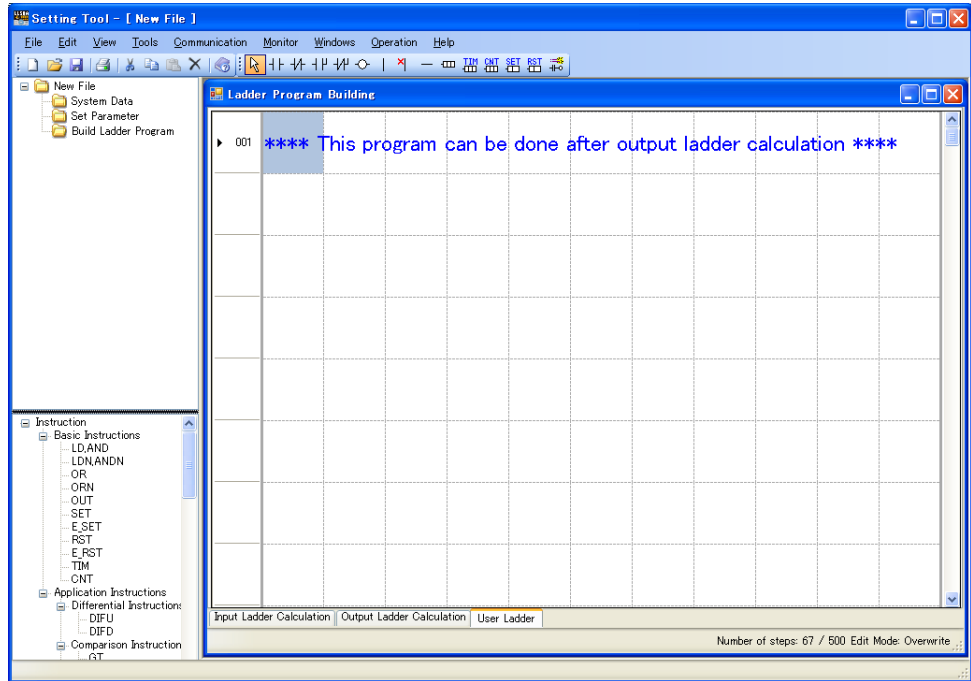

6. Click the [Input Ladder Calculation] tab.

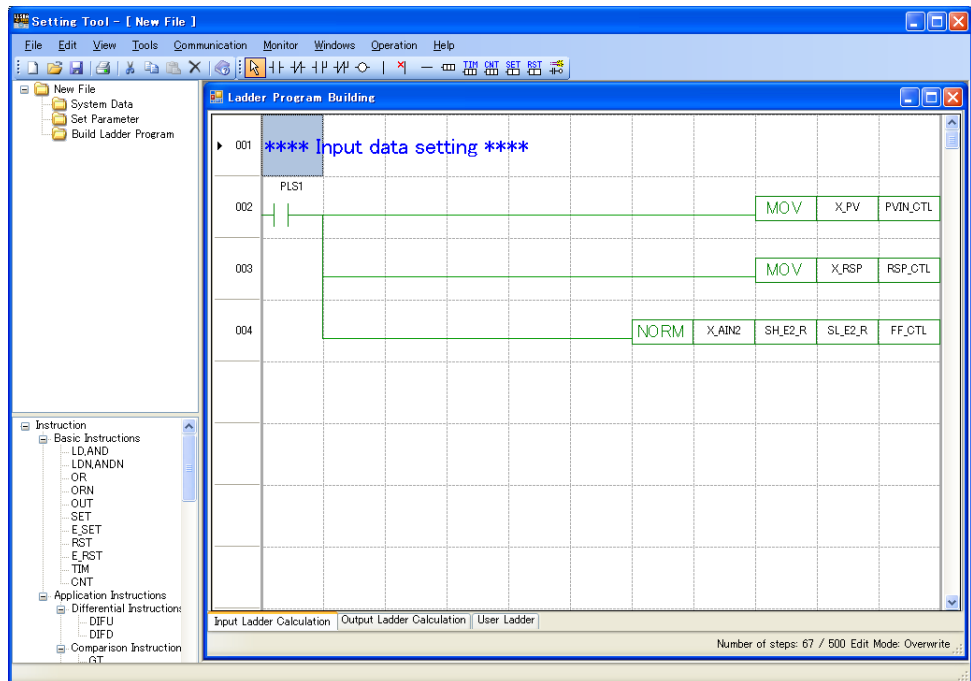

## 7. Build a circuit on the 5th line.

Click on (select)  (“a” contact instruction) on the instruction palette and click on the column of the location where you want to input the instruction.

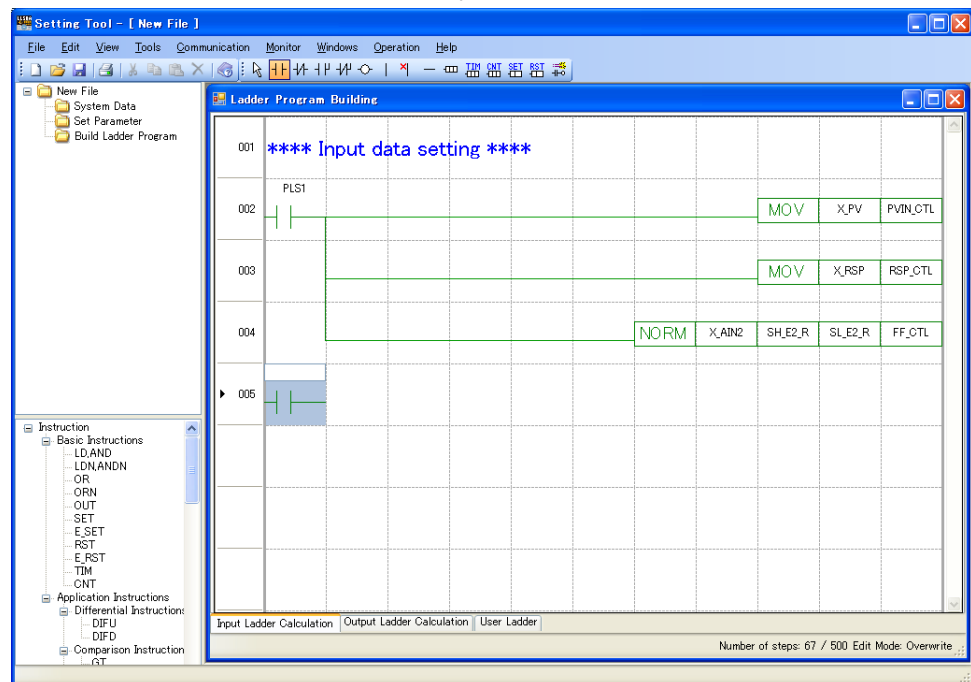

## 8. This causes the input field to appear. Input a DI2 register (X\_DI2) in the “a” contact instruction’s input field. (It is also possible to input a register by drag-and-drop from the Register window.)

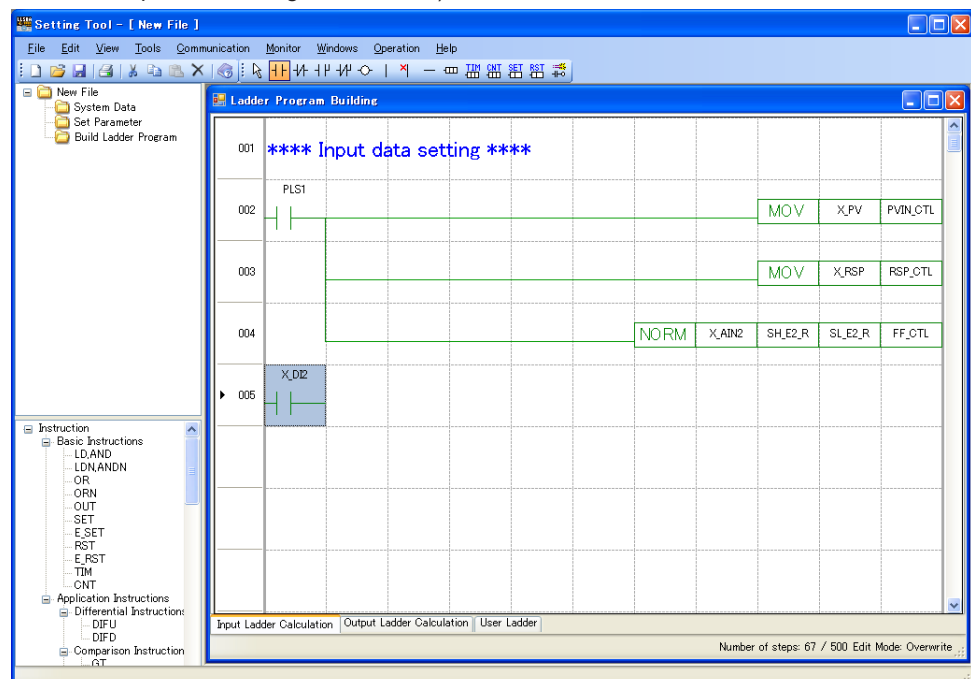

### 3.4 Building a Ladder Program

- Click on  (Application Instructions) on the instruction palette to display the Input Instruction window.

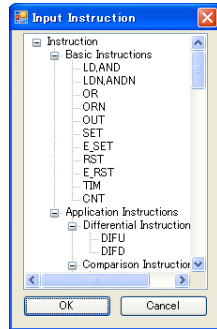

- Click on (select) the E\_SET instruction and click the column of the location where you want to input the instruction. This causes a connection line to be drawn from the “a” contact instruction to the E\_SET instruction.

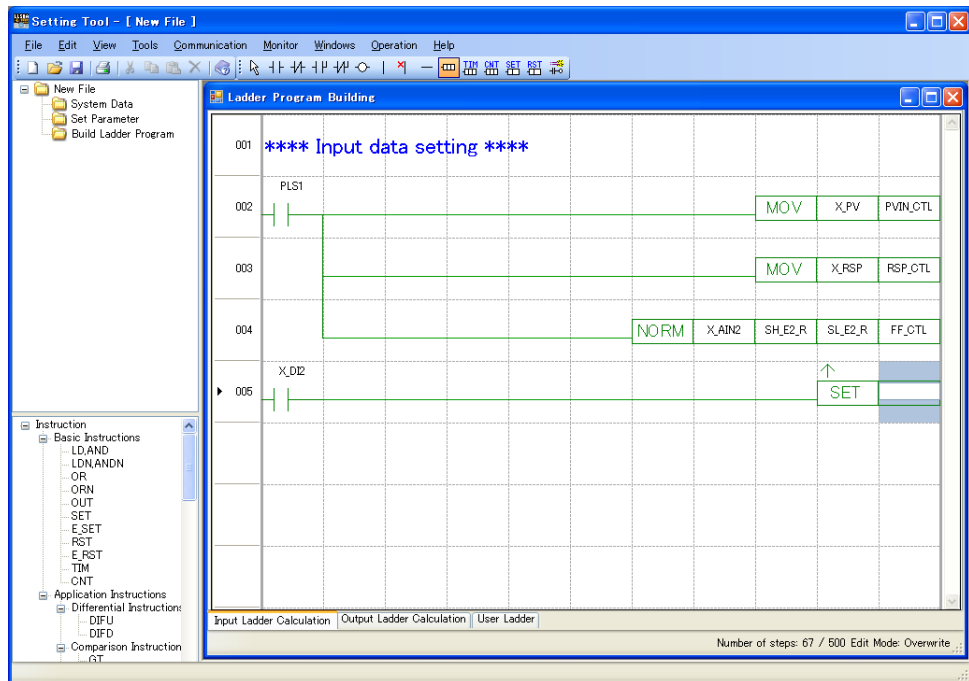

11. This causes the input field to appear. Enter an M127 register (M127) in the E\_ SET instruction's input field. (It is also possible to input a register by drag-and-drop from the Register window.)

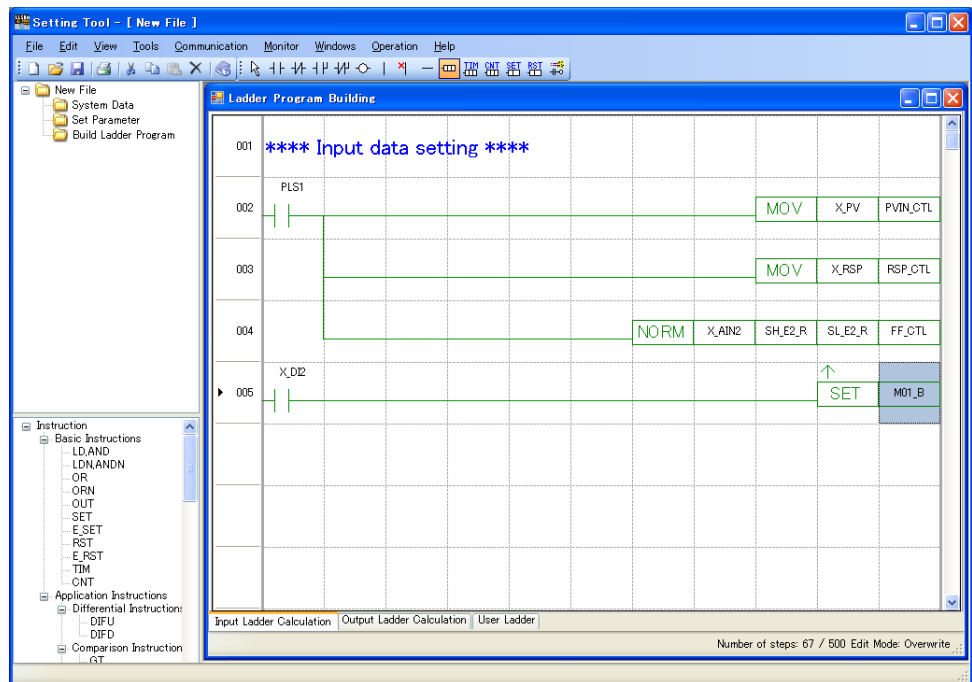

12. Locate  (OR Connection Line) on the 6th line.

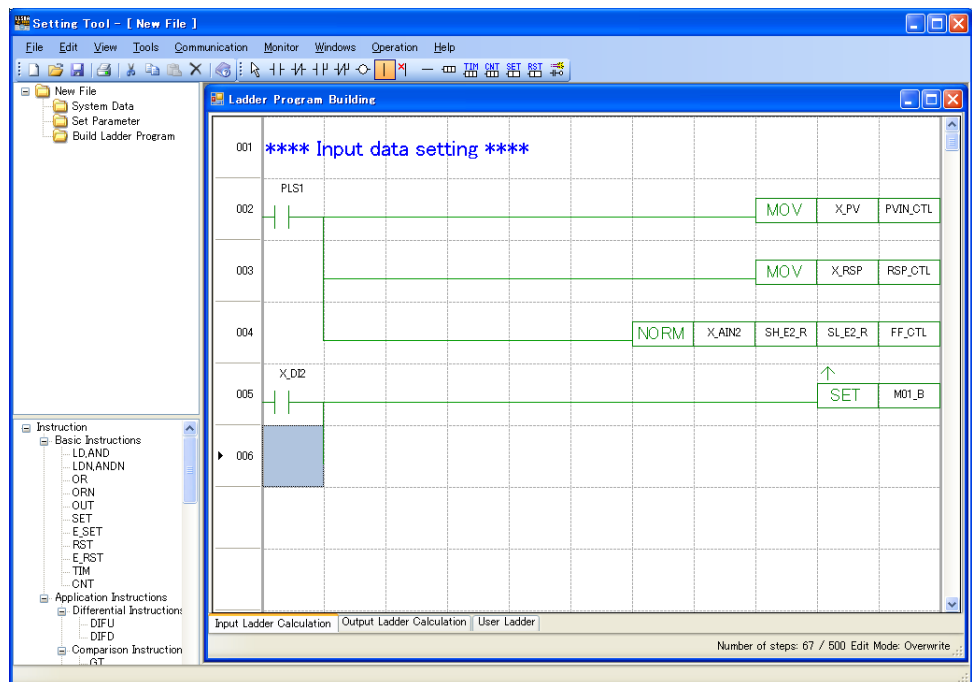

### 3.4 Building a Ladder Program

**13.** Locate the E\_RST instruction on the 6th line.

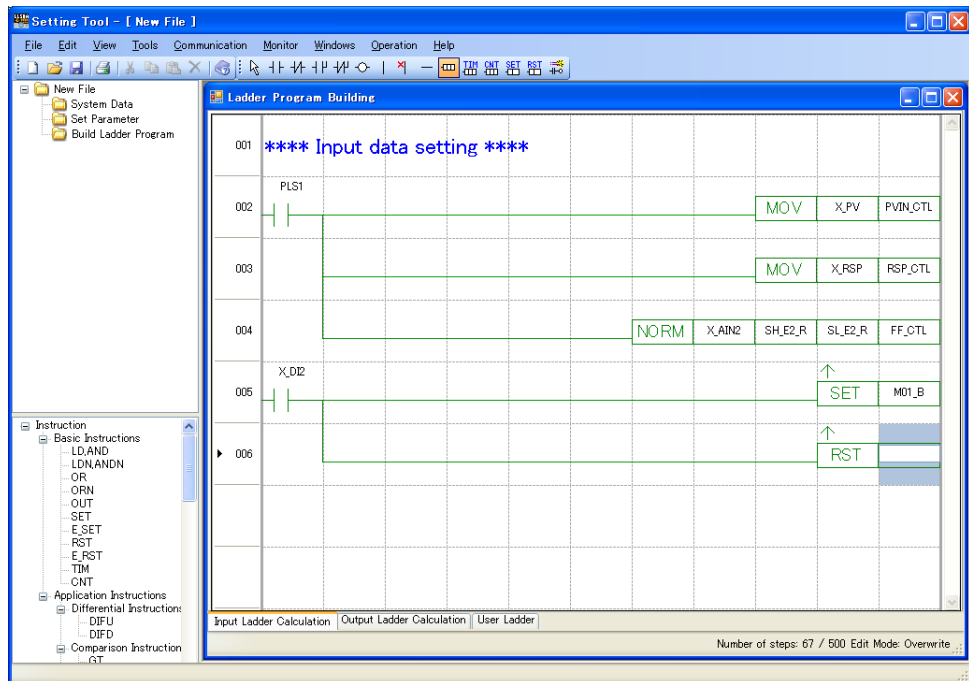

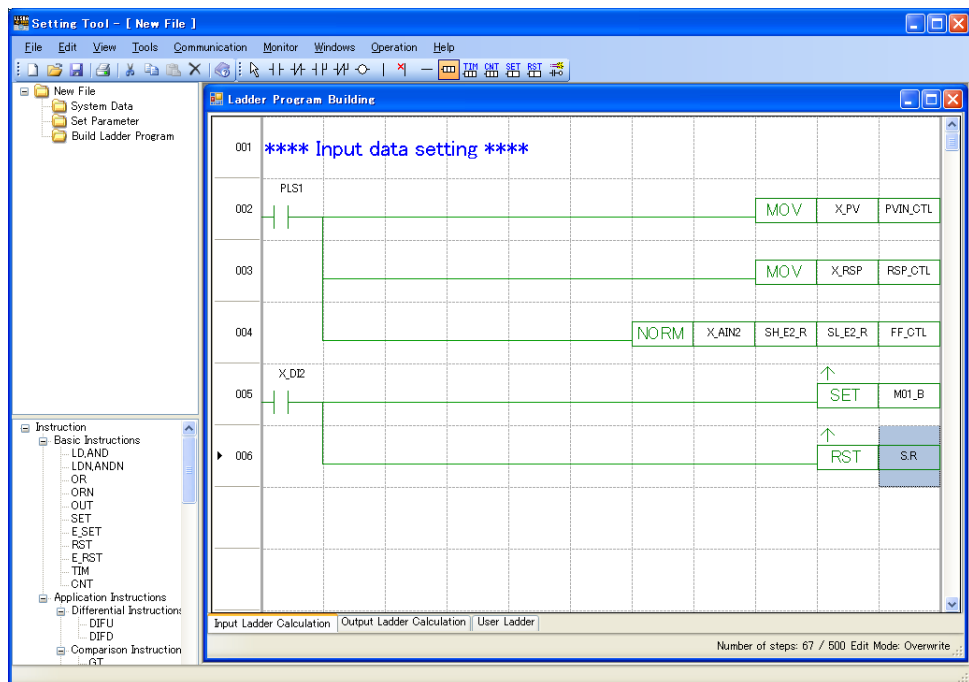

**14.** This causes the input field to appear. Enter an S/R register (S.R) in the E\_RST instruction's input field. (It is also possible to input a register by drag-and-drop from the Register window.)

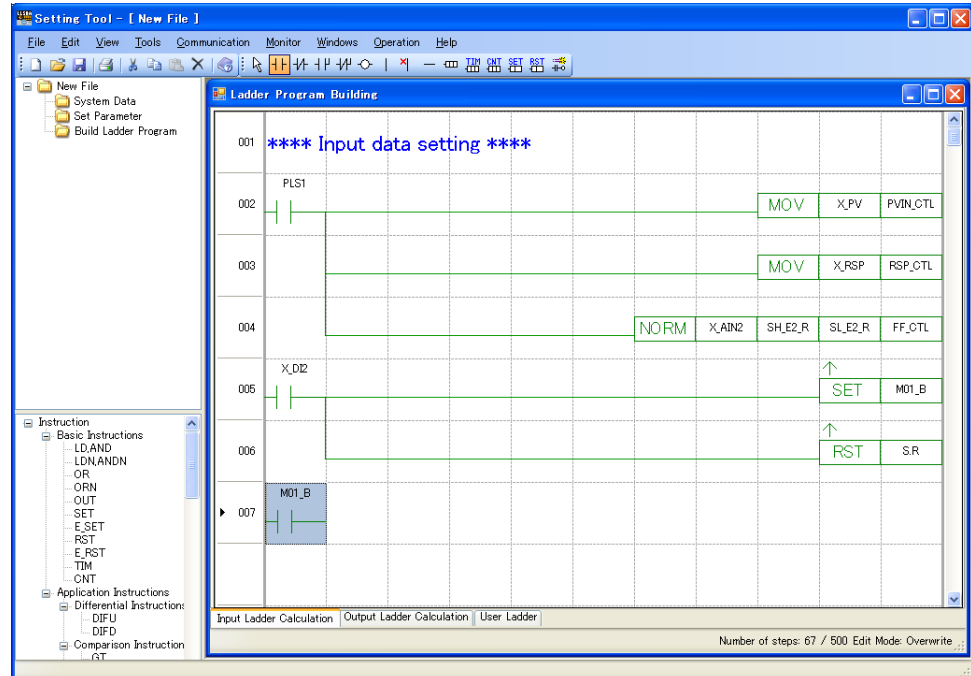

**15.** Build a circuit on the 7th line.

Click on (select)  (“a” contact instruction) on the instruction palette and click the column of the location where you want to input the instruction. Enter “M01\_B” in the input field. (It is also possible to input a register by drag-and-drop from the Register window.)

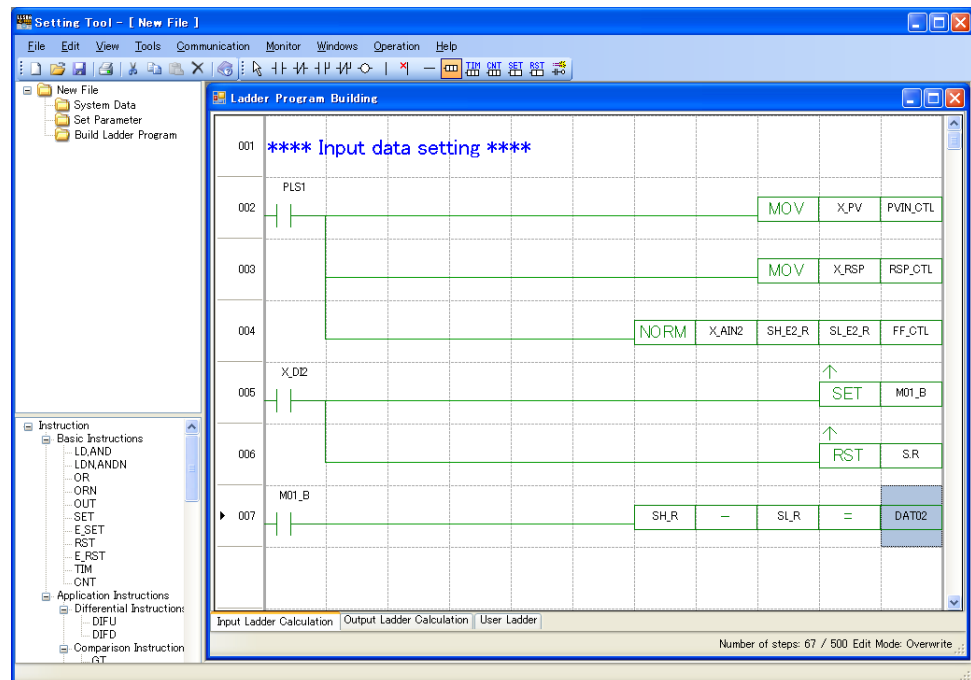
**16.** Select SUB (Subtraction) from the Input Instruction window by clicking on  (Application Instructions) of the instruction palette and locate it as shown below. Enter “SH\_R”, “SL\_R”, and “DAT02” in the input fields.



### 3.4 Building a Ladder Program

#### 17. Build a circuit on the 8th to 13th lines.

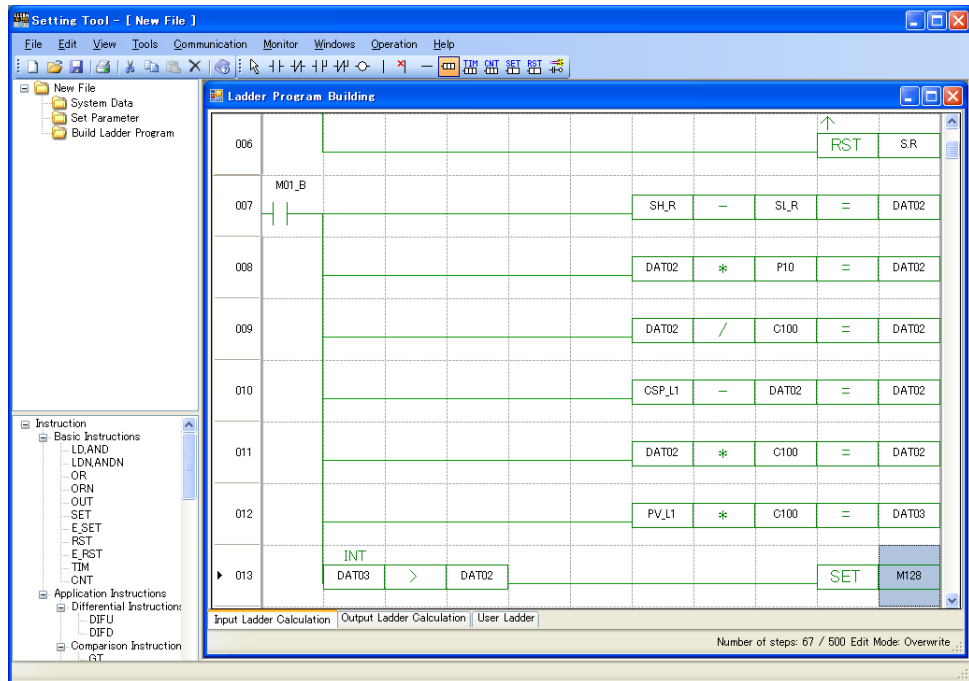
Locate  (OR Connection Line) on the 8th to 13th lines first. Then, Locate MUL (Multiplication) instruction on the 8th line, DIV (Division) instruction on the 9th line, SUB (Subtraction) instruction on the 10th line, MUL instruction on the 11th to 12th lines, GT (>) and SET instruction on the 13th line. Also enter the register in the input field.



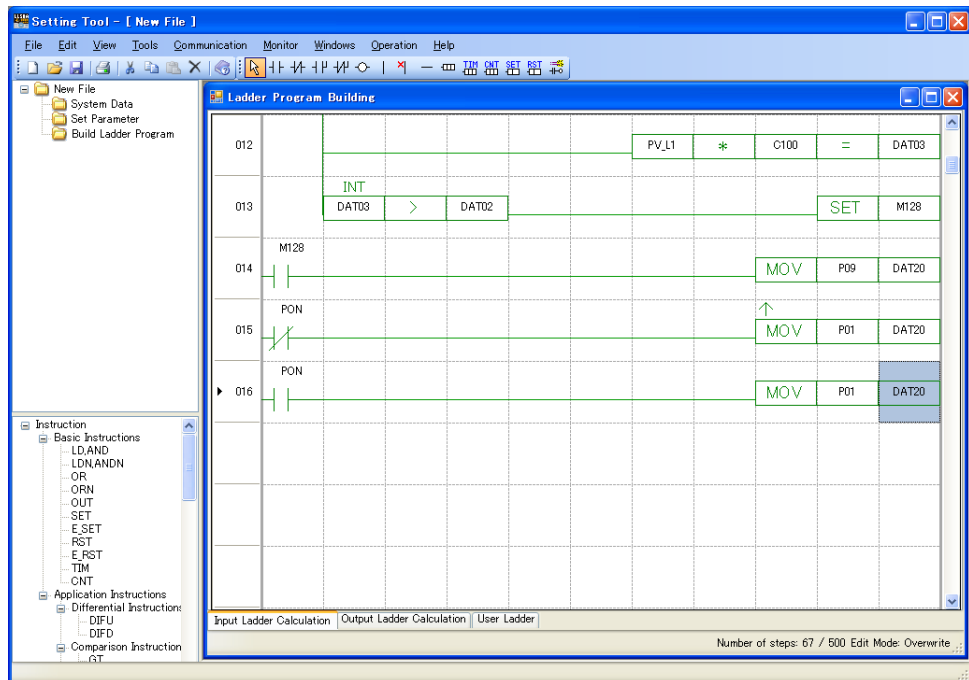

#### 18. Build a circuit on the 14th to 16th lines same as above.

Locate  ("a" contact instruction) and MOV (Move) instruction on the 14th line,  ("b" contact instruction) and E\_MOV instruction on the 15th line,  ("a" contact instruction) and MOV instruction on the 16th line. Also enter the register in the input field.

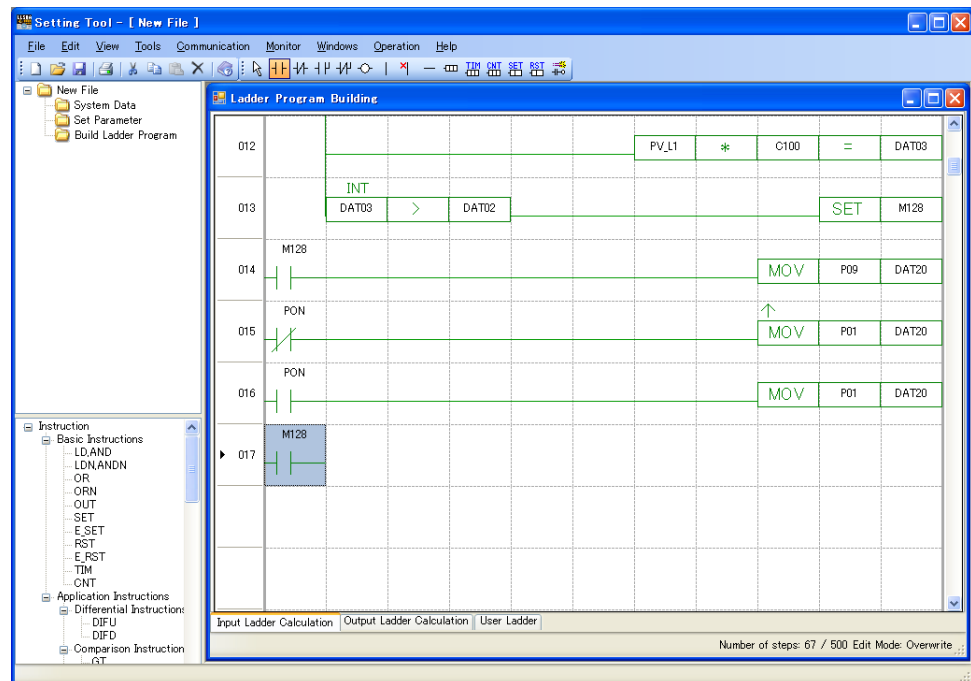

**19.** Build a circuit on the 17th line.

Click on (select)  (“a” contact instruction) on the instruction palette and click the column of the location where you want to input the instruction. Enter “M128” in the input field.

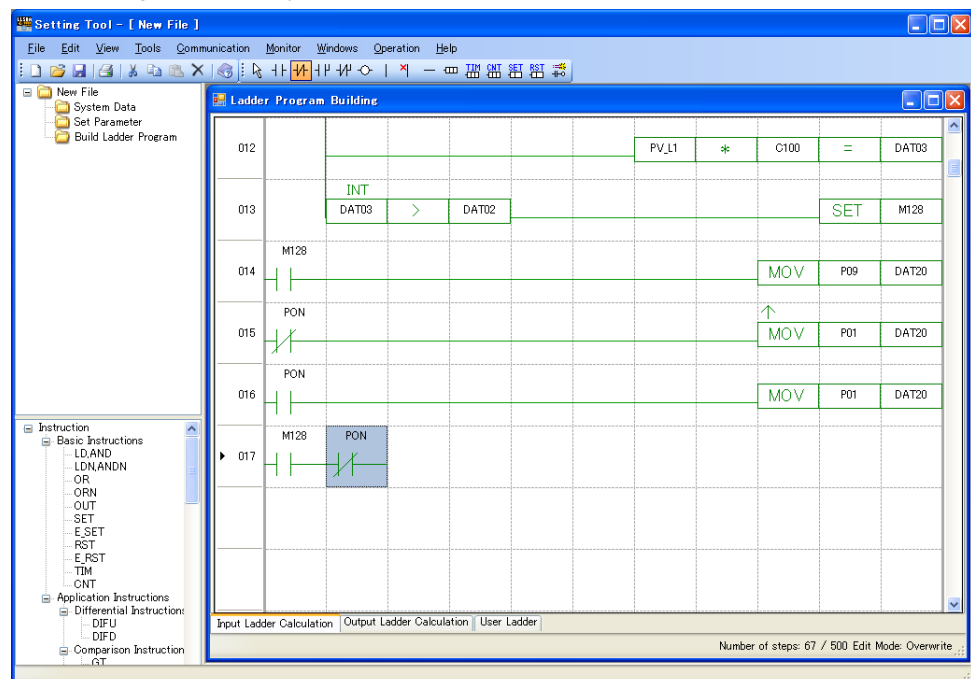
**20.** Click on (select)  (“b” contact instruction) on the instruction palette and click the column of the location where you want to input the instruction. Enter “PON” in the input field. (It is also possible to input a register by drag-and-drop from the Register window.)



### 3.4 Building a Ladder Program

- 21.** Select TIM (Timer) from the Input Instruction window by clicking on  (Application Instructions) of the Instruction Palette and locate it as shown below.

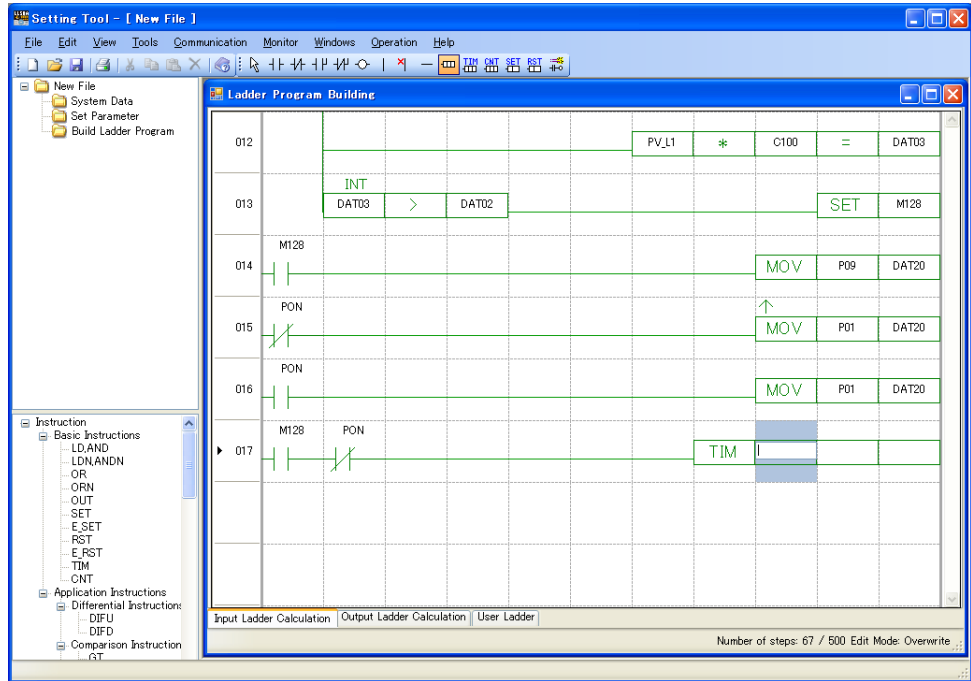

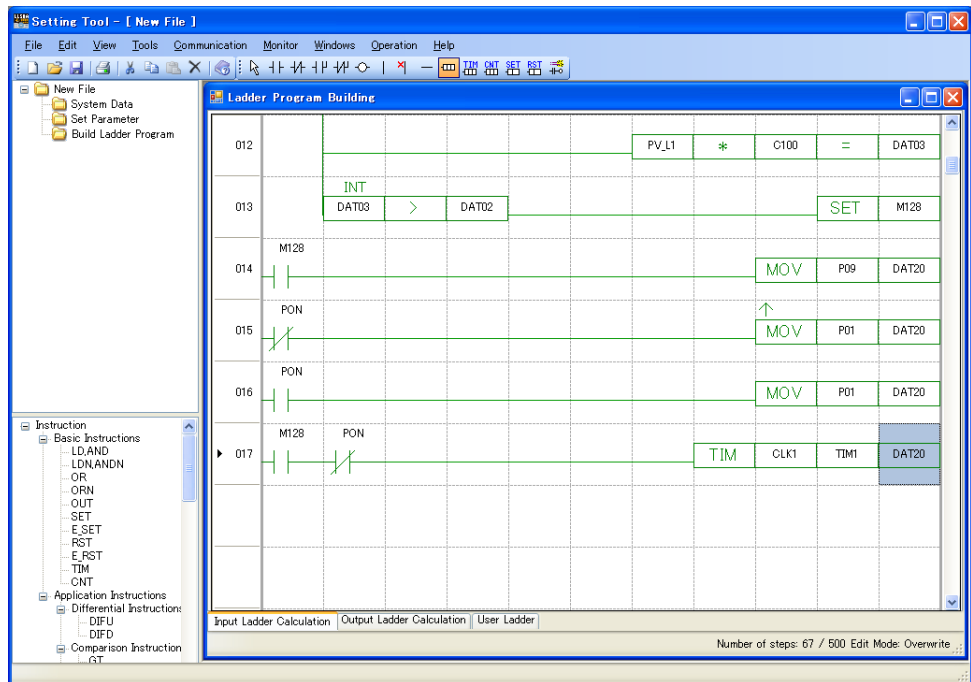

- 22.** Enter “CLK1” (1-sec clock), “TIM1” (time-out relay), and “DAT20” (timer set value) in the input fields.

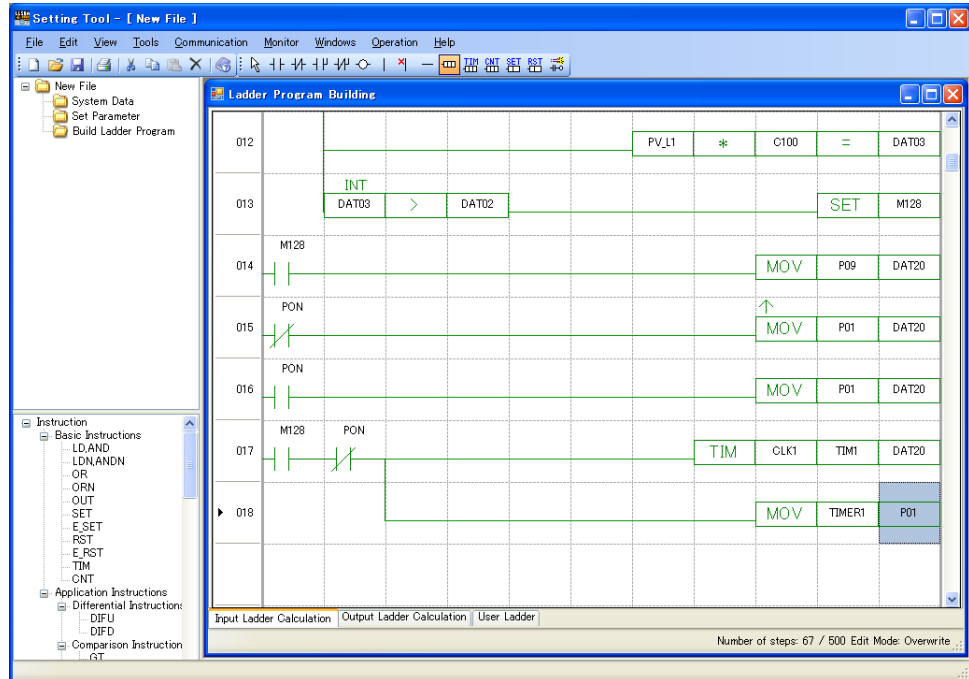

- 23.** Locate the MOV instruction on the 18th line.  
Enter "TIMER1" (timer current value) and "P01" in the input fields.



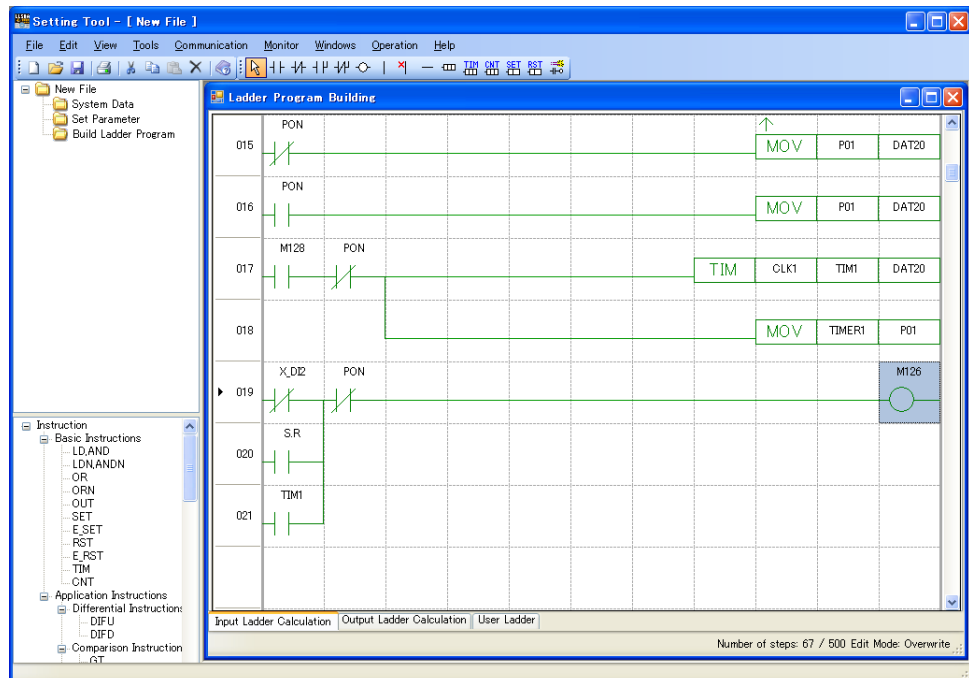

- 24.** Build a circuit on the 19th to 21th lines.

Locate  ("b" contact instruction) and  OUT instruction on the 19th line,  ("a" contact OR instruction) on the 20th and 21th lines. Also enter the register in the input field.



### 3.4 Building a Ladder Program

**25.** Build a circuit on the 22th to 24th lines same as above.

Locate  ("a" contact instruction) and RST (Reset) instruction on the 22th line,  (OR connection line) on the 23th to 24th lines, RST instruction on the 23th line, SET instruction on the 24th line. (It is also possible to input a register by drag-and-drop from the Register window.)

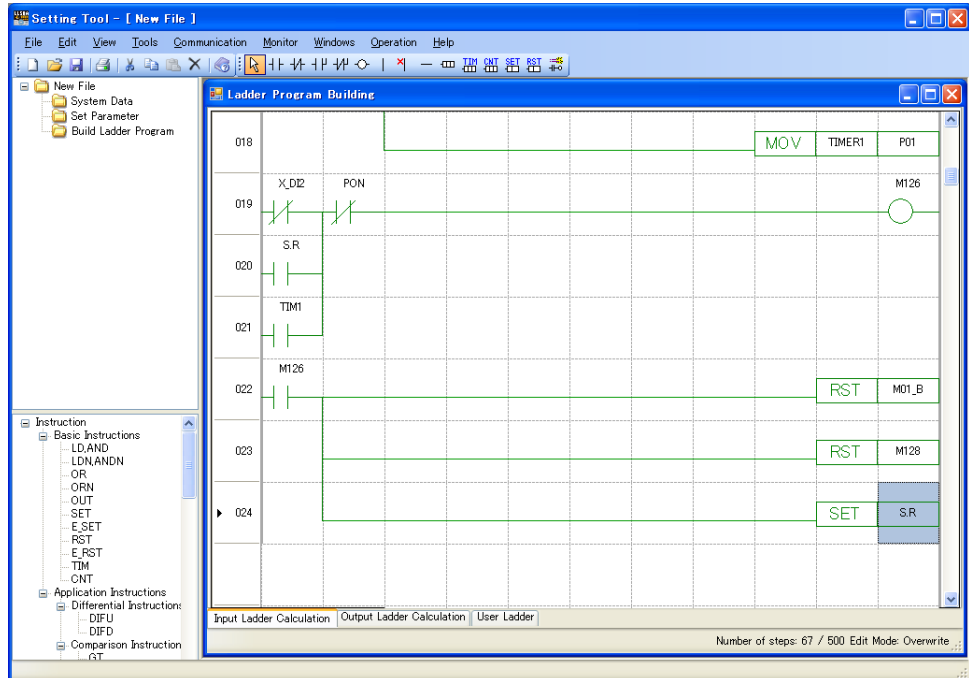

**26.** Complete the ladder program building.

Ladder program

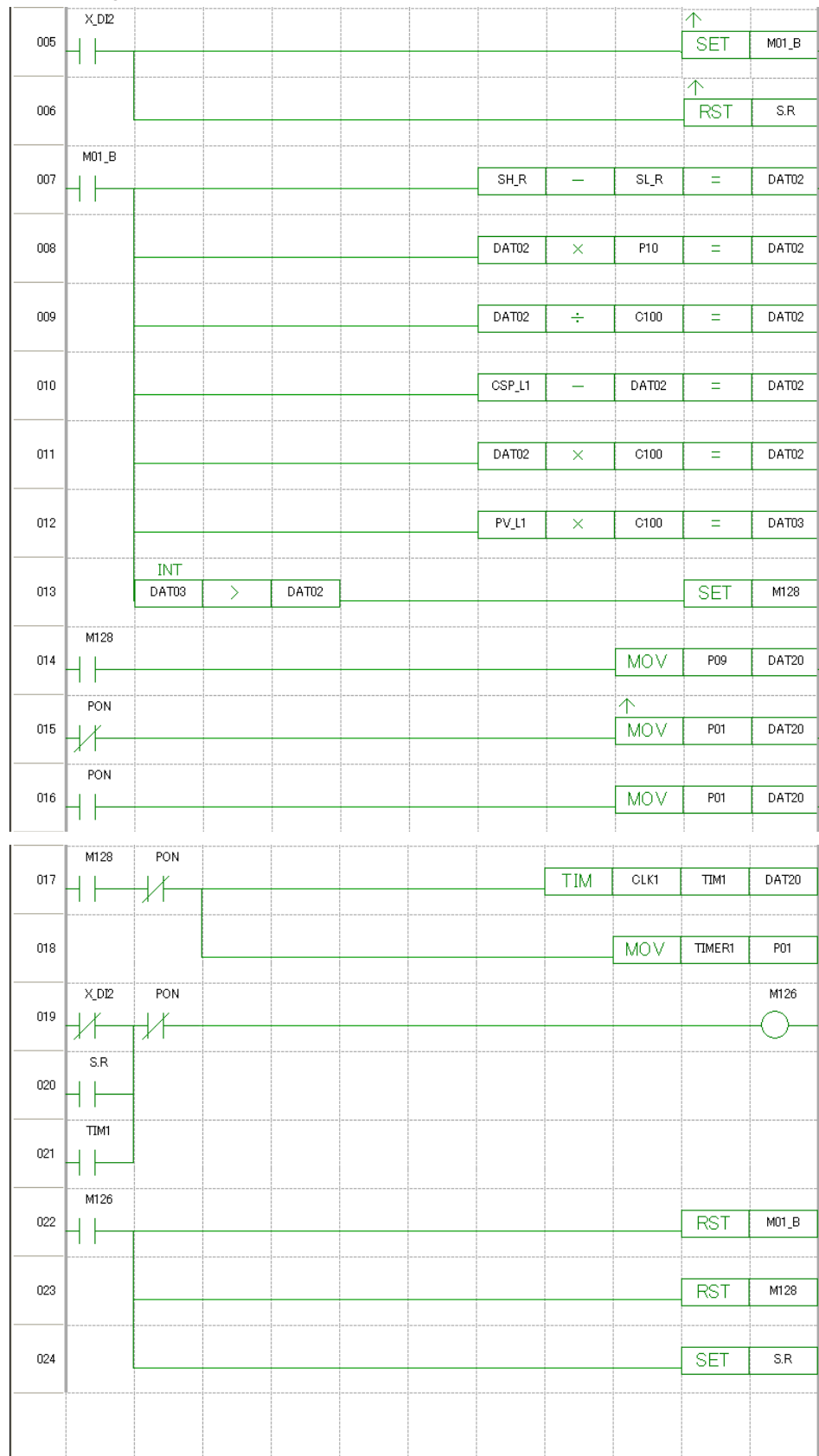

## 3.5 Editing Ladder Programs

### 3.5.1 Overwrite and Insert Modes

Instructions are input in either the Overwrite or Insert mode. The Insert key is used to switch between the two modes.

- Overwrite mode  
Inputting an instruction in Overwrite mode when there is already an instruction at the location of the cursor erases the existing instruction and causes the new instruction to be entered there.
- Insert mode  
Inputting an instruction in Insert mode when there is already an instruction at the location of the cursor causes the existing instruction to be shifted to the right and the new instruction to be entered at that location. If the existing instruction cannot be moved to the right or if moving an instruction to the right would cause it to be placed at the 11th column, no instruction can be input.

### 3.5.2 Circuit Editing Elements

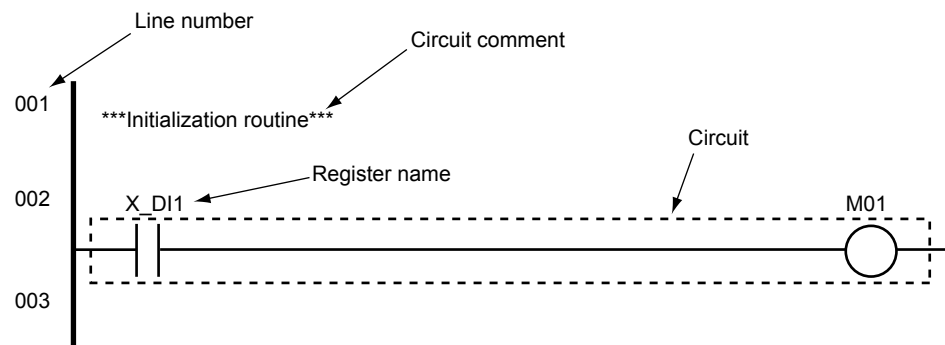

Circuit	Item	Specifications
Circuit	Number of lines per circuit	15 lines or less
	Number of instructions per circuit	125 instructions or less
	Continuous line	None
	Horizontal columns	Fixed to 11 columns
Circuit comment	Number of characters	70 single-byte characters (35 two-byte characters) or less
	Available characters	Alphanumeric characters and symbols
	Number of items registered	50
Register name	Specification method	Contact input: X Contact output: Y Others: Register symbols

#### Limitations

- Only one output instruction can be registered in one line.
- No input instruction can be registered at the 11th column, or an input instruction extending to the 11th column cannot be registered.

### 3.5.3 Inserting a Blank Line

This section describes how to insert a blank line in a ladder program.

#### Procedure

1. Place the cursor at the location where you want to insert a blank line.
2. Click on [Edit] – [Insert Line] in the menu.

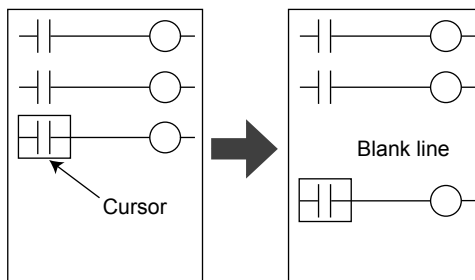

### 3.5.4 Selecting a Circuit Range

The following describes how to specify a circuit range. A cut, copy, or delete is performed by specifying the range of a circuit.

#### Selection in units of lines

##### Selecting a range using the mouse

To select a circuit range using the mouse, generally drag across the line number area with the cursor.

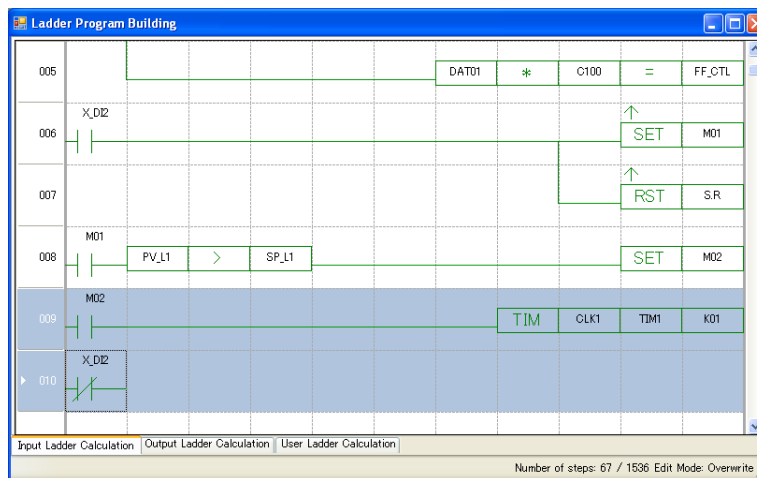

##### Selecting a range using the keyboard

To select a circuit range using the keyboard, move the cursor to any cell on the line where you want to start selection, press the Ctrl + Space keys to activate a line-selection status, or press the Shift + [Up arrow] keys or Shift + [Down arrow] keys to select the range.

## 3.5 Editing Ladder Programs

### Selection in units of cells

#### Selecting a range using the mouse

To select a circuit range using the mouse, drag across the cell range area with the mouse cursor.

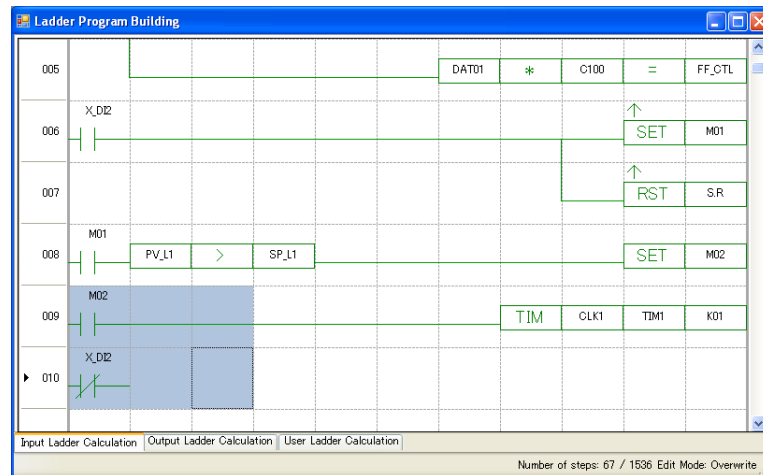

#### Selecting a range using the keyboard

To select a circuit range using the keyboard, press:

- Shift + [Right arrow] keys
- Shift + [Left arrow] keys
- Shift + [Up arrow] keys
- Shift + [Down arrow] keys

If the line-selection status has been activated, press the TAB key to cancel it.

With the SHIFT key held down, press any of the [Right arrow], [Left arrow], [Up arrow], and [Down arrow] keys.

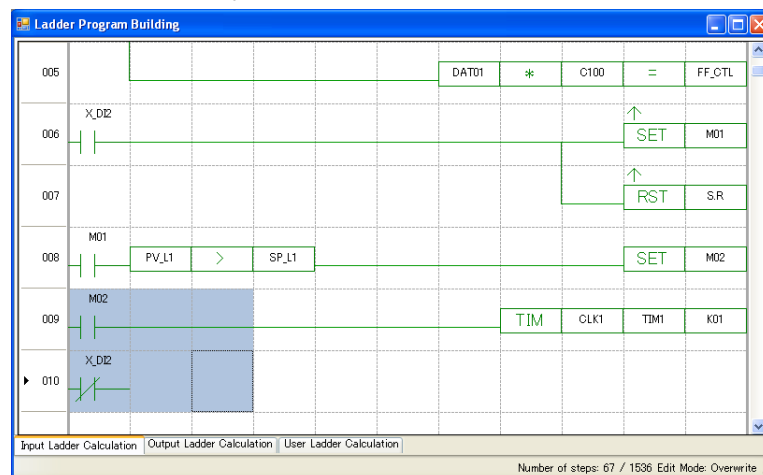

### 3.5.5 Deleting a Circuit

This section describes how to delete a circuit.

#### Deleting circuits in units of lines

Circuits can be deleted on a line basis by specifying the range of circuit lines and then selecting either [Edit] – [Delete] in the menu, or [Edit] – [Delete Line].

To select a circuit range:

1. Specify a circuit range in lines (see Section 3.5.4).
2. Click on [Edit] – [Delete] or [Edit] – [Delete Line] in the menu.
3. The line deletion confirmation message appears.

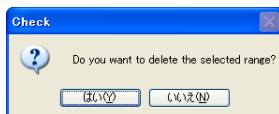

When not selecting a circuit range:

Click on [Edit] – [Delete Line] in the menu. This causes one selected line to be deleted.

1. Move the cursor to any cell on the line that you want to delete.

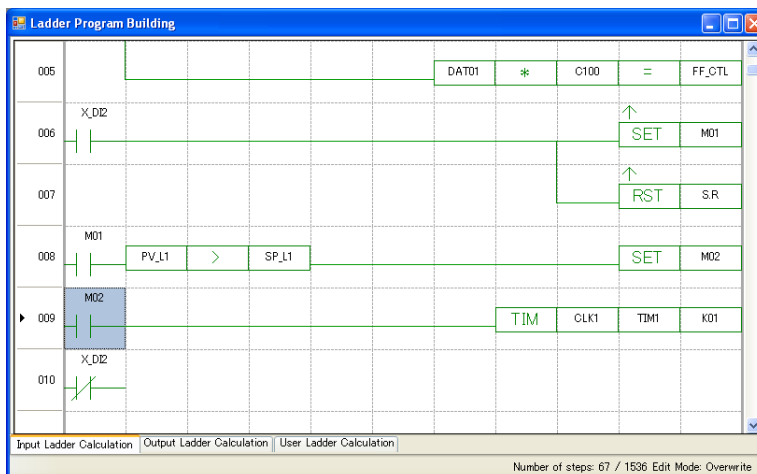

2. Click on [Edit] – [Delete Line] in the menu.
3. The line deletion confirmation message appears.

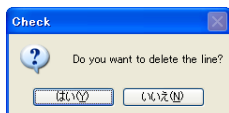



### 3.5 Editing Ladder Programs

#### Results of deletion

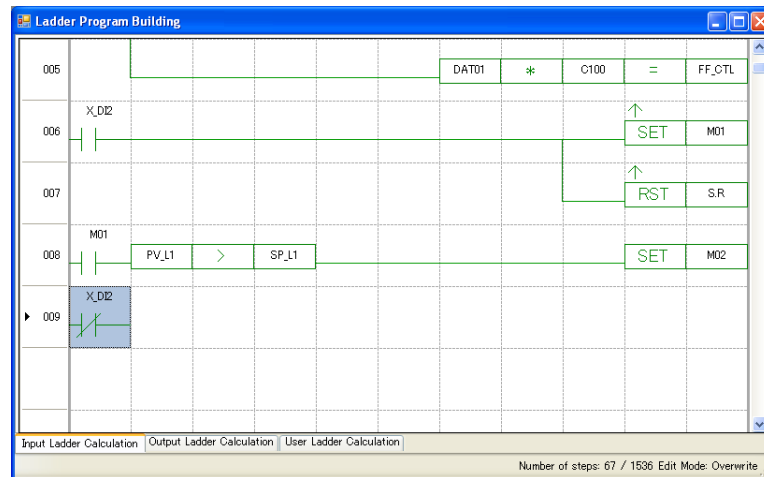

#### Deleting circuits in units of cells

To delete a specified circuit range in cells, click on [Edit] – [Delete] in the menu.

1. Specify a circuit range in cells (see Section 3.5.4).
2. Click on [Edit] – [Delete] in the menu.
3. This causes the line deletion confirmation message to appear.

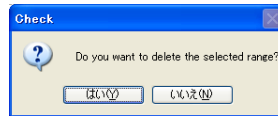

Deletion is not possible if a selected circuit range includes part of an instruction.

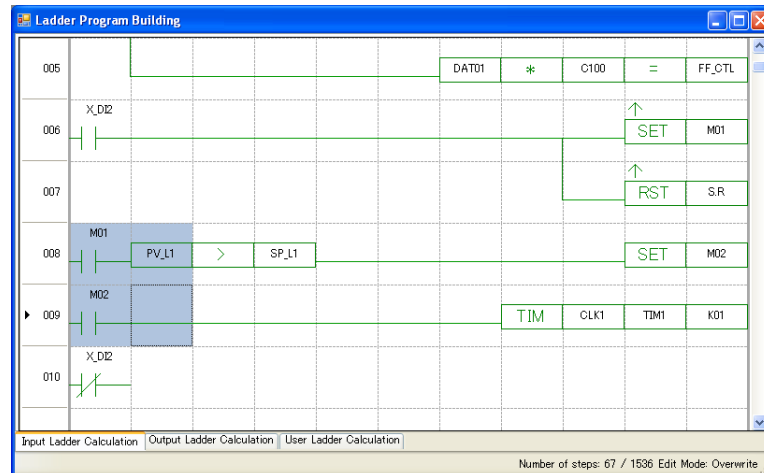

### 3.5.6 Copying a Circuit

This section describes how to copy a circuit.

#### Copying circuits in units of lines

1. Specify a circuit range in lines (see 3.5.4).
2. Click on [Edit] – [Copy] in the menu.
3. Move the cursor to left side cell on the line at the copy destination.
4. Click on [Edit] – [Paste] in the menu.

The circuits are copied to lines starting at the line where the cursor is placed.

#### In Overwrite mode

Circuits starting at the line where the cursor is placed are replaced with the circuits to be copied, by the number of circuit lines to be copied.

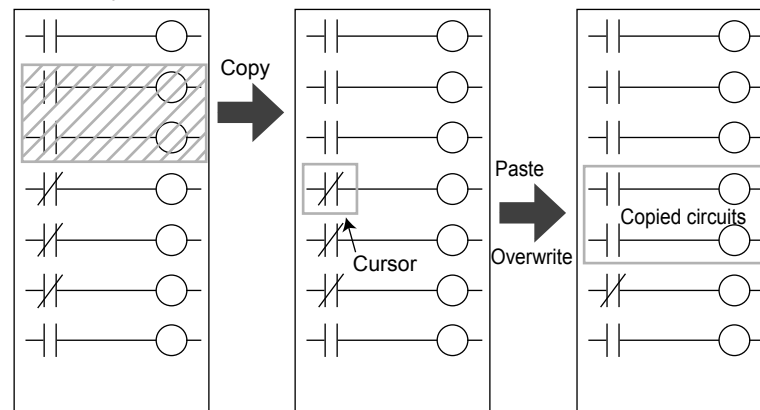

#### In Insert mode

Circuits to be copied are inserted before the line where the cursor is placed.

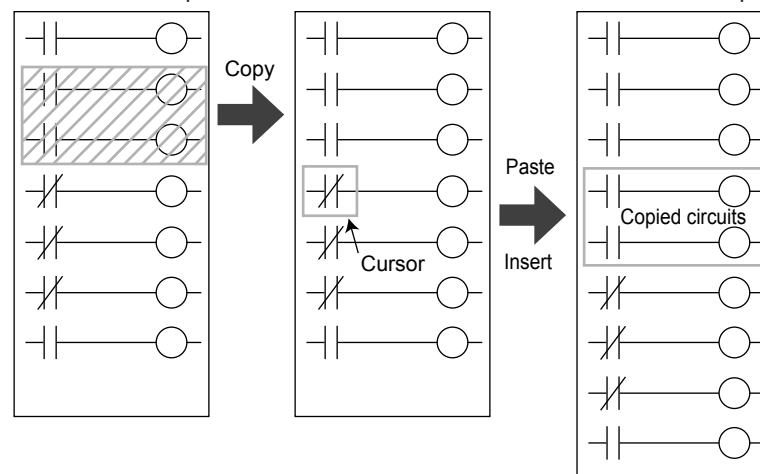

In Insert mode, it is not possible to copy if the number of circuit lines exceeds 200 lines after making the copy.

### Copying circuits in units of cells

1. Specify a circuit range in cells (see 3.5.4).
2. Click on [Edit] – [Copy] in the menu.
3. Move the cursor to a cell at the copy destination.
4. Click on [Edit] – [Paste] in the menu.

Circuits start to be copied to cells starting at the position of the cursor.

#### In Overwrite mode

The cells of circuits starting at the line where the cursor is placed are replaced with those of the circuits to be copied, by the number of circuit lines to be copied.

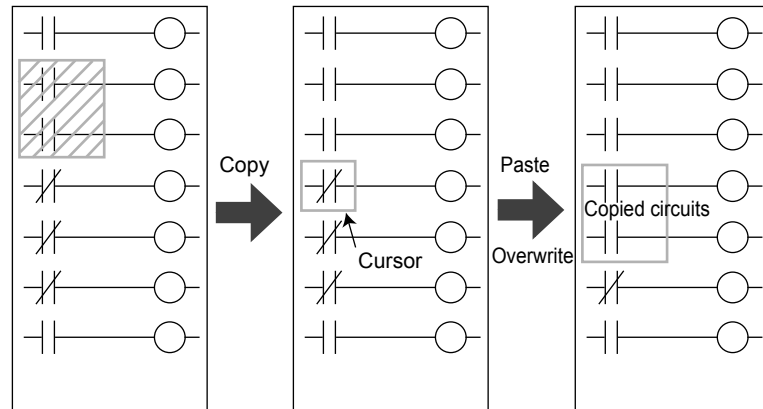

#### In Insert mode

The cells of circuits to be copied are inserted before the line where the cursor is placed.

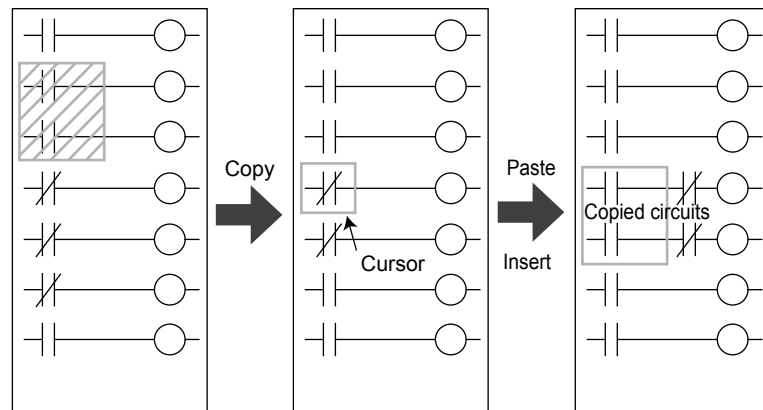

Copying cannot be made on a cell basis in the following cases:

- An input instruction is pasted to column 11
- A paste in which an output instruction does not extend to column 11
- Data obtained after pasting exceeds the display range of columns
- A paste range in Overwrite mode reaches to within an instruction
- The number of instructions per line after a paste in Insert mode exceeds 11
- A line in a paste range in Insert mode is ORed with a line out of the paste range

### 3.5.7 Moving a Circuit

This section describes how to move a circuit.

#### Moving circuits in units of lines

1. Specify a circuit range in lines (see 3.5.4).
2. Click on [Edit] – [Cut] in the menu.
3. Move the cursor to left side cell on the line at the move destination.
4. Click on [Edit] – [Paste] in the menu.  
Circuits are moved to lines starting at the position of the cursor.

#### In Overwrite mode

The circuits starting at the line where the cursor is placed are replaced with the circuits to be moved, by the number of circuit lines to be moved.

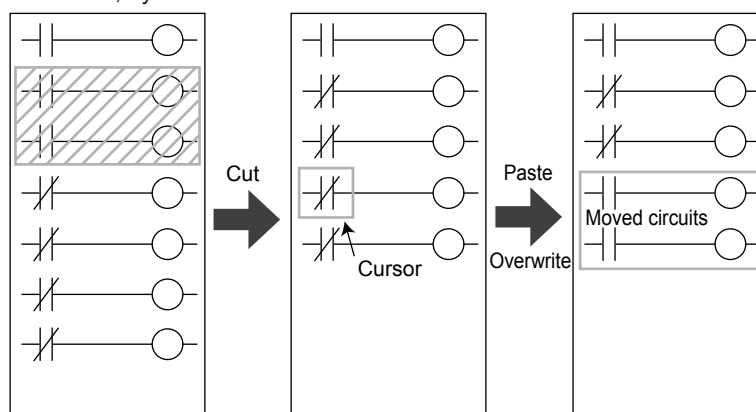

#### In Insert mode

Circuits to be moved are inserted before the line where the cursor is placed.

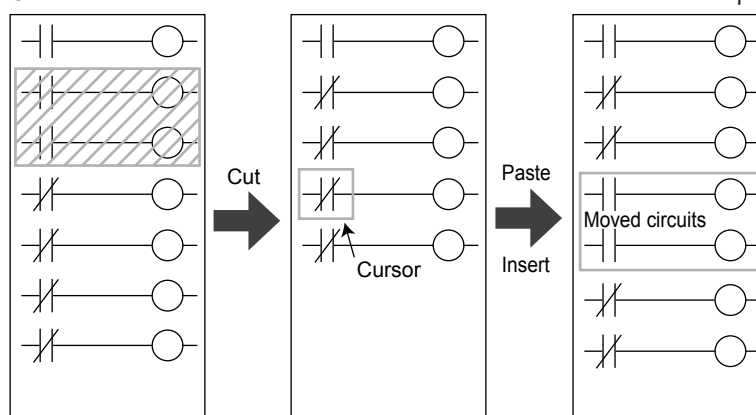

#### Moving circuits in units of cells

1. Specify a circuit range in cells (see 3.5.4).
2. Click on [Edit] – [Move] in the menu.
3. Move the cursor to a cell at the move destination.
4. Click on [Edit] – [Paste] in the menu.  
Circuits are moved to cells starting at the position of the cursor.

### 3.5 Editing Ladder Programs

#### In Overwrite mode

The cells of circuits starting at the line where the cursor is placed are replaced with those of the circuits to be moved, by the number of circuit lines to be moved.

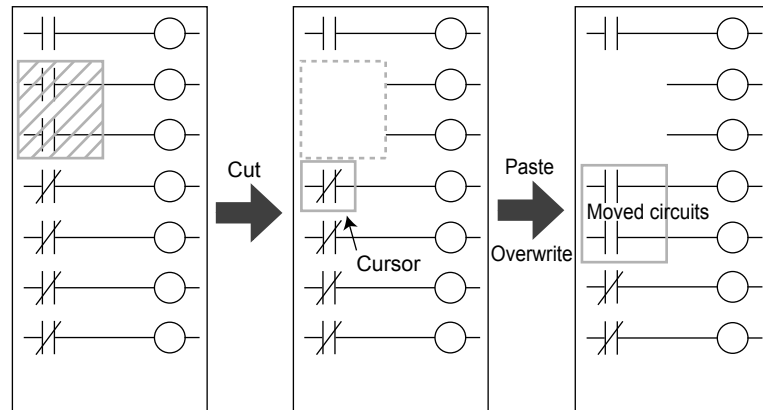

#### In Insert mode

The cells of circuits to be moved are inserted before the line where the cursor is placed.

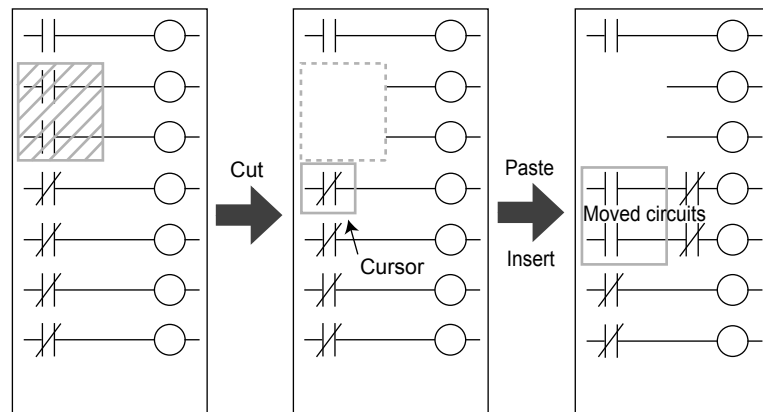

A move cannot be made on a cell basis in the following cases:

- An input instruction is pasted to column 11
- A paste in which an output instruction does not extend to column 11
- Data obtained after pasting exceeds the display range of columns
- A paste range in Overwrite mode reaches to within an instruction
- The number of instructions per line after a paste in Insert mode exceeds 11
- A line in a paste range in Insert mode is ORed with a line out of the paste range

### 3.5.8 Finding a Register or Instruction

This section describes how to find a register name or instruction in a ladder program.

#### Procedure

1. Click on [Edit] – [Find] in the menu to display the Find window.

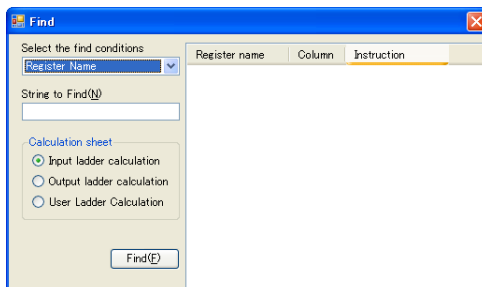

2. Input the character string you want to find.  
Number of characters: Up to 20  
Input characters: Single-byte alphanumeric characters + wildcard characters (\*: number of characters is undefined, ?: 1 character)
3. Click the Find button to display a list of the results.
4. Clicking on a result causes the cursor to move to that position.

### 3.5.9 Replacing a Register or Instruction

This section describes how to replace a register name or instruction in a ladder program with a character string.

#### Procedure

1. Click on [Edit] – [Replace] in the menu to display the Replace window.

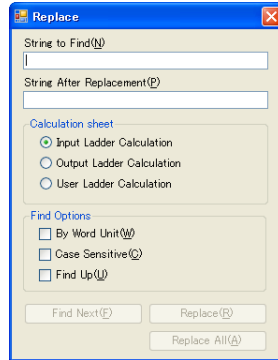

2. Enter the character string you want to search.  
Number of characters: Up to 20  
Input characters: Single-byte alphanumeric characters + wildcard characters (\*: number of characters is undefined, ?: 1 character)  
Number of characters after replacement: Up to 20  
Input characters after replacement: Single-byte alphanumeric characters  
  
Search options  
Word basis: Character strings contained in a sentence are excluded.  
Case sensitive  
Upward search: with checkmark, Downward search: without checkmark
3. Click the [Replace Next] button to move the cursor to the position where the searched results are displayed.
4. Click the [Replace] button to replace the searched character string with the replacement character string. To replace all searched character strings in the program, click the [Replace All] button.

### 3.5.10 Setting a Burnout Connection

Burnout Connection Setting is only for UT75A/UT55A/UT52A/UP55A.

To change the burnout connection setting of the default ladder programs, select the analog input terminals connected to LOOP1 PV, LOOP1 RSP, LOOP2 PV, and LOOP2 RSP. (LOOP2 is displayed in Cascade control.)

The burnout information of the analog input terminals set up here can be detected by the control loop connected.

#### Procedure

1. Click on [Tool] – [Set Burnout Connection] in the menu to display the Set Burnout Connection window.

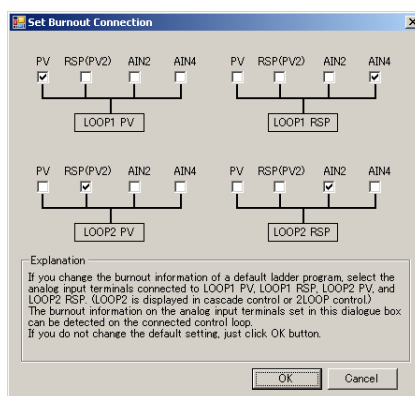

Item	Specification
LOOP1 PV	Select the input terminal connecting burnout information to loop-1 PV from among PV, RSP (PV2), AIN2, and AIN4.
LOOP1 RSP	Select the input terminal connecting burnout information to loop-1 RSP from among PV, RSP (PV2), AIN2, and AIN4.
LOOP2 PV	Select the input terminal connecting burnout information to loop-2 PV from among PV, RSP (PV2), AIN2, and AIN4.
LOOP2 RSP	Select the input terminal connecting burnout information to loop-2 RSP from among PV, RSP (PV2), AIN2, and AIN4.

LOOP2 PV and LOOP2 RSP are displayed in Cascade control or Dual-loop control.



## 3.6 Checking Ladder Programs

This section describes how to check the program calculation instructions, program syntax, and step count when creating or editing a ladder program.

### Setting up a syntax check

#### Procedure

1. Click [Tool] – [Set Option] in the menu to display the Options window.

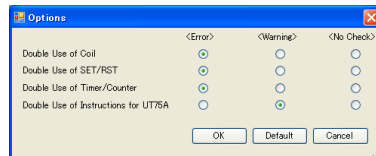

2. Click on (select) the syntax check level and click the [OK] button.

#### The Options window

Item	Specification
Double use of coil	This option sets whether an error or warning is generated or whether no check is made if a coil (OUT) is used for the same device twice or more. Default: Error
Double use of SET/RST	This option sets whether an error or warning is generated or whether no check is made if SET/RST is used for the same device twice or more. Default: Error
Double use of timer/counter	This option sets whether an error or warning is generated or whether no check is made if the timer/counter instruction is used for the same device twice or more. Default: Error
Double use of instruction for UT75A	If two or more of the following instructions are used for the same device, this option determines whether it is indicated as an error or warning, or whether no check is made. MXHD1, MNHLD1, FLTR1 to FLTR4, DED1 to DED3, MAV1 to MAV3, VEL1 to VEL3, CLMT1 to CLMT4, CPO1, ONDY1 to ONDY8, OFDY1 to OFDY8. Default: Warning
Default	Returns the settings of the options to the defaults.

### Checking the syntax

#### Procedure

1. After building a ladder program, click on [Tool] – [Check Program] in the menu to conduct a syntax check.
2. If an error is found, the Program Error window appears.

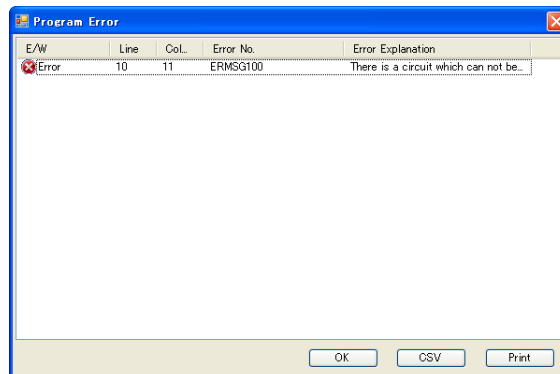

**List of the Ladder Program Error Message**

<b>Error No.</b>	<b>Error Explanation</b>
ERMSG11	The number of steps has been exceeded.
ERMSG100	There is a circuit which can not be converted.
ERMSG101	Exceeded max line number.
ERMSG102	Exceeded max step number.
ERMSG103	Exceeded max comment number.
ERMSG104	Exceeded max commands number.
ERMSG105	Double Use of Coil
ERMSG106	Double Use of SET
ERMSG107	Double Use of RST
ERMSG108	Double Use of Timer
ERMSG109	Double Use of Counter
ERMSG110	The address has not entered.
ERMSG111	The address is not suitable.
ERMSG112	Double use of instruction for UT75A

---

## 3.7 Saving a Ladder Program in a File and Downloading/Uploading It

After building and editing a ladder program, save it in a file, download it to the main unit, monitor and debug it, and then upload it from the main unit to save in the file.

For the details of each operation, see the following sections:

- Saving in a file: Section 2.15, Managing files
- Downloading to main unit: Section 2.11, Downloading Data
- Uploading from main unit: Section 2.12, Uploading Data

## 3.8 Monitoring a Ladder Program

### Procedure

1. Display the Basic window.

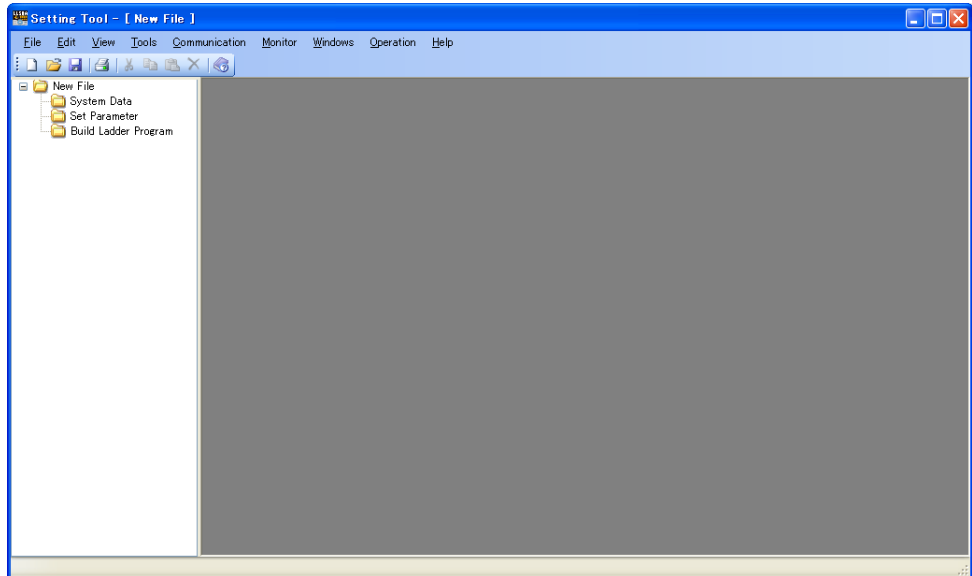

2. Click on [Monitor] – [Monitor Ladder Program] in the menu to display the Execute Communication window.

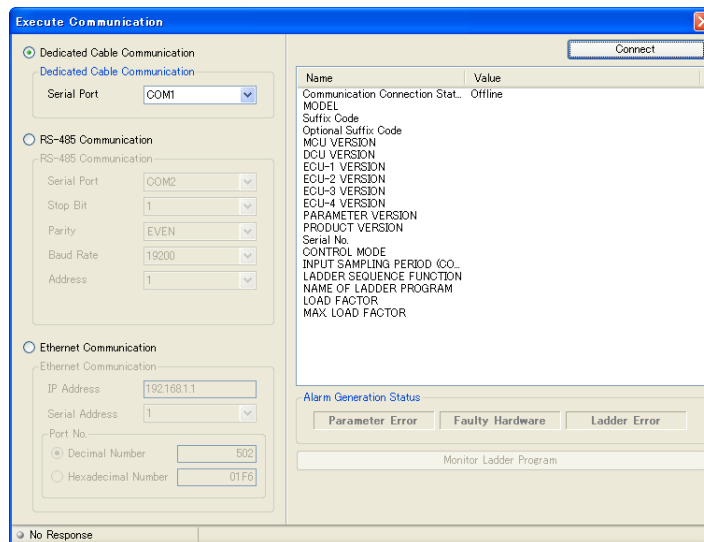

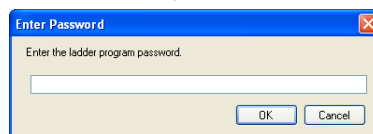

3. Set up the communication conditions and click the [Monitor Ladder Program] button to display the Enter Password dialog box.

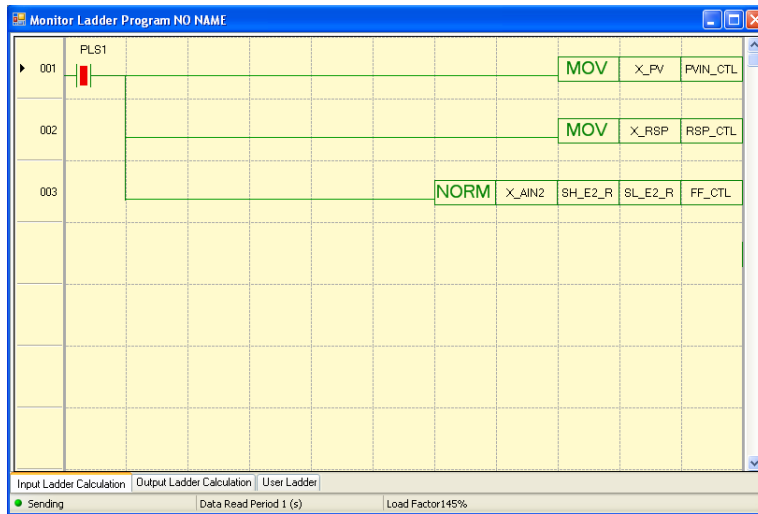

### 3.8 Monitoring a Ladder Program

4. If a ladder program password has been set to the ladder program, enter the password and click the [OK] button.  
If a ladder program password has not been set to the ladder program, click the [OK] button as is. The Monitor Ladder Program window appears.



5. To close the window, click .

#### Switching between the input ladder calculation, output ladder calculation, and user ladder windows

Click on the desired tab at the bottom of the Monitor Ladder Program window to switch to any of these windows.

### Detailed display of the Monitor Ladder Program window

#### Procedure

1. Place a check mark (  ) in front of [Detail View] that is accessed from [Monitor] in the menu to show a detailed view of the Monitor Ladder Program window. This view shows the current values of registers, etc.

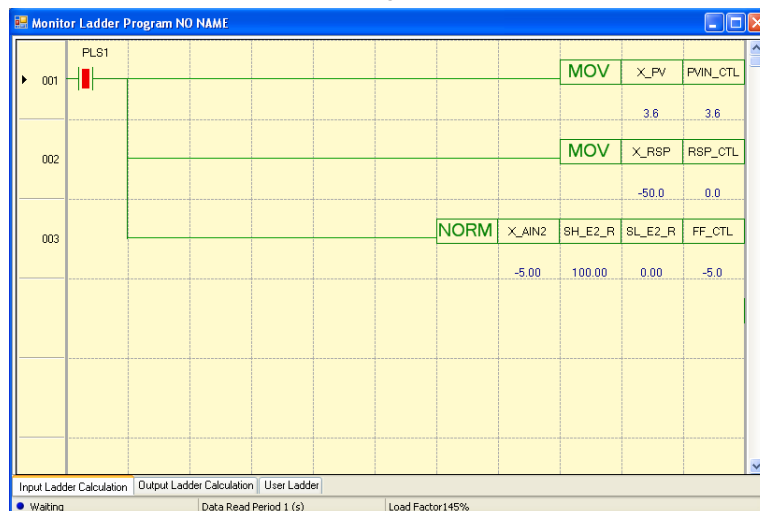

## The Monitor Ladder Program window

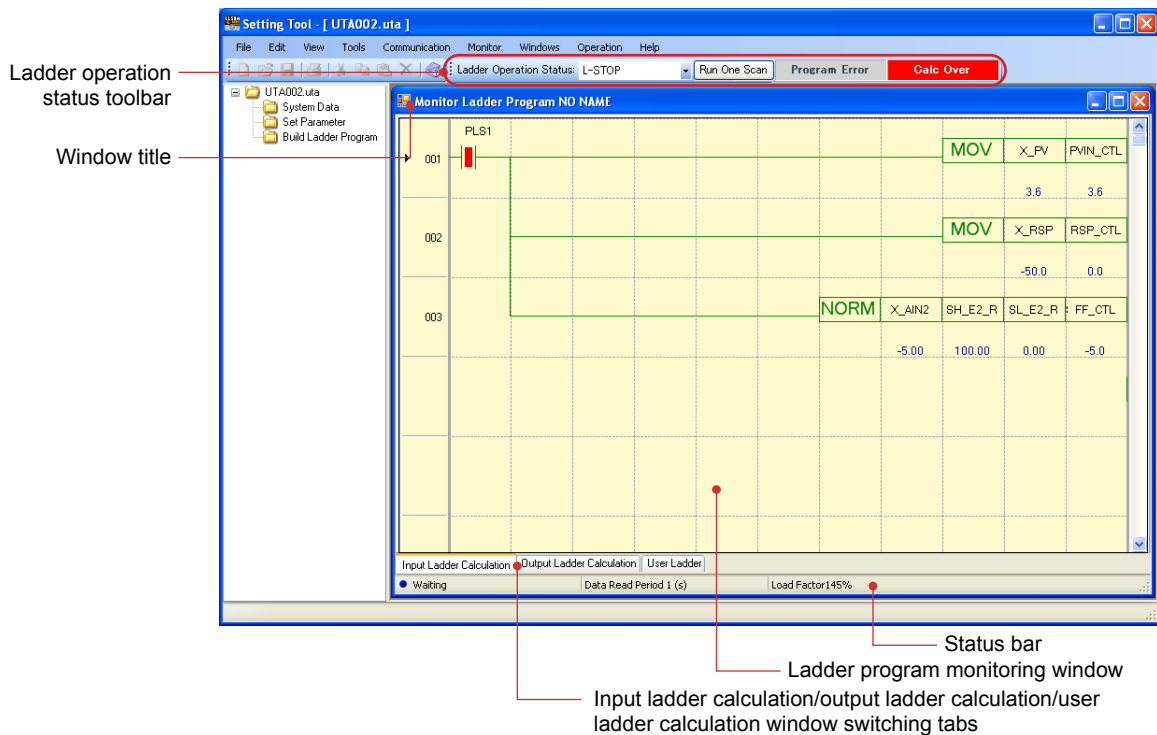

### Window title

Indicates “Monitor Ladder Program, a program name read from the main unit.”

### Monitor Ladder Program window

Displays the main unit ladder program. This is the monitor window used when debugging the ladder program. This window displays ladder program switches, lamp ON/OFF, and register values.

### Input ladder calculation/output ladder calculation/user ladder calculation window switching tabs

Click on a tab at the bottom of the Ladder Program Building window to switch between the input ladder calculation, output ladder calculation, and user ladder calculation.

### Ladder operation status toolbar

The following toolbar is displayed during ladder program monitoring.

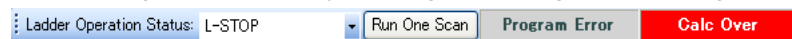

- Ladder Operation Status**  
 Indicates the operating status of the main unit’s ladder program.  
 Running: L-RUN  
 Stopped: L-STOP  
 The status in the combo box can be switched to change the ladder program operation status of the main unit.
- Run One Scan (1SCAN)**  
 When this button is pressed, the LL50A runs one scan of the main unit ladder program and then stops it. This button is not available during L-RUN.
- Reset Start (L-RESET RUN)**  
 When this button is pressed, the main unit will perform the same operation as at power-on.

### 3.8 Monitoring a Ladder Program

- Ladder program error (Program Error)  
If the ladder program is corrupted, "Program Error" is lit.
- Ladder calculation overflow (Calc Over)  
If a non-numerical value or infinity occurs during calculation or arises as a result, "Calc over" is lit.

#### Status bar

##### Communication status

This item displays the status of communication with the main unit.

Green (blinking): Communicating

Red (lit): A communication delay occurred.

##### Data read cycle

Double-clicking on this area causes the Set Data Read Cycle window to appear. This item sets the read cycle for displaying main unit data on a PC.

If communication does not meet the set update cycle, a communication delay occurs.

Setting range: 1 to 3600 sec

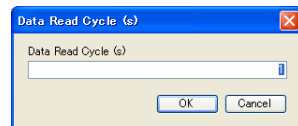

##### Load factor

Indicates the load factor of the main unit's ladder program.

#### Displaying the current value of a timer or counter

The current value of a timer or counter is displayed in the detail view.

TIM	CLK1	TIM1	K01
		10	10

The current value can also be confirmed on the Monitor Register window.

- Register symbol of Timer-1 current value: TIMER1
- Register symbol of Timer-2 current value: TIMER2
- Register symbol of Timer-3 current value: TIMER3
- Register symbol of Timer-4 current value: TIMER4
- Register symbol of Timer-1 with back-up current value: TIMER1\_B
- Register symbol of Timer-2 with back-up current value: TIMER2\_B
  
- Register symbol of Counter-1 current value: COUNTER1
- Register symbol of Counter-2 current value: COUNTER2
- Register symbol of Counter-3 current value: COUNTER3
- Register symbol of Counter-4 current value: COUNTER4
- Register symbol of Counter-1 with back-up current value: COUNTER1\_B
- Register symbol of Counter-2 with back-up current value: COUNTER2\_B

## Description









The Monitor Ladder Program window and Monitor Register window can be simultaneously displayed. The monitored data is refreshed only on the active window. For the Monitor Register window, see Section 3.9, Monitoring/Changing Register Data.

### Execute Communication window

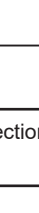
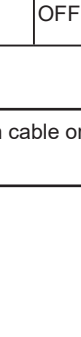
- Serial port: A port available for a PC is automatically displayed.
- Stop bit, parity, baud rate, data length, and address: Set these items according to the main unit's communication conditions.
- IP address: Set this address according to the main unit's IP address (for Ethernet communication).
- Serial address: Set the main unit's RS-485 communication address if communication is made via an Ethernet/RS-485 converter (e.g., model VJET). (Not allowed to be duplicated)
- Port number: Set the port number.

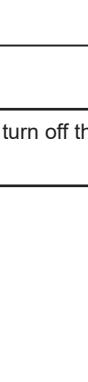
### ON/OFF display of relays

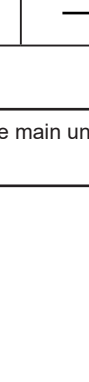
The ON/OFF status of relays in the Monitor Ladder Program window is displayed as shown below. Other instructions are also displayed in the same way.

Device Type		Status	Display
Input	"a" contact	ON	
		OFF	
	"b" contact	ON	
		OFF	
Output	Out	ON	
		OFF	
	SET	ON	
		OFF	
	RST	ON	
		OFF	

### Note

Do not disconnect a connection cable or turn off the main unit power supply during register monitoring.



## 3.9 Monitoring/Changing Register Data

### Procedure

1. Display the Basic window.

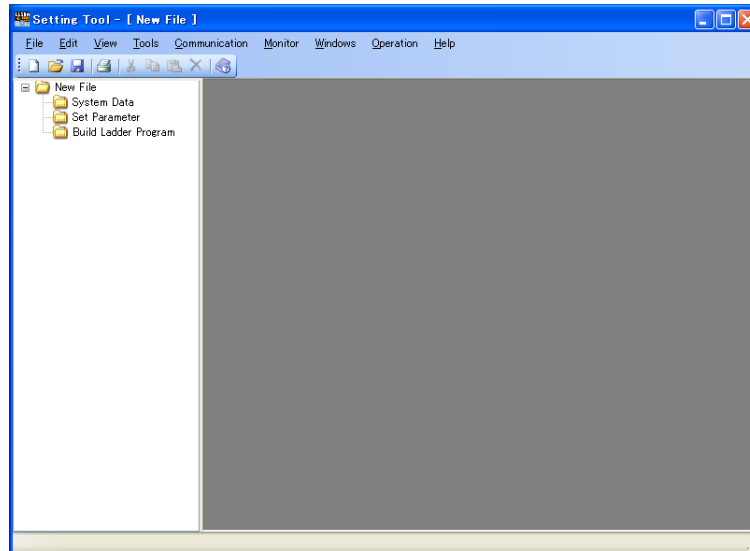

2. Click on [Monitor] – [Monitor Register] in the menu to display the Execute Communication window.

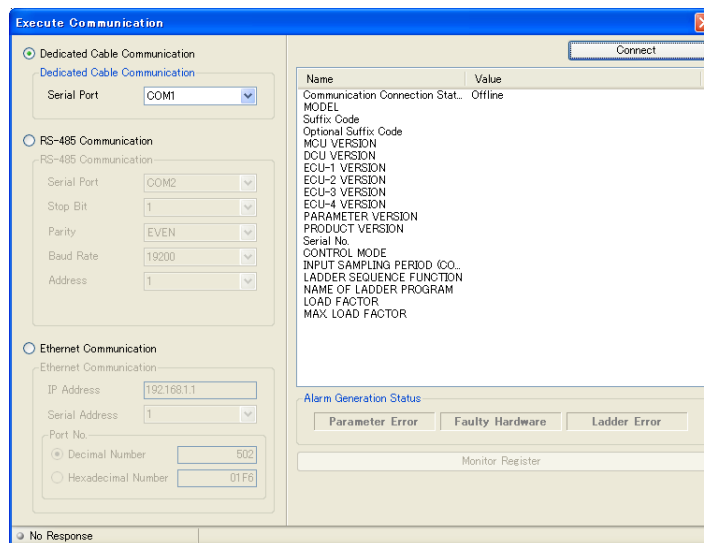

3. Set up the communication conditions and click the [Execute Register Monitoring] button to display the Monitor Register window.

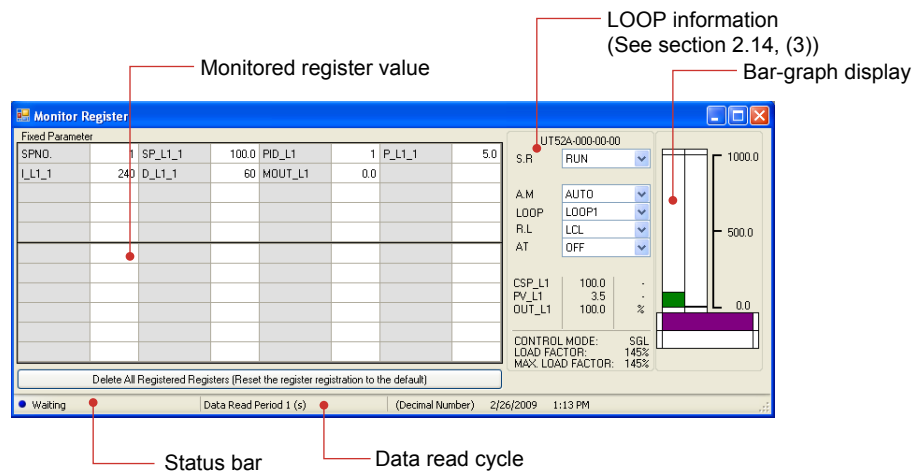

4. By observing PV, SP, and OUT trends, change the register settings.
5. Click to close the window.

### What are register symbols?

Register symbols are the symbols of registers containing data such as main unit parameters, operation status, alarm status, contact input, and error information in 16 bits or 1 bit.

When performing communication, registers are used as D-registers or I-relays.

For more information on them, see the UTAdvanced Communication Interface (RS-485, Ethernet) User's Manual.

### D-register symbols

For some register symbols, the loop number, terminal area number, and group number are indicated with an underscore ( \_ ) added after the parameter symbol. If a parameter symbol has both a loop number and group number, they are added to it in the order of \_ loop number and \_ group number.

xxxx\_Ln\_Y

Ln: loop number (L1 or L2)

Y: group number (1 to 8 (20) or 1 to 16, R)

xxxx\_En

En: terminal area number (E1 to E4)

Example: SP\_L1\_3: This means loop-1 group-3 target setpoint.

PYS\_2: This means group-2 PYS.

DI1.D\_E1: This means E1-terminal area DI1.D.

### Note

Since the UT35A/UT32A/UP35A/UP32A is a single-loop controller, it has no distinction between Loop-1 and Loop-2. However, the register symbol has "L1" which indicates Loop-1.

#### Switching between decimal and hexadecimal displays

##### Procedure

1. Click on [Monitor], select [Display Format], and click on [Decimal] or [Hexadecimal] in the menu.

##### Description

The monitor register function is used to check the operation of the main unit's ladder program. If a register value is modified, the modification is reflected in the main unit.

##### Note

If the control mode, control type, scale parameter, or other item is changed while the Monitor Register window is displayed, once close the Monitor Register window and then re-open it to display the new values.

---



##### Execute Communication window

- Serial Port: A port available for a PC is automatically displayed.
- Stop Bit, Parity, Baud Rate, and address: Set these items according to the main unit's communication conditions. Data length: fixed 8 bit
- IP Address: Set this address according to the main unit's IP address (for Ethernet communication).
- Serial Address: Set the main unit's RS-485 communication address if communication is made via an Ethernet/RS-485 converter (e.g., model VJET). (Not allowed to be duplicated)
- Port Number: Set the port number. (Decimal Number or Hexadecimal Number)

##### Note

Do not disconnect a connection cable or turn off the main unit power supply during register monitoring.

---

# 3.10 Default Ladder Programs

## 3.10.1 UT35A/UT32A/UP35A/UP32A

### Input ladder calculation program

Input registers	X_PV
Output registers	PVIN_CTL

For an explanation of the registers, see Section 4.2, Registers.

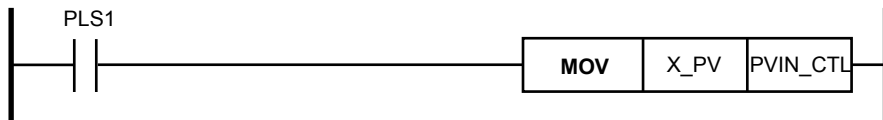

### Output ladder calculation program

Input registers	OUT_CTL, RET_CTL, OTR_CTL, OUT2R_CTL, DOAL, DO10_E1, DO40_E3
Output registers	Y_OUT, Y_RET, Y_OTR, Y_OUT2R, Y000, Y100_E1, Y400_E4

For an explanation of the registers, see Section 4.2, Registers.

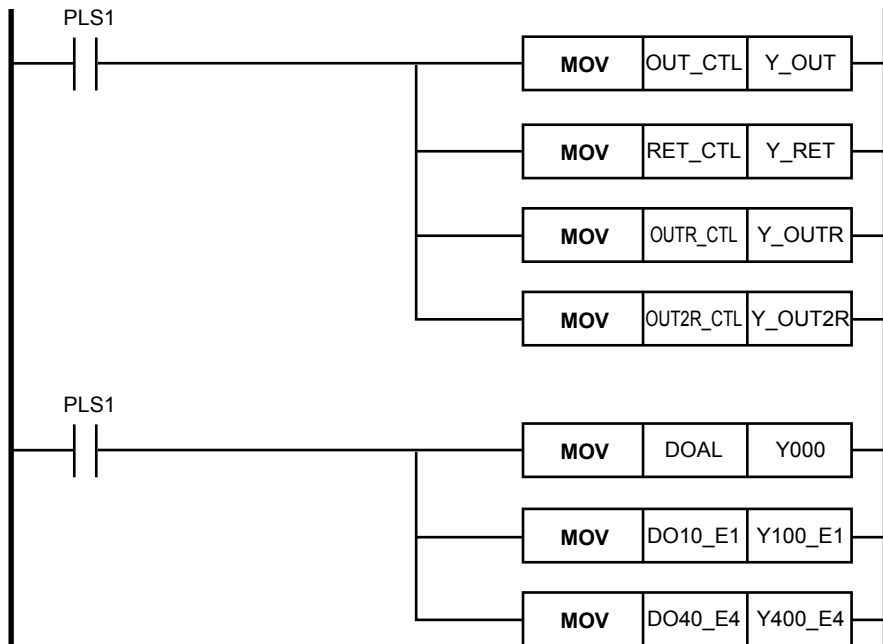

3.10.2 UT55A/UT52A/UP55A Single-loop Control

Input ladder calculation program

UT55A/UT52A

Input registers	X_PV, X_RSP, X_AIN2
Parameter registers	SH_E2_R, SL_E2_R
Output registers	PVIN_CTL, RSP_CTL, FF_CTL

For an explanation of the registers, see Section 4.2, Registers.

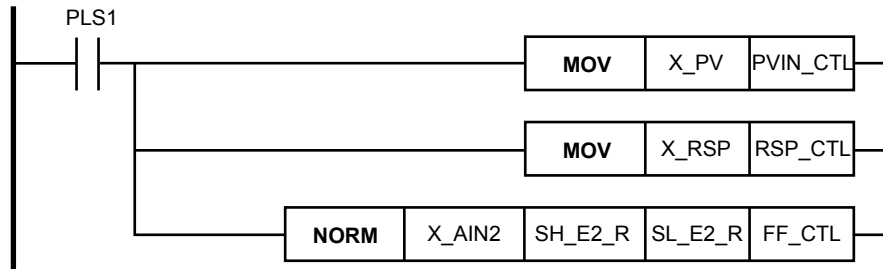

UP55A

Input registers	X_PV, X_RSP
Parameter registers	SH_E2_R, SL_E2_R

For an explanation of the registers, see Section 4.2, Registers.

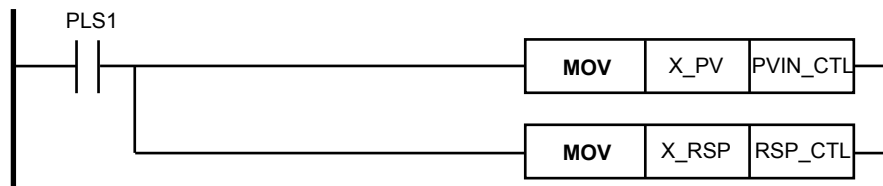

Output ladder calculation program

Input registers	OUT_CTL, OUT2_CTL, RET_CTL, OUTF_CTL, OUT2R_CTL, DOAL, DO10_E1, DO20_E2, DO30_E3, DO40_E3
Output registers	Y_OUT, Y_OUT2, Y_RET, Y_OUTR, Y_OUT2R, Y000, Y100_E1, Y200_E2, Y300_E3, Y400_E4

For an explanation of the registers, see Section 4.2, Registers.

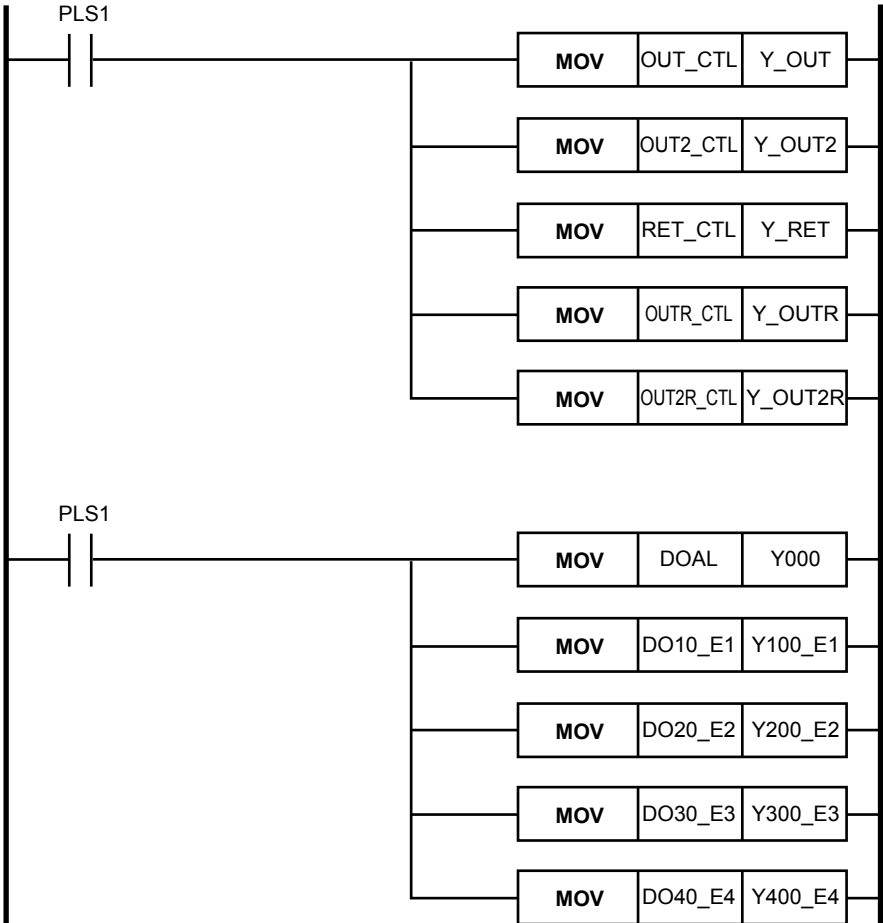

### 3.10.3 UT55A/UT52A/UP55A Cascade Primary-loop Control

#### Input ladder calculation program

Input registers	X_PV, X_RSP, X_AIN2
Parameter registers	SH_E1_R, SL_E1_R
Output registers	PVIN_CTL, TRK_CTL, RSP_CTL

For an explanation of the registers, see Section 4.2, Registers.

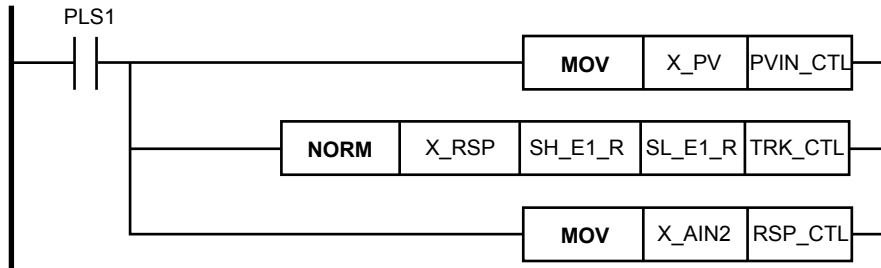

#### Output ladder calculation program

The output ladder calculation program is the same as that of UT55A/UT52A/UP55A Single-loop control.

### 3.10.4 UT55A/UT52A Cascade Secondary-loop Control

#### Input ladder calculation program

Input registers	X_PV, X_RSP
Output registers	PVIN_CTL, RSP_CTL

For an explanation of the registers, see Section 4.2, Registers.

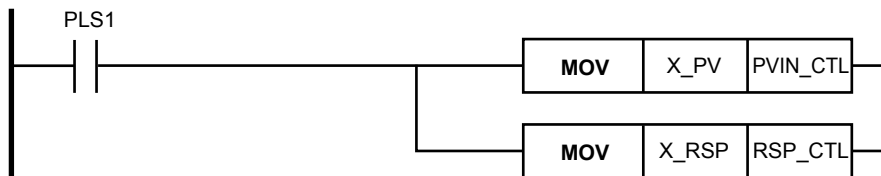

#### Output ladder calculation program

The output ladder calculation program is the same as that of UT55A/UT52A Single-loop control.

### 3.10.5 UT55A/UT52A/UP55A Cascade Control

#### Input ladder calculation program

Input registers	X_PV, X_RSP, X_AIN2
Output registers	PVIN_CTL, PV2IN_CTL, RSP_CTL

For an explanation of the registers, see Section 4.2, Registers.

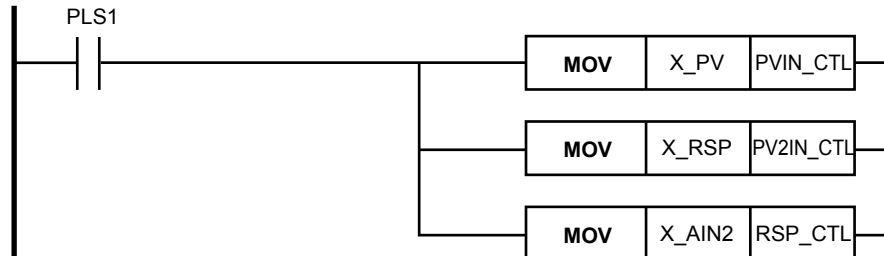

#### Output ladder calculation program

The output ladder calculation program is the same as that of UT55A/UT52A /UP55A Single-loop control.

### 3.10.6 UT55A/UT52A Loop Control for Backup

#### Input ladder calculation program

The input ladder calculation program is the same as that of UT55A/UT52A Cascade primary-loop control.

#### Output ladder calculation program

The output ladder calculation program is the same as that of UT55A/UT52A Single-loop control.



### 3.10.7 UT55A/UT52A/UP55A Loop Control with PV Switching

#### Input ladder calculation program

Input registers	X_PV, X_RSP, X_AIN2
Output registers	PVIN1_CTL, PVIN2_CTL, RSP_CTL

For an explanation of the registers, see Section 4.2, Registers.

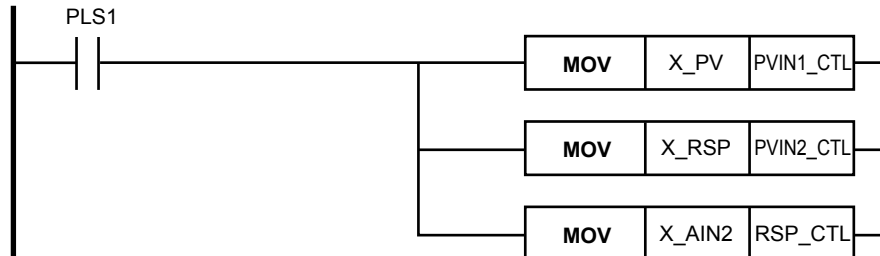

#### Output ladder calculation program

The output ladder calculation program is the same as that of UT55A/UT52A/UP55A Single-loop control.

### 3.10.8 UT55A/UT52A/UP55A Loop Control with PV Auto-selector

#### Input ladder calculation program

Input registers	X_PV, X_RSP, X_AIN2, X_AIN4
Output registers	PVIN1_CTL, PVIN2_CTL, PVIN3_CTL, PVIN4_CTL

PVIN3\_CTL and PVIN4\_CTL can be used according to the number of inputs.

For an explanation of the registers, see Section 4.2, Registers.

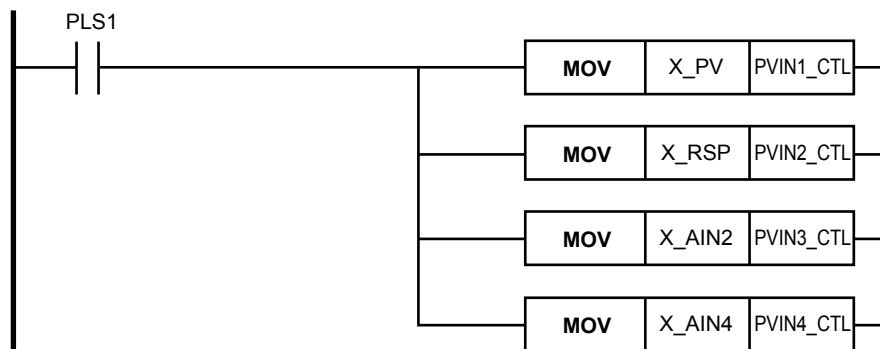

#### Output ladder calculation program

The output ladder calculation program is the same as that of UT55A/UT52A/UP55A Single-loop control.

### 3.10.9 UT55A/UT52A Loop Control with PV-hold Function

#### **Input ladder calculation program**

The input ladder calculation program is the same as that of UT55A/UT52A Single-loop control.

#### **Output ladder calculation program**

The output ladder calculation program is the same as that of UT55A/UT52A Single-loop control.

### 3.10.10 UT75A Single-loop Control

#### Input ladder calculation program

Input registers	X_PV, X_AIN2, X_AIN4
Parameter registers	SH_E2_R, SL_E2_R
Output registers	PVIN_CTL, RSP_CTL, FF_CTL

For an explanation of the registers, see Section 4.2, Registers.

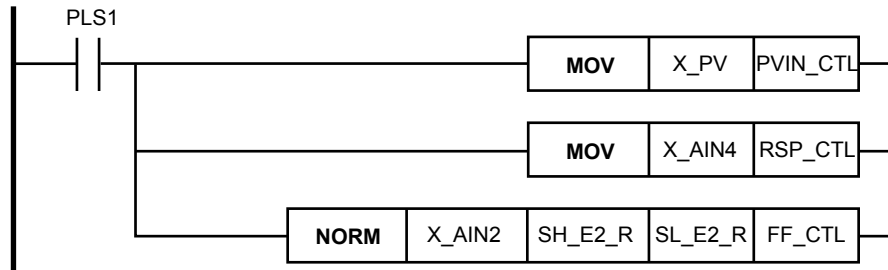

#### Output ladder calculation program

Input registers	OUT_CTL, OUT2_CTL, RET_CTL, OUTR_CTL, OUT2R_CTL, ALM3_CTL, ALM2R_CTL, DOAL, DO20_E2
Output registers	Y_OUT, Y_OUT2, Y_RET, Y_OUTR, Y_OUT2R, Y_ALM3, Y_ALM2R, Y000, Y200_E2

For an explanation of the registers, see Section 4.2, Registers.

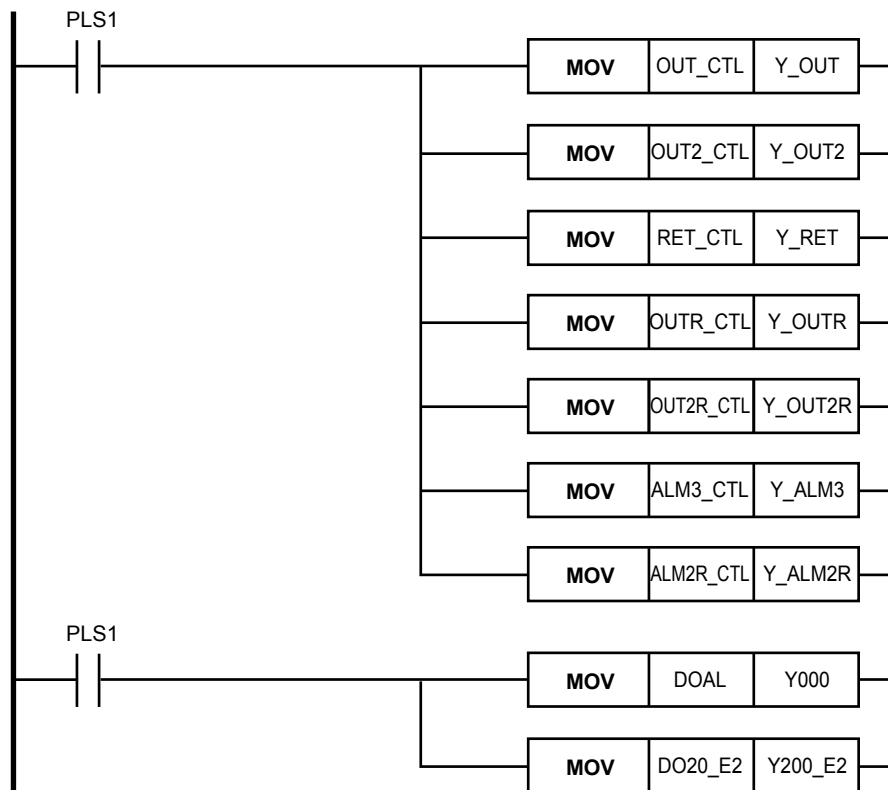

### 3.10.11 UT75A Cascade Primary-loop Control

#### Input ladder calculation program

Input registers	X_PV, X_AIN2, X_AIN4
Parameter registers	SH_E4_R, SL_E4_R
Output registers	PVIN_CTL, TRK_CTL, RSP_CTL

For an explanation of the registers, see Section 4.2, Registers.

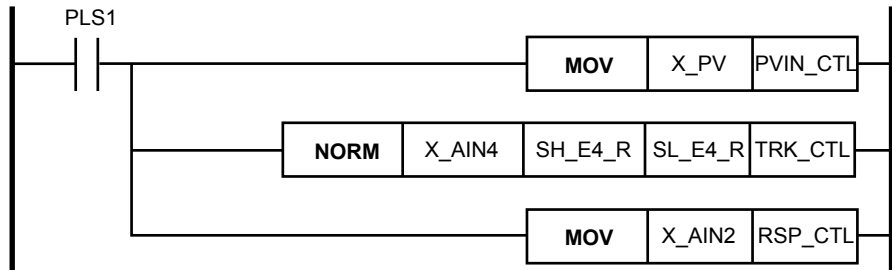

#### Output ladder calculation program

The output ladder calculation program is the same as that of UT75A Single-loop control.

### 3.10.12 UT75A Cascade Secondary-loop Control

#### Input ladder calculation program

Input registers	X_PV, X_AIN4
Output registers	PVIN_CTL, RSP_CTL

For an explanation of the registers, see Section 4.2, Registers.

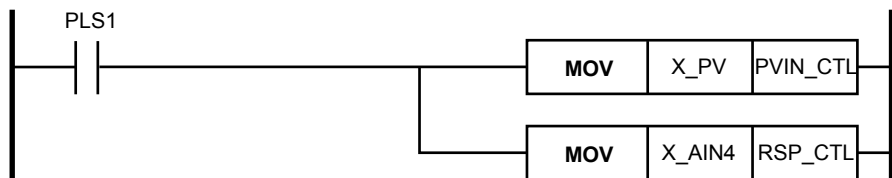

#### Output ladder calculation program

The output ladder calculation program is the same as that of UT75A Single-loop control.

### 3.10.13 UT75A Cascade Control

#### Input ladder calculation program

Input registers	X_PV, X_AIN2, X_AIN4
Output registers	PVIN_CTL, PVIN2_CTL, RSP_CTL

For an explanation of the registers, see Section 4.2, Registers.

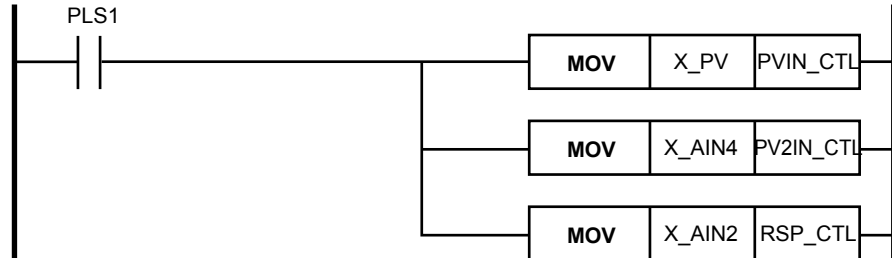

#### Output ladder calculation program

The output ladder calculation program is the same as that of UT75A Single-loop control.

### 3.10.14 UT75A Loop Control for Backup

#### Input ladder calculation program

The input ladder calculation program is the same as that of UT75A Cascade primary-loop control.

#### Output ladder calculation program

The output ladder calculation program is the same as that of UT75A Single-loop control.

### 3.10.15 UT75A Loop Control with PV Switching

#### Input ladder calculation program

Input registers	X_PV, X_AIN2, X_AIN4
Output registers	PVIN1_CTL, PVIN2_CTL, RSP_CTL

For an explanation of the registers, see Section 4.2, Registers.

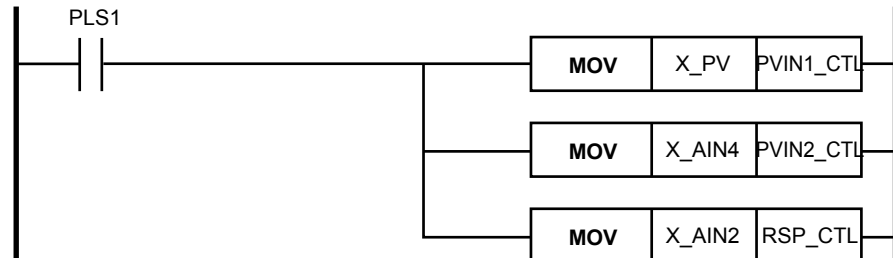

#### Output ladder calculation program

The output ladder calculation program is the same as that of UT75A Single-loop control.

### 3.10.16 UT75A Loop Control with PV Auto-selector

#### Input ladder calculation program

Input registers	X_PV, X_PV2, X_AIN2, X_AIN4
Output registers	PVIN1_CTL, PVIN2_CTL, PVIN3_CTL, PVIN4_CTL

PVIN3\_CTL and PVIN4\_CTL can be used depending to the input numbers.

For an explanation of the registers, see Section 4.2, Registers.

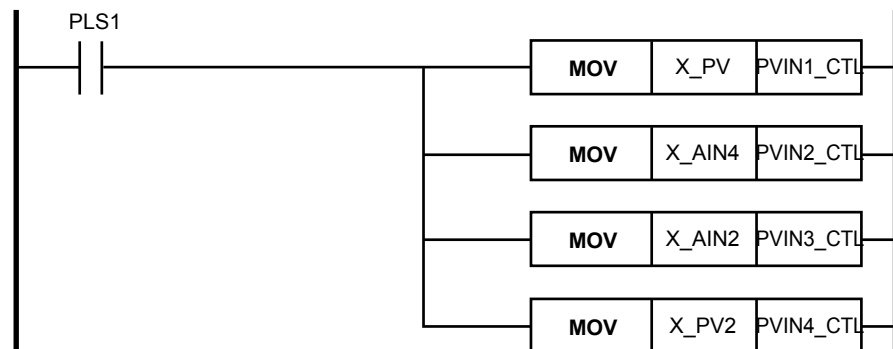

#### Output ladder calculation program

The output ladder calculation program is the same as that of UT75A Single loop control.

### 3.10.17 UT75A Loop Control with PV-hold Function

#### Input ladder calculation program

The input ladder calculation program is the same as that of UT75A Single-loop control.

#### Output ladder calculation program

The output ladder calculation program is the same as that of UT75A Single-loop control.

### 3.10.18 UT75A Dual-loop Control

#### Input ladder calculation program

Input registers	X_PV, X_PV2, X_AIN2, X_AIN4
Output registers	PVIN_CTL, RSP_CTL, PV2IN_CTL, RSP2_CTL

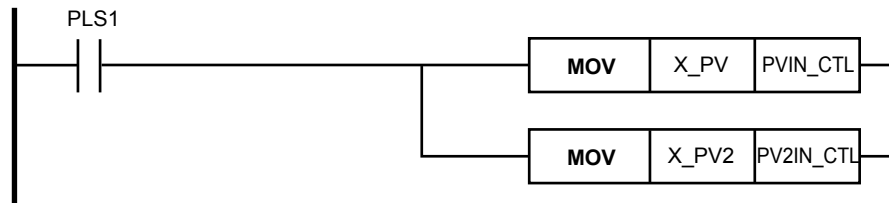

#### Output ladder calculation program

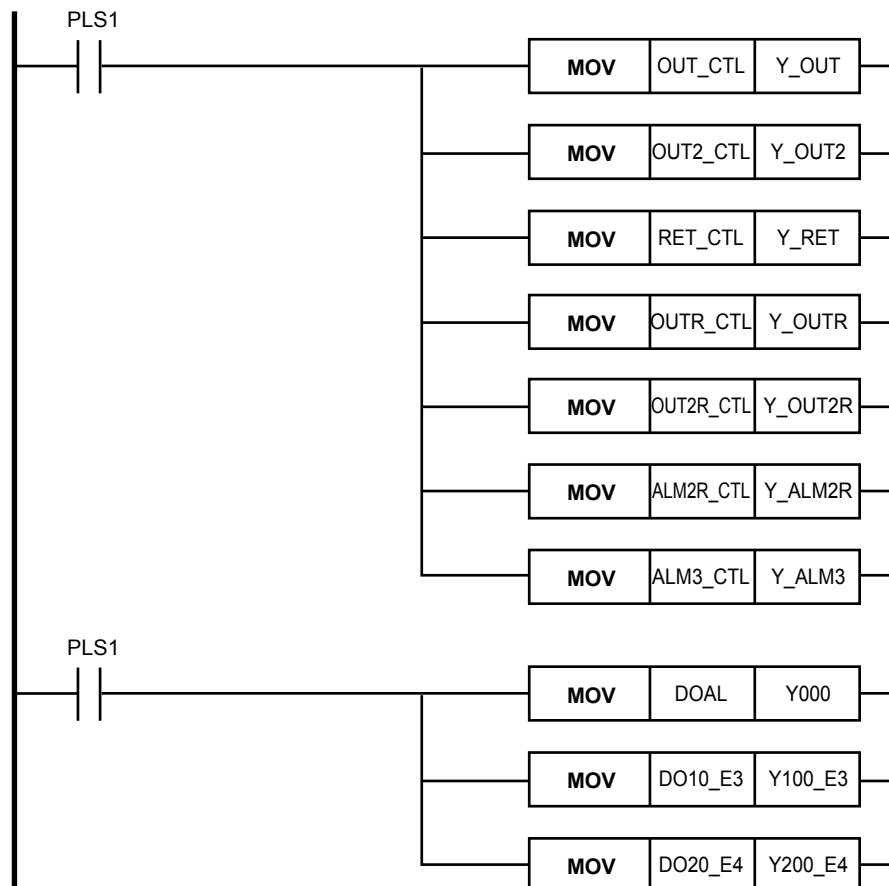

3.10.19 UT32A-D Dual-loop Control

Input ladder calculation program

Input registers	X_PV, X_PV2
Output registers	PVIN_CTL, PV2IN_CTL

For an explanation of the registers, see Section 4.2, Registers.

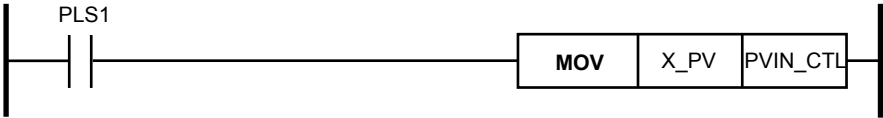

Output ladder calculation program

Input registers	OUT_CTL, RET_CTL, OUTF_CTL, OUT2R_CTL, DOAL, DO10_E1, DO40_E3
Output registers	Y_OUT, Y_RET, Y_OUTR, Y_OUT2R, Y000, Y100_E1, Y400_E4

For an explanation of the registers, see Section 4.2, Registers.

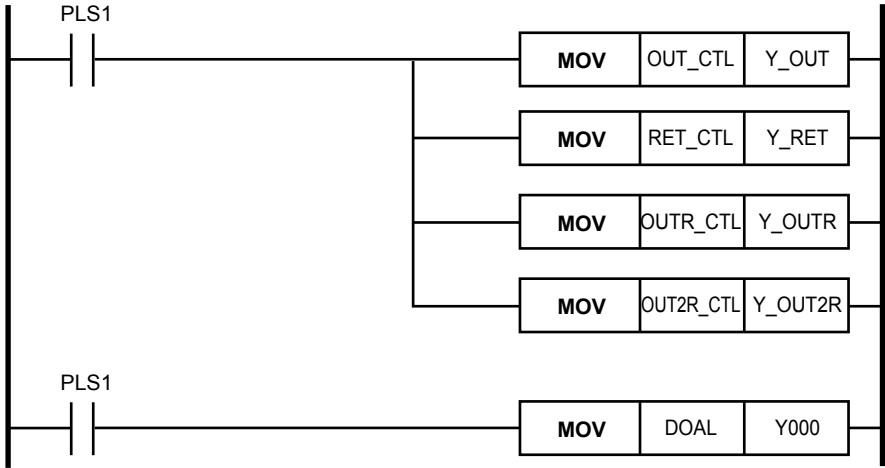





## 4.1 Basic Specifications

### 4.1.1 Control Period (Scan Time)

The control period is set using the parameter (SMP). The control period of UT35A/UT32A/UP35A/UP32A is fixed to 200 ms. The control period functions in the set period irrespective of the ladder program capacity. The table below shows guidelines for the ladder program capacity (approximate average value) for each control period. The average of one ladder instruction is equivalent to four steps. In performing actual operations, check the load factor with the Monitor Ladder Program before using the ladder programs. The step count varies depending on the types of instructions used, parameter setting in the main unit, and control period. This step count includes the step count for the default ladder program.

The step count of the ladder program is the step count for Mnemonics into which the ladder program has been converted from a ladder diagram. For the number of steps of ladder instructions, see the lists of basic instructions and application instructions described later.

- ▶ Parameters: UT35A/UT32A Digital Indicating Controllers User's Manual or Operation Guide
- ▶ Parameters: UT55A/UT52A Digital Indicating Controllers User's Manual or Operation Guide
- ▶ Parameters: UT75A Digital Indicating Controllers User's Manual or Operation Guide
- ▶ Parameters: UP35A/UP32A Program Controller User's Manual or Operation Guide
- ▶ Parameters: UP55A Program Controller User's Manual or Operation Guide
- ▶ Default ladder programs: Section 3.10, Default Ladder Programs

#### UT35A/UT32A/UP35A/UP32A

Control period	Ladder program capacity (as a guide)
200 ms	300 steps

#### UT75A/UT55A/UT52A/UP55A

Control period	Ladder program capacity (as a guide)
50 ms *	100 steps
100 ms	200 steps
200 ms	400 steps

\* Only for UT75A/UT55A/UT52A.

#### Max. Ladder Program Capacity

Model	Ladder program capacity (Max.)
UT35A/UT32A/UP35A/UP32A	300 steps
UT55A/UT52A/UP55A	500 steps
UT75A	1000 steps

### 4.1.2 Number of Inputs/Outputs

The table below shows the maximum number of inputs/outputs, which varies depending on the model and suffix codes. See App.2, Input/Output Tables, of the each User's Manual.

		UT35A	UT32A	UT55A	UT52A	UT75A	UP32A	UP35A	UP55A
Contact inputs	Standard model	Max. 7 points	Max. 4 points	Max. 9 points	Max. 5 points	Max. 13 points	Max. 5 points	Max. 9 points	Max. 8 points
	Detailed model	Max. 12 points	Max. 7 points	Max. 23 points	Max. 8 points	–	Max. 8 points	Max. 23 points	Max. 13 points
Contact outputs	Standard model	Max. 8 points	Max. 5 points	Max. 18 points	Max. 5 points	Max. 8 points	Max. 5 points	Max. 18 points	Max. 8 points
	Detailed model	Max. 13 points	Max. 8 points	Max. 23 points	Max. 8 points	–	Max. 8 points	Max. 23 points	Max. 13 points

\* The number of contact outputs excludes control relays.

## 4.1 Basic Specifications

### 4.1.3 Types of Instructions

There are 13 types of basic instructions and 73 types of application instructions.

There are 15 types of basic instructions and 119 types of application instructions for UT75A.

For more information, see section 4.4 or later.

### 4.1.4 Sequence Devices

	Device Type	Number of Points	Remarks
Contact inputs/outputs	Input relay (bit data)	See 4.1.2.	
	Output relay (bit data)		
Internal devices	M: relay (bit data)	256	Holding type/non-holding type
	DAT: register (floating point number)	28 or 58*	Holding type/non-holding type
	P: register (floating point number, held at power failure)	10 or 30*	Parameter settable
	K: register (floating point number)	30 or 50*	
Timers	Time-out relay (bit data)	4	
Timers with back-up	Time-out relay with back-up (bit data)	2*	
Counters	Count-out relay (bit data)	4	
Counters with back-up	Count-out relay with back-up (bit data)	2*	
Special devices	Relay (bit data)	12	
Registers	Process data, operation mode, parameter data, etc.	See Communication Interface User's Manual.	
Relays	Alarm status, alarm output status, key status, display status, events, etc.		

\* UT75A only.

### 4.1.5 Operation Status

Whether or not to use the ladder sequence can be set.

When using the ladder sequence, there are four operation modes:

- L-STOP (No ladder program is run.)
- 1SCAN (The ladder program is run by one scan.)
- L-RUN (The ladder program is run.)
- L-RESET RUN (The main unit will perform the same operation as at power-on.)

These operation modes can be specified on the Monitor Ladder Program window.

▶ [Monitor Ladder Program: Section 3.8, Monitoring a Ladder Program](#)

### 4.1.6 Operation Conditions

The ladder programs run in all control modes (CTLM). UT35A/UT32A/UP35A/UP32A does not have the parameter CTLM (Control mode.)

To use a ladder program, set the Ladder Sequence Function to "USE" on the System Data window.

### 4.1.7 Operation in Operation Mode L-RUN/L-STOP on the Monitor Ladder Program

When the operation mode is set to L-STOP on the Monitor Ladder Program, control computation and sequence control stop, the output is fixed to the value before stop, and input measurement is stopped.

When ladder operation is executed by one scan, the input is measured during one scan and control computation and sequence calculation are made. The ladder operation then enters the L-STOP status.

If the Monitor Ladder Program is exited and the main unit's power is restarted, the timer's current value, etc. are initialized. The timer's current value, etc. will be held unless the main unit's power is restarted.

## 4.2 Registers

### 4.2.1 Input/Output Ladder Calculation Relays/Registers

#### ■ UT35A/UT32A/UP35A/UP32A

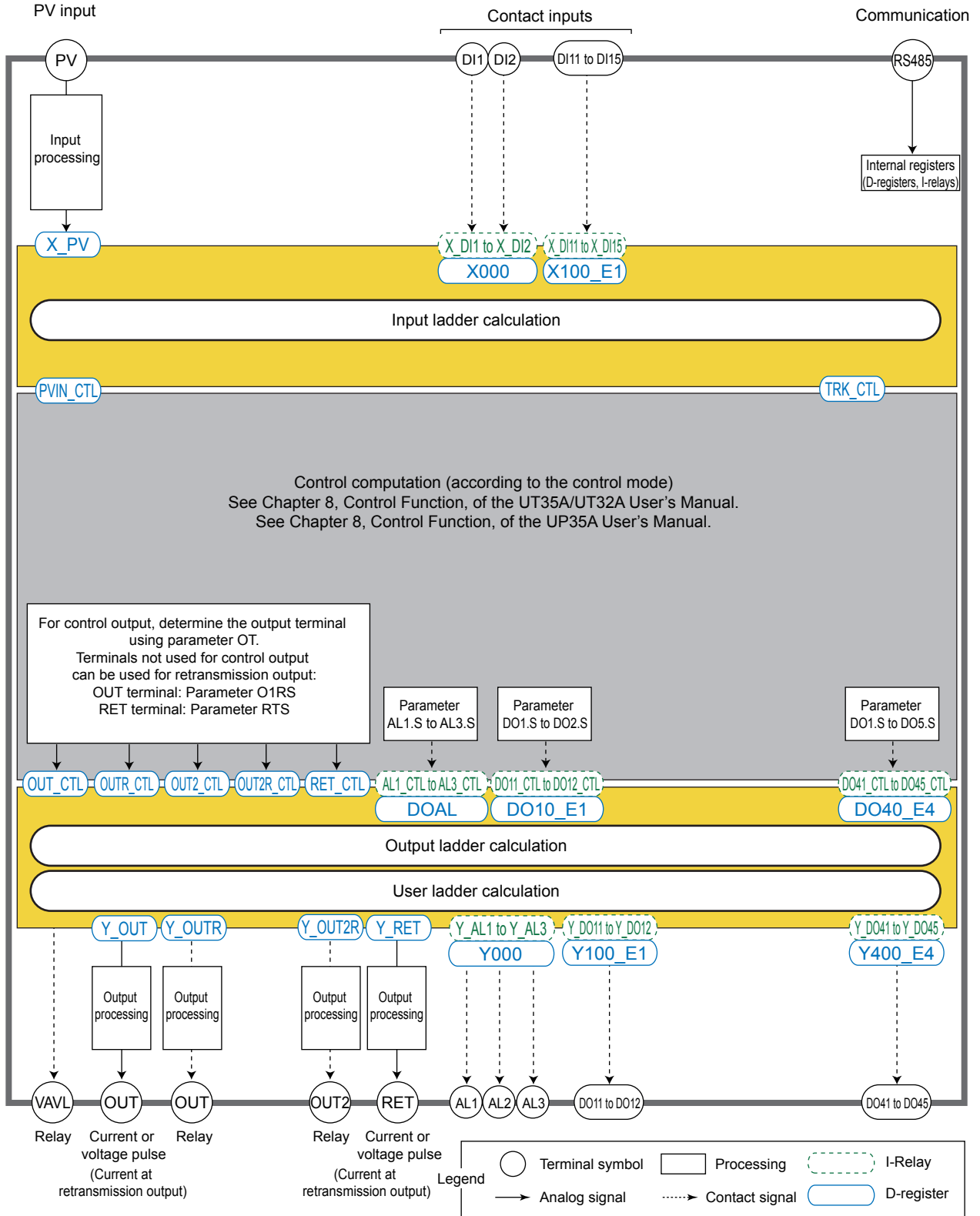

## 4.2 Registers

### ■ UT55A/UT52A/UP55A

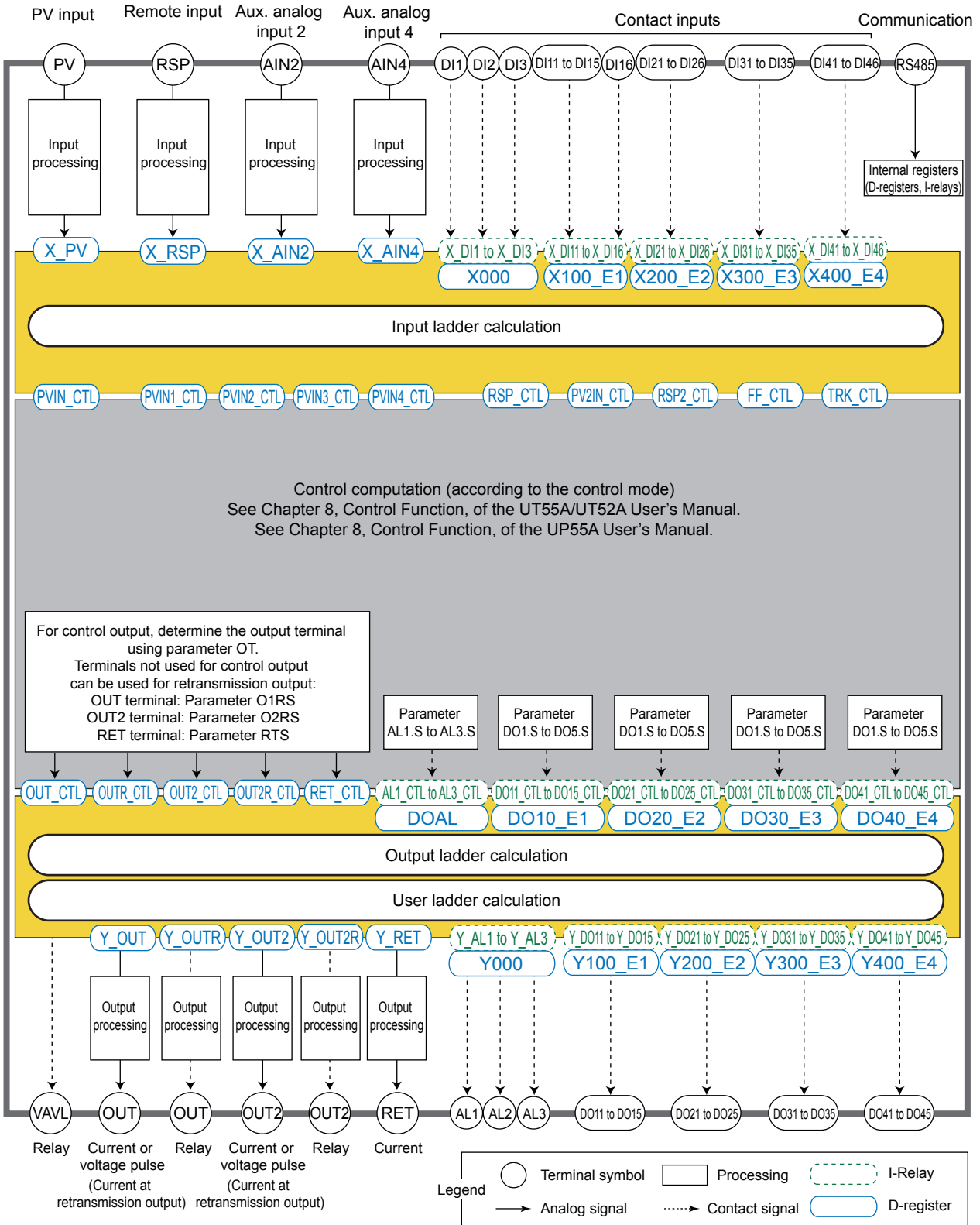

■ UT75A

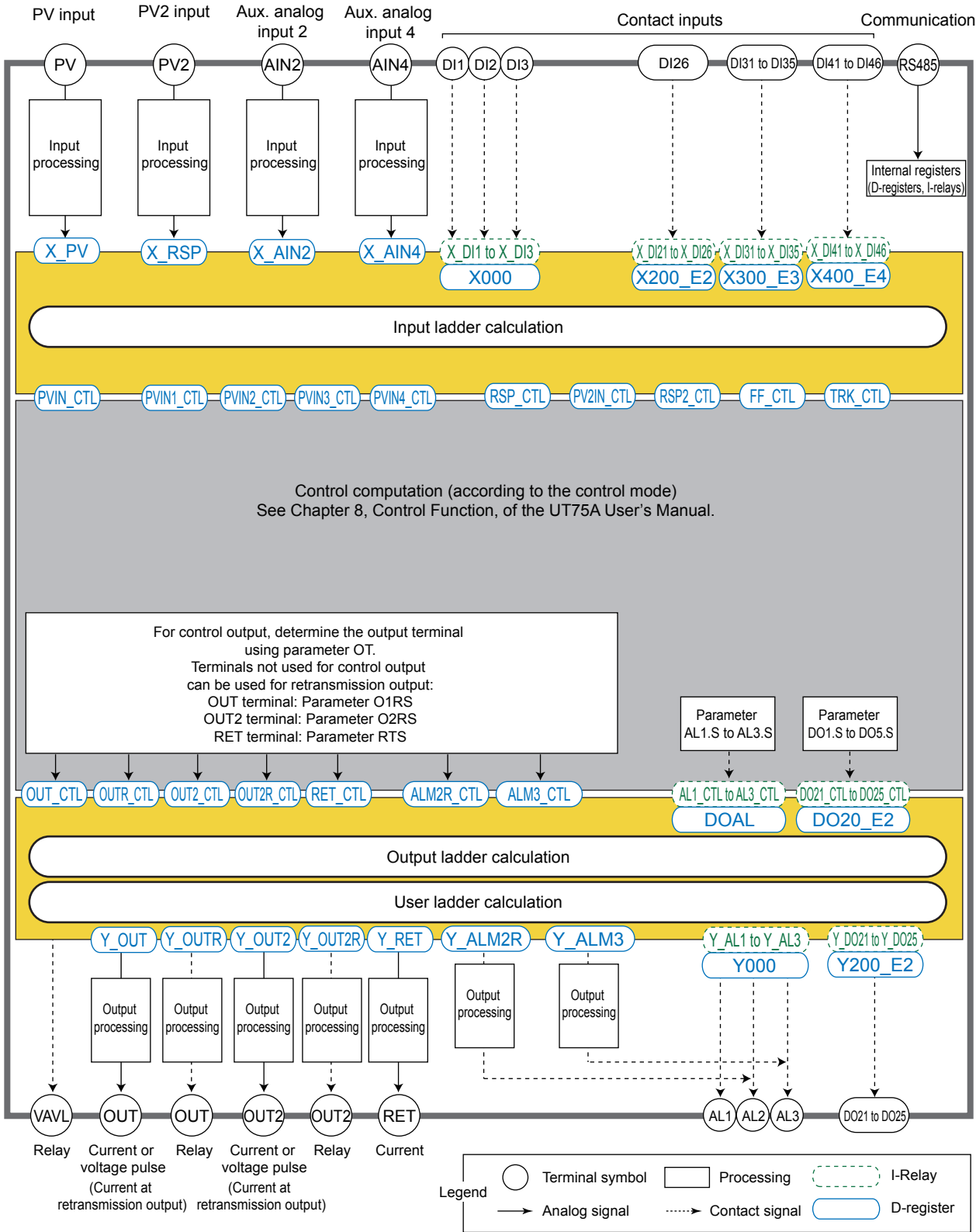

### Input ladder calculation

Analog input registers (X\_PV, X\_RSP (X\_PV2 in case of UT75A), X\_AIN2, and X\_AIN4) and input (status) relays (X\_DI1 to X\_DI3, X\_DI11 to X\_DI16, X\_DI21 to X\_DI26, X\_DI31 to X\_DI35, and X\_DI41 to X\_DI46) are captured to perform calculation in the input ladder calculation section. The calculated results are written into control input registers (PVIN\_CTL, PVIN1\_CTL, PVIN2\_CTL, PVIN3\_CTL, PVIN4\_CTL, RSP\_CTL, PV2IN\_CTL, RSP2\_CTL, FF\_CTL, and TRK\_CTL) and then passed to the control computation section.

Input (status) relays (X\_DI1 to X\_DI3, X\_DI11 to X\_DI16, X\_DI21 to X\_DI26, X\_DI31 to X\_DI35, and X\_DI41 to X\_DI46) are also stored in the input status registers (X000, X100\_E1, X200\_E2, X300\_E3, and X400\_E4).

### Output ladder calculation

Control computation registers computed in the control computation section (OUT\_CTL, OUTR\_CTL, OUT2\_CTL, OUT2R\_CTL, RET\_CTL, ALM2R\_CTL\*, and ALM3\_CTL\*), and control status registers (DOAL, DO10\_E1, DO20\_E2, DO30\_E3, and DO40\_E4) are captured to perform calculation in the output ladder calculation or user ladder calculation section. The calculated results are written into output registers (Y\_OUT, Y\_OUTR, Y\_OUT2, Y\_OUT2R, Y\_RET, Y\_ALM2R\*, and Y\_ALM3\*), and output status registers (Y000, Y100\_E1, Y200\_E2, Y300\_E3, and E400\_E4) and then output to the terminals.

Control status registers are also stored in control (status) relays (AL1\_CTL to AL3\_CTL, DO11\_CTL to DO45\_CTL).

Output status registers are also stored in the output (status) relays (Y\_AL1 to Y\_AL3, Y\_DO11 to Y\_DO45).

\* UT75A only.

### User ladder calculation

It is recommended that the user ladder calculation section be used if a sequence is desired to be configured regardless of controller control computation.

As the initial status, the default ladder programs are described in the input ladder calculation and output ladder calculation sections on a control mode basis. No program is written in the user ladder calculation section.

► [Default ladder programs: Section 3.10, Default Ladder Programs](#)

### Order of executing computation/calculation

The order of executing computation/calculation is as follows:

- (1) Input ladder calculation
- (2) Control computation
- (3) Output ladder calculation
- (4) User ladder calculation

Inputs/outputs differ depending on the model and suffix codes:

► [Input/output: App.2, Input/Output Tables.](#)

## Input Ladder Calculation: Analog Input Registers (Read Only)

Position	Terminal Symbol	Register (16 bits)	Description
Standard terminal area	PV	<b>X_PV</b>	PV analog input
E1-terminal area	RSP	<b>X_RSP</b>	RSP analog input
E1-terminal area	PV2	<b>X_PV2</b>	PV2 analog input ( for UT75A)
E2-terminal area	AIN2	<b>X_AIN2</b>	AIN2 aux. analog input
E4-terminal area	AIN4	<b>X_AIN4</b>	AIN4 aux. analog input

Registers can also be read in the output ladder calculation section or user ladder calculation section.

**Data format**

These registers handle analog inputs as values consisting of signed two-byte data of -19999 to 30000 including the decimal point position. They are range or scaling processed values (actual quantities).

Internal processing handles data as 4-byte floating-point numbers (IEEE 754 single-precision floating-point format).

## Input Ladder Calculation: Input (Status) Relays/Input Status Registers (Read Only)

Position	Terminal Symbol	Relay (1 bit)	Status Register (16 bits)	Description
Standard terminal area	DI1	<b>X_DI1</b>	<b>X000</b>	DI1 status
	DI2	<b>X_DI2</b>		DI2 status
	DI3	<b>X_DI3</b>		DI3 status
E1-terminal area	DI11	<b>X_DI11</b>	<b>X100_E1</b>	DI11 status
	DI12	<b>X_DI12</b>		DI12 status
	DI13	<b>X_DI13</b>		DI13 status
	DI14	<b>X_DI14</b>		DI14 status
	DI15	<b>X_DI15</b>		DI15 status
	DI16	<b>X_DI16</b>		DI16 status
E2-terminal area	DI21	<b>X_DI21</b>	<b>X200_E2</b>	DI21 status
	DI22	<b>X_DI22</b>		DI22 status
	DI23	<b>X_DI23</b>		DI23 status
	DI24	<b>X_DI24</b>		DI24 status
	DI25	<b>X_DI25</b>		DI25 status
	DI26	<b>X_DI26</b>		DI26 status
E3-terminal area	DI31	<b>X_DI31</b>	<b>X300_E3</b>	DI31 status
	DI32	<b>X_DI32</b>		DI32 status
	DI33	<b>X_DI33</b>		DI33 status
	DI34	<b>X_DI34</b>		DI34 status
	DI35	<b>X_DI35</b>		DI35 status
E4-terminal area	DI41	<b>X_DI41</b>	<b>X400_E4</b>	DI41 status
	DI42	<b>X_DI42</b>		DI42 status
	DI43	<b>X_DI43</b>		DI43 status
	DI44	<b>X_DI44</b>		DI44 status
	DI45	<b>X_DI45</b>		DI45 status
	DI46	<b>X_DI46</b>		DI46 status

Relays/status registers can also be read in the output ladder calculation section or user ladder calculation section.

**Data format**

- Input ladder calculation      Relays: 0 or 1
- Input ladder calculation      Status registers: Unsigned 16-bit integers



## 4.2 Registers

### Note

When the contact input status is used in the ladder, deactivate the contact input function (STOP/RUN switch, AUTO/MAN switch, etc.) using the main main unit's parameter.

Check the parameter settings belonging to the setup parameter menu DI.SL (DI function registration menu) or DI.NU (DI function numbering menu).

Status register: X000

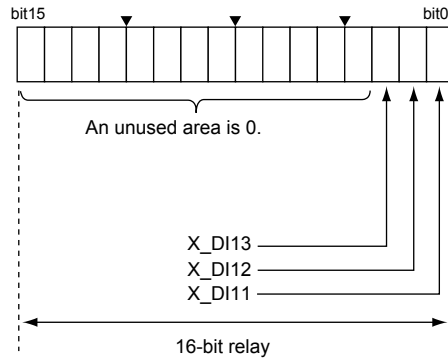

Status register: X100\_E1

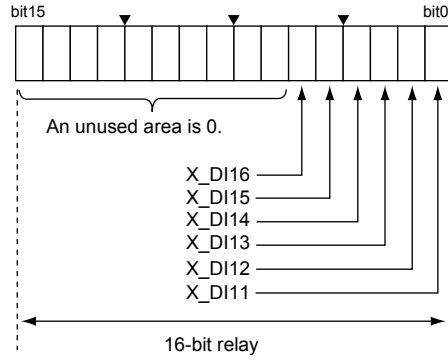

Status register: X200\_E2

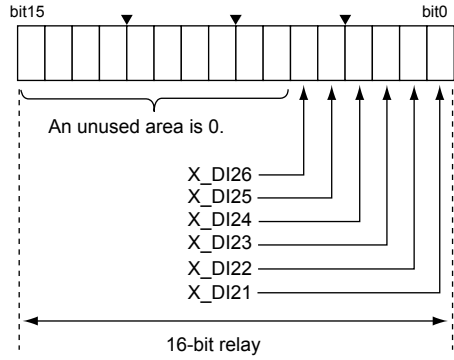

Status register: X300\_E3

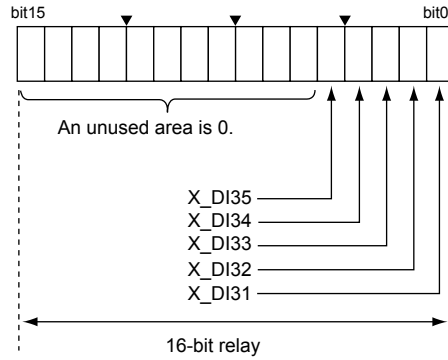

Status register: X400\_E4

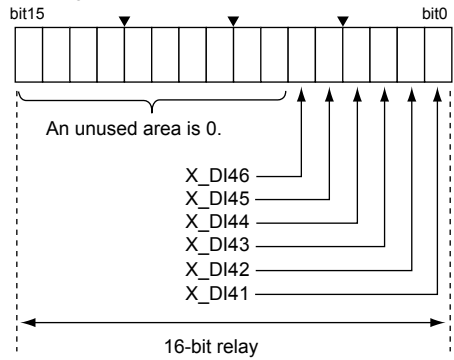

### Input Ladder Calculation: Control Input Registers (Read/Write)

Register (16 bits)	Description
PVIN_CTL	Control PV input (in controls other than Loop control with PV switching or Loop control with PV auto-selector)
PVIN1_CTL	Control PV input 1 (in Loop control with PV switching or Loop control with PV auto-selector)
PVIN2_CTL	Control PV input 2 (in Loop control with PV auto-selector or Loop control with PV switching)
PVIN3_CTL	Control PV input 3 (in Loop control with PV auto-selector)
PVIN4_CTL	Control PV input 4 (in Loop control with PV auto-selector)
PV2IN_CTL	Control PV2 input (in Cascade control)
RSP_CTL	Control RSP input
RSP2_CTL	Control RSP2 input (in Cascade control)
TRK_CTL	Control tracking input (except for Cascade control)
FF_CTL	Control feedforward input (in Single-loop control or Loop control with PV-hold function)

Registers can also be read in the output ladder calculation section or user ladder calculation section.

#### Data format

These registers handle calculated results as values consisting of signed two-byte data of -19999 to 30000 including the decimal point position.

Internal processing handles data as 4-byte floating-point numbers (IEEE 754 single-precision floating-point format).

**Output Ladder Calculation: Control Computation Registers (Read Only)**

Register (16 bits)	Description
<a href="#">OUT_CTL</a>	Control OUT output (current and voltage pulses)
<a href="#">OUTR_CTL</a>	Control OUT output (relays)
<a href="#">OUT2_CTL</a>	Control OUT2 output (current and voltage pulses)
<a href="#">OUT2R_CTL</a>	Control OUT2 output (relays)
<a href="#">RET_CTL</a>	Control RET output (current)
<a href="#">ALM2R_CTL</a>	Control ALM2 output (relays)
<a href="#">ALM3_CTL</a>	Control ALM3 output (relays)

Registers can also be read in the input ladder calculation section or user ladder calculation section.

**Data format**

These registers handle computed data as values consisting of signed two-byte data of -19999 to 30000 including the decimal point position.

**Scaling**

Internal processing handles data as 4-byte floating-point numbers (IEEE 754 single-precision floating-point format).

**Output Ladder Calculation: Control (Status) Relays/Control Status Registers (Read Only)**

Relay (1 bit)	Status Register (16 bits)	Description	
<a href="#">AL1_CTL</a>	<a href="#">DOAL</a>	Control AL1 status	Function set using parameter AL1.S
<a href="#">AL2_CTL</a>		Control AL2 status	Function set using parameter AL2.S
<a href="#">AL3_CTL</a>		Control AL3 status	Function set using parameter AL3.S
<a href="#">DO11_CTL</a>	<a href="#">DO10_E1</a>	Control DO11 status	Function set using parameter DO1.S
<a href="#">DO12_CTL</a>		Control DO12 status	Function set using parameter DO2.S
<a href="#">DO13_CTL</a>		Control DO13 status	Function set using parameter DO3.S
<a href="#">DO14_CTL</a>		Control DO14 status	Function set using parameter DO4.S
<a href="#">DO15_CTL</a>		Control DO15 status	Function set using parameter DO5.S
<a href="#">DO21_CTL</a>	<a href="#">DO20_E2</a>	Control DO21 status	Function set using parameter DO1.S
<a href="#">DO22_CTL</a>		Control DO22 status	Function set using parameter DO2.S
<a href="#">DO23_CTL</a>		Control DO23 status	Function set using parameter DO3.S
<a href="#">DO24_CTL</a>		Control DO24 status	Function set using parameter DO4.S
<a href="#">DO25_CTL</a>		Control DO25 status	Function set using parameter DO5.S
<a href="#">DO31_CTL</a>	<a href="#">DO30_E3</a>	Control DO31 status	Function set using parameter DO1.S
<a href="#">DO32_CTL</a>		Control DO32 status	Function set using parameter DO2.S
<a href="#">DO33_CTL</a>		Control DO33 status	Function set using parameter DO3.S
<a href="#">DO34_CTL</a>		Control DO34 status	Function set using parameter DO4.S
<a href="#">DO35_CTL</a>		Control DO35 status	Function set using parameter DO5.S
<a href="#">DO41_CTL</a>	<a href="#">DO40_E4</a>	Control DO41 status	Function set using parameter DO1.S
<a href="#">DO42_CTL</a>		Control DO42 status	Function set using parameter DO2.S
<a href="#">DO43_CTL</a>		Control DO43 status	Function set using parameter DO3.S
<a href="#">DO44_CTL</a>		Control DO44 status	Function set using parameter DO4.S
<a href="#">DO45_CTL</a>		Control DO45 status	Function set using parameter DO5.S

Relays/status registers can also be read in the input ladder calculation section or user ladder calculation section.

- ▶ Parameters: [UT35A/UT32A Digital Indicating Controllers User's Manual or Operation Guide](#), [UT55A/UT52A Digital Indicating Controllers User's Manual or Operation Guide](#), [UT75A Digital Indicating Controllers User's Manual or Operation Guide](#), [UP55A Program Controller User's Manual or Operation Guide](#), or [UP35A Program Controller User's Manual or Operation Guide](#)

**Data format**

- Output ladder calculation      Relays: 0 or 1  
     Internal processing handles a value of less than 0.5 as “0” and a value of 0.5 or more as “1.” This is internal processing used for transferring register data to relays, etc.
- Output ladder calculation      Status registers: Unsigned 16-bit integers

Status register: DOAL

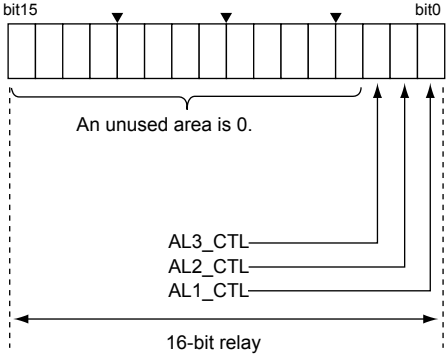

Status register: DO10\_E1

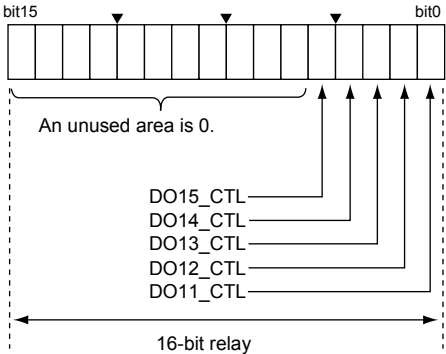

Status register: DO20\_E2

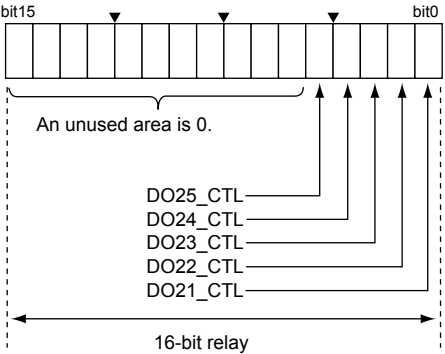

Status register: DO30\_E3

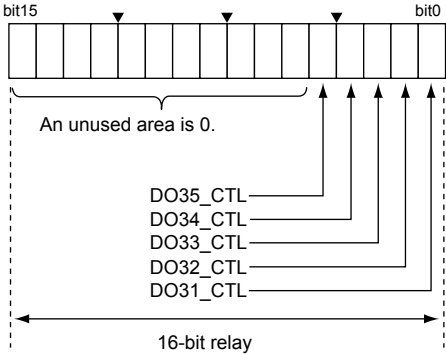

Status register: DO40\_E4

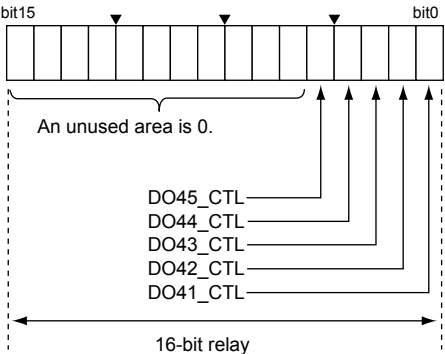

The default ladder programs transfer control status registers in the output ladder calculation section to the output status registers collectively.

	Control Status Registers	Output Status Registers
AL1 to AL3 status outputs	DOAL	Y000
DO11 to DO15 status outputs	DO10_E1	Y100_E1
DO21 to DO25 status outputs	DO20_E2	Y200_E2
DO31 to DO35 status outputs	DO30_E3	Y300_E3
DO41 to DO45 status outputs	DO40_E4	Y400_E4

▶ Default ladder programs: Section 3.10, Default Ladder Programs

Leaving the default ladder programs as is and describing a ladder program desired to be computed after the default ladder programs causes data to be overwritten and executed.

**Output Ladder Calculation: Output Registers (Read/Write)**

Position	Terminal Symbol	Register (16 bits)	Description
Standard terminal area	OUT	Y_OUT	OUT control output (current and voltage pulses)
	OUT	Y_OUTR	OUTR control output (relays)
	OUT2	Y_OUT2	OUT2 control output (current and voltage pulses)
	OUT2	Y_OUT2R	OUT2R control output (relays)
	RET	Y_RET	RET retransmission output (current)
	AL2	Y_ALM2R	ALM2 control output (relays)*
	AL3	Y_ALM3	ALM3 control output (relays)*

Registers can also be read/write in the input ladder calculation section or user ladder calculation section.  
 \* UT75A only.

**Data format**

These registers handle calculated results as values consisting of signed two-byte data of -19999 to 30000 including the decimal point position.

Output data is -5.0 to 105.0% data; the range of data that can be actually handled is from -50 to 1050.

Internal processing handles data as 4-byte floating-point numbers (IEEE 754 single-precision floating-point format).

**Output Ladder Calculation: Output (Status) Relays/Output Status Registers (Read/Write)**

Position	Terminal Symbol	Relay (1 bit)	Status Register (16 bits)	Description
Standard terminal area	AL1	Y_AL1	Y000	AL1 status
	AL2	Y_AL2		AL2 status
	AL3	Y_AL3		AL3 status
E1-terminal area	DO11	Y_DO11	Y100_E1	DO11 status
	DO12	Y_DO12		DO12 status
	DO13	Y_DO13		DO13 status
	DO14	Y_DO14		DO14 status
	DO15	Y_DO15		DO15 status
E2-terminal area	DO21	Y_DO21	Y200_E2	DO21 status
	DO22	Y_DO22		DO22 status
	DO23	Y_DO23		DO23 status
	DO24	Y_DO24		DO24 status
	DO25	Y_DO25		DO25 status
E3-terminal area	DO31	Y_DO31	Y300_E3	DO31 status
	DO32	Y_DO32		DO32 status
	DO33	Y_DO33		DO33 status
	DO34	Y_DO34		DO34 status
	DO35	Y_DO35		DO35 status
E4-terminal area	DO41	Y_DO41	Y400_E4	DO41 status
	DO42	Y_DO42		DO42 status
	DO43	Y_DO43		DO43 status
	DO44	Y_DO44		DO44 status
	DO45	Y_DO45		DO45 status

Relays/status registers can also be read/write in the input ladder calculation section or user ladder calculation section.

Data format

- Output ladder calculation Relays: 0 or 1  
Internal processing handles a value of less than 0.5 as "0" and a value of 0.5 or more as "1." This is internal processing used for transferring register data to relays, etc.
- Output ladder calculation Status registers: Unsigned 16-bit integers

Status register: Y000

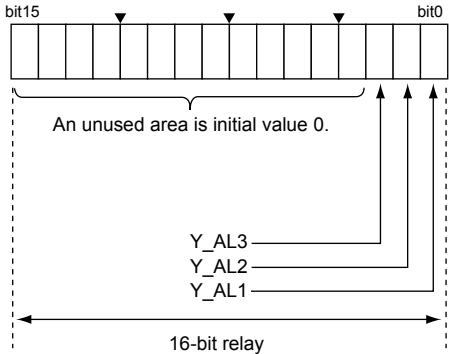

Status register: Y100\_E1

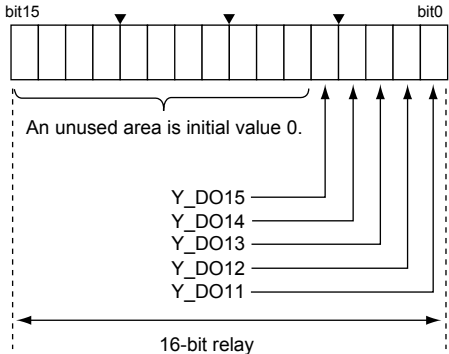

Status register: Y200\_E2

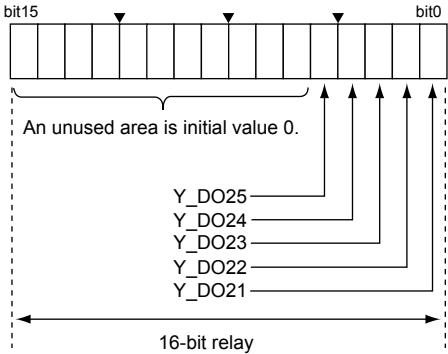

Status register: Y300\_E3

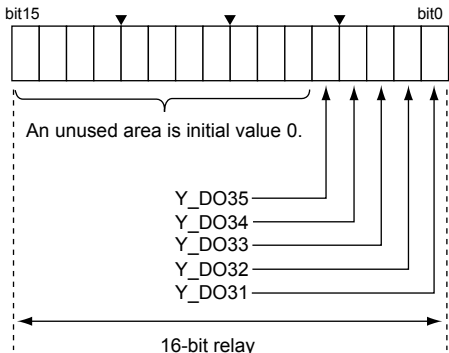

Status register: Y400\_E4

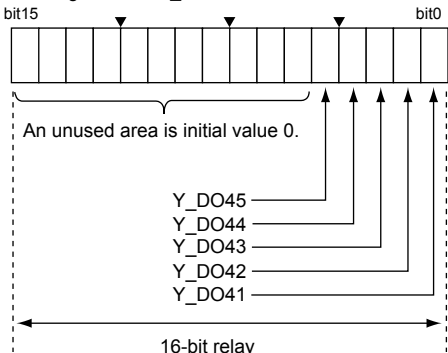

Note

- The presence/absence of inputs/outputs differs depending on the model and suffix codes. See App.2, Input/Output Tables.
- For function registers other than the input/output registers, see the "UTAdvanced Series Communication Interface User's Manual."

Note

The contact output links the event display. When the contact output is changed in a ladder program, check the event display settings (parameters EV1 to EV8).

4.2 Registers

4.2.2 Internal Devices (Read/Write)

Device Name	Relay/Register	Data Format	Remarks
Internal (M) relays	M01 to M128	0 or 1 Internal processing handles a value of less than 0.5 as "0" and a value of 0.5 or more as "1." M1_16: status registers of M01 to M16 relays M17_32: status registers of M17 to M32 relays M33_48: status registers of M33 to M48 relays M49_64: status registers of M49 to M64 relays M65_80: status registers of M65 to M80 relays M81_96: status registers of M81 to M96 relays M97_112: status registers of M97 to M112 relays M113_128: status registers of M113 to M128 relays	Non-holding type
	M01_B to M32_B	0 or 1 Internal processing handles a value of less than 0.5 as "0" and a value of 0.5 or more as "1." M1_16_B: status registers of M01_B to M16_B relays M17_32_B: status registers of M17_B to M32_B relays	Holding type
	M33_B to M128_B	0 or 1 Internal processing handles a value of less than 0.5 as "0" and a value of 0.5 or more as "1." M33_48_B: status registers of M33_B to M48_B relays M49_64_B: status registers of M49_B to M64_B relays M65_80_B: status registers of M65_B to M80_B relays M81_96_B: status registers of M81_B to M96_B relays M97_112_B: status registers of M97_B to M112_B relays M113_128_B: status registers of M113_B to M128_B relays	Holding type However, when the control period is 50ms, the data is non-holding type.
DAT registers	DAT01 to DAT20 (DAT01 to DAT50 in case of UT75A)	Handles data as 4-byte floating-point numbers (IEEE 754 single-precision floating-point format).	Non-holding type
	DAT01_B to DAT08_B		Holding type However, when the control period is 50ms, the data is non-holding type.
P-registers	P01 to P10 (P01 to P30 in case of UT75A)	Handles 2-byte integer ranging from -19999 to 30000 and the decimal point position.	Holding type, parameter setting P-registers are the same as P-parameters displayed on the main unit.

Device Name	Relay/Register	Data Format	Remarks
K-registers	<b>K01 to K30</b> ( <b>K01 to K50 in case of UT75A</b> )	K01 to K20, K31 to K50: Handles 2-byte integer ranging from -32768 to 32767 and the decimal point position. K21 to K30: Handles 2-byte integer ranging from 0 to 65535 and the decimal point position.	Holding type In the ladder program, do not write to K-registers. K-register constants can be set by clicking on [Tools] – [Set Constant] in the menu when the Ladder Program Building window is being displayed.
Constant registers	<b>C_1</b>	Constant -1 (unsigned 2-byte integer)	Fixed values. Write disabled.
	<b>C0</b>	Constant 0 (unsigned 2-byte integer)	
	<b>C1</b>	Constant 1 (unsigned 2-byte integer)	
	<b>C2</b>	Constant 2 (unsigned 2-byte integer)	
	<b>C3</b>	Constant 3 (unsigned 2-byte integer)	
	<b>C4</b>	Constant 4 (unsigned 2-byte integer)	
	<b>C5</b>	Constant 5 (unsigned 2-byte integer)	
	<b>C10</b>	Constant 10 (unsigned 2-byte integer)	
	<b>C50</b>	Constant 50 (unsigned 2-byte integer)	
	<b>C60</b>	Constant 60 (unsigned 2-byte integer)	
	<b>C100</b>	Constant 100 (unsigned 2-byte integer)	
	<b>C1000</b>	Constant 1000 (unsigned 2-byte integer)	
	<b>C10000</b>	Constant 10000 (unsigned 2-byte integer)	
Time-out relays	<b>TIM1 to TIM4</b>	"1" at time-out or "0" at reset TIM_RELAY: status registers of TIM1 to TIM4 relays	Used by a timer instruction. Write disabled.
	<b>TIM1_B to TIM2_B</b>	(UT75A only.) "1" at time-out or "0" at reset TIM_RELAY_B: status registers of TIM1_B to TIM2_B relays	
Count-out relays	<b>CNT1 to CNT4</b>	"1" at count-out or "0" at reset CNT1 to CNT4: status registers of CNT_RELAY relays	Used by a counter instruction. Write disabled.
	<b>CNT1_B to CNT2_B</b>	(UT75A only.) "1" at count-out or "0" at reset CNT1_B to CNT2_B: status registers of CNT_RELAY_B relays	



Internal relays

Status registers: M1\_16

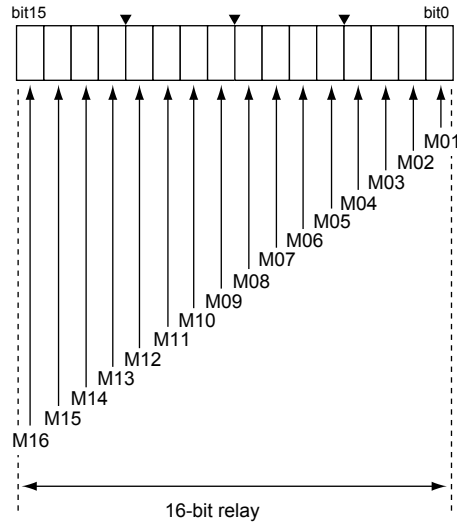

Status registers: M17\_32

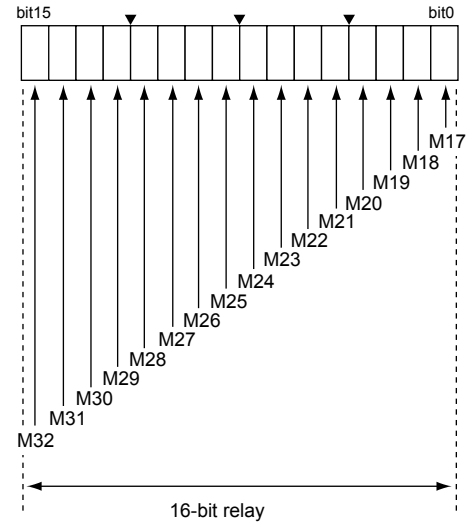

Status registers: M33\_48

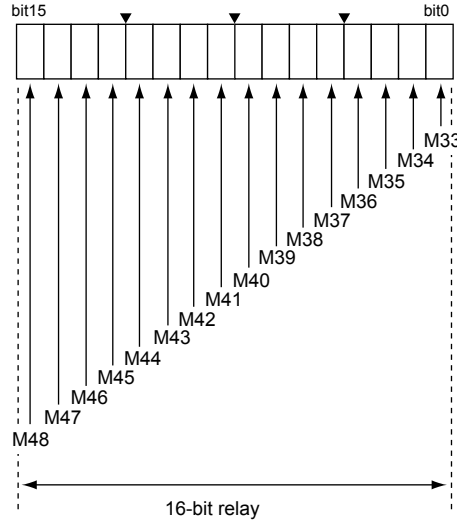

Status registers: M49\_64

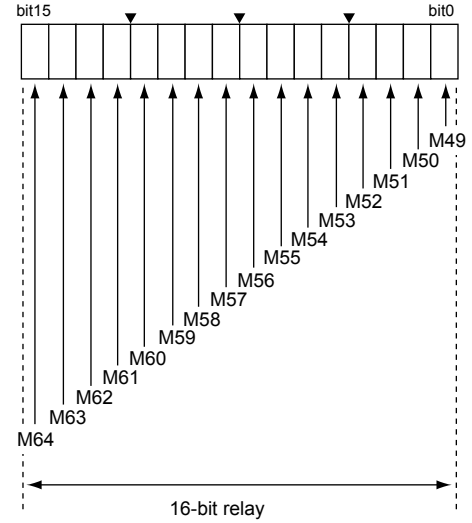

Bits M65 to M128 are also arranged in the status registers in the same way.

## Time-out relay and count-out relay

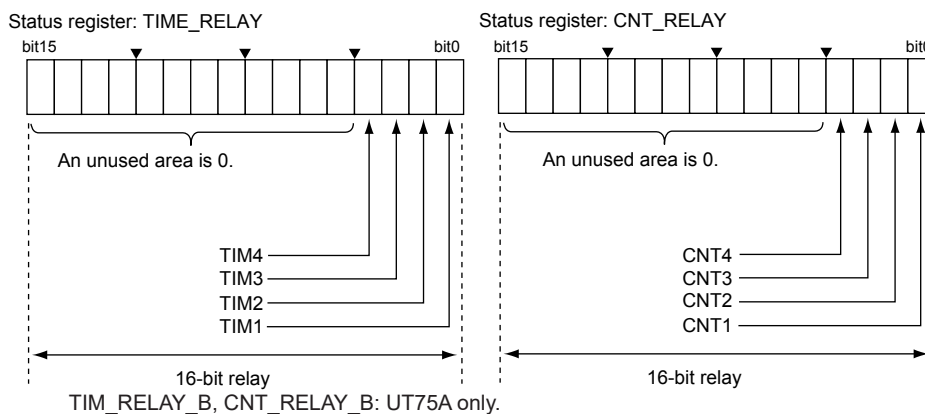

No power failure is detected in the following cases, and the unit maintains normal operations.

- A momentary power failure of 20 ms or less in the case of 100 – 240 V AC
- A momentary power failure of 1 ms in the case of 24 V AC/DC

In case of a power failure, the timer and counter will be initialized.

### 4.2.3 Parameter Registers and Status Relays (Read/Write)

Parameter registers contain main unit's target setpoints, alarm setpoints, etc. Parameter register data is 16-bit integers.

Registers are provided for process data and operation modes in addition to parameters.

Relays are provided for the alarm statuses, operation modes, bar graphs, events, etc.

► [Parameter Registers: UTAdvanced Series Communication Interface User's Manual](#)

#### **Note**

In the ladder programs, read/write of setup parameter data is impossible. However, the range, decimal point position, and scale of each analog input can be read only. (D registers D7501 to 7539)

## 4.2 Registers

### 4.2.4 Special Relays (Read Only)

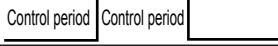
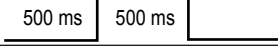
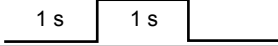
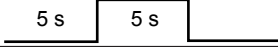
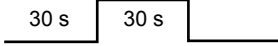
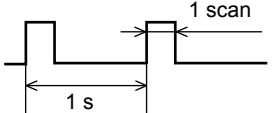
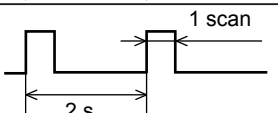
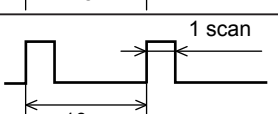
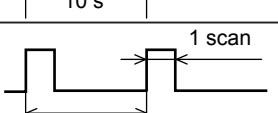
Special Relay	Action
<b>PON</b>	Activates a device for control period at power-on, reset start (L-RESET RUN), download the ladder program, or change of each input type and control period.
<b>PLS1</b>	Always ON
<b>ZERO</b>	Always OFF
<b>SMPCLK</b>	Control period clock 
<b>CLK1</b>	1-second clock 
<b>CLK2</b>	2-second clock 
<b>CLK10</b>	10-second clock 
<b>CLK60</b>	60-second clock 
<b>CLK1P</b>	1-second clock pulse 
<b>CLK2P</b>	2-second clock pulse 
<b>CLK10P</b>	10-second clock pulse 
<b>CLK60P</b>	60-second clock pulse 

#### Data format

0 or 1

Internal processing handles a value of less than 0.5 as "0" and a value of 0.5 or more as "1."

### 4.2.5 Registers/Relays for Peer-to-peer Communication (Read/Write)

Device Name	Address	Data Format
Analog input registers for peer-to-peer communication	<b>CX01 to CX16</b>	Handles data as 4-byte floating-point numbers (IEEE 754 single-precision floating-point format).
Analog output registers for peer-to-peer communication	<b>CY01 to CY04</b>	
Status input relays for peer-to-peer communication	<b>CI01 to CI64</b>	0 or 1
Status output relays for peer-to-peer communication	<b>CO1 to CO16</b>	Internal processing handles a value of less than 0.5 as "0" and a value of 0.5 or more as "1."
Reception time-out flag for peer-to-peer communication	<b>CF01 to CF04</b>	0 (normal) or 1 (error)
End of data reception flag for peer-to-peer communication	<b>CE01 to CE04</b>	0 (during reception) or 1 (end of reception) (*1)

\*1: The data reception flag will change from 0 to 1 after the PON relay is turned on.

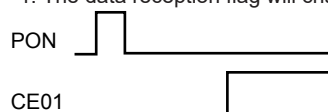

## 4.3 Data Format

This section gives an overview of the instructions. For more details, see sections 4.4 and 4.5.

### 4.3.1 Relay (Bit) Processing

Bit processing refers to processing that is performed when a bit device is specified in a basic instruction. It is executed in bits.

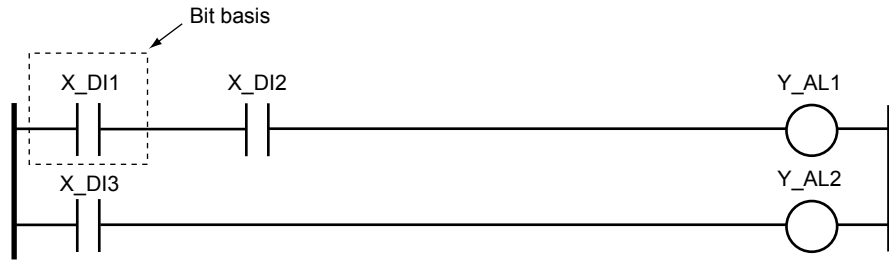

Type	Display Data	Internal Processing Data
Relay	0 or 1	Floating point number (Float)

### 4.3.2 Data (Register) Processing

Data processing refers to the processing of registers whose data is computed in 16-bit integers or in floating-point numbers.

Type	Display Data	Internal Processing Data
D-register	Signed 16-bit integer	Floating point number (Float)
Status register	Unsigned 16-bit integer	Unsigned 16-bit integer
DAT register	Floating point number (Float)	Floating point number (Float)

#### D-registers

Contain parameter data or process data. In the ladder programs, D-register data is handled as signed 16-bit integers (-19999 to 31500). In internal processing, it is handled as 4-byte floating-point numbers.

P-registers and K-registers are also in the same data format as D-registers.

Transfer source data is restricted according to the data format of the storage destination in case of using a transfer instruction, etc., so check and use the data format of the storage destination.

► [D-Registers: UTAdvanced Series Communication Interface User's Manual](#)

#### Status registers

M1\_16 (status registers of internal relays M01 to M16), M17\_32 (status registers of internal relays M17 to M32), M33\_48 (status registers of internal relays M33 to M48), and M49\_64 (status registers of internal relays M49 to M64)

These status registers are used to capture the statuses of contact inputs, etc. in 16 bits or to output the bit-basis ladder calculation results in 16 bits.

#### DAT registers

These registers are temporary registers used to store data during calculations. The Monitor Ladder Program window enables data to be monitored in floating-point numbers.

### 4.3 Data format

#### ■ Data register processing

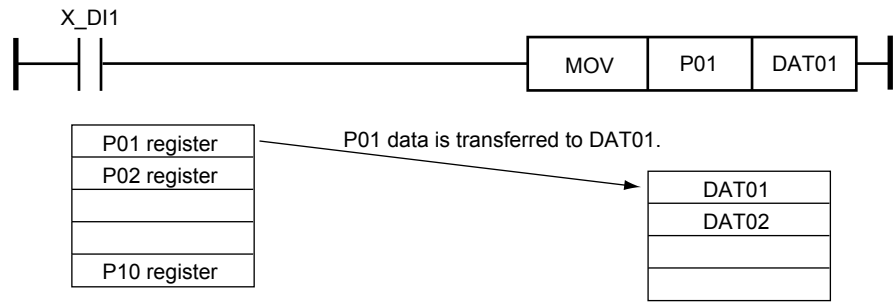

#### ■ Status register processing

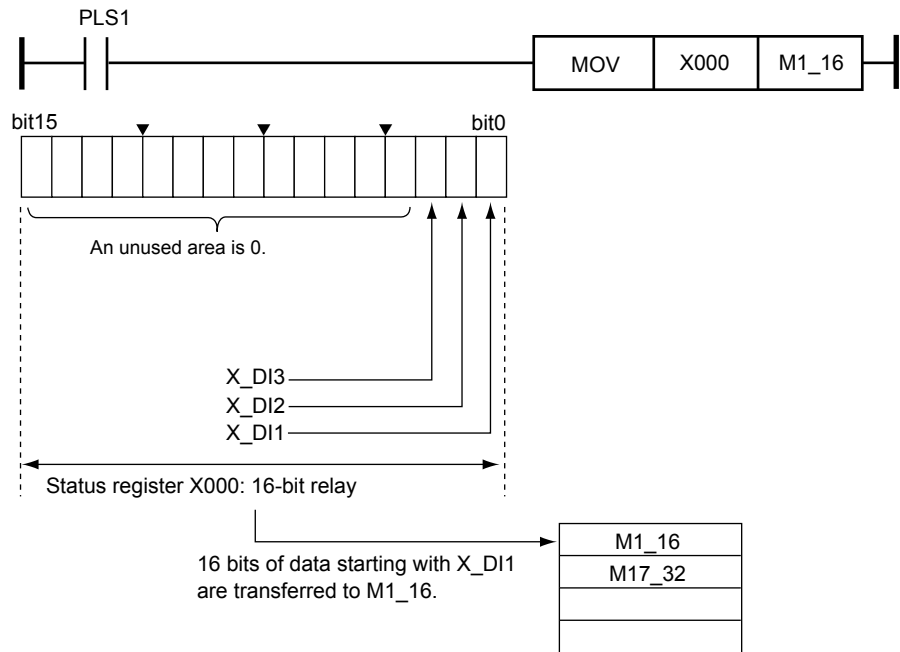

### 4.3.3 Floating Point Processing (Float)

Floating point data is represented by the IEEE 754 single-precision floating-point number format shown below. The DAT registers are represented by floating-point numbers.

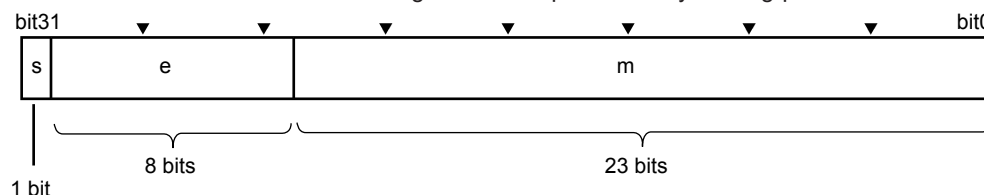

s: sign specification (1 bit) (0: +, 1: -)  
 e: exponential specification (8 bits)  
 m: argument specification (23 bits)

(1) When  $e \neq 0$ ,  $r = (-1)^s \times 1.m \times 2^{e-127}$

(2) When  $e = 0$ ,  $m = 0$  and  $r = 0$  (0 for all bits, indicating a numerical value "0")

When a floating point data is stored in a short integer, the integer which rounded off below the decimal point is stored. For example, "1234.5f will be 1235.

It is displayed in the form **\*\*\*E-\*\*** on the Monitor Register or Monitor Ladder Program window. For a tool tip (placing the mouse on a register), it is displayed as **\*\*\*\*\*E-\*\***.

### 4.3.4 Execution-while-ON Instructions and Input Differential Instructions

There are execution-while-ON and input differential types in application instructions.

#### Execution-while-ON type

An instruction is executed for each scan while the execution condition of the application instruction is ON.

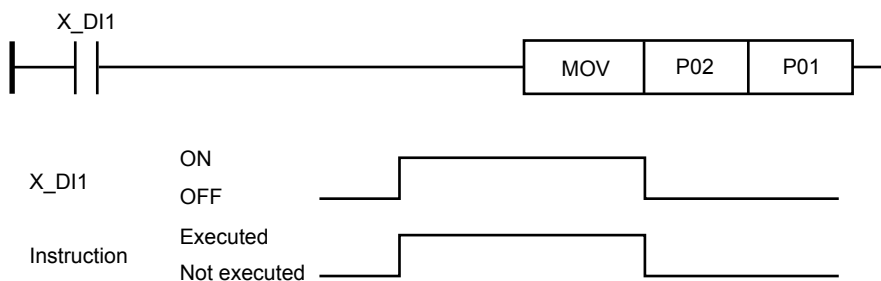

#### Input differential type





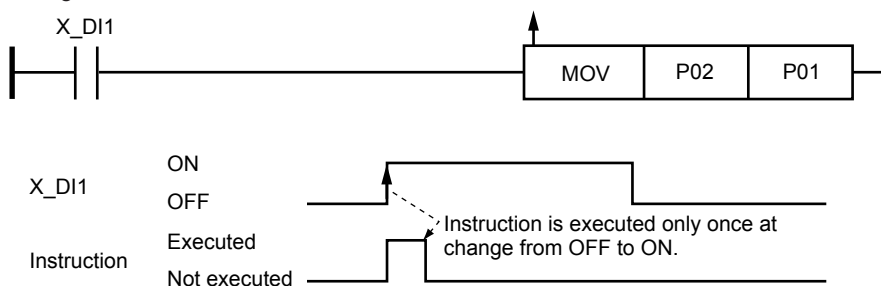

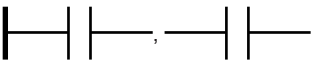
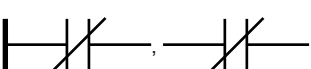

An instruction is executed only once when the execution condition of the application instruction changes from OFF to ON.

When you want to execute an instruction only for one scan, using this type of instruction conserves programs and shortens scan time because no input circuit needs to be configured in a differential instruction.

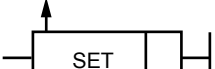
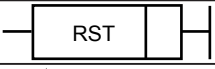
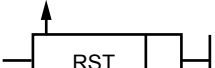

## 4.4 List of Instructions

### 4.4.1 List of Basic Instructions

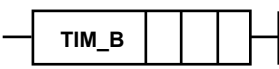
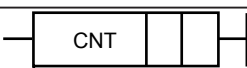
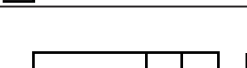
Instruction	Mnemonic	Display on Instruction Window	Number of Instructions	Symbol	Function
Load, And	LD, AND	√	1		Starts logic ("a" contact) Performs connection in logical AND ("a" contact in series).
Load Not, And Not	LDN, ANDN	√	1		Starts logical NOT ("b" contact). Performs connection in NAND ("b" contact in series).
Or	OR	√	1		Performs connection in logical OR ("a" contact in parallel).
Or Not	ORN	√	1		Performs connection in NOR ("b" contact in parallel).
And Load	ANDLD	*1	1		Executes logical AND between circuit elements.
Or Load	ORLD	*1	1		Executes logical OR between circuit elements.
Out	OUT	√	1		Outputs the previous calculation result.
Set	SET	√	1		Activates a specified device when input is ON.
	E_SET	√	1		Activates a specified device when an input changes from OFF to ON.
Reset	RST	√	1		Deactivates a specified device when input is ON.
	E_RST	√	1		Deactivates a specified device when an input changes from OFF to ON.
Timer	TIM	√	4		Performs a synchronous backward timer action.
Timer with back-up	TIM_B	√ (UT75A only)	4		Performs a synchronous backward timer action. The timer value is held even if the power is turned off. When recovered, the timer starts from the held value.
Counter	CNT	√	3		Performs a backward counter action.
Counter with back-up	CNT_B	√ (UT75A only)	3		Performs a backward counter action. The counter value is held even if the power is turned off. When recovered, the counter starts from the held value.

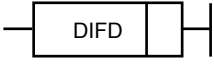
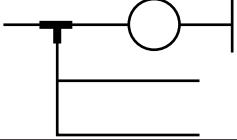
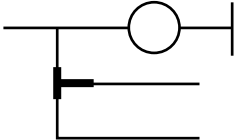
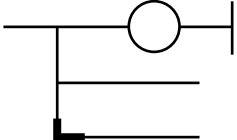
Instruction	Mnemonic	Display on Instruction Window	Number of Instructions	Symbol	Function
Differential Up	DIFU	√	1		Activates a device only for one scan when an input signal changes from OFF to ON.
Differential Down	DIFD	√	1		Activates a device only for one scan when an input signal changes from ON to OFF.
Push	PUSH	*1	1		Stores the calculation result (ON/OFF) obtained immediately before a Push.
Stack Read	STCRD	*1	1		Reads out the calculation result stored by Push and passes it to the next calculation processing.
Pop	POP	*1	1		Reads out the calculation result stored by Push and passes it to the next calculation processing. In addition, it clears the calculation result stored by Push.
End	-	*1	4	-	Indicates the exit of the input ladder calculation.

√: Visible

\*1: Automatically appended when a ladder program is created.







#### 4.4 List of Instructions

#### 4.4.2 List of Application Instructions

Instruction	Mnemonic	Display on Instruction Window	Number of Instructions	Symbol	Function
Comparison (Integers)	GT	√	4		Performs comparison and activates a device if the condition is met or deactivates it if the condition is not met.
	LT	√	4		
	GE	√	4		
	LE	√	4		
	EQ	√	4		
	NEQ	√	4		
Comparison (floating point numbers)	GTF	√ (UT75A only)	4		Performs comparison and activates a device if the condition is met or deactivates it if the condition is not met.
	LTF	√ (UT75A only)	4		
	GEF	√ (UT75A only)	4		
	LEF	√ (UT75A only)	4		
In range	IRNGF	√ (UT75A only)	5		Performs comparison and activates a device if the condition is met or deactivates it if the condition is not met.
Out of range	ORNGF	√ (UT75A only)	5		
Addition	ADD	√	4		Performs addition when an input signal is ON.
	E_ADD	√	4		Performs addition when an input signal changes from OFF to ON.
Subtraction	SUB	√	4		Performs subtraction when an input signal is ON.
	E_SUB	√	4		Performs subtraction when an input signal changes from OFF to ON.
Multiplication	MUL	√	4		Performs multiplication when an input signal is ON.
	E_MUL	√	4		Performs multiplication when an input signal changes from OFF to ON.

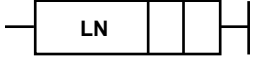
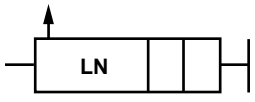
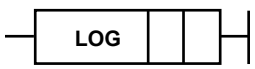
Instruction	Mnemonic	Display on Instruction Window	Number of Instructions	Symbol	Function
Division	DIV	√	4		Performs division when an input signal is ON.
	E_DIV	√	4		Performs division when an input signal changes from OFF to ON.
Square Root (%)	SQR	√	3		Performs square root extraction when an input signal is ON.
	E_SQR	√	3		Performs square root extraction when an input signal changes from OFF to ON.
Square Root (floating point numbers)	SQRF	√ (UT75A only)	3		Performs square root extraction when an input signal changes from OFF to ON.
	E_SQRF	√ (UT75A only)	3		Performs square root extraction when an input signal is ON.
Square Root Extraction (Low cutoff point or less: zero)	SQT	√ (UT75A only)	4		Performs square root extraction (low cutoff point or less = zero) when an input signal changes from OFF to ON.
	E_SQT	√ (UT75A only)	4		Performs square root extraction (low cutoff point or less = zero) when an input signal is ON.
Square Root Extraction with variable low cutoff	SQTE	√ (UT75A only)	4		Performs square root extraction (with variable low cutoff) when an input signal changes from OFF to ON.
	E_SQTE	√ (UT75A only)	4		Performs square root extraction (with variable low cutoff) when an input signal is ON.
Absolute Value	ABS	√	3		Performs absolute-value calculation when an input signal is ON.
	E_ABS	√	3		Performs absolute-value calculation when an input signal changes from OFF to ON.
Exponential	EXP	√ (UT75A only)	3		Performs exponential calculation when an input signal is ON.
	E_EXP	√ (UT75A only)	3		Performs exponential calculation when an input signal changes from OFF to ON.
Power	PWR	√ (UT75A only)	4		Performs power calculation when an input signal is ON.
	E_PWR	√ (UT75A only)	4		Performs power calculation when an input signal changes from OFF to ON.

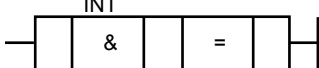
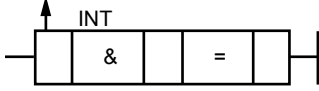
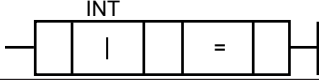
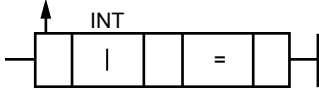
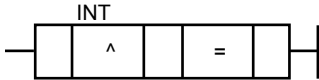
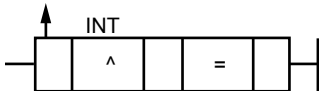
#### 4.4 List of Instructions

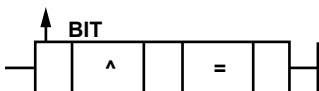
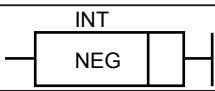
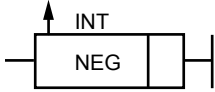
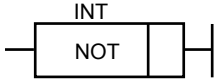
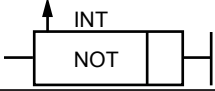
Instruction	Mnemonic	Display on Instruction Window	Number of Instructions	Symbol	Function
Natural Logarithm	LN	√ (UT75A only)	3		Performs natural logarithmic calculation when an input signal is ON.
	E_LN	√ (UT75A only)	3		Performs natural logarithmic calculation when an input signal changes from OFF to ON.
Common Logarithm	LOG	√ (UT75A only)	3		Performs common logarithmic calculation when an input signal is ON.
	E_LOG	√ (UT75A only)	3		Performs common logarithmic calculation when an input signal changes from OFF to ON.
Logical AND	AND	√	4		Executes logical AND when an input signal is ON.
	E_AND	√	4		Executes logical AND when an input signal changes from OFF to ON.
Logical OR	OR	√	4		Executes logical OR when an input signal is ON.
	E_OR	√	4		Executes logical OR when an input signal changes from OFF to ON.
Logical XOR	XOR	√	4		Executes logical XOR when an input signal is ON.
	E_XOR	√	4		Executes logical XOR when an input signal changes from OFF to ON.
Logical XOR (1 bit)	XORB	√ (UT75A only)	4		Executes logical XOR when an input signal is ON.
	E_XORB	√ (UT75A only)	4		Executes logical XOR when an input signal changes from OFF to ON.
Two's Complement	NEG	√	2		Converts data to two's complement when an input signal is ON.
	E_NEG	√	2		Converts data to two's complement when an input signal changes from OFF to ON.
Not	NOT	√	2		Inverts data when an input signal is ON.
	E_NOT	√	2		Inverts data when an input signal changes from OFF to ON.

Instruction	Mnemonic	Display on Instruction Window	Number of Instructions	Symbol	Function
Not (1bit)	NOTB	√ (UT75A only)	2		Inverts data when an input signal is ON.
	E_NOTB	√ (UT75A only)	2		Inverts data when an input signal changes from OFF to ON.
Right Rotate	RROT	√	3		Turns data to the right when an input signal is ON.
	E_RROT	√	3		Turns data to the right when an input signal changes from OFF to ON.
Left Rotate	LROT	√	3		Turns data to the left when an input signal is ON.
	E_LROT	√	3		Turns data to the left when an input signal changes from OFF to ON.
Right Shift	RSFT	√	3		Shifts data to the right when an input signal is ON.
	E_RSFT	√	3		Shifts data to the right when an input signal changes from OFF to ON.
Left Shift	LSFT	√	3		Shifts data to the left when an input signal is ON.
	E_LSFT	√	3		Shifts data to the left when an input signal changes from OFF to ON.
Shift Register	E_SFT	√	3		Shifts data to the right or left by 1 bit when an input signal changes from OFF to ON.
Move	MOV	√	3		Moves data to a destination when an input signal is ON.
	E_MOV	√	3		Moves data to a destination when an input signal changes from OFF to ON.
Binary Conversion	BIN	√	3		Converts data to binary data when an input signal is ON.
	E_BIN	√	3		Converts data to binary data when an input signal changes from OFF to ON.
BCD Conversion	BCD	√	3		Converts data to BCD codes when an input signal is ON.
	E_BCD	√	3		Converts data to BCD codes when an input signal changes from OFF to ON.

#### 4.4 List of Instructions

Instruction	Mnemonic	Display on Instruction Window	Number of Instructions	Symbol	Function
Ratio	RATIO	√	5		Calculates a ratio when an input signal is ON.
	E_RATIO	√	5		Calculates a ratio when an input signal changes from OFF to ON.
Reciprocal	RECIP	√ (UT75A only)	5		Calculates a reciprocal when an input signal is ON.
	E_RECIP	√ (UT75A only)	5		Calculates a reciprocal when an input signal changes from OFF to ON.
High Selector	HSL	√	4		Selects a higher value when an input signal is ON.
	E_HSL	√	4		Selects a higher value when an input signal changes from OFF to ON.
Low Selector	LSL	√	4		Selects a lower value when an input signal is ON.
	E_LSL	√	4		Selects a lower value when an input signal changes from OFF to ON.
High Limiter	HLM	√	4		Imposes a high limit on the input value when an input signal is ON.
	E_HLM	√	4		Imposes a high limit on the input value when an input signal changes from OFF to ON.
Low Limiter	LLM	√	4		Imposes a low limit on the input value when an input signal is ON.
	E_LLM	√	4		Imposes a low limit on the input value when an input signal changes from OFF to ON.
Limit	LIMIT	√ (UT75A only)	5		Calculates a reciprocal when an input signal is ON.
	E_LIMIT	√ (UT75A only)	5		Calculates a reciprocal when an input signal changes from OFF to ON.
Scaling	SCAL	√	5		Scales an input value when an input signal is ON.
	E_SCAL	√	5		Scales an input value when an input signal changes from OFF to ON.
Normalization	NORM	√	5		Normalizes an input value when an input signal is ON.
	E_NORM	√	5		Normalizes an input value when an input signal changes from OFF to ON.

Instruction	Mnemonic	Display on Instruction Window	Number of Instructions	Symbol	Function
Maximum Value	MAX	√	7		Selects the maximum value when an input signal is ON.
	E_MAX	√	7		Selects the maximum value when an input signal changes from OFF to ON.
Minimum Value	MIN	√	7		Selects the minimum value when an input signal is ON.
	E_MIN	√	7		Selects the minimum value when an input signal changes from OFF to ON.
Average Value	AVE	√	7		Obtains the average value of input values when an input signal is ON.
	E_AVE	√	7		Obtains the average value of input values when an input signal changes from OFF to ON.
Temperature Compensation (deg C)	TCMP1	√	5		Performs temperature compensation (in °C) when an input signal is ON.
	E_TCMP1	√	5		Performs temperature compensation (in °C) when an input signal changes from OFF to ON.
Temperature Compensation (deg F)	TCMP2	√	5		Performs temperature compensation (in °F) when an input signal is ON.
	E_TCMP2	√	5		Performs temperature compensation (in °F) when an input signal changes from OFF to ON.
Pressure Compensation (MPa)	PCMP1	√	5		Performs pressure compensation (in MPa) when an input signal is ON.
	E_PCMP1	√	5		Performs pressure compensation (in MPa) when an input signal changes from OFF to ON.
Pressure Compensation (kgf/cm²)	PCMP2	√	5		Performs pressure compensation (in kgf/cm²) when an input signal is ON.
	E_PCMP2	√	5		Performs pressure compensation (in kg/cm²) when an input signal changes from OFF to ON.

#### 4.4 List of Instructions

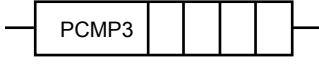
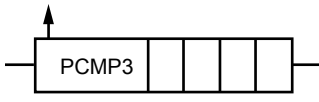
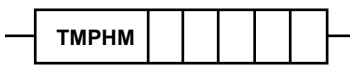
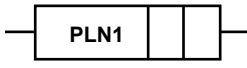
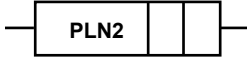
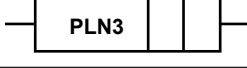
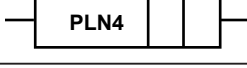
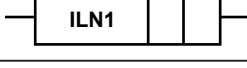
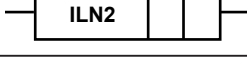
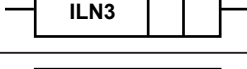
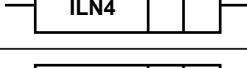
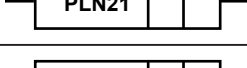
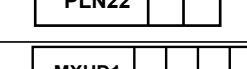
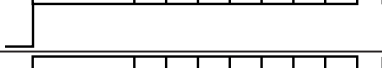
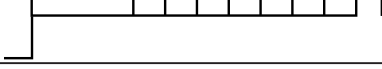

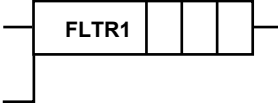
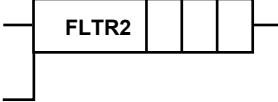
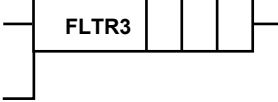
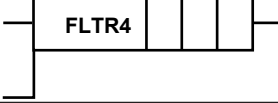
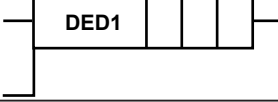
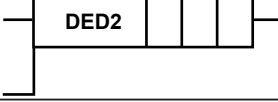
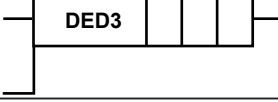
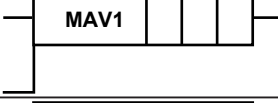
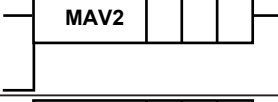
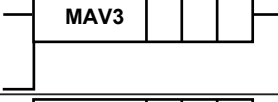
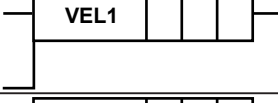
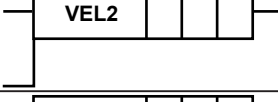
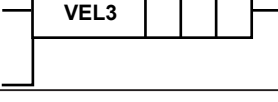
Instruction	Mnemonic	Display on Instruction Window	Number of Instructions	Symbol	Function
Pressure Compensation (psi)	PCMP3	√	5		Performs pressure compensation (in psi) when an input signal is ON.
	E_PCMP3	√	5		Performs pressure compensation (in psi) when an input signal changes from OFF to ON.
Temperature and Humidity Calculation	TMPHM	√ (UT75A only)	6		Calculates temperature and humidity when an input signal is ON.
10-segment Linearizer Approximation	PLN1	√ (UT75A only)	3		Performs 10-segment linearizer approximation when an input signal is ON.
	PLN2	√ (UT75A only)	3		
	PLN3	√ (UT75A only)	3		
	PLN4	√ (UT75A only)	3		
Inverse Conversion of 10-segment Linearizer Approximation	ILN1	√ (UT75A only)	3		Performs inverse conversion of 10-segment linearizer approximation when an input signal is ON.
	ILN2	√ (UT75A only)	3		
	ILN3	√ (UT75A only)	3		
	ILN4	√ (UT75A only)	3		
20-segment Linearizer Approximation	PLN21	√ (UT75A only)	3		Performs 20-segment linearizer approximation when an input signal is ON.
	PLN22	√ (UT75A only)	3		
Maximum Input Hold	MXHD1	√ (UT75A only)	8		Hold the maximum input value when an input signal is ON.
Minimum Input Hold	MNHD1	√ (UT75A only)	8		Hold the minimum input value when an input signal is ON.

Instruction	Mnemonic	Display on Instruction Window	Number of Instructions	Symbol	Function
Filter	FLTR1	√ (UT75A only)	4		Calculates the first-order lag when an input signal is ON.
	FLTR2	√ (UT75A only)	4		
	FLTR3	√ (UT75A only)	4		
	FLTR4	√ (UT75A only)	4		
Dead Time	DED1	√ (UT75A only)	4		Calculates the dead time when an input signal is ON.
	DED2	√ (UT75A only)	4		
	DED3	√ (UT75A only)	4		
Moving Average	MAV1	√ (UT75A only)	4		Calculates the moving average when an input signal is ON.
	MAV2	√ (UT75A only)	4		
	MAV3	√ (UT75A only)	4		
Velocity Computation	VEL1	√ (UT75A only)	4		Performs the velocity computation when an input signal is ON.
	VEL2	√ (UT75A only)	4		
	VEL3	√ (UT75A only)	4		

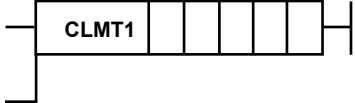
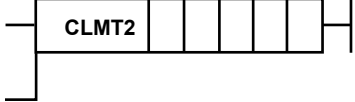
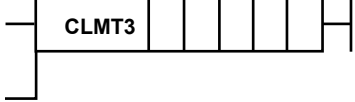
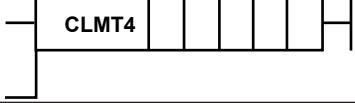
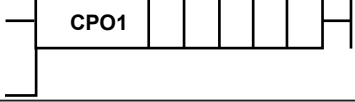
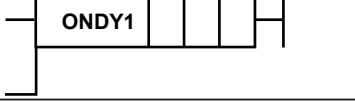
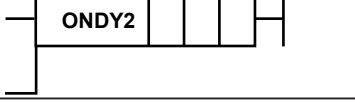
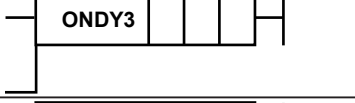
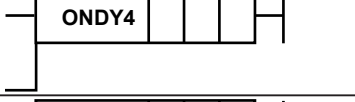
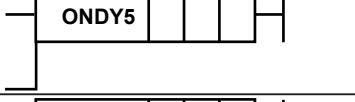
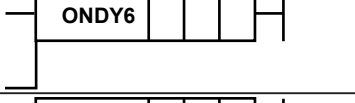
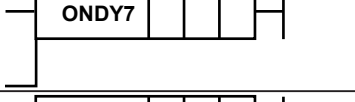
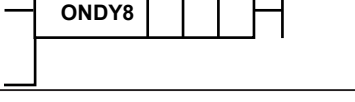

#### 4.4 List of Instructions

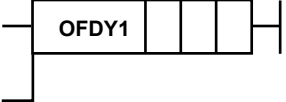
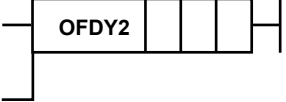
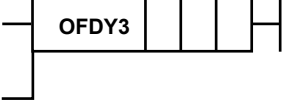
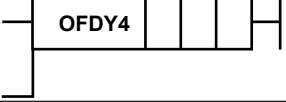
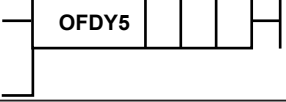
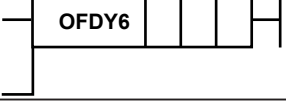
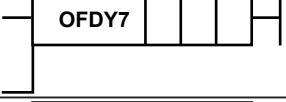
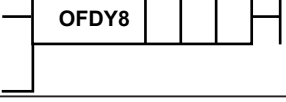
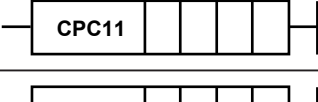
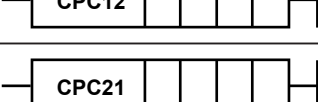
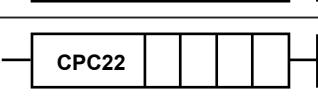
Instruction	Mnemonic	Display on Instruction Window	Number of Instructions	Symbol	Function
Velocity Limiter	CLMT1	√ (UT75A only)	4		Executes the velocity limiter when an input signal is ON.
	CLMT2	√ (UT75A only)	4		
	CLMT3	√ (UT75A only)	4		
	CLMT4	√ (UT75A only)	4		
Totalizer Pulse Output	CPO1	√ (UT75A only)	6		Calculates the totalizer pulse output when an input signal is ON.
On-delay Timer	ONDY1	√ (UT75A only)	4		Sets the on-delay timer when an input signal is ON.
	ONDY2	√ (UT75A only)	4		
	ONDY3	√ (UT75A only)	4		
	ONDY4	√ (UT75A only)	4		
	ONDY5	√ (UT75A only)	4		
	ONDY6	√ (UT75A only)	4		
	ONDY7	√ (UT75A only)	4		
	ONDY8	√ (UT75A only)	4		

Instruction	Mnemonic	Display on Instruction Window	Number of Instructions	Symbol	Function
Off-delay Timer	OFDY1	√ (UT75A only)	4		Sets the off-delay timer when an input signal is ON.
	OFDY2	√ (UT75A only)	4		
	OFDY3	√ (UT75A only)	4		
	OFDY4	√ (UT75A only)	4		
	OFDY5	√ (UT75A only)	4		
	OFDY6	√ (UT75A only)	4		
	OFDY7	√ (UT75A only)	4		
	OFDY8	√ (UT75A only)	4		
CP Calculation 11 (°C)	CPC11	√ (UT75A only)	5		Performs the CP calculation when an input signal is ON.  Available for UT75A with "CP" option.
CP Calculation 12 (°F)	CPC12	√ (UT75A only)	5		
CP Calculation 21 (°C)	CPC21	√ (UT75A only)	5		
CP Calculation 22 (°F)	CPC22	√ (UT75A only)	5		

√: Visible

## 4.4 List of Instructions

### 4.4.3 Custom Ladder Instructions (UT75A only)

Custom ladder instructions can be created according to the procedure in section 4.7.2, “Creating Custom Ladder Instructions (UT75A Only).” Up to 100 instructions can be registered in the LL50A. You can use custom ladder instructions in the same way on the LL50A as basic instructions and application instructions by selecting the customer ladder instructions that you have created from a custom ladder instruction tree, as shown below. The example below shows an LL50A ladder instruction tree in which four custom ladder instructions—CP1, CP2, CP3, and HUM1—are registered.

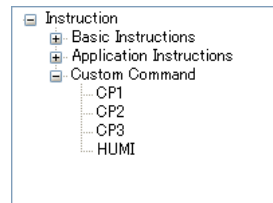
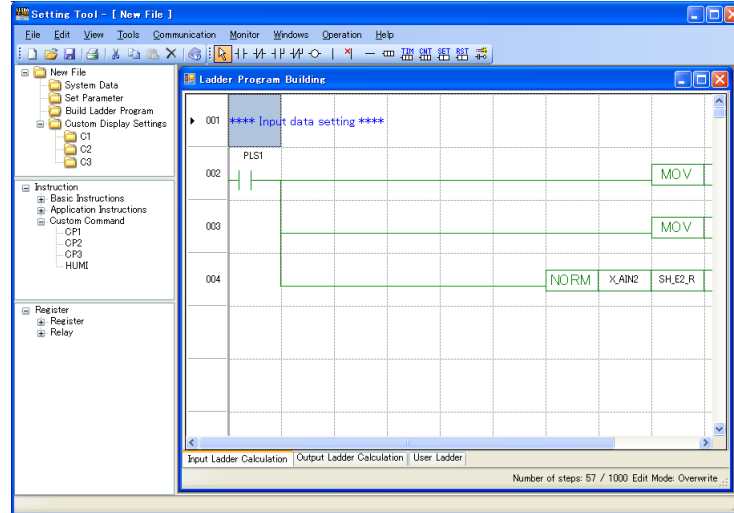

## 4.5 Details of Basic Instructions

Functional quick reference guide

The following functional quick reference guide is provided at the start of the explanation of all the application instructions.

Instruction	Mnemonic	Symbol	Input Condition Required?		Execution Condition	Step Count	Data Format
			Yes	No			
Set	SET		√	-		1	Relay
	E_SET		√	-		1	

↑ (1)      ↑ (2)      ↑ (3)      ↑ (4)      ↑ (5)      ↑ (6)      ↑ (7)

### (1) Instruction

Indicates an instruction name.

### (2) Mnemonic

Indicates the representation of an instruction by Mnemonic.

### (3) Symbol

Indicates a representation method on LL50A.

### (4) Input Condition Required?

Indicates whether the input condition is required for the instruction concerned.

An instruction with the "√" symbol in the Yes column always requires the input condition.

An instruction with the "-" symbol in the No column requires no input condition.

### (5) Execution Condition

Symbol	Execution Condition
	This represents an execute-while-ON instruction. The instruction is executed only when the pre-condition of that instruction is ON. It is not executed if the pre-condition is OFF.
	This represents an instruction that is executed once when the pre-condition is set to ON. The instruction is executed only when the pre-condition of the instruction changes from OFF to ON, or a rise. After that, it is not executed even if the pre-condition is ON.
	This represents an instruction that is executed once when the pre-condition is set to OFF. The instruction is executed only when the pre-condition of the instruction changes from ON to OFF, or a fall. After that, it is not executed even if the pre-condition is OFF.
-	This indicates an instruction that is always executed. The instruction is executed irrespective of ON/OFF of the pre-condition of the instruction.

### (6) Step Count

Indicates the number of steps of the instruction concerned. The step count differs depending on the presence/absence of the execution condition.

### (7) Data Format

Indicates the processing unit to be used during execution of the instruction concerned. In principle, all data formats are available for each instruction. The column shows the data format that is mainly used.

Instructions whose processing unit is a relay are intended for relays.

Instructions whose processing unit is a D-register, status register, or DAT register are intended for registers.

Relay data can be handled by integrating it in 16 bits or 32 bits.

► [Data format: Section 4.3, Data Format](#)

## 4.5 Details of Basic Instructions

### 4.5.1 Load, And

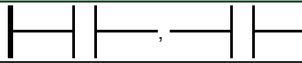
Instruction	Mnemonic	Symbol	Input Condition Required?		Execution Condition	Step Count	Data Format
			Yes	No			
Load, And	LD, AND		-	√	-	1	Relay

Load is a logical ("a" contact) operation start instruction. It captures the ON/OFF information of a specified device and regards it as the calculation result.

#### Program example:

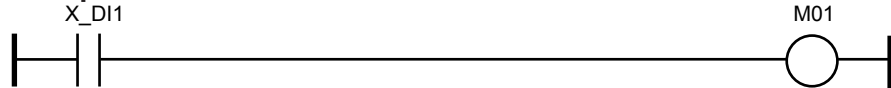

And is a logical AND ("a" contact in series connection) instruction. It captures the ON/OFF information of a specified device, ANDs it with the previous calculation result, and takes the obtained value as the calculation result.

#### Program example:

When X\_DI1 is ON and X\_DI2 is ON, M03 becomes ON. M03 is OFF in all other cases.

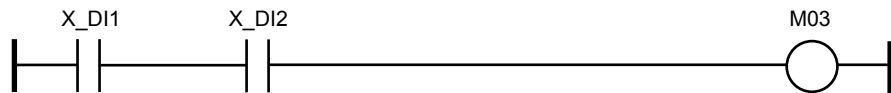

### 4.5.2 Load Not, And Not

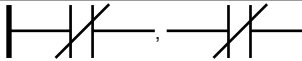
Instruction	Mnemonic	Symbol	Input Condition Required?		Execution Condition	Step Count	Data Format
			Yes	No			
Load Not, And Not	LDN, ANDN		-	√	-	1	Relay

Load Not is a logical NOT ("b" contact) operation start instruction. It captures the ON/OFF information of a specified device and regards it as the calculation result.

#### Program example:

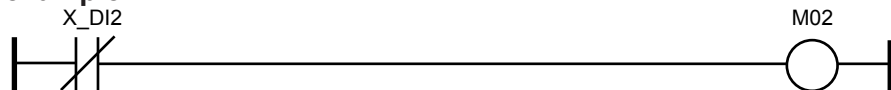

And Not is an NAND ("b" contact in series connection) instruction. It captures the ON/OFF information of a specified device, ANDs it with the previous calculation result, and takes the obtained value as the calculation result.

#### Program example:

When X\_DI1 is ON and X\_DI2 is OFF, M04 becomes ON. M04 is OFF in all other cases.

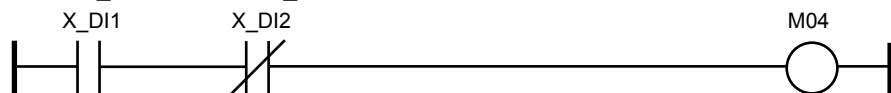

## 4.5.3 Or

Instruction	Mnemonic	Symbol	Input Condition Required?		Execution Condition	Step Count	Data Format
			Yes	No			
Or	OR		-	√	-	1	Relay

Or is a logical OR ("a" contact in parallel connection) instruction. It captures the ON/OFF information of a specified device, ORs it with the previous calculation result, and takes the obtained value as the calculation result.

**Program example:**

When X\_D11 is ON or X\_D12 is ON, M05 becomes ON. M05 is OFF in all other cases.

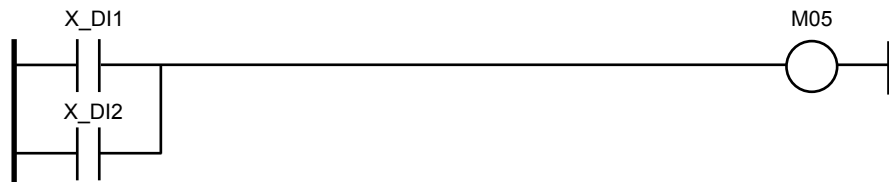

## 4.5.4 Or Not

Instruction	Mnemonic	Symbol	Input Condition Required?		Execution Condition	Step Count	Data Format
			Yes	No			
Or Not	ORN		-	√	-	1	Relay

Or Not is an NOR ("b" contact in parallel connection) instruction. It captures the ON/OFF information of a specified device, ORs it with the previous calculation result, and takes the obtained value as the calculation result.

**Program example:**

When X\_D11 is ON or X\_D12 is OFF, M06 is activated. M06 is OFF in all other cases.

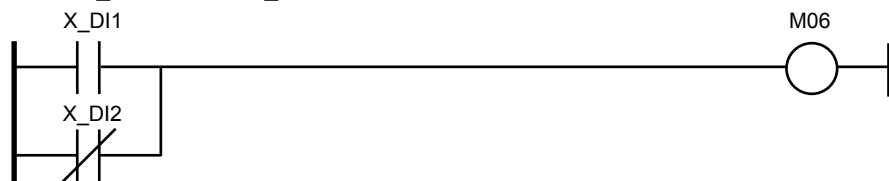

4.5.5 And Load

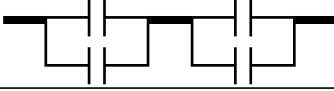
Instruction	Mnemonic	Symbol	Input Condition Required?		Execution Condition	Step Count	Data Format
			Yes	No			
And Load	ANDLD		-	√	-	1	-

An And load instruction is not represented in thick lines in the actual ladder sequence program (circuit).

This instruction performs logical AND between circuit elements and passes the ANDed result to the next calculation processing.

An And Load instruction is automatically added to the ladder program by the combination of "a" contacts, "b" contacts, and compare instructions. The step counts are also added.

**Program example:**

When X\_DI1 is ON or X\_DI3 is ON and X\_DI2 is ON or X\_DI11 is ON, M07 is activated. M07 is OFF in all other cases.

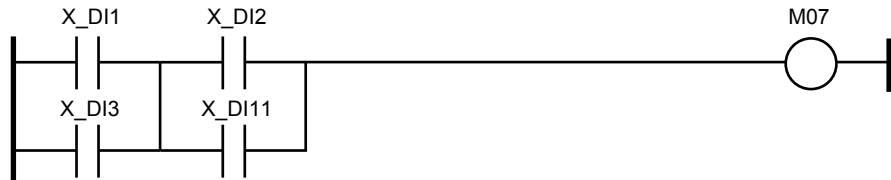

4.5.6 Or Load

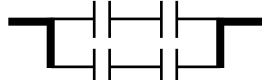
Instruction	Mnemonic	Symbol	Input Condition Required?		Execution Condition	Step Count	Data Format
			Yes	No			
Or Load	ORLD		-	√	-	1	-

An Or load instruction is not represented in thick lines in the actual ladder sequence program (circuit).

This instruction performs logical OR between circuit elements and passes the ORed result to the next calculation processing.

An Or Load instruction is automatically added to the ladder program by the combination of "a" contacts, "b" contacts, and compare instructions. The step counts are also added.

**Program example:**

When X\_DI1 is ON and X\_DI2 is ON or X\_DI3 is ON and X\_DI11 is ON, M08 is activated. M08 is OFF in all other cases.

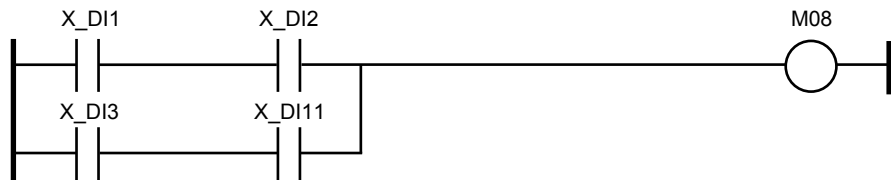

### 4.5.7 Out

Instruction	Mnemonic	Symbol	Input Condition Required?		Execution Condition	Step Count	Data Format
			Yes	No			
Out	OUT		√	-		1	Relay

Out is an output instruction. It outputs the previous calculation result to a specified device as is. Direct output from the bus bar to a device is not possible.

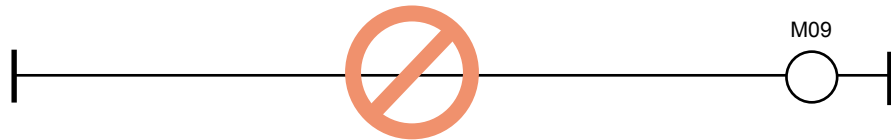

Furthermore, if output to a device is required irrespective of ON/OFF of a contact, use an always-ON relay (PLS1).

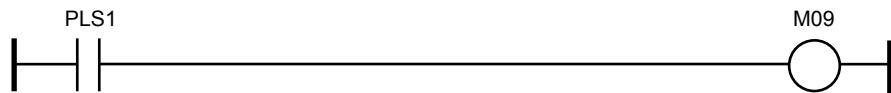

It is not possible to insert a contact next to an Out instruction.

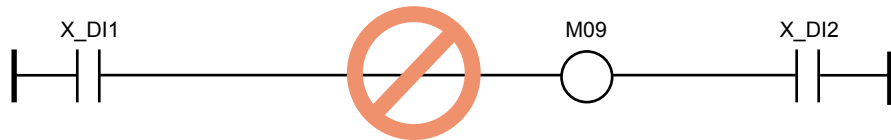

If the same device is used for two or more Out instructions, only the last Out is enabled and the results of Out instructions before that Out will be ignored.



Same relay number  
Only the last Out is enabled.

▶ [Double use of coil: Section 3.6, Checking Ladder Programs](#)

Out instructions can be used in parallel.

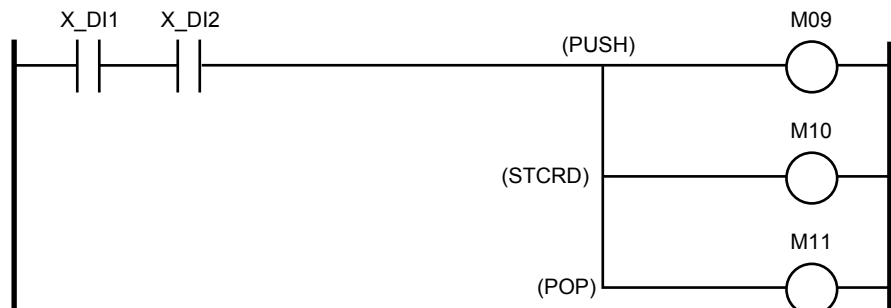

**Program example:**





4.5.8 Set

Instruction	Mnemonic	Symbol	Input Condition Required?		Execution Condition	Step Count	Data Format
			Yes	No			
Set	SET		√	-		1	Relay
	E_SET		√	-		1	Relay

Parameter

When the execution condition is met, a specified device (d1) is activated.



Program example:

When X\_DI1 changes from OFF to ON, M10 is activated.

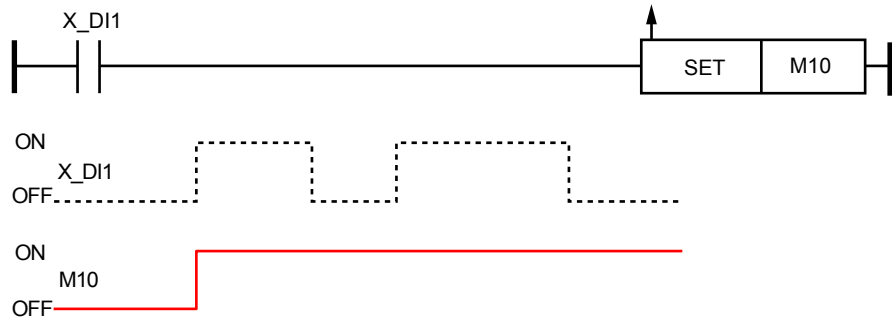

### 4.5.9 Reset

Instruction	Mnemonic	Symbol	Input Condition Required?		Execution Condition	Step Count	Data Format
			Yes	No			
Reset	RST		√	-		1	Relay
	E_RST		√	-		1	Relay

#### Parameter

When the execution condition is met, a specified device (d1) is deactivated.

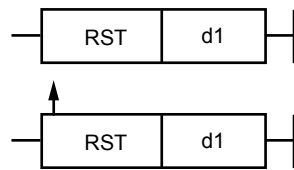



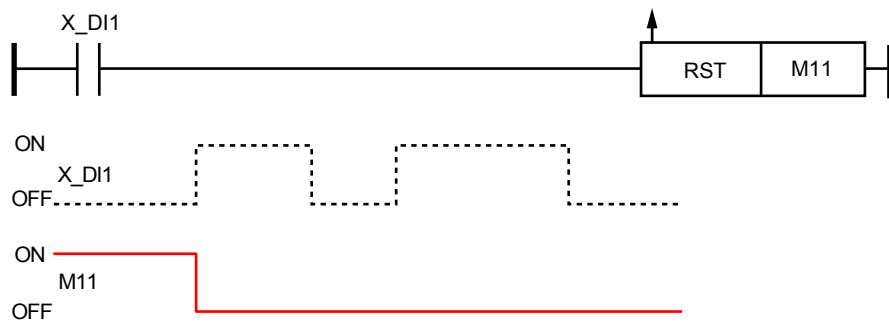

#### Program example:

When X\_DI1 changes from OFF to ON, M11 is OFF.

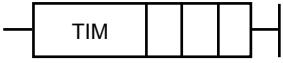

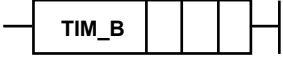
4.5.10 Timer

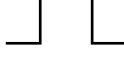
Instruction	Mnemonic	Symbol	Input Condition Required?		Execution Condition	Step Count	Data Format
			Yes	No			
Timer	TIM		√	-	at start  during count 	4	Time-out Relay (TIM1 to TIM4): Relay  Timer's current value (TIMER1 to TIMER4) Unsigned 16-bit integers
Timer with back-up	TIM_B		√	-	at start  during count 	4	Time-out Relay (TIM1_B to TIM2_B): Relay  Timer's current value (TIMER1_B to TIMER2_B) Unsigned 16-bit integers

Parameter

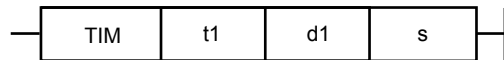

This instruction performs synchronous backward timer operation.

The synchronous type refers to the condition that ON/OFF of a timeout relay (d1) and the timer's current value (value obtained by subtraction from the timer set value (s)) do not change during the execution of one scan of the program. TIM1 to TIM4 are described in the timeout relay (d1).

For the timer, if the input condition is ON (while it is ON), the timer's current value is subtracted, and when it reaches 0, the corresponding timeout relay (d1) is activated. (The action of the timer's current value reaching "0" is called "to time out.")

When the input condition is ON and the timer set value (s) is "0," the timeout relay is always ON.

If there is a backup timer, the timeout relay behaves as follows when the power is turned off and then back on.

If the count is in progress, the count value continues, and the timeout relay is set to OFF. If count-out is reached, the count value is zero, and the timeout relay is turned on.

If the following actions are implemented while the input condition is ON, the timer's current value is set to "0" and time-out relay is set to OFF; power OFF/ON, Reset Start (L-RESET RUN), ladder sequence program download, change of the input type and control period. Change the input condition into OFF again.

If the input condition is OFF and is switched from OFF to ON, the timer's current value returns to the timer set value (s) (namely initialized). If the timer set value (s) is other than "0", the time-out relay (d1) is OFF.

The timer's current value can be checked using the Monitor Ladder Program function of the LL50A Parameter Setting Software.

Timer (t1) should be selected from among five types: the special register's control period clock (SMPCLK), one-sec clock (CLK1), two-sec clock (CLK2), 10-sec clock (CLK10), and 60-sec clock (CLK60).

When timer (t1) is selected, it functions according to each attribute.

The setting time of the timer differs depending on the timer (t1) used. See the timer types and setting times described below.

The timer set value (s) should be set using a K-register or P-register.

If the timer set value (s) is a negative value (value of less than "0"), it is handled as "0," and if it is "65535" or more, it is handled as "65535." Moreover, digits to the right of the decimal point will be discarded.

#### Timer types and setting time

Timer Type	Resolution	Setting Time
SMPCLK	50 ms	0 ms to 3276.75 seconds
	100 ms	0 ms to 6553.5 seconds
	200 ms	0 ms to 13107 seconds
CLK1	1 sec	0 sec to 65535 seconds
CLK2	2 sec	0 sec to 131070 seconds
CLK10	10 sec	0 sec to 655350 seconds
CLK60	60 sec	0 sec to 2199180 seconds

Note 1: SMPCLK works in the period set with the input sampling period (control period) parameter SMP.

Note 2: The maximum value of the set time is within the range handled by a K-register or P-register.

#### Example of timer operation

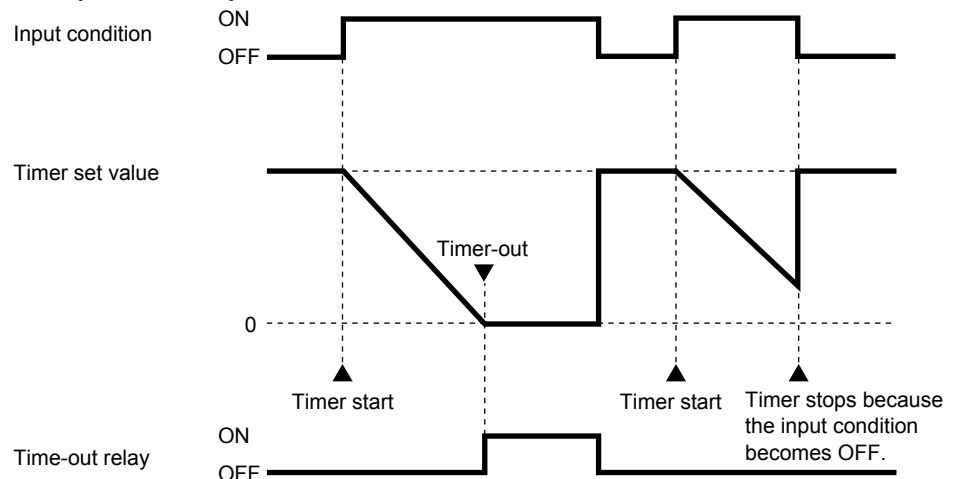

#### 4.5 Details of Basic Instructions



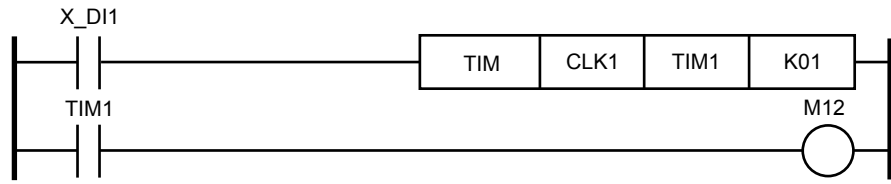

---

**Program example:**

When X\_DI1 becomes ON, M12 is activated 10 seconds later. The example uses a 1-second clock (CLK1). K01 = 10

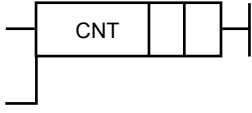

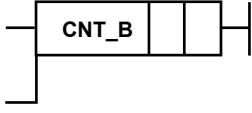
## 4.5.11 Counter

Instruction	Mnemonic	Symbol	Input Condition Required?		Execution Condition	Step Count	Data Format
			Yes	No			
Counter	CNT		√	-	at start  during count 	3	Count-out Relay (CNT1 to CNT4): Relay  Current timer (COUNTER1 to COUNTER4) Unsigned 16-bit integers
Counter with back-up	CNT_B		√	-	at start  during count 	3	Count-out Relay (CNT1_B to CNT2_B): Relay  Current timer (COUNTER1_B to COUNTER2_B) Unsigned 16-bit integers

## Parameter

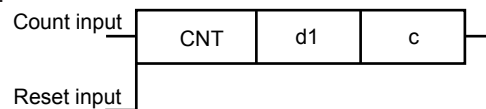

This instruction performs backward counter operation.

When the count input changes from OFF to ON once, one count is subtracted from the counter set value (c).

When the counter's current value (value obtained by subtraction from the counter set value (s)) reaches 0, the corresponding count-out relay (d1) is activated.

(The action of the counter's current value reaching "0" is called "to count out.")

No counting is performed excepting when the count input changes from OFF to ON. CNT1 to CNT4 are described in the count-out relay.

The counter current value is reset to the counter set value while the reset input is ON or power is switched from ON to OFF.

If the following actions are implemented while the reset input is OFF, the counter's current value is set to "0" and count-out flag is set to OFF; power OFF/ON, Reset Start (L-RESET RUN), ladder sequence program download, change of the input type and control period. Change the reset input into ON again.

If there is a backup counter, the count-out relay behaves as follows when the power is turned off and then back on.

If the count is in progress, the count value continues, and the count-out relay is set to OFF.

If count-out is reached, the count value is zero, and the count-out relay is turned on.

The counter set value (c) should be set using a K-register or P-register.

If the counter set value (s) is a negative value (value of less than "0"), it is handled as "0." and if it is more than "65535", it is handled as "65535."

Moreover, values at the right of the decimal point will be discarded.

## 4.5 Details of Basic Instructions

Before entering a count input, reset the counter's current value by reset input. If a count input and reset input are simultaneously made, the reset input has priority.

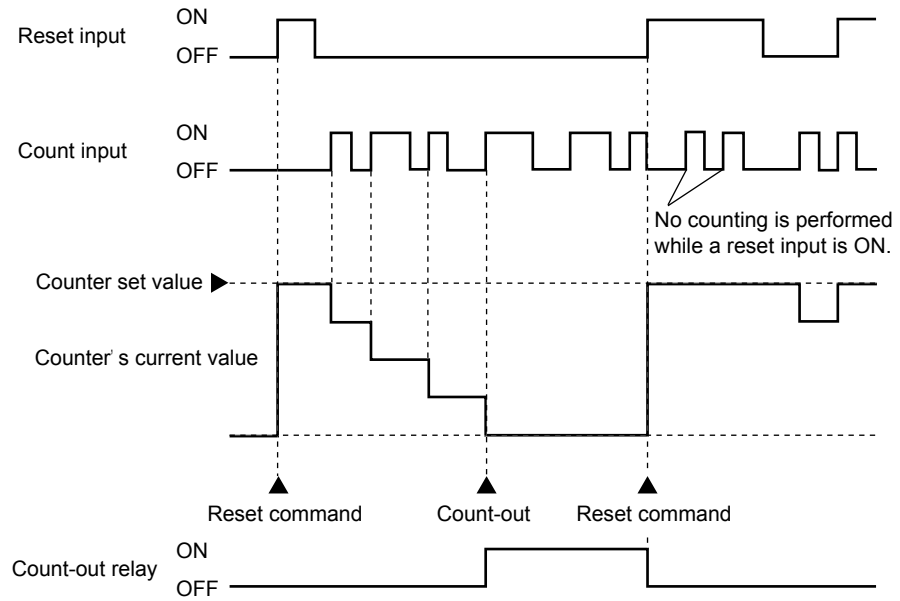

### Program example:

When X\_DI1 becomes ON 15 times, M13 is activated. K01 = 15

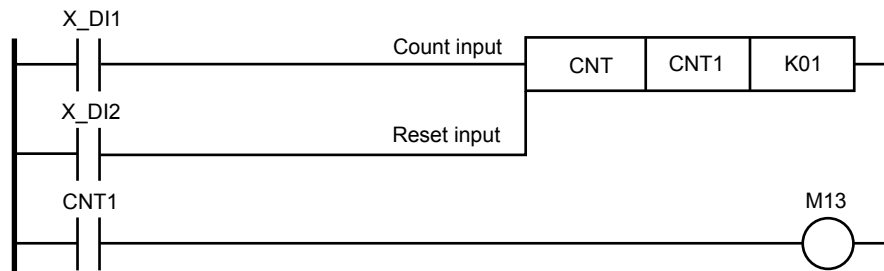

### 4.5.12 Differential Up and Differential Down

Instruction	Mnemonic	Symbol	Input Condition Required?		Execution Condition	Step Count	Data Format
			Yes	No			
Differential Up	DIFU		√	-		1	Relay
Differential Down	DIFD		√	-		1	Relay

#### Parameters

##### Differential up

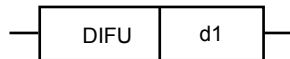

When an input signal changes from OFF to ON (raise), a specified device (d1) is activated for one scan.

For any condition other than a change of input signal from OFF to ON (raise), a specified device (d1) is OFF.

##### Differential up

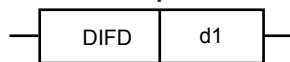

When an input signal changes from ON to OFF (fall), a specified device (d1) is activated for one scan.

For any condition other than a change of input signal from ON to OFF (fall), a specified device (d1) is OFF.

#### Program example

When X\_DI1 changes from OFF to ON, M01 is activated for one scan. Also, when X\_DI2 changes from ON to OFF, M02 is activated for one scan.

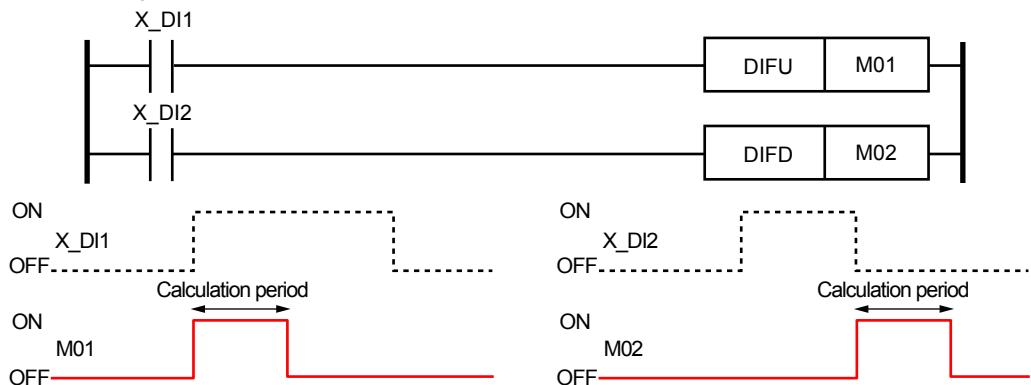

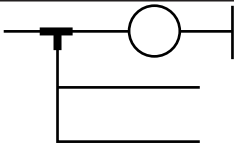
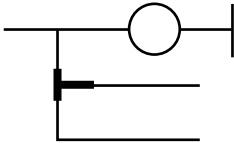
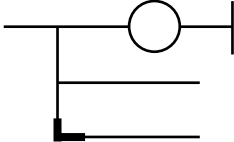

4.5.13 Push, Stack Read, and Pop

Instruction	Mnemonic	Symbol	Input Condition Required?		Execution Condition	Step Count	Data Format
			Yes	No			
Push	PUSH		-	√	-	1	-
Stack Read	STCRD		-	√	-	1	-
Pop	POP		-	√	-	1	-

The Push, Stack read, and Pop instructions are not represented by thick lines in the actual ladder sequence program (circuit).

**Push**

This instruction stores the calculation result (ON/OFF) obtained immediately before a Push. The number of pushes available in a circuit is up to 16.

**Stack read**

This instruction reads out the calculation result stored by Push and passes it to the next calculation processing.

**Pop**

This instruction reads out the calculation result stored by Push and passes it to the next calculation processing. Moreover, it clears the calculation result stored by Push. The number of Push instructions used and the number of Pop instructions used must be the same.

Note that it is not necessary for the user to program a Push, Stack read, or Pop instruction. These instructions are automatically appended.

Program example:

Example of a program using braches

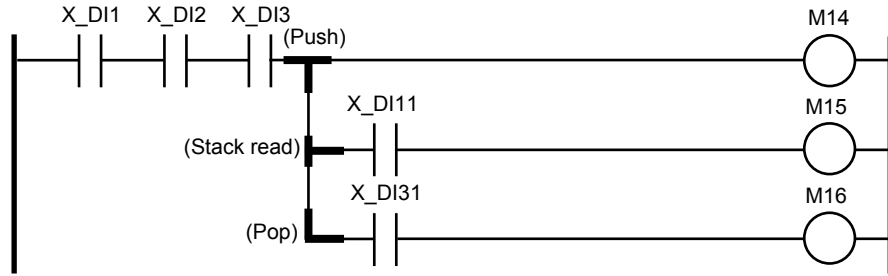

Step count = 11 steps

Example of a program without branches

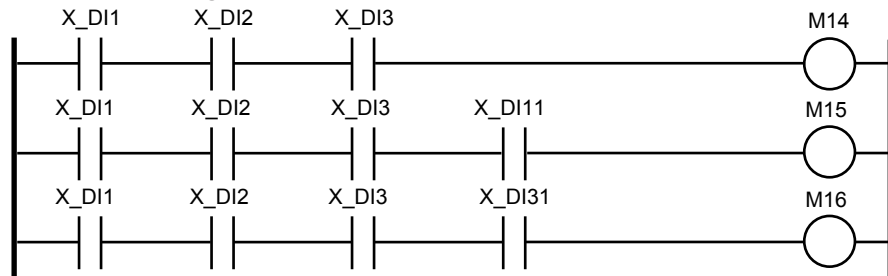

Step count = 14 steps

4.5.14 End

Instruction	Mnemonic	Symbol	Input Condition Required?		Execution Condition	Step Count	Data Format
			Yes	No			
End	-	-	-	√	-	4	-

The End instruction is automatically appended to the end of a ladder sequence program created.

## 4.6 Details of Application Instructions

Functional quick reference guide

The following functional quick reference guide is provided at the start of the explanation of all the application instructions.

Instruction	Mnemonic	Symbol	Input Condition Required?		Execution Condition	Step Count	Data Format
			Yes	No			
Move	MOV		√	-		3	D-register, status register, relay, or DAT register
	E_MOV		√	-		3	

↑ (1)      ↑ (2)      ↑ (3)      ↑ (4)      ↑ (5)      ↑ (6)      ↑ (7)

### (1) Instruction

Indicates an instruction name.

### (2) Mnemonic

Indicates the representation of an instruction by Mnemonic.

### (3) Symbol

Indicates a representation method on LL50A.

### (4) Input Condition Required?

Indicates whether the input condition is required for the instruction concerned.

An instruction with the "√" symbol in the Yes column always requires the input condition.

An instruction with the "-" symbol in the No column requires no input condition.

### (5) Execution Condition

Symbol	Execution Condition
	This represents an execute-while-ON instruction. The instruction is executed only when the pre-condition of that instruction is ON. It is not executed if the pre-condition is OFF.
	This represents an instruction that is executed once when the pre-condition is set to ON. The instruction is executed only when the pre-condition of the instruction changes from OFF to ON, or a rise. After that, it is not executed even if the pre-condition is ON.
	This represents an instruction that is executed once when the pre-condition is set to OFF. The instruction is executed only when the pre-condition of the instruction changes from ON to OFF, or a fall. After that, it is not executed even if the pre-condition is OFF.
-	This indicates an instruction that is always executed. The instruction is executed irrespective of ON/OFF of the pre-condition of the instruction.

### (6) Step Count

Indicates the number of steps of the instruction concerned.

### (7) Data Format

Indicates the processing unit to be used during execution of the instruction concerned.

In principle, all data formats are available for each instruction. The column shows the data format that is mainly used.

Instructions whose processing unit is a relay are intended for relays.

Instructions whose processing unit is a D-register, status register, or DAT register are intended for registers.

Relay data can be handled by integrating it in 16 bits or 32 bits.

► [Data format: Section 4.3, Data Format](#)

## 4.6.1 Comparison

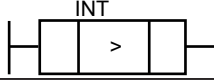
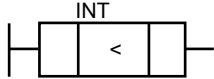
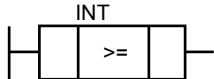
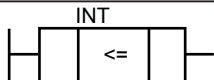
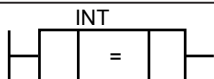
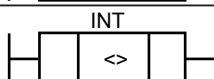
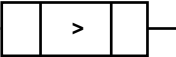
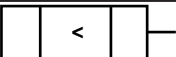
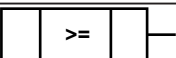
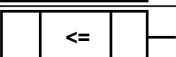
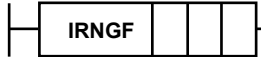
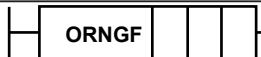
Instruction	Mnemonic	Symbol	Input Condition Required?		Execution Condition	Step Count	Data Format
			Yes	No			
Comparison (Integers)	GT		-	√	-	4	D-register, DAT register or status register
	LT		-	√	-	4	
	GE		-	√	-	4	
	LE		-	√	-	4	
	EQ		-	√	-	4	
	NEQ		-	√	-	4	
Comparison (Floating-point numbers)	GTF		-	√	-	4	D-register, or DAT register
	LTF		-	√	-	4	
	GEF		-	√	-	4	
	LEF		-	√	-	4	
In range	IRNGF		-	√	-	5	D-register, or DAT register
Out of range	ORNGF		-	√	-	5	

## Parameter

**Integer**

This instruction compares two integers and outputs the calculation result as “a” contact. An Compare instruction is the instruction comparing the integer part (rounded-off below the decimal point). For the comparison including decimal points, execute a compare instruction after applying required multipliers such as C10 (constant 10) and C100 (constant 100.)

**Floating-Point Number**

This instruction compares two single-precision floating-point numbers (32 bits) and outputs the calculation result as “a” contact. The calculation result is as follows.

## 4.6 Details of Application Instructions

Mnemonic	Condition and Calculation Result			
	Condition	Result	Condition	Result
GT, GTF	$d1 > d2$	ON (1)	$d1 \leq d2$	OFF (0)
LT, LTF	$d1 < d2$		$d1 \geq d2$	
GE, GEF	$d1 \geq d2$		$d1 < d2$	
LE, LEF	$d1 \leq d2$		$d1 > d2$	
EQ	$d1 = d2$		$d1 \neq d2$	
NEQ	$d1 \neq d2$		$d1 = d2$	
IRNGF	$d1 \leq d3 \leq d2$		$d3 < d1$ or $d2 < d3$	
ORNGF	$d3 \leq d1$ or $d2 \leq d3$		$d1 < d3 < d2$	

Greater than

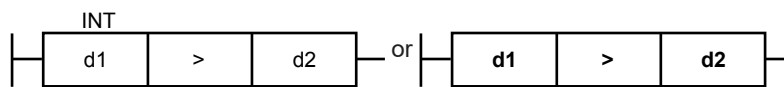

Less than

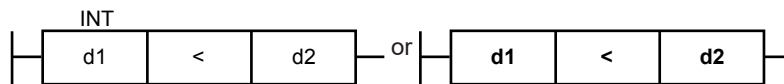

Greater than or equal

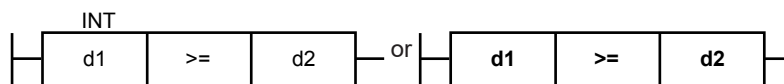

Less than or equal

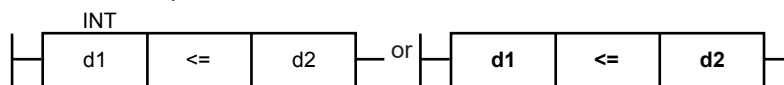

Equal

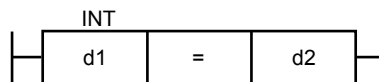

Not equal



In range

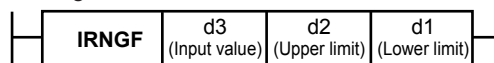

Out of range

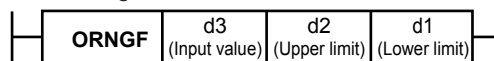

**Program example**

DAT01 is always calculated (PLS1).

When PVIN\_CTL is more than 300.0 (3000) °C, M01 is activated. Moreover, when PVIN\_CTL is less than 150.0 (1500) °C, M02 is activated.

(K01: 3000, K02: 1500)

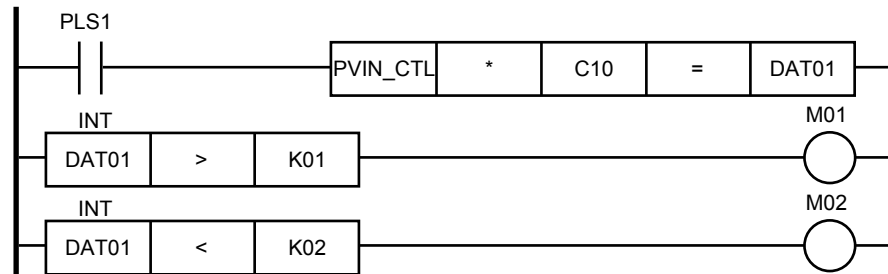

4.6.2 Four Fundamental Arithmetic Operations

Instruction	Mnemonic	Symbol	Input Condition Required?		Execution Condition	Step Count	Data Format
			Yes	No			
Addition	ADD		√	-		4	D-register or DAT register
	E_ADD		√	-		4	
Subtraction	SUB		√	-		4	
	E_SUB		√	-		4	
Multiplication	MUL		√	-		4	
	E_MUL		√	-		4	
Division	DIV		√	-		4	
	E_DIV		√	-		4	

Parameter

When the calculation result immediately before any of the four fundamental arithmetic operations is ON or changes from OFF to ON, the fundamental arithmetic operation concerned is performed using two single-precision floating-point numbers d2 and d3 (32 bits) and stores the result in a specified device (d1).

However, if a non-numerical value or infinity occurs during calculation or arises as a result, a ladder calculation overflow error occurs.

Addition

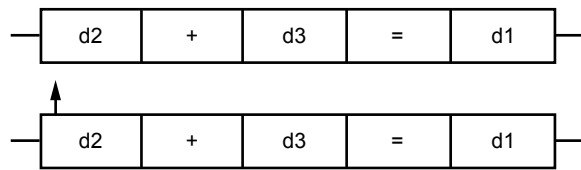

Subtraction

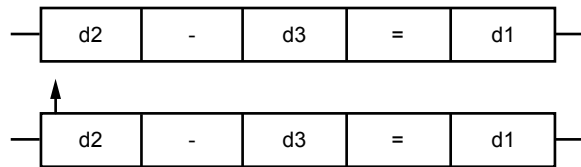

Multiplication

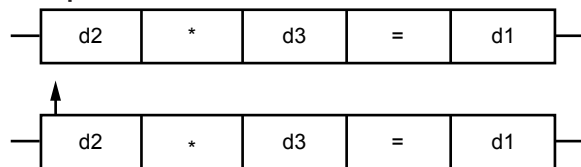

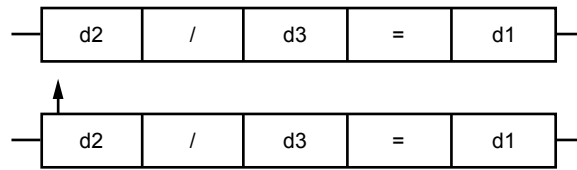
**Division****Program example**

When X\_DI1 becomes ON, DAT01 and DAT02 are added together and stored in P01.  
 Each time X\_DI2 is turned off and on, DAT03 is incremented.

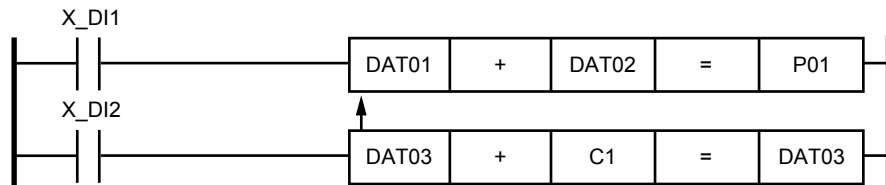



### 4.6.3 Square Root

Instruction	Mnemonic	Symbol	Input Condition Required?		Execution Condition	Step Count	Data Format
			Yes	No			
Square Root (%)	SQR		√	-		3	D-register or DAT register
	E_SQR		√	-		3	
Square Root (floating point numbers)	SQRF		√	-		3	D-register or DAT register
	E_SQRF		√	-		3	

#### Parameter

##### Percent data

Square root extraction is performed to the normalized input value (0 to 100%), and the calculated result is stored in the specified device (d1.)

In a square root, the input value and the calculated result are expressed as percent data, i.e. the calculated result for the input value 100 (%) is 100 (%); 50 (%) is 70.71 (%); 25 (%) is 50 (%).

Furthermore, negative input values are calculated as "0" (%). The calculated result is 0 (%).

##### Floating-Point Number

This instruction takes the square root of a real single-precision floating-point number and stores the result in the specified device (d1).

If  $d2 \leq 0.0$ , the calculated result is 0.0.

Square root of 1.0 is 1.0. Square root of 100.0 is 10.0.

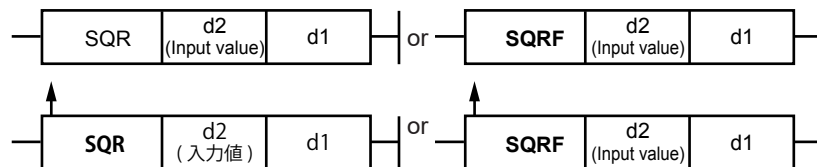

#### Program example

When X\_DI1 becomes ON, X\_PV data is normalized to SL\_R to SH\_R and the result is stored in DAT01. The SQR instruction obtains the square root extraction of DAT01 data and stores it in DAT02.

(X\_PV=100.0 to 500.0, SH\_R=500.0, SL\_R=100.0, DAT01=0.0 to 100.0%)

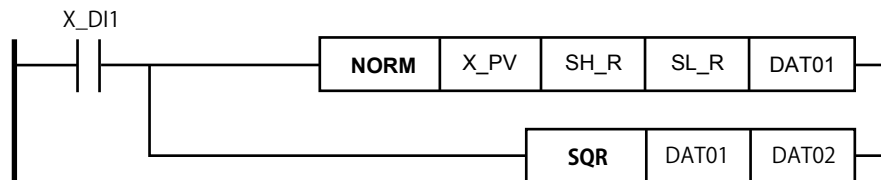

4.6.4 Square Root Extraction

Instruction	Mnemonic	Symbol	Input Condition Required?		Execution Condition	Step Count	Data Format
			Yes	No			
Square Root Extraction (Low cutoff point or less: zero)	SQT		√	-		4	D-register or DAT register
	E_SQT		√	-		4	
Square Root Extraction with variable low cutoff	SQTE		√	-		4	
	E_SQTE		√	-		4	

Parameter

Square Root Extraction (Low Cutoff Point or Less: Zero)

This instruction takes the square root extraction of the input value (d3) and stores the result in the specified device (d1).

If the input value (d3) < low cutoff point (d2), 0 is stored in the specified device (d1).

If the input value (d3) ≥ low cutoff point (d2), √d3 is stored in the specified device (d1).

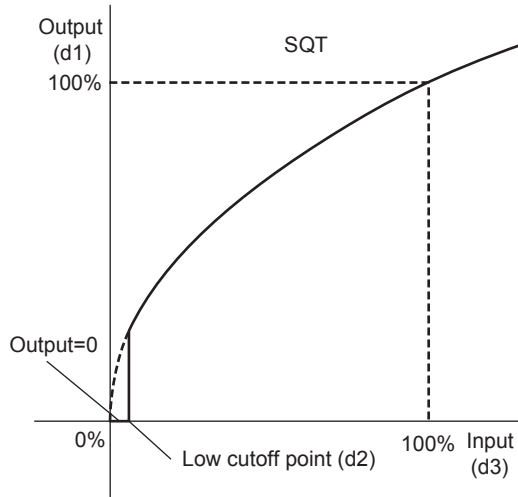
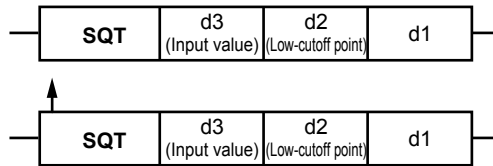

## 4.6 Details of Application Instructions

### Square Root Extraction (Low Cutoff Point or Less)

This instruction takes the square root extraction of the input value (d3) and stores the result in the specified device (d1).

If the input value (d3) < low cutoff point (d2), d3 is stored as-is in the specified device (d1).

If the input value (d3) ≥ low cutoff point (d2),  $\sqrt{d3}$  is output.

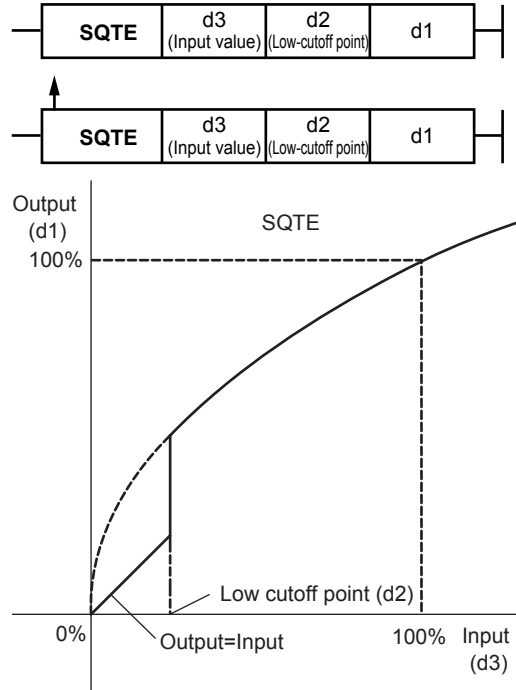

In both cases, the input and output are between 0.0% and 100.0%.

If the low cutoff point (d2) < 0.0, it is assumed to be 0.0. There is no hysteresis for the low cutoff point.

### Program example

When X\_DI1 becomes ON, a square root extraction is performed on DAT02 and stored in DAT01. If the result is less than or equal to the low cutoff point (P1), 0 is stored in DAT01. When X\_DI2 becomes ON, a square root extraction is performed on DAT04 and stored in DAT03. If the result is less than or equal to the low cutoff point (P2), DAT04 is stored as-is in DAT03.

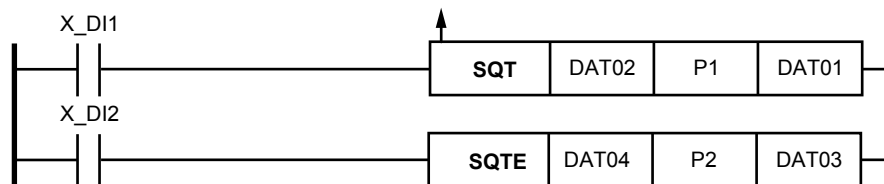

### 4.6.5 Absolute Value

Instruction	Mnemonic	Symbol	Input Condition Required?		Execution Condition	Step Count	Data Format
			Yes	No			
Absolute Value	ABS		√	-		3	D-register or DAT register
	E_ABS		√	-		3	

#### Parameter

This instruction obtains the absolute value from the input value (d2) and the result is stored in a specified device (d1).

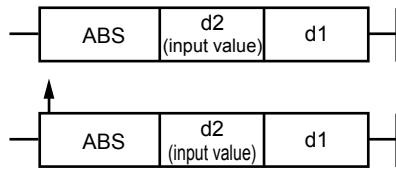

#### Program example

When X\_DI1 becomes ON, the instruction obtains the absolute value of DAT02 data and stores it in DAT01.

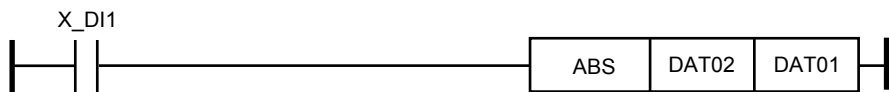

4.6.6 Exponential

Instruction	Mnemonic	Symbol	Input Condition Required?		Execution Condition	Step Count	Data Format
			Yes	No			
Exponential	EXP		√	-		3	D-register or DAT register
	E_EXP		√	-		3	

Parameter

When the calculation result of the previous operations is ON or changes from OFF to ON, this instruction performs an  $e^{d2}$  calculation using a single-precision floating-point number d2 (32 bits) and stores the result in a specified device (d1). However, if a non-numerical value or infinity occurs during calculation or arises as a result, a ladder calculation overflow error occurs.

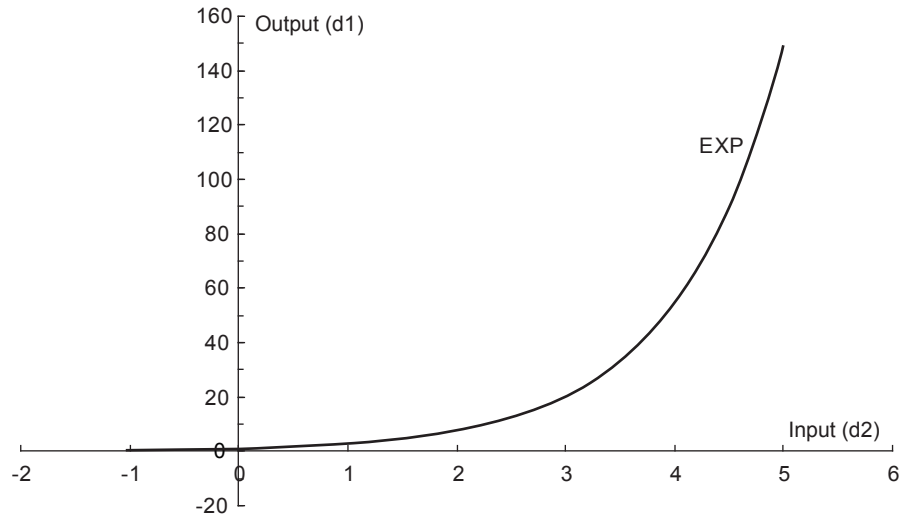
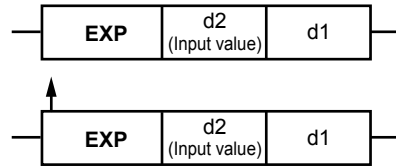

Program example

When X\_DI1 becomes ON,  $e^{DAT01}$  is calculated and stored in P01.

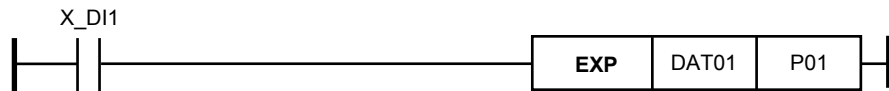

### 4.6.7 Power

Instruction	Mnemonic	Symbol	Input Condition Required?		Execution Condition	Step Count	Data Format
			Yes	No			
Power	PWR		√	-		4	D-register or DAT register
	E_PWR		√	-		4	

#### Parameter

When the calculation result of the previous operations is ON or changes from OFF to ON, this instruction performs a  $d3^{d2}$  calculation using a single-precision floating-point number d2 (32 bits) and stores the result in a specified device (d1).

However, a ladder calculation overflow will occur in the following cases.

- If the base (d3) = 0.0 and the exponent (d2) ≤ 0.0
- If the base (d3) < 0.0 and the exponent is not an integer.
- If a non-numerical value or infinity occurs during calculation or arises as a result.

The output when a ladder calculation overflow occurs is 0.0.

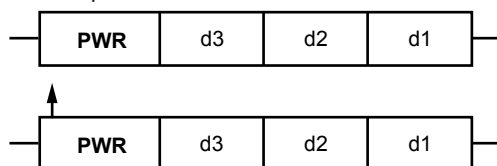

#### Program example

When X\_DI1 becomes ON,  $DAT01^{DAT02}$  is calculated and stored in P01.

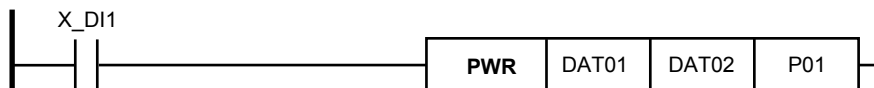

### 4.6.8 Natural Logarithm

Instruction	Mnemonic	Symbol	Input Condition Required?		Execution Condition	Step Count	Data Format
			Yes	No			
Natural Logarithm	LN		√	-		3	D-register or DAT register
	E_LN		√	-		3	

#### Parameter

When the calculation result of the previous operations is ON or changes from OFF to ON, this instruction perform a  $\log_e^{d2}$  calculation using a single-precision floating-point number d2 (32 bits) and stores the result in a specified device (d1).

However, a ladder calculation overflow will occur in the following cases.

- If input (d2)  $\leq 0$
- If a non-numerical value or infinity occurs during calculation or arises as a result.

The output when a ladder calculation overflow occurs is input value d2.

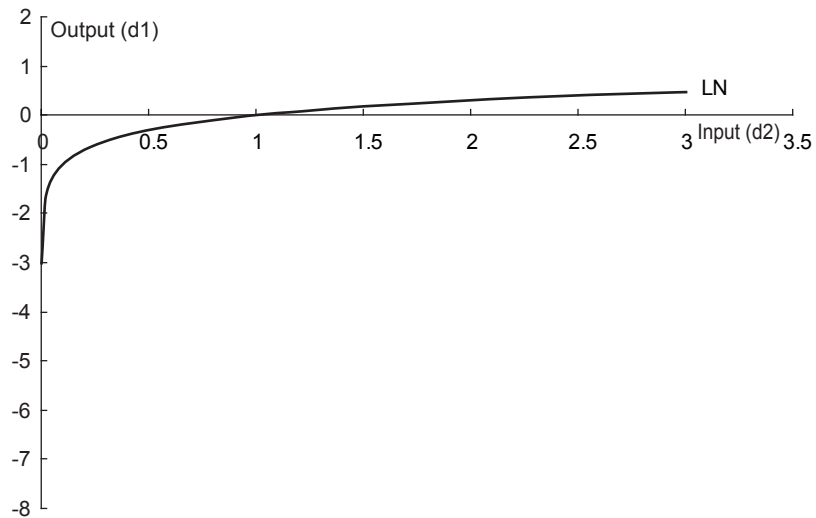
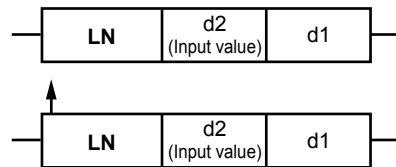

#### Program example

When X\_DI1 becomes ON,  $\log_e^{DAT01}$  is calculated and stored in P01.

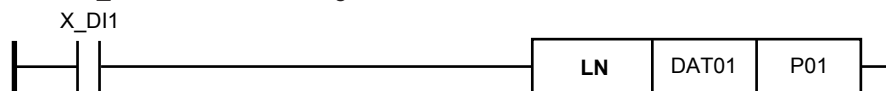

### 4.6.9 Common Logarithm

Instruction	Mnemonic	Symbol	Input Condition Required?		Execution Condition	Step Count	Data Format
			Yes	No			
Common Logarithm	LOG		√	-		3	D-register or DAT register
	E_LOG		√	-		3	

#### Parameter

When the calculation result of the previous operations is ON or changes from OFF to ON, this instruction performs a  $\log_{10}^{d2}$  calculation using a single-precision floating-point number d2 (32 bits) and stores the result in a specified device (d1).

However, a ladder calculation overflow will occur in the following cases.

- If input (d2)  $\leq 0$
- If a non-numerical value or infinity occurs during calculation or arises as a result.

The output when a ladder calculation overflow occurs is input value d2.

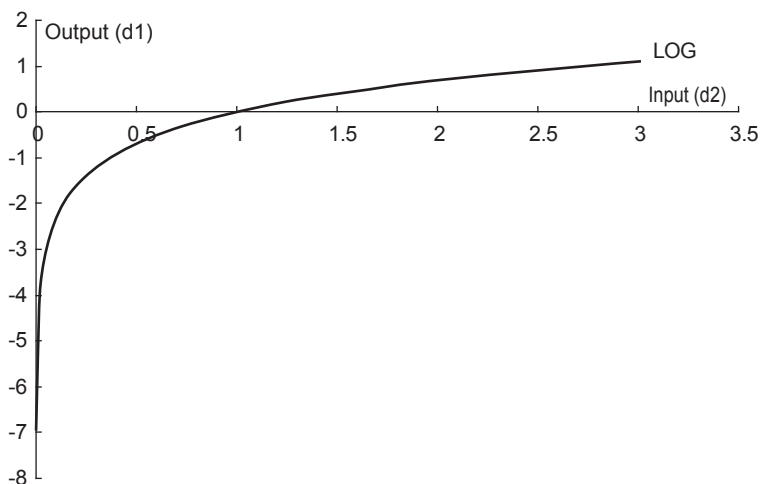
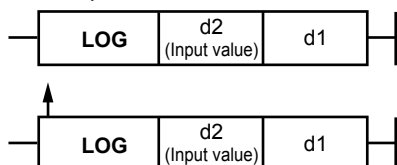

#### Program example

When X\_DI1 becomes ON,  $\log_{10}^{DAT01}$  is calculated and stored in P01.

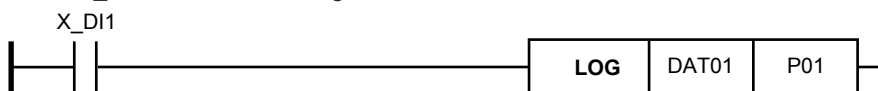



4.6.10 Logical Operation

Instruction	Mnemonic	Symbol	Input Condition Required?		Execution Condition	Step Count	Data Format	
			Yes	No				
Logical AND	AND		√	-		4	Status register	
	E_AND		√	-		4		
Logical OR	OR		√	-		4		
	E_OR		√	-		4		
Logical XOR	XOR		√	-		4		
	E_XOR		√	-		4		
Logical XOR (1 bit)	XORB		√	-		4		Relay
	E_XORB		√	-		4		
Two's Complement	NEG		√	-		2	Status register	
	E_NEG		√	-		2		
Not	NOT		√	-		2		
	E_NOT		√	-		2		
Not (1bit)	NOTB		√	-		2	Relay	
	E_NOTB		√	-		2		

**Parameter**

**Data format: 16-bit integer**

**(Logical AND, logical OR, and logical XOR)**

These instructions perform logical operations using two 16-bit data (d2 and d3) and store the result in a specified device (d1). If two 16-bit data (d2 and d3) is greater than negative or 65535, the calculation is not executed. In this case, a ladder calculation overflow error occurs.

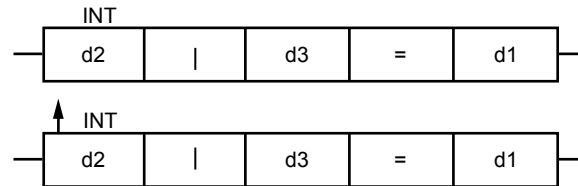
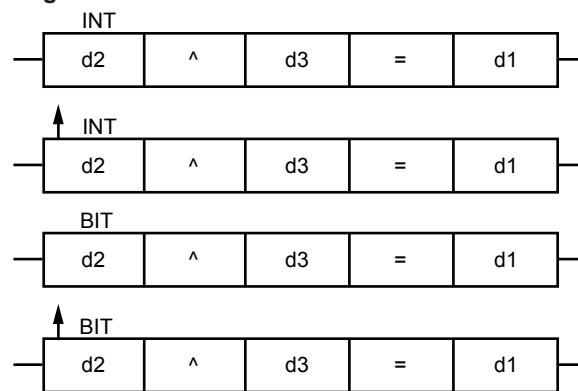
**Logical AND****Logical OR****Logical XOR****When d2 and d3 Are Floating-Point Numbers**

For example, if PV1 is 34.5, the fraction is rounded and handled as a 16-bit integer. If relay data (1 bit: 0 or 1) is assigned to d1, 0 is stored when the 16-bit integer is 0, and 1 is stored otherwise.

## 4.6 Details of Application Instructions

Logical AND (16-bit data)

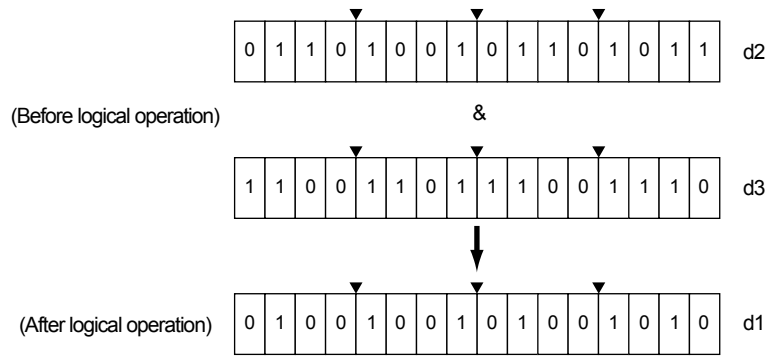

Logical OR (16-bit data)

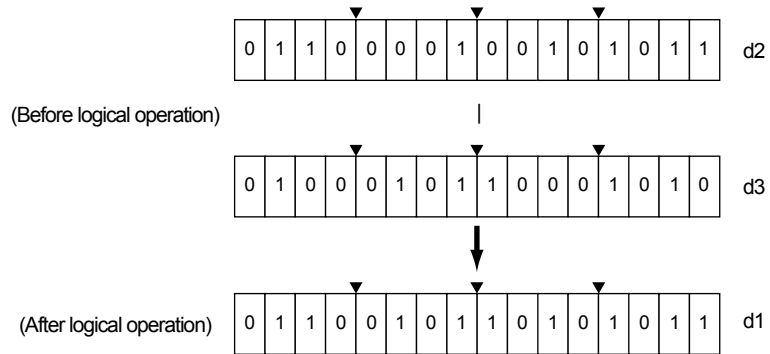

Logical XOR (16-bit data)

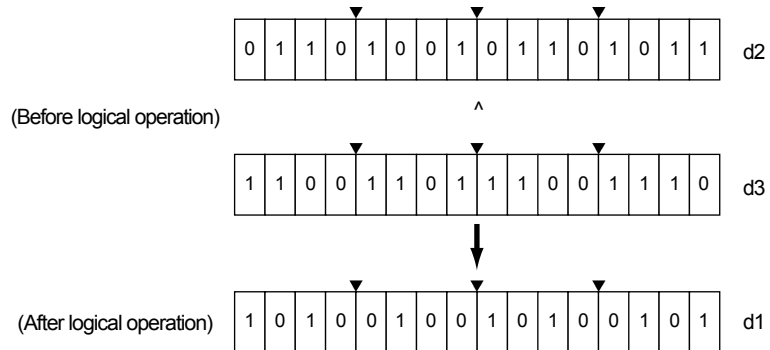

Logical XOR (1-bit data)

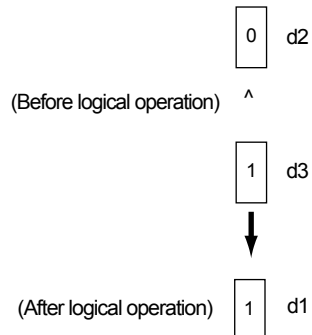

**(Not and Two's complement)**

**Two's complement**

This instruction obtains the two's complement of 16-bit data (d1) and the result is stored in a specified device (d1).

If 16-bit data (d1) is greater than negative or 65535, the calculation is not executed. In this case, a ladder calculation overflow error occurs.

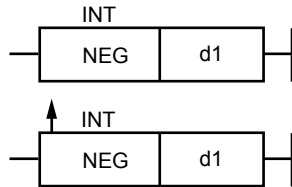

**Not**

This instruction invert 16-bit data (d1) and the result is stored in a specified device (d1).

If 16-bit data (d1) is greater than negative or 65535, the calculation is not executed. In this case, a ladder calculation overflow error occurs.

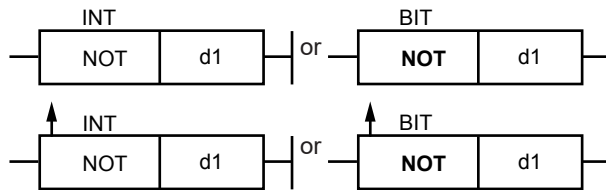

These instructions invert 16-bit data (d1) or obtain the two's complement of it and store the result in a specified device (d1).

Two's complement (16-bit data)

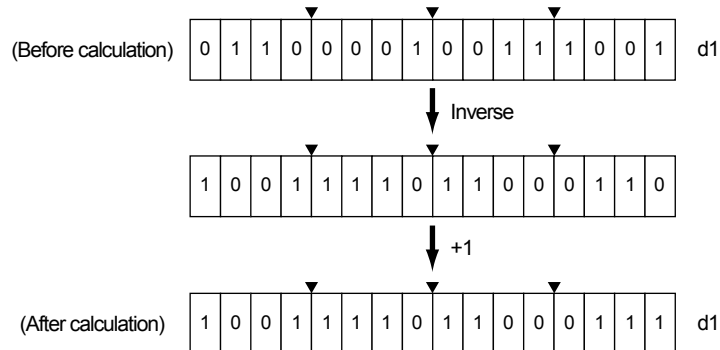

Not (16-bit data)

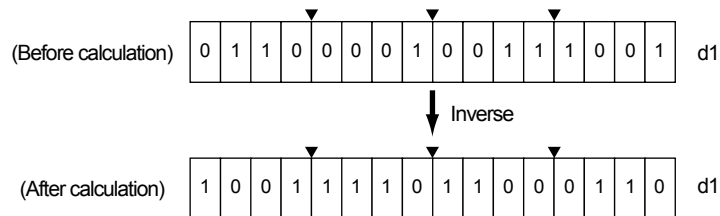

## 4.6 Details of Application Instructions

Not (1-bit data)

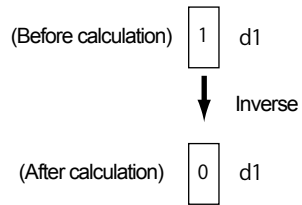

If the relay data is specified to the parameter, the data is handled as 16-bit data "0" (0x000) or "1" (0x0001).

### Program example

When X\_DI1 becomes ON, the instruction converts M1\_16 data to the two's complement.

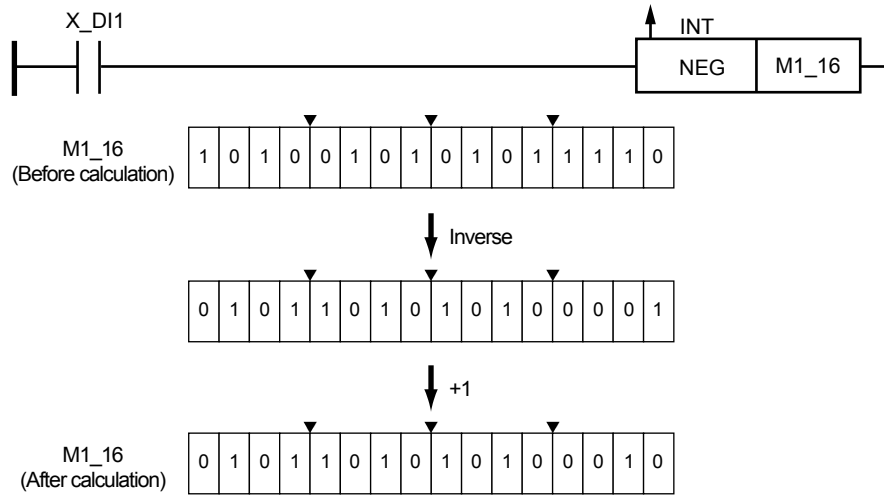

### 4.6.11 Rotation

Instruction	Mnemonic	Symbol	Input Condition Required?		Execution Condition	Step Count	Data Format
			Yes	No			
Right Rotate	RROT		√	-		3	Status register
	E_RROT		√	-		3	
Left Rotate	LROT		√	-		3	
	E_LROT		√	-		3	

#### Parameter

These instructions rotate 16-bit data (d1) to the right or left by “n” bits and store the rotation result in a specified device (d1).

If 16-bit data (d1) is greater than negative or 65535, the calculation is not executed. In this case, a ladder calculation overflow error occurs.

Specify the number of bits (n) within the range 1 to 16 when the number of bits out of the range is specified, the Rotation instruction is not executed.

The number of bits (n) is handled as

- “1” if  $0.5 \leq d2 < 1.5$
- “2” if  $1.5 \leq d2 < 2.5$
- ⋮
- ⋮
- ⋮
- “16” if  $15.5 \leq d2 < 16.5$

#### Right rotate

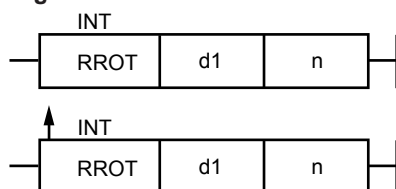

#### Left rotate

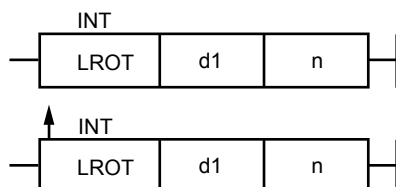

## 4.6 Details of Application Instructions

### Program example

When X\_DI1 becomes ON, M1\_16 data is rotated to the right by P01 (number of rotations) bits.

When X\_DI2 changes from OFF to ON, M17\_32 data is rotated to the left by P02 (number of rotations) bits.

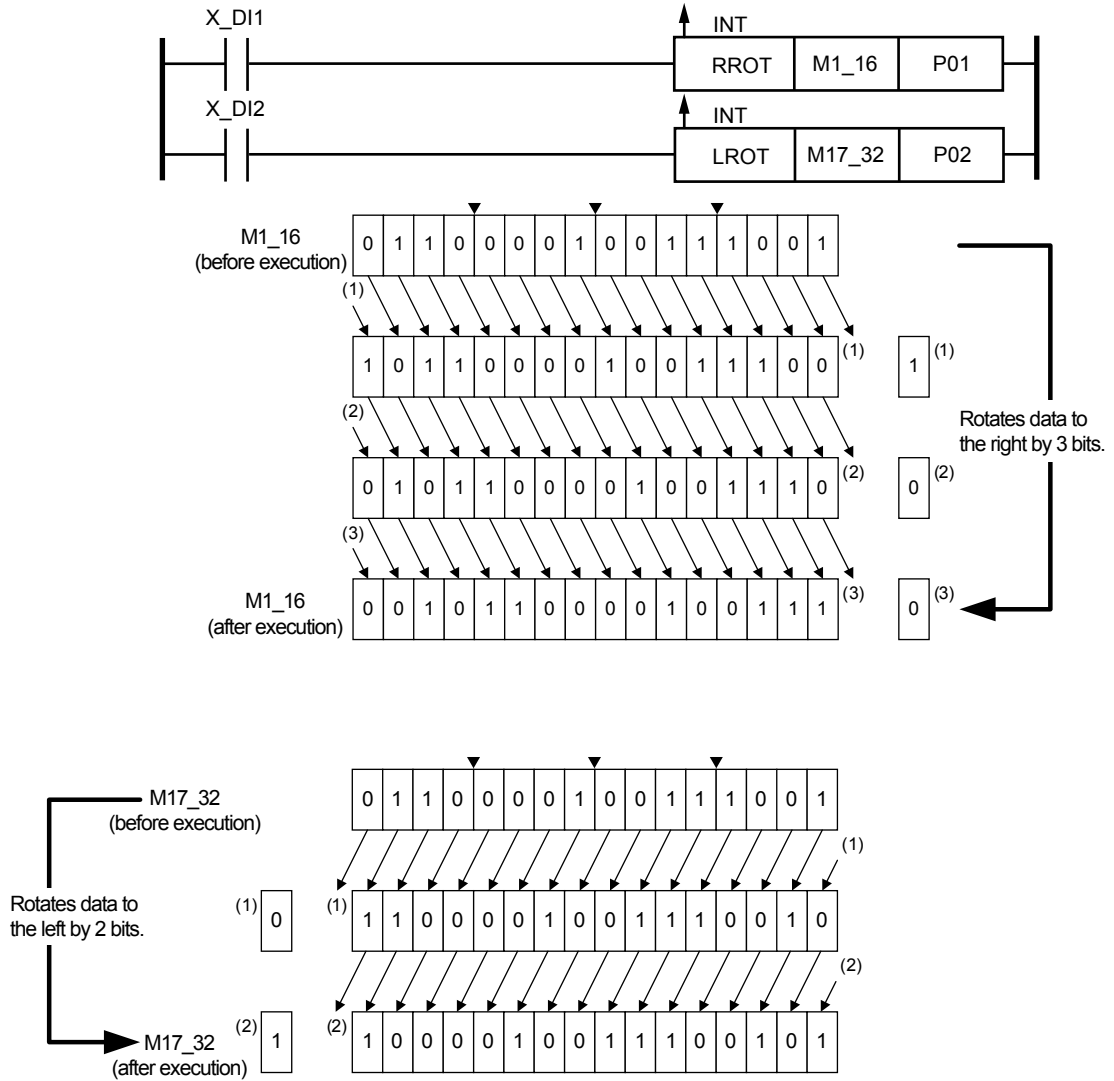

4.6.12 Shift

Instruction	Mnemonic	Symbol	Input Condition Required?		Execution Condition	Step Count	Data Format
			Yes	No			
Right Shift	RSFT		√	-		3	Status register
	E_RSFT		√	-		3	
Left Shift	LSFT		√	-		3	
	E_LSFT		√	-		3	
Shift Register	SFT		√	-		3	

Parameter

Right and left shifts

These instructions shift 16-bit data (d1) to the right or left by “n” bits and store the shift result in a specified device (d1).

If 16-bit data (d1) is greater than negative or 65535, the calculation is not executed. In this case, a ladder calculation overflow error occurs.

Specify the number of bits (n) within the range 1 to 16 when the number of bits out of the range is specified, the Right/Left shift instructions are not executed.

The number of bits (n) is handled as

- “1” if  $0.5 \leq d2 < 1.5$
- “2” if  $1.5 \leq d2 < 2.5$
- ⋮
- ⋮
- ⋮
- “16” if  $15.5 \leq d2 < 16.5$

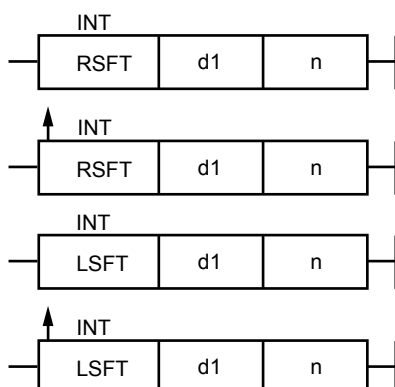



## 4.6 Details of Application Instructions

### Shift register

This instruction shifts 16-bit data (d1) to either the right or the left by one bit. If 16-bit data (d1) is greater than negative or 65535, the calculation is not executed. In this case, a ladder calculation overflow error occurs.

The shift timing is at the rise of a shift signal (OFF to ON) and the shift direction is specified by "s."

The instruction shifts data to the left if the value of the device specified by "s" is "0" or to the right if the value is "1." ("s" is handled a value of less than 0.5 as "0" and a value of 0.5 or more as "1".)

When data is shifted to the right or left, the shift input value enters the leftmost bit or rightmost bit.

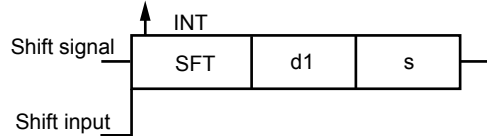

### Program example

#### Right and left shifts

When X\_DI1 changes from OFF to ON, M1\_16 data is shifted to the right by P01 (number of shifts) bits. P01 = 3

When X\_DI2 becomes ON, M17\_32 data is shifted to the left by P02 (number of shifts) bits. P02 = 5

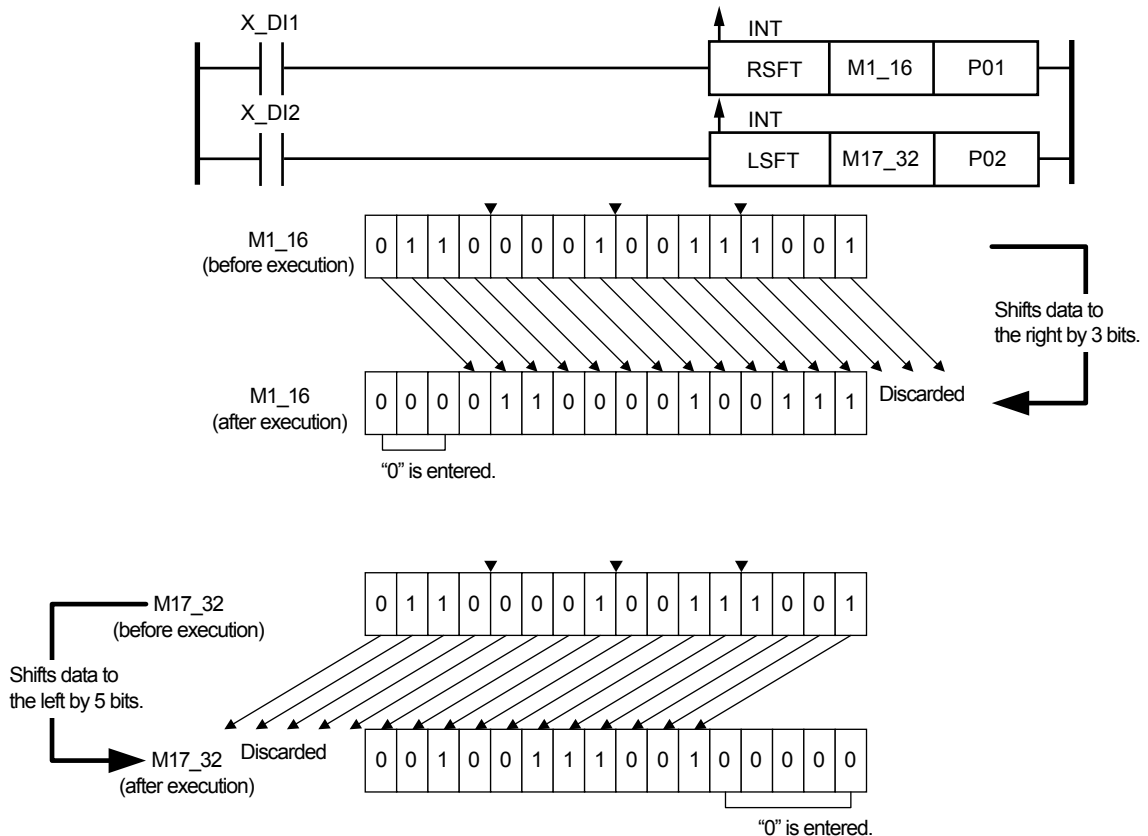

**Shift register**

When X\_DI1 or X\_DI2 becomes ON, the instruction shifts M33\_48 data to the right by M49 bits (0 or 1.)

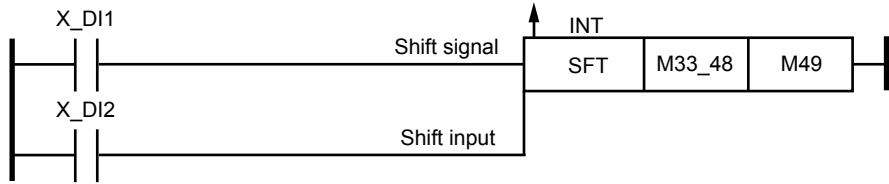

For right shift

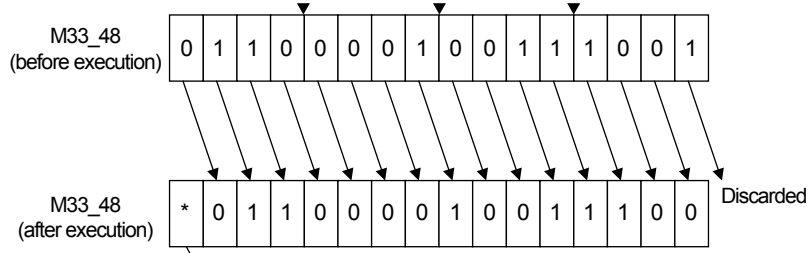

"0" or "1" is entered according to shift input.

4.6.13 Move

Instruction	Mnemonic	Symbol	Input Condition Required?		Execution Condition	Step Count	Data Format
			Yes	No			
Move	MOV		√	-		3	D-register, status register, relay or DAT register
	E_MOV		√	-		3	

**Parameter**

This instruction moves data from the transfer source (d2) to transfer destination (d1).

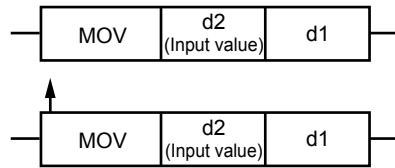

**(1) For specification of d2 (relay) to d1 (relay)**

The instruction moves M03 relay data (0 or 1) to the M30 relay.

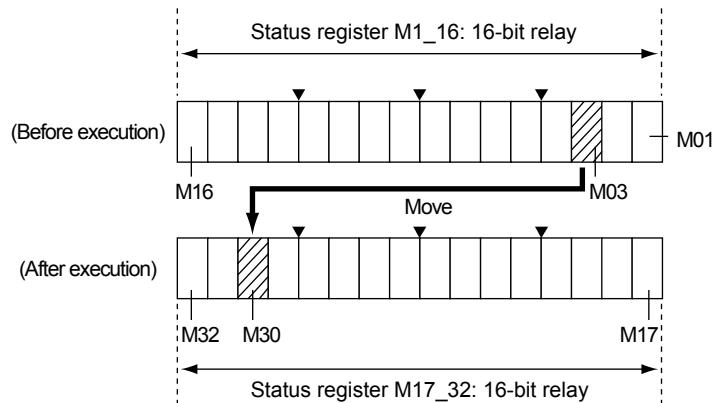
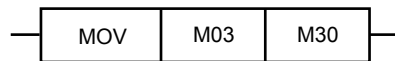

**(2) For specification of d2 (relay) to d1 (status register)**

The instruction moves M03 relay data (0 or 1) to the M17\_32 status registers. The M03 relay data is stored in the M17 relay, and the M18 to M32 relays become "0."

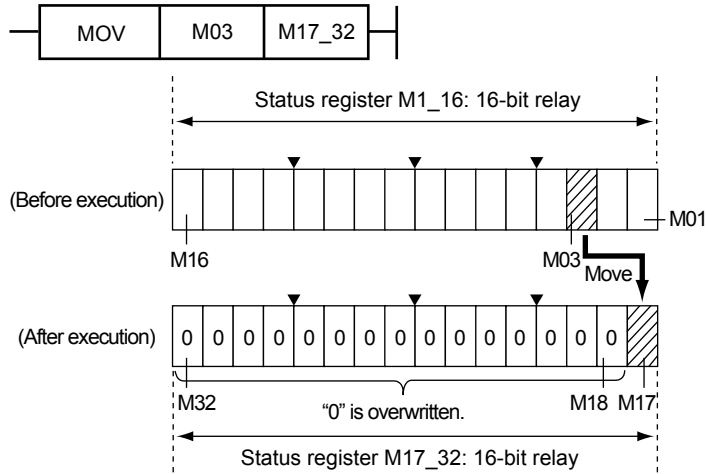

**(3) For specification of d2 (status register) to d1 (relay)**

The instruction moves M1\_16 status register data (0 to 65535) to the M30 relay. If any one of the M01 to M16 relays is "1," "1" is stored in the M30 relay and if the M01 to M16 are all "0," "0" is stored in the M30 relay.

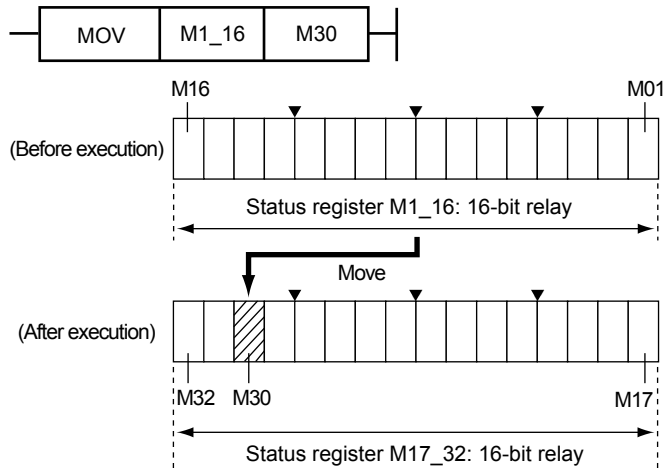

## 4.6 Details of Application Instructions

### (4) For specification of d2 (relay) to d1 (DAT register)

The instruction moves M03 relay data (0 or 1) to the DAT01 register. If the M03 relay data is 0, "0.0f (0x00000000)" is stored in DAT01, and if it is 1, "1.0f (0x3F800000)" is stored in DAT01.

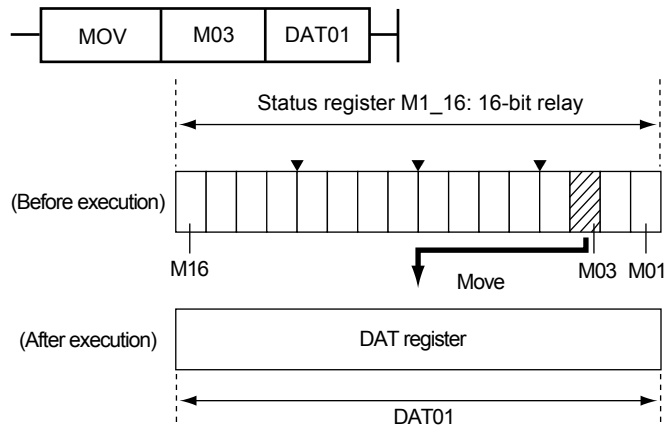

### (5) For specification of d2 (DAT register) to d1 (relay)

The instruction moves data in the DAT01 register to the M30 relay. If the DAT01 register data is less than "0.5f", "0" is stored in the M30 relay, and if it is "0.5f" or more, "1" is stored in the M30 relay.

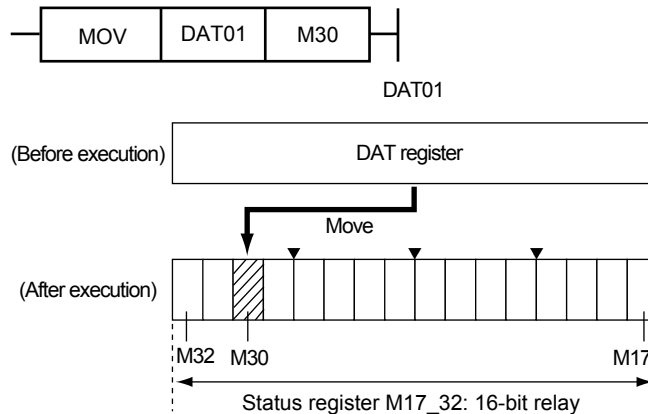

### (6) For specification of d2 (D register) to d1 (DAT register)

The instruction moves data in the D register (PV\_L1) to the DAT01 register.

Example: When the PV input range is -270.0 to 1370.0 °C and PV is 250.3 °C, if the PV (PV\_L1 register) is moved to the DAT01 register, "250.3f" is stored. The data to move includes decimal point position.

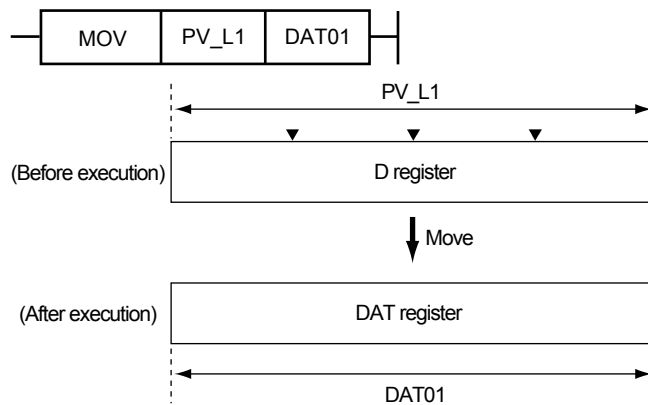

**(7) For specification of d2 (DAT register) to d1 (D register)**

The instruction moves data in the DAT01 register to the SP\_L1\_1 register.

Example: When the PV input range is -270.0 to 1370.0 °C, if the DAT01 register data "250.3f" is moved to the SP (SP\_L1\_1 register), "250.3f" is stored. When the DAT01 register data is out of the range of the storage destination register (parameter), data at the transfer source is restricted to the setting range of the storage destination register.

The data to move includes decimal point position.

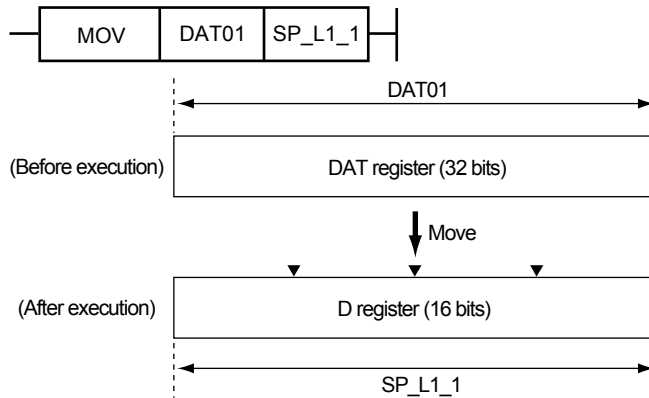

For data other than range and scale

If the data "1" to "8" of the SPNO. register is moved to the DAT01 register, data "1.0f" to "8.0f" is stored.



If the DAT01 register data "5.4f" is moved to the SPNO. register, data "5" is stored. If "5.5f" is moved to the SPNO. register, data "6" is stored.



**(8) Specification of d2 (DAT register) to d1 (DAT register)**

The instruction moves DAT register of the transfer source (d2) to the storage destination (d1) (DAT register).

**Program example**

When X\_DI1 becomes ON, P02 data is moved to the P01 register.

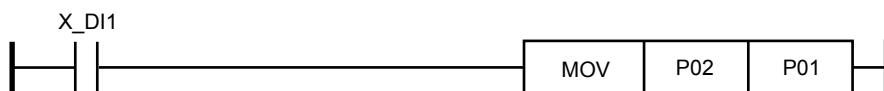

4.6.14 Binary/BCD Conversion

Instruction	Mnemonic	Symbol	Input Condition Required?		Execution Condition	Step Count	Data Format
			Yes	No			
Binary Conversion	BIN		√	-		3	D-register or status register
	E_BIN		√	-		3	
BCD Conversion	BCD		√	-		3	
	E_BCD		√	-		3	

Parameter

Binary conversion

This instruction converts the data of the transfer source for BCD code (d2) to an integer, and stores it to the transfer destination (d1).

If the data before binary conversion is negative or out of the BCD codes (each digit: 10 (0xa) to 15 (0xf)), binary conversion is not executed and the source value (d1) is not changed.

In this case, a ladder calculation overflow error occurs.

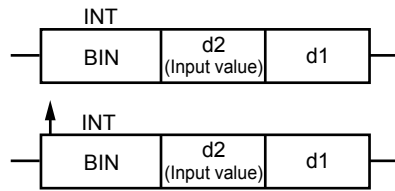

BCD conversion

This instruction converts the data of the transfer source for 16-bit binary code (an integer) to BCD, and stores it to the transfer destination (d1).

If the binary code (an integer) of the transfer source (d2) is greater than negative or 65535, BCD conversion is not executed and the transfer source value (d1) is not changed. In this case, a ladder calculation overflow error occurs.

If the binary code (an integer) of the transfer source (d2) is greater than ten-thousand (10,000), the value is BCD converted up to the thousands digit (1,000) and more than ten-thousands digit (10,000) is not converted.

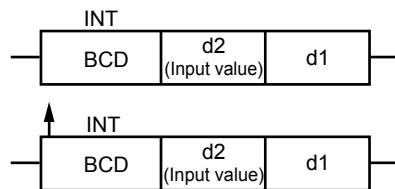

**Program example**

When X\_DI1 becomes ON, M1\_16 data is binary converted and the result is stored in M33\_48.

When X\_DI2 becomes ON, M17\_32 data is BCD converted and the result is stored in M49\_64.

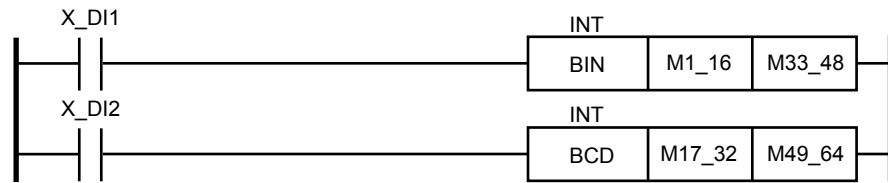



## 4.6 Details of Application Instructions

### 4.6.15 Ratio

Instruction	Mnemonic	Symbol	Input Condition Required?		Execution Condition	Step Count	Data Format
			Yes	No			
Ratio	RATIO		√	-		5	D-register or DAT register
	E_RATIO		√	-		5	

#### Parameter

This instruction obtains the ratio from the equation “input value (d4) x ratio (d3) + bias value (d2)” and stores the result in a specified device (d1).

If a non-numerical value or infinity occurs during calculation or arises as a result, a ladder calculation overflow error occurs.

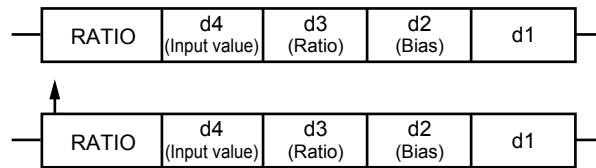

#### Program example

When X\_DI1 changes from OFF to ON, PV\_L1 input data is multiplied by P01, P02 is added to the value obtained, and the result is stored in DAT01.

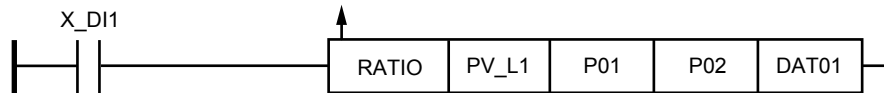

## 4.6.16 Reciprocal

Instruction	Mnemonic	Symbol	Input Condition Required?		Execution Condition	Step Count	Data Format
			Yes	No			
Reciprocal	RECIP		√	-		5	D-register
	E_RECIP		√	-		5	

## Parameter

When the calculation result of the previous operations is ON or changes from OFF to ON, this instruction takes the reciprocal of the single-precision floating-point number d4 using d3 and d2 and stores the result in a specified device (d1).

$$d1 = d3 \div (d4 + d2)$$

However, if a non-numerical value or infinity occurs during calculation or arises as a result, a ladder calculation overflow error occurs.

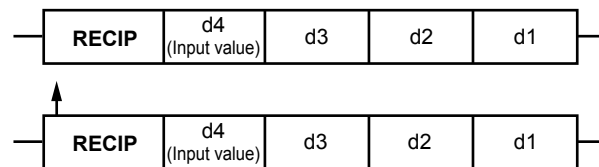

## Program example

When X\_DI1 becomes ON,  $P03 \div (DAT01 + P02)$  is calculated and stored in P01.

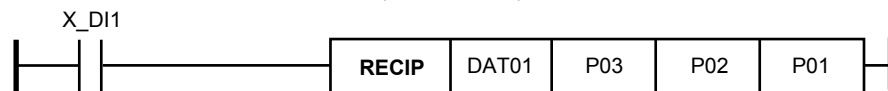

4.6.17 Selectors

Instruction	Mnemonic	Symbol	Input Condition Required?		Execution Condition	Step Count	Data Format
			Yes	No			
High Selector	HSL		√	-		4	D-register
	E_HSL		√	-		4	
Low Selector	LSL		√	-		4	
	E_LSL		√	-		4	

Parameter

**High selector**

When input value (d3) > input value (d2), this instruction stores the input value (d3) in a specified device (d1).

When input value (d3) ≤ input value (d2), the instruction stores the input value (d2) in a specified device (d1).

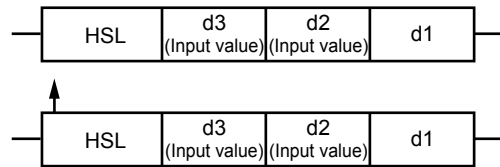

**Low selector**

When input value (d3) > input value (d2), this instruction stores the input value (d2) in a specified device (d1).

When input value (d3) ≤ input value (d2), the instruction stores the input value (d3) in a specified device (d1).

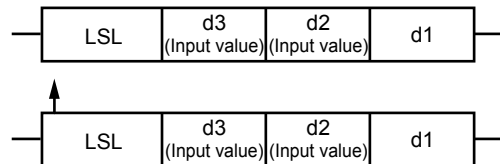

Program example

When X\_DI1 becomes ON, DAT04 data is stored in DAT01 if DAT04 > DAT03. If DAT04 ≤ DAT03, DAT03 data is stored in DAT01.

When X\_DI2 becomes ON, DAT05 data is stored in DAT02 if DAT06 > DAT05. If DAT06 ≤ DAT05, DAT06 data is stored in DAT02.

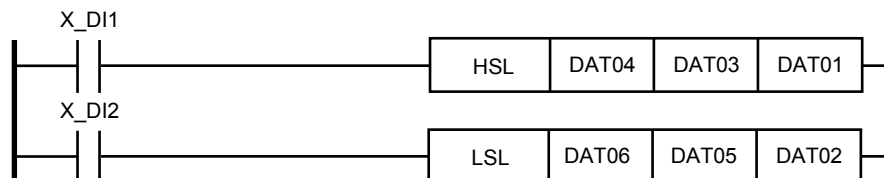

### 4.6.18 Limiters

Instruction	Mnemonic	Symbol	Input Condition Required?		Execution Condition	Step Count	Data Format
			Yes	No			
High Limiter	HLM		√	-		4	D-register
	E_HLM		√	-		4	
Low Limiter	LLM		√	-		4	
	E_LLM		√	-		4	

#### Parameter

##### High limiter

When input value (d3) < high-limit value (d2), this instruction stores the input value (d3) in a specified device (d1).

When input value (d3) ≥ high-limit value (d2), the instruction stores the high-limit value (d2) in a specified device (d1).

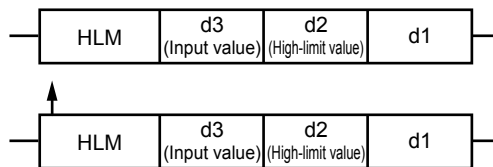

##### Low limiter

When input value (d3) < low-limit value (d2), this instruction stores the low-limit value (d2) in a specified device (d1).

When input value (d3) ≥ low-limit value (d2), the instruction stores the input value (d3) in a specified device (d1).

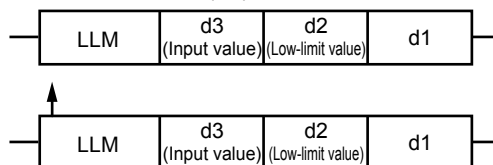

#### Program example

When X\_DI1 becomes ON, DAT03 data is stored in DAT01 if DAT03 < P01. If DAT03 ≥ P1, P01 data is stored in DAT01.

When X\_DI2 becomes ON, P02 data is stored in DAT02 if DAT04 < P02. If DAT04 ≥ P02, DAT04 data is stored in DAT02.

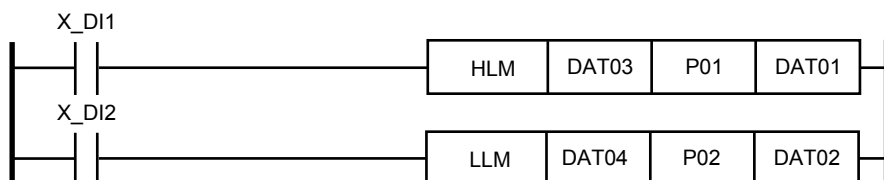

4.6.19 Limit

Instruction	Mnemonic	Symbol	Input Condition Required?		Execution Condition	Step Count	Data Format
			Yes	No			
Limit	LIMIT		√	-		5	D-register
	E_LIMIT		√	-		5	

Parameter

When the calculation result of the previous operations is ON or changes from OFF to ON, this instruction limits the single-precision floating-point number d4 using d3 (upper limit) and d2 (lower limit) and stores the result in a specified device (d1).

The calculation result is  $d1 = d3$  if  $d4 > d3$ . Otherwise,  $d1 = d2$  if  $d4 < d2$ . Otherwise,  $d1 = d4$ .

If  $d3 < d2$ , d3 is constantly output.

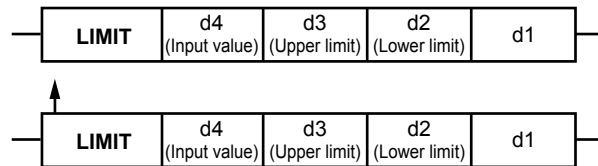

Program example

When X\_DI1 becomes ON, input (DAT01) is stored in P01. However, If the result is outside the limits defined by the upper limit (P03) and lower limit (P02), the relevant limit value is stored in P01.

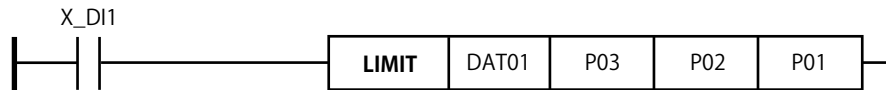

## 4.6.20 Scaling and Normalization

Instruction	Mnemonic	Symbol	Input Condition Required?		Execution Condition	Step Count	Data Format
			Yes	No			
Scaling	SCAL		√	-		5	D-register or DAT register
	E_SCAL		√	-		5	
Normalization	NORM		√	-		5	
	E_NORM		√	-		5	

## Parameter

## Scaling

This instruction performs scaling calculation for normalized input value (d5) and stores the result in a specified device (d1).

Scaling calculation is done by the following equation:

$$d1 = \text{input value (d4)} / 100 \times (100\% \text{ scale (d3)} - 0\% \text{ scale (d2)}) + 0\% \text{ scale value (d2)}$$

If a non-numerical value or infinity occurs during calculation or arises as a result, a ladder calculation overflow error occurs.

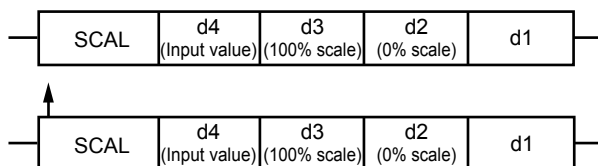

## Normalization

This instruction performs normalization calculation for scaled input value (d4) and stores the result in a specified device (d1).

Normalization is done by percent data of 0.0 to 100.0, and the following equation:

$$d1 = (\text{input value (d4)} - 0\% \text{ scale (d2)}) / (100\% \text{ scale (d3)} - 0\% \text{ scale value (d2)}) \times 100$$

If a non-numerical value or infinity occurs during calculation or arises as a result, a ladder calculation overflow error occurs.

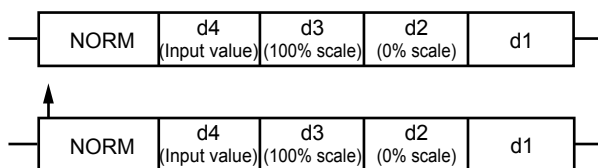

## 4.6 Details of Application Instructions

---

### Program example

When X\_DI1 changes from OFF to ON, X\_AIN2 data is scaled with SL\_R to SH\_R and the result is stored in DAT01.

When X\_DI2 becomes ON, X\_PV data is normalized with RL\_R to RH\_R and the result is stored in Y\_RET.

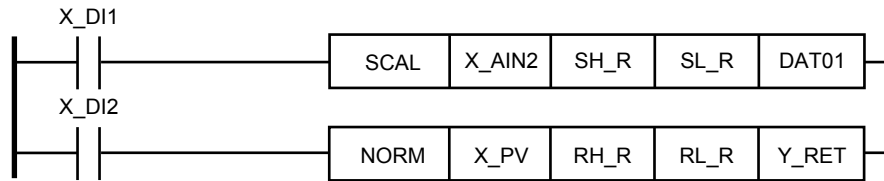

### 4.6.21 Maximum, Minimum, and Average Values

Instruction	Mnemonic	Symbol	Input Condition Required?		Execution Condition	Step Count	Data Format
			Yes	No			
Maximum	MAX		√	-		7	D-register or DAT register
	E_MAX		√	-		7	
Minimum	MIN		√	-		7	
	E_MIN		√	-		7	
Average	AVE		√	-		7	
	E_AVE		√	-		7	

#### Parameter

##### Maximum value

This instruction obtains the maximum value from up to four inputs: inputs 1 to 4 (d5 to d2) and stores the result in a specified device (d1).

If the number of inputs (d6) is one, the instruction stores input 1 (d5) in the specified device (d1).

If the number of inputs (d6) is two, it stores input 1 (d5) or input 2 (d4), whichever is the greater, in the specified device (d1).

If the number of inputs (d6) is three, it stores the maximum value of input 1 (d5) through input 3 (d3) in the specified device (d1).

If the number of inputs (d6) is four, it stores the maximum value of input 1 (d5) through input 4 (d2) in the specified device (d1).

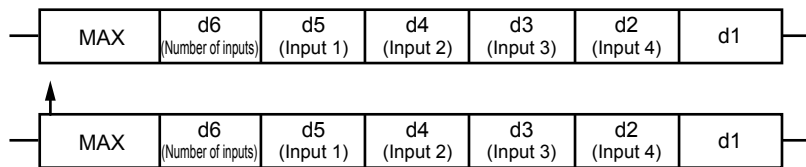



## 4.6 Details of Application Instructions

### Minimum value

This instruction obtains the minimum value from up to four inputs: inputs 1 to 4 (d5 to d2) and stores the result in a specified device (d1).

If the number of inputs (d6) is one, the instruction stores input 1 (d5) in the specified device (d1).

If the number of inputs (d6) is two, it stores input 1 (d5) or input 2 (d4), whichever is the smaller, in the specified device (d1).

If the number of inputs (d6) is three, it stores the minimum value of input 1 (d5) through input 3 (d3) in the specified device (d1).

If the number of inputs (d6) is four, it stores the minimum value of input 1 (d5) through input 4 (d2) in the specified device (d1).

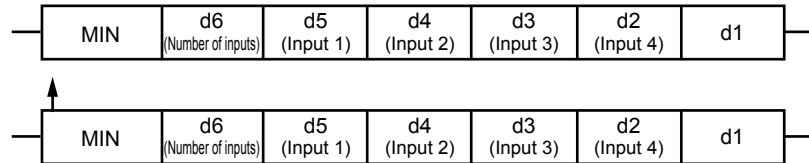

### Average value

This instruction obtains the average value of up to four inputs: inputs 1 to 4 (d5 to d2) and stores the result in a specified device (d1).

If the number of inputs (d6) is one, the instruction stores input 1 (d5) in the specified device (d1).

If the number of inputs (d6) is two, it obtains the average value of input 1 (d5) and input 2 (d4) and stores it in the specified device (d1).

If the number of inputs (d6) is three, it stores the average value of input 1 (d5) through input 3 (d3) in the specified device (d1).

If the number of inputs (d6) is four, it stores the average value of input 1 (d5) through input 4 (d2) in the specified device (d1).

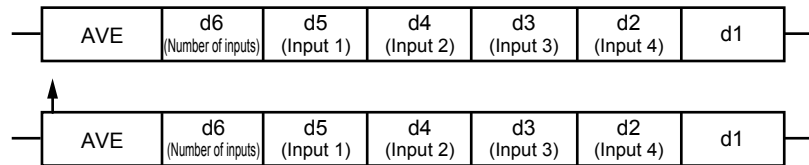

The number of inputs (d6) is regarded as

- “1” if  $d6 < 1.5$
- “2” if  $1.5 \leq d6 < 2.5$
- “3” if  $2.5 \leq d6 < 3.5$
- “4” if  $3.5 \leq d6$

Digits to the right of the decimal point will be discarded.

### Program example

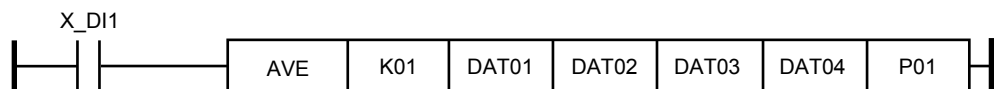

## 4.6.22 Temperature Compensation

Instruction	Mnemonic	Symbol	Input Condition Required?		Execution Condition	Step Count	Data Format
			Yes	No			
Temperature Compensation (deg C)	TCMP1		√	-		5	D-register or DAT register
	E_TCMP1		√	-		5	
Temperature Compensation (deg F)	TCMP2		√	-		5	
	E_TCMP2		√	-		5	

## Parameter

**Temperature compensation (°C)**

This instruction performs temperature compensation (in °C) based on the reference temperature d2 (°C), temperature d3 (°C), and flow rate d4 and stores the result in a specified device (d1). Temperature compensation (°C) is done by the following equation.  
 $d1 = \text{flow rate (d4)} \times (\text{reference temperature (d2)} + 273.15) / (\text{temperature (d3)} + 273.15)$

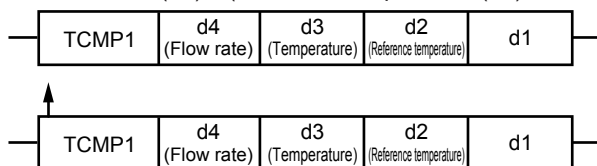
**Temperature compensation (°F)**

This instruction performs temperature compensation (in °F) based on the reference temperature d2 (°F), temperature d3 (°F), and flow rate d4 and stores the result in a specified device (d1). Temperature compensation (°F) is done by the following equation.  
 $d1 = \text{flow rate (d4)} \times ((\text{reference temperature (d2)} - 32) / 1.8 + 273.15) / ((\text{temperature (d3)} - 32) / 1.8 + 273.15)$

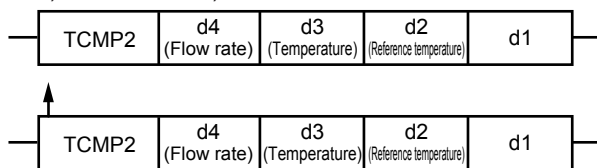

If a non-numerical value or infinity occurs during calculation or arises as a result, a ladder calculation overflow error occurs.

**Program example**

In the following program, the control PV input range (P.RH/P.RL) [PVIN\_CTL: 0 to 100% scale] and the PV input range (RH/RL) or PV input scale (SH/SL) need to be equal.

X\_PV: Temperature input that is scaled to 0 to 500°C.

X\_AIN2: Flow input that is scaled to 0 to 100%.

K01: Reference temperature 300°C.

X\_AIN4: Pressure input that is scaled to 0 to 1MPa.

K02: Reference pressure 0.6MPa.

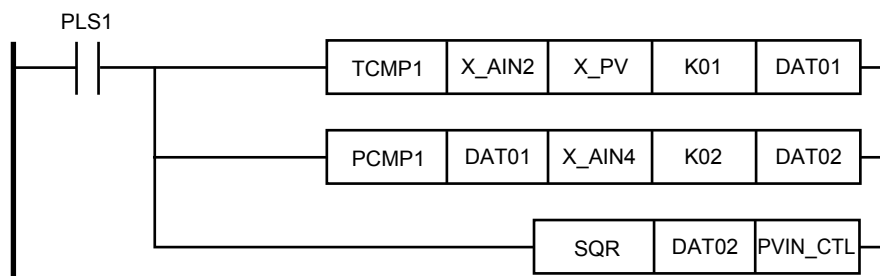

### 4.6.23 Pressure Compensation

Instruction	Mnemonic	Symbol	Input Condition Required?		Execution Condition	Step Count	Data Format
			Yes	No			
Pressure Compensation (MPa)	PCMP1		√	-		5	D-register
	E_PCMP1		√	-		5	
Pressure Compensation (kgf/cm <sup>2</sup> )	PCMP2		√	-		5	
	E_PCMP2		√	-		5	
Pressure Compensation (psi)	PCMP3		√	-		5	
	E_PCMP3		√	-		5	

psi:pound per square inch

#### Parameter

##### Pressure compensation (MPa)

This instruction performs pressure compensation (in MPa) based on the reference pressure d2 (MPa), pressure d3 (MPa), and flow rate d4 and stores the result in a specified device (d1).

Pressure compensation (MPa) is done by the following equation.

$$d1 = \text{flow rate (d4)} \times (\text{pressure (d3)} + 0.101325) / (\text{reference pressure (d2)} + 0.101325)$$

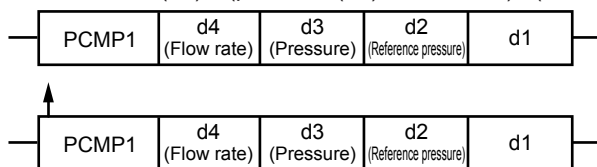

##### Pressure compensation (kgf/cm<sup>2</sup>)

This instruction performs pressure compensation (in kgf/cm<sup>2</sup>) based on the reference pressure d2 (kgf/cm<sup>2</sup>), pressure d3 (kgf/cm<sup>2</sup>), and flow rate d4 and stores the result in a specified device (d1).

Pressure compensation (kgf/cm<sup>2</sup>) is done by the following equation.

$$d1 = \text{flow rate (d4)} \times (\text{pressure (d3)} + 1.03323) / (\text{reference pressure (d2)} + 1.03323)$$

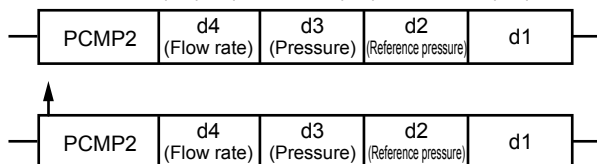

## 4.6 Details of Application Instructions

### Pressure compensation (psi)

This instruction performs pressure compensation (in psi) based on the reference pressure d2 (psi), pressure d3 (psi), and flow rate d4 and stores the result in a specified device (d1).

Pressure compensation (psi) is done by the following equation.

$$d1 = \text{flow rate (d4)} \times (\text{pressure (d3)} + 14.6959) / (\text{reference pressure (d2)} + 14.6959)$$

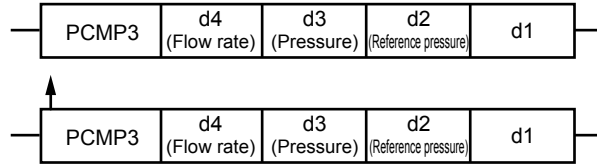

If a non-numerical value or infinity occurs during calculation or arises as a result, a ladder calculation overflow error occurs.

### Program example

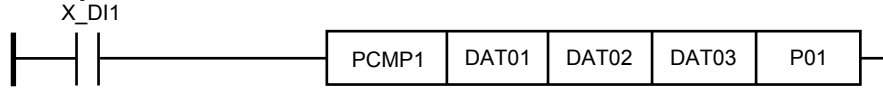

### 4.6.24 Temperature and Humidity Calculation

Instruction	Mnemonic	Symbol	Input Condition Required?		Execution Condition	Step Count	Data Format
			Yes	No			
Temperature and Humidity Calculation	TMPHM		√	-		6	D-register

#### Parameter

When the calculation result of the previous operations is ON,

$$\text{Relative humidity } H \text{ (\%RH)} = \frac{1}{ed} \times \left( ew - 0.5 \times P \times \frac{Td - Tw}{755} \right)$$

is calculated, and the result is stored in the specified device (d1).

ed: Saturated vapor pressure at dry-bulb temperature (hPa, calculated from d3)

ew: Saturated vapor pressure at wet-bulb temperature (hPa), calculated from d2

Td (d5): Dry-bulb temperature (°C or °F)

Tw (d4): Wet-bulb temperature (°C or °F)

P: Air pressure 1013.25 (hPa)

d2: Wet-bulb temperature input selection (0: X\_PV, 1: X\_PV2, 2: X\_AIN2, 3: X\_AIN4)

d3: Dry-bulb temperature input selection (0: X\_PV, 1: X\_PV2, 2: X\_AIN2, 3: X\_AIN4)

If °F was specified for the unit of temperature, the temperatures are converted to °C to calculate the saturation vapor pressure and relative humidity.

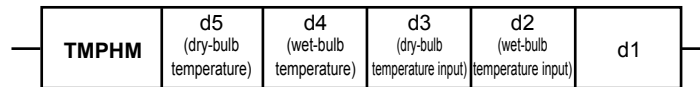

If d2 or d3 is outside the range (less than 0.5 or 3.5 or greater), it is assumed to be 0. However, if a non-numerical value or infinity occurs during calculation or arises as a result, a ladder calculation overflow error occurs.

This instruction calculates the relative humidity from the dry-bulb temperature and wet-bulb temperature.

Output data range = 0.0 to 100.0 %Rh

Calculation precision: ±0.01 %Rh

This calculation is possible when Td and Tw are between 0 to 100 °C and Td > Tw.

If Td or Tw < 0 °C, and the calculated result is negative, the relative humidity H is 0 %Rh.

If Td or Tw > 100 °C and Td ≤ Tw, the relative humidity H is 100 %Rh.

Saturation vapor pressure is calculated using the expression in JISZ8806—2001 SON-NTAG.

#### Program example

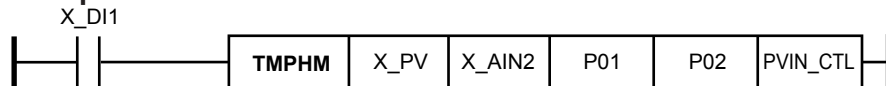

To use the temperature and humidity calculation, humidity input errors must be considered.

We recommend that you use RTD input for the dry-bulb temperature input and wet-bulb temperature input.

(This is because TC input includes errors in RJC input.)

In addition, the errors in the two temperature inputs must be corrected in advance with a BS parameter or other means with the use of dry-bulb temperature input and wet-bulb temperature input not immersed in water.

4.6.25 10-segment Linearizer Approximation

Instruction	Mnemonic	Symbol	Input Condition Required?		Execution Condition	Step Count	Data Format
			Yes	No			
10-segment Linearizer Approximation	PLN1		√	-		3	D-register
	PLN2		√	-		3	
	PLN3		√	-		3	
	PLN4		√	-		3	

Parameter

When the calculation result of the previous operations is ON, this instruction performs the following calculation and stores the result in a specified device (d1).

If  $d2 < A1\_m$ ,  $d1 = B1\_m$  extension

If  $d2 > A11\_m$ ,  $d1 = B11\_m$  extension

If  $An\_m \leq d2 \leq An+1\_m$ ,  $d1 = Bn\_m + (Bn+1\_m - Bn\_m) \times (d2 - An\_m) / (An+1\_m - An\_m)$   
 (n = 1 to 10, m = 1 to 4)

An\_m: 10-segment linearizer input parameter value

Bn\_m: 10-segment linearizer input parameter value

Operation parameters PYS1 to PYS4 are used. Set 10-segment linearizer selection (PYS) parameters to the ladder program's 10 segments.

The input and output are handled as 0.0 to 100.0%. For engineering units (EUs), NORM and SCAL are necessary before the calculation. The output is limited in the range of -66.70% to 105.00%.

10-segment linearizer approximation, Inverse conversion of 10-segment linearizer approximation, and 20-segment linearizer approximation share the linearizer parameters.

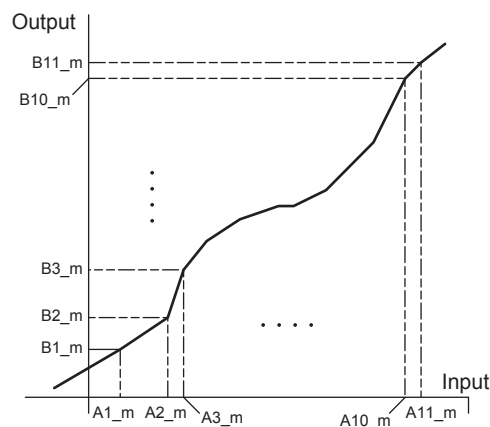
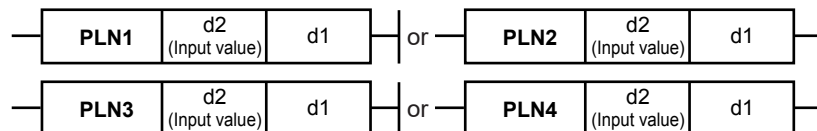

## Program example

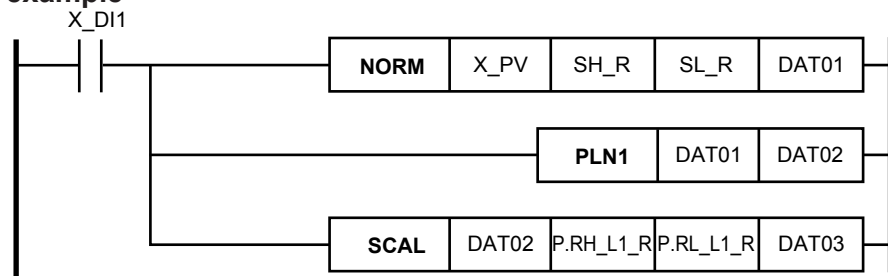
**Note**

Set 10-segment linearizer inputs (A1 to A11) so that they increase linearly.



4.6.26 Inverse Conversion of 10-segment Linearizer Approximation

Instruction	Mnemonic	Symbol	Input Condition Required?		Execution Condition	Step Count	Data Format
			Yes	No			
Inverse Conversion of 10-segment Linearizer Approximation	ILN1		√	-		3	D-register
	ILN2		√	-		3	
	ILN3		√	-		3	
	ILN4		√	-		3	

Parameter

When the calculation result of the previous operations is ON, this instruction performs the following calculation and stores the result in a specified device (d1).

If  $d2 < B1\_m$ ,  $d1 = A1\_m$  extension

If  $d2 > B11\_m+1$ ,  $d1 = A11\_m+1$  extension

If  $Bn\_m \leq d2 \leq Bn+1\_m$ ,  $d1 = An\_m + (An+1\_m - An\_m) \times (d2 - Bn\_m) / (Bn+1\_m - Bn\_m)$   
 (n = 1 to 10, m = 1, 3)

An\_m: 10-segment linearizer input parameter value

Bn\_m: 10-segment linearizer output parameter value

Operation parameters PYS1 to PYS4 are used. Set 10-segment linearizer selection (PYS) parameters to the ladder program's 10 segments.

The input and output are handled as 0.0 to 100.0%. For engineering units (EUs), NORM and SCAL are necessary before the calculation. The output is limited in the range of -66.70% to 105.00%.

10-segment linearizer approximation, Inverse conversion of 10-segment linearizer approximation, and 20-segment linearizer approximation share the linearizer parameters.

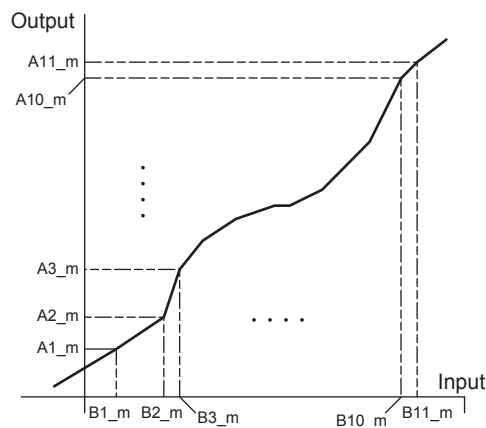
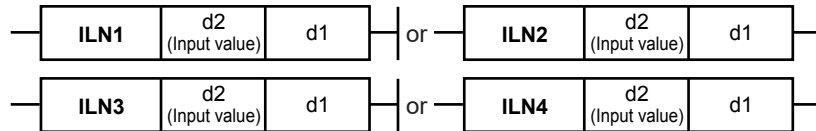

## Program example

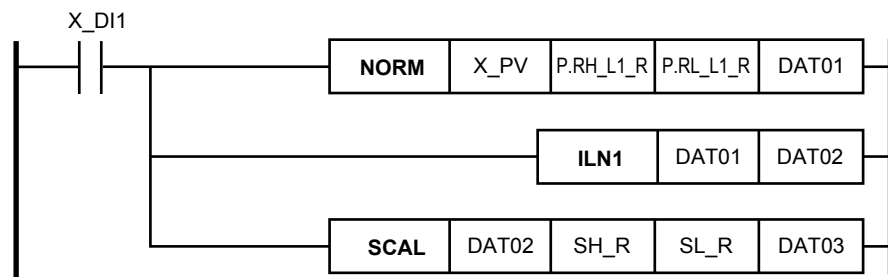
**Note**

Set 10-segment linearizer inputs (B1 to B11) so that they increase linearly.

4.6.27 20-segment Linearizer Approximation

Instruction	Mnemonic	Symbol	Input Condition Required?		Execution Condition	Step Count	Data Format
			Yes	No			
20-segment Linearizer Approximation	PLN21		√	-		3	D-register
	PLN22		√	-		3	

Parameter

When the calculation result of the previous operations is ON, this instruction performs the following calculation and stores the result in a specified device (d1).

If  $d2 < A1_m$ ,  $d1 = B1_m$  extension

If  $d2 > A1_{m+1}$ ,  $d1 = B1_{m+1}$  extension

If  $A_n \leq d2 \leq A_{n+1}$ ,  $d1 = B_n + (B_{n+1} - B_n) \times (d2 - A_n) / (A_{n+1} - A_n)$   
( $n = 1$  to  $10$ ,  $m = 1$  or  $3$ )

If  $A1_m \leq d2 \leq A2_{m+1}$ ,  $d1 = B1_m + (B2_{m+1} - B1_m) \times (d2 - A1_m) / (A2_{m+1} - A1_m)$

( $m=1$  or  $3$ )

If  $A_{n+1} \leq d2 \leq A_{n+2}$ ,  $d1 = B_{n+1} + (B_{n+2} - B_{n+1}) \times (d2 - A_{n+1}) / (A_{n+2} - A_{n+1})$

( $n=2$  to  $10$ ,  $m=1$  or  $3$ )

$A_n$ : 10-segment linearizer input parameter value ( $A1_2, A1_4$  are nonusable.)

$B_n$ : 10-segment linearizer output parameter value ( $B1_2, B1_4$  are nonusable.)

Operation parameters PYS1 to PYS4 are used. Set 10-segment linearizer selection (PYS) parameters to the ladder program's 20 segments.

The input and output are handled as 0.0 to 100.0%. For engineering units (EUs), NORM and SCAL are necessary before the calculation. The output is limited in the range of -66.70% to 105.00%.

10-segment linearizer approximation, Inverse conversion of 10-segment linearizer approximation, and 20-segment linearizer approximation share the linearizer parameters.

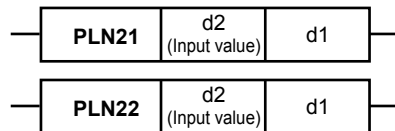

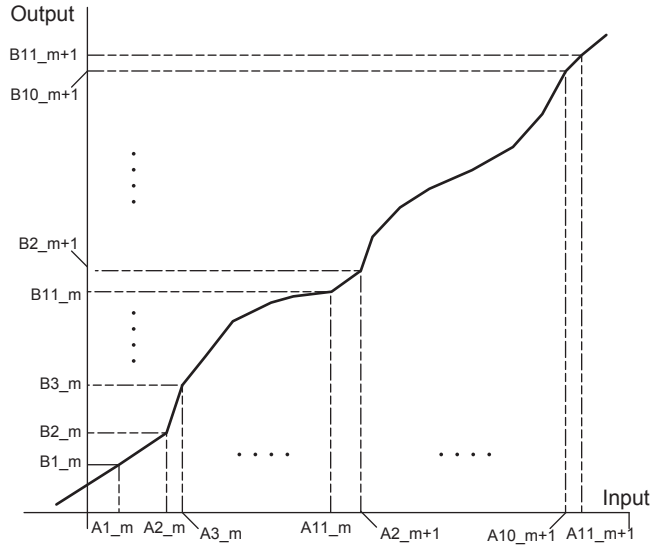

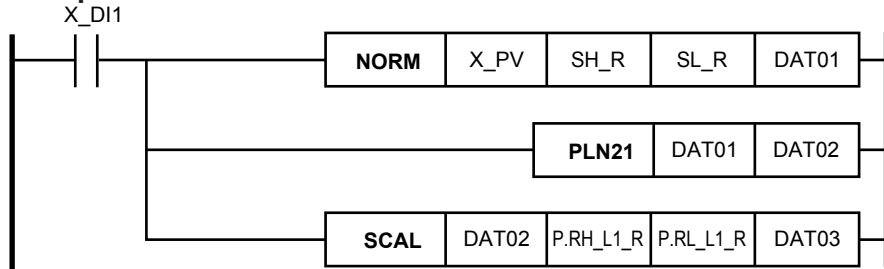

**Program example**



**Note**

Set 10-segment linearizer inputs (A1\_m to A11\_m, A2\_m+1 to A11\_m+1) so that they increase linearly.

### 4.6.28 Maximum Input Hold

Instruction	Mnemonic	Symbol	Input Condition Required?		Execution Condition	Step Count	Data Format
			Yes	No			
Maximum Input Hold	MXHD1		√	-		8	D-register

#### Parameter

When the calculation result of the previous operations is ON, this instruction compares the maximum value among d6 to d3 and the previous output and stores the larger value in d1.

If  $d7 < 1$ , 1 is selected.

If  $d7 > 4$ , 4 is selected.

(If  $0.5 \leq d7 < 1.5$ , 1 is selected. If  $1.5 \leq d7 \leq 2.5$ , 2 is selected. . . If  $3.5 \leq d7$ , 4 is selected.)

If the initialization conditions are met irrespective of a power failure, d2 is output.

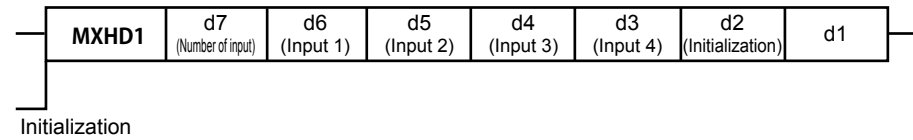

d7: Specify the number of inputs (1 to 4). The number of inputs specified by d7 among d6 to d3 are used in the calculation.

The first output is the maximum input after power recovery.

This instruction is executed once.

Data is retained, so if the instruction is executed once in the control period, an appropriate calculation will be performed.

The number of inputs (d7) is regarded as

“1” if  $d7 < 1.5$

“2” if  $1.5 \leq d7 < 2.5$

“3” if  $2.5 \leq d7 < 3.5$



“4” if  $3.5 \leq d7$

Digits to the right of the decimal point will be discarded.

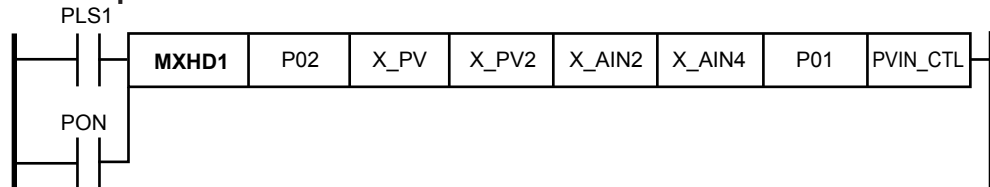
#### Program example

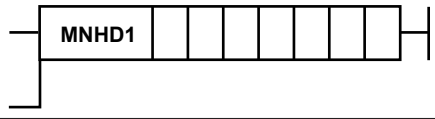

### 4.6.29 Minimum Value Hold

Instruction	Mnemonic	Symbol	Input Condition Required?		Execution Condition	Step Count	Data Format
			Yes	No			
Minimum Input Hold	MNHD1		√	-		8	D-register

#### Parameter

When the calculation result of the previous operations is ON, this instruction compares the maximum value among d6 to d3 and the previous output and stores the larger value in d1.

If  $d7 < 1$ , 1 is selected.

If  $d7 > 4$ , 4 is selected.

(If  $0.5 \leq d7 \leq 1.5$ , 1 is selected. If  $1.5 \leq d7 \leq 2.5$ , 2 is selected. . . If  $3.5 \leq d7 \leq 4.5$ , 4 is selected.)

If the initialization conditions are met irrespective of a power failure, d2 is output.

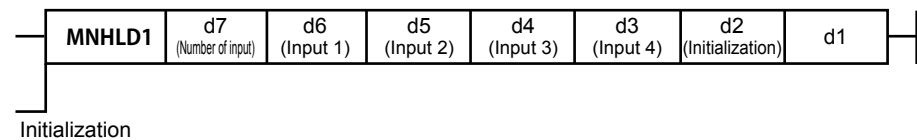

d7: Specify the number of inputs (1 to 4). The number of inputs specified by d7 among d6 to d3 are used in the calculation.

The first output is the maximum input after power recovery.  
This instruction is executed once.

Data is retained, so if the instruction is executed once in the control period, an appropriate calculation will be performed.

The number of inputs (d7) is regarded as

“1” if  $d7 < 1.5$

“2” if  $1.5 \leq d7 < 2.5$

“3” if  $2.5 \leq d7 < 3.5$

“4” if  $3.5 \leq d7$

Digits to the right of the decimal point will be discarded.

#### Program example

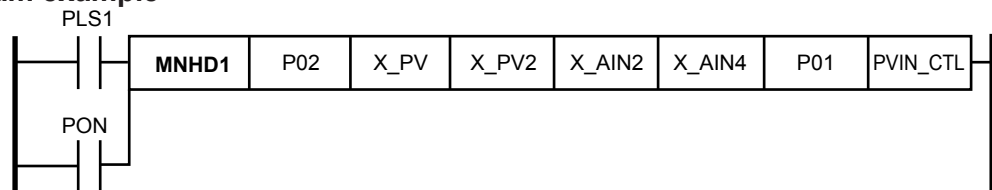

4.6.30 Filter

Instruction	Mnemonic	Symbol	Input Condition Required?		Execution Condition	Step Count	Data Format
			Yes	No			
Filter	FLTR1		√	-		4	D-register
	FLTR2		√	-		4	
	FLTR3		√	-		4	
	FLTR4		√	-		4	

Parameter

When the calculation result of the previous operations is ON, this instruction performs the following calculation and stores the result in a specified device (d1).

$$d1 = \text{previous output} + (d3 - \text{previous output}) / (1 + d2 / \text{control period})$$

If the calculation result of the previous operations is OFF, d1 is not retained.

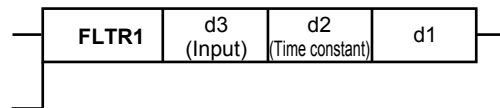

Initialization

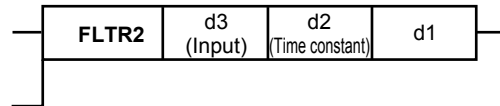

Initialization

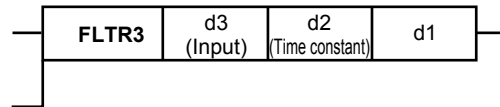

Initialization

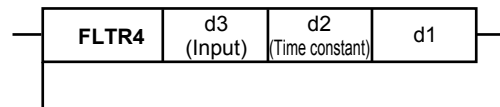

Initialization

When d2 = 0, the filter is off and d3 = d1.

When d2 = 1 to 120 (seconds), the filter is a first order delay filter.

When d2 ≠ 1 to 120, the filter is off and d3 = d1.

When the initialization flag is ON, d1 = d3.

When a power failure occurs, the calculation is reset (first order delay).

Normally, the power-on relay (PON: 5457) is connected to the initialization flag.

d2 is converted to an integer and used in units of seconds. Fractions are rounded.

d3 (input value) is handled as a percentage between 0.0 and 100.0%, so for engineering units (EUs), NORM and SCAL calculations are needed before and after the calculation.

Up to four values can be used.

Data is retained, so if the instruction is executed once in the control period, an appropriate calculation will be performed.

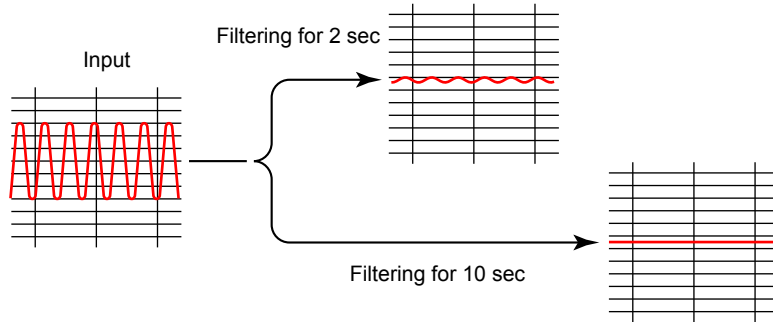
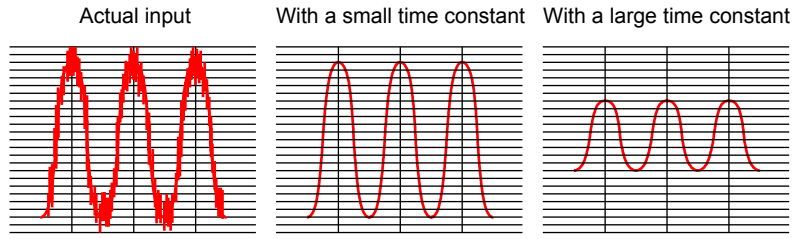

**Program example**

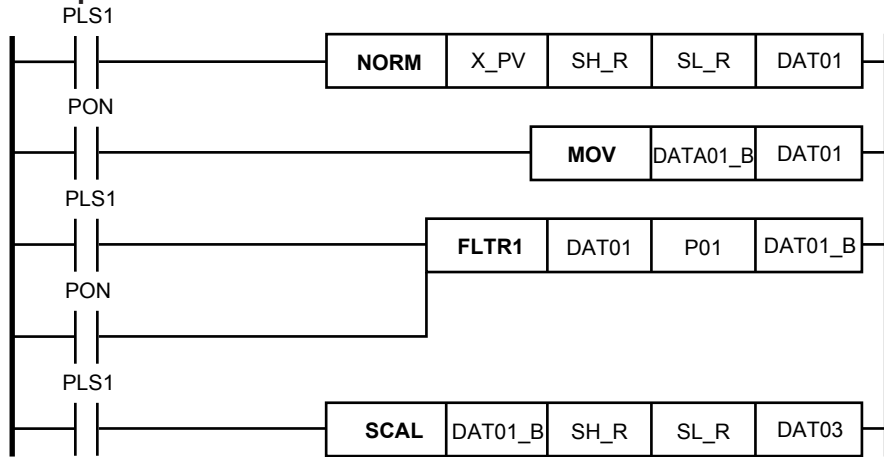



4.6.31 Dead Time

Instruction	Mnemonic	Symbol	Input Condition Required?		Execution Condition	Step Count	Data Format
			Yes	No			
Dead Time	DED1		√	-		4	D-register
	DED2		√	-		4	
	DED3		√	-		4	

**Parameter**

When the calculation result of the previous operations is ON, this instruction performs the following calculation and stores the result in a specified device (d1).

This instruction outputs the d3 value d2 hours earlier.

When the initialization flag is ON, d3 = d1.

The sampling time is d2/20 seconds. (If d2/20 is less than the control period, the sampling time is set to the control period.)

d2: Dead time (0 to 10000 seconds)

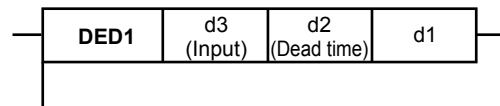

Initialization

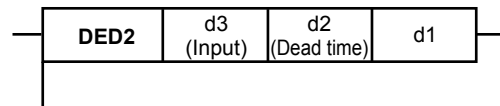

Initialization

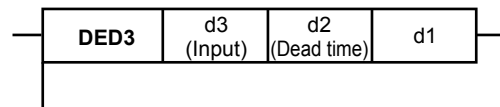

Initialization

When a power failure occurs, d1 is reset to 0.0%.

Normally, the power-on relay (PON: 5457) is connected to the initialization flag.

When d2 = 0, the dead time is off and d3 = d1.

d2 is converted to an integer and used in units of seconds. When d2 < 0 or d2 > 10000, d2 = 0. Fractions are rounded.

Up to three values can be used.

Data is retained, so if the instruction is executed once in the control period, an appropriate calculation will be performed.

However, if a non-numerical value or infinity occurs during calculation or arises as a result, a ladder calculation overflow error occurs.

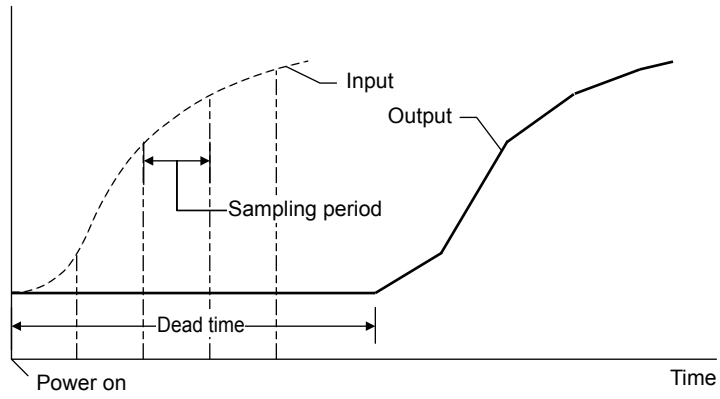

**Program example**

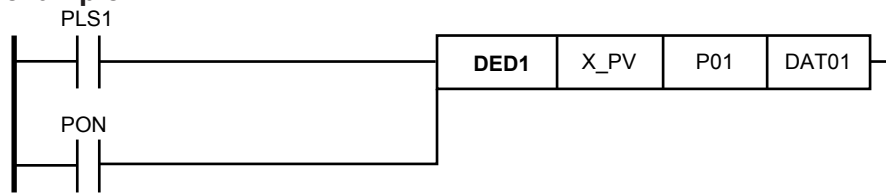

4.6.32 Moving Average

Instruction	Mnemonic	Symbol	Input Condition Required?		Execution Condition	Step Count	Data Format
			Yes	No			
Moving Average	MAV1		√	-		4	D-register
	MAV2		√	-		4	
	MAV3		√	-		4	

Parameter

When the calculation result of the previous operations is ON, this instruction performs the following calculation and stores the result in a specified device (d1).

This instruction outputs the d3 average of d2 hours.

When the initialization flag is ON, d3 = d1.

The sampling time is d2/20 seconds. (If d2/20 is less than the control period, the sampling time is set to the control period.)

d2: Moving average time (0 to 10000 seconds)

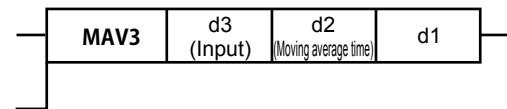
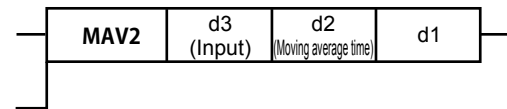
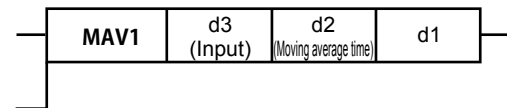

When a power failure occurs, d1 is reset to 0.0%.

Normally, the power-on relay (PON: 5457) is connected to the initialization flag.

When d2 = 0, the moving average time is off and d3 = d1.

d2 is converted to an integer and used in units of seconds. When d2 < 0 or d2 > 10000, d2 = 0. Fractions are rounded.

Up to three values can be used.

Data is retained, so if the instruction is executed once in the control period, an appropriate calculation will be performed.

However, if a non-numerical value or infinity occurs during calculation or arises as a result, a ladder calculation overflow error occurs.

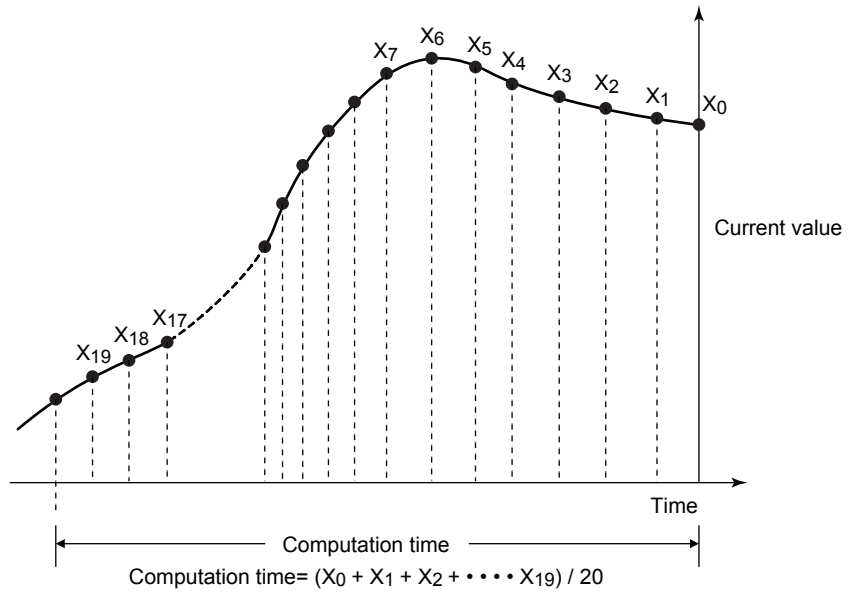

**Program example**

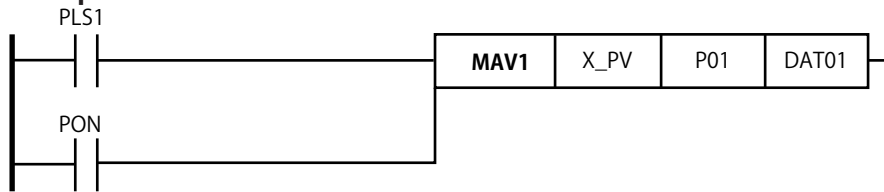

4.6.33 Velocity Computation

Instruction	Mnemonic	Symbol	Input Condition Required?		Execution Condition	Step Count	Data Format
			Yes	No			
Velocity Computation	VEL1		√	-		4	D-register
	VEL2		√	-		4	
	VEL3		√	-		4	

Parameter

When the calculation result of the previous operations is ON, this instruction performs the following calculation and stores the result in a specified device (d1).

This instruction outputs the difference between the current d2 and the d3 value d2 hours earlier.

When the initialization flag is ON, d1 = 0.0%.

The sampling time is d2/20 seconds. (If d2/20 is less than the control period, the sampling time is set to the control period.)

d2: Dead time (0 to 10000 seconds)

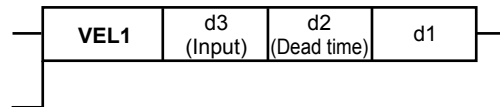

Initialization

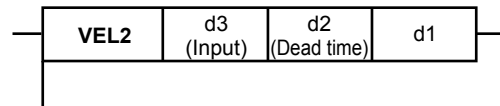

Initialization

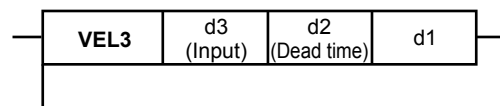

Initialization

When a power failure occurs, d1 is reset to 0.0%.

Normally, the power-on relay (PON: 5457) is connected to the initialization flag.

When d2 = 0, the dead time is off and d3 = d1.

d2 is converted to an integer and used in units of seconds. When d2 < 0 or d2 > 10000, d2 = 0. Fractions are rounded.

Up to three values can be used.

Data is retained, so if the instruction is executed once in the control period, an appropriate calculation will be performed.

However, if a non-numerical value or infinity occurs during calculation or arises as a result, a ladder calculation overflow error occurs.

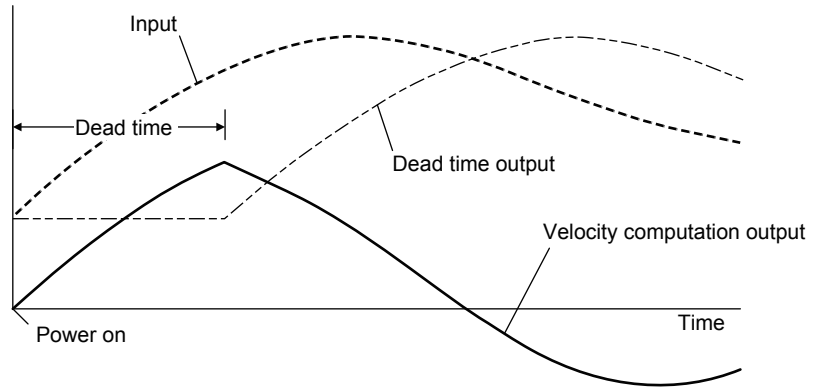

**Program example**

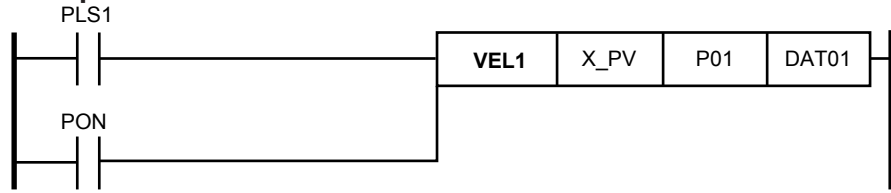

4.6.34 Velocity Limiter

Instruction	Mnemonic	Symbol	Input Condition Required?		Execution Condition	Step Count	Data Format
			Yes	No			
Velocity Limiter	CLMT1		√	-		4	D-register
	CLMT2		√	-		4	
	CLMT3		√	-		4	
	CLMT4		√	-		4	

Parameter

When the calculation result of the previous operations is ON, this instruction performs the following calculation and stores the result in a specified device (d1).

If the calculation result of the previous operations is OFF, d1 is not retained.

d4: Rise velocity limit; limited within this value

d3: Fall velocity limit; limited within this value

d2: Velocity limit unit

d2 = 0: hours, d2 = 1: minutes

If the initialization flag is ON, d5 is output as it is. Normally, the power-on relay (PON: 5457) is connected to the initialization flag.

d5 (input value) is handled as a percentage between 0.0 and 100.0%, so for engineering units (EUs), NORM and SCAL calculations are needed before and after the calculation.

If the input is less than -5% or 105% or greater, the output is limited within -5% to 105%. d3 and d4 are velocity limits that range from 0.1 to 100.0%. (If a value less than 0.1% or greater than 100.0% is specified, it is assumed to be 100.0%.)

d2 is converted to an integer and used as the unit of change. If d2 is set to a value other than 0 or 1, it is assumed to be 0 (time).

When a power failure occurs, the output is 0.0%.

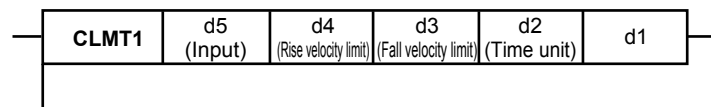

Initialization

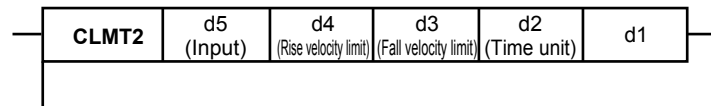

Initialization

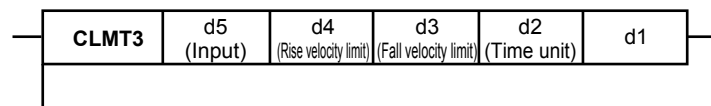

Initialization

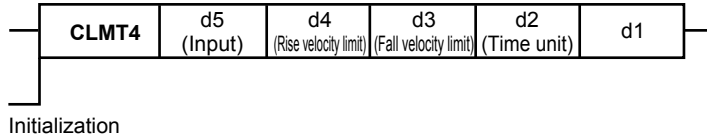

Up to four values can be used.

Data is retained, so if the instruction is executed once in the control period, an appropriate calculation will be performed.

However, if a non-numerical value or infinity occurs during calculation or arises as a result, a ladder calculation overflow error occurs.

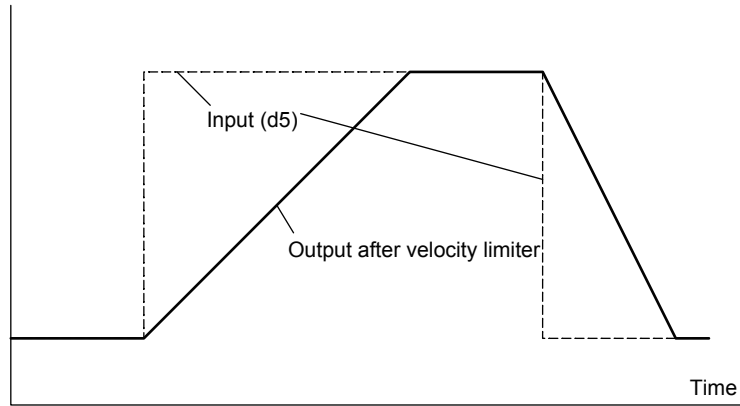

d4: Rise velocity limit  
d3: Fall velocity limit

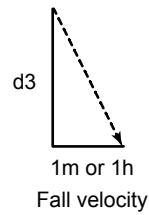
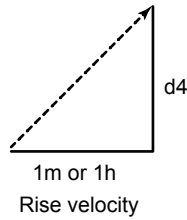

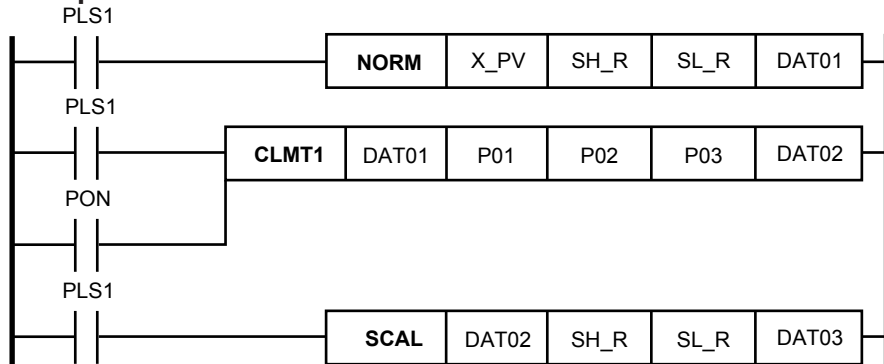

**Program example**



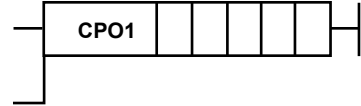

4.6.35 Totalizer Pulse Output

Instruction	Mnemonic	Symbol	Input Condition Required?		Execution Condition	Step Count	Data Format
			Yes	No			
Totalizer Pulse Output	CPO1		√	-		6	D-register

Parameter

When the calculation result of the previous operations is ON, this instruction performs the following calculation and outputs the result to the storage location (d1).

Initialization flag (OFF: disable initialization, ON: enable initialization)

d4: Enable flag (OFF: stop calculation, ON: continue calculation)

d3: Totalization rate (unit: pulse/time)

Setting range: 100 to 8000

d2: Low cutoff value [%] 0.0 to 100.0% (values outside this range is assumed to be 0.0)

Inputs less than the low cutoff value are not totalized.

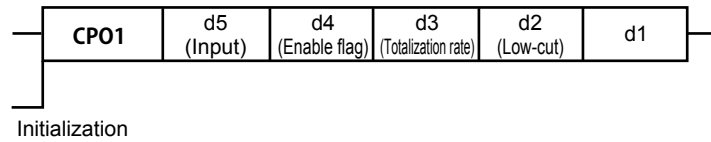

If d3 is set to a value less than 100, it is assumed to be 100. If d3 is set to a value greater than 8000, it is assumed to be 8000.

When a power failure occurs, the output is reset to 0.

d5 (input value) is handled as a percentage between 0.0 and 100.0%, so for engineering units (EUs), NORM calculation is needed before the calculation.

One value can be used.

Data is retained, so if the instruction is executed once in the control period, an appropriate calculation will be performed.

However, if a non-numerical value or infinity occurs during calculation or arises as a result, a ladder calculation overflow error occurs.

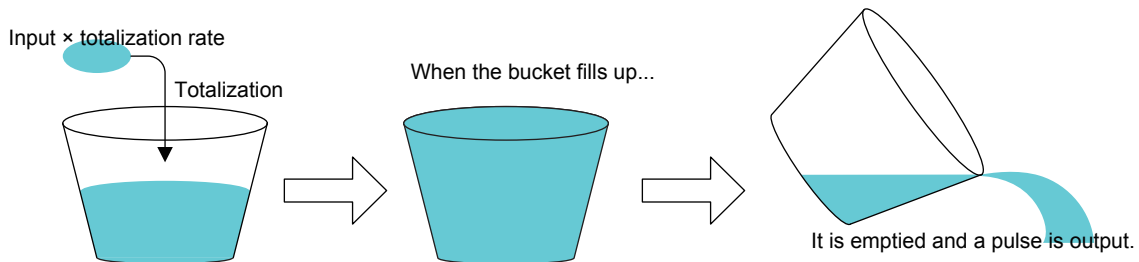

Program example

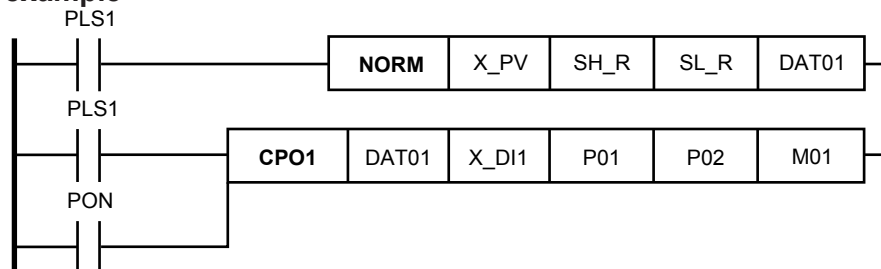

4.6.36 On-delay Timer

Instruction	Mnemonic	Symbol	Input Condition Required?		Execution Condition	Step Count	Data Format
			Yes	No			
On-delay Timer	ONDY1		√	-		4	D-register
	ONDY2		√	-		4	
	ONDY3		√	-		4	
	ONDY4		√	-		4	
	ONDY5		√	-		4	
	ONDY6		√	-		4	
	ONDY7		√	-		4	
	ONDY8		√	-		4	

Parameter

When the calculation result of the previous operations is ON, this instruction performs the following calculation and stores the result in a specified device (d1).

d2 seconds after the d3 input is set to ON, d1 is set to ON.

When the d3 input is set to OFF, d1 is immediately set to OFF.

After initialization, d1 = d3.

d2: Time constant (0 to 10000 seconds)

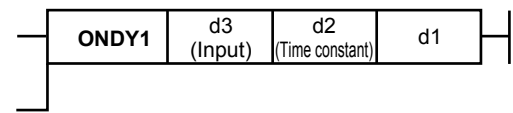
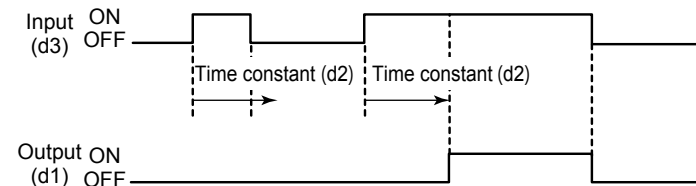

Initialization

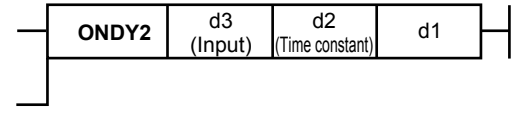

Initialization

## 4.6 Details of Application Instructions

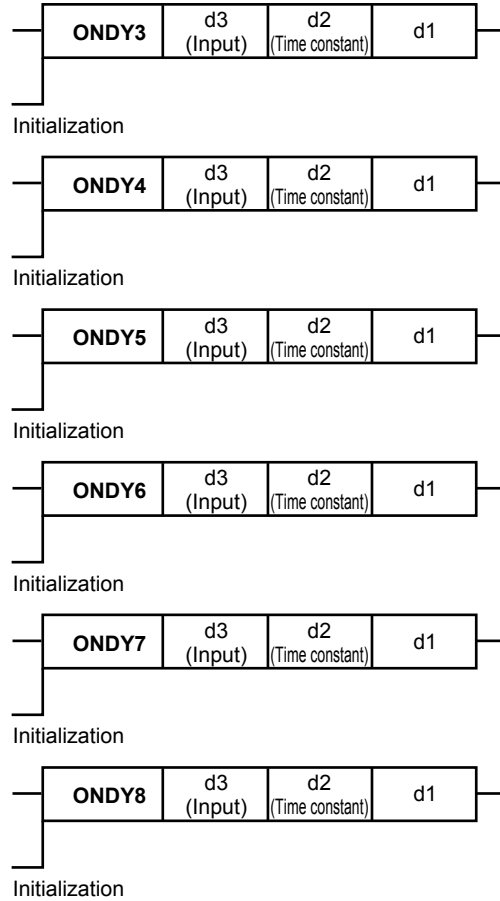

When a power failure occurs, initialize.

d2 is converted to an integer and used in units of seconds. When  $d2 < 0$  or  $d2 > 10000$ ,  $d2 = 0$ . Fractions are rounded.

Up to eight values can be used.

Data is retained, so if the instruction is executed once in the control period, an appropriate calculation will be performed.

### Program example

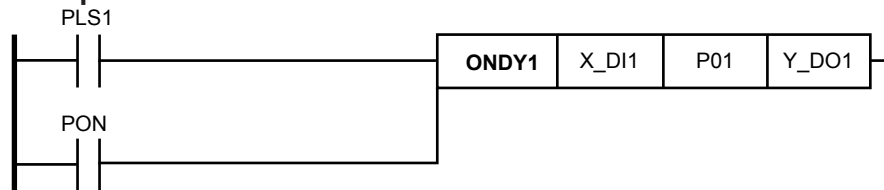

4.6.37 Off-delay Timer

Instruction	Mnemonic	Symbol	Input Condition Required?		Execution Condition	Step Count	Data Format
			Yes	No			
Off-delay Timer	OFDY1		√	-		4	D-register
	OFDY2		√	-		4	
	OFDY3		√	-		4	
	OFDY4		√	-		4	
	OFDY5		√	-		4	
	OFDY6		√	-		4	
	OFDY7		√	-		4	
	OFDY8		√	-		4	

Parameter

When the calculation result of the previous operations is ON, this instruction performs the following calculation and stores the result in a specified device (d1).

When the d3 input is set to ON, d1 is immediately set to ON.

d2 seconds after the d3 input is set to OFF, d1 is set to OFF.

After initialization, d1 = d3.

d2: Time constant (0 to 10000 seconds)

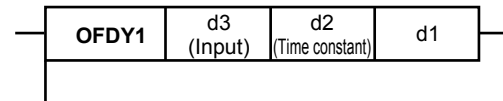
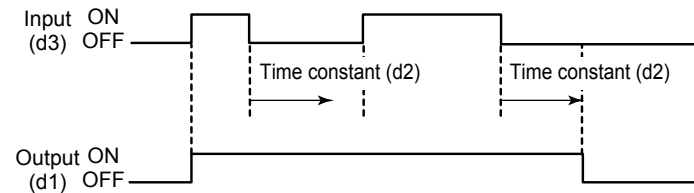

Initialization

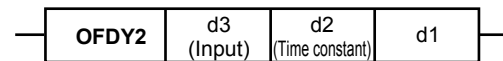

Initialization

## 4.6 Details of Application Instructions

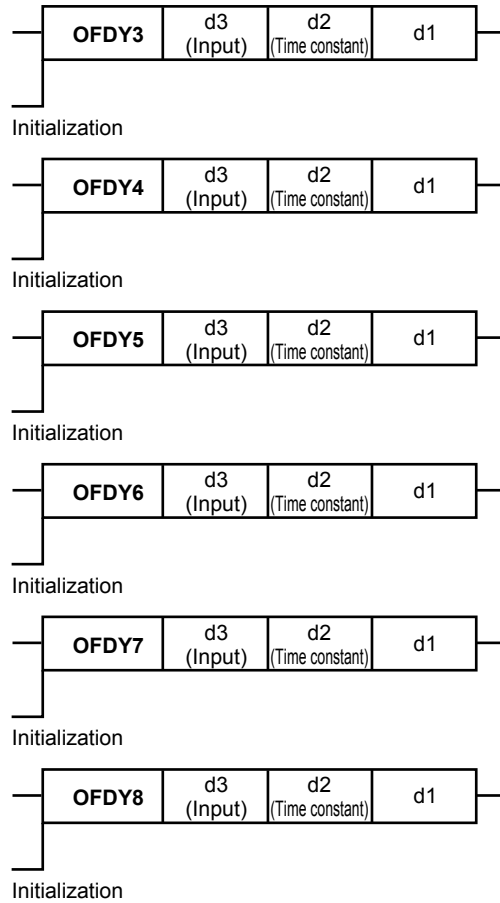

When a power failure occurs, initialize.

d2 is converted to an integer and used in units of seconds. When  $d2 < 0$  or  $d2 > 10000$ ,  $d2 = 0$ . Fractions are rounded.

Up to eight values can be used.

Data is retained, so if the instruction is executed once in the control period, an appropriate calculation will be performed.

### Program example

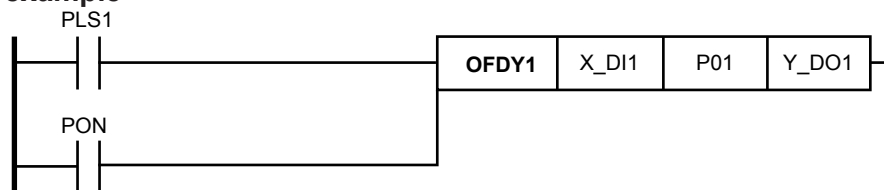

### 4.6.38 CP Calculation

This instruction can be used on a UT75A with the /CP option.

Instruction	Mnemonic	Symbol	Input Condition Required?		Execution Condition	Step Count	Data Format
			Yes	No			
CP Calculation 1	CPC11		√	-		5	D-register
	CPC12		√	-		5	
CP Calculation 2	CPC21		√	-		5	
	CPC22		√	-		5	

#### CP Calculation 1 Parameter

When the calculation result of the previous operations is ON, this instruction performs the following calculation and outputs the result to the storage location (d1).

CP expression based on chamber temperature, CO partial pressure, and zirconia O<sub>2</sub> sensor electromotive force

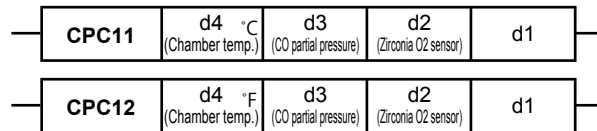

d4 = Chamber temperature (°C or °F)

If the chamber temperature is less than 727.2°C or if a calculation overflow occurs, the CP value is set to 2.000 through error handling.

d3 = CO partial pressure (vol %)

(Input range: 0 to 100%; 0 for values less than 0; 100 for values greater than 100)

d2 = Zirconia O<sub>2</sub> sensor electromotive force (mV)

(Input range: 0 to 1250 mV; 0 for values less than 0; 1250 for values greater than 1250)

The calculation output will range from 0.000 to 2.000.

#### Note

When executing CP calculation 1, set the following setup parameters.

Burnout operation for input (PV), which is the chamber temperature input (d4): DOWN

High resistance input voltage range (AIN2 or AIN4): 0.000 to 1.250 V, scale 0 to 1250

Control PV input range (P.UNI, P.DP, P.RH, P.RL): 0.000 to 2.000

#### Program example

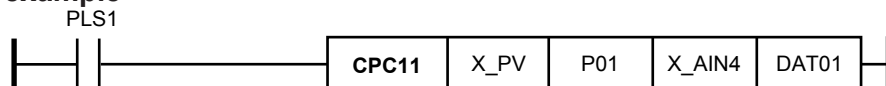

**CP Calculation 2  
Parameter**

When the calculation result of the previous operations is ON, this instruction performs the following calculation and outputs the result to the storage location (d1).  
CP expression based on the chamber temperature, CO partial pressure, and CO<sub>2</sub> partial pressure.

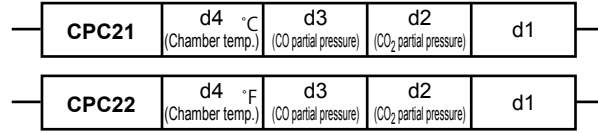

d4 = Chamber temperature (°C or °F)

If the chamber temperature is less than 727.2°C or if a calculation overflow occurs, the CP value is set to 2.000 through error handling.

d3 = CO partial pressure (vol %)

(Input range: 0 to 100%; 0 for values less than 0; 100 for values greater than 100)

d2 = CO<sub>2</sub> partial pressure (vol %)

(Input range: 0 to 100%; 0 for values less than 0; 100 for values greater than 100)

The calculation output will range from 0.000 to 2.000.

**Program example**

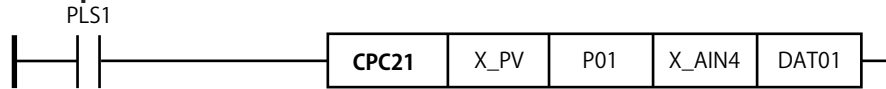

## 4.7 Details of Custom Ladder Instructions (UT75A Only)

### 4.7.1 Registering Custom Ladder Instructions

Custom ladder instructions can be created according to the procedure in section 4.7.2, “Creating Custom Ladder Instructions (UT75A Only).” Up to 100 instructions can be registered in the LL50A. You can use custom ladder instructions in the same way on the LL50A as basic instructions and application instructions by selecting the customer ladder instructions that you have created from a custom ladder instruction tree, as shown below. The example below shows an LL50A ladder instruction tree in which four custom ladder instructions—CP1, CP2, CP3, and HUMI—are registered.

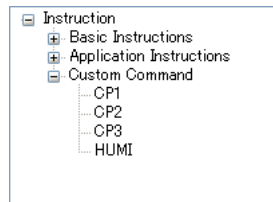
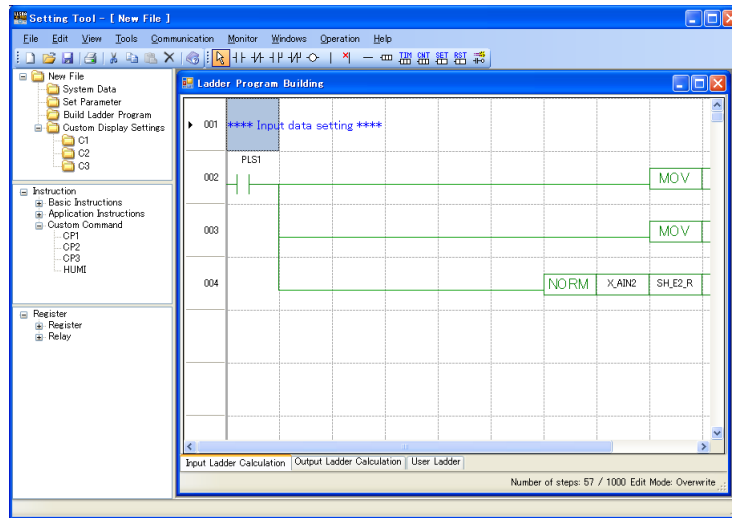

**Note**

To edit on an LL50A of another PC a ladder program that uses the custom ladder instructions that you have created, import the custom ladder instruction file into the LL50A of the other PC. The procedure is the same for importing and editing a main unit ladder program on the LL50A.

If a ladder program that includes a custom ladder instruction that is not registered in the LL50A is imported from a user file or the main unit, the following limitations exist.

Function	Operation
Open or save user files	Yes
Write to or read from the main unit	Yes
Edit parameters	Yes
Edit ladder programs	No
Edit custom ladder instructions	Yes (however unregistered instructions cannot be edited)
Monitor ladders	Unregistered instructions are displayed using temporary names.



## 4.7 Details of Custom Ladder Instructions

---

### **Note**

If you change or delete a custom ladder instruction that is already in use, you will no longer be able to edit ladder programs that use the instruction. To achieve a different function, register a new instruction with a new custom ladder name.

---

### **Note**

Assign a unique name to each custom ladder instruction.  
Do not use names that are already used by basic instructions and application instructions.  
If there is a custom ladder instruction that has the same expression as another instruction but registered with a different name, its name will be changed to the name of the other instruction that appears higher in the instruction tree when the instructions are uploaded via communication.

---

## 4.7.2 Creating Custom Ladder Instructions

You can create custom ladder instructions. By creating custom ladder instructions, you can easily create calculations consists of multiple expressions. Up to five custom ladder instructions can be registered.

The custom ladder instructions that you create here can be used in the same way as application instructions when you create ladder programs.

Custom ladder instructions can be saved to files and be used in other ladder programs.

File name extension: \*\*\*\*\*.LCF

See section 2.15.4, “Opening Custom Ladder Instruction Files,” and section 2.15.10, “Saving Ladder Instruction Files.”

### Procedure

1. On the Tools menu, click “Edit custom ladder instruction” to display the Custom ladder instruction selection window.

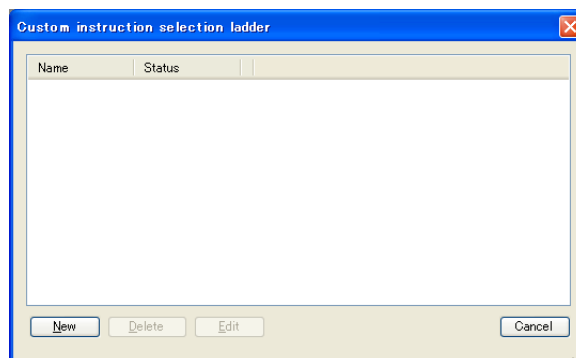

2. Click [New] to display the Create a custom ladder instruction window. To edit an existing custom ladder instruction, click [Edit].

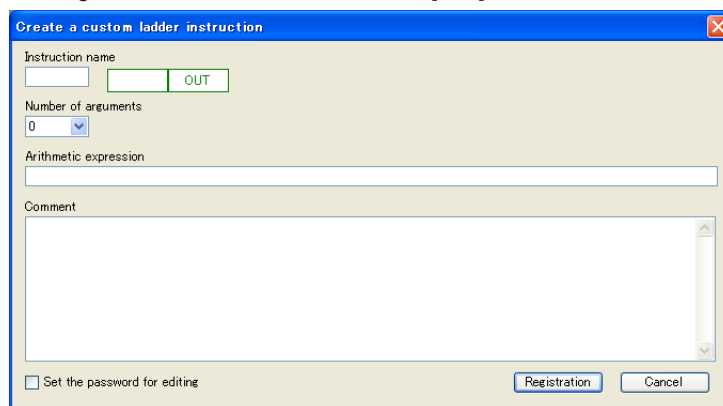

3. Set the instruction name, number of arguments, and arithmetic expression. If necessary, enter a comment. To enable the security feature, select the Set the password for editing check box.
4. When you are finished entering the information, click [Registration].

#### 4.7 Details of Custom Ladder Instructions

Item	Specifications
Instruction name	The characters that you can use are alphanumeric characters (uppercase and lowercase). The maximum length is five characters. The first character cannot be a number. Symbols cannot be used.
Number of arguments	0 to 8
Arithmetic expression	ARGU01 to ARGU08 can be used as arguments in the calculation expression. Registers such as PV input can also be used. Registers are not handled as arguments. If you use ARGU01 to ARGU08, you will need to specify registers in the custom ladder instruction input fields (arguments) when you create programs. For the available operators, see the list of instructions on the next page. Calculation expressions can be as long as 150 characters.
Comment	You can register operator descriptions, revisions, and other information as comments
Set the password for editing	Selecting this check box and clicking Registration opens a password input dialog box. If you set a password, you will need to enter the password when you edit instructions. The password is up to 8 alphanumeric characters.

Example: Instruction name: CUST1, Number of arguments: 1 (ARGU01),  
Arithmetic expression: PV input + AIN4 input ÷ argument (ARGU01)

The screenshot shows a dialog box titled "Create a custom ladder instruction". It contains the following fields and controls:

- Instruction name:** A text box containing "CUST1". To its right are three buttons labeled "CUST1", "ARGU01", and "OUT".
- Number of arguments:** A dropdown menu showing "1".
- Arithmetic expression:** A text box containing the expression "X\_PV+X\_AIN4/ARGU01".
- Comment:** A large empty text area for entering comments.
- Set the password for editing:** A checked checkbox.
- Buttons:** "Registration" and "Cancel" buttons are located at the bottom right of the dialog.

## List of Instructions

Instruction	Name
(ADD, +)	Addition
(SUB, -)	Subtraction
(MUL, *)	Multiplication
(DIV, /)	Division
SQRF (Input value)	Square root
ABS (Input value)	Absolute
EXP (Input value)	Exponential
PWR (base, exponent)	Power
LN (Input value)	Natural Logarithm
LOG (Input value)	Common Logarithm
RATIO (Input value, Ratio, Bias)	Ratio
RECIP (Input value, Parameter 1, Parameter 2)	Reciprocal
HSL (Input value1, Input value 2)	High Selector
LSL (Input value1, Input value 2)	Low Selector
HLM (Input value1, Input value 2)	High Limiter
LLM (Input value1, Input value 2)	Low Limiter
LIMIT (Input value, upper value, lower value)	Limit
MAX (Number of inputs, Input 1, Input 2, Input 3, Input4)	Maximum
MIN (Number of inputs, Input 1, Input 2, Input 3, Input4)	Minimum
AVE (Number of inputs, Input 1, Input 2, Input 3, Input4)	Average
PLN1 (Input value)	10-segment Linearizer Approximation
PLN2 (Input value)	10-segment Linearizer Approximation
PLN3 (Input value)	10-segment Linearizer Approximation
PLN4 (Input value)	10-segment Linearizer Approximation
ILN1 (Input value)	Inverse Conversion of 10-segment Linearizer Approximation
ILN2 (Input value)	Inverse Conversion of 10-segment Linearizer Approximation
ILN3 (Input value)	Inverse Conversion of 10-segment Linearizer Approximation
ILN4 (Input value)	Inverse Conversion of 10-segment Linearizer Approximation
PLN21 (Input value)	20-segment Linearizer Approximation
PLN22 (Input value)	20-segment Linearizer Approximation

## Calculating the Number of Steps in a Custom Ladder Instruction

(Number of arguments × 1) + (total number of steps in the arithmetic expression) + (number of variables in the arithmetic expression × 1) + 5

Example: Custom ladder instruction that divides two inputs by one argument value

Arithmetic expression:  $X\_PV + X\_AIN4 / ARGU01$

Number of steps =  $(1 \times 1) + (4 + 4) + (0 \times 1) + 5 = 14$



## 5.1 Precautions for Using Ladder Program

When building a ladder program, its actions upon power restoration should also be considered. This chapter explains the key items related to the actions of a ladder program upon power recovery.

UT35A/UT32A/UP35A/UP32A does not have the parameter CTLM (Control mode.)

This chapter describes the examples for UT55A/UT52A.

The ladder program for UT75A/UT35A/UT32A/UP55A/UP35A/UP32A can be created in the same way as UT55A/UT52A.

## 5.1 Precautions for Using Ladder Program

### ■ UT35A/UT32A/UP35A/UP32A

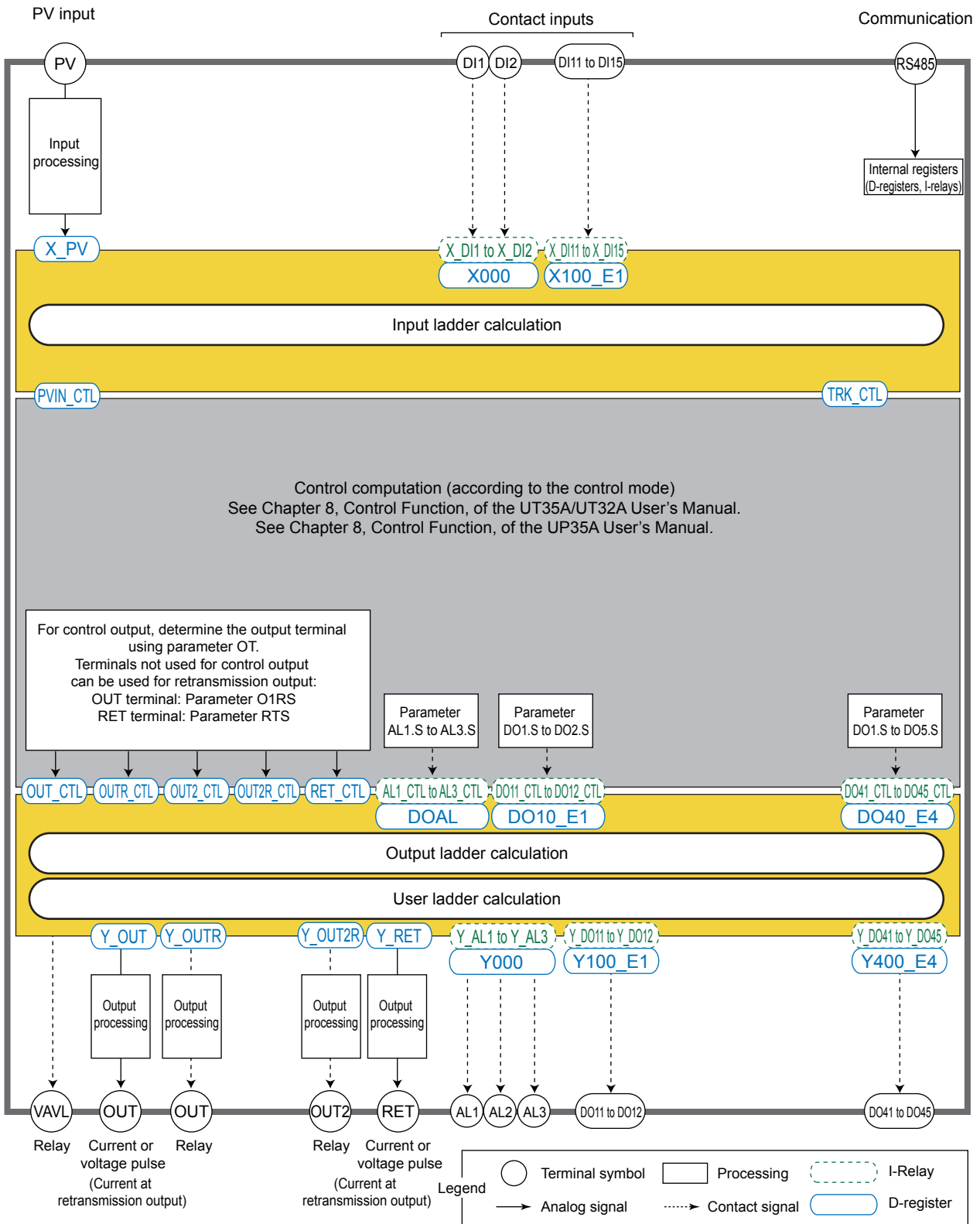

■ UT55A/UT52A/UP55A

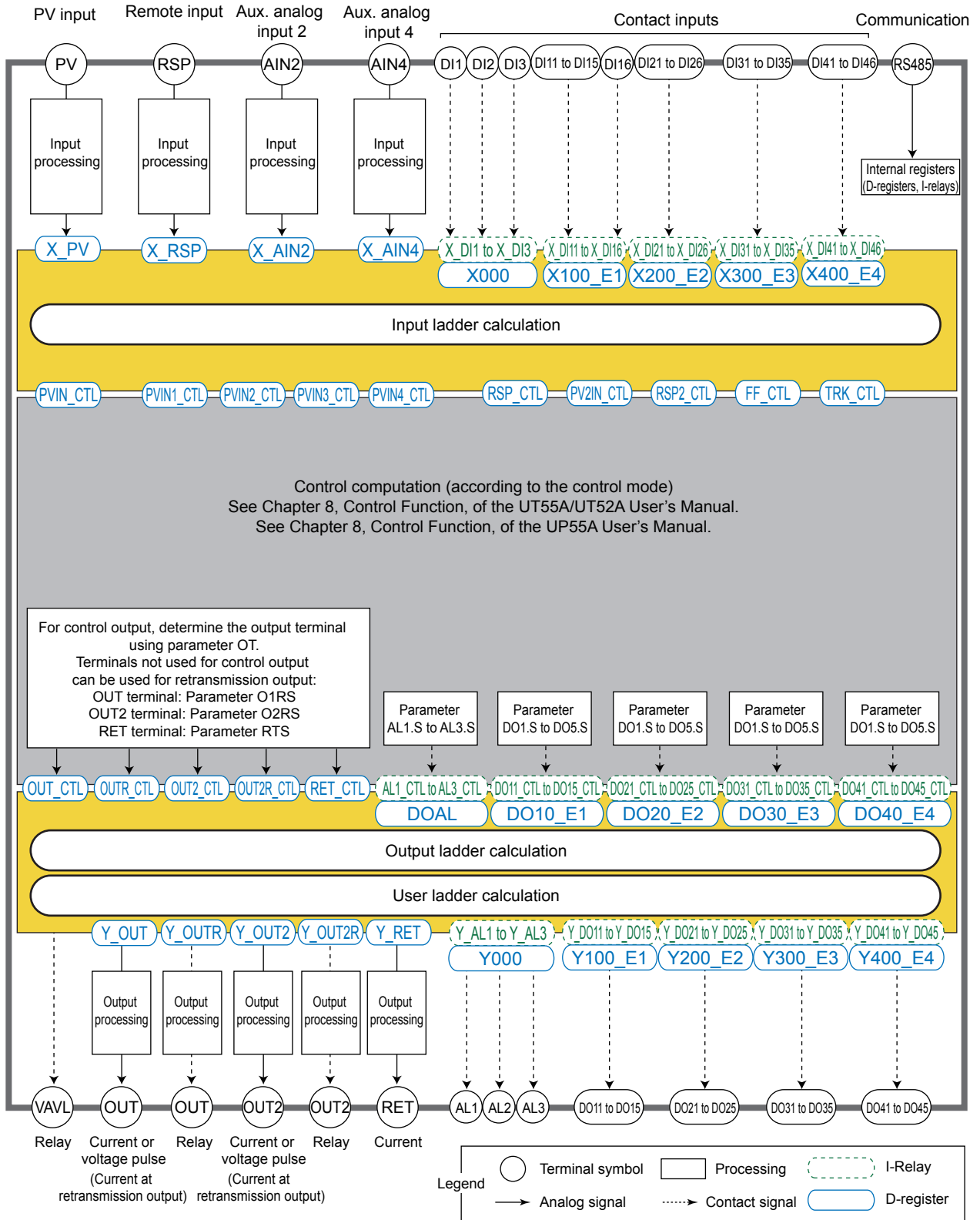



## 5.1 Precautions for Using Ladder Program

### ■ UT75A

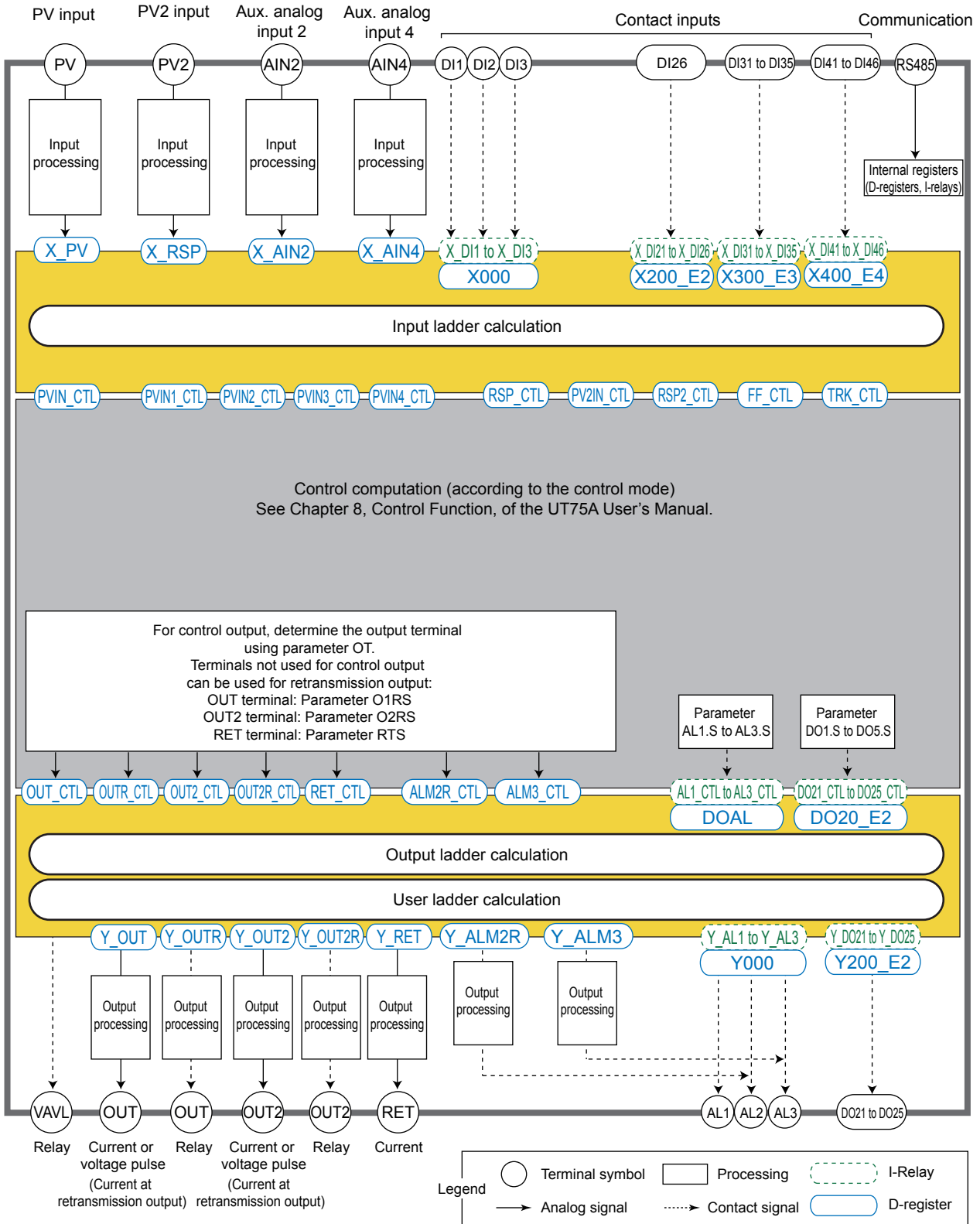

### Input ladder calculation

It is recommended that the input ladder calculation section is used for sequence or arithmetic process before outputting the signal from input terminals into the control computation section.

### Output ladder calculation

It is recommended that the output ladder calculation section is used in cases where control, alarm, and status outputs are outputted to output terminals after sequence or arithmetic process.

### User ladder calculation

It is recommended that the user ladder calculation section be used if a sequence is desired to be configured regardless of controller control computation.

### Order of executing computation/calculation

The order of executing computation/calculation is as follows:

- (1) Input ladder calculation
- (2) Control computation
- (3) Output ladder calculation
- (4) User ladder calculation

### **Note**

---

Create your own programs using examples described in this manual.

---

### 5.1.1 Relay and Register Values upon Recovery from Power Failure

- Analog input registers (X\_PV, X\_RSP, X\_AIN2, and X\_AIN4), input (status) relays (X\_DI1 to X\_DI3, X\_DI11 to X\_DI16, X\_DI21 to X\_DI26, X\_DI31 to X\_DI35, and X\_DI41 to X\_DI46) and status input registers (X000, X100\_E1, X200\_E2, X300\_E3, and X400\_E4): The values must be defined before execution of the input ladder calculation.
- Control input registers (PVIN\_CTL, PVIN1\_CTL, PVIN2\_CTL, PVIN3\_CTL, PVIN4\_CTL, RSP\_CTL, PV2IN\_CTL, RSP2\_CTL, FF\_CTL, and TRK\_CTL): Reset to zeros immediately when the power supply recovers, and then their respective values will be defined by the input ladder calculation during execution.
- Control computation registers (OUT\_CTL, OUTR\_CTL, OUT2\_CTL, OUT2R\_CTL, , RET\_CTL, , ALM2R\_CTL, and ALM3\_CTL), control status registers (DOAL, DO10\_E1, DO20\_E2, DO30\_E3, and DO40\_E4), and control (status) relays (AL1\_CTL to AL3\_CTL, and DO11\_CTL to DO45\_CTL): Reset to zeros immediately when the power supply recovers, and then their respective values will be defined by the control computation during execution. Thus, all values must be defined before execution of the output ladder calculation.
- Output registers (Y\_OUT, Y\_OUTR, Y\_OUT2, Y\_OUT2R, Y\_RET, , Y\_ALM2R, and Y\_ALM3), status output registers (Y000, Y100\_E1, Y200\_E2, Y300\_E3, and Y400\_E4), and output (status) relays (Y\_AL1 to Y\_AL3 and Y\_DO11 to Y\_DO45): The values are defined by the output ladder calculation.
- Operation parameters of Loops 1 and 2 (such as SPs, SPNo's, alarm settings, PID tuning parameters): The values must be defined before execution of the input ladder calculation.
- Process data (such as PV, CSP, DEV, and PIDNo): The values must be defined when the control computation runs. Thus, their values will not be defined by execution of the input ladder calculation for the first time after a power recovery.
- Internal relays, internal status registers, and DAT registers: Whether the values are held or not is determined by the control period.

Device Name	Relay/Register	Holding type/Non-holding type		
		Control period		
		50 ms	100 ms	200 ms
Internal (M) relays	M01 to M128	N/A	N/A	N/A
	M01_B to M32_B	√	√	√
	M33_B to M128_B	N/A	√	√
Internal status registers	M1_M16, M17_32, M33_48, M49_64, M65_80, M81_96, M97_112, M113_M128	N/A	N/A	N/A
	M1_16_B, M17_32_B	√	√	√
	M33_48_B, M49_64_B, M65_80_B, M81_96_B, M97_112_B, M113_128_B	N/A	√	√
DAT registers	DAT01 to DAT20	N/A	N/A	N/A
	DAT01_B to DAT08_B	N/A	√	√
Time-out relays	TIM1 to TIM4	N/A	N/A	N/A
Timer registers (current value)	TIMER1 to TIMER4	N/A	N/A	N/A
Time-out relays with back-up (UT75A only)	TIM1_B to TIM4_B	N/A	√	√
Timer registers with back-up (current value) (UT75A only)	TIMER1_B to TIMER4_B	N/A	√	√
Count-out relays	CNT1 to CNT4	N/A	N/A	N/A
Counter registers (Current value)	COUNTER1 to COUNTER4	N/A	N/A	N/A
Count-out relays with back-up (UT75A only)	CNT1_B to CNT2_B	N/A	√	√
Counter registers with back-up (Current value) (UT75A only)	CNTER1_B to CNTER2_B	N/A	√	√

√: Available, N/A: Not available

- The internal relays and registers are either the holding or the non-holding type. The non-holding type includes non-holding internal relays, non-holding DAT registers, time-out relays, count-out relays, timer registers, and counter registers, which will be reset to zeros upon power recovery. While, the holding type includes holding internal relays, holding DAT registers, P registers, and K registers, whose respective values immediately before a power failure will remain after power recovery. Holding internal relays in groups of 16 bits each can be used as status registers.

- ▶ [Internal relay, internal register: Section 4.2.2, Internal Devices \(Read/Write\)](#)
- ▶ [Process data, operation mode, alarm status, alarm output status, key status, display status: UTAdvanced Series Communication Interface \(RS-485, Ethernet\) User's Manual](#)

### 5.1.2 Circuit Actions upon Recovery from Power Failure

Instructions are divided into two main types: those instructions that are executed continuously during the period when the execution condition is met; and those that are executed only once when the condition is met. Upon power recovery, instructions of the former type will be executed from the first time after the recovery, whereas instructions of the latter type will ignore the respective conditions at the first time and start judging the conditions and being executed depending on the condition from the second time.

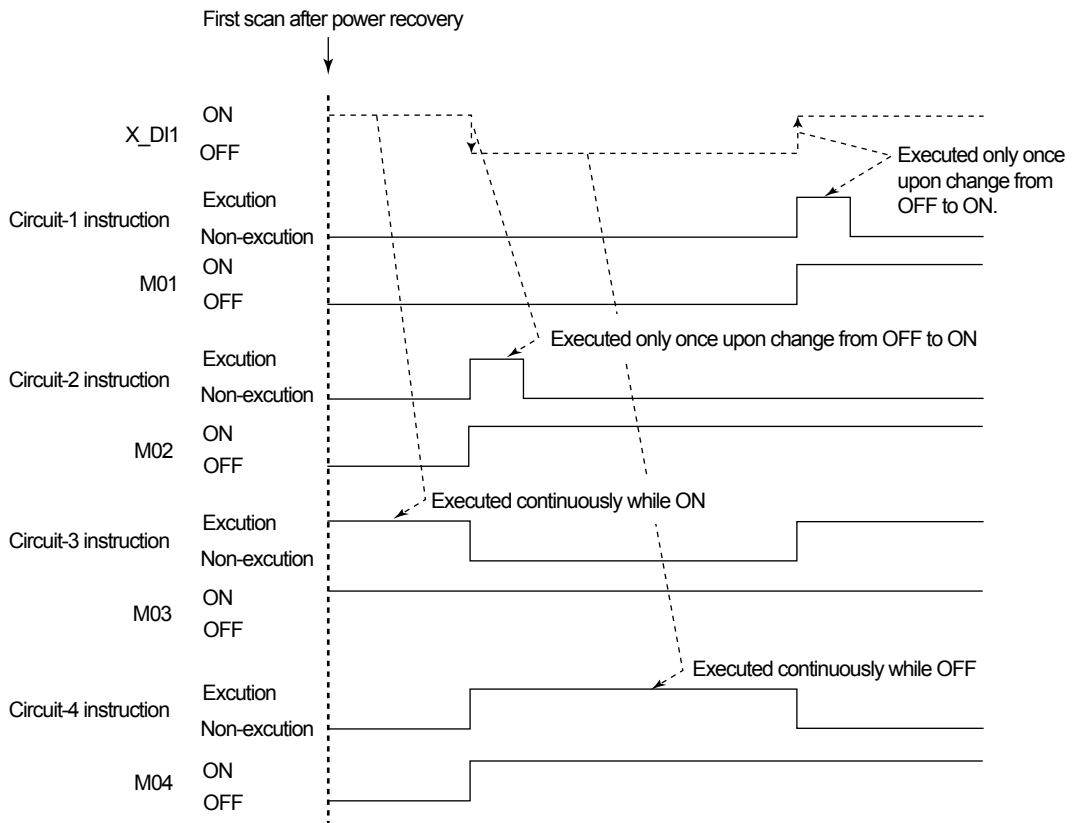
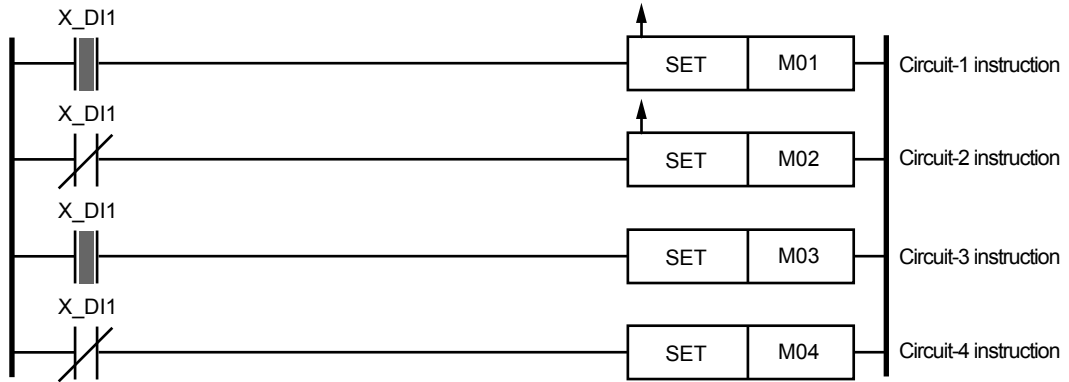

## 5.2 Functions That Require Parameter Setting

Some ladder programs require parameter setting before running. You can set parameters either with the keys on the front panel of the main unit controller, or using the LL50A parameter setting software and downloading the settings to the main unit controller. The following explains the method of using the LL50A parameter setting software.

### 5.2.1 Setting P Parameters

To set the values and decimal point positions of the individual P parameters, use the Parameter Setting window. The decimal point positions can only be set by using the LL50A parameter setting software.

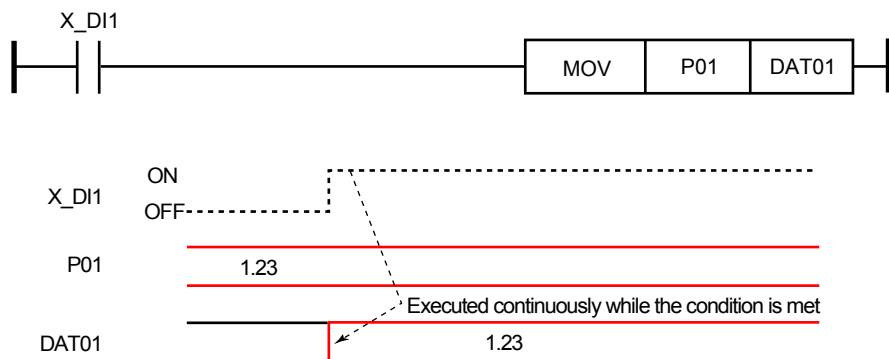

#### Parameter Settings

P1D: 2:###.##

P01: 1.23

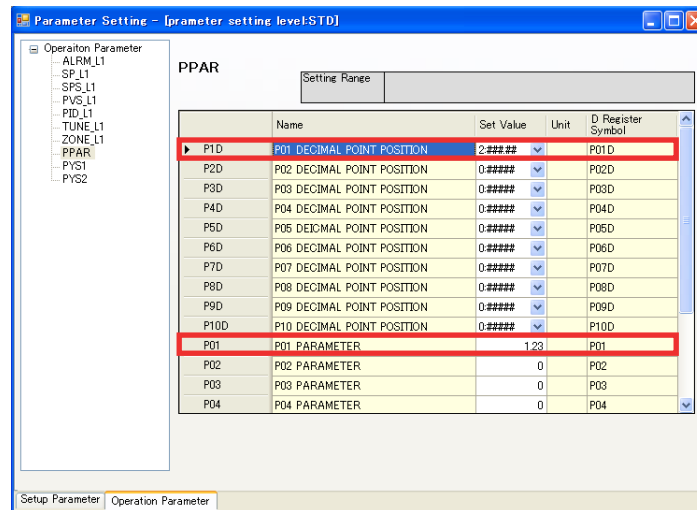

## 5.2 Functions That Require Parameter Setting

### 5.2.2 Setting Contact Inputs for Switching Operation Mode from Ladder Program

Operation mode switching can be performed in a ladder program. However, when contact inputs have been assigned to remote operation mode switching, those contact input statuses take precedence over the ladder program.

#### DI Function Registration Menu

Parameter	Name	Action type	Default
			Contact name (I relay number)
A/M	AUTO/MAN switch	Status	X_DI1 (5026)
R/L	REM/LCL switch	Status	X_DI16 (5046)
S/R	STOP/RUN switch	Status	X_DI2 (5027)

Note: An edge action results when in cascade mode.

The table above shows the contact inputs assigned to mode switching by default. Use the LL50A parameter setting software or keys on the front panel of the main unit to change the parameter settings. The following shows an example when using LL50A.

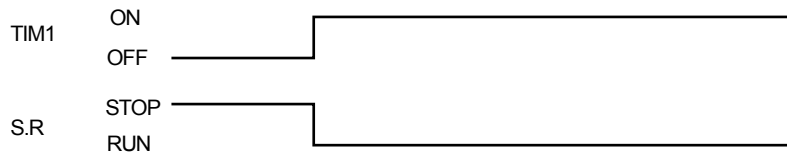
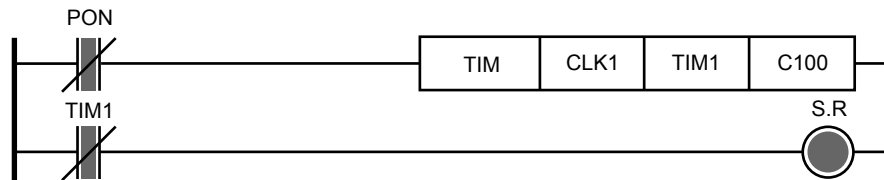

#### Parameter Settings

S/R: OFF

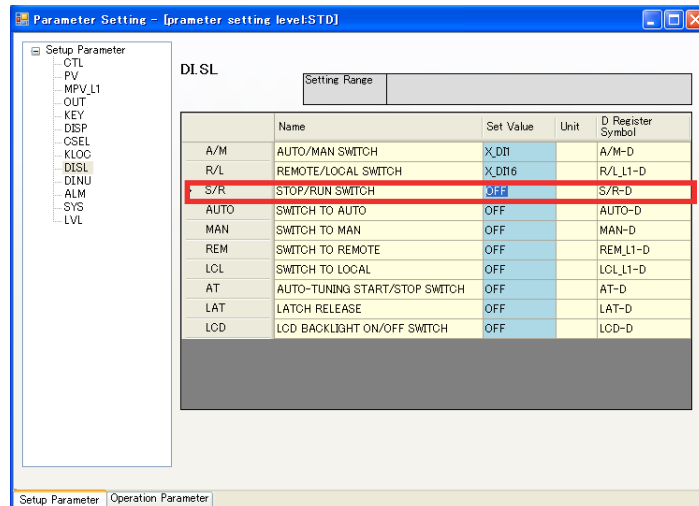

### 5.2.3 Assigning Operation Mode Switching Functions to Keys on main unit's Front Panel

Operation mode switching can be performed from a ladder program as mentioned above. The mode switching functions can also be assigned to keys on the front panel of the main unit controller.

The keys to which the mode switching functions can be assigned and the window for setting are shown below.

#### Front keys to which mode switching functions can be assigned

Parameter	Factory set default
FN	PID tunig swtich
A/M	AUTO/MAN switch

#### Parameter Settings

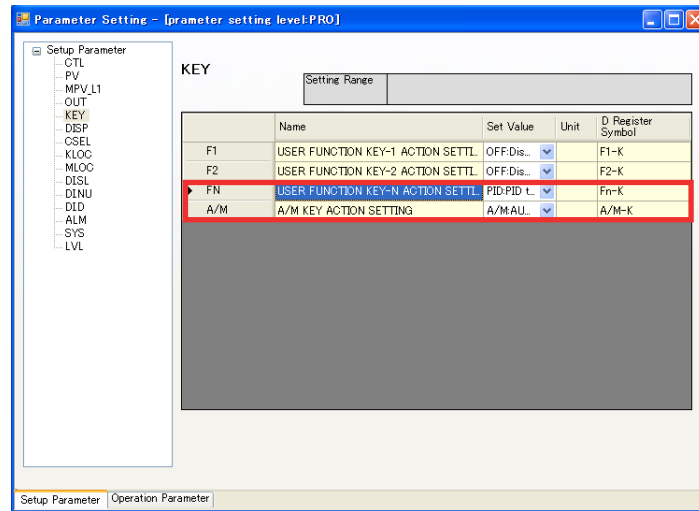



## 5.2 Functions That Require Parameter Setting

### 5.2.4 Settings for Activating Contact Outputs and Event Lamps

To activate contact outputs and event lamps from a ladder program for event status indications, the respective parameters must be set in the main unit controller. An example of setting using the LL50A parameter setting software is shown below.

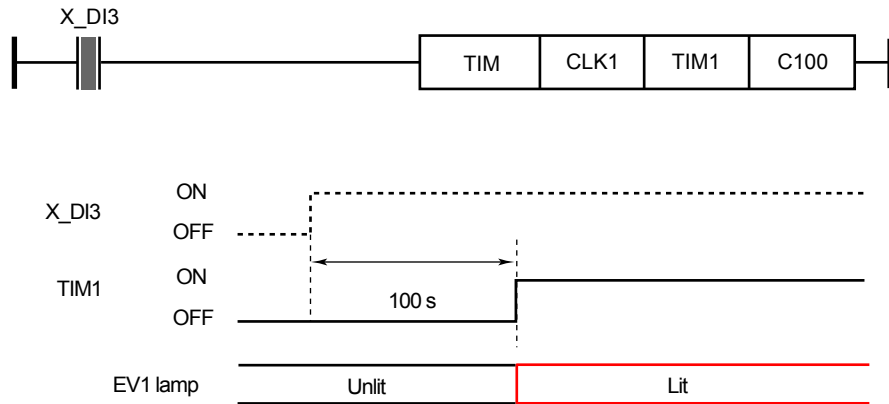

#### Parameter Settings

EV1: TIM1

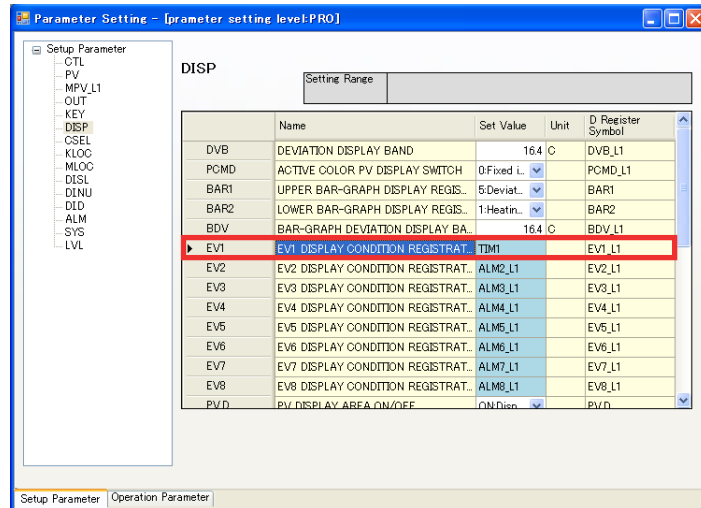

### 5.2.5 Settings for Interrupt Message Display in PV Display Area

To let a ladder program display interrupt messages, the respective parameters must be set in the main unit controller. An example of setting using the LL50A parameter setting software is shown below.

**Note**

Merely writing "1" in the D registers for interrupt message display (MG1 to MG4) inside a ladder program does not cause the message to appear.

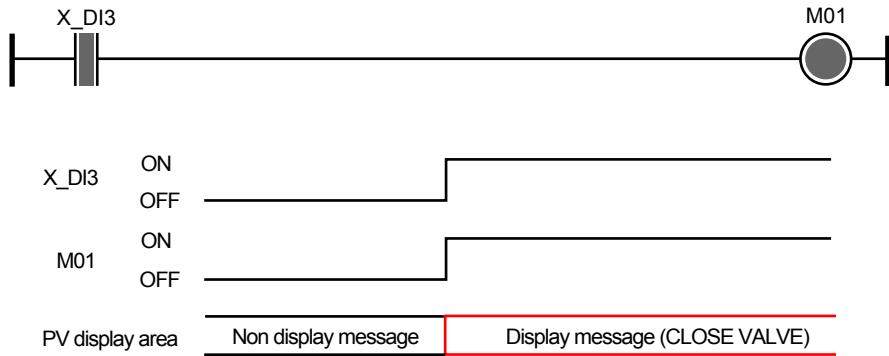

**Parameter Settings**

MG1: M01

MSG1: CLOSE VALVE

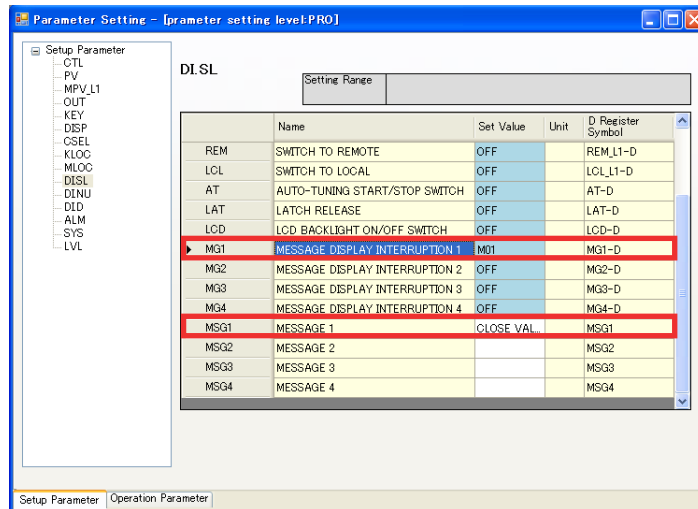

## 5.3 Examples of Supplementing Instructions and General Specifications in Ladder Programming

Some functions cannot be achieved using only instructions provided with a ladder program. The following are examples of implementing such functions.

### 5.3.1 Retaining Timers and Counters from Previous Values after Power Failure

Examples of restarting a timer and counter after the power recovery with the value immediately before the power failure are shown below.

#### Timer

A timer instruction does not retain the current timer value during a power failure. The following shows an example of ladder programming when it is desired to restart a timer after the power recovery from the value immediately before the power failure.

#### Specifications of Example:

- If DI2 is ON, set STOP/RUN (S.R) to STOP.
- When DI2 turns ON to OFF, start the timer. When the timer value reaches the time (in seconds) set in P01, namely, when time-out is reached, set STOP/RUN (S.R) to RUN.
- If a power failure and recovery occur while the timer is running, the timer restarts continuously without its value being reset.

#### Ladder program

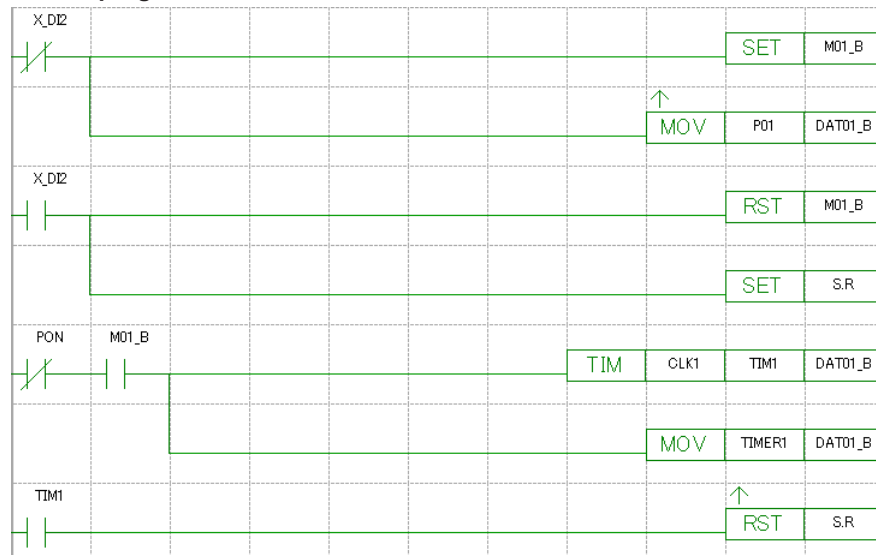

Note: Code the ladder program above in the input ladder calculation.

Note: Make sure to disable the contact input function for DI2.

Register	Function
X_DI2	OFF: Timer start ON: Timer stop
P01	Timer set value (s)
S.R	STOP/RUN ON: STOP OFF: RUN
M01_B	ON: Timer enable flag OFF: Timer disable flag
DAT01_B	Timer set value (use value)
TIM1	Time-out relay
TIMER1	Timer current value

### 5.3 Examples of Supplementing Instructions and General Specifications in Ladder Programming

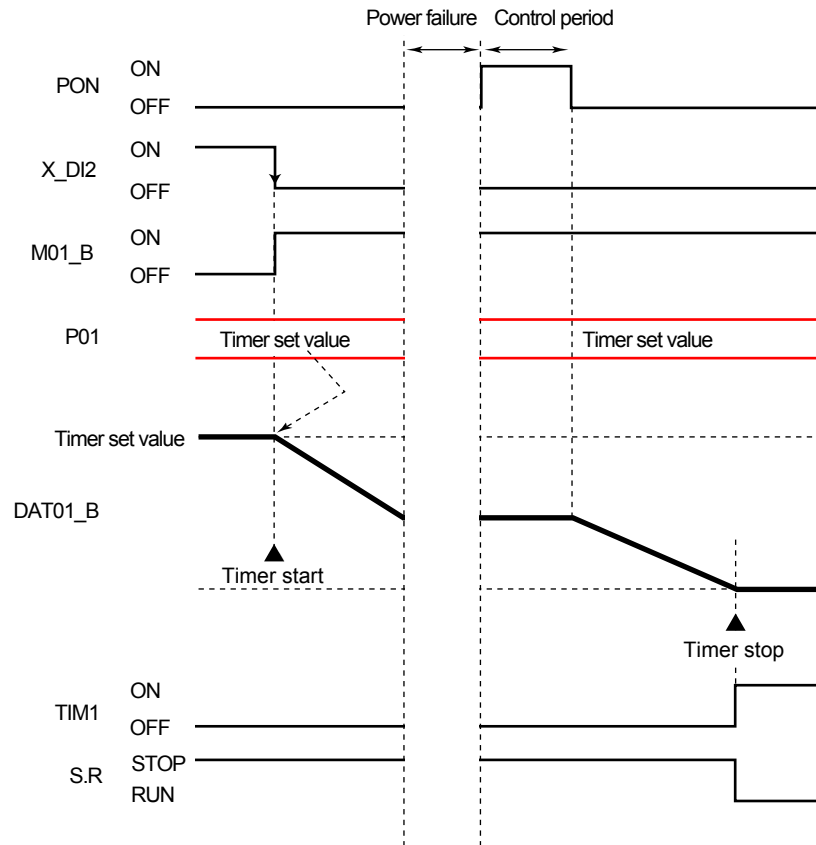

### 5.3 Examples of Supplementing Instructions and General Specifications in Ladder Programming

#### Counter

A counter instruction does not retain the current counter value during a power failure. The following shows an example of ladder programming when it is desired to restart a counter after the power recovery from the value immediately before the power failure.

#### Specifications of example:

- When DI1 turns ON, increment the counter by 1.
- If DI2 is ON, set STOP/RUN (S.R) to STOP.
- When DI2 turns ON to OFF, start the counter. When the counter value reaches the number set in P01, namely, when count-out is reached, set STOP/RUN (S.R) to RUN.
- If a power failure and recovery occur while the counter is running, the counter restarts continuously without its value being reset.

#### Ladder program

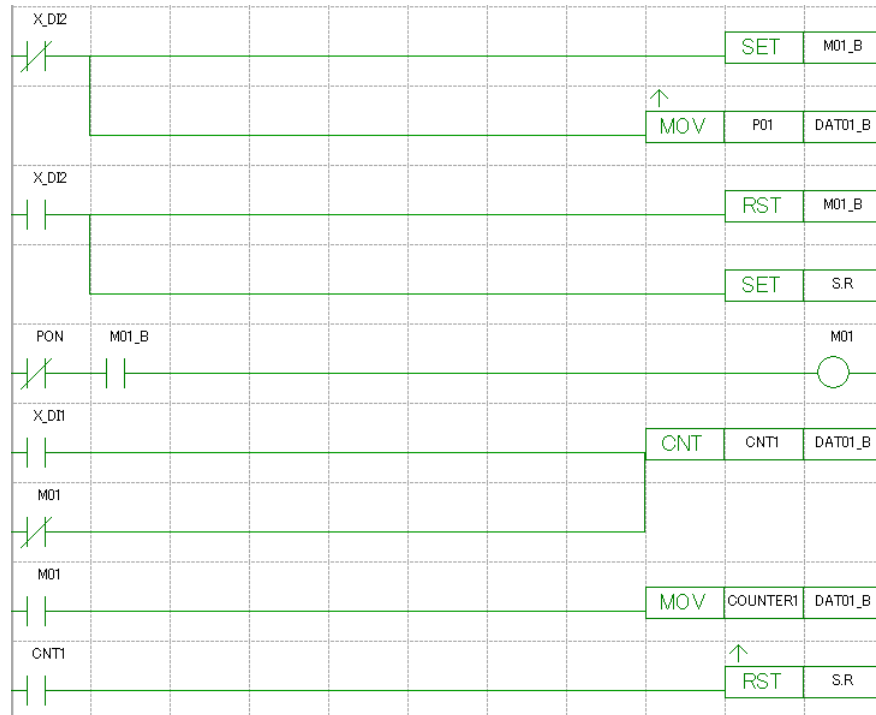

Note: Code the ladder program above in the input ladder calculation.

Note: Make sure to disable the contact input function for DI1 and DI2.

### 5.3.2 Holding Timer and Counter Values

Examples of programming to hold a timer and counter depending on a contact input status are shown below.

#### Timer

A timer instruction does not retain the current timer value. The following shows an example of ladder programming to hold the timer value.

#### Specifications of example

- If DI2 is ON, set STOP/RUN (S.R) to STOP.
- When DI2 turns ON to OFF, the timer starts. When the timer value reaches the time (in seconds) set in P01, namely, when time-out is reached, set STOP/RUN (S.R) to RUN.
- If a power failure and recovery occur while the timer is running, the timer restarts continuously without its value being reset.
- If DI3 turns OFF to request holding while the timer is running, the timer pauses holding the current value. If DI3 turns ON to release the timer holding, restart the timer from the value held.

#### Ladder program

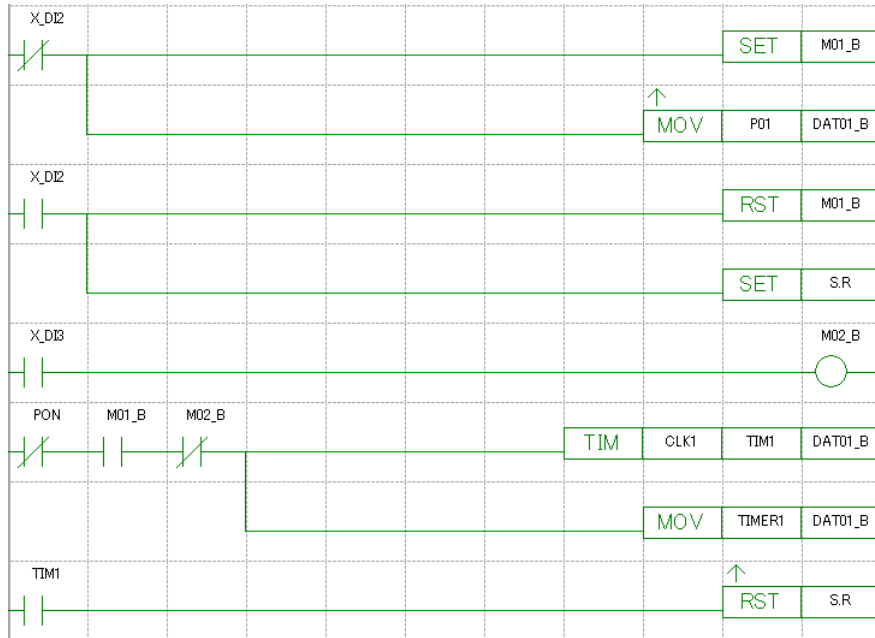

Note: Code the ladder program above in the input ladder calculation.

Note: Make sure to disable the contact input function for DI2 and DI3.

### 5.3 Examples of Supplementing Instructions and General Specifications in Ladder Programming

Register	Function
X_DI2	OFF: Timer start ON: Timer stop
X_DI3	ON: Timer hold OFF: Timer holding release
P01	Timer set value (s)
S.R	STOP/RUN ON: STOP OFF: RUN
M01_B	ON: Timer enable flag OFF: Timer disable flag
M02_B	ON: Timer hold flag OFF: Timer holding release flag
DAT01_B	Timer set value (use value)
TIM1	Time-out relay
TIMER1	Timer current value

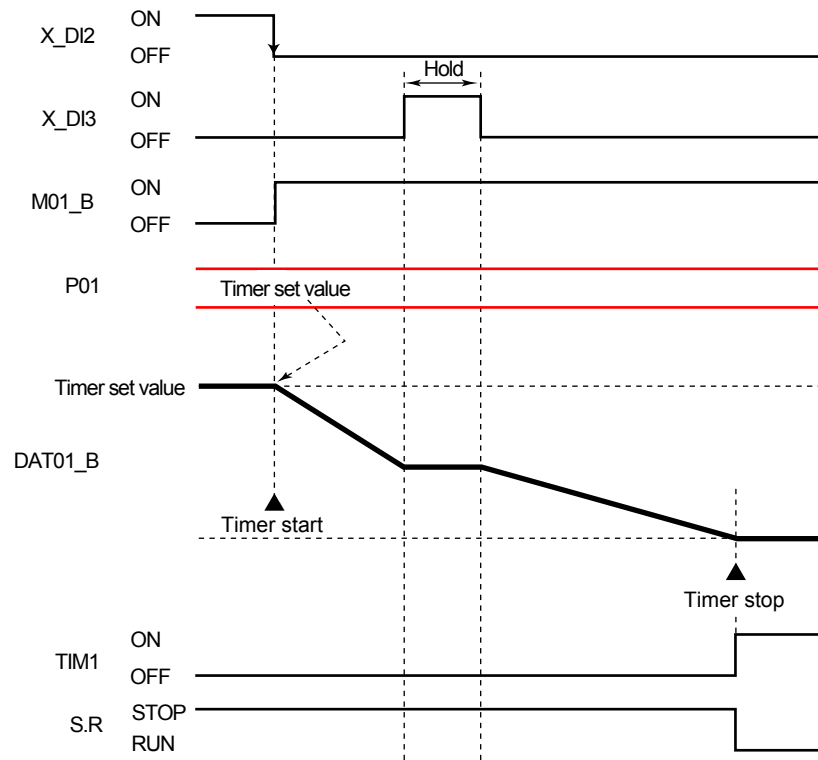

**Counter**

A counter instruction does not retain the current counter value. The following shows an example of ladder programming to hold the counter value.

**Specifications of example**

- When DI1 turns ON, increment the counter by 1.
- If DI2 is ON, set STOP/RUN (S.R) to STOP.
- When DI2 turns ON to OFF, the counter starts. When the counter value reaches the number set in P01, namely, when count-out is reached, set STOP/RUN (S.R) to RUN.
- If a power failure and recovery occur while the counter is running, the counter restarts continuously without its value being reset.
- If DI3 turns OFF to request holding while the counter is running, the counter pauses holding the current value. If DI3 turns ON to release the counter holding, restart the counter from the value held.

**Ladder program**

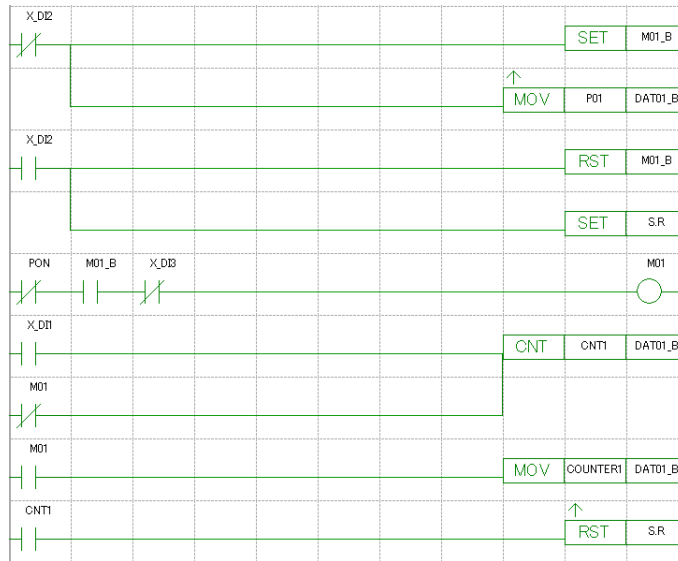

Note: Code the ladder program above in the input ladder calculation.  
 Note: Make sure to disable the contact input function for DI1 and DI2.



### 5.3.3 Retaining the Values of Peer-to-Peer Communication Status Input Relays (CI<sub>n</sub>) during Power Failure of Master or Slave main unit

This section describes the program to retain the values in peer-to-peer communication status input relays (CI<sub>n</sub>) during a power failure of the master or slave main unit by the time when the power recovers and receipt of communication data is completed.

**Specifications of example:**

- The automatic/manual mode (A.M) of the master main unit is controlled depending on the status of a slave main unit. Communication address 1 in peer-to-peer communication indicates the master main unit, and its status is written to peer-to-peer communication status input relay CI01.
- If communication is established, and if CI01 is ON, then set the automatic/manual mode (A.M) to manual (1). If communication is established, and if CI01 is OFF, then set the automatic/manual mode (A.M) to automatic (0).
- Immediately after the power to the master main unit recovers, the automatic/manual mode (A.M) is retained at the value before the power failure. Then, when reception is enabled, the normal action based on the value of CI01 takes place. This is controlled based on flag CE01.
- When the communication is interrupted, the automatic/manual mode (A.M) is retained at the value before the communication failure.
- Control by communication is enabled only while DI1 is ON. If DI1 is OFF, then set A.M forcibly to automatic.

**Ladder program**

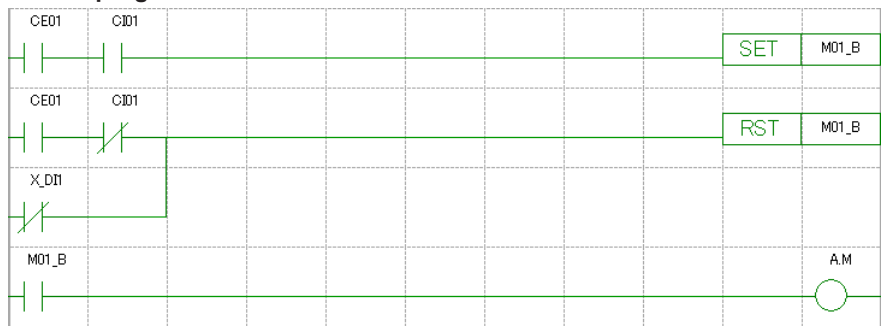

Note: Code the ladder program above in the input ladder calculation.

Note: Make sure to disable the contact input function for DI1.

Register	Function
DI1	ON: Enable control by peer-to-peer communication. OFF: Set the mode to automatic forcibly.
CI01	ON: Request switching to manual. OFF: Request switching to automatic.
CE01	OFF from the time of power recovery by the time of communication restart; ON after communication restart, and kept ON during communication interrupt
A.M	AUTO/MAN 1: Manual 0: Automatic
M01_B	ON: Manual OFF: Automatic

### 5.3 Examples of Supplementing Instructions and General Specifications in Ladder Programming

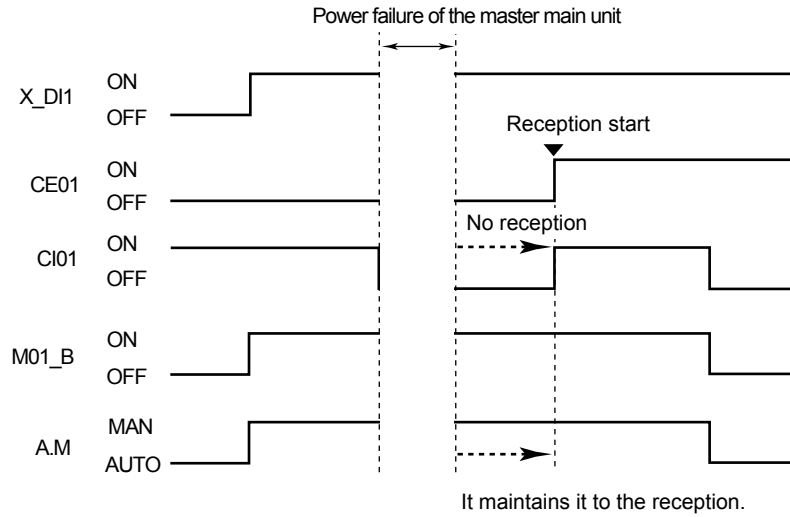

### 5.3.4 Retaining the Values of Peer-to-Peer Communication Analog Input Registers (CXn) during Power Failure of Master or Slave main unit

This section describes the program to retain the values in peer-to-peer communication analog input registers (CXn) during a power failure of the master or slave main unit by the time when the power recovers and receipt of communication data is complete.

**Specifications of example:**

- A register value in a slave main unit is set in RSP\_CTL of the master main unit. Communication address 1 in peer-to-peer communication indicates the master main unit, and its register value is written to peer-to-peer communication analog input register CX01.
- If a communication error has been detected, the set value for RSP\_CTL will be "2".
- Communication is available only when DI1 is ON. When DI1 is OFF, the set value for RSP\_CTL is "2".

**Ladder program**

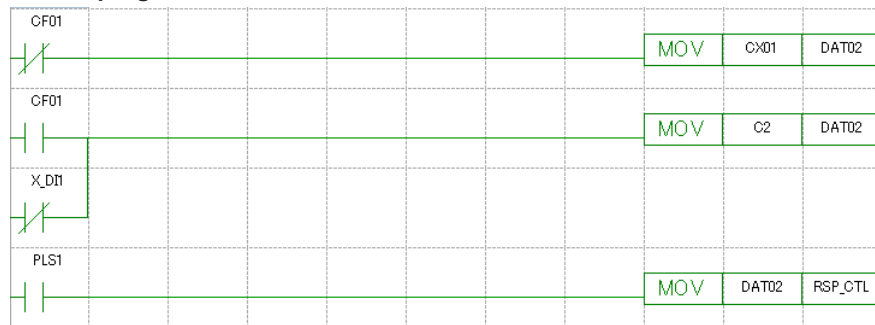

Note: Code the ladder program above in the input ladder calculation.

Register	Function
CX01	Specified register for storing communication value
CF01	ON: Communication failure OFF: Normal
RSP_CTL	Remote setpoint for control

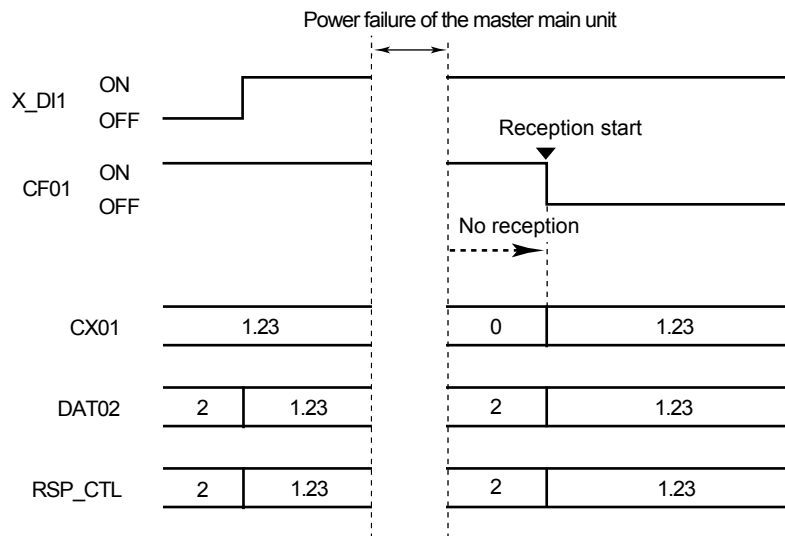

### 5.3.5 Detecting Communication Failure and Recovery Other Than Using Peer-to-Peer Communication

Communication failures and recoveries can also be detected using a non-holding internal relay (M).

An example to detect communication failures and recoveries using a non-holding internal relay (M) for setting of holding-type data C.RSP is shown below.

- During a communication failure, an internal value is written to C.RSP.
- P01 is outputted when a communication error is determined. A margin (sec) assigned in K01 is set for the communication error determination.
- After a power supply returns, P01 is outputted until the communication becomes normal.

**Ladder program**

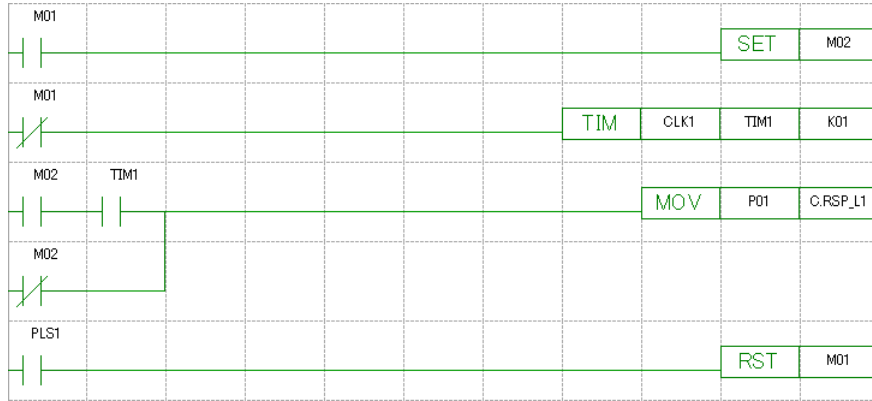

Note: Code the ladder program above in the input ladder calculation.

Register	Function
M01	Communication decision flag Write "1" from the upper device.
K01	A margin (timer value) for communication disconnect
P01	Output value at the communication error determination

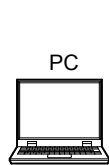
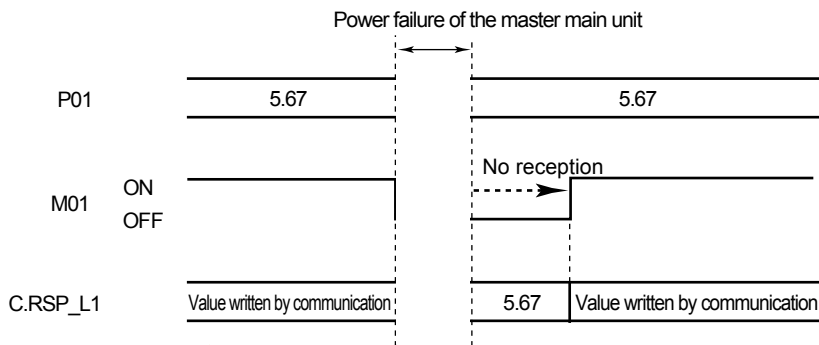

Writing to the register by means other than peer-to-peer communication; the M01 and C.RSP values are written to communication registers directly.

## 5.4 Peer-to-peer Communication

### 5.4.1 Overview of Function Peer-to-peer Communication

Peer-to-peer communication enables up to 32 main units to be connected. Of these 32 main units, four units can send four analog data and 16 status data, and receive 16 analog data and 64 status data. The remaining 28 units can only receive 16 analog data and 64 status data. The user can send and receive data simply by reading data from peer-to-peer communication registers (data reception) or writing data to peer-to-peer communication registers (data transmission) by the ladder program on the main unit without being aware that communications is being performed.

Controller Nos.1 to 4 can send and receive data.

Controller Nos.5 to 32 can only receive data.

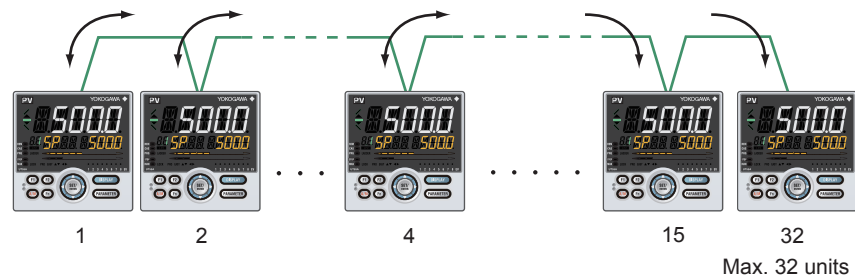

#### Specifications of Peer-to-peer Communications

Item	Specifications
Number of connected units	Max. 32 (4 transmitting/receiving controllers, 28 receiving-only controllers)
Amount of data transmitted	(4 analog data + 16 status data) per send/receiving controller
Amount of data received	16 analog data + 64 status data
Transmitted data update period	200 ms

## 5.4.2 Setting Peer-to-peer Communication and Communication Address

## Setting Details

Parameter symbol	Name	Display level	Setting range	Menu symbol
<b>PSL</b>	Protocol selection	EASY	PCL: PC link communication PCLSM: PC link communication (with checksum) LADR: Ladder communication CO-M: Coordinated master station CO-S: Coordinated slave station MBASC: Modbus (ASCII) MBRTU: Modbus (RTU) CO-S1: Coordinated slave station (Loop-1 mode) CO-S2: Coordinated slave station (Loop-2 mode) P-P: Peer-to-peer communication	R485 <b>Set</b>
<b>ADR</b>	Address	EASY	1 to 4: Controllers that can send and receive data 5 to 99: Controllers that only can receive data (Note)	

**Set** : Setup parameter

Note: Do not set the same communication address to two or more controllers.

- **Protocol selection**

Set "P-P" to the controllers that are made to perform peer-to-peer communication.

- **Address**

Set any communication address between 1 to 4 to controllers that transmit and receive data. Set a unique address to each controller. Do not set the same address to two or more controllers.

Set any communication address within the range 5 to 32 to controllers that only receive data. Set a unique address to each controller. Do not set the same address to two or more controllers.

### 5.4.3 Peer-to-peer Communication Relays and Registers

Data that can be transferred by peer-to-peer communication is analog data and status relay data. Status relay data is in either of two states, ON (1) or OFF (0), depending on the rules of the ladder program.

Transmitted/received data can be used in the ladder program via peer-to-peer communication registers.

The following table shows the peer-to-peer communication registers and the read/write operations performed on these registers by the ladder program.

\*Registers are floating point numbers (single-precision real numbers).

**Peer-to-peer Communication Registers**

Register symbol	Name	Explanation	Data Type
<b>CXn</b>	Peer-to-peer communication analog input register	n: 01 to 04 Data received from communication address 1 n: 05 to 08 Data received from communication address 2 n: 09 to 12 Data received from communication address 3 n: 13 to 16 Data received from communication address 4	Floating point number (single-precision real number)
<b>CYn</b>	Peer-to-peer communication analog output register	n: 01 to 04 Data transmitted to other controllers	Floating point number (single-precision real number)
<b>Cl<sub>n</sub></b>	Peer-to-peer communication status input relay	n: 01 to 16 Data received from communication address 1 n: 17 to 32 Data received from communication address 2 n: 33 to 48 Data received from communication address 3 n: 49 to 64 Data received from communication address 4	Relay status data (0, 1)
<b>CO<sub>n</sub></b>	Peer-to-peer communication status output relay	n: 01 to 16 Data transmitted to other controllers	Relay status data (0, 1)
<b>CF<sub>n</sub></b>	Reception time-out flag	n: 01 to 04 Indicates the status (normal/error) of the data received from communication address n.	Status data (0: normal, 1: error)
<b>CE<sub>n</sub></b>	End of data reception flag	n: 01 to 04 Indicates the status (end of reception/during of reception) of the data received from communication address n.	Status data (0: during reception, 1: end of reception)

## Processing at Communication Failure

Item	Cause of Failure	Processing on Receiving Controller	Processing on Transmitting Controller
1	Broken communication line Receiving controller communication card malfunction	The receiving controller holds the previously received peer-to-peer communication input data. If the error continues for two seconds, the reception timeout flag changes the state to 1 (error).	An error cannot be detected. When the transmitting controller receives data, it detects an error on the transmitting controller as the receiving controller.
2	The user program is being downloaded or uploaded, or parameters are being set the transmitting controller.	Same as above	Functions are stopped.
3	The user program is being downloaded or uploaded, or parameters are being set the receiving controller.	Functions are stopped. Even if functions are stopped, peer-to-peer communication input data is received normally, and stored to registers CX and CI.	An error cannot be detected. When the transmitting controller receives data, it detects an error on the transmitting controller as the receiving controller.
4	Failure of transmitting controller	The receiving controller holds the previously received peer-to-peer communication input data. If the error continues for two seconds, the reception timeout flag changes the state to 1 (error).	Failure
5	Power failure on transmitting controller	The receiving controller holds the previously received peer-to-peer communication input data. If the error continues for two seconds, the reception timeout flag changes the state to 1 (error).	A power failure has occurred. For details on processing during a power failure, see "Processing at Power Failure."
6	Power failure on receiving controller	A power failure has occurred. For details on processing during a power failure, see "Processing at Power Failure."	An error cannot be detected. When the transmitting controller receives data, it detects an error on the transmitting controller as the receiving controller.
7	Communication error (parity error, framing error)	The receiving controller holds the previously received peer-to-peer communication input data. If the error continues for two seconds, the reception timeout flag changes the state to 1 (error).	An error cannot be detected. When the transmitting controller receives data, it detects an error on the transmitting controller as the receiving controller.

## Processing at Power Failure

This item describes the processing when a main unit controller is recovered from a power failure during peer-to-peer communication.

The values of registers CX, CY, CI, and CO start from 0%.

When the transmitting controller or ladder program writes data to these registers, that data becomes valid.

At a start, the state of the reception time-out flag (CFn) is 1 (error). However, when communication is recovered, it changes to 0 (normal).



### 5.4.4 Ladder Programming Example

The following is an example of making four main unit controllers perform the same programmed-setpoint control synchronously.

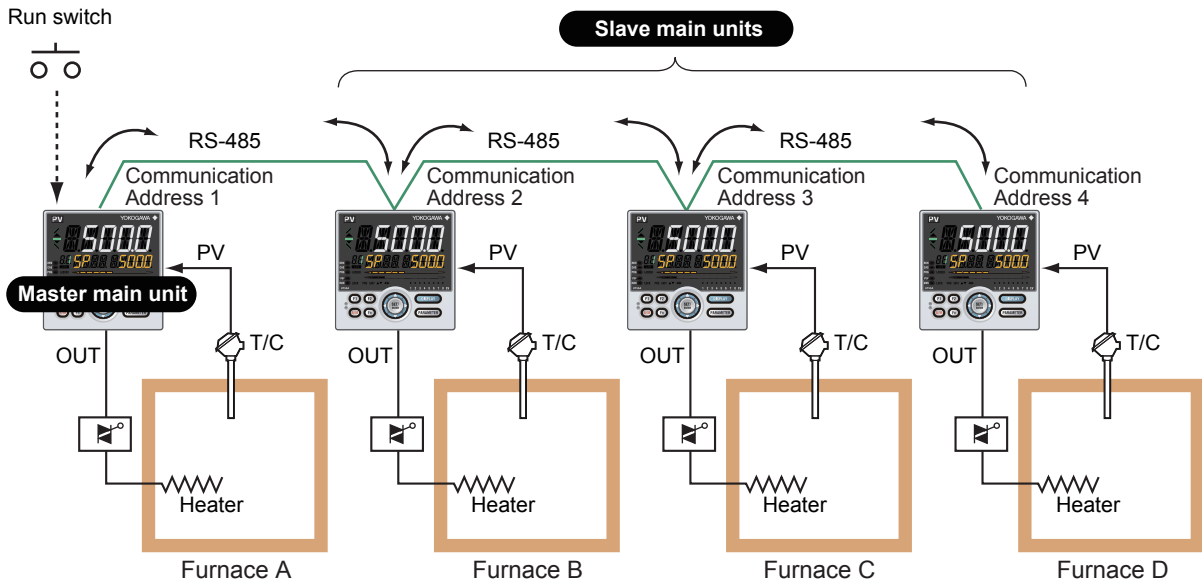

**Specifications of example:**

- Four main unit controllers are linked via peer-to-peer communication, where one serves as the master main unit and others as slave main units. Slave main units perform programmed-setpoint control and change their modes synchronously with the master main unit.
- There are four operation modes: Run/Stop and Remote/Local.
- The program control starts when a contact input for the master main unit is turned on, and stops when the same input is turned off.
- When the program control starts, the modes of the master and slave main units are forcibly changed to Remote and Run.
- The program pattern is set as the remote setpoints.
- The time span of the program pattern is calculated based on the control period (200 ms).
- The operation mode changes to Stop when the program pattern has been implemented to the end. The modes of the master and local main units are changed to Local. Concurrently, and the setpoints are the final value of the programmed pattern.
- The control is forcibly stopped immediately when the contact input to the master main unit turns off or when an A/D converter error or burn-out error is detected in one of the four main units. The modes of the master and local main units are changed to Local. Concurrently, and the setpoints are the final value of the programmed pattern.

The programmed pattern is shown below.

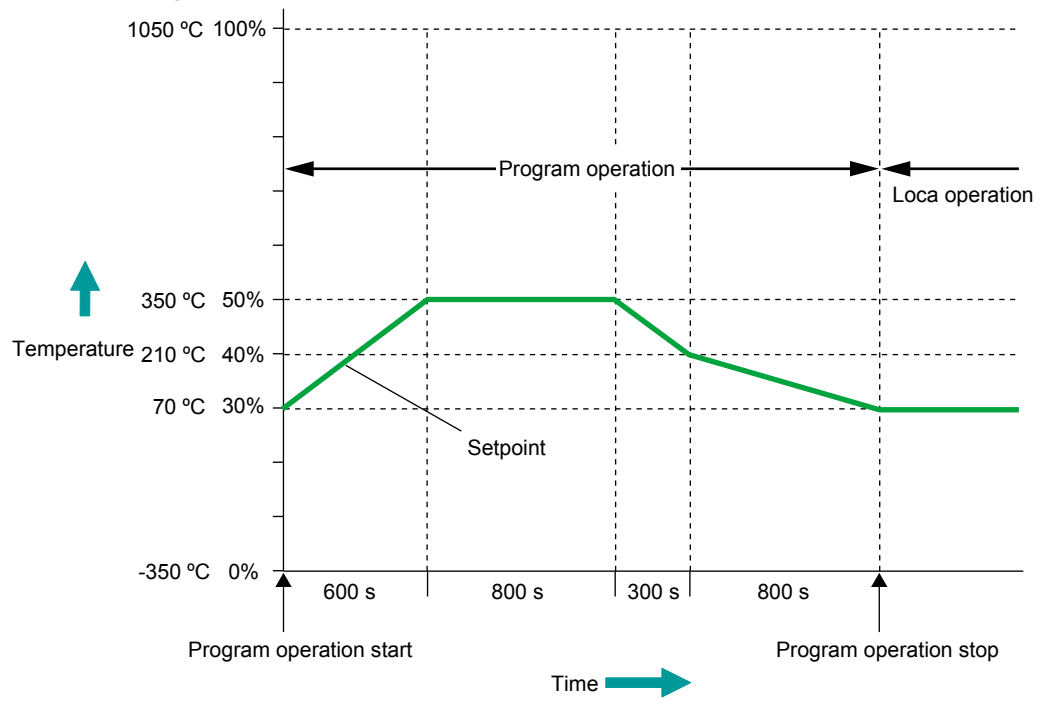

**Setting of master main unit**

**Parameter settings (main unit)**

- Control mode (CTLM): SGL (Single-loop control)
- Input sampling period (control period) (SMP): 200 ms
- STOP/RUN switch (S/R): 0 (disable switching by a contact input)
- REMOTE/LOCAL switch (R/L): 0 (disable switching by a contact input)

**Burnout connection settings**

- LOOP1 PV: PV, LOOP1 RSP: RSP

**Parameter settings (LL50A)**

- K constant

Symbol	Set value	Description
<b>K01</b>	0.2	Control period at 200 ms, for program time span calculation
<b>K02</b>	4	Number of program pattern segments
<b>K03</b>	7	Slave main unit communication time-out interval (added to the time-out interval CF)

- P parameter

Symbol	Set value	Decimal point position	Description
<b>P01</b>	-	-	Unused
<b>P02</b>	30	0	Starting target setpoint (SSP)
<b>P03</b>	50	2	Segment-1 target setpoint (%)
<b>P04</b>	600	0	Segment-1 time (s)
<b>P05</b>	50	2	Segment-2 target setpoint (%)
<b>P06</b>	800	0	Segment-2 time (s)
<b>P07</b>	40	2	Segment-3 target setpoint (%)
<b>P08</b>	300	0	Segment-3 time (s)
<b>P09</b>	30	2	Segment-4 target setpoint (%)
<b>P10</b>	800	0	Segment-4 time (s)

**Devices used**

- Registers for peer-to-peer communication

Symbol	Description
<b>CO01</b> <b>CI01</b>	Main unit of communication address 1 1: Start program operation (LOCAL -> REMOTE) 0: Stop program operation (REMOTE -> LOCAL)
<b>CY01</b> <b>CX01</b>	Main unit of communication address 1 Programmed setpoint (CSP) output/input
<b>CO01</b> <b>CI17</b>	Main unit of communication address 2 1: Input error in main unit of communication address 2 0: Input normal in main unit of communication address 2
<b>CO01</b> <b>CI33</b>	Main unit of communication address 3 1: Input error in main unit of communication address 3 0: Input normal in main unit of communication address 3
<b>CO01</b> <b>CI49</b>	Main unit of communication address 4 1: Input error in main unit of communication address 4 0: Input normal in main unit of communication address 4
<b>CF01</b>	1: Communication time-out in main unit of communication address 1 0: Communication normal in main unit of communication address 1
<b>CF02</b>	1: Communication time-out in main unit of communication address 2 0: Communication normal in main unit of communication address 2
<b>CF03</b>	1: Communication time-out in main unit of communication address 3 0: Communication normal in main unit of communication address 3
<b>CF04</b>	1: Communication time-out in main unit of communication address 4 0: Communication normal in main unit of communication address 4

- Parameter registers and control registers

Symbol	Description
<b>S.R</b>	1: Stop program control; 0: Start program control
<b>R.L_L1</b>	1: REMOTE; 0: LOCAL
<b>ADERR</b>	1: ADC error of PV input, 0: normal
<b>BOERR</b>	1: PV input burnout error, 0: normal
<b>RSP_CTL</b>	Control RSP input

- DAT registers

Symbol	Set value	Description
<b>DAT02_B</b>	0	Segment number
<b>DAT03_B</b>	0.00	CSP
<b>DAT04_B</b>		Elapsed time (1-second increment)
<b>DAT07</b>		Target setpoint of previous segment
<b>DAT08</b>		Target setpoint (TSP)
<b>DAT09</b>		Segment time
<b>DAT10</b>		Work data 1
<b>DAT11</b>		Work data 2

- M relays

Symbol	Set value	Description
<b>M01</b>		Master-slave communication input status 0: Normal, 1: Abnormal
<b>M02</b>		Forced stop by contact input, or master-slave communication input status 0: Normal, 1: Abnormal
<b>M03</b>		Segment end flag 0: Running within a segment interval 1: Segment end (for one scan only)
<b>M04</b>		Slave main unit communication error flag. Start a timer when this value changes to 1 for time-out monitoring.
<b>M11</b>		ADC error or burnout error in master main unit
<b>M03_B</b>		Flag used to delay the mode switching from Remote to Local by one scan
<b>M02_B</b>		Single-segment interval timeout
<b>M01_B</b>		1: Program running 0: Program stopped

**Contact input:**

DI2: Start/stop program control

**Setting of slave units (identical for all units)**

**Parameter settings (main unit)**

- Control mode (CTLM): SGL (Single-loop control)
- Input sampling period (control period) (SMP): 200 ms
- STOP/RUN switch (S/R): 0 (disable switching by a contact input)
- REMOTE/LOCAL switch (R/L): 0 (disable switching by a contact input)

**Burnout connection setting**

- LOOP1 PV: PV, LOOP1 RSP: RSP

**Burnout connection setting**

- K constant

Symbol	Set value	Description
<b>K01</b>	0.2	Control period at 200 ms, for program time span calculation
<b>K02</b>	4	Number of program pattern segments
<b>K03</b>	7	Slave main unit communication time-out interval (added to the time-out interval CF)

**Devices used**

- Registers for peer-to-peer communication

Symbol	Symbol	Description
<b>CO01</b>	<b>CI01</b>	Main unit of communication address 1 1: Start program operation (LOCAL -> REMOTE) 0: Stop program operation (REMOTE -> LOCAL)
<b>CY01</b>	<b>CX01</b>	Main unit of communication address 1 Programmed setpoint (CSP) output/input
<b>CO01</b>	<b>CI17</b>	Main unit of communication address 2 1: Input error in main unit of communication address 2 0: Input normal in main unit of communication address 2
<b>CO01</b>	<b>CI33</b>	Main unit of communication address 3 1: Input error in main unit of communication address 3 0: Input normal in main unit of communication address 3
<b>CO01</b>	<b>CI49</b>	Main unit of communication address 4 1: Input error in main unit of communication address 4 0: Input normal in main unit of communication address 4
	<b>CF01</b>	1: Communication time-out in main unit of communication address 1 0: Communication normal in main unit of communication address 1

- M relays

Symbol	Set value	Description
<b>M01</b>		Master-slave communication input status 0: Normal, 1: Abnormal
<b>M03_B</b>		Flag used to delay the mode switching from Remote to Local by one scan
<b>M01_B</b>		1: Program running 0: Program stopped

- Parameter registers and control registers

Symbol	Description
<b>S.R</b>	1: Stop program control; 0: Start program control
<b>R.L_L1</b>	1: REMOTE; 0: LOCAL
<b>ADERR</b>	1: ADC error of PV input, 0: normal
<b>BOERR</b>	1: PV input burnout error, 0: normal
<b>RSP_CTL</b>	Control RSP input

Ladder program in master main unit

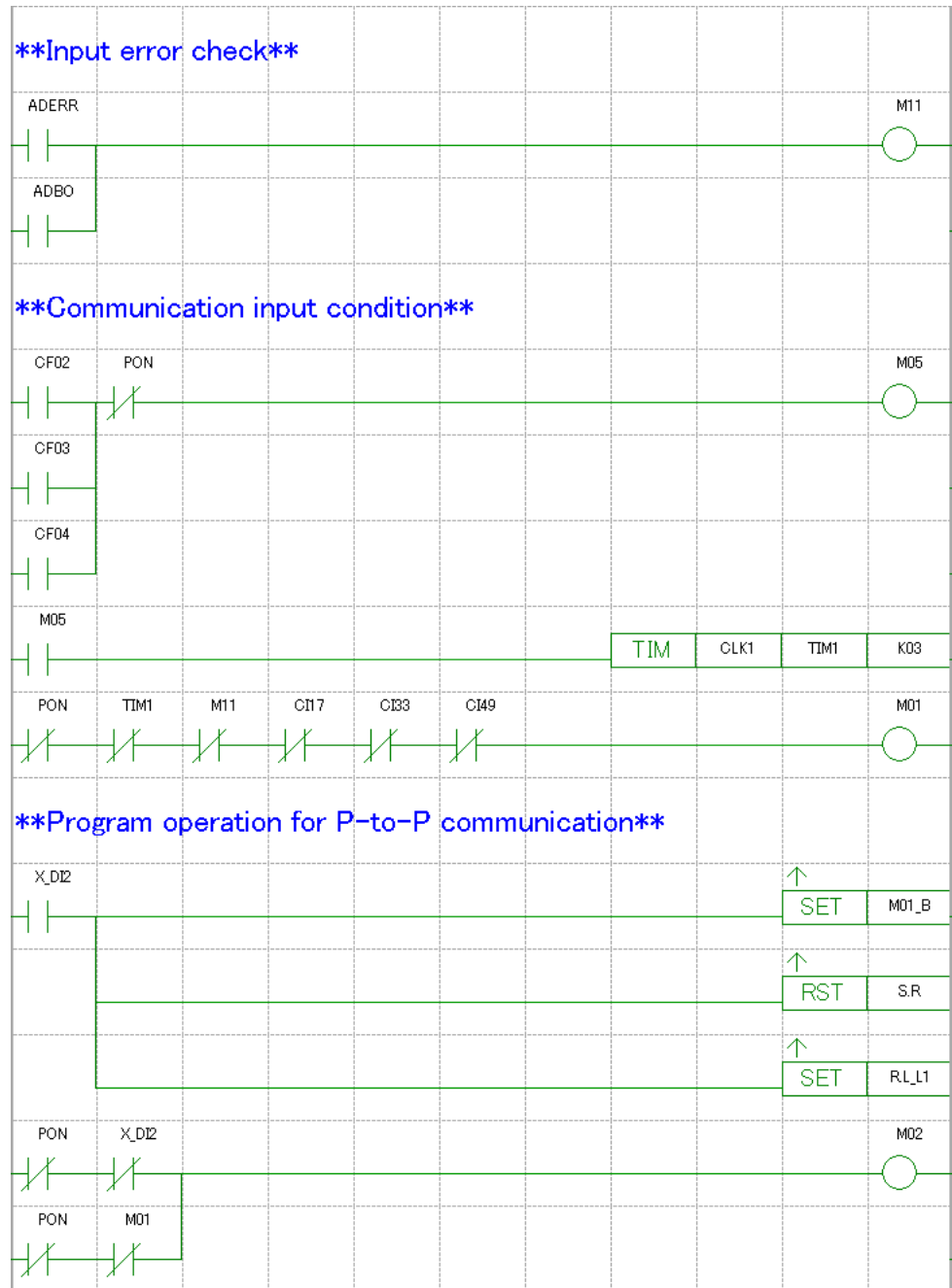

## 5.4 Peer-to-peer Communication

(continuing)

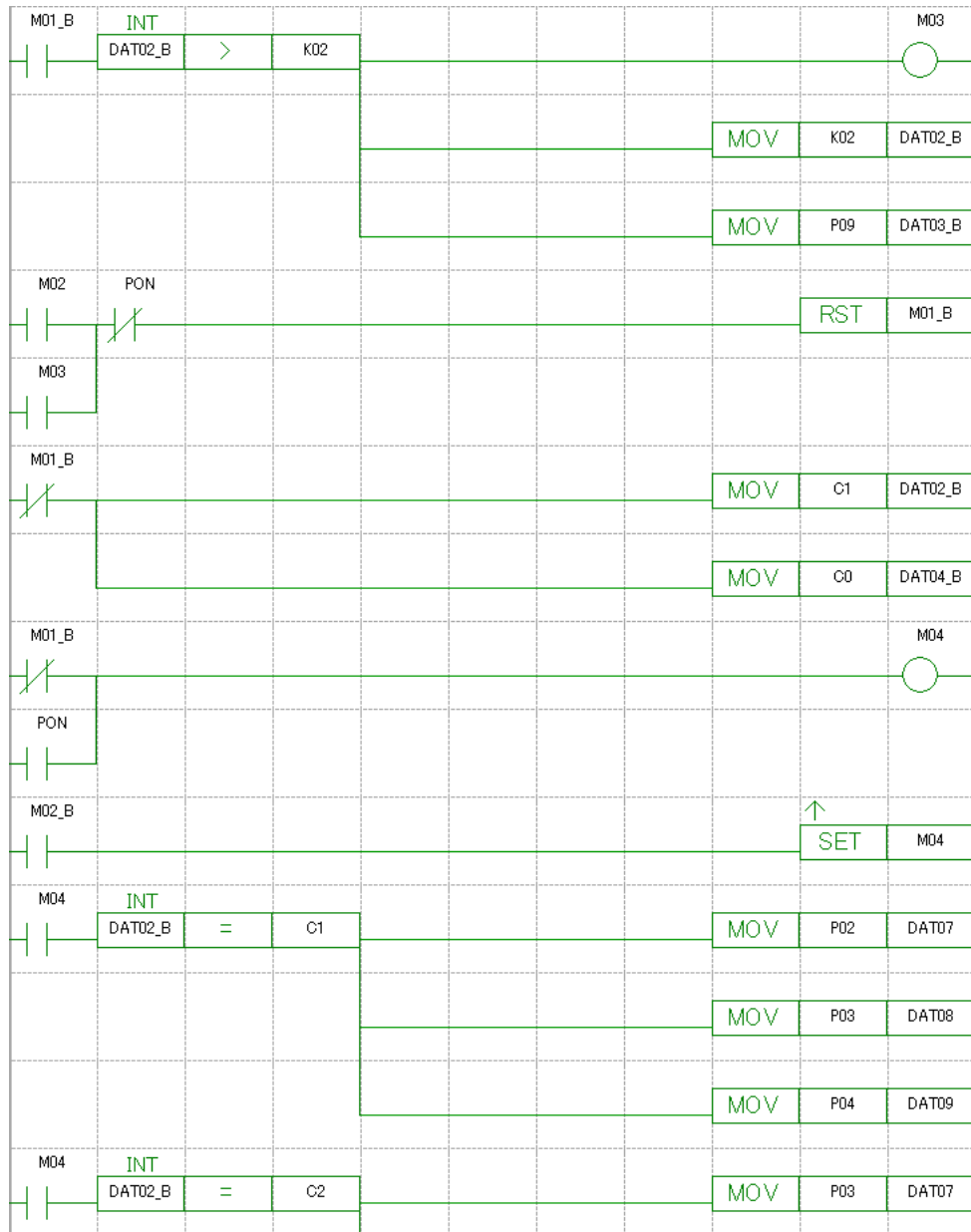





## 5.4 Peer-to-peer Communication

(continuing)

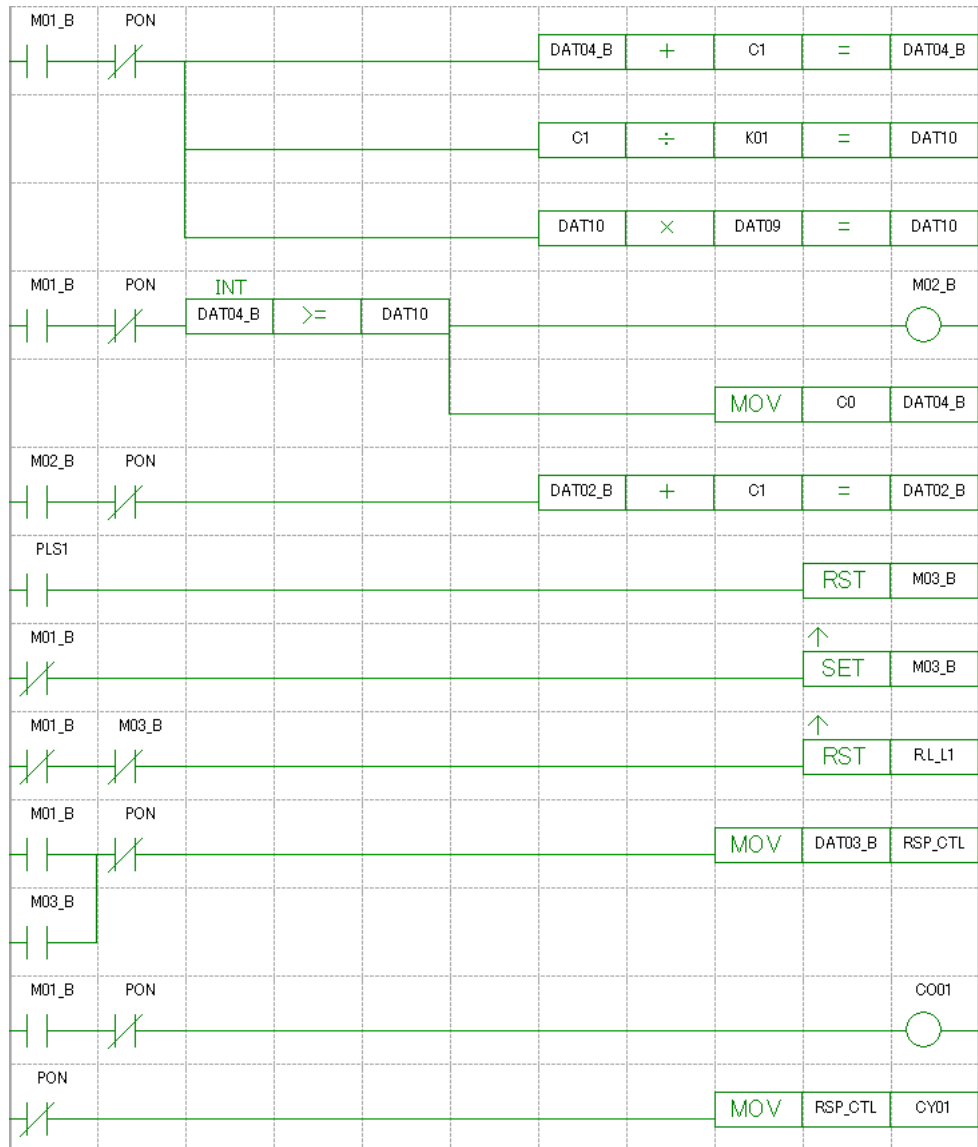

Ladder program of slave main units

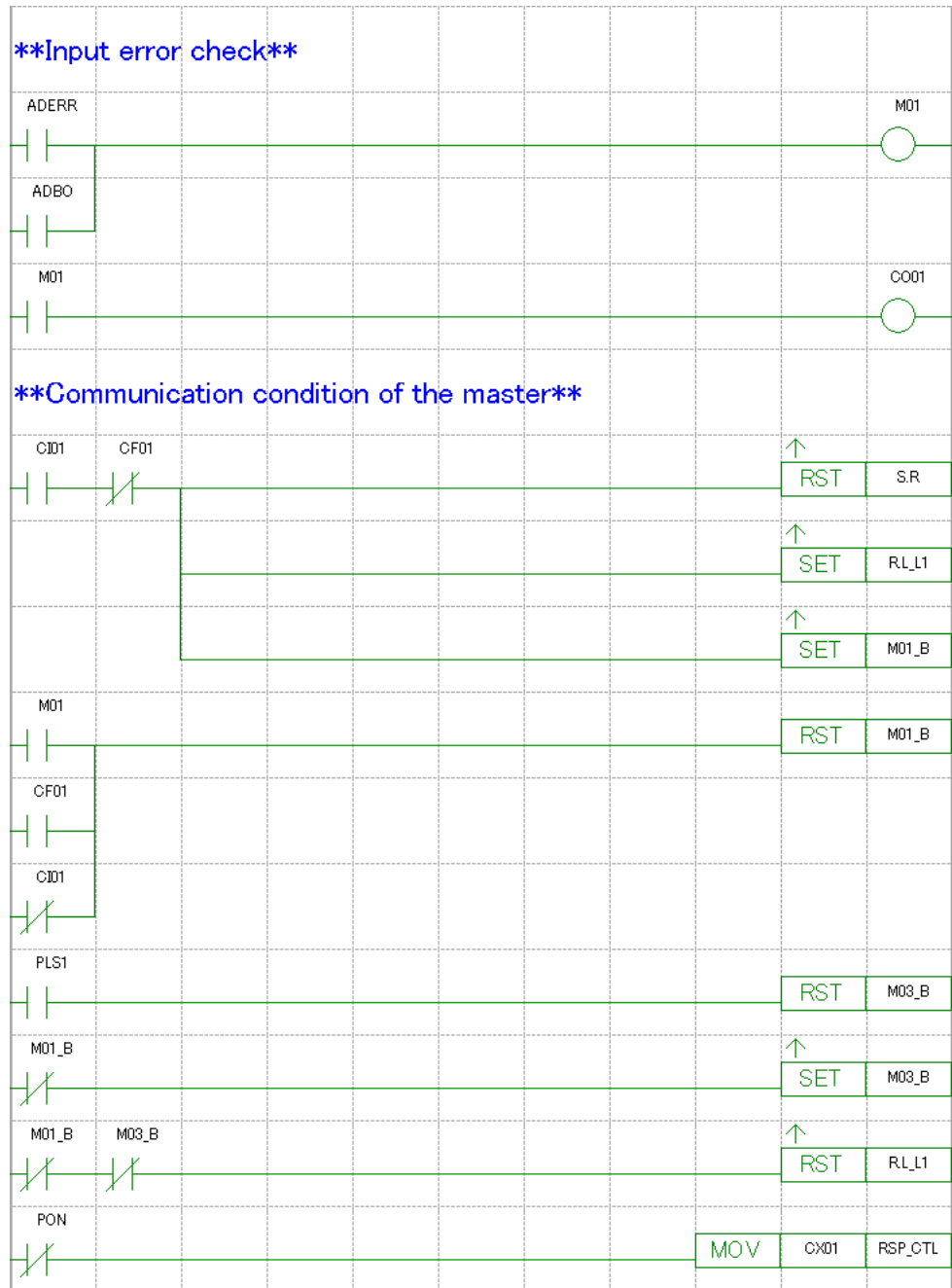

## 5.5 Extension Method of Control Input Combination

The description in this section applies to UT75A/UT55A/UT52A/UP55A only.

### 5.5.1 Using Four-wired RTD as PV (Example of using UT55A)

The following example shows interchanging the connection of a PV input terminal and RSP input terminal using the ladder in Single-loop control. (On the UT75A, the RSP input terminal in the following figure is the PV2 input terminal.) The parameter RTD.S must needs to set to 4-W.

For Detailed model, for the case where the input of the optional suffix code "/U1" is used as the PV.

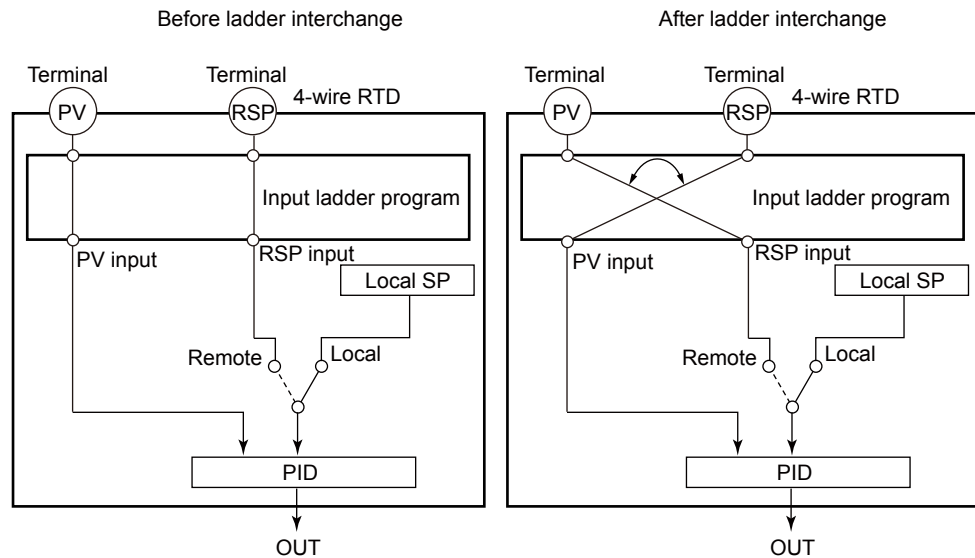

If the PV and RSP terminal inputs are interchanged with each other, it is also necessary to change the burnout connection settings.

► Burnout connection settings: [Section 3.5.10, Setting a Burnout Connection](#)

### Input ladder calculation program

Input registers	X_PV, X_RSP, X_AIN2
Parameter registers	SH_E2_R, SL_E2_R
Output registers	PVIN_CTL, RSP_CTL, FF_CTL

For an explanation of the registers, see [Section 4.2, Registers](#).

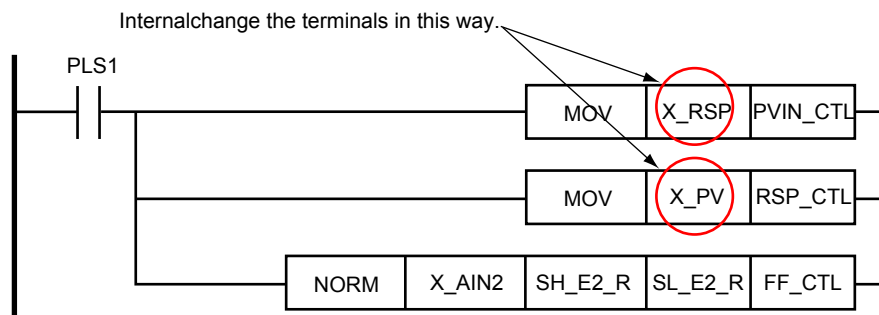

### Output ladder calculation program

The output ladder calculation program is the same as that of Single-loop control.

## 5.5.2 Build the Loop-2 RSP of Cascade Control Using the Ladder Program (Example for UT55A)

To capture the Loop-2 RSP via an analog input, build the function using the ladder program. This section describes an example to use AIN4 aux. analog input. AIN4 aux. analog input can be used when the suffix code: Type 2 = 7.

For Detailed model, AIN4 auxiliary analog input is for the controller with the optional suffix code "/A4" or "/AC4."

Change the default ladder program for Cascade control as follows.

### Input ladder calculation program

Input registers	X_PV, X_RSP, X_AIN2, X_AIN4
Output registers	PVIN_CTL, PV2IN_CTL, RSP_CTL, RSP2_CTL

For an explanation of the registers, see Section 4.2, Registers.

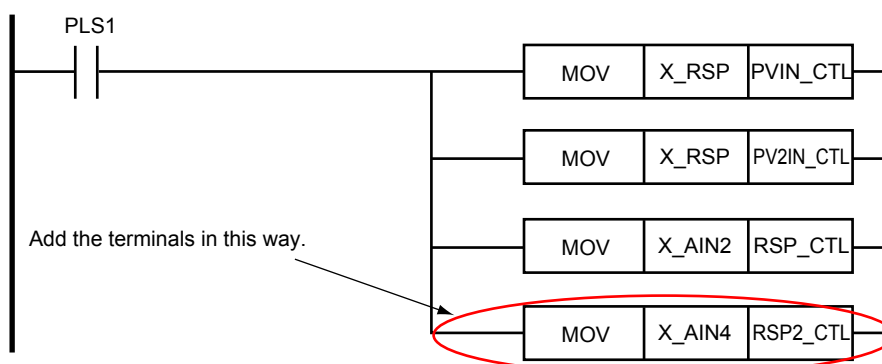

### Output ladder calculation program

Do not change it.

### 5.5.3 Build the Feedforward Control Using the Ladder Program (Example for UT55A)

To use Feedforward control, use the prebuild Feedforward control (AIN2 aux. analog input) or any aux. analog input.

Feedforward control is available when the control mode is Single-loop control or Loop control with PV-hold function.

- ▶ [Feedforward Control: Section 8.2.8, Feedforward Control, of the UT55A/UT52A Digital Indicating Controllers User's Manual](#)
- ▶ [Feedforward Control: Section 8.2.8, Feedforward Control, of the UT75A Digital Indicating Controllers User's Manual](#)

To use any aux. analog input, build the function using the ladder program.

This section describes an example to use AIN4 aux. analog input as feedforward input.

AIN4 aux. analog input can be used when the suffix code: Type 2 = 7.

For Detailed model:

AIN2 auxiliary analog input is for the specification with the optional suffix code "/A2".

AIN4 auxiliary analog input is for the specification with the optional suffix code "/A4" or "/AC4."

Change the default ladder program for Single-loop control as follows.

#### Input ladder calculation program

Input registers	X_PV, X_RSP, X_AIN4
Parameter registers	SH_E4_R, SL_E4_R
Output registers	PVIN_CTL, RSP_CTL, FF_CTL

For an explanation of the registers, see Section 4.2, Registers.

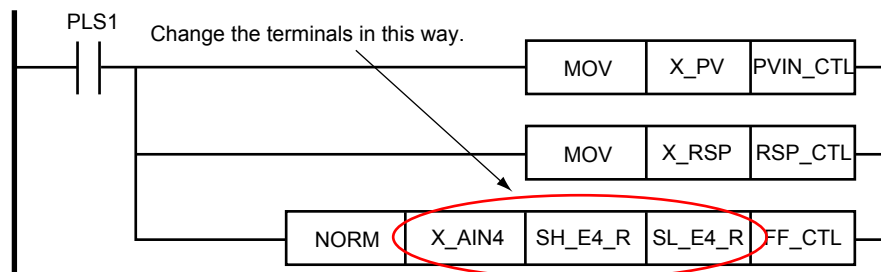

#### Output ladder calculation program

Do not change it.

# 6.1 Creating Flow

The profile creating guide describes how to set connection device, setting the profile, downloading, uploading, file management, printing, etc. For Open Network communication functions, see UTAdvanced Series Communication Interface (Open Network) User's Manual.

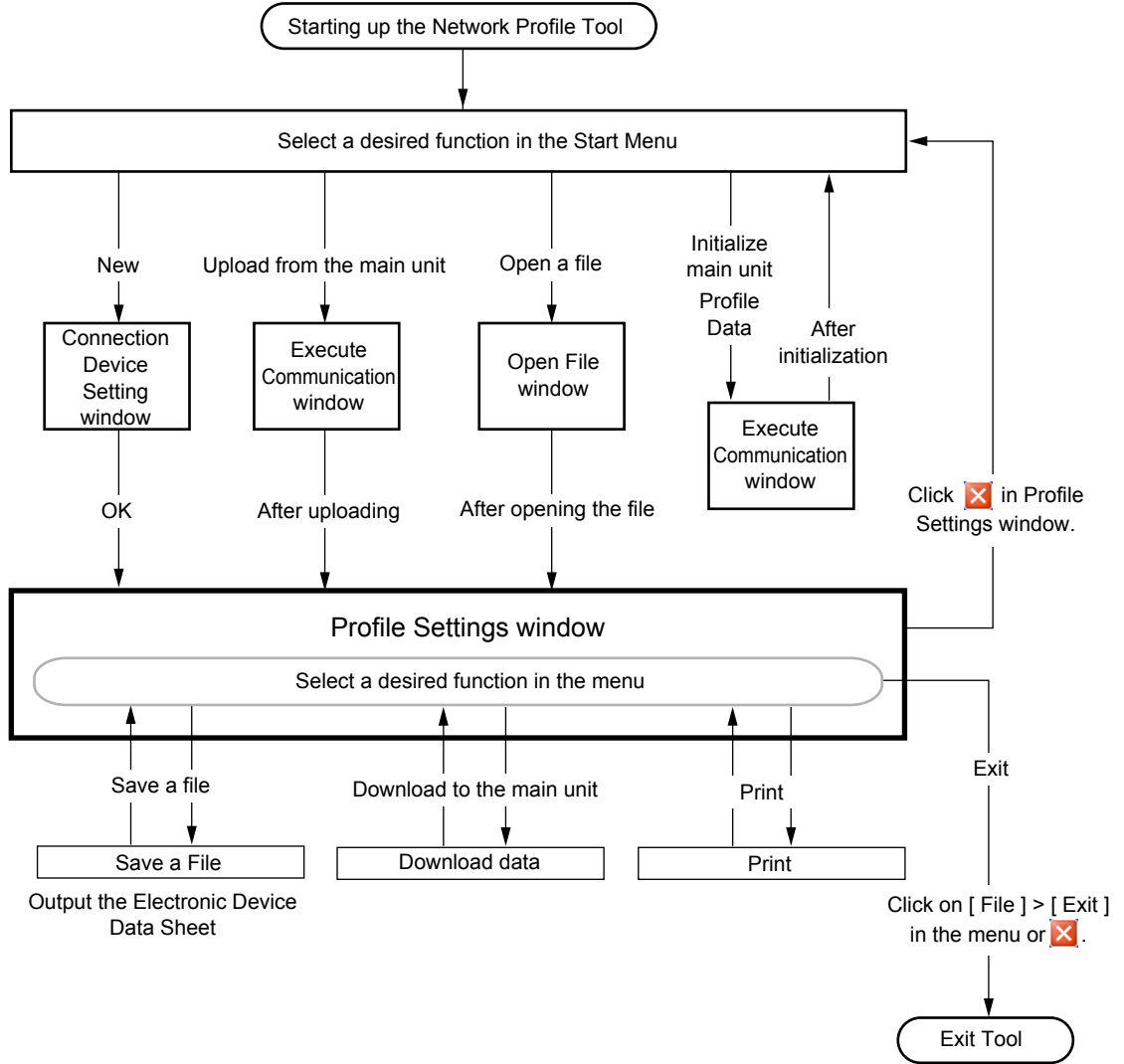

## 6.2 Starting up/Exiting the Network Profile Tool

### Starting up the Network Profile Tool

#### Procedure

1. For Windows 11, click on Windows' [Start] menu, select [All apps] - [UTAdvanced], and then click on [Network Profile Tool].  
For Windows 10, Apps in the Windows Start menu - [UTAdvanced], and then click on [Network Profile Tool].  
For Windows 8.1, click on Windows' [Start] menu, select [All Programs] - [UTAdvanced], and then click on [Network Profile Tool].

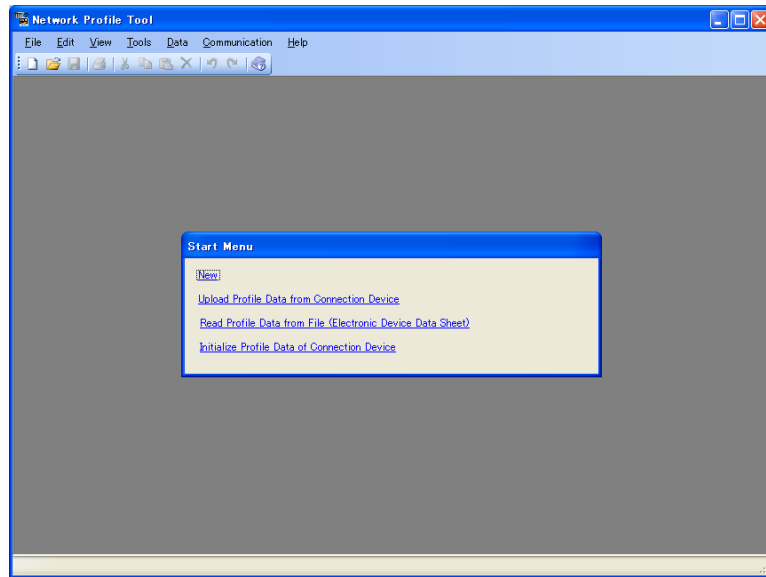

2. Select a desired function in the Start Menu.
  - New  
Enables you to create a new profile.  
Enables you to configure the connection device settings and profile settings, respectively.
  - Upload Profile Data from Connection Device  
Enables you to read out and edit data from the main unit.
  - Read Profile Data from File (Electronic Device Data Sheet)  
Enables you to open and edit an existing user file.
  - Initialize Profile Data of Connection Device  
See 6.12 Initializing the main unit's Profile Data

The Network Profile Tool can also be started up by double-clicking on the Network Profile Tool shortcut on the Desktop.

### Exiting the Network Profile Tool

#### Procedure

1. Click on [File] – [Exit] in the menu or click .

#### Note

Save the current editing file as necessary.

## 6.3 Part Names of Window and Their Functions

### Basic window

The Basic window is a background window for connection device settings, profile settings etc.

The window below shows an example display of the Profile Settings window.

### PROFIBUS-DP/DeviceNet

Window Title: Network Profile Tool - [ File Name ]

Toolbar

Menu

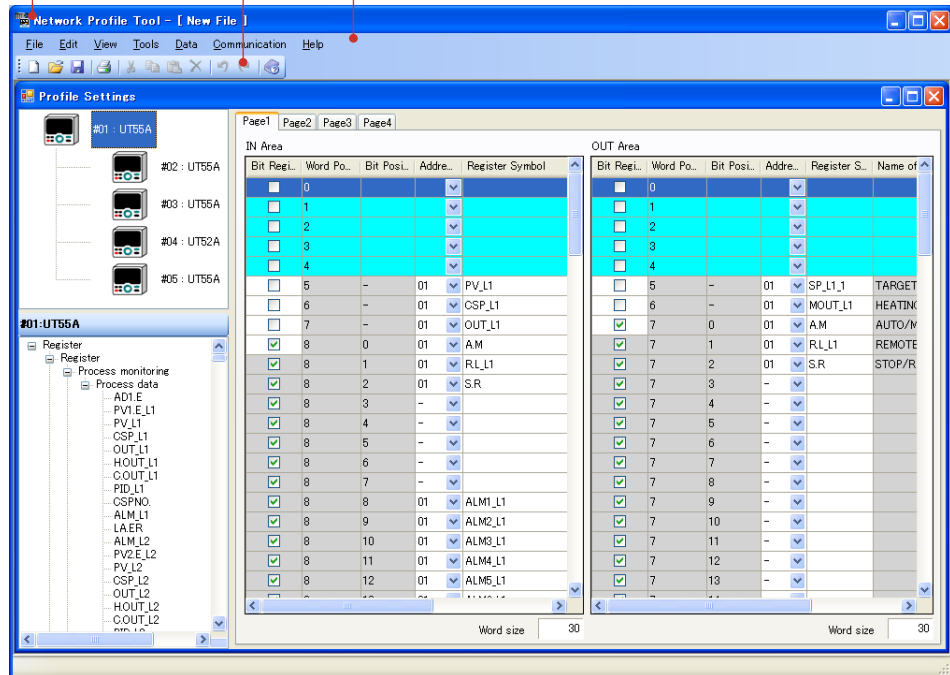

### CC-Link

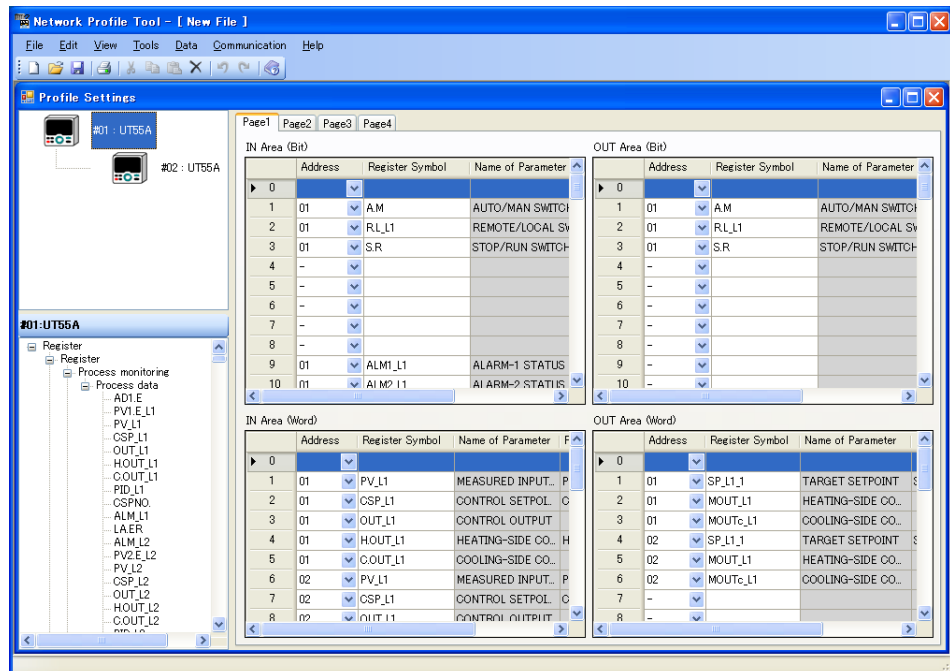



### 6.3 Part Names of Window and Their Functions

#### Connection Device Settings window

This is a window that enables you to set the device information for the open network slave/Modbus master device and Modbus slave devices.

PROFIBUS-DP/DeviceNet

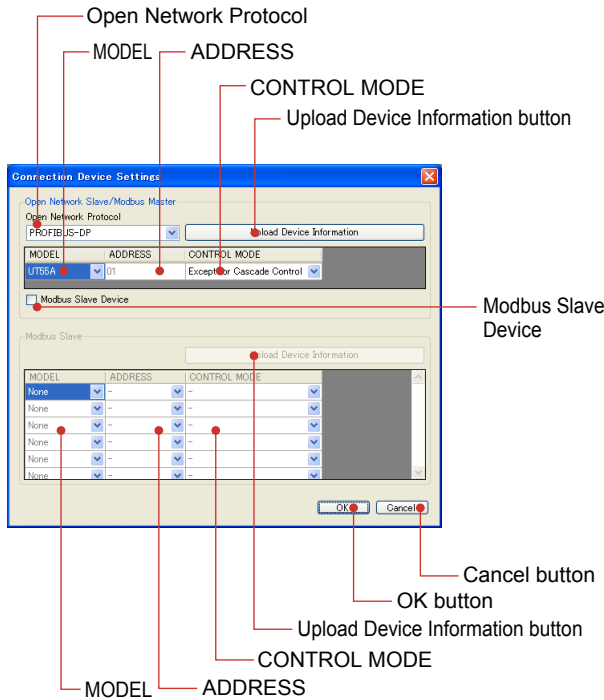

CC-Link

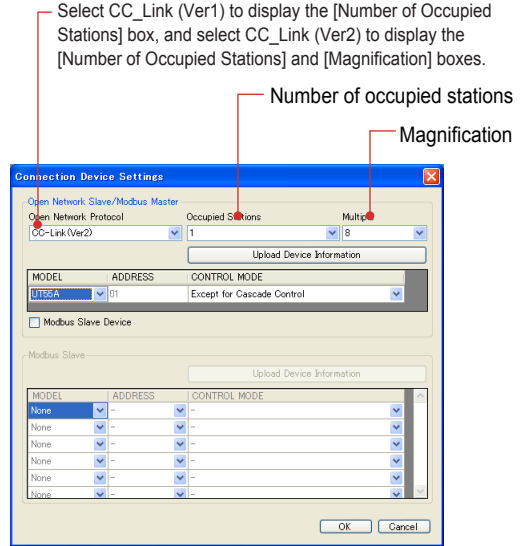

Name		Specifications
Open Network Slave/Modbus Master Device	Open Network Protocol	Select the open network protocol. PROFIBUS-DP, DeviceNet, CC-Link (Ver1), and CC-Link (Ver2)  When CC-Link (Ver1) or CC-Link (Ver2) is selected, select the number of occupied stations and the magnification. CC-Link (Ver1): number of occupied stations (3 or 4) CC-Link (Ver2): number of occupied stations (1 or 2) and magnification (8)
	Upload Device Information button	Connecting the open network slave/Modbus master device and clicking this button in a communication state loads the device information such as the model and control mode.
	MODEL	Displays UT55A. Select UT75A, UT55A, UT35A, UP55A or UP35A. When CC-Link (Ver1 or Ver2) Select UT75A, UT55A, UT52A, UT35A, UT32A, UP55A, UP35A, UP32A or UM33A.
	ADDRESS	Fixed to 01. This is a Modbus/RTU communication address. There is no parameter in the main unit.
	CONTROL MODE	Enables you to select the control mode. <ul style="list-style-type: none"> <li>Except for Cascade Control and Dual-loop control: Single-loop control, Cascade primary-loop control, Cascade secondary-loop control, Loop control for backup, Loop control with PV switching, Loop control with PV auto-selector, Loop control with PV-hold function</li> <li>Cascade Control: Cascade control</li> <li>Dual-loop Control: Dual-loop control</li> </ul> The default for the area setting is determined by the control mode when creating a new profile. (See Area Setting for Data Part in Each Control Mode [Default]) ► See "Area Setting for Data Part in Each Control Mode (Default)"

Name		Specifications
Modbus Slave Device	Modbus Slave Device	Select the checkbox when connecting Modbus slave devices.
	Upload Device Information button	Connecting Modbus slave devices and clicking this button in a communication state loads the device information such as the model, address, and control mode.
	MODEL	Enables you to select UT75A, UT55A, UT52A, UT35A, UT32A, UP55A, UP35A, Up32A, UT32D (UT32-D) or None.
	ADDRESS	This is a Modbus/RTU communication address. Enables you to select from 02 to 30. Duplicate addresses cannot be selected.
	CONTROL MODE	Enables you to select the control mode. <ul style="list-style-type: none"> <li>• Except for Cascade Control and Dual-loop control: Single-loop control, Cascade primary-loop control, Cascade secondary-loop control, Loop control for backup, Loop control with PV switching, Loop control with PV auto-selector, Loop control with PV-hold function</li> <li>• Cascade Control: Cascade control</li> <li>• Dual-loop Control: Dual-loop control</li> </ul> The default for the area setting is determined by the control mode when creating a new profile. (See Area Setting for Data Part in Each Control Mode [Default]) ► See "Area Setting for Data Part in Each Control Mode (Default)"
[OK] button		Clicking the [OK] button displays the Profile Settings window according to the setting details.
[Cancel] button		Clicking the [Cancel] button closes the Connection Device Settings window.

### 6.3 Part Names of Window and Their Functions

#### Area Setting for Data Part in Each Control Mode (Default)

##### Example of PROFIBUS-DP: UT35A/UT32A (For Single Model)

Page	IN area PROFIBUS-DP slave (UTAdvanced) → PROFIBUS-DP master			OUT area PROFIBUS-DP master → PROFIBUS-DP slave (UTAdvanced)		
	Data Format	Register Symbol	Name of Parameter	Data Format	Register Symbol	Name of Parameter
1	Word	PV_L1	Measurement value	Word		
		CSP_L1	Control setpoint		SP_L1_1	Target setpoint of group 1
		OUT_L1	Control output (Valve opening in Position proportional control)		MOUT_L1	Control output in MAN mode (Heatingside)
		H.OUT_L1	Heating-side control output			
		C.OUT_L1	Cooling-side control output		MOUTc_L1	Cooling-side control output in MAN mode
	Bit	A.M	AUTO/MAN switch	Bit	A.M	AUTO/MAN switch
		R.L_L1	REMOTE/LOCAL switch		R.L_L1	REMOTE/LOCAL switch
		S.R	STOP/RUN switch		S.R	STOP/RUN switch
		ALM1_L1	Alarm-1 status			
		ALM2_L1	Alarm-2 status			
2	Word	P_L1_1	Proportional band of group 1	Word	P_L1_1	Proportional band of group 1
		I_L1_1	Integral time of group 1		I_L1_1	Integral time of group 1
		D_L1_1	Derivative time of group 1		D_L1_1	Derivative time of group 1
		SPNO.	SP number selection		SPNO.	SP number selection
3	Word	Pc_L1_1	Cooling-side proportional band of group 1	Word	Pc_L1_1	Cooling-side proportional band of group 1
		Ic_L1_1	Cooling-side integral time of group 1		Ic_L1_1	Cooling-side integral time of group 1
		Dc_L1_1	Cooling-side derivative time of group 1		Dc_L1_1	Cooling-side derivative time of group 1
		SPNO.	SP number selection		SPNO.	SP number selection
4	Word	A1_L1_1	Alarm-1 setpoint of group 1	Word	A1_L1_1	Alarm-1 setpoint of group 1
		A2_L1_1	Alarm-2 setpoint of group 1		A2_L1_1	Alarm-2 setpoint of group 1
		A3_L1_1	Alarm-3 setpoint of group 1		A3_L1_1	Alarm-3 setpoint of group 1
		A4_L1_1	Alarm-4 setpoint of group 1		A4_L1_1	Alarm-4 setpoint of group 1

**Note**

UT35A/UT32A/UP35A/UP32A don't have the CONTROL MODE. Select "-" for the CONTROL MODE in Connection Device Settings window.

## Area Setting for Data Part in Each Control Mode (Default)

Example of PROFIBUS-DP:

Other than UT55A/UT52A Cascade Control (for One Model)

Page	IN area PROFIBUS-DP slave (UTAdvanced) → PROFIBUS-DP master			OUT area PROFIBUS-DP master → PROFIBUS-DP slave (UTAdvanced)		
	Data Format	Register Symbol	Name of Parameter	Data Format	Register Symbol	Name of Parameter
1	Word	PV_L1	Measurement value	Word		
		CSP_L1	Control setpoint		SP_L1_1	Target setpoint of group 1
		OUT_L1	Control output (Valve opening in Position proportional control)		MOUT_L1	Control output in MAN mode (Heating-side)
		H.OUT_L1	Heating-side control output			
		C.OUT_L1	Cooling-side control output		MOUTc_L1	Cooling-side control output in MAN mode
	Bit	A.M	AUTO/MAN switch	Bit	A.M	AUTO/MAN switch
		R.L_L1	REMOTE/LOCAL switch		R.L_L1	REMOTE/LOCAL switch
		S.R	STOP/RUN switch		S.R	STOP/RUN switch
		ALM1_L1	Alarm-1 status			
		ALM2_L1	Alarm-2 status			
		ALM3_L1	Alarm-3 status			
		ALM4_L1	Alarm-4 status			
		ALM5_L1	Alarm-5 status			
	ALM6_L1	Alarm-6 status				
ALM7_L1	Alarm-7 status					
ALM8_L1	Alarm-8 status					
2	Word	P_L1_1	Proportional band of group 1	Word	P_L1_1	Proportional band of group 1
		I_L1_1	Integral time of group 1		I_L1_1	Integral time of group 1
		D_L1_1	Derivative time of group 1		D_L1_1	Derivative time of group 1
		SPNO.	SP number selection		SPNO.	SP number selection
3	Word	Pc_L1_1	Cooling-side proportional band of group 1	Word	Pc_L1_1	Cooling-side proportional band of group 1
		Ic_L1_1	Cooling-side integral time of group 1		Ic_L1_1	Cooling-side integral time of group 1
		Dc_L1_1	Cooling-side derivative time of group 1		Dc_L1_1	Cooling-side derivative time of group 1
		SPNO.	SP number selection		SPNO.	SP number selection
4	Word	A1_L1_1	Alarm-1 setpoint of group 1	Word	A1_L1_1	Alarm-1 setpoint of group 1
		A2_L1_1	Alarm-2 setpoint of group 1		A2_L1_1	Alarm-2 setpoint of group 1
		A3_L1_1	Alarm-3 setpoint of group 1		A3_L1_1	Alarm-3 setpoint of group 1
		A4_L1_1	Alarm-4 setpoint of group 1		A4_L1_1	Alarm-4 setpoint of group 1
		A5_L1_1	Alarm-5 setpoint of group 1		A5_L1_1	Alarm-5 setpoint of group 1

### 6.3 Part Names of Window and Their Functions

Example of PROFIBUS-DP: UT55A/UT52A Cascade Control (for One Model)

Page	IN area PROFIBUS-DP slave (UTAdvanced) → PROFIBUS-DP master			OUT area PROFIBUS-DP master → PROFIBUS-DP slave (UTAdvanced)		
	Data Format	Register Symbol	Name of Parameter	Data Format	Register Symbol	Name of Parameter
1	Word	PV_L1	Loop-1 measurment value	Word		
		PV_L2	Loop-2 measurment value			
		CSP_L1	Loop-1 control setpoint		SP_L1_1	Loop-1 target setpoint of group 1
		CSP_L2	Loop-2 control setpoint		SP_L2_1	Loop-2 target setpoint of group 1
		C.A.M	CAS/AUTO/MAN switch		C.A.M	CAS/AUTO/MAN switch
		OUT_L2	Control output (Valve opening in Position proportional control)		MOU_T_L2	Control output in MAN mode (Heating-side)
		H.OUT_L2	Heating-side control output			
		C.OUT_L2	Cooling-side control output		MOU_Tc_L2	Cooling-side control output in MAN mode
	Bit	R.L_L1	REMOTE/LOCAL switch	Bit	R.L_L1	REMOTE/LOCAL switch
		S.R	STOP/RUN switch		S.R	STOP/RUN switch
		ALM1_L1	Loop-1 alarm-1 status			
		ALM2_L1	Loop-1 alarm-2 status			
		ALM3_L1	Loop-1 alarm-3 status			
		ALM4_L1	Loop-1 alarm-4 status			
		ALM5_L1	Loop-1 alarm-5 status			
		ALM6_L1	Loop-1 alarm-6 status			
		ALM7_L1	Loop-1 alarm-7 status			
		ALM8_L1	Loop-1 alarm-8 status			
		ALM1_L2	Loop-2 alarm-1 status			
		ALM2_L2	Loop-2 alarm-2 status			
ALM3_L2	Loop-2 alarm-3 status					
ALM4_L2	Loop-2 alarm-4 status					
ALM5_L2	Loop-2 alarm-5 status					
ALM6_L2	Loop-2 alarm-6 status					
ALM7_L2	Loop-2 alarm-7 status					
ALM8_L2	Loop-2 alarm-8 status					
2	Word	P_L1_1	Loop-1 Proportional band of group 1	Word	P_L1_1	Loop-1 Proportional band of group 1
		I_L1_1	Loop-1 Integral time of group 1		I_L1_1	Loop-1 Integral time of group 1
		D_L1_1	Loop-1 Derivative time of group 1		D_L1_1	Loop-1 Derivative time of group 1
		P_L2_1	Loop-2 Proportional band of group 1		P_L2_1	Loop-2 Proportional band of group 1
		I_L2_1	Loop-2 Integral time of group 1		I_L2_1	Loop-2 Integral time of group 1
		D_L2_1	Loop-2 Derivative time of group 1		D_L2_1	Loop-2 Derivative time of group 1
		SPNO.	SP number selection		SPNO.	SP number selection
3	Word	Pc_L1_1	Loop-1 Cooling-side proportional band of group 1	Word	Pc_L1_1	Loop-1 Cooling-side proportional band of group 1
		Ic_L1_1	Loop-1 Cooling-side integral time of group 1		Ic_L1_1	Loop-1 Cooling-side integral time of group 1
		Dc_L1_1	Loop-1 Cooling-side derivative time of group 1		Dc_L1_1	Loop-1 Cooling-side derivative time of group 1
		Pc_L2_1	Loop-2 Cooling-side proportional band of group 1		Pc_L2_1	Loop-2 Cooling-side proportional band of group 1
		Ic_L2_1	Loop-2 Cooling-side integral time of group 1		Ic_L2_1	Loop-2 Cooling-side integral time of group 1
		Dc_L2_1	Loop-2 Cooling-side derivative time of group 1		Dc_L2_1	Loop-2 Cooling-side derivative time of group 1
		SPNO.	SP number selection		SPNO.	SP number selection
4	Word	A1_L1_1	Loop-1 Alarm-1 setpoint of group 1	Word	A1_L1_1	Loop-1 Alarm-1 setpoint of group 1
		A2_L1_1	Loop-1 Alarm-2 setpoint of group 1		A2_L1_1	Loop-1 Alarm-2 setpoint of group 1
		A3_L1_1	Loop-1 Alarm-3 setpoint of group 1		A3_L1_1	Loop-1 Alarm-3 setpoint of group 1
		A4_L1_1	Loop-1 Alarm-4 setpoint of group 1		A4_L1_1	Loop-1 Alarm-4 setpoint of group 1
		A5_L1_1	Loop-1 Alarm-5 setpoint of group 1		A5_L1_1	Loop-1 Alarm-5 setpoint of group 1
		A1_L2_1	Loop-2 Alarm-1 setpoint of group 1		A1_L2_1	Loop-2 Alarm-1 setpoint of group 1
		A2_L2_1	Loop-2 Alarm-2 setpoint of group 1		A2_L2_1	Loop-2 Alarm-2 setpoint of group 1
		A3_L2_1	Loop-2 Alarm-3 setpoint of group 1		A3_L2_1	Loop-2 Alarm-3 setpoint of group 1
		A4_L2_1	Loop-2 Alarm-4 setpoint of group 1		A4_L2_1	Loop-2 Alarm-4 setpoint of group 1
		A5_L2_1	Loop-2 Alarm-5 setpoint of group 1		A5_L2_1	Loop-2 Alarm-5 setpoint of group 1

Example of PROFIBUS-DP: UT75A Dual-loop Control (for One Model)

Page	IN area PROFIBUS-DP slave (UTAdvanced) → PROFIBUS-DP master			OUT area PROFIBUS-DP master → PROFIBUS-DP slave (UTAdvanced)		
	Data Format	Register Symbol	Name of Parameter	Data Format	Register Symbol	Name of Parameter
1	Word	PV_L1	Loop-1 measurement value	Word		
		PV_L2	Loop-2 measurement value			
		CSP_L1	Loop-1 control setpoint		SP_L1_1	Loop-1 target setpoint of group 1
		CSP_L2	Loop-2 control setpoint		SP_L1_1	Loop-2 target setpoint of group 1
		OUT_L1	Loop-1 control output		MOUT_L1	Loop-1 control output in MAN mode (Heating-side)
		OUT_L2	Loop-2 control output		MOUT_L2	Loop-2 control output in MAN mode (Heating-side)
	Bit	A.M	Loop-1 AUTO/MAN switch	Bit	A.M	Loop-1 AUTO/MAN switch
		R.L_L1	Loop-1 REMOTE/LOCAL switch		R.L_L1	Loop-1 REMOTE/LOCAL switch
		S.R	Loop-1 STOP/RUN switch		S.R	Loop-1 STOP/RUN switch
		ALM1_L1	Loop-1 alarm-1 status			
		ALM2_L1	Loop-1 alarm-2 status			
		ALM3_L1	Loop-1 alarm-3 status			
		ALM4_L1	Loop-1 alarm-4 status			
		ALM5_L1	Loop-1 alarm-5 status			
		ALM6_L1	Loop-1 alarm-6 status			
		ALM7_L1	Loop-1 alarm-7 status			
		ALM8_L1	Loop-1 alarm-8 status			
		A.M_L2	Loop-2 AUTO/MAN switch	Bit	A.M_L2	Loop-2 AUTO/MAN switch
		R.L_L2	Loop-2 REMOTE/LOCAL switch		R.L_L2	Loop-2 REMOTE/LOCAL switch
		S.R_L2	Loop-2 STOP/RUN switch		S.R_L2	Loop-2 STOP/RUN switch
		ALM1_L2	Loop-2 alarm-1 status			
		ALM2_L2	Loop-2 alarm-2 status			
		ALM3_L2	Loop-2 alarm-3 status			
		ALM4_L2	Loop-2 alarm-4 status			
		ALM5_L2	Loop-2 alarm-5 status			
		ALM6_L2	Loop-2 alarm-6 status			
	ALM7_L2	Loop-2 alarm-7 status				
	ALM8_L2	Loop-2 alarm-8 status				
2	Word	P_L1_1	Loop-1 Proportional band of group 1	Word	P_L1_1	Loop-1 Proportional band of group 1
		I_L1_1	Loop-1 Integral time of group 1		I_L1_1	Loop-1 Integral time of group 1
		D_L1_1	Loop-1 Derivative time of group 1		D_L1_1	Loop-1 Derivative time of group 1
		SPNO.	SP number selection		SPNO.	SP number selection
		P_L2_1	Loop-2 Proportional band of group 1		P_L2_1	Loop-2 Proportional band of group 1
		I_L2_1	Loop-2 Integral time of group 1		I_L2_1	Loop-2 Integral time of group 1
		D_L2_1	Loop-2 Derivative time of group 1		D_L2_1	Loop-2 Derivative time of group 1
4	Word	A1_L1_1	Loop-1 Alarm-1 setpoint of group 1	Word	A1_L1_1	Loop-1 Alarm-1 setpoint of group 1
		A2_L1_1	Loop-1 Alarm-2 setpoint of group 1		A2_L1_1	Loop-1 Alarm-2 setpoint of group 1
		A3_L1_1	Loop-1 Alarm-3 setpoint of group 1		A3_L1_1	Loop-1 Alarm-3 setpoint of group 1
		A4_L1_1	Loop-1 Alarm-4 setpoint of group 1		A4_L1_1	Loop-1 Alarm-4 setpoint of group 1
		A5_L1_1	Loop-1 Alarm-5 setpoint of group 1		A5_L1_1	Loop-1 Alarm-5 setpoint of group 1
		A1_L2_1	Loop-2 Alarm-1 setpoint of group 1		A1_L2_1	Loop-2 Alarm-1 setpoint of group 1
		A2_L2_1	Loop-2 Alarm-2 setpoint of group 1		A2_L2_1	Loop-2 Alarm-2 setpoint of group 1
		A3_L2_1	Loop-2 Alarm-3 setpoint of group 1		A3_L2_1	Loop-2 Alarm-3 setpoint of group 1
		A4_L2_1	Loop-2 Alarm-4 setpoint of group 1		A4_L2_1	Loop-2 Alarm-4 setpoint of group 1
		A5_L2_1	Loop-2 Alarm-5 setpoint of group 1		A5_L2_1	Loop-2 Alarm-5 setpoint of group 1

### 6.3 Part Names of Window and Their Functions

---

#### **IN area**

This is an area for a PLC to refer to the slave data. Parameters of the open network and Modbus slaves that are defined in the profile are always updated.

#### **OUT area**

This is an area for a PLC to rewrite the slave parameters. When the OUT area is rewritten, the corresponding parameters of the open network and Modbus slaves are also rewritten.

### Profile Settings window (PROFIBUS-DP/DeviceNet)

This is a window that enables you to set the profile.

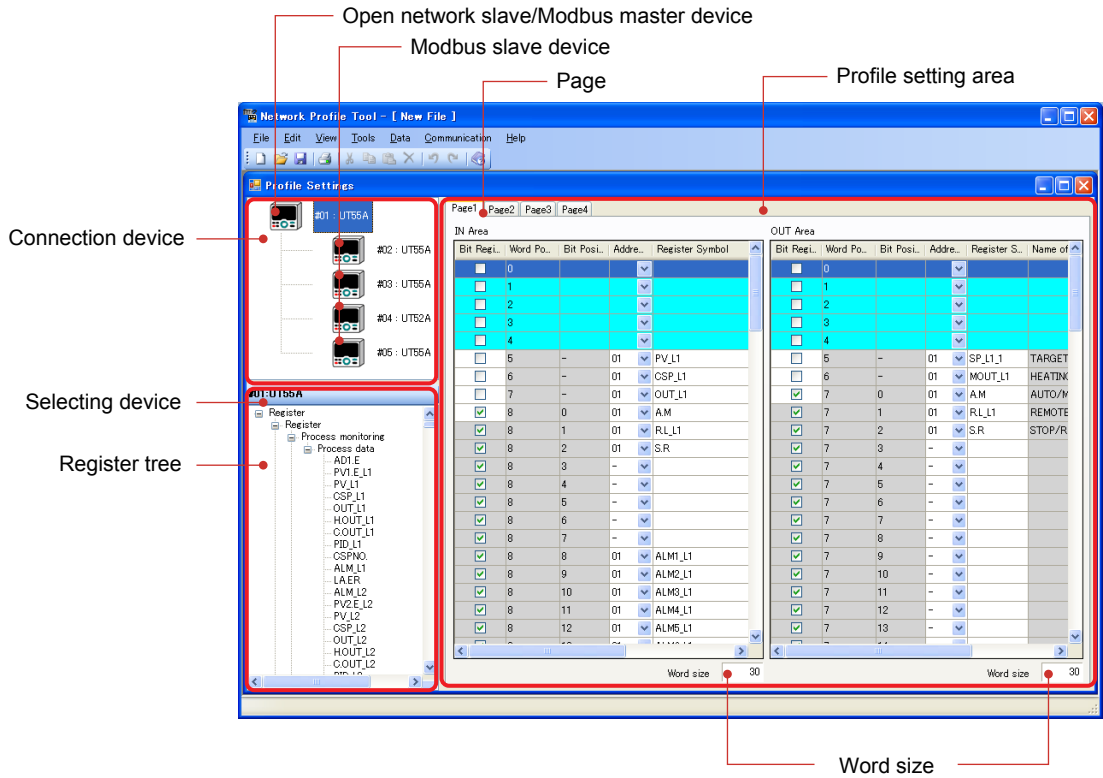

#### Profile setting area (Example of IN area)

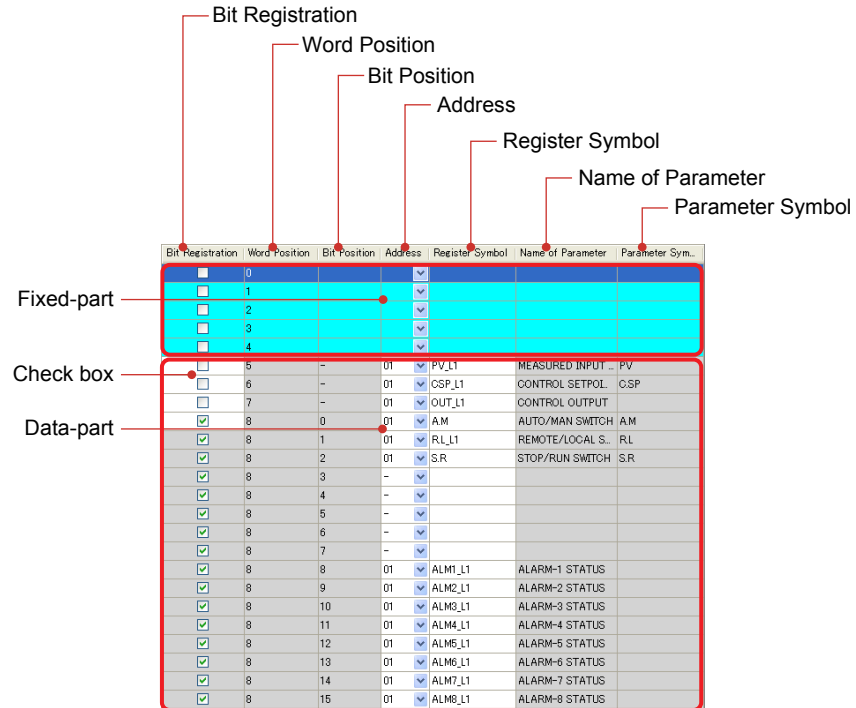



### 6.3 Part Names of Window and Their Functions

#### Profile Settings window (CC-Link)

This is a window that enables you to set the profile.

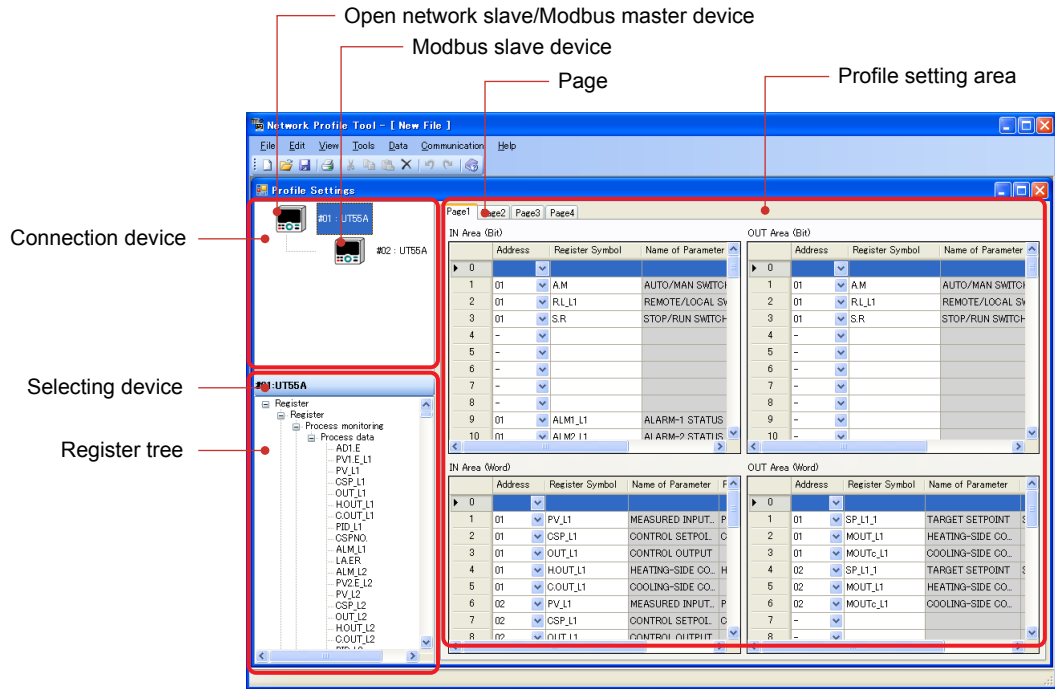

#### Profile setting area (Example of IN area, bit data)

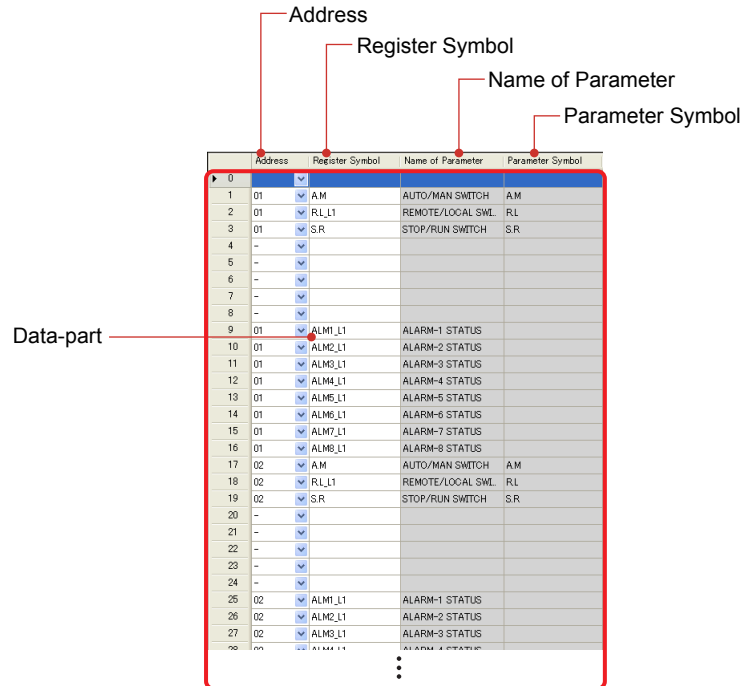

Name	Specifications
Connection device	<p>Connection devices are displayed on the left in the Profile Settings window. They can be displayed and hidden.</p> <p>The device configuration set in the Connection Device Settings window is displayed.</p> <p>Clicking on the connection device switches to the display of the register tree for the device.</p>
Open network slave/Modbus master device	This is a diagram for the device with address 01.
Modbus slave device	This is a diagram for the devices with addresses 02 to 32.
Register tree	<p>The register tree is displayed on the left in the Profile Settings window. It can be displayed and hidden. It is used when creating the profile.</p> <p>To register a parameter, drag the register and drop it on the table (in the white area) for the profile.</p> <p>Right-clicking on the register tree enables you to select Expand or Collapse in the shortcut menu. When the register tree is expanded, a desired register can be searched for by keyboard input.</p> <p>More information on the register classification is described later in this page.</p>
Selecting device	<p>Displays the model and address for the device that is clicked in Connection device.</p> <p>Example: #02: UT55A (UT55A with Modbus/RTU communication address 02)</p>
Profile setting area	<p>The profile setting area consists of an IN Area, OUT Area, and Pages 1 to 4.</p> <p>Displays the details according to the connection device settings.</p> <p>Data can be set in the white cells and cannot be set in the gray cells.</p>
Page	Parameters that are supposed to be frequently read/written are registered with Page 1 and parameters that are supposed to be less frequently read/written are registered with Pages 2 to 4 when creating a new profile. The number of pages is fixed.
Word size	<p>Displays the size for the area in the range of 5 to 122 words.</p> <p>Click on [Data] - [Set Word Size] in the menu.</p> <p>Specify the data for the profile by word size.</p> <p>The word size can be set in the IN and OUT areas, respectively. The word size is the same on each page.</p>
Bit Registration	<p>When the checkbox is unselected, the registered parameter is handled as word data.</p> <p>When the checkbox is selected, the parameter registered with each bit is handled as bit data.</p> <p>Selecting the [Bit Registration] checkbox when registered as word data deletes the content registered as word data.</p>
Word Position	Displays the word numbers from the top up to the set word size.
Bit Position	<p>When the [Bit Registration] checkbox is unselected, "-" is displayed.</p> <p>When the [Bit Registration] checkbox is selected, 0 to 15 (from 16 bits) is displayed.</p>
Address	<p>Sets the Modbus/RTU communication address for each device.</p> <p>Modbus master device: Fixed to 01.</p> <p>Modbus slave device: 02 to 32.</p>
Register Symbol	The register symbol for the parameter to register can be dragged from the register tree and dropped. The register symbol can also be directly input into the cell, or selected from the drop-down list.
Name of Parameter	Displays the parameter name.
Parameter Symbol	Displays the parameter symbol. Display is the same as that in the main unit.
Fixed-part	<p>The fixed part is an area for flags for received data valid, normal connection, rescan request, write request, batch write request, and so on. It is a fixed 5-word area. The details in the fixed part cannot be changed.</p> <p>Select [Display] in the menu and then select or deselect the [Display Fixed Part] checkbox to display or hide the fixed part. The fixed part is the same on each page.</p>
Data-part	<p>Enables you to register the UTAdvanced data.</p> <p>The data part can be used by switching the page</p>

### 6.3 Part Names of Window and Their Functions

Example of PROFIBUS-DP/DeviceNet: Details in the fixed part (same on each page)

IN area PROFIBUS-DP slave (UTAdvanced) → PROFIBUS-DP master			OUT area PROFIBUS-DP master → PROFIBUS-DP slave (UTAdvanced)		
Word position	Bit position	Contents of assignment	Word position	Bit position	Contents of assignment
0	0	Receive data valid	0	0	Rescan request
	1	During-write		1	(Reserved)
	2	Write acknowledgement		2	Write request
	3	(Reserved)		3	(Reserved)
	4	(Reserved)		4	(Reserved)
	5	(Reserved)		5	(Reserved)
	6	(Reserved)		6	(Reserved)
	7	(Reserved)		7	(Reserved)
	8	(Reserved)		8	(Reserved)
	9	(Reserved)		9	(Reserved)
	10	(Reserved)		10	(Reserved)
	11	(Reserved)		11	(Reserved)
	12	(Reserved)		12	(Reserved)
	13	(Reserved)		13	(Reserved)
	14	(Reserved)		14	(Reserved)
	15	(Reserved)		15	(Reserved)
1	0	Normal connection slave (address 01)	1	0	Batch write request (address 01)
	1	Normal connection slave (address 02)		1	Batch write request (address 02)
	2	Normal connection slave (address 03)		2	Batch write request (address 03)
	3	Normal connection slave (address 04)		3	Batch write request (address 04)
	4	Normal connection slave (address 05)		4	Batch write request (address 05)
	5	Normal connection slave (address 06)		5	Batch write request (address 06)
	6	Normal connection slave (address 07)		6	Batch write request (address 07)
	7	Normal connection slave (address 08)		7	Batch write request (address 08)
	8	Normal connection slave (address 09)		8	Batch write request (address 09)
	9	Normal connection slave (address 10)		9	Batch write request (address 10)
	10	Normal connection slave (address 11)		10	Batch write request (address 11)
	11	Normal connection slave (address 12)		11	Batch write request (address 12)
	12	Normal connection slave (address 13)		12	Batch write request (address 13)
	13	Normal connection slave (address 14)		13	Batch write request (address 14)
	14	Normal connection slave (address 15)		14	Batch write request (address 15)
	15	Normal connection slave (address 16)		15	Batch write request (address 16)
2	0	Normal connection slave (address 17)	2	0	Batch write request (address 17)
	1	Normal connection slave (address 18)		1	Batch write request (address 18)
	2	Normal connection slave (address 19)		2	Batch write request (address 19)
	3	Normal connection slave (address 20)		3	Batch write request (address 20)
	4	Normal connection slave (address 21)		4	Batch write request (address 21)
	5	Normal connection slave (address 22)		5	Batch write request (address 22)
	6	Normal connection slave (address 23)		6	Batch write request (address 23)
	7	Normal connection slave (address 24)		7	Batch write request (address 24)
	8	Normal connection slave (address 25)		8	Batch write request (address 25)
	9	Normal connection slave (address 26)		9	Batch write request (address 26)
	10	Normal connection slave (address 27)		10	Batch write request (address 27)
	11	Normal connection slave (address 28)		11	Batch write request (address 28)
	12	Normal connection slave (address 29)		12	Batch write request (address 29)
	13	Normal connection slave (address 30)		13	Batch write request (address 30)
	14	Normal connection slave (address 31)		14	Batch write request (address 31)
	15	Normal connection slave (address 32)		15	Batch write request (address 32)
3		Current profile number	3		(Unused)
4		Current page	4		Page change request

► [Fixed-part contents: UTAdvanced Series Communication Interface \(Open Network\) User's Manual](#)

## Example of CC-Link: Details in the fixed part (same on each page)

The shaded areas indicate fixed parts.

IN area CC-Link slave (UTAdvanced) → CC-Link master			OUT area CC-Link master → CC-Link slave (UTAdvanced)		
Word position	Bit position	Contents of assignment	Word position	Bit position	Contents of assignment
	RX0	Receive data valid		RY0	Rescan request
	RX1	During-write		RY1	(Reserved)
	RX2	Write acknowledgement		RY2	Write request
	RX3	(Reserved)		RY3	(Reserved)
	RX4	(Reserved)		RY4	(Reserved)
	RX5	(Reserved)		RY5	(Reserved)
	RX6	(Reserved)		RY6	(Reserved)
	RX7	(Reserved)		RY7	(Reserved)
	RX8	(Reserved)		RY8	(Reserved)
	RX9	(Reserved)		RY9	(Reserved)
	RX10	(Reserved)		RY10	(Reserved)
	RX11	(Reserved)		RY11	(Reserved)
	RX12	(Reserved)		RY12	(Reserved)
	RX13	(Reserved)		RY13	(Reserved)
	RX14	(Reserved)		RY14	(Reserved)
	RX15	(Reserved)		RY15	(Reserved)
	RX16	Normal connection slave (address 01)		RY16	Batch write request (address 01)
	RX17	Normal connection slave (address 02)		RY17	Batch write request (address 02)
	RX18	Normal connection slave (address 03)		RY18	Batch write request (address 03)
	RX19	Normal connection slave (address 04)		RY19	Batch write request (address 04)
	RX20	Normal connection slave (address 05)		RY20	Batch write request (address 05)
	RX21	Normal connection slave (address 06)		RY21	Batch write request (address 06)
	RX22	Normal connection slave (address 07)		RY22	Batch write request (address 07)
	RX23	Normal connection slave (address 08)		RY23	Batch write request (address 08)
	RX24	Normal connection slave (address 09)		RY24	Batch write request (address 09)
	RX25	Normal connection slave (address 10)		RY25	Batch write request (address 10)
	RX26	Normal connection slave (address 11)		RY26	Batch write request (address 11)
	RX27	Normal connection slave (address 12)		RY27	Batch write request (address 12)
	RX28	Normal connection slave (address 13)		RY28	Batch write request (address 13)
	RX29	Normal connection slave (address 14)		RY29	Batch write request (address 14)
	RX30	Normal connection slave (address 15)		RY30	Batch write request (address 15)
	RX31	Normal connection slave (address 16)		RY31	Batch write request (address 16)
	RX32	Normal connection slave (address 17)		RY32	Batch write request (address 17)
	RX33	Normal connection slave (address 18)		RY33	Batch write request (address 18)
	RX34	Normal connection slave (address 19)		RY34	Batch write request (address 19)
	RX35	Normal connection slave (address 20)		RY35	Batch write request (address 20)
	RX36	Normal connection slave (address 21)		RY36	Batch write request (address 21)
	RX37	Normal connection slave (address 22)		RY37	Batch write request (address 22)
	RX38	Normal connection slave (address 23)		RY38	Batch write request (address 23)
	RX39	Normal connection slave (address 24)		RY39	Batch write request (address 24)
	RX40	Normal connection slave (address 25)		RY40	Batch write request (address 25)
	RX41	Normal connection slave (address 26)		RY41	Batch write request (address 26)
	RX42	Normal connection slave (address 27)		RY42	Batch write request (address 27)
	RX43	Normal connection slave (address 28)		RY43	Batch write request (address 28)
	RX44	Normal connection slave (address 29)		RY44	Batch write request (address 29)
	RX45	Normal connection slave (address 30)		RY45	Batch write request (address 30)
	RX46	Normal connection slave (address 31)		RY46	Batch write request (address 31)
	RX47	Normal connection slave (address 32)		RY47	Batch write request (address 32)
	RX48	01: A.M		RY48	01: A.M
	RX49	01: R.L_L1		RY49	01: R.L_L1
	RX50	01: S.R		RY50	01: S.R
	RX51	(Unused)		RY51	(Unused)
	RX52	(Unused)		RY52	(Unused)
	RX53	(Unused)		RY53	(Unused)
	RX54	(Unused)		RY54	(Unused)
	RX55	(Unused)		RY55	(Unused)
	⋮			⋮	
	⋮			⋮	

Continued to the next page

### 6.3 Part Names of Window and Their Functions

IN area CC-Link slave (UTAdvanced) → CC-Link master			OUT area CC-Link master → CC-Link slave (UTAdvanced)		
Word position	Bit position	Contents of assignment	Word position	Bit position	Contents of assignment
	RX80	(Reserved)		RY80	(Reserved)
	⋮			⋮	
	RX91	Remote Ready		RY91	(Reserved)
	⋮			⋮	
	RX95	(Reserved)		RY95	(Reserved)

RWr0		Current page	RWw0		Page change request
RWr1		01: PV_L1	RWw1		(Unused)
RWr2		02: PV_L1	RWw2		(Unused)
RWr3		01: CSP_L1	RWw3		01: SP_L1_1
RWr4		02: CSP_L1	RWw4		02: SP_L1_1
RWr5		01: OUT_L1	RWw5		01: MOUT_L1
RWr6		02: OUT_L1	RWw6		02: MOUT_L1
RWr7		(Unused)	RWw7		(Unused)
RWr8		(Unused)	RWw8		(Unused)
RWr9		(Unused)	RWw9		(Unused)
RWr10		(Unused)	RWw10		(Unused)
RWr11		(Unused)	RWw11		(Unused)

**Note**

- The shaded areas indicate fixed parts.
- The bit position of remote Ready flag varies depending on the profile.

► [Fixed-part contents: UTAdvanced Series Communication Interface \(Open Network\) User's Manual](#)

Data category of Register tree

Large class.	Middle class.	Small class.	UT75A	UT55A UT52A	UT35A UT32A	UP55A	UP35A UP32A	UM33A
Register	Process monitoring	Process data	✓	✓	✓	✓	✓	✓
	Program pattern	Local mode setting	N/A	N/A	N/A	✓	✓	N/A
	Operation mode parameters	Loop-1/Loop-2 operation mode	✓	✓	N/A	✓	N/A	N/A
		Operation mode	N/A	N/A	✓	N/A	✓	N/A
	Operation parameter	Loop-1/Loop-2 alarm setpoint setting	N/A	N/A	N/A	✓	N/A	N/A
		Alarm setpoint setting	N/A	N/A	N/A	N/A	✓	✓
	Loop-1 operation parameters	SP and alarm setpoint setting	✓	✓	✓	N/A	N/A	N/A
		SP-related setting	✓	✓	✓	✓	✓	N/A
		Alarm function setting	✓	✓	✓	✓	✓	✓
		PV-related setting	✓	✓	✓	✓	✓	✓
		PID setting	✓	✓	✓	✓	✓	N/A
		Control action-related setting	✓	✓	✓	✓	✓	N/A
	Loop-2 operation parameters	SP and alarm setpoint setting	✓	✓	N/A	N/A	N/A	N/A
		SP-related setting	✓	✓	N/A	N/A	N/A	N/A
		Alarm function setting	✓	✓	N/A	✓	N/A	N/A
		PV-related setting	✓	✓	N/A	✓	N/A	N/A
		PID setting	✓	✓	N/A	✓	N/A	N/A
	P-parameters	P-parameter	✓	✓	✓	✓	✓	N/A
		Registers for ladder program	For input ladder calculation	✓	✓	✓	✓	✓
	For output ladder calculation		✓	✓	✓	✓	✓	N/A
	Input range / scale		✓	✓	✓	✓	✓	N/A
	Program pattern	Program pattern	✓	N/A	N/A	N/A	N/A	N/A
	Relay	Function status	System error	✓	✓	✓	✓	✓
Input error			✓	✓	✓	✓	✓	✓
Operation mode			✓	✓	✓	✓	✓	N/A
Program pattern end signal, Wait end signal			✓	N/A	N/A	N/A	N/A	N/A
Alarm			✓	✓	✓	✓	✓	✓
Alarm latch			✓	✓	✓	✓	✓	✓
Heater break alarm			N/A	✓	✓	✓	✓	N/A
SP number, PID number			N/A	✓	✓	N/A	N/A	N/A
SP number, PID number, Segment number			✓	N/A	N/A	N/A	N/A	N/A
PID number, Pattern number, Segment number			N/A	N/A	N/A	✓	✓	N/A
Key			✓	✓	✓	✓	✓	✓
Display			✓	✓	✓	✓	✓	✓
PV event status			N/A	N/A	N/A	✓	✓	N/A
Time event status			N/A	N/A	N/A	✓	✓	N/A
Pattern number status, Segment number status			N/A	N/A	N/A	✓	✓	N/A
Segment number status		✓	N/A	N/A	N/A	N/A	N/A	
Status for ladder program		Input (status) relay	✓	✓	✓	✓	✓	✓
		Output (status) relay	✓	✓	✓	✓	✓	✓
		Control (status) relay	✓	✓	✓	✓	✓	N/A
		Special relay	✓	✓	✓	✓	✓	N/A
	Internal relay	✓	✓	✓	✓	✓	✓	

✓: Available N/A: Not available

### Note

The registers and relays of Loop-2 can be used only for UT75A/UT55A/UT52A/UP55A.

- ▶ Register symbols and register numbers: UTAdvanced Series Communication Interface (RS-485, Ethernet) User's Manual

## 6.4 Create the Profile

The following describes an example of PROFIBUS-DP. This operating procedure also applies to DeviceNet and CC-Link.

### Procedure

1. Click on Windows' [Start], select [All Programs] – [UTAdvanced], and then click on [Network Profile Tool].

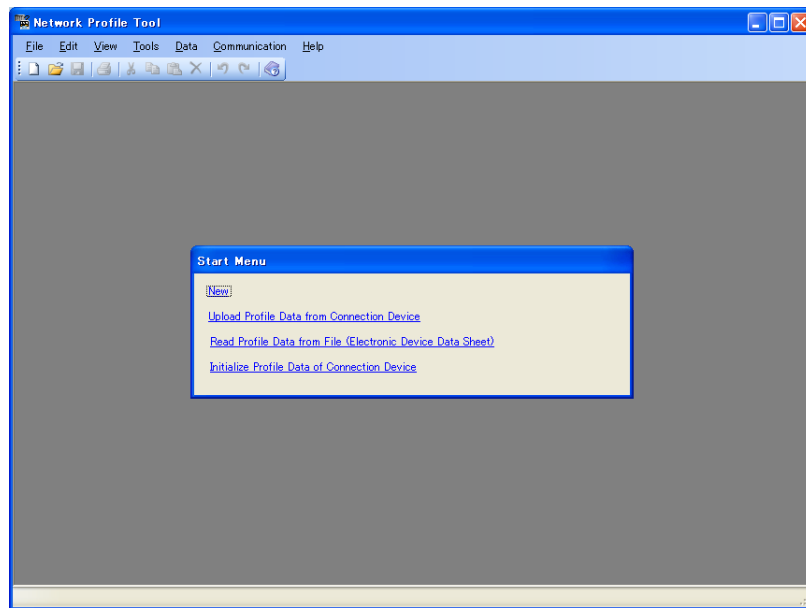

2. Click on "New" and click [OK] in the Start Menu window, click on [File] – [New] in the menu, or click  on the toolbar to display the Connection Device Settings window.

In addition to New, there are the following options.

- Upload Profile Data from Connection Device  
Enables you to read out and edit data from the main unit.
- Read Profile Data from File (Electronic Device Data Sheet)  
Enables you to open and edit an existing user file.
- Initialize Profile Data of Connection Device  
See 6.12 Initializing the main unit's Profile Data

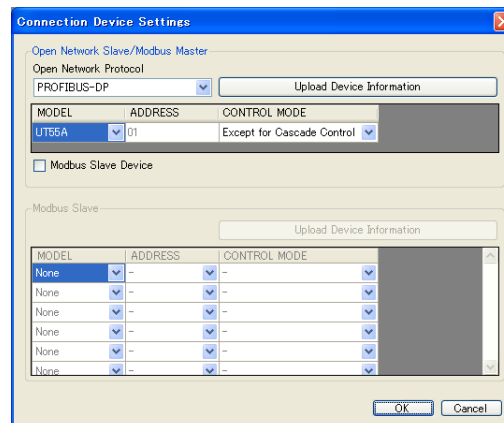

3. The following shows how to set the device information for the open network slave /Modbus master device.

To upload the device information from the open network slave/Modbus master device, click the [Upload Connection Device Information] button to display the Execute Communication window, and execute the upload.

If there are Modbus slave devices, select the [Modbus Slave Device] checkbox, set the device information for the Modbus slave devices, and click the [OK] button to display the Profile Settings window.

The following window shows an example of one open network slave/Modbus master device and three Modbus slave devices.

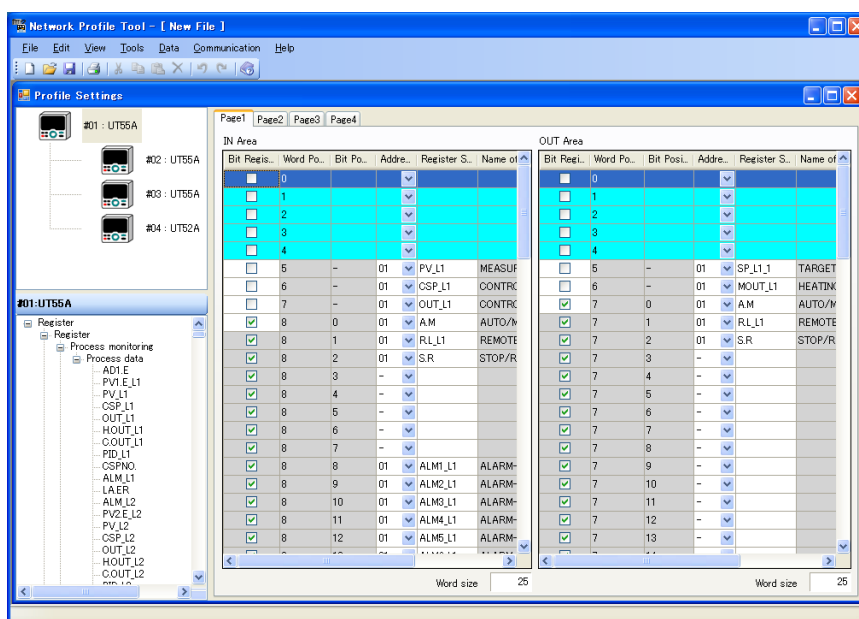
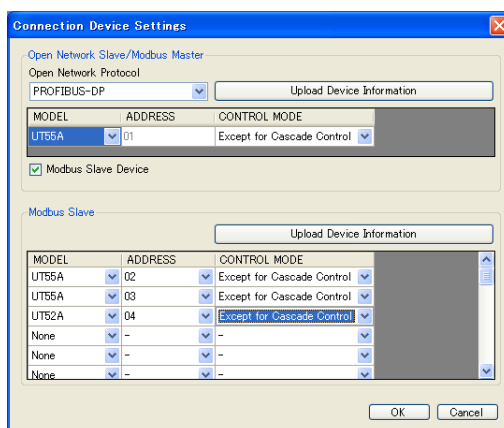

### Note

- UT35A/UT32A/UP35A/UP32A don't have the CONTROL MODE. Select "-" for the CONTROL MODE in Connection Device Settings window.
- In the case of CC-link communication, only "4 occupied stations, 8 magnification" of CC-Link (ver.2) is available for pattern settings in the CONTROL MODE. When the "pattern settings" is selected, "4 occupied stations, 8 magnification" is set automatically.



## 6.4 Create the Profile

- Clicking on the device diagram for which to set a profile enables you to switch to the register tree for that device.

The default is registered in the profile setting area according to the control mode (other than cascade control or cascade control). Check the default conditions and set the word size and add or delete registers as necessary.

To cancel the profile settings, click . The Start Menu window appears.



The following describes how to add or delete a register.

- The following describes how to add a register.

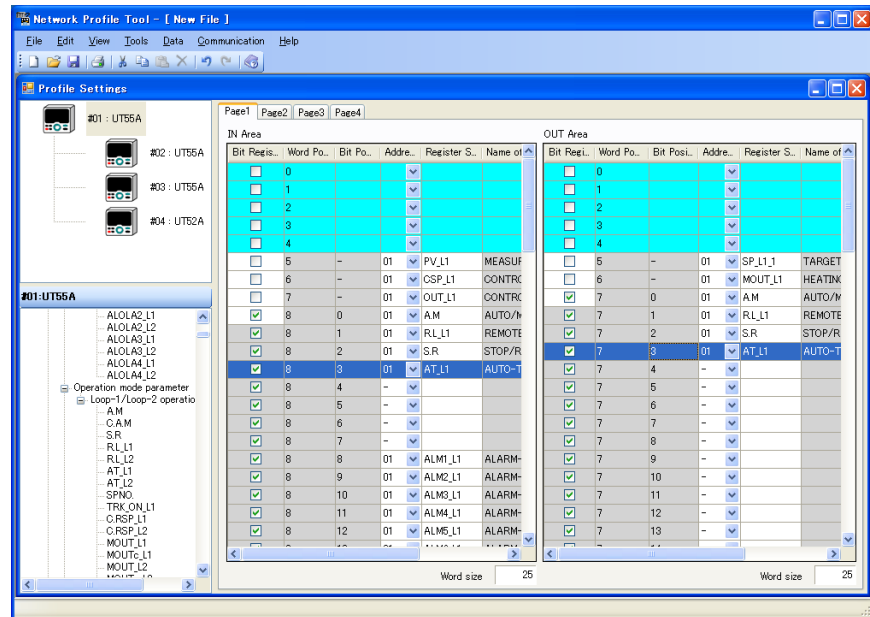
The following shows an example of registering the auto-tuning execution register (AT\_L1) with the IN and OUT areas.



- The address can be selected from the drop-down list.
  - The register symbol can be dragged from the register tree and dropped into the cell to which to register it. Inputting the register symbol displays a candidate list. Select the desired one from the list.
- ▶ [Register symbols and register numbers: UTAdvanced Series Communication Interface \(RS-485, Ethernet\) User's Manual](#)

Icon	Status
	Status enabling a drop
	Status disabling a drop

## 6. The following describes how to delete a register.

The following shows an example of deleting the remote/local switching register (R.L\_L1) from the IN and OUT areas. Place the cursor on the cells marked in red and press the Delete key, or click [Edit] – [Delete] in the menu.

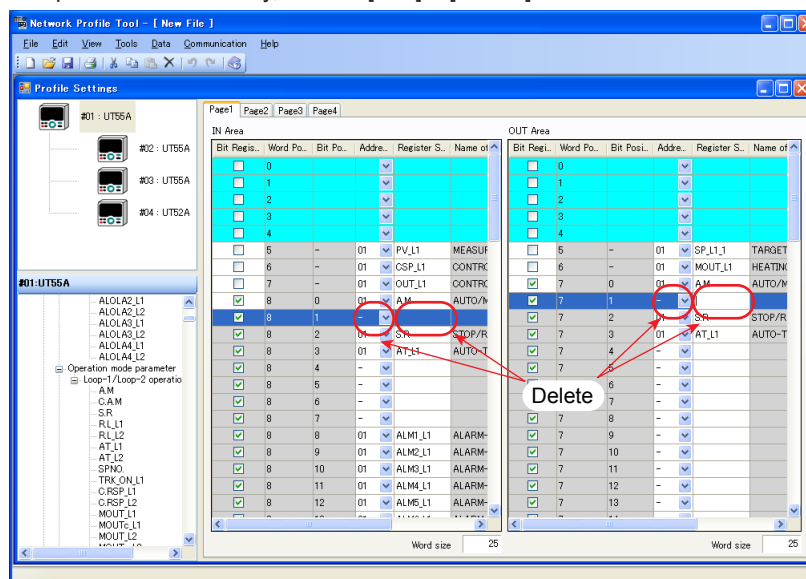

## 7. To add or delete other registers, repeat steps 5 and 6.

For more information on the other editing methods, see 6.5, Edit the Profile.

## 8. Next, check the area setting.

Click [Tool] – [Check Area Setting] in the menu to execute the check.

If an error occurs, the Area Setting window appears.

## 9. Perform the following operations as necessary.

- Save the file: Saves the data as an Electronic Device Data Sheet (GSD file and EDS file).<sup>\*1</sup>  
See 6.10, Managing Files.  
The GSD and EDS files need to be loaded into the configuration tool.<sup>\*2</sup>  
The file name is fixed to YEC45F2.GSD for PROFIBUS-DP.
- Download: Downloads the created profile data to the main unit.  
See 6.7, Downloading the Profile Data.
- Print: Prints data. See 6.11, Printing.

<sup>\*1</sup>: GSD is an extension for PROFIBUS-DP.  
EDS is for DeviceNet, and CCL is for CC-Link.  
These files can be assigned any name.

<sup>\*2</sup>: Only PROFIBUS-DP and DeviceNet

## 10. Saving the file and executing the download completes the profile setting.

### What are register symbols?

Register symbols are the symbols of registers containing data such as main unit parameter, operation status, alarm status, contact input, or error information in 16 bits or 1 bit.

When performing communication, registers are used as D-registers or I-relays.

For more information on them, see the UTAdvanced Communication Interface (RS-485, Ethernet) User's Manual.

### D-register symbols

For some register symbols, the loop number, terminal area number, and group number are indicated by adding the underscore (\_) to the end of a parameter symbol. If both the loop number and group number are added to a parameter symbol, they are added to it in the order of \_loop number and \_group number.

xxxx\_Ln\_Y

Ln: loop number (L1 or L2)

Y: group number (1 to 8 (29) or 1 to 16, R)

xxxx\_En

En: terminal area number (E1 to E4)

Example:

SP\_L1\_3: This means Loop-1 group-3 target setpoint.

PYS\_2: This means group-2 PYS.

DI1.D\_E1: This means E1-terminal area DI1.D.

#### **Note**

---

Since the UT35A/UT32A/UP35A/UM33A is a single-loop controller, it has no distinction between Loop-1 and Loop-2. However, the register symbol has "L1" which indicates Loop-1.

---

### Menu symbols and parameter symbols different from those in the main unit

For menu symbols and parameter symbols, the loop number and terminal area number are indicated like register symbols. For example, the alarm function menu is indicated as ALRM in the main unit, while it is indicated as ALRM\_L1 in the LL50A.

For the notation, refer to "D-register symbols" above.

- Alarm function setting parameters  
In the main unit, the alarm type, standby operation, energized/non-energized, and latch settings are made using one parameter. However, they are set using one parameter each in the LL50A.
- Output type parameters  
These parameters are used only for setting during heating/cooling control. The output types are set using one parameter in the main unit, while they are set using the heating- and cooling-side parameters in the LL50A.
- P-parameters (when the ladder is used)  
The decimal point position can be set only in the LL50A.

## 6.5 Edit the Profile

The following describes an example of PROFIBUS-DP. This operating procedure also applies to DeviceNet and CC-Link.

### 6.5.1 Inserting a Row

The following shows how to insert rows in the editable area. Insertion into a bit row is not possible. The inserted rows delete the word data for the rows that cannot fit in the area as a result of the row insertion.

#### Selecting multiple rows

Select the row area with the cursor (from the current cursor position using the Shift key + up/down keys) or mouse. The rows are inserted into the top row of the selected row area.

The following shows an example of inserting 2 rows from the word position 6.

### Procedure

1. Select the inserting row.

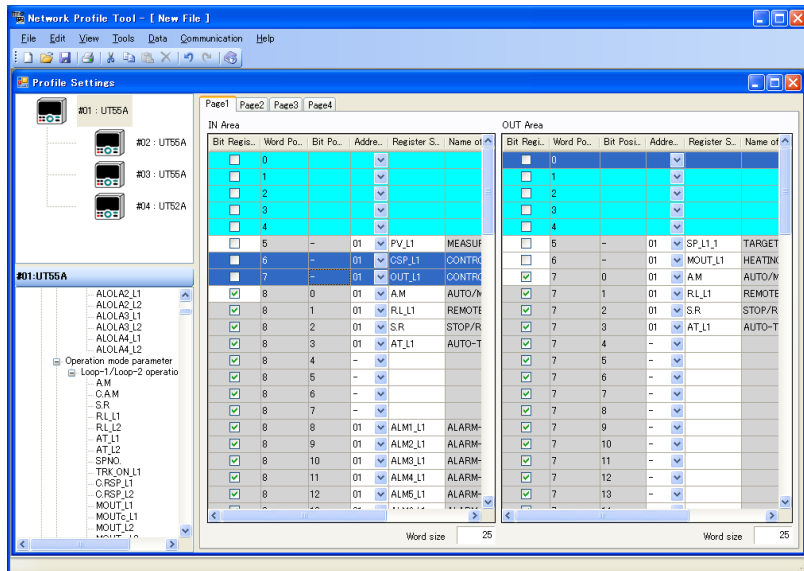

2. Click on [Edit] – [Insert Row] in the menu.

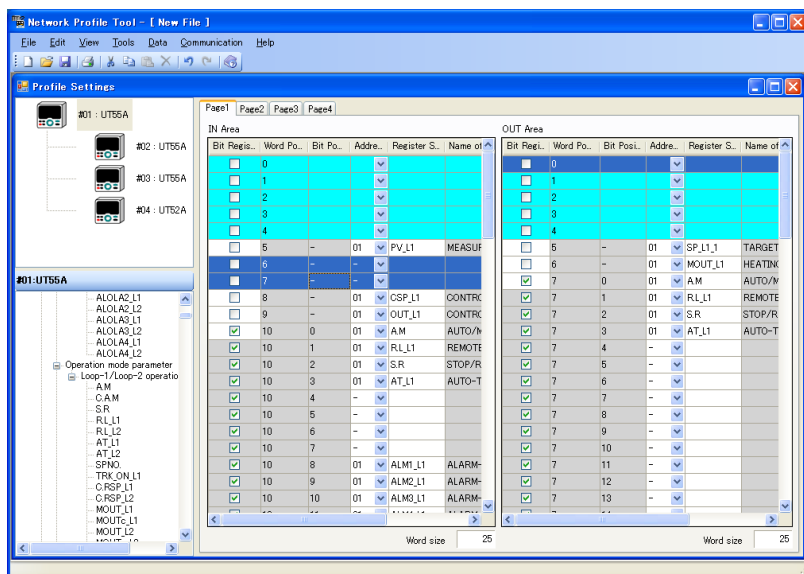

## 6.5 Edit the Profile

### 6.5.2 Deleting a Row

The following shows how to delete rows from the editable area. A bit row cannot be deleted. When a row is deleted, the space for the deleted row is replaced by the next row.

#### Selecting multiple rows

Select the row area with the cursor (from the current cursor position using the Shift key + up/down keys) or mouse.

The following shows an example of deleting 2 rows from the word position 6.

### Procedure

1. Select the deleting row.

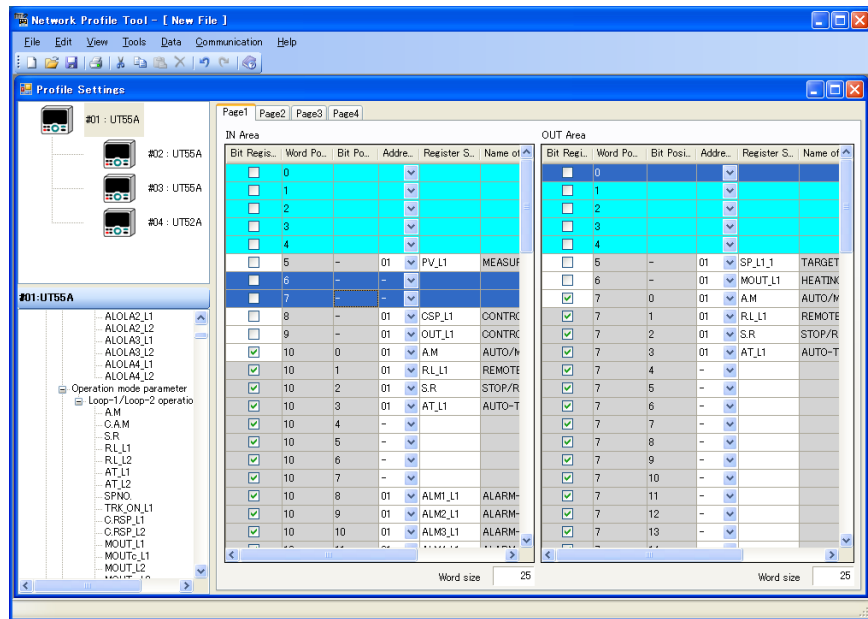

2. Click on [Edit] – [Delete Row] in the menu.

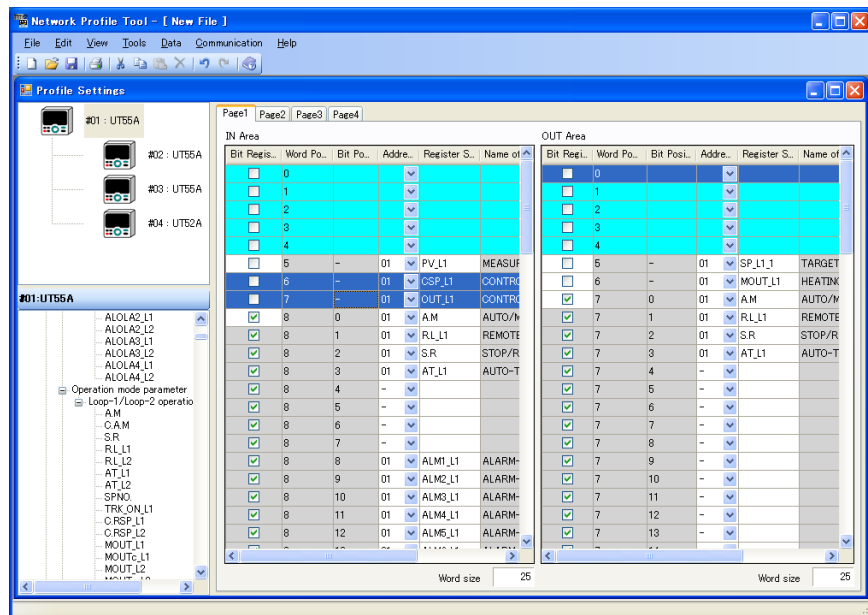

### 6.5.3 Copying a Row

The following shows how to copy rows in the editable area. The copied row overwrites the copy destination.

#### Selecting multiple rows

Select the row area with the cursor (from the current cursor position using the Shift key + up/down keys) or mouse.

The following shows an example of copying 2 rows from the word position 6 to the word position 10.

#### Procedure

1. Select the copying row.

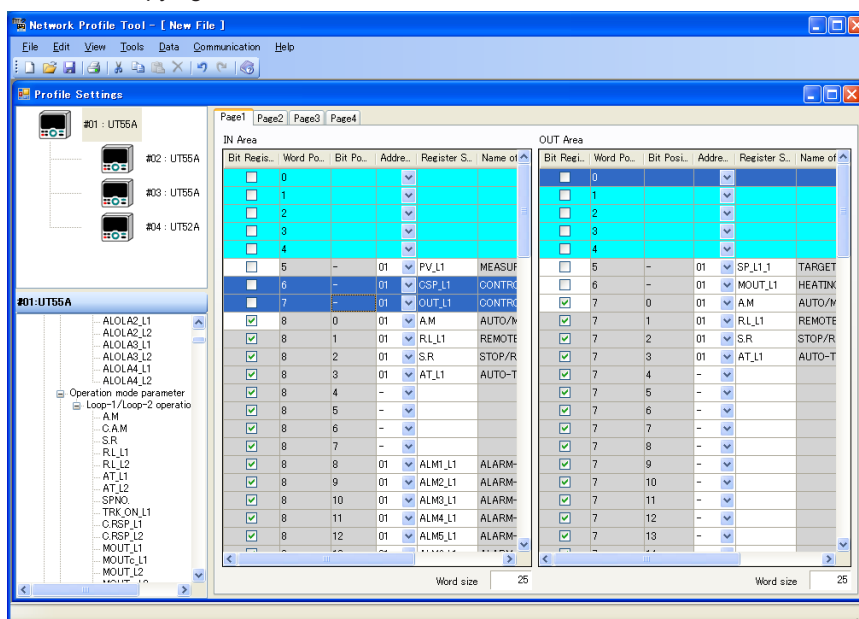

2. Click on [Edit] – [Copy] in the menu.

3. Click the copying row.

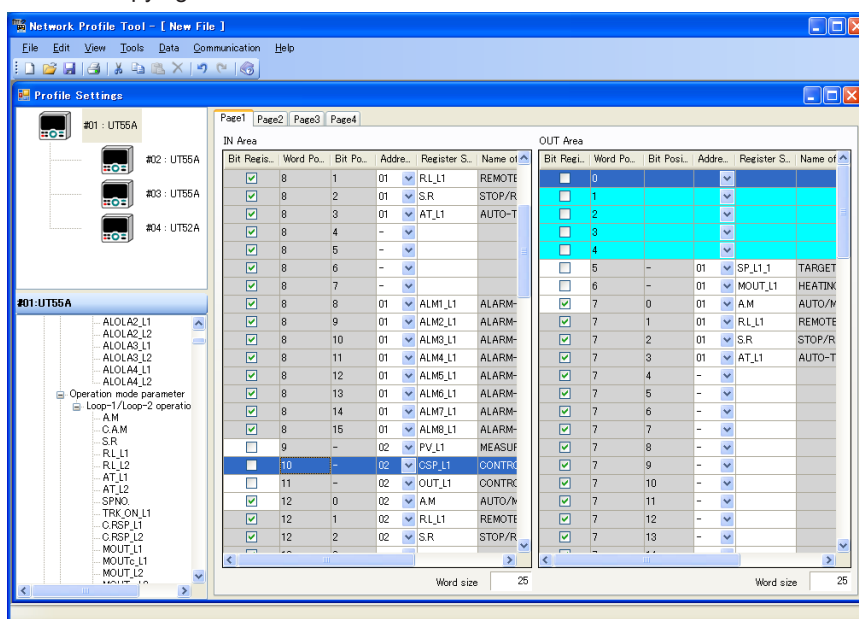

- Click on [Edit] – [Paste] in the menu.

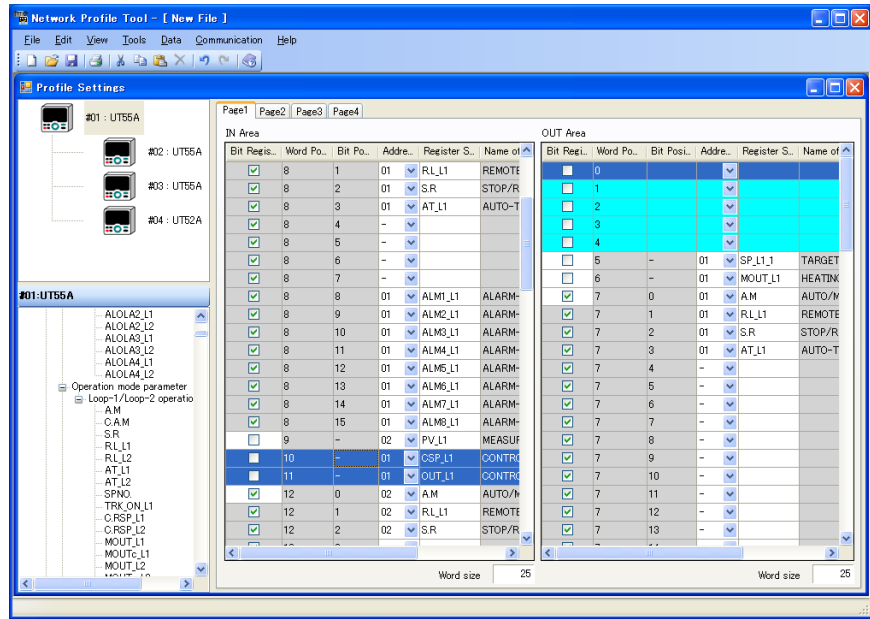

### 6.5.4 Setting the Word Size

The following shows how to set the data size for the IN and OUT areas for the profile. The word size is the same on Pages 1 through 4.

Protocol	Area	Setting range of word size
PROFIBUS-DP/ DeviceNet	IN	5 to 122 words
	OUT	5 to 122 words

**Note**

Reducing the word size deletes the word data for the rows that cannot fit in the area as a result of reducing the word size.

**Procedure**

- Click on [Data] – [Set Word Size] in the menu.

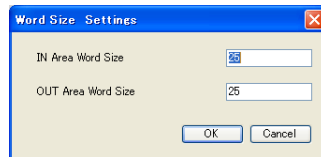

- Enter the word size and click the [OK] button. To cancel the settings, click the [Cancel] button.

### 6.5.5 Others

Functions	Specifications
Undo	Returns the area setting to the previous state. (Undo can be performed up to 5 times including the redo operation) The following operations can be undone. <ul style="list-style-type: none"><li>▪ Changing the profile data</li><li>▪ Changing the area size</li></ul>
Redo	Redo the operation that was undone. (Redo can be performed up to 5 times including the undo operation) The following operations can be redone. <ul style="list-style-type: none"><li>▪ Changing the profile data</li><li>▪ Changing the area size</li></ul>
Cut	Cut the string. The row is not deleted.
Paste	Paste the string and row.
Delete	Delete the string.



## 6.6 Window Operations

The following describes an example of PROFIBUS-DP. This operating procedure also applies to DeviceNet and CC-Link.

### Sort Profile

#### Procedure

1. Click on [Data] – [Sort] in the menu, and select "Word Position", "Address" or "Register Symbol" in the Profile Settings window. Then click [OK] button. Click "Word Position", "Address" or "Register Symbol" in the Profile setting area of Profile Settings window.

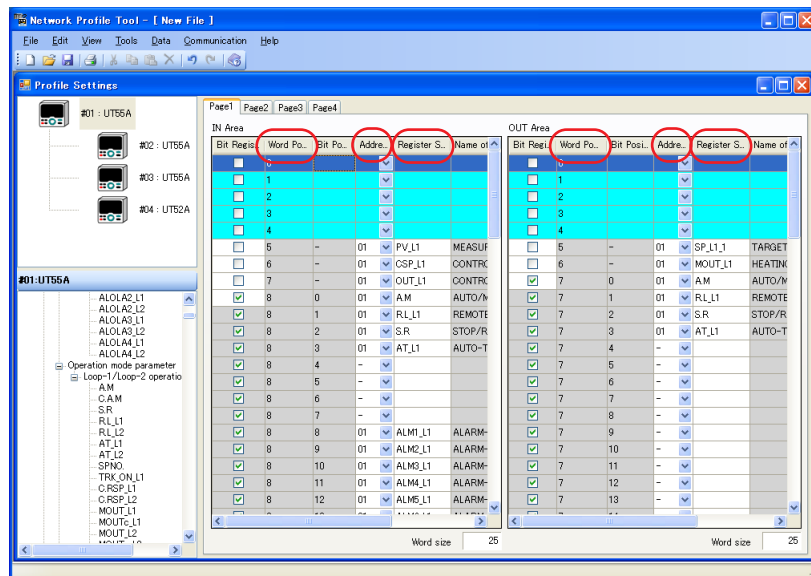
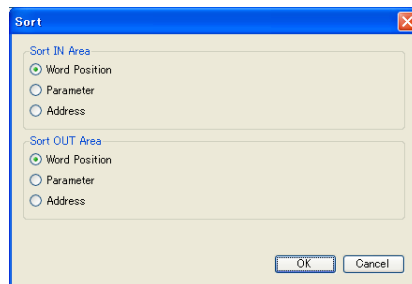

#### Note

When the registers are sorted by register symbol, the registers are listed in order with the smallest D register number at the top and with the largest D register number at the bottom. A D register number is assigned to all the registers.

- ▶ Register symbols and register numbers: [UTAdvanced Series Communication Interface \(RS-485, Ethernet\) User's Manual](#)

## Making the toolbar, status bar, Connection Device, Register Tree, Fixed-part of the profile or Connection Device Settings window visible/invisible

### Procedure

1. Click on [View] – [following command] in the menu.

The following operations are available:

- Making the toolbar visible/invisible



- Making the status bar visible/invisible



- Making the Connection Device visible/invisible

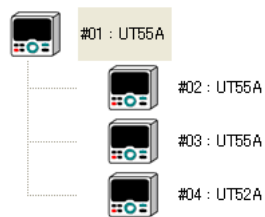

- Making the Register Tree visible/invisible

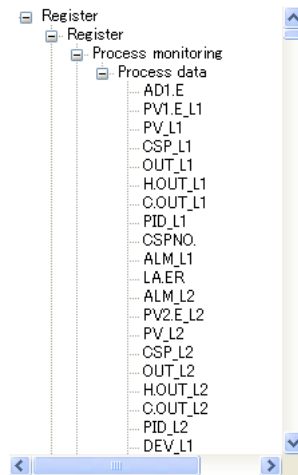

## 6.6 Window Operations

- Making the fixed-part of the profile visible/invisible

Bit Registration	Word Position	Bit Position	Address	Register Symbol	Name of Para...
<input checked="" type="checkbox"/>	0	0	-	Receive data valid	
<input checked="" type="checkbox"/>	0	1	-	Write completed	
<input checked="" type="checkbox"/>	0	2	-	Write acknowledgement	
<input checked="" type="checkbox"/>	0	3	-	(reserved)	
<input checked="" type="checkbox"/>	0	4	-	(reserved)	
<input checked="" type="checkbox"/>	0	5	-	(reserved)	
<input checked="" type="checkbox"/>	0	6	-	(reserved)	
<input checked="" type="checkbox"/>	0	7	-	(reserved)	
<input checked="" type="checkbox"/>	0	8	-	(reserved)	
<input checked="" type="checkbox"/>	0	9	-	(reserved)	
<input checked="" type="checkbox"/>	0	10	-	(reserved)	
<input checked="" type="checkbox"/>	0	11	-	(reserved)	
<input checked="" type="checkbox"/>	0	12	-	(reserved)	
<input checked="" type="checkbox"/>	0	13	-	(reserved)	
<input checked="" type="checkbox"/>	0	14	-	(reserved)	
<input checked="" type="checkbox"/>	0	15	-	(reserved)	
<input checked="" type="checkbox"/>	1	0	-	Normal connection slave ...	
<input checked="" type="checkbox"/>	1	1	-	Normal connection slave ...	
<input checked="" type="checkbox"/>	1	2	-	Normal connection slave ...	
<input checked="" type="checkbox"/>	1	3	-	Normal connection slave ...	
<input checked="" type="checkbox"/>	1	4	-	Normal connection slave ...	
<input checked="" type="checkbox"/>	1	5	-	Normal connection slave ...	
<input checked="" type="checkbox"/>	1	6	-	Normal connection slave ...	
<input checked="" type="checkbox"/>	1	7	-	Normal connection slave ...	
<input checked="" type="checkbox"/>	1	8	-	Normal connection slave ...	
<input checked="" type="checkbox"/>	1	9	-	Normal connection slave ...	
<input checked="" type="checkbox"/>	1	10	-	Normal connection slave ...	
<input checked="" type="checkbox"/>	1	11	-	Normal connection slave ...	
<input checked="" type="checkbox"/>	1	12	-	Normal connection slave ...	
<input checked="" type="checkbox"/>	1	13	-	Normal connection slave ...	
<input checked="" type="checkbox"/>	1	14	-	Normal connection slave ...	
<input checked="" type="checkbox"/>	1	15	-	Normal connection slave ...	
<input checked="" type="checkbox"/>	2	0	-	Normal connection slave ...	
<input checked="" type="checkbox"/>	2	1	-	Normal connection slave ...	
<input checked="" type="checkbox"/>	2	2	-	Normal connection slave ...	

Word size 25

- Making the Connection Device Settings window visible/invisible

**Connection Device Settings**

Open Network Slave/Modbus Master

Open Network Protocol: PROFIBUS-DP Upload Device Information

MODEL	ADDRESS	CONTROL MODE
UT55A	01	Except for Cascade Control

Modbus Slave Device

Modbus Slave Upload Device Information

MODEL	ADDRESS	CONTROL MODE
UT55A	02	Except for Cascade Control
UT55A	03	Except for Cascade Control
UT52A	04	Except for Cascade Control
None	-	-
None	-	-
None	-	-

OK Cancel

## 6.7 Downloading the Profile Data

### CAUTION

Do not download data while the controller is being used for control loop. Otherwise, it may cause a sudden change of the control output.

Be sure to disconnect the main unit from the target unit before downloading data.

### Procedure

1. Click on [Communication] – [Download] in the menu to display the Execute Communication window.

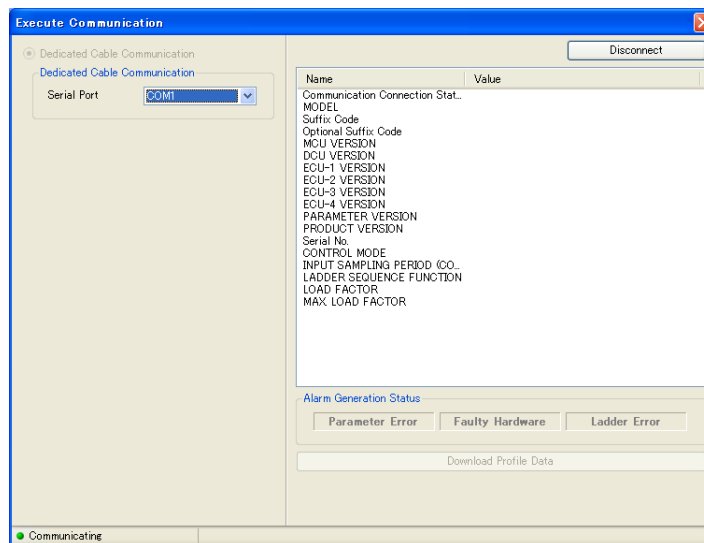

2. Set up the communication conditions and click the [Download Profile Data] button. When download is complete, the message appears.
3. Click [OK] to close the Execute Communication window.

To save a file in use, save it by entering a file name.

- ▶ Saving file: [Section 6.10.4 Saving a File as](#)

## 6.7 Downloading the Profile Data

---

### Description

Downloading the user file from the LL50A stops Open network communication. In case of PROFIBUS-DP, RDY LED (green) turns off and the ERR LED (red) blinks.\*

After the download is completed, the main unit changes the profile number (in the parameter file) to 0, and restarts PROFIBUS-DP communication. If the I/O size of the user profile matches the I/O size configured in the PLC, a connection can be established. If the size does not match, a connection cannot be established. The PLC does not recognize the main unit during downloading.

\*: For DeviceNet, one MNS LED turns on (green) or blinks (red).  
For CC-Link, the L RUN LED turns off (green) and the L ERR LED blinks (red).

### <Execute Communication window>

- Serial Port: A port available for a PC is automatically displayed.

### **Note**

---

Do not disconnect a connection cable or turn off the main unit power supply during a download.

---

## 6.8 Uploading the Profile Data

### Procedure

1. Click on [Communication] – [Upload] in the menu to display the Execute Communication window.

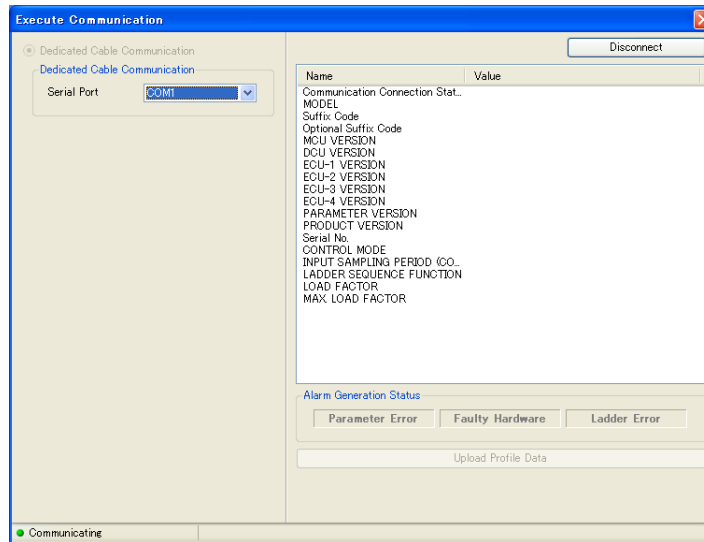

2. Set up the communication conditions and click the [Upload Profile Data] button. When an upload is complete, the Execute Communication window.

If the data in use has not yet been saved, a dialog box asking if you want to save data appears.

- To save the data, click the [Yes] button.
- To cancel an upload, click the [Cancel] button.
- ▶ Saving file: [Section 6.10.4 Saving a File as](#)

### Description

#### <Execute Communication window>

- Serial Port: A port available for a PC is automatically displayed.

#### **Note**

Do not disconnect a connection cable or turn off the main unit power supply during an upload.

## 6.9 Comparing Data with Main Unit's Profile Data

### Procedure

1. Click on [Communication] – [Compare Communication] in the menu to display the Execute Communication window.

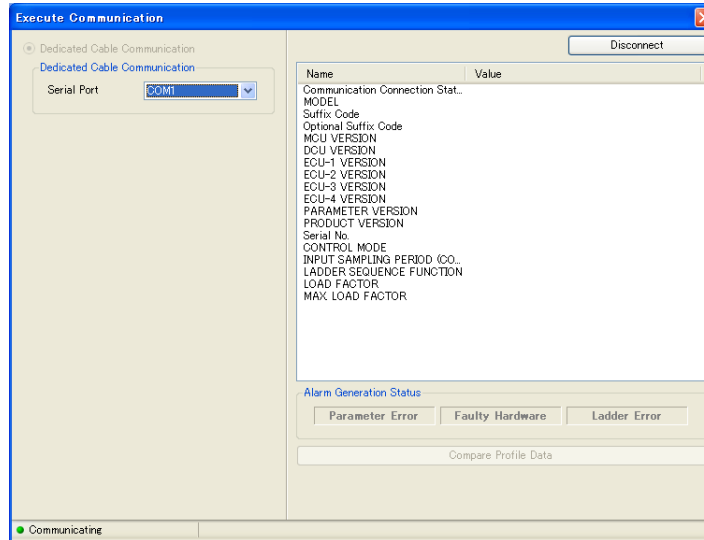

2. Set up the communication conditions and click the [Compare Profile Data] button to start parameter comparison. When parameter data matches/mismatch the main unit's data, the message appears.

### Description

#### <Execute Communication window>

- Serial Port: A port available for a PC is automatically displayed.

#### **Note**

Do not disconnect a connection cable or turn off the main unit power supply during a comparing.

## 6.10 Managing Files

### 6.10.1 Creating a New File

#### Procedure

1. Click on [File] – [New] in the menu or click  on the toolbar to display the Connection Device Settings window.

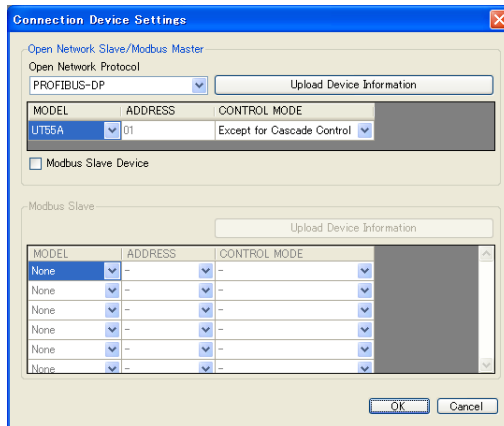

2. Set the connection device or click the [OK] button.
3. For operations such as setting profile, see section 6.4 or 6.5.



### 6.10.2 Opening a User File

#### Procedure

1. Click on [File] – [Open] in the menu or click  on the toolbar to display the Select Open Network Protocol window.

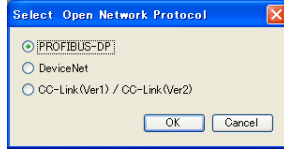

2. In the window, select the protocol and click the [OK] button. Open File window appears.

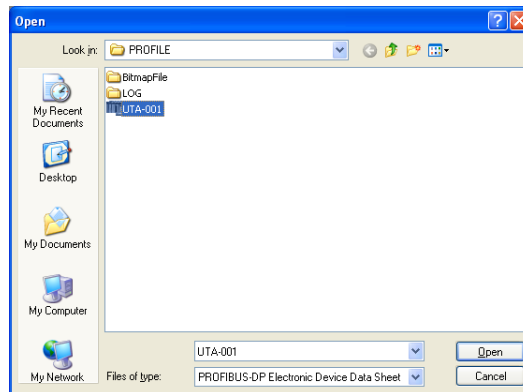

3. Specify the folder for which icon (  ) is displayed.  
The folder contains the GSD file or EDS file\* and connection device bitmap file.  
The GSD file name is fixed to **YEC45F2.GSD**.  
For more information on the profile setting operation, see 6.4 and 6.5.  
\*: GSD is an extension for PROFIBUS-DP. EDS is for DeviceNet, and CCL is for CC-Link.  
These files can be assigned any name.

### 6.10.3 Saving by Overwrite

#### Procedure

1. Click on [File] – [Save] in the menu or click  on the toolbar to save data in use.

### 6.10.4 Saving a File as

#### Procedure

1. Click on [File] – [Save as] in the menu to display the Save As window.

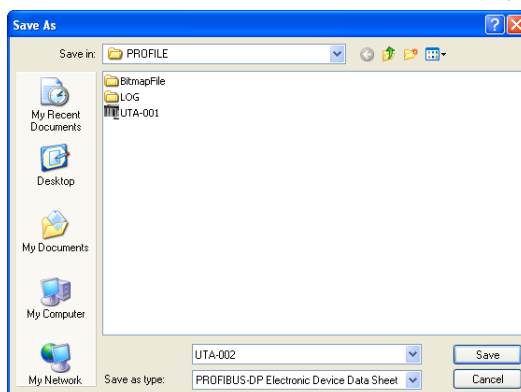



2. Name the folder and click the [Save] button.

The folder icon () appears in the LL50A.  
 The GSD file and connection device bitmap file are created in the created folder.  
 The file name for the GSD file<sup>\*1</sup> is fixed to [YEC45F2.GSD](#) because it needs to be loaded into the configuration tool.<sup>\*2</sup>

\*1: GSD is an extension for PROFIBUS-DP. EDS is for DeviceNet, and CCL is for CC-Link.  
 These files can be assigned any name..

\*2: Only PROFIBUS-DP and DeviceNet.

#### Connection Device Bitmap

UTA_SF.DIB	UTA_DE.DIB	UTA_DI.DIB
		

### 6.10.5 Comparing with File Data

**Procedure**

1. Click on [File] – [Compare File] in the menu to display the Select Compare Range window.
2. Select the comparison folder for which the icon (  ) appears and click the [Open] button.

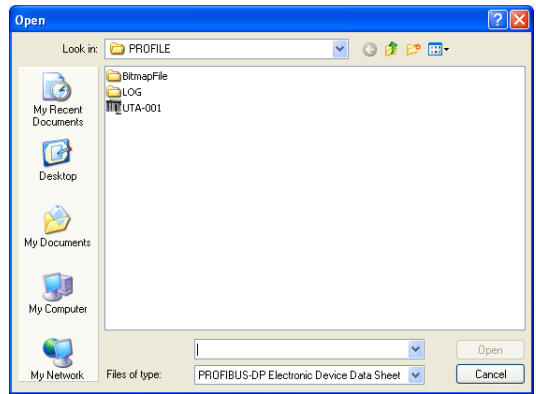

3. Execute the comparison. When parameter data matches/mismatch the file data, the message appears.

## 6.10.6 Making Environmental Settings

### Procedure

1. Click on [File] – [Environmental Setting] in the menu to display the Environmental Setting window.

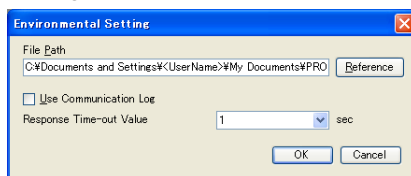

2. Set the path and click the [OK] button.

### Description

- File Path  
Shows the predetermined Electronic Device Data Sheet storage location.

#### Note

Do not set a path that includes the Program Files folder. Otherwise, the LL50A Parameter Setting Software will not run properly.

- Use Communication Log  
If this item is checked, communication logs are output to the specified location.
- Response time-out value  
Set the response time-out value longer if the response of main unit is late in each monitoring.  
The value can be set for 1 to 10 seconds.

The directories (default values) to which each file is stored are as shown below:

File Type	Storage Directory (Default)
Electronic Device Data Sheet (.gsd)	C:\Users\<UserName>\My Documents\PROFILE
Electronic Device Data Sheet (.eds)	
Electronic Device Data Sheet (.ccl)	
Communication log files (.log)	C:\Users\<UserName>\Documents\PROFILE\Log The directory cannot be changed.

# 6.11 Printing

## Procedure

1. Click on [File] – [Print] in the menu or click  on the toolbar to display the Select Print Range window.

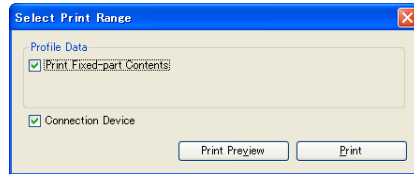

2. Select the data to be printed and click the [Print] button to display the Printing window.  
Clicking [Print Preview] enables a printing image to be displayed as shown below.
3. After finishing printing, click .

## Description

The following shows a printing image.

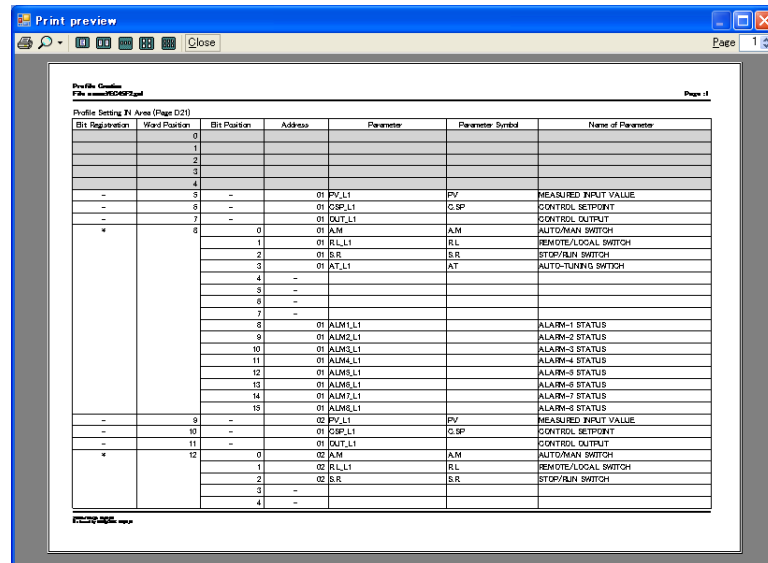

## 6.12 Initializing the Main Unit's Profile Data

### Procedure

1. Change to the status that enables communication with the main unit.
2. Click on [Initialize Profile Data of Connection Device] while the Start Menu window is displayed to display the confirmation message.

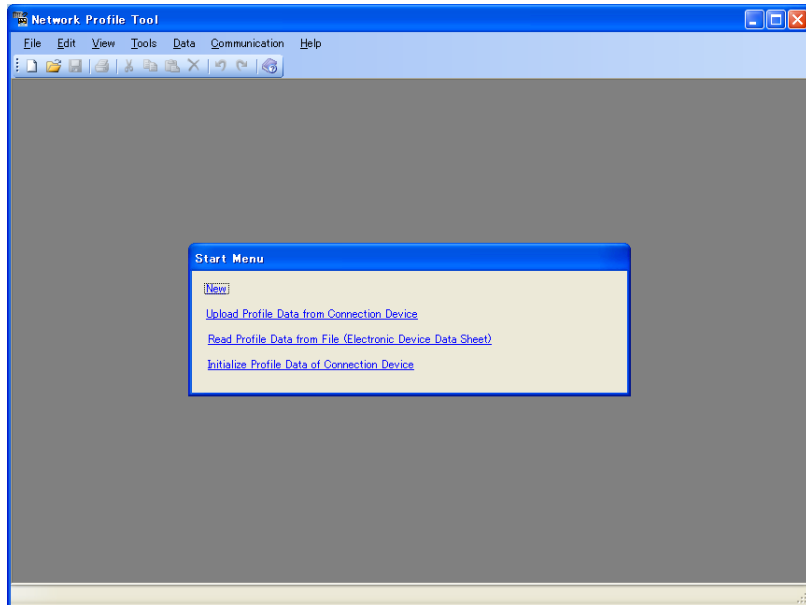

3. Enter the initialization password "UTAdvanced\_INIT" and click the [OK] button. (Single-byte alphanumeric characters)

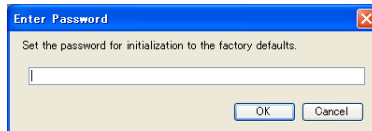

4. When the Execute Communication window appears, click on the [Initialize to Factory Defaults] button to start the initialization. Click on  to stop the initialization. When the initialization is completed, a message appears.

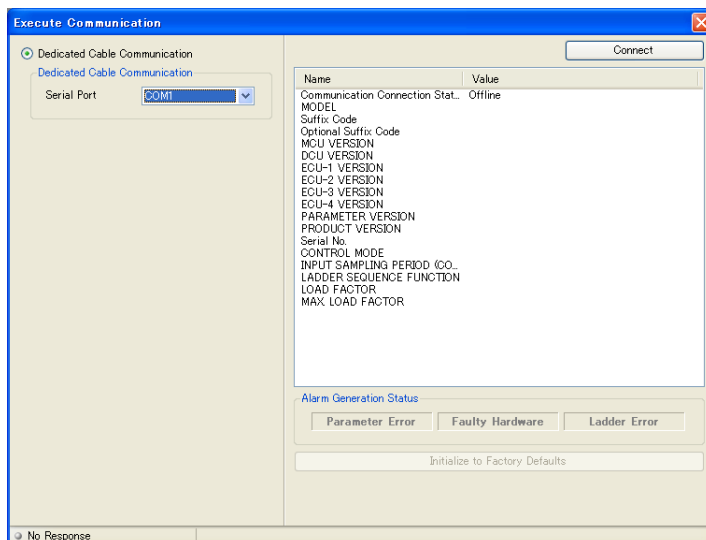

## 6.12 Initializing the Main Unit's Profile Data

---

### Description

Executing the initialization initializes the profile data for the main unit. The initialized profile data is the default for the profile number 0 (in the parameter file).

Use this method if the profile is broken.

Be careful to make sure that the password described here is not used by unauthorized users.

▶ [Initial value: UTAdvanced Series Communication Interface \(Open Network\) User's Manual](#)

## 6.13 Checking Network Profile Tool Version

### Procedure

1. Click on [Help] – [About...] in the menu to display the Network Profile Tool Version Information window.

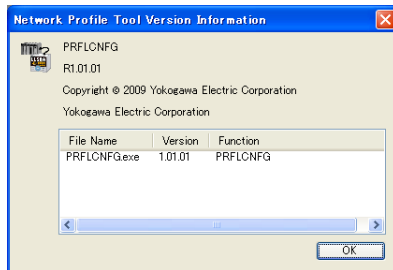

2. To close the window, click the [OK] button or .





## 6.14 Viewing the List of Tables

The list of tables shows the names of .dll and .xml files contained in the Table folder of the LL50A Network Profile Tool.

### Procedure

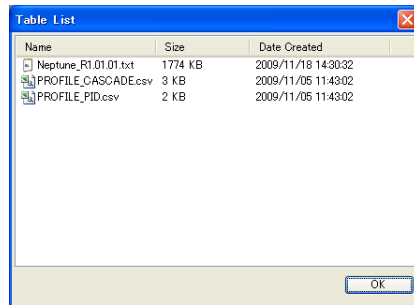
1. Click on [Help] – [Table List] in the menu to display the Table List window.



2. To close the window, click the [OK] button or .

# App.1 Worksheet

<b>UTAdvanced</b>  <b>WORKSHEET</b>	<input type="checkbox"/> UT35A <input type="checkbox"/> UP35A <input type="checkbox"/> UT32A <input type="checkbox"/> UP32A <input type="checkbox"/> UT55A <input type="checkbox"/> UP55A <input type="checkbox"/> UT52A <input type="checkbox"/> UM33A <input type="checkbox"/> UT75A	Doc. No.			P. /
		Order No.	Sec.	Loop	Item
		Serial No.			
	Customer	Model and Suffix			
Plant	Tag No.				

					CUSTOMER		REP.		ENGINEER		
					DR.	CH.	DR.	CH.	DR.	CH.	
REV.	n	REMARKS	DATE	REV. BY							



**WS 05P05A01-01JA**  
5th Edition: 2015. 04.01



---

# Revision Information

- Title : LL50A Parameter Setting Software  
with Ladder Program Building Function and Network Profile Creating Function  
User's Manual
- Manual No. : IM 05P05A01-02EN

**May 2009/1st Edition**

Newly published

**Nov. 2009/2nd Edition**

Addition of network profile creating function and correct error

**Jan. 2010/3rd Edition**

Addition of applicable model (UT35A/UT32A).

**Sep. 2010/4th Edition**

Addition of applicable model (UP55A/UP35A/UM33A) and CC-Link/DeviceNet communication.

**Jan. 2011/5th Edition**

Supporting OS for LL50A and correct error

**Feb.2013/6th Edition**

Revised for supporting UT75A, Windows 7, and Windows 8.

**Apr.2015/7th Edition**

Revised for UP32A and function addition.

**Mar.2016/8th Edition**

Error correction

**July 2017/9th Edition**

Windows 10 support.

Deleted CD media from product accessory.

**July 2022/10th Edition**

Windows 11 support.

- Written by Yokogawa Electric Corporation
  - Published by Yokogawa Electric Corporation  
2-9-32 Nakacho, Musashino-shi, Tokyo 180-8750, JAPAN
-





---

## YOKOGAWA ELECTRIC CORPORATION

### Headquarters

9-32, Nakacho, 2-chome, Musashino-shi, Tokyo, 180-8750 JAPAN  
Phone : 81-422-52-5555

### Branch Sales Offices

Osaka, Nagoya, Kurashiki, Hiroshima, Fukuoka, Kitakyusyu

---

## YOKOGAWA CORPORATION OF AMERICA

### Head Office

12530 West Airport Blvd, Sugar Land, Texas 77478, USA  
Phone : 1-281-340-3800 Fax : 1-281-340-3838

### Georgia Office

2 Dart Road, Newnan, Georgia 30265, USA  
Phone : 1-800-888-6400 Fax : 1-770-254-0928

## YOKOGAWA AMERICA DO SUL LTDA.

Alameda Xingu 850 Barueri CEP 06455-030-Barueri-SP/ BRAZIL  
Phone : 55-11-3513-1300 Fax : 55-11-5681-2400

## YOKOGAWA EUROPE SOLUTIONS B. V.

Euroweg 2, 3825 HD Amersfoort, THE NETHERLANDS  
Phone : 31-88-4641000 Fax : 31-88-4641111

## YOKOGAWA ELECTRIC CIS LTD.

1, Samarskaya street, business center Novion, Moscow, Russia, 129110, RUSSIA  
Phone : 7-495-737-7868 Fax : 7-495-737-7869

## YOKOGAWA CHINA CO., LTD.

3F Tower D Cartelo Crocodile Building, No.568 West Tianshan Road,  
Shanghai 200335, CHINA  
Phone : 86-21-62396262 Fax : 86-21-62387866

## YOKOGAWA ELECTRIC KOREA CO., LTD.

(Yokogawa B/D, Yangpyeong-dong 4-Ga), 21, Seonyu-ro 45-gil, Yeongdeungpo-gu,  
Seoul, 07209, KOREA  
Phone : 82-2-2628-6000 Fax : 82-2-2628-6400

## YOKOGAWA ENGINEERING ASIA PTE. LTD.

5 Bedok South Road, Singapore 469270, SINGAPORE  
Phone : 65-6241-9933 Fax : 65-6444-6252

## YOKOGAWA INDIA LTD.

Plot No.96, Electronic City Complex, Hosur Road, Bangalore - 560 100, INDIA  
Phone : 91-80-4158-6000 Fax : 91-80-2852-1442

## YOKOGAWA AUSTRALIA PTY. LTD.

Tower A, 112-118 Talavera Road, Macquarie Park NSW 2113, AUSTRALIA  
Phone : 61-2-8870-1100 Fax : 61-2-8870-1111

## YOKOGAWA MIDDLE EAST & AFRICA B.S.C.(C)

P.O. Box 10070, Manama, Building 577, Road 2516, Busaiteen 225, Muharraq,  
Kingdom of BAHRAIN  
Phone : 973-17358100 Fax : 973-17336100