



# ProDIGITAL User Manual

PROFESSIONAL SERIES DIGITAL HANDHELD METERS



a xylem brand

# ProDIGITAL

The information contained in this manual is subject to change without notice.

Effort has been made to make the information in this manual complete, accurate, and current.

The manufacturer shall not be held responsible for errors or omissions in this manual.

Consult [YSI.com](http://YSI.com) for the most up-to-date version of this manual.

---

Thank you for purchasing a YSI Professional Series Digital handheld meter. This manual covers setup, operation, and functionality of the ProDIGITAL handhelds which include the ProDSS and ProSolo.

ProDIGITAL Handheld features include:

- Digital smart probes that are automatically recognized by the instrument when connected
- Waterproof (IP-67) case
- Long-life rechargeable lithium-ion battery pack
- Color display and backlit keypad
- User-selectable cable options
- USB connectivity
- Global Positioning System (GPS) (optional on ProDSS)
- Depth sensor (optional on 4-port cable)
- Large memory with extensive site list capabilities
- Rugged enclosure with rubber over-molded case and military-spec (MS) connectors
- KorDSS data management software included with each instrument (Please see [Installation Instructions](#))

## Safety Information


Please read this entire manual before unpacking, setting up or operating this equipment. Pay attention to all precautionary statements. Failure to do so could result in serious injury to the operator or damage to the equipment. Do not use or install this equipment in any manner other than that specified in this manual.


The manufacturer is not responsible for any damages due to misapplication or misuse of this product including, without limitation, direct, incidental and consequential damages, and disclaims such damages to the full extent permitted under applicable law. The user is solely responsible to identify critical application risks and install appropriate mechanisms to protect processes during a possible equipment malfunction.

## Precautionary Symbols

**NOTE:** Information that requires special emphasis

**NOTICE:** Indicates a situation which, if not avoided, may cause damage to the instrument

 **CAUTION:** Indicates a potentially hazardous situation that may result in minor or moderate injury

 **WARNING:** Indicates a potentially or imminently hazardous situation which, if not avoided, could result in death or serious injury

## Product Components

Carefully unpack the instrument and accessories and inspect for damage. If any parts or materials are damaged, contact YSI Customer Service at 800-897-4151 (+1 937 767-7241) or the authorized YSI distributor from whom the instrument was purchased.

# TABLE OF CONTENTS

## 1. Introduction

- 1.1 Battery Use and Battery Life
- 1.2 Charging the Battery Pack
- 1.3 Battery Replacement
- 1.4 Connect the Handheld to the Cable Assembly
- 1.5 Sensor Installation/Removal

## 2. Operation

- 2.1 Keypad and Navigation
- 2.2 Startup
- 2.3 Navigation
- 2.4 Main Display Description
- 2.5 System Menu
- 2.6 Sensor Menu
- 2.7 Calibration Menu
- 2.8 Files Menu
- 2.9 Taking Measurements

## 3. Calibration

- 3.1 Calibration Setup
- 3.2 Depth
- 3.3 Conductivity
- 3.4 Barometer
- 3.5 Dissolved Oxygen
- 3.6 Turbidity
- 3.7 Total Algae
- 3.8 pH/ORP
- 3.9 ISEs

## 4. Maintenance and Storage

- 4.1 ProDIGITAL Handheld
- 4.2 4-Port Bulkhead
- 4.3 Sensor Guard
- 4.4 Depth Sensor
- 4.5 Temperature Sensor
- 4.6 Conductivity Sensor
- 4.7 Optical Dissolved Oxygen Sensor
- 4.8 Turbidity & Total Algae Sensors
- 4.9 pH/ORP Sensor
- 4.10 ISE Sensor
- 4.11 ProDSS Sensor Module Replacement

## 5. KorDSS Software

- 5.1 Introduction
- 5.2 Installing the Driver and Software

## 6. Accessories

- 6.1 Ordering

## 7. Safety and Support

- 7.1 Rechargeable Lithium-Ion Battery Pack
- 7.2 Service Information
- 7.3 Technical Support
- 7.4 Declarations of Conformity
- 7.5 Warranty

## 8. Appendices

- 8.1 Appendix A - DO% Calibration Values
- 8.2 Appendix B - Oxygen Solubility Table



THIS IS AN  
INTERACTIVE DOCUMENT

When viewing this document as an Adobe™ PDF, hovering your cursor over certain phrases will bring up the finger-point icon. Clicking elements of the Table of Contents, website URLs, or references to certain sections will take you automatically to those locations.

# 1. Introduction

## 1.1 Battery Use and Battery Life

ProSeries Digital handhelds use a rechargeable lithium-ion (Li-Ion) battery pack as a power source. The battery comes pre-installed in the handheld and ships at less than 50% full capacity. Battery life depends on use, enabled parameters, LCD brightness, and GPS use.

A new battery, that has been fully charged, is expected to last for the following durations at 25°C, with Sampling set to Auto, Backlight set to Auto, and GPS enabled:

- ProDIGITAL handheld only - 48 hours
- ProDSS with fully loaded 4-port cable assembly and 25% LCD brightness - 20 hours

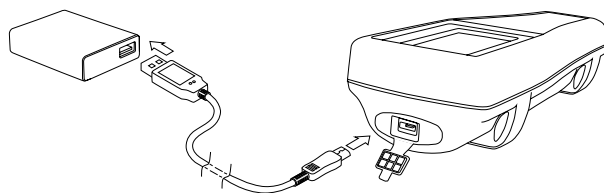
To increase battery life, enable manual sampling mode ([Sampling](#)). Manual sampling mode powers the sensor(s) on to take a measurement and then powers down to conserve battery life.

As with all lithium-ion batteries, battery life will decline over time and use. This decay should be expected. For the long-term health of the battery, a larger discharge is better than a small discharge between recharges.

## 1.2 Charging the Battery Pack

A USB cable is included with the handheld to charge the instrument battery pack and connect the instrument to a PC. The battery pack can be charged from the AC power adapter, directly from a computer USB connection or from an external, portable USB battery pack (sold separately, see [Accessories](#)).

Plug the USB connector into the AC power adapter, computer USB connector or external USB battery pack, then plug the micro USB connector into the handheld ([Figure 1](#)).



**Figure 1** Connecting the handheld to AC power supply

**⚠ WARNING:** Charge the battery pack in an open area away from flammable materials, liquids, and surfaces. Do not charge or handle a battery pack that is hot to the touch. Failure to follow the safety warnings and precautions can result in personal injury and/or instrument damage not covered under warranty. Read [Rechargeable Lithium-Ion battery pack safety warnings and precautions](#).

For the handheld to recognize that it is using AC power, you must start charging the handheld while it is turned on. After the instrument recognizes it is being charged, it can be turned off to finish charging.

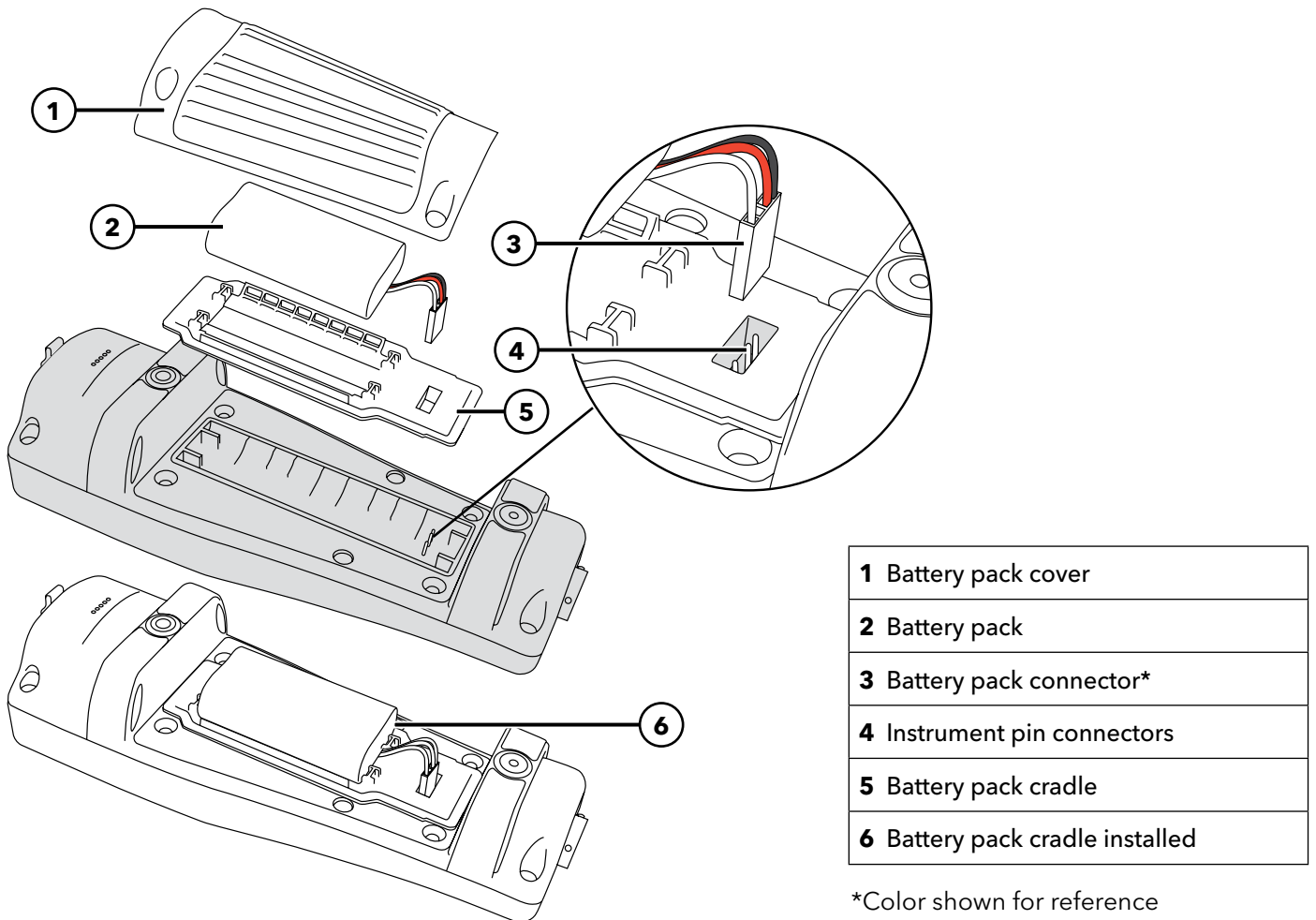
AC Charging	DC Charging
9 hr	14 hr

# 1.3

## Battery Replacement

1. Remove the battery pack cover by unscrewing (counter-clockwise) the four screws with a flat or Phillips head screwdriver (Figure 2). The retaining screws are captured into the battery pack cover and are not removable.
2. If replacing an existing battery pack, remove the Li-Ion battery pack and rubber battery pack cradle. With two fingers, grasp the battery pack connector and pull the connector straight up to disconnect and remove. Properly dispose of the old battery pack (See [Battery Disposal](#)).
3. Inspect the replacement battery pack and battery pack cradle for damage. Contact YSI [technical support](#) if there is any damage.
4. Correctly align and seat the battery pack cradle and battery pack into the instrument.
5. Align the battery pack connector wire terminals with the three instrument pins, then connect the battery pack to the instrument. Make sure that the three wire terminal connectors and three instrument pins are correctly aligned before connecting the battery pack connector. Incorrect installation can damage the battery pack connectors or instrument pins.
6. Install the battery pack cover, then hand tighten the cover screws with a screwdriver. DO NOT use any power tools. Make sure that the cover sealing surface is correctly aligned and free of any contamination or damage.

**NOTICE:** The battery cover does NOT need to make a compressed seal. Overtightening the cover screws can damage the battery cover and the handheld.



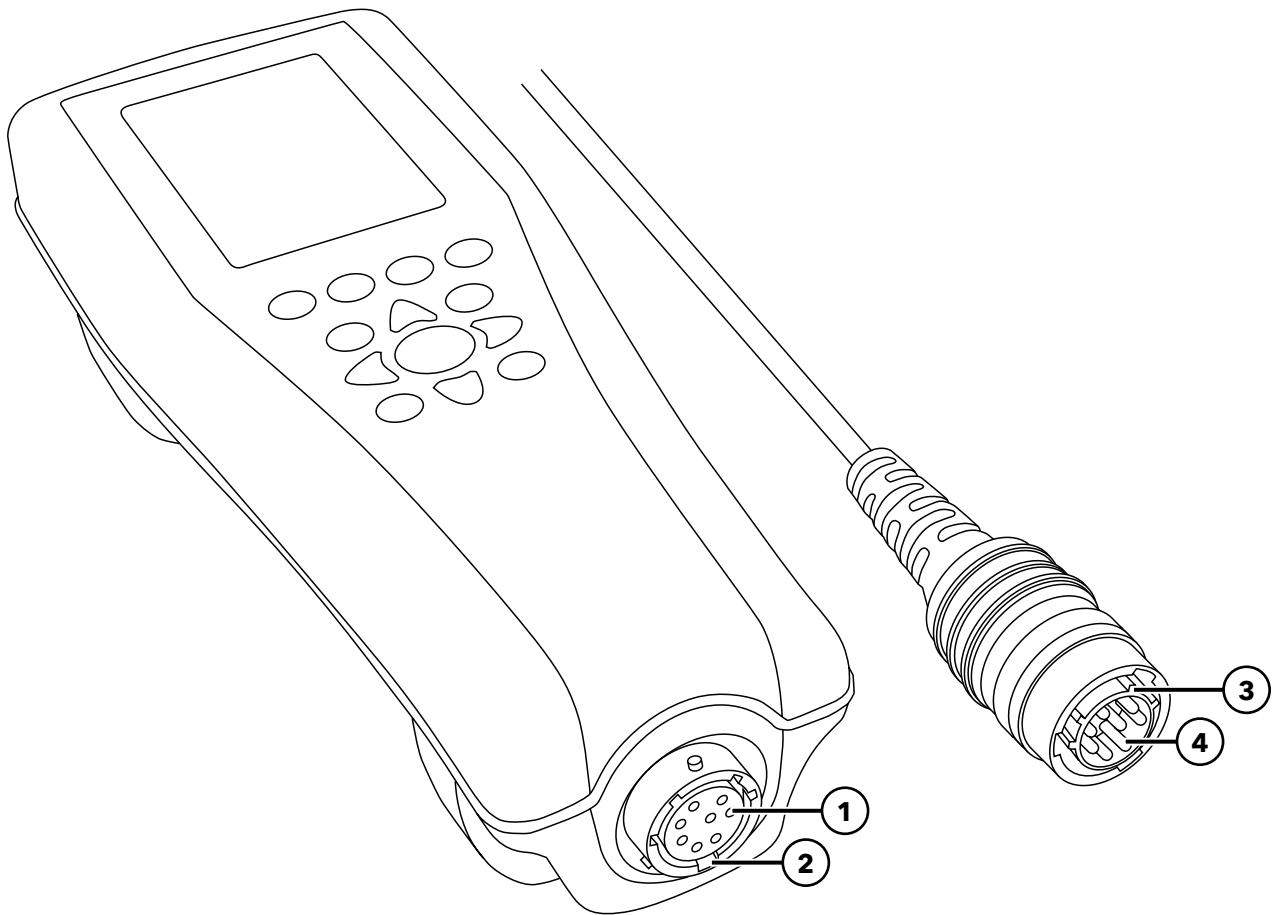
**Figure 2** Battery replacement

# 1.4

## Connect the Handheld to the Cable Assembly

The cable connectors are keyed for positive mating and to prevent connector damage (Figure 3). The handheld retains its IP-67 waterproof rating when the cable is disconnected. However, the connectors are not wet-mateable and should be clean and dry before connecting.

Align the keys on the cable connector with the slots on the handheld connector. Push together firmly, then twist the outer ring clockwise until it locks into place.



**Figure 3** Keyed connectors

<b>1</b> Handheld female connector	<b>3</b> Keyed area of connector
<b>2</b> Slotted area of connector	<b>4</b> Cable male connector

# 1.5

## Sensor Installation/Removal

Probe assemblies like the ODO/CT, ODO/T, and ProOBOD feature integral sensors. These sensors cannot be removed from the cable. Therefore, this section pertains only to the ProDSS 4-port cable.

### ProDSS 4-port Cable

ProDSS 4-port cables feature user-replaceable sensors. The ports on the bulkhead are universal, meaning that you can install any sensor into any port. A conductivity/temperature sensor must be installed for accurate measurement of all parameters except turbidity and TSS.

Bulkhead ports are numbered (Figure 4), so if multiple sensors of the same type are installed, the port number will be added to the Run screen display to clarify the measurement value of each sensor.

**NOTICE:** The bulkhead ports and sensor connectors are not wet-mateable. Make sure that the sensor connectors and bulkhead ports are clean and dry before sensor installation.

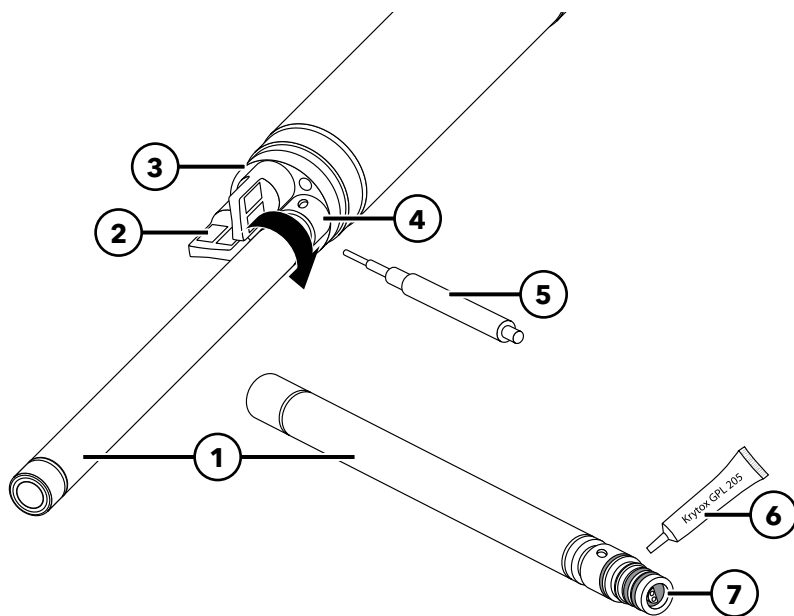


Figure 4 Sensor installation

1	Sensor
2	Port plug
3	Bulkhead
4	Sensor retaining nut
5	Sensor installation/removal tool
6	O-ring lubricant
7	Sensor port

### Sensor Installation

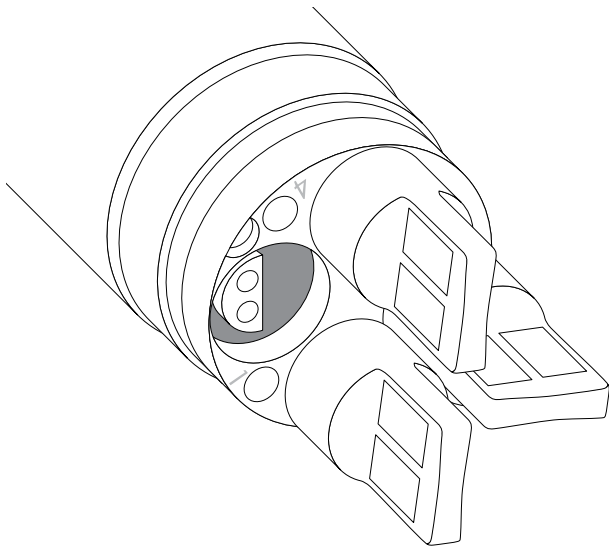
1. Remove the port cover shipped with the 4-port cable. This cover can be kept to protect the bulkhead ports from contamination during long-term storage.
2. Inspect each bulkhead port for contamination. If the port is dirty or wet, clean it with compressed air.
3. Apply a thin coat of o-ring lubricant to the sensor o-rings. Wipe off excess o-ring grease with a lint-free cloth.
4. Carefully align the sensor and bulkhead connectors by inserting the sensor into the port then gently rotating the sensor until the connectors align. Once aligned, push the sensor toward the bulkhead until the sensor seats in the port.

5. Carefully finger-tighten the retaining nut clockwise. If any resistance is felt, loosen the retaining nut completely to prevent cross-threading.
6. Use the sensor installation/removal tool to tighten the retaining nut clockwise until snug, about a  $\frac{1}{4}$  to  $\frac{1}{2}$  additional turn of the retaining nut. Be careful not to over-tighten the retaining nut.

**NOTICE:** Incorrect installation or over-tightening can cause damage to the sensor or bulkhead that is not covered by the warranty.

## Sensor Removal

To remove a sensor, insert the sensor installation/removal tool into the retaining nut, then rotate the retaining nut counterclockwise to loosen. After the retaining nut has been completely unscrewed from the bulkhead, pull the sensor straight out of the port and place it on a clean surface. Install a port plug if not reinstalling a sensor in the exposed port. Exposure to water can cause damage or corrosion to the bulkhead connectors not covered by the warranty.



**Figure 5** Sensor port plugs and port numbering (4-port cables)

## Port plugs

Port plugs and a tube of o-ring lubricant are included in the maintenance kit that ships with all 4-port cables.

## Installation

1. Apply a thin coat of o-ring lubricant to the o-rings on the plug port.
2. Remove any excess lubricant from the o-rings and port plug with a lint-free cloth.
3. Insert the port plug into the empty port and press until firmly seated.
4. Finger-tighten the port plug clockwise to install. If necessary, use the sensor installation tool to make sure that the plug is fully seated into the port. The o-rings will not be visible if a port plug is correctly installed. Do not over-tighten the port plug.

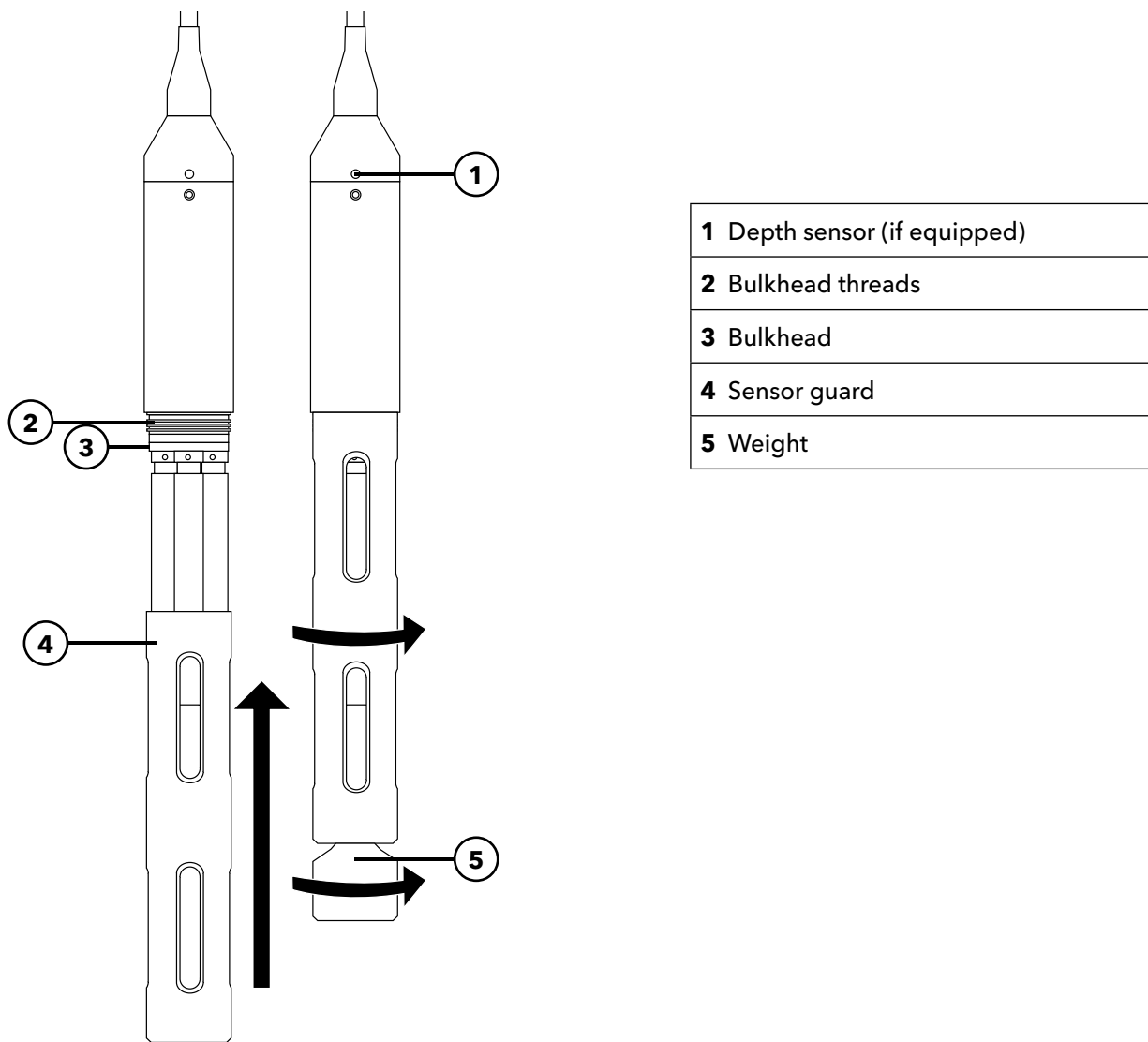
**NOTICE:** Do not submerge the bulkhead without a sensor or port plug installed in all ports.

## Sensor Guard and Weight Installation

1. Carefully slide the sensor guard over the bulkhead and attached sensors/port plugs. Push the sensor guard toward the bulkhead until the sensor guard threads align with the bulkhead threads.
2. Carefully hand-tighten the sensor guard clockwise. If any resistance is felt, loosen the sensor guard completely to prevent cross-threading. Incorrect installation may cause damage to the sensor guard or bulkhead that is not covered by the warranty.



## Sensor Guard and Weight Installation (continued)



**Figure 6** Sensor guard and weight installation on a 4-port cable assembly

## Sensor Guard Weights

To help stabilize the sensors when profiling at deeper depths, a 1 lb. sensor guard weight is supplied with 4-port assemblies 10 meters and longer. To attach the weight, carefully hand-tighten it clockwise on to the bottom of the sensor guard (Figure 6). If any resistance is felt, loosen the sensor guard weight completely to prevent cross-threading.

The bottom of the weight is threaded so that additional weights can be added if needed. YSI recommends installing no more than 5 lbs of weight on ProDIGITAL cables. See [Accessories](#).

**NOTE:** Do not have any weights installed on the sensor guard when calibrating using the calibration cup.

# 2. Operation

## 2.1 Keypad and Navigation

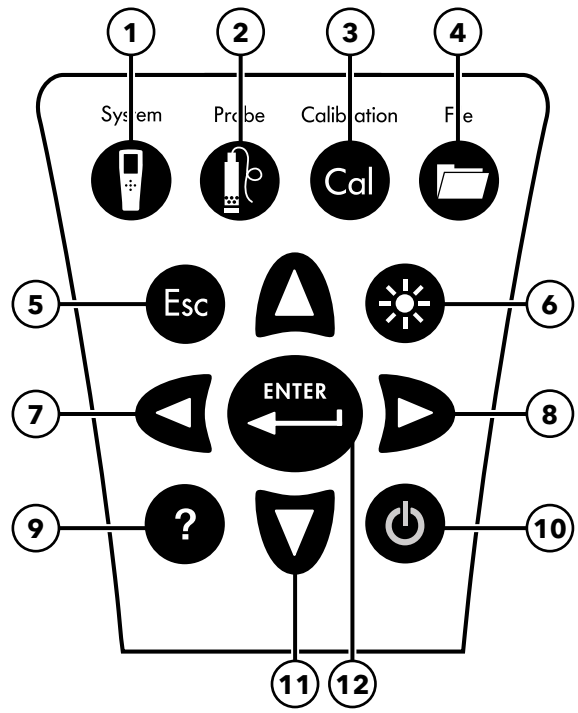


Figure 7 Keypad description

<p><b>1 System:</b> Opens the system menu. Use to adjust system settings.</p>	<p><b>7 Left arrow key:</b> Navigate left in an alpha/numeric entry screen. Push to return to previous menu in all screens except alpha/numeric entry. On the Run screen, push to show graphical representations of the displayed measurements.</p>
<p><b>2 Probe:</b> Opens the sensor menu. Use to setup sensors, change the units shown, select the sensor averaging mode, and turn on/off Auto Stable and GPS.</p>	<p><b>8 Right arrow key:</b> Navigate right in an alpha/numeric entry screen. On the Run screen, push to show graphical representations of the displayed measurements. In the View Data screen, push to view additional parameters in the data set.</p>
<p><b>3 Calibrate:</b> Opens the calibration menu. Use to calibrate sensors or restore default calibration.</p>	<p><b>9 Help:</b> Shows context sensitive help.</p>
<p><b>4 File:</b> Opens the file menu. Use to view logged data and calibration files, backup data to a USB stick, and delete data.</p>	<p><b>10 ON/OFF:</b> Turn on or turn off the instrument.</p>
<p><b>5 Exit/Escape key:</b> Exits to the Run screen. When in an alpha/numeric entry screen, returns to previous menu.</p>	<p><b>11 Up/Down arrow keys:</b> Scroll through menus or enter numbers and letters.</p>
<p><b>6 Backlight:</b> Turns the keypad backlight on or off for use in low light conditions.</p>	<p><b>12 Enter key:</b> Push to confirm selections. On the Run screen, push to log a single data point or start continuous data logging.</p>

## 2.2 Startup

Push the On/Off (⏻) key to turn on the handheld. If the handheld does not turn on, make sure that the battery is charged. Push and hold the ⏻ key for 1.5 seconds to turn the handheld off.

## 2.3 Navigation

The handheld contains menus to change user-defined options, functions, and parameters. Use the arrow keys (▲ and ▼) to highlight different options within menus and sub-menus, then push the Enter (↵) key to select the option. Push the left arrow (←) key to return to the previous menu.

Push the Exit/Escape (Esc) key to return to the Run screen. To enable or disable an option, highlight the option, then push the Enter (↵) key. Enabled functions appear as a circle with a dot (●) or a box with a check mark (☑). Disabled functions appear as a circle only (○) or an empty box (□).

### Alpha/Numeric Entry

When required, an alpha/numeric entry screen will be shown. Use the arrow keys to highlight a specific character and push the Enter (↵) key to select it for entry. When finished entering information, highlight **ENTER**, then push the Enter (↵) key to save the entry (Figure 8).

**NOTE:** When in an alpha/numeric screen, the ← key is for alpha/numeric navigation only. Push the Esc key to cancel and return to the previous menu.

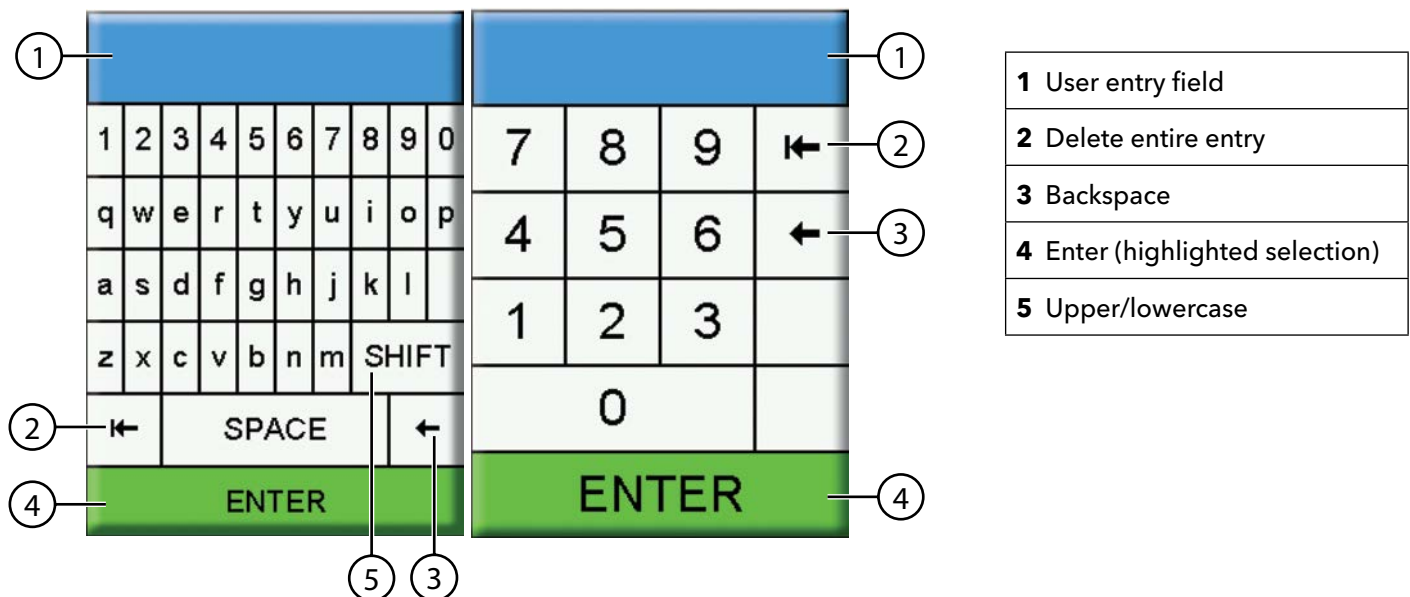


Figure 8 Alpha/numeric and numeric entry screens

# 2.4

## Main Display Description

The main display (Run screen) shows the current measurements and units as defined in the Sensor Display menu. If more measurements are selected than can be displayed on the Run screen, a scroll bar will be shown. Use the ▲ and ▼ arrow keys to view the additional measurements (Figure 9).

The message area shows status messages, error messages, and information about selected functions.

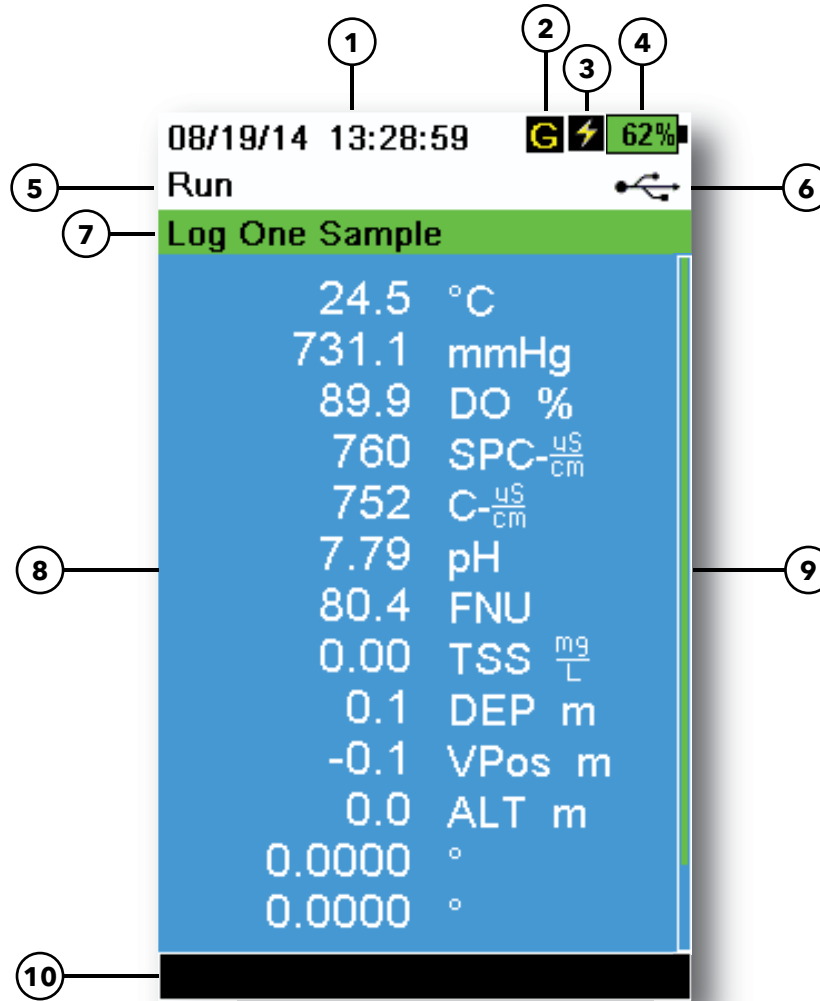




Figure 9 Main display example

1	Date/Time	6	USB/PC connection indicator
2	GPS signal indicator	7	Log or sampling (update measurements) prompt on Run screen (single or continuous)
3	Battery charging indicator	8	Displayed measurements
4	Battery charge %	9	Scroll bar
5	Current screen/menu	10	Message area

# 2.5

## System Menu

Push the System (  ) key to view and adjust instrument settings. Highlight a sub-menu then push the  key to view the sub-menu options (Figure 10).

Pre-defined or user-selected options are noted within brackets ( [ ] ).

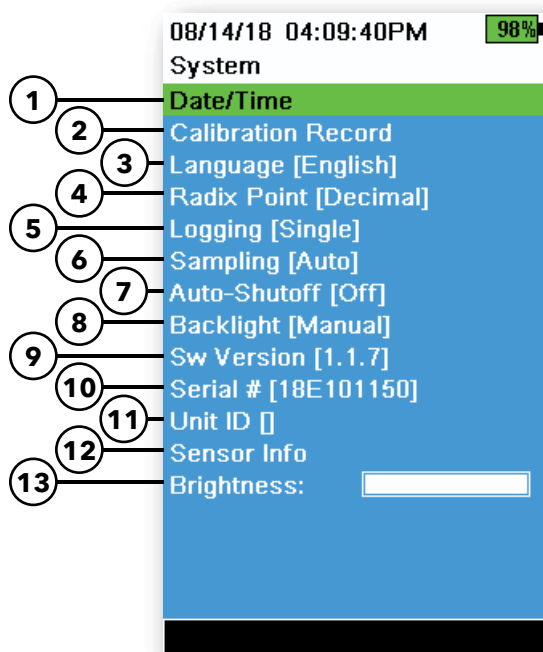


Figure 10 System menu

1	Set the Date and Time
2	Change the user-defined Calibration Options
3	Change the instrument Language settings
4	Change the Radix Point
5	Change the Logging options
6	Change the Sampling options
7	Set the handheld Auto-Shutoff time
8	Set the Backlight mode
9	View the Software Version
10	View the handheld Serial Number
11	View and adjust the Unit ID
12	View the Sensor specific information
13	Adjust the display Brightness

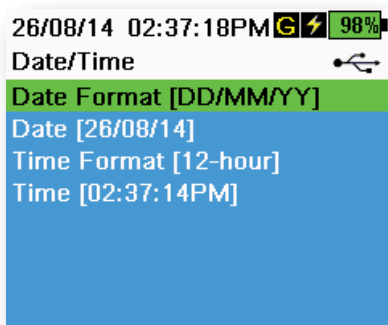


Figure 11 Date/Time

### Date/Time

 → Date/Time

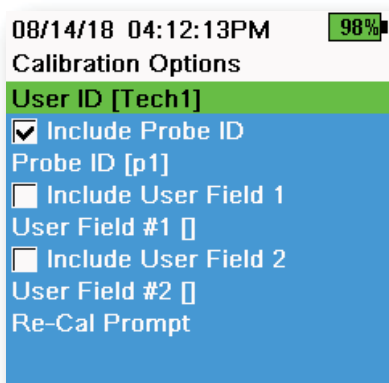
For accurate logging and calibration data, correctly set the date and time options (Figure 11). Select any of the following options to set the Date/Time.

#### Date/Time options:

- Set YY/MM/DD, MM/DD/YY, DD/MM/YY or YY/DD/MM date format
- Set the correct date
- Select 12 or 24 hour time format
- Set the correct time

## Calibration Record

Detailed sensor calibration information is stored for later review. The instrument's internal memory can save up to 400 individual calibration records. After 400 records, the instrument will overwrite previously stored calibration records, starting with the oldest. To prevent the permanent loss of calibration records, periodically download the calibration files to a computer using the KorDSS software.



**Figure 12** Calibration Options

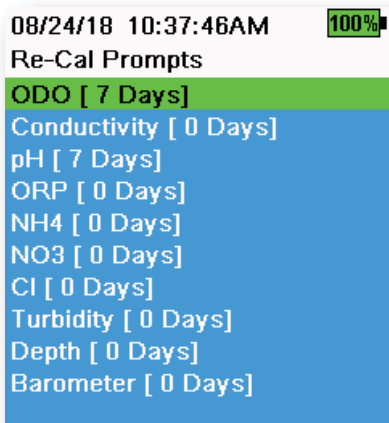
## Calibration Options

☰ → Calibration Record → Options

User ID, Probe ID, or User Field #1 or 2 can be user-defined for positive calibration file identification of:

- The person calibrating the instrument
- The sensor/cable serial number used during calibration (or other, user-defined Probe ID)
- Other user-specific identification (User Field #1 and #2) (Figure 12)

**NOTE:** User Field can be used to describe the condition of the probe. For example, new sensor or new ODO cap.



**Figure 13** Re-Cal Prompts

## Re-Cal Prompts

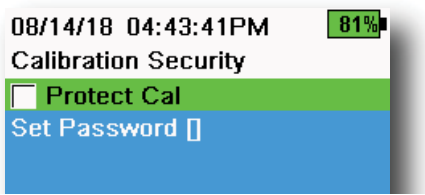
☰ → Calibration Record → Options → Re-Cal Prompts

Re-Cal Prompts provide a reminder to recalibrate a probe in the user-defined number of days (Figure 13). Select the desired sensor Re-Cal prompt, then enter the desired number of days before the Re-Cal prompt occurs. This reminder will be provided when the instrument is powered on and will reoccur every day until the sensor is re-calibrated.

Set the sensor value to zero (0) days (default) to turn off Re-Cal prompts.

## Calibration Security

 → **Calibration Record** → **Security**



**Figure 14** Calibration Security

The Calibration menu can be password protected to prevent accidental or unauthorized sensor calibration (Figure 14).

1. From the Calibration Record menu, select **Security**, then enter the default password "ysi123".
2. Select **Set Password** [ ] and change the default password.
3. Select the **Protect Cal** check box to password protect the Calibration menu.

**NOTE:** Write down and keep the password in a safe place. Contact YSI Technical Support if you lose the password ([Technical support](#)).

## Language

 → **Language**



**Figure 15** Language

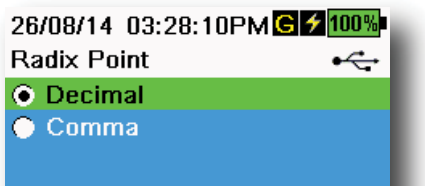
The instrument is shipped with English enabled. If a different language is desired and selected, the handheld will take approximately 10 to 20 seconds to enable the new language (during the first installation only).

### Optional languages:

- Spanish
- French
- German
- Italian
- Portuguese
- Norwegian
- Japanese
- Simplified Chinese
- Traditional Chinese
- Korean
- Thai

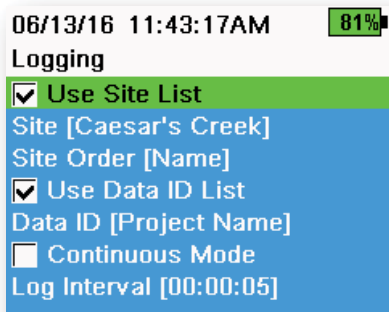
## Radix Point

 → **Radix Point**

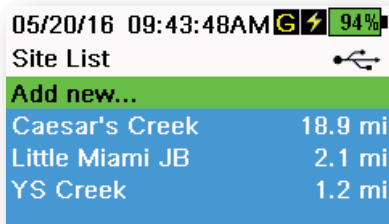


**Figure 16** Radix Point

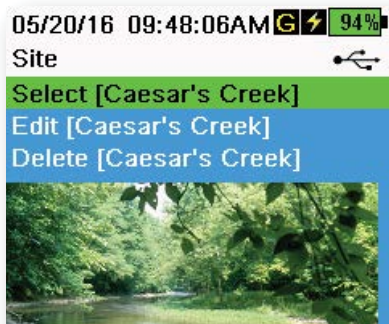
The radix point can be changed to display a comma or a decimal in numeric displays (e.g. 1.00 becomes 1,00 when Comma is selected) (Figure 16).



**Figure 17** Logging



**Figure 18** Site List



**Figure 19** Site

## Logging



The handheld can add a user-defined Site and/or Data ID to a data record if these functions are enabled under the Logging menu. A check mark in the box next to these features indicates they are enabled (Figure 17).


After selecting **Site** [ ] or **Data ID** [ ], the Site List or Data ID List will be shown (Figure 18). New entries can be created by choosing **Add new...**


If the handheld has a GPS signal, the current GPS coordinates will be auto-populated when creating a new site. If the handheld does not have a built-in GPS, the coordinates and altitude can be entered manually.


Sites can be listed in order of Name (*i.e.* alphanumeric order) or Distance from the current position (Figure 18).

Choose an entry from the Site List or Data ID List to **Select**, **Edit**, or **Delete** (Figure 19). When selected, data recorded will be tagged with the specific site and/or data ID.

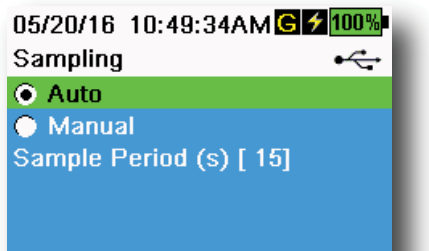
**NOTE:** *The Manage Sites menu in KorDSS Software can be used to send a picture of the Site to the instrument.*

**Continuous Mode** (Interval logging): Select the Continuous Mode check box and enter the user-defined Log Interval (in hours:minutes:seconds) to log samples continuously at the specified time interval. The Run screen will display **Start Logging...** when in Continuous Mode. Press  to begin logging.

**One sample logging:** Clear the Continuous Mode check box. The Run screen will display **Log One Sample**. A sample will be logged each time the  key is pushed when in the Run screen.

**NOTE:** *An option to change Site and/or Data ID (if enabled) appears once  is pressed to begin logging.*





**Figure 20** Sampling

## Sampling



Auto sampling mode continuously updates measurements on the display (Figure 20).

When in Manual mode, the instrument will take measurements for the duration of the user-defined Sample Period (in seconds) then “lock” or hold the readings on the display. The default sample period is 50 seconds, and can be adjusted from 15 to 60 seconds. Manual mode helps conserve battery power.

Once the measurements are locked, push the  key to log the held data, or the  key and then the  key to take a new measurement.

**NOTE:** When both Continuous Logging Mode and Manual Sampling mode are enabled, the handheld will power the sensors on and take measurements for 15 seconds before logging a data set.

## Auto-Shutoff



To conserve battery power, auto-shutoff powers off the instrument after a user-defined time period (in minutes). The auto-shutoff time can be adjusted from 1 to 255 minutes. Set to 0 (zero) to disable Auto-Shutoff.

## Backlight



In Automatic mode, the instrument display will dim 60 seconds after the last key was pushed. Once any key is pushed, the instrument display will return to the user-defined brightness setting and the keypad backlight will turn on. The screen will dim and the keypad backlight will turn off after another 60 seconds of inactivity.

In manual mode, the instrument display remains at the user-defined brightness and the keypad backlight is turned on and off by the Backlight key. Setting the backlight to manual mode is recommended for bright conditions.

## Software (Sw) Version



Sw Version shows the instrument's software version number. The latest instrument software and update instructions are available at [YSI.com](http://YSI.com). Instrument software can be updated through the KorDSS Software under the **Instrument and Sensors** tab.

## Serial #



Serial # shows the serial number of the handheld instrument. Note the serial number when contacting YSI support.

## Unit ID



Users can set a custom Unit ID. The Unit ID identifies the instrument in KorDSS Software.

## Sensor Info

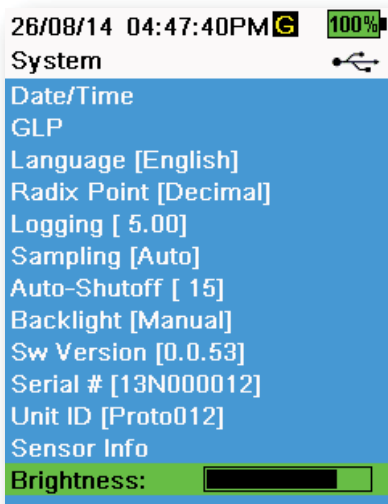


Sensor info shows measurement data, and hardware/software information for each component of the system: instrument, sensor, and bulkhead. Use the ▲ and ▼ arrow keys to scroll through the components.

## Brightness




The screen brightness can be adjusted to accommodate lighting conditions and to conserve battery power (Figure 21). Use the ◀ and ▶ arrow keys to adjust the screen brightness.

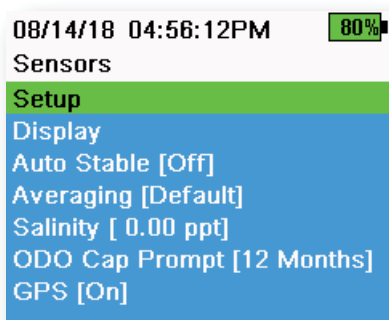


**Figure 21** Display Brightness

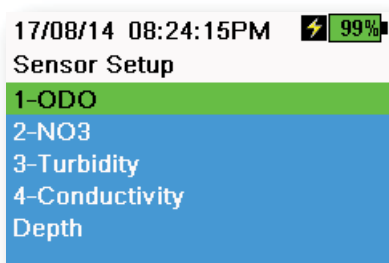
## 2.6

# Sensor Menu

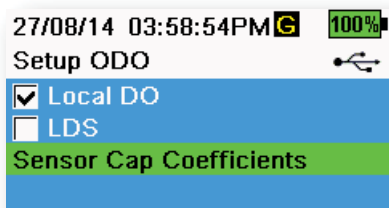
Use the Probe (  ) key to access the Sensor menu and change sensor settings (if applicable), enable the measurement units displayed on the Run screen, set Auto Stable parameters, change the sensor averaging mode, and if equipped, turn on/off GPS.





**Figure 22** Probe (Sensor) menu



**Figure 23** Sensor Setup

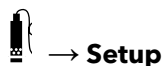


**Figure 24** Setup ODO

Push the  key to access the sensor menu (Figure 22). Highlight a sub-menu then push the  key to view sub-menu options.

Pre-defined or user-selected sensor settings are noted within brackets ([ ]).

## Sensor Setup



The Sensor Setup menu will show all sensors connected to the instrument (Figure 23). If a sensor is connected but is not listed on the Sensor Setup menu (<None> displayed), check the sensor and cable connections.

## Setup ODO

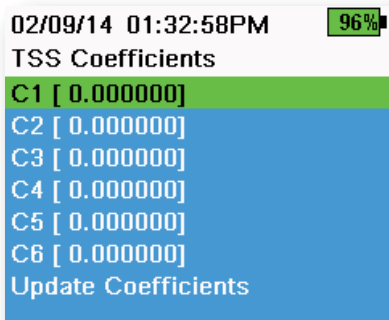


**Local DO:** Enable or disable localized DO% measurements. When enabled, the calibration value is set to 100% regardless of altitude or barometric pressure. When enabled, an L will be shown next to DO% on the run screen. DO mg/L measurements are unaffected when Local DO is enabled (Figure 24).

**LDS:** Last Digit Supression (LDS) rounds the DO value to the nearest tenth, e.g. 8.27 mg/L becomes 8.3 mg/L.

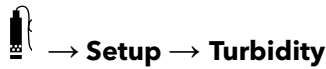
**Sensor Cap Coefficients:** The sensor cap coefficients must be updated after sensor cap replacement. Update the sensor cap coefficients using the coefficient sheet provided with the new sensor cap. Once updated, the coefficients are saved to the ODO sensor and do not need to be re-entered.

**NOTE:** The coefficients stay with the sensor even when used with different handheld meters.



**Figure 25** TSS coefficients

## Setup Turbidity



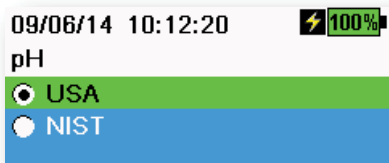
**TSS Coefficients:** Total Suspended Solids (TSS) can be measured if correlation coefficients are calculated in KorDSS.

To obtain these coefficients, collect turbidity data at the sampling site with corresponding grab samples. Analyze the samples in a lab to determine a true TSS measurement (mg/L). At least 2 and up to 6 value pairs of turbidity and TSS measurements can be used.

Correlation data must be collected for each unique sampling site, as this correlation is site-specific.

In KorDSS Software, enter the field-obtained turbidity measurements and the corresponding lab-obtained TSS measurements in the Instrument and Sensors menu. Coefficients can then be calculated with KorDSS and sent to the sensor.

**NOTE:** Although correlation coefficients can be entered directly into the handheld (Figure 25), only KorDSS Software can calculate the coefficients.

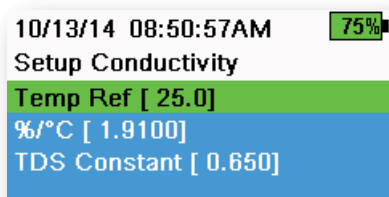


**Figure 26** Setup pH

## Setup pH

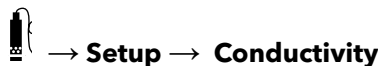


Select USA auto-buffer recognition (4.00, 7.00, and 10.00) or NIST auto-buffer recognition (4.01, 6.86, and 9.18) (Figure 26). Calibration values are automatically compensated for temperature for both buffer sets.



**Figure 27** Setup Conductivity

## Setup Conductivity



**Temp Ref:** Reference temperature is used to calculate temperature compensated specific conductance. All specific conductance values are compensated to the Temp Ref temperature. The default value is 25°C (Figure 27). Enter a new value between 15.00°C and 25.00°C.

**%/°C** (Percent per degree Celsius): The temperature coefficient is used to calculate temperature compensated specific conductance. The default is 1.91% based on KCl standards. Enter a new value between 0 and 4%.

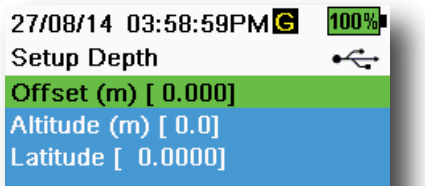
**TDS Constant:** This is a multiplier used to calculate an estimated Total Dissolved Solids (TDS) value from conductivity. The multiplier is used to convert specific conductance in mS/cm to TDS in g/L. The default value is 0.65. Enter a new value between 0 and 0.99.

## Setup Conductivity (continued)

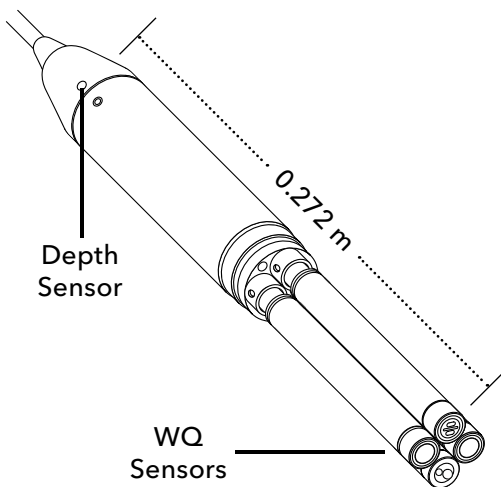
The TDS multiplier is highly dependent on the nature of the ionic species present in the water sample. To be assured of moderate accuracy for the conversion, you must determine a multiplier for the water at your sampling site. Use the following procedure to determine the multiplier for a specific sample:

1. Determine the specific conductance of a water sample from the site.
2. Filter a portion of water from the site.
3. Carefully measure a volume of the filtered water. Completely evaporate to yield a dry solid.
4. Accurately weigh the remaining solid.
5. Divide the weight of the solid (in grams) by the volume of water used (in liters) to yield the TDS value in g/L for the site.
6. Divide the TDS value in g/L by the specific conductance of the water in mS/cm to yield the conversion multiplier.

**NOTE:** If the nature of the ionic species at the site changes between sampling studies, the TDS values will be in error. TDS cannot be calculated accurately from specific conductance unless the make-up of the chemical species in the water remains constant.



**Figure 28** Setup Depth



**Figure 29** Distance of depth sensor to WQ sensors on 4-port cable

## Setup Depth

 → Setup → Depth

Cable assemblies with a depth sensor in the bulkhead can measure virtual vented depth. The virtual vented depth measurement allows for real time compensation for atmospheric pressure using the handheld's barometer.

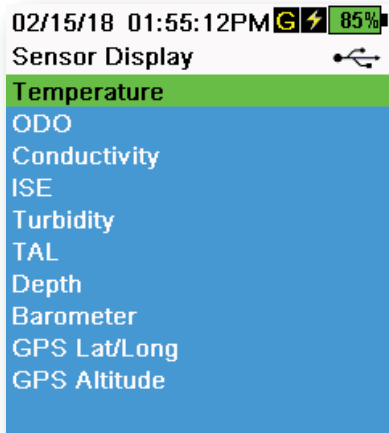
**Depth offset:** Depth offset can be used if referencing water elevation against a known value. If a depth offset is entered (in meters), the output value will shift by the value of the offset (Figure 28).

A common offset entered by the user is the depth sensor location relative to the rest of the WQ sensors. This value is 0.272 m on the 4-port cable (Figure 29).

**Altitude/Latitude:** To compensate for atmospheric pressure based on elevation and gravitational pull, enter the local altitude in meters relative to sea level and latitude in degrees where the instrument is sampling.

Latitude effect: Varying latitudes can cause up to a 200 mm change in depth from equator to pole.

Altitude effect: A 100 m change in altitude causes a 1.08 mm of change to the depth readings.



**Figure 30** Sensor Display

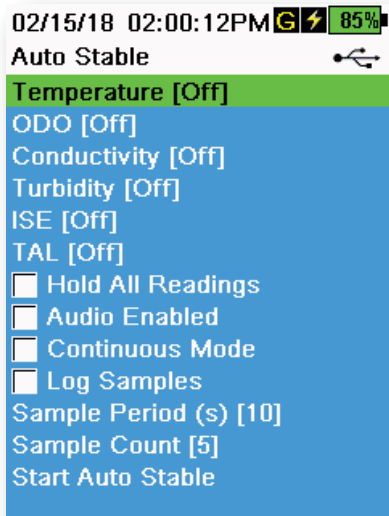
## Sensor Display



The Sensor Display menu determines the parameters and units that are shown on the Run screen (Figure 9). The Run screen will only show measurements for sensors that are attached to the cable bulkhead.

If more measurements are selected than can be displayed on one screen, a scroll bar will be shown. Use the ▲ and ▼ keys to scroll through the measurements.

**NOTE:** For depth profiling, enable Vertical Position under Depth Display to view the real-time position of the depth sensor in the water column. This is helpful in profiling applications to ensure the depth sensor is lowered to the desired depth without waiting for the depth data to stabilize.



**Figure 31** Auto Stable

## Auto Stable



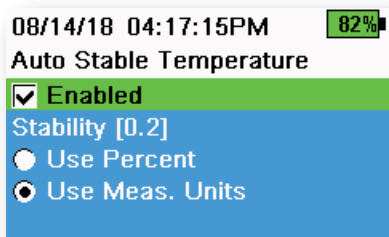
Auto Stable indicates when a measurement is stable. Sensors with Auto Stable enabled will have <sup>A</sup>s flash beside the measurement on the Run screen. <sup>A</sup>s will flash green when the measurement is stable.

Select a sensor to enable or disable Auto Stable (Figure 31). Then set the stability threshold parameters.

The Auto Stable stability threshold can be set by percent of measurement or in the units of measurement selected in the Sensor Display menu. Enter the stability value, then select **Use Percent** or **Use Meas. Units** (Figure 32).

This threshold is used to compare the last reading with the previous. The smaller the number entered in % or units, the longer it will take for the instrument to reach the auto stable criteria.

Example: For temperature in °C, if Measurement Units threshold is set to 0.2 and the temperature reading changes by more than 0.2 degrees, <sup>A</sup>s will continue to be red until the reading does not change by more than 0.2°C over the defined sample period and sample count.



**Figure 32** Auto Stable stability threshold

**Hold All Readings:** After all sensors have reached their stability criteria, the measurements will be held or 'locked' on the display. If disabled, the sensor measurements will continue to change in real time.

**Audio Enabled:** An audio alert will sound when stability is reached.

## Auto Stable (continued)

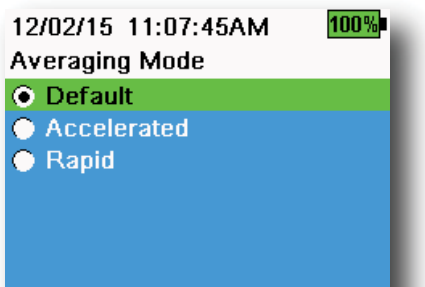
**Continuous Mode:** The handheld will continuously check sensor values against the stability criteria even after the sample period and sample count have been met.

**Log Samples:** Logs the sample/s defined by the Sample Period to memory.

**Sample Period:** Time interval between samples that are used to determine stability. Set the interval in seconds (1 to 900).

**Sample Count:** Number of consecutive samples required for stability (1 to 10).

Select Start Auto Stable to enable.



**Figure 33** Averaging

## Averaging

 → **Averaging** (Figure 33)

The averaging mode determines how the handheld will filter data. A smaller time frame for the rolling average window allows changes in the sensor's measurements to be more quickly observed, while a larger rolling window provides more stable measurement readings and a smooth result. Each averaging mode will decrease the time span of the rolling window if a large change in the sensor measurement is detected, allowing the handheld to adapt when an event occurs.

The **Default** mode provides optimum averaging for all sensors. This mode has up to 40 seconds of averaging on the sensors to curb spikes and outliers, resulting in more stable data.

In **Accelerated** mode, changes in sensor measurements are more quickly observed than default (approximately 10 seconds of averaging). This mode is recommended when the sensors are moving through the water, such as during profiling studies and most spot sampling applications.

**NOTE:** For profiling applications, enable Vertical Position under Depth Display to view unfiltered depth measurements. This helps to ensure the depth sensor is lowered to the desired depth without waiting for the averaged measurement.

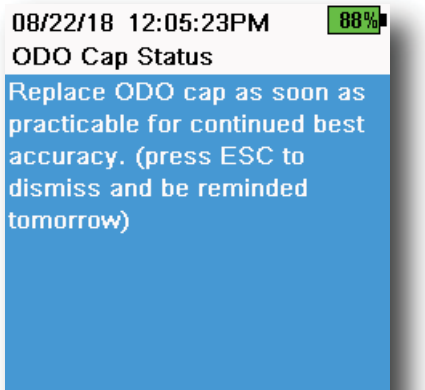
In **Rapid** mode, sensor response is very fast (approximately 2 seconds of averaging), but the instrument will never settle on a single steady number. This mode is recommended when the sensors are moving quickly through the water, such as rapid profiling and towed applications.

## Salinity



Salinity is determined by calculations derived from the conductivity and temperature sensors.

When a conductivity sensor is installed, the instrument will automatically use the salinity measurement for DO and “As Measured” will be displayed. If no conductivity sensor is installed (e.g. ODO/T cable assembly used), the salinity value will be user-selectable.



**Figure 34** ODO Cap Status

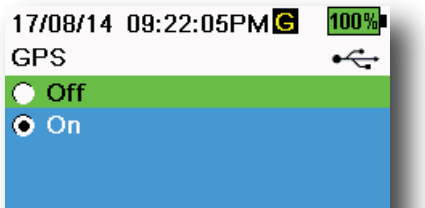
## ODO Cap Prompt



The handheld can remind users when it is time to replace the ODO Cap based on a user-defined interval (Figure 34). To set the reminder, select ODO Cap Prompt and **input a number in months**. YSI recommends enabling this setting to match the warranty period of the ODO Cap:

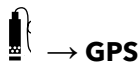
- ProDSS ODO Sensor Cap [SKU: 626890] = **12** months
- ODO Extended Warranty Sensor Cap [SKU: 627180] = **24** months

The handheld will automatically recognize the last time the ODO Sensor Cap coefficients were updated and alert the user when the Cap is due for replacement. To disable the prompt, simply enter **0** for the number of months.



**Figure 35** GPS

## GPS (Optional)



Some handhelds feature a built-in GPS. GPS turns the handheld Global Positioning System On or Off. The **G** symbol is shown when a GPS signal is received (Figure 35).



When enabled, the GPS coordinates will be saved with the Calibration Record and logged data. Note that the battery will drain more rapidly when GPS is enabled than when it is not enabled.

**NOTE:** GPS data will be most accurate when there is a clear line of sight to satellites. It may be difficult for the handheld to receive a good GPS signal when under canopy or indoors.

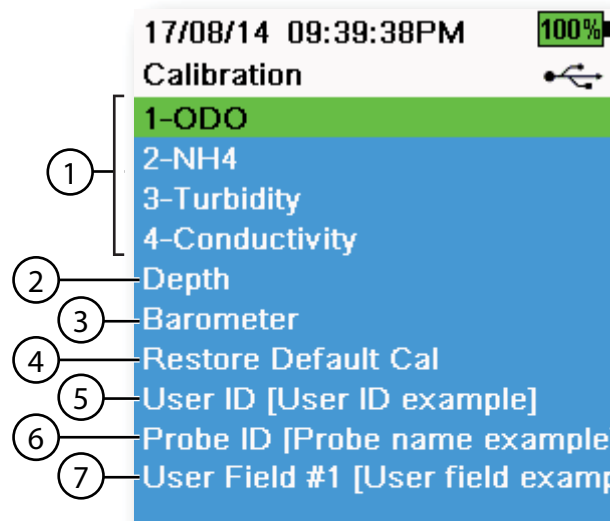


# 2.7

## Calibration Menu

Push the Calibrate (  ) key to access the Calibration menu (Figure 36). Highlight a sub-menu then push the  key to view sub-menu options. Pre-defined or user-selected parameters are noted within brackets ( [ ] ). Refer to the Calibration section for sensor specific calibration procedures.



**NOTE:** User ID, Probe ID, and User Field #1 and #2 can be enabled in the **Calibration Settings** under the System menu.



**Figure 36** Calibration menu

<b>1</b> Sensors connected	<b>5</b> User ID
<b>2</b> Optional Depth sensor calibration	<b>6</b> Probe ID
<b>3</b> Barometer calibration	<b>7</b> User Field #1
<b>4</b> Restore Default Calibration - restores specified sensor to factory default	

## 2.8 Files Menu

Push the File (  ) key to access the Files menu (Figure 37). Highlight a sub-menu then push the  key to view sub-menu options.

Use the Files menu to view, delete or backup logged data or the calibration file. Data can be filtered by a specific date and time range and by user-created Site and Data ID lists.

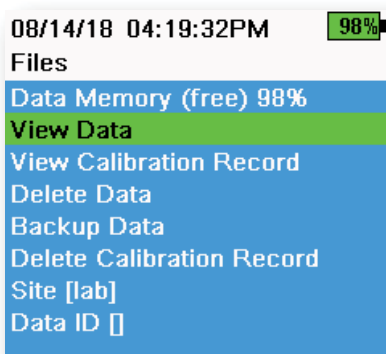


Figure 37 Files menu

**Data Memory:** (free) % shows the remaining memory available. Download or delete data to free available internal memory.

The Site List and/or Data ID List can be seen by selecting **Site [ ]** or **Data ID [ ]**. To enable the use of Site and/or Data ID when logging data, select **Logging** under the System menu.

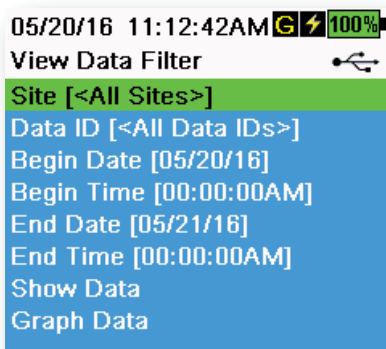


Figure 38 View Data Filter

### View Data Filter

 → **View Data**

Enter the desired filter criteria, then select **Show Data** or **Graph Data** to view the tabular or graphical data. If necessary, use the arrow keys to scroll through the data (Figure 38 and Figure 39).

**Site:** View data from one site or all sites.

**Data ID:** View data from one ID or all IDs.

**Begin/End:** View data within specific date and time ranges.

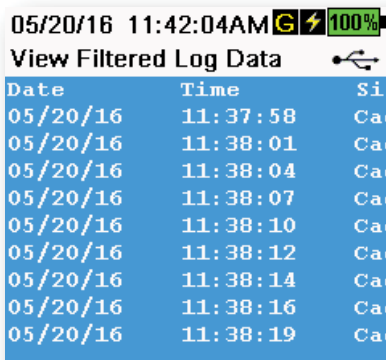
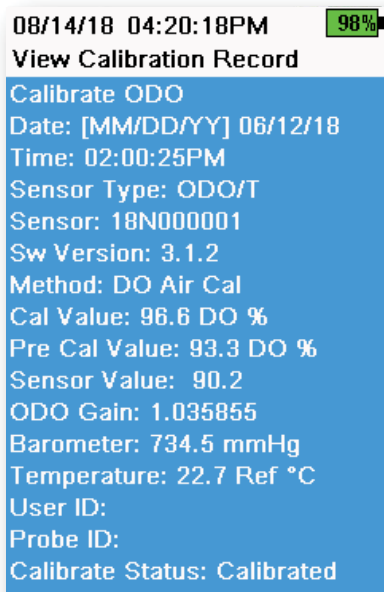


Figure 39 View Filtered Log Data



**Figure 40** View GLP

## View Calibration Record



Select **View Calibration Record** to show the stored sensor calibrations (Figure 40).

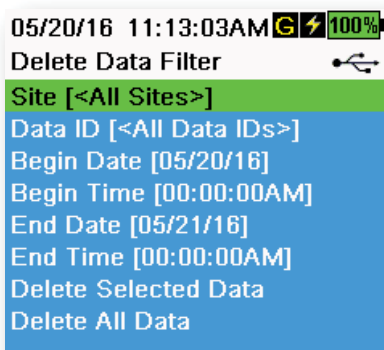
Use the arrow keys to scroll through the calibration file data.

## Calibration Information

### Information in each calibration record:

- Sensor calibrated
- Date/time stamp
- Sensor ID
- Sensor serial #
- Sensor software version
- User ID (optional)
- Probe ID (optional)
- User Fields #1 and #2 (optional)
- Calibration status
- Calibration value
- Temperature

Depending on the parameter, a calibration record may include additional information such as the Conductivity cell constant, ODO gain, ORP offset, and pH slope.



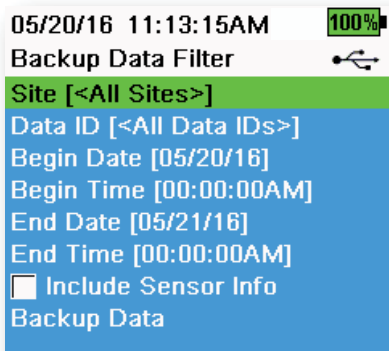
**Figure 41** Delete Data Filter

## Delete Data

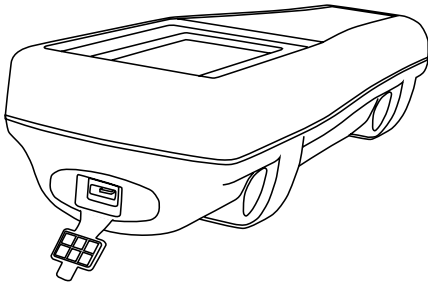


Enter the desired filter criteria, then select **Delete Selected Data** to *permanently* delete the data (Figure 41).

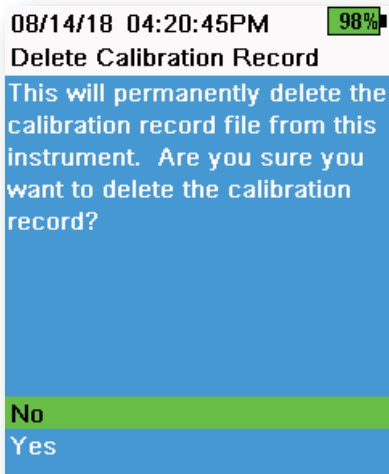
Select **Delete All Data** to permanently delete all logged data from the handheld.



**Figure 42** Backup Data



**Figure 43** Micro USB female connector



**Figure 44** Delete Calibration Record

## Backup Data



This function allows you to backup logged data to a flash drive based on Site, Data ID, and log date (Figure 42). A USB female to micro USB male adapter is included with new instruments for this data backup.

**NOTE:** The USB storage device must be formatted as FAT32, not NTFS or exFAT. The handheld will only support FAT32.

If the box next to “**Include Sensor Info**” is checked, each data set will be sent to a flash drive as a separate file with sensor serial number and sensor software information included. If the box is not checked (default), all data sets will be sent in a single backup file with no sensor serial number or sensor software information.


**NOTE:** It is suggested to send data to the USB flash drive as a single file (i.e. box is not checked) unless this sensor information is needed. This makes importing the data much faster and easier.

Once the filter settings are configured, select **Backup Data** to send the data to a flash drive. The data is exported in a CSV file.

If the data backup is not successful, ensure the correct filter criteria are selected and the USB connection indicator can be seen at the top of the screen (Figure 9).

## Delete Calibration Record





To permanently delete the Calibration Record file from the instrument, select **Yes**, then push the  key (Figure 44).


## 2.9

# Taking Measurements

For the highest accuracy, calibrate the sensor(s) before taking measurements.

1. Create Site and Data ID lists for logged data (if applicable).
2. Set the logging method (single or interval).
3. Set the Auto Stable parameters (if applicable).
4. Verify that the sensors and/or port plugs are correctly installed in all bulkhead ports.
5. Install the probe guard.
6. Insert the probe into the sample. Make sure the probe is fully submerged.
7. Move the probe in the sample to release any air bubbles and to provide a fresh sample to the sensors.
8. Wait for the sensor/s to stabilize in the sample.
9. On the main run screen, press  to begin logging (single or interval) (See [Logging](#)).

**NOTE:** An option to change Site and/or Data ID (if enabled) appears once  is pressed to begin logging.

10. To stop continuous logging, simply press  key again.

# 3. Calibration

ProDIGITAL sensors (except temperature) require periodic calibration. Calibration procedures follow the same basic steps with variations for specific parameters. Before calibration, adjust *Calibration Record* settings under the **System** menu if applicable to user requirements. Set up sensor options, settings, and coefficients as applicable.

## 3.1 Calibration Setup

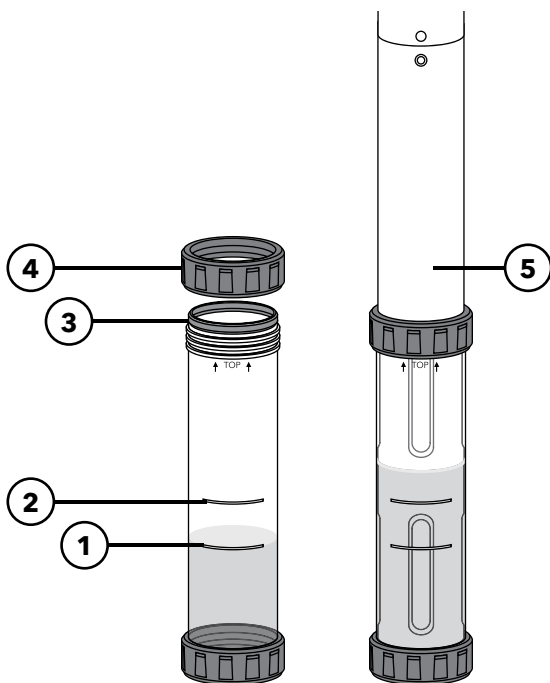
Make sure the calibration cup, sensor guard, and all sensors are clean. YSI recommends installing the sensor guard before placing the sensors into the calibration cup.

For highest data accuracy, thoroughly rinse the calibration cup and sensors with a small amount of the calibration standard for the sensor to be calibrated. Discard the rinse standard, and proceed with a fresh standard.

Be careful to avoid cross-contamination with other standards between calibrations by thoroughly rinsing with DI water and drying the calibration cup and sensors.

Ensure the calibration cup gasket is correctly seated. Loosely install the retaining nut on the cup. Slide the calibration cup over the sensors and sensor guard and tighten the retaining nut (Figure 45).

### Calibration Cup Installation for 4-Port Cable Assemblies

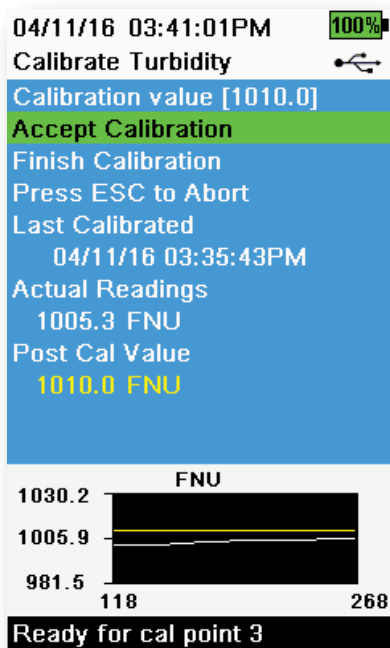


<b>1</b> Fill line one (for all calibration solutions except for conductivity)
<b>2</b> Fill line two (for conductivity calibration solution)
<b>3</b> Gasket
<b>4</b> Retaining nut
<b>5</b> Calibration cup installed

It takes 170 mL of solution to fill the calibration cup to line 1, while it takes 225 mL to fill to line 2.

**Figure 45** Calibration cup standard volume (4-port cable)

## Calibration Setup (continued)



**Figure 46** Layout of calibration screen

### Calibration Screen Layout

The calibration screen has the same basic layout for each parameter (Figure 46).

**Calibration value:** This is the value the sensor will be calibrated to. The Yellow Line on the graph corresponds to this value.

**Accept Calibration:** Select this to calibrate the sensor to the calibration value.

**Finish Calibration:** This option is only available with multi-point calibrations (*i.e.* pH, ISE, turbidity, PC, PE, and chlorophyll). Finishes the calibration by applying previously accepted points.

**Press ESC to Abort:** Press the ESC key to leave the calibration. The sensor will not be calibrated to any points. The last successful calibration will be used.

**Last Calibrated:** View the date and time of the last successful sensor calibration.

**Actual Readings:** This shows the current measurement value on the Run screen. The White Line on the graph corresponds to this value. Observe the White Line to ensure the measurement is stable before choosing Accept Calibration.

**Post Cal Value:** This is the same as the calibration value. This will be the measurement value in the current solution after the calibration is finished.

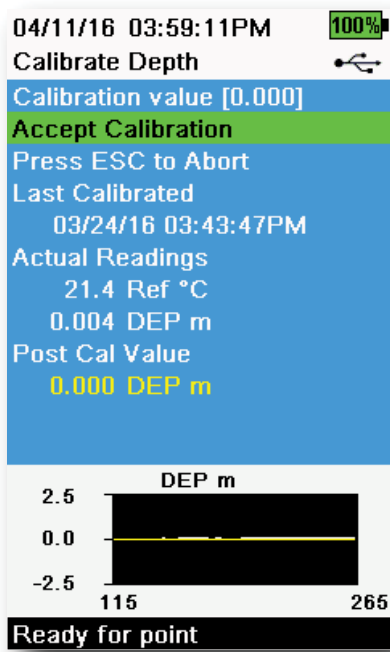
## 3.2 Depth

**NOTE:** This calibration option is available only if your bulkhead is equipped with a depth sensor.

Depth is calculated from the pressure exerted by the water column minus atmospheric pressure. Factors influencing depth measurement include barometric pressure, water density, and temperature. Calibration in the atmosphere “zeros” the sensor with respect to the local barometric pressure.


YSI recommends calibrating depth at the location of measurement. A change in barometric pressure will result in a zero shift unless the transducer is recalibrated to the new pressure.

If applicable, enter the depth offset to set the depth measurement to something other than zero. Enter the altitude and latitude of your sampling location to increase the accuracy of your depth measurement.



**Figure 47** Calibrate Depth

### Depth Calibration

1. Make sure that the depth sensor is clean and dry in air, not immersed in any solution. For best results, keep the bulkhead still and in one position while calibrating.
2. Push the  key, then select **Depth**. The **Calibration Value** is set to 0.000 and should not be changed for air calibrations, even if using an offset.
3. Observe the actual measurement readings for stability (white line on graph shows no significant change for 40 seconds), then select **Accept Calibration** (Figure 47).

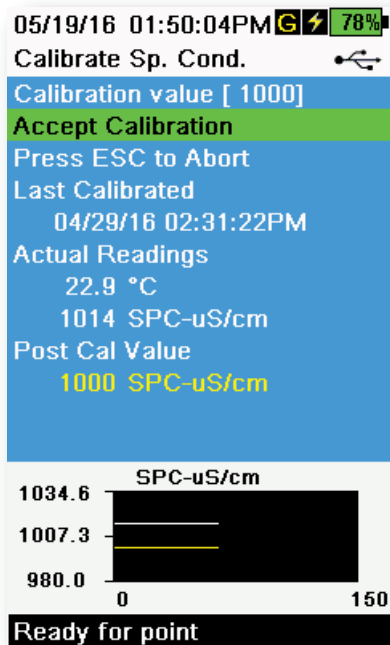
If the depth offset is used, the depth measurement will be adjusted after calibration.



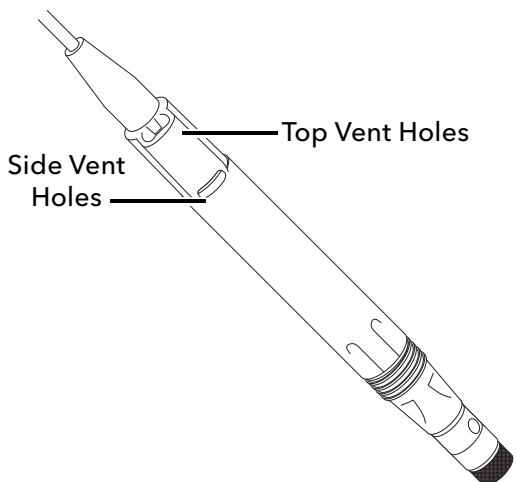
## 3.3 Conductivity

The conductivity/temperature sensor can measure and calculate conductivity, specific conductance (temperature compensated conductivity), salinity, non-linear function (nLF) conductivity, TDS, resistivity, and density. Calibration is only available for specific conductance, conductivity, and salinity. Calibrating one of these options automatically calibrates the other conductivity/temperature parameters listed above. For both ease of use and accuracy, YSI recommends calibrating specific conductance.

Select the appropriate calibration standard for the conductivity of the sampling environment. Standards at least 1 mS/cm (1000  $\mu\text{S}/\text{cm}$ ) are recommended for the greatest stability. For fresh water applications, calibrate to 1,000. For salt water applications, calibrate to 50,000  $\mu\text{S}$ .



**Figure 48** Calibrate specific conductance



**Figure 49** ODO/CT Cable Assembly

### Conductivity Calibration

1. Make sure the conductivity sensor is clean prior to calibration. If necessary, clean the conductivity cell with the supplied soft brush.
2. Place the correct amount of conductivity standard into a clean and dry or pre-rinsed calibration cup.
3. Carefully immerse the sensors into the solution. Make sure the solution is above the vent holes on the side of the conductivity sensor.

If using the ODO/CT assembly, ensure the vent holes at the top of the sensor are completely immersed and the solution level is at least 1 cm higher than the top vent holes (Figure 49). A graduated cylinder is included with ODO/CT cable assemblies for the purpose of calibrating conductivity.

For 4-port cable assemblies, fill the calibration cup to the second line with fresh calibration standard. It takes 225 mL of solution to fill to line 2.

4. Gently rotate and/or move the sensor up and down to remove any bubbles from the conductivity cell. Allow at least 40 seconds for temperature equilibration before proceeding.
5. Push the  $\text{Cal}$  key, select **Conductivity**, then select **Specific Conductance**.
6. Select **Calibration value** then enter the calibration value of the standard used. Note the measurement units the instrument is reporting and calibrating and be sure to enter in the correct calibration value for the units being used. For example, 10,000  $\mu\text{S}$  = 10 mS. Make sure that the units are correct and match the units displayed on the handheld.
7. Observe the actual measurement readings for stability (white line on graph shows no significant change for 40 seconds), then select **Accept Calibration** (Figure 48). "Calibration successful!" will be displayed in the message area.

(continued on next page)

## Conductivity Calibration (continued)

8. Rinse the sensor in clean water then dry.

**NOTE:** If the data is not stabilized after 40 seconds, gently rotate the sensor or remove/reinstall the calibration cup to make sure that no air bubbles are in the conductivity cell.

If you get calibration error messages, check for proper sensor immersion, verify the calibration solutions is fresh, the correct value has been entered into the handheld, and/or try cleaning the sensor.

## 3.4 Barometer

The barometer is factory calibrated and should rarely need to be recalibrated. The barometer is used for DO calibration, %Local measurements, and for virtual vented depth measurements. Verify that the barometer is accurately reading “true” barometric pressure and recalibrate as necessary.

Laboratory barometer readings are usually “true” (uncorrected) values of air pressure and can be used “as is” for barometer calibration. Weather service readings are usually not “true”, i.e. they are corrected to sea level and cannot be used until they are “uncorrected”. Use this approximate formula:

$$\text{True BP in mmHg} = [\text{Corrected BP in mmHg}] - [2.5 * (\text{Local altitude in ft. above sea level} / 100)]$$

Example:

Corrected BP = 759 mmHg

Local altitude above sea level = 978 ft

$$\text{True BP} = 759 \text{ mmHg} - [2.5 * (978 \text{ ft} / 100)] = 734.55 \text{ mmHg}$$

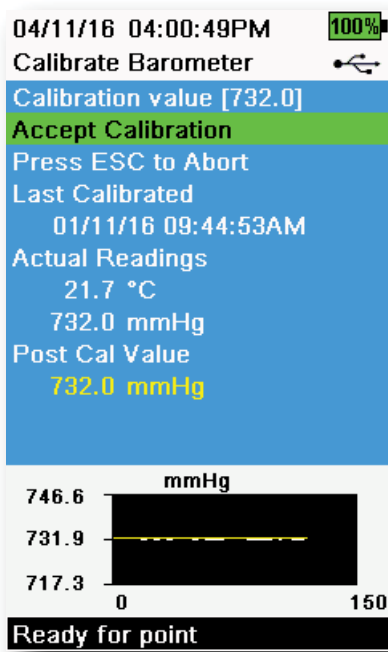


Figure 50 Calibrate Barometer

### Barometer Calibration

1. Push the **Cal** key, then select **Barometer**.
2. Select **Calibration value** then enter the correct “true” barometric pressure.

**NOTE:** The measurement units during calibration are dictated by what is enabled in the sensor setup menu. Be sure to enter in the correct units.

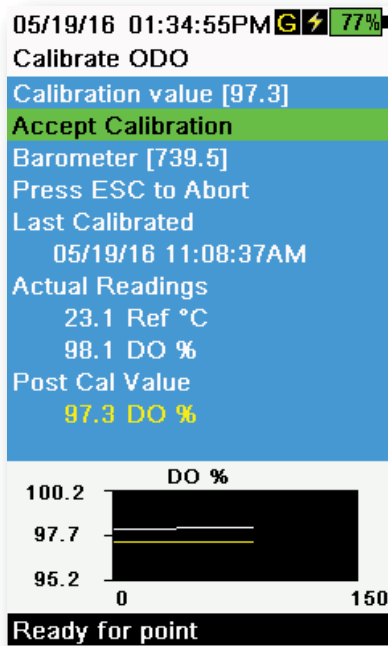
- BP in mmHg = 25.4 x BP inHg
- BP in mmHg = 0.750062 x BP mb
- BP in mmHg = 51.7149 x BP psi
- BP in mmHg = 7.50062 x BP kPa
- BP in mmHg = 760 x BP atm

3. Select **Accept Calibration** (Figure 50). “Calibration successful!” will be displayed in the message area.

## 3.5 Dissolved Oxygen

ODO calibration requires the current “true” barometric pressure. Make sure that the barometer is reading accurately prior to ODO calibration.

Calibrating in DO% or DO% local automatically calibrates the mg/L and ppm measurement. There is no reason to calibrate both parameters. For both ease of use and accuracy, we recommend that you calibrate DO% or DO% Local and not mg/L.



**Figure 51** Calibrate ODO %

### ODO% and ODO% Local - Water Saturated Air Calibration

1. Place a small amount of clean water (5 mL) in the calibration cup or a wet sponge into the calibration sleeve (for ODO/T and ODO/CT probes).
2. Make sure there are no water droplets on the ODO sensor cap or temperature sensor.
3. Attach the probe guard and carefully slide into the calibration cup. Make sure a seal is not created around the probe. Atmospheric venting is required for accurate calibration.
4. Turn the instrument on and wait approximately 5 to 15 minutes for the air in the storage container to be completely saturated with water.
5. Push the key, then select **ODO**. Select **DO%**.
6. Observe the actual measurement readings for stability (white line on graph shows no significant change for 40 seconds), then select **Accept Calibration** (Figure 51). “Calibration successful!” will be displayed in the message area.

**NOTE:** If you see a calibration error message, verify the barometer reading and inspect the sensor cap. Clean and/or replace the sensor cap as needed.

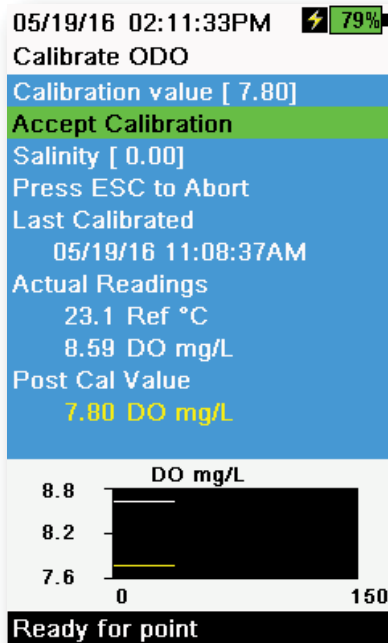



Figure 52 Calibrate ODO mg/L

## ODO mg/L Calibration

1. Place the ODO and conductivity/temperature sensor into a water sample that has been titrated by the Winkler method to determine the dissolved oxygen concentration in mg/L.
2. Push the  key, then select **ODO**. Select **DO mg/L**.
3. Select **Calibration value**.
4. Enter the dissolved oxygen concentration of the sample in mg/L.
5. Observe the actual measurement readings for stability (white line on graph shows no significant change for 40 seconds), then select **Accept Calibration** (Figure 52). "Calibration successful!" will be displayed in the message area.
6. Rinse the bulkhead and sensors in clean water then dry.

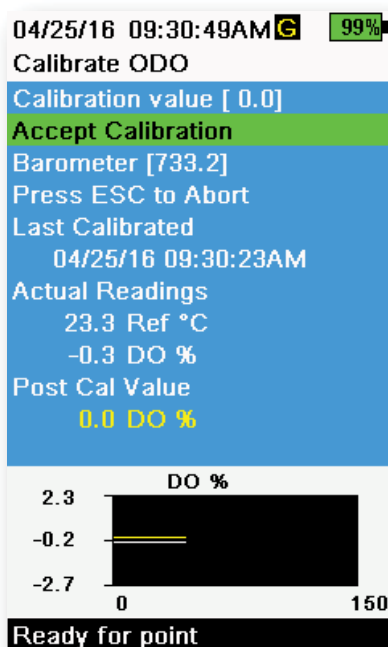



Figure 53 Calibrate ODO zero point

## ODO Zero Point Calibration

1. Place the ODO and Conductivity/Temperature sensors in a solution of zero DO.
 

**NOTE:** A zero DO solution can be made by dissolving approximately 8-10 grams of sodium sulfite into 500 mL of tap water. Mix the solution thoroughly. It may take the solution 60 minutes to be oxygen-free.
2. Push the  key, then select **ODO**. Select **Zero**.
3. Observe the actual measurement readings for stability (white line on graph shows no significant change for 40 seconds), then select **Accept Calibration** (Figure 53). "Calibration successful!" will be displayed in the message area.
4. Thoroughly rinse the bulkhead and sensors in clean water then dry.
5. Perform a ODO % water-saturated air calibration after performing a zero point calibration.

# 3.6

## Turbidity

### Standards

For best results, YSI recommends the following standards for turbidity calibration:

Calibration Point	Standard Value
1	0 FNU [SKU: 608000]
2	12.4 FNU [SKU: 607200] or 124 FNU [SKU: 607300]
3	1010 FNU [SKU: 607400]

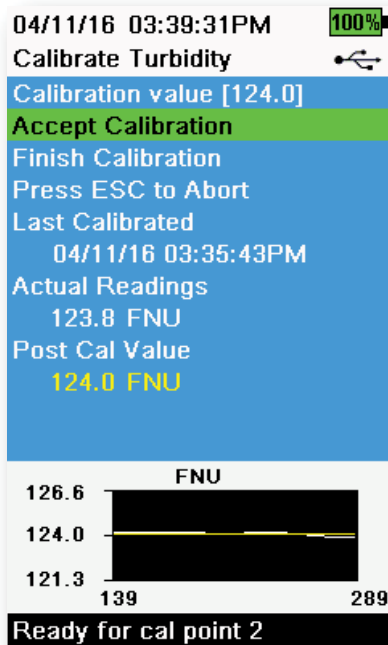
Other standards may be acceptable as long as they have been prepared according to details in Standard Methods for the Treatment of Water and Wastewater (Section 2130 B). These standards include:

- YSI Certified AMCO-AEPA polymer-based standards (see above)
- Hach StablCal™ standards in various NTU denominations
- Dilutions of 4000 NTU formazin concentrate purchased from Hach
- Other formazin standards prepared according to the Standard Methods

The use of standards other than those mentioned above will result in calibration errors and inaccurate field readings. It is important to use the same type of standard for all calibration points; do not mix formazin and polymer-based standards for different points in a multi-point calibration.

When using an alternative standard (non-YSI), calibration can be completed using the following limits:

	Min	Max	Unit
1st Calibration Point	0.0	1.0	FNU or NTU
2nd Calibration Point	5.0	200	FNU or NTU
3rd Calibration Point	400	4000	FNU or NTU



**Figure 54** Calibrate Turbidity

## Turbidity Calibration 2-Point

Turbidity calibrations, more than most other parameters, are susceptible to interference from contamination. It is critical for calibrations to be performed with very clean sensors, guards, and cups.

**NOTE:** Calibration standards should not be re-used.

1. Fill the calibration cup to the appropriate level with 0 FNU standard (deionized water may be used as a substitute). The sensor guard must be installed to ensure an accurate calibration. Make sure the guard is installed and immerse the probe in the zero standard.
2. Push the **Cal** key, then select **Turbidity**.
3. Select **Calibration Value** and enter 0.00.
4. Make sure there are no air bubbles on the turbidity sensor lens. If present, lightly tap the guard against the cup to dislodge any bubbles. Observe the actual measurement readings for stability (white line on graph shows no significant change for 40 seconds), and then select **Accept Calibration**. "Ready for cal point 2" will be displayed in the message area.
5. Discard the used standard, and rinse the probe, guard, and calibration cup with a small amount of the next calibration point standard. Discard the rinse standard.
6. Fill the calibration cup to the appropriate level with fresh standard for the second calibration point. Immerse the probe in the standard.
7. Select **Calibration Value** and enter the value of the second calibration standard.
8. Make sure there are no air bubbles on the turbidity sensor lens. Observe the actual measurement readings for stability, and then select **Accept Calibration** (Figure 54). "Ready for cal point 3" will be displayed in the message area.
9. Select **Finish Calibration** to complete a 2-point calibration or continue for the 3-point calibration.

Repeat steps 5 through 8 for a 3-point calibration. "Calibration successful!" will be displayed in the message area. After calibration, rinse with water and dry the probe.

## 3.7 Total Algae

### TAL Sensors

YSI offers two Total Algae (TAL) sensor options. Both are dual-channel fluorescence sensors.

The channels on the TAL-PC sensor refer to two independent data sets: one results from a blue excitation beam that excites the chlorophyll a (Chl) molecule and the second results from an orange excitation beam that excites the phycocyanin (PC) accessory pigment. TAL-PC sensors are typically selected for monitoring freshwater cyanobacteria.

The TAL-PE sensor is similar in having a chlorophyll channel, but utilizes a slightly blueshifted beam that excites the pigment phycoerythrin (PE). TAL-PE sensors are typically selected for monitoring marine cyanobacteria.

### TAL Units

The TAL sensors report data in RFU and  $\mu\text{g/L}$  of pigment (Chl, PC or PE) units. YSI recommends reporting in Relative Fluorescence Units (RFU).

RFU is used to set sensor output relative to a stable secondary standard, Rhodamine WT dye. This allows users to calibrate sensors identically so that results from sensor to sensor can be compared. Calibration with Rhodamine WT also enables users to monitor for sensor drift and external factors such as biofouling or declining sensor optical performance over time as the LEDs age.

The excellent linearity of RFU, once the channels are calibrated with Rhodamine WT, translates to the best accuracy of measurements. For example, a chlorophyll reading of 100 units will represent twice the pigment detected by the sensor than with a chlorophyll reading of 50 units. This high linearity ( $R^2 > 0.9999$ ) doesn't always hold for  $\mu\text{g/L}$  of pigment since that unit was derived from laboratory monocultures, and an environmental algal population can behave quite differently. This is also why the TAL sensors and in situ monitoring should not be regarded as a perfect replacement for other methods such as pigment extractions and cell counting.

The  $\mu\text{g/L}$  output generates an estimate of pigment concentration that is based upon correlations built with sensor outputs and extractions of pigments from laboratory-grown blue-green algae. Synonymous with parts per billion (ppb),  $\mu\text{g/L}$  is still commonly used by regulatory agencies, but has the drawback that it is very dependent upon the composition of the algal population, the time of day, the physiological health of the algae, and a number of other environmental factors. Thus, users are advised to do their own check of our correlation with a population of algae relevant to their own sites, as described below.

A 2-point RFU calibration is advised to be performed first. Next, with samples collected from the site of interest, measure both RFU and  $\mu\text{g/L}$  with the sensor(s). Observing careful handling and preservation of the samples, as soon as possible extract the pigments from the samples, using standardized methods to determine the  $\mu\text{g/L}$  in each sample. The extraction data may be used to assess how RFU and  $\mu\text{g/L}$  delivered by the sensor compare with the  $\mu\text{g/L}$  of pigment that would be predicted by RFU from the sensor. The user's requirements can guide the decision as to whether RFU or  $\mu\text{g/L}$  is the best unit to read from the sensor for any specific application.

TAL Raw values can only be seen under [Sensor info](#) in the System menu and are unaffected by user calibrations. These values range from 0-100, representing the percent of full scale that the sensor detects in a sample, and are used for diagnostic purposes.

## Rhodamine WT Dye Solution Preparation

Rhodamine WT dye solution must be used when completing a 2-point calibration. Purchase Rhodamine WT as a 2.5% solution to follow the procedure below. Kingscote Chemicals (Miamisburg, OH, 1-800-394-0678) has historically had a 2.5% solution (item #106023) that works well with this procedure. Note that there are many types of Rhodamine—make sure Rhodamine **WT** is selected. If a 2.5% solution cannot be obtained commercially, prepare it from a solid or from another concentration of a liquid solution to a 2.5% final concentration, or adjust the dilutions below accordingly. It should be stored in the refrigerator when not in use.

For PC and chlorophyll channel calibrations, a 0.625 mg/L solution of Rhodamine WT should be prepared. For PE channel calibration, a 0.025 mg/L solution of Rhodamine WT should be prepared. The steps below describe one procedure to prepare these solutions.

1. *For any TAL sensor calibration, prepare a 125 mg/L solution of Rhodamine WT.* Transfer 5.0 mL of the 2.5% Rhodamine WT solution into a 1000 mL volumetric flask. Fill the flask to the volumetric mark with deionized or distilled water and mix well to produce a solution that is approximately 125 mg/L of Rhodamine WT. Transfer to a storage bottle and retain it for future use.  
  
\*This solution can be stored in the refrigerator (4°C). Its degradation will depend upon light exposure and repeated warming cycles, but solutions used 1-2 times a year can be stored for up to two years. Users should implement their own procedures to safeguard against degradation.
2. *For PC and chlorophyll channel calibrations, prepare a 0.625 mg/L solution of Rhodamine WT.* Transfer 5.0 mL of the 125 mg/L solution prepared in step one into a 1000 mL volumetric flask. Fill the flask to the volumetric mark with deionized or distilled water. Mix well to obtain a solution that is 0.625 mg/L of Rhodamine WT. Use this solution within 24 hours of preparation and discard it after use.
3. *For PE channel calibration, prepare a 0.025 mg/L solution of Rhodamine WT.* Transfer 0.2 mL of the 125 mg/L solution prepared in step one into a 1000 mL volumetric flask. Fill the flask to the volumetric mark with deionized or distilled water. Mix well to obtain a solution that is 0.025 mg/L of Rhodamine WT. Use this solution within 24 hours of preparation and discard it after use.

In addition to preparing the Rhodamine solution(s), it is also necessary to determine temperature-compensated calibration values for solutions. In general, fluorescence is inversely related with temperature. Measure the temperature of the Rhodamine solution(s) and use the temperature of the solution at the time of calibration to select the compensated solution concentrations, in either RFU (recommended) or µg/L pigment equivalents, from the table below.

As an example, assume that you will calibrate the chlorophyll channel in RFU, and that the temperature measured in the 0.625 mg/L Rhodamine WT solution is 22°C. The first standard value entered will be 0, and the second standard value will be 16.4 (see table on page 41). Likewise, if you intend to use the default µg/L unit when calibrating chlorophyll, the second standard value would be 66 in this example. Using the same 0.625 mg/L Rhodamine WT solution to calibrate the PC channel will yield a second standard value of 16.0 RFU or 16 µg/L. These values will be entered when performing a 2-point calibration.



## Rhodamine WT Dye Solution Preparation (continued)

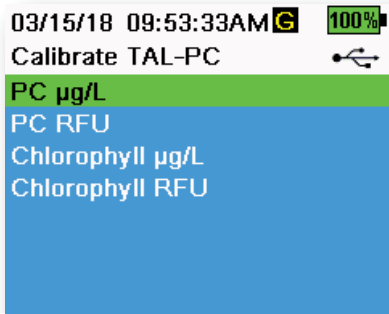
Temp (°C)	Chlorophyll		Phycocyanin		Phycoerythrin	
	RFU	µg/L	RFU	µg/L	RFU	µg/L
30	14.0	56.5	11.4	11.4	37.3	104.0
28	14.6	58.7	13.1	13.1	39.1	109.0
26	15.2	61.3	14.1	14.1	41.0	115.0
24	15.8	63.5	15.0	15.0	43.0	120.0
22	16.4	66	16.0	16.0	45.0	126.0
20	17.0	68.4	17.1	17.1	47.0	132.0
18	17.6	70.8	17.5	17.5	49.2	138.0
16	18.3	73.5	19.1	19.1	51.4	144.0
14	18.9	76	20.1	20.1	53.6	150.0
12	19.5	78.6	21.2	21.2	55.9	157.0
10	20.2	81.2	22.2	22.2	58.2	163.0
8	20.8	83.8	22.6	22.6	60.6	170.0

## TAL Calibration

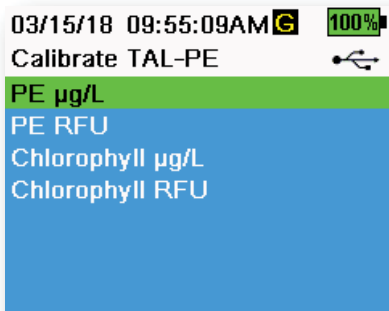
A 1- or 2-point calibration can be completed for all channels on the TAL-PC and TAL-PE sensors.

A 1-point calibration, typically completed in clear deionized or distilled water, is simply a re-zeroing of the sensor. This calibration does not reset the second point entered during the previous 2-point calibration. The consequence is that error will be alleviated at and near zero, but more error can accumulate in the measurement the farther away from zero the measured value is. The amount of error is dependent upon how much the second point drifts, which is not always equivalent to how much the zero point drifts.

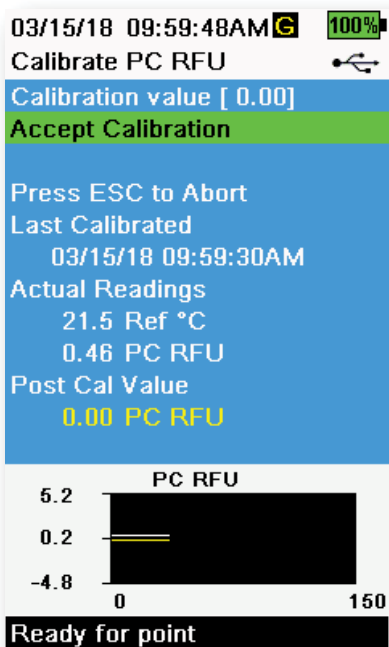
For many users, especially those with sites where pigment is rarely detected and values are at or near zero most of the time, the far-from-zero accumulation of error is a non-issue. For others, it is best to perform a 2-point calibration using a Rhodamine WT solution.



**Figure 55** TAL-PC Calibration Options



**Figure 56** TAL-PE Calibration Options



**Figure 57** Calibrate PC RFU

## PE, PC and Chlorophyll Calibration 2-Point

Each channel of the sensor must be calibrated independently. Calibration of the chlorophyll channel does not set the calibration for the PC channel or the PE channel. In addition, calibrating in RFU for a channel does not automatically calibrate the  $\mu\text{g/L}$  measurement for the same channel. The following calibration procedure must be performed for each channel and each unit the user would like to display.

1. Fill the calibration cup to the appropriate level with deionized water (0 standard). Immerse the probe in the standard. Make sure the sensor guard is installed.
2. Push the  $\text{Cal}$  key, then select either **TAL-PC** or **TAL-PE**, depending on the sensor to be calibrated.
3. Select the channel and units to be calibrated. Options for the TAL-PC sensor are shown in [Figure 55](#), while options for the TAL-PE sensor are shown in [Figure 56](#).
4. Select **Calibration Value** and enter 0.00.
5. Make sure there are no air bubbles on the sensor lens. If present, lightly tap the guard against the cup to dislodge any bubbles. Observe the actual measurement readings for stability (white line on graph shows no significant change for 40 seconds), and then select **Accept Calibration**. "Ready for cal point 2" will be displayed in the message area.
6. Discard the used water, and rinse the probe, guard, and calibration cup with a small amount of the standard for calibration point #2. Discard the rinse standard.

**NOTE:** For standard #2, use the 0.625 mg/L Rhodamine WT solution when calibrating chlorophyll (RFU or  $\mu\text{g/L}$ ) on either TAL sensor, or when completing a PC (RFU or  $\mu\text{g/L}$ ) calibration on a TAL-PC sensor. Use the 0.025 mg/L Rhodamine WT solution when completing a PE (RFU or  $\mu\text{g/L}$ ) calibration on a TAL-PE sensor.

7. Fill the calibration cup to the appropriate level with fresh standard #2. Immerse the sensors in the second calibration standard.
8. Observe the temperature reading on the calibration display ([Figure 57](#)). Use the table in the [Rhodamine WT dye solution preparation section](#) to identify the appropriate value for the calibration standard.
9. Select **Calibration Value** and enter the value of the second calibration standard.
10. Observe the actual measurement readings for stability (white line on graph shows no significant change for 40 seconds), then select **Accept Calibration**. The procedure will automatically finish after calibrating using the second standard.

# 3.8

## pH/ORP

Observe the pH mV readings during calibration to understand the condition and response of the pH sensor. In buffer 7, pH mVs should be between -50 and +50. In pH4 buffer, the mV reading should be 165 to 185 mV higher than the reading in pH 7 buffer. In pH 10 buffer, the mV reading should be 165 to 185 mV lower than the reading in pH 7 buffer. The theoretically ideal slope is -59 mV/pH unit.

### 1-Point

While a 1-point pH calibration is possible, this calibration procedure adjusts only the pH offset and leaves the previously determined slope unaltered. This should only be performed if you are adjusting a previous 2-point or 3-point calibration.

### 2-point

Perform a 2-point pH calibration if the pH of the media to be monitored is known to be either basic or acidic. In this procedure, the pH sensor is calibrated with a pH 7 buffer and a pH 10 or pH 4 buffer depending upon the pH range you anticipate for your water to be sampled.

### 3-point

Perform a 3-point pH calibration to assure maximum accuracy when the pH of the environmental water cannot be anticipated or fluctuates above and below pH 7. In this procedure, the pH sensor is calibrated with pH 7, pH 10, and pH 4 buffer solutions.

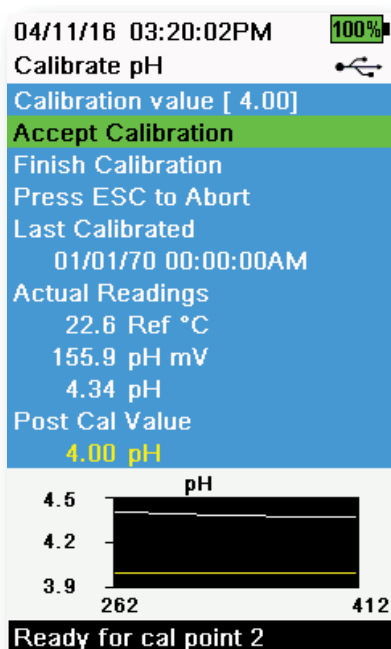



Figure 58 Calibrate pH 2- or 3-point

## pH Calibration 3-Point

1. Always start the calibration with pH 7 buffer. Fill the calibration cup to the appropriate level with pH 7 buffer solution.
2. With the probe guard installed, carefully immerse the probe into the buffer solution. Make sure both the pH sensor and temperature sensor are submerged.
3. Push the **Cal** key; then select **pH** or **pH/ORP**.
4. The **Calibration value** will automatically be adjusted based on the selected buffer and temperature. Alternatively, the Calibration value can be manually entered..
5. Wait for the pH mV and temperature readings to stabilize; the white line on the graph should be flat for about 40 seconds.
6. Select **Accept Calibration** and press the **ENTER** key. "Ready for cal point 2" will be displayed in the message area.
7. Rinse the probe and calibration cup. Fill to the appropriate level with either pH 10 or pH 4 buffer solution; it doesn't matter which one comes next.
8. Immerse the probe into the buffer solution. The **Calibration value** will automatically be adjusted based on the selected buffer and temperature.
9. Wait for the pH mV and temperature readings to stabilize; the white line on the graph should be flat for about 40 seconds.
10. Select **Accept Calibration** and press the **ENTER** key. "Ready for cal point 3" will be displayed in the message area.



## pH Calibration 3-Point (continued)

**NOTE:** For 2-Point calibrations, select Accept Calibration before selecting Finish Calibration.

11. Rinse the probe and calibration cup. Fill to the appropriate level with the final buffer solution.
12. Immerse the probe into the buffer solution. The **Calibration value** will automatically be adjusted based on the selected buffer and temperature.
13. Wait for the pH mV and temperature readings to stabilize; the white line on the graph should be flat for about 40 seconds.
14. Select **Accept Calibration** and press the  key. The procedure will automatically finish after calibrating the third point.



## ORP Calibration

1. Obtain a premixed standard solution that is approved for use with Ag/AgCl ORP sensors or prepare a standard with a known oxidation reduction potential (ORP) value. Zobell solution is recommended.
2. With the probe guard installed, carefully immerse the probe into the standard solution. Make sure both the ORP sensor and temperature sensor are submerged.
3. Push the  key, then select **pH/ORP**, then **ORP**.
4. If using YSI Zobell solution, the **Calibration value** will automatically be adjusted based on the temperature. Otherwise, refer to the table included with the standard solution and enter the mV value that corresponds to the temperature of the solution.
5. Wait for the ORP mV and temperature readings to stabilize; the white line on the graph should be flat for about 40 seconds.
6. Select **Accept Calibration** and press the  key. "Calibration successful!" will be displayed in the message area.

**Figure 59** Calibrate ORP

# 3.9

## ISEs

### Ammonium, Nitrate, & Chloride

YSI recommends a 2-point calibration for ISEs. For best results, use standards that differ by 2 orders of magnitude:

- 1 mg/L and 100 mg/L for Ammonium and Nitrate
- 10 mg/L and 1,000 mg/L for Chloride

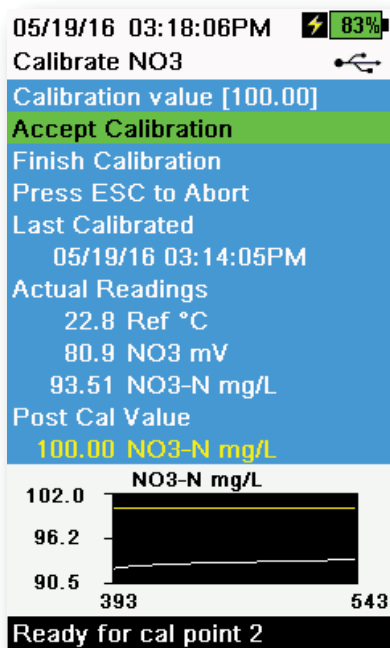


Figure 60 Calibrate ISE

### ISE Calibration

1. Fill the calibration cup to the appropriate level standard for calibration point #1. Immerse the probe in the standard.
2. Push the **Cal** key, then select the applicable ISE sensor.
3. Select **Calibration value** and enter the value that corresponds to the first calibration standard.
4. Observe the actual measurement readings for stability (white line on graph shows no significant change for 40 seconds), then select **Accept Calibration**. "Ready for cal point 2" will be displayed in the message area.
5. Discard the used standard and rinse the probe and calibration cup with a small amount of the next calibration point standard. Discard the rinse standard.
6. Fill the calibration cup to the appropriate level with fresh standard for the second calibration point. Immerse the probe in the standard.
7. Select **Calibration value** and enter the value of the second calibration standard.
8. Observe the actual measurement readings for stability, and then select **Accept Calibration** (Figure 60). "Ready for cal point 3" will be displayed in the message area.
9. Select **Finish Calibration** to complete a 2-point calibration.

### Optimal mV for ISE calibration

#### Ammonium mV values

- $\text{NH}_4$  1 mg/L = 0 mV +/- 20 mV (new sensor only)
- $\text{NH}_4$  100 mg/L = 90 to 130 mV greater than the mV reading in the 1 mg/L standard
- The mV span between 1 mg/L and 100 mg/L values should be approximately 90 to 130 mV. The slope should be 45 to 65 mV per decade of ammonium concentration in mg/L

#### Nitrate mV values

- $\text{NO}_3$  1 mg/L = 200 mV +/- 20 mV (new sensor only)
- $\text{NO}_3$  100 mg/L = 90 to 130 mV less than the mV reading in the 1 mg/L mV standard
- The mV span between 1 mg/L and 100 mg/L values should be approximately 90 to 130 mV. The slope should be -45 to -65 mV per decade of nitrate concentration in mg/L

#### Chloride mV values

- Cl 10 mg/L = 225 mV +/- 20 mV (new sensor only)
- Cl 1,000 mg/L = 80 to 130 mV < 10 mg/L mV value
- The mV span between 10 mg/L and 1000 mg/L values should be approximately 80 to 130 mV. The slope should be -40 to -65 mV per decade of chloride concentration in mg/L


## Chilled Third Calibration Point

The chilled 3-point calibration is recommended if there is a large temperature variation during sampling or when the temperature of the media cannot be anticipated. The highest concentration solution and one of the lower concentration solutions should be at ambient temperature. The other lower concentration solution should be chilled to less than 10°C to prior calibration point.

1. Discard the used standard and rinse the probe and calibration cup with a small amount of the next calibration point standard. Discard the rinse standard.
2. Fill the calibration cup to the appropriate level with fresh standard for the third calibration point. Immerse the probe in the standard.
3. Select **Calibration value** and enter the value of the third calibration standard.
4. Observe the actual measurement readings for stability, and then select **Accept Calibration**. "Calibration successful!" will be displayed in the message area.

## Preparing Standards


We recommend using YSI calibration solutions whenever possible. However, qualified users can follow these recipes to prepare their own standards.

 **CAUTION:** Some of the chemicals required for these solutions could be hazardous under some conditions; therefore, the standards should only be prepared by qualified chemists in laboratories where proper safety precautions are possible. It is the responsibility of the user to obtain and study the MSDS for each chemical and to follow the required instructions with regard to handling and disposal of these chemicals.

## Ammonium Standards

You will need:

- Solid ammonium chloride or a certified 100 mg/L  $\text{NH}_4^+\text{-N}$  from a supplier
- Lithium acetate dihydrate
- Concentrated hydrochloric acid
- High purity water
- A good quality analytical balance
- A 1000 mL volumetric flask
- Accurate volumetric measuring devices for 100 mL and 10 mL of solution
- And a 1000 mL glass or plastic storage vessels

 **CAUTION:** Hydrochloric acid is highly corrosive and toxic and should therefore be handled with extreme care in a well-ventilated fume hood. The equivalent amount of a less-hazardous, more dilute sample of the acid may be used if preferred.

### 100 mg/L Standard

1. Accurately weigh 0.3817 g of ammonium chloride and transfer quantitatively into a 1000 mL volumetric flask. Add 2.6 g of lithium acetate dihydrate to the flask.
2. Add approximately 500 mL of distilled or deionized water to the flask. Swirl to dissolve all of the reagents and then dilute to the volumetric mark with distilled or deionized water.
3. Mix well by repeated inversion and then transfer the 100 mg/L standard to a storage bottle.
4. Add 3 drops of concentrated hydrochloric acid to the bottle, then seal and agitate to assure homogeneity. Alternatively, 100 mL of certified 100 mg/L  $\text{NH}_4^+\text{-N}$  standard can be used in place of the solid ammonium chloride.

## Ammonium Standards (continued)

### 1 mg/L Standard

1. Accurately measure 10.0 mL of the above 100 mg/L standard solution into a 1000 mL volumetric flask. Add 2.6 g of lithium acetate dihydrate to the flask.
2. Add approximately 500 mL of distilled or deionized water. Swirl to dissolve the solid reagents and then dilute to the volumetric mark with water.
3. Mix well by repeated inversion and then transfer the 1 mg/L standard to a storage bottle.
4. Add 3 drops of concentrated hydrochloric acid to the bottle, then seal and agitate to assure homogeneity.

Other concentrations can be made by altering the amount of ammonium chloride. All other ingredient concentrations should remain unchanged.

## Nitrate Standards

You will need:

- Solid potassium nitrate or a certified 1000 mg/l  $\text{NO}_3\text{-N}$  from a supplier
- Magnesium sulfate, high purity water
- A good quality analytical balance
- 1000 mL volumetric flask
- Accurate volumetric measuring devices for 100 mL, 10 mL and 1 mL of solution
- And 1000 mL glass or plastic storage vessels

### 100 mg/L standard

1. Accurately weigh 0.7222 g of anhydrous potassium nitrate and transfer quantitatively into a 1000 mL volumetric flask. Add 1.0 g of anhydrous magnesium sulfate to the flask.
2. Add approximately 500 mL of water to the flask. Swirl to dissolve all of the reagents, and then dilute to the volumetric mark with distilled or deionized water.
3. Mix well by repeated inversion and then transfer the 100 mg/L standard to a storage bottle.
4. Rinse the flask extensively with water prior to its use in the preparation of the 1 mg/l standard. Alternatively, 100 mL of certified 1000 mg/L  $\text{NO}_3\text{-N}$  standard can be used in place of the solid potassium nitrate.

### 1 mg/L standard

1. Accurately measure 10.0 mL of the above 100 mg/L standard solution into a 1000 mL volumetric flask. Add 1.0 g of anhydrous magnesium sulfate to the flask.
2. Add approximately 500 mL of distilled or deionized water. Swirl to dissolve the solid reagents, and then dilute to the volumetric mark with water.
3. Mix well by repeated inversion and then transfer the 1 mg/L standard to a storage bottle.

Other concentrations can be made by altering the amount of potassium nitrate. All other ingredient concentrations should remain unchanged.

# Chloride Standards

You will need:

- Solid sodium chloride or a certified 1000 mg/L chloride solution from a supplier
- Magnesium sulfate
- High-purity water
- A good quality analytical balance
- 1000 mL volumetric flask
- An accurate 10 mL measuring devices
- And 1000 mL glass or plastic storage vessels

## 1000 mg/L Standard

1. Accurately weigh 1.655 grams of anhydrous sodium chloride and transfer into a 1000 mL volumetric flask.
2. Add 0.5 grams of anhydrous magnesium sulfate to the flask.
3. Add 500 mL of water to the flask, swirl to dissolve all of the reagents, then dilute to the volumetric mark with water.
4. Mix well by repeated inversion, then transfer the 1000 mg/L standard to a storage bottle.
5. Rinse the flask extensively with water prior to its use in the preparation of the 10 mg/L standard. Alternatively, simply add 0.5 grams of magnesium sulfate to a liter of a 1000 mg/L chloride standard from a certified supplier.

## 10 mg/L Standard

1. Accurately measure 10 mL of the above 1000 mg/L standard solution into a 1000 mL volumetric flask.
2. Add 0.5 grams of anhydrous magnesium sulfate to the flask.
3. Add 500 mL of water, swirl to dissolve the solid reagents, then dilute to the volumetric mark with water.
4. Mix well by repeated inversion, then transfer the 10 mg/L standard to a storage bottle.



# 4. Maintenance and Storage

Follow all maintenance and storage procedures in this section. Incorrect or unapproved maintenance and/or storage can cause handheld, sensor or cable damage not covered by the warranty.

Storage terms are defined as follows:

## Short-term Storage = Less than 4 weeks

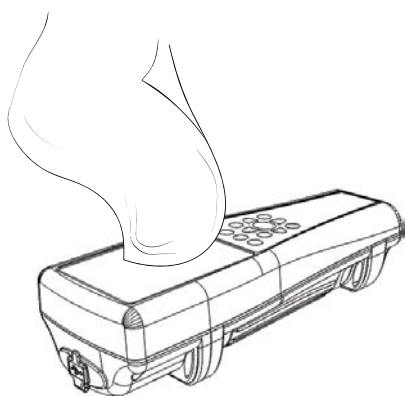
Short-term storage is appropriate when the handheld, cables, and sensors will be used at regular intervals (daily, weekly, etc.).

## Long-term Storage = More than 4 weeks

During long periods of inactivity, such as the “off-season” for environmental monitoring, the instrument, sensors, and cables should be placed in long-term storage.

YSI recommends cleaning and maintenance before long-term storage.

## 4.1 ProDIGITAL Handheld



**Figure 61** Handheld cleaning

Wipe the keypad, screen, and case with a cloth dampened with a mild solution of clean water and dish soap (Figure 61). Optimal storage temperature of the handheld instrument is 0-45°C. The battery pack permanently loses capacity at a faster rate when above 45°C.

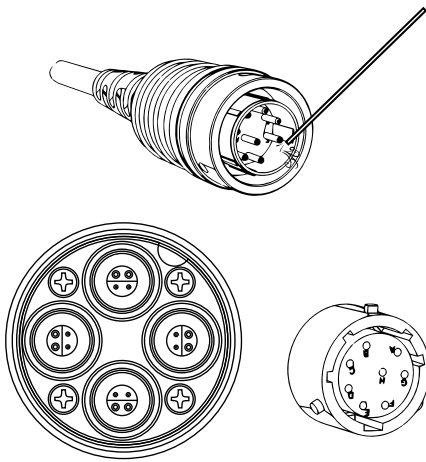
### Short-term Storage:

Assure that the handheld instrument is powered off, and store it in a temperature-controlled, secure location. Ideally all ports should be covered to prevent dust, water, or other contamination.

### Long-term Storage:

In addition to the short-term storage guidelines above, remove the battery pack to prevent any damage from possible battery leaks. Reinstall the battery cover. Store the battery pack in a dry place ideally around 25°C.

## 4.2 4-Port Bulkhead



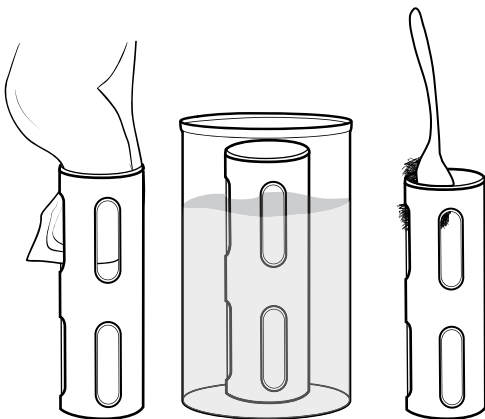
**Figure 62** Cable, bulkhead, connector maintenance

Wipe the cable and bulkhead with a cloth dampened with a mild solution of clean water and dish soap. Make sure sensors or port plugs are installed in ProDSS 4-port cable assemblies so the bulkhead ports do not get wet when cleaning. Exposure to water can cause damage or corrosion to the bulkhead connectors not covered by the warranty.

For short-term storage, YSI recommends leaving the sensors installed on the bulkhead. The ODO, pH, and pH/ORP sensors must be kept in a moist air environment; therefore, place a small amount of water (5-10 mL) in the calibration cup and tighten the retaining nut to seal the storage chamber.

For long-term storage, YSI recommends uninstalling the sensors from the bulkhead and following each sensor's respective long-term storage instructions. Inspect the bulkhead ports and cable connectors for contamination. If dirty or wet, clean it with compressed air (Figure 62). Install the cap that protected the bulkhead during initial shipment. Alternatively, install the bulkhead port plugs.

## 4.3 Sensor Guard



**Figure 63** Sensor guard maintenance

Remove light bio-fouling with a cloth soaked in a mild solution of clean water and dish soap. Soak in vinegar to remove hard growth and deposits. Use a plastic scrub brush to remove any remaining bio-fouling. Rinse the sensor guard with clean water (Figure 63).

**NOTICE:** Do not sand or polish the guard. Removal of the guard coating can affect some sensor readings.

## 4.4 Depth Sensor

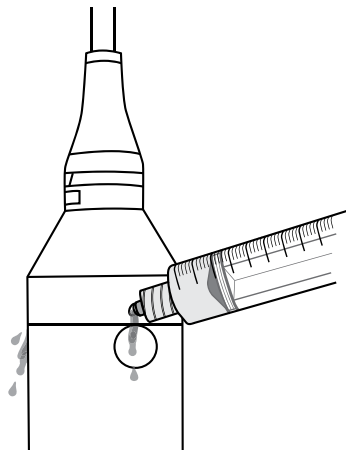


Figure 64 Depth sensor flush

The depth sensor on 4-port ProDSS cables should be flushed after each use. Fill the syringe (included with the maintenance kit) with clean water and gently push water through the ports located on the bulkhead. Flush until clean water flows from the opposite depth port (Figure 64).

The sensor can be stored wet or dry. For long-term storage, YSI recommends storing the sensor dry.

**NOTICE:** Do not insert objects into the depth ports. Damage to the depth transducer from incorrect cleaning is not covered by the warranty.

## 4.5 Temperature Sensor

To ensure optimal performance, it is important to keep the temperature sensor free of any deposits. Rinse the thermistor after each use. If deposits have formed, use mild soapy water and a soft bristle cleaning brush. The sensor can be stored wet or dry.

## 4.6 Conductivity Sensor

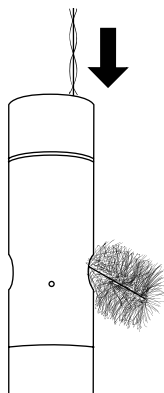


Figure 65 Channel brush

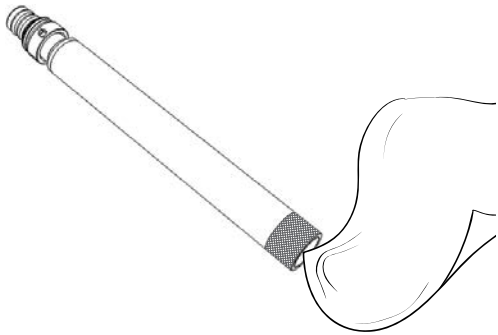
The conductivity channels should be cleaned after each use. Dip the sensor's cleaning brush (included with the maintenance kit) in clean water, insert the brush at the top of the channels, and sweep the channels 15 to 20 times (Figure 65).

If deposits have formed on the electrodes, use a mild solution of dish soap and water to brush the channels. For heavy deposits, soak the sensor in white vinegar, then scrub with the cleaning brush. Rinse the channels with clean water following the sweepings or soak.

The sensor can be stored wet or dry. For long-term storage, YSI recommends storing the sensor dry.

## 4.7

# Optical Dissolved Oxygen Sensor

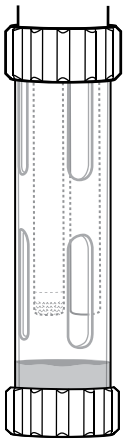


**Figure 66** ODO sensor window

The ODO sensor should be kept clean since some types of fouling may consume oxygen which could affect the dissolved oxygen measurements.

To clean the sensor cap, gently wipe away any fouling with a lens cleaning tissue that has been moistened with water to prevent scratches (Figure 66). Do not clean the ODO sensor with organic solvents as they may damage the cap.

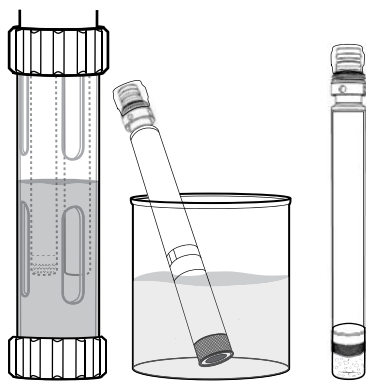
To minimize sensor drift, always store the ODO sensor in a wet or water-saturated air environment.



**Figure 67** ODO short-term storage

### Short-term Storage:

Store the ODO sensor in a moist air environment. A storage sleeve with a wet sponge or the calibration cup with a small amount of water is recommended (Figure 67).

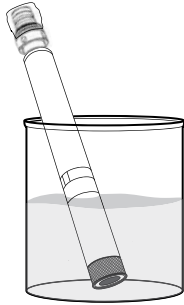


**Figure 68** ODO long-term storage

### Long-term Storage:

- **Method 1:** Submerge the sensing end of the sensor in a container of distilled or deionized water. Periodically check the level of the water to make sure that it does not evaporate.
- **Method 2:** Wet the sponge located in the cap originally included with the ODO sensor, then install on sensing end of the ODO sensor. Replace the sponge if it becomes dirty.

For ProDSS ODO sensors, the sensor can be left on the 4-port bulkhead or removed for long-term storage (Figure 68).



**Figure 69** ODO rehydration

## ODO Sensor Rehydration

If the ODO sensor has accidentally been left dry for longer than 8 hours, it must be rehydrated. To rehydrate, soak the ODO sensor in room temperature tap water for approximately 24 hours. After the soak, calibrate the sensor ([Figure 69](#)).

## ODO Sensor Cap

Optical DO sensor caps are warrantied for either 12 or 24 months depending on the model:

- ProDSS ODO Sensor Cap [SKU: 626890] = **12** months
- ODO Extended Warranty Sensor Cap [SKU: 627180] = **24** months

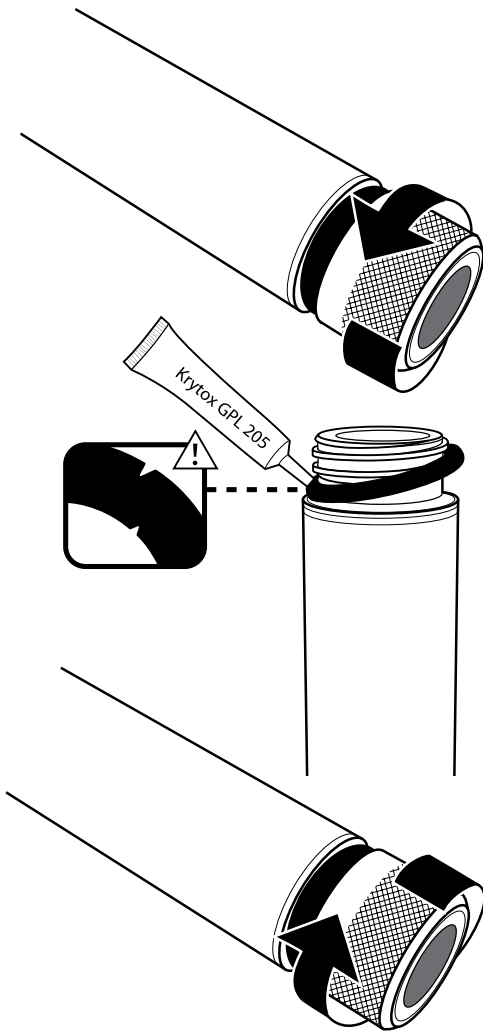
Depending on usage and storage practices, the cap may last longer than its warranty period.

As the ODO sensor caps ages, deterioration of the dye layer can reduce measurement stability and response time. Periodically inspect the sensor cap for damage and large scratches in the dye layer. Replace the cap when readings become unstable and cleaning the cap and DO recalibration do not remedy the symptoms.

## ODO Sensor Cap Replacement

The instruction sheet shipped with the replacement ODO sensor cap includes the calibration coefficients specific to that sensor cap. Make sure to save the ODO sensor cap instruction sheet in case you need to reload the calibration coefficients.

1. Remove the old sensor cap assembly from the probe by grasping the probe body with one hand and rotating the sensor cap counterclockwise until it is completely free. Do not use any tools for this procedure.
2. Carefully remove the o-ring by pinching it with your fingers and rolling it up. Do not use any tools to remove the o-ring. Clean the area of any debris with a lens cleaning tissue.
3. Install the new o-ring that is included with the replacement sensor cap.
4. Apply a thin coat of o-ring lubricant (included with the new cap) to the installed o-ring. Remove any excess o-ring lubricant with a lens cleaning tissue. Be careful to avoid contact with the sensor lens.
5. Inspect the sensor lens for any moisture or debris. If necessary, wipe the lens carefully with a non-abrasive, lint-free cloth to prevent scratches. Do not use organic solvents to clean the ODO sensor lens.
6. Remove the new sensor cap from its hydrated container and dry the inside cavity of the sensor cap with lens cleaning tissue. Make sure the cavity is completely dry before proceeding with the installation.
7. Using clockwise motion, thread the new sensor cap onto the probe assembly until it is finger-tight. The o-ring should be compressed between the sensor cap and probe. Do not over-tighten the sensor cap and do not use any tools for the installation process.
8. After installing the new sensor cap, store the sensor in either water or in the water-saturated air storage chamber.





**Figure 70** ODO cap replacement

**NOTE:** Be sure to update the ODO Sensor Cap Coefficients after replacement.

## Updating the ODO Sensor Cap Coefficients

After installing a new sensor cap, connect the probe to the handheld and turn the instrument on. Locate the Calibration Code Label on the ODO Sensor Cap Instruction Sheet. This contains the calibration codes for this particular sensor cap. Follow the procedures below to enter the new calibration coefficients into the instrument.

1. Push the  key to access the Sensor menu, then select **Setup**, then **ODO**.
2. Select **Sensor Cap Coefficients**.
3. Highlight each coefficient in turn (K1 through KC) and use the numeric entry screen to enter the corresponding new coefficient from the Calibration Code Label. Push the  key after each entry and then proceed to the next K selection.
4. After all the new coefficients have been entered, select **Update Sensor Cap Coefficients**.
5. A message will appear warning that you will be overwriting the current sensor cap coefficients and you should confirm that you wish to carry out this action. Select **Yes** to confirm the new coefficients.

After updating the Coefficients, the Serial # in the Sensor Cap menu will be updated automatically based on your entries.

If errors are made in entering the Sensor Cap Coefficients, the instrument will block the update and an error message will appear on the display. If you see this error message, re-enter the coefficients and check them carefully.

**NOTE:** After entering the sensor cap coefficients, the ODO sensor must be calibrated.

## 4.8 Turbidity & Total Algae Sensors

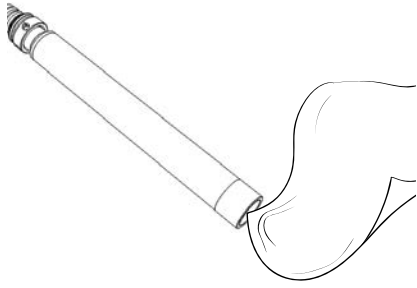


Figure 71 Sensor window

Clean the sensing window with a non-abrasive, lint-free cloth (Figure 71). If necessary, use mild soapy water.

The sensor can be stored wet or dry. For long-term storage, YSI recommends storing the sensor dry. Install the shipping cap or sensor guard to prevent scratches or damage to the optical sensing window.

## 4.9 pH/ORP Sensor

The pH and pH/ORP sensors are shipped with their tips in a storage bottle containing potassium chloride (KCl) solution. Keep this bottle for long-term storage.

Periodic maintenance is necessary to clear contamination from the sensing elements. Contaminants on the bulb and/or junction can slow sensor response time. Clean the sensors when deposits, bio-fouling or other contamination appears on the glass or when the sensor response time is noticeably slow. There are several methods to clean and restore the sensor depending on the severity of fouling or contamination.

### Cleaning Methods

#### Standard Rinse

Rinse the sensor with tap water each time it is brought in from the field. This is generally recommended for most sensors and use cases to clear mild contamination.

If contaminants remain or the sensor exhibits a slow response time, continue with advanced cleaning.

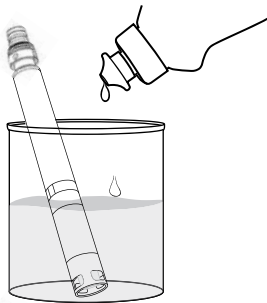


Figure 72 Cleaning the pH and pH/ORP sensor with dish soap

#### Advanced Cleaning

For moderate contamination or slow response after advanced rinsing, remove the sensor from the bulkhead and perform the following steps:

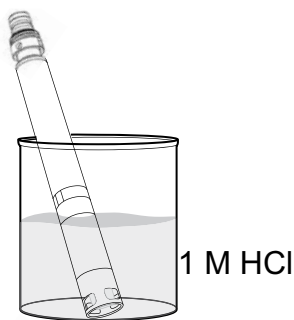
1. Remove any foreign matter from the sensor tip. If necessary, use a moistened cotton swab to carefully remove foreign material from the glass bulb and junction. Be careful to avoid direct contact with the glass bulb. The bulbs are fragile and will break if pressed with sufficient force.
2. Soak for 10 minutes in a mild solution of clean water and dish soap (Figure 72). Rinse the sensor with tap water and inspect.

If contaminants are removed, attach the sensor to the bulkhead and test the response time.

If contaminants remain or response time does not improve, continue to the hydrochloric acid (HCl) soak.



## pH/ORP Sensor Maintenance and Storage (continued)



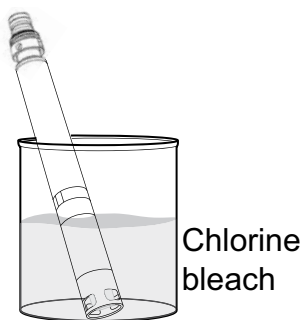
**Figure 73** Cleaning the pH and pH/ORP sensor with hydrochloric acid

### Acid Soak

For heavy contamination or slow response after advanced cleaning, remove the sensor from the bulkhead and perform the following steps:

1. Soak the sensor for 30 to 60 minutes in one molar (1 M) HCl (Figure 73). HCl reagent can be purchased from most chemical or laboratory distributors. To prevent injury, carefully follow the HCl manufacturer's instructions. If HCl is not available, soak in white vinegar.
2. After soaking, thoroughly rinse the sensor with tap water. Then soak the sensor in clean tap water for 60 minutes, stirring occasionally. Finally, rinse the sensor once again with tap water.

Attach the sensor to the bulkhead and test the response time. If response time does not improve or biological contamination of the reference junction is suspected, continue to the chlorine bleach soak.



**Figure 74** Cleaning the pH and pH/ORP sensor with chlorine bleach

### Bleach Cleanse

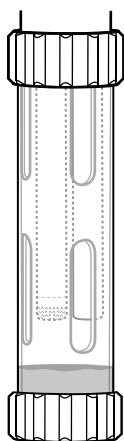
If biological contamination of the reference junction is suspected or if good response is not restored by the previous methods, remove the sensor from the bulkhead and perform the following steps:

1. Soak the sensor for 60 minutes in a 1:1 dilution of chlorine bleach and tap water.
2. After soaking, thoroughly rinse the sensor with tap water. Then soak the sensor in clean tap water for 60 minutes. Finally, rinse the sensor once again with tap water.

Attach the sensor to the bulkhead and test the response time. If response time does not improve the sensor may be nearing the end of its useful life.

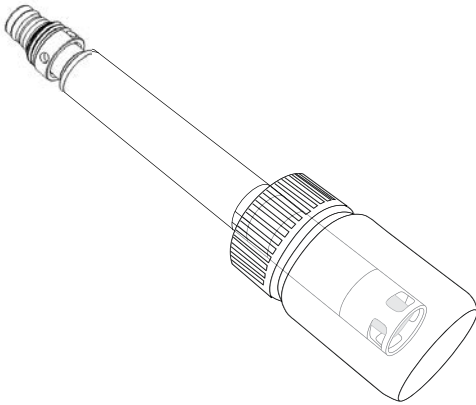
### Short-term Storage:

When in regular field use, the pH-pH/ORP sensors should remain on the bulkhead with the calibration/storage cup installed. Place a small amount of tap or surface water in the cup prior to storage or transport. The probes should be kept in this water-saturated air chamber between uses; not submerged (Figure 75). Make sure the storage cup makes a tight connection to prevent evaporation.



**Figure 75** pH and pH/ORP short-term storage

## pH/ORP Sensor Maintenance and Storage *(continued)*



**Figure 76** pH and pH/ORP  
long-term storage

### Long-term Storage:

Remove the sensor from the bulkhead and plug the bulkhead port. Insert the sensor tip into the storage bottle and solution that were originally supplied with the sensor (Figure 76). The storage bottle features an open cap and o-ring to form a tight seal around the sensor tip; the solution contains KCl with potassium phthalate and a preservative. If this original solution is not available, one can prepare a 2 M KCl solution or use pH 4 buffer as an alternative, though these solutions should be monitored for microbial growth and replaced if growth is apparent. Other sensors and system components should not be stored in or exposed to these pH buffers for long periods of time.

**NOTICE:** Do NOT let the sensor dry out. Do NOT store the sensor in distilled or deionized water. Either of these will radically shorten the lifespan of the sensor module and void its warranty.

## Sensor Module

The pH and pH/ORP sensors feature user-replaceable sensor modules. These modules contain a reference solution that depletes over time. The warranty period for both of these modules is 12 months:

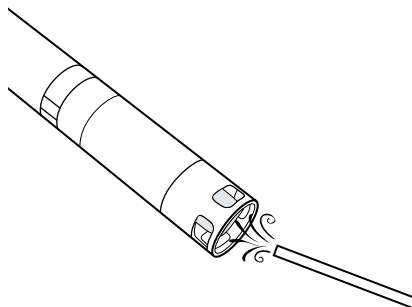
- Replacement pH Module [SKU: 626963] = **12** months
- Replacement pH/ORP Module [SKU: 626964] = **12** months

Depending on usage and storage practices, the module may last longer than its warranty period. Replace the module if the sensor exhibits a slow response time after trying all the cleaning methods listed above.

## 4.10 ISE Sensor

ISE sensors are shipped with their tips in a storage bottle. Keep this bottle for long-term storage.

Do not let the ISE sensor reference electrode junctions dry out. Clean the sensors when deposits, bio-fouling or other contamination appears on the membrane.

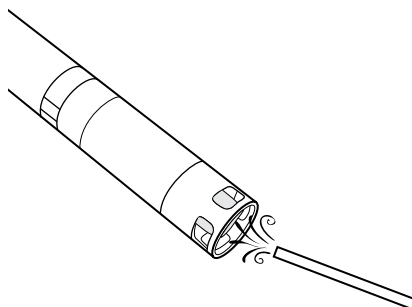


**Figure 77** Ammonium and nitrate maintenance

### Ammonium and Nitrate Sensor Maintenance

1. Carefully clean the ammonium or nitrate sensor by rinsing with DI water followed by soaking in the high standard calibration solution.
2. Carefully dab the sensor dry with a clean, lint-free cloth.

**NOTICE:** The ion-selective membranes are very fragile. Do not use coarse material (e.g. paper towels) to clean the membranes or permanent damage to the sensor can occur. The only exception is fine emery cloth on the chloride sensor.



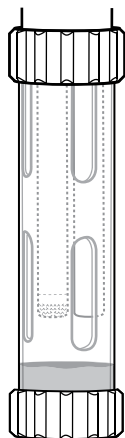
**Figure 78** Chloride maintenance

### Chloride Sensor Maintenance

1. Carefully clean the chloride sensor by carefully polishing with fine emery paper in a circular motion to remove deposits or discoloration.
2. Carefully rinse with DI water to remove any debris.

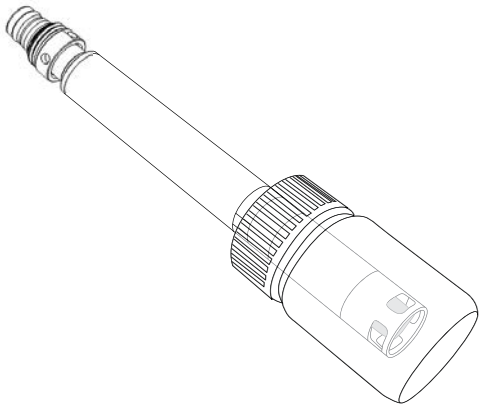
### Short-term Storage:

When in regular field use, ISEs should remain on the bulkhead with the calibration/storage cup installed. Place a small amount of tap or surface water in the cup prior to storage or transport. The probes should be kept in this water-saturated air chamber between uses; not submerged. Make sure the storage cup makes a tight connection to prevent evaporation (Figure 79).



**Figure 79** ISE short-term storage

## ISE Sensor Maintenance and Storage (continued)



**Figure 80** ISE long-term storage

### Long-term Storage:

Remove the sensor from the bulkhead and plug the bulkhead port. Insert the sensor tip into the storage bottle with a small amount of high-calibration solution or tap water. The sensor tip should not be submerged. The storage bottle features an open cap and o-ring to form a tight seal around the sensor tip (Figure 80).

**NOTICE:** Do NOT let the sensor dry out. Do NOT store the ISE sensor in conductivity standard, pH buffer, or salt water. Either of these will radically shorten the lifespan or kill the sensor module and void its warranty.

### Rehydrating the Reference Junction

If an ISE module has been allowed to dry, soak the sensor for several hours (preferably overnight) in the sensor's high-calibration solution. If the sensor is irreparably damaged, the sensor module must be replaced.

## Sensor Module

Ammonium, chloride and nitrate sensors feature user-replaceable sensor modules. These modules contain a reference solution that depletes over time. The warranty period for ISE modules is 6 months:

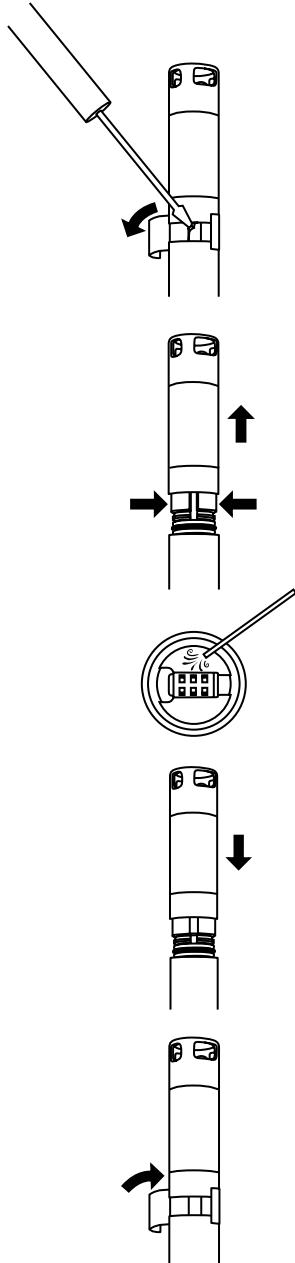
- Replacement Nitrate Module [SKU: 626965] = **6** months
- Replacement Ammonium Module [SKU: 626966] = **6** months
- Replacement Chloride Module [SKU: 626967] = **6** months

Depending on usage and storage practices, the module may last longer than its warranty period. When it is time, perform a sensor module replacement in a clean, dry laboratory environment.

# 4.11

## ProDSS Sensor Module Replacement

Sensor modules for pH, pH/ORP, nitrate, ammonium, and chloride all require periodic replacement. Perform a sensor module replacement in a clean, dry laboratory environment. Remove the sensor from the bulkhead and perform the following steps:



**Figure 81** Sensor module replacement

### Module Replacement

1. Peel off and discard the sticker that covers the junction of the sensor body and the module (Figure 81).
2. With a small, flat-blade screwdriver, carefully remove the square rubber plug from the gap in the hard plastic ring at the base of the sensor module.
3. Using two fingers, squeeze the sensor module's hard plastic ring so that it compresses the gap left by the rubber plug.
4. While squeezing, steadily pull the sensor module straight from the sensor body, rocking slightly if necessary. Do not keep the used o-rings as they are unusable after removal from the sensor body. Discard the old sensor module.
5. Inspect the sensor connector port for debris or moisture. If detected, remove it with lint-free cloth or a light blast of compressed air.
6. The new sensor module comes with two o-rings installed and pre-lubricated. Visually inspect the o-rings for nicks, tears, contaminants or particles. Replace any damaged o-rings.
7. Align the prongs on the base of the sensor module with the slots in the sensor body. The sensor module is keyed to insert in only one orientation. Push the sensor module firmly into position until it clicks. Wipe any excess o-ring lubricant from the assembled components.
8. Wrap the junction of the sensor module and sensor body with the new sticker included in the sensor module kit. The sticker helps keep the sensor module junction clean and retain the rubber plug throughout deployment.
9. Write the replacement date on the sticker.

**NOTICE:** If a sensor module is removed for any reason, the o-rings must be replaced.

**NOTE:** Be sure to calibrate the sensor after module replacement.

# 5. KorDSS Software

## 5.1 Introduction

KorDSS Software and drivers require permissions for successful installation. Administrative privileges may be necessary for a business or networked PC. Contact your organization's IT department for admin privileges.

### System Requirements

#### Supported 32 bit (x86) and 64 bit (x64) Microsoft Operating Systems:

- Microsoft Windows 7 Home Basic SP1
- Microsoft Windows 7 Home Premium SP1
- Microsoft Windows 7 Professional SP1
- Microsoft Windows 7 Enterprise SP1
- Microsoft Windows 7 Ultimate SP1
- Microsoft Windows 8 Home Basic
- Microsoft Windows 8 Home Premium
- Microsoft Windows 8 Professional
- Microsoft Windows 8 Enterprise
- Microsoft Windows 8.1 Basic
- Microsoft Windows 8.1 Professional
- Microsoft Windows 8.1 Enterprise
- Microsoft Windows 10 Home
- Microsoft Windows 10 Professional
- Microsoft Windows 10 Enterprise
- Microsoft Windows 10 Education

#### Ram Memory Requirement:

- Minimum of 2 GB of RAM installed

#### Hard Disk Free Space:

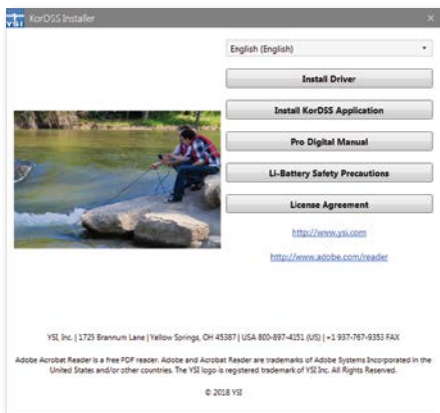
- Minimum of 500 MB of free hard drive space

#### Internet Access Required to Support:

- Software and device updates, software licensing

## 5.2

# Installing the Driver and Software



**Figure 82** KorDSS Installer



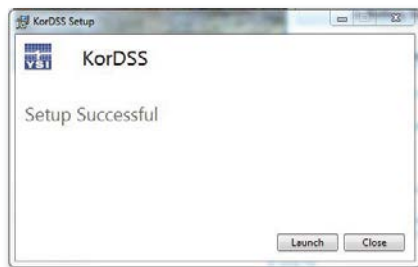
**Figure 83** ProDSS Driver Installer



**Figure 84** Back button



**Figure 85** KorDSS license agreement



**Figure 86** Launch KorDSS

Follow these steps to complete the installation process and establish connection to the handheld:

**NOTE:** Be sure to install the driver **before** connecting the handheld to your PC for the first time.

1. Insert the supplied USB flash drive into a USB port on your computer.
2. Depending on the PC operating system and system settings, the KorDSS Installer may appear. If it does not appear, open the flash drive in Windows Explorer and double-click **Start.exe** to start the installer. [Figure 82](#) shows how the installer will appear once it starts.
3. On the KorDSS Installer, click **Install Driver**. Then choose to Install the driver on the screens that follow ([Figure 83](#)).
4. After the driver has installed, choose to go **Back** to the KorDSS Installer ([Figure 84](#)).
5. On the KorDSS Installer, click **Install KorDSS Application**. A license agreement will appear ([Figure 85](#)).
6. You may be asked if you want to allow a program from an unknown publisher to make changes on the computer. If so, select **Yes**.
7. After successful installation of KorDSS, click **Launch** to start the program ([Figure 86](#)).
8. Connect the handheld meter to the PC with the supplied USB cable.
9. Power on the handheld and click **Connect** when it appears under the **Instrument Connection Panel**; there may be a short delay before it appears in the software.

# 6. Accessories

## 6.1 Ordering

Telephone: 800 897 4151 (USA)

+1 937 767 7241 (Globally) Monday through Friday

8:00 AM to 5:00 ET

Fax: +1 937 767 9353 (orders)

Email: [info@ysi.com](mailto:info@ysi.com)

Mail: YSI Incorporated 1725 Brannum Lane

Yellow Springs, OH 45387 USA

Web: Visit [YSI.com](http://YSI.com) to order replacement parts, accessories, and calibration solutions.

When placing an order please have the following available:

1. YSI account number (if available)
2. Name and phone number
3. Purchase Order or Credit Card number
4. Model Number or brief description
5. Billing and shipping addresses
6. Quantity



## ProDIGITAL Handhelds

YSI Item #	Description
626650	ProSolo handheld, no GPS, not compatible with ProDSS 4-port cable assemblies
626870-1	ProDSS handheld, no GPS
626870-2	ProDSS handheld with GPS

## ProDIGITAL Probe Assemblies

**NOTE:** The ODO and OBOD sensor caps come pre-installed on the following probe assemblies, with calibration coefficients of the sensor cap pre-loaded into the probe at the factory.

YSI Item #	Description
	Optical Dissolved Oxygen and Temperature Probes
627200-1	ODO/T Probe Assembly, 1m
627200-4	ODO/T Probe Assembly, 4m
627200-10	ODO/T Probe Assembly, 10m
627200-20	ODO/T Probe Assembly, 20m
627200-30	ODO/T Probe Assembly, 30m
627200-50	ODO/T Probe Assembly, 50m
627200-100	ODO/T Probe Assembly, 100m
	Optical Dissolved Oxygen, Conductivity, and Temperature Probes
627150-1	ODO/CT Probe Assembly, 1m
627150-4	ODO/CT Probe Assembly, 4m
627150-10	ODO/CT Probe Assembly, 10m
627150-20	ODO/CT Probe Assembly, 20m
627150-30	ODO/CT Probe Assembly, 30m
627150-50	ODO/CT Probe Assembly, 50m
627150-100	ODO/CT Probe Assembly, 100m
	Self-Stirring Optical Biochemical Oxygen Demand Probes
626400	ProOBOD probe assembly (lab BOD probe); U.S./Japanese version with power supply
626401	ProOBOD probe assembly (lab BOD probe); International version with power supply

## ProDSS 4-Port Cable Assemblies (No Sensors Included)

YSI Item #	Description
626909-1	ProDSS-1 meter 4-port cable assembly, no depth
626909-4	ProDSS-4 meter 4-port cable assembly, no depth
626909-10	ProDSS-10 meter 4-port cable assembly, no depth
626909-20	ProDSS-20 meter 4-port cable assembly, no depth
626909-30	ProDSS-30 meter 4-port cable assembly, no depth
626909-40	ProDSS-40 meter 4-port cable assembly, no depth
626909-50	ProDSS-50 meter 4-port cable assembly, no depth
626909-60	ProDSS-60 meter 4-port cable assembly, no depth
626909-70	ProDSS-70 meter 4-port cable assembly, no depth
626909-80	ProDSS-80 meter 4-port cable assembly, no depth
626909-90	ProDSS-90 meter 4-port cable assembly, no depth
626909-100	ProDSS-100 meter 4-port cable assembly, no depth
626910-1	ProDSS-1 meter 4-port cable assembly, with depth
626910-4	ProDSS-4 meter 4-port cable assembly, with depth
626910-10	ProDSS-10 meter 4-port cable assembly, with depth
626911-20	ProDSS-20 meter 4-port cable assembly, with depth
626911-30	ProDSS-30 meter 4-port cable assembly, with depth
626911-40	ProDSS-40 meter 4-port cable assembly, with depth
626911-50	ProDSS-50 meter 4-port cable assembly, with depth
626911-60	ProDSS-60 meter 4-port cable assembly, with depth
626911-70	ProDSS-70 meter 4-port cable assembly, with depth
626911-80	ProDSS-80 meter 4-port cable assembly, with depth
626911-90	ProDSS-90 meter 4-port cable assembly, with depth
626911-100	ProDSS-100 meter 4-port cable assembly, with depth

## ProDSS Sensors (for 4-Port Cable Assemblies)

YSI Item #	Description
626900	Optical dissolved oxygen sensor
626902	Conductivity and temperature sensor
626901	Turbidity sensor
626903	pH sensor with module
626904	pH/ORP sensor with module
626906	Ammonium sensor with module
626905	Nitrate sensor with module
626907	Chloride sensor with module
626210	Total algae sensor, PC
626211	Total algae sensor, PE

## Replacement Sensor Modules and ODO Sensor Caps

YSI Item #	Description
626890	Replacement ProDSS Optical Dissolved Oxygen sensor cap (for 626900 smart sensor)
626482	Replacement ProOBOD Optical Dissolved Oxygen sensor cap (for 626400 or 626401 lab probes)
627180	Replacement ODO Extended Warranty Sensor Cap (only compatible with ODO/T and ODO/CT probe assemblies)
626963	Replacement ProDSS pH sensor module
626964	Replacement ProDSS pH/ORP sensor module
626966	Replacement ProDSS Ammonium sensor module
626965	Replacement ProDSS Nitrate sensor module
626967	Replacement ProDSS Chloride sensor module

## Calibration Standards

YSI Item #	Description
065270	Conductivity standard, 1000 $\mu\text{mhos/cm}$ (quart, glass); ideal for fresh water
065272	Conductivity standard, 10000 $\mu\text{mhos/cm}$ (quart, glass); ideal for brackish water
065274	Conductivity standard, 100000 $\mu\text{mhos/cm}$ (quart, glass); ideal for supersaturated sea water
060907	Conductivity standard, 1000 $\mu\text{mhos/cm}$ (box of 8 individual pints, plastic); ideal for fresh water
060906	Conductivity standard, 1413 $\mu\text{mhos/cm}$ , $\pm 1\%$ , 0.01 M KCl (box of 8 individual pints, plastic)
060911	Conductivity standard, 10000 $\mu\text{mhos/cm}$ (box of 8 individual pints, plastic); ideal for brackish water
060660	Conductivity standard, 50000 $\mu\text{mhos/cm}$ (box of 8 individual pints, plastic); ideal for sea water
061320	ORP (mV) standard, Zobell solution, powder - needs hydrated (125 mL bottle, plastic)
061321	ORP (mV) standard, Zobell solution, powder - needs hydrated (250 mL bottle, plastic)
061322	ORP (mV) standard, Zobell solution, powder - needs hydrated (500 mL bottle, plastic)
003821	pH 4 buffer (box of 6 individual pints, plastic); ideal for storage solution for pH sensor
003822	pH 7 buffer (box of 6 individual pints, plastic)
003823	pH 10 buffer (box of 6 individual pints, plastic)
603824	Assorted case of pH 4, 7, and 10 buffers (2 individual pints of each buffer, plastic)
005580	Confidence solution to verify conductivity, pH and ORP system (box of 6 individual 475 mL bottles, plastic). <b>Note:</b> <i>Not for calibration</i>
003841	Ammonium standard, 1 mg/L (500 mL, plastic)
003842	Ammonium standard, 10 mg/L (500 mL, plastic)
003843	Ammonium standard, 100 mg/L (500 mL, plastic)
003885	Nitrate standard, 1 mg/L (500 mL, plastic)
003886	Nitrate standard, 10 mg/L (500 mL, plastic)
003887	Nitrate standard, 100 mg/L (500 mL, plastic)
608000	Turbidity standard, 0 FNU (1 gallon, plastic)
607200	Turbidity standard, 12.4 FNU (1 gallon, plastic)
607300	Turbidity standard, 124 FNU (1 gallon, plastic)
607400	Turbidity standard, 1010 FNU (1 gallon, plastic)





## ProDIGITAL Accessories

YSI Item #	Description
626946	Large, hard-sided carrying case (Fits ProDSS 4-port cables 10, 20, and 30 meters in length, cable management kit, handheld, and accessories)
603075	Large, soft-sided carrying case
626945	Small, hard-sided carrying case (Fits ProDSS 4-port cables 1 and 4 meters in length, handheld, flow cell, and accessories)
599080	Flow cell for ProDSS 4-port cables
603076	Flow cell for ODO/CT cables (requires single port adapter; 603078)
603078	Adapter required for ODO/CT flow cell (603076)
603056	Flow cell mounting spike
063507	Tripod (screws into back of meter)
063517	Ultra clamp (screws into back of meter)
603070	Shoulder strap
603069	Belt clip (screws into back of meter)
626942	USB car charger
626943	Small external Li-Ion rechargeable battery pack (Typical performance: will charge a completely discharged handheld battery to about 50%)
626944	Large external Li-Ion rechargeable battery pack (Typical performance: will charge a completely discharged battery to full charge, plus have power to charge a second battery to 20%)
626940	AC charger (USA). Includes power supply and USB cable (included with handheld)
626941	AC charger (international). Includes power supply, USB cable and outlet adapters (included with handheld)
626846	Replacement Lithium-ion battery pack
626969	USB flash drive (included with handheld)
626991	Cable for charging and PC connection (included as part of 626940 and 626941)
626992	Cable for connection to USB drive (included with handheld)
626990	ProDSS maintenance kit (included with all ProDSS 4-port cables): <ul style="list-style-type: none"> <li>• 3 port plugs</li> <li>• 1 tube of o-ring lubricant</li> <li>• 1 brush</li> <li>• 1 syringe</li> <li>• 1 sensor installation/removal tool</li> <li>• O-rings (6)</li> </ul>
626919	Sensor guard for 4-port ProDSS cable assembly (included with all 4-port cables)
599786	Calibration/storage cup for 4-port ProDSS cable assembly (included with all 4-port ProDSS cables)
627195	Calibration cup for ODO/CT cable assembly (included with all ODO/CT cables)
603062	Cable management kit (included with <b>ProDSS 4-port cables</b> 10, 20, and 30-meters long; <b>ODO/CT cables</b> 4, 10, 20, and 30-meters long; and <b>ODO/T cables</b> 4, 10, 20, and 30-meters long)
626918	1 lb weight (included with ProDSS 4-port cables 10-meters and longer)
605978	4.9 oz weight

# 7. Safety and Support

## 7.1

## Rechargeable Lithium-Ion Battery Pack Safety Warnings and Precautions

-  **CAUTION:** Failure to follow the safety warnings and precautions can result in fire, personal injury and/or equipment damage not covered under warranty.
-  **CAUTION:** If the internal battery fluid comes into contact with skin, wash the affected area(s) with soap and water immediately. If it comes into contact with your eye(s), flush them with generous amounts of water for 15 minutes and seek immediate medical attention.
-  **CAUTION:** Always keep batteries away from children.
-  **WARNING:** In the unlikely event a lithium-ion battery catches fire, **DO NOT** attempt to put the fire out with water, use a Class A, B or C fire extinguisher.


### Do:


- Store the battery pack in a cool, dry, ventilated area.
- Store the battery pack in a non-conductive and fireproof container.
- Store the battery pack at approximately 50% of the capacity.
- Disconnect the battery pack when not in use and for long-term storage.
- Follow applicable laws and regulations for transporting and shipping of batteries.
- *Immediately discontinue* use of the battery pack if, while using, charging or storing the battery pack:
  - Emits an unusual smell
  - Feel hot
  - Changes color
  - Changes shape
  - Appears abnormal in any other way.

### Battery Pack General Precautions:

- **DO NOT** put the battery in fire or heat the battery.
- **DO NOT** connect the positive and the negative terminal of the battery to each other with any metal object (e.g. wire).
- **DO NOT** carry or store the battery pack with necklaces, hairpins or other metal objects.
- **DO NOT** carry or store the battery pack with hazardous or combustible materials.
- **DO NOT** pierce the battery pack with nails, strike with a hammer, step on or otherwise subject the battery pack to strong impacts or shocks.
- **DO NOT** solder directly onto the battery pack.
- **DO NOT** expose the battery pack to water or salt water or allow it to get wet.
- **DO NOT** disassemble or modify the battery pack. The battery contains safety and protection devices that, if damaged, can cause the battery to generate heat, rupture or ignite.
- **DO NOT** place the battery pack on or near fires, stoves or other high-temperature locations.
- **DO NOT** place the battery pack in direct sunlight or extreme temperatures for extended periods of time or store the battery pack inside cars in hot weather. Doing so may cause the battery pack to generate heat, rupture or ignite. Using the battery pack in this manner may also result in a loss of performance and a shortened life expectancy.
- **DO NOT** place the battery pack in microwave ovens, high-pressure containers or on induction cookware.
- **DO NOT** ship damaged or potentially defective batteries to YSI or any of our authorized service centers unless instructed otherwise. All federal and international shipping laws should be consulted prior to shipping lithium-ion batteries.

## Charging/Discharging/Handling the Battery Pack

 **WARNING:** Failure to follow the battery pack charging/discharging instructions can cause the battery to become hot, rupture or ignite and cause serious injury and/or equipment damage.

 **WARNING:** Only charge the battery using charging devices designed specifically for the ProDIGITAL handheld by YSI. Use of unapproved chargers can result in battery failure and potentially serious injury to the user.

If at any time the battery pack becomes damaged, hot or begins to balloon or swell, discontinue charging (or discharging) immediately. Quickly and safely disconnect the charger. Then place the battery pack and/or charger in a safe, open area away from flammable materials. After one hour of observation, remove the battery pack from service. **DO NOT** continue to handle, attempt to use or ship the battery.

Damaged or swollen batteries can be unstable and very hot. **DO NOT** touch batteries until they have cooled. In the event of a fire use a Class A, B, or C fire extinguisher. **DO NOT** use water.

- **DO NOT** attach the battery pack to a power supply plug or directly to a car's cigarette lighter.
- **DO NOT** place the battery pack in or near fire or into direct extended exposure to sunlight. When the battery pack becomes hot, the built-in safety equipment is activated, preventing the battery pack from charging further. Heating the battery pack can destroy the safety equipment and cause additional heating, breaking or ignition.
- **DO NOT** leave the battery pack unattended while charging.

**NOTICE:** The ambient temperature range over which the battery pack can be discharged is -20°C to 60°C (-4°F to 140°F). Use of the battery pack outside of this temperature range may damage the performance of the battery pack or may reduce its life expectancy.

- **DO NOT** discharge the battery pack using any device except for a ProDIGITAL handheld. When the battery pack is used in other devices it may damage the performance of the battery or reduce its life expectancy. Use of a non-approved device to discharge the battery pack can cause an abnormal current to flow, resulting in the battery pack to become hot, rupture or ignite and cause serious injury.
- **DO NOT** leave the battery pack unattended while discharging.

## Battery Disposal

When the battery pack is worn out, insulate the terminals with adhesive tape or similar materials before disposal. Dispose of the battery pack in the manner required by your city, county, state or country. For details on recycling lithium-ion batteries, please contact a government recycling agency, your waste-disposal service or visit reputable online recycling sources such as [www.batteryrecycling.com](http://www.batteryrecycling.com).

This product must not be disposed of with other waste. Instead, it is the user's responsibility to dispose of their waste equipment by handing it over to a designated collection point for the recycling of waste electrical and electronic equipment. The separate collection and recycling of your waste equipment at the time of disposal will help to conserve natural resources and ensure that it is recycled in a manner that protects human health and the environment.

For more information about where you can drop off your waste equipment for recycling, please contact your local city office, or your local waste disposal service. **DO NOT ship batteries to YSI or a YSI authorized service center unless instructed to do otherwise.**

Contact YSI Technical Support at (937) 767-7241 if you have additional questions.

## 7.2 Service Information

YSI has authorized service centers throughout the United States and Internationally. For the nearest service center information, please visit [ysi.com](http://ysi.com) and click 'Support' or contact YSI Technical Support directly at 800-897-4151 (+1 937-767-7241).

When returning a product for service, include the Product Return form with cleaning certification. The form must be completely filled out for a YSI Service Center to accept the instrument for service. The form may be downloaded from [YSI.com](http://YSI.com).

## 7.3 Technical Support

Telephone: 800 897 4151 (USA)

+1 937 767 7241 (Globally) Monday through Friday, 8:00 AM to 5:00 ET

Fax: +1 937 767 9353 (orders)

Email: [info@ysi.com](mailto:info@ysi.com)

Mail: YSI Incorporated 1725 Brannum Lane Yellow Springs, OH 45387 USA

Internet: [YSI.com](http://YSI.com)

# 7.4

## Declaration of Conformity

The undersigned hereby declares on behalf of the named manufacturer under our sole responsibility that the listed product conforms to the requirements for the listed European Council Directive(s) and carries the CE mark accordingly.

<i>Manufacturer:</i>	YSI Incorporated 1725 Brannum Lane Yellow Springs, OH 45387 USA
<i>Product Name:</i>	ProDSS, ProSolo
<i>Conforms to the following:</i>	
<i>Directives:</i>	EMC 2004/108/EC RoHS 2011/65/EU WEEE 2012/19/EU
<i>Harmonized Standards:</i>	EN61326-1:2013 (IEC 61326-1:2012) IEC 61000-3-2:2005 +A1:2008+A2:2009 IEC 61000-3-3:2008
<i>Supplementary Information:</i>	All performance met the operation criteria as follows: 1. ESD, IEC 61000-4-2:2008 2. Radiated Immunity, IEC 61000-4-3:2006 +A1:2007+A2:2010 3. Electrical Fast Transient (EFT), IEC 61000-4-4:2004 +A1:2010 4. Immunity to Surge, IEC 61000-4-5:2005 5. Radio Frequency, Continuous Conducted Immunity, IEC61000-4-6:2008 6. IEC 61000-4-8:2009 7. IEC 61000-4-11:2004
<i>Authorized EU Representative</i>	Xylem Analytics UK Ltd Unit 2 Focal Point, Lacerta Court, Works Road Letchworth, Hertfordshire, SG6 1FJ UK



Signed: Lisa M. Abel  
Title: Director of Quality

Date: March 16, 2018



The undersigned hereby declares on behalf of the named manufacturer under our sole responsibility that the listed product conforms to the requirements for electrical equipment under US FCC Part 15 and ICES-003 for unintentional radiators.

<i>Manufacturer:</i>	YSI Incorporated 1725 Brannum Lane Yellow Springs, OH 45387 USA
<i>Product Name:</i>	Professional Digital Sampling System Instrument
<i>Model Numbers</i>	
<i>Instrument/Accessory:</i>	ProDSS non-GPS (626870-1) / ProDSS GPS (626870-2), ProSolo (626650)
<i>Probe/Cable Assemblies:</i>	626909-1, 626909-4, 626909-10, 626909-20, 626909-30, 626909-40, 626909-50, 626909-60, 626909-70, 626909-80, 626909-90, 626909-100, 626910-1, 626910-4, 626910-10, 626911-20, 626911-30, 626911-40, 626911-50, 626911-60, 626911-70, 626911-80, 626911-90, 626911-100  627200-1, 62700-4, 627200-10, 627200-20, 627200-30, 627200-50, 627200-100  627150-1, 627150-4, 627150-10, 627150-20, 627150-30, 627150-50, 627150-100  626250-1, 626250-4, 626250-10, 626250-20, 626250-30, 626250-40, 626250-50, 626250-60, 626250-70, 626250-80, 626250-90, 626250-100  626400, 626401
<i>Sensors:</i>	626900, 626902, 626901, 626903, 626904, 626906, 626905, 626907, 626210, 626211
<i>Conforms to the following:</i>	
<i>Standards:</i>	<ul style="list-style-type: none"> <li>• FCC 47 CFR Part 15-2008, Subpart B, Class B, Radio Frequency Devices</li> <li>• ICES-003:2004, Digital Apparatus</li> </ul>
<i>Supplementary Information:</i>	Tested using ANSI C63.4-2003 (excluding sections 4.1, 5.2, 5.7, 9, and 14)



Signed: Lisa M. Abel  
Title: Director of Quality

Date: March 16, 2018

# 7.5

## Warranty

The YSI Professional Series Digital (ProDIGITAL) handheld meters are warranted for three (3) years from date of purchase by the end user against defects in materials and workmanship. Digital sensors and cables (ProDSS 4-port, ODO/CT, ODO/T, and ProOBOD) are warranted for two (2) years from date of purchase by the end user against defects in material and workmanship. The ODO Extended Warranty Sensor Cap (627180) for the ODO/T and ODO/CT cable assemblies is warranted for two (2) years from date of purchase by the end user against defects in material and workmanship. ProDSS pH and pH/ORP sensor modules, optical ODO sensor caps (all but the 627180 cap previously mentioned), and Li-Ion battery pack are warranted for one (1) year from date of purchase by the end user against defects in material and workmanship; ProDSS ISE sensor modules (ammonium, nitrate, and chloride) are warranted for 6 months. ProDIGITAL systems (instrument, cables & sensors) are warranted for 1 year (excluding sensor modules) from date of purchase by the end user against defects in material and workmanship when purchased by rental agencies for rental purposes. Within the warranty period, YSI will repair or replace, at its sole discretion, free of charge, any product that YSI determines to be covered by this warranty.

To exercise this warranty, call your local YSI representative, or contact YSI Customer Service in Yellow Springs, Ohio at +1 937 767-7241, 800-897-4151 or visit [www.YSI.com](http://www.YSI.com) (Support tab) for a Product Return Form. Send the product and proof of purchase, transportation prepaid, to the Authorized Service Center selected by YSI. Repair or replacement will be made and the product returned, transportation prepaid. Repaired or replaced products are warranted for the balance of the original warranty period, or at least 90 days from date of repair or replacement.

### LIMITATION OF WARRANTY

This Warranty does not apply to any YSI product damage or failure caused by:

1. Failure to install, operate or use the product in accordance with YSI's written instructions;
2. Abuse or misuse of the product;
3. Failure to maintain the product in accordance with YSI's written instructions or standard industry procedure;
4. Any improper repairs to the product;
5. Use by you of defective or improper components or parts in servicing or repairing the product;
6. Modification of the product in any way not expressly authorized by YSI.

THIS WARRANTY IS IN LIEU OF ALL OTHER WARRANTIES, EXPRESSED OR IMPLIED, INCLUDING ANY WARRANTY OF MERCHANTABILITY OR FITNESS FOR A PARTICULAR PURPOSE. YSI's LIABILITY UNDER THIS WARRANTY IS LIMITED TO REPAIR OR REPLACEMENT OF THE PRODUCT, AND THIS SHALL BE YOUR SOLE AND EXCLUSIVE REMEDY FOR ANY DEFECTIVE PRODUCT COVERED BY THIS WARRANTY. IN NO EVENT SHALL YSI BE LIABLE FOR ANY SPECIAL, INDIRECT, INCIDENTAL OR CONSEQUENTIAL DAMAGES RESULTING FROM ANY DEFECTIVE PRODUCT COVERED BY THIS WARRANTY.

# 8. Appendices

## 8.1

### Appendix A DO% Calibration Values

Calibration Value D.O. %	Pressure			
	in Hg	mmHg	kPa	mbar
101%	30.22	767.6	102.34	1023.38
100%	29.92	760.0	101.33	1013.25
99%	29.62	752.4	100.31	1003.12
98%	29.32	744.8	99.30	992.99
97%	29.02	737.2	98.29	982.85
96%	28.72	729.6	97.27	972.72
95%	28.43	722.0	96.26	962.59
94%	28.13	714.4	95.25	952.46
93%	27.83	706.8	94.23	942.32
92%	27.53	699.2	93.22	932.19
91%	27.23	691.6	92.21	922.06
90%	26.93	684.0	91.19	911.93
89%	26.63	676.4	90.18	901.79
88%	26.33	668.8	89.17	891.66
87%	26.03	661.2	88.15	881.53
86%	25.73	653.6	87.14	871.40
85%	25.43	646.0	86.13	861.26
84%	25.13	638.4	85.11	851.13
83%	24.83	630.8	84.10	841.00
82%	24.54	623.2	83.09	830.87
81%	24.24	615.6	82.07	820.73
80%	23.94	608.0	81.06	810.60
79%	23.64	600.4	80.05	800.47
78%	23.34	592.8	79.03	790.34
77%	23.04	585.2	78.02	780.20
76%	22.74	577.6	77.01	770.07
75%	22.44	570.0	75.99	759.94
74%	22.14	562.4	74.98	749.81
73%	21.84	554.8	73.97	739.67
72%	21.54	547.2	72.95	729.54

# 8.2

## Appendix B Oxygen Solubility Table

Solubility of oxygen in mg/L in water exposed to water-saturated air at 760 mm Hg pressure.

Salinity = Measure of quantity of dissolved salts in water.

Chlorinity = Measure of chloride content, by mass, of water.

$$S(0/00) = 1.80655 \times \text{Chlorinity (0/00)}$$

Temp °C	Chlorinity : 0 Salinity: 0	5.0 ppt 9.0 ppt	10.0 ppt 18.1 ppt	15.0 ppt 27.1 ppt	20.0 ppt 36.1 ppt	25.0 ppt 45.2 ppt
0.0	14.62	13.73	12.89	12.10	11.36	10.66
1.0	14.22	13.36	12.55	11.78	11.07	10.39
2.0	13.83	13.00	12.22	11.48	10.79	10.14
3.0	13.46	12.66	11.91	11.20	10.53	9.90
4.0	13.11	12.34	11.61	10.92	10.27	9.66
5.0	12.77	12.02	11.32	10.66	10.03	9.44
6.0	12.45	11.73	11.05	10.40	9.80	9.23
7.0	12.14	11.44	10.78	10.16	9.58	9.02
8.0	11.84	11.17	10.53	9.93	9.36	8.83
9.0	11.56	10.91	10.29	9.71	9.16	8.64
10.0	11.29	10.66	10.06	9.49	8.96	8.45
11.0	11.03	10.42	9.84	9.29	8.77	8.28
12.0	10.78	10.18	9.62	9.09	8.59	8.11
13.0	10.54	9.96	9.42	8.90	8.41	7.95
14.0	10.31	9.75	9.22	8.72	8.24	7.79
15.0	10.08	9.54	9.03	8.54	8.08	7.64
16.0	9.87	9.34	8.84	8.37	7.92	7.50
17.0	9.67	9.15	8.67	8.21	7.77	7.36
18.0	9.47	8.97	8.50	8.05	7.62	7.22
19.0	9.28	8.79	8.33	7.90	7.48	7.09
20.0	9.09	8.62	8.17	7.75	7.35	6.96
21.0	8.92	8.46	8.02	7.61	7.21	6.84
22.0	8.74	8.30	7.87	7.47	7.09	6.72
23.0	8.58	8.14	7.73	7.34	6.96	6.61
24.0	8.42	7.99	7.59	7.21	6.84	6.50
25.0	8.26	7.85	7.46	7.08	6.72	6.39
26.0	8.11	7.71	7.33	6.96	6.62	6.28
27.0	7.97	7.58	7.20	6.85	6.51	6.18
28.0	7.83	7.44	7.08	6.73	6.40	6.09
29.0	7.69	7.32	6.93	6.62	6.30	5.99
30.0	7.56	7.19	6.85	6.51	6.20	5.90
31.0	7.43	7.07	6.73	6.41	6.10	5.81
32.0	7.31	6.96	6.62	6.31	6.01	5.72

<b>Temp °C</b>	<b>Chlorinity : 0 Salinity: 0</b>	<b>5.0 ppt 9.0 ppt</b>	<b>10.0 ppt 18.1 ppt</b>	<b>15.0 ppt 27.1 ppt</b>	<b>20.0 ppt 36.1 ppt</b>	<b>25.0 ppt 45.2 ppt</b>
33.0	7.18	6.84	6.52	6.21	5.91	5.63
34.0	7.07	6.73	6.42	6.11	5.82	5.55
35.0	6.95	6.62	6.31	6.02	5.73	5.46
36.0	6.84	6.52	6.22	5.93	5.65	5.38
37.0	6.73	6.42	6.12	5.84	5.56	5.31
38.0	6.62	6.32	6.03	5.75	5.48	5.23
39.0	6.52	6.22	5.98	5.66	5.40	5.15
40.0	6.41	6.12	5.84	5.58	5.32	5.08
41.0	6.31	6.03	5.75	5.49	5.24	5.01
42.0	6.21	5.93	5.67	5.41	5.17	4.93
43.0	6.12	5.84	5.58	5.33	5.09	4.86
44.0	6.02	5.75	5.50	5.25	5.02	4.79
45.0	5.93	5.67	5.41	5.17	4.94	4.72

# Xylem |'zīləm|

- 1) The tissue in plants that brings water upward from the roots;
- 2) a leading global water technology company.

We're a global team unified in a common purpose: creating advanced technology solutions to the world's water challenges. Developing new technologies that will improve the way water is used, conserved, and re-used in the future is central to our work. Our products and services move, treat, analyze, monitor and return water to the environment, in public utility, industrial, residential and commercial building services settings. Xylem also provides a leading portfolio of smart metering, network technologies and advanced analytics solutions for water, electric and gas utilities. In more than 150 countries, we have strong, long-standing relationships with customers who know us for our powerful combination of leading product brands and applications expertise with a strong focus on developing comprehensive, sustainable solutions.

**For more information on how Xylem can help you, go to [www.xylem.com](http://www.xylem.com)**



YSI, a Xylem brand  
1725 Brannum Lane  
Yellow Springs, OH 45387  
Tel +1.800.897.4151  
Fax +1.937.767.9353  
[www.xylem.com](http://www.xylem.com)