



ProDSS

USER MANUAL



a xylem brand

This page left intentionally blank

Introduction	3
Safety information	3
Precautionary symbols	3
Product components	3
Battery use and battery life	4
Charging the battery pack	5
Battery replacement	6
Connect the handheld to the cable assembly	8
ProDSS sensor installation/removal	9
Operation	13
Keypad and navigation	13
Startup	14
Navigation	14
Main display description	15
System menu	16
Sensor menu	22
Calibration menu	28
Files menu	29
Taking measurements	32
Calibration	33
Before calibration	33
Calibration setup (pH, ORP, ISE, conductivity, turbidity)	33
Conductivity	35
Barometer	36
Dissolved oxygen	37
pH/ORP	39
Depth	41
Turbidity	42
ISEs: Ammonium, Nitrate, & Chloride	44
Maintenance and storage	51

ProDSS handheld instrument.....	52
Cable, bulkhead, and connectors	53
Sensor guard.....	53
Depth sensor maintenance and storage	54
Turbidity sensor	55
Conductivity/temperature sensor.....	56
Dissolved oxygen sensor.....	57
pH - pH/ORP sensors	61
ISE sensors.....	63
KorDSS software installation.....	67
Install the KorDSS software.....	68
ProDSS driver installation.....	69
KorDSS startup wizard.....	72
Accessories.....	73
Ordering	73
ProDSS handhelds.....	74
ProDSS cable assemblies (No sensors included).....	74
ODO/OBOD sensor and cable assemblies - DO/Temp only.....	75
ProDSS smart sensors.....	75
Replacement sensor modules and ODO sensor caps	75
ProDSS accessories.....	76
Calibration standards	77
Safety and support.....	79
Rechargeable Lithium-Ion battery pack safety warnings and precautions.....	79
Service information.....	81
Technical support.....	81
Declaration of Conformity.....	82
Warranty	84
Appendix A - DO% calibration values.....	85
Appendix B - oxygen solubility table.....	87

Introduction

Thank you for purchasing the YSI Professional Digital Sampling System (ProDSS).

ProDSS features include:

- Digital smart probes that are automatically recognized by the instrument when connected
- Waterproof (IP-67) case
- Long-life rechargeable lithium-ion battery pack
- Color display and backlit keypad
- User-selectable cable options
- USB connectivity
- Global Positioning System (GPS) (optional)
- Depth sensor (optional)
- Large memory with extensive site list capabilities
- Rugged enclosure with rubber over-molded case and military-spec (MS) connectors

Safety information

Please read this entire manual before unpacking, setting up or operating this equipment. Pay attention to all precautionary statements. Failure to do so could result in serious injury to the operator or damage to the equipment. Make sure that the protection provided by this equipment is not impaired. Do not use or install this equipment in any manner other than that specified in this manual.

NOTICE: The manufacturer is not responsible for any damages due to misapplication or misuse of this product including, without limitation, direct, incidental and consequential damages, and disclaims such damages to the full extent permitted under applicable law. The user is solely responsible to identify critical application risks and install appropriate mechanisms to protect processes during a possible equipment malfunction.

Precautionary symbols

NOTE: *Information that requires special emphasis*

NOTICE: Indicates a situation which, if not avoided, may cause damage to the instrument

 **CAUTION:** Indicates a potentially hazardous situation that may result in minor or moderate injury

 **WARNING:** Indicates a potentially or imminently hazardous situation which, if not avoided, could result in death or serious injury

Product components

Carefully unpack the instrument and accessories and inspect for damage. If any parts or materials are damaged, contact YSI Customer Service at 800-897-4151 (+1 937 767-7241) or the authorized YSI distributor from whom the instrument was purchased.

Introduction

Battery use and battery life

The ProDSS uses a rechargeable lithium-ion (Li-Ion) battery pack as a power source. The battery comes pre-installed in the ProDSS and does not need to be replaced until the battery charge capacity is deemed unacceptable by the user. The battery is shipped at ~50% full capacity and charging the battery is not required before first use.

Battery life depends on use, enabled parameters, LCD brightness, and GPS use. As with all lithium-ion batteries, battery life will decline over time and use. This decay is typical and should be expected.

A new ProDSS battery is expected to last for the following durations (25 °C (77 °F), auto sampling, GPS on, keypad backlight off):

- ProDSS instrument only - 48 hours
- ProDSS with fully loaded cable assembly and 25% (Default) LCD brightness - 20 hours
- ProDSS with fully loaded cable assembly and 100% LCD brightness - 14 hours

To increase battery life, enable manual sampling mode ([Sampling on page 20](#)). Manual sampling mode powers the sensor/s on to take a measurement and then powers down to conserve battery life. Battery life may also depend on the battery charging practices used. For maximum battery life, keep the battery 40% to 80% charged. Also, a larger discharge (e.g. to 50%) is better than a small discharge (e.g. to 90%) between recharges.

Charging the battery pack

A USB cable is included with the ProDSS to charge the instrument battery pack and connect the instrument to a PC. The instrument battery pack can be charged from the AC power adapter, directly from a computer USB connection or from an external, portable USB battery pack (sold separately, see [ProDSS accessories on page 76](#)).

Plug the USB connector into the AC power adapter, computer USB connector or external USB battery pack, then plug the micro USB connector into the ProDSS instrument ([Figure 1](#)).

NOTE: The ProDSS internal charge controller only allows the battery pack to be charged if the temperature is between 0 and 45 °C (32 and 113 °F).

⚠ WARNING: Charge the battery pack in an open area away from flammable materials, liquids, and surfaces. Read [Rechargeable Lithium-Ion battery pack safety warnings and precautions on page 79](#).

The ProDSS will charge faster when plugged into an AC outlet for charging rather than a PC's USB port. For the instrument to recognize that it is using AC power, you must start charging the ProDSS while on. After the instrument recognizes it is being charged, it can be turned off to finish charging.

When using the AC adapter, it takes approximately 14 hours to charge the ProDSS battery when the instrument is turned off during the charge. The amount of time required to completely charge the battery pack when the ProDSS is initially turned on during the charge is approximately 9 hours.

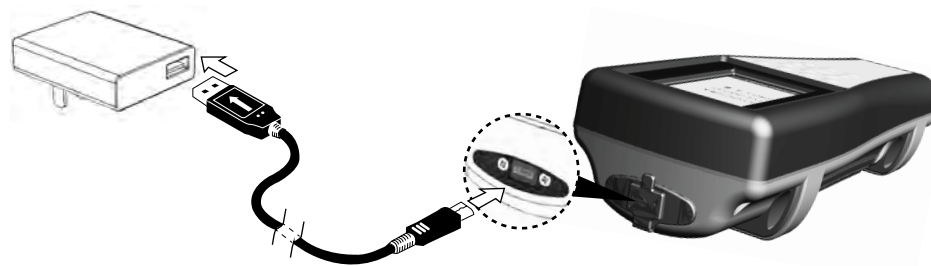



Figure 1 Connecting the ProDSS to AC power supply

Introduction

Battery replacement

NOTE: The battery pack is pre-installed in the ProDSS instrument.

 **WARNING:** Do not charge or handle a battery pack that is hot to the touch. Failure to follow the safety warnings and precautions can result in personal injury and/or instrument damage not covered under warranty. Read [Rechargeable Lithium-Ion battery pack safety warnings and precautions on page 79](#).

1. Remove the battery pack cover by unscrewing (counter-clockwise) the four screws with a flat or Phillips head screwdriver ([Figure 2 on page 7](#)).

NOTE: The retaining screws are captured into the battery pack cover and are not removable.

2. If replacing an existing battery pack, remove the Li-Ion battery pack and battery pack gasket/cradle. With two fingers, grasp the battery pack connector and pull the connector straight up to disconnect and remove.

NOTE: Properly dispose of the old battery pack ([Battery Disposal on page 80](#)).

NOTE: A new gasket/cradle is included with a new battery pack to prevent water leaking into the instrument case. When replacing the battery pack, use the new battery pack gasket/cradle supplied with the replacement battery pack.

3. Inspect the replacement battery pack and battery pack gasket/cradle for damage. Contact YSI customer service if the new battery pack and/or replacement gasket/cradle is damaged.
4. Correctly align and seat the battery pack gasket/cradle and battery pack into the instrument.
5. Align the battery pack connector wire terminals with the three instrument pins, then connect the battery pack to the instrument.

NOTICE: Make sure that the three wire terminal connectors and three instrument pins are correctly aligned before connecting the battery pack connector. Incorrect installation can damage the battery pack connectors or instrument pins.

6. Install the battery pack cover, then tighten the cover screws. Make sure that the cover sealing surface is correctly aligned and free of any contamination or damage.

NOTICE: Overtightening the cover screws can damage the battery cover.

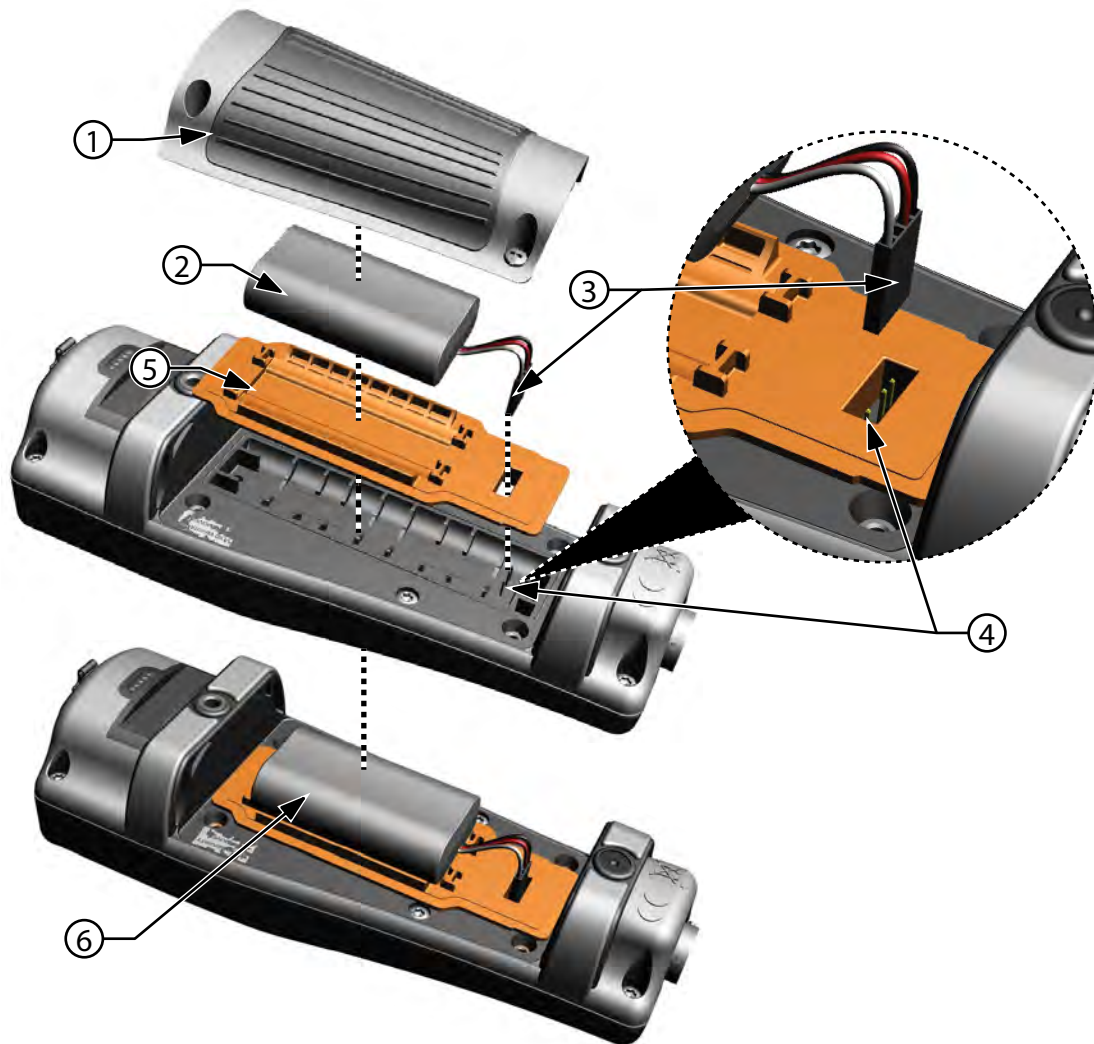
**Figure 2** Battery replacement

1 Battery pack cover	4 Instrument pin connectors
2 Battery pack	5 Battery pack gasket/cradle*
3 Battery pack connector	6 Battery pack gasket/cradle installed

*Color shown for reference

Introduction

Connect the handheld to the cable assembly

The ProDSS cable connectors are keyed for positive mating and to prevent connector damage (Figure 3). The ProDSS instrument retains its IP-67 rating when the cable is disconnected. However, the connectors are not wet-mateable and should be clean and dry before connecting.

Align the keys on the cable assembly connector with the slots on the instrument connector. Push together firmly, then twist the outer ring clockwise until it locks into place.

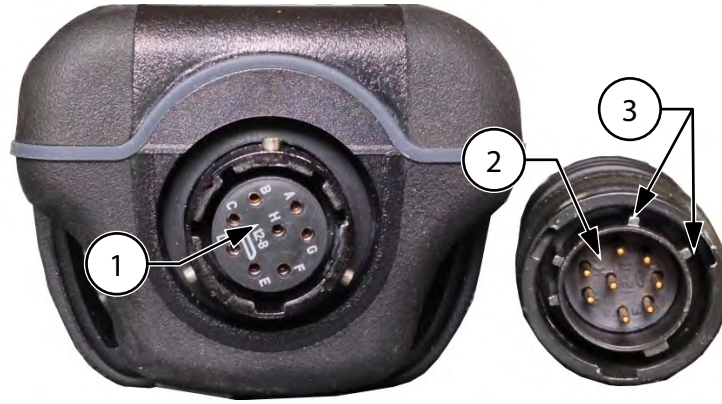

Figure 3 Keyed connectors

1 Handheld female connector	3 Keyed area of connectors
2 Cable male connector	

ProDSS sensor installation/removal

NOTICE: The ProDSS bulkhead and sensor connectors are not wet-mateable. Make sure that the sensor and bulkhead connectors are clean and dry before sensor installation.

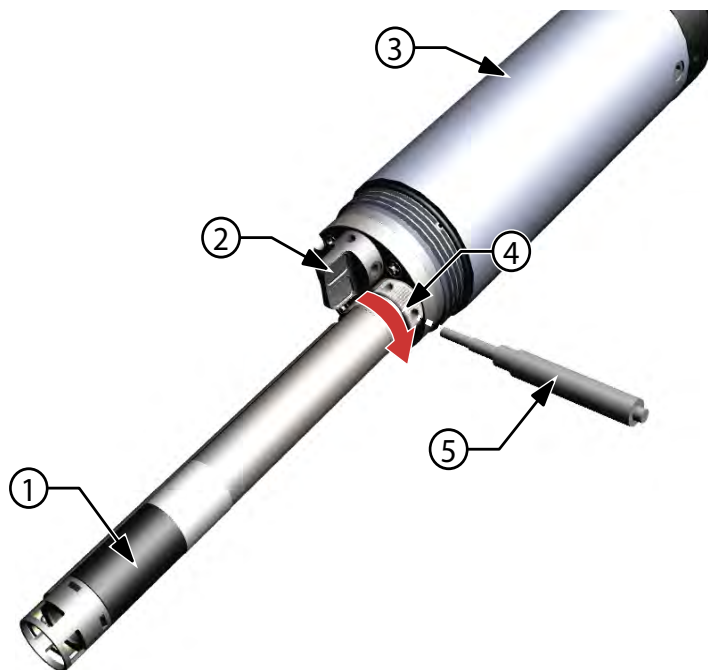

Figure 4 Sensor installation

1 Sensor	4 Sensor retaining nut
2 Port plug	5 Sensor installation/removal tool
3 Bulkhead	

Sensor installation

The ports on the ProDSS bulkhead are universal; therefore, you can install any sensor into any port. For highest accuracy, always install a conductivity/temperature sensor to compensate all measurement data for temperature and dissolved oxygen data for conductivity.

1. Remove and discard the dust plugs shipped with the instrument (Figure 5 on page 10).
2. Inspect the bulkhead port for contamination. If the port is wet, clean it with compressed air.
3. Apply a thin coat of Krytox o-ring lubricant to the sensor o-rings. Wipe off any excess o-ring grease with a lint-free cloth.
4. Carefully align the sensor and bulkhead connectors by inserting the sensor into the port then gently rotating the sensor until the connectors align. Once aligned, push the sensor toward the bulkhead until the sensor seats in the port.
5. Carefully finger-tighten the retaining nut clockwise.

NOTICE: If any resistance is felt, loosen the retaining nut completely to prevent cross-threading. Incorrect installation may cause damage to the sensor or bulkhead that is not covered by the warranty.

6. Use the sensor installation/removal tool to tighten the retaining nut clockwise until snug, about a 1/4 to 1/2 additional turn of the retaining nut.

NOTICE: Do not over-tighten the retaining nut. Over-tightening can cause damage to the sensor or bulkhead not covered by the warranty.

Introduction

Sensor removal

To remove a sensor, insert the sensor installation/removal tool into the retaining nut, then rotate the retaining nut counterclockwise to loosen. After the retaining nut has been completely unscrewed from the bulkhead, pull the sensor straight out of the port and place it on a clean surface.

NOTICE: Install a port plug if not reinstalling a sensor in the exposed port. Exposure to water can cause damage or corrosion to the bulkhead connectors not covered by the warranty.

Port plugs



Figure 5 Port plugs

1 Shipping dust cover*

2 Port plug

*Color shown for reference

To protect the bulkhead connectors from damage, install a port plug into any port without an installed sensor. Port plugs and a tube of o-ring lubricant are included in the maintenance kit that ships with all ProDSS cables. Refer to the accessories section if an additional maintenance kit is needed ([Ordering on page 73](#)).

NOTICE: The shipping dust covers installed on the bulkhead when purchased (not sensor installation/removal tool compatible) are not o-ring sealed and must be replaced with a port plug before field use.

NOTICE: Do not submerge the bulkhead without a sensor or port plug installed in all ports.

Installation

1. Apply a thin coat of Krytox o-ring lubricant to the o-rings on the plug port.
2. Remove any excess lubricant from the o-rings and port plug with a lint-free cloth.
3. Insert the port plug into the empty port and press until firmly seated.
4. Finger-tighten the port plug clockwise to install. If necessary, use the sensor installation tool to make sure that the plug is fully seated into the port.

NOTICE: The o-rings will not be visible if a port plug is correctly installed.

NOTICE: Do not over-tighten the port plug. Over-tightening can cause damage to the port plug or bulkhead not covered by the warranty.

Sensor guard and weight installation

1. Carefully slide the sensor guard over the bulkhead and attached sensors/port plugs. Push the sensor guard toward the bulkhead until the sensor guard threads align with the bulkhead threads.
2. Carefully finger-tighten the sensor guard clockwise.

NOTICE: If any resistance is felt, loosen the sensor guard completely to prevent cross-threading. Incorrect installation may cause damage to the sensor guard or bulkhead that is not covered by the warranty.

NOTICE: Do not submerge the bulkhead without a sensor or port plug installed in all ports.

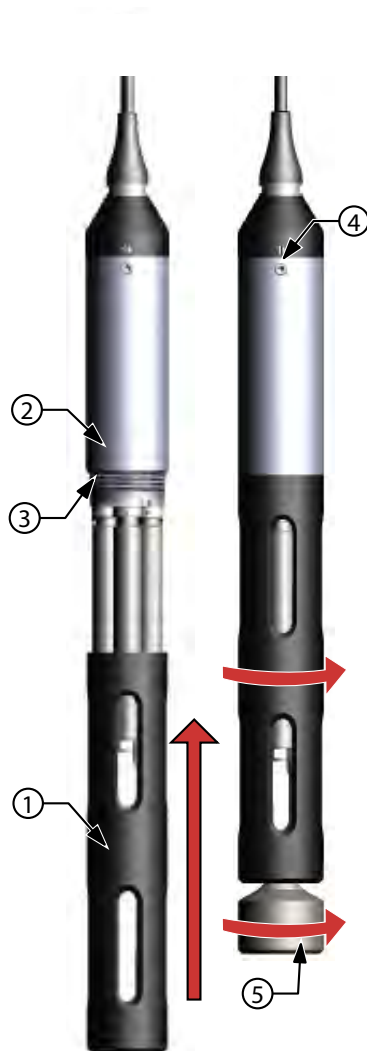

Figure 6 Sensor guard and weight installation

1 Sensor guard	4 Depth sensor (if equipped)
2 Bulkhead	5 Weight
3 Bulkhead threads	

Introduction

Sensor guard weights

To help stabilize the sensors when profiling at deeper depths, a sensor guard weight is supplied with cables 10 meters and longer. To attach the weight, carefully hand-tighten it clockwise on to the bottom of the sensor guard ([Figure 6 on page 11](#)).

NOTICE: If any resistance is felt, loosen the sensor guard weight completely to prevent cross-threading. Incorrect installation may cause damage to the sensor guard.

The bottom of the weight is threaded so that additional weights can be added if needed. See [ProDSS accessories on page 76](#).

NOTE: *Do not have any weights installed on the sensor guard when calibrating using the calibration cup.*

Operation

Keypad and navigation

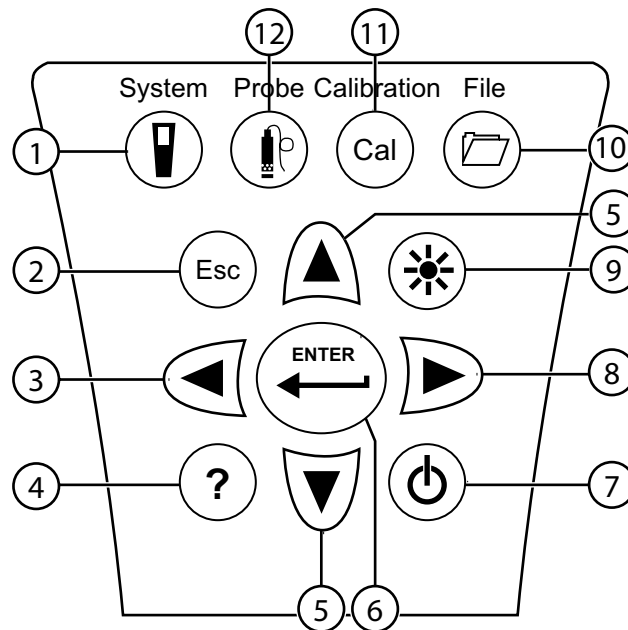



Figure 7 Keypad description





<p>1 System: Opens the system menu. Use to adjust system settings</p>	<p>7 ON/OFF: Turn on or turn off the instrument</p>
<p>2 Exit/Escape key: Exits to the Run screen. When in an alpha/numeric entry screen, returns to previous menu</p>	<p>8 Right arrow key: Navigate right in an alpha/numeric entry screen. On the Run screen, push to show graphical representations of the displayed measurements. Push the right or left arrow to return to the Run screen. In the View Data screen, push to view additional parameters in the data set</p>
<p>3 Left arrow key: Navigate left in an alpha/numeric entry screen. Push to return to previous menu in all screens except alpha/numeric entry. On the Run screen, push to show graphical representations of the displayed measurements. Push the right or left arrow to return to the Run screen</p>	<p>9 Backlight: Turns the keypad backlight on or off for use in low light conditions</p>
<p>4 Help: Shows context sensitive help</p>	<p>10 File: Opens the file menu. Use to view logged data and GLP files, backup data to a USB stick, and delete data</p>
<p>5 Up/down arrow keys: Scroll through menus or enter numbers and letters</p>	<p>11 Calibrate: Opens the calibration menu. Use to calibrate all parameters except temperature</p>
<p>6 Enter key: Push to confirm selections. On the Run screen, push to log a single data point or start continuous data logging</p>	<p>12 Probe: Opens the sensor menu. Use to setup sensors, change the measurements shown on the run screen, and turn on/off Auto Stable and GPS</p>



Operation







Startup

Push the  key to turn on the handheld. If the handheld does not turn on, make sure that the battery pack is correctly installed and charged. Push and hold the  key for 1.5 seconds to turn the handheld off.

Navigation



The ProDSS contains menus to change user-defined options, functions, and parameters. Use the arrow keys ( and ) to highlight different options within menus and sub-menus, then push the  key to select the option. Push the  key to return to the previous menu.

NOTE: When in an alpha/numeric screen, the  key is for alpha/numeric navigation only. Push the  key to return to the previous menu.

Push the  key to return to the Run screen. To enable or disable an option, highlight the option, then push the  key. Enabled functions appear as a circle with a dot  or a box with a check mark . Disabled functions appear as a circle only  or an empty box .

Alpha/numeric entry

When required, an alpha or alpha/numeric entry screen will be shown. When finished entering information, highlight **ENTER**, then push the  key to save the entry (Figure 8).

NOTE: When in an alpha/numeric screen, the  key is for alpha/numeric navigation only. Push the  key to return to the previous menu.

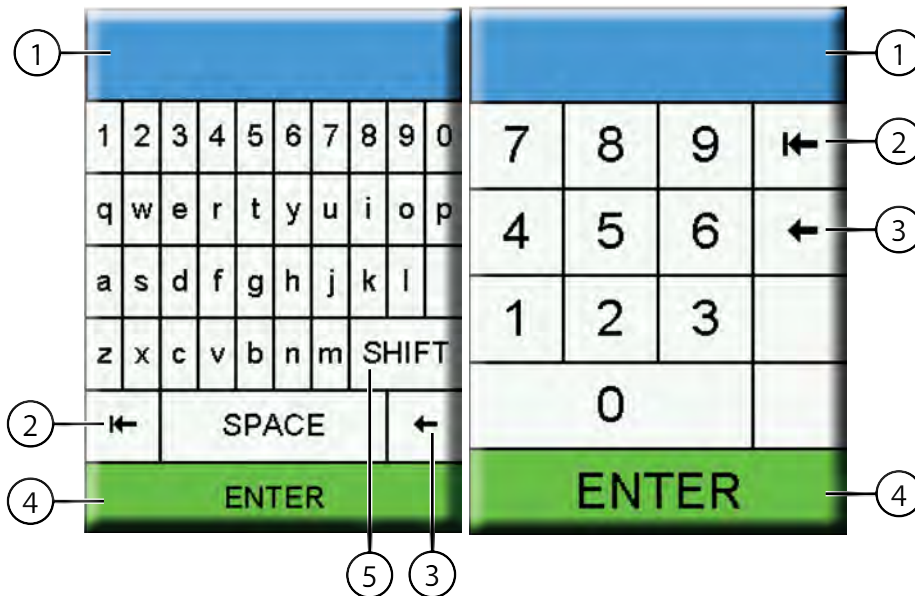

Figure 8 Alpha/numeric and numeric entry screens

1 User entry field	4 Enter selection
2 Delete entire entry	5 Upper/lowercase
3 Backspace	

Main display description

The main display (Run screen) shows the current measurements as defined in the Sensor Display menu ([Sensor Display on page 25](#)). If more measurements are selected than can be displayed on the Run screen, a scroll bar will be shown. Use the ▲ and ▼ arrow keys to view the additional measurements ([Figure 9](#)).

The message area shows status messages, error messages, and information about selected functions.

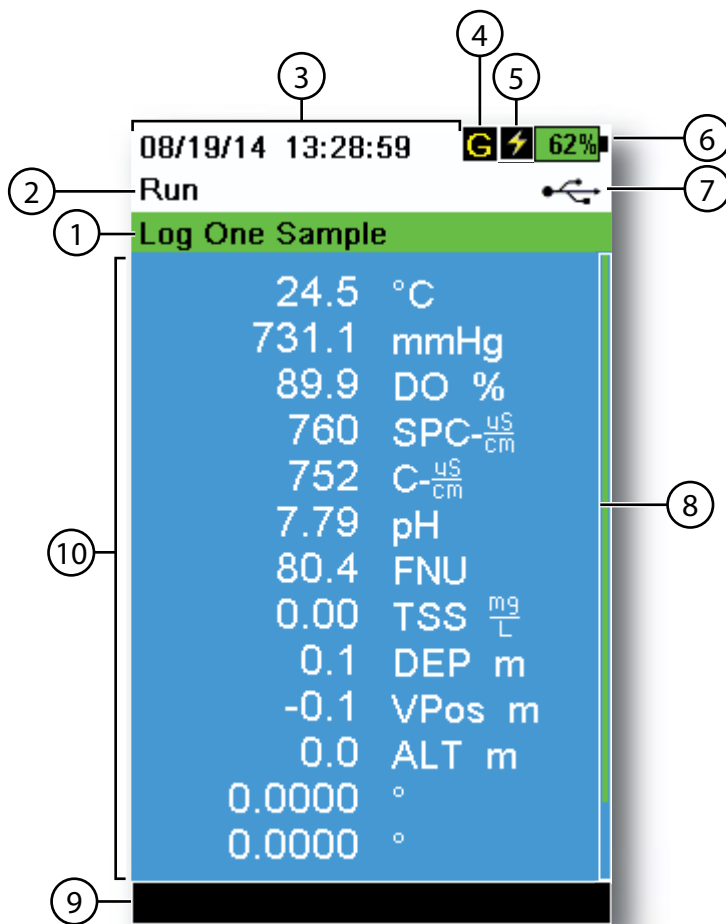



Figure 9 Main display example

1 Log or sampling (update measurements) prompt on Run screen (single or continuous)	6 Battery charge %
2 Current screen/menu	7 USB/PC connection indicator
3 Date/Time	8 Scroll bar
4 GPS signal indicator	9 Message area
5 Battery charging indicator	10 Displayed measurements

Operation

System menu

Push the System  key to view and adjust instrument settings. Highlight a sub-menu then push the  key to view the sub-menu options (Figure 10).

Pre-defined or user-selected options are noted within brackets ([]). See [Alpha/numeric entry on page 14](#).

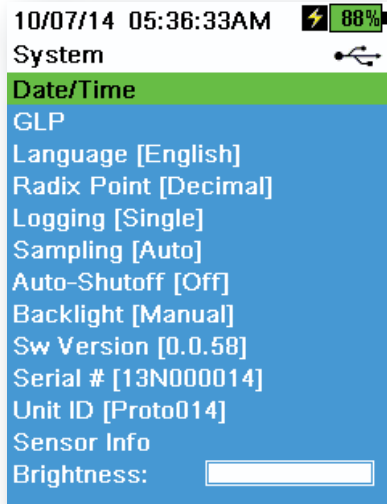

Figure 10 System menu

Use the System menu to:

- Set the date and time ([Date/Time on page 17](#))
- Change the user-defined Good Laboratory Practices (GLP) options ([GLP menu on page 17](#))
- Change the instrument language setting ([Language on page 19](#))
- Change the radix point ([Radix Point on page 19](#))
- Change logging options ([Logging on page 19](#))
- Change sampling options ([Sampling on page 20](#))
- Set the handheld auto-shutoff time ([Auto-Shutoff on page 20](#))
- Set the backlight mode ([Backlight on page 21](#))
- View the software version ([Alpha/numeric entry on page 14](#))
- View the handheld serial number ([Serial # on page 21](#))
- View and adjust the Unit ID ([Unit ID on page 21](#))
- View the sensor specific information ([Sensor info on page 22](#))
- Adjust the display brightness ([Brightness on page 22](#))

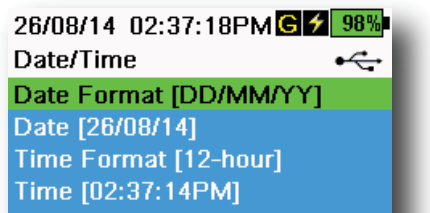

Figure 11 Date/Time

Date/Time



For accurate logging and GLP data, correctly set the date and time options (Figure 11). Select any of the following options to set the Date/Time in the ProDSS.

Date/Time options:

- Set YY/MM/DD, MM/DD/YY, DD/MM/YY or YY/DD/MM date format
- Set the correct date
- Select 12 or 24 hour time format
- Set the correct time

GLP menu

Detailed sensor calibration information is stored in the Good Laboratory Practice (GLP) file for later review.

One GLP file is used to store all calibration records. The instrument's internal memory can save up to 400 individual calibration records. After 400 records, the instrument will overwrite previously stored calibration records, starting with the oldest.

To prevent the permanent loss of GLP records, periodically download the GLP file to a computer using the KorDSS software.

NOTE: GLP files uploaded to the PC will overwrite a previously downloaded GLP file if it has the same file name. To prevent data loss, move or rename previously downloaded GLP files before downloading the GLP file.

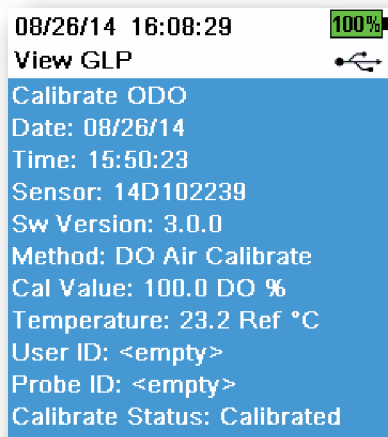

Figure 12 GLP record example (single point % DO calibration)

GLP saved information

See Figure 12.

- Sensor calibrated
- Date/time stamp
- Sensor ID
- Sensor software version
- Calibration method (Conductivity and ODO calibrations)
- Calibration value
- Temperature
- User ID (optional)
- Probe ID (optional)
- User fields #1 and #2 (optional)
- Calibration status

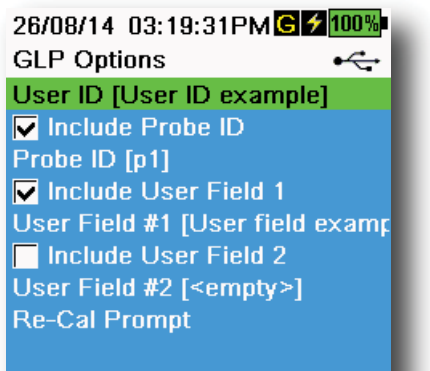

Figure 13 GLP Options



Figure 14 Re-Cal Prompts

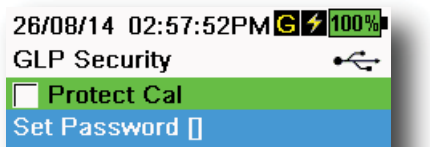



Figure 15 GLP Security

GLP Options

 → **GLP** → **Options**

User ID, Probe ID, or User Field #1 or 2 can be user-defined for positive GLP file identification of:

- The person calibrating the instrument.
- The sensor/cable serial number used during calibration (or other, user-defined Probe ID).
- Other user-specific identification (User Field #1 and #2) (Figure 13).

NOTE: User Field can be used to describe the condition of the probe. For example, new sensor or new ODO cap.

Re-Cal Prompts

 → **GLP** → **Options** → **Re-Cal Prompts**

Re-Cal Prompts provide a reminder to recalibrate a probe in the user-defined number of days (Figure 14).

The Re-Cal prompt will be displayed in the message area of the main display when the set time has elapsed (Figure 9 on page 15).

Select the desired sensor Re-Cal prompt, then enter the desired number of days before the Re-Cal prompt occurs.

Set the sensor value to zero (0) days (default) to turn off Re-Cal prompts.

NOTE: When enabled and the set amount of time since the last calibration has passed, the Re-Cal prompt will be shown when the instrument is turned on.

GLP Security

 → **GLP** → **Security**

The Calibration menu can be password protected to prevent accidental or unauthorized sensor calibration (Figure 15).

1. From the GLP menu, select **Security**, then enter the default password "ysi123".
2. Select **Set Password []** and change the default password.
3. Select the **Protect Cal** check box to password protect the Calibration menu.

NOTE: Write down and keep the password in a safe place. Contact YSI Technical Support if you lose the password (Technical support on page 81).

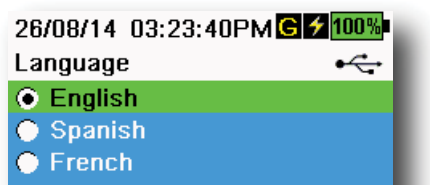

Figure 16 Language

Language



The ProDSS is shipped with English enabled. If a different language is desired and selected, the ProDSS will take approximately 10 to 20 seconds to enable the new language (during the first installation only).

Optional languages:

- French
- German
- Italian
- Japanese
- Norwegian
- Portuguese
- Simplified Chinese
- Spanish
- Traditional Chinese

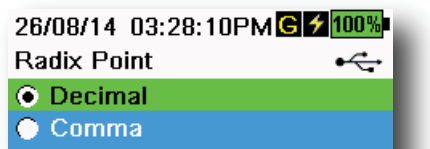

Figure 17 Radix Point

Radix Point



The radix point can be changed to display a comma or a decimal in numeric displays (e.g. 1.00 becomes 1,00 when Comma is selected) (Figure 17).

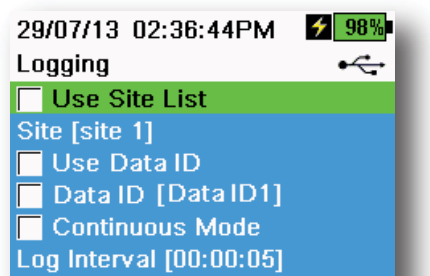



Figure 18 Logging

Logging



The Logging menu allows user-defined site and Data ID lists to be added to the logged data. Add a Site or Data ID, then select the applicable check box to log data to that site and/or Data ID (Figure 18).

Continuous Mode (Interval logging): Select the Continuous Mode check box and enter the user-defined Log Interval (in HH:MM:SS - hours:minutes:seconds) to log samples continuously at the specified time interval. The Run screen will display **Start Logging...** when in Continuous Mode.

One sample logging: Clear the Continuous Mode check box. The Run screen will display **Log One Sample**. A sample will be logged each time the  key is pushed when in the Run screen.

Operation

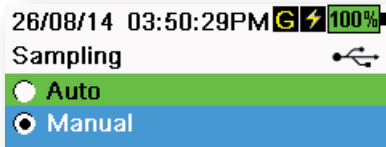

Figure 19 Sampling

Sampling



Auto sampling mode continuously updates measurements on the display (Figure 19).

Manual mode helps conserve battery power. The user-defined Sample Period determines the measurement time limit.

When in Manual mode, the instrument will take measurements for the duration of the Sample Period then “lock” or hold the readings on the display (sample period default 50 seconds, user-defined between 15 to 60 seconds).

Once the measurements are locked, push the  key to log the held data, or the  key and then the  key to take a new measurement.

Enter the desired Sample Period time.

NOTE: When both Continuous Logging Mode and Manual Sampling mode are enabled, the ProDSS will power the sensors on and take measurements for 15 seconds before logging a data set.

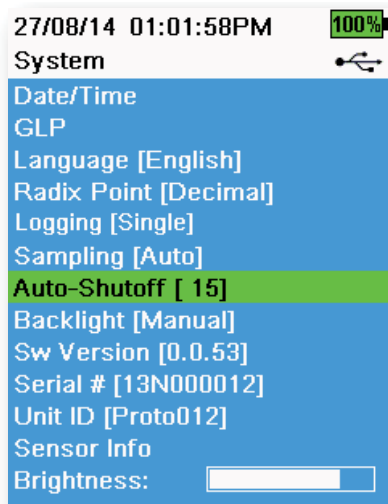

Figure 20 Auto-Shutoff

Auto-Shutoff



To conserve battery power, auto-shutoff powers off the instrument after a user-defined time period (in minutes) (Figure 20). Set to 0 (zero) to disable Auto-Shutoff.



Figure 21 Backlight

Backlight



In Automatic mode, the instrument display will dim 60 seconds after the last key was pushed. Once any key is pushed, the instrument display will return to the user-defined brightness setting and the keypad backlight will turn on. The screen will dim and the keypad backlight will turn off after another 60 seconds of inactivity.

In manual mode, the instrument display remains at the user-defined brightness until manually changed and the keypad backlight is turned on and off by the Backlight key (Figure 21).

NOTE: In bright conditions, set the backlight to Manual mode.

Software (Sw) Version



Sw Version ([System menu on page 16](#))

Sw Version shows the ProDSS software version number. The latest instrument software version is available at ysi.com. Instrument software can be updated through the KorDSS PC software program when connected to the internet or if the firmware file has been transferred to the PC. See the KorDSS help section for more information.

Serial



Serial # ([System menu on page 16](#))

Serial # shows the serial number of the ProDSS handheld instrument. Note the serial number when contacting YSI support.

Unit ID



Unit ID ([System menu on page 16](#))

Unit ID identifies the instrument in the KorDSS PC software program that was included with the instrument.

Select **Unit ID** to change the default ID.

Sensor info

 → **Sensor info** (System menu on page 16)

Sensor info shows measurement data, and hardware/software information for each component of the system: instrument, sensor, and bulkhead. Use the ▲ and ▼ arrow keys to scroll through the components.

Brightness

 → **Brightness**

The screen brightness can be adjusted to accommodate lighting conditions and to conserve battery power (Figure 22).

Select **Brightness** then use the ◀ and ▶ arrow keys to adjust the screen brightness.

NOTE: In bright conditions, set the screen brightness to 75% or greater.

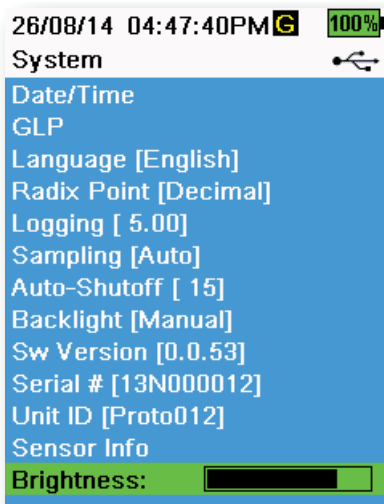



Figure 22 Display Brightness

Sensor menu

Use the Probe  key to access the Sensor menu and change sensor settings (if applicable), enable the measurement units displayed on the Run screen, set Auto Stable parameters, and if equipped, turn on/off GPS.

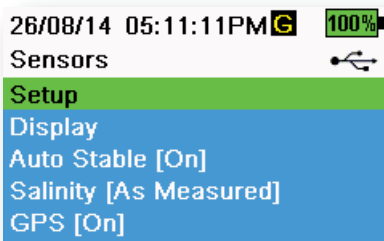



Figure 23 Probe (Sensor) menu

Push the  key to access the sensor menu (Figure 23). Highlight a sub-menu then push the  key to view sub-menu options.

Pre-defined or user-selected sensor settings are noted within brackets ([]).

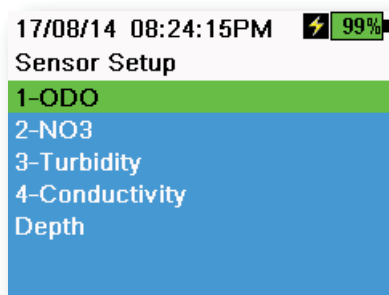

Figure 24 Sensor Setup

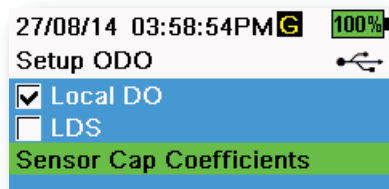

Figure 25 Setup ODO

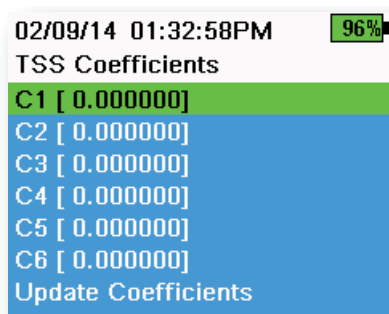
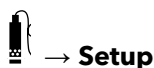

Figure 26 TSS coefficients

Sensor Setup



The Sensor Setup menu will show all sensors installed on the bulkhead (Figure 24). If a sensor is installed on the bulkhead and is not listed on the Sensor Setup menu (**<None>** displayed), check the sensor and cable connections ([ProDSS sensor installation/removal on page 9](#)).

Setup ODO



Local DO: Enable or disable localized DO% measurements. When enabled, the calibration value is set to 100% regardless of altitude or barometric pressure. When enabled, an L will be shown next to DO% on the run screen. DO mg/L measurements are unaffected when Local DO is enabled (Figure 25).

LDS: Last Digit Supression (LDS) rounds the DO value to the nearest tenth, e.g. 8.27 mg/L becomes 8.3 mg/L.

Sensor Cap Coefficients: The sensor cap coefficients must be updated after sensor cap replacement. Update the sensor cap coefficients using the KorDSS software and the coefficient sheet provided with the new sensor cap.

Setup Turbidity



TSS Coefficients: The Total Suspended Solids (TSS) coefficients are calculated in KorDSS by entering turbidity and TSS correlation data.

Measure turbidity and take a grab sample for laboratory analysis of TSS to obtain a value pair for the correlation. At least two and up to six value pairs can be entered into KorDSS.

The TSS coefficients can be entered manually or updated through the KorDSS software (Figure 26).

For highest accuracy, obtain 6 values pairs and calculate new coefficients for each unique sampling site.

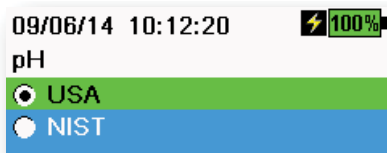

Figure 27 Setup pH

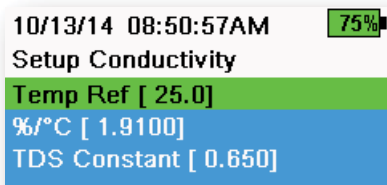

Figure 28 Setup Conductivity

Setup pH



Select USA auto-buffer recognition (4.01, 7.00, and 10.00) or NIST auto-buffer recognition (4.01, 6.86, and 9.18) (Figure 27).

Setup Conductivity

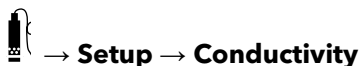

Temp Ref (Temperature reference): Reference temperature used to calculate temperature compensated specific conductance. All specific conductance values are compensated to the Temp Ref temperature. The default value is 25 °C (77 °C) (Figure 28). Enter a new value between 15.00 °C (59 °F) and 25.00 °C (77 °F).

%/°C (Percent per degree Celsius): Temperature coefficient used to calculate temperature compensated specific conductance. The default is 1.91% based on KCl standards. Enter a new value between 0 and 4%.

TDS Constant: Multiplier used to calculate an estimated Total Dissolved Solids (TDS) value from conductivity. The multiplier is used to convert specific conductance in mS/cm to TDS in g/L. The default value is 0.65. Enter a new value between 0 and 0.99.

This multiplier is highly dependent on the nature of the ionic species present in the water sample. To be assured of moderate accuracy for the conversion, you must determine a multiplier for the water at your sampling site. Use the following procedure to determine the multiplier for a specific sample:

1. Determine the specific conductance of a water sample from the site.
2. Filter a portion of water from the site.
3. Carefully measure a volume of the filtered water. Completely evaporate to yield a dry solid.
4. Accurately weight the remaining solid.
5. Divide the weight of the solid (in grams) by the volume of water used (in liters) to yield the TDS value in g/L for the site.
6. Divide the TDS value in g/L by the specific conductance of the water in mS/cm to yield the conversion multiplier.

NOTE: Make sure to use the correct units.

NOTE: If the nature of the ionic species at the site changes between sampling studies, the TDS values will be in error. TDS cannot be calculated accurately from specific conductance unless the make-up of the chemical species in the water remains constant.

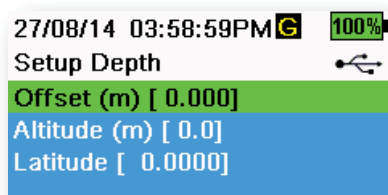

Figure 29 Setup Depth

Setup Depth



For ProDSS bulkheads with the depth sensor:

The ProDSS cable assemblies with a depth sensor in the bulkhead can measure virtual vented depth (Figure 6 on page 11). The virtual vented depth measurement allows for real time compensation for atmospheric pressure using the instrument's barometer.

Depth offset: Depth offset can be used if referencing water elevation against a known datum. If a depth offset is entered (in meters), the output value will shift by the value of the offset (Figure 29).

Altitude/Latitude: To compensate for atmospheric pressure based on elevation and gravitational pull, enter the local altitude in meters relative to sea level and latitude in degrees where the ProDSS is sampling.

Latitude effect: Varying latitudes cause a 200 mm change in depth from equator to pole.

Altitude effect: Varying altitudes cause approximately 90 mm change from sea level to 8000 m. A 100 m change causes 1.08 mm of change to the readings.

Sensor Display



The Sensor display menu determines the measurements that are shown on the Run screen (Figure 3 Main display example on page 28). The Run screen will only show measurements for sensors that are attached to the cable bulkhead.

If more measurements are selected than can be displayed on one screen, a scroll bar will be shown. Use the ▲ and ▼ keys to scroll through the measurements.

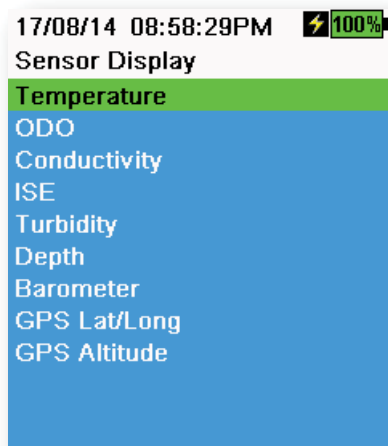

Figure 30 Sensor Display

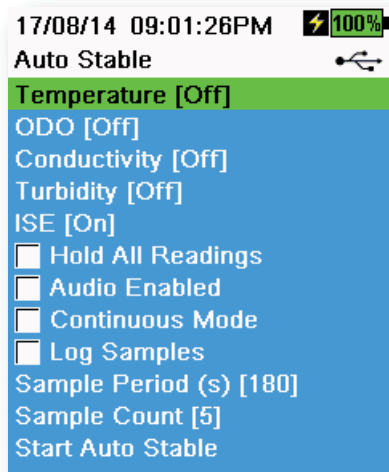

Figure 31 Auto Stable

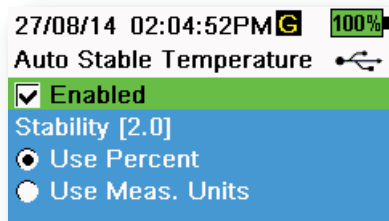

Figure 32 Auto Stable stability threshold

Auto Stable



Auto Stable indicates when a measurement is stable. Sensors with Auto Stable enabled will have ^As flash beside the measurement on the Run screen.

^As will flash green when the measurement is stable.

Select a sensor to enable or disable Auto Stable. Set the stability threshold parameters (Figure 31).

The Auto Stable stability threshold can be set by percent of measurement or in the units of measurement selected in the Sensor Display menu.

Enter the stability value, then select **Use Percent** or **Use Meas. Units** (Figure 32).

This threshold is used to compare the last reading with the previous. The smaller the number entered in % or units, the longer it will take for the instrument to reach the auto stable criteria.

Example: For temperature in °C, if unit threshold is set to 0.2 and the temperature reading changes by more than 0.2 degrees, ^As will continue to be red until the reading does not change by more than 0.2 °C over the defined sample period and sample count.

Hold All Readings: After all sensors have reached their stability criteria, the measurements will be held or 'locked' on the display. If disabled, the sensor measurements will continue to change in real time.

Audio Enabled: An audio alert will sound when stability is reached.

Continuous Mode: The ProDSS will continuously check sensor values against the stability criteria even after the sample period and sample count have been met.

Log Samples: Logs the sample/s defined by the Sample Period to memory.

Sample Period: Time interval between the sensor measurements (sample) that are used to determine stability. Set the interval in seconds (1 to 900).

Sample Count: Number of consecutive samples required for stability (1 to 10).

Select **Start Auto Stable** to enable.

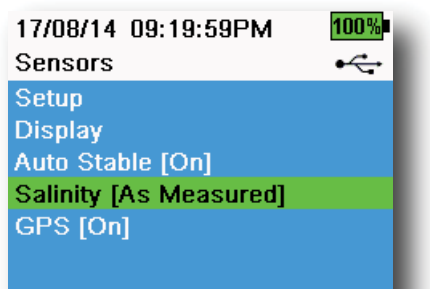

Figure 33 Salinity

Salinity



Salinity is determined by calculations derived from the conductivity and temperature sensors.

Because salinity is an important factor in determining dissolved oxygen, YSI does not recommend calibrating or taking dissolved oxygen measurements without the conductivity/temperature sensor installed in the bulkhead.



Figure 34 GPS

GPS (optional)



GPS turns the ProDSS Global Positioning System On or Off. The **G** symbol is shown when a GPS signal is received (Figure 34).

When enabled, the GPS coordinates will be saved with the GLP file and logged data.

Operation

Calibration menu

Push the **Cal** key to access the Calibration menu (Figure 35). Highlight a sub-menu then push the **ENTER** key to view sub-menu options.

Pre-defined or user-selected parameters are noted within brackets ([]). See [Alpha/numeric entry on page 14](#).

Refer to the Calibration section for sensor specific calibration procedures ([Calibration on page 33](#)).

NOTE: Attached sensors are listed according to the bulkhead port in which they are installed.

NOTE: User ID, Probe ID, and User Field #1 and #2 must be enabled in the GLP menu to appear in the Calibration menu ([GLP Options on page 18](#)).

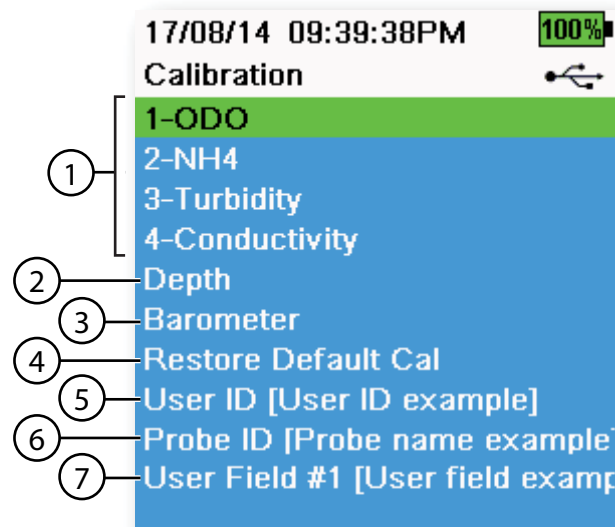



Figure 35 Calibration menu

1	Sensors connected to bulkhead	5	User ID
2	Optional Depth sensor calibration	6	Probe ID
3	Barometer calibration	7	User Field #1
4	Restore Default Calibration - restores all calibrations to factory default		

Files menu

Push the  key to access the Files menu (Figure 36). Highlight a sub-menu then push the  key to view sub-menu options.

Use the Files menu to view, delete or backup logged data or the GLP file. Data can be filtered by a specific date and time range and by user-created site and Data ID lists (Logging on page 29).

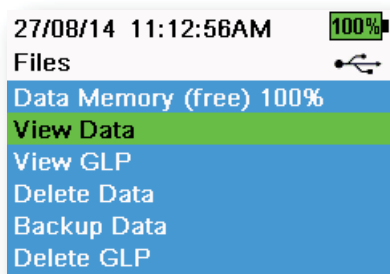

Figure 36 Files menu

Data Memory (free) % shows the remaining memory available. Download or delete data to free available internal memory.

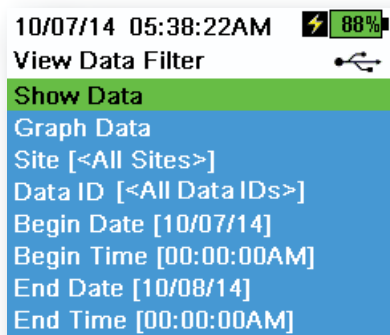

Figure 37 View Data Filter

View Data Filter

 → **View Data**

Enter the desired filter criteria, then select **Show Data** or **Graph Data** to view the tabular or graphical data. If necessary, use the ▲ and ▼ arrow keys to scroll through the data (Figure 37 and Figure 38).

Site: View data from one site or all sites.

Data ID: View data from one ID or all IDs.

Begin/End: View data within specific date and time ranges.

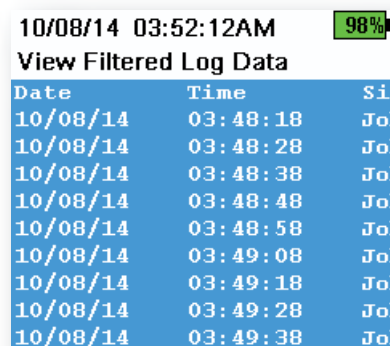

Figure 38 View Filtered Log Data

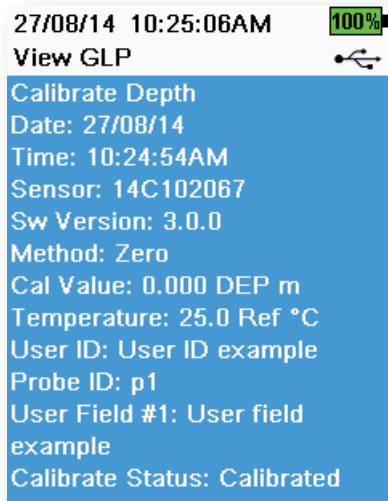

Figure 39 View GLP

View GLP



Select **View GLP** to show the stored sensor calibrations (Figure 39).

Use the arrow keys to scroll through the GLP file data.

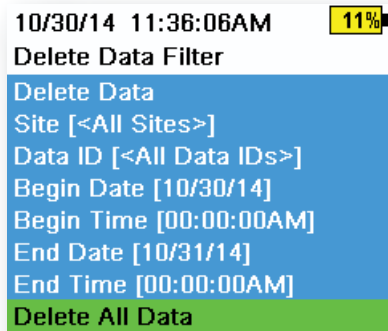

Figure 40 Delete Data Filter

Delete Data



Enter the desired filter criteria, then select **Delete Data** to permanently delete the data (Figure 40).

NOTE: *If filter criteria are not selected, all logged data will be permanently deleted.*

Select **Delete All Data** to permanently delete all logged data from the ProDSS.

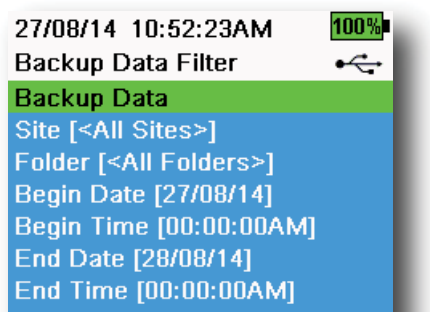

Figure 41 Backup Data

Backup Data



A USB female to micro USB male adapter is included to directly backup files from the handheld to a standard USB storage device. The data is exported as a CSV file.

Enter the desired filter criteria then connect the handheld to the USB storage device using the supplied adapter. Select **Backup Data** to export the data to an USB storage device (Figure 41 and Figure 42).

NOTE: The USB storage device must be formatted as FAT32, not NTFS or exFAT. The handheld will only support FAT32.



Figure 42 Micro USB female connector

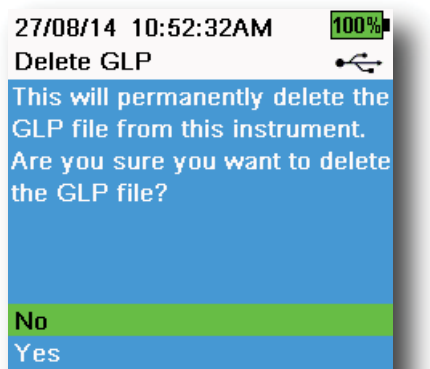



Figure 43 Delete GLP

Delete GLP



To permanently delete the GLP file from the instrument, select **Yes**, then push the  key (Figure 43).

Operation

Taking measurements

For the highest accuracy, calibrate the instrument before taking measurements ([Calibration on page 33](#)).

1. Create site and Data ID lists for logged data (if applicable) ([Logging on page 19](#)).
2. Set the logging method (single or interval) ([Logging on page 19](#)).
3. Set the Auto Stable parameters (if applicable) ([Auto Stable on page 26](#)).
4. Verify that the sensors and/or port plugs are correctly installed in all bulkhead ports ([on page 8](#)).
5. Install the sensor guard ([Figure 6 on page 11](#)).
6. Insert the sensors into the sample.

NOTE: *Make sure to submerge the sensors completely. If using a depth sensor, submerge to where the cable assembly attaches to the bulkhead.*

7. Move the bulkhead in the sample to release any air bubbles and to provide a fresh sample to the sensors.
8. Wait for the sensor/s to stabilize in the sample.
9. If logging, select **Log One Sample** or **Start Logging** ([Logging on page 19](#)).

Calibration

ProDSS sensors (except temperature) require periodic calibration to maintain accurate measurements. Calibration procedures follow the same basic steps with variations for specific parameters.

Before calibration

- Enter GLP user-defined data if applicable to user requirements (User ID, Probe ID, User Field #1/2) ([GLP menu on page 17](#)).
- Setup sensor options, settings, and coefficients as applicable ([Probe menu on page 37](#)).

NOTICE: Install a gray port plug in all exposed ports. Exposure to water can cause damage or corrosion to the bulkhead connectors not covered by the warranty.

Calibration setup (pH, ORP, ISE, conductivity, turbidity)

NOTE: Make sure the calibration cup, sensor guard, and all sensors are clean.

NOTE: If using the calibration cup, make sure to install the sensor guard before placing the sensors into the calibration cup.

NOTE: The sensor guard and calibration cup should be used for the turbidity and DO calibration. All other calibrations can be performed in other laboratory glassware.

NOTE: Make sure to use a clean probe guard during calibration to prevent contamination of the calibration environment.

1. Install a clean, dry sensor and sensor guard (if used) onto the bulkhead ([Figure 4 on page 9](#)).

NOTICE: Install a gray port plug in any exposed port. All sensors must have either a sensor or port plug installed.

2. Fill the calibration cup with a moderate amount of water and tighten the calibration cup onto the bulkhead. Use the water to rinse the cup and the sensor to be calibrated. Discard the rinse.
3. Thoroughly rinse the calibration cup with a small amount of the calibration standard for the sensor to be calibrated. Discard the standard.
4. Refill the calibration cup with fresh calibration standard to approximately the first line for pH, ORP, and turbidity calibration. Fill to the second line for conductivity calibration ([Figure 44 on page 34](#)).

NOTE: Volumes will vary. Make sure that the temperature sensor and the sensor to be calibrated are submerged in calibration solution, except when performing a DO% saturation calibration.

NOTE: Be careful to avoid cross-contamination with other standards.

NOTE: These rinsing recommendations are only suggested guidelines for highest data accuracy. Make sure to follow your organization Standard Operating Procedures (SOPs) for instrument calibration and operation.

5. Immerse the sensor(s) in the standard and tighten the calibration cup onto the bulkhead.
6. Calibrate the sensor(s).

Calibration

Alternately, pH, ORP, and conductivity calibrations can be completed in a beaker or other container using the same basic procedure described above. Make sure that the temperature sensor and the sensor to be calibrated are completely submerged. When submerging the conductivity sensor, make sure that the calibration solution covers the vent hole on the side of the conductivity sensor and there is at least 25.4 mm (1 in) distance between the sides and bottom of the calibration container and the conductivity probe.

Calibration cup installation

1. Make sure the calibration cup gasket is correctly seated (Figure 44). Loosely install the retaining nut on the calibration cup.
2. Slide the calibration cup over the sensors and sensor guard.
3. Tighten the retaining nut.

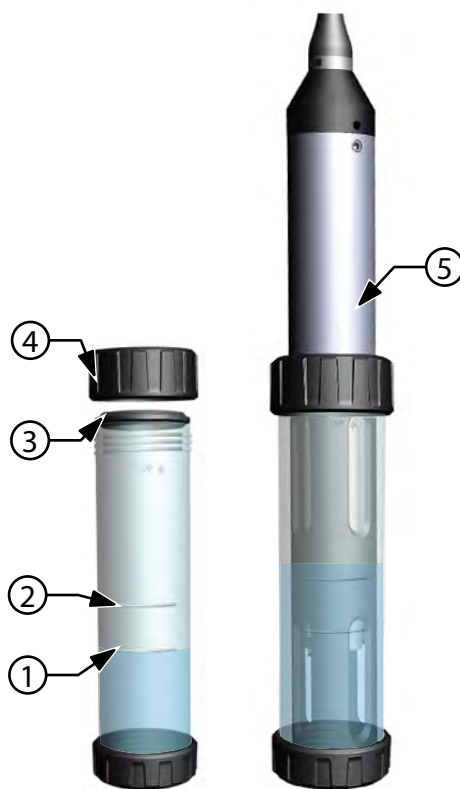

Figure 44 Calibration cup standard volume

1 Fill line one (used for Turbidity, pH, and ORP calibration solution)	4 Retaining nut
2 Fill line two (used for conductivity calibration solution)	5 Calibration cup installed
3 Gasket	

Conductivity

A conductivity/temperature sensor must be installed on the bulkhead for accurate temperature compensation and measurements of all other parameters (Figure 4 on page 9). Temperature calibration is not available or required for accurate temperature measurements.

The conductivity/temperature sensor can measure and calculate conductivity, specific conductance (temperature compensated conductivity), salinity, non-linear function (nLF) conductivity, TDS, resistivity, and density. Calibration is only available for specific conductance, conductivity, and salinity. Calibrating one of these options automatically calibrates the other conductivity/temperature parameters listed above. For both ease of use and accuracy, YSI recommends calibrating specific conductance.

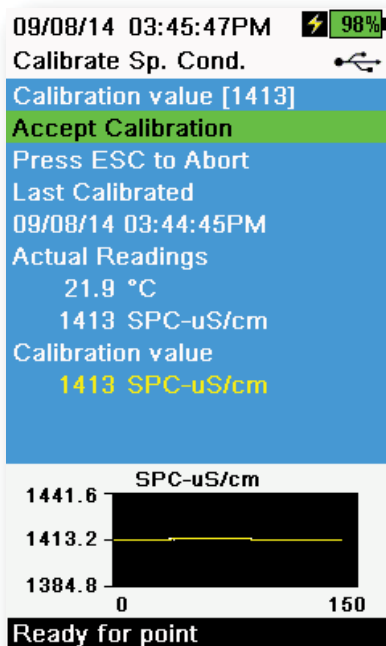

Figure 45 Calibrate specific conductance

Conductivity calibration

1. If necessary, clean the conductivity cell with the supplied soft brush. See [Conductivity/temperature sensor maintenance](#) on page 56.
2. Perform the [Calibration setup \(pH, ORP, ISE, conductivity, turbidity\)](#) on page 33.
3. Place the correct amount of conductivity standard (225 mL if using the calibration cup) into a clean and dry or pre-rinsed calibration cup.

NOTE: Select the appropriate calibration standard for the conductivity of the sampling environment. Standards greater than 1 mS/cm (1000 μ S/cm) are recommended for the greatest stability. For fresh water applications, calibrate to 1,000 or 10,000 μ S. For salt water applications, calibrate to 50,000 μ S.

4. Carefully immerse the sensors into the solution. Make sure the solution is above the vent holes on the side of the conductivity sensor.
5. Gently rotate and/or move the sensor up and down to remove any bubbles from the conductivity cell. Allow at least one minute for temperature equilibration before proceeding.
6. Push the Cal key, select **Conductivity**, then select **Specific Conductance**.

NOTE: Calibrating any conductivity calibration option will automatically calibrate the other options. Specific conductance is recommended for both ease of use and accuracy.

7. Select **Calibration value** then enter the calibration value of the standard used. Note the measurement units the instrument is reporting and calibrating and be sure to enter in the correct calibration value for the units being used. For example, 10,000 μ S = 10 mS. Make sure that the units are correct and match the units displayed on the handheld.
8. Observe the actual measurement readings for stability (white line on graph shows no significant change for 40 seconds), then select **Accept Calibration** (Figure 45). "Calibration successful!" will be displayed in the message area.

Calibration

NOTE: If the data is not stabilized after 40 seconds, gently rotate the sensor or remove/reinstall the calibration cup to make sure that no air bubbles are in the conductivity cell.

NOTE: If the actual measurement data is about 1/2 if the expected calibration value, the conductivity sensor is not completely submerged. Add more calibration standard to the calibration cup.

NOTE: If you get calibration error messages, check for proper sensor immersion, verify the calibration solutions is fresh, the correct value has been entered into the ProDSS, and/or try cleaning the sensor.

9. Rinse the bulkhead and sensors in clean water then dry.

Barometer

The barometer is factory calibrated and should rarely need to be recalibrated. The barometer is used for DO calibration, %Local measurements, and for virtual depth measurements. Verify that the barometer is accurately reading "true" barometric pressure and recalibrate as necessary.

Laboratory barometer readings are usually "true" (uncorrected) values of air pressure and can be used "as is" for barometer calibration. Weather service readings are usually not "true", i.e. they are corrected to sea level and cannot be used until they are "uncorrected". Use this approximate formula:

True BP in mmHg=[Corrected BP in mmHg] - [2.5* (Local altitude in ft. above sea level/100)]

Example:

Corrected BP = 759 mmHg

Local altitude above sea level = 978 ft

True BP = 759 mmHg - [2.5*(978ft/100)] = 734.55 mmHg

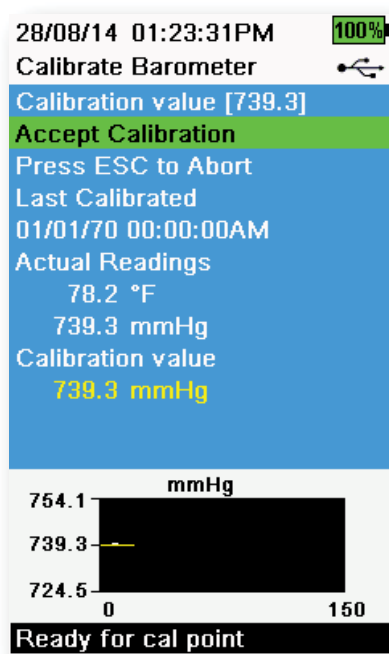

Figure 46 Calibrate Barometer

Barometer calibration

1. Push the Cal key, then select **Barometer**.
2. Select **Calibration value** then enter the correct "true" barometric pressure.

NOTE: The measurement units during calibration are dictated by what is enabled in the sensor setup menu. Be sure to enter in the correct units.

- BP in mmHg=25.4 x BP inHg
- BP in mmHg=0.750062 x BP mb
- BP in mmHg=51.7149 x BP psi
- BP in mmHg=7.50062 x BP kPa
- BP in mmHg=760 x BP atm

3. Select **Accept Calibration** (Figure 46). "Calibration successful!" will be displayed in the message area.

Dissolved oxygen

ODO calibration requires the current “true” barometric pressure. Make sure that the barometer is reading accurately and recalibrate the barometer as necessary.

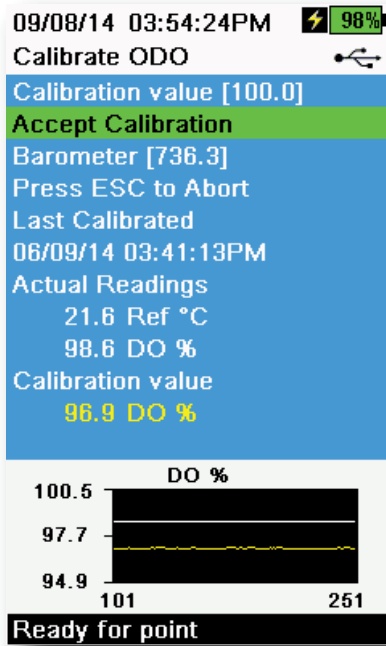

Figure 47 Calibrate ODO %

ODO% and ODO% local - water saturated air calibration

NOTE: This method calibrates the instrument’s DO% measurement or DO% Local measurement if DO% local is enabled in the sensor setup menu.

NOTE: Calibrating in DO% or DO% local automatically calibrates the mg/L and ppm measurement. There is no reason to calibrate both parameters. For both ease of use and accuracy, we recommend that you calibrate DO% or DO% Local and not mg/L.

1. Place a small amount of clean water (1/8 inch) into the calibration cup.
2. Make sure there are no water droplets on the ODO sensor cap or temperature sensor.
3. Attach the sensor guard to the bulkhead and carefully place the guard/sensor into the calibration cup. Partially tighten the calibration cup to the bulkhead.

NOTE: Do not fully tighten the calibration cup to the bulkhead. Atmospheric venting is required for accurate calibration.

NOTE: Make sure the ODO and temperature sensors are not immersed in water.

4. Turn the instrument on and wait approximately 5 to 15 minutes for the air in the storage container to be completely saturated with water.
5. Push the Cal key, then select **ODO**. Select **DO%**. This will calibrate the instrument’s DO% measurement or DO% Local measurement if DO% Local is enabled in the sensor setup menu.
6. Observe the actual measurement readings for stability (white line on graph shows no significant change for 40 seconds), then select **Accept Calibration** (Figure 47). “Calibration successful!” will be displayed in the message area.

NOTE: If you see a calibration error message, verify the barometer reading and inspect the sensor cap. Clean and/or replace the sensor cap as needed.

Calibration

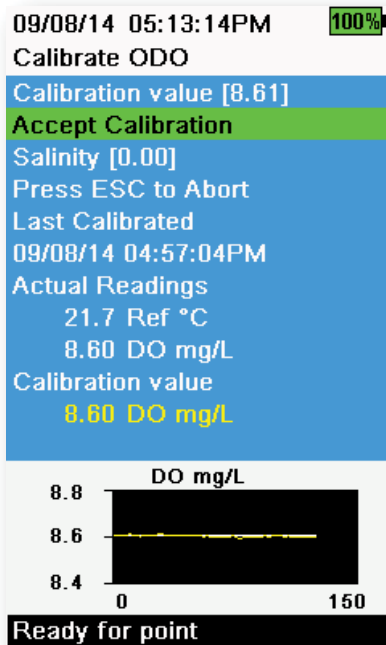

Figure 48 Calibrate ODO mg/L

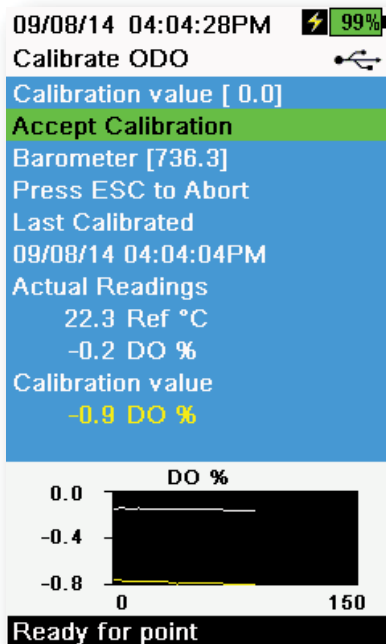

Figure 49 Calibrate ODO zero point

ODO mg/L calibration

1. Place the ODO and conductivity/temperature sensor into a water sample that has been titrated by the Winkler method to determine the dissolved oxygen concentration in mg/L.
2. Push the Cal key, then select **ODO**. Select **DO mg/L**.
3. Select **Calibration value**.
4. Enter the dissolved oxygen concentration of the sample in mg/L.
5. Observe the actual measurement readings for stability (white line on graph shows no significant change for 40 seconds), then select **Accept Calibration** (Figure 48). "Calibration successful!" will be displayed in the message area.
6. Rinse the bulkhead and sensors in clean water then dry.

ODO zero point calibration

1. Place the ODO and Conductivity/Temperature sensors in a solution of zero DO.

NOTE: A zero DO solution can be made by dissolving approximately 8-10 grams of sodium sulfite into 500 mL of tap water. Mix the solution thoroughly. It may take the solution 60 minutes to be oxygen-free.
2. Push the Cal key, then select **ODO**. Select **Zero**.
3. Observe the actual measurement readings for stability (white line on graph shows no significant change for 40 seconds), then select **Accept Calibration** (Figure 49). "Calibration successful!" will be displayed in the message area.
4. Thoroughly rinse the bulkhead and sensors in clean water then dry.
5. Perform a ODO % water-saturated air calibration after performing a zero point calibration.

pH/ORP

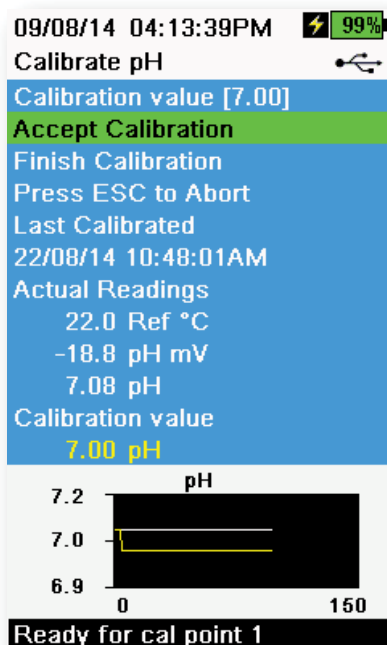



Figure 50 Calibrate pH 1-point

pH calibration 1-point

NOTE: If performing a 1-point calibration, use buffer 7 (6.86) as your calibration point for highest accuracy.

NOTE: Observe the pH mV readings during calibration to understand the condition and response of the pH sensor. In buffer 7, pH mVs should be between -50 and +50. In buffer 4, the mVs should be a +165 to 185 away from the pH 7 mV value or a 59 mV per decade slope. In buffer 10, the mVs should be a -165 to -185 away from the pH 7 mV value or a -59 mV per decade slope.

1. Perform the [Calibration setup](#) (pH, ORP, ISE, conductivity, turbidity) on page 33.
2. Fill the calibration cup to the appropriate level (170 mL) with pH 7 buffer solution (or 6.86 if using NIST buffers).
3. Carefully immerse the probe end of the sensors into the buffer solution.
4. Push the  key, then select **pH** or **pH/ORP**.

NOTE: If using a pH/ORP sensor, select **pH/ORP**, then **pH**.
5. Allow at least one minute for temperature stabilization, then select **Calibration value**.
6. Enter the pH buffer value that corresponds to the measured temperature reading (example: the value of pH 7 buffer solution @ 20 °C (68 °F) is 7.02 - this value can be found on the bottle of most pH buffers).
7. Observe the actual measurement readings for stability (white line on graph shows no significant change for 40 seconds), then select **Accept Calibration** (Figure 50). "Ready for cal point 2" will be displayed in the message area.
8. Select **Finish Calibration** for a 1-point calibration or continue on to the 2-3 point calibration procedure ([Calibration cup installation](#) on page 34).

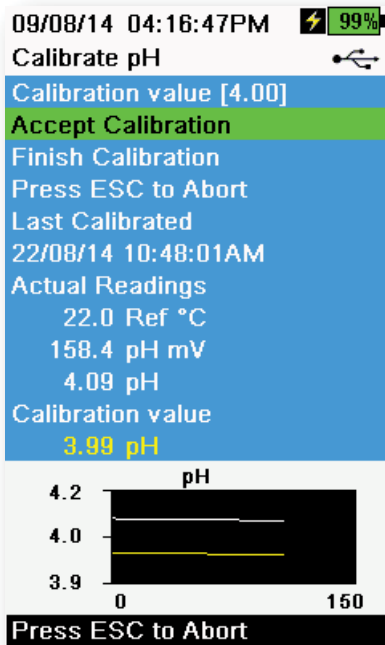

Figure 51 Calibrate pH 2- or 3-point

pH calibration 2- or 3-point

NOTE: If performing a 2- or 3-point calibration, one point should be in buffer 7; however, the calibration points can be in any order.

1. Perform steps 1-7 of the pH calibration 1-point procedure (pH calibration 1-point on page 39).
2. Rinse the sensor 2-3 times with a small amount of pH 4 or pH 10 buffer solution.
3. Rinse, then fill the calibration cup to the appropriate level with the buffer solution (approximately 170 mLs) that is the same value (pH 4 or pH 10) used to rinse the sensor.
4. Carefully immerse the sensors into the solution.
5. Allow at least one minute for temperature stabilization, then select **Calibration value**.
6. Enter the pH buffer value that corresponds to the buffer temperature reading (value may be located on pH buffer bottle).
7. Observe the actual measurement readings for stability (white line on graph shows no significant change for 40 seconds), then select **Accept Calibration** (Figure 51). "Ready for cal point 3" will be displayed in the message area.
8. Select **Finish Calibration** for a 2-point calibration or repeat the 2- or 3-point calibration procedure with the third buffer solution.

ORP calibration

1. Obtain/prepare a standard with a known oxidation reduction potential (ORP) value.
NOTE: YSI recommends Zobell solution.
2. Fill the solution to fill line 1 on the calibration cup (approximately 170 mLs).
3. Carefully immerse the sensors into the solution.
4. Push the Cal key, then select **pH/ORP**, then **ORP**.
5. Allow the temperature of the standard to stabilize then select **Calibration value**.
6. Enter the ORP calibration value that corresponds to the measured temperature reading (example: the value of YSI Zobell @ 20 °C is 237.5)
7. Observe the actual measurement readings for stability (white line on graph shows no significant change for 40 seconds), then select **Accept Calibration** (Figure 52). "Calibration successful!" will be displayed in the message area.

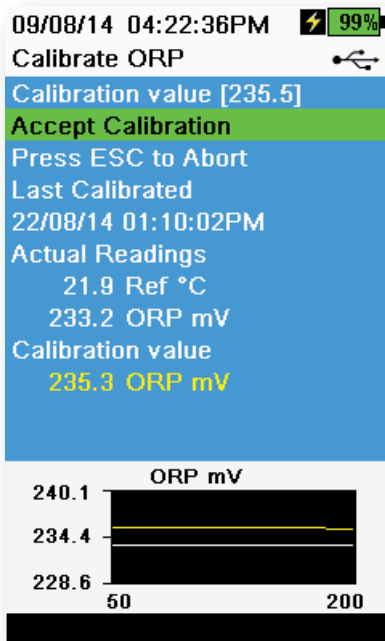

Figure 52 Calibrate ORP

Depth

NOTE: This calibration option is available only if your bulkhead is equipped with a depth sensor. The depth sensor is located where the cable connects to the bulkhead (Figure 59 on page 54).

For the calibration, make sure that the depth sensor is clean and in air, not immersed in any solution. For highest accuracy, keep the bulkhead still and in one position while calibrating.

NOTE: Cables 10 m and longer are supplied with a weight that can be attached to the sensor guard for sampling at water depths 10 m and greater.



Figure 53 Calibrate Depth

Depth calibration

1. If applicable, enter the depth offset, altitude, and latitude (Figure 29 Setup Depth on page 25).

NOTE: Depth offset allows you to set the depth measurement to something other than zero. If the depth offset is used, the depth measurement will be adjusted by the offset after calibration. Enter the altitude and latitude of your sampling location to increase the accuracy of your depth measurement.

2. Push the  key, then select **Depth**.
3. Observe the actual measurement readings for stability (white line on graph shows no significant change for 40 seconds), then select **Accept Calibration** (Figure 53). "Calibration successful!" will be displayed in the message area.

Calibration

Turbidity

Before performing the calibration, review “[Calibration setup \(pH, ORP, ISE, conductivity, turbidity\)](#)” on page 33.

For proper calibration, you must use standards that have been prepared according to details in Standard Methods for the Treatment of Water and Wastewater (Section 2130 B).

Acceptable standards include:

- AMCO-AEPA standards prepared specifically for the ProDSS turbidity sensor manufactured by YSI (YSI turbidity standards)
- Formazin prepared according to Standard Methods, especially for calibration points greater than 1010
- Dilutions of 4000 FNU (NTU) formazin concentrate purchased from Hach
- Hach StablCal™ standards in various FNU (NTU) denominations

The use of standards other than those mentioned above will result in calibration errors and inaccurate field readings. It is important to use the same type of standard for all calibration points. (i.e. do not mix formazine and AMCO-AEPA standard for different points in a multi-point calibration).

Calibration limits

Because of the non-linear response of the turbidity sensor, calibration ranges may be limited. A 1-, 2- or 3-point calibration can be completed using the following limits:

1-point	2-point	3-point
0-1 FNU (NTU)	5-200 FNU (NTU)	400-4200 FNU (NTU)

Calibration standards

The following standards are available for the ProDSS turbidity sensor:

608000	0 (all turbidity sensors); 1 gallon
607200	12.4 FNU (NTU) (ProDSS); 1 gallon
607300	124 FNU (NTU) (ProDSS); 1 gallon
607400	1010 FNU (NTU) (ProDSS); 1 gallon

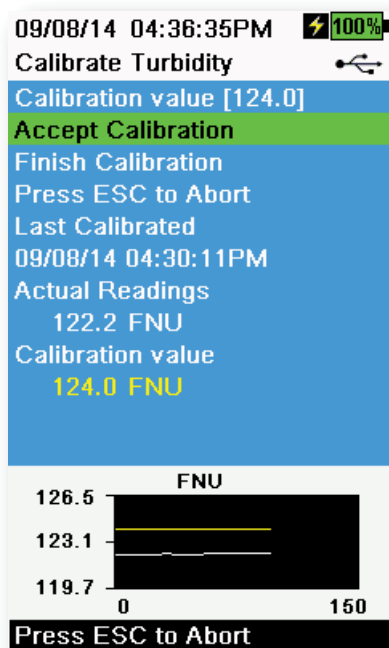

Figure 54 Calibrate turbidity

Turbidity calibration 1-, 2- or 3-point

NOTE: The sensor guard must be installed for the turbidity sensor calibration.

NOTE: When performing a turbidity calibration, the first point must be zero. Select **Calibration Value** and enter 0.00.

1. Perform the **Calibration setup** (pH, ORP, ISE, conductivity, turbidity) on page 33. Rinse the sensor 2-3 times with a small amount of 0 FNU (NTU) standard.
2. Fill the calibration cup to fill line one of the calibration cup (approximately 170 mLs) with 0 FNU (NTU) standard (clear deionized or distilled water is suitable). Immerse the sensors into the water.
3. Push the **Cal** key, then select **Turbidity**.
4. Select **Calibration Value** and enter 0.00.
5. Observe the data points readings for stability with the 0 FNU (NTU) standard (white line on graph shows no significant change for 40 seconds), then select **Accept Calibration**. "Ready for cal point 2" will be displayed in the message area.
6. Select **Finish Calibration** to complete a 1-point calibration or continue for the 2- or 3-point calibration.
7. Rinse the sensors, calibration cup, and sensor guard 2-3 times with a small amount of standard #2. Discard the standard after each rinse.
8. Fill the calibration cup to fill line 1 with standard #2. Immerse the sensors in the second calibration standard.
9. Select **Calibration Value** and enter the value of the second calibration standard.
10. Observe the actual measurement readings for stability (white line on graph shows no significant change for 40 seconds), then select **Accept Calibration** (Figure 54). "Ready for cal point 3" will be displayed in the message area.
11. Select **Finish Calibration** to complete a 2-point calibration or continue for the 3-point calibration.
12. Rinse the sensors, calibration cup, and sensor guard 2-3 times with a small amount of standard #3. Discard the standard after each rinse.
13. Fill the calibration cup to fill line 1 with standard #3. Immerse the sensors in the third calibration standard.
14. Select **Calibration Value** and enter the value of the third calibration standard.
15. Observe the data points readings for stability, then select **Finish Calibration**. "Calibration successful!" will be displayed in the message area.
16. Rinse the sensors in clean water then dry.

Calibration

ISEs: Ammonium, Nitrate, & Chloride

Before performing the calibration, review [Calibration setup \(pH, ORP, ISE, conductivity, turbidity\)](#) on page 33.

The ISE sensors can be calibrated to one, two or three points. A 2-point calibration without chilling a third calibration solution is extremely accurate and is the preferred method. However, if there is a large temperature variation during sampling, a chilled third calibration point is recommended.

Higher calibration accuracy can be obtained if the standards used have a least one order of magnitude difference between them. For example, 1 mg/L and 10 mg/L or 10 mg/L and 100 mg/L.

mV information for the ISE calibration

Ammonium mV values

- NH_4 1 mg/L = 0 mV +/- 20 mV (new sensor only)
- NH_4 100 mg/L = 90 to 130 mV > 1 mg/L mV value
- The mV span between 1 mg/L and 100 mg/L values should be \approx 90 to 130 mV. The slope should be 45 to 65 mV per decade.

Nitrate mV values

- NO_3 1 mg/L = 200 mV +/- 20 mV (new sensor only)
- NO_3 100 mg/L = 90 to 130 mV < 1 mg/L mV value
- The mV span between 1 mg/L and 100 mg/L values should be \approx 90 to 130 mV. The slope should be -45 to -65 mV per decade.

Chloride mV values

- Cl 10 mg/L = 225 mV +/- 20 mV (new sensor only)
- Cl 1,000 mg/L = 80 to 130 mV < 10 mg/L mV value
- The mV span between 10 mg/L and 1000 mg/L values should be \approx 80 to 130 mV. The slope should be -40 to -65 mV per decade.

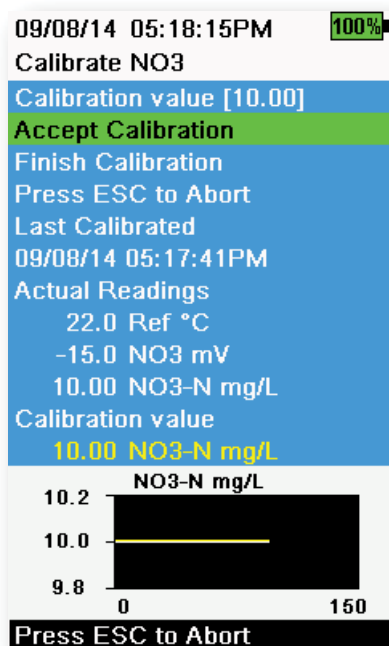



Figure 55 Calibrate ISE

ISE calibration 3-point

1. Perform the [Calibration setup \(pH, ORP, ISE, conductivity, turbidity\)](#) on page 33.
2. Fill the calibration cup to fill line one with standard #1 (approximately 170 mLs).
3. Push the  key, then select the applicable ISE sensor.
4. Carefully immerse the sensors into the standard solution.
5. Allow the temperature of the standard to stabilize, then select **Calibration value**. Enter the calibration value that corresponds to standard #1.
6. Observe the actual measurement readings for stability (white line on graph shows no significant change for 40 seconds), then select **Accept Calibration** (Figure 55). "Ready for cal point 2" will be displayed in the message area.
7. Rinse the sensor 2-3 times with a small amount of standard #2.
8. Rinse, then fill the calibration cup to fill line one with standard #2 (approximately 170 mLs).
9. Carefully immerse the sensors into the solution.
10. Allow the temperature of the solution to stabilize then select **Calibration value**. Enter the calibration value that corresponds to standard #2.
11. Observe the actual measurement readings for stability (white line on graph shows no significant change for 40 seconds), then select **Accept Calibration** (Figure 55). "Ready for cal point 3" will be displayed in the message area.
12. Rinse, then fill the calibration cup to fill line 1 with standard #3 (approximately 170 mLs).

NOTE: To calibrate with a chilled third standard, see [Chilled third calibration point](#) on page 46.
13. Carefully immerse the sensor into the solution. Allow the temperature of the solution to stabilize then select **Calibration value**. Enter the calibration value that corresponds to standard #3.
14. Observe the actual measurement readings for stability (white line on graph shows no significant change for 40 seconds), then select **Finish Calibration**. "Calibration successful!" will be displayed in the message area.

Calibration

Chilled third calibration point

The 3-point calibration method assures maximum accuracy when the temperature of the media to be monitored cannot be anticipated. If you must perform a chilled 3-point calibration, the following procedure requires one portion of the high concentration calibration solution and two portions of the low concentration calibration solution.

The high concentration solution and one of the low concentration solutions should be at ambient temperature. The other low concentration solution should be chilled to less than 10 °C (50 °F) to prior calibration point.

See [ISE calibration 3-point on page 45](#).

1. When "Ready for cal point 3" is displayed in the message area during ISE calibration, place the proper amount of chilled 1 mg/L standard (10 mg/L for the chloride) into a clean, dry or pre-rinsed calibration cup.
2. Carefully immerse the sensor into the solution. Allow for temperature equilibration. If necessary, select **Calibration value** to manually enter the standard #3 value.
3. Once the readings are stable, select **Accept Calibration**. "Calibration successful!" will be displayed in the message area.

Preparing chloride standards

The following recipes are provided for preparation of 10 and 1000 mg/L chloride reagents. Nitrate and Ammonium standards can be purchased from YSI or other laboratory supply companies.

 **WARNING:** Some of the chemicals required for these solutions could be hazardous under some conditions. It is the responsibility of the user to obtain and study the MSDS for each chemical and to follow the required instructions with regard to handling and disposal of these chemicals.

You will need:

- Solid sodium chloride or a certified 1000 mg/L chloride solution from a supplier
- Magnesium sulfate
- High-purity water
- A good quality analytical balance
- 1000 mL volumetric flask
- An accurate 10 mL measuring devices
- And 1000 mL glass or plastic storage vessels.

1000 mg/L Standard

1. Accurately weigh 1.655 grams of anhydrous sodium chloride and transfer into a 1000 mL volumetric flask.
2. Add 0.5 grams of anhydrous magnesium sulfate to the flask.
3. Add 500 mL of water to the flask, swirl to dissolve all of the reagents, then dilute to the volumetric mark with water.
4. Mix well by repeated inversion, then transfer the 1000 mg/L standard to a storage bottle.
5. Rinse the flask extensively with water prior to its use in the preparation of the 10 mg/L standard. Alternatively, simply add 0.5 grams of magnesium sulfate to a liter of a 1000 mg/L chloride standard from a certified supplier.

10 mg/L Standard

1. Accurately measure 10 mL of the above 1000 mg/L standard solution into a 1000 mL volumetric flask.
2. Add 0.5 grams of anhydrous magnesium sulfate to the flask.
3. Add 500 mL of water, swirl to dissolve the solid reagents, then dilute to the volumetric mark with water.
4. Mix well by repeated inversion, then transfer the 10 mg/L standard to a storage bottle.

Calibration

Preparing nitrate standards

We recommend using YSI calibration solutions whenever possible. However, qualified users can save cost by following these recipes for 1 and 100 mg/L nitrate standards. Other concentrations can be made by altering the amount of potassium nitrate. All other concentrations should remain unchanged.

 **CAUTION:** Some of these chemicals are hazardous and therefore, the standards should only be prepared by qualified chemists in laboratories where proper safety precautions are possible. It is the responsibility of the user to obtain and study the MSDS for each chemical and to follow the required instructions with regard to handling and disposal of these materials.

You will need:

- Solid potassium nitrate or a certified 1000 mg/l NO₃-N from a supplier
- Magnesium sulfate, high purity water
- A good quality analytical balance
- 1000 mL volumetric flask
- Accurate volumetric measuring devices for 100 mL, 10 mL and 1 mL of solution
- And 1000 mL glass or plastic storage vessels.
-

100 mg/L standard

1. Accurately weigh 0.7222 g of anhydrous potassium nitrate and transfer quantitatively into a 1000 mL volumetric flask. Add 1.0 g of anhydrous magnesium sulfate to the flask.
2. Add approximately 500 mL of water to the flask. Swirl to dissolve all of the reagents, and then dilute to the volumetric mark with distilled or deionized water.
3. Mix well by repeated inversion and then transfer the 100 mg/L standard to a storage bottle.
4. Rinse the flask extensively with water prior to its use in the preparation of the 1 mg/l standard. Alternatively, 100 mL of certified 1000 mg/L NO₃-N standard can be used in place of the solid potassium nitrate.

1 mg/L standard

1. Accurately measure 10.0 mL of the above 100 mg/L standard solution into a 1000 mL volumetric flask. Add 1.0 g of anhydrous magnesium sulfate to the flask.
2. Add approximately 500 mL of distilled or deionized water. Swirl to dissolve the solid reagents, and then dilute to the volumetric mark with water.
3. Mix well by repeated inversion and then transfer the 1 mg/L standard to a storage bottle.

NOTE: Recipes are given for 1 and 100 mg/L. Other concentrations can be made by altering the amount of potassium nitrate. All other concentrations should remain unchanged.

Preparing ammonium standards

We recommend using YSI calibration solutions whenever possible. However, qualified users can save cost by following these recipes for 1 and 100 mg/L standards. Other concentrations can be made by altering the amount of ammonium chloride. All other ingredient concentrations should remain unchanged.

 **CAUTION:** Some of these chemicals are hazardous and therefore, the standards should only be prepared by qualified chemists in laboratories where proper safety precautions are possible. It is the responsibility of the user to obtain and study the MSDS for each chemical and to follow the required instructions with regard to handling and disposal of these materials.

You will need:

- Solid ammonium chloride or a certified 100 mg/L $\text{NH}_4^+\text{-N}$ from a supplier
- Lithium acetate dihydrate
- Concentrated hydrochloric acid
- High purity water
- A good quality analytical balance
- A 1000 mL volumetric flask
- Accurate volumetric measuring devices for 100 mL and 10 mL of solution
- And a 1000 mL glass or plastic storage vessels.

 **CAUTION:** Hydrochloric acid is highly corrosive and toxic and should therefore be handled with extreme care in a well-ventilated fume hood. The user could also add the equivalent amount of a less-hazardous, more dilute sample of the acid if preferred.)

100 mg/L Standard

1. Accurately weigh 0.3817 g of ammonium chloride and transfer quantitatively into a 1000 mL volumetric flask. Add 2.6 g of lithium acetate dihydrate to the flask.
2. Add approximately 500 mL of distilled or deionized water to the flask. Swirl to dissolve all of the reagents and then dilute to the volumetric mark with distilled or deionized water.
3. Mix well by repeated inversion and then transfer the 100 mg/L standard to a storage bottle.
4. Add 3 drops of concentrated hydrochloric acid to the bottle, then seal and agitate to assure homogeneity. Alternatively, 100 mL of certified 100 mg/L $\text{NH}_4^+\text{-N}$ standard can be used in place of the solid ammonium chloride.

1 mg/L Standard

1. Accurately measure 10.0 mL of the above 100 mg/L standard solution into a 1000 mL volumetric flask. Add 2.6 g of lithium acetate dihydrate to the flask.
2. Add approximately 500 mL of distilled or deionized water. Swirl to dissolve the solid reagents and then dilute to the volumetric mark with water.
3. Mix well by repeated inversion and then transfer the 1 mg/L standard to a storage bottle.
4. Add 3 drops of concentrated hydrochloric acid to the bottle, then seal and agitate to assure homogeneity.

This page left intentionally blank

Maintenance and storage

Follow all maintenance and storage procedures in this section.

NOTICE: Incorrect or unapproved maintenance and/or storage can cause handheld, sensor or cable damage not covered by the warranty.

Unless otherwise specified, storage terms are defined as follows:

Short-term storage (less than 4 weeks): Storage when the ProDSS will be used at regular intervals (daily, weekly, biweekly, etc.)

Long-term storage: Storage when the ProDSS will have long periods of inactivity (over winter, end of monitoring season, etc.)

NOTICE: Perform sensor maintenance before long-term storage.

NOTICE: To prevent damage, do not store sensors in corrosive solutions.

Maintenance and storage

ProDSS handheld instrument

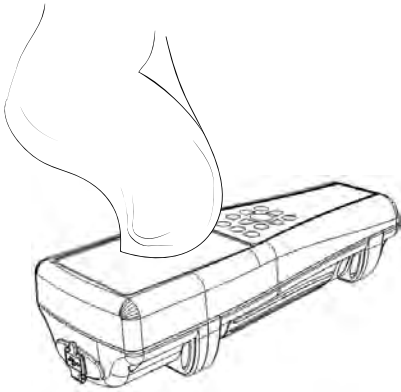

Figure 56 Handheld cleaning

Handheld instrument maintenance

Wipe the keypad, screen, and case with a cloth dampened with a mild solution of clean water and dish soap (Figure 56).

Handheld storage temperature

Optimal storage temperature of the handheld instrument:

- With battery pack installed: 0-45 °C (32-113 °F)
- Without battery pack installed: 0-60 °C (32-140 °F)

NOTICE: The battery pack permanently loses capacity at a faster rate when above 45 °C (113 °F).

Handheld short-term storage (less than 4 weeks)

Power off the handheld and store in a secure location (Startup on page 14).

Handheld long-term storage

1. Clean the handheld instrument.
2. Remove the battery pack to prevent possible battery leaks (on page 3). Reinstall the battery cover.
3. Install the protective covers on the USB and cable connectors.
4. Store the handheld and removed battery pack in a secure location. See [Rechargeable Lithium-Ion battery pack safety warnings and precautions on page 79](#).

Cable, bulkhead, and connectors

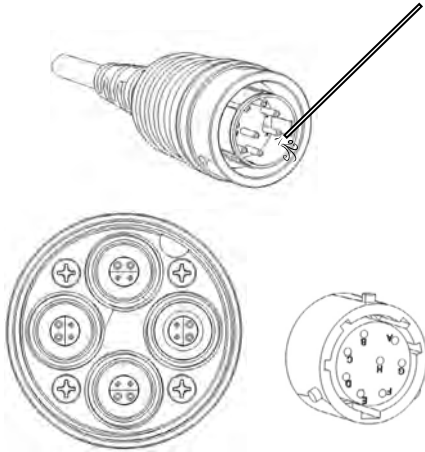

Figure 57 Cable, bulkhead, connector maintenance

Cable, bulkhead, and connector maintenance

Wipe the bulkhead cable with a cloth dampened with a mild solution of clean water and dish soap.

NOTICE: Install sensors or port plugs so that the bulkhead ports do not get wet when cleaning. Exposure to water can cause damage or corrosion to the bulkhead connectors not covered by the warranty.

Inspect the bulkhead ports and cable connectors for contamination. If dirty or wet, clean it with compressed air (Figure 57).

Cable, bulkhead, and connector storage

Clean the connectors and bulkhead cable. Install the connector covers and the bulkhead port plugs when not in use (Port plugs on page 10).

Sensor guard

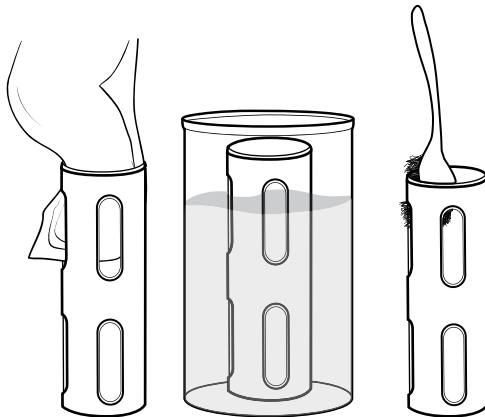

Figure 58 Sensor guard maintenance

Sensor guard maintenance

Remove minimal bio-fouling with a cloth soaked in a mild solution of clean water and dish soap (Figure 58).

Remove heavy bio-fouling by soaking the guard in a with a solution of clean water and dish soap. Soak in vinegar to remove hard growth and deposits.

Use a plastic scrub brush to remove any remaining bio-fouling. Rinse the sensor guard with clean water.

NOTICE: Do not sand or polish the guard. Removal of the guard coating can affect turbidity readings.

Maintenance and storage

Depth sensor maintenance and storage

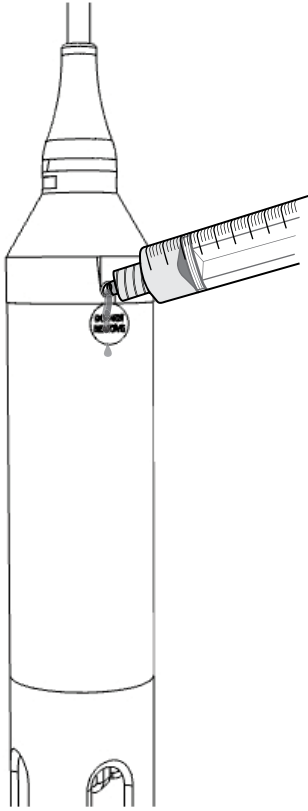

Figure 59 Depth sensor flush

Depth sensor storage

The ProDSS optional depth sensor accesses water through ports located in the bulkhead (Figure 59). Although not directly accessible, correct maintenance and storage is necessary for reliable operation.

The depth sensor can be stored dry, in water-saturated air or submerged in water.

NOTICE: To prevent damage to the sensor's strain gauge, do not store the sensor in corrosive solutions.

Depth sensor maintenance

Periodically clean the depth ports with the syringe included in the ProDSS maintenance kit (626990). Fill the syringe with clean water and gently force water into one of the ports. Flush until clean water flows from the opposite depth port.

NOTICE: Do not insert objects into the depth ports. Damage to the depth transducer from incorrect cleaning is not covered by the warranty.

Turbidity sensor

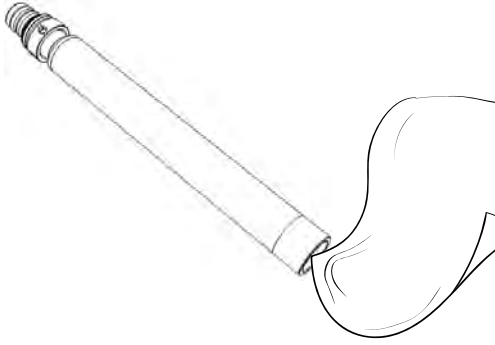

Figure 60 Turbidity sensor window



Figure 61 Turbidity sensor storage

Turbidity sensor maintenance

Clean the sensing window with a non-abrasive, lint-free cloth (Figure 60).

NOTICE: Clean the window carefully to prevent scratches. If necessary, use mild soapy water.

Turbidity sensor short-term storage (less than 4 weeks)

When in regular field use, the turbidity sensor can remain installed on the bulkhead in an environment of water-saturated air (Figure 61).

NOTE: *The turbidity sensor can be stored dry if stored separate from other sensors.*

Place approximately 0.5 in (1 cm) of any water (tap or environmental) in calibration cup.

Install the calibration cup on the bulkhead and firmly tighten to prevent evaporation.

Turbidity sensor long-term storage

Store the turbidity sensor in dry air. The turbidity sensor can be left on the bulkhead or removed for storage.

If removed from the bulkhead, install the shipping cap on the sensor to prevent scratches or damage to the optical sensing window.

NOTICE: Install a port plug into the empty port on the bulkhead.

Maintenance and storage

Conductivity/temperature sensor

NOTICE: Use care when handling the conductivity/temperature sensor to prevent any impact on the exposed thermistor.

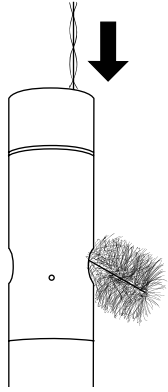

Figure 62 Channel brush

Conductivity/temperature sensor maintenance

1. Dip the sensor's cleaning brush (included with the maintenance kit) in clean water.
2. Insert the brush at the top of the channels, and sweep the channels 15 to 20 times (Figure 62).

NOTICE: If deposits have formed on the electrodes, use a mild solution of dish soap and water to brush the channels. For heavy deposits, soak the sensor in white vinegar to assist cleaning, then scrub with the cleaning brush after soaking.

3. Rinse the channels with clean water following the sweepings or soak.

Conductivity/temperature sensor short-term storage (less than 4 weeks)

When in regular field use, the conductivity/temperature sensor should remain installed on the bulkhead in a dry or water-saturated air environment.

Place approximately 0.5 in (1 cm) of any water (deionized, distilled or environmental) in calibration cup.

Install the calibration cup on the bulkhead and firmly tighten to prevent evaporation (Figure 63).

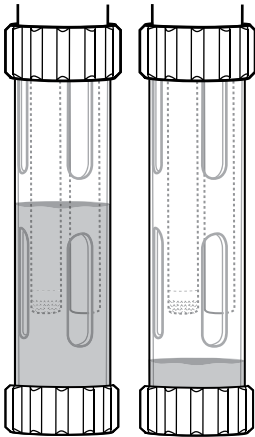

Figure 63 Conductivity/Temperature Short-term storage

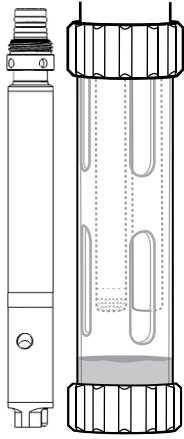

Figure 64 Conductivity/Temperature
Long-term storage

Conductivity/temperature sensor long-term storage

The Conductivity/Temperature sensor can be stored dry or wet, installed on the bulkhead or detached ([Figure 64](#)).

Dissolved oxygen sensor

ODO sensor caps are warranted for 1 year but have a typical working life of 18 to 24 months. As the ODO sensor caps ages, large scratches in the paint/dye layer and changes in the dye layer can reduce measurement stability and response time.

Periodically inspect the sensor cap for damage and large scratches in the paint/dye layer. Replace the cap when readings become unstable and cleaning the cap and DO recalibration do not remedy the symptoms.

Cleaning the sensor cap

The sensor cap should be kept clean since some types of fouling may consume oxygen which could affect the dissolved oxygen measurements. To clean the sensor cap, gently wipe away any fouling with a lens cleaning tissue that has been moistened with water.

NOTICE: Do not use organic solvents to clean the sensor cap. Using an organic solvent to clean the sensor cap may cause permanent damage to the cap. For example, alcohol will dissolve the outer paint layer and other organic solvents will likely dissolve the dye in the cap.

ODO sensor cap replacement

The sensor cap should be replaced about once per year but may last longer. It should also be replaced if it is cracked or damaged. The instruction sheet shipped with the replacement ODO sensor cap includes the calibration coefficients specific to your sensor cap.

NOTE: Make sure to save the ODO sensor cap instruction sheet in case you need to reload the calibration coefficients.

NOTE: The replacement ODO sensor cap is shipped in a humidified container and the package should not be opened until immediately before sensor cap replacement.

Once the sensor cap has been installed on the ODO sensor, it is important to keep the sensor in a 100% humid environment. If the sensor dries out, refer to the rehydration procedure ([ODO sensor rehydration on page 60](#)).

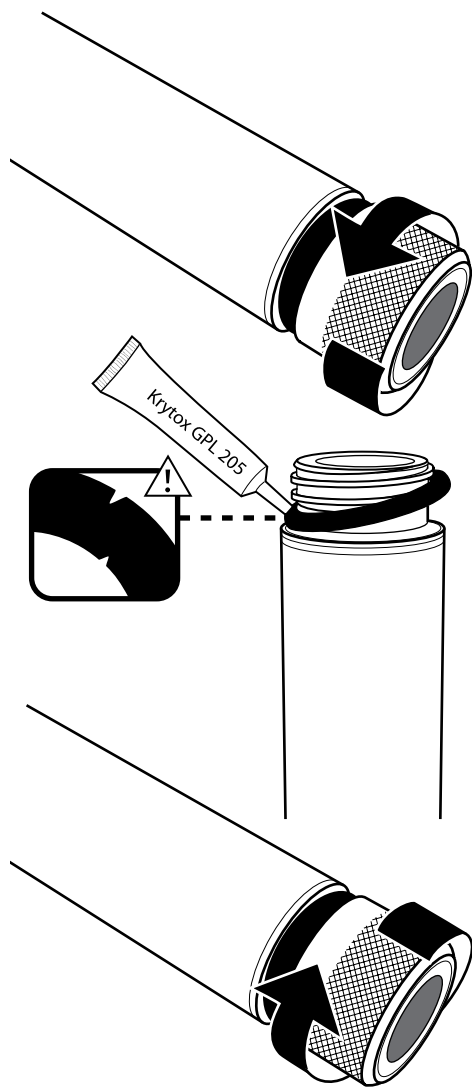

Figure 65 ODO cap replacement

ODO sensor cap replacement (continued)

1. Turn the used sensor cap counterclockwise to remove it from the sensor.

NOTE: If possible, do not use a tool to remove the cap from the sensor. If necessary, carefully turn the cap counterclockwise with pliers until it breaks loose. Do not use the pliers on the sensor body. Make sure to not damage the sensor cap threads.

2. Without using tools, remove the used o-ring from the sensor body (pinch the o-ring out, then roll it upward over the threads), then discard it.
3. Clean the sensor threads with a clean, lint-free cloth.
4. Visually inspect the new o-ring for nicks, tears, contaminants or particles. Discard damaged o-rings.
5. Without twisting it, carefully install the new o-ring over the threads and into the o-ring groove.
6. Apply a thin coat of Krytox to the o-ring only. Wipe any excess from the threads and sensor body.
7. Clean the sensor window with a clean, lint-free cloth.
8. Make sure the new sensor cap cavity is completely dry, then carefully finger-tighten the cap clockwise onto the sensor. The o-ring should be compressed between the sensor cap and body, not pinched.

NOTICE: Do not over-tighten the sensor cap. Do not use tools.



9. Store the ODO sensor in a moist environment.

NOTE: If the o-ring is pinched, remove and discard it. Repeat steps 3 to 8.

Updating the ODO sensor cap coefficients

After installing a new sensor cap, connect the bulkhead cable assembly to the ProDSS instrument and turn the instrument on. Locate the Calibration Code Label on the ODO sensor cap instruction sheet and note the six numbers which are listed as K1 through K5 and KC. These six numbers contain the calibration code for this particular sensor cap.

Follow the procedures below to enter the new calibration coefficients into the instrument.

1. Push the Probe  key to access the Sensor menu, then select **Setup**, then **ODO**.
2. Select **Sensor Cap Coefficients**.
3. Highlight each coefficient in turn (K1 through KC) and use the numeric entry screen to enter the corresponding new coefficient from the Calibration Code Label. Push the  key after each entry and then proceed to the next K selection.
4. After all the new coefficients have been entered, select **Update Sensor Cap Coefficients**.
5. A message will appear warning that you will be overwriting the current sensor cap coefficients and you should confirm that you wish to carry out this action. Select **Yes** to confirm the new coefficients.

After updating the Coefficients, the Serial # in the Sensor Cap menu will be updated automatically based on your entries. If errors are made in entering the Sensor Cap Coefficients, the instrument will block the update and an error message will appear on the display.

If you see this error message, re-enter the coefficients and check them carefully for correct transcription from the Calibration Code Label prior to selecting Update Sensor Cap Coefficients. If you receive an error message after several entry attempts, contact YSI Technical Support for assistance.

After entering the new Sensor Cap coefficients, perform a 1-point DO calibration ([ODO% and ODO% local - water saturated air calibration on page 37](#)).

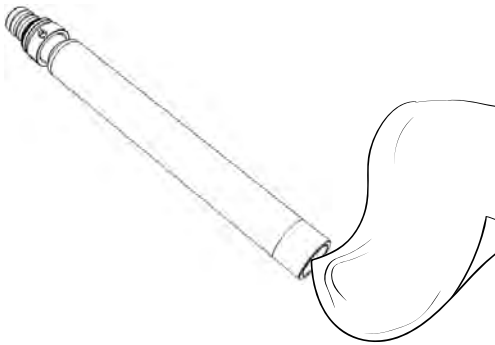

Figure 66 ODO sensor window

ODO sensor maintenance

Clean the sensing window with a non-abrasive, lint-free cloth ([Figure 66](#)).

NOTICE: Clean the window carefully to prevent scratches. Do not use organic solvents to clean the ODO sensor or sensor cap.

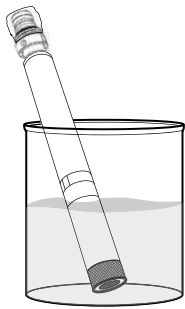

Figure 67 ODO rehydration

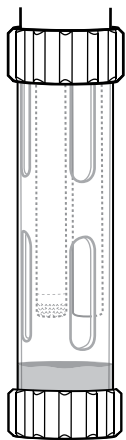

Figure 68 ODO short-term storage

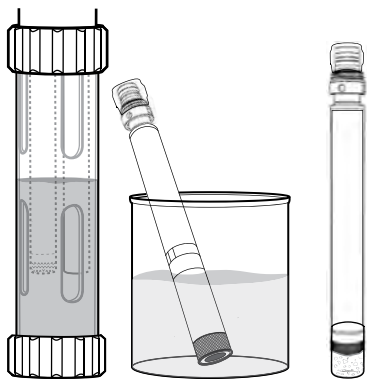

Figure 69 ODO long-term storage

ODO sensor rehydration

To prevent sensor drift, always store the ODO sensor in a wet or water-saturated air environment. If the ODO sensor has accidentally been left dry for longer than 8 hours, it must be rehydrated.

If rehydration is necessary, soak the ODO sensor cap in warm (room temperature) tap water for approximately 24 hours. After the soak, calibrate the sensor ([Figure 67](#)).

ODO sensor short-term storage (less than 4 weeks)

When in regular field use, the ODO sensor should remain installed on the bulkhead. Place approximately 0.5 in (1 cm) of any water (tap or environmental) in the calibration cup ([Figure 68](#)).

Install the calibration cup onto the bulkhead and firmly tighten to prevent evaporation.

ODO sensor long-term storage

The ODO sensor can be left on the bulkhead or removed for long-term storage ([Figure 69](#)).

Installed on bulkhead

Fill the calibration cup with clean water (use distilled or deionized water if a pH sensor is not installed). Submerge the sensor in the calibration cup then firmly tighten to prevent evaporation.

Removed from bulkhead

Remove the sensor from the bulkhead ([Sensor removal on page 10](#)).

Method 1 : Cover the sensor connector end with the plastic storage cap. Submerge the sensing end of the sensor in a container of clean water (use distilled or deionized water if a pH sensor is not installed). Periodically check the level of the water to make sure that it does not evaporate.

Method 2: Wet the sponge located in the cap originally included with the ODO sensor, then install on sensing end of the ODO sensor. Replace the sponge if it becomes dirty.

pH - pH/ORP sensors

NOTE: pH and pH/ORP sensors require periodic maintenance to clear contamination from the sensing elements. These contaminants can slow sensor response time. Clean the sensors when deposits, bio-fouling or other contamination appears on the glass or when the sensor response time is noticeably slow.

NOTICE: Do not physically scrub or swab the glass bulb. The bulbs are fragile and will break if pressed with sufficient force.

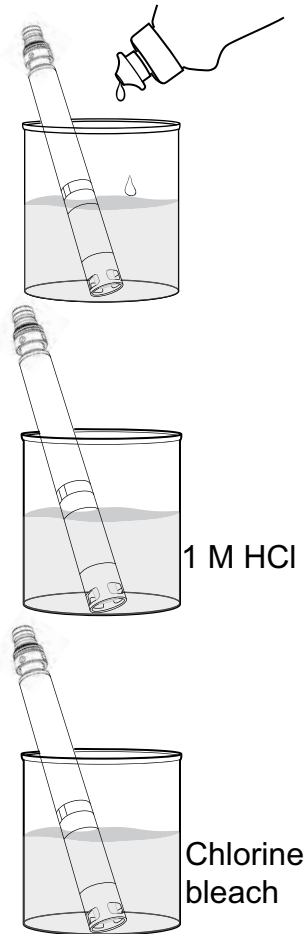

Figure 70 pH and pH/ORP sensor maintenance

pH - pH/ORP sensor maintenance

1. Remove the sensor from the bulkhead and soak for 10 to 15 minutes in a mild solution of clean water and dish soap (Figure 70).
2. Rinse the sensor with clean tap water and inspect.
3. If contaminants are removed, attach the sensor to the bulkhead and test the response time ([ProDSS sensor installation/removal on page 9](#)).

OR

If contaminants remain or response time does not improve, continue to the hydrochloric acid (HCl) soak in step 4.

4. Soak the sensor for 30 to 60 minutes in one molar (1 M) HCl.

NOTE: HCl reagent can be purchased from most chemical or laboratory distributors. If HCl is not available, soak in white vinegar.



CAUTION: To prevent injury, carefully follow the HCl manufacturer's instructions.

5. Rinse the sensor in clean tap water.
6. Soak the sensor in clean tap water for 60 minutes, stirring occasionally. Repeat the clean tap water rinse.
7. Attach the sensor to the bulkhead and test the response time. If response time does not improve or biological contamination of the reference junction is suspected, continue to the chlorine bleach soak in step 8.
8. Soak the sensor for approximately one hour in a 1:1 dilution of chlorine bleach and tap water.
9. Rinse the sensor with clean tap water.
10. Soak the sensor in clean tap water for one hour or longer. Repeat the clean tap water rinse.

Maintenance and storage

pH - pH/ORP sensor storage

The pH - pH/ORP sensors are shipped with their tips in a storage bottle containing KCl. Store the pH - pH/ORP sensors in the shipping container when not in use.

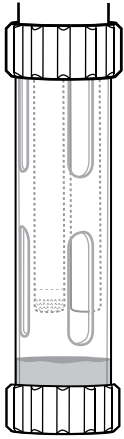

Figure 71 pH - pH/ORP short-term storage

pH - pH/ORP sensor short-term storage (less than 4 weeks)

When in regular field use, the pH-pH/ORP sensors should remain installed on the bulkhead. Place approximately 0.5 in (1 cm) of any water (tap or environmental) in the calibration cup (Figure 71).

Install the calibration cup onto the bulkhead and firmly tighten to prevent evaporation.

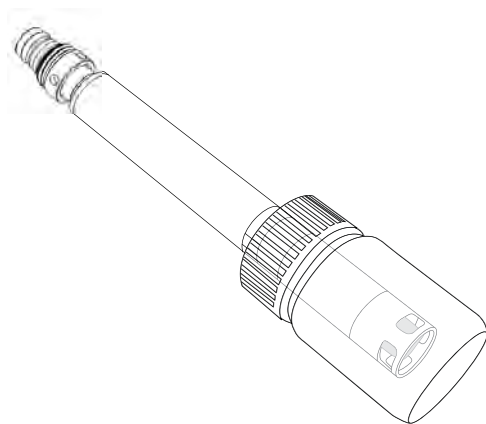

Figure 72 pH - pH/ORP long-term storage

pH - pH/ORP sensor long-term storage

Remove the sensor from the bulkhead and insert the sensing end into the shipping bottle. Install the bottle o-ring and tighten (Figure 72).

The shipping bottle contains a 2 molar solution of pH 4 buffer. If this solution is not available, store the sensor in tap water.

NOTICE: To prevent damage, do not store the pH - pH/ORP sensors in Zobell solution or DI water.

ISE sensors

Do not let the ISE sensor reference electrode junctions dry out. Clean the sensors when deposits, bio-fouling or other contamination appears on the membrane.

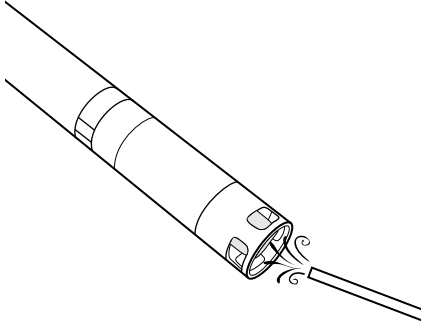

Figure 73 Ammonium and nitrate maintenance

Ammonium and nitrate sensor maintenance

1. Carefully clean the ammonium or nitrate sensor by using a fine jet of DI water or rinsing in alcohol followed by soaking in the high standard calibration solution (Figure 73).
2. Carefully dab the sensor dry with a clean, lint-free cloth.

NOTICE: The ion-selective membranes are very fragile. Do not use coarse material (e.g. paper towels) to clean the membranes or permanent damage to the sensor can occur. The only exception is fine emery cloth on the chloride sensor.

Chloride sensor maintenance

Carefully clean the chloride sensor by rinsing with alcohol and/or carefully polishing with fine emery paper in a circular motion to remove deposits or discoloration (Figure 74).

Carefully rinse with DI water to remove any debris.

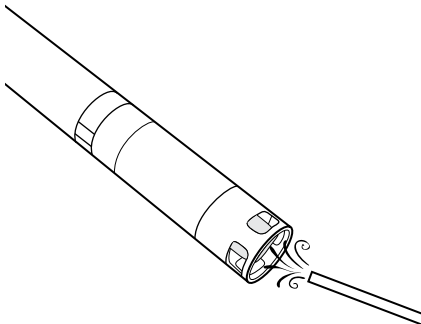

Figure 74 Chloride maintenance

Maintenance and storage

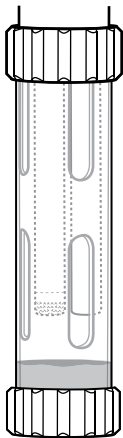

Figure 75 ISE short-term storage

ISE sensor short-term storage (less than 4 weeks)

When in regular field use, the ISE sensors should remain installed on the bulkhead in an environment of water-saturated air. Place approximately 0.5 in (1 cm) of any water (deionized, distilled or environmental) in the calibration cup (Figure 75).

Install the calibration cup onto the bulkhead and firmly tighten to prevent evaporation.

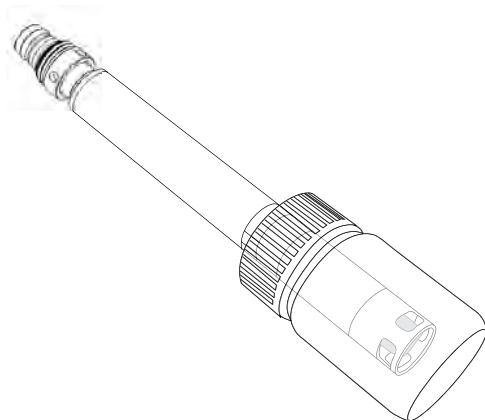

Figure 76 ISE long-term storage

ISE sensor long-term storage

NOTICE: Do not let the ISE junctions dry out. Junctions that have been allowed to dry out by improper storage may be irreparably damaged by dehydration and will require replacement.

1. Place a small amount of high-calibration solution or tap water in the storage bottle originally included with the sensor.
2. Remove the sensor from the bulkhead and insert the sensing end into the shipping bottle.
3. Install the bottle o-ring and tighten (Figure 76).

NOTICE: The sensors should not be immersed in water.

NOTICE: Do not store the ISE sensors in conductivity standard, pH buffer or salt water.

Rehydrating the reference junction

If an ISE sensor has been allowed to dry, soak the sensor for several hours (preferably overnight) in the sensor's high-calibration solution. If the sensor is irreparably damaged, the sensor module must be replaced.

ProDSS sensor module replacement

ProDSS pH, pH/ORP, ammonium, chloride and nitrate sensors feature replaceable sensor modules. These modules can be replaced by the user as needed. Typical working life of a pH or pH/ORP sensor module is 18 to 24 months. Typical working life of ammonium, chloride and nitrate sensor modules is 4 to 8 months.

Perform the pH - pH/ORP and ISE sensor module replacement in a clean, dry laboratory environment.

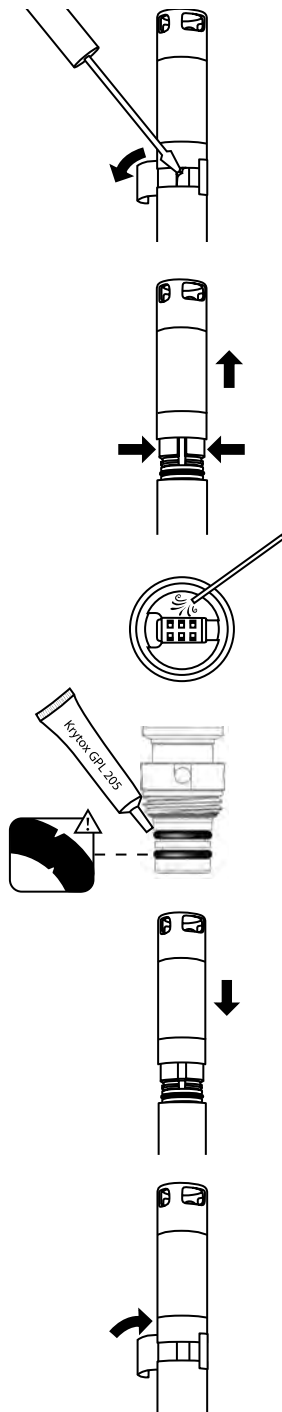

Figure 77 pH - pH/ORP sensor module replacement

Module replacement

1. Peel off and discard the sticker that covers the junction of the sensor body and the module (Figure 77).
2. With a small, flat-blade screwdriver, carefully remove the small rubber plug from the gap in the hard plastic ring at the base of the sensor module.
3. Using two fingers, squeeze the sensor module's hard plastic ring so that it compresses the gap left by the rubber plug.
4. Steadily pull the sensor module straight from the sensor body, rocking slightly if necessary.

NOTICE: The o-ring is unusable after removal from the sensor body. Do not reinstall the removed sensor module or o-ring after removal. Dispose of the module according to your organization's guidelines or return it to YSI for recycling (Service information on page 81).

5. Inspect the sensor connector port for debris or moisture. If detected, remove it with lint-free cloth or a light blast of compressed air.
6. Visually inspect the two new o-rings for nicks, tears, contaminants or particles. Discard damaged o-rings.
7. Without twisting, carefully install the new o-rings over the threads and into the o-ring grooves.
8. Apply a thin coat of Krytox to the o-rings only. Wipe any excess from the threads and sensor module.

NOTICE: If a sensor module is removed for any reason, the o-rings must be replaced.

9. Align the prongs on the base of the sensor module with the slots in the sensor body. The sensor module is keyed to insert in only one orientation.
10. Push the sensor module firmly into position until it clicks. Wipe any excess Krytox from the assembled components.
11. Wrap the junction of the sensor module and sensor body with the new sticker included in the sensor module kit. The sticker helps keep the sensor module junction clean and retain the rubber plug throughout deployment.
12. Write the replacement date on the sticker.
13. Calibrate the sensor (pH/ORP on page 39 or ISE calibration 3-point on page 45).

This page left intentionally blank

KorDSS software installation

NOTE: YSI recommends that you have administrative privileges on the PC in which KorDSS will be installed.

Follow these steps to complete the KorDSS installation process:

1. Install the KorDSS software from the USB flash drive included with the instrument.
2. Install the ProDSS instrument driver.
3. Start KorDSS for the first time and complete the KorDSS Startup Wizard.

System requirements

Supported 32 bit (x86) Microsoft Operating Systems:

- Microsoft Windows XP Home SP3
- Microsoft Windows XP Professional SP3
- Microsoft Windows 7 Home Basic SP1
- Microsoft Windows 7 Home Premium SP1
- Microsoft Windows 7 Professional SP1
- Microsoft Windows 7 Enterprise SP1
- Microsoft Windows 7 Ultimate SP1
- Microsoft Windows 8/8.1
- Microsoft Windows 8/8.1 Professional
- Microsoft Windows 8/8.1 Enterprise

Supported 64 bit (x64) Microsoft Operating Systems:

- Microsoft Windows 7 Home Basic SP1
- Microsoft Windows 7 Home Premium SP1
- Microsoft Windows 7 Professional SP1
- Microsoft Windows 7 Enterprise SP1
- Microsoft Windows 7 Ultimate SP1
- Microsoft Windows 8/8.1
- Microsoft Windows 8/8.1 Professional
- Microsoft Windows 8/8.1 Enterprise

Ram Memory Requirement:

- Minimum of 2 GB of RAM installed

Hard Disk Free Space:

- Minimum of 500 MB of free hard drive space

Internet Access Required to Support:

- Software and device updates, software licensing, and maps

KorDSS software installation

Install the KorDSS software

1. Insert the supplied USB flash drive into a USB port on your computer.
2. Depending on the PC operating system and system settings, the KorDSS Installer Guide may appear. If it does not appear, double-click **Start.exe** to start the installer guide (Figure 78).

NOTE: If desired, view the ProDSS User Manual or the end-user license agreement.



Figure 78 KorDSS Installer Guide

3. Click **Install** on the KorDSS Installer Guide.
4. Check the license agreement box. Click **Install** (Figure 79).

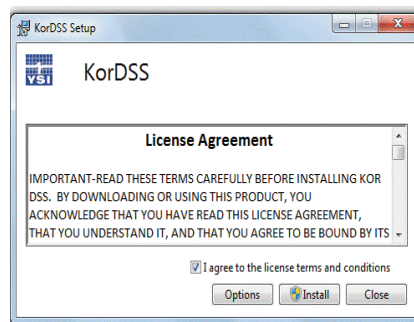

Figure 79 KorDSS license agreement

5. You may be asked if you want to allow a program from an unknown publisher to make changes on the computer. If so, select **Yes**.

KorDSS is now installed. Before using KorDSS to manage data, you must install the driver for the ProDSS instrument on your PC.

ProDSS driver installation

NOTE: The ProDSS driver installation procedure allows the KorDSS software to recognize the instrument. To connect more than one ProDSS instrument to KorDSS, perform the driver installation procedure for each additional instrument.

The driver installation procedure is different for each operating system. Follow the applicable installation procedure carefully.

[Windows XP ProDSS driver on page 70](#)

[Windows 8 and 8.1 ProDSS driver on page 71](#)

Windows 7 ProDSS driver

1. Turn the instrument on and connect it to the PC with the included USB cable.

If a message appears indicating successful download of the driver, proceed to the KorDSS Startup Wizard ([page 72](#)).

If you do not see a message indicating the successful download of the driver or if you see a message indicating unsuccessful download of the driver, continue this driver installation procedure.

2. Open the Device Manager. To access: Click the **Start** button, click **Control Panel**, click **System and Security**, and then, under **System**, click **Device Manager**.
3. Under **Other devices**, right click on **smxUSB Serial Emulator** and select **Update Driver Software** ([Figure 80](#)).

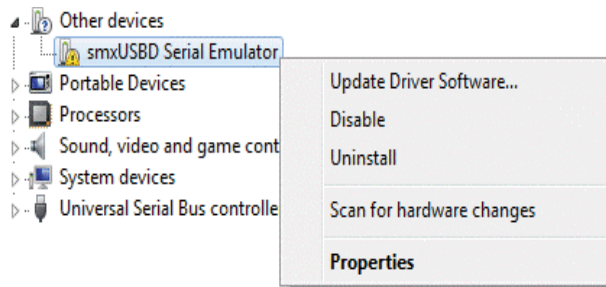

Figure 80 Device Manager Windows 7

4. Click **Browse my computer for driver software**.
5. Click **Browse**, then navigate to the file location: **C:\Program Files (x86)\YSI\KorDSS** for 64 bit systems or **C:\Program Files\YSI\KorDSS** for 32 bit systems. Click **Next**.
6. A warning will appear indicating that Windows can't verify the publisher of the driver software. Select **Install this driver software anyway**.
7. After driver installation, proceed to the KorDSS Startup Wizard ([page 72](#)).

KorDSS software installation

Windows XP ProDSS driver

1. Turn the instrument on and connect it to the PC with the included USB cable.
2. On the **Found New Hardware Wizard** window, select **No, not at this time** when asked if Windows can connect to Windows Update. Click **Next**.
3. Select **Install from a list or specific location**, then click **Next**.
4. Select **Search for the best driver in these locations**, then **Include this location in the search:**. Click **Browse**, then navigate to the file location: **C:\Program Files (x86)\YSI\KorDSS** for 64 bit systems or **C:\Program Files\YSI\KorDSS** for 32 bit systems (Figure 81). Click **Next**.



Figure 81 Found New Hardware Wizard file location

5. Select **Continue Anyway** when warned that the software has not passed Windows Logo testing.
6. Click **Finish** to close the New Hardware Wizard.
7. After driver installation, proceed to the KorDSS Startup Wizard (page 72).

Windows 8 and 8.1 ProDSS driver

1. Save any open files and close all programs. Your computer will restart during this process.
2. Open **Settings** by moving the computer mouse to the bottom right corner of the computer screen. If using a touch screen, swipe the screen from the right to reveal the Settings charm. Alternately, settings can be opened by pressing the Windows key + I.
3. Complete the following navigation steps under Settings:
 - For Windows 8.1: **Change PC Settings** → **Update and Recovery** → **Advanced Setup** → **Restart now**
 - For Windows 8: **Change PC Settings** → **General** → **Advanced Setup** → **Restart now**
4. When the **Choose an option** appears, select **Troubleshoot**, then **Advanced Options**.
5. Select **Startup Settings**, then **Restart**.
6. After the computer reboots, the **Startup Settings** screen will be shown. Use the **F7** or **7** key to select **Disable driver signature enforcement**.
7. Connect the ProDSS to the PC with the included USB cable. After connection, turn the instrument on.
8. Open Device Manager by pressing the Windows Key + X to open the Start Menu, then selecting **Device Manager**. Alternately, search for **devmgmt**, then select **Device Manager**.
9. Under **Other devices**, right click on **smxUSB Serial Emulator** and select **Update Driver Software** (Figure 82).

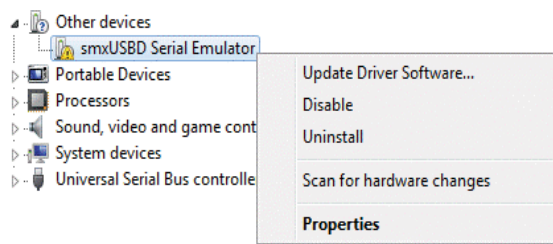

Figure 82 Device Manager Windows 8/8.1

10. Click **Browse my computer for driver software**.
11. Click **Browse**, then navigate to the file location: **C:\Program Files (x86)\YSI\KorDSS** for 64 bit systems or **C:\Program Files\YSI\KorDSS** for 32 bit systems (Figure 83). Click **Next**.

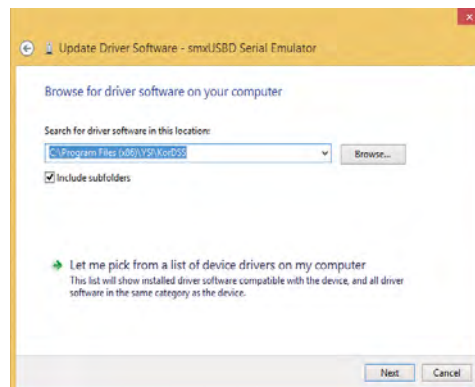

Figure 83 Driver location Windows 8/8.1

12. A warning will appear indicating that Windows can't verify the publisher of the driver software. Select **Install this driver software anyway**.
13. After driver installation, reboot the computer, then proceed to the KorDSS Startup Wizard (page 72).

KorDSS software installation

KorDSS startup wizard

1. After Windows has successfully updated the driver software, start KorDSS and set the language preference (Figure 84). Click **Next**.

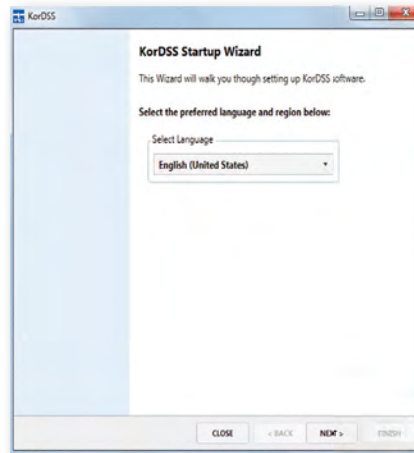

Figure 84 KorDSS language preference

2. On the Software Licensing Mode screen, select **Premium Mode** if you would like to view sampling locations on a map (internet connection required) (Figure 85). To upgrade to Premium Mode for free, follow the link, register your ProDSS, then use the code sent to you via email to upgrade to the Premium Mode. You can upgrade to Premium Mode at any time by going to the File tab in KorDSS.

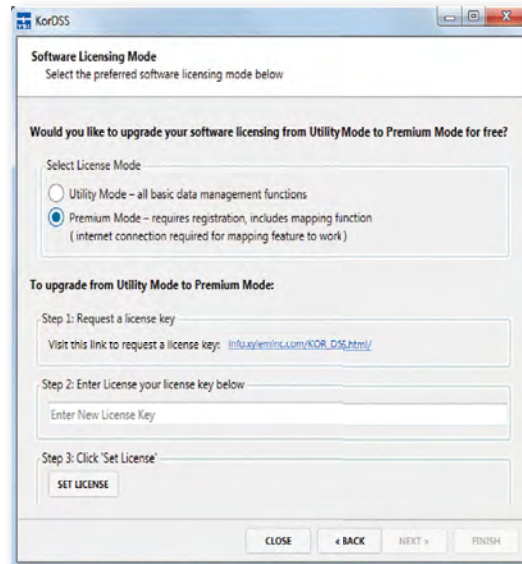

Figure 85 Software licensing mode screen

3. Select your ProDSS and KorDSS update preference to finish the installation process. Consult the HTML help file, found under the File tab of the KorDSS software, for a complete description of all KorDSS features.

Accessories

Ordering

Telephone: 800 897 4151 (USA)

+1 937 767 7241 (Globally) Monday through Friday, 8:00 AM to 5:00 ET

Fax: +1 937 767 9353 (orders)

Email: info@ysi.com

Mail: YSI Incorporated 1725 Brannum Lane Yellow Springs, OH 45387 USA

Internet: ysi.com

When placing an order please have the following available:

1. YSI account number (if available)
2. Name and phone number
3. Purchase Order or Credit Card number
4. Model Number or brief description
5. Billing and shipping addresses
6. Quantity

Accessories

ProDSS handhelds

YSI Item #	Description
626870-1	ProDSS handheld, no GPS
626870-2	ProDSS handheld with GPS

ProDSS cable assemblies (No sensors included)

YSI Item #	Description
626909-1	DSS-1 meter 4 port cable assembly, no depth
626909-4	DSS-4 meter 4 port cable assembly, no depth
626909-10	DSS-10 meter 4 port cable assembly, no depth
626909-20	DSS-20 meter 4 port cable assembly, no depth
626909-30	DSS-30 meter 4 port cable assembly, no depth
626909-40	DSS-40 meter 4 port cable assembly, no depth
626909-50	DSS-50 meter 4 port cable assembly, no depth
626909-60	DSS-60 meter 4 port cable assembly, no depth
626909-70	DSS-70 meter 4 port cable assembly, no depth
626909-80	DSS-80 meter 4 port cable assembly, no depth
626909-90	DSS-90 meter 4 port cable assembly, no depth
626909-100	DSS-100 meter 4 port cable assembly, no depth
626910-1	DSS-1 meter 4 port cable assembly, with depth
626910-4	DSS-4 meter 4 port cable assembly, with depth
626910-10	DSS-10 meter 4 port cable assembly, with depth
626911-20	DSS-20 meter 4 port cable assembly, with depth
626911-30	DSS-30 meter 4 port cable assembly, with depth
626911-40	DSS-40 meter 4 port cable assembly, with depth
626911-50	DSS-50 meter 4 port cable assembly, with depth
626911-60	DSS-60 meter 4 port cable assembly, with depth
626911-70	DSS-70 meter 4 port cable assembly, with depth
626911-80	DSS-80 meter 4 port cable assembly, with depth
626911-90	DSS-90 meter 4 port cable assembly, with depth
626911-100	DSS-100 meter 4 port cable assembly, with depth

ODO/OBOD sensor and cable assemblies - DO/Temp only

NOTE: ODO/OBOD cable assemblies feature non-replaceable temperature and optical DO sensors with replaceable DO sensor caps (626320 for ODO cable assemblies; 626482 for OBOD cable assemblies). There is no depth option with ODO/OBOD cables.

YSI Item #	Description
626250-1	ODO-1 meter cable assembly with non-replaceable ODO/temperature sensors, no depth
626250-4	ODO-4 meter cable assembly with non-replaceable ODO/temperature sensors, no depth
626250-10	ODO-10 meter cable assembly with non-replaceable ODO/temperature sensors, no depth
626250-20	ODO-20 meter cable assembly with non-replaceable ODO/temperature sensors, no depth
626250-30	ODO-30 meter cable assembly with non-replaceable ODO/temperature sensors, no depth
626250-40	ODO-40 meter cable assembly with non-replaceable ODO/temperature sensors, no depth
626250-50	ODO-50 meter cable assembly with non-replaceable ODO/temperature sensors, no depth
626250-60	ODO-60 meter cable assembly with non-replaceable ODO/temperature sensors, no depth
626250-100	ODO-100 meter cable assembly with non-replaceable ODO/temperature sensors, no depth
626400	ProOBOD BOD probe/cable assembly, lab probe; U.S./Japanese version with power supply
626401	ProOBOD BOD probe/cable assembly, lab probe; International version with power supply

ProDSS smart sensors

YSI Item #	Description
626900	ProDSS Optical Dissolved Oxygen sensor
626902	ProDSS conductivity and temperature sensor
626901	ProDSS turbidity sensor
626903	ProDSS pH sensor with module
626904	ProDSS pH/ORP sensor with module
626906	ProDSS ammonium sensor with module
626905	ProDSS nitrate sensor with module
626907	ProDSS chloride sensor with module

Replacement sensor modules and ODO sensor caps

YSI Item #	Description
626890	Replacement ProDSS Optical Dissolved Oxygen sensor cap (for 626900 smart sensor)
626320	Replacement ODO Optical Dissolved Oxygen sensor cap (for 626250 probe/cable assemblies)
626482	Replacement OBOD Optical Dissolved Oxygen sensor cap (for 626400 or 626401 lab probes)
626963	Replacement ProDSS pH sensor module
626964	Replacement ProDSS pH/ORP sensor module
626966	Replacement ProDSS Ammonium sensor module
626965	Replacement ProDSS Nitrate sensor module
626967	Replacement ProDSS Chloride sensor module

Accessories

ProDSS accessories

YSI Item #	Description
626946	Large, hard-sided carrying case
603075	Large, soft-sided carrying case
626945	Small, hard-sided carrying case (fits 1- and 4-meter cables)
599080	Flow cell
603056	Flow cell mounting spike
063507	Tripod (screws into back of meter)
063517	Ultra clamp (screws into back of meter)
603070	Shoulder strap
603069	Belt clip (screws into back of meter)
626942	USB car charger
626943	Small external Li-Ion rechargeable battery pack (Typical performance: will charge a completely discharged ProDSS battery to about 50%)
626944	Large external Li-Ion rechargeable battery pack (Typical performance: will charge a completely discharged ProDSS battery to full charge, plus have power to charge a second battery to 20%)
626940	AC charger (USA). Includes power supply and USB cable (included with ProDSS handheld)
626941	AC charger (international). Includes power supply, USB cable and outlet adapters (included with ProDSS handheld)
626846	Replacement Lithium-ion battery pack
626969	ProDSS USB flash drive (included with ProDSS handheld)
626991	Cable for charging and PC connection (included as part of 626940 and 626941)
626992	Cable for connection to USB drive (included with ProDSS handheld)
626990	ProDSS maintenance kit (included with all ProDSS cables): <ul style="list-style-type: none">• 3 port plugs• 1 Krytox tube• 1 brush• 1 syringe• 1 sensor installation/removal tool• O-rings (6)
626919	Sensor guard for 4 port ProDSS cable assembly (included with all ProDSS cables)
599786	Calibration/storage cup for 4 port ProDSS cable assembly (included with all ProDSS cables)
603062	Cable management kit (included with any ProDSS cable 10, 20, or 30-meters long; included with any ODO cable 4, 10, 20, or 30-meters long)
626918	1 lb weight (included with any ProDSS cable 10-meters and longer)
605978	4.9 oz weight





Calibration standards

YSI Item #	Description
065270	Conductivity standard, 1000 $\mu\text{mhos/cm}$ (quart, glass); ideal for fresh water
065272	Conductivity standard, 10000 $\mu\text{mhos/cm}$ (quart, glass); ideal for brackish water
065274	Conductivity standard, 100000 $\mu\text{mhos/cm}$ (quart, glass); ideal for supersaturated sea water
060907	Conductivity standard, 1000 $\mu\text{mhos/cm}$ (box of 8 individual pints, plastic); ideal for fresh water
060906	Conductivity standard, 1413 $\mu\text{mhos/cm}$, $\pm 1\%$, 0.01 M KCl (box of 8 individual pints, plastic)
060911	Conductivity standard, 10000 $\mu\text{mhos/cm}$ (box of 8 individual pints, plastic); ideal for brackish water
060660	Conductivity standard, 50000 $\mu\text{mhos/cm}$ (box of 8 individual pints, plastic); ideal for sea water
061320	ORP (mV) standard, Zobell solution, powder - needs hydrated (125 mL bottle, plastic)
003821	pH 4 buffer (box of 6 individual pints, plastic); ideal for storage solution for pH sensor
003822	pH 7 buffer (box of 6 individual pints, plastic)
003823	pH 10 buffer (box of 6 individual pints, plastic)
603824	Assorted case of pH 4, 7, and 10 buffers (2 individual pints of each buffer, plastic)
005580	Confidence solution to verify conductivity, pH and ORP system (box of 6 individual 475 mL bottles, plastic). Note: <i>Not for calibration</i>
003841	Ammonium standard, 1 mg/L (500 mL, plastic)
003842	Ammonium standard, 10 mg/L (500 mL, plastic)
003843	Ammonium standard, 100 mg/L (500 mL, plastic)
003885	Nitrate standard, 1 mg/L (500 mL, plastic)
003886	Nitrate standard, 10 mg/L (500 mL, plastic)
003887	Nitrate standard, 100 mg/L (500 mL, plastic)
608000	Turbidity standard, 0 FNU (1 gallon, plastic)
607200	Turbidity standard, 12.4 FNU (1 gallon, plastic)
607300	Turbidity standard, 124 FNU (1 gallon, plastic)
607400	Turbidity standard, 1010 FNU (1 gallon, plastic)

This page left intentionally blank

Safety and support

Rechargeable Lithium-Ion battery pack safety warnings and precautions

-  **CAUTION:** Failure to follow the safety warnings and precautions can result in fire, personal injury and/or equipment damage not covered under warranty.
-  **CAUTION:** If the internal battery fluid comes into contact with skin, wash the affected area(s) with soap and water immediately. If it comes into contact with your eye(s), flush them with generous amounts of water for 15 minutes and seek immediate medical attention.
-  **CAUTION:** Always keep batteries away from children.
-  **WARNING:** In the unlikely event a lithium-ion battery catches fire, **DO NOT** attempt to put the fire out with water, use a Class A, B or C fire extinguisher.

Do:

- Store the battery pack in a cool, dry, ventilated area.
- Store the battery pack in a non-conductive and fireproof container.
- Store the battery pack at approximately 50% of the capacity.
- Disconnect the battery pack when not in use and for long-term storage.
- Follow applicable laws and regulations for transporting and shipping of batteries.
- *Immediately discontinue* use of the battery pack if, while using, charging or storing the battery pack:
 - Emits an unusual smell
 - Feel hot
 - Changes color
 - Changes shape
 - Appears abnormal in any other way.

Battery pack general precautions:

- **DO NOT** put the battery in fire or heat the battery.
- **DO NOT** connect the positive and the negative terminal of the battery to each other with any metal object (e.g. wire).
- **DO NOT** carry or store the battery pack with necklaces, hairpins or other metal objects.
- **DO NOT** carry or store the battery pack with hazardous or combustible materials.
- **DO NOT** pierce the battery pack with nails, strike with a hammer, step on or otherwise subject the battery pack to strong impacts or shocks.
- **DO NOT** solder directly onto the battery pack.
- **DO NOT** expose the battery pack to water or salt water or allow it to get wet.
- **DO NOT** disassemble or modify the battery pack. The battery contains safety and protection devices that, if damaged, can cause the battery to generate heat, rupture or ignite.
- **DO NOT** place the battery pack on or near fires, stoves or other high-temperature locations.
- **DO NOT** place the battery pack in direct sunlight or extreme temperatures for extended periods of time or store the battery pack inside cars in hot weather. Doing so may cause the battery pack to generate heat, rupture or ignite. Using the battery pack in this manner may also result in a loss of performance and a shortened life expectancy.
- **DO NOT** place the battery pack in microwave ovens, high-pressure containers or on induction cookware.
- **DO NOT** ship damaged or potentially defective batteries to YSI or any of our authorized service centers unless instructed otherwise. All federal and international shipping laws should be consulted prior to shipping lithium-ion batteries.

Safety and support

Charging/discharging/handling the battery pack

 **WARNING:** Failure to follow the battery pack charging/discharging instructions can cause the battery to become hot, rupture or ignite and cause serious injury and/or equipment damage.

 **WARNING:** Only charge the battery using charging devices designed specifically for the ProDSS by YSI. Use of unapproved chargers can result in battery failure and potentially serious injury to the user.

If at any time the battery pack becomes damaged, hot or begins to balloon or swell, discontinue charging (or discharging) immediately. Quickly and safely disconnect the charger. Then place the battery pack and/or charger in a safe, open area away from flammable materials. After one hour of observation, remove the battery pack from service. **DO NOT** continue to handle, attempt to use or ship the battery.

Damaged or swollen batteries can be unstable and very hot. **DO NOT** touch batteries until they have cooled. In the event of a fire use a Class A, B, or C fire extinguisher. **DO NOT** use water.

- **DO NOT** attach the battery pack to a power supply plug or directly to a car's cigarette lighter.
- **DO NOT** place the battery pack in or near fire or into direct extended exposure to sunlight. When the battery pack becomes hot, the built-in safety equipment is activated, preventing the battery pack from charging further. Heating the battery pack can destroy the safety equipment and cause additional heating, breaking or ignition.
- **DO NOT** leave the battery pack unattended while charging.

NOTICE: The ambient temperature range over which the battery pack can be discharged is -20°C to 60°C (-4°F to 140°F). Use of the battery pack outside of this temperature range may damage the performance of the battery pack or may reduce its life expectancy.

- **DO NOT** discharge the battery pack using any device except for the ProDSS handheld. When the battery pack is used in other devices it may damage the performance of the battery or reduce its life expectancy. Use of a non-approved device to discharge the battery pack can cause an abnormal current to flow, resulting in the battery pack to become hot, rupture or ignite and cause serious injury.
- **DO NOT** leave the battery pack unattended while discharging.

Battery Disposal

When the battery pack is worn out, insulate the terminals with adhesive tape or similar materials before disposal. Dispose of the battery pack in the manner required by your city, county, state or country. For details on recycling lithium-ion batteries, please contact a government recycling agency, your waste-disposal service or visit reputable online recycling sources such as www.batteryrecycling.com.

This product must not be disposed of with other waste. Instead, it is the user's responsibility to dispose of their waste equipment by handing it over to a designated collection point for the recycling of waste electrical and electronic equipment. The separate collection and recycling of your waste equipment at the time of disposal will help to conserve natural resources and ensure that it is recycled in a manner that protects human health and the environment.

For more information about where you can drop off your waste equipment for recycling, please contact your local city office, or your local waste disposal service. **DO NOT** ship batteries to YSI unless instructed to do otherwise.

Contact YSI Technical Support at (937) 767-7241 if you have additional questions.

Service information

YSI has authorized service centers throughout the United States and Internationally. For the nearest service center information, please visit ysi.com and click 'Support' or contact YSI Technical Support directly at 800-897-4151 (+1 937-767-7241).

When returning a product for service, include the Product Return form with cleaning certification. The form must be completely filled out for a YSI Service Center to accept the instrument for service. The form may be downloaded from ysi.com.

Technical support

Telephone: 800 897 4151 (USA)

+1 937 767 7241 (Globally) Monday through Friday, 8:00 AM to 5:00 ET

Fax: +1 937 767 9353 (orders)

Email: info@ysi.com

Mail: YSI Incorporated 1725 Brannum Lane Yellow Springs, OH 45387 USA

Internet: ysi.com

Safety and support

Declaration of Conformity

The undersigned hereby declares on behalf of the named manufacturer under our sole responsibility that the listed product conforms to the requirements for the listed European Council Directive(s) and carries the CE mark accordingly.

Manufacturer:	YSI Incorporated 1725 Brannum Lane Yellow Springs, OH 45387 USA
Product Name:	ProDSS
Conforms to the following:	
Directives:	EMC 2004/108/EC RoHS 2011/65/EU WEEE 2012/19/EU
Harmonized Standards:	EN61326-1:2013 (IEC 61326-1:2012) IEC 61000-3-2:2005 +A1:2008+A2:2009 IEC 61000-3-3:2008
Supplementary Information:	All performance met the operation criteria as follows: 1. ESD, IEC 61000-4-2:2008 2. Radiated Immunity, IEC 61000-4-3:2006 +A1:2007+A2:2010 3. Electrical Fast Transient (EFT), IEC 61000-4-4:2004 +A1:2010 4. Immunity to Surge, IEC 61000-4-5:2005 5. Radio Frequency, Continuous Conducted Immunity, IEC61000-4-6:2008 6. IEC 61000-4-8:2009 7. IEC 61000-4-11:2004
Authorized EU Representative	Xylem Analytics UK Ltd Unit 2 Focal Point, Lacerta Court, Works Road Letchworth, Hertfordshire, SG6 1FJ UK



Signed: Lisa M. Abel
Title: Director of Quality

Date: September 24 2014

Safety and support

The undersigned hereby declares on behalf of the named manufacturer under our sole responsibility that the listed product conforms to the requirements for electrical equipment under US FCC Part 15 and ICES-003 for unintentional radiators.

<i>Manufacturer:</i>	YSI Incorporated 1725 Brannum Lane Yellow Springs, OH 45387 USA
<i>Product Name:</i>	Professional Digital Sampling System Instrument
<i>Model Numbers</i>	
<i>Instrument/Accessory:</i>	ProDSS non-GPS (626870-1) / ProDSS GPS (626870-2)
<i>Probe/Cable Assemblies:</i>	626909-1, 626909-4, 626909-10, 626909-20, 626909-30, 626909-40, 626909-50, 626909-60, 626909-70, 626909-80, 626909-90, 626909-100, 626910-1, 626910-4, 626910-10, 626911-20, 626911-30, 626911-40, 626911-50, 626911-60, 626911-70, 626911-80, 626911-90, 626911-100
<i>Sensors:</i>	626900, 626902, 626901, 626903, 626904, 626906, 626905, 626907
<i>Conforms to the following:</i>	
<i>Standards:</i>	<ul style="list-style-type: none">• FCC 47 CFR Part 15-2008, Subpart B, Class B, Radio Frequency Devices• ICES-003:2004, Digital Apparatus
<i>Supplementary Information:</i>	Tested using ANSI C63.4-2003 (excluding sections 4.1, 5.2, 5.7, 9, and 14)



Signed: Lisa M. Abel
Title: Director of Quality

Date: September 24 2014

Safety and support

Warranty

The YSI Professional Digital Sampling System (ProDSS) is warranted for three (3) years from date of purchase by the end user against defects in materials and workmanship. The ProDSS bulkhead, sensors and cable assemblies are warranted for two (2) years from date of purchase by the end user against defects in material and workmanship. ProDSS pH and pH/ORP sensor modules, optical ODO sensor caps, and Li-Ion battery pack are warranted for one (1) year from date of purchase by the end user against defects in material and workmanship (6 months for ammonium, nitrate, chloride sensor modules). ProDSS systems (instrument, cables & sensors) are warranted for 1 year (excluding sensor modules) from date of purchase by the end user against defects in material and workmanship when purchased by rental agencies for rental purposes. Within the warranty period, YSI will repair or replace, at its sole discretion, free of charge, any product that YSI determines to be covered by this warranty.

To exercise this warranty, call your local YSI representative, or contact YSI Customer Service in Yellow Springs, Ohio at +1 937 767-7241, 800-897-4151 or visit www.YSI.com (Support tab) for a Product Return Form. Send the product and proof of purchase, transportation prepaid, to the Authorized Service Center selected by YSI. Repair or replacement will be made and the product returned, transportation prepaid. Repaired or replaced products are warranted for the balance of the original warranty period, or at least 90 days from date of repair or replacement.

LIMITATION OF WARRANTY

This Warranty does not apply to any YSI product damage or failure caused by:

1. Failure to install, operate or use the product in accordance with YSI's written instructions;
2. Abuse or misuse of the product;
3. Failure to maintain the product in accordance with YSI's written instructions or standard industry procedure;
4. Any improper repairs to the product;
5. Use by you of defective or improper components or parts in servicing or repairing the product;
6. Modification of the product in any way not expressly authorized by YSI.

THIS WARRANTY IS IN LIEU OF ALL OTHER WARRANTIES, EXPRESSED OR IMPLIED, INCLUDING ANY WARRANTY OF MERCHANTABILITY OR FITNESS FOR A PARTICULAR PURPOSE. YSI's LIABILITY UNDER THIS WARRANTY IS LIMITED TO REPAIR OR REPLACEMENT OF THE PRODUCT, AND THIS SHALL BE YOUR SOLE AND EXCLUSIVE REMEDY FOR ANY DEFECTIVE PRODUCT COVERED BY THIS WARRANTY. IN NO EVENT SHALL YSI BE LIABLE FOR ANY SPECIAL, INDIRECT, INCIDENTAL OR CONSEQUENTIAL DAMAGES RESULTING FROM ANY DEFECTIVE PRODUCT COVERED BY THIS WARRANTY.

Appendix A - DO% calibration values

Calibration Value	Pressure			
	D.O. %	in Hg	mmHg	kPa
101%	30.22	767.6	102.34	1023.38
100%	29.92	760.0	101.33	1013.25
99%	29.62	752.4	100.31	1003.12
98%	29.32	744.8	99.30	992.99
97%	29.02	737.2	98.29	982.85
96%	28.72	729.6	97.27	972.72
95%	28.43	722.0	96.26	962.59
94%	28.13	714.4	95.25	952.46
93%	27.83	706.8	94.23	942.32
92%	27.53	699.2	93.22	932.19
91%	27.23	691.6	92.21	922.06
90%	26.93	684.0	91.19	911.93
89%	26.63	676.4	90.18	901.79
88%	26.33	668.8	89.17	891.66
87%	26.03	661.2	88.15	881.53
86%	25.73	653.6	87.14	871.40
85%	25.43	646.0	86.13	861.26
84%	25.13	638.4	85.11	851.13
83%	24.83	630.8	84.10	841.00
82%	24.54	623.2	83.09	830.87
81%	24.24	615.6	82.07	820.73
80%	23.94	608.0	81.06	810.60
79%	23.64	600.4	80.05	800.47
78%	23.34	592.8	79.03	790.34
77%	23.04	585.2	78.02	780.20
76%	22.74	577.6	77.01	770.07
75%	22.44	570.0	75.99	759.94
74%	22.14	562.4	74.98	749.81
73%	21.84	554.8	73.97	739.67
72%	21.54	547.2	72.95	729.54

This page left intentionally blank

Appendix B - oxygen solubility table

Solubility of oxygen in mg/L in water exposed to water-saturated air at 760 mm Hg pressure.

Salinity = Measure of quantity of dissolved salts in water.

Chlorinity = Measure of chloride content, by mass, of water.

$S(0/00) = 1.80655 \times \text{Chlorinity}(0/00)$

Temp °C	Chlorinity : 0 Salinity: 0	5.0 ppt 9.0 ppt	10.0 ppt 18.1 ppt	15.0 ppt 27.1 ppt	20.0 ppt 36.1 ppt	25.0 ppt 45.2 ppt
0.0	14.62	13.73	12.89	12.10	11.36	10.66
1.0	14.22	13.36	12.55	11.78	11.07	10.39
2.0	13.83	13.00	12.22	11.48	10.79	10.14
3.0	13.46	12.66	11.91	11.20	10.53	9.90
4.0	13.11	12.34	11.61	10.92	10.27	9.66
5.0	12.77	12.02	11.32	10.66	10.03	9.44
6.0	12.45	11.73	11.05	10.40	9.80	9.23
7.0	12.14	11.44	10.78	10.16	9.58	9.02
8.0	11.84	11.17	10.53	9.93	9.36	8.83
9.0	11.56	10.91	10.29	9.71	9.16	8.64
10.0	11.29	10.66	10.06	9.49	8.96	8.45
11.0	11.03	10.42	9.84	9.29	8.77	8.28
12.0	10.78	10.18	9.62	9.09	8.59	8.11
13.0	10.54	9.96	9.42	8.90	8.41	7.95
14.0	10.31	9.75	9.22	8.72	8.24	7.79
15.0	10.08	9.54	9.03	8.54	8.08	7.64
16.0	9.87	9.34	8.84	8.37	7.92	7.50
17.0	9.67	9.15	8.67	8.21	7.77	7.36
18.0	9.47	8.97	8.50	8.05	7.62	7.22
19.0	9.28	8.79	8.33	7.90	7.48	7.09
20.0	9.09	8.62	8.17	7.75	7.35	6.96
21.0	8.92	8.46	8.02	7.61	7.21	6.84
22.0	8.74	8.30	7.87	7.47	7.09	6.72
23.0	8.58	8.14	7.73	7.34	6.96	6.61
24.0	8.42	7.99	7.59	7.21	6.84	6.50
25.0	8.26	7.85	7.46	7.08	6.72	6.39
26.0	8.11	7.71	7.33	6.96	6.62	6.28
27.0	7.97	7.58	7.20	6.85	6.51	6.18
28.0	7.83	7.44	7.08	6.73	6.40	6.09
29.0	7.69	7.32	6.93	6.62	6.30	5.99
30.0	7.56	7.19	6.85	6.51	6.20	5.90
31.0	7.43	7.07	6.73	6.41	6.10	5.81
32.0	7.31	6.96	6.62	6.31	6.01	5.72

Appendix B - oxygen solubility table

Temp °C	Chlorinity : 0 Salinity: 0	5.0 ppt 9.0 ppt	10.0 ppt 18.1 ppt	15.0 ppt 27.1 ppt	20.0 ppt 36.1 ppt	25.0 ppt 45.2 ppt
33.0	7.18	6.84	6.52	6.21	5.91	5.63
34.0	7.07	6.73	6.42	6.11	5.82	5.55
35.0	6.95	6.62	6.31	6.02	5.73	5.46
36.0	6.84	6.52	6.22	5.93	5.65	5.38
37.0	6.73	6.42	6.12	5.84	5.56	5.31
38.0	6.62	6.32	6.03	5.75	5.48	5.23
39.0	6.52	6.22	5.98	5.66	5.40	5.15
40.0	6.41	6.12	5.84	5.58	5.32	5.08
41.0	6.31	6.03	5.75	5.49	5.24	5.01
42.0	6.21	5.93	5.67	5.41	5.17	4.93
43.0	6.12	5.84	5.58	5.33	5.09	4.86
44.0	6.02	5.75	5.50	5.25	5.02	4.79
45.0	5.93	5.67	5.41	5.17	4.94	4.72