

Immersion Heaters

WATROD™ and FIREBAR® Screw Plug Immersion Heaters

Screw plug immersion heaters are ideal for direct immersion heating of liquids, including all types of oils and heat transfer solutions.

Available in a variety of sizes, Watlow® screw plug immersion heaters feature both WATROD™ round and FIREBAR® flat tubular elements.

Heating elements are hairpin bent and either welded or brazed into the screw plug—depending on element sheath and plug material compatibility.

General purpose terminal enclosures are standard; with optional moisture resistant, explosion resistant and explosion/moisture resistant enclosures available to meet specific application needs.

Optional thermostats provide convenient process temperature regulation.

Performance Capabilities

- Watt densities up to 120 W/in² (18.6 W/cm²)
- Wattages up to 38 kilowatts
- UL® and CSA component recognition up to 480VAC and 600VAC respectively
- Alloy 800/840 sheath temperatures up to 1600°F (870°C)
- Passivated 316 stainless steel sheath temperatures up to 1200°F (650°C)
- 304 stainless steel sheath temperatures up to 1200°F (650°C)
- Steel sheath temperatures up to 750°F (400°C)

Features and Benefits

A variety of element sheath and screw plug materials

- Meets your application needs

Integral thermowells

- Provides convenient temperature sensor insertion and replacement without draining the fluid being heated

Terminal enclosures

- Provides ability to be rotated to simplify connection with existing conduits

Welding or brazing WATROD and FIREBAR elements to the screw plug

- Provides a pressure tight seal

WATROD hairpins are repressed (recompacted)

- Maintains MgO density, dielectric strength, heat transfer and life

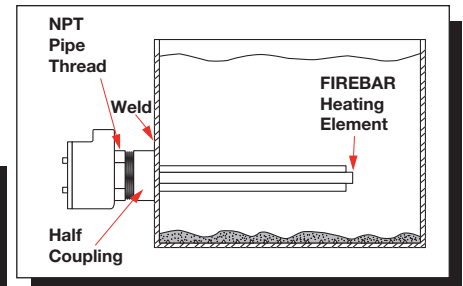
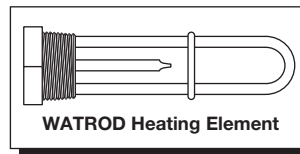

2 1/2 in. (64 mm) NPT screw plug assemblies feature element support(s)

- Ensures proper spacing for maximizing heater performance and life

• Screw plug and element sizes:

1 in. NPT	0.260 and 0.315 in. WATROD
1 1/4 in. NPT	0.260 and 0.315 in. WATROD 1 in. FIREBAR
2 in. NPT	0.430 and 0.475 in. WATROD
2 1/2 in. NPT	0.430 and 0.475 in. WATROD 1 in. FIREBAR

• Phase capability:

1 in. NPT	1-Phase
1 1/4, 2, 2 1/2 in., NPT	1- or 3-Phase

UL® and CSA component recognition under File E52951 and 31388 respectively, see pages 561 to 568 for details.

Immersion Heaters

WATROD and FIREBAR Screw Plug Immersion Heaters

Typical Applications

- Water:
 - Deionized
 - Demineralized
 - Clean
 - Potable
 - Process
- Industrial water rinse tanks
- Vapor degreasers
- Hydraulic oil, crude, asphalt
- Lubricating oils at API specified watt densities
- Air and gas flow
- Caustic solutions
- Chemical baths
- Anti-freeze (glycol) solutions
- Paraffin

Screw Plug Orientation

Correct element/thermowell orientation assures proper process temperature sensing.

Correct horizontal mounting of WATROD and FIREBAR screw plugs is shown below. Correct orientation assures optimum performance and maximum heater life. Additional mounting information is provided in the *Installation and Maintenance Instructions*.

FIREBAR Heating Elements

1 1/4 in. (32 mm) NPT—One Element

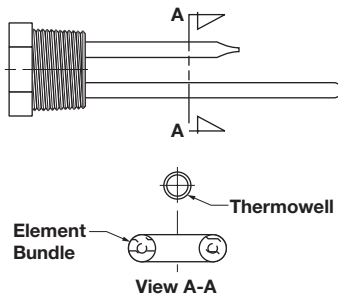

2 1/2 in. (64 mm) NPT—Three Elements

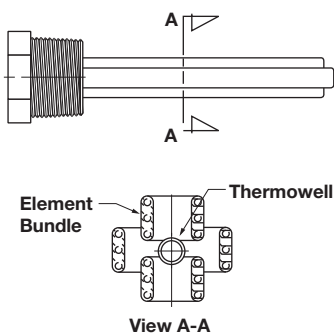

WATROD Heating Element

1 in. (25 mm) NPT—One Element

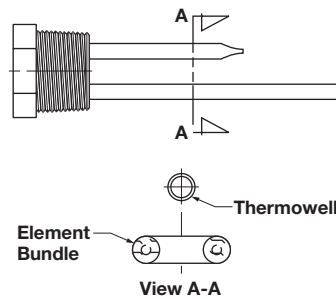

1 1/4 in. (32 mm) and 2 in. (51 mm) NPT—Two Elements

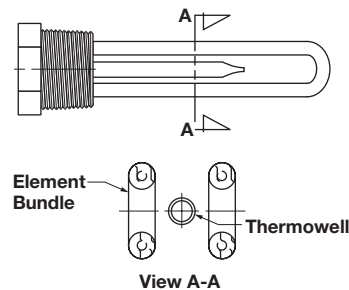

2 in. (51 mm) and 2 1/2 in. (64 mm) NPT—Three Elements

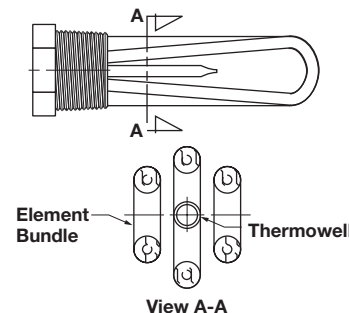

Immersion Heaters

WATROD and FIREBAR Screw Plug Immersion Heaters

Options

Terminal Enclosures

General purpose terminal enclosures, without thermostats, are available on all screw plug immersion heaters. To meet specific application requirements, Watlow offers the following optional terminal enclosures:

- General purpose with single or double pole thermostat
- Moisture-resistant or corrosion resistant—available with optional single or double pole thermostat
- Explosion-resistant class 1, groups B, C and D explosion resistant—available with optional single or double-pole thermostat
- Explosion and moisture-resistant combination—available with optional single- or double-pole thermostat

Note: Unless otherwise stated on the accompanying illustrations, both WATROD and FIREBAR screw plugs are centered on the terminal enclosure. To order, add the suffix letter(s) to the screw plug heater's base part number. This is depicted on the ordering example on page 234. Also, specify class and group, if applicable.

CSA Certified Enclosures

CSA certified moisture and/or explosion-resistant terminal enclosures protect wiring in hazardous gas environments. These terminal enclosures, covered under CSA File number 61707, are available on all WATROD and FIREBAR screw plug immersion heaters. For additional information, contact your Watlow representative.

To order, specify **CSA certified enclosure**, **process temperature** (°F), maximum **working pressure** of application (psig), **media** being heated and heater **mounting orientation** (horizontal or vertical) and **screw plug size**.

ASME Pressure Vessel Code Welding

Screw plug assemblies can be provided with an ASME Section VIII, Div. I pressure vessel stamp upon request.

Pilot Light

The optional pilot light gives the operator visual indication of heater on or off power status.

The PL10 pilot light is configured to a maximum 250VAC and supplied with 6 in. (152 mm) leads.

The PL11 pilot light is rated for 480VAC and supplied with 4 in. (102 mm) leads.

Pilot lights may be attached to either single or double pole thermostats with general purpose enclosure only.

Thermostats

To provide process temperature control, Watlow offers optional single-pole, single-throw (SPST) and double pole, single throw (DPST) thermostats.

Unless otherwise specified, thermostats are mounted inside the terminal enclosure. For details and ordering information, refer to *Thermostats* on pages 534 to 538. Please verify that the thermostat's sensing bulb O.D. is compatible with the screw plug's thermowell I.D.



Caution:

Explosion-resistant terminal enclosures are intended to provide explosion containment in the electrical termination/wiring enclosure only. No portion of the assembly outside of this enclosure is covered under this enclosure rating. Enclosure rating effectiveness may be compromised by abuse or misapplication.

Immersion Heaters

WATROD and FIREBAR Screw Plug Immersion Heaters

Options (Continued)

Thermocouples

Type J or K thermocouples offer extremely accurate sensing of process and/or sheath temperatures. A thermocouple may be inserted into the thermowell or attached to the heater's sheath.

Thermocouples are supplied with 120 in. (3048 mm) leads (longer lead lengths available). Unless otherwise specified, thermocouples are supplied with temperature ranges detailed on the *Thermocouple Types* chart.

Using a thermocouple requires an appropriate temperature and power controller and these must be purchased separately. Watlow offers a wide variety of temperature and power controllers to meet virtually all applications. Temperature controllers can be configured to accept process variable inputs, too. Contact your Watlow representative for details.

To order, specify **Type J** or **K** thermocouple and lead length. Indicate if the thermocouple is for **process temperature sensing** or heater sheath **high-limit protection**. Please specify if the screw plug will be mounted **vertical** or **horizontal** in the tank. **If vertical, indicate if the housing is on top or bottom.**

If the screw plug heater is mounted in an in-line circulation heating application, indicate flow direction relative to the heater's enclosure.

Thermocouple Types

ASTM Type	Conductor Characteristics		Recommended ① Temperature Range	
	Positive	Negative	°F	(°C)
J	Iron (Magnetic)	Constantan (Non-Magnetic)	0 to 1000	(-20 to 540)
K	Chromel® (non-magnetic)	Alumel® (Magnetic)	0 to 2000	(-20 to 1100)

① Type J and Type K thermocouples are rated 32 to 1382°F and 32 to 2282°F (0-750°C and 0-1250°C), respectively. Watlow does not recommend exceeding temperature ranges shown on this chart for the tubular product line.

Wattages and Voltages

Watlow routinely supplies screw plug immersion heaters with 120 to 480VAC as well as wattages from 250 watts to 38kW.

Sheath Materials

The following sheath materials are available on WATROD and FIREBAR heating elements:

Standard Sheath Materials

WATROD	Alloy 800/840
	316 SS
	Steel
FIREBAR	Alloy 800

Exotic Sheath Materials

Contact your Watlow representative for details and availability.

External Finishing

Passivation

During the manufacturing process, particles of iron or tool steel may become embedded in the stainless steel or alloy sheath. If not removed, these particles may corrode, produce rust spots and/or contaminate the process. For critical applications, passivation will remove free iron from the sheath. To order, specify **passivation**.

Other Finishes

Bright annealing available to meet cosmetic demands.

Screw Plug Materials

The following screw plug materials are available:

To order, specify **screw plug size** and **material**.

Standard Screw Plug Materials

WATROD	304 SS, Brass
	Steel
FIREBAR	304 SS

Made-to-Order Plug Materials

For both WATROD and FIREBAR, contact your Watlow representative about details and availability.

Immersion Heaters

WATROD and FIREBAR Screw Plug Immersion Heaters

Options (Continued)

Screw Plug Sizes

Including European

- NPT— 3/4, 1, 1 1/4, 2, 2 1/2 in.

To order, specify **size**, **style** (NPT) and material.

Screw Plug to Flange Adapters

Screw plug to flange adaptors permit replacing flange heaters with screw plug heaters. To order, specify the appropriate part number.

Screw Plug to Flange Adapters

Screw Plug to Flange Adapter Sizes	Material	Estimated Shipping Wt.		Delivery	Part Number
		lbs	(kg)		
1 1/4 to 3 in.-150#	Steel	13	(5.9)	RS	125X3SA
2 1/2 to 3 in.-150#	Steel	11	(5.0)	RS	250X3SA
2 1/2 to 4 in.-150#	Steel	16	(7.3)	RS	250X4SA
2 1/2 to 5 in.-150#	Steel	25	(11.3)	RS	250X5SA
2 1/2 to 6 in.-150#	Steel	33	(15.0)	RS	250X6SA

RAPID SHIP

- RS - Next day shipment up to 3 pieces

Application Hints

- Select the recommended sheath material and watt density for the substance being heated. Use the *Supplemental Applications Chart* on pages 555 to 560. If unable to determine the correct heater material and type, contact your Watlow representative.
- Extend the element's no-heat section completely into the fluid being heated to help prevent premature heater failure. See illustration below for proper no-heat section placement.
- Locate screw plug heater low in the tank, but above the sludge level.

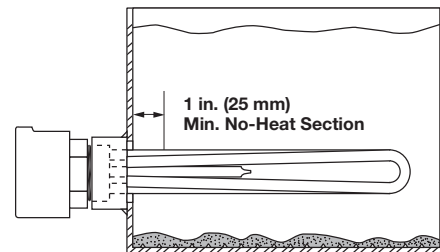

- Choose a FIREBAR element when the application requires a smaller system package or lower watt density.
- Ensure wiring integrity by making sure terminal enclosure temperature does not exceed 400°F (205°C).
- Keep electrical connections clean, dry and tight.
- Size power feeder wires in accordance with National Electrical Code guidelines and other applicable codes.
- Size power feeder wires in accordance with national electrical code guidelines and other applicable codes.
- Minimize problems associated with low liquid level conditions by using a low liquid level sensor or sheath temperature high-limit control.
- Periodically remove the screw plug assembly for inspection and clean the heating element(s). This preventive maintenance will reduce premature failure and optimize heater performance.
- Refer to the *Installation and Maintenance Instructions* for correct orientation of FIREBAR elements. Correct element orientation to flow minimizes pressure drop, increases buoyancy force and heater performance.

Extended Capabilities For WATROD and FIREBAR Screw Plug Immersion Heaters

Options

Pilot Light

The optional pilot light gives the operator visual indication of heater on or off power status.

The PL10 pilot light is configured to a maximum 250VAC and supplied with 6 in. (152 mm) leads.

The PL11 pilot light is rated for 480VAC and supplied with 4 in. (102 mm) leads.

Pilot lights may be attached to either single or double pole thermostats with general purpose enclosure only. For moisture or explosion resistant terminal enclosures, contact your Watlow representative.

To order, refer to the *Ordering Information* on page 234.

Wattages and Voltages

Watlow routinely supplies screw plug immersion heaters with 120 to 480VAC as well as wattages from 250 watts to 38kW. If required, Watlow may configure heaters with voltages and wattages outside these parameters. For more information on special voltage and wattage configurations, contact your Watlow representative.

Extended Sheath Materials

The following sheath materials are available on WATROD and FIREBAR heating elements:

Extended Sheath Materials

WATROD	304 and 321 SS Alloy 400 and 600 Titanium Hastelloy C276
FIREBAR	304 SS Alloy 800

Screw Plug Materials

The following screw plug materials are available:

To order, specify **screw plug size** and **material**.

Extended Screw Plug Materials

WATROD	304, 304H, 316H, 321 SS Titanium Alloy 400 and 600 Hastelloy C276 Alloy 800/840
---------------	---

Screw Plug Sizes

Including European

- **Gas (Gas Pipe Standard)** – G1¹/₄, G1¹/₂, G2 in. (brass only)
- **BSP (British Standard Pipe)** – 1¹/₂, 2 in. (stainless steel only)

Contact your Watlow representative for sizes and materials not listed.

Immersion Heaters

WATROD and FIREBAR Screw Plug Immersion Heaters

Optional Moisture Resistant Housings

Single-Pole Thermostat

1 and 1¹/₄ inch NPT-1 WATROD Element

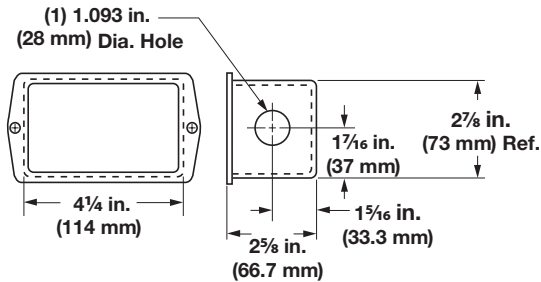

Note: The thermostat is not centered on the WATROD screw plug immersion heater.

Single-Pole Thermostat

All 2 and 2¹/₂ inch NPT

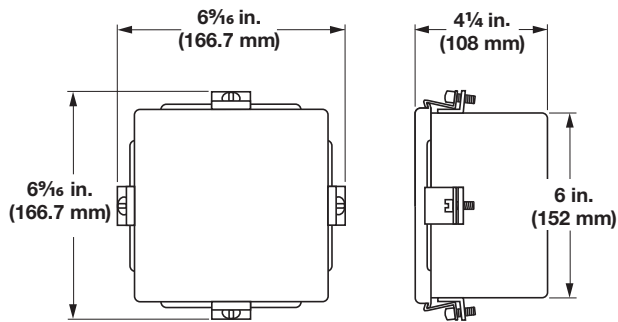

To order: Reference "W" in the *Ordering Information* section on page 234.

Double-Pole Thermostat

1¹/₄ inch NPT-2 WATROD Elements

1¹/₄ inch NPT-1 FIREBAR Element

All 2 and 2¹/₂ inch NPT screw plugs

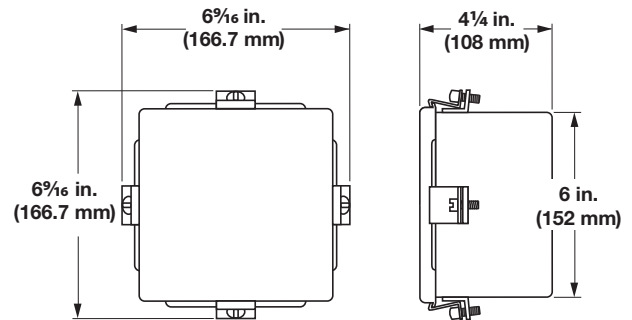

Note: The thermostat is not centered on the screw plug immersion heater.

Without Thermostat

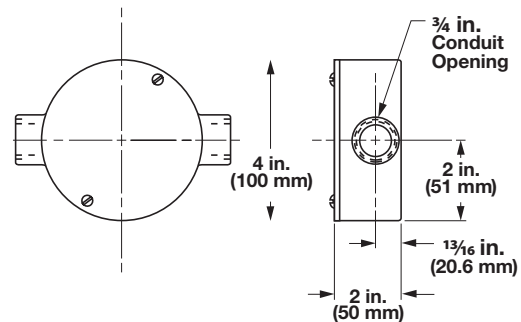

Immersion Heaters

WATROD and FIREBAR Screw Plug Immersion Heaters



Application: Clean Water

- 1 inch NPT screw plug
- WATROD elements
- With thermostat (SPST)
- General purpose enclosure

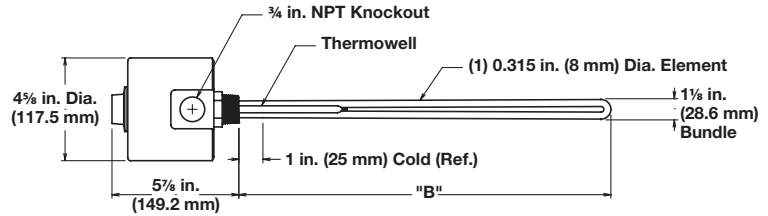

Description	Volts	kW	Ph	"B" Dim. in. (mm)	Ship Wt. lbs (kg)	Type 2 (30 to 250°F)		Type 3 (175 to 550°F)	
						Part Number	Del.	Part Number ②	Del.
General Purpose Enclosure									
60 W/in² Brass Plug 1-Alloy 800 Element	120	0.50	1	4 1/2 (114.0)	3 (2)	BCN4J1S2	RS	BCN4J1S3	RS
	240	0.50	1	4 1/2 (114.0)	3 (2)	BCN4J10S2	RS	BCN4J10S3	RS
	120	0.75	1	6 1/2 (165.0)	3 (2)	BCN6J1S2	RS	BCN6J1S3	RS
	240	0.75	1	6 1/2 (165.0)	3 (2)	BCN6J10S2	RS	BCN6J10S3	RS
	120	1.00	1	6 5/8 (168.3)	3 (2)	BCN6L1S2	RS	BCN6L1S3	RS
	240	1.00	1	6 5/8 (168.3)	3 (2)	BCN6L10S2	RS	BCN6L10S3	RS
	120	1.25	1	8 (203.0)	4 (2)	BCN8A1S2	RS	BCN8A1S3	RS
	240	1.25	1	8 (203.0)	4 (2)	BCN8A10S2	RS	BCN8A10S3	RS
	120	1.50	1	10 5/8 (269.9)	4 (2)	BCN10L1S2	RS	BCN10L1S3	RS
	240	1.50	1	10 5/8 (269.9)	4 (2)	BCN10L10S2	RS	BCN10L10S3	RS
	120	2.00	1	12 1/2 (318.0)	5 (3)	BCN12J1S2	RS	BCN12J1S3	RS
	240	2.00	1	12 1/2 (318.0)	5 (3)	BCN12J10S2	RS	BCN12J10S3	RS
	120	2.50	1	14 3/4 (375.0)	5 (3)	BCN14N1S2	RS	BCN14N1S3	RS
	240	2.50	1	14 3/4 (375.0)	5 (3)	BCN14N10S2	RS	BCN14N10S3	RS
	120	3.00	1	16 3/4 (425.0)	6 (3)	BCN16N1S2	RS	BCN16N1S3	RS
	240	3.00	1	16 3/4 (425.0)	6 (3)	BCN16N10S2	RS	BCN16N10S3	RS
240	4.00	1	21 (533.0)	6 (3)	BCN21A10S2	RS	BCN21A10S3	RS	

RAPID SHIP

- RS - Next day shipment up to 5 pieces

Note: All screw plug bundles are designed to fit the inside diameter of the equivalent mating coupling. They will not fit into the equivalent pipe inside diameter.

② UL® recognized only

Immersion Heaters

WATROD and FIREBAR Screw Plug Immersion Heaters



Application: Clean Water

- 1 inch NPT screw plug
- WATROD elements
- With thermostat (SPST)
- Moisture/explosion-resistant enclosure

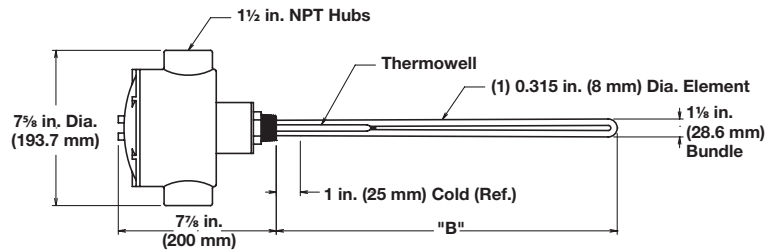

Description	Volts	kW	Ph	"B" Dim. in. (mm)	Ship Wt. lbs (kg)	Type 2 (30 to 250°F)		Type 3 (175 to 550°F)	
						Part Number	Del.	Part Number ⑤	Del.
Moisture/Explosion-Resistant Enclosure									
60 W/in² Brass Plug 1-Alloy 800 Element (9.3 W/cm²)	120	0.50	1	4 1/2 (114.0)	3 (2)	BCN4J1C2	RS	BCN4J1C3	RS
	240	0.50	1	4 1/2 (114.0)	3 (2)	BCN4J10C2	RS	BCN4J10C3	RS
	120	0.75	1	6 1/2 (165.0)	3 (2)	BCN6J1C2	RS	BCN6J1C3	RS
	240	0.75	1	6 1/2 (165.0)	3 (2)	BCN6J10C2	RS	BCN6J10C3	RS
	120	1.00	1	6 5/8 (168.3)	3 (2)	BCN6L1C2	RS	BCN6L1C3	RS
	240	1.00	1	6 5/8 (168.3)	3 (2)	BCN6L10C2	RS	BCN6L10C3	RS
	120	1.25	1	8 (203.0)	4 (2)	BCN8A1C2	RS	BCN8A1C3	RS
	240	1.25	1	8 (203.0)	4 (2)	BCN8A10C2	RS	BCN8A10C3	RS
	120	1.50	1	10 5/8 (269.9)	4 (2)	BCN10L1C2	RS	BCN10L1C3	RS
	240	1.50	1	10 5/8 (269.9)	4 (2)	BCN10L10C2	RS	BCN10L10C3	RS
	120	2.00	1	12 1/2 (318.0)	5 (3)	BCN12J1C2	RS	BCN12J1C3	RS
	240	2.00	1	12 1/2 (318.0)	5 (3)	BCN12J10C2	RS	BCN12J10C3	RS
	120	2.50	1	14 3/4 (375.0)	5 (3)	BCN14N1C2	RS	BCN14N1C3	RS
	240	2.50	1	14 3/4 (375.0)	5 (3)	BCN14N10C2	RS	BCN14N10C3	RS
	120	3.00	1	16 3/4 (425.0)	6 (3)	BCN16N1C2	RS	BCN16N1C3	RS
	240	3.00	1	16 3/4 (425.0)	6 (3)	BCN16N10C2	RS	BCN16N10C3	RS
240	4.00	1	21 (533.0)	6 (3)	BCN21A10C2	RS	BCN21A10C3	RS	

RAPID SHIP

- RS - Next day shipment up to 5 pieces

Note: All screw plug bundles are designed to fit the inside diameter of the equivalent mating coupling. They will not fit into the equivalent pipe inside diameter.

⑤ No third party recognition

Immersion Heaters

WATROD and FIREBAR Screw Plug Immersion Heaters



Application: Clean Water

- 1 inch NPT screw plug
- WATROD elements
- Without thermostat
- General purpose or moisture/explosion-resistant enclosure

General Purpose

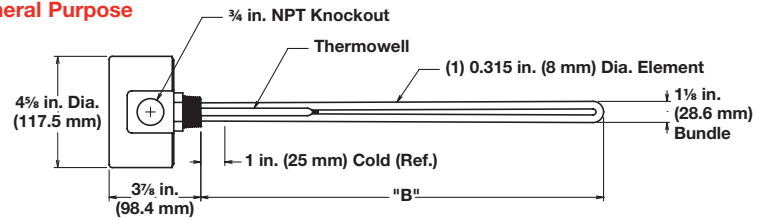

Moisture/Explosion-Resistant

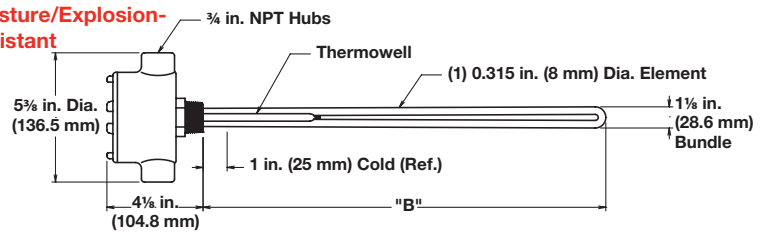

Description	Volts	kW	Ph	"B" Dim. in. (mm)	Part Number	Del.	Ship Wt. lbs (kg)	Part Number ⑦	Del.	Ship Wt. lbs (kg)
					General Purpose Enclosure			Moisture/Explosion-Resistant Enclosure		
60 W/in² Brass Plug 1-Alloy 800 Element (9.3 W/cm²)	120	0.50	1	4 1/2 (114.0)	BCN4J1S	RS	3 (2)	BCN4J1C	RS	6 (3)
	240	0.50	1	4 1/2 (114.0)	BCN4J10S	RS	3 (2)	BCN4J10C	RS	6 (3)
	120	0.75	1	6 1/2 (165.0)	BCN6J1S	RS	3 (2)	BCN6J1C	RS	6 (3)
	240	0.75	1	6 1/2 (165.0)	BCN6J10S	RS	3 (2)	BCN6J10C	RS	6 (3)
	120	1.00	1	6 5/8 (168.3)	BCN6L1S	RS	3 (2)	BCN6L1C	RS	6 (3)
	240	1.00	1	6 5/8 (168.3)	BCN6L10S	RS	3 (2)	BCN6L10C	RS	6 (3)
	120	1.25	1	8 (203.0)	BCN8A1S	RS	4 (2)	BCN8A1C	RS	7 (4)
	240	1.25	1	8 (203.0)	BCN8A10S	RS	4 (2)	BCN8A10C	RS	7 (4)
	120	1.50	1	10 5/8 (269.9)	BCN10L1S	RS	4 (2)	BCN10L1C	RS	7 (4)
	240	1.50	1	10 5/8 (269.9)	BCN10L10S	RS	4 (2)	BCN10L10C	RS	7 (4)
	120	2.00	1	12 1/2 (318.0)	BCN12J1S	RS	5 (3)	BCN12J1C	RS	8 (4)
	240	2.00	1	12 1/2 (318.0)	BCN12J10S	RS	5 (3)	BCN12J10C	RS	8 (4)
	120	2.50	1	14 3/4 (375.0)	BCN14N1S	RS	5 (3)	BCN14N1C	RS	8 (4)
	240	2.50	1	14 3/4 (375.0)	BCN14N10S	RS	5 (3)	BCN14N10C	RS	8 (4)
	120	3.00	1	16 3/4 (425.0)	BCN16N1S	RS	6 (3)	BCN16N1C	RS	9 (4)
	240	3.00	1	16 3/4 (425.0)	BCN16N10S	RS	6 (3)	BCN16N10C	RS	9 (4)
240	4.00	1	21 (533.0)	BCN21A10S	RS	6 (3)	BCN21A10C	RS	9 (4)	

RAPID SHIP

- RS - Next day shipment up to 5 pieces

Note: All screw plug bundles are designed to fit the inside diameter of the equivalent mating coupling. They will not fit into the equivalent pipe inside diameter.

⑦ CSA certified only

Immersion Heaters

WATROD and FIREBAR Screw Plug Immersion Heaters



Application: Clean Water

- 1 1/4 inch NPT screw plug
- WATROD elements
- With thermostat (SPST)
- General purpose or moisture/explosion-resistant enclosure

General Purpose

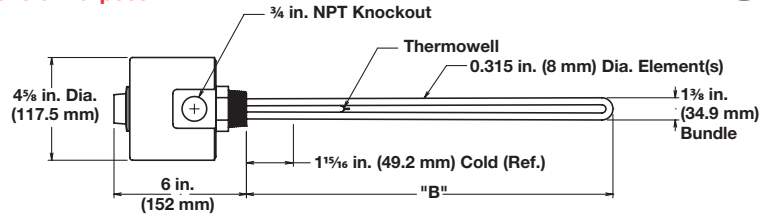

Moisture/Explosion-Resistant

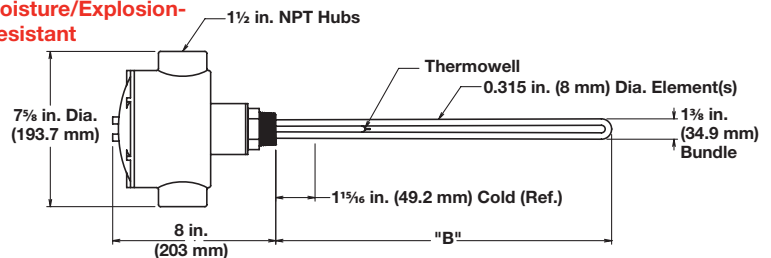

Description	Volts	kW	Ph	"B" Dim. in. (mm)	Ship Wt. lbs (kg)	Type 2 (30 to 250°F)		Type 3 (175 to 550°F)	
						Part Number	Del.	Part Number ⑤	Del.
General Purpose Enclosure									
60 W/in² Brass Plug 1-Alloy 800 Element (9.3 W/cm²)	120	0.50	1	4 ³ / ₈ (111.1)	3 (2)	BDN4G1S2	RS	BDN4G1S3	RS
	240	0.50	1	4 ³ / ₈ (111.1)	3 (2)	BDN4G10S2	RS	BDN4G10S3	RS
	120	0.75	1	6 ³ / ₈ (161.9)	3 (2)	BDN6G1S2	RS	BDN6G1S3	RS
	240	0.75	1	6 ³ / ₈ (161.9)	3 (2)	BDN6G10S2	RS	BDN6G10S3	RS
60 W/in² ④ Brass Plug 2-Alloy 800 Elements (9.3 W/cm²)	120/240	1.00	1	4 ³ / ₈ (111.1)	4 (2)	BEN4G6S2	RS	BEN4G6S3	RS
	120/240	1.50	1	6 ³ / ₈ (161.9)	4 (2)	BEN6G6S2	RS	BEN6G6S3	RS
	120/240	2.00	1	8 ¹ / ₂ (216.0)	5 (3)	BEN8J6S2	RS	BEN8J6S3	RS
	120/240	2.50	1	10 ³ / ₄ (273.0)	5 (3)	BEN10N6S2	RS	BEN10N6S3	RS
	120/240	3.00	1	15 (381.0)	6 (3)	BEN15A6S2	RS	BEN15A6S3	RS
	240	4.00	1	19 (483.0)	7 (4)	BEN19A10S2	RS	BEN19A10S3	RS
	240	5.00	1	23 ¹ / ₂ (597.0)	8 (4)	BEN23J10S2	RS	BEN23J10S3	RS
	240	6.00	1	27 ¹ / ₂ (699.0)	9 (4)	BEN27J10S2	RS	BEN27J10S3	RS
Moisture/Explosion-Resistant Enclosure ⑦									
60 W/in² Brass Plug 1-Alloy 800 Element (9.3 W/cm²)	120	0.50	1	4 ³ / ₈ (111.1)	7 (4)	BDN4G1C2	RS	BDN4G1C3	RS
	240	0.50	1	4 ³ / ₈ (111.1)	7 (4)	BDN4G10C2	RS	BDN4G10C3	RS
	120	0.75	1	6 ³ / ₈ (161.9)	7 (4)	BDN6G1C2	RS	BDN6G1C3	RS
	240	0.75	1	6 ³ / ₈ (161.9)	7 (4)	BDN6G10C2	RS	BDN6G10C3	RS
60 W/in² ④ Brass Plug 2-Alloy 800 Elements (9.3 W/cm²)	120/240	1.00	1	4 ³ / ₈ (111.1)	8 (4)	BEN4G6C2	RS	BEN4G6C3	RS
	120/240	1.50	1	6 ³ / ₈ (161.9)	8 (4)	BEN6G6C2	RS	BEN6G6C3	RS
	120/240	2.00	1	8 ¹ / ₂ (216.0)	9 (4)	BEN8J6C2	RS	BEN8J6C3	RS
	120/240	2.50	1	10 ³ / ₄ (273.0)	9 (4)	BEN10N6C2	RS	BEN10N6C3	RS
	120/240	3.00	1	15 (381.0)	10 (5)	BEN15A6C2	RS	BEN15A6C3	RS
	240	4.00	1	19 (483.0)	11 (5)	BEN19A10C2	RS	BEN19A10C3	RS
	240	5.00	1	23 ¹ / ₂ (597.0)	12 (6)	BEN23J10C2	RS	BEN23J10C3	RS
	240	6.00	1	27 ¹ / ₂ (699.0)	13 (6)	BEN27J10C2	RS	BEN27J10C3	RS



- RS - Next day shipment up to 5 pieces

Note: All screw plug bundles are designed to fit the inside diameter of the equivalent mating coupling. They will not fit into the equivalent pipe inside diameter.

- ④ Wired for higher voltage
- ⑤ No third party recognition
- ⑦ CSA certified only

Immersion Heaters

WATROD and FIREBAR Screw Plug Immersion Heaters



Application: Clean Water

- 1 1/4 inch NPT screw plug
- WATROD elements
- Without thermostat
- General purpose or moisture/explosion-resistant enclosure

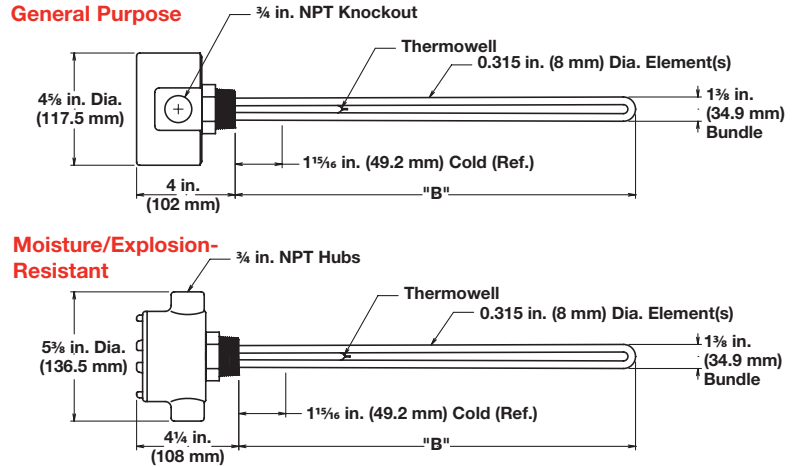

Description	Volts	kW	Ph	"B" Dim. in. (mm)	Part Number	Del.	Ship Wt. lbs (kg)	Part Number ⑦	Del.	Ship Wt. lbs (kg)	
					General Purpose Enclosure			Moisture/Explosion-Resistant Enclosure			
60 W/in² Brass Plug 1-Alloy 800 Element (9.3 W/cm²)	120	0.50	1	4 ³ / ₈ (111.1)	BDN4G1S	RS	3 (2)	BDN4G1C	RS	6 (3)	
	240	0.50	1	4 ³ / ₈ (111.1)	BDN4G10S	RS	3 (2)	BDN4G10C	RS	6 (3)	
	120	0.75	1	6 ³ / ₈ (161.9)	BDN6G1S	RS	3 (2)	BDN6G1C	RS	6 (3)	
	240	0.75	1	6 ³ / ₈ (161.9)	BDN6G10S	RS	3 (2)	BDN6G10C	RS	6 (3)	
60 W/in² ④ Brass Plug 2-Alloy 800 Elements (9.3 W/cm²)	120/240	1.00	1	4 ³ / ₈ (111.1)	BEN4G6S	RS	4 (2)	BEN4G6C	RS	7 (4)	
	120/240	1.50	1	6 ³ / ₈ (161.9)	BEN6G6S	RS	4 (2)	BEN6G6C	RS	7 (4)	
	120/240	2.00	1	8 ¹ / ₂ (216.0)	BEN8J6S	RS	5 (3)	BEN8J6C	RS	8 (4)	
	120/240	2.50	1	10 ³ / ₄ (273.0)	BEN10N6S	RS	5 (3)	BEN10N6C	RS	8 (4)	
	120/240	3.00	1	15 (381.0)	BEN15A6S	RS	6 (3)	BEN15A6C	RS	9 (4)	
	240	4.00	1	19 (483.0)	BEN19A10S	RS	7 (4)	BEN19A10C	RS	10 (5)	
	240	5.00	1	23 ¹ / ₂ (597.0)	BEN23J10S	RS	8 (4)	BEN23J10C	RS	11 (5)	
	240	6.00	1	27 ¹ / ₂ (699.0)	BEN27J10S	RS	9 (4)	BEN27J10C	RS	12 (6)	

RAPID SHIP

- RS - Next day shipment up to 5 pieces

Note: All screw plug bundles are designed to fit the inside diameter of the equivalent mating coupling. They will not fit into the equivalent pipe inside diameter.

- ④ Wired for higher voltage
- ⑦ CSA certified only

Immersion Heaters

WATROD and FIREBAR Screw Plug Immersion Heaters



Application: Clean Water

- 1 1/4 inch NPT screw plug
- FIREBAR elements
- With thermostat (DPST)
- General purpose enclosure

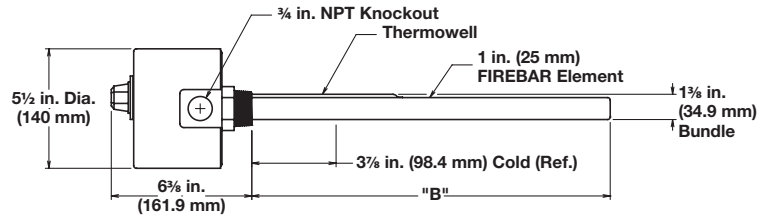

Description	Volts	kW	Ph	"B" Dim. in. (mm)	Ship Wt. lbs (kg)	Type 5A (60 to 250°F)		Type 7A (100 to 550°F)		
						Part Number	Del.	Part Number	Del.	
General Purpose Enclosure										
90 W/in² Ⓢ 304 SS Plug 1-Alloy 800 Element (14 W/cm²)	240	1.5	1	7 ⁵ / ₈ (193.7)	6 (3)	BDNF7R10S5A	RS	BDNF7R10S7A	RS	
	480	1.5	1	7 ⁵ / ₈ (193.7)	6 (3)	BDNF7R11S5A	RS	BDNF7R11S7A	RS	
	240	3.0	1	11 ¹ / ₈ (282.6)	7 (4)	BDNF11G10S5A	RS	BDNF11G10S7A	RS	
	480	3.0	1	11 ¹ / ₈ (282.6)	7 (4)	BDNF11G11S5A	RS	BDNF11G11S7A	RS	
	240	5.0	3	16 ¹ / ₈ (409.6)	8 (4)	BDNF16G3S5A	RS	BDNF16G3S7A	RS	
	480	5.0	3	16 ¹ / ₈ (409.6)	8 (4)	BDNF16G5S5A	RS	BDNF16G5S7A	RS	
	240	6.5	3	19 ¹ / ₈ (485.8)	9 (4)	BDNF19G3S5A	RS	BDNF19G3S7A	RS	
	480	6.5	3	19 ¹ / ₈ (485.8)	9 (4)	BDNF19G5S5A	RS	BDNF19G5S7A	RS	
	240	8.5	3	24 ³ / ₈ (619.1)	10 (5)	BDNF24L3S5A	RS	BDNF24L3S7A	RS	
	480	8.5	3	24 ³ / ₈ (619.1)	10 (5)	BDNF24L5S5A	RS	BDNF24L5S7A	RS	
	240	10.5	3	29 ⁵ / ₈ (752.5)	11 (5)	BDNF29R3S5A	RS	BDNF29R3S7A	RS	

RAPID SHIP

- RS - Next day shipment up to 5 pieces

Note: All screw plug bundles are designed to fit the inside diameter of the equivalent mating coupling. They will not fit into the equivalent pipe inside diameter.

Ⓢ Can be wired for 1-phase operation

Immersion Heaters

WATROD and FIREBAR Screw Plug Immersion Heaters



Application: Clean Water

- 1 1/4 inch NPT screw plug
- FIREBAR elements
- With thermostat (DPST)

Note: Higher amperage products require a pilot duty thermostat with separate power controller. Please see following pages for available heaters without thermostats.

- Moisture/explosion-resistant enclosure

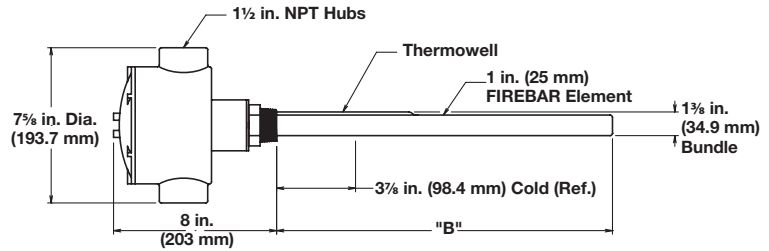

Description	Volts	kW	Ph	"B" Dim. in. (mm)	Ship Wt. lbs (kg)	Type 5A (60 to 250°F)		Type 7A (100 to 550°F)	
						Part Number	Del.	Part Number	Del.
Moisture/Explosion-Resistant Enclosure									
90 W/in² Ⓢ 304 SS Plug 1-Alloy 800 Element (14 W/cm²)	240	1.5	1	7 ⁵ / ₈ (193.7)	9 (4)	BDNF7R10C5A	RS	BDNF7R10C7A	RS
	480	1.5	1	7 ⁵ / ₈ (193.7)	9 (4)	BDNF7R11C5A	RS	BDNF7R11C7A	RS
	240	3.0	1	11 ¹ / ₈ (282.6)	10 (5)	BDNF11G10C5A	RS	BDNF11G10C7A	RS
	480	3.0	1	11 ¹ / ₈ (282.6)	10 (5)	BDNF11G11C5A	RS	BDNF11G11C7A	RS
	240	5.0	3	16 ¹ / ₈ (409.6)	11 (5)	BDNF16G3C5A	RS	BDNF16G3C7A	RS
	480	5.0	3	16 ¹ / ₈ (409.6)	11 (5)	BDNF16G5C5A	RS	BDNF16G5C7A	RS
	240	6.5	3	19 ¹ / ₈ (485.8)	12 (6)	BDNF19G3C5A	RS	BDNF19G3C7A	RS
	480	6.5	3	19 ¹ / ₈ (485.8)	12 (6)	BDNF19G5C5A	RS	BDNF19G5C7A	RS
	240	8.5	3	24 ³ / ₈ (619.1)	13 (6)	BDNF24L3C5A	RS	BDNF24L3C7A	RS

RAPID SHIP

- **RS** - Next day shipment up to 5 pieces

Note: All screw plug bundles are designed to fit the inside diameter of the equivalent mating coupling. They will not fit into the equivalent pipe inside diameter.

Ⓢ Can be wired for 1-phase operation

Immersion Heaters

WATROD and FIREBAR Screw Plug Immersion Heaters



Application: Clean Water

- 1 1/4 inch NPT screw plug
- FIREBAR elements
- Without thermostat
- General purpose or moisture/explosion-resistant enclosure

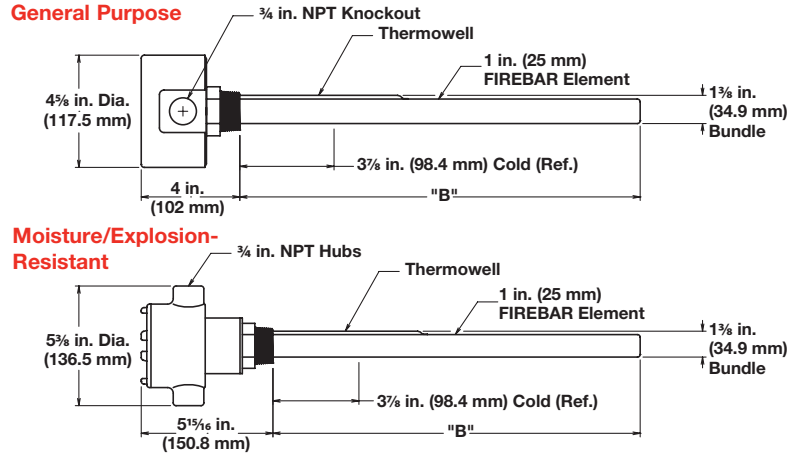

Description	Volts	kW	Ph	"B" Dim. in. (mm)	General Purpose Enclosure		Moisture/Explosion-Resistant Enclosure			
					Part Number	Del.	Ship Wt. lbs (kg)	Part Number ⑦	Del.	Ship Wt. lbs (kg)
90 W/in ² ⑧ 304 SS Plug 1-Alloy 800 Element (9.3 W/cm ²)	240	1.5	1	7 ⁵ / ₈ (193.7)	BDNF7R10S	RS	5 (3)	BDNF7R10C	RS	8 (4)
	480	1.5	1	7 ⁵ / ₈ (193.7)	BDNF7R11S	RS	5 (3)	BDNF7R11C	RS	8 (4)
	240	3.0	1	11 ¹ / ₈ (282.6)	BDNF11G10S	RS	6 (3)	BDNF11G10C	RS	9 (4)
	480	3.0	1	11 ¹ / ₈ (282.6)	BDNF11G11S	RS	6 (3)	BDNF11G11C	RS	9 (4)
	240	5.0	3	16 ¹ / ₈ (409.6)	BDNF16G3S	RS	7 (4)	BDNF16G3C	RS	10 (5)
	480	5.0	3	16 ¹ / ₈ (409.6)	BDNF16G5S	RS	7 (4)	BDNF16G5C	RS	10 (5)
	240	6.5	3	19 ¹ / ₈ (485.8)	BDNF19G3S	RS	8 (4)	BDNF19G3C	RS	11 (5)
	480	6.5	3	19 ¹ / ₈ (485.8)	BDNF19G5S	RS	8 (4)	BDNF19G5C	RS	11 (5)
	240	8.5	3	24 ³ / ₈ (619.1)	BDNF24L3S	RS	9 (4)	BDNF24L3C	RS	12 (6)
	480	8.5	3	24 ³ / ₈ (619.1)	BDNF24L5S	RS	9 (4)	BDNF24L5C	RS	12 (6)
	240	10.5	3	29 ⁵ / ₈ (752.5)	BDNF29R3S	RS	10 (5)	BDNF29R3C	RS	13 (6)
	480	10.5	3	29 ⁵ / ₈ (752.5)	BDNF29R5S	RS	10 (5)	BDNF29R5C	RS	13 (6)
	240	12.7	3	34 ⁵ / ₈ (879.5)	BDNF34R3S	RS	11 (5)	BDNF34R3C	RS	14 (7)
	480	12.7	3	34 ⁵ / ₈ (879.5)	BDNF34R5S	RS	11 (5)	BDNF34R5C	RS	14 (7)
	240	17.0	3	45 ¹ / ₈ (1146.2)	BDNF45G3S	RS	13 (6)	BDNF45G3C	RS	16 (8)
	480	17.0	3	45 ¹ / ₈ (1146.2)	BDNF45G5S	RS	13 (6)	BDNF45G5C	RS	16 (8)
480	21.5	3	55 ⁵ / ₈ (1412.9)	BDNF55R5S	RS	15 (7)	BDNF55R5C	RS	18 (9)	

RAPID SHIP

- RS - Next day shipment up to 5 pieces

Note: All screw plug bundles are designed to fit the inside diameter of the equivalent mating coupling. They will not fit into the equivalent pipe inside diameter.

⑦ CSA certified only

⑧ Can be wired for 1-phase operation

Immersion Heaters

WATROD and FIREBAR Screw Plug Immersion Heaters



Application: Clean Water

- 2 inch NPT screw plug
- WATROD elements
- With thermostat (DPST)

Note: Higher amperage products require a pilot duty thermostat with separate power controller. Please see following pages for available heaters without thermostats.

- General purpose enclosure

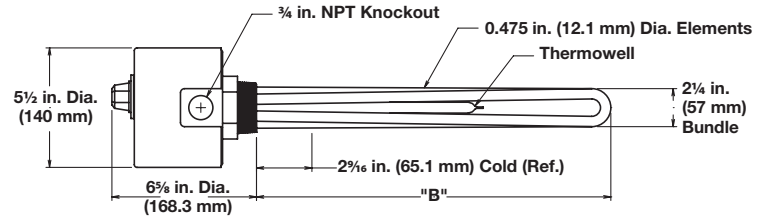

Description	Volts	kW	Ph	"B" Dim. in. (mm)	Ship Wt. lbs (kg)	Type 4 (30 to 110°F)		Type 5A (60 to 250°F)		Type 7A (100 to 550°F)	
						Part Number	Del.	Part Number	Del.	Part Number	Del.
General Purpose Enclosure											
60 W/in² ④ 304 SS Plug 2-Alloy 800 Elements (9.3 W/cm²)	120/240	2.0	1	8 ¹ / ₈ (206.4)	5 (3)	BGN78C6S4	RS	BGN78C6S5A	RS	BGN78C6S7A	RS
	240/480	2.0	1	8 ¹ / ₈ (206.4)	5 (3)	BGN78C7S4	RS	BGN78C7S5A	RS	BGN78C7S7A	RS
	120/240	3.0	1	11 ¹ / ₈ (282.6)	6 (3)	BGN711C6S4	RS	BGN711C6S5A	RS	BGN711C6S7A	RS
	240/480	3.0	1	11 ¹ / ₈ (282.6)	6 (3)	BGN711C7S4	RS	BGN711C7S5A	RS	BGN711C7S7A	RS
	120/240	4.0	1	15 ¹ / ₈ (384.2)	7 (4)	BGN715C6S4	RS	BGN715C6S5A	RS	BGN715C6S7A	RS
	120/240	5.0	1	18 ¹ / ₈ (460.4)	7 (4)	BGN718C6S4	RS	BGN718C6S5A	RS	BGN718C6S7A	RS
60 W/in² 304 SS Plug 3-Alloy 800 Elements (9.3 W/cm²)	240	3.0	3	8 ¹ / ₈ (206.4)	6 (3)	BHN78C3S4	RS	BHN78C3S5A	RS	BHN78C3S7A	RS
	480	3.0	3	8 ¹ / ₈ (206.4)	6 (3)	BHN68C13S4	RS	BHN68C13S5A	RS	BHN68C13S7A	RS
	240	4.5	3	11 ¹ / ₈ (282.6)	7 (4)	BHN711C3S4	RS	BHN711C3S5A	RS	BHN711C3S7A	RS
	480	4.5	3	11 ¹ / ₈ (282.6)	7 (4)	BHN611C13S4	RS	BHN611C13S5A	RS	BHN611C13S7A	RS
	240	6.0	3	15 ¹ / ₈ (384.2)	8 (4)	BHN715C3S4	RS	BHN715C3S5A	RS	BHN715C3S7A	RS
	480	6.0	3	15 ¹ / ₈ (384.2)	8 (4)	BHN715C5S4	RS	BHN715C5S5A	RS	BHN715C5S7A	RS
	240	7.5	3	18 ¹ / ₈ (460.4)	8 (4)	BHN718C3S4	RS	BHN718C3S5A	RS	BHN718C3S7A	RS
	240	9.0	3	21 ¹ / ₈ (536.6)	9 (4)	BHN721C3S4	RS	BHN721C3S5A	RS	BHN721C3S7A	RS

RAPID SHIP

- RS - Next day shipment up to 5 pieces

Note: All screw plug bundles are designed to fit the inside diameter of the equivalent mating coupling. They will not fit into the equivalent pipe inside diameter.

④ Wired for higher voltage

Immersion Heaters

WATROD and FIREBAR Screw Plug Immersion Heaters



Application: Clean Water

- 2 inch NPT screw plug
- WATROD elements
- With thermostat (DPST)

Note: Higher amperage products require a pilot duty thermostat with separate power controller. Please see following pages for available heaters without thermostats.

- Moisture/explosion-resistant enclosure

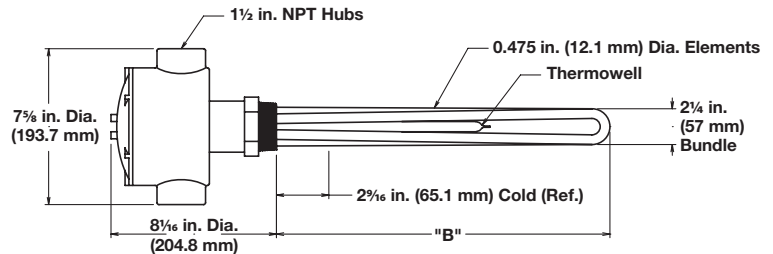

Description	Volts	kW	Ph	"B" Dim. in. (mm)	Ship Wt. lbs (kg)	Type 4 (30 to 110°F)		Type 5A (60 to 250°F)		Type 7A (100 to 550°F)	
						Part Number	Del.	Part Number	Del.	Part Number	Del.
Moisture/Explosion-Resistant Enclosure											
60 W/in² ④ 304 SS Plug 2-Alloy 800 Elements (9.3 W/cm²)	120/240	2.0	1	8 ¹ / ₈ (206.4)	8 (4)	BGN78C6C4	RS	BGN78C6C5A	RS	BGN78C6C7A	RS
	240/480	2.0	1	8 ¹ / ₈ (206.4)	8 (4)	BGN78C7C4	RS	BGN78C7C5A	RS	BGN78C7C7A	RS
	120/240	3.0	1	11 ¹ / ₈ (282.6)	9 (4)	BGN711C6C4	RS	BGN711C6C5A	RS	BGN711C6C7A	RS
	240/480	3.0	1	11 ¹ / ₈ (282.6)	9 (4)	BGN711C7C4	RS	BGN711C7C5A	RS	BGN711C7C7A	RS
	120/240	4.0	1	15 ¹ / ₈ (384.2)	10 (5)	BGN715C6C4	RS	BGN715C6C5A	RS	BGN715C6C7A	RS
	120/240	5.0	1	18 ¹ / ₈ (460.4)	10 (5)	BGN718C6C4	RS	BGN718C6C5A	RS	BGN718C6C7A	RS
60 W/in² 304 SS Plug 3-Alloy 800 Elements (9.3 W/cm²)	240	3.0	3	8 ¹ / ₈ (206.4)	9 (4)	BHN78C3C4	RS	BHN78C3C5A	RS	BHN78C3C7A	RS
	480	3.0	3	8 ¹ / ₈ (206.4)	9 (4)	BHN68C13C4	RS	BHN68C13C5A	RS	BHN68C13C7A	RS
	240	4.5	3	11 ¹ / ₈ (282.6)	10 (5)	BHN711C3C4	RS	BHN711C3C5A	RS	BHN711C3C7A	RS
	480	4.5	3	11 ¹ / ₈ (282.6)	10 (5)	BHN611C13C4	RS	BHN611C13C5A	RS	BHN611C13C7A	RS
	240	6.0	3	15 ¹ / ₈ (384.2)	11 (5)	BHN715C3C4	RS	BHN715C3C5A	RS	BHN715C3C7A	RS
	480	6.0	3	15 ¹ / ₈ (384.2)	11 (5)	BHN715C5C4	RS	BHN715C5C5A	RS	BHN715C5C7A	RS
	240	7.5	3	18 ¹ / ₈ (460.4)	11 (5)	BHN718C3C4	RS	BHN718C3C5A	RS	BHN718C3C7A	RS
	240	9.0	3	21 ¹ / ₈ (536.6)	12 (6)	BHN721C3C4	RS	BHN721C3C5A	RS	BHN721C3C7A	RS

RAPID SHIP

- RS - Next day shipment up to 5 pieces

Note: All screw plug bundles are designed to fit the inside diameter of the equivalent mating coupling. They will not fit into the equivalent pipe inside diameter.

- ④ Wired for higher voltage

Immersion Heaters

WATROD and FIREBAR Screw Plug Immersion Heaters



Application: Clean Water

- 2 inch NPT screw plug
- WATROD elements
- Without thermostat
- General purpose or moisture/explosion-resistant enclosure

General Purpose

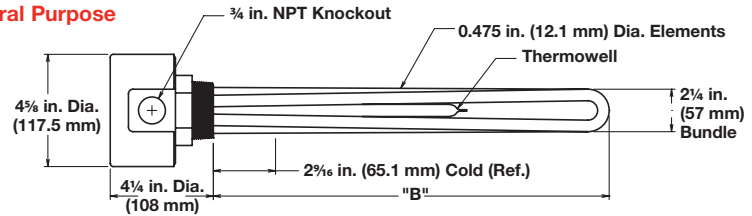

Moisture/Explosion-Resistant

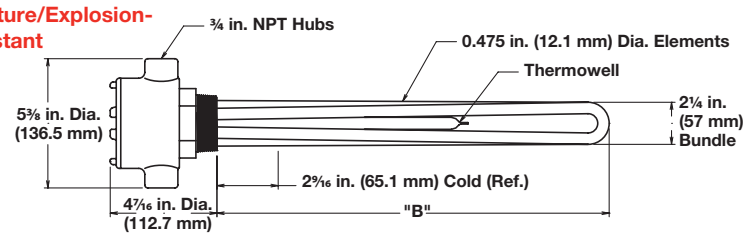

Description	Volts	kW	Ph	"B" Dim. in. (mm)	Part Number	Del.	Ship Wt. lbs (kg)	Part Number ⑦	Del.	Ship Wt. lbs (kg)
					General Purpose Enclosure			Moisture/Explosion-Resistant Enclosure		
60 W/in ² ④ 304 SS Plug 2-Alloy 800 Elements (9.3 W/cm ²)	120/240	2.0	1	8 ¹ / ₈ (206.4)	BGN78C6S	RS	4 (2)	BGN78C6C	RS	7 (4)
	240/480	2.0	1	8 ¹ / ₈ (206.4)	BGN78C7S	RS	4 (2)	BGN78C7C	RS	7 (4)
	120/240	3.0	1	11 ¹ / ₈ (282.6)	BGN711C6S	RS	5 (3)	BGN711C6C	RS	8 (4)
	240/480	3.0	1	11 ¹ / ₈ (282.6)	BGN711C7S	RS	5 (3)	BGN711C7C	RS	8 (4)
	120/240	4.0	1	15 ¹ / ₈ (384.2)	BGN715C6S	RS	6 (3)	BGN715C6C	RS	9 (4)
	240/480	4.0	1	15 ¹ / ₈ (384.2)	BGN715C7S	RS	6 (3)	BGN715C7C	RS	9 (4)
	120/240	5.0	1	18 ¹ / ₈ (460.4)	BGN718C6S	RS	6 (3)	BGN718C6C	RS	9 (4)
	240/480	5.0	1	18 ¹ / ₈ (460.4)	BGN718C7S	RS	6 (3)	BGN718C7C	RS	9 (4)
	240/480	6.0	1	21 ¹ / ₈ (536.6)	BGN721C7S	RS	7 (4)	BGN721C7C	RS	10 (5)
	240/480	8.0	1	26 ⁵ / ₈ (676.3)	BGN726L7S	RS	7 (4)	BGN726L7C	RS	10 (5)
60 W/in ² 304 SS Plug 3-Alloy 800 Elements (9.3 W/cm ²)	120	3.0	1	8 ¹ / ₈ (206.4)	BHN78C1S	RS	5 (3)	BHN78C1C	RS	8 (4)
	240	3.0	3	8 ¹ / ₈ (206.4)	BHN78C3S	RS	5 (3)	BHN78C3C	RS	8 (4)
	480	3.0	3	8 ¹ / ₈ (206.4)	BHN68C13S	RS	5 (3)	BHN68C13C	RS	8 (4)
	120	4.5	1	11 ¹ / ₈ (282.6)	BHN711C1S	RS	6 (3)	BHN711C1C	RS	9 (4)
	240	4.5	3	11 ¹ / ₈ (282.6)	BHN711C3S	RS	6 (3)	BHN711C3C	RS	9 (4)
	480	4.5	3	11 ¹ / ₈ (282.6)	BHN611C13S	RS	6 (3)	BHN611C13C	RS	9 (4)
	240	6.0	3	15 ¹ / ₈ (384.2)	BHN715C3S	RS	7 (4)	BHN715C3C	RS	10 (5)
	480	6.0	3	15 ¹ / ₈ (384.2)	BHN715C5S	RS	7 (4)	BHN715C5C	RS	10 (5)
	240	7.5	3	18 ¹ / ₈ (460.4)	BHN718C3S	RS	7 (4)	BHN718C3C	RS	10 (5)
	480	7.5	3	18 ¹ / ₈ (460.4)	BHN718C5S	RS	7 (4)	BHN718C5C	RS	10 (5)
	240	9.0	3	21 ¹ / ₈ (536.6)	BHN721C3S	RS	8 (4)	BHN721C3C	RS	11 (5)
	480	9.0	3	21 ¹ / ₈ (536.6)	BHN721C5S	RS	8 (4)	BHN721C5C	RS	11 (5)
	240	12.0	3	26 ⁵ / ₈ (676.3)	BHN726L3S	RS	8 (4)	BHN726L3C	RS	11 (5)
	480	12.0	3	26 ⁵ / ₈ (676.3)	BHN726L5S	RS	8 (4)	BHN726L5C	RS	11 (5)
240	15.0	3	32 ¹ / ₈ (816.0)	BHN732C3S	RS	9 (4)	BHN732C3C	RS	12 (6)	
480	15.0	3	32 ¹ / ₈ (816.0)	BHN732C5S	RS	9 (4)	BHN732C5C	RS	12 (6)	

RAPID SHIP

- RS - Next day shipment up to 5 pieces

Note: All screw plug bundles are designed to fit the inside diameter of the equivalent mating coupling. They will not fit into the equivalent pipe inside diameter.

- ④ Wired for higher voltage
- ⑦ CSA certified only

Immersion Heaters

WATROD and FIREBAR Screw Plug Immersion Heaters



Application: Clean Water

- 2 1/2 inch NPT screw plug
- WATROD elements
- With thermostat (DPST)

Note: Higher amperage products require a pilot duty thermostat with separate power controller. Please see following pages for available heaters without thermostats.

- General purpose or moisture/explosion-resistant enclosure

General Purpose

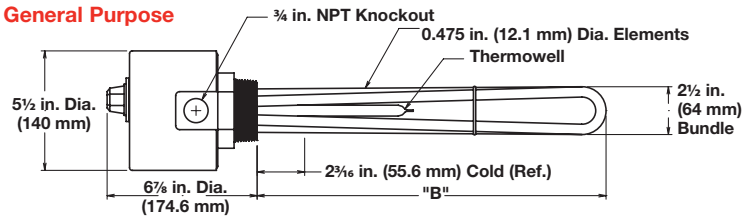

Moisture/Explosion-Resistant

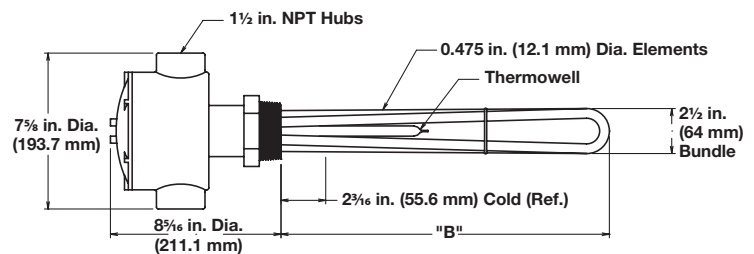

Description	Volts	kW	Ph	"B" Dim. in. (mm)	Ship Wt. lbs (kg)	Type 4 (30 to 110°F)		Type 5A (60 to 250°F)		Type 7A (100 to 550°F)	
						Part Number	Del.	Part Number	Del.	Part Number	Del.
General Purpose Enclosure											
60 W/in² 304 SS Plug 3-Alloy 800 Elements (9.3 W/cm²)	240	3.0	3	7 ⁵ / ₈ (193.7)	7 (4)	BLN77L3S4	RS	BLN77L3S5A	RS	BLN77L3S7A	RS
	480	3.0	3	7 ⁵ / ₈ (193.7)	7 (4)	BLN77L13S4	RS	BLN77L13S5A	RS	BLN77L13S7A	RS
	240	4.5	3	10 ⁵ / ₈ (269.9)	8 (4)	BLN710L3S4	RS	BLN710L3S5A	RS	BLN710L3S7A	RS
	480	4.5	3	10 ⁵ / ₈ (269.9)	8 (4)	BLN610K13S4	RS	BLN610K13S5A	RS	BLN610K13S7A	RS
	240	6.0	3	14 ⁵ / ₈ (371.5)	10 (5)	BLN714L3S4	RS	BLN714L3S5A	RS	BLN714L3S7A	RS
	480	6.0	3	14 ⁵ / ₈ (371.5)	10 (5)	BLN714L5S4	RS	BLN714L5S5A	RS	BLN714L5S7A	RS
	240	7.5	3	17 ⁵ / ₈ (447.7)	10 (5)	BLN717L3S4	RS	BLN717L3S5A	RS	BLN717L3S7A	RS
	240	9.0	3	20 ⁵ / ₈ (523.9)	12 (6)	BLN720L3S4	RS	BLN720L3S5A	RS	BLN720L3S7A	RS
Moisture/Explosion-Resistant Enclosure ⑦											
60 W/in² 304 SS Plug 3-Alloy 800 Elements (9.3 W/cm²)	240	3.0	3	7 ⁵ / ₈ (193.7)	10 (5)	BLN77L3C4	RS	BLN77L3C5A	RS	BLN77L3C7A	RS
	480	3.0	3	7 ⁵ / ₈ (193.7)	10 (5)	BLN77L13C4	RS	BLN77L13C5A	RS	BLN77L13C7A	RS
	240	4.5	3	10 ⁵ / ₈ (269.9)	11 (5)	BLN710L3C4	RS	BLN710L3C5A	RS	BLN710L3C7A	RS
	480	4.5	3	10 ⁵ / ₈ (269.9)	11 (5)	BLN610K13C4	RS	BLN610K13C5A	RS	BLN610K13C7A	RS
	240	6.0	3	14 ⁵ / ₈ (371.5)	13 (6)	BLN714L3C4	RS	BLN714L3C5A	RS	BLN714L3C7A	RS
	480	6.0	3	14 ⁵ / ₈ (371.5)	13 (6)	BLN714L5C4	RS	BLN714L5C5A	RS	BLN714L5C7A	RS
	240	7.5	3	17 ⁵ / ₈ (447.7)	13 (6)	BLN717L3C4	RS	BLN717L3C5A	RS	BLN717L3C7A	RS
	240	9.0	3	20 ⁵ / ₈ (523.9)	15 (7)	BLN720L3C4	RS	BLN720L3C5A	RS	BLN720L3C7A	RS

RAPID SHIP

- RS - Next day shipment up to 5 pieces

Note: All screw plug bundles are designed to fit the inside diameter of the equivalent mating coupling. They will not fit into the equivalent pipe inside diameter.

⑦ CSA certified only

Immersion Heaters

WATROD and FIREBAR Screw Plug Immersion Heaters



Application: Clean Water

- 2 1/2 inch NPT screw plug
- WATROD elements
- Without thermostat
- General purpose or moisture/explosion-resistant enclosure

General Purpose

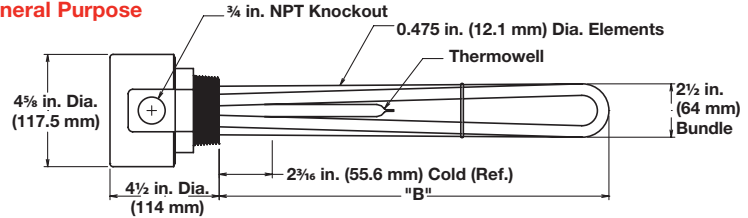

Moisture/Explosion-Resistant

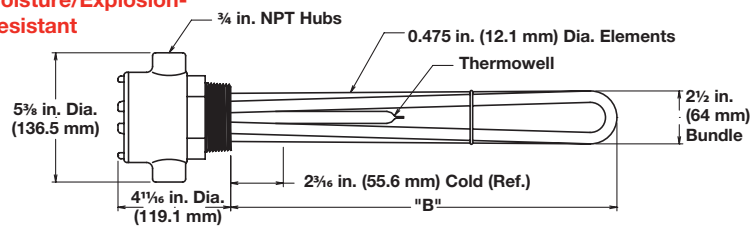

Description	Volts	kW	Ph	"B" Dim. in. (mm)	Part Number	Del.	Ship Wt. lbs (kg)	Part Number ⑦	Del.	Ship Wt. lbs (kg)	
60 W/in² 304 SS Plug 3-Alloy 800 Elements (9.3 W/cm²)	General Purpose Enclosure					Moisture/Explosion-Resistant Enclosure					
	120	3.0	1	7 ⁵ / ₈ (193.7)	BLN77L1S	RS	6 (3)	BLN77L1C	RS	9 (4)	
	240	3.0	3	7 ⁵ / ₈ (193.7)	BLN77L3S	RS	6 (3)	BLN77L3C	RS	9 (4)	
	480	3.0	3	7 ⁵ / ₈ (193.7)	BLN77L13S	RS	6 (3)	BLN77L13C	RS	9 (4)	
	120	4.5	1	10 ⁵ / ₈ (269.9)	BLN710L1S	RS	7 (4)	BLN710L1C	RS	10 (5)	
	240	4.5	3	10 ⁵ / ₈ (269.9)	BLN710L3S	RS	7 (4)	BLN710L3C	RS	10 (5)	
	480	4.5	3	10 ⁵ / ₈ (269.9)	BLN610K13S	RS	7 (4)	BLN610K13C	RS	10 (5)	
	240	6.0	3	14 ⁵ / ₈ (371.5)	BLN714L3S	RS	9 (4)	BLN714L3C	RS	12 (6)	
	480	6.0	3	14 ⁵ / ₈ (371.5)	BLN714L5S	RS	9 (4)	BLN714L5C	RS	12 (6)	
	240	7.5	3	17 ⁵ / ₈ (447.7)	BLN717L3S	RS	9 (4)	BLN717L3C	RS	12 (6)	
	480	7.5	3	17 ⁵ / ₈ (447.7)	BLN717L5S	RS	9 (4)	BLN717L5C	RS	12 (6)	
	240	9.0	3	20 ⁵ / ₈ (523.9)	BLN720L3S	RS	11 (5)	BLN720L3C	RS	14 (7)	
	480	9.0	3	20 ⁵ / ₈ (523.9)	BLN720L5S	RS	11 (5)	BLN720L5C	RS	14 (7)	
	240	12.0	3	26 ¹ / ₈ (663.6)	BLN726C3S	RS	12 (6)	BLN726C3C	RS	15 (7)	
	480	12.0	3	26 ¹ / ₈ (663.6)	BLN726C5S	RS	12 (6)	BLN726C5C	RS	15 (7)	
	240	15.0	3	31 ⁵ / ₈ (803.3)	BLN731L3S	RS	14 (7)	BLN731L3C	RS	17 (8)	
	480	15.0	3	31 ⁵ / ₈ (803.3)	BLN731L5S	RS	14 (7)	BLN731L5C	RS	17 (8)	
	240	18.0	3	37 ¹ / ₈ (943.0)	BLN737C3S	RS	15 (7)	BLN737C3C	RS	18 (9)	
480	18.0	3	37 ¹ / ₈ (943.0)	BLN737C5S	RS	15 (7)	BLN737C5C	RS	18 (9)		

RAPID SHIP

- RS - Next day shipment up to 5 pieces

Note: All screw plug bundles are designed to fit the inside diameter of the equivalent mating coupling. They will not fit into the equivalent pipe inside diameter.

⑦ CSA certified only

Immersion Heaters

WATROD and FIREBAR Screw Plug Immersion Heaters



Application: Clean Water

- 2 1/2 inch NPT screw plug
- FIREBAR elements
- Without thermostat
- General purpose or moisture/explosion-resistant enclosure

General Purpose

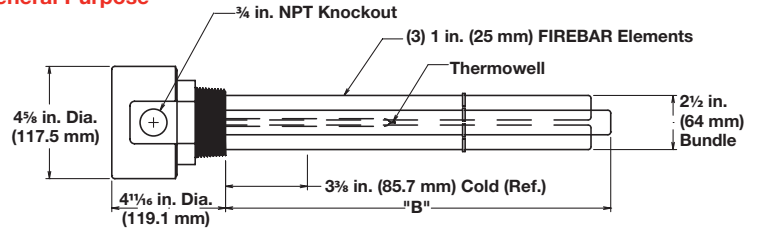

Moisture/Explosion-Resistant

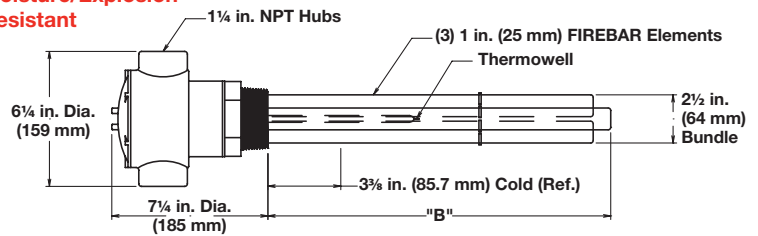

Description	Volts	kW	Ph	"B" Dim. in. (mm)	Part Number	Del.	Ship Wt.		Part Number ⑦	Del.	Ship Wt.		
							lbs	(kg)			lbs	(kg)	
						General Purpose Enclosure				Moisture/Explosion-Resistant Enclosure			
90 W/in² ⑧ 304 SS Plug 3-Alloy 800 Elements (14 W/cm²)	240	15.0	3	15 1/8 (384.2)	BLNF15C3S	RS	11	(5)	BLNF15C3C	RS	14	(7)	
	480	15.0	3	15 1/8 (384.2)	BLNF15C5S	RS	11	(5)	BLNF15C5C	RS	14	(7)	
	240	20.0	3	18 1/8 (460.4)	BLNF18C3S	RS	12	(6)	BLNF18C3C	RS	15	(7)	
	480	20.0	3	18 1/8 (460.4)	BLNF18C5S ③	RS	12	(6)	BLNF18C5C ③	RS	15	(7)	
	480	25.0	3	23 1/8 (587.4)	BLNF23C5S	RS	14	(7)	BLNF23C5C	RS	17	(8)	
	480	32.0	3	28 5/8 (727.1)	BLNF28L5S	RS	17	(8)	BLNF28L5C	RS	20	(9)	
	480	38.0	3	33 5/8 (854.1)	BLNF33L5S	RS	18	(9)	BLNF33L5C	RS	21	(10)	

RAPID SHIP

- RS - Next day shipment up to 5 pieces

Note: All screw plug bundles are designed to fit the inside diameter of the equivalent mating coupling. They will not fit into the equivalent pipe inside diameter.

- ③ Wired for 3-phase operation only
- ⑦ CSA certified only
- ⑧ Can be wired for 1-phase operation

Immersion Heaters

WATROD and FIREBAR Screw Plug Immersion Heaters



Application: Deionized/ Demineralized Water

- 2 1/2 inch NPT screw plug
- WATROD elements
- With thermostat (DPST)

Note: Higher amperage products require a pilot duty thermostat with separate power controller. Please see following pages for available heaters without thermostats.

- General purpose enclosure

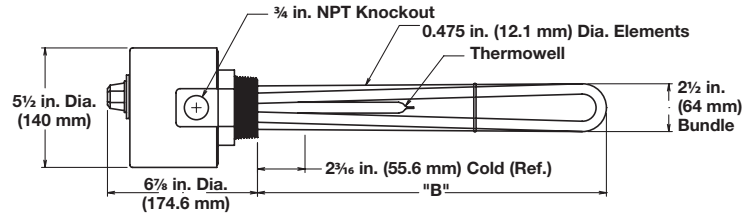

Description	Volts	kW	Ph	"B" Dim. in. (mm)	Ship Wt. lbs (kg)	Type 4 (30 to 110°F)		Type 5A (60 to 250°F)		Type 7A (100 to 550°F)	
						Part Number	Del.	Part Number	Del.	Part Number	Del.
General Purpose Enclosure											
60 W/in² 316 SS Plug 3-316 SS Elements (9.3 W/cm²) (Passivated)	240	3.0	3	7 ⁵ / ₈ (193.7)	7 (4)	BLR77L3S4	RS	BLR77L3S5A	RS	BLR77L3S7A	RS
	480	3.0	3	7 ⁵ / ₈ (193.7)	7 (4)	BLR77L5S4	RS	BLR77L5S5A	RS	BLR77L5S7A	RS
	240	4.5	3	10 ⁵ / ₈ (269.9)	8 (4)	BLR710L3S4	RS	BLR710L3S5A	RS	BLR710L3S7A	RS
	480	4.5	3	10 ⁵ / ₈ (269.9)	8 (4)	BLR710L5S4	RS	BLR710L5S5A	RS	BLR710L5S7A	RS
	240	6.0	3	14 ⁵ / ₈ (371.5)	10 (5)	BLR714L3S4	RS	BLR714L3S5A	RS	BLR714L3S7A	RS
	480	6.0	3	14 ⁵ / ₈ (371.5)	10 (5)	BLR714L5S4	RS	BLR714L5S5A	RS	BLR714L5S7A	RS
	240	7.5	3	17 ⁵ / ₈ (447.7)	10 (5)	BLR717L3S4	RS	BLR717L3S5A	RS	BLR717L3S7A	RS
	240	9.0	3	20 ⁵ / ₈ (523.9)	12 (6)	BLR720L3S4	RS	BLR720L3S5A	RS	BLR720L3S7A	RS

RAPID SHIP

- **RS** - Next day shipment up to 5 pieces

Note: All screw plug bundles are designed to fit the inside diameter of the equivalent mating coupling. They will not fit into the equivalent pipe inside diameter.

Immersion Heaters

WATROD and FIREBAR Screw Plug Immersion Heaters



Application: Deionized/ Demineralized Water

- 2 1/2 inch NPT screw plug
- WATROD elements
- With thermostat (DPST)

Note: Higher amperage products require a pilot duty thermostat with separate power controller. Please see following pages for available heaters without thermostats.

- Moisture/explosion-resistant enclosure

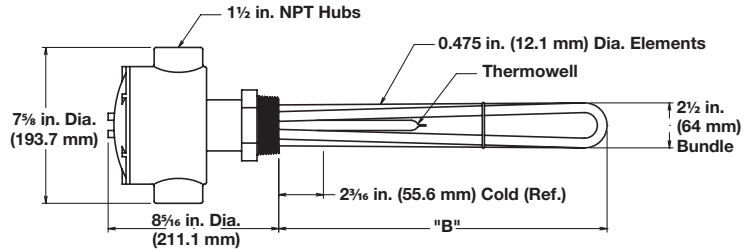

Description	Volts	kW	Ph	"B" Dim. in. (mm)	Ship Wt. lbs (kg)	Type 4 (30 to 110°F)		Type 5A (60 to 250°F)		Type 7A (100 to 550°F)	
						Part Number	Del.	Part Number	Del.	Part Number	Del.
Moisture/Explosion-Resistant Enclosure											
60 W/in² 316 SS Plug 3-316 SS Elements (9.3 W/cm²) (Passivated)	240	3.0	3	7 ⁵ / ₈ (193.7)	10 (5)	BLR77L3C4	RS	BLR77L3C5A	RS	BLR77L3C7A	RS
	480	3.0	3	7 ⁵ / ₈ (193.7)	10 (5)	BLR77L5C4	RS	BLR77L5C5A	RS	BLR77L5C7A	RS
	240	4.5	3	10 ⁵ / ₈ (269.9)	11 (5)	BLR710L3C4	RS	BLR710L3C5A	RS	BLR710L3C7A	RS
	480	4.5	3	10 ⁵ / ₈ (269.9)	11 (5)	BLR710L5C4	RS	BLR710L5C5A	RS	BLR710L5C7A	RS
	240	6.0	3	14 ⁵ / ₈ (371.5)	13 (6)	BLR714L3C4	RS	BLR714L3C5A	RS	BLR714L3C7A	RS
	480	6.0	3	14 ⁵ / ₈ (371.5)	13 (6)	BLR714L5C4	RS	BLR714L5C5A	RS	BLR714L5C7A	RS
	240	7.5	3	17 ⁵ / ₈ (447.7)	13 (6)	BLR717L3C4	RS	BLR717L3C5A	RS	BLR717L3C7A	RS
	240	9.0	3	20 ⁵ / ₈ (523.9)	15 (7)	BLR720L3C4	RS	BLR720L3C5A	RS	BLR720L3C7A	RS

RAPID SHIP

- **RS** - Next day shipment up to 5 pieces

Note: All screw plug bundles are designed to fit the inside diameter of the equivalent mating coupling. They will not fit into the equivalent pipe inside diameter.

Immersion Heaters

WATROD and FIREBAR Screw Plug Immersion Heaters



Application: Deionized/ Demineralized Water

- 2 1/2 inch NPT screw plug
- WATROD elements
- Without thermostat
- General purpose or moisture/explosion-resistant enclosure

General Purpose

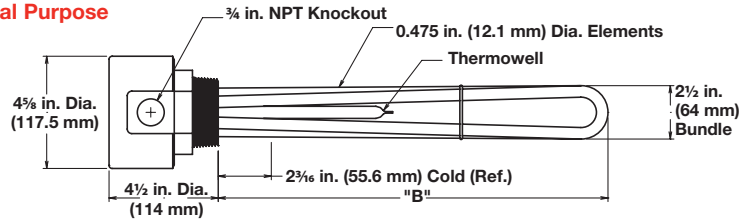

Moisture/Explosion-Resistant

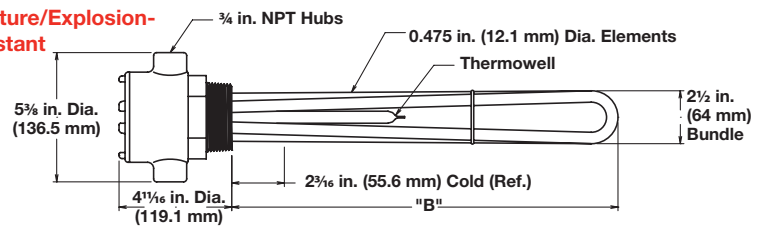

Description	Volts	kW	Ph	"B" Dim. in. (mm)	Part Number	Del.	Ship Wt. lbs (kg)	Part Number ⑦	Del.	Ship Wt. lbs (kg)
					General Purpose Enclosure			Moisture/Explosion-Resistant Enclosure		
60 W/in ² 316 SS Plug 3-316 SS Elements (9.3 W/cm ²) (Passivated)	120	3.0	1	7 ⁵ / ₈ (193.7)	BLR77L1S	RS	6 (3)	BLR77L1C	RS	9 (4)
	240	3.0	3	7 ⁵ / ₈ (193.7)	BLR77L3S	RS	6 (3)	BLR77L3C	RS	9 (4)
	480	3.0	3	7 ⁵ / ₈ (193.7)	BLR77L5S	RS	6 (3)	BLR77L5C	RS	9 (4)
	120	4.5	1	10 ⁵ / ₈ (269.9)	BLR710L1S	RS	7 (4)	BLR710L1C	RS	10 (5)
	240	4.5	3	10 ⁵ / ₈ (269.9)	BLR710L3S	RS	7 (4)	BLR710L3C	RS	10 (5)
	480	4.5	3	10 ⁵ / ₈ (269.9)	BLR710L5S	RS	7 (4)	BLR710L5C	RS	10 (5)
	240	6.0	3	14 ⁵ / ₈ (371.5)	BLR714L3S	RS	9 (4)	BLR714L3C	RS	12 (6)
	480	6.0	3	14 ⁵ / ₈ (371.5)	BLR714L5S	RS	9 (4)	BLR714L5C	RS	12 (6)
	240	7.5	3	17 ⁵ / ₈ (447.7)	BLR717L3S	RS	9 (4)	BLR717L3C	RS	12 (6)
	480	7.5	3	17 ⁵ / ₈ (447.7)	BLR717L5S	RS	9 (4)	BLR717L5C	RS	12 (6)
	240	9.0	3	20 ⁵ / ₈ (523.9)	BLR720L3S	RS	11 (5)	BLR720L3C	RS	14 (7)
	480	9.0	3	20 ⁵ / ₈ (523.9)	BLR720L5S	RS	11 (5)	BLR720L5C	RS	14 (7)
	240	12.0	3	26 ¹ / ₈ (663.6)	BLR726C3S	RS	12 (6)	BLR726C3C	RS	15 (7)
	480	12.0	3	26 ¹ / ₈ (663.6)	BLR726C5S	RS	12 (6)	BLR726C5C	RS	15 (7)
	240	15.0	3	31 ⁵ / ₈ (803.3)	BLR731L3S	RS	14 (7)	BLR731L3C	RS	17 (8)
	480	15.0	3	31 ⁵ / ₈ (803.3)	BLR731L5S	RS	14 (7)	BLR731L5C	RS	17 (8)
240	18.0	3	37 ¹ / ₈ (943.0)	BLR737C3S	RS	15 (7)	BLR737C3C	RS	18 (9)	
480	18.0	3	37 ¹ / ₈ (943.0)	BLR737C5S	RS	15 (7)	BLR737C5C	RS	18 (9)	

RAPID SHIP

- RS - Next day shipment up to 5 pieces

Note: All screw plug bundles are designed to fit the inside diameter of the equivalent mating coupling. They will not fit into the equivalent pipe inside diameter.

⑦ CSA certified only

Immersion Heaters

WATROD and FIREBAR Screw Plug Immersion Heaters



Application: Process Water

- 1 1/4 inch NPT screw plug
- FIREBAR elements
- With thermostat (DPST)

Note: Higher amperage products require a pilot duty thermostat with separate power controller. Please see following pages for available heaters without thermostats.

- General purpose or moisture/explosion-resistant enclosure

General Purpose

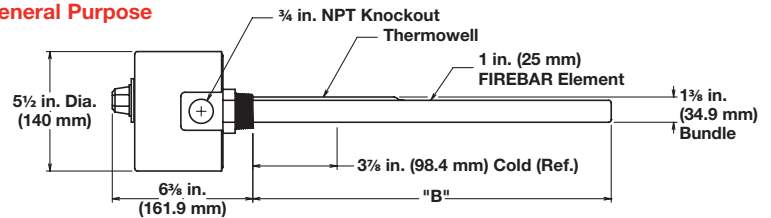

Moisture/Explosion-Resistant

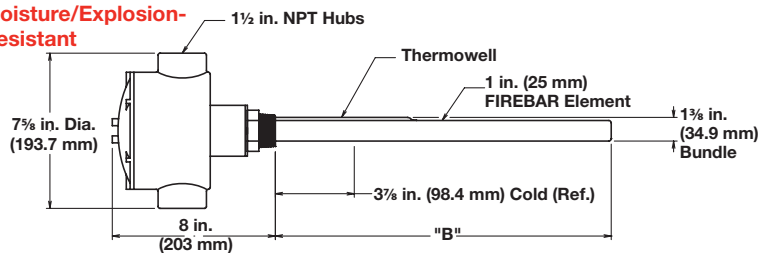

Description	Volts	kW	Ph	"B" Dim. in. (mm)	Ship Wt. lbs (kg)	Type 5A (60 to 250°F)		Type 7A (100 to 550°F)		
						Part Number	Del.	Part Number	Del.	
General Purpose Enclosure										
45 W/in ² ® 304 SS Plug 1-Alloy 800 Element (7 W/cm ²)	240	2.0	3	13 (330)	7 (4)	BDNF13A27S5A	RS	BDNF13A27S7A	RS	
	240	2.5	3	15 1/2 (394)	8 (4)	BDNF15J27S5A	RS	BDNF15J27S7A	RS	
	240	3.0	3	18 (457)	9 (4)	BDNF18A27S5A	RS	BDNF18A27S7A	RS	
	240	4.0	3	22 1/2 (572)	10 (5)	BDNF22J27S5A	RS	BDNF22J27S7A	RS	
	480	4.0	3	22 1/2 (572)	10 (5)	BDNF22J28S5A	RS	BDNF22J28S7A	RS	
	240	5.0	3	27 1/2 (699)	11 (5)	BDNF27J27S5A	RS	BDNF27J27S7A	RS	
	480	5.0	3	27 1/2 (699)	11 (5)	BDNF27J28S5A	RS	BDNF27J28S7A	RS	
	240	6.0	3	32 1/2 (826)	12 (6)	BDNF32J27S5A	RS	BDNF32J27S7A	RS	
	480	6.0	3	32 1/2 (826)	12 (6)	BDNF32J28S5A	RS	BDNF32J28S7A	RS	
	240	8.0	3	42 (1067)	14 (7)	BDNF42A27S5A	RS	BDNF42A27S7A	RS	
	240	10.0	3	51 1/2 (1308)	16 (8)	BDNF51J27S5A	RS	BDNF51J27S7A	RS	
	Moisture/Explosion-Resistant Enclosure ⑦									
45 W/in ² ® 304 SS Plug 1-Alloy 800 Element (7 W/cm ²)	240	2.0	3	13 (330)	10 (5)	BDNF13A27C5A	RS	BDNF13A27C7A	RS	
	240	2.5	3	15 1/2 (394)	11 (5)	BDNF15J27C5A	RS	BDNF15J27C7A	RS	
	240	3.0	3	18 (457)	12 (6)	BDNF18A27C5A	RS	BDNF18A27C7A	RS	
	240	4.0	3	22 1/2 (572)	13 (6)	BDNF22J27C5A	RS	BDNF22J27C7A	RS	
	480	4.0	3	22 1/2 (572)	13 (6)	BDNF22J28C5A	RS	BDNF22J28C7A	RS	
	240	5.0	3	27 1/2 (699)	14 (7)	BDNF27J27C5A	RS	BDNF27J27C7A	RS	
	480	5.0	3	27 1/2 (699)	14 (7)	BDNF27J28C5A	RS	BDNF27J28C7A	RS	
	240	6.0	3	32 1/2 (826)	15 (7)	BDNF32J27C5A	RS	BDNF32J27C7A	RS	
	480	6.0	3	32 1/2 (826)	15 (7)	BDNF32J28C5A	RS	BDNF32J28C7A	RS	
	240	8.0	3	42 (1067)	17 (8)	BDNF42A27C5A	RS	BDNF42A27C7A	RS	
	240	10.0	3	51 1/2 (1308)	19 (9)	BDNF51J27C5A	RS	BDNF51J27C7A	RS	

RAPID SHIP

- RS - Next day shipment up to 5 pieces

Note: All screw plug bundles are designed to fit the inside diameter of the equivalent mating coupling. They will not fit into the equivalent pipe inside diameter.

⑦ CSA certified only

⑧ Can be wired for 1-phase operation

Immersion Heaters

WATROD and FIREBAR Screw Plug Immersion Heaters



Application: Process Water

- 1 1/4 inch NPT screw plug
- FIREBAR elements
- Without thermostat
- General purpose or moisture/explosion-resistant enclosures

General Purpose

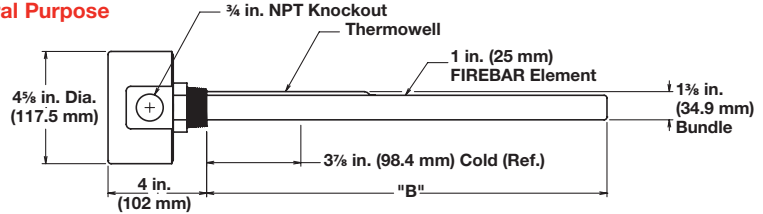

Moisture/Explosion-Resistant

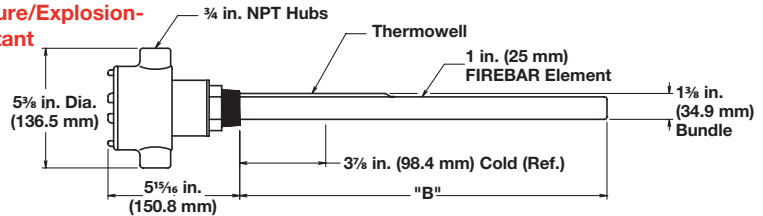

Description	Volts	kW	Ph	"B" Dim. in. (mm)	Part Number	Del.	Ship Wt. lbs (kg)	Part Number ⑦	Del.	Ship Wt. lbs (kg)	
					General Purpose Enclosure			Moisture/Explosion-Resistant Enclosure			
45 W/in ² ⑧ 304 SS Plug 1-Alloy 800 Element (7 W/cm ²)	240	2.0	3	13 (330)	BDNF13A27S	RS	6 (3)	BDNF13A27C	RS	9 (4)	
	240	2.5	3	15 1/2 (394)	BDNF15J27S	RS	7 (4)	BDNF15J27C	RS	10 (5)	
	240	3.0	3	18 (457)	BDNF18A27S	RS	8 (4)	BDNF18A27C	RS	11 (5)	
	240	4.0	3	22 1/2 (572)	BDNF22J27S	RS	9 (4)	BDNF22J27C	RS	12 (6)	
	480	4.0	3	22 1/2 (572)	BDNF22J28S	RS	9 (4)	BDNF22J28C	RS	12 (6)	
	240	5.0	3	27 1/2 (699)	BDNF27J27S	RS	10 (5)	BDNF27J27C	RS	13 (6)	
	480	5.0	3	27 1/2 (699)	BDNF27J28S	RS	10 (5)	BDNF27J28C	RS	13 (6)	
	240	6.0	3	32 1/2 (826)	BDNF32J27S	RS	11 (5)	BDNF32J27C	RS	14 (7)	
	480	6.0	3	32 1/2 (826)	BDNF32J28S	RS	11 (5)	BDNF32J28C	RS	14 (7)	
	240	8.0	3	42 (1067)	BDNF42A27S	RS	13 (6)	BDNF42A27C	RS	16 (8)	
	480	8.0	3	42 (1067)	BDNF42A28S	RS	13 (6)	BDNF42A28C	RS	16 (8)	
	240	10.0	3	51 1/2 (1308)	BDNF51J27S	RS	15 (7)	BDNF51J27C	RS	18 (9)	
	480	10.0	3	51 1/2 (1308)	BDNF51J28S	RS	15 (7)	BDNF51J28C	RS	18 (9)	

RAPID SHIP

- RS - Next day shipment up to 5 pieces

Note: All screw plug bundles are designed to fit the inside diameter of the equivalent mating coupling. They will not fit into the equivalent pipe inside diameter.

⑦ CSA certified only

⑧ Can be wired for 1-phase operation

Immersion Heaters

WATROD and FIREBAR Screw Plug Immersion Heaters



Application: Process Water

- 2 inch NPT screw plug
- WATROD elements
- With thermostat (DPST)

Note: Higher amperage products require a pilot duty thermostat with separate power controller. Please see following pages for available heaters without thermostats.

- General purpose enclosure

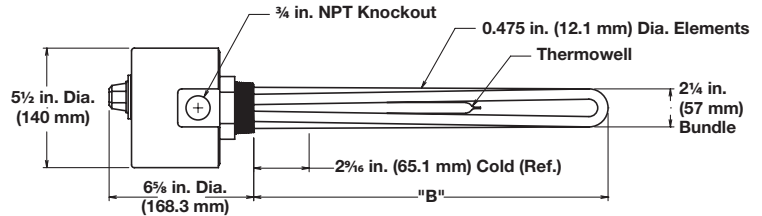

Description	Volts	kW	Ph	"B" Dim. in. (mm)	Ship Wt. lbs (kg)	Type 4 (30 to 110°F)		Type 5A (60 to 250°F)		Type 7A (100 to 550°F)	
						Part Number	Del.	Part Number	Del.	Part Number	Del.
General Purpose Enclosure											
48 W/in² ④ 304 SS Plug 2-Alloy 800 Elements (7.5 W/cm²)	120/240	2.0	1	9 ³ / ₄ (248)	5 (3)	BGN79N6S4	RS	BGN79N6S5A	RS	BGN79N6S7	RS
	240/480	2.0	1	9 ³ / ₄ (248)	5 (3)	BGN79N7S4	RS	BGN79N7S5A	RS	BGN79N7S7A	RS
	120/240	3.0	1	13 ¹ / ₄ (337)	6 (3)	BGN713E6S4	RS	BGN713E6S5A	RS	BGN713E6S7A	RS
	240/480	3.0	1	13 ¹ / ₄ (337)	6 (3)	BGN713E7S4	RS	BGN713E7S5A	RS	BGN713E7S7A	RS
	120/240	4.0	1	17 ³ / ₄ (451)	7 (4)	BGN717N6S4	RS	BGN717N6S5A	RS	BGN717N6S7A	RS
	120/240	5.0	1	20 ¹ / ₄ (514)	8 (4)	BGN720E6S4	RS	BGN720E6S5A	RS	BGN720E6S7A	RS
48 W/in² 304 SS Plug 3-Alloy 800 Elements (7.5 W/cm²)	240	3.0	3	9 ³ / ₄ (248)	6 (3)	BHN79N3S4	RS	BHN79N3S5A	RS	BHN79N3S7A	RS
	480	3.0	3	9 ³ / ₄ (248)	6 (3)	BHN79N5S4	RS	BHN79N5S5A	RS	BHN79N5S7A	RS
	240	4.5	3	13 ¹ / ₄ (337)	7 (4)	BHN713E3S4	RS	BHN713E3S5A	RS	BHN713E3S7A	RS
	480	4.5	3	13 ¹ / ₄ (337)	7 (4)	BHN713E5S4	RS	BHN713E5S5A	RS	BHN713E5S7A	RS
	240	6.0	3	17 ³ / ₄ (451)	8 (4)	BHN717N3S4	RS	BHN717N3S5A	RS	BHN717N3S7A	RS
	480	6.0	3	17 ³ / ₄ (451)	8 (4)	BHN717N5S4	RS	BHN717N5S5A	RS	BHN717N5S7A	RS
	240	7.5	3	20 ¹ / ₄ (514)	9 (4)	BHN720E3S4	RS	BHN720E3S5A	RS	BHN720E3S7A	RS
	240	9.0	3	25 ¹ / ₄ (641)	10 (5)	BHN725E3S4	RS	BHN725E3S5A	RS	BHN725E3S7A	RS

RAPID SHIP

- RS - Next day shipment up to 5 pieces

Note: All screw plug bundles are designed to fit the inside diameter of the equivalent mating coupling. They will not fit into the equivalent pipe inside diameter.

- ④ Wired for higher voltage

Immersion Heaters

WATROD and FIREBAR Screw Plug Immersion Heaters



Application: Process Water

- 2 inch NPT screw plug
- WATROD elements
- With thermostat (DPST)

Note: Higher amperage products require a pilot duty thermostat with separate power controller. Please see following pages for available heaters without thermostats.

- Moisture/explosion-resistant enclosure

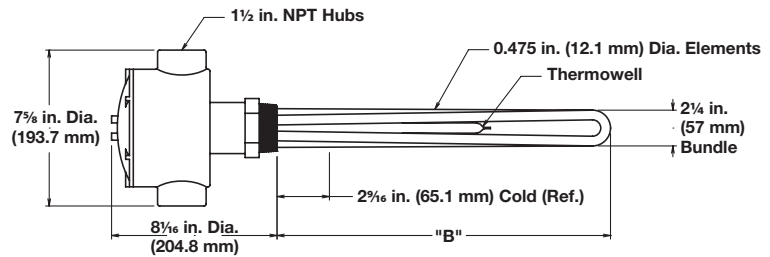

Description	Volts	kW	Ph	"B" Dim. in. (mm)	Ship Wt. lbs (kg)	Type 4 (30 to 110°F)		Type 5A (60 to 250°F)		Type 7A (100 to 550°F)	
						Part Number	Del.	Part Number	Del.	Part Number	Del.
Moisture/Explosion-Resistant Enclosure											
48 W/in² ④ 304 SS Plug 2-Alloy 800 Elements (7.5 W/cm²)	120/240	2.0	1	9 ³ / ₄ (248)	8 (4)	BGN79N6C4	RS	BGN79N6C5A	RS	BGN79N6C7A	RS
	240/480	2.0	1	9 ³ / ₄ (248)	8 (4)	BGN79N7C4	RS	BGN79N7C5A	RS	BGN79N7C7A	RS
	120/240	3.0	1	13 ¹ / ₄ (337)	9 (4)	BGN713E6C4	RS	BGN713E6C5A	RS	BGN713E6C7A	RS
	240/480	3.0	1	13 ¹ / ₄ (337)	9 (4)	BGN713E7C4	RS	BGN713E7C5A	RS	BGN713E7C7A	RS
	120/240	4.0	1	17 ³ / ₄ (451)	10 (5)	BGN717N6C4	RS	BGN717N6C5A	RS	BGN717N6C7A	RS
	120/240	5.0	1	20 ¹ / ₄ (514)	11 (5)	BGN720E6C4	RS	BGN720E6C5A	RS	BGN720E6C7A	RS
48 W/in² 304 SS Plug 3-Alloy 800 Elements (7.5 W/cm²)	240	3.0	3	9 ³ / ₄ (248)	9 (4)	BHN79N3C4	RS	BHN79N3C5A	RS	BHN79N3C7A	RS
	480	3.0	3	9 ³ / ₄ (248)	9 (4)	BHN79N5C4	RS	BHN79N5C5A	RS	BHN79N5C7A	RS
	240	4.5	3	13 ¹ / ₄ (337)	10 (5)	BHN713E3C4	RS	BHN713E3C5A	RS	BHN713E3C7A	RS
	480	4.5	3	13 ¹ / ₄ (337)	10 (5)	BHN713E5C4	RS	BHN713E5C5A	RS	BHN713E5C7A	RS
	240	6.0	3	17 ³ / ₄ (451)	11 (5)	BHN717N3C4	RS	BHN717N3C5A	RS	BHN717N3C7A	RS
	480	6.0	3	17 ³ / ₄ (451)	11 (5)	BHN717N5C4	RS	BHN717N5C5A	RS	BHN717N5C7A	RS
	240	7.5	3	20 ¹ / ₄ (514)	12 (6)	BHN720E3C4	RS	BHN720E3C5A	RS	BHN720E3C7A	RS
	240	9.0	3	25 ¹ / ₄ (641)	13 (6)	BHN725E3C4	RS	BHN725E3C5A	RS	BHN725E3C7A	RS

RAPID SHIP

- RS - Next day shipment up to 5 pieces

Note: All screw plug bundles are designed to fit the inside diameter of the equivalent mating coupling. They will not fit into the equivalent pipe inside diameter.

④ Wired for higher voltage

Immersion Heaters

WATROD and FIREBAR Screw Plug Immersion Heaters

Application: Process Water

- 2 inch NPT screw plug
- WATROD elements
- Without thermostat
- General purpose or moisture/explosion-resistant enclosure



General Purpose

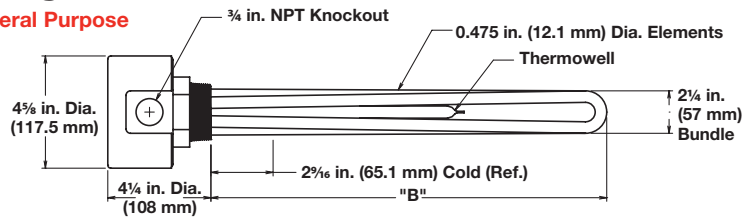

Moisture/Explosion-Resistant

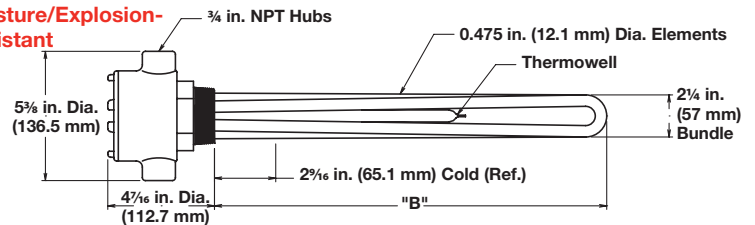

Description	Volts	kW	Ph	"B" Dim. in. (mm)	General Purpose Enclosure		Moisture/Explosion-Resistant Enclosure			
					Part Number	Del.	Ship Wt. lbs (kg)	Part Number ⑦	Del.	Ship Wt. lbs (kg)
48 W/in ² ④ 304 SS Plug 2-Alloy 800 Elements (7.5 W/cm ²)	120/240	2.0	1	9 ³ / ₄ (248)	BGN79N6S	RS	4 (2)	BGN79N6C	RS	7 (4)
	240/480	2.0	1	9 ³ / ₄ (248)	BGN79N7S	RS	4 (2)	BGN79N7C	RS	7 (4)
	120/240	3.0	1	13 ¹ / ₄ (337)	BGN713E6S	RS	5 (3)	BGN713E6C	RS	8 (4)
	240/480	3.0	1	13 ¹ / ₄ (337)	BGN713E7S	RS	5 (3)	BGN713E7C	RS	8 (4)
	120/240	4.0	1	17 ³ / ₄ (451)	BGN717N6S	RS	6 (3)	BGN717N6C	RS	9 (4)
	240/480	4.0	1	17 ³ / ₄ (451)	BGN717N7S	RS	6 (3)	BGN717N7C	RS	9 (4)
	120/240	5.0	1	20 ¹ / ₄ (514)	BGN720E6S	RS	7 (4)	BGN720E6C	RS	10 (5)
	240/480	5.0	1	20 ¹ / ₄ (514)	BGN720E7S	RS	7 (4)	BGN720E7C	RS	10 (5)
	240/480	6.0	1	25 ¹ / ₄ (641)	BGN725E7S	RS	7 (4)	BGN725E7C	RS	10 (5)
	240/480	8.0	1	32 ³ / ₄ (832)	BGN732N7S	RS	8 (4)	BGN732N7C	RS	11 (5)
240/480	10.0	1	40 ¹ / ₄ (1022)	BGN740E7S	RS	9 (4)	BGN740E7C	RS	12 (6)	
48 W/in ² 304 SS Plug 3-Alloy 800 Element (7.5 W/cm ²)	120	3.0	1	9 ³ / ₄ (248)	BHN79N1S	RS	5 (3)	BHN79N1C	RS	8 (4)
	240	3.0	3	9 ³ / ₄ (248)	BHN79N3S	RS	5 (3)	BHN79N3C	RS	8 (4)
	480	3.0	3	9 ³ / ₄ (248)	BHN79N5S	RS	5 (3)	BHN79N5C	RS	8 (4)
	120	4.5	1	13 ¹ / ₄ (337)	BHN713E1S	RS	6 (3)	BHN713E1C	RS	9 (4)
	240	4.5	3	13 ¹ / ₄ (337)	BHN713E3S	RS	6 (3)	BHN713E3C	RS	9 (4)
	480	4.5	3	13 ¹ / ₄ (337)	BHN713E5S	RS	6 (3)	BHN713E5C	RS	9 (4)
	240	6.0	3	17 ³ / ₄ (451)	BHN717N3S	RS	7 (4)	BHN717N3C	RS	10 (5)
	480	6.0	3	17 ³ / ₄ (451)	BHN717N5S	RS	7 (4)	BHN717N5C	RS	10 (5)
	240	7.5	3	20 ¹ / ₄ (514)	BHN720E3S	RS	8 (4)	BHN720E3C	RS	11 (5)
	480	7.5	3	20 ¹ / ₄ (514)	BHN720E5S	RS	8 (4)	BHN720E5C	RS	11 (5)
	240	9.0	3	25 ¹ / ₄ (641)	BHN725E3S	RS	9 (4)	BHN725E3C	RS	12 (6)
	480	9.0	3	25 ¹ / ₄ (641)	BHN725E5S	RS	9 (4)	BHN725E5C	RS	12 (6)
	240	12.0	3	32 ³ / ₄ (832)	BHN732N3S	RS	9 (4)	BHN732N3C	RS	12 (6)
	480	12.0	3	32 ³ / ₄ (832)	BHN732N5S	RS	9 (4)	BHN732N5C	RS	12 (6)
	240	15.0	3	40 ¹ / ₄ (1022)	BHN740E3S	RS	10 (5)	BHN740E3C	RS	13 (6)
	480	15.0	3	40 ¹ / ₄ (1022)	BHN740E5S	RS	10 (5)	BHN740E5C	RS	13 (6)
	240	18.0	3	47 ³ / ₄ (1213)	BHN747N3S	RS	11 (5)	BHN747N3C	RS	14 (7)
480	18.0	3	47 ³ / ₄ (1213)	BHN747N5S	RS	11 (5)	BHN747N5C	RS	14 (7)	

RAPID SHIP

- RS - Next day shipment up to 5 pieces

Note: All screw plug bundles are designed to fit the inside diameter of the equivalent mating bundles. They will not fit into the equivalent pipe inside diameter.

④ Wired for higher voltage

⑦ CSA certified only

Immersion Heaters

WATROD and FIREBAR Screw Plug Immersion Heaters



Application: Process Water

- 2 1/2 inch NPT screw plug
- WATROD elements
- With thermostat (DPST)

Note: Higher amperage products require a pilot duty thermostat with separate power controller. Please see following pages for available heaters without thermostats.

- General purpose or moisture/explosion-resistant enclosure

General Purpose

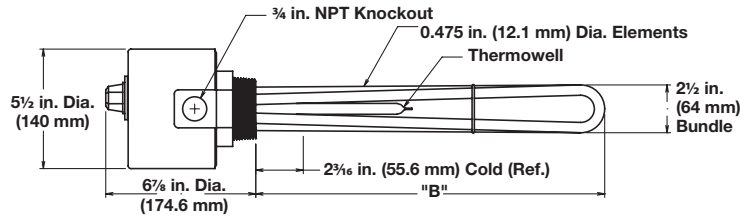

Moisture/Explosion-Resistant

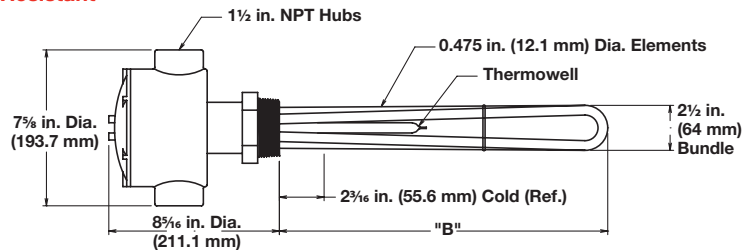

Description	Volts	kW	Ph	"B" Dim. in. (mm)	Ship Wt. lbs (kg)	Type 4 (30 to 110°F)		Type 5A (60 to 250°F)		Type 7A (100 to 550°F)	
						Part Number	Del.	Part Number	Del.	Part Number	Del.
General Purpose Enclosure											
48 W/in ² 304 SS Plug 3-Alloy 800 Elements (7.5 W/cm ²)	240	3.0	3	9 ³ / ₈ (238.1)	7 (4)	BLN79G3S4	RS	BLN79G3S5A	RS	BLN79G3S7A	RS
	480	3.0	3	9 ³ / ₈ (238.1)	7 (4)	BLN79G5S4	RS	BLN79G5S5A	RS	BLN79G5S7A	RS
	240	4.5	3	12 ⁷ / ₈ (327.0)	8 (4)	BLN712R3S4	RS	BLN712R3S5A	RS	BLN712R3S7A	RS
	480	4.5	3	12 ⁷ / ₈ (327.0)	8 (4)	BLN712R5S4	RS	BLN712R5S5A	RS	BLN712R5S7A	RS
	240	6.0	3	17 ³ / ₈ (441.3)	10 (5)	BLN717G3S4	RS	BLN717G3S5A	RS	BLN717G3S7A	RS
	480	6.0	3	17 ³ / ₈ (441.3)	10 (5)	BLN717G5S4	RS	BLN717G5S5A	RS	BLN717G5S7A	RS
	240	7.5	3	19 ⁷ / ₈ (504.8)	12 (6)	BLN719R3S4	RS	BLN719R3S5A	RS	BLN719R3S7A	RS
	240	9.0	3	24 ⁷ / ₈ (631.8)	13 (6)	BLN724R3S4	RS	BLN724R3S5A	RS	BLN724R3S7A	RS
Moisture/Explosion-Resistant Enclosure ⑦											
48 W/in ² 304 SS Plug 3-Alloy 800 Elements (7.5 W/cm ²)	240	3.0	3	9 ³ / ₈ (238.1)	10 (5)	BLN79G3C4	RS	BLN79G3C5A	RS	BLN79G3C7A	RS
	480	3.0	3	9 ³ / ₈ (238.1)	10 (5)	BLN79G5C4	RS	BLN79G5C5A	RS	BLN79G5C7A	RS
	240	4.5	3	12 ⁷ / ₈ (327.0)	11 (5)	BLN712R3C4	RS	BLN712R3C5A	RS	BLN712R3C7A	RS
	480	4.5	3	12 ⁷ / ₈ (327.0)	11 (5)	BLN712R5C4	RS	BLN712R5C5A	RS	BLN712R5C7A	RS
	240	6.0	3	17 ³ / ₈ (441.3)	13 (6)	BLN717G3C4	RS	BLN717G3C5A	RS	BLN717G3C7A	RS
	480	6.0	3	17 ³ / ₈ (441.3)	13 (6)	BLN717G5C4	RS	BLN717G5C5A	RS	BLN717G5C7A	RS
	240	7.5	3	19 ⁷ / ₈ (504.8)	15 (7)	BLN719R3C4	RS	BLN719R3C5A	RS	BLN719R3C7A	RS
	240	9.0	3	24 ⁷ / ₈ (631.8)	16 (8)	BLN724R3C4	RS	BLN724R3C5A	RS	BLN724R3C7A	RS

RAPID SHIP

- RS - Next day shipment up to 5 pieces

Note: All screw plug bundles are designed to fit the inside diameter of the equivalent mating coupling. They will not fit into the equivalent pipe inside diameter.

⑦ CSA certified only

Immersion Heaters

WATROD and FIREBAR Screw Plug Immersion Heaters



Application: Process Water

- 2 1/2 inch NPT screw plug
- WATROD elements
- Without thermostat
- General purpose or moisture/explosion-resistant enclosure

General Purpose

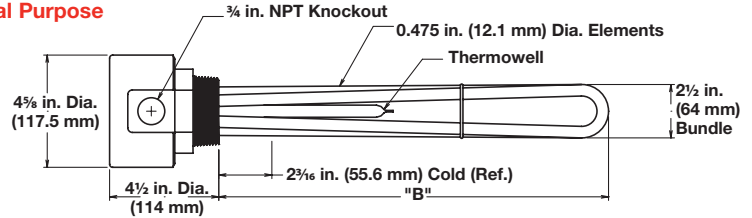

Moisture/Explosion-Resistant

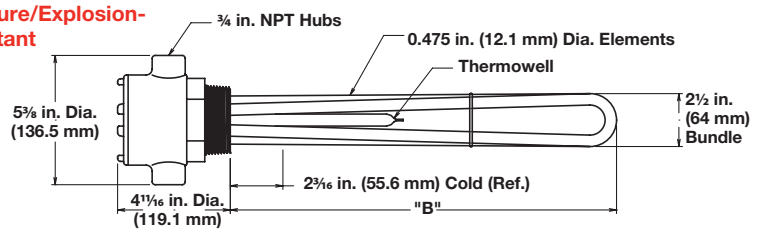

Description	Volts	kW	Ph	"B" Dim. in. (mm)	Part Number	Del.	Ship Wt. lbs (kg)	Part Number ⑦	Del.	Ship Wt. lbs (kg)	
48 W/in² 304 SS Plug 3-Alloy 800 Elements (7.5 W/cm²)						General Purpose Enclosure			Moisture/Explosion-Resistant Enclosure		
	120	3.0	1	9 ³ / ₈ (238.1)	BLN79G1S	RS	6 (3)	BLN79G1C	RS	9 (4)	
	240	3.0	3	9 ³ / ₈ (238.1)	BLN79G3S	RS	6 (3)	BLN79G3C	RS	9 (4)	
	480	3.0	3	9 ³ / ₈ (238.1)	BLN79G5S	RS	6 (3)	BLN79G5C	RS	9 (4)	
	120	4.5	1	12 ⁷ / ₈ (327.0)	BLN712R1S	RS	7 (4)	BLN712R1C	RS	10 (5)	
	240	4.5	3	12 ⁷ / ₈ (327.0)	BLN712R3S	RS	7 (4)	BLN712R3C	RS	10 (5)	
	480	4.5	3	12 ⁷ / ₈ (327.0)	BLN712R5S	RS	7 (4)	BLN712R5C	RS	10 (5)	
	240	6.0	3	17 ³ / ₈ (441.3)	BLN717G3S	RS	9 (4)	BLN717G3C	RS	12 (6)	
	480	6.0	3	17 ³ / ₈ (441.3)	BLN717G5S	RS	9 (4)	BLN717G5C	RS	12 (6)	
	240	7.5	3	19 ⁷ / ₈ (504.8)	BLN719R3S	RS	11 (5)	BLN719R3C	RS	14 (7)	
	480	7.5	3	19 ⁷ / ₈ (504.8)	BLN719R5S	RS	11 (5)	BLN719R5C	RS	14 (7)	
	240	9.0	3	24 ⁷ / ₈ (631.8)	BLN724R3S	RS	12 (6)	BLN724R3C	RS	15 (7)	
	480	9.0	3	24 ⁷ / ₈ (631.8)	BLN724R5S	RS	12 (6)	BLN724R5C	RS	15 (7)	
	240	12.0	3	32 ³ / ₈ (822.3)	BLN732G3S	RS	14 (7)	BLN732G3C	RS	17 (8)	
	480	12.0	3	32 ³ / ₈ (822.3)	BLN732G5S	RS	14 (7)	BLN732G5C	RS	17 (8)	
	240	15.0	3	39 ⁷ / ₈ (1012.8)	BLN739R3S	RS	15 (7)	BLN739R3C	RS	18 (9)	
480	15.0	3	39 ⁷ / ₈ (1012.8)	BLN739R5S	RS	15 (7)	BLN739R5C	RS	18 (9)		
240	18.0	3	47 ³ / ₈ (1203.3)	BLN747G3S	RS	17 (8)	BLN747G3C	RS	20 (9)		
480	18.0	3	47 ³ / ₈ (1203.3)	BLN747G5S	RS	17 (8)	BLN747G5C	RS	20 (9)		

RAPID SHIP

- RS - Next day shipment up to 5 pieces

Note: All screw plug bundles are designed to fit the inside diameter of the equivalent mating coupling. They will not fit into the equivalent pipe inside diameter.

⑦ CSA certified only

Immersion Heaters

WATROD and FIREBAR Screw Plug Immersion Heaters



Application: Process Water

- 2 1/2 inch NPT screw plug
- FIREBAR elements
- With thermostat (DPST)

Note: Higher amperage products require a pilot duty thermostat with separate power controller. Please see following pages for available heaters without thermostats.

- General purpose or moisture/explosion-resistant enclosure

General Purpose

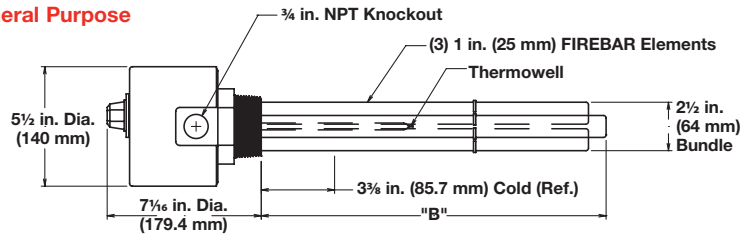

Moisture/Explosion-Resistant

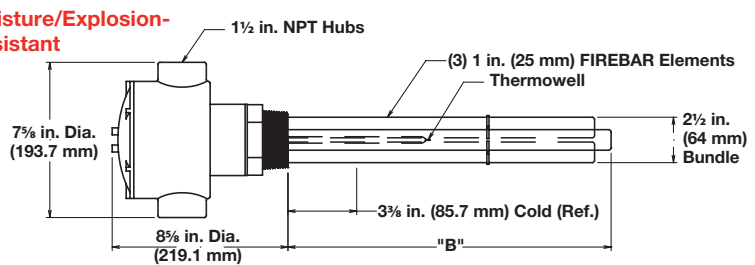

Description	Volts	kW	Ph	"B" Dim. in. (mm)		Ship Wt. lbs (kg)	Type 5A (60 to 250°F)		Type 7A (100 to 550°F)	
							Part Number	Del.	Part Number	Del.
General Purpose Enclosure										
45 W/in² ⑧ 304 SS Plug 3-Alloy 800 Elements (7 W/cm²)	240	6.0	3	12	(305)	12 (6)	BLNF12A27S5A	RS	BLNF12A27S7A	RS
	240	7.5	3	14 1/2	(368)	12 (6)	BLNF14J27S5A	RS	BLNF14J27S7A	RS
	240	9.0	3	17	(432)	13 (6)	BLNF17A27S5A	RS	BLNF17A27S7A	RS
	240	12.0	3	21 1/2	(546)	15 (7)	BLNF21J27S5A	RS	BLNF21J27S7A	RS
Moisture/Explosion-Resistant Enclosure ⑦										
45 W/in² ⑧ 304 SS Plug 3-Alloy 800 Elements (7 W/cm²)	240	6.0	3	12	(305)	14 (7)	BLNF12A27C5A	RS	BLNF12A27C7A	RS
	240	7.5	3	14 1/2	(368)	15 (7)	BLNF14J27C5A	RS	BLNF14J27C7A	RS
	240	9.0	3	17	(432)	16 (8)	BLNF17A27C5A	RS	BLNF17A27C7A	RS
	240	12.0	3	21 1/2	(546)	18 (9)	BLNF21J27C5A	RS	BLNF21J27C7A	RS

RAPID SHIP

- RS - Next day shipment up to 5 pieces

Note: All screw plug bundles are designed to fit the inside diameter of the equivalent mating coupling. They will not fit into the equivalent pipe inside diameter.

⑦ CSA certified only

⑧ Can be wired for 1-phase operation

Immersion Heaters

WATROD and FIREBAR Screw Plug Immersion Heaters



Application: Process Water

- 2 1/2 inch NPT screw plug
- FIREBAR elements
- Without thermostat
- General purpose or moisture/explosion-resistant enclosure

General Purpose

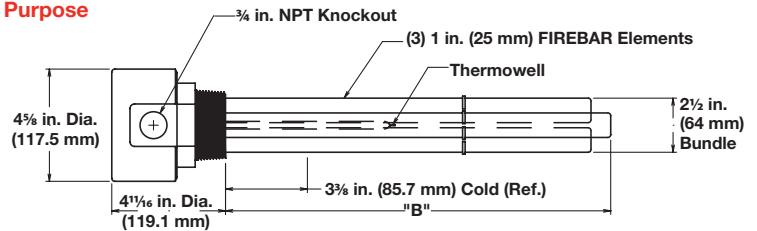

Moisture/Explosion-Resistant

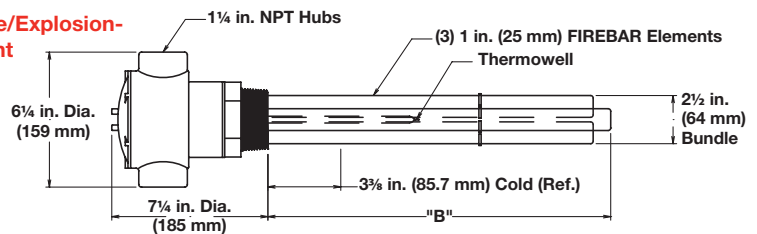

Description	Volts	kW	Ph	"B" Dim. in.	(mm)	Part Number	Del.	Ship Wt. lbs	(kg)	Part Number ⑦	Del.	Ship Wt. lbs	(kg)
						General Purpose Enclosure				Moisture/Explosion-Resistant Enclosure			
45 W/in² ⑧ 304 SS Plug 3-Alloy 800 Elements (7 W/cm²)	240	6.0	3	12	(305)	BLNF12A27S	RS	10	(5)	BLNF12A27C	RS	13	(6)
	240	7.5	3	14 1/2	(368)	BLNF14J27S	RS	11	(5)	BLNF14J27C	RS	14	(7)
	240	9.0	3	17	(432)	BLNF17A27S	RS	12	(6)	BLNF17A27C	RS	15	(7)
	240	12.0	3	21 1/2	(546)	BLNF21J27S	RS	14	(7)	BLNF21J27C	RS	17	(8)
	480	12.0	3	21 1/2	(546)	BLNF21J28S	RS	14	(7)	BLNF21J28C	RS	17	(8)
	240	15.0	3	26 1/2	(673)	BLNF26J27S	RS	17	(8)	BLNF26J27C	RS	20	(9)
	480	15.0	3	26 1/2	(673)	BLNF26J28S	RS	17	(8)	BLNF26J28C	RS	20	(9)
	240	18.0	3	31 1/2	(800)	BLNF31J27S	RS	18	(9)	BLNF31J27C	RS	21	(10)
	480	18.0	3	31 1/2	(800)	BLNF31J28S	RS	18	(9)	BLNF31J28C	RS	21	(10)
	480	24.0	3	41	(1041)	BLNF41A28S	RS	20	(9)	BLNF41A28C	RS	23	(11)
480	30.0	3	50 1/2	(1283)	BLNF50J28S	RS	22	(10)	BLNF50J28C	RS	25	(12)	

RAPID SHIP

- RS - Next day shipment up to 5 pieces

Note: All screw plug bundles are designed to fit the inside diameter of the equivalent mating coupling. They will not fit into the equivalent pipe inside diameter.

⑦ CSA certified only

⑧ Can be wired for 1-phase operation

Immersion Heaters

WATROD and FIREBAR Screw Plug Immersion Heaters



Application: Forced Air and Caustic Solutions

- 1 1/4 inch NPT screw plug
- WATROD elements
- With thermostat (SPST)
- General purpose or moisture/explosion-resistant enclosure

General Purpose

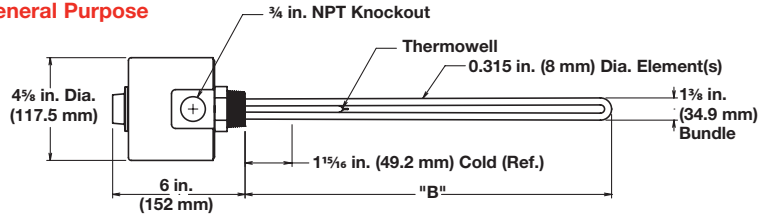

Moisture/Explosion-Resistant

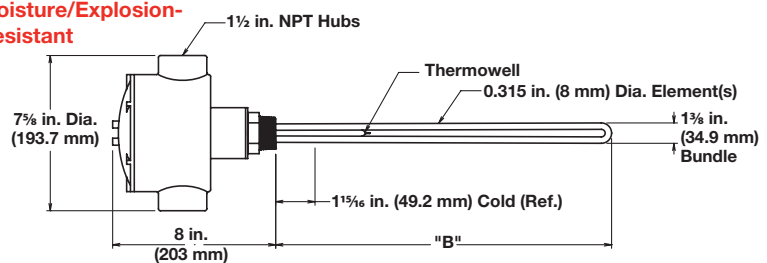

Description	Volts	kW	Ph	"B" Dim. in. (mm)	Ship Wt. lbs (kg)	Type 2 (30 to 250°F)		Type 3 (175 to 550°F)	
						Part Number	Del.	Part Number	Del.
						General Purpose Enclosure			
23 W/in² ④ 304 SS Plug 2-Alloy 800 Elements (3.6 W/cm²)	120/240	1.0	1	13 ³ / ₈ (339.7)	6 (3)	BEN13G6S2	RS	BEN13G6S3	RS
	120/240	1.5	1	19 (483.0)	7 (4)	BEN19A6S2	RS	BEN19A6S3	RS
	120/240	2.0	1	24 ³ / ₈ (619.1)	8 (4)	BEN24G6S2	RS	BEN24G6S3	RS
						Moisture/Explosion-Resistant Enclosure ⑦			
23 W/in² ④ 304 SS Plug 2-Alloy 800 Elements (3.6 W/cm²)	120/240	1.0	1	13 ³ / ₈ (339.7)	10 (5)	BEN13G6C2	RS	BEN13G6C3	RS
	120/240	1.5	1	19 (483.0)	11 (5)	BEN19A6C2	RS	BEN19A6C3	RS
	120/240	2.0	1	24 ³ / ₈ (619.1)	12 (6)	BEN24G6C2	RS	BEN24G6C3	RS

RAPID SHIP

- RS - Next day shipment up to 5 pieces

Note: All screw plug bundles are designed to fit the inside diameter of the equivalent mating coupling. They will not fit into the equivalent pipe inside diameter.

- ④ Wired for higher voltage
- ⑦ CSA certified only

Immersion Heaters

WATROD and FIREBAR Screw Plug Immersion Heaters



Application: Forced Air and Caustic Solutions

- 1 1/4 inch NPT screw plug
- WATROD elements
- Without thermostat
- General purpose or moisture/explosion-resistant enclosure

General Purpose

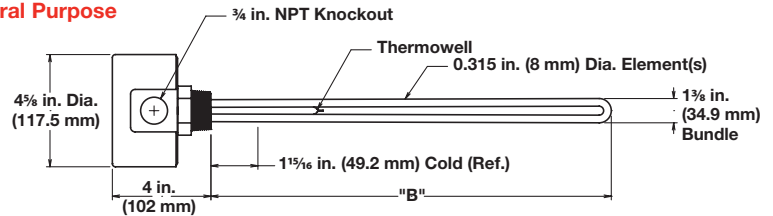

Moisture/Explosion-Resistant

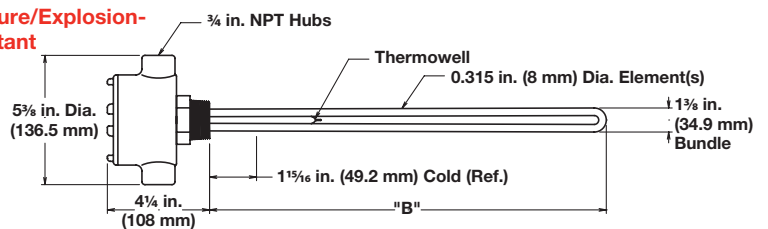

Description	Volts	kW	Ph	"B" Dim. in. (mm)	Part Number	Del.	Ship Wt. lbs (kg)	Part Number ⑦	Del.	Ship Wt. lbs (kg)	
					General Purpose Enclosure			Moisture Explosion-Resistant Enclosure			
23 W/in ² ④ 304 SS Plug 2-Alloy 800 Elements (3.6 W/cm ²)	120/240	1.0	1	13 ^{3/8} (339.7)	BEN13G6S	RS	6 (3)	BEN13G6C	RS	9 (4)	
	120/240	1.5	1	19 (483.0)	BEN19A6S	RS	7 (4)	BEN19A6C	RS	10 (5)	
	120/240	2.0	1	24 ^{3/8} (619.1)	BEN24G6S	RS	8 (4)	BEN24G6C	RS	11 (5)	

RAPID SHIP

- RS - Next day shipment up to 5 pieces

Note: All screw plug bundles are designed to fit the inside diameter of the equivalent mating coupling. They will not fit into the equivalent pipe inside diameter.

- ④ Wired for higher voltage
- ⑦ CSA certified only

Immersion Heaters

WATROD and FIREBAR Screw Plug Immersion Heaters



Application: Forced Air and Caustic Solutions

- 2 inch NPT screw plug
- WATROD elements
- With thermostat (DPST)

Note: Higher amperage products require a pilot duty thermostat with separate power controller. Please see following pages for available heaters without thermostats.

- General purpose or moisture/explosion-resistant enclosure

General Purpose

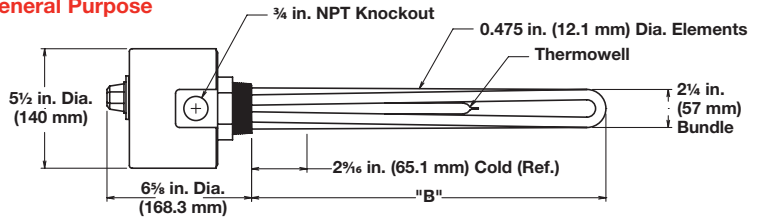

Moisture/Explosion-Resistant

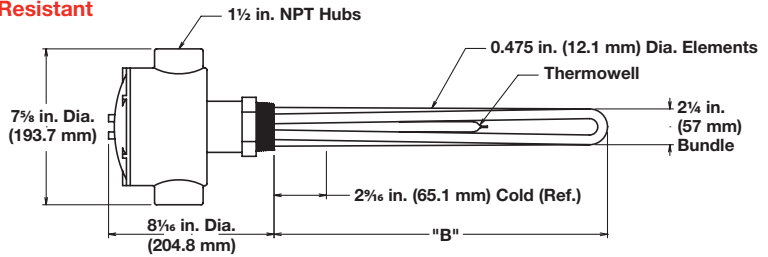

Description	Volts	kW	Ph	"B" Dim. in. (mm)	Ship Wt. lbs (kg)	Type 4 (30 to 110°F)		Type 5A (60 to 250°F)		Type 7A (100 to 550°F)	
						Part Number	Del.	Part Number	Del.	Part Number	Del.
General Purpose Enclosure											
23 W/in ² Ⓞ 304 SS Plug 3-Alloy 800 Elements (3.6 W/cm ²)	240	3.0	3	17 ³ / ₄ (451)	8 (4)	BHNA17N3S4	RS	BHNA17N3S5A	RS	BHNA17N3S7A	RS
	480	3.0	3	17 ³ / ₄ (451)	8 (4)	BHNA17N5S4	RS	BHNA17N5S5A	RS	BHNA17N5S7A	RS
	240	4.5	3	25 ¹ / ₄ (641)	10 (5)	BHNA25E3S4	RS	BHNA25E3S5A	RS	BHNA25E3S7A	RS
	480	4.5	3	25 ¹ / ₄ (641)	10 (5)	BHNA25E5S4	RS	BHNA25E5S5A	RS	BHNA25E5S7A	RS
	240	6.0	3	32 ³ / ₄ (832)	10 (5)	BHNA32N3S4	RS	BHNA32N3S5A	RS	BHNA32N3S7A	RS
	480	6.0	3	32 ³ / ₄ (832)	10 (5)	BHNA32N5S4	RS	BHNA32N5S5A	RS	BHNA32N5S7A	RS
	240	7.5	3	40 ¹ / ₄ (1022)	11 (5)	BHNA40E3S4	RS	BHNA40E3S5A	RS	BHNA40E3S7A	RS
240	9.0	3	47 ³ / ₄ (1213)	12 (6)	BHNA47N3S4	RS	BHNA47N3S5A	RS	BHNA47N3S7A	RS	
Moisture/Explosion-Resistant Enclosure Ⓞ											
23 W/in ² Ⓞ 304 SS Plug 3-Alloy 800 Elements (3.6 W/cm ²)	240	3.0	3	17 ³ / ₄ (451)	11 (5)	BHNA17N3C4	RS	BHNA17N3C5A	RS	BHNA17N3C7A	RS
	480	3.0	3	17 ³ / ₄ (451)	11 (5)	BHNA17N5C4	RS	BHNA17N5C5A	RS	BHNA17N5C7A	RS
	240	4.5	3	25 ¹ / ₄ (641)	13 (6)	BHNA25E3C4	RS	BHNA25E3C5A	RS	BHNA25E3C7A	RS
	480	4.5	3	25 ¹ / ₄ (641)	13 (6)	BHNA25E5C4	RS	BHNA25E5C5A	RS	BHNA25E5C7A	RS
	240	6.0	3	32 ³ / ₄ (832)	13 (6)	BHNA32N3C4	RS	BHNA32N3C5A	RS	BHNA32N3C7A	RS
	480	6.0	3	32 ³ / ₄ (832)	13 (6)	BHNA32N5C4	RS	BHNA32N5C5A	RS	BHNA32N5C7A	RS
	240	7.5	3	40 ¹ / ₄ (1022)	14 (7)	BHNA40E3C4	RS	BHNA40E3C5A	RS	BHNA40E3C7A	RS
240	9.0	3	47 ³ / ₄ (1213)	15 (7)	BHNA47N3C4	RS	BHNA47N3C5A	RS	BHNA47N3C7A	RS	

RAPID SHIP

- RS - Next day shipment up to 5 pieces

Note: All screw plug bundles are designed to fit the inside diameter of the equivalent mating coupling. They will not fit into the equivalent pipe inside diameter.

Ⓞ Can be rewired wye to produce 1/3 of the original kW and watt density (3-phase only)

Ⓞ CSA certified only

Immersion Heaters

WATROD and FIREBAR Screw Plug Immersion Heaters



Application: Forced Air and Caustic Solutions

- 2 inch NPT screw plug
- WATROD elements
- Without thermostat
- General purpose or moisture/explosion-resistant enclosure

General Purpose

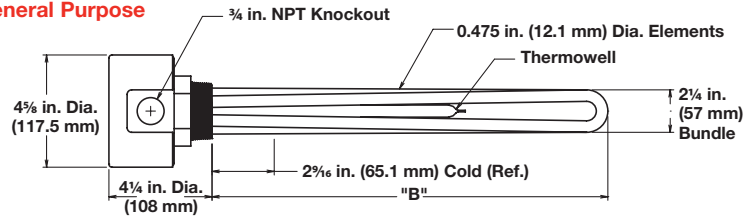

Moisture/Explosion-Resistant

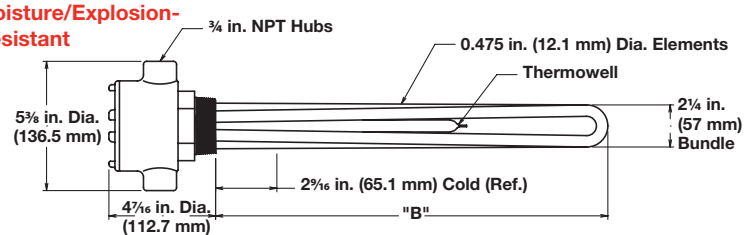

Description	Volts	kW	Ph	"B" Dim. in. (mm)	Part Number	Del.	Ship Wt. lbs (kg)	Part Number ⑦	Del.	Ship Wt. lbs (kg)	
					General Purpose Enclosure				Moisture/Explosion-Resistant Enclosure		
23 W/in² ⑥ 304 SS Plug 3-Alloy 800 Elements (3.6 W/cm²)	120	3.0	1	17 ³ / ₄ (451)	BHNA17N1S	RS	7 (4)	BHNA17N1C	RS	10 (5)	
	240	3.0	3	17 ³ / ₄ (451)	BHNA17N3S	RS	7 (4)	BHNA17N3C	RS	10 (5)	
	480	3.0	3	17 ³ / ₄ (451)	BHNA17N5S	RS	7 (4)	BHNA17N5C	RS	10 (5)	
	120	4.5	1	25 ¹ / ₄ (641)	BHNA25E1S	RS	8 (4)	BHNA25E1C	RS	11 (5)	
	240	4.5	3	25 ¹ / ₄ (641)	BHNA25E3S	RS	8 (4)	BHNA25E3C	RS	11 (5)	
	480	4.5	3	25 ¹ / ₄ (641)	BHNA25E5S	RS	8 (4)	BHNA25E5C	RS	11 (5)	
	240	6.0	3	32 ³ / ₄ (832)	BHNA32N3S	RS	9 (4)	BHNA32N3C	RS	12 (6)	
	480	6.0	3	32 ³ / ₄ (832)	BHNA32N5S	RS	9 (4)	BHNA32N5C	RS	12 (6)	
	240	7.5	3	40 ¹ / ₄ (1022)	BHNA40E3S	RS	10 (5)	BHNA40E3C	RS	13 (6)	
	480	7.5	3	40 ¹ / ₄ (1022)	BHNA40E5S	RS	10 (5)	BHNA40E5C	RS	13 (6)	
	240	9.0	3	47 ³ / ₄ (1213)	BHNA47N3S	RS	11 (5)	BHNA47N3C	RS	14 (7)	
	480	9.0	3	47 ³ / ₄ (1213)	BHNA47N5S	RS	11 (5)	BHNA47N5C	RS	14 (7)	
	240	12.5	3	64 ¹ / ₄ (1632)	BHNA64E3S	RS	15 (7)	BHNA64E3C	RS	18 (9)	
	480	12.5	3	64 ¹ / ₄ (1632)	BHNA64E5S	RS	15 (7)	BHNA64E5C	RS	18 (9)	
	240	15.0	3	76 ³ / ₄ (1950)	BHNA76E3S	RS	18 (9)	BHNA76E3C	RS	21 (10)	
480	15.0	3	76 ³ / ₄ (1950)	BHNA76E5S	RS	18 (9)	BHNA76E5C	RS	21 (10)		

RAPID SHIP

- RS - Next day shipment up to 5 pieces

Note: All screw plug bundles are designed to fit the inside diameter of the equivalent mating coupling. They will not fit into the equivalent pipe inside diameter.

⑥ Can be rewired wye to produce 1/3 of the original kW and watt density (3-phase only)

⑦ CSA certified only

Immersion Heaters

WATROD and FIREBAR Screw Plug Immersion Heaters



Application: Forced Air and Caustic Solutions

- 2 1/2 inch NPT screw plug
- WATROD elements
- With thermostat (DPST)

Note: Higher amperage products require a pilot duty thermostat with separate power controller. Please see following pages for available heaters without thermostats.

- General purpose or moisture/explosion-resistant enclosure

General Purpose

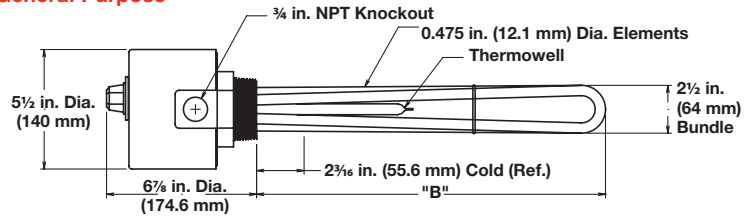

Moisture/Explosion-Resistant

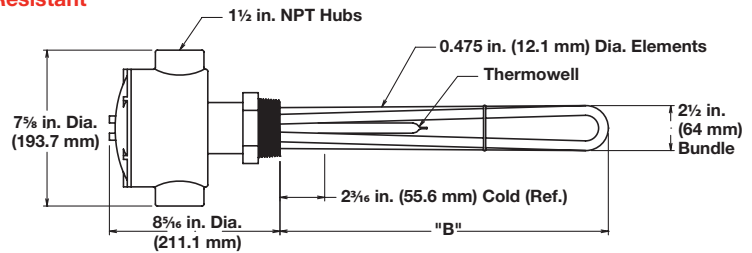

Description	Volts	kW	Ph	"B" Dim. in. (mm)	Ship Wt. lbs (kg)	Type 4 (30 to 110°F)		Type 5A (60 to 250°F)		Type 7A (100 to 550°F)	
						Part Number	Del.	Part Number	Del.	Part Number	Del.
General Purpose Enclosure											
23 W/in ² ⑥ 304 SS Plug 3-Alloy 800 Elements (3.6 W/cm ²)	240	3.0	3	17 ³ / ₈ (441.3)	10 (5)	BLNA17G3S4	RS	BLNA17G3S5A	RS	BLNA17G3S7A	RS
	480	3.0	3	17 ³ / ₈ (441.3)	10 (5)	BLNA17G5S4	RS	BLNA17G5S5A	RS	BLNA17G5S7A	RS
	240	4.5	3	24 ⁷ / ₈ (631.8)	13 (6)	BLNA24R3S4	RS	BLNA24R3S5A	RS	BLNA24R3S7A	RS
	480	4.5	3	24 ⁷ / ₈ (631.8)	13 (6)	BLNA24R5S4	RS	BLNA24R5S5A	RS	BLNA24R5S7A	RS
	240	6.0	3	32 ³ / ₈ (822.3)	15 (7)	BLNA32G3S4	RS	BLNA32G3S5A	RS	BLNA32G3S7A	RS
	480	6.0	3	32 ³ / ₈ (822.3)	15 (7)	BLNA32G5S4	RS	BLNA32G5S5A	RS	BLNA32G5S7A	RS
	240	7.5	3	39 ⁷ / ₈ (1012.8)	16 (8)	BLNA39R3S4	RS	BLNA39R3S5A	RS	BLNA39R3S7A	RS
	240	9.0	3	47 ³ / ₈ (1203.3)	18 (9)	BLNA47G3S4	RS	BLNA47G3S5A	RS	BLNA47G3S7A	RS
Moisture/Explosion-Resistant Enclosure ⑦											
23 W/in ² ⑥ 304 SS Plug 3-Alloy 800 Elements (3.6 W/cm ²)	240	3.0	3	17 ³ / ₈ (441.3)	13 (6)	BLNA17G3C4	RS	BLNA17G3C5A	RS	BLNA17G3C7A	RS
	480	3.0	3	17 ³ / ₈ (441.3)	13 (6)	BLNA17G5C4	RS	BLNA17G5C5A	RS	BLNA17G5C7A	RS
	240	4.5	3	24 ⁷ / ₈ (631.8)	16 (8)	BLNA24R3C4	RS	BLNA24R3C5A	RS	BLNA24R3C7A	RS
	480	4.5	3	24 ⁷ / ₈ (631.8)	16 (8)	BLNA24R5C4	RS	BLNA24R5C5A	RS	BLNA24R5C7A	RS
	240	6.0	3	32 ³ / ₈ (822.3)	18 (9)	BLNA32G3C4	RS	BLNA32G3C5A	RS	BLNA32G3C7A	RS
	480	6.0	3	32 ³ / ₈ (822.3)	18 (9)	BLNA32G5C4	RS	BLNA32G5C5A	RS	BLNA32G5C7A	RS
	240	7.5	3	39 ⁷ / ₈ (1012.8)	19 (9)	BLNA39R3C4	RS	BLNA39R3C5A	RS	BLNA39R3C7A	RS
	240	9.0	3	47 ³ / ₈ (1203.3)	21 (10)	BLNA47G3C4	RS	BLNA47G3C5A	RS	BLNA47G3C7A	RS

RAPID SHIP

- RS - Next day shipment up to 5 pieces

Note: All screw plug bundles are designed to fit the inside diameter of the equivalent mating coupling. They will not fit into the equivalent pipe inside diameter.

⑥ Can be rewired wye to produce 1/3 of the original kW and watt density (3-phase only)

⑦ CSA certified only

Immersion Heaters

WATROD and FIREBAR Screw Plug Immersion Heaters



Application: Forced Air and Caustic Solutions

- 2 1/2 inch NPT screw plug
- WATROD elements
- Without thermostat
- General purpose or moisture/explosion-resistant enclosure

General Purpose

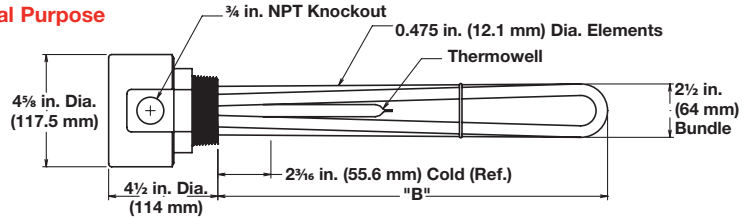

Moisture/Explosion-Resistant

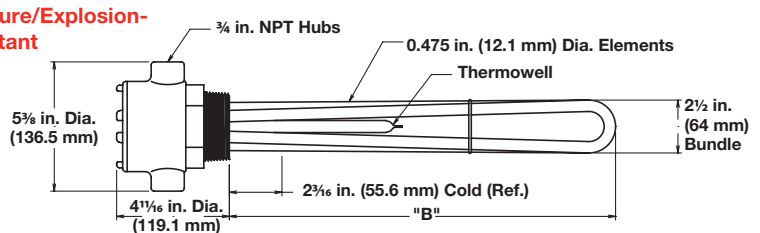

Description	Volts	kW	Ph	"B" Dim. in. (mm)	Part Number	Del.	Ship Wt. lbs (kg)	Part Number ⑦	Del.	Ship Wt. lbs (kg)	
					General Purpose Enclosure			Moisture/Explosion-Resistant Enclosure			
23 W/in² ⑥ 304 SS Plug 3-Alloy 800 Elements (3.6 W/cm²)	120	3.0	1	17 ³ / ₈ (441.3)	BLNA17G1S	RS	9 (4)	BLNA17G1C	RS	12 (6)	
	240	3.0	3	17 ³ / ₈ (441.3)	BLNA17G3S	RS	9 (4)	BLNA17G3C	RS	12 (6)	
	480	3.0	3	17 ³ / ₈ (441.3)	BLNA17G5S	RS	9 (4)	BLNA17G5C	RS	12 (6)	
	120	4.5	1	24 ⁷ / ₈ (631.8)	BLNA24R1S	RS	12 (6)	BLNA24R1C	RS	15 (7)	
	240	4.5	3	24 ⁷ / ₈ (631.8)	BLNA24R3S	RS	12 (6)	BLNA24R3C	RS	15 (7)	
	480	4.5	3	24 ⁷ / ₈ (631.8)	BLNA24R5S	RS	12 (6)	BLNA24R5C	RS	15 (7)	
	240	6.0	3	32 ³ / ₈ (822.3)	BLNA32G3S	RS	14 (7)	BLNA32G3C	RS	17 (8)	
	480	6.0	3	32 ³ / ₈ (822.3)	BLNA32G5S	RS	14 (7)	BLNA32G5C	RS	17 (8)	
	240	7.5	3	39 ⁷ / ₈ (1012.8)	BLNA39R3S	RS	15 (7)	BLNA39R3C	RS	18 (9)	
	480	7.5	3	39 ⁷ / ₈ (1012.8)	BLNA39R5S	RS	15 (7)	BLNA39R5C	RS	18 (9)	
	240	9.0	3	47 ³ / ₈ (1203.3)	BLNA47G3S	RS	17 (8)	BLNA47G3C	RS	20 (9)	
	480	9.0	3	47 ³ / ₈ (1203.3)	BLNA47G5S	RS	17 (8)	BLNA47G5C	RS	20 (9)	
	240	12.5	3	63 ⁷ / ₈ (1622.4)	BLNA63R3S	RS	20 (9)	BLNA63R3C	RS	23 (11)	
	480	12.5	3	63 ⁷ / ₈ (1622.4)	BLNA63R5S	RS	20 (9)	BLNA63R5C	RS	23 (11)	
	240	15.0	3	76 ³ / ₈ (1939.9)	BLNA76G3S	RS	23 (11)	BLNA76G3C	RS	26 (12)	
480	15.0	3	76 ³ / ₈ (1939.9)	BLNA76G5S	RS	23 (11)	BLNA76G5C	RS	26 (12)		

RAPID SHIP

- RS - Next day shipment up to 5 pieces

Note: All screw plug bundles are designed to fit the inside diameter of the equivalent mating coupling. They will not fit into the equivalent pipe inside diameter.

- ⑥ Can be rewired wye to produce 1/3 of the original kW and watt density (3-phase only)
- ⑦ CSA certified only

Immersion Heaters

WATROD and FIREBAR Screw Plug Immersion Heaters



Application: Lightweight Oils and Heat Transfer Oils

- 1 inch NPT screw plug
- WATROD elements
- With thermostat (SPST)
- General purpose or moisture/explosion-resistant enclosure

General Purpose

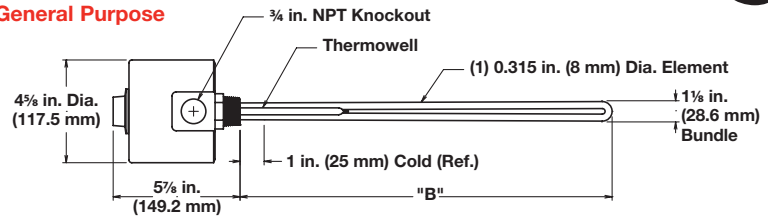

Moisture/Explosion-Resistant

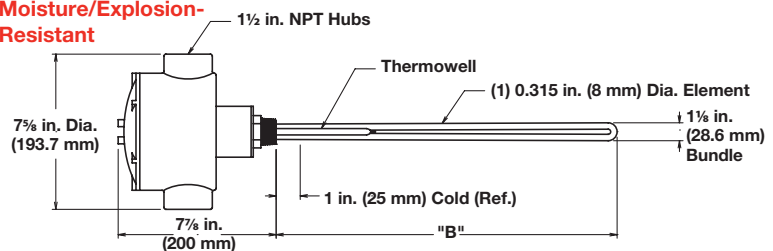

Description	Volts	kW	Ph	"B" Dim. in. (mm)	Ship Wt. lbs (kg)	Type 2 (30 to 250°F)		Type 3 (175 to 550°F)	
						Part Number	Del.	Part Number	Del.
General Purpose Enclosure									
23 W/in² Steel Plug 1-Steel Element (3.6 W/cm²)	120	0.25	1	6 1/2 (165)	3 (2)	BCS6J1S2	RS	BCS6J1S3	RS
	240	0.25	1	6 1/2 (165)	3 (2)	BCS6J10S2	RS	BCS6J10S3	RS
	120	0.35	1	9 1/4 (235)	4 (2)	BCS9E1S2	RS	BCS9E1S3	RS
	240	0.35	1	9 1/4 (235)	4 (2)	BCS9E10S2	RS	BCS9E10S3	RS
	120	0.50	1	9 3/8 (238)	4 (2)	BCS9G1S2	RS	BCS9G1S3	RS
	240	0.50	1	9 3/8 (238)	4 (2)	BCS9G10S2	RS	BCS9G10S3	RS
	120	0.75	1	13 1/2 (343)	5 (3)	BCS13J1S2	RS	BCS13J1S3	RS
	240	0.75	1	13 1/2 (343)	5 (3)	BCS13J10S2	RS	BCS13J10S3	RS
	120	1.00	1	16 3/4 (426)	6 (3)	BCS16N1S2	RS	BCS16N1S3	RS
	240	1.00	1	16 3/4 (426)	6 (3)	BCS16N10S2	RS	BCS16N10S3	RS
	120	1.50	1	23 3/4 (603)	7 (4)	BCS23N1S2	RS	BCS23N1S3	RS
	240	1.50	1	23 3/4 (603)	7 (4)	BCS23N10S2	RS	BCS23N10S3	RS
Moisture/Explosion-Resistant Enclosure ⑦									
23 W/in² Steel Plug 1-Steel Element (3.6 W/cm²)	120	0.25	1	6 1/2 (165)	3 (2)	BCS6J1C2	RS	BCS6J1C3	RS
	240	0.25	1	6 1/2 (165)	3 (2)	BCS6J10C2	RS	BCS6J10C3	RS
	120	0.35	1	9 1/4 (235)	4 (2)	BCS9E1C2	RS	BCS9E1C3	RS
	240	0.35	1	9 1/4 (235)	4 (2)	BCS9E10C2	RS	BCS9E10C3	RS
	120	0.50	1	9 3/8 (238)	4 (2)	BCS9G1C2	RS	BCS9G1C3	RS
	240	0.50	1	9 3/8 (238)	4 (2)	BCS9G10C2	RS	BCS9G10C3	RS
	120	0.75	1	13 1/2 (343)	5 (3)	BCS13J1C2	RS	BCS13J1C3	RS
	240	0.75	1	13 1/2 (343)	5 (3)	BCS13J10C2	RS	BCS13J10C3	RS
	120	1.00	1	16 3/4 (426)	6 (3)	BCS16N1C2	RS	BCS16N1C3	RS
	240	1.00	1	16 3/4 (426)	6 (3)	BCS16N10C2	RS	BCS16N10C3	RS
	120	1.50	1	23 3/4 (603)	7 (4)	BCS23N1C2	RS	BCS23N1C3	RS
	240	1.50	1	23 3/4 (603)	7 (4)	BCS23N10C2	RS	BCS23N10C3	RS

RAPID SHIP

- RS - Next day shipment up to 5 pieces

Note: All screw plug bundles are designed to fit the inside diameter of the equivalent mating coupling. They will not fit into the equivalent pipe inside diameter.

⑦ CSA certified only

Immersion Heaters

WATROD and FIREBAR Screw Plug Immersion Heaters



Application: Lightweight Oils and Heat Transfer Oils

- 1 inch NPT screw plug
- WATROD elements
- Without thermostat
- General purpose or moisture/explosion-resistant enclosure

General Purpose

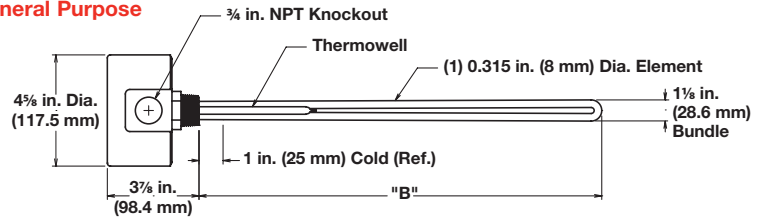

Moisture/Explosion-Resistant

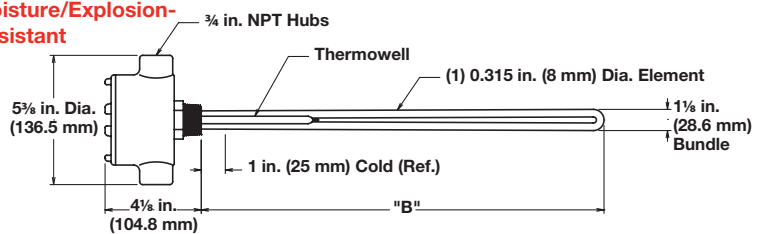

Description	Volts	kW	Ph	"B" Dim. in. (mm)	Part Number	Del.	Ship Wt. lbs (kg)	Part Number ⑦	Del.	Ship Wt. lbs (kg)
					General Purpose Enclosure			Moisture/Explosion-Resistant Enclosure		
23 W/in² Steel Plug 1-Steel Element (3.6 W/cm²)	120	0.25	1	6 ¹ / ₂ (165)	BCS6J1S	RS	3 (2)	BCS6J1C	RS	6 (3)
	240	0.25	1	6 ¹ / ₂ (165)	BCS6J10S	RS	3 (2)	BCS6J10C	RS	6 (3)
	120	0.35	1	9 ¹ / ₄ (235)	BCS9E1S	RS	4 (2)	BCS9E1C	RS	7 (4)
	240	0.35	1	9 ¹ / ₄ (235)	BCS9E10S	RS	4 (2)	BCS9E10C	RS	7 (4)
	120	0.50	1	9 ³ / ₈ (238)	BCS9G1S	RS	4 (2)	BCS9G1C	RS	7 (4)
	240	0.50	1	9 ³ / ₈ (238)	BCS9G10S	RS	4 (2)	BCS9G10C	RS	7 (4)
	120	0.75	1	13 ¹ / ₂ (343)	BCS13J1S	RS	5 (3)	BCS13J1C	RS	8 (4)
	240	0.75	1	13 ¹ / ₂ (343)	BCS13J10S	RS	5 (3)	BCS13J10C	RS	8 (4)
	120	1.00	1	16 ³ / ₄ (426)	BCS16N1S	RS	6 (3)	BCS16N1C	RS	9 (4)
	240	1.00	1	16 ³ / ₄ (426)	BCS16N10S	RS	6 (3)	BCS16N10C	RS	9 (4)
	120	1.50	1	23 ³ / ₄ (603)	BCS23N1S	RS	7 (4)	BCS23N1C	RS	10 (5)
	240	1.50	1	23 ³ / ₄ (603)	BCS23N10S	RS	7 (4)	BCS23N10C	RS	10 (5)

RAPID SHIP

- RS - Next day shipment up to 5 pieces

Note: All screw plug bundles are designed to fit the inside diameter of the equivalent mating coupling. They will not fit into the equivalent pipe inside diameter.

⑦ CSA certified only

Immersion Heaters

WATROD and FIREBAR Screw Plug Immersion Heaters



Application: Lightweight Oils and Heat Transfer Oils

- 1 1/4 inch NPT screw plug
- WATROD elements
- With thermostat (SPST)
- General purpose or moisture/explosion-resistant enclosure

General Purpose

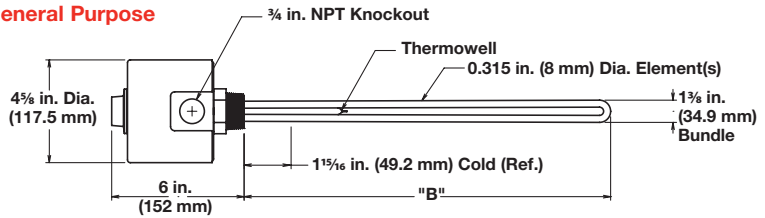

Moisture/Explosion-Resistant

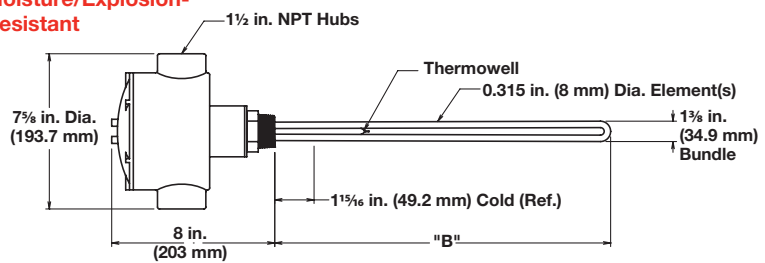

Description	Volts	kW	Ph	"B" Dim. in. (mm)	Ship Wt. lbs (kg)	Type 2 (30 to 250°F)		Type 3 (175 to 550°F)	
						Part Number	Del.	Part Number	Del.
General Purpose Enclosure									
23 W/in² ④ Steel Plug 2-Steel Elements (3.6 W/cm²)	120/240	0.50	1	6 ³ / ₈ (161.9)	4 (2)	BES6G6S2	RS	BES6G6S3	RS
	120/240	0.50	1	7 ³ / ₈ (187.3)	4 (2)	BES7G6S2	RS	BES7G6S3	RS
	120/240	0.70	1	8 ⁷ / ₈ (225.4)	5 (3)	BES8R6S2	RS	BES8R6S3	RS
	120/240	0.75	1	10 ¹ / ₁₆ (255.6)	5 (3)	BES10B6S2	RS	BES10B6S3	RS
	120/240	1.00	1	12 ³ / ₄ (324.0)	6 (3)	BES12N6S2	RS	BES12N6S3	RS
	120/240	1.50	1	19 ³ / ₈ (492.1)	7 (4)	BES19G6S2	RS	BES19G6S3	RS
	120/240	2.00	1	25 ³ / ₈ (644.5)	8 (4)	BES25G6S2	RS	BES25G6S3	RS
	120/240	3.00	1	36 ⁷ / ₈ (936.6)	9 (4)	BES36R6S2	RS	BES36R6S3	RS
Moisture/Explosion-Resistant Enclosure ⑦									
23 W/in² ④ Steel Plug 2-Steel Elements (3.6 W/cm²)	120/240	0.50	1	6 ³ / ₈ (161.9)	8 (4)	BES6G6C2	RS	BES6G6C3	RS
	120/240	0.50	1	7 ³ / ₈ (187.3)	8 (4)	BES7G6C2	RS	BES7G6C3	RS
	120/240	0.70	1	8 ⁷ / ₈ (225.6)	9 (4)	BES8R6C2	RS	BES8R6C3	RS
	120/240	0.75	1	10 ¹ / ₁₆ (256.0)	9 (4)	BES10B6C2	RS	BES10B6C3	RS
	120/240	1.00	1	12 ³ / ₄ (324.0)	10 (5)	BES12N6C2	RS	BES12N6C3	RS
	120/240	1.50	1	19 ³ / ₈ (492.1)	11 (5)	BES19G6C2	RS	BES19G6C3	RS
	120/240	2.00	1	25 ³ / ₈ (644.5)	12 (6)	BES25G6C2	RS	BES25G6C3	RS
	120/240	3.00	1	36 ⁷ / ₈ (936.7)	13 (6)	BES36R6C2	RS	BES36R6C3	RS

RAPID SHIP

- RS - Next day shipment up to 5 pieces

Note: All screw plug bundles are designed to fit the inside diameter of the equivalent mating coupling. They will not fit into the equivalent pipe inside diameter.

④ Wired for higher voltage

⑦ CSA certified only

Immersion Heaters

WATROD and FIREBAR Screw Plug Immersion Heaters



Application: Lightweight Oils and Heat Transfer Oils

- 1 1/4 inch NPT screw plug
- WATROD elements
- Without thermostat
- General purpose or moisture/explosion-resistant enclosure

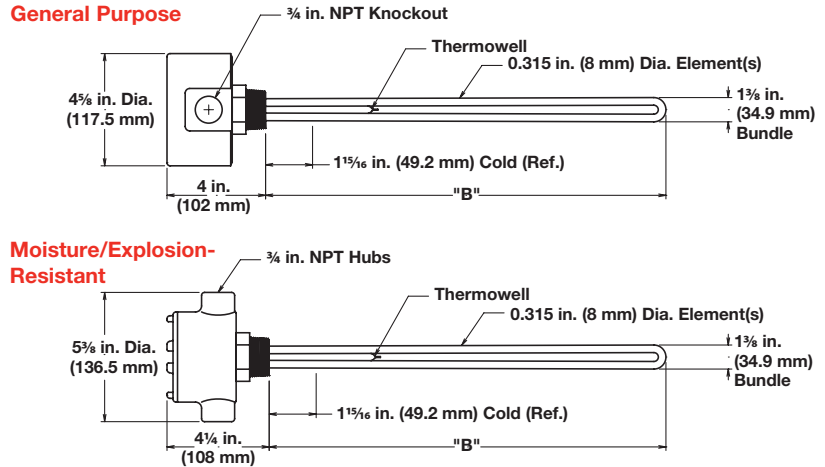

Description	Volts	kW	Ph	"B" Dim. in. (mm)	Part Number	Del.	Ship Wt. lbs (kg)	Part Number ⑦	Del.	Ship Wt. lbs (kg)
					General Purpose Enclosure			Moisture/Explosion-Resistant Enclosure		
23 W/in² ④ Steel Plug 2-Steel Elements (3.6 W/cm²)	120/240	0.50	1	6 ³ / ₈ (161.9)	BES6G6S	RS	4 (2)	BES6G6C	RS	7 (4)
	120/240	0.50	1	7 ³ / ₈ (187.3)	BES7G6S	RS	4 (2)	BES7G6C	RS	7 (4)
	120/240	0.70	1	8 ⁷ / ₈ (225.4)	BES8R6S	RS	5 (3)	BES8R6C	RS	8 (4)
	120/240	0.75	1	10 ¹ / ₁₆ (255.6)	BES10B6S	RS	5 (3)	BES10B6C	RS	8 (4)
	120/240	1.00	1	12 ³ / ₄ (324.0)	BES12N6S	RS	6 (3)	BES12N6C	RS	9 (4)
	120/240	1.50	1	19 ³ / ₈ (492.1)	BES19G6S	RS	7 (4)	BES19G6C	RS	10 (5)
	120/240	2.00	1	25 ³ / ₈ (644.5)	BES25G6S	RS	8 (4)	BES25G6C	RS	11 (5)
	120/240	3.00	1	36 ⁷ / ₈ (936.6)	BES36R6S	RS	9 (4)	BES36R6C	RS	12 (6)

RAPID SHIP

- RS - Next day shipment up to 5 pieces

Note: All screw plug bundles are designed to fit the inside diameter of the equivalent mating coupling. They will not fit into the equivalent pipe inside diameter.

- ④ Wired for higher voltage
- ⑦ CSA certified only

Immersion Heaters

WATROD and FIREBAR Screw Plug Immersion Heaters



Application: Lightweight Oils and Heat Transfer Oils

- 1 1/4 inch NPT screw plug
- FIREBAR elements
- With thermostat (DPST)

Note: Higher amperage products require a pilot duty thermostat with separate power controller, please see following pages for available heaters without thermostats

- General purpose enclosure

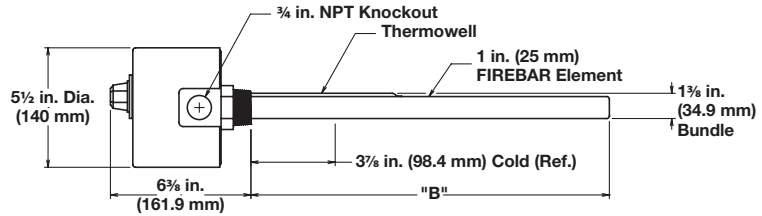

Description	Volts	kW	Ph	"B" Dim. in. (mm)	Ship Wt. lbs (kg)	Type 5A (60 to 250°F)		Type 7A (100 to 550°F)	
						Part Number	Del.	Part Number	Del.
General Purpose Enclosure									
30 W/in² ③ 304 SS Plug 1-Alloy 800 Element (4.7 W/cm²)	240	1.70	3	16 1/8 (409.6)	8 (4)	BDNF16G12S5A	RS	BDNF16G12S7A	RS
	480	1.70	3	16 1/8 (409.6)	8 (4)	BDNF16G13S5A	RS	BDNF16G13S7A	RS
	240	2.20	3	19 1/8 (485.8)	9 (4)	BDNF19G12S5A	RS	BDNF19G12S7A	RS
	480	2.20	3	19 1/8 (485.8)	9 (4)	BDNF19G13S5A	RS	BDNF19G13S7A	RS
	240	2.80	3	24 3/8 (619.1)	10 (5)	BDNF24L12S5A	RS	BDNF24L12S7A	RS
	480	2.80	3	24 3/8 (619.1)	10 (5)	BDNF24L13S5A	RS	BDNF24L13S7A	RS
	240	3.50	3	29 5/8 (752.5)	11 (5)	BDNF29R12S5A	RS	BDNF29R12S7A	RS
	480	3.50	3	29 5/8 (752.5)	11 (5)	BDNF29R13S5A	RS	BDNF29R13S7A	RS
	240	4.25	3	34 5/8 (879.5)	12 (6)	BDNF34R12S5A	RS	BDNF34R12S7A	RS
	480	4.25	3	34 5/8 (879.5)	12 (6)	BDNF34R13S5A	RS	BDNF34R13S7A	RS
	240	5.70	3	45 1/8 (1146.2)	14 (7)	BDNF45G12S5A	RS	BDNF45G12S7A	RS
	480	5.70	3	45 1/8 (1146.2)	14 (7)	BDNF45G13S5A	RS	BDNF45G13S7A	RS
240	7.20	3	55 5/8 (1412.9)	16 (8)	BDNF55R12S5A	RS	BDNF55R12S7A	RS	
23 W/in² ⑧ 304 SS Plug 1-Alloy 800 Element (3.6 W/cm²)	240	1.25	3	16 1/8 (409.6)	8 (4)	BDNF16G20S5A	RS	BDNF16G20S7A	RS
	240	1.65	3	19 1/8 (485.8)	9 (4)	BDNF19G20S5A	RS	BDNF19G20S7A	RS
	240	2.15	3	24 3/8 (619.1)	10 (5)	BDNF24L20S5A	RS	BDNF24L20S7A	RS
	480	2.15	3	24 3/8 (619.1)	10 (5)	BDNF24L19S5A	RS	BDNF24L19S7A	RS
	240	2.65	3	29 5/8 (752.5)	11 (5)	BDNF29R20S5A	RS	BDNF29R20S7A	RS
	480	2.65	3	29 5/8 (752.5)	11 (5)	BDNF29R19S5A	RS	BDNF29R19S7A	RS
	240	3.20	3	34 5/8 (879.5)	12 (6)	BDNF34R20S5A	RS	BDNF34R20S7A	RS
	480	3.20	3	34 5/8 (879.5)	12 (6)	BDNF34R19S5A	RS	BDNF34R19S7A	RS
	240	4.25	3	45 1/8 (1146.2)	14 (7)	BDNF45G20S5A	RS	BDNF45G20S7A	RS
	480	4.25	3	45 1/8 (1146.2)	14 (7)	BDNF45G19S5A	RS	BDNF45G19S7A	RS
	240	5.40	3	55 5/8 (1412.9)	16 (8)	BDNF55R20S5A	RS	BDNF55R20S7A	RS
	480	5.40	3	55 5/8 (1412.9)	16 (8)	BDNF55R19S5A	RS	BDNF55R19S7A	RS

RAPID SHIP

- RS - Next day shipment up to 5 pieces

Note: All screw plug bundles are designed to fit the inside diameter of the equivalent mating coupling. They will not fit into the equivalent pipe inside diameter.

③ Wired for 3-phase operation only

⑧ Can be wired for 1-phase operation

Immersion Heaters

WATROD and FIREBAR Screw Plug Immersion Heaters



Application: Lightweight Oils and Heat Transfer Oils

- 1 1/4 inch NPT screw plug
- FIREBAR elements
- With thermostat (DPST)

Note: Higher amperage products require a pilot duty thermostat with separate power controller. Please see following pages for available heaters without thermostats.

- Moisture/explosion-resistant enclosure

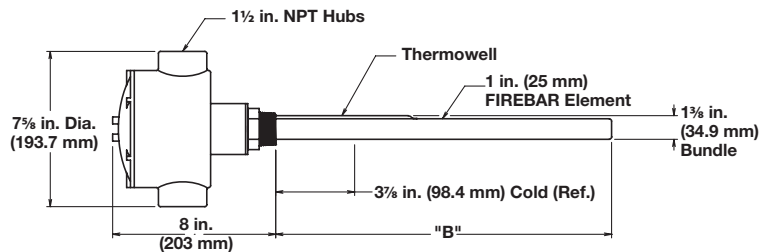

Description	Volts	kW	Ph	"B" Dim. in. (mm)		Ship Wt. lbs (kg)		Type 5A (60 to 250°F)		Type 7A (100 to 550°F)	
								Part Number	Del.	Part Number	Del.
Moisture/Explosion-Resistant Enclosure											
30 W/in² ③ 304 SS Plug 1-Alloy 800 Element (4.7 W/cm²)	240	1.70	3	16 ¹ / ₈	(409.6)	11	(5)	BDNF16G12C5A	RS	BDNF16G12C7A	RS
	480	1.70	3	16 ¹ / ₈	(409.6)	11	(5)	BDNF16G13C5A	RS	BDNF16G13C7A	RS
	240	2.20	3	19 ¹ / ₈	(485.8)	12	(6)	BDNF19G12C5A	RS	BDNF19G12C7A	RS
	480	2.20	3	19 ¹ / ₈	(485.8)	12	(6)	BDNF19G13C5A	RS	BDNF19G13C7A	RS
	240	2.80	3	24 ³ / ₈	(619.1)	13	(6)	BDNF24L12C5A	RS	BDNF24L12C7A	RS
	480	2.80	3	24 ³ / ₈	(619.1)	13	(6)	BDNF24L13C5A	RS	BDNF24L13C7A	RS
	240	3.50	3	29 ⁵ / ₈	(752.5)	14	(7)	BDNF29R12C5A	RS	BDNF29R12C7A	RS
	480	3.50	3	29 ⁵ / ₈	(752.5)	14	(7)	BDNF29R13C5A	RS	BDNF29R13C7A	RS
	240	4.25	3	34 ⁵ / ₈	(879.5)	15	(7)	BDNF34R12C5A	RS	BDNF34R12C7A	RS
	480	4.25	3	34 ⁵ / ₈	(879.5)	15	(7)	BDNF34R13C5A	RS	BDNF34R13C7A	RS
	240	5.70	3	45 ¹ / ₈	(1146.2)	17	(8)	BDNF45G12C5A	RS	BDNF45G12C7A	RS
	480	5.70	3	45 ¹ / ₈	(1146.2)	17	(8)	BDNF45G13C5A	RS	BDNF45G13C7A	RS
23 W/in² ⑧ 304 SS Plug 1-Alloy 800 Element (3.6 W/cm²)	240	1.25	3	16 ¹ / ₈	(409.6)	11	(5)	BDNF16G20C5A	RS	BDNF16G20C7A	RS
	240	1.65	3	19 ¹ / ₈	(485.8)	12	(6)	BDNF19G20C5A	RS	BDNF19G20C7A	RS
	240	2.15	3	24 ³ / ₈	(619.1)	13	(6)	BDNF24L20C5A	RS	BDNF24L20C7A	RS
	480	2.15	3	24 ³ / ₈	(619.1)	13	(6)	BDNF24L19C5A	RS	BDNF24L19C7A	RS
	240	2.65	3	29 ⁵ / ₈	(752.5)	14	(7)	BDNF29R20C5A	RS	BDNF29R20C7A	RS
	480	2.65	3	29 ⁵ / ₈	(752.5)	14	(7)	BDNF29R19C5A	RS	BDNF29R19C7A	RS
	240	3.20	3	34 ⁵ / ₈	(879.5)	15	(7)	BDNF34R20C5A	RS	BDNF34R20C7A	RS
	480	3.20	3	34 ⁵ / ₈	(879.5)	15	(7)	BDNF34R19C5A	RS	BDNF34R19C7A	RS
	240	4.25	3	45 ¹ / ₈	(1146.2)	17	(8)	BDNF45G20C5A	RS	BDNF45G20C7A	RS
	480	4.25	3	45 ¹ / ₈	(1146.2)	17	(8)	BDNF45G19C5A	RS	BDNF45G19C7A	RS
	240	5.40	3	55 ⁵ / ₈	(1412.9)	19	(9)	BDNF55R20C5A	RS	BDNF55R20C7A	RS
	480	5.40	3	55 ⁵ / ₈	(1412.9)	19	(9)	BDNF55R19C5A	RS	BDNF55R19C7A	RS

RAPID SHIP

- RS - Next day shipment up to 5 pieces

Note: All screw plug bundles are designed to fit the inside diameter of the equivalent mating coupling. They will not fit into the equivalent pipe inside diameter.

- ③ Wired for 3-phase operation only
- ⑧ Can be wired for 1-phase operation

Immersion Heaters

WATROD and FIREBAR Screw Plug Immersion Heaters



Application: Lightweight Oils and Heat Transfer Oils

- 1 1/4 inch NPT screw plug
- FIREBAR elements
- Without thermostat
- General purpose or moisture/explosion-resistant enclosure

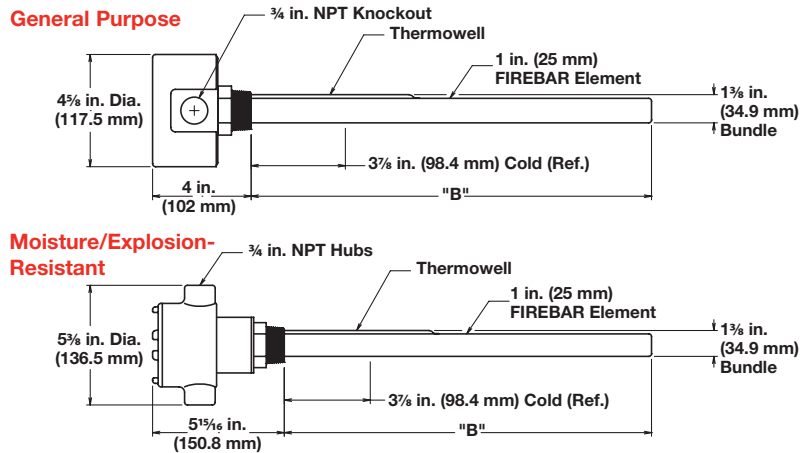

Description	Volts	kW	Ph	"B" Dim. in. (mm)	Part Number	Del.	Ship Wt. lbs (kg)	Part Number ⑦	Del.	Ship Wt. lbs (kg)	
					General Purpose Enclosure			Moisture/Explosion-Resistant Enclosure			
30 W/in² ③ 304 SS Plug 1-Alloy 800 Element (4.7 W/cm²)	240	1.70	3	16 1/8 (409.6)	BDNF16G12S	RS	7 (4)	BDNF16G12C	RS	10 (5)	
	480	1.70	3	16 1/8 (409.6)	BDNF16G13S	RS	7 (4)	BDNF16G13C	RS	10 (5)	
	240	2.20	3	19 1/8 (485.8)	BDNF19G12S	RS	8 (4)	BDNF19G12C	RS	11 (5)	
	480	2.20	3	19 1/8 (485.8)	BDNF19G13S	RS	8 (4)	BDNF19G13C	RS	11 (5)	
	240	2.80	3	24 3/8 (619.1)	BDNF24L12S	RS	9 (4)	BDNF24L12C	RS	12 (6)	
	480	2.80	3	24 3/8 (619.1)	BDNF24L13S	RS	9 (4)	BDNF24L13C	RS	12 (6)	
	240	3.50	3	29 5/8 (752.5)	BDNF29R12S	RS	10 (5)	BDNF29R12C	RS	13 (6)	
	480	3.50	3	29 5/8 (752.5)	BDNF29R13S	RS	10 (5)	BDNF29R13C	RS	13 (6)	
	240	4.25	3	34 5/8 (879.5)	BDNF34R12S	RS	11 (5)	BDNF34R12C	RS	14 (7)	
	480	4.25	3	34 5/8 (879.5)	BDNF34R13S	RS	11 (5)	BDNF34R13C	RS	14 (7)	
	240	5.70	3	45 1/8 (1146.2)	BDNF45G12S	RS	13 (6)	BDNF45G12C	RS	16 (8)	
	480	5.70	3	45 1/8 (1146.2)	BDNF45G13S	RS	13 (6)	BDNF45G13C	RS	16 (8)	
23 W/in² ⑧ 304 SS Plug 1-Alloy 800 Element (3.6 W/cm²)	240	1.25	3	16 1/8 (409.6)	BDNF16G20S	RS	7 (4)	BDNF16G20C	RS	10 (5)	
	240	1.65	3	19 1/8 (485.8)	BDNF19G20S	RS	8 (4)	BDNF19G20C	RS	11 (5)	
	240	2.15	3	24 3/8 (619.1)	BDNF24L20S	RS	9 (4)	BDNF24L20C	RS	12 (6)	
	480	2.15	3	24 3/8 (619.1)	BDNF24L19S	RS	9 (4)	BDNF24L19C	RS	12 (6)	
	240	2.65	3	29 5/8 (752.5)	BDNF29R20S	RS	10 (5)	BDNF29R20C	RS	13 (6)	
	480	2.65	3	29 5/8 (752.5)	BDNF29R19S	RS	10 (5)	BDNF29R19C	RS	13 (6)	
	240	3.20	3	34 5/8 (879.5)	BDNF34R20S	RS	11 (5)	BDNF34R20C	RS	14 (7)	
	480	3.20	3	34 5/8 (879.5)	BDNF34R19S	RS	11 (5)	BDNF34R19C	RS	14 (7)	
	240	4.25	3	45 1/8 (1146.2)	BDNF45G20S	RS	13 (6)	BDNF45G20C	RS	16 (8)	
	480	4.25	3	45 1/8 (1146.2)	BDNF45G19S	RS	13 (6)	BDNF45G19C	RS	16 (8)	
	240	5.40	3	55 5/8 (1412.9)	BDNF55R20S	RS	15 (7)	BDNF55R20C	RS	18 (9)	
	480	5.40	3	55 5/8 (1412.9)	BDNF55R19S	RS	15 (7)	BDNF55R19C	RS	18 (9)	

RAPID SHIP

- RS - Next day shipment up to 5 pieces

Note: All screw plug bundles are designed to fit the inside diameter of the equivalent mating coupling. They will not fit into the equivalent pipe inside diameter.

- ③ Wired for 3-phase operation only
- ⑦ CSA certified only
- ⑧ Can be wired for 1-phase operation

Immersion Heaters

WATROD and FIREBAR Screw Plug Immersion Heaters



Application: Lightweight Oils and Heat Transfer Oils

- 2 inch NPT screw plug
- WATROD elements
- With thermostat (DPST)

Note: Higher amperage products require a pilot duty thermostat with separate power controller. Please see following pages for available heaters without thermostats.

- General purpose enclosure

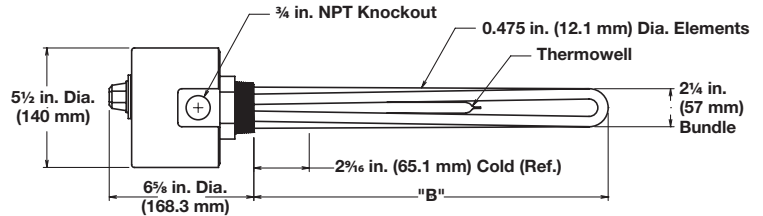

Description	Volts	kW	Ph	"B" Dim. in. (mm)		Ship Wt. lbs (kg)		Type 4 (30 to 110°F)		Type 5A (60 to 250°F)		Type 7A (100 to 550°F)	
								Part Number	Del.	Part Number	Del.	Part Number	Del.
General Purpose Enclosure													
23 W/in² ④ Steel Plug 2-Steel Elements (3.6 W/cm²)	120/240	1.0	1	9 ¹ / ₂	(241)	5	(3)	BGS79J6S4	RS	BGS79J6S5A	RS	BGS79J6S7A	RS
	240/480	1.0	1	9 ¹ / ₂	(241)	5	(3)	BGS79J7S4	RS	BGS79J7S5A	RS	BGS79J7S7A	RS
	120/240	1.5	1	13 ¹ / ₂	(343)	6	(3)	BGS713J6S4	RS	BGS713J6S5A	RS	BGS713J6S7A	RS
	240/480	1.5	1	13 ¹ / ₂	(343)	6	(3)	BGS713J7S4	RS	BGS713J7S5A	RS	BGS713J7S7A	RS
	120/240	2.0	1	17 ¹ / ₂	(445)	7	(4)	BGS717J6S4	RS	BGS717J6S5A	RS	BGS717J6S7A	RS
	240/480	2.0	1	17 ¹ / ₂	(445)	7	(4)	BGS717J7S4	RS	BGS717J7S5A	RS	BGS717J7S7A	RS
	120/240	2.5	1	20 ¹ / ₂	(521)	8	(4)	BGS720J6S4	RS	BGS720J6S5A	RS	BGS720J6S7A	RS
	240/480	2.5	1	20 ¹ / ₂	(521)	8	(4)	BGS720J7S4	RS	BGS720J7S5A	RS	BGS720J7S7A	RS
	120/240	3.0	1	25	(635)	8	(4)	BGS725A6S4	RS	BGS725A6S5A	RS	BGS725A6S7A	RS
	240/480	3.0	1	25	(635)	8	(4)	BGS725A7S4	RS	BGS725A7S5A	RS	BGS725A7S7A	RS
	120/240	4.0	1	32 ¹ / ₂	(826)	9	(4)	BGS732J6S4	RS	BGS732J6S5A	RS	BGS732J6S7A	RS
120/240	5.0	1	40	(1016)	10	(5)	BGS740A6S4	RS	BGS740A6S5A	RS	BGS740A6S7A	RS	
23 W/in² Steel Plug 3-Steel Elements (3.6 W/cm²)	120	1.5	1	9 ¹ / ₂	(241)	6	(3)	BHS79J1S4	RS	BHS79J1S5A	RS	BHS79J1S7A	RS
	240	1.5	3	9 ¹ / ₂	(241)	6	(3)	BHS79J3S4	RS	BHS79J3S5A	RS	BHS79J3S7A	RS
	480	1.5	3	9 ¹ / ₂	(241)	6	(3)	BHS79J13S4	RS	BHS79J13S5A	RS	BHS79J13S7A	RS
	240	3.0	3	17 ¹ / ₂	(445)	8	(4)	BHS717J3S4	RS	BHS717J3S5A	RS	BHS717J3S7A	RS
	480	3.0	3	17 ¹ / ₂	(445)	8	(4)	BHS717J5S4	RS	BHS717J5S5A	RS	BHS717J5S7A	RS
	240	4.5	3	25	(635)	10	(5)	BHS725A3S4	RS	BHS725A3S5A	RS	BHS725A3S7A	RS
	480	4.5	3	25	(635)	10	(5)	BHS725A5S4	RS	BHS725A5S5A	RS	BHS725A5S7A	RS
	240	6.0	3	32 ¹ / ₂	(826)	13	(6)	BHS732J3S4	RS	BHS732J3S5A	RS	BHS732J3S7A	RS
	480	6.0	3	32 ¹ / ₂	(826)	13	(6)	BHS732J5S4	RS	BHS732J5S5A	RS	BHS732J5S7A	RS
	240	7.5	3	40	(1016)	14	(7)	BHS740A3S4	RS	BHS740A3S5A	RS	BHS740A3S7A	RS
	480	7.5	3	40	(1016)	14	(7)	BHS740A5S4	RS	BHS740A5S5A	RS	BHS740A5S7A	RS
240	9.0	3	47 ¹ / ₂	(1207)	14	(7)	BHS747J3S4	RS	BHS747J3S5A	RS	BHS747J3S7A	RS	

RAPID SHIP

- RS - Next day shipment up to 5 pieces

Note: All screw plug bundles are designed to fit the inside diameter of the equivalent mating coupling. They will not fit into the equivalent pipe inside diameter.

- ④ Wired for higher voltage

Immersion Heaters

WATROD and FIREBAR Screw Plug Immersion Heaters



Application: Lightweight Oils and Heat Transfer Oils

- 2 inch NPT screw plug
- WATROD elements
- With thermostat (DPST)

Note: Higher amperage products require a pilot duty thermostat with separate power controller. Please see following pages for available heaters without thermostats.

- Moisture/explosion-resistant enclosure

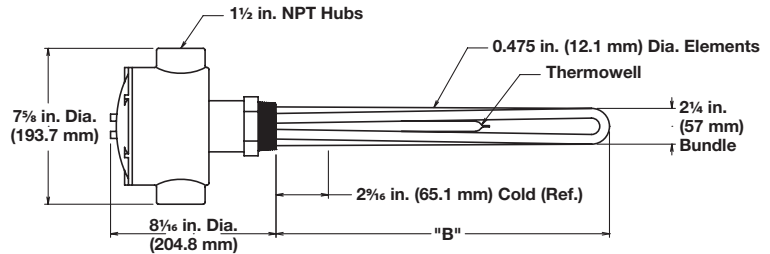

Description	Volts	kW	Ph	"B" Dim. in. (mm)	Ship Wt. lbs (kg)	Type 4 (30 to 110°F)		Type 5A (60 to 250°F)		Type 7A (100 to 550°F)	
						Part Number	Del.	Part Number	Del.	Part Number	Del.
Moisture/Explosion-Resistant Enclosure											
23 W/in² ④ Steel Plug 2-Steel Elements (3.6 W/cm²)	120/240	1.0	1	9 1/2 (241)	8 (4)	BGS79J6C4	RS	BGS79J6C5A	RS	BGS79J6C7A	RS
	240/480	1.0	1	9 1/2 (241)	8 (4)	BGS79J7C4	RS	BGS79J7C5A	RS	BGS79J7C7A	RS
	120/240	1.5	1	13 1/2 (343)	9 (4)	BGS713J6C4	RS	BGS713J6C5A	RS	BGS713J6C7A	RS
	240/480	1.5	1	13 1/2 (343)	9 (4)	BGS713J7C4	RS	BGS713J7C5A	RS	BGS713J7C7A	RS
	120/240	2.0	1	17 1/2 (445)	10 (5)	BGS717J6C4	RS	BGS717J6C5A	RS	BGS717J6C7A	RS
	240/480	2.0	1	17 1/2 (445)	10 (5)	BGS717J7C4	RS	BGS717J7C5A	RS	BGS717J7C7A	RS
	120/240	2.5	1	20 1/2 (521)	11 (5)	BGS720J6C4	RS	BGS720J6C5A	RS	BGS720J6C7A	RS
	240/480	2.5	1	20 1/2 (521)	11 (5)	BGS720J7C4	RS	BGS720J7C5A	RS	BGS720J7C7A	RS
	120/240	3.0	1	25 (635)	11 (5)	BGS725A6C4	RS	BGS725A6C5A	RS	BGS725A6C7A	RS
	240/480	3.0	1	25 (635)	11 (5)	BGS725A7C4	RS	BGS725A7C5A	RS	BGS725A7C7A	RS
23 W/in² Steel Plug 3-Steel Elements (3.6 W/cm²)	120	1.5	1	9 1/2 (241)	9 (4)	BHS79J1C4	RS	BHS79J1C5A	RS	BHS79J1C7A	RS
	240	1.5	3	9 1/2 (241)	9 (4)	BHS79J3C4	RS	BHS79J3C5A	RS	BHS79J3C7A	RS
	480	1.5	3	9 1/2 (241)	9 (4)	BHS79J13C4	RS	BHS79J13C5A	RS	BHS79J13C7A	RS
	240	3.0	3	17 1/2 (445)	11 (5)	BHS717J3C4	RS	BHS717J3C5A	RS	BHS717J3C7A	RS
	480	3.0	3	17 1/2 (445)	11 (5)	BHS717J5C4	RS	BHS717J5C5A	RS	BHS717J5C7A	RS
	240	4.5	3	25 (635)	13 (6)	BHS725A3C4	RS	BHS725A3C5A	RS	BHS725A3C7A	RS
	480	4.5	3	25 (635)	13 (6)	BHS725A5C4	RS	BHS725A5C5A	RS	BHS725A5C7A	RS
	240	6.0	3	32 1/2 (826)	16 (8)	BHS732J3C4	RS	BHS732J3C5A	RS	BHS732J3C7A	RS
	480	6.0	3	32 1/2 (826)	16 (8)	BHS732J5C4	RS	BHS732J5C5A	RS	BHS732J5C7A	RS
	240	7.5	3	40 (1016)	17 (8)	BHS740A3C4	RS	BHS740A3C5A	RS	BHS740A3C7A	RS
480	7.5	3	40 (1016)	17 (8)	BHS740A5C4	RS	BHS740A5C5A	RS	BHS740A5C7A	RS	
240	9.0	3	47 1/2 (1207)	17 (8)	BHS747J3C4	RS	BHS747J3C5A	RS	BHS747J3C7A	RS	

RAPID SHIP

- RS - Next day shipment up to 5 pieces

Note: All screw plug bundles are designed to fit the inside diameter of the equivalent mating coupling. They will not fit into the equivalent pipe inside diameter.

- ④ Wired for higher voltage

Immersion Heaters

WATROD and FIREBAR Screw Plug Immersion Heaters



Application: Lightweight Oils and Heat Transfer Oils

- 2 inch NPT screw plug
- WATROD elements
- Without thermostat
- General purpose or moisture/explosion-resistant enclosure

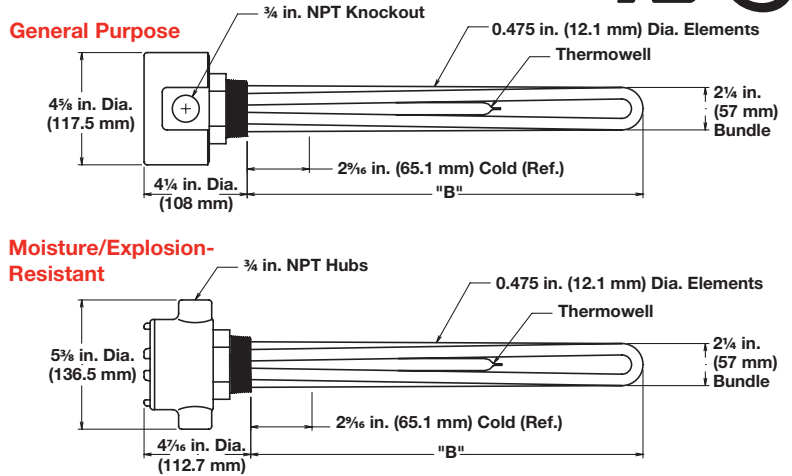

Description	Volts	kW	Ph	"B" Dim. in. (mm)	Part Number	Del.	Ship Wt. lbs (kg)	Part Number ⑦	Del.	Ship Wt. lbs (kg)
23 W/in² ④ Steel Plug 2-Steel Elements (3.6 W/cm²)	120/240	1.0	1	9 1/2 (241)	BGS79J6S	RS	4 (2)	BGS79J6C	RS	7 (4)
	240/480	1.0	1	9 1/2 (241)	BGS79J7S	RS	4 (2)	BGS79J7C	RS	7 (4)
	120/240	1.5	1	13 1/2 (343)	BGS713J6S	RS	5 (3)	BGS713J6C	RS	8 (4)
	240/480	1.5	1	13 1/2 (343)	BGS713J7S	RS	5 (3)	BGS713J7C	RS	8 (4)
	120/240	2.0	1	17 1/2 (445)	BGS717J6S	RS	6 (3)	BGS717J6C	RS	9 (4)
	240/480	2.0	1	17 1/2 (445)	BGS717J7S	RS	6 (3)	BGS717J7C	RS	9 (4)
	120/240	2.5	1	20 1/2 (521)	BGS720J6S	RS	7 (4)	BGS720J6C	RS	10 (5)
	240/480	2.5	1	20 1/2 (521)	BGS720J7S	RS	7 (4)	BGS720J7C	RS	10 (5)
	120/240	3.0	1	25 (635)	BGS725A6S	RS	7 (4)	BGS725A6C	RS	10 (5)
	240/480	3.0	1	25 (635)	BGS725A7S	RS	7 (4)	BGS725A7C	RS	10 (5)
	120/240	4.0	1	32 1/2 (826)	BGS732J6S	RS	8 (4)	BGS732J6C	RS	11 (5)
	240/480	4.0	1	32 1/2 (826)	BGS732J7S	RS	8 (4)	BGS732J7C	RS	11 (5)
	120/240	5.0	1	40 (1016)	BGS740A6S	RS	9 (4)	BGS740A6C	RS	12 (6)
	240/480	5.0	1	40 (1016)	BGS740A7S	RS	9 (4)	BGS740A7C	RS	12 (6)
	240/480	6.0	1	47 1/2 (1207)	BGS747J7S	RS	10 (5)	BGS747J7C	RS	13 (6)
23 W/in² Steel Plug 3-Steel Elements (3.6 W/cm²)	120	1.5	1	9 1/2 (241)	BHS79J1S	RS	5 (3)	BHS79J1C	RS	8 (4)
	240	1.5	3	9 1/2 (241)	BHS79J3S	RS	5 (3)	BHS79J3C	RS	8 (4)
	480	1.5	3	9 1/2 (241)	BHS79J13S	RS	5 (3)	BHS79J13C	RS	8 (4)
	120	3.0	1	17 1/2 (445)	BHS717J1S	RS	7 (4)	BHS717J1C	RS	10 (5)
	240	3.0	3	17 1/2 (445)	BHS717J3S	RS	7 (4)	BHS717J3C	RS	10 (5)
	480	3.0	3	17 1/2 (445)	BHS717J5S	RS	7 (4)	BHS717J5C	RS	10 (5)
	120	4.5	1	25 (635)	BHS725A1S	RS	9 (4)	BHS725A1C	RS	12 (6)
	240	4.5	3	25 (635)	BHS725A3S	RS	9 (4)	BHS725A3C	RS	12 (6)
	480	4.5	3	25 (635)	BHS725A5S	RS	9 (4)	BHS725A5C	RS	12 (6)
	240	6.0	3	32 1/2 (826)	BHS732J3S	RS	12 (6)	BHS732J3C	RS	15 (7)
	480	6.0	3	32 1/2 (826)	BHS732J5S	RS	12 (6)	BHS732J5C	RS	15 (7)
	240	7.5	3	40 (1016)	BHS740A3S	RS	13 (6)	BHS740A3C	RS	16 (8)
	480	7.5	3	40 (1016)	BHS740A5S	RS	13 (6)	BHS740A5C	RS	16 (8)
	240	9.0	3	47 1/2 (1207)	BHS747J3S	RS	13 (6)	BHS747J3C	RS	16 (8)
	480	9.0	3	47 1/2 (1207)	BHS747J5S	RS	13 (6)	BHS747J5C	RS	16 (8)
240	12.5	3	64 (1626)	BHS764A3S	RS	17 (8)	BHS764A3C	RS	20 (9)	
480	12.5	3	64 (1626)	BHS764A5S	RS	17 (8)	BHS764A5C	RS	20 (9)	

RAPID SHIP

- RS - Next day shipment up to 5 pieces

Note: All screw plug bundles are designed to fit the inside diameter of the equivalent mating coupling. They will not fit into the equivalent pipe inside diameter.

④ Wired for higher voltage

⑦ CSA certified only

Immersion Heaters

WATROD and FIREBAR Screw Plug Immersion Heaters



Application: Lightweight Oils and Heat Transfer Oils

- 2 1/2 inch NPT screw plug
- WATROD elements
- With thermostat (DPST)

Note: Higher amperage products require a pilot duty thermostat with separate power controller. Please see following pages for available heaters without thermostats.

- General purpose or moisture/explosion-resistant enclosure

General Purpose

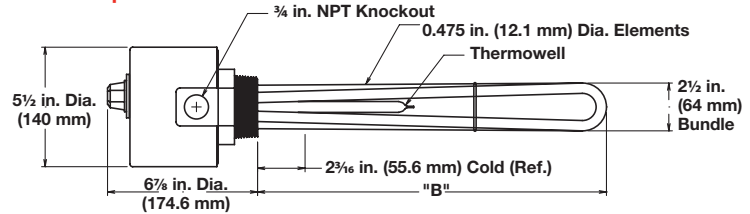

Moisture/Explosion-Resistant

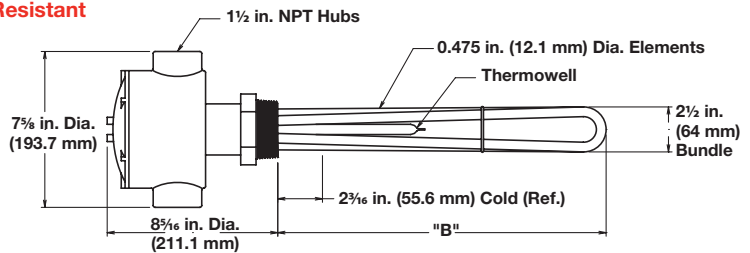

Description	Volts	kW	Ph	"B" Dim. in. (mm)		Ship Wt. lbs (kg)		Type 4 (30 to 110°F)		Type 5A (60 to 250°F)		Type 7A (100 to 550°F)	
								Part Number	Del.	Part Number	Del.	Part Number	Del.
General Purpose Enclosure													
23 W/in ² ⑥ Steel Plug 3-Steel Elements (3.6 Wcm ²)	240	3.0	3	17 1/4	(438)	10	(5)	BLS717E3S4	RS	BLS717E3S5A	RS	BLS717E3S7A	RS
	480	3.0	3	17 1/4	(438)	10	(5)	BLS717E5S4	RS	BLS717E5S5A	RS	BLS717E5S7A	RS
	240	4.5	3	24 3/4	(629)	13	(6)	BLS724N3S4	RS	BLS724N3S5A	RS	BLS724N3S7A	RS
	480	4.5	3	24 3/4	(629)	13	(6)	BLS724N5S4	RS	BLS724N5S5A	RS	BLS724N5S7A	RS
	240	6.0	3	32 1/4	(819)	15	(7)	BLS732E3S4	RS	BLS732E3S5A	RS	BLS732E3S7A	RS
	480	6.0	3	32 1/4	(819)	15	(7)	BLS732E5S4	RS	BLS732E5S5A	RS	BLS732E5S7A	RS
	240	7.5	3	39 3/4	(1010)	16	(8)	BLS739N3S4	RS	BLS739N3S5A	RS	BLS739N3S7A	RS
	480	7.5	3	39 3/4	(1010)	16	(8)	BLS739N5S4	RS	BLS739N5S5A	RS	BLS739N5S7A	RS
	240	9.0	3	47 1/4	(1200)	18	(9)	BLS747E3S4	RS	BLS747E3S5A	RS	BLS747E3S7A	RS
Moisture/Explosion-Resistant Enclosure ⑦													
23 W/in ² ⑥ Steel Plug 3-Steel Elements (3.6 Wcm ²)	240	3.0	3	17 1/4	(438)	13	(6)	BLS717E3C4	RS	BLS717E3C5A	RS	BLS717E3C7A	RS
	480	3.0	3	17 1/4	(438)	13	(6)	BLS717E5C4	RS	BLS717E5C5A	RS	BLS717E5C7A	RS
	240	4.5	3	24 3/4	(629)	16	(8)	BLS724N3C4	RS	BLS724N3C5A	RS	BLS724N3C7A	RS
	480	4.5	3	24 3/4	(629)	16	(8)	BLS724N5C4	RS	BLS724N5C5A	RS	BLS724N5C7A	RS
	240	6.0	3	32 1/4	(819)	18	(9)	BLS732E3C4	RS	BLS732E3C5A	RS	BLS732E3C7A	RS
	480	6.0	3	32 1/4	(819)	18	(9)	BLS732E5C4	RS	BLS732E5C5A	RS	BLS732E5C7A	RS
	240	7.5	3	39 3/4	(1010)	19	(9)	BLS739N3C4	RS	BLS739N3C5A	RS	BLS739N3C7A	RS
	480	7.5	3	39 3/4	(1010)	19	(9)	BLS739N5C4	RS	BLS739N5C5A	RS	BLS739N5C7A	RS
	240	9.0	3	47 1/4	(1200)	21	(10)	BLS747E3C4	RS	BLS747E3C5A	RS	BLS747E3C7A	RS

RAPID SHIP

- RS - Next day shipment up to 5 pieces

Note: All screw plug bundles are designed to fit the inside diameter of the equivalent mating coupling. They will not fit into the equivalent pipe inside diameter.

⑥ Can be rewired to produce 1/3 of original kW and watt density (3-phase only)

⑦ CSA certified only

Immersion Heaters

WATROD and FIREBAR Screw Plug Immersion Heaters



Application: Lightweight Oils and Heat Transfer Oils

- 2 1/2 inch NPT screw plug
- WATROD elements
- Without thermostat
- General purpose or moisture/explosion-resistant enclosure

General Purpose

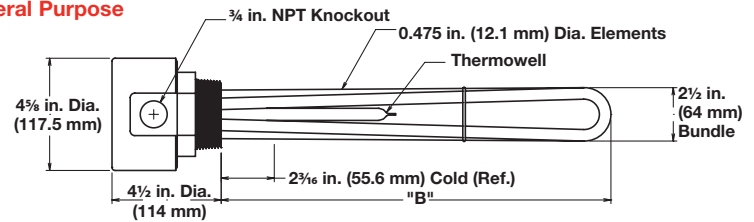

Moisture/Explosion-Resistant

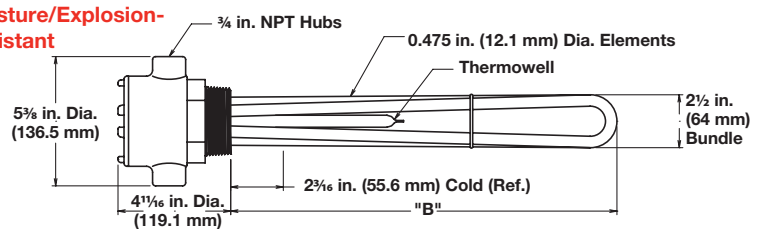

Description	Volts	kW	Ph	"B" Dim. in. (mm)		Part Number	Del.	Ship Wt. lbs (kg)		Part Number ⑦	Del.	Ship Wt. lbs (kg)	
						General Purpose Enclosure				Moisture /Explosion-Resistant Enclosure			
23 W/in ² ⑥ Steel Plug 3-Steel Elements (3.6 Wcm ²)	120	3.0	1	17 1/4	(438)	BLS717E1S	RS	9	(4)	BLS717E1C	RS	12	(6)
	240	3.0	3	17 1/4	(438)	BLS717E3S	RS	9	(4)	BLS717E3C	RS	12	(6)
	480	3.0	3	17 1/4	(438)	BLS717E5S	RS	9	(4)	BLS717E5C	RS	12	(6)
	120	4.5	1	24 3/4	(629)	BLS724N1S	RS	12	(6)	BLS724N1C	RS	15	(7)
	240	4.5	3	24 3/4	(629)	BLS724N3S	RS	12	(6)	BLS724N3C	RS	15	(7)
	480	4.5	3	24 3/4	(629)	BLS724N5S	RS	12	(6)	BLS724N5C	RS	15	(7)
	240	6.0	3	32 1/4	(819)	BLS732E3S	RS	14	(7)	BLS732E3C	RS	17	(8)
	480	6.0	3	32 1/4	(819)	BLS732E5S	RS	14	(7)	BLS732E5C	RS	17	(8)
	240	7.5	3	39 3/4	(1010)	BLS739N3S	RS	15	(7)	BLS739N3C	RS	18	(9)
	480	7.5	3	39 3/4	(1010)	BLS739N5S	RS	15	(7)	BLS739N5C	RS	18	(9)
	240	9.0	3	47 1/4	(1200)	BLS747E3S	RS	17	(8)	BLS747E3C	RS	20	(9)
	480	9.0	3	47 1/4	(1200)	BLS747E5S	RS	17	(8)	BLS747E5C	RS	20	(9)
	240	12.5	3	63 3/4	(1619)	BLS763N3S	RS	20	(9)	BLS763N3C	RS	23	(11)
	480	12.5	3	63 3/4	(1619)	BLS763N5S	RS	20	(9)	BLS763N5C	RS	23	(11)
	240	15.0	3	76 1/4	(1937)	BLS776E3S	RS	23	(11)	BLS776E3C	RS	26	(12)
	480	15.0	3	76 1/4	(1937)	BLS776E5S	RS	23	(11)	BLS776E5C	RS	26	(12)

RAPID SHIP

- RS - Next day shipment up to 5 pieces

Note: All screw plug bundles are designed to fit the inside diameter of the equivalent mating coupling. They will not fit into the equivalent pipe inside diameter.

⑥ Can be rewired to produce 1/3 of original kW and watt density (3-phase only)

⑦ CSA certified only

Immersion Heaters

WATROD and FIREBAR Screw Plug Immersion Heaters



Application: Lightweight Oils and Heat Transfer Oils

- 2 1/2 inch NPT screw plug
- FIREBAR elements
- With thermostat (DPST)

Note: Higher amperage products require a pilot duty thermostat with separate power controller. Please see following pages for available heaters without thermostats.

- General purpose or moisture/explosion-resistant enclosure

General Purpose

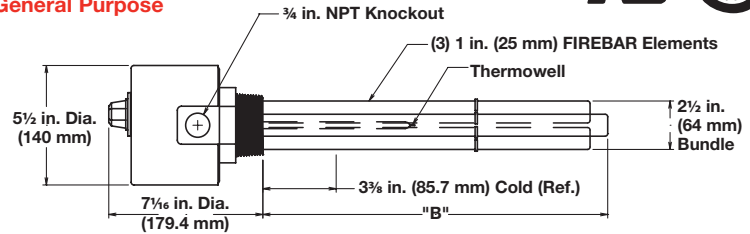

Moisture/Explosion-Resistant

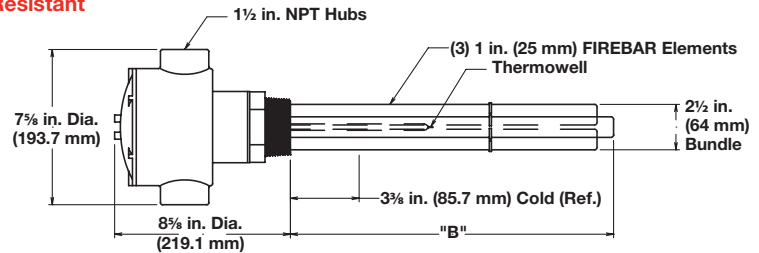

Description	Volts	kW	Ph	"B" Dim. in. (mm)	Ship Wt. lbs (kg)	Type 5A (60 to 250°F)		Type 7A (100 to 550°F)		
						Part Number	Del.	Part Number	Del.	
General Purpose Enclosure										
30 W/in² ③ 304 SS Plug 3-Alloy 800 Elements (4.7 W/cm²)	240	5.0	3	15 1/8 (384.2)	12 (6)	BLNF15C12S5A	RS	BLNF15C12S7A	RS	
	480	5.0	3	15 1/8 (384.2)	12 (6)	BLNF15C13S5A	RS	BLNF15C13S7A	RS	
	240	6.5	3	18 1/8 (460.4)	13 (6)	BLNF18C12S5A	RS	BLNF18C12S7A	RS	
	480	6.5	3	18 1/8 (460.4)	13 (6)	BLNF18C13S5A	RS	BLNF18C13S7A	RS	
23 W/in² ⑧ 304 SS Plug 3-Alloy 800 Elements (3.6 W/cm²)	240	8.5	3	23 1/8 (587.4)	15 (7)	BLNF23C12S5A	RS	BLNF23C12S7A	RS	
	240	3.8	3	15 1/8 (384.2)	12 (6)	BLNF15C20S5A	RS	BLNF15C20S7A	RS	
	240	4.9	3	18 1/8 (460.4)	13 (6)	BLNF18C20S5A	RS	BLNF18C20S7A	RS	
	240	6.4	3	23 1/8 (587.4)	15 (7)	BLNF23C20S5A	RS	BLNF23C20S7A	RS	
	480	6.4	3	23 1/8 (587.4)	15 (7)	BLNF23C19S5A	RS	BLNF23C19S7A	RS	
	240	7.9	3	28 5/8 (727.1)	18 (9)	BLNF28L20S5A	RS	BLNF28L20S7A	RS	
240	9.6	3	33 5/8 (854.1)	19 (9)	BLNF33L20S5A	RS	BLNF33L20S7A	RS		
Moisture/Explosion-Resistant Enclosure ⑦										
30 W/in² ③ 304 SS Plug 3-Alloy 800 Elements (4.7 W/cm²)	240	5.0	3	15 1/8 (384.2)	14 (7)	BLNF15C12C5A	RS	BLNF15C12C7A	RS	
	480	5.0	3	15 1/8 (384.2)	14 (7)	BLNF15C13C5A	RS	BLNF15C13C7A	RS	
	240	6.5	3	18 1/8 (460.4)	16 (8)	BLNF18C12C5A	RS	BLNF18C12C7A	RS	
	480	6.5	3	18 1/8 (460.4)	16 (8)	BLNF18C13C5A	RS	BLNF18C13C7A	RS	
	240	8.5	3	23 1/8 (587.4)	18 (9)	BLNF23C12C5A	RS	BLNF23C12C7A	RS	
23 W/in² ⑧ 304 SS Plug 3-Alloy 800 Elements (3.6 W/cm²)	240	3.8	3	15 1/8 (384.2)	14 (7)	BLNF15C20C5A	RS	BLNF15C20C7A	RS	
	240	4.9	3	18 1/8 (460.4)	16 (8)	BLNF18C20C5A	RS	BLNF18C20C7A	RS	
	240	6.4	3	23 1/8 (587.4)	18 (9)	BLNF23C20C5A	RS	BLNF23C20C7A	RS	
	480	6.4	3	23 1/8 (587.4)	18 (9)	BLNF23C19C5A	RS	BLNF23C19C7A	RS	
	240	7.9	3	28 5/8 (727.1)	21 (10)	BLNF28L20C5A	RS	BLNF28L20C7A	RS	
	240	9.6	3	33 5/8 (854.1)	22 (10)	BLNF33L20C5A	RS	BLNF33L20C7A	RS	

RAPID SHIP

- RS - Next day shipment up to 5 pieces

Note: All screw plug bundles are designed to fit the inside diameter of the equivalent mating coupling. They will not fit into the equivalent pipe inside diameter.

- ③ Wired for 3-phase operation only
- ⑦ CSA certified only
- ⑧ Can be wired for 1-phase operation

Immersion Heaters

WATROD and FIREBAR Screw Plug Immersion Heaters



Application: Lightweight Oils and Heat Transfer Oils

- 2 1/2 inch NPT screw plug
- FIREBAR elements
- Without thermostat
- General purpose or moisture/explosion-resistant enclosure

General Purpose

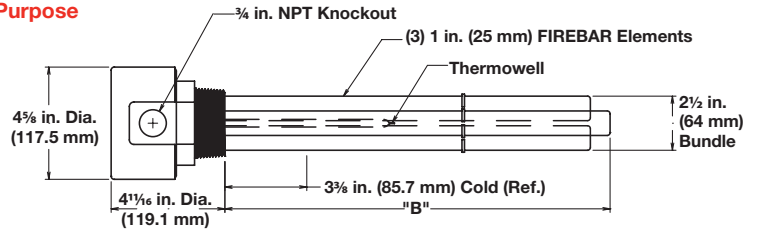

Moisture/Explosion-Resistant

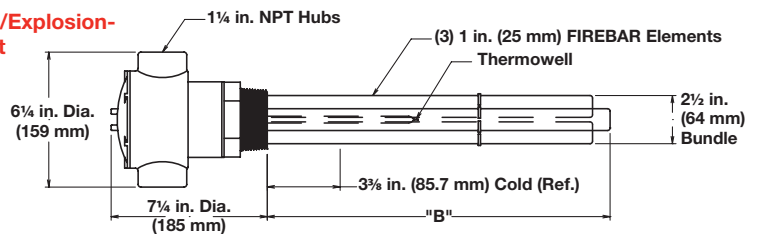

Description	Volts	kW	Ph	"B" Dim. in. (mm)	Part Number	Del.	Ship Wt. lbs (kg)	Part Number ⑦	Del.	Ship Wt. lbs (kg)
					General Purpose Enclosure			Moisture/Explosion-Resistant Enclosure		
30 W/in² ③ 304 SS Plug 3-Alloy 800 Elements (4.7 W/cm²)	240	5.0	3	15 1/8 (384.2)	BLNF15C12S	RS	11 (5)	BLNF15C12C	RS	14 (7)
	480	5.0	3	15 1/8 (384.2)	BLNF15C13S	RS	11 (5)	BLNF15C13C	RS	14 (7)
	240	6.5	3	18 1/8 (460.4)	BLNF18C12S	RS	12 (6)	BLNF18C12C	RS	15 (7)
	480	6.5	3	18 1/8 (460.4)	BLNF18C13S	RS	12 (6)	BLNF18C13C	RS	15 (7)
	240	8.5	3	23 1/8 (587.4)	BLNF23C12S	RS	14 (7)	BLNF23C12C	RS	17 (8)
	480	8.5	3	23 1/8 (587.4)	BLNF23C13S	RS	14 (7)	BLNF23C13C	RS	17 (8)
	240	10.5	3	28 5/8 (727.1)	BLNF28L12S	RS	17 (8)	BLNF28L12C	RS	20 (9)
	480	10.5	3	28 5/8 (727.1)	BLNF28L13S	RS	17 (8)	BLNF28L13C	RS	20 (9)
	240	12.8	3	33 5/8 (854.1)	BLNF33L12S	RS	18 (9)	BLNF33L12C	RS	21 (10)
	480	12.8	3	33 5/8 (854.1)	BLNF33L13S	RS	18 (9)	BLNF33L13C	RS	21 (10)
	240	17.0	3	44 1/8 (1120.8)	BLNF44C12S	RS	20 (9)	BLNF44C12C	RS	23 (11)
	480	17.0	3	44 1/8 (1120.8)	BLNF44C13S	RS	20 (9)	BLNF44C13C	RS	23 (11)
480	21.5	3	54 5/8 (1387.5)	BLNF54L13S	RS	22 (10)	BLNF54L13C	RS	25 (12)	
23 W/in² ⑧ 304 SS Plug 3-Alloy 800 Elements (3.6 W/cm²)	240	3.8	3	15 1/8 (384.2)	BLNF15C20S	RS	11 (5)	BLNF15C20C	RS	14 (7)
	240	4.9	3	18 1/8 (460.4)	BLNF18C20S	RS	12 (6)	BLNF18C20C	RS	15 (7)
	240	6.4	3	23 1/8 (587.4)	BLNF23C20S	RS	14 (7)	BLNF23C20C	RS	17 (8)
	480	6.4	3	23 1/8 (587.4)	BLNF23C19S	RS	14 (7)	BLNF23C19C	RS	17 (8)
	240	7.9	3	28 5/8 (727.1)	BLNF28L20S	RS	17 (8)	BLNF28L20C	RS	20 (9)
	480	7.9	3	28 5/8 (727.1)	BLNF28L19S	RS	17 (8)	BLNF28L19C	RS	20 (9)
	240	9.6	3	33 5/8 (854.1)	BLNF33L20S	RS	18 (9)	BLNF33L20C	RS	21 (10)
	480	9.6	3	33 5/8 (854.1)	BLNF33L19S	RS	18 (9)	BLNF33L19C	RS	21 (10)
	240	12.8	3	44 1/8 (1120.8)	BLNF44C20S	RS	20 (9)	BLNF44C20C	RS	23 (11)
	480	12.8	3	44 1/8 (1120.8)	BLNF44C19S	RS	20 (9)	BLNF44C19C	RS	23 (11)
	240	16.1	3	54 5/8 (1387.5)	BLNF54L20S	RS	22 (10)	BLNF54L20C	RS	25 (12)
	480	16.1	3	54 5/8 (1387.5)	BLNF54L19S	RS	22 (10)	BLNF54L19C	RS	25 (12)

RAPID SHIP

- RS - Next day shipment up to 5 pieces

Note: All screw plug bundles are designed to fit the inside diameter of the equivalent mating coupling. They will not fit into the equivalent pipe inside diameter.

③ Wired for 3-phase operation only

⑦ CSA certified only

⑧ Can be wired for 1-phase operation

Immersion Heaters

WATROD and FIREBAR Screw Plug Immersion Heaters



Application: Medium Weight Oils and Heat Transfer Oils

- 1 1/4 inch NPT screw plug
- FIREBAR elements
- With thermostat (DPST)
- General purpose or moisture/explosion-resistant enclosure

General Purpose

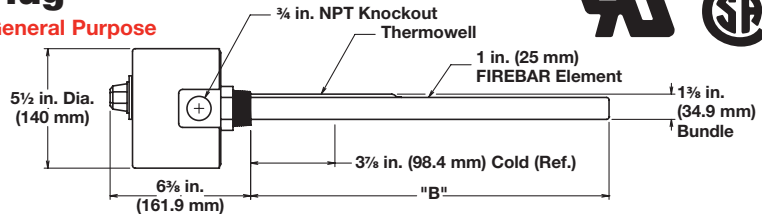

Moisture/Explosion-Resistant

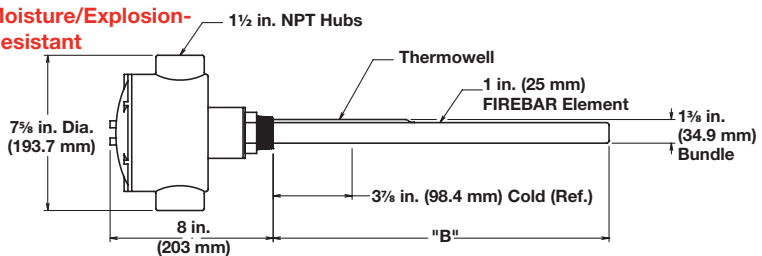

Description	Volts	kW	Ph	"B" Dim. in. (mm)		Ship Wt. lbs (kg)		Type 5A (60 to 250°F)		Type 7A (100 to 550°F)	
								Part Number	Del.	Part Number	Del.
General Purpose Enclosure											
15 W/in ² ③ 304 SS Plug 1-Alloy 800 Element (2.3 W/cm ²)	240	0.67	3	13	(330)	7	(4)	BDNF13A29S5A	RS	BDNF13A29S7A	RS
	240	0.83	3	15 1/2	(394)	8	(4)	BDNF15J29S5A	RS	BDNF15J29S7A	RS
	240	1.00	3	18	(457)	9	(4)	BDNF18A29S5A	RS	BDNF18A29S7A	RS
	240	1.33	3	22 1/2	(572)	10	(5)	BDNF22J29S5A	RS	BDNF22J29S7A	RS
	480	1.33	3	22 1/2	(572)	10	(5)	BDNF22J30S5A	RS	BDNF22J30S7A	RS
	240	1.67	3	27 1/2	(699)	11	(5)	BDNF27J29S5A	RS	BDNF27J29S7A	RS
	480	1.67	3	27 1/2	(699)	11	(5)	BDNF27J30S5A	RS	BDNF27J30S7A	RS
	240	2.00	3	32 1/2	(826)	12	(6)	BDNF32J29S5A	RS	BDNF32J29S7A	RS
	480	2.00	3	32 1/2	(826)	12	(6)	BDNF32J30S5A	RS	BDNF32J30S7A	RS
	240	2.67	3	42	(1067)	14	(7)	BDNF42A29S5A	RS	BDNF42A29S7A	RS
	480	2.67	3	42	(1067)	14	(7)	BDNF42A30S5A	RS	BDNF42A30S7A	RS
	240	3.33	3	51 1/2	(1308)	16	(8)	BDNF51J29S5A	RS	BDNF51J29S7A	RS
	480	3.33	3	51 1/2	(1308)	16	(8)	BDNF51J30S5A	RS	BDNF51J30S7A	RS
Moisture/Explosion-Resistant Enclosure ⑦											
15 W/in ² ③ 304 SS Plug 1-Alloy 800 Element (2.3 W/cm ²)	240	0.67	3	13	(330)	10	(5)	BDNF13A29C5A	RS	BDNF13A29C7A	RS
	240	0.83	3	15 1/2	(394)	11	(5)	BDNF15J29C5A	RS	BDNF15J29C7A	RS
	240	1.00	3	18	(457)	12	(6)	BDNF18A29C5A	RS	BDNF18A29C7A	RS
	240	1.33	3	22 1/2	(572)	13	(6)	BDNF22J29C5A	RS	BDNF22J29C7A	RS
	480	1.33	3	22 1/2	(572)	13	(6)	BDNF22J30C5A	RS	BDNF22J30C7A	RS
	240	1.67	3	27 1/2	(699)	14	(7)	BDNF27J29C5A	RS	BDNF27J29C7A	RS
	480	1.67	3	27 1/2	(699)	14	(7)	BDNF27J30C5A	RS	BDNF27J30C7A	RS
	240	2.00	3	32 1/2	(826)	15	(7)	BDNF32J29C5A	RS	BDNF32J29C7A	RS
	480	2.00	3	32 1/2	(826)	15	(7)	BDNF32J30C5A	RS	BDNF32J30C7A	RS
	240	2.67	3	42	(1067)	17	(8)	BDNF42A29C5A	RS	BDNF42A29C7A	RS
	480	2.67	3	42	(1067)	17	(8)	BDNF42A30C5A	RS	BDNF42A30C7A	RS
	240	3.33	3	51 1/2	(1308)	19	(9)	BDNF51J29C5A	RS	BDNF51J29C7A	RS
	480	3.33	3	51 1/2	(1308)	19	(9)	BDNF51J30C5A	RS	BDNF51J30C7A	RS



- RS - Next day shipment up to 5 pieces

Note: All screw plug bundles are designed to fit the inside diameter of the equivalent mating coupling. They will not fit into the equivalent pipe inside diameter.

③ Wired for 3-phase operation only

⑦ CSA certified only

Immersion Heaters

WATROD and FIREBAR Screw Plug Immersion Heaters



Application: Medium Weight Oils and Heat Transfer Oils

- 1 1/4 inch NPT screw plug
- FIREBAR elements
- Without thermostat
- General purpose or moisture/explosion-resistant enclosure

General Purpose

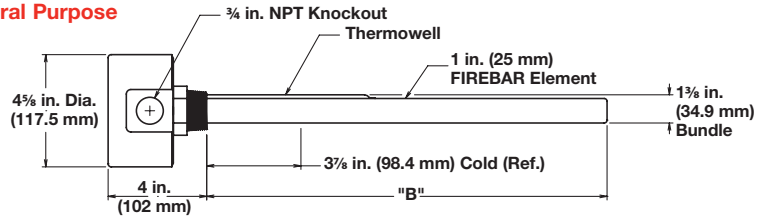

Moisture/Explosion-Resistant

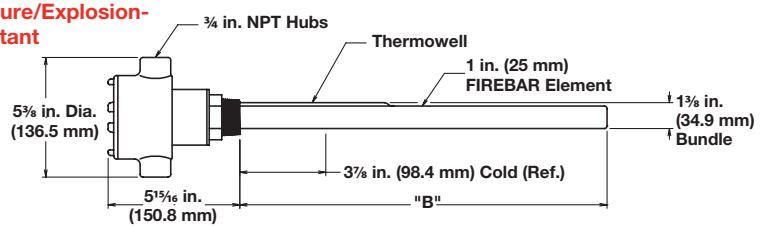

Description	Volts	kW	Ph	"B" Dim. in.	"B" Dim. (mm)	Part Number	Del.	Ship Wt. lbs (kg)	Part Number ③	Del.	Ship Wt. lbs (kg)	
						General Purpose Enclosure			Moisture/Explosion-Resistant Enclosure			
15 W/in² ③ 304 SS Plug 1-Alloy 800 Element (2.3 W/cm²)	240	0.67	3	13	(330)	BDNF13A29S	RS	6 (3)	BDNF13A29C	RS	9 (4)	
	240	0.83	3	15 1/2	(394)	BDNF15J29S	RS	7 (4)	BDNF15J29C	RS	10 (5)	
	240	1.00	3	18	(457)	BDNF18A29S	RS	8 (4)	BDNF18A29C	RS	11 (5)	
	240	1.33	3	22 1/2	(572)	BDNF22J29S	RS	9 (4)	BDNF22J29C	RS	12 (6)	
	480	1.33	3	22 1/2	(572)	BDNF22J30S	RS	9 (4)	BDNF22J30C	RS	12 (6)	
	240	1.67	3	27 1/2	(699)	BDNF27J29S	RS	10 (5)	BDNF27J29C	RS	13 (6)	
	480	1.67	3	27 1/2	(699)	BDNF27J30S	RS	10 (5)	BDNF27J30C	RS	13 (6)	
	240	2.00	3	32 1/2	(826)	BDNF32J29S	RS	11 (5)	BDNF32J29C	RS	14 (7)	
	480	2.00	3	32 1/2	(826)	BDNF32J30S	RS	11 (5)	BDNF32J30C	RS	14 (7)	
	240	2.67	3	42	(1067)	BDNF42A29S	RS	13 (6)	BDNF42A29C	RS	16 (8)	
	480	2.67	3	42	(1067)	BDNF42A30S	RS	13 (6)	BDNF42A30C	RS	16 (8)	
	240	3.33	3	51 1/2	(1308)	BDNF51J29S	RS	15 (7)	BDNF51J29C	RS	18 (9)	
	480	3.33	3	51 1/2	(1308)	BDNF51J30S	RS	15 (7)	BDNF51J30C	RS	18 (9)	

RAPID SHIP

- RS - Next day shipment up to 5 pieces

Note: All screw plug bundles are designed to fit the inside diameter of the equivalent mating coupling. They will not fit into the equivalent pipe inside diameter.

③ Wired for 3-phase operation only

⑦ CSA certified only

Immersion Heaters

WATROD and FIREBAR Screw Plug Immersion Heaters



Application: Medium Weight Oils and Heat Transfer Oils

- 2 inch NPT screw plug
- WATROD elements
- With thermostat (DPST)

Note: Higher amperage products require a pilot duty thermostat with separate power controller. Please see following pages for available heaters without thermostats.

- General purpose enclosure

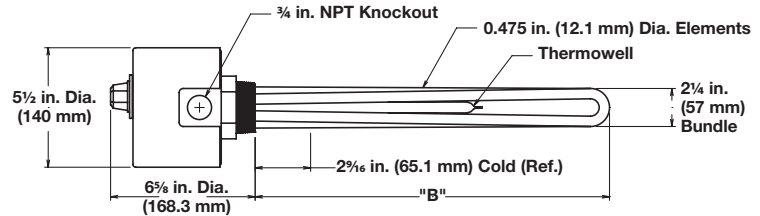

Description	Volts	kW	Ph	"B" Dim. in. (mm)		Ship Wt. lbs (kg)		Type 4 (30-110°F)		Type 5A (60 to 250°F)		Type 7A (100 to 550°F)	
								Part Number	Del.	Part Number	Del.	Part Number	Del.
General Purpose Enclosure													
16 W/in² ③ 304 SS Plug 3-Alloy 800 Elements (2.5 W/cm²)	240	1.0	3	9 ³ / ₄	(248)	6	(3)	BHN79N12S4	RS	BHN79N12S5A	RS	BHN79N12S7A	RS
	480	1.0	3	9 ³ / ₄	(248)	6	(3)	BHN79N13S4	RS	BHN79N13S5A	RS	BHN79N13S7A	RS
	240	1.5	3	13 ¹ / ₄	(337)	7	(4)	BHN713E12S4	RS	BHN713E12S5A	RS	BHN713E12S7A	RS
	480	1.5	3	13 ¹ / ₄	(337)	7	(4)	BHN713E13S4	RS	BHN713E13S5A	RS	BHN713E13S7A	RS
	240	2.0	3	17 ³ / ₄	(451)	8	(4)	BHN717N12S4	RS	BHN717N12S5A	RS	BHN717N12S7A	RS
	480	2.0	3	17 ³ / ₄	(451)	8	(4)	BHN717N13S4	RS	BHN717N13S5A	RS	BHN717N13S7A	RS
	240	2.5	3	20 ¹ / ₄	(514)	9	(4)	BHN720E12S4	RS	BHN720E12S5A	RS	BHN720E12S7A	RS
	480	2.5	3	20 ¹ / ₄	(514)	9	(4)	BHN720E13S4	RS	BHN720E13S5A	RS	BHN720E13S7A	RS
	240	3.0	3	25 ¹ / ₄	(641)	10	(5)	BHN725E12S4	RS	BHN725E12S5A	RS	BHN725E12S7A	RS
	480	3.0	3	25 ¹ / ₄	(641)	10	(5)	BHN725E13S4	RS	BHN725E13S5A	RS	BHN725E13S7A	RS
	240	4.0	3	32 ³ / ₄	(832)	10	(5)	BHN732N12S4	RS	BHN732N12S5A	RS	BHN732N12S7A	RS
	480	4.0	3	32 ³ / ₄	(832)	10	(5)	BHN732N13S4	RS	BHN732N13S5A	RS	BHN732N13S7A	RS
	240	5.0	3	40 ¹ / ₄	(1022)	11	(5)	BHN740E12S4	RS	BHN740E12S5A	RS	BHN740E12S7A	RS
	480	5.0	3	40 ¹ / ₄	(1022)	11	(5)	BHN740E13S4	RS	BHN740E13S5A	RS	BHN740E13S7A	RS
240	6.0	3	47 ³ / ₄	(1213)	12	(6)	BHN747N12S4	RS	BHN747N12S5A	RS	BHN747N12S7A	RS	
480	6.0	3	47 ³ / ₄	(1213)	12	(6)	BHN747N13S4	RS	BHN747N13S5A	RS	BHN747N13S7A	RS	
15 W/in² Steel Plug 3-Steel Elements (2.3 W/cm²)	240	1.5	3	13 ¹ / ₄	(337)	7	(4)	BHSS13E3S4	RS	BHSS13E3S5A	RS	BHSS13E3S7A	RS
	480	1.5	3	13 ¹ / ₄	(337)	7	(4)	BHSS13E13S4	RS	BHSS13E13S5A	RS	BHSS13E13S7A	RS
	240	2.0	3	17 ¹ / ₂	(445)	8	(4)	BHSS17J3S4	RS	BHSS17J3S5A	RS	BHSS17J3S7A	RS
	480	2.0	3	17 ¹ / ₂	(445)	8	(4)	BHSS17J5S4	RS	BHSS17J5S5A	RS	BHSS17J5S7A	RS
	240	2.5	3	20 ¹ / ₂	(521)	9	(4)	BHSS20J3S4	RS	BHSS20J3S5A	RS	BHSS20J3S7A	RS
	480	2.5	3	20 ¹ / ₂	(521)	9	(4)	BHSS20J5S4	RS	BHSS20J5S5A	RS	BHSS20J5S7A	RS
	240	3.0	3	25	(635)	10	(5)	BHSS25A3S4	RS	BHSS25A3S5A	RS	BHSS25A3S7A	RS
	480	3.0	3	25	(635)	10	(5)	BHSS25A5S4	RS	BHSS25A5S5A	RS	BHSS25A5S7A	RS
	240	4.0	3	32 ¹ / ₂	(826)	13	(6)	BHSS32J3S4	RS	BHSS32J3S5A	RS	BHSS32J3S7A	RS
	480	4.0	3	32 ¹ / ₂	(826)	13	(6)	BHSS32J5S4	RS	BHSS32J5S5A	RS	BHSS32J5S7A	RS
	240	5.0	3	40	(1016)	14	(7)	BHSS40A3S4	RS	BHSS40A3S5A	RS	BHSS40A3S7A	RS
	480	5.0	3	40	(1016)	14	(7)	BHSS40A5S4	RS	BHSS40A5S5A	RS	BHSS40A5S7A	RS
	240	6.0	3	47 ¹ / ₂	(1207)	14	(7)	BHSS47J3S4	RS	BHSS47J3S5A	RS	BHSS47J3S7A	RS
	480	6.0	3	47 ¹ / ₂	(1207)	14	(7)	BHSS47J5S4	RS	BHSS47J5S5A	RS	BHSS47J5S7A	RS
240	7.5	3	58 ¹ / ₂	(1486)	17	(8)	BHSS58J3S4	RS	BHSS58J3S5A	RS	BHSS58J3S7A	RS	
240	9.0	3	69 ³ / ₄	(1772)	21	(10)	BHSS69N3S4	RS	BHSS69N3S5A	RS	BHSS69N3S7A	RS	

RAPID SHIP

- RS - Next day shipment up to 5 pieces

Note: All screw plug bundles are designed to fit the inside diameter of the equivalent mating coupling. They will not fit into the equivalent pipe inside diameter.

③ Wired for 3-phase operation only

Immersion Heaters

WATROD and FIREBAR Screw Plug Immersion Heaters



Application: Medium Weight Oils and Heat Transfer Oils

- 2 inch NPT screw plug
- WATROD elements
- With thermostat (DPST)

Note: Higher amperage products require a pilot duty thermostat with separate power controller. Please see following pages for available heaters without thermostats.

- Moisture/explosion-resistant enclosure

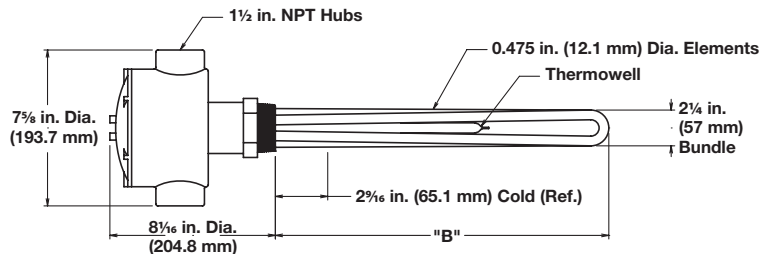

Description	Volts	kW	Ph	"B" Dim. in. (mm)	Ship Wt. lbs (kg)	Type 4 (30 to 110°F)		Type 5A (60 to 250°F)		Type 7A (100 to 550°F)	
						Part Number	Del.	Part Number	Del.	Part Number	Del.
Moisture/Explosion-Resistant Enclosure											
16 W/in² ③ 304 SS Plug 3-Alloy 800 Elements (2.5 W/cm²)	240	1.0	3	9 ³ / ₄ (248)	9 (4)	BHN79N12C4	RS	BHN79N12C5A	RS	BHN79N12C7A	RS
	480	1.0	3	9 ³ / ₄ (248)	9 (4)	BHN79N13C4	RS	BHN79N13C5A	RS	BHN79N13C7A	RS
	240	1.5	3	13 ¹ / ₄ (337)	10 (5)	BHN713E12C4	RS	BHN713E12C5A	RS	BHN713E12C7A	RS
	480	1.5	3	13 ¹ / ₄ (337)	10 (5)	BHN713E13C4	RS	BHN713E13C5A	RS	BHN713E13C7A	RS
	240	2.0	3	17 ³ / ₄ (451)	11 (5)	BHN717N12C4	RS	BHN717N12C5A	RS	BHN717N12C7A	RS
	480	2.0	3	17 ³ / ₄ (451)	11 (5)	BHN717N13C4	RS	BHN717N13C5A	RS	BHN717N13C7A	RS
	240	2.5	3	20 ¹ / ₄ (514)	12 (6)	BHN720E12C4	RS	BHN720E12C5A	RS	BHN720E12C7A	RS
	480	2.5	3	20 ¹ / ₄ (514)	12 (6)	BHN720E13C4	RS	BHN720E13C5A	RS	BHN720E13C7A	RS
	240	3.0	3	25 ¹ / ₄ (641)	13 (6)	BHN725E12C4	RS	BHN725E12C5A	RS	BHN725E12C7A	RS
	480	3.0	3	25 ¹ / ₄ (641)	13 (6)	BHN725E13C4	RS	BHN725E13C5A	RS	BHN725E13C7A	RS
	240	4.0	3	32 ³ / ₄ (832)	13 (6)	BHN732N12C4	RS	BHN732N12C5A	RS	BHN732N12C7A	RS
	480	4.0	3	32 ³ / ₄ (832)	13 (6)	BHN732N13C4	RS	BHN732N13C5A	RS	BHN732N13C7A	RS
	240	5.0	3	40 ¹ / ₄ (1022)	14 (7)	BHN740E12C4	RS	BHN740E12C5A	RS	BHN740E12C7A	RS
	480	5.0	3	40 ¹ / ₄ (1022)	14 (7)	BHN740E13C4	RS	BHN740E13C5A	RS	BHN740E13C7A	RS
	240	6.0	3	47 ³ / ₄ (1213)	15 (7)	BHN747N12C4	RS	BHN747N12C5A	RS	BHN747N12C7A	RS
	480	6.0	3	47 ³ / ₄ (1213)	15 (7)	BHN747N13C4	RS	BHN747N13C5A	RS	BHN747N13C7A	RS
15 W/in² Steel Plug 3-Steel Elements (2.3 W/cm²)	240	1.5	3	13 ¹ / ₄ (337)	10 (5)	BHSS13E3C4	RS	BHSS13E3C5A	RS	BHSS13E3C7A	RS
	480	1.5	3	13 ¹ / ₄ (337)	10 (5)	BHSS13E13C4	RS	BHSS13E13C5A	RS	BHSS13E13C7A	RS
	240	2.0	3	17 ¹ / ₂ (445)	11 (5)	BHSS17J3C4	RS	BHSS17J3C5A	RS	BHSS17J3C7A	RS
	480	2.0	3	17 ¹ / ₂ (445)	11 (5)	BHSS17J5C4	RS	BHSS17J5C5A	RS	BHSS17J5C7A	RS
	240	2.5	3	20 ¹ / ₂ (521)	12 (6)	BHSS20J3C4	RS	BHSS20J3C5A	RS	BHSS20J3C7A	RS
	480	2.5	3	20 ¹ / ₂ (521)	12 (6)	BHSS20J5C4	RS	BHSS20J5C5A	RS	BHSS20J5C7A	RS
	240	3.0	3	25 (635)	13 (6)	BHSS25A3C4	RS	BHSS25A3C5A	RS	BHSS25A3C7A	RS
	480	3.0	3	25 (635)	13 (6)	BHSS25A5C4	RS	BHSS25A5C5A	RS	BHSS25A5C7A	RS
	240	4.0	3	32 ¹ / ₂ (826)	16 (8)	BHSS32J3C4	RS	BHSS32J3C5A	RS	BHSS32J3C7A	RS
	480	4.0	3	32 ¹ / ₂ (826)	16 (8)	BHSS32J5C4	RS	BHSS32J5C5A	RS	BHSS32J5C7A	RS
	240	5.0	3	40 (1016)	17 (8)	BHSS40A3C4	RS	BHSS40A3C5A	RS	BHSS40A3C7A	RS
	480	5.0	3	40 (1016)	17 (8)	BHSS40A5C4	RS	BHSS40A5C5A	RS	BHSS40A5C7A	RS
	240	6.0	3	47 ¹ / ₂ (1207)	17 (8)	BHSS47J3C4	RS	BHSS47J3C5A	RS	BHSS47J3C7A	RS
	480	6.0	3	47 ¹ / ₂ (1207)	17 (8)	BHSS47J5C4	RS	BHSS47J5C5A	RS	BHSS47J5C7A	RS
	240	7.5	3	58 ¹ / ₂ (1486)	20 (9)	BHSS58J3C4	RS	BHSS58J3C5A	RS	BHSS58J3C7A	RS
	240	9.0	3	69 ³ / ₄ (1772)	24 (11)	BHSS69N3C4	RS	BHSS69N3C5A	RS	BHSS69N3C7A	RS

RAPID SHIP

- RS - Next day shipment up to 5 pieces

Note: All screw plug bundles are designed to fit the inside diameter of the equivalent mating coupling. They will not fit into the equivalent pipe inside diameter.

③ Wired for 3-phase operation only

Immersion Heaters

WATROD and FIREBAR Screw Plug Immersion Heaters

Application: Medium Weight Oils and Heat Transfer Oils

- 2 inch NPT screw plug
- WATROD elements
- Without thermostat
- General purpose or moisture/explosion-resistant enclosure

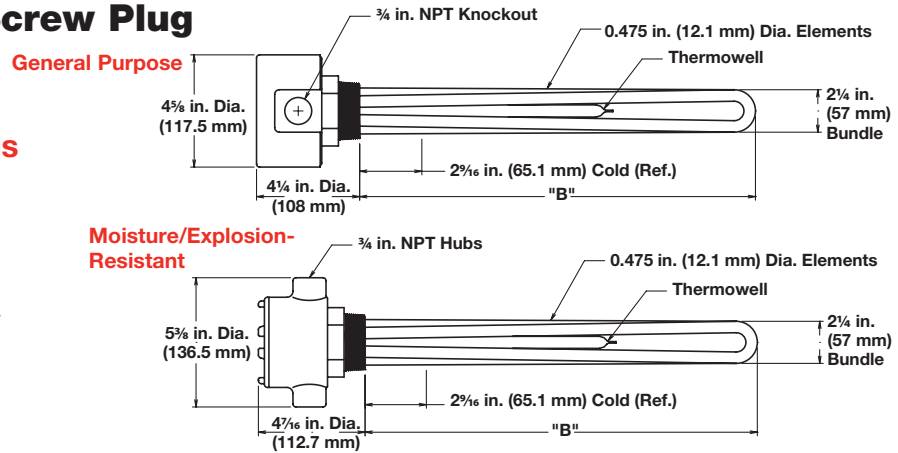

Description	Volts	kW	Ph	"B" Dim. in. (mm)	Part Number	Del.	Ship Wt. lbs (kg)	General Purpose Enclosure		Moisture/Explosion-Resistant Enclosure	
								Part Number ⑦	Del.	Part Number ⑦	Del.
16 W/in² ③ 304 SS Plug 3-Alloy 800 Elements (2.5 W/cm²)	240	1.0	3	9 ³ / ₄ (248)	BHN79N12S	RS	5 (3)	BHN79N12C	RS	8 (4)	
	480	1.0	3	9 ³ / ₄ (248)	BHN79N13S	RS	5 (3)	BHN79N13C	RS	8 (4)	
	240	1.5	3	13 ¹ / ₄ (337)	BHN713E12S	RS	6 (3)	BHN713E12C	RS	9 (4)	
	480	1.5	3	13 ¹ / ₄ (337)	BHN713E13S	RS	6 (3)	BHN713E13C	RS	9 (4)	
	240	2.0	3	17 ³ / ₄ (451)	BHN717N12S	RS	7 (4)	BHN717N12C	RS	10 (5)	
	480	2.0	3	17 ³ / ₄ (451)	BHN717N13S	RS	7 (4)	BHN717N13C	RS	10 (5)	
	240	2.5	3	20 ¹ / ₄ (514)	BHN720E12S	RS	8 (4)	BHN720E12C	RS	11 (5)	
	480	2.5	3	20 ¹ / ₄ (514)	BHN720E13S	RS	8 (4)	BHN720E13C	RS	11 (5)	
	240	3.0	3	25 ¹ / ₄ (641)	BHN725E12S	RS	9 (4)	BHN725E12C	RS	12 (6)	
	480	3.0	3	25 ¹ / ₄ (641)	BHN725E13S	RS	9 (4)	BHN725E13C	RS	12 (6)	
	240	4.0	3	32 ³ / ₄ (832)	BHN732N12S	RS	9 (4)	BHN732N12C	RS	12 (6)	
	480	4.0	3	32 ³ / ₄ (832)	BHN732N13S	RS	9 (4)	BHN732N13C	RS	12 (6)	
	240	5.0	3	40 ¹ / ₄ (1022)	BHN740E12S	RS	10 (5)	BHN740E12C	RS	13 (6)	
	480	5.0	3	40 ¹ / ₄ (1022)	BHN740E13S	RS	10 (5)	BHN740E13C	RS	13 (6)	
15 W/in² Steel Plug 3-Steel Elements (2.3 W/cm²)	240	1.5	3	13 ¹ / ₄ (337)	BHSS13E3S	RS	6 (3)	BHSS13E3C	RS	9 (4)	
	480	1.5	3	13 ¹ / ₄ (337)	BHSS13E13S	RS	6 (3)	BHSS13E13C	RS	9 (4)	
	240	2.0	3	17 ¹ / ₂ (445)	BHSS17J3S	RS	7 (4)	BHSS17J3C	RS	10 (5)	
	480	2.0	3	17 ¹ / ₂ (445)	BHSS17J5S	RS	7 (4)	BHSS17J5C	RS	10 (5)	
	240	2.5	3	20 ¹ / ₂ (521)	BHSS20J3S	RS	8 (4)	BHSS20J3C	RS	11 (5)	
	480	2.5	3	20 ¹ / ₂ (521)	BHSS20J5S	RS	8 (4)	BHSS20J5C	RS	11 (5)	
	240	3.0	3	25 (635)	BHSS25A3S	RS	9 (4)	BHSS25A3C	RS	12 (6)	
	480	3.0	3	25 (635)	BHSS25A5S	RS	9 (4)	BHSS25A5C	RS	12 (6)	
	240	4.0	3	32 ¹ / ₂ (826)	BHSS32J3S	RS	9 (4)	BHSS32J3C	RS	12 (6)	
	480	4.0	3	32 ¹ / ₂ (826)	BHSS32J5S	RS	9 (4)	BHSS32J5C	RS	12 (6)	
	240	5.0	3	40 (1016)	BHSS40A3S	RS	10 (5)	BHSS40A3C	RS	13 (6)	
	480	5.0	3	40 (1016)	BHSS40A5S	RS	10 (5)	BHSS40A5C	RS	13 (6)	
	240	6.0	3	47 ¹ / ₂ (1207)	BHSS47J3S	RS	11 (5)	BHSS47J3C	RS	14 (7)	
	480	6.0	3	47 ¹ / ₂ (1207)	BHSS47J5S	RS	11 (5)	BHSS47J5C	RS	14 (7)	
240	7.5	3	58 ¹ / ₂ (1486)	BHSS58J3S	RS	14 (7)	BHSS58J3C	RS	17 (8)		
480	7.5	3	58 ¹ / ₂ (1486)	BHSS58J5S	RS	14 (7)	BHSS58J5C	RS	17 (8)		
240	9.0	3	69 ³ / ₄ (1772)	BHSS69N3S	RS	16 (8)	BHSS69N3C	RS	19 (9)		

RAPID SHIP

- RS - Next day shipment up to 5 pieces

Note: All screw plug bundles are designed to fit the inside diameter of the equivalent mating coupling. They will not fit into the equivalent pipe inside diameter.

- ③ Wired for 3-phase operation only
- ⑦ CSA certified only

Immersion Heaters

WATROD and FIREBAR Screw Plug Immersion Heaters



Application: Medium Weight Oils and Heat Transfer Oils

- 2 1/2 inch NPT screw plug
- WATROD elements
- With thermostat (DPST)
- General purpose enclosure

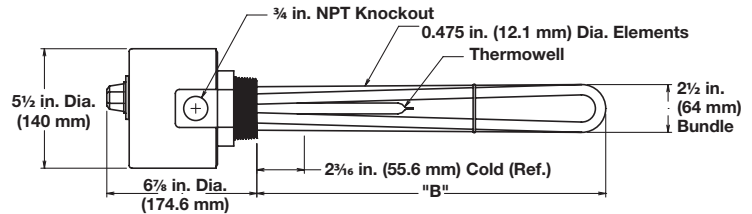

Description	Volts	kW	Ph	"B" Dim. in. (mm)	Ship Wt. lbs (kg)	Type 4 (30-110°F)		Type 5A (60-250°F)		Type 7A (100-550°F)	
						Part Number	Del.	Part Number	Del.	Part Number	Del.
General Purpose Enclosure											
16 W/in² ③ 304 SS Plug 3-Alloy 800 Elements (2.5 W/cm²)	240	1.0	3	9 ³ / ₈ (238.1)	7 (4)	BLN79G12S4	RS	BLN79G12S5A	RS	BLN79G12S7A	RS
	480	1.0	3	9 ³ / ₈ (238.1)	7 (4)	BLN79G13S4	RS	BLN79G13S5A	RS	BLN79G13S7A	RS
	240	1.5	3	12 ⁷ / ₈ (327.0)	8 (4)	BLN712R12S4	RS	BLN712R12S5A	RS	BLN712R12S7A	RS
	480	1.5	3	12 ⁷ / ₈ (327.0)	8 (4)	BLN712R13S4	RS	BLN712R13S5A	RS	BLN712R13S7A	RS
	240	2.0	3	17 ³ / ₈ (441.3)	10 (5)	BLN717G12S4	RS	BLN717G12S5A	RS	BLN717G12S7A	RS
	480	2.0	3	17 ³ / ₈ (441.3)	10 (5)	BLN717G13S4	RS	BLN717G13S5A	RS	BLN717G13S7A	RS
	240	2.5	3	19 ⁷ / ₈ (504.8)	12 (6)	BLN719R12S4	RS	BLN719R12S5A	RS	BLN719R12S7A	RS
	480	2.5	3	19 ⁷ / ₈ (504.8)	12 (6)	BLN719R13S4	RS	BLN719R13S5A	RS	BLN719R13S7A	RS
	240	3.0	3	24 ⁷ / ₈ (631.8)	13 (6)	BLN724R12S4	RS	BLN724R12S5A	RS	BLN724R12S7A	RS
	480	3.0	3	24 ⁷ / ₈ (631.8)	13 (6)	BLN724R13S4	RS	BLN724R13S5A	RS	BLN724R13S7A	RS
	240	4.0	3	32 ³ / ₈ (822.3)	15 (7)	BLN732G12S4	RS	BLN732G12S5A	RS	BLN732G12S7A	RS
	480	4.0	3	32 ³ / ₈ (822.3)	15 (7)	BLN732G13S4	RS	BLN732G13S5A	RS	BLN732G13S7A	RS
	240	5.0	3	39 ⁷ / ₈ (1012.8)	16 (8)	BLN739R12S4	RS	BLN739R12S5A	RS	BLN739R12S7A	RS
	480	5.0	3	39 ⁷ / ₈ (1012.8)	16 (8)	BLN739R13S4	RS	BLN739R13S5A	RS	BLN739R13S7A	RS
	240	6.0	3	47 ³ / ₈ (1203.3)	18 (9)	BLN747G12S4	RS	BLN747G12S5A	RS	BLN747G12S7A	RS
	480	6.0	3	47 ³ / ₈ (1203.3)	18 (9)	BLN747G13S4	RS	BLN747G13S5A	RS	BLN747G13S7A	RS

RAPID SHIP

- RS - Next day shipment up to 5 pieces

Note: All screw plug bundles are designed to fit the inside diameter of the equivalent mating coupling. They will not fit into the equivalent pipe inside diameter.

③ Wired for 3-phase operation only

Immersion Heaters

WATROD and FIREBAR Screw Plug Immersion Heaters



Application: Medium Weight Oils and Heat Transfer Oils

- 2 1/2 inch NPT screw plug
- WATROD elements
- With thermostat (DPST)
- Moisture/explosion-resistant enclosure

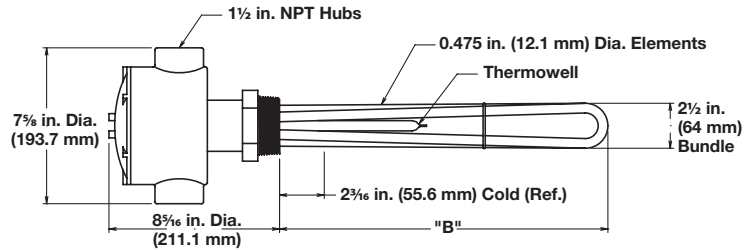

Description	Volts	kW	Ph	"B" Dim. in. (mm)	Ship Wt. lbs (kg)	Type 4 (30-110°F)		Type 5A (60-250°F)		Type 7A (100-550°F)	
						Part Number	Del.	Part Number	Del.	Part Number	Del.
Moisture/Explosion-Resistant Enclosure											
16 W/in² ③ 304 SS Plug 3-Alloy 800 Elements (2.5 W/cm²)	240	1.0	3	9 ³ / ₈ (238.1)	10 (5)	BLN79G12C4	RS	BLN79G12C5A	RS	BLN79G12C7A	RS
	480	1.0	3	9 ³ / ₈ (238.1)	10 (5)	BLN79G13C4	RS	BLN79G13C5A	RS	BLN79G13C7A	RS
	240	1.5	3	12 ⁷ / ₈ (327.0)	11 (5)	BLN712R12C4	RS	BLN712R12C5A	RS	BLN712R12C7A	RS
	480	1.5	3	12 ⁷ / ₈ (327.0)	11 (5)	BLN712R13C4	RS	BLN712R13C5A	RS	BLN712R13C7A	RS
	240	2.0	3	17 ³ / ₈ (441.3)	13 (6)	BLN717G12C4	RS	BLN717G12C5A	RS	BLN717G12C7A	RS
	480	2.0	3	17 ³ / ₈ (441.3)	13 (6)	BLN717G13C4	RS	BLN717G13C5A	RS	BLN717G13C7A	RS
	240	2.5	3	19 ⁷ / ₈ (504.8)	15 (7)	BLN719R12C4	RS	BLN719R12C5A	RS	BLN719R12C7A	RS
	480	2.5	3	19 ⁷ / ₈ (504.8)	15 (7)	BLN719R13C4	RS	BLN719R13C5A	RS	BLN719R13C7A	RS
	240	3.0	3	24 ⁷ / ₈ (631.8)	16 (8)	BLN724R12C4	RS	BLN724R12C5A	RS	BLN724R12C7A	RS
	480	3.0	3	24 ⁷ / ₈ (631.8)	16 (8)	BLN724R13C4	RS	BLN724R13C5A	RS	BLN724R13C7A	RS
	240	4.0	3	32 ³ / ₈ (822.3)	18 (9)	BLN732G12C4	RS	BLN732G12C5A	RS	BLN732G12C7A	RS
	480	4.0	3	32 ³ / ₈ (822.3)	18 (9)	BLN732G13C4	RS	BLN732G13C5A	RS	BLN732G13C7A	RS
	240	5.0	3	39 ⁷ / ₈ (1012.8)	19 (9)	BLN739R12C4	RS	BLN739R12C5A	RS	BLN739R12C7A	RS
	480	5.0	3	39 ⁷ / ₈ (1012.8)	19 (9)	BLN739R13C4	RS	BLN739R13C5A	RS	BLN739R13C7A	RS
	240	6.0	3	47 ³ / ₈ (1203.3)	21 (10)	BLN747G12C4	RS	BLN747G12C5A	RS	BLN747G12C7A	RS
	480	6.0	3	47 ³ / ₈ (1203.3)	21 (10)	BLN747G13C4	RS	BLN747G13C5A	RS	BLN747G13C7A	RS

RAPID SHIP

- RS - Next day shipment up to 5 pieces

Note: All screw plug bundles are designed to fit the inside diameter of the equivalent mating coupling. They will not fit into the equivalent pipe inside diameter.

③ Wired for 3-phase operation only

Immersion Heaters

WATROD and FIREBAR Screw Plug Immersion Heaters



Application: Medium Weight Oils and Heat Transfer Oils

- 2 1/2 inch NPT screw plug
- WATROD elements
- Without thermostat
- General purpose or moisture/explosion-resistant enclosure

General Purpose

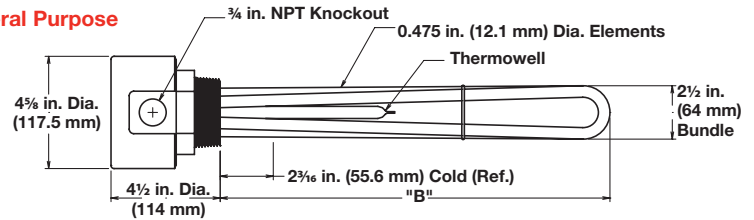

Moisture/Explosion-Resistant

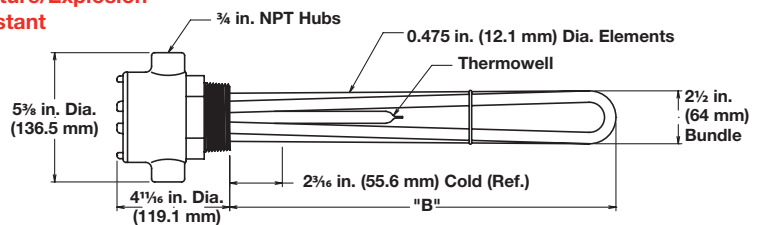

Description	Volts	kW	Ph	"B" Dim. in. (mm)	General Purpose Enclosure				Moisture/Explosion-Resistant Enclosure			
					Part Number	Del.	Ship Wt. lbs (kg)	Part Number ⑦	Del.	Ship Wt. lbs (kg)		
16 W/in ² ③ 304 SS Plug 3-Alloy 800 Elements (2.5 W/cm ²)	240	1.0	1	9 ³ / ₈ (238.1)	BLN79G12S	RS	6 (3)	BLN79G12C	RS	9 (4)		
	480	1.0	3	9 ³ / ₈ (238.1)	BLN79G13S	RS	6 (3)	BLN79G13C	RS	9 (4)		
	240	1.5	3	12 ⁷ / ₈ (327.0)	BLN712R12S	RS	7 (4)	BLN712R12C	RS	10 (5)		
	480	1.5	1	12 ⁷ / ₈ (327.0)	BLN712R13S	RS	7 (4)	BLN712R13C	RS	10 (5)		
	240	2.0	3	17 ³ / ₈ (441.3)	BLN717G12S	RS	9 (4)	BLN717G12C	RS	12 (6)		
	480	2.0	3	17 ³ / ₈ (441.3)	BLN717G13S	RS	9 (4)	BLN717G13C	RS	12 (6)		
	240	2.5	3	19 ⁷ / ₈ (504.8)	BLN719R12S	RS	11 (5)	BLN719R12C	RS	14 (7)		
	480	2.5	3	19 ⁷ / ₈ (504.8)	BLN719R13S	RS	11 (5)	BLN719R13C	RS	14 (7)		
	240	3.0	3	24 ⁷ / ₈ (631.8)	BLN724R12S	RS	12 (6)	BLN724R12C	RS	15 (7)		
	480	3.0	3	24 ⁷ / ₈ (631.8)	BLN724R13S	RS	12 (6)	BLN724R13C	RS	15 (7)		
	240	4.0	3	32 ³ / ₈ (822.3)	BLN732G12S	RS	14 (7)	BLN732G12C	RS	17 (8)		
	480	4.0	3	32 ³ / ₈ (822.3)	BLN732G13S	RS	14 (7)	BLN732G13C	RS	17 (8)		
	240	5.0	3	39 ⁷ / ₈ (1012.8)	BLN739R12S	RS	15 (7)	BLN739R12C	RS	18 (9)		
	480	5.0	3	39 ⁷ / ₈ (1012.8)	BLN739R13S	RS	15 (7)	BLN739R13C	RS	18 (9)		
	240	6.0	3	47 ³ / ₈ (1203.3)	BLN747G12S	RS	17 (8)	BLN747G12C	RS	20 (9)		
	480	6.0	3	47 ³ / ₈ (1203.3)	BLN747G13S	RS	17 (8)	BLN747G13C	RS	20 (9)		

RAPID SHIP

- RS - Next day shipment up to 5 pieces

Note: All screw plug bundles are designed to fit the inside diameter of the equivalent mating coupling. They will not fit into the equivalent pipe inside diameter.

- ③ Wired for 3-phase operation only
- ⑦ CSA certified only

Immersion Heaters

WATROD and FIREBAR Screw Plug Immersion Heaters



Application: Medium Weight Oils and Heat Transfer Oils

- 2 1/2 inch NPT screw plug
- FIREBAR elements
- With thermostat (DPST)

Note: Higher amperage products require a pilot duty thermostat with separate power controller. Please see following pages for available heaters without thermostats.

- General purpose or moisture/explosion-resistant enclosure

General Purpose

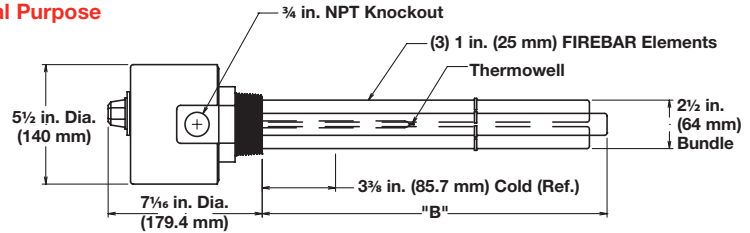

Moisture/Explosion-Resistant

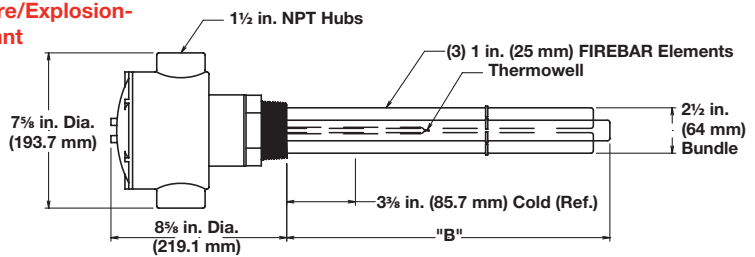

Description	Volts	kW	Ph	"B" Dim. in. (mm)	Ship Wt. lbs (kg)	Type 5A (60-250°F)		Type 7A (100-550°F)	
						Part Number	Del.	Part Number	Del.
General Purpose Enclosure									
15 W/in ² ③ 304 SS Plug 3-Alloy 800 Elements (2.3 W/cm ²)	240	2.0	3	12 (305)	11 (5)	BLNF12A29S5A	RS	BLNF12A29S7A	RS
	240	2.5	3	14 1/2 (368)	12 (6)	BLNF14J29S5A	RS	BLNF14J29S7A	RS
	240	3.0	3	17 (432)	13 (6)	BLNF17A29S5A	RS	BLNF17A29S7A	RS
	240	4.0	3	21 1/2 (546)	15 (7)	BLNF21J29S5A	RS	BLNF21J29S7A	RS
	480	4.0	3	21 1/2 (546)	15 (7)	BLNF21J30S5A	RS	BLNF21J30S7A	RS
	240	5.0	3	26 1/2 (673)	18 (9)	BLNF26J29S5A	RS	BLNF26J29S7A	RS
	480	5.0	3	26 1/2 (673)	18 (9)	BLNF26J30S5A	RS	BLNF26J30S7A	RS
	240	6.0	3	31 1/2 (800)	19 (9)	BLNF31J29S5A	RS	BLNF31J29S7A	RS
	480	6.0	3	31 1/2 (800)	19 (9)	BLNF31J30S5A	RS	BLNF31J30S7A	RS
	240	8.0	3	41 (1041)	21 (10)	BLNF41A29S5A	RS	BLNF41A29S7A	RS
240	10.0	3	50 1/2 (1283)	23 (11)	BLNF50J29S5A	RS	BLNF50J29S7A	RS	
Moisture/Explosion-Resistant Enclosure ⑦									
15 W/in ² ③ 304 SS Plug 3-Alloy 800 Elements (2.3 W/cm ²)	240	2.0	3	12 (305)	14 (7)	BLNF12A29C5A	RS	BLNF12A29C7A	RS
	240	2.5	3	14 1/2 (368)	15 (7)	BLNF14J29C5A	RS	BLNF14J29C7A	RS
	240	3.0	3	17 (432)	16 (8)	BLNF17A29C5A	RS	BLNF17A29C7A	RS
	240	4.0	3	21 1/2 (546)	18 (9)	BLNF21J29C5A	RS	BLNF21J29C7A	RS
	480	4.0	3	21 1/2 (546)	18 (9)	BLNF21J30C5A	RS	BLNF21J30C7A	RS
	240	5.0	3	26 1/2 (673)	21 (10)	BLNF26J29C5A	RS	BLNF26J29C7A	RS
	480	5.0	3	26 1/2 (673)	21 (10)	BLNF26J30C5A	RS	BLNF26J30C7A	RS
	240	6.0	3	31 1/2 (800)	22 (10)	BLNF31J29C5A	RS	BLNF31J29C7A	RS
	480	6.0	3	31 1/2 (800)	22 (10)	BLNF31J30C5A	RS	BLNF31J30C7A	RS
	240	8.0	3	41 (1041)	24 (11)	BLNF41A29C5A	RS	BLNF41A29C7A	RS
240	10.0	3	50 1/2 (1283)	26 (11)	BLNF50J29C5A	RS	BLNF50J29C7A	RS	

RAPID SHIP

- RS - Next day shipment up to 5 pieces

Note: All screw plug bundles are designed to fit the inside diameter of the equivalent mating coupling. They will not fit into the equivalent pipe inside diameter.

- ③ Wired for 3-phase operation only
- ⑦ CSA certified only

Immersion Heaters

WATROD and FIREBAR Screw Plug Immersion Heaters



Application: Medium Weight Oils and Heat Transfer Oils

- 2 1/2 inch NPT screw plug
- FIREBAR elements
- Without thermostat
- General purpose or moisture/explosion-resistant enclosure

General Purpose

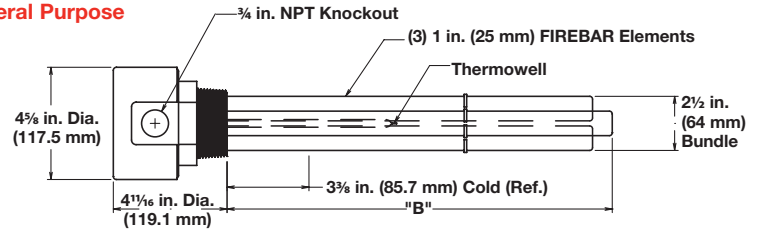

Moisture/Explosion-Resistant

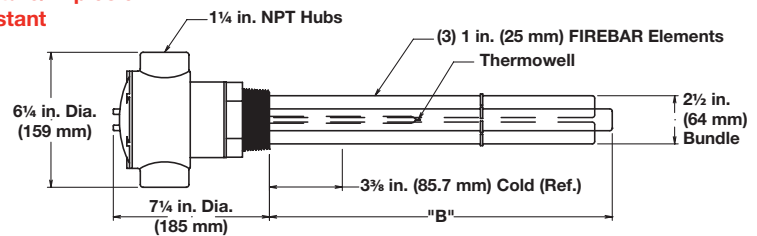

Description	Volts	kW	Ph	"B" Dim. In. (mm)	General Purpose Enclosure		Moisture/Explosion-Resistant Enclosure			
					Part Number	Del.	Ship Wt. lbs (kg)	Part Number ⑦	Del.	Ship Wt. lbs (kg)
15 W/in ² ③ 304 SS Plug 3-Alloy 800 Elements (2.3 W/cm ²)	240	2.0	3	12 (305)	BLNF12A29S	RS	10 (5)	BLNF12A29C	RS	13 (6)
	240	2.5	3	14 1/2 (368)	BLNF14J29S	RS	11 (5)	BLNF14J29C	RS	14 (7)
	240	3.0	3	17 (432)	BLNF17A29S	RS	12 (6)	BLNF17A29C	RS	15 (7)
	240	4.0	3	21 1/2 (546)	BLNF21J29S	RS	14 (7)	BLNF21J29C	RS	17 (8)
	480	4.0	3	21 1/2 (546)	BLNF21J30S	RS	14 (7)	BLNF21J30C	RS	17 (8)
	240	5.0	3	26 1/2 (673)	BLNF26J29S	RS	17 (8)	BLNF26J29C	RS	20 (9)
	480	5.0	3	26 1/2 (673)	BLNF26J30S	RS	17 (8)	BLNF26J30C	RS	20 (9)
	240	6.0	3	31 1/2 (800)	BLNF31J29S	RS	18 (9)	BLNF31J29C	RS	21 (10)
	480	6.0	3	31 1/2 (800)	BLNF31J30S	RS	18 (9)	BLNF31J30C	RS	21 (10)
	240	8.0	3	41 (1041)	BLNF41A29S	RS	20 (9)	BLNF41A29C	RS	23 (11)
	480	8.0	3	41 (1041)	BLNF41A30S	RS	20 (9)	BLNF41A30C	RS	23 (11)
	240	10.0	3	50 1/2 (1283)	BLNF50J29S	RS	22 (10)	BLNF50J29C	RS	25 (12)
	480	10.0	3	50 1/2 (1283)	BLNF50J30S	RS	22 (10)	BLNF50J30C	RS	25 (12)

RAPID SHIP

- RS - Next day shipment up to 5 pieces

Note: All screw plug bundles are designed to fit the inside diameter of the equivalent mating coupling. They will not fit into the equivalent pipe inside diameter.

- ③ Wired for 3-phase operation only
- ⑦ CSA certified only

Immersion Heaters

WATROD and FIREBAR Screw Plug Immersion Heaters



Application: Bunker C, Asphalt and #6 Fuel Oil

- 1 1/4 inch NPT screw plug
- FIREBAR elements
- With thermostat (DPST)
- General purpose or moisture/explosion-resistant enclosure

General Purpose

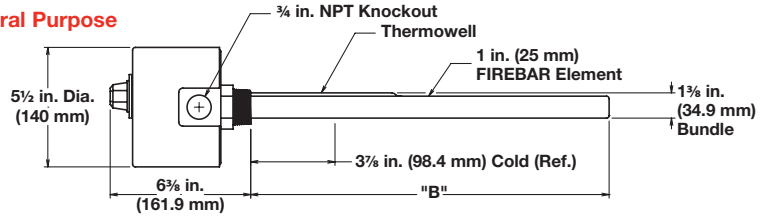

Moisture/Explosion-Resistant

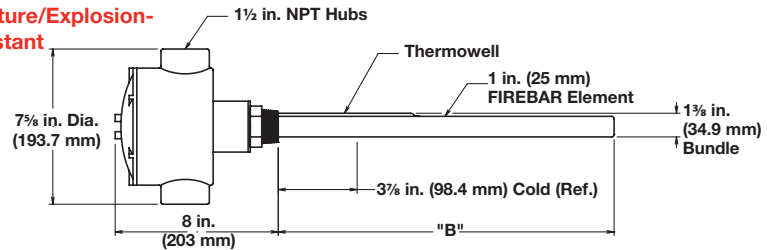

Description	Volts	kW	Ph	"B" Dim. in. (mm)	Ship Wt. lbs (kg)	Type 5A (60-250°F)		Type 7A (100-550°F)	
						Part Number	Del.	Part Number	Del.
General Purpose									
8 W/in² ③ 304 SS Plug 1-Alloy 800 Element (1.3 W/cm²)	240	0.43	3	16 1/8 (409.6)	8 (4)	BDNF16G22S5A	RS	BDNF16G22S7A	RS
	240	0.55	3	19 1/8 (485.8)	9 (4)	BDNF19G22S5A	RS	BDNF19G22S7A	RS
	240	0.70	3	24 3/8 (619.1)	10 (5)	BDNF24L22S5A	RS	BDNF24L22S7A	RS
	480	0.70	3	24 3/8 (619.1)	10 (5)	BDNF24L21S5A	RS	BDNF24L21S7A	RS
	240	0.88	3	29 5/8 (752.5)	11 (5)	BDNF29R22S5A	RS	BDNF29R22S7A	RS
	480	0.88	3	29 5/8 (752.5)	11 (5)	BDNF29R21S5A	RS	BDNF29R21S7A	RS
	240	1.08	3	34 5/8 (879.5)	12 (6)	BDNF34R22S5A	RS	BDNF34R22S7A	RS
	480	1.08	3	34 5/8 (879.5)	12 (6)	BDNF34R21S5A	RS	BDNF34R21S7A	RS
	240	1.40	3	45 1/8 (1146.2)	14 (7)	BDNF45G22S5A	RS	BDNF45G22S7A	RS
	480	1.40	3	45 1/8 (1146.2)	14 (7)	BDNF45G21S5A	RS	BDNF45G21S7A	RS
	240	1.80	3	55 5/8 (1412.9)	16 (8)	BDNF55R22S5A	RS	BDNF55R22S7A	RS
	480	1.80	3	55 5/8 (1412.9)	16 (8)	BDNF55R21S5A	RS	BDNF55R21S7A	RS
Moisture/Explosion-Resistant Enclosure ⑦									
8 W/in² ③ 304 SS Plug 1-Alloy 800 Element (1.3 W/cm²)	240	0.43	3	16 1/8 (409.6)	11 (5)	BDNF16G22C5A	RS	BDNF16G22C7A	RS
	240	0.55	3	19 1/8 (485.8)	12 (6)	BDNF19G22C5A	RS	BDNF19G22C7A	RS
	240	0.70	3	24 3/8 (619.1)	13 (6)	BDNF24L22C5A	RS	BDNF24L22C7A	RS
	480	0.70	3	24 3/8 (619.1)	13 (6)	BDNF24L21C5A	RS	BDNF24L21C7A	RS
	240	0.88	3	29 5/8 (752.5)	14 (7)	BDNF29R22C5A	RS	BDNF29R22C7A	RS
	480	0.88	3	29 5/8 (752.5)	14 (7)	BDNF29R21C5A	RS	BDNF29R21C7A	RS
	240	1.08	3	34 5/8 (879.5)	15 (7)	BDNF34R22C5A	RS	BDNF34R22C7A	RS
	480	1.08	3	34 5/8 (879.5)	15 (7)	BDNF34R21C5A	RS	BDNF34R21C7A	RS
	240	1.40	3	45 1/8 (1146.2)	17 (8)	BDNF45G22C5A	RS	BDNF45G22C7A	RS
	480	1.40	3	45 1/8 (1146.2)	17 (8)	BDNF45G21C5A	RS	BDNF45G21C7A	RS
	240	1.80	3	55 5/8 (1412.9)	19 (9)	BDNF55R22C5A	RS	BDNF55R22C7A	RS
	480	1.80	3	55 5/8 (1412.9)	19 (9)	BDNF55R21C5A	RS	BDNF55R21C7A	RS

RAPID SHIP

- RS - Next day shipment up to 5 pieces

Note: All screw plug bundles are designed to fit the inside diameter of the equivalent mating coupling. They will not fit into the equivalent pipe inside diameter.

③ Wired for 3-phase operation only

⑦ CSA certified only

Immersion Heaters

WATROD and FIREBAR Screw Plug Immersion Heaters



Application: Bunker C, Asphalt and #6 Fuel Oil

- 1 1/4 inch NPT screw plug
- FIREBAR elements
- Without thermostat
- General purpose or moisture/explosion-resistant enclosure

General Purpose

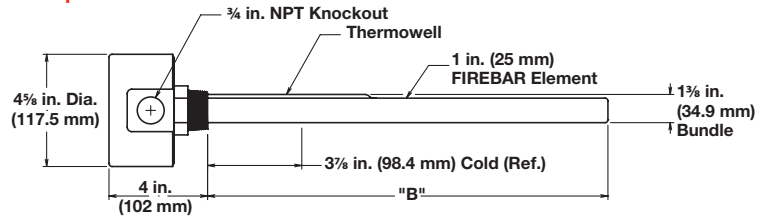

Moisture/Explosion-Resistant

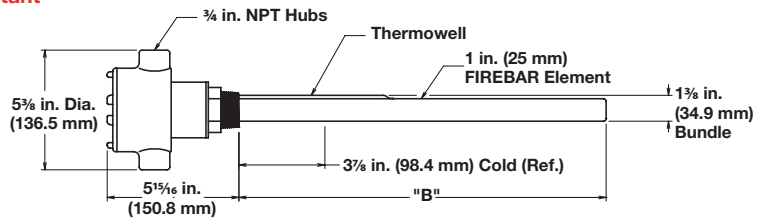

Description	Volts	kW	Ph	"B" Dim. in. (mm)	Part Number	Del.	Ship Wt. lbs (kg)	Part Number ⑦	Del.	Ship Wt. lbs (kg)	
					General Purpose Enclosure			Moisture/Explosion-Resistant Enclosure			
8 W/in² ③ 304 SS Plug 1-Alloy 800 Element (1.3 W/cm²)	240	0.43	3	16 ¹ / ₈ (409.6)	BDNF16G22S	RS	7 (4)	BDNF16G22C	RS	10 (5)	
	240	0.55	3	19 ¹ / ₈ (485.8)	BDNF19G22S	RS	8 (4)	BDNF19G22C	RS	11 (5)	
	240	0.70	3	24 ³ / ₈ (619.1)	BDNF24L22S	RS	9 (4)	BDNF24L22C	RS	12 (6)	
	480	0.70	3	24 ³ / ₈ (619.1)	BDNF24L21S	RS	9 (4)	BDNF24L21C	RS	12 (6)	
	240	0.88	3	29 ⁵ / ₈ (752.5)	BDNF29R22S	RS	10 (5)	BDNF29R22C	RS	13 (6)	
	480	0.88	3	29 ⁵ / ₈ (752.5)	BDNF29R21S	RS	10 (5)	BDNF29R21C	RS	13 (6)	
	240	1.08	3	34 ⁵ / ₈ (879.5)	BDNF34R22S	RS	11 (5)	BDNF34R22C	RS	14 (7)	
	480	1.08	3	34 ⁵ / ₈ (879.5)	BDNF34R21S	RS	11 (5)	BDNF34R21C	RS	14 (7)	
	240	1.40	3	45 ¹ / ₈ (1146.2)	BDNF45G22S	RS	13 (6)	BDNF45G22C	RS	16 (8)	
	480	1.40	3	45 ¹ / ₈ (1146.2)	BDNF45G21S	RS	13 (6)	BDNF45G21C	RS	16 (8)	
	240	1.80	3	55 ⁵ / ₈ (1412.9)	BDNF55R22S	RS	15 (7)	BDNF55R22C	RS	18 (9)	
	480	1.80	3	55 ⁵ / ₈ (1412.9)	BDNF55R21S	RS	15 (7)	BDNF55R21C	RS	18 (9)	

RAPID SHIP

- RS - Next day shipment up to 5 pieces

Note: All screw plug bundles are designed to fit the inside diameter of the equivalent mating coupling. They will not fit into the equivalent pipe inside diameter.

③ Wired for 3-phase operation only

⑦ CSA certified only

Immersion Heaters

WATROD and FIREBAR Screw Plug Immersion Heaters

Application: Bunker C, Asphalt and #6 Fuel Oil

- 2 1/2 inch NPT screw plug
- WATROD elements
- With thermostat (DPST)
- General purpose or moisture/explosion-resistant enclosure



General Purpose

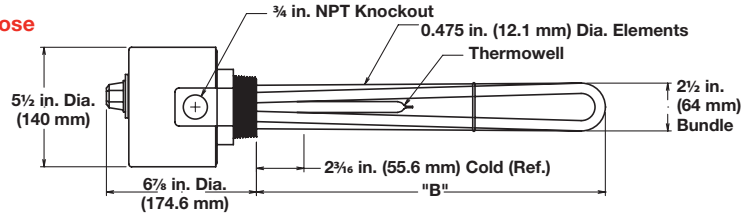

Moisture/Explosion-Resistant

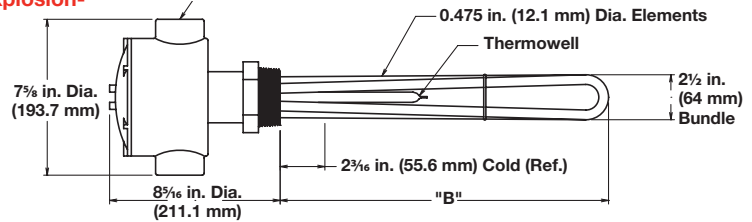

Description	Volts	kW	Ph	"B" Dim. in. (mm)	Ship Wt. lbs (kg)	Type 4 (30-110°F)		Type 5A (60-250°F)		Type 7A (100-550°F)	
						Part Number	Del.	Part Number	Del.	Part Number	Del.
General Purpose Enclosure											
8 W/in ² ③ Steel Plug 3-Steel Elements (1.3 W/cm ²)	240	1.0	3	17 1/4 (438)	10 (5)	BLS717E12S4	RS	BLS717E12S5A	RS	BLS717E12S7	RS
	480	1.0	3	17 1/4 (438)	10 (5)	BLS717E13S4	RS	BLS717E13S5A	RS	BLS717E13S7	RS
	240	1.5	3	24 3/4 (629)	13 (6)	BLS724N12S4	RS	BLS724N12S5A	RS	BLS724N12S7	RS
	480	1.5	3	24 3/4 (629)	13 (6)	BLS724N13S4	RS	BLS724N13S5A	RS	BLS724N13S7	RS
	240	2.0	3	32 1/4 (819)	15 (7)	BLS732E12S4	RS	BLS732E12S5A	RS	BLS732E12S7	RS
	480	2.0	3	32 1/4 (819)	15 (7)	BLS732E13S4	RS	BLS732E13S5A	RS	BLS732E13S7	RS
	240	2.5	3	39 3/4 (1010)	16 (8)	BLS739N12S4	RS	BLS739N12S5A	RS	BLS739N12S7	RS
	480	2.5	3	39 3/4 (1010)	16 (8)	BLS739N13S4	RS	BLS739N13S5A	RS	BLS739N13S7	RS
	240	3.0	3	47 1/4 (1200)	18 (9)	BLS747E12S4	RS	BLS747E12S5A	RS	BLS747E12S7	RS
	480	3.0	3	47 1/4 (1200)	18 (9)	BLS747E13S4	RS	BLS747E13S5A	RS	BLS747E13S7	RS
	240	4.0	3	63 3/4 (1619)	21 (10)	BLS763N12S4	RS	BLS763N12S5A	RS	BLS763N12S7	RS
	480	4.0	3	63 3/4 (1619)	21 (10)	BLS763N13S4	RS	BLS763N13S5A	RS	BLS763N13S7	RS
	240	5.0	3	76 1/4 (1937)	24 (11)	BLS776E12S4	RS	BLS776E12S5A	RS	BLS776E12S7	RS
	480	5.0	3	76 1/4 (1937)	24 (11)	BLS776E13S4	RS	BLS776E13S5A	RS	BLS776E13S7	RS
Moisture/Explosion-Resistant Enclosure ⑦											
8 W/in ² ③ Steel Plug 3-Steel Elements (1.3 W/cm ²)	240	1.0	3	17 1/4 (438)	13 (6)	BLS717E12C4	RS	BLS717E12C5A	RS	BLS717E12C7A	RS
	480	1.0	3	17 1/4 (438)	13 (6)	BLS717E13C4	RS	BLS717E13C5A	RS	BLS717E13C7A	RS
	240	1.5	3	24 3/4 (629)	16 (8)	BLS724N12C4	RS	BLS724N12C5A	RS	BLS724N12C7A	RS
	480	1.5	3	24 3/4 (629)	16 (8)	BLS724N13C4	RS	BLS724N13C5A	RS	BLS724N13C7A	RS
	240	2.0	3	32 1/4 (819)	18 (9)	BLS732E12C4	RS	BLS732E12C5A	RS	BLS732E12C7A	RS
	480	2.0	3	32 1/4 (819)	18 (9)	BLS732E13C4	RS	BLS732E13C5A	RS	BLS732E13C7A	RS
	240	2.5	3	39 3/4 (1010)	19 (9)	BLS739N12C4	RS	BLS739N12C5A	RS	BLS739N12C7A	RS
	480	2.5	3	39 3/4 (1010)	19 (9)	BLS739N13C4	RS	BLS739N13C5A	RS	BLS739N13C7A	RS
	240	3.0	3	47 1/4 (1200)	21 (10)	BLS747E12C4	RS	BLS747E12C5A	RS	BLS747E12C7A	RS
	480	3.0	3	47 1/4 (1200)	21 (10)	BLS747E13C4	RS	BLS747E13C5A	RS	BLS747E13C7A	RS
	240	4.0	3	63 3/4 (1619)	24 (11)	BLS763N12C4	RS	BLS763N12C5A	RS	BLS763N12C7A	RS
	480	4.0	3	63 3/4 (1619)	24 (11)	BLS763N13C4	RS	BLS763N13C5A	RS	BLS763N13C7A	RS
	240	5.0	3	76 1/4 (1937)	27 (13)	BLS776E12C4	RS	BLS776E12C5A	RS	BLS776E12C7A	RS
	480	5.0	3	76 1/4 (1937)	27 (13)	BLS776E13C4	RS	BLS776E13C5A	RS	BLS776E13C7A	RS

RAPID SHIP

- RS - Next day shipment up to 5 pieces

Note: All screw plug bundles are designed to fit the inside diameter of the equivalent mating coupling. They will not fit into the equivalent pipe inside diameter.

- ③ Wired for 3-phase operation only
- ⑦ CSA certified only

Immersion Heaters

WATROD and FIREBAR Screw Plug Immersion Heaters



Application: Bunker C, Asphalt and #6 Fuel Oil

- 2 1/2 inch NPT screw plug
- WATROD elements
- Without thermostat
- General purpose or moisture/explosion-resistant enclosure

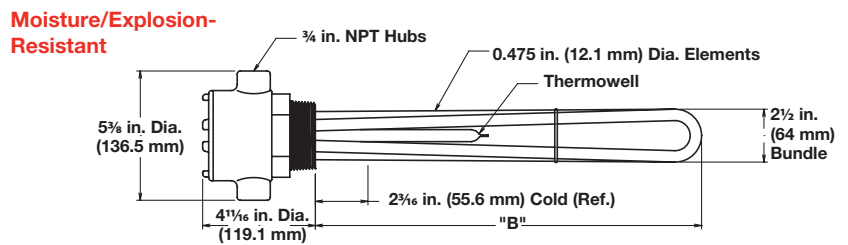
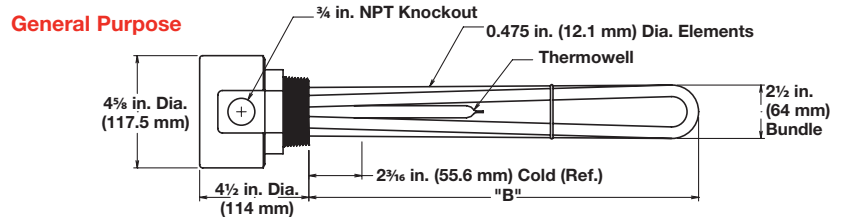

Description	Volts	kW	Ph	"B" Dim. in. (mm)	General Purpose Enclosure				Moisture/Explosion-Resistant Enclosure			
					Part Number	Del.	Ship Wt. lbs (kg)		Part Number ⑦	Del.	Ship Wt. lbs (kg)	
8 W/in ² ③ Steel Plug 3-Steel Elements (1.3 W/cm ²)	240	1.0	1	17 1/4 (438)	BLS717E12S	RS	9 (4)		BLS717E12C	RS	12 (6)	
	480	1.0	3	17 1/4 (438)	BLS717E13S	RS	9 (4)		BLS717E13C	RS	12 (6)	
	240	1.5	3	24 3/4 (629)	BLS724N12S	RS	12 (6)		BLS724N12C	RS	15 (7)	
	480	1.5	1	24 3/4 (629)	BLS724N13S	RS	12 (6)		BLS724N13C	RS	15 (7)	
	240	2.0	3	32 1/4 (819)	BLS732E12S	RS	14 (7)		BLS732E12C	RS	17 (8)	
	480	2.0	3	32 1/4 (819)	BLS732E13S	RS	14 (7)		BLS732E13C	RS	17 (8)	
	240	2.5	3	39 3/4 (1010)	BLS739N12S	RS	15 (7)		BLS739N12C	RS	18 (9)	
	480	2.5	3	39 3/4 (1010)	BLS739N13S	RS	15 (7)		BLS739N13C	RS	18 (9)	
	240	3.0	3	47 1/4 (1200)	BLS747E12S	RS	17 (8)		BLS747E12C	RS	20 (9)	
	480	3.0	3	47 1/4 (1200)	BLS747E13S	RS	17 (8)		BLS747E13C	RS	20 (9)	
	240	4.0	3	63 3/4 (1619)	BLS763N12S	RS	20 (9)		BLS763N12C	RS	23 (11)	
	480	4.0	3	63 3/4 (1619)	BLS763N13S	RS	20 (9)		BLS763N13C	RS	23 (11)	
	240	5.0	3	76 1/4 (1937)	BLS776E12S	RS	23 (11)		BLS776E12C	RS	26 (12)	
	480	5.0	3	76 1/4 (1937)	BLS776E13S	RS	23 (11)		BLS776E13C	RS	26 (12)	

RAPID SHIP

- RS - Next day shipment up to 5 pieces

Note: All screw plug bundles are designed to fit the inside diameter of the equivalent mating coupling. They will not fit into the equivalent pipe inside diameter.

- ③ Wired for 3-phase operation only
- ⑦ CSA certified only

Immersion Heaters

WATROD and FIREBAR Screw Plug Immersion Heaters



Application: Bunker C, Asphalt and #6 Fuel Oil

- 2 1/2 inch NPT screw plug
- FIREBAR elements
- With thermostat (DPST)
- General purpose or moisture/explosion-resistant enclosure

General Purpose

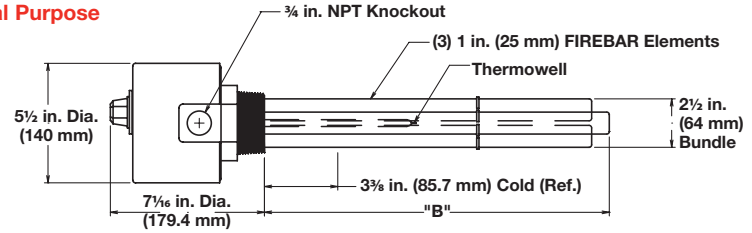

Moisture/Explosion-Resistant

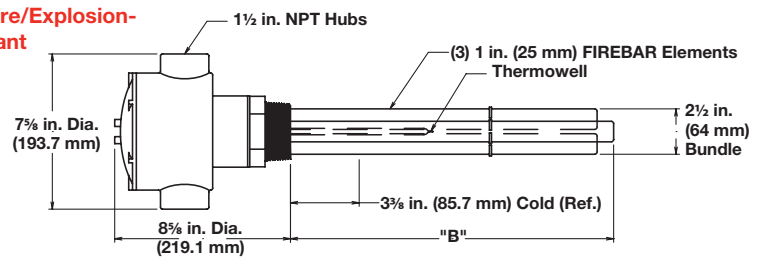

Description	Volts	kW	Ph	"B" Dim. in. (mm)		Ship Wt. lbs (kg)		Type 5A (60-250°F)		Type 7A (100-550°F)	
								Part Number	Del.	Part Number	Del.
General Purpose Enclosure											
8 W/in ² ③ 304 SS Plug 3-Alloy 800 Elements (1.3 W/cm ²)	240	1.25	3	15 1/8	(384.2)	11	(5)	BLNF15C22S5A	RS	BLNF15C22S7A	RS
	240	1.63	3	18 1/8	(460.4)	13	(6)	BLNF18C22S5A	RS	BLNF18C22S7A	RS
	240	2.13	3	23 1/8	(587.4)	15	(7)	BLNF23C22S5A	RS	BLNF23C22S7A	RS
	480	2.13	3	23 1/8	(587.4)	15	(7)	BLNF23C21S5A	RS	BLNF23C21S7A	RS
	240	2.63	3	28 5/8	(727.1)	18	(9)	BLNF28L22S5A	RS	BLNF28L22S7A	RS
	480	2.63	3	28 5/8	(727.1)	18	(9)	BLNF28L21S5A	RS	BLNF28L21S7A	RS
	240	3.19	3	33 5/8	(854.1)	19	(9)	BLNF33L22S5A	RS	BLNF33L22S7A	RS
	480	3.19	3	33 5/8	(854.1)	19	(9)	BLNF33L21S5A	RS	BLNF33L21S7A	RS
	240	4.25	3	44 1/8	(1120.8)	21	(10)	BLNF44C22S5A	RS	BLNF44C22S7A	RS
	480	4.25	3	44 1/8	(1120.8)	21	(10)	BLNF44C21S5A	RS	BLNF44C21S7A	RS
	240	5.38	3	54 5/8	(1387.5)	23	(11)	BLNF54L22S5A	RS	BLNF54L22S7A	RS
	480	5.38	3	54 5/8	(1387.5)	23	(11)	BLNF54L21S5A	RS	BLNF54L21S7A	RS
Moisture/Explosion-Resistant Enclosure ⑦											
8 W/in ² ③ 304 SS Plug 3-Alloy 800 Elements (1.3 W/cm ²)	240	1.25	3	15 1/8	(384.2)	14	(7)	BLNF15C22C5A	RS	BLNF15C22C7A	RS
	240	1.63	3	18 1/8	(460.4)	16	(8)	BLNF18C22C5A	RS	BLNF18C22C7A	RS
	240	2.13	3	23 1/8	(587.4)	18	(9)	BLNF23C22C5A	RS	BLNF23C22C7A	RS
	480	2.13	3	23 1/8	(587.4)	18	(9)	BLNF23C21C5A	RS	BLNF23C21C7A	RS
	240	2.63	3	28 5/8	(727.1)	21	(10)	BLNF28L22C5A	RS	BLNF28L22C7A	RS
	480	2.63	3	28 5/8	(727.1)	21	(10)	BLNF28L21C5A	RS	BLNF28L21C7A	RS
	240	3.19	3	33 5/8	(854.1)	22	(10)	BLNF33L22C5A	RS	BLNF33L22C7A	RS
	480	3.19	3	33 5/8	(854.1)	22	(10)	BLNF33L21C5A	RS	BLNF33L21C7A	RS
	240	4.25	3	44 1/8	(1120.8)	24	(11)	BLNF44C22C5A	RS	BLNF44C22C7A	RS
	480	4.25	3	44 1/8	(1120.8)	24	(11)	BLNF44C21C5A	RS	BLNF44C21C7A	RS
	240	5.38	3	54 5/8	(1387.5)	26	(11)	BLNF54L22C5A	RS	BLNF54L22C7A	RS
	480	5.38	3	54 5/8	(1387.5)	26	(11)	BLNF54L21C5A	RS	BLNF54L21C7A	RS

RAPID SHIP

- RS - Next day shipment up to 5 pieces

Note: All screw plug bundles are designed to fit the inside diameter of the equivalent mating coupling. They will not fit into the equivalent pipe inside diameter.

- ③ Wired for 3-phase operation only
- ⑦ CSA certified only

Immersion Heaters

WATROD and FIREBAR Screw Plug Immersion Heaters



Application: Bunker C, Asphalt and #6 Fuel Oil

- 2 1/2 inch NPT screw plug
- FIREBAR elements
- Without thermostat
- General purpose or moisture/explosion-resistant enclosure

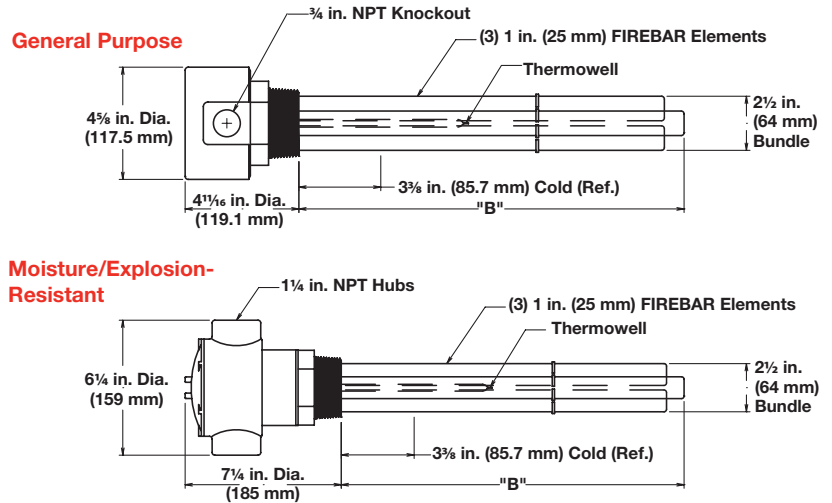

Description	Volts	kW	Ph	"B" Dim. in. (mm)	Part Number	Del.	Ship Wt. lbs (kg)	Part Number ⑦	Del.	Ship Wt. lbs (kg)	
					General Purpose Enclosure			Moisture/Explosion-Resistant Enclosure			
8 W/in ² ③ 304 SS Plug 3-Alloy 800 Elements (1.3 W/cm ²)	240	1.25	3	15 1/8 (384.2)	BLNF15C22S	RS	11 (5)	BLNF15C22C	RS	14 (7)	
	240	1.63	3	18 1/8 (460.4)	BLNF18C22S	RS	12 (6)	BLNF18C22C	RS	15 (7)	
	240	2.13	3	23 1/8 (587.4)	BLNF23C22S	RS	14 (7)	BLNF23C22C	RS	17 (8)	
	480	2.13	3	23 1/8 (587.4)	BLNF23C21S	RS	14 (7)	BLNF23C21C	RS	17 (8)	
	240	2.63	3	28 5/8 (727.1)	BLNF28L22S	RS	17 (8)	BLNF28L22C	RS	20 (9)	
	480	2.63	3	28 5/8 (727.1)	BLNF28L21S	RS	17 (8)	BLNF28L21C	RS	20 (9)	
	240	3.19	3	33 5/8 (854.1)	BLNF33L22S	RS	18 (9)	BLNF33L22C	RS	21 (10)	
	480	3.19	3	33 5/8 (854.1)	BLNF33L21S	RS	18 (9)	BLNF33L21C	RS	21 (10)	
	240	4.25	3	44 1/8 (1120.8)	BLNF44C22S	RS	20 (9)	BLNF44C22C	RS	23 (11)	
	480	4.25	3	44 1/8 (1120.8)	BLNF44C21S	RS	20 (9)	BLNF44C21C	RS	23 (11)	
	240	5.38	3	54 5/8 (1387.5)	BLNF54L22S	RS	22 (10)	BLNF54L22C	RS	25 (12)	
	480	5.38	3	54 5/8 (1387.5)	BLNF54L21S	RS	22 (10)	BLNF54L21C	RS	25 (12)	

RAPID SHIP

- RS - Next day shipment up to 5 pieces

Note: All screw plug bundles are designed to fit the inside diameter of the equivalent mating coupling. They will not fit into the equivalent pipe inside diameter.

- ③ Wired for 3-phase operation only
- ⑦ CSA certified only

Immersion Heaters

WATROD and FIREBAR Screw Plug Immersion Heaters

Ordering Information

Part Number

Stock Screw Plug Part Number	Optional Terminal Enclosures	Optional Process Sensors	Sheath Limit Sensors

Stock Screw Plug Part Number

Note: Catalog part numbers include standard option enclosures and process sensors. To order optional enclosures or sensors, substitute the appropriate suffix.

Optional Terminal Enclosures

S =	General purpose enclosure
W =	Moisture-resistant enclosure
E =	Explosion-resistant enclosure
C =	Moisture/explosion-resistant enclosure

Note: Catalog listings include either a general purpose enclosure or moisture/explosion-resistant enclosure. Substitute enclosure options are noted.

Optional Process Sensors

2 =	30 to 250°F, (-1 to 121°C) SPST
3 =	175 to 550°F, (79 to 288°C) SPST
4 =	30 to 110°F, (-1 to 43°C) DPST
5A=	60 to 250°F, (16 to 121°C) DPST (FIREBAR)
7A=	100 to 550°F, (38 to 288°C) DPST (FIREBAR)
PJ=	Type J process thermocouple in thermowell
PK=	Type K process thermocouple in thermowell

Note: Thermostat part numbers are shown in the *Thermostat Chart* on page 537.

Example Part Number: BHC78C6 S 1 HJ

Sheath Limit Sensors

HJ=	Type J high-limit thermocouple, horizontal mount
TJ=	Type J high-limit thermocouple, vertical/housing at top
BJ=	Type J high-limit thermocouple, vertical/housing at bottom
HK=	Type K high-limit thermocouple, horizontal mount
TK=	Type K high-limit thermocouple, vertical/housing at top
BK=	Type K high-limit thermocouple, vertical/housing at bottom

Note: Heater orientation is critical to accurate sensing of limit conditions. Use the appropriate code to indicate heater mounting orientation.

Immersion Heaters

WATROD and FIREBAR Screw Plug Immersion Heaters

Screw Plug with Control Assembly

Constructed from a WATROD screw plug heater, a moisture resistant terminal enclosure and built-in temperature sensor and power controller, this assembly comes pre-wired and ready for hook-up to any 120VAC control circuit.

Optional sheath materials, NPT screw plug sizes and materials, wattages, voltages and terminal enclosures extend application versatility.

Performance Capabilities

- Watt densities up to 60 W/in² (9.3 W/cm²)
- Wattages up to 20 kilowatts
- Voltages up to 600VAC
- Alloy 800/840 sheath temperatures up to 1600°F (870°C)

Features and Benefits

Three 0.475 in. (12 mm) diameter WATROD elements brazed to a 2 in. (51 mm) NPT brass screw plug

- Produces a pressure-tight seal

WATROD hairpins are repressed (recompacted) after bending

- Maintains MgO density, dielectric strength, heat transfer and life

Two built-in thermostats, one on-off with manual reset

- Helps ensure safe operation by automatically cycling on and off when process or sheath temperatures reach a predetermined set point selectable from 30° to 250°F (0° to 120°C)

Internal mechanical contactor

- Works on a 120VAC control circuit to switch higher volts/amps to the heating elements

Hinged, moisture resistant terminal enclosure has two conduit openings

- Accommodates 3/4 in. (19 mm) NPT conduit fittings

Terminal enclosures can be rotated to mate with existing conduits

- Minimal fastener adjustment required

Thermowells allow replacing the thermostat sensing element without draining the fluid being heated

- Labor required to maintain and repair is minimized

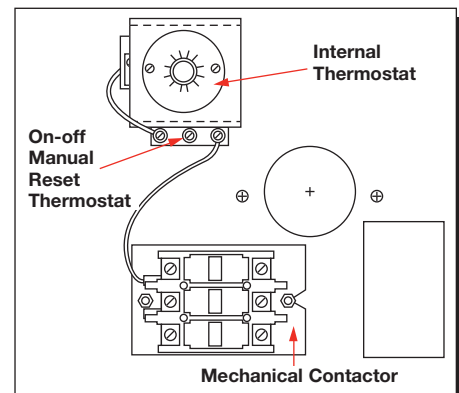
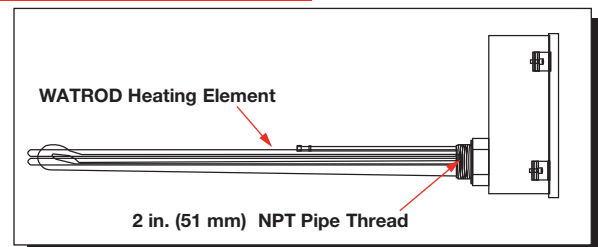
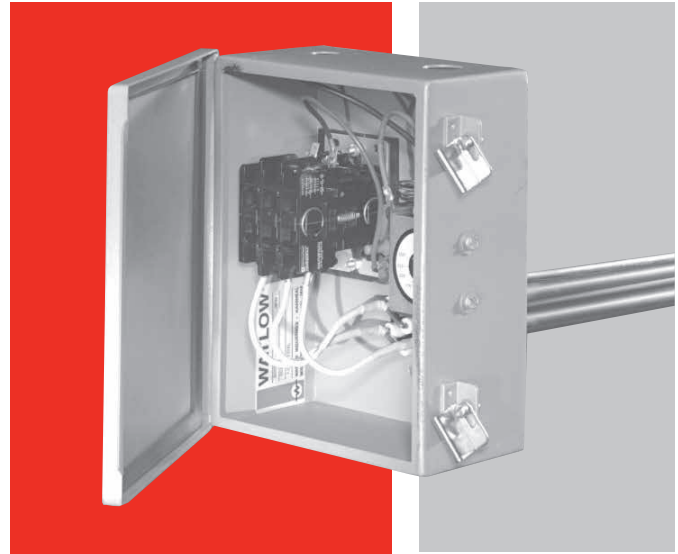

Typical Applications

- Water heating
- Commercial dishwashers and glass washers
- Sterilizing equipment

Application Hints

Same as *Screw Plug Immersion Heaters*. See page 169 for details.

Accessories

Clamping Nut, Gasket and Washers—for mounting to thin-wall tanks, use optional clamping nut, gasket and washers. To order, specify **NGW**.

Immersion Heaters

WATROD and FIREBAR Screw Plug Immersion Heaters

Screw Plug with Control Assembly

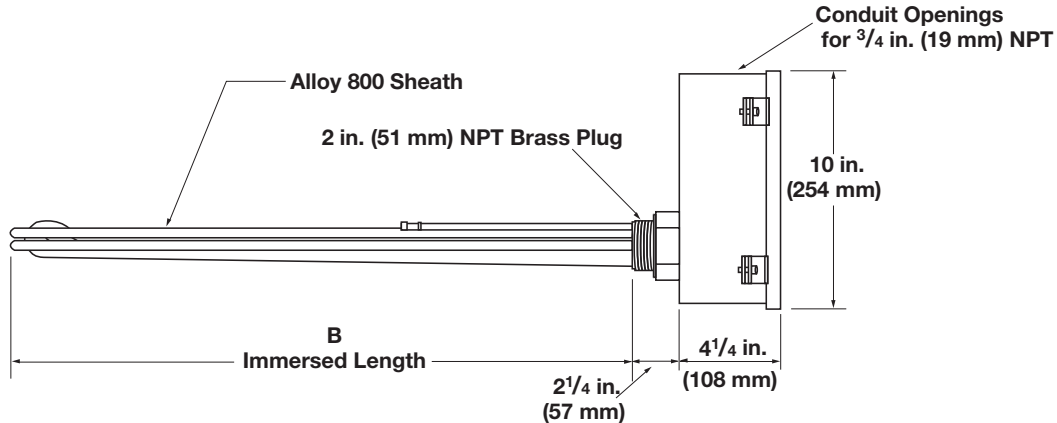

2 in. (51 mm) NPT Brass Screw Plug With Control Box (Assembly Stock)

WATROD Desc.	kW	Immersed Length in. (mm)	Part Number					Est. Net Wt. lbs(kg)	Del.
			208VAC 3-Phase	240VAC 3-Phase	380VAC 3-Phase	480VAC 3-Phase	575VAC 3-Phase		
50 W/in ²	9	24% (629.0)		BHNB24N3W2C11		BHNB24N5W2C11	BHNB24N16W2C11	23 (10)	M
Brass Plug	12	30 (762.0)	BHNB30A2W2C11	BHNB30A3W2C11	BHNB30A8W2C11	BHNB30A5W2C11	BHNB30A16W2C11	24 (11)	M
3-Alloy 800	16	35% (904.8)	BHNB35L2W2C11	BHNB35L3W2C11	BHNB35L8W2C11	BHNB35L5W2C11	BHNB35L16W2C11	25 (11)	M
(7.8 W/cm ²)	20	45% (1158.8)		BHNB45L3W2C11	BHNB45L8W2C11	BHNB45L5W2C11	BHNB45L16W2C11	27 (12)	M

• M - Manufacturing lead times

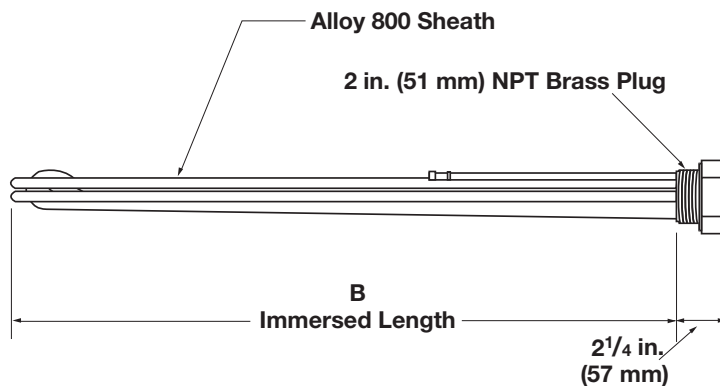

2 in. (51 mm) NPT Brass Screw Plug With Control Box (Replacement Heater Only)

WATROD Desc.	kW	Immersed Length in. (mm)	Part Number					Est. Net Wt. lbs (kg)	Del.
			208VAC 3-Phase	240VAC 3-Phase	380VAC 3-Phase	480VAC 3-Phase	575VAC 3-Phase		
50 W/in ²	9	24% (628.7)		BHNB24N3		BHNB24N5	BHNB24N16	21 (9)	M
Brass Plug	12	30 (762.0)	BHNB30A2	BHNB30A3	BHNB30A8	BHNB30A5	BHNB30A16	22 (10)	M
Alloy 800	16	35% (904.8)	BHNB35L2	BHNB35L3	BHNB35L8	BHNB35L5	BHNB35L16	23 (10)	M
(7.8 W/cm ²)	20	45% (1158.8)		BHNB45L3	BHNB45L8	BHNB45L5	BHNB45L16	25 (11)	M

• M - Manufacturing lead times