

EZ-ZONE[®] PM

User's Guide



Limit Controller Models



WATLOW[®]

Powered by Possibility



ISO 9001



1241 Bundy Boulevard., Winona, Minnesota USA 55987
Phone: +1 (507) 454-5300, Fax: +1 (507) 452-4507
<http://www.watlow.com>

0600-0057-0000 Rev. N













August 2016



Made in the U.S.A.

Safety Information

We use note, caution and warning symbols throughout this book to draw your attention to important operational and safety information.

- A “NOTE” marks a short message to alert you to an important detail.
- A “CAUTION” safety alert appears with information that is important for protecting your equipment and performance. Be especially careful to read and follow all cautions that apply to your application.
- A “WARNING” safety alert appears with information that is important for protecting you, others and equipment from damage. Pay very close attention to all warnings that apply to your application.
- The electrical hazard symbol,  (a lightning bolt in a triangle) precedes an electric shock hazard CAUTION or WARNING safety statement.

Sym- bol	Explanation
	CAUTION - Warning or Hazard that needs further explanation than label on unit can provide. Consult User's Guide for further information.
	ESD Sensitive product, use proper grounding and handling techniques when installing or servicing product.
	Unit protected by double/reinforced insulation for shock hazard prevention.
	Do not throw in trash, use proper recycling techniques or consult manufacturer for proper disposal.
	Enclosure made of Polycarbonate material. Use proper recycling techniques or consult manufacturer for proper disposal.
	Unit can be powered with either alternating current (ac) voltage or direct current (dc) voltage.
	Unit is a Listed device per Underwriters Laboratories®. It has been evaluated to United States and Canadian requirements for Process Control Equipment. UL 61010 and CSA C22.2 No. 61010. File E185611 QUXX, QUXX7. See: www.ul.com
	Unit is compliant with European Union directives. See Declaration of Conformity for further details on Directives and Standards used for Compliance.
	Unit has been reviewed and approved by Factory Mutual as a Temperature Limit Device per FM Class 3545 standard. See: www.fmglobal.com
	Unit has been reviewed and approved by CSA International for use as Temperature Indicating-Regulating Equipment per CSA C22.2 No. 24. See: www.csa-international.org

	Unit has been reviewed and approved by ODVA for compliance with DeviceNet communications protocol. See: www.odva.org
	Unit has been reviewed and approved by ODVA for compliance with Ethernet/IP communications protocol. See: www.odva.org

Warranty

The EZ-ZONE PM is manufactured by ISO 9001-registered processes and is backed by a three-year warranty to the first purchaser for use, providing that the units have not been misapplied. Since Watlow has no control over their use, and sometimes misuse, we cannot guarantee against failure. Watlow's obligations hereunder, at Watlow's option, are limited to replacement, repair or refund of purchase price, and parts which upon examination prove to be defective within the warranty period specified. This warranty does not apply to damage resulting from transportation, alteration, misuse or abuse. The purchaser must use Watlow parts to maintain all listed ratings.

Technical Assistance

If you encounter a problem with your Watlow controller, review your configuration information to verify that your selections are consistent with your application: inputs, outputs, alarms, limits, etc. If the problem persists, you can get technical assistance from your local Watlow representative (see back cover), by e-mailing your questions to wintechsupport@watlow.com or by dialing +1 (507) 494-5656 between 7 a.m. and 5 p.m., Central Standard Time (CST). Ask for for an Applications Engineer. Please have the following information available when calling:

- Complete model number
- All configuration information
- User's Guide
- Factory Page

Return Material Authorization (RMA)

1. Call Watlow Customer Service, (507) 454-5300, for a Return Material Authorization (RMA) number before returning any item for repair. If you do not know why the product failed, contact an Application Engineer or Product Manager. All RMA's require:
 - Ship-to address
 - Bill-to address
 - Contact name
 - Phone number
 - Method of return shipment
 - Your P.O. number
 - Detailed description of the problem
 - Any special instructions
 - Name and phone number of person returning the product.
2. Prior approval and an Return Merchandise Authorization number from the Customer Service Department is required when returning any product for credit, repair or evaluation. Make sure the Return Merchandise Authorization number is on the outside of the

carton and on all paperwork returned. Ship on a Freight Prepaid basis.

3. After we receive your return, we will examine it and try to verify the reason for returning it.
4. In cases of manufacturing defect, we will enter a repair order, replacement order or issue credit for material returned. In cases of customer misuse, we will provide repair costs and request a purchase order to proceed with the repair work.
5. To return products that are not defective, goods must be in new condition, in the original boxes and they must be returned within 120 days of receipt. A 20 percent restocking charge is applied for all returned stock controls and accessories.
6. If the unit cannot be repaired, you will receive a letter of explanation and be given the option to have the unit returned to you at your expense or to have us scrap the unit.
7. Watlow reserves the right to charge for no trouble found (NTF) returns.

This EZ-ZONE® PM User's Guide is copyrighted by Watlow Electric, Inc., © August 2016 with all rights reserved.

EZ-ZONE PML is covered by U.S. Patent Numbers: 6,005,577 and Patents Pending



Table of Contents

- Table of Contents 1**
- Chapter 1: Overview 4**
 - Available EZ-ZONE PM Literature and Resources 4
 - Introduction 5
 - A Conceptual View of the PM 6
 - Inputs 6
 - Internal Functions 6
 - Outputs 7
 - Input Events and Output Events 7
- Chapter 2: Install and Wire 11**
 - Dimensions 11
 - 1/32 DIN (PM3) 11
 - 1/32 DIN (PM3) Recommended Panel Spacing 11
 - 1/16 DIN (PM6) 12
 - 1/16 DIN (PM6) Recommended Panel Spacing 12
 - 1/8 DIN (PM8) Vertical 13
 - 1/8 DIN (PM8) Vertical Recommended Panel Spacing 13
 - 1/8 DIN (PM9) Horizontal 14
 - 1/8 DIN (PM9) Horizontal Recommended Panel Spacing 14
 - 1/4 DIN (PM4) 15
 - 1/4 DIN (PM4) Recommended Panel Spacing 15
 - Installation 16
 - Wiring 18
 - PM Integrated Isolation Block 21
- Chapter 3: Keys and Displays 39**
 - Responding to a Displayed Message 40
- Chapter 4: Home Page 41**
 - Changing the Set Point 43
 - Modifying the Home Page 43
 - Modifying the Display Pairs 43
 - Conventions Used in the Menu Pages 44
 - Display 45
 - Communication Protocols 45
 - Modbus Introduction to the Modbus Protocol 46
 - Profibus DP 47
- Chapter 5: Operations Page 48**
 - Analog Input Menu 49
 - Digital Input/Output Menu 50
 - Limit Menu 50
 - Alarm Menu 51



Table of Contents (cont.)

- Chapter 6: Setup Page 54**
 - Analog Input Menu 57
 - Digital Input/Output Menu 60
 - Limit Menu 62
 - Output Menu. 64
 - Alarm Menu 66
 - Function Key 70
 - Global Menu 71
 - Communications Menu. 72
- Chapter 7: Factory Page 81**
 - Custom 83
 - Lock Menu 84
 - Unlock Menu 86
 - Diagnostics Menu. 87
 - Calibration Menu 89
- Chapter 8: Features 91**
 - Changing PM Integrated Model Number to PM Express 92
 - Saving and Restoring Settings. 94
 - Programming the Home Page 94
 - Inputs. 94
 - Calibration Offset 94
 - Calibration 95
 - Filter Time Constant 97
 - Sensor Selection. 97
 - Set Point Minimum and Maximum. 97
 - Scale High and Scale Low 97
 - Range High and Range Low 98
 - Outputs 98
 - Retransmitting a Process Value or Set Point 98
 - Resetting a Tripped Limit. 98
 - Alarms 99
 - Process Alarms 99
 - Set Points 99
 - Hysteresis. 100
 - Latching 100
 - Silencing. 100
 - Blocking 101
 - Using Lockout and Password Security 101
 - Using Lockout Method 1 (Read and Set Lock). 101
 - Using Lockout Method 2 (Password Enable) 103



Table of Contents (cont.)

- Modbus - Using Programmable Memory Blocks..... 105
- CIP - Communications Capabilities 106
 - CIP Implicit Assemblies 107
- Profibus DP - (Decentralized Peripherals) 108
- Software Configuration 108
 - Using EZ-ZONE Configurator Software..... 108
- Chapter 9: Appendix 112**
 - Troubleshooting Alarms, Errors and Control Issues 112
 - Modbus - Programmable Memory Blocks..... 117
 - Modbus - Programmable Memory Blocks..... 118
 - CIP Implicit Assembly Structures 120
 - PM Specifications 128
 - Ordering Information for Enhanced Limit Controller Models..... 134
 - Ordering Information for Limit Controller Models..... 135
 - How to Reach Us..... 137

1

Chapter 1: Overview

Available EZ-ZONE PM Literature and Resources

Document Title and Part Number	Description
EZ-ZONE PM Integrated PID Controller User's Guide, part number: 0600-0059-0000	Describes how to connect and use an advanced PID loop controller. This particular model can be ordered with two loops of PID control and integrated limit controller with up to 4 outputs. Like all PM controllers, it comes with Standard Bus communications while also offering as an option many of the most popular industrial protocols available today.
EZ-ZONE PM PID Controller User's Guide, part number: 0600-0058-0000	Describes how to connect and use an advanced PID loop controller. This particular model is limited to one control loop and 2 outputs. Like all PM controllers, it comes with Standard Bus communications. As an additional option, it can also be ordered with Modbus® RTU communications.
EZ-ZONE Remote User Interface (RUI) User's Guide, part number: 0600-0060-0000	The RUI provides a visual remote LED display for the PM/RM configuration and setup menus. This document illustrates and describes connections and also describes the Home Page for each EZ-ZONE device as viewed from the RUI.
EZ-ZONE PM Specification Sheet, part number: winez-pm0516	Describes the PM family hardware options, features, benefits and technical specifications.
Watlow Support Tools DVD, part number: 0601-0001-0000	Contains all related user documents, tutorial videos, application notes, utility tools, etc...

The DVD described above ships with the product and as stated contains all of the literature above as well as much more. If the DVD is not available one can be acquired by contacting Watlow Customer Service at 1-507-454-5300.

As an alternative to the DVD, all of the user documentation described above can also be found on the Watlow website. Click on the following link to find your document of choice: <http://www.watlow.com/literature/index.cfm>. Once there, simply type in the desired part number (or name) into the search box and download free copies. Printed versions of all user documents can also be purchased here as well.

Your Comments are Appreciated

In an effort to continually improve our technical literature and ensure that we are providing information that is useful to you, we would very much appreciate your comments and suggestions. Please send any comments you may have to the following e-mail address:

TechlitComments@watlow.com

Introduction

The EZ-ZONE® PM takes the pain out of solving your thermal loop requirements. Watlow's EZ-ZONE PM controllers offer options to reduce system complexity and the cost of control loop ownership. You can order the EZ-ZONE PM as a Limit, PID or an Integrated PID/Limit controller. You can also select from a number of industrial serial communications protocols as options to enable connectivity into a distributed control system or to simply help manage system performance over a network.

Standard Features and Benefits

EZ-ZONE configuration communications and software

- Saves time and improves the reliability of controller set up

FM Approved Over-under Limit with Auxiliary Outputs

- Increases user and equipment safety for over-under temperature conditions
- To meet agency requirements, output 2 is the fixed limit output.

Parameter Save & Restore Memory

- Reduces service calls and down time

Agency approvals: UL® Listed, CSA, CE, RoHS, W.E.E.E. FM

- Assures prompt product acceptance
- Reduces end product documentation costs
- Semi F47-0200

P3T Armor Sealing System

- NEMA 4X and IP65 offers water and dust resistance, can be cleaned and washed down (indoor use only)
- Backed up by UL 50 independent certification to NEMA 4X specification

Three-year warranty

- Demonstrates Watlow's reliability and product support

Touch-safe Package

- IP2X increased safety for installers and operators

EZ-Key/s

- Programmable EZ-Key enables simple one-touch operation of repetitive user activities

Programmable Menu System

- Reduces set up time and increases operator efficiency

Full Featured Alarms

- Improves operator recognition of system faults
- Provides control of auxiliary devices

Three-year warranty

- Demonstrates Watlow's reliability and product support

A Conceptual View of the PM

The flexibility of the PM software and hardware allows for a large range of configurations. Acquiring a better understanding of the controller's overall functionality and capabilities while at the same time planning out how the controller can be used will deliver maximum effectiveness in your application.

It is useful to think of the controller in terms of functions; there are internal and external functions. An input and an output would be considered external functions where the limit, PID or alarm function would be an internal function. Information flows from an input function to an internal function to an output function when the controller is properly configured. A single PM controller can carry out several functions at the same time, for instance (but not limited to), PID control, checking for a limit condition, monitoring for several different alarm situations, etc... To ensure that the application requirements are being met, it is important to first give thought to each external process and then configuring the controller's internal functions to properly accommodate the application requirements.

Inputs

The inputs provide the information that any given programmed procedure can act upon. In a simple form, this information may come from an operator pushing a button or from a sensor monitoring the temperature of a part being heated or cooled.

Each analog input typically uses a thermocouple or RTD to read the process temperature. It can also read volts, current or resistance, allowing it to use various devices to read a wide array of values. The settings in the Analog Input Menu (Setup Page) for each analog input must be configured to match the device connected to that input.

A PM with digital input/output (DIO) hardware includes two sets of terminals where each of which can be used as either an input or an output. Each pair of terminals must be configured to function as either an input or output with the direction parameter in the Digital Input/Output Menu (Setup Page). Each digital input reads whether a device is active or inactive.

The Function or EZ Key/s (PM4/6/8/9 only) on the front panel of the PM also operates as a digital input by toggling the function assigned to it in the Digital Input Function parameter in the Function Key Menu (Setup Page).

Internal Functions

The controller will use input signals to calculate a value and then perform an operation. A sample of some functions may be as simple as:

- Detect a failure of the primary sensing device and trip a contactor to remove power from the heating element
- Reading a digital input to set a state to true or false
- Evaluate an incoming temperature to determine an alarm state (on or off)
- Compare an input value to the set point and calculate the optimal power for a heater

To set up a function, it's important to define the source, or instance, to use. For example, if the control is equipped with DIO they can be configured to respond to an alarm. If configured as such, the digital output must be tied to the desired alarm instance (1 to 4). Using this as an example, the Function for the digital output would be defined as an Alarm where the Instance would be selected as 1, 2, 3, or 4 corresponding to the alarm instance that will drive the output.

Keep in mind that a function is a user-programmed internal process that does not execute any action outside of the controller. To have any effect outside of the controller, an output must be configured to respond to a function.

Outputs

Outputs can perform various functions or actions in response to information provided by a function such as, removal of the control voltage to a contactor; operating a heater, turning a light on or off, unlocking a door, etc...

Assign a Function to any available output on the Setup Page within the Output Menu or Digital Input/Output Menu. Then select which instance of that function will drive the selected output. For example, you might assign an output to respond to alarm 4 (instance 4).

You can assign more than one output to respond to a single instance of a function. For example, alarm 2 could be used to trigger a light connected to output 1 and a siren connected to digital output 5.

Input Events and Output Events

Input events are internal states that are set by the digital inputs. Digital Input 5 provides the state of input event 1, and Digital Input 6 provides the state of input event 2. The setting of Digital Input Function (Setup Page, Digital Input/Output Menu) does not change the relationship between the input and the event. An input will still control the input event state, even if Digital Input Function is set to None.

EZ-ZONE[®] PM Enhanced Limit PM4/6/8/9 Models - System Diagram (with communications options 2, 3, 5 or 6)

Universal Sensor Input, Configuration Communications,
Red/Green 7-Segment Display

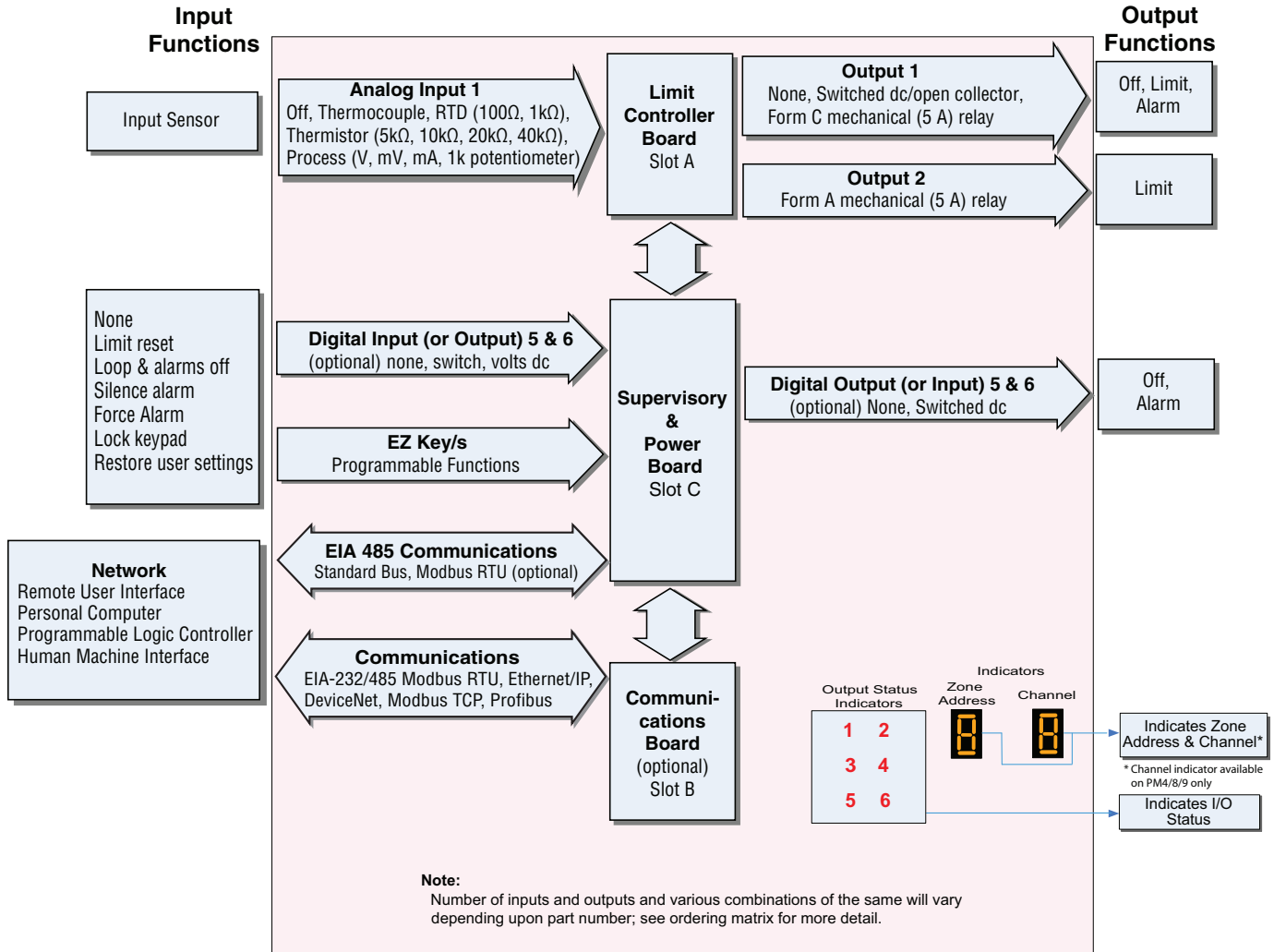

EZ-ZONE[®] PM Enhanced Limit PM4/6/8/9 Models - Input/Output (no communications options 2, 3, 5 or 6)

Universal Sensor Input, Configuration Communications,
Red/Green 7-Segment Display

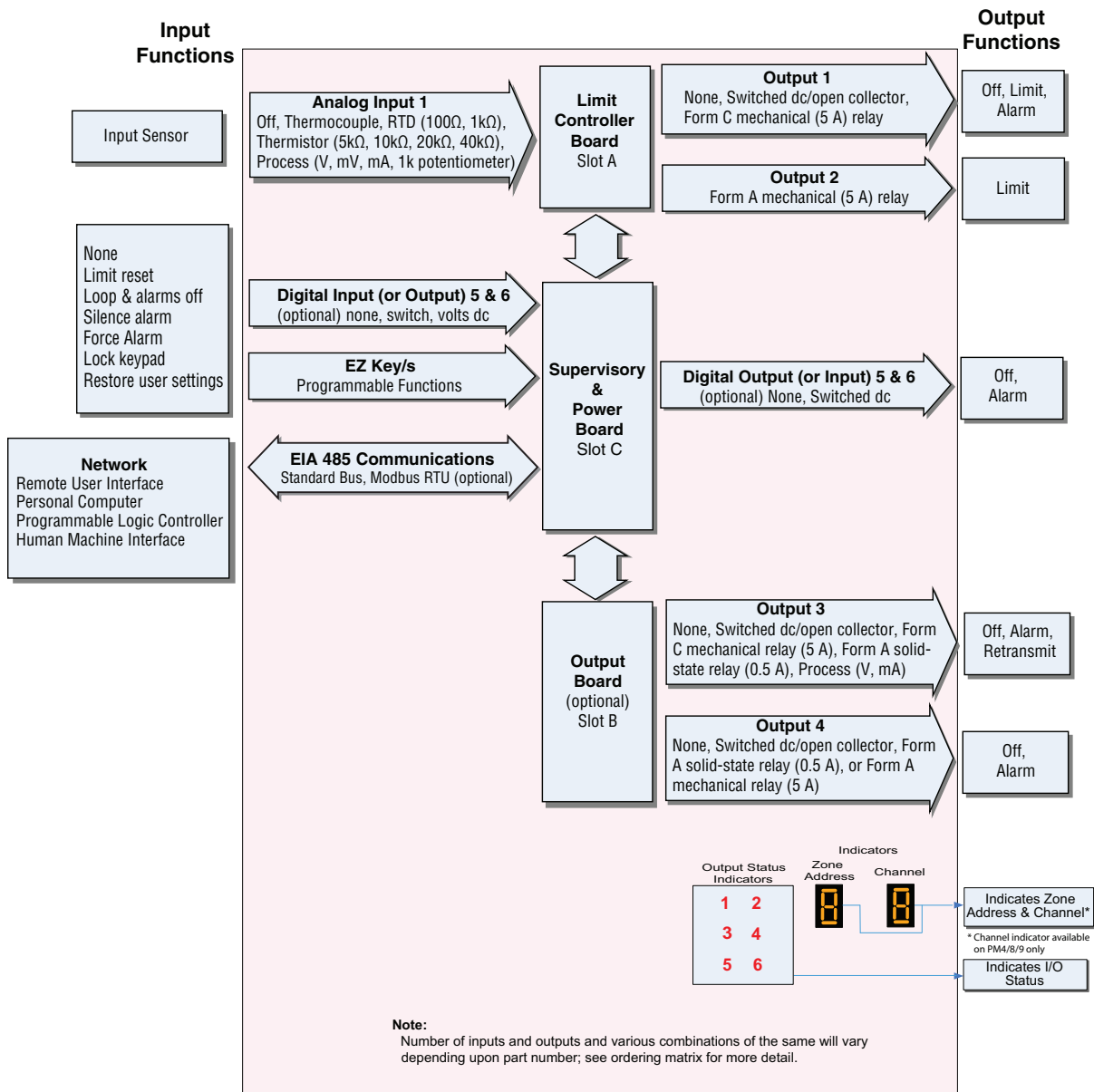

EZ-ZONE® PM Limit All Models System Diagram

Universal Sensor Input, Configuration Communications,
Red/Green 7-Segment Display

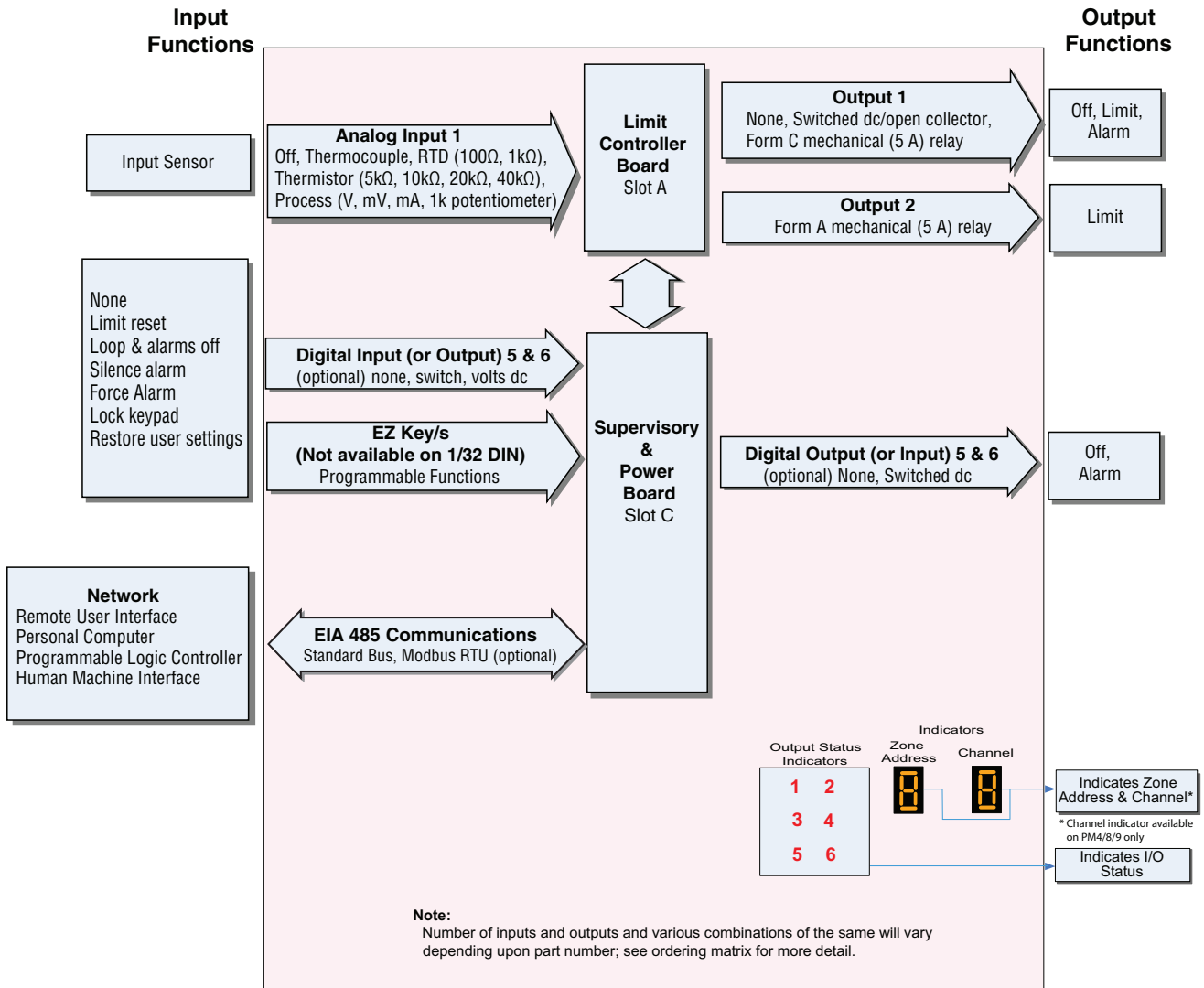

2

Chapter 2: Install and Wire

Dimensions

1/32 DIN (PM3)

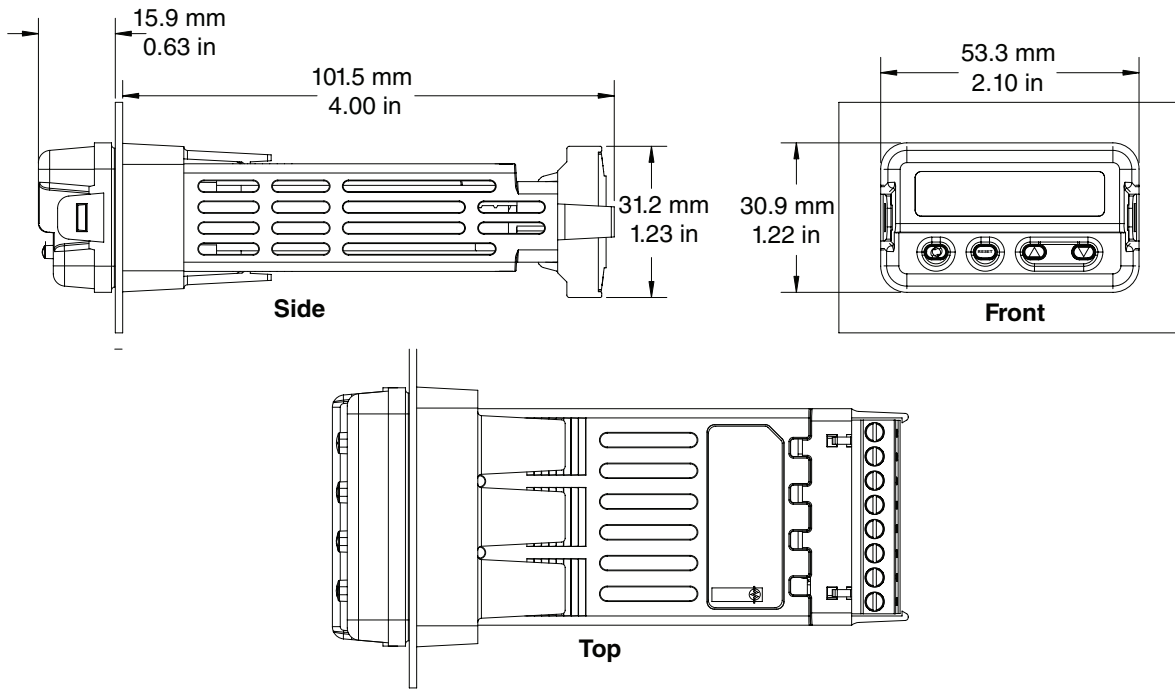

1/32 DIN (PM3) Recommended Panel Spacing

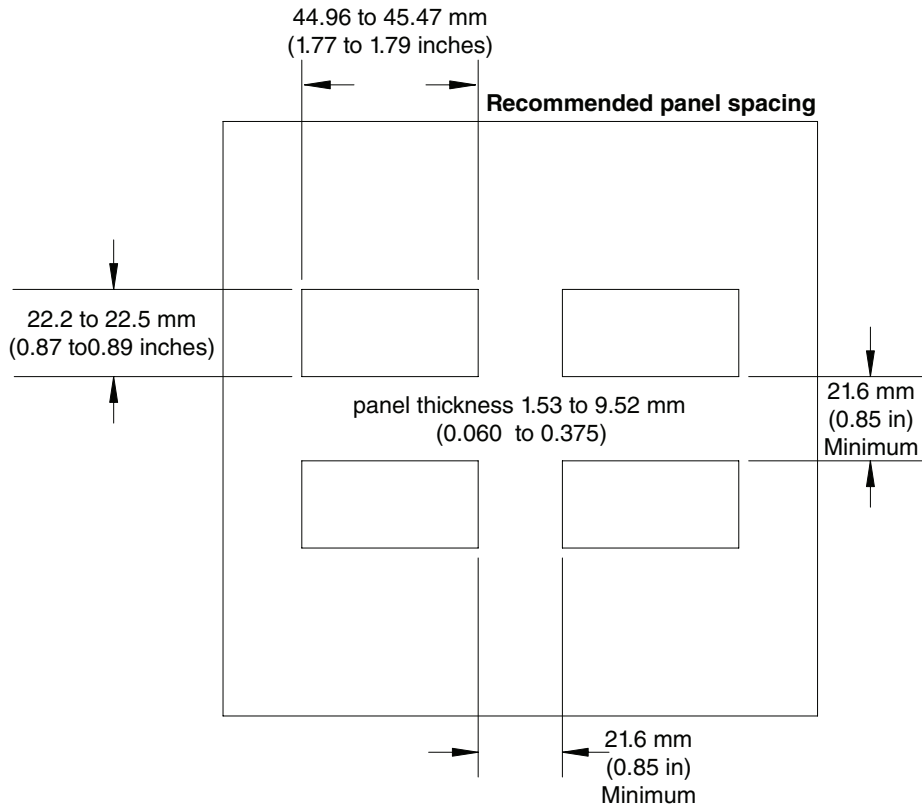

1/16 DIN (PM6)

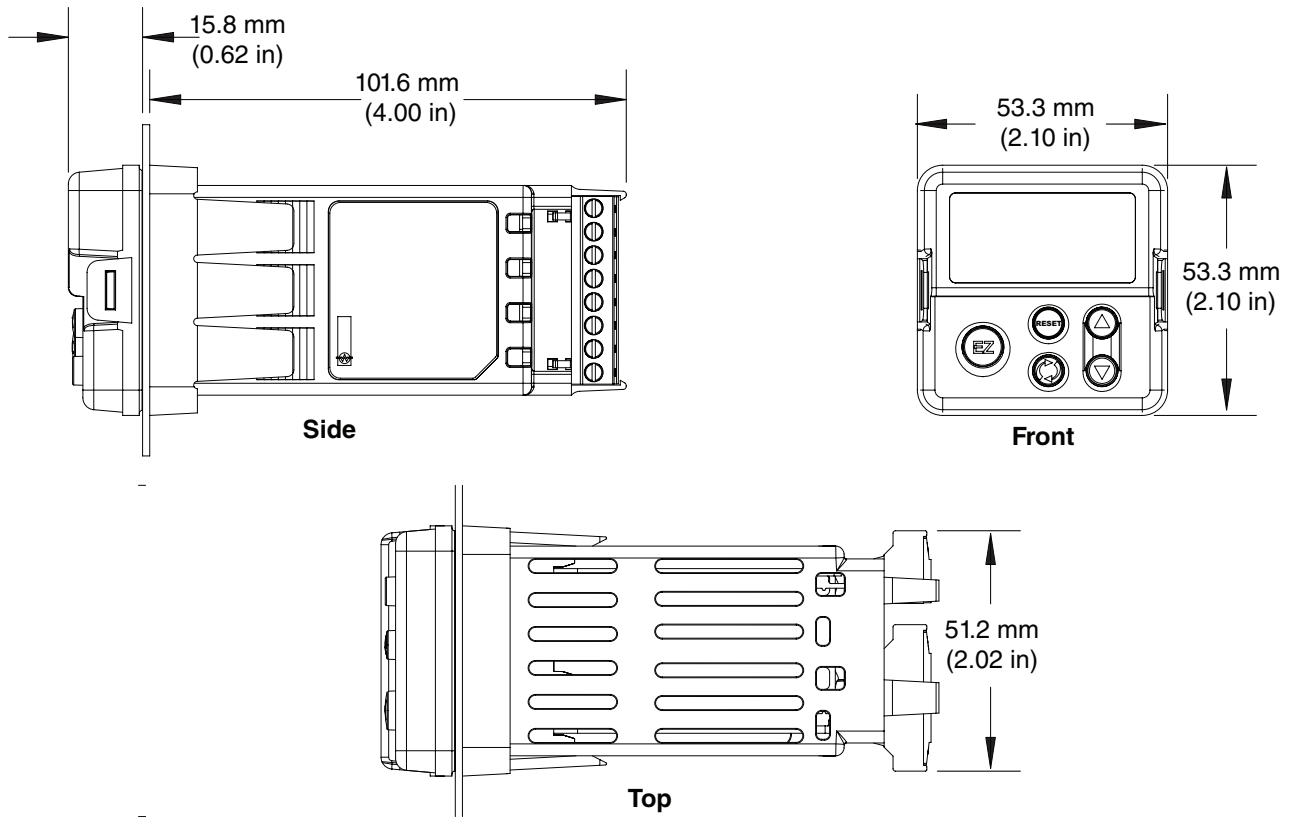

1/16 DIN (PM6) Recommended Panel Spacing

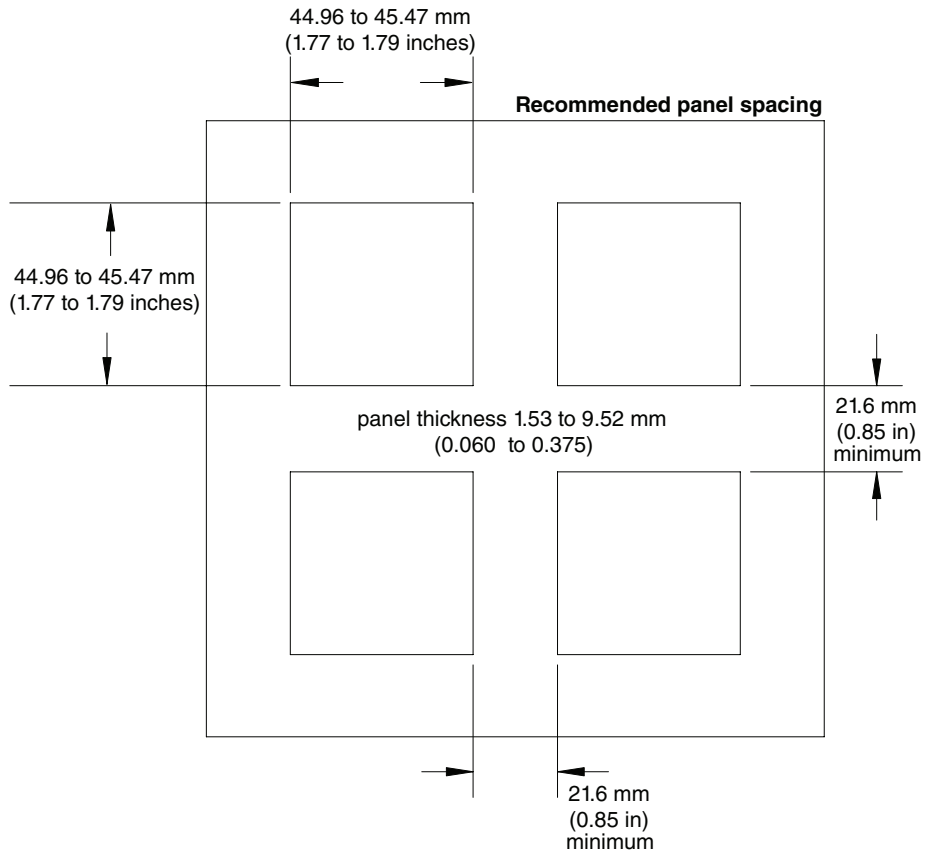

1/8 DIN (PM8) Vertical

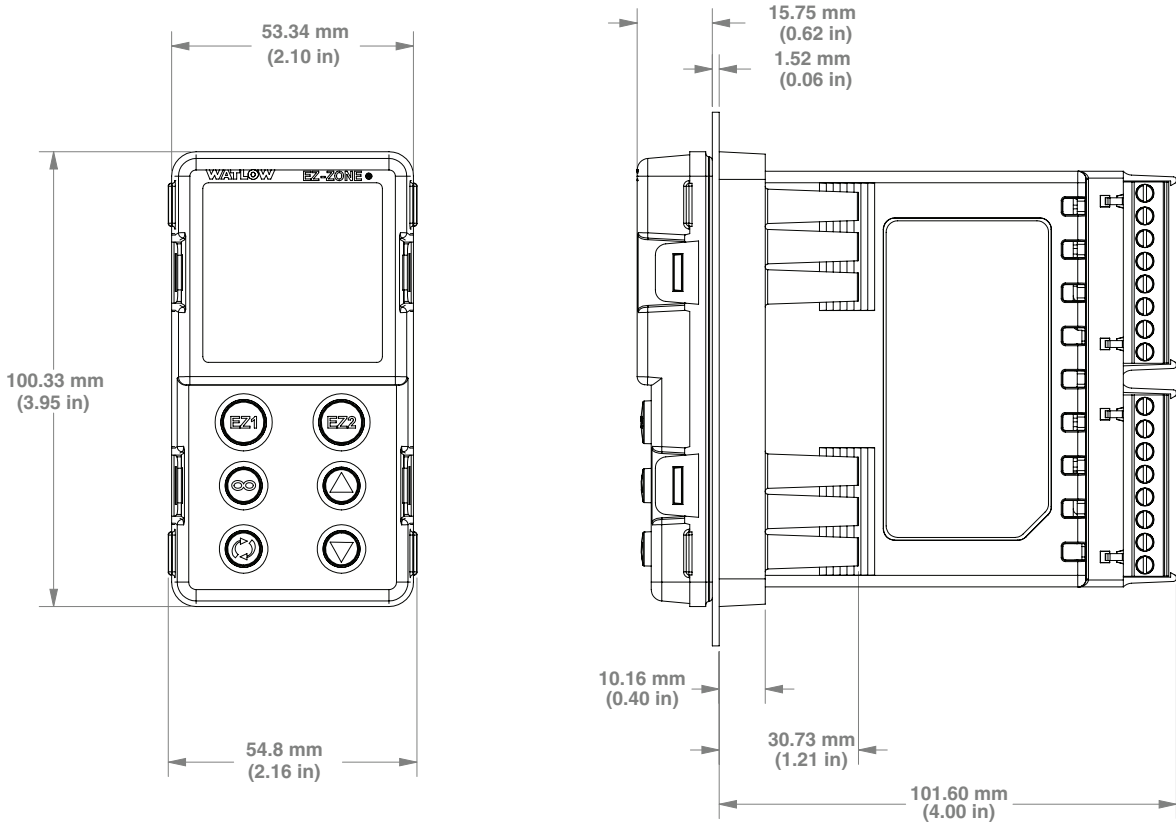

1/8 DIN (PM8) Vertical Recommended Panel Spacing

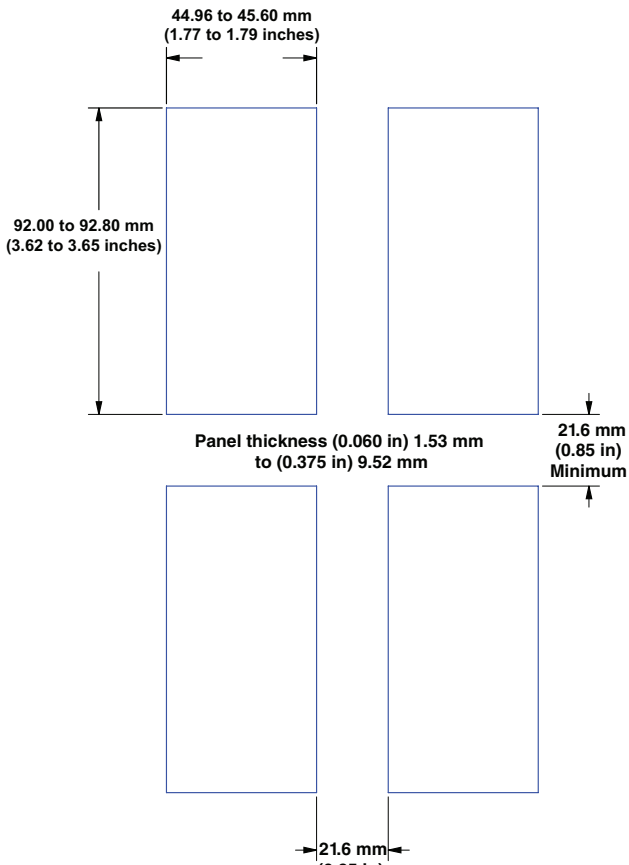

1/8 DIN (PM9) Horizontal

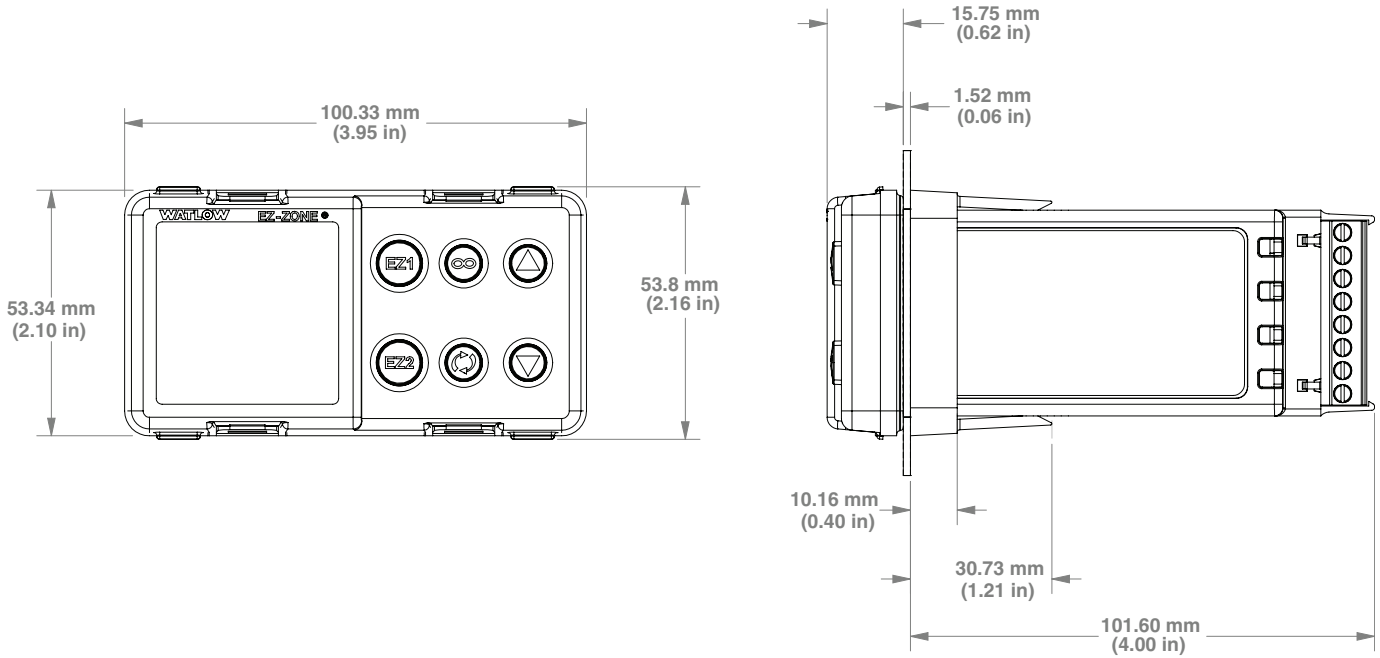

1/8 DIN (PM9) Horizontal Recommended Panel Spacing

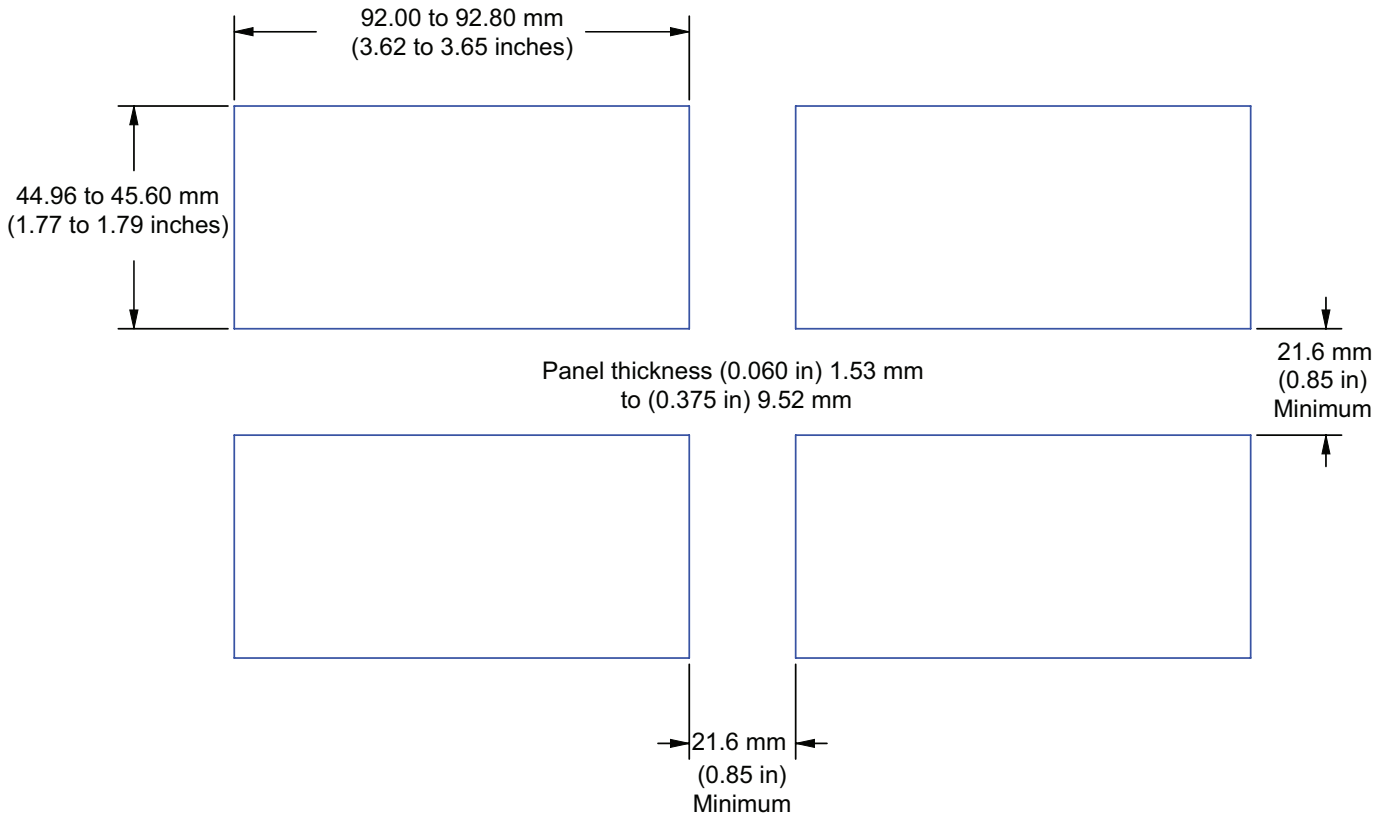

1/4 DIN (PM4)

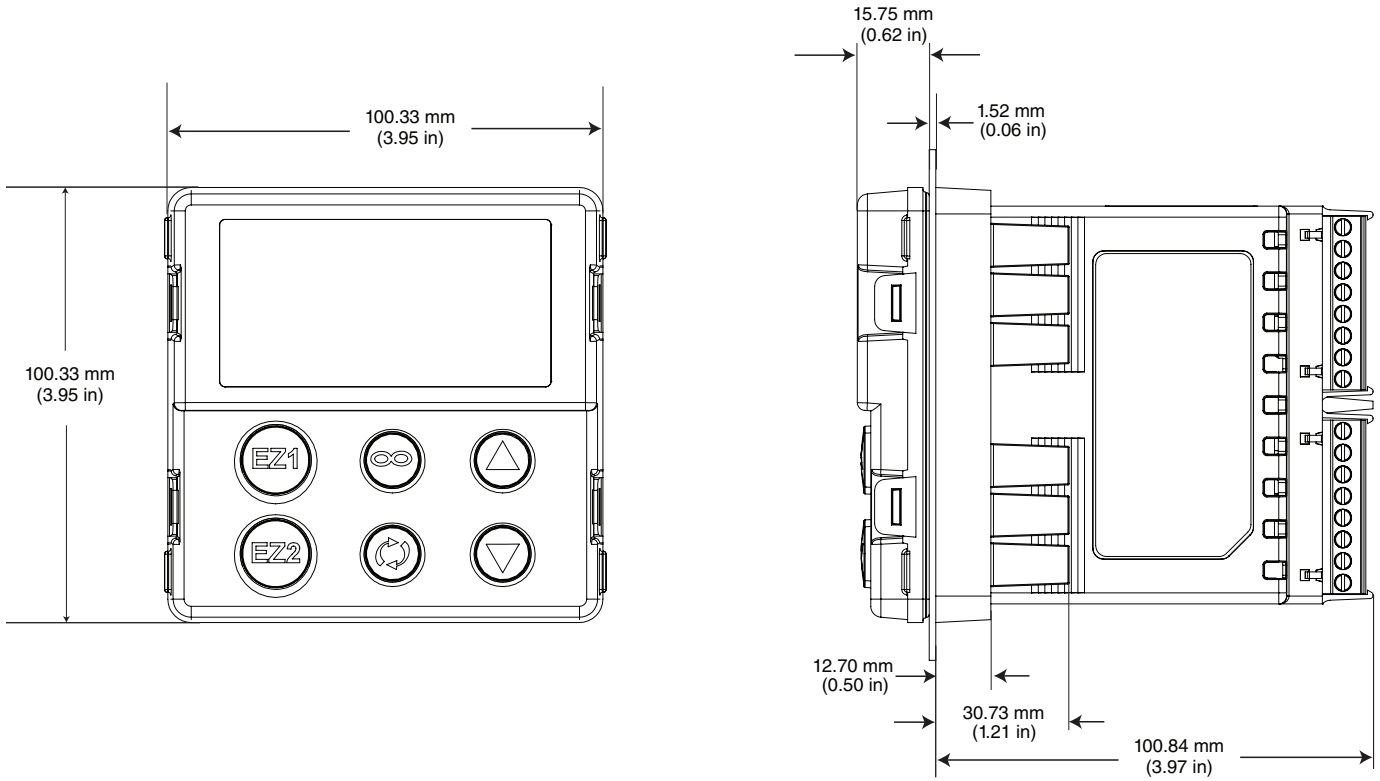

1/4 DIN (PM4) Recommended Panel Spacing

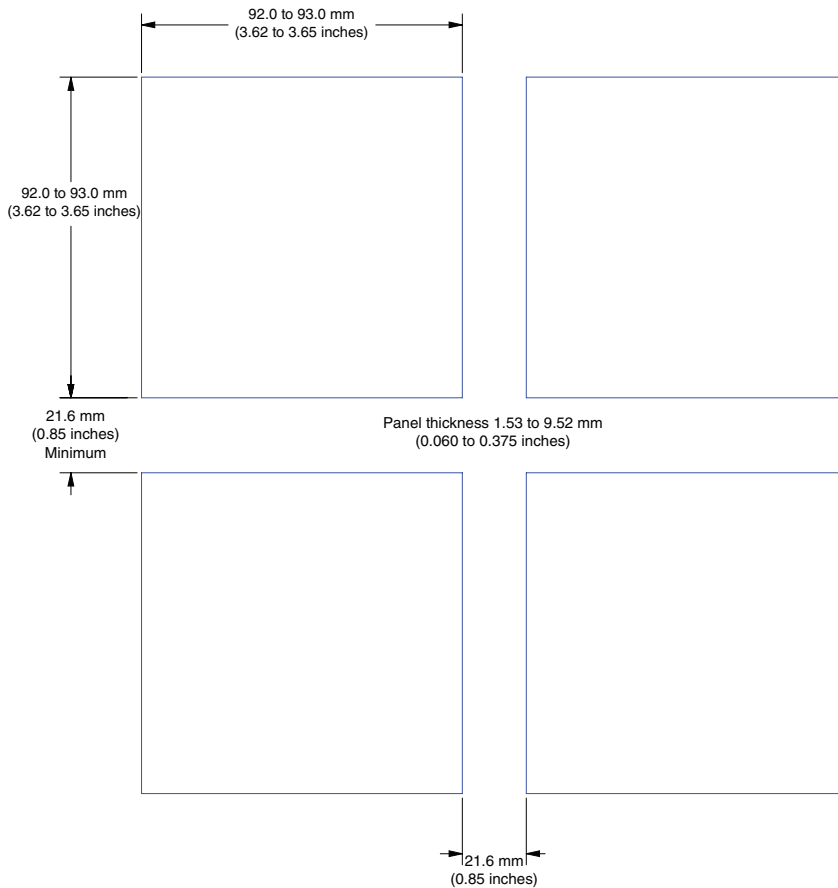

Installation

1. Make the panel cutout using the mounting template dimensions in this chapter. Insert the case assembly into the panel cutout.
2. While pressing the case assembly firmly against the panel, slide the mounting collar over the back of the controller. If the installation does not require a NEMA 4X seal, simply slide together until the gasket is compressed.
3. For a NEMA 4X (UL50, IP65) seal, alternately place and push the blade of a screwdriver against each of the the four corners of the mounting collar assembly. Apply pressure to the face of the controller while pushing with the screwdriver. Don't be afraid to apply enough pressure to properly install the controller. The seal system is compressed more by mating the mounting collar tighter to the front panel (see pictures above). If you can move the case assembly back and forth in the cutout, you do not have a proper seal. The tabs on each side of the mounting collar have teeth that latch into the ridges on the sides of the controller. Each tooth is staggered at a different depth from the front so that only one of the tabs, on each side, is locked onto the ridges at a time.

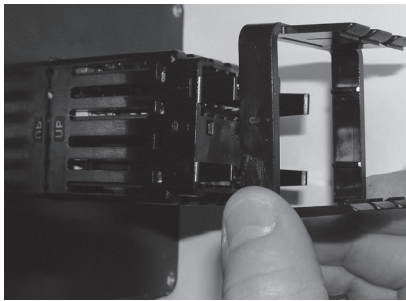
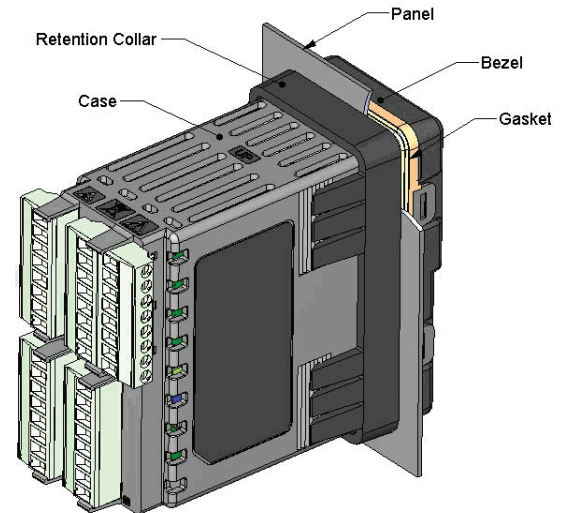

Slide the mounting collar over the back of the controller.

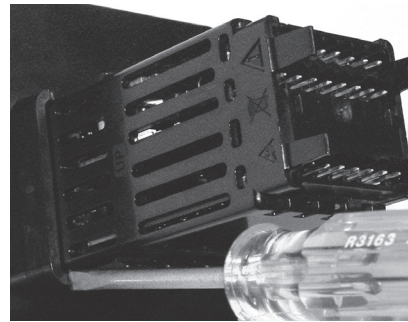

Place the blade of a screwdriver in any of the corner of the mounting collar assembly.

Note:

There is a graduated measurement difference between the upper and lower half of the display to the panel. In order to meet the seal requirements mentioned above, ensure that the distance from the front of the top half of the display to the panel is 16 mm (0.630 in.) or less, and the distance from the front of the bottom half and the panel is 13.3 mm (0.525 in.) or less.

Removing the Mounted Controller from Its Case

1. From the controller's face, pull out the tabs on each side until you hear it click.

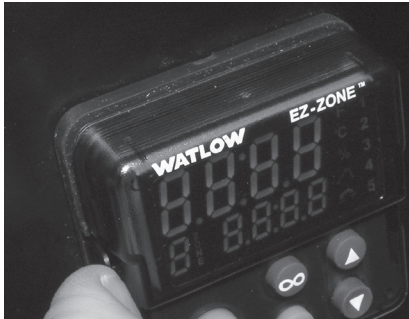

Pull out the tab on each side until you hear it click.



Grab the unit above and below the face and pull forward.

2. Grab the unit above and below the face with two hands and pull the unit out. On the PM4/8/9 controls slide a screwdriver under the pry tabs and turn.

Returning the Controller to its Case

1. Ensure that the orientation of the controller is correct and slide it back into the housing.

Note:

The controller is keyed so if it feels that it will not slide back in do not force it. Check the orientation again and reinsert after correcting.

2. Using your thumbs push on either side of the controller until both latches click.

Chemical Compatibility

This product is compatible with acids, weak alkalis, alcohols, gamma radiation and ultraviolet radiation. This product is not compatible with strong alkalis, organic solvents, fuels, aromatic hydrocarbons, chlorinated hydrocarbons, esters and ketones.

Wiring

Slot A	Slot B	Slot E	Terminal Function	Configuration
Inputs			Universal, RTD and Thermistor Inputs	
T1 S1 R1			S2 (RTD) or current + S3 (RTD), thermocouple -, current -, volts - or potentiometer wiper, thermistor S1 (RTD), thermocouple + or volts +, thermistor, potentiometer	Universal Sensor Input 1: all configurations
Outputs			Switched dc/open collector	
1	2	3	4	
X1 W1 Y1		X3 W3 Y3		common (Any switched dc output can use this common.) dc- (open collector) dc+
			Switched dc	
		W4 Y4		dc- dc+
			Universal Process	
		F3 G3 H3		voltage or current - voltage + current +
			Mechanical Relay 5 A, Form C	
L1 K1 J1		L3 K3 J3		normally open common normally closed
			Mechanical Relay 5 A, Form A	
	L2 K2		L4 K4	normally open common
			Solid-State Relay 0.5 A, Form A	
		L3 K3	L4 K4	normally open common
Communications			Modbus RTU 232/485 Communications	
	CB CA CC CB CA C5 C3 C2	CB CA CC CB CA C5 C3 C2	Modbus RTU EIA-485 T+/R+ Modbus RTU EIA-485 T-/R- Modbus RTU EIA-485 common Modbus RTU EIA-485 T+/R+ Modbus RTU EIA-485 T-/R- Modbus RTU EIA-232 common Modbus RTU EIA-232 to DB9 pin 2 Modbus RTU EIA-232 to DB9 pin 3	Slot B: PM6 ___-[-2] A A A AAA Slot E: PM [4, 8, 9] ___-[-2] A A A AAA
			DeviceNet™ Communications	
	V+ CH SH CL V-	V+ CH SH CL V-	DeviceNet™ power Positive side of DeviceNet™ bus Shield interconnect Negative side of DeviceNet™ bus DeviceNet™ power return	DeviceNet™ Communications Slot B: PM6 ___-[-5] A A A AAA Slot E: PM [4, 8, 9] ___-[-5] A A A AAA

Wiring (cont.)

Slot A	Slot B	Slot E	Terminal Function	Configuration
Communications (cont.)			EtherNet/IP™ and Modbus® TCP	
	E8	E8	EtherNet/IP™ and Modbus TCP unused	Slot B: PM6 _ _ _ -[3] A A A AAA Slot E: PM [4, 8, 9] _ _ _ -[3] A A A AAA
	E7	E7	EtherNet/IP™ and Modbus TCP unused	
	E6	E6	EtherNet/IP™ and Modbus TCP receive -	
	E5	E5	EtherNet/IP™ and Modbus TCP unused	
	E4	E4	EtherNet/IP™ and Modbus TCP unused	
	E3	E3	EtherNet/IP™ and Modbus TCP receive +	
	E2	E2	EtherNet/IP™ and Modbus TCP transmit -	
	E1	E1	EtherNet/IP™ and Modbus TCP transmit +	
			Profibus DP Communications	
	VP	VP	Voltage Potential	Slot B: PM6 _ _ _ -[6] A A A AAA Slot E: PM [4, 8, 9] _ _ _ -[6] A A A AAA
	B	B	EIA-485 T+/R+	
	A	A	EIA-485 T-/R-	
	DG	DG	Digital ground (common)	
	trB	trB	Termination resistor B	
	B	B	EIA-485 T+/R+	
	A	A	EIA-485 T-/R-	
	trA	trA	Termination resistor A	

Terminal Definitions for Slot C

Slot C	Terminal Function	Configuration
Power		
98	Power input: ac or dc+	all
99	Power input: ac or dc-	
Standard Bus or Modbus EIA-485		
CC	Standard Bus or Modbus RTU EIA-485	Standard Bus or Modbus PM _ _ _ _ -[1] _ _ _ AAA
CA	Common	
CB	Standard Bus or Modbus RTU EIA-485 T-/R- Standard Bus or Modbus RTU EIA-485 T+/ R+	
Standard Bus or Modbus EIA-232/485		
CF	Standard Bus EIA-485 common	PM _ _ _ _ -[A, 2 or 3] _ _ _ AAA
CD	Standard Bus EIA-485 T-/R-	
CE	Standard Bus EIA-485 T+/R+	
2 - Digital I/O Points		
B5	Digital input-output common	PM _ _ [2] _ _ - _ _ _ AAA
D6	Digital input or output 6	PM _ _ [4] _ _ - _ _ _ AAA
D5	Digital input or output 5	

Slot Orientation - Back View

1/8 DIN Vertical PM8

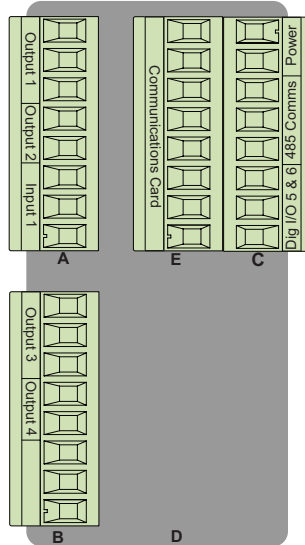

1/8 DIN Horizontal PM9

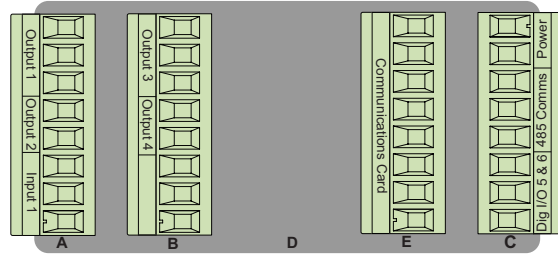

1/32 DIN Horizontal PM3

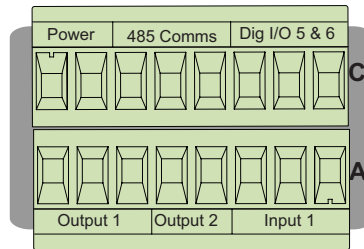

1/16 DIN Vertical PM6

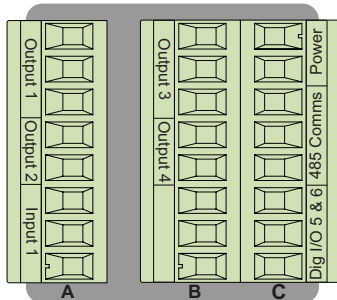

1/4 DIN Vertical PM4

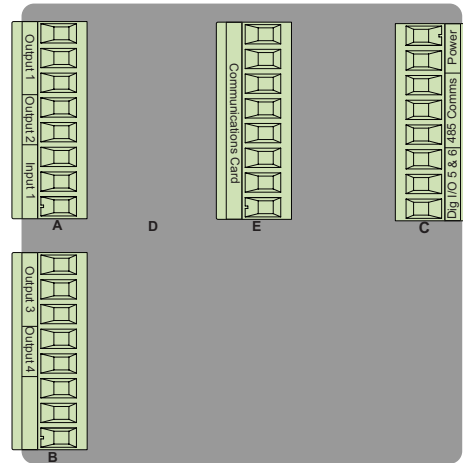

Note:
Slot B above can also be configured with a communications card.

PM Integrated Isolation Block

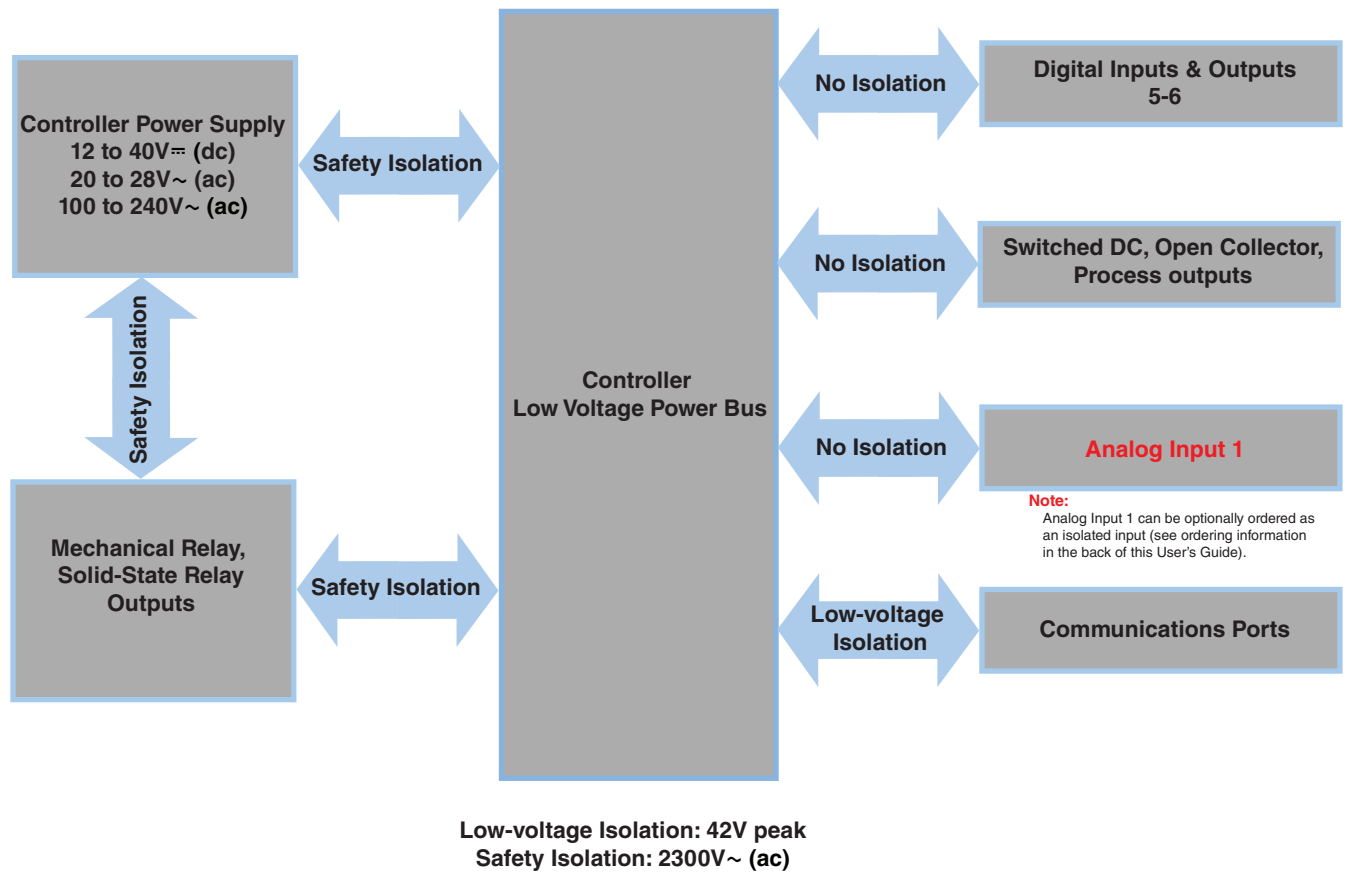

Warning: ⚠

Use National Electric (NEC) or other country-specific standard wiring and safety practices when wiring and connecting this controller to a power source and to electrical sensors or peripheral devices. Failure to do so may result in damage to equipment and property, and/or injury or loss of life.

Note:

Maximum wire size termination and torque rating:

- 0.0507 to 3.30 mm² (30 to 12 AWG) single-wire termination or two 1.31 mm² (16 AWG)
- 0.56 Nm (5.0 in-lb.) torque

Note:

Adjacent terminals may be labeled differently, depending on the model number.

Note:

To prevent damage to the controller, do not connect wires to unused terminals.

Note:

Maintain electrical isolation between analog input 1, digital input-outputs, switched dc/open collector outputs and process outputs to prevent ground loops.

Low Power

PM__ [3,4] __ - _ A _____

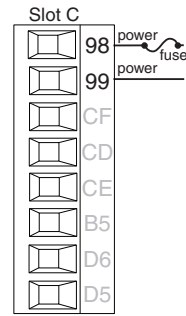

- Minimum/Maximum Ratings
- 12 to 40V \equiv (dc)
- 20 to 28V \sim (ac) Semi Sig F47
- 47 to 63 Hz
- 14VA maximum power consumption (PM4, 8 and 9)
- 10VA maximum power consumption (PM6)

High Power

PM__ [1,2] __ - _ A _____

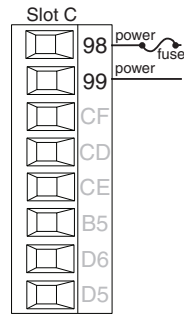

- Minimum/Maximum Ratings
- 85 to 264V \sim (ac)
- 100 to 240V \sim (ac) Semi Sig F47
- 47 to 63 Hz
- 14VA maximum power consumption (PM4, 8 and 9)
- 10VA maximum power consumption (PM6)

Digital Input 5 - 6

PM __ [2,4] __ - _ A _____

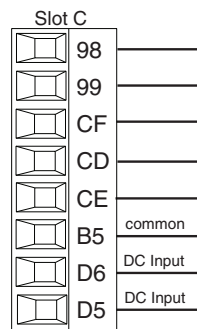

Digital Input

- Update rate 10 Hz
- Dry contact or dc voltage

DC Voltage

- Input not to exceed 36V \equiv (dc) at 3mA
- Input active when > 3V \equiv (dc) @ 0.25mA
- Input inactive when < 2V

Dry Contact

- Input inactive when > 500 Ω
- Input active when < 100 Ω
- Maximum short circuit 13mA

Voltage Input

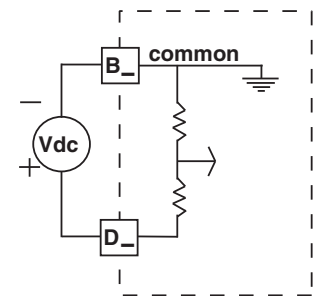

Dry Contact

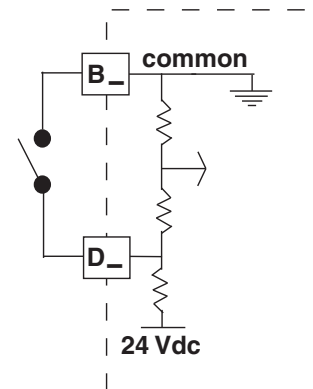

Warning: ⚠

Use National Electric (NEC) or other country-specific standard wiring and safety practices when wiring and connecting this controller to a power source and to electrical sensors or peripheral devices. Failure to do so may result in damage to equipment and property, and/or injury or loss of life.

Note:

Maximum wire size termination and torque rating:

- 0.0507 to 3.30 mm² (30 to 12 AWG) single-wire termination or two 1.31 mm² (16 AWG)
- 0.56 Nm (5.0 in-lb.) torque

Note:

Adjacent terminals may be labeled differently, depending on the model number.

Note:

To prevent damage to the controller, do not connect wires to unused terminals.

Note:

Maintain electrical isolation between analog input 1, digital input-outputs, switched dc/open collector outputs and process outputs to prevent ground loops.

Input 1 Thermocouple

PM_ [L] _ _ _ - _ A _ _ _ _ _

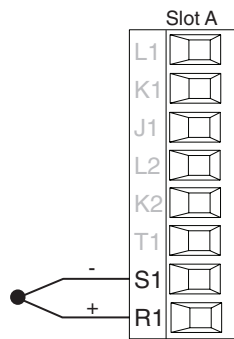

- 2kΩ maximum source resistance
- >20MΩ input impedance
- 3μA open-sensor detection
- Thermocouples are polarity sensitive. The negative lead (usually red) must be connected to S1
- To reduce errors, the extension wire for thermocouples must be of the same alloy as the thermocouple

Input 1 RTD

PM_ [L] _ _ _ - _ A _ _ _ _ _

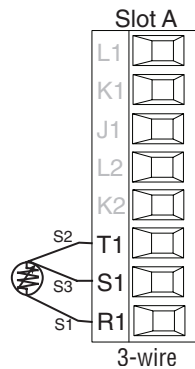
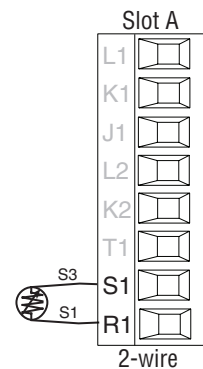

- Platinum, 100 and 1kΩ @ 0°C
- Calibration to DIN curve (0.00385 Ω/Ω/°C)
- 20Ω total lead resistance
- RTD excitation current of 0.09mA typical. Each ohm of lead resistance may affect the reading by 0.03°C.
- For 3-wire RTDs, the S1 lead (usually white) must be connected to R1 and/or R2
- For best accuracy use a 3-wire RTD to compensate for lead-length resistance. All three lead wires must have the same resistance

Input 1 Process

PM_ [L] _ _ _ - _ A _ _ _ _ _

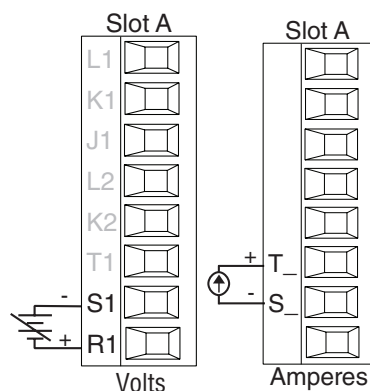

- 0 to 20mA @ 100Ω input impedance
- 0 to 10V_{rms} (dc) @ 20kΩ input impedance
- 0 to 50mV_{rms} (dc) @ 20kΩ input impedance
- Scalable

Warning: ⚠

Use National Electric (NEC) or other country-specific standard wiring and safety practices when wiring and connecting this controller to a power source and to electrical sensors or peripheral devices. Failure to do so may result in damage to equipment and property, and/or injury or loss of life.

Note:

Maximum wire size termination and torque rating:

- 0.0507 to 3.30 mm² (30 to 12 AWG) single-wire termination or two 1.31 mm² (16 AWG)
- 0.56 Nm (5.0 in-lb.) torque

Note:

Adjacent terminals may be labeled differently, depending on the model number.

Note:

To prevent damage to the controller, do not connect wires to unused terminals.

Note:

Maintain electrical isolation between analog input 1, digital input-outputs, switched dc/open collector outputs and process outputs to prevent ground loops.

Quencharc Note:

Switching pilot duty inductive loads (relay coils, solenoids, etc.) with the mechanical relay, solid state relay or open collector output options requires use of an R.C. suppressor.

Input 1 Potentiometer

PM_ [L] _ _ _ - _ A _ _ _ _ _

- Use a 1kΩ potentiometer.

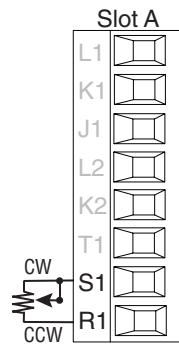

Input 1 Thermistor

PM_ [M] _ _ _ - _ A _ _ _ _ _

- >20MΩ input impedance
- 3μA open-sensor detection

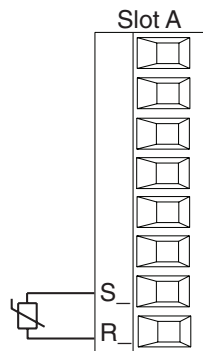

Digital Output 5 - 6

PM _ _ [2,4] _ _ - _ A _ _ _ _ _

Digital Output

- SSR drive signal
- Update rate 10 Hz
- Maximum open circuit voltage is 22 to 25V_{DC} (dc)
- PNP transistor source
- Typical drive; 21mA @ 4.5V_{DC} (dc) for DO5, and 11mA @ 4.5V for DO6
- Current limit 24mA for Output 5 and 12mA Output 6
- Output 5 capable of driving one 3-pole DIN-A-MITE
- Output 6 capable of driving one 1-pole DIN-A-MITE

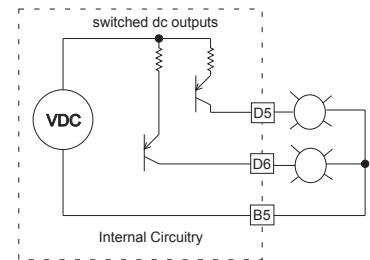

Note:

See output curves below.

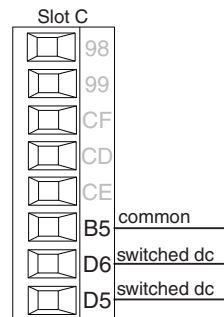

Warning: ⚠

Use National Electric (NEC) or other country-specific standard wiring and safety practices when wiring and connecting this controller to a power source and to electrical sensors or peripheral devices. Failure to do so may result in damage to equipment and property, and/or injury or loss of life.

Note:

- Maximum wire size termination and torque rating:
- 0.0507 to 3.30 mm² (30 to 12 AWG) single-wire termination or two 1.31 mm² (16 AWG)
 - 0.56 Nm (5.0 in-lb.) torque

Note:

Adjacent terminals may be labeled differently, depending on the model number.

Note:

To prevent damage to the controller, do not connect wires to unused terminals.

Note:

Maintain electrical isolation between analog input 1, digital input-outputs, switched dc/open collector outputs and process outputs to prevent ground loops.

Quencharc Note:

Switching pilot duty inductive loads (relay coils, solenoids, etc.) with the mechanical relay, solid state relay or open collector output options requires use of an R.C. suppressor.

Output 1, 3 Mechanical Relay, Form C

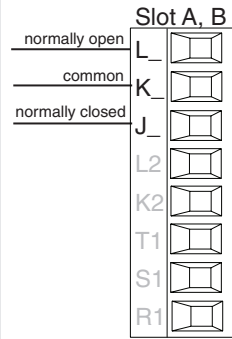

- 5A at 240V~ (ac) or 30V= (dc) maximum resistive load
- 20mA at 24V minimum load
- 125VA pilot duty at 120/240V~ (ac), 25VA at 24V~ (ac)
- 100,000 cycles at rated load
- Output does not supply power.
- For use with ac or dc

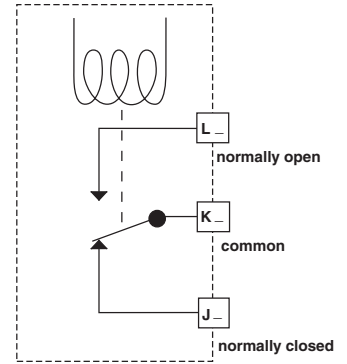

See Quencharc note

Outputs 1 and 3:

PM_ _ _ [E] _ - _ A [E] _
- - -

Output 3 Mechanical Relay, Form C

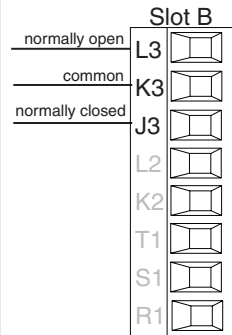

- 5A at 240V~ (ac) or 30V= (dc) maximum resistive load
- 20mA at 24V minimum load
- 125VA pilot duty at 120/240V~ (ac), 25VA at 24V~ (ac)
- 100,000 cycles at rated load
- Output does not supply power.
- For use with ac or dc

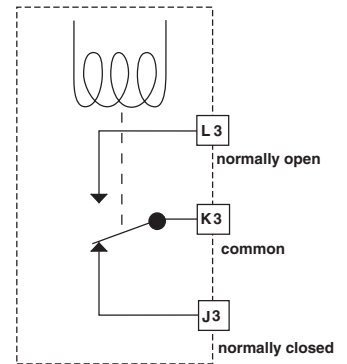

See Quencharc note

Outputs 1 and 3:

PM_ _ _ [E] _ - _ A [E] _
- - -

Warning: ⚠

Use National Electric (NEC) or other country-specific standard wiring and safety practices when wiring and connecting this controller to a power source and to electrical sensors or peripheral devices. Failure to do so may result in damage to equipment and property, and/or injury or loss of life.

Note:

Maximum wire size termination and torque rating:

- 0.0507 to 3.30 mm² (30 to 12 AWG) single-wire termination or two 1.31 mm² (16 AWG)
- 0.56 Nm (5.0 in-lb.) torque

Note:

Adjacent terminals may be labeled differently, depending on the model number.

Note:

To prevent damage to the controller, do not connect wires to unused terminals.

Note:

Maintain electrical isolation between analog input 1, digital input-outputs, switched dc/open collector outputs and process outputs to prevent ground loops.

Quencharc Note:

Switching pilot duty inductive loads (relay coils, solenoids, etc.) with the mechanical relay, solid state relay or open collector output options requires use of an R.C. suppressor.

Output 2, 4 Mechanical Relay, Form A

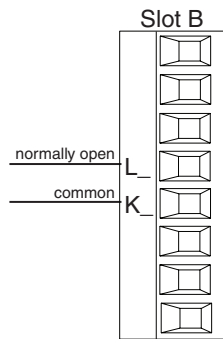

- 5A at 240V~ (ac) or 30V= (dc) maximum resistive load
- 20mA at 24V minimum load
- 125VA pilot duty @ 120/240V~ (ac), 25VA at 24V~ (ac)
- 100,000 cycles at rated load
- Output does not supply power
- For use with ac or dc

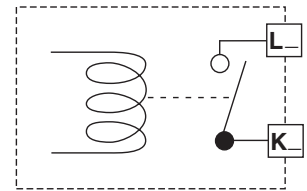

See Quencharc note

Outputs 2 and 4:

PM _ _ _ [J] - _ A _ [J] _
--

Output 3, 4 Solid-State Relay, Form A

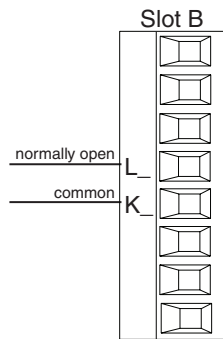

- 0.5A at 20 to 264V~ (ac) maximum resistive load
- 20VA 120/240V~ (ac) pilot duty
- Opto-isolated, without contact suppression
- Maximum off state leakage of 105µA
- Minimum holding current of 10mA
- Output does not supply power
- Do not use on dc loads.

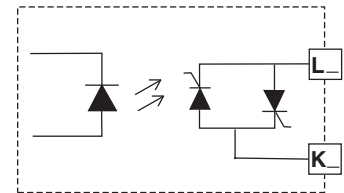

See Quencharc note

Output 2: (L2, K2)

PM _ _ _ [K] - _ _ _ _
--

Output 4: (L4, K4)

PM _ _ _ _ - _ _ _ [K] _
--

Warning: 

Use National Electric (NEC) or other country-specific standard wiring and safety practices when wiring and connecting this controller to a power source and to electrical sensors or peripheral devices. Failure to do so may result in damage to equipment and property, and/or injury or loss of life.

Note:

Maximum wire size termination and torque rating:

- 0.0507 to 3.30 mm² (30 to 12 AWG) single-wire termination or two 1.31 mm² (16 AWG)
- 0.56 Nm (5.0 in-lb.) torque

Note:

Adjacent terminals may be labeled differently, depending on the model number.

Note:

To prevent damage to the controller, do not connect wires to unused terminals.

Note:

Maintain electrical isolation between analog input 1, digital input-outputs, switched dc/open collector outputs and process outputs to prevent ground loops.

Quencharc Note:

Switching pilot duty inductive loads (relay coils, solenoids, etc.) with the mechanical relay, solid state relay or open collector output options requires use of an R.C. suppressor.

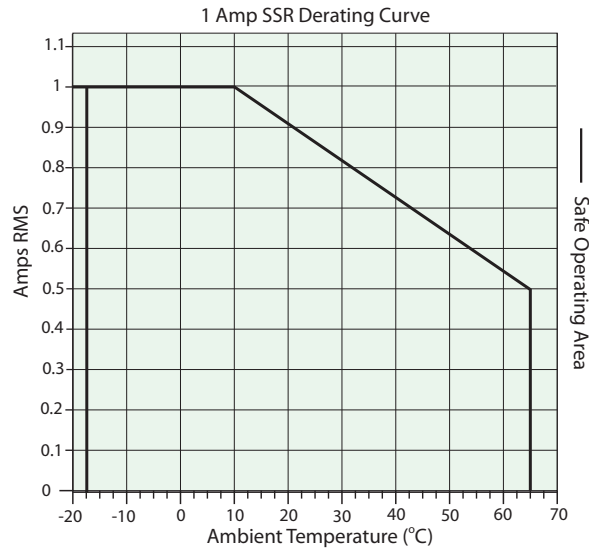

Output 3 Universal Process

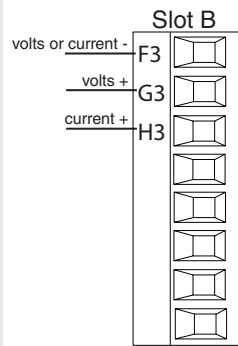

- 0 to 20mA into 800 Ω maximum load
- 0 to 10V_{DC} into 1 kΩ minimum load
- Scalable
- Output supplies power
- Cannot use voltage and current outputs at same time
- Output may be used as retransmit or control.

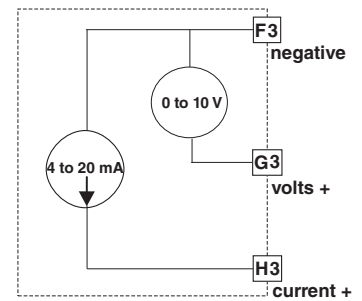

Output 3:

PM _____ - _ A [F] _
 _ _ _

Warning: ⚠

Use National Electric (NEC) or other country-specific standard wiring and safety practices when wiring and connecting this controller to a power source and to electrical sensors or peripheral devices. Failure to do so may result in damage to equipment and property, and/or injury or loss of life.

Note:

Maximum wire size termination and torque rating:

- 0.0507 to 3.30 mm² (30 to 12 AWG) single-wire termination or two 1.31 mm² (16 AWG)
- 0.56 Nm (5.0 in-lb.) torque

Note:

Adjacent terminals may be labeled differently, depending on the model number.

Note:

To prevent damage to the controller, do not connect wires to unused terminals.

Note:

Maintain electrical isolation between analog input 1, digital input-outputs, switched dc/open collector outputs and process outputs to prevent ground loops.

Quencharc Note:

Switching pilot duty inductive loads (relay coils, solenoids, etc.) with the mechanical relay, solid state relay or open collector output options requires use of an R.C. suppressor.

Output 4 Switched DC

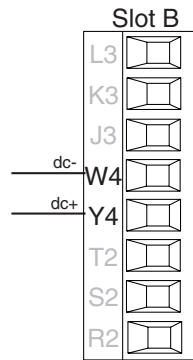

- Maximum open circuit voltage is 22 to 25V_{DC} (dc)
- 30mA max. per single output / 40mA max. total per paired outputs (1 & 2, 3 & 4)
- Typical drive; 4.5V_{DC} (dc) @ 30mA
- Short circuit limited to <50mA
- NPN transistor sink
- Use dc- and dc+ to drive external solid-state relay
- 1-pole DIN-A-MITE: up to 4 in parallel or 4 in series
- 2-pole DIN-A-MITE: up to 2 in parallel or 2 in series
- 3-pole DIN-A-MITE: up to 2 in series

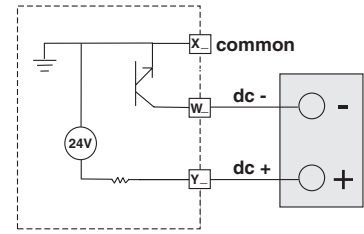

Output 4:

PM _ _ _ _ _ - _ A _ [C]

_ _ _ _

Warning: ⚠

Use National Electric (NEC) or other country-specific standard wiring and safety practices when wiring and connecting this controller to a power source and to electrical sensors or peripheral devices. Failure to do so may result in damage to equipment and property, and/or injury or loss of life.

Note:

Maximum wire size termination and torque rating:

- 0.0507 to 3.30 mm² (30 to 12 AWG) single-wire termination or two 1.31 mm² (16 AWG)
- 0.56 Nm (5.0 in-lb.) torque

Note:

Adjacent terminals may be labeled differently, depending on the model number.

Note:

To prevent damage to the controller, do not connect wires to unused terminals.

Note:

Maintain electrical isolation between analog input 1, digital input-outputs, switched dc/open collector outputs and process outputs to prevent ground loops.

Quencharc Note:

Switching pilot duty inductive loads (relay coils, solenoids, etc.) with the mechanical relay, solid state relay or open collector output options requires use of an R.C. suppressor.

Output 1, 3 Switched DC/Open Collector

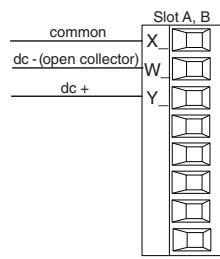

Switched DC

- Maximum open circuit voltage is 22 to 25V_{DC} (dc)
- 30mA max. per single output
- Typical drive; 4.5V_{DC} (dc) @ 30mA
- Short circuit limited to <50mA
- NPN transistor sink
- Use dc- and dc+ to drive external solid-state relay
- 1-pole DIN-A-MITE: up to 4 in parallel or 4 in series
- 2-pole DIN-A-MITE: up to 2 in parallel or 2 in series
- 3-pole DIN-A-MITE: up to 2 in series

Open Collector

- 100mA maximum output current sink
- 30V_{DC} (dc) max. supply voltage
- Any switched dc output can use the common terminal.
- Use an external power supply to control a dc load, with the load positive to the positive of the power supply, the load negative to the open collector and common to the power supply negative.

See Quencharc note.

Switched DC

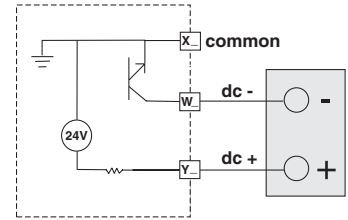

Open Collector

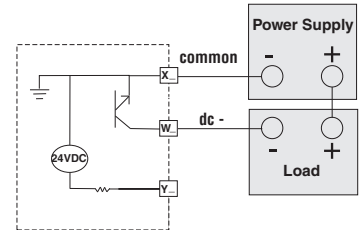

Output 1: (X1,-W1,+Y1)

PM _____ [C] _____

Output 3: (X3,-W3,+Y3)

PM _____ [C] _____

Quencharc Wiring Example

In this example the Quencharc circuit (Watlow part# 0804-0147-0000) is used to protect PM internal circuitry from the counter electromagnetic force from the inductive user load when de-energized. It is recommended that this or an equivalent Quencharc be used when connecting inductive loads to PM outputs.

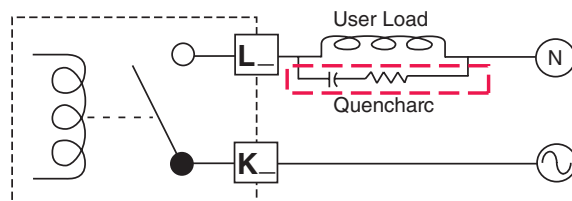

Standard Bus EIA-485 Communications

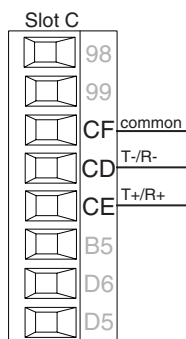

- Wire T-/R- to the A terminal of the EIA-485 port.
- Wire T+/R+ to the B terminal of the EIA-485 port.
- Wire common to the common terminal of the EIA-485 port.
- Do not route network wires with power wires. Connect network wires in daisy-chain fashion when connecting multiple devices in a network.
- Do not connect more than 16 EZ-ZONE PM controllers on a network.
- Maximum network length: 1,200 meters (4,000 feet)
- 1/8th unit load on EIA-485 bus

PM [3,4,6,8,9] _ _ _ _ - [*] _ _ _ _ _

* All models include Standard Bus communications (instance 1)

Note:

Do not leave a USB to EIA-485 converter connected to Standard Bus without power (i.e., disconnecting the USB end from the computer while leaving the converter connected on Standard Bus). Disturbance on the Standard Bus may occur.

Modbus RTU or Standard Bus EIA-485 Communications

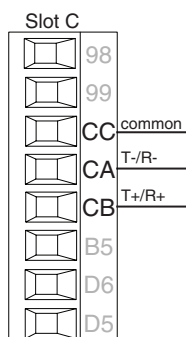

- Wire T-/R- to the A terminal of the EIA-485 port.
- Wire T+/R+ to the B terminal of the EIA-485 port.
- Wire common to the common terminal of the EIA-485 port.
- Do not route network wires with power wires. Connect network wires in daisy-chain fashion when connecting multiple devices in a network.
- A termination resistor may be required. Place a 120 Ω resistor across T+/R+ and T-/R- of last controller on network.
- Only one protocol per port is available at a time: either Modbus RTU or Standard Bus.
- Do not connect more than 16 EZ-ZONE controllers on a Standard Bus network.
- Maximum number of EZ-ZONE controllers on a Modbus network is 247.
- Maximum network length: 1,200 meters (4,000 feet)
- 1/8th unit load on EIA-485 bus.
- Communications instance 1

PM [3,4,6,8,9] _ _ _ _ - [1] _ _ _ _ _

Note:

Do not leave a USB to EIA-485 converter connected to Standard Bus without power (i.e., disconnecting the USB end from the computer while leaving the converter connected on Standard Bus). Disturbance on the Standard Bus may occur.

EIA-232/485 Modbus RTU Communications

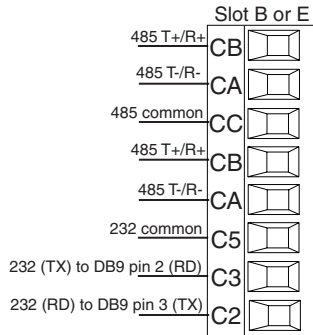

- Wire T-/R- to the A terminal of the EIA-485 port.
- Wire T+/R+ to the B terminal of the EIA-485 port.
- Wire common to the common terminal of the EIA-485 port.
- Do not route network wires with power wires. Connect network wires in daisy-chain fashion when connecting multiple devices in a network.
- A termination resistor may be required. Place a 120 Ω resistor across T+/R+ and T-/R- of last controller on network.
- Do not wire to both the EIA-485 and the EIA-232 pins at the same time.
- Two EIA-485 terminals of T/R are provided to assist in daisy-chain wiring.
- Do not connect more than one EZ-ZONE PM controller on an EIA-232 network.
- Maximum number of EZ-ZONE controllers on a Modbus network is 247.
- Maximum EIA-232 network length: 15 meters (50 feet)
- Maximum EIA-485 network length: 1,200 meters (4,000 feet)
- 1/8th unit load on EIA-485 bus.
- Communications instance 2

Slot B

PM [6] _ _ _ _ - [2] _ _ _ _ _

Slot E

PM [4,8,9] _ _ _ _ - [2] _ _ _ _ _

Modbus-IDA Terminal	EIA/TIA-485 Name	Watlow Terminal Label	Function
DO	A	CA or CD	T-/R-
D1	B	CB or CE	T+/R+
common	common	CC or CF	common

EtherNet/IP™, PCCC and Modbus® TCP Communications

	Slot B, E		RJ-45 pin	T568B wire color	Signal	Slot B, E
unused	E8		8	brown	unused	E8
unused	E7		7	brown & white	unused	E7
receive -	E6		6	green	receive -	E6
unused	E5		5	white & blue	unused	E5
unused	E4		4	blue	unused	E4
receive +	E3		3	white & green	receive +	E3
transmit -	E2		2	orange	transmit -	E2
transmit +	E1		1	white & orange	transmit +	E1

- Do not route network wires with power wires.
- Connect one Ethernet cable per controller to a 10/100 Mbps Ethernet switch. Both Modbus TCP and EtherNet/IP™ are available on the network.
- Communications instance 2

Slot B

PM [6] _ _ _ _ - [3] _ _ _ _ _

Slot E

PM[4,8,9] _ _ _ _ - [3] _ _ _ _ _

Note:

When changing the fixed IP address cycle module power for new address to take effect.

Ethernet LED Indicators

Viewing the control from the front and then looking on top four LEDs can be seen aligned vertically front to back. The LEDs are identified accordingly: closest to the front reflects the Network (Net) Status, Module (Mod) Status is next, Activity status follows and lastly, the LED closest to the rear of the control reflects the Link status.

Note:

When using Modbus TCP, the Network Status and Module Status LEDs are not used.

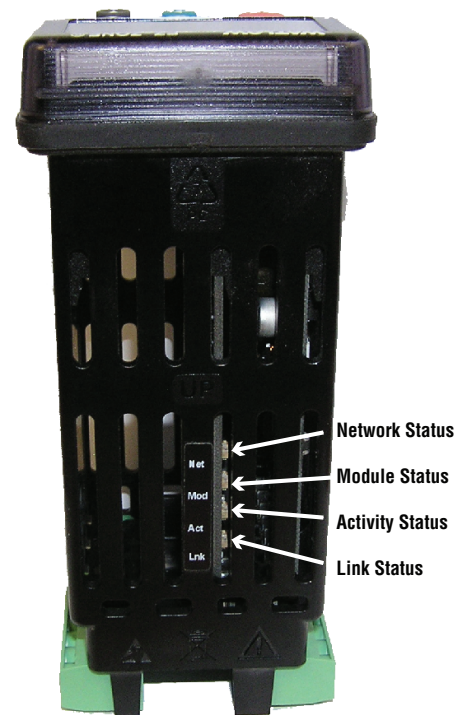

Network Status

Indicator State	Summary	Requirement
Steady Off	Not powered, no IP address	If the device does not have an IP address (or is powered off), the network status indicator shall be steady off.
Flashing Green	No connections	If the device has no established connections, but has obtained an IP address, the network status indicator shall be flashing green.
Steady Green	Connected	If the device has at least one established connection (even to the Message Router), the network status indicator shall be steady green.
Flashing Red	Connection timeout	If one or more of the connections in which this device is the target has timed out, the network status indicator shall be flashing red. This shall be left only if all timed out connections are reestablished or if the device is reset.
Steady Red	Duplicate IP	If the device has detected that its IP address is already in use, the network status indicator shall be steady red.
Flashing Green / Red	Self-test	While the device is performing its power up testing, the network status indicator shall be flashing green / red.

Module Status

Indicator State	Summary	Requirement
Steady Off	No power	If no power is supplied to the device, the module status indicator shall be steady off.
Steady Green	Device operational	If the device is operating correctly, the module status indicator shall be steady green.
Flashing Green	Standby	If the device has not been configured, the module status indicator shall be flashing green.
Flashing Red	Minor fault	If the device has detected a recoverable minor fault, the module status indicator shall be flashing red. NOTE: An incorrect or inconsistent configuration would be considered a minor fault.
Steady Red	Major fault	If the device has detected a non-recoverable major fault, the module status indicator shall be steady red.
Flashing Green / Red	Self-test	While the device is performing its power up testing, the module status indicator shall be flashing green / red.

Activity Status

Indicator State	Summary	Requirement
Flashing Green	Detects activity	If the MAC detects activity, the LED will be flashing green.
Red	- - - -	If the MAC detects a collision, the LED will be red.

Link Status

Indicator State	Summary	Requirement
Steady Off	Not powered, unknown link speed	If the device cannot determine link speed or power is off, the network status indicator shall be steady off.
Green	- - - -	If cable is wired and connected correctly, the LED will be Green.

DeviceNet™ Communications

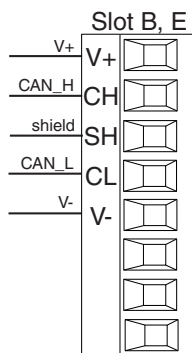

Terminal	Signal	Function
V+	V+	DeviceNet™ power
CH	CAN_H	positive side of DeviceNet™ bus
SH	shield	shield interconnect
CL	CAN_L	negative side of DeviceNet™ bus
V-	V-	DeviceNet™ power return

- Communications instance 2

Slot B (PM [6] _ _ _ _ _ - [5] _ _ _ _ _)

Slot E (PM [4,8,9] _ _ _ _ _ - [5] _ _ _ _ _)

DeviceNet LED Indicators

Viewing the control from the front and then looking on top two LEDs can be seen aligned vertically front to back. The LED closest to the front is identified as the network (Net) LED where the one next to it would be identified as the module (Mod) LED.

Network Status

Indicator LED	Description
Off	The device is not online and has not completed the duplicate MAC ID test yet. The device may not be powered.
Green	The device is online and has connections in the established state (allcated to a Master).
Red	Failed communication device. The device has detected an error that has rendered it incapable of communicating on the network (duplicate MAC ID or Bus-off).
Flashing Green	The device is online, but no connection has been allocated or an explicit connection has timed out.
Flashing Red	A poll connection has timed out.

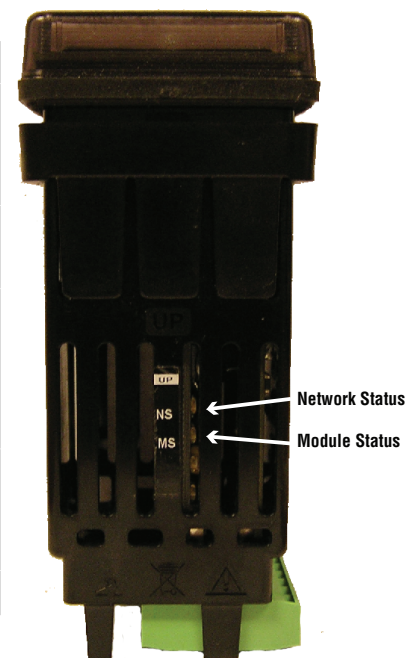

Profibus DP Communications

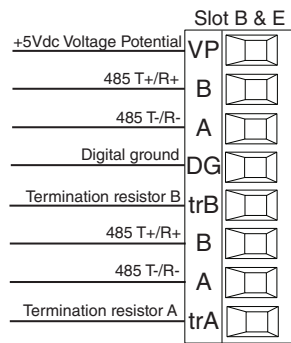

- Wire T-/R- to the A terminal of the EIA-485 port.
- Wire T+/R+ to the B terminal of the EIA-485 port.
- Wire Digital Ground to the common terminal of the EIA-485 port.
- Do not route network wires with power wires. Connect network wires in daisy-chain fashion when connecting multiple devices in a network.
- A termination resistor should be used if this control is the last one on the network.
- If using a 150 Ω cable Watlow provides internal termination. Place a jumper across pins trB and B and trA and A.
- If external termination is to be used with a 150 Ω cable place a 390 Ω resistor across pins VP and B, a 220 Ω resistor across pins B and A, and lastly, place a 390 Ω resistor across pins DG and A.
- Do not connect more than 32 EZ-ZONE PM controllers on any given segment.
- Maximum EIA-485 network length: 1,200 meters (4,000 feet)
- 1/8th unit load on EIA-485 bus
- When termination jumpers are in place, there is 392 ohm pull up resistor to 5V and 392 ohm pull down resistor to DP. There is also a 221 ohm resistor between A and B.
- Communications instance 2

Slot B: PM [6] _ _ _ _-[6] _ _ _ _ _

Slot E: PM [4, 8, 9] _ _ _ _-[6] _ _ _ _ _

Profibus Terminal	EIA/TIA-485 Name	Watlow Terminal Label	Function
VP (Voltage Potential)	- - - -	VP	+5Vdc
B-Line	B	B	T+/R+
A-Line	A	A	T-/R-
DP-GND	common	DG	common

Profibus DP LED Indicators

Viewing the unit from the front and then looking on top of the controller two bi-color LEDs can be seen where only the front one is used. Definition follows:

Closest to the Front

Indicator LED	Description
Red	Profibus network not detected
Red Flashing	Indicates that the Profibus card is waiting for data exchange.
Green	Data exchange mode

Wiring a Serial EIA-485 Network

Do not route network wires with power wires. Connect network wires in daisy-chain fashion when connecting multiple devices in a network. A termination resistor may be required. Place a 120 Ω resistor across T+/R+ and T-/R- of the last controller on a network.

Only one protocol per port is available at a time: either Modbus RTU or Standard Bus.

A Network Using Watlow's Standard Bus and an RUI/Gateway.

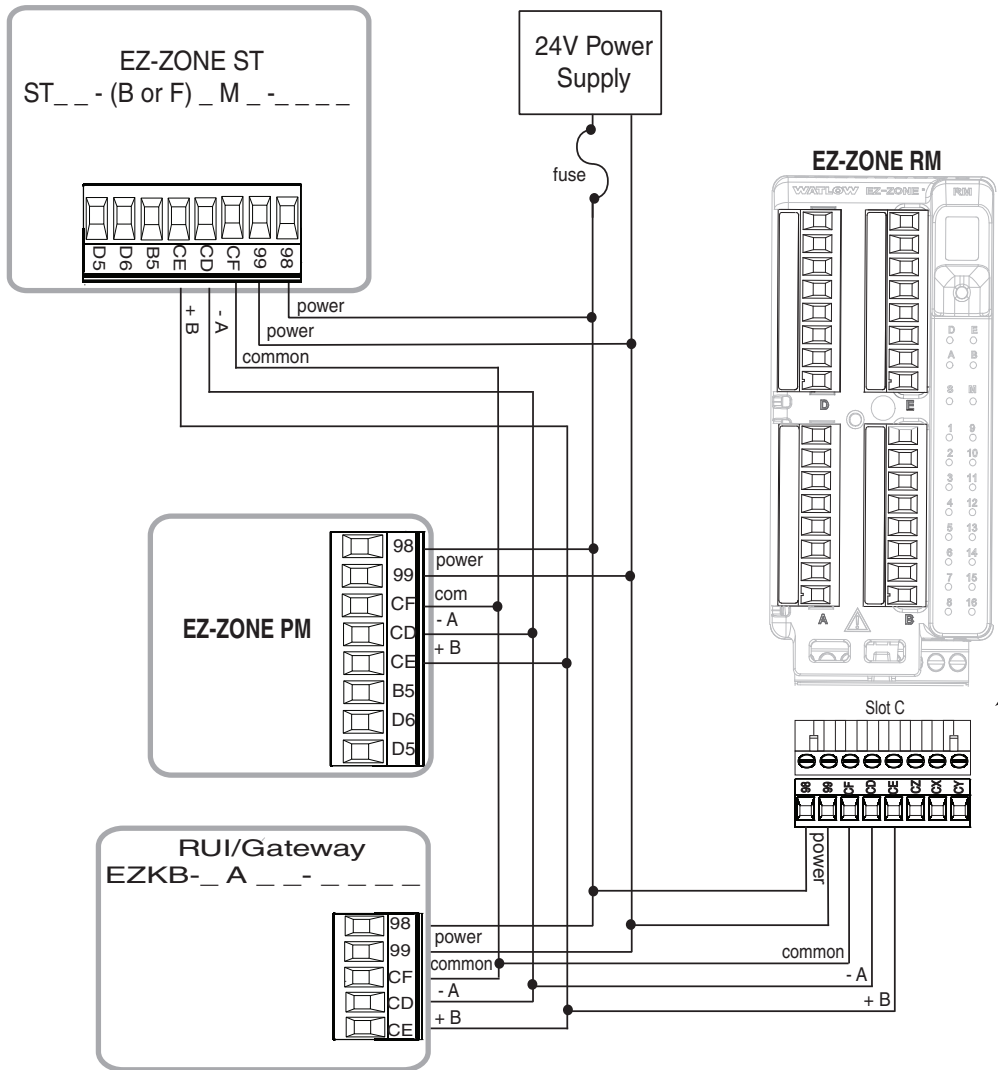

A Network with all Devices Configured using Modbus RTU.

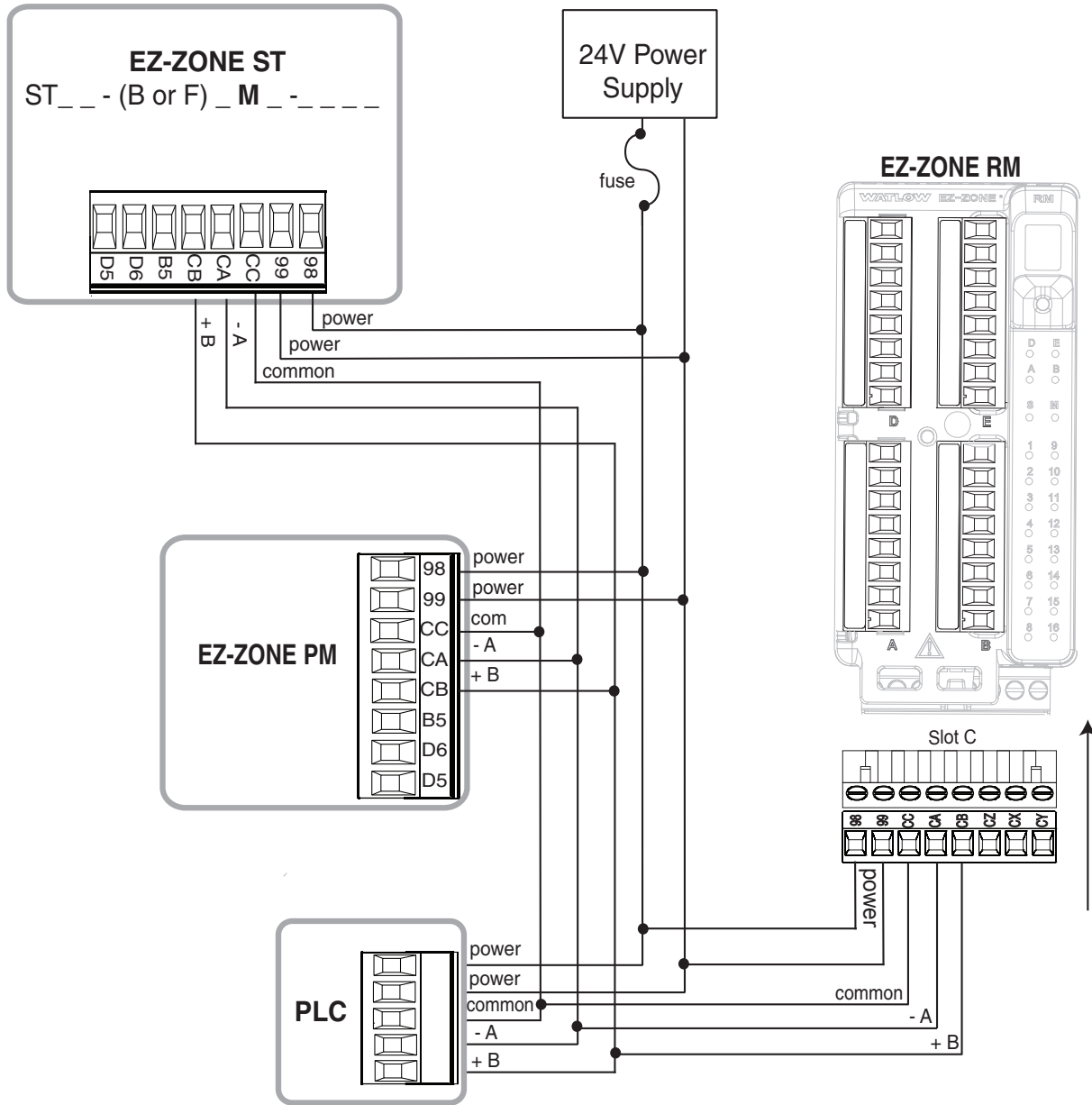

Connecting a Computer to PM Controls Using B&B 485 to USB Converter

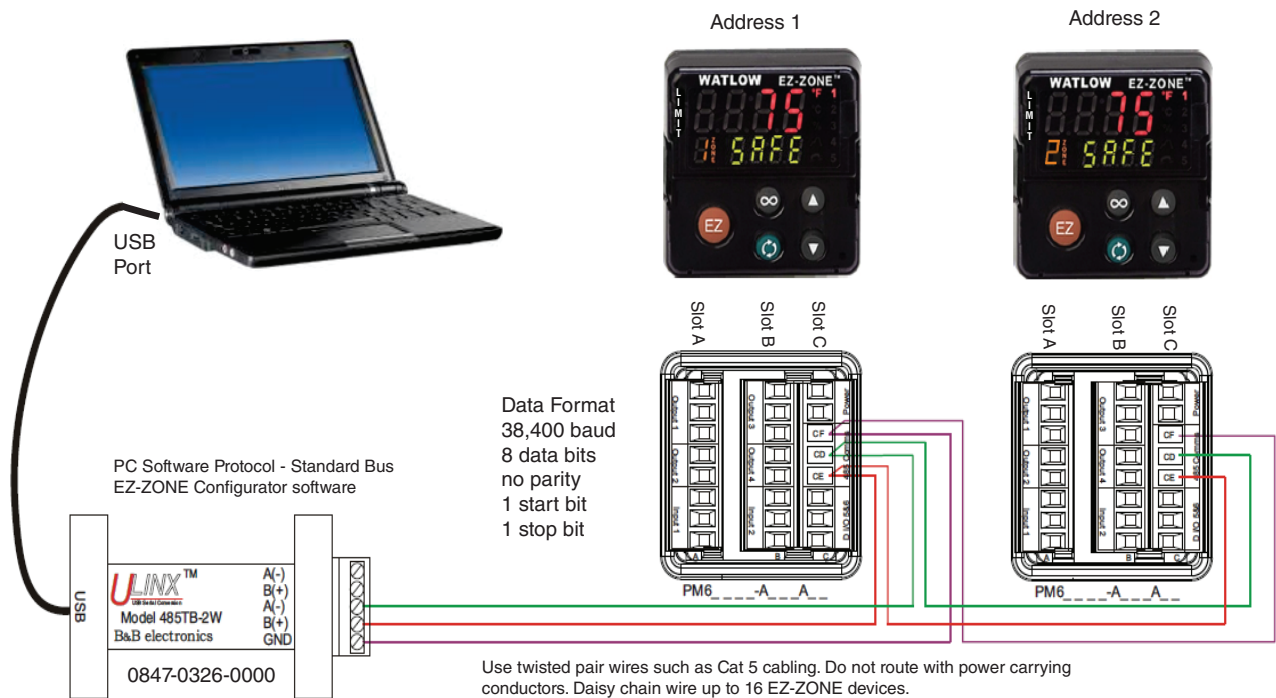

Note:

Do not leave a USB to EIA-485 converter connected to Standard Bus without power (i.e., disconnecting the USB end from the computer while leaving the converter connected on Standard Bus). Disturbance on the Standard Bus may occur.

Note:

When connecting the USB converter to the PC it is suggested that the Latency Timer be changed from the default of 16 msec to 1 msec. Failure to make this change may cause communication loss between the PC running EZ-ZONE Configurator software and the control.

To modify Latency Timer settings follow the steps below:

1. Navigate to Device Manager.
2. Double click on Ports.
3. Right click on the USB serial port in use and select Properties.
4. Click the tab labeled Port settings and then click the Advance button.

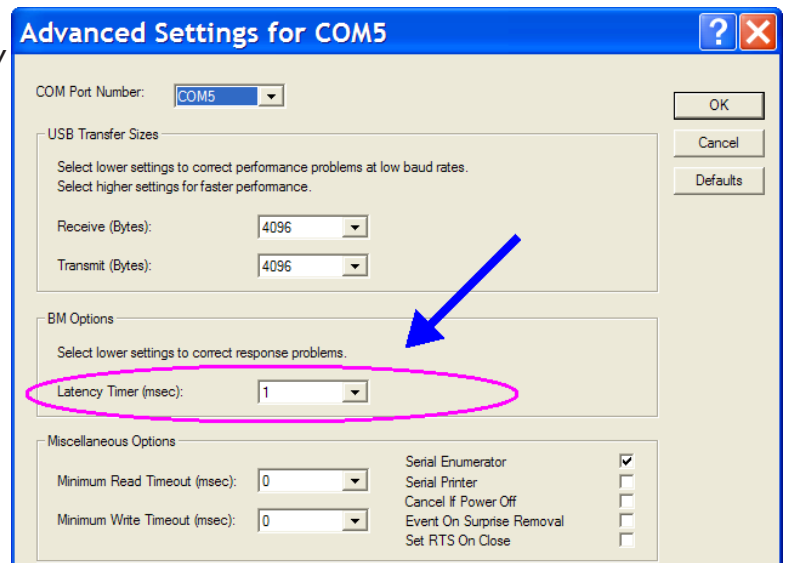

3

Chapter 3: Keys and Displays

Upper (Left, 32nd DIN) Display:

In the Home Page, displays the process value, otherwise displays the value of the parameter in the lower display.

Zone Display:

Indicates the controller zone.

- 1** to **9** = zones 1 to 9
- A** = zone 10 **E** = zone 14
- b** = zone 11 **F** = zone 15
- C** = zone 12 **h** = zone 16
- d** = zone 13

Percent Units:

Lights when the controller is displaying values as a percentage.

Channel Display:

Indicates the channel for any given EZ-ZONE module.
- Available with the PM4, 8 and 9 only.

Reset Key

Press to back up one level, or press and hold for two seconds to return to the Home Page. From the Home Page will reset the limit and clear alarms and errors if clearable.

Advance Key

Advances through parameter prompts.

Note:

Upon power up, the upper or left display will briefly indicate the firmware revision and the lower or right display will show PM representing the model.

1/32 DIN (PM3)

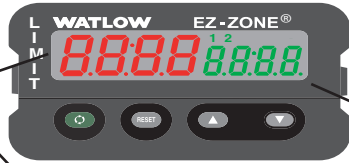

1/16 DIN (PM6)



1/8 DIN (PM9) Horizontal

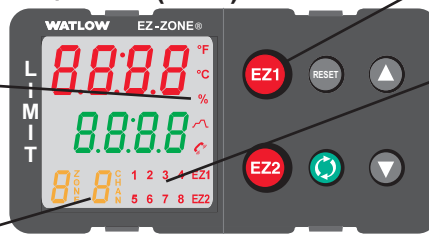

1/8 DIN (PM8) Vertical



1/4 DIN (PM4)



Lower (Right, 32nd DIN) Display:

Indicates the limit is **SAFE** or **ALrn** for an active message. It may also show the parameter whose value appears in the upper display.

EZ Key/s:

These keys can be programmed to do various tasks, such as starting a profile.

Output Activity:

Number LEDs indicate activity of outputs. A flashing light indicates output activity.

Communications Activity

Flashes when another device is communicating with this controller.

Temperature Units:

Indicates whether the temperature is displayed in Fahrenheit or Celsius.





Up and Down Keys







In the Home Page, adjusts the set point in the lower display. In other pages, changes the upper display to a higher or lower value, or changes a parameter selection.

Responding to a Displayed Message

An active message will cause the display to toggle between the normal settings and the active message in the upper display and *Attn* in the lower display.

Your response will depend on the message and the controller settings. Some messages, such as Ramping and Tuning, indicate that a process is underway. If the message was generated by a latched alarm and the condition no longer exists or if an alarm has silencing enabled it can be silenced simply by pushing the Infinity  key. Alternatively, use the method below to view all and then clear.

Push the Advance Key to display *9nr* in the upper display and the message source (such as *ALh i*) in the lower display. Use the Up  or Down  keys to scroll through possible responses, such as Clear *CLR* or Silence *SIL*, then push the Advance  or Infinity  key to execute the action. See the Home Page for further information on the Attention Codes.



Display	Parameter Name Description	Range	Appears If
<i>Attn</i>	<p><i>Attention</i></p> <p>An active message will cause the display to toggle between the normal settings and the active message in the upper display and <i>Attn</i> in the lower display. Your response will depend on the message and the controller settings. Some messages, such as Ramping and Tuning, indicate that a process is underway. If the message was generated by a latched alarm, the message can be cleared when the condition no longer exists. If an alarm has silencing enabled, it can be silenced.</p> <ol style="list-style-type: none"> 1. Push the Advance Key  to display <i>9nr</i> in the upper display and the message source (such as <i>ALh i</i>) in the lower display. 2. Use the Up  and Down  keys to scroll through possible responses, such as Clear <i>CLR</i> or Silence <i>SIL</i>. 3. Press the Advance Key  or Reset  button to execute the action. <p>Alternatively, rather than scrolling through all messages simply push the Reset  button to generate a clear.</p>	<p><i>ALL 1 ALL 2 ALL 3 ALL 4</i> Alarm Low 1 to 4</p> <p><i>ALh 1 ALh 2 ALh 3 ALh 4</i> Alarm High 1 to 4</p> <p><i>ALE 1 ALE 2 ALE 3 ALE 4</i> Alarm Error 1 to 4</p> <p><i>Err 1</i> Error Input 1</p> <p><i>L l 1</i> Limit Low 1</p> <p><i>L h 1</i> Limit High 1</p> <p><i>L e 1</i> Limit Error 1</p> <p><i>uALh</i> Value to high to be displayed in 4 digit LED display >9999</p> <p><i>uALL</i> Value to low to be displayed in 4 digit LED display <-1999</p>	An alarm or error message is active.

4

Chapter 4: Home Page

Default Home Page Parameters

Watlow's patented user-defined menu system improves operational efficiency. The user-defined Home Page provides you with a shortcut to monitor or change the parameter values that you use most often. The default Home Page is shown on the following page. When a parameter normally located in the Setup Page or Operations Page is placed in the Home Page, it is accessible through both. If you change a parameter in the Home Page, it is automatically changed in its original page. If you change a parameter in its original page it is automatically changed in the Home Page.

Use the Advance Key  to step through the other parameters. When not in pairs, the parameter prompt will appear in the lower display, and the parameter value will appear in the upper display. You can use the Up  and Down  keys to change the value of writable parameters, just as you would in any other menu.

Note:

If a writable value is placed on the upper display and is paired with another read only parameter on the lower display, the arrow keys affect the setting of the upper display. If two writable parameters are paired, the arrow keys affect the lower display.

- The Attention *ALERT* parameter appears only if there is an active message. An example of an active message could be a Input Error *Err. I.*
- If a sensor failure has occurred, dashes *----* will be displayed in the upper display and the Manual Power (read-write) is in the lower display.

Navigating the EZ-ZONE PM Limit Controller PM6 Shown, Applies to All Models

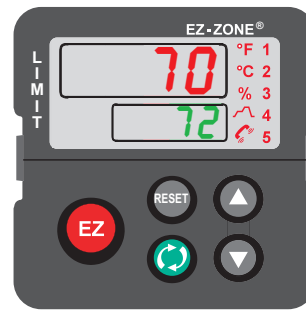
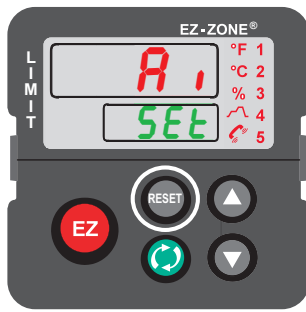

Home Page from anywhere: Press the Reset  key for two seconds to return to the Home Page.

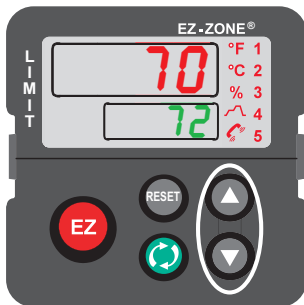

Operations Page from Home Page: Press both the Up  and Down  keys for three seconds.

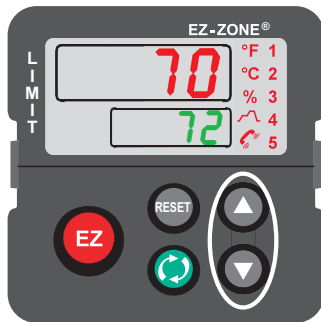

Setup Page from Home Page: Press both the Up  and Down  keys for six seconds.







Note:

Keys must be held continuously until *SEt* is displayed in green. If keys are released when *oPEr* is displayed, press the infinity key or reset key to exit and repeat until *SEt* is displayed.







Factory Page from Home Page: Press both the Advance  and Reset  keys for six seconds..

Changing the Set Point



From the default Home Page the Limit Set Points, high and low, can be changed. If high and low limits have been configured push the Advance  key one time and the Low Limit Set Point *LLS 1* prompt will appear in the lower display while the current set point will be displayed above. Pushing the Up  or Down  keys will change the set point. Once done, simply push the Advance  key to display the High Limit Set Point *LhS 1* will appear below and the current High Limit Set Point will be displayed above. Again, to change simply push the Up  and Down  arrow keys.

Modifying the Home Page

Follow the steps below to modify the Home Page:

1. Push and hold the Advance  key and the Infinity  key for approximately six seconds. Upon entering the Factory Page the first menu will be the Custom Menu *CUSE*.
2. Push the Advance  key where the lower display will show *CUSE* and the upper display will show *1*.
3. Push the Advance  button where the prompt for the Custom *CUSE* will be displayed on top and Parameter *PAR* in the bottom.

There are twenty positions available that can be customized.

4. Pushing the Up  or Down  arrow keys will allow for a customized selection to be made (see list of available parameters below).

Custom Menu Parameter Options	
Description	Prompt *
All Models	
None	Blank
Analog Input Value	<i>A in 1</i>
Cal In Offset	<i>.CA 1</i>
Display Units	<i>C_F 1</i>
Load Parameter Set	<i>USr.1 USr.2</i>
Low Set Point	<i>ALo 1 ALo 2 ALo 3 ALo 4</i>
High Set Point	<i>Ah , 1 Ah , 2 Ah , 3 Ah , 4</i>
Hysteresis	<i>AhY 1 AhY 2 AhY 3 AhY 4</i>
Low Limit Set Point	<i>LLS 1</i>
High Limit Set Point	<i>LhS 1</i>
Hysteresis	<i>LhY 1</i>
Limit Status	<i>LSL 1</i>

* The numerical digit shown in the prompts above (last digit), represents the parameter instance and can be greater than one.

Modifying the Display Pairs



The Home Page, being a customized list of as many as 20 parameters, can be configured in pairs of up to 10 via the Display Pairs *dPr 5* prompt found in the Global Menu *9LbL* (Setup Page). The listing in the table that follows represents the Limit default Home page. It is important to note that some of the prompts shown may not appear simply because the feature is not being used or is turned off. As an example, the prompt shown in position 3 (Limit Low Set

Point, *LLS I*) will not appear unless the Limit Sides is set for low or both found on the Setup page under the Limit Menu.

Home Page Default Parameters			
Custom Menu Number	Home Page Display (defaults)	Parameter Name	Custom Menu Display (defaults)
1 (Upper or left display)	Numerical value	Active Process Value	<i>Pr o</i> Firmware revision 11.0 and above <i>A in I</i> Firmware below revision 11.0
2 (Lower or right display)	<i>SAFE</i> or <i>FR IL</i>	Limit Status	<i>LSE</i>
3	Numerical value	Low Limit Set Point	<i>LLS I</i>
4	Numerical value	High Limit Set Point	<i>LHS I</i>
5 to 20	(skipped)		<i>none</i>

Note:

When the Limit is in a default state (as shipped from factory), the display will flash where the top display will show the Process Value and the bottom display will flash *ALEn* and *FRIL*.

As stated above, the user can define ten pairs of prompts to appear on the display every time the Advance  key is pushed. In a default state, the Display Pairs *dP-5* prompt (Setup Page under the Global Menu) is equal to one with the first pair displayed as is defined in the Home Page table above. If the Display Pairs prompt were to be changed to two, pushing the Advance  key one time would cause the display to show the Low Limit Set Point on the top and the High Limit Set Point on the bottom reflecting position 3 and 4 respectively.

Note

Both of these parameters are writable and being paired in this manner only the High Limit Set Point can be changed. Pairing two writable prompts will only allow for the bottom one to be changed. On the other hand, if a writable value is placed on the upper display and is paired with another read only parameter on the lower display, the arrow keys affect the setting of the upper display.

The display can be configured to scroll through the Display Pairs by going to the Setup Page under the Global Menu and changing the Display Time *dEt*, prompt to something greater than 0. If set to 2, the display will scroll through the pairs every 2 seconds starting with Custom Menu Pair 1 and 2, 3 and 4, etc...

Conventions Used in the Menu Pages

To better understand the menu pages that follow review the naming conventions used. When encountered throughout this document, the word “default” implies as shipped from the factory.

Conventions Used (cont.)

Each page (Operations, Setup, Profile and Factory) and their associated menus have identical headers defined below:

Header Name	Definition
Display	Visually displayed information from the control.
Parameter Name	Describes the function of the given parameter.
Range	Defines options available for this prompt, i.e., min/max values (numerical), yes/no, etc... (further explanation below).
Default	Values as delivered from the factory.
Modbus Relative Address	Identifies unique parameters using either the Modbus RTU or Modbus TCP protocols (further explanation below).
CIP (Common Industrial Protocol)	Identifies unique parameters using either the DeviceNet or EtherNet/IP protocol (further explanation below).
Profibus Index	Identifies unique parameters using Profibus DP protocol (further explanation below).
Parameter ID	Identifies unique parameters used with other software such as, LabVIEW.
Data Type R/W	uint = Unsigned 16 bit integer dint = Signed 32-bit, long string = ASCII (8 bits per character) float = IEEE 754 32-bit RWES = Readable Writable EEPROM (saved) User Set (saved)

Display

Visual information from the control is displayed to the observer using a fairly standard 7 segment display. Due to the use of this technology, several characters displayed need some interpretation, see the list below:

1 = 1	7 = 7	c, C = c	i = i	o = o	u, U = u
2 = 2	8 = 8	d = d	J = J	P = P	v, V = v
3 = 3	9 = 9	E = E	H = K	q = q	W, W = W
4 = 4	0 = 0	F = F	L = L	r = r	y = y
5 = 5	A = A	g = g	M, M = M	S = S	Z = Z
6 = 6	b = b	h = h	n = n	t = t	

Range

Within this column notice that on occasion there will be numbers found within parenthesis. This number represents the enumerated value for that particular selection. Range selections can be made simply by writing the enumerated value of choice using any of the available communications protocols. As an example, turn to the Setup Page and look at the Analog Input **A1** menu and then the Sensor Type **SEn** prompt. To turn the sensor off using Modbus simply write the value of 62 (off) to register 368 and send that value to the control.

Communication Protocols

When using a communications protocol in conjunction with the EZ-ZONE PM there are two possible ports (instances) used. Port 1 or instance 1 is always dedicated to Standard Bus communications. This same instance can also be used for Modbus RTU if ordered. Depending on the

controller part number, port 2 (instance 2) can be used with Modbus, CIP and Profibus. For further information read through the remainder of this section.

Modbus Introduction to the Modbus Protocol

Gould Modicon, now called AEG Schneider, first created the protocol referred to as “Modbus RTU” used in process control systems. Modbus provides the advantage of being extremely reliable in exchanging information, a highly desirable feature for industrial data communications. This protocol works on the principle of packet exchanges. The packet contains the address of the controller to receive the information, a command field that says what is to be done with the information, and several fields of data. Each PM parameter has a unique Modbus address and they can be found in the following Operations, Setup and Factory Pages.

All Modbus registers are 16-bits and as displayed in this User’s Guide are relative addresses (actual). Some legacy software packages limit available Modbus registers to 40000 to 49999 (5 digits). Many applications today require access to all available Modbus registers which range from 400000 to 465535 (6 digits). For parameters listed as float, notice that only one (low order) of the two registers is listed; this is true throughout this document. By default, the low order word contains the two low bytes of the 32-bit parameter. As an example, look in the Operations Page under the Analog Input Menu for the Analog Input Value. Find the column identified in the header as Modbus and notice that it lists register 360. Because this parameter is a float it is actually represented by registers 360 (low order bytes) and 361 (high order bytes). The Modbus specification does not dictate which register should be high or low order therefore, Watlow provides the user the ability to swap this order (Setup Page, **CONF** Menu) from the default low/high **LoHi** to high/low **HiLo**.

Note:

With the release of firmware revision 7.00 and above new functions were introduced into this product line. With the introduction of these new functions there was a reorganization of Modbus registers. Notice in the column identified as Modbus the reference to Map 1 and Map 2 registers for each of the various parameters. If the new functions of this product line are not to be used, Map 1 (legacy PM controls) Modbus registers will be sufficient. The Modbus register mapping **MAP** can be changed in the Setup Page under the **CONF** Menu. This setting will apply across the control. We recommend using Map 2 for all new applications. Use Map 1 only if it is desired to maintain backwards compatibility.

It should also be noted that some of the cells in the Modbus column contain wording pertaining to an offset. Several parameters in the control contain more than one instance, such as, alarms (4). The Modbus register shown always represents instance one. Take for an example the Silence Alarm parameter found in the Setup Page under the Alarm Menu. Instance one of Map 1 is shown as address 1490 and +50 is identified as the offset to the next instance. If there was a desire to read or write to instance 3, simply add 100 to 1490 to find its address, in this case, the instance 3 address for Silence Alarm is 1590.

The Modbus communications instance can be either 1 or 2 depending on the part number.

Instance 1:

PM _____ - [1] A _____

Instance 2:

PM _____ - [2] A _____

To learn more about the Modbus protocol point your browser to <http://www.modbus.org>.

Common Industrial Protocol (CIP) Introduction to CIP

Both DeviceNet and EtherNet/IP use open object based programming tools and use the same addressing scheme. In the following menu pages notice the column header identified as CIP. There you will find the Class, Instance and Attribute in hexadecimal, (decimal in parenthesis) which makes up the addressing for both protocols.

The CIP communications instance will always be instance 2.

Data Types Used with CIP

int	= Signed 16-bit integer
uint	= Signed 16-bit integer
dint	= Signed 32-bits, long
real	= Float, IEEE 754 32-bit
string	= ASCII, 8 bits per character
sint	= Signed 8 bits , byte

To learn more about the DeviceNet and EtherNet/IP protocol point your browser to <http://www.odva.org>.

Profibus DP

To accommodate for Profibus DP addressing the following menus contain a column identified as Profibus Index. Data types used in conjunction with Profibus DP can be found in the table below.

The Profibus communications instance will always be instance 2.

real	= Float, IEEE 754 32-bit
int	= Signed 16-bit integer
byte	= 8-bits

To learn more about the Profibus DP protocol point your browser to <http://www.profibus.org>

5

Chapter 5: Operations Page

PM Operation Page Parameters

To navigate to the Operations Page, follow the steps below:

1. From the Home Page, press both the Up ▲ and Down ▼ keys for three seconds. *A I* will appear in the upper display and *oPEr* will appear in the lower display.
2. Press the Up ▲ or Down ▼ key to view available menus.
3. Press the Advance Key ⏩ to enter the menu of choice.
4. If a sub-menu exists (more than one instance), press the Up ▲ or Down ▼ key to select and then press the Advance Key ⏩ to enter.
5. Press the Up ▲ or Down ▼ key to move through available menu prompts.
6. Press the Infinity Key ∞ to move backwards through the levels: parameter to sub-menu, sub-menu to menu, menu to Home Page.
7. Press and hold the Infinity Key ∞ for two seconds to return to the Home Page.

On the following pages, top level menus are identified with a yellow background color.

Note:

Some of these menus and parameters may not appear, depending on the controller's options. See model number information in the Appendix for more information. If there is only one instance of a menu, no sub-menus will appear.

Note:

Some of the listed parameters may not be visible. Parameter visibility is dependent upon controller part number.

A I
oPEr Analog Input Menu

I
A I Analog Input (1 to 2)
A I n Analog Input Value
.Er Input Error
.cA Calibration Offset

d i o
oPEr Digital Input/Output Menu

I
d i o Digital Input/Output (5 to 6)
d o S Output State
d i S Input State
E i S Event Status

L i m
oPEr Limit Menu

I
L i m Limit
LLS Low Limit Set Point
LhS High Limit Set Point
LCr Clear Limit
LSt Limit Status

ALPp
oPEr Alarm Menu

I
ALPp Alarm (1 to 4)
ALo Low Set Point
Ahi High Set Point
ACLR Clear Alarm
ASir Silence Alarm
ASt Alarm State

Operations Page

Display	Parameter Name Description	Range	Default	Modbus Relative Address	CIP Class Instance Attribute hex (dec)	Pro-fibus Index	Pa-rame-ter ID	Data Type and Access **
A , oPEr Analog Input Menu								
A in Ain	Analog Input Analog Input Value View the process value. Note: Ensure that the Input Error (below) indicates no error (61) when reading this value using a field bus protocol. If an error exists, the last known value prior to the error occurring will be returned.	-1,999.000 to 9,999.000°F or units -1,128.000 to 5,537.000°C	- - - -	Instance 1 Map 1 Map 2 360 360	0x68 (104) 1 1	0	4001	float R
i.Er i.Er	Analog Input Input Error View the cause of the most recent error. If the Attn message is Er.it , this parameter will display the cause of the input error.	nonE None (61) OPEn Open (65) Shrt Shorted (127) Er.M Measurement Error (140) ECAL Bad Calibration Data (139) Er.Ab Ambient Error (9) Er.td RTD Error (141) FA.iL Fail (32) NSrc Not Sourced (246)	- - - -	Instance 1 Map 1 Map 2 362 362	0x68 (104) 1 2	1	4002	uint R
i.CA i.CA	Analog Input Calibration Offset Offset the input reading to compensate for lead wire resistance or other factors that cause the input reading to vary from the actual process value.	-1,999.000 to 9,999.000°F or units -1,110.555 to 5,555.000°C	0.0	Instance 1 Map 1 Map 2 382 382	0x68 (104) 1 0xC (12)	2	4012	float RWES
** R: Read, W: Write, E: EEPROM, S: User Set								

Operations Page

Display	Parameter Name Description	Range	Default	Modbus Relative Address	CIP Class Instance Attribute hex (dec)	Pro-fibus Index	Parameter ID	Data Type and Access **
d io oPEr Digital Input/Output Menu								
do.S do.S	<i>Digital Output (5 to 6)</i> Output State View the state of this output.	oFF Off (62) oN On (63)	- - - -	Instance 5 Map 1 Map 2 1012 1132 Offset to next instance equals +30	0x6A (106) 5 to 6 7	46	6007	uint R
di.S di.S	<i>Digital Input (5 to 6)</i> Input State View this event input state.	oFF Off (62) oN On (63)	- - - -	Instance 5 Map 1 Map 2 1020 1140 Offset to next instance equals +30	0x6A (106) 5 to 6 0x0B (11)	- - - -	6011	uint R
Ei.S Ei.S	<i>Digital Input (5 to 6)</i> Event Status View this event input state.	, Act Inactive (41) Act Active (5)	- - - -	Instance 5 Map 1 Map 2 1408 1648 Offset to next instance equals +20	0x6E (110) 5 to 6 5	140	10005	uint R
No Display	<i>EZ-Key/s (1 to 2)</i> Event Status View this event input state.	, Act Inactive (41) Act Active (5)	- - - -	Instance 1 Map 1 Map 2 1328 1568 Instance 2 Map 1 Map 2 1348 1588	0x6E (110) 3 to 4 5	140	10005	uint R
L iM oPEr Limit Menu								
LL.S LL.S	<i>Limit</i> Low Limit Set Point Set the low process value that will trigger the limit.	-1,999.000 to 9,999.000 °F or units -1,128.000 to 5,537.000 °C	0.0 °F or units -18.0 °C	Instance 1 Map 1 Map 2 684 724	0x70 (112) 1 3	38	12003	float RWES
Lh.S Lh.S	<i>Limit</i> High Limit Set Point Set the high process value that will trigger the limit.	-1,999.000 to 9,999.000 °F or units -1,128.000 to 5,537.000 °C	0.0 °F or units -18.0 °C	Instance 1 Map 1 Map 2 686 726	0x70 (112) 1 4	39	12004	float RWES
** R: Read, W: Write, E: EEPROM, S: User Set								

Operations Page

Display	Parameter Name Description	Range	Default	Modbus Relative Address	CIP Class Instance Attribute hex (dec)	Pro-fibus Index	Parameter ID	Data Type and Access **
<i>LEr</i> <i>LEr</i>	<i>Limit (1)</i> Clear Limit Clear limit once limit condition is cleared.	Clear (0) No Change (255)	- - - -	Instance 1 Map 1 Map 2 680 720	0x70 (112) 1 1	- - - -	12014	uint W
<i>LSt</i> <i>LSt</i>	<i>Limit (1)</i> Limit Status Reflects whether or not the limit is in a safe or failed mode..	<i>FAIL</i> Fail (32) <i>SAFE</i> Safe (1667)	- - - -	Instance 1 Map 1 Map 2 - - - - 744	0x70 (112) 1 0x0D (13)	- - - -	12013	uint R
No Display	<i>Limit</i> Limit State Clear limit once limit condition is cleared.	Off (62) None (61) Limit High (51) Limit Low (52) Error (225)	- - - -	Instance 1 Map 1 Map 2 690 730	0x70 (112) 1 6	- - - -	12006	uint R

ALP7
oPEr

Alarm Menu

<i>ALo</i> A.Lo	<i>Alarm (1 to 4)</i> Low Set Point If Type (Setup Page, Alarm Menu) is set to: Process - set the process value that will trigger a low alarm.	-1,999.000 to 9,999.000°F or units -1,128.000 to 5,537.000°C	32.0°F or units 0.0°C	Instance 1 Map 1 Map 2 1482 1882 Offset to next instance (Map 1) equals +50 Offset to next instance (Map 2) equals +60	0x6D (109) 1 to 4 2	18	9002	float RWES
<i>Ahi</i> A.hi	<i>Alarm (1 to 4)</i> High Set Point If Type (Setup Page, Alarm Menu) is set to: Process - set the process value that will trigger a high alarm.	-1,999.000 to 9,999.000°F or units -1,128.000 to 5,537.000°C	300.0°F or units 150.0°C	Instance 1 Map 1 Map 2 1480 1880 Offset to next instance (Map 1) equals +50 Offset to next instance (Map 2) equals +60	0x6D (109) 1 to 4 1	19	9001	float RWES

** R: Read, W: Write, E: EEPROM, S: User Set

Operations Page

Display	Parameter Name Description	Range	Default	Modbus Relative Address	CIP Class Instance Attribute hex (dec)	Pro-fibus Index	Parameter ID	Data Type and Access **
A CLR A.Clr	Alarm (1 to 4) Clear Alarm Write to this register to clear an alarm	CLR Clear (1003) IGNR Ignore (204)	- - - -	Instance 1 Map 1 Map 2 1504 1904 Offset to next instance (Map1 1 equals +50, Map 2 equals +60)	0x6D (109) 1 to 4 0x0D (13)	- - - -	9026	uint W
A SIR A.Sir	Alarm (1 to 4) Silence Alarm Write to this register to silence an alarm	SIL Silence (1010)		Instance 1 Map 1 Map 2 1506 1906 Offset to next instance (Map1 1 equals +50, Map 2 equals +60)	0x6D (109) 1 to 4 0x0E (14)	- - - -	9027	uint W
A ST A.St	Alarm (1 to 4) State Current state of alarm	Startup (88) None (61) Blocked (12) Alarm low (8) Alarm high (7) Error (28)	- - - -	Instance 1 Map 1 Map 2 1496 1896 Offset to next instance (Map1 1 equals +50, Map 2 equals +60)	0x6D (109) 1 to 4 9	- - - -	9009	uint R
No Display	Alarm (1 to 4) Alarm Clearable Indicates if alarm can be cleared.	No (59) Yes (106)		Instance 1 Map 1 Map 2 1502 1902 Offset to next instance (Map1 1 equals +50, Map 2 equals +60)	0x6D (109) 1 to 4 0xC (12)	- - - -	9012	uint R
No Display	Alarm (1 to 4) Alarm Silenced Indicates if alarm is silenced.	No (59) Yes (106)	- - - -	Instance 1 Map 1 Map 2 1500 1900 Offset to next instance (Map1 1 equals +50, Map 2 equals +60)	0x6D (109) 1 to 4 0x0B (11)	- - - -	9011	uint R

** R: Read, W: Write, E: EEPROM, S: User Set

Operations Page

Display	Parameter Name Description	Range	Default	Modbus Relative Ad- dress	CIP Class Instance Attribute hex (dec)	Pro- fibus Index	Pa- rame- ter ID	Data Type and Ac- cess **
No Dis- play	<i>Alarm (1 to 4)</i> Alarm Latched Indicates if alarm is latched.	No (59) Yes (106)	- - - -	Instance 1 Map 1 Map 2 1498 1898 Offset to next instance (Map1 1 equals +50, Map 2 equals +60)	0x6D (109) 1 to 4 0x0A (10)	- - - -	9010	uint R

** R: Read, W: Write, E: EEPROM, S: User Set

6

Chapter 6: Setup Page

Navigating the Setup Page

To navigate to the Setup Page follow the steps below:

1. From the Home Page, press and hold both the Up \uparrow and Down \downarrow keys for six seconds. A_i will appear in the upper display and SEt will appear in the lower display. If the up and down arrow keys are released where $oPEr$ appears in the lower display, simply press and hold those same keys for an additional 3 seconds.

Note: (for firmware release 13 and below)

If keys are released when $oPEr$ is displayed, press the Infinity Key ∞ or reset key to exit and repeat until SEt is displayed.

2. Press the Up \uparrow or Down \downarrow key to view available menus.
3. Press the Advance Key \rightarrow to enter the menu of choice.
4. If a sub-menu exists (more than one instance), press the Up \uparrow or Down \downarrow key to select and then press the Advance Key \rightarrow to enter.
5. Press the Up \uparrow or Down \downarrow key to move through available menu prompts.
6. Press the Infinity Key ∞ to move backwards through the levels: parameter to sub-menu, sub-menu to menu, menu to Home Page.
7. Press and hold the Infinity Key ∞ for two seconds to return to the Home Page.

On the following pages, top level menus are identified with a yellow background color.

Note:

Some of these menus and parameters may not appear, depending on the controller's options. See model number information in the Appendix for more information. If there is only one instance of a menu, no sub-menus will appear.

Note:

Some of the listed parameters may not be visible. Parameter visibility is dependent upon controller part number.

A_i	rLo Range Low	iEr Calibration Offset *
SEt Analog Input Menu	rHi Range High	Ain Analog Input Value *
i	PEE Process Error Enable	iEr Input Error *
A_i Analog Input (1 to 2)	PEL Process Error Low Value	dIo
SEn Sensor Type	tC Thermistor Curve	SEt Digital Input/Output Menu
Lin TC Linearization	rR Resistance Range	S
rEL RTD Leads	FiL Filter	dIo Digital Input/Output (5 to 6)
$Units$ Units	iEr Input Error Latching	dIr Direction
SLo Scale Low	dEC Display Precision	F_n Function
SHi Scale High		

* These parameters/prompts are available with firmware revisions 11.0 and above.

F_i Output Function Instance
LE_v Active Level
F_n Action Function
F_i Function Instance

L_{LP}

SEE Limit Menu

LS_d Sides
*L_h*Y** Hysteresis
SP_{Lh} Maximum Set Point
SP_{LL} Minimum Set Point
*L_h*S** High Limit Set Point *
LL_S Low Limit Set Point *
SF_{nA} Source Function A*
S_{iA} Source Instance A*
LE_r Clear Limit *
LS_t Limit Status *

o_tP_t

SEE Output Menu

o_tP_t Output (1 to 4)
F_n Function
F_i Output Function Instance
o_tP_t Output Process 3
o_tY Type
F_n Function
F_i Output Function Instance
*S_L*o** Scale Low
*S_h*i** Scale High
*r_L*o** Range Low
*r_h*i** Range High
o_CA Calibration Offset

ALP_n

SEE Alarm Menu

ALP_n Alarm (1 to 4)
o_tY Type
S_rA Alarm Source
i_SA Alarm Source Instance
o_tY Hysteresis
AL_g Logic
AL_o Low Set Point *
o_th_i High Set Point *
AL_A Latching
o_tb_L Blocking
AS_i Silencing
o_dSP Display
o_dL Delay Time
o_CL_r Clear Alarm *
AS_ir Silence Alarm *
AS_t Alarm State *

F_U_n

SEE Variable Menu

F_U_n Function Key (1 to 2)
LE_v Active Level
F_n Action Function
F_i Function Instance

GL_bL

SEE Global Menu

GL_bL Global
C_LF Display Units
o_CL_F AC Line Frequency
C_LE_d Communications LED Action
z_onE Zone
C_hA_n Channel
d_Pr_S Display Pairs
d_t_i Display Time
US_r_S Save Settings As
US_r_r Restore Settings From

CO_nP

SEE Communications Menu

CO_nP Communications (1 to 2)
P_Co_L Protocol
o_dS Standard Bus Address
o_dP_n Modbus Address
b_AU_d Baud Rate
P_Ar Parity
P_nh_L Modbus Word Order
i_PP_n IP Address Mode
i_PF₁ IP Fixed Address Part 1
i_PF₂ IP Fixed Address Part 2
i_PF₃ IP Fixed Address Part 3
i_PF₄ IP Fixed Address Part 4
i_PF₅ IP Fixed Address Part 5
i_PF₆ IP Fixed Address Part 6
i_PS₁ IP Fixed Subnet Part 1
i_PS₂ IP Fixed Subnet Part 2
i_PS₃ IP Fixed Subnet Part 3
i_PS₄ IP Fixed Subnet Part 4
i_PS₅ IP Fixed Subnet Part 5
i_PS₆ IP Fixed Subnet Part 6
i_Pg₁ IP Fixed Subnet Part 1
i_Pg₂ IP Fixed Subnet Part 2
i_Pg₃ IP Fixed Subnet Part 3
i_Pg₄ IP Fixed Subnet Part 4
i_Pg₅ IP Fixed Subnet Part 5

.P96 IP Fixed Subnet
Part 6

P7bE Modbus TCP Enable

E .PE EtherNet/IP Enable

Ao.nb CIP Implicit Assembly Output Member
Quantity

A .nb CIP Implicit Assembly Input Member
Quantity

Add DeviceNet™ Node
Address

BAUD Baud Rate Device-
Net™

FCE DeviceNet™ Quick
Connect Enable

PAdd Profibus Address

ALoC Profibus Address
Lock

SEAL Profibus Status

C_F Display Units

P7AP Data Map

nUS Non-volatile Save

Setup Page

Display	Parameter Name Description	Range	Default	Modbus Relative Address	CIP - Class Instance Attribute hex (dec)	Pro-fibus Index	Parameter ID	Data Type and Access **
A , SEt Analog Input Menu								
SEn SEn	Analog Input Sensor Type Set the analog sensor type to match the device wired to this input. Note: There is no open sensor protection for process inputs.	oFF Off (62) tC Thermocouple (95) mV Millivolts (56) vdc Volts dc (104) mA Milliamps dc (112) RTD 100 RTD 100 Ω (113) RTD 1000 RTD 1,000 Ω (114) Pot Potentiometer 1 kΩ (155) ThEr Thermistor (229)	Thermocouple or Thermistor	Instance 1 Map 1 Map 2 368 368	0x68 (104) 1 5	3	4005	uint RWES
Lin Lin	Analog Input TC Linearization Set the linearization to match the thermocouple wired to this input.	b B (11) H K (48) C C (15) N N (58) D D (23) R R (80) E E (26) S S (84) F F (30) T T (93) J J (46)	J	Instance 1 Map 1 Map 2 370 370	0x68 (104) 1 6	4	4006	uint RWES
rt.L rt.L	Analog Input RTD Leads Set to match the number of leads on the RTD wired to this input.	2 2 (1) 3 3 (2)	2	Instance 1 Map 1 Map 2 372 372	0x68 (104) 1 7	- - - -	4007	uint RWES
Unit Unit	Analog Input Units Set the type of units the sensor will measure.	ATP Absolute Temperature (1540) rh Relative Humidity (1538) Pro Process (75) Power Power (73)	Process	Instance 1 Map 1 Map 2 - - - - 442	0x68 (104) 1 0x2A (42)	5	4042	uint RWES

* These parameters/prompts are available in these menus with firmware revisions 11.0 and above.
 ** R: Read, W: Write, E: EEPROM, S: User Set

Setup Page

Display	Parameter Name Description	Range	Default	Modbus Relative Ad- dress	CIP - Class Instance Attribute hex (dec)	Pro- fibus Index	Param- eter ID	Data Type and Access **
S.Lo S.Lo	Analog Input Scale Low Set the low scale for process inputs. This value, in millivolts, volts or milliamps, will correspond to the Range Low output of this function block.	-100.00 to 1,000.00	0.0	Instance 1 Map 1 Map 2 388 388	0x68 (104) 1 0xF (15)	6	4015	float RWES
S.hi S.hi	Analog Input Scale High Set the high scale for process inputs. This value, in millivolts, volts or milliampers, will correspond to the Range High output of this function block.	-100.00 to 1,000.00	20.0	Instance 1 Map 1 Map 2 390 390	0x68 (104) 1 0x10 (16)	7	4016	float RWES
r.Lo r.Lo	Analog Input Range Low Set the low range for this function block's output.	-1,999.000 to 9,999.000	0.0	Instance 1 Map 1 Map 2 392 392	0x68 (104) 1 0x11 (17)	8	4017	float RWES
r.hi r.hi	Analog Input Range High Set the high range for this function block's output.	-1,999.000 to 9,999.000	9,999	Instance 1 Map 1 Map 2 394 394	0x68 (104) 1 0x12 (18)	9	4018	float RWES
P.EE P.EE	Analog Input Process Error Enable Turn the Process Error Low feature on or off.	oFF Off (62) LoBd Low (53)	Off	Instance 1 Map 1 Map 2 418 418	0x68 (104) 1 0x1E (30)	10	4030	uint RWES
P.EL P.EL	Analog Input Process Error Low Value If the process value drops below this value, it will trigger an input error.	-100.00 to 1,000.00	0.0	Instance 1 Map 1 Map 2 420 420	0x68 (104) 1 0x1F (31)	11	4031	float RWES

* These parameters/prompts are available in these menus with firmware revisions 11.0 and above.

** R: Read, W: Write, E: EEPROM, S: User Set

Setup Page

Display	Parameter Name Description	Range	Default	Modbus Relative Address	CIP - Class Instance Attribute hex (dec)	Pro-fibus Index	Parameter ID	Data Type and Access **
t.C t.C	<i>Analog Input</i> Thermistor Curve Select a curve to apply to the thermistor input.	<i>A</i> Curve A (1451) <i>b</i> Curve B (1452) <i>C</i> Curve C (1453) <i>CUSt</i> Custom (180)	Curve A	<i>Instance 1</i> Map 1 Map 2 434 434	0x68 (104) 1 0x26 (38)	- - - -	4038	uint RWES
r.r r.r	<i>Analog Input</i> Resistance Range Set the maximum resistance of the thermistor input.	<i>5</i> 5K (1448) <i>10</i> 10K (1360) <i>20</i> 20K (1361) <i>40</i> 40K (1449)	40K	<i>Instance 1</i> Map 1 Map 2 432 432	0x68 (104) 1 0x25 (37)	- - - -	4037	uint RWES
F iL FiL	<i>Analog Input</i> Filter Filtering smooths out the process signal to both the display and the input. Increase the time to increase filtering. Note: Filter does not apply to the Limit sensor but does apply to all other functions.	0.0 to 60.0 seconds	0.5	<i>Instance 1</i> Map 1 Map 2 386 386	0x68 (104) 1 0xE (14)	12	4014	float RWES
i.Er i.Er	<i>Analog Input</i> Input Error Latching Turn input error latching on or off. If latching is on, errors must be manually cleared.	<i>oFF</i> Off (62) <i>oN</i> On (63)	Off	<i>Instance 1</i> Map 1 Map 2 414 414	0x68 (104) 1 0x1C (28)	- - - -	4028	uint RWES
dEC dEC	<i>Analog Input</i> Display Precision Set the precision of the displayed value.	<i>0</i> Whole (105) <i>0.0</i> Tenths (94) <i>0.00</i> Hundredths (40) <i>0.000</i> Thousandths (96)	Whole	<i>Instance 1</i> Map 1 Map 2 398 398	0x68 (104) 1 0x14 (20)	- - - -	4020	uint RWES
i.CA i.CA	<i>Analog Input</i> Calibration Offset * Offset the input reading to compensate for lead wire resistance or other factors that cause the input reading to vary from the actual process value.	-1,999.000 to 9,999.000 °F or units -1,110.555 to 5,555.000 °C	0.0	<i>Instance 1</i> Map 1 Map 2 382 382	0x68 (104) 1 0xC (12)	2	4012	float RWES

* These parameters/prompts are available in these menus with firmware revisions 11.0 and above.

** R: Read, W: Write, E: EEPROM, S: User Set

Setup Page

Display	Parameter Name Description	Range	Default	Modbus Relative Address	CIP - Class Instance Attribute hex (dec)	Pro-fibus Index	Parameter ID	Data Type and Access **
<i>A in</i> Ain	<i>Analog Input</i> Analog Input Value * View the process value. Note: Ensure that the Error Status (below) indicates no error (61) when reading this value using a field bus protocol. If an error exists, the last known value prior to the error occurring will be returned.	-1,999.000 to 9,999.000°F or units -1,128.000 to 5,537.000°C	- - - -	Instance 1 Map 1 Map 2 360 360	0x68 (104) 1 1	0	4001	float R
<i>i.Er</i> i.Er	<i>Analog Input</i> Input Error * View the cause of the most recent error.	<i>nonE</i> None (61) <i>OPEn</i> Open (65) <i>Shrt</i> Shorted (127) <i>EP7</i> Measurement Error (140) <i>E.CAL</i> Bad Calibration Data (139) <i>Er.Ab</i> Ambient Error (9) <i>Er.td</i> RTD Error (141) <i>FR.iL</i> Fail (32)	- - - -	Instance 1 Map 1 Map 2 362 442	0x68 (104) 1 2	1	4002	uint R
<div style="display: flex; justify-content: space-between; align-items: center;"> d io SET </div> <h3 style="text-align: center; margin: 0;">Digital Input/Output Menu</h3>								
<i>d ir</i> dir	<i>Digital Input/Output</i> (5 to 6) Direction Set this function to operate as an input or output.	<i>o t P t</i> Output (68) <i>i n</i> Input Voltage (193) <i>i Con</i> Input Dry Contact (44)	Output	Instance 5 Map 1 Map 2 1000 1120 Offset to next instance (Map 1 & Map 2) equals +30	0x6A (106) 5 to 6 1	82	6001	uint RWES
<p>* These parameters/prompts are available in these menus with firmware revisions 11.0 and above. ** R: Read, W: Write, E: EEPROM, S: User Set</p>								

Setup Page

Display	Parameter Name Description	Range	Default	Modbus Relative Address	CIP - Class Instance Attribute hex (dec)	Pro-fibus Index	Parameter ID	Data Type and Access **
<i>F_n</i> Fn	<i>Digital Output (5 to 6)</i> Function Select what function will drive this output.	<i>oFF</i> Off (62) <i>ALPn</i> Alarm (6)	Off	<i>Instance 5</i> Map 1 Map 2 1008 1128 Offset to next instance (Map 1 & Map 2) equals +30	0x 6A (106) 5 to 6 5	83	6005	uint RWES
<i>F_i</i> Fi	<i>Digital Output (5 to 6)</i> Output Function Instance Set the instance of the function selected above. Note: Modbus Map 1 has instances 5 through 8 only	1 to 4	1	<i>Instance 5</i> Map 1 Map 2 1010 1130 Offset to next instance (Map 1 & Map 2) equals +30	0x6A (106) 5 to 6 6	84	6006	uint RWES
<i>LE_v</i> LEv	<i>Digital Input (5 to 6)</i> Active Level Select which action will be interpreted as a true state.	<i>h_{igh}</i> High (37) <i>Lo_w</i> Low (53)	High	<i>Instance 5</i> Map 1 Map 2 1320 1560 Offset to next instance (Map 1 & Map 2) equals +20	0x6E (110) 5 to 6 1	137	10001	uint RW
<i>F_n</i> Fn	<i>Digital Input (5 to 6)</i> Action Function Select the function that will be triggered by a true state for Digital Inputs 5 to 6.	<i>nonE</i> None (61) <i>F.AL</i> Force Alarm to occur, level triggered (218) <i>RoF</i> Control Loops Off and Alarms to Non-alarm State, level triggered (220) <i>S_iL</i> Silence Alarms, edge triggered (108) <i>ALPn</i> Alarm Reset, edge triggered (6) <i>P.LoC</i> Keypad Lock-out, level triggered (217) <i>uS_rr</i> User Set Restore, edge triggered (227)	None	<i>Instance 5</i> Map 1 Map 2 1324 1564 Offset to next instance (Map 1 & Map 2) equals +20	0x6E (110) 5 to 6 3	138	10003	uint RWES

* These parameters/prompts are available in these menus with firmware revisions 11.0 and above.

** R: Read, W: Write, E: EEPROM, S: User Set

Setup Page

Display	Parameter Name Description	Range	Default	Modbus Relative Address	CIP - Class Instance Attribute hex (dec)	Pro-fibus Index	Parameter ID	Data Type and Access **
<i>F</i> , <i>Fi</i>	Digital Input (5 to 6) Function Instance Select which Digital Input will be triggered by a true state.	0 to 40	0	Instance 5 Map 1 Map 2 1326 1566 Offset to next instance (Map 1 & Map 2) equals +20	0x6E (110) 5 to 6 4	139	10004	uint RWES
<div style="display: flex; justify-content: space-between; align-items: center;"> L.P7 SEt </div> <p>Limit Menu</p>								
<i>L.Sd</i> L.Sd	Limit Sides Select which side or sides of the process value will be monitored.	<i>both</i> Both (13) <i>high</i> High (37) <i>low</i> Low (53)	Both	Instance 1 Map 1 Map 2 688 728	0x70 (112) 1 5	40	12005	uint RWES
<i>L.hy</i> L.hy	Limit Hysteresis Set the hysteresis for the limit function. This determines how far into the safe range the process value must move before the limit can be cleared.	0.001 to 9,999.000°F or units 0.001 to 5,555.000°C	3.0°F or units 2.0°C	Instance 1 Map 1 Map 2 682 722	0x70 (112) 1 2	41	12002	float RWES
<i>SP.Lh</i> SP.Lh	Limit Maximum Set Point Set the high end of the limit set point range.	-1,999.000 to 9,999.000	9,999.000	Instance 1 Map 1 Map 2 696 736	0x70 (112) 1 9	42	12009	float RWES
<i>SP.LL</i> SP.LL	Limit Minimum Set Point Set the low end of the limit set point range.	-1,999.000 to 9,999.000	-1,999.000	Instance 1 Map 1 Map 2 698 738	0x70 (112) 1 0xA (10)	43	12010	float RWES
<i>Lh.S</i> Lh.S	Limit High Limit Set Point * Set the high process value that will trigger the limit.	-1,999.000 to 9,999.000°F or units -1,128.000 to 5,537.000°C	0.0°F or units -18.0°C	Instance 1 Map 1 Map 2 686 726	0x70 (112) 1 4	39	12004	float RWES

* These parameters/prompts are available in these menus with firmware revisions 11.0 and above.

** R: Read, W: Write, E: EEPROM, S: User Set

Setup Page

Display	Parameter Name Description	Range	Default	Modbus Relative Address	CIP - Class Instance Attribute hex (dec)	Pro-fibus Index	Parameter ID	Data Type and Access **
LLS LL.S	Limit Low Limit Set Point * Set the low process value that will trigger the limit.	-1,999.000 to 9,999.000°F or units -1,128.000 to 5,537.000°C	0.0°F or units -18.0°C	Instance 1 Map 1 Map 2 684 724	0x70 (112) 1 3	38	12003	float RWES
SFn.A SFn.A	Limit Source Function A * Set the source for the limit reset function.	nOnE None (61) dIo Digital I/O (1142) FUn Function Key (1001)	None	Instance 1 Map 1 Map 2 - - - - 748	0x70 (112) 1 0x0F (15)	- - - -	12015	uint RWES
Si.A Si.A	Limit Source Instance A * Set the instance of the function selected above.	1 to 12	1	- - - -	0x70 (112) 1 0x10 (16)	- - - -	12016	uint RWES
LEr LEr	Limit Clear Limit * Clear limit once limit condition is safe.	CLr Clear (0) iGnr Ignore (204)	- - - -	Instance 1 Map 1 Map 2 680 720	0x70 (112) 1 1	- - - -	12014	uint W
LSt LSt	Limit Limit Status * Reflects whether or not the limit is in a safe or failed mode.	FAiL Fail (32) SAFE Safe (1667)	- - - -	Instance 1 Map 1 Map 2 - - - - 744	0x70 (112) 1 0x0D (13)	- - - -	12013	uint R
No Display	Limit Limit State Clear limit once limit condition is cleared.	Off (62) None (61) Limit High (51) Limit Low (52) Error (28)	- - - -	Instance 1 Map 1 Map 2 690 730	0x70 (112) 1 6	- - - -	12006	uint R

* These parameters/prompts are available in these menus with firmware revisions 11.0 and above.

** R: Read, W: Write, E: EEPROM, S: User Set

Setup Page

Display	Parameter Name Description	Range	Default	Modbus Relative Address	CIP - Class Instance Attribute hex (dec)	Pro-fibus Index	Parameter ID	Data Type and Access **
<p style="color: red; margin: 0;">o.tPt</p> <p style="color: green; margin: 0;">SEt</p> <p>Output Menu</p>								
Fn Fn	<p><i>Output Digital (1 to 4)</i></p> <p>Function Select what function will drive this output.</p> <p>Note: Output 2 is always a limit. Use as primary limit connection.</p>	<p>oFF Off (62)</p> <p>L.PP Limit (126)</p> <p>ALPP Alarm (6)</p>	<p>Output 1 - Alarm</p> <p>Output 2 - Limit</p> <p>Output 3 - Off</p> <p>Output 4 - Off</p>	<p>Instance 1</p> <p>Map 1 888 Map 2 1008</p> <p>Offset to next instance (Map 1 & Map 2) equals +30</p>	<p>0x6A (106)</p> <p>1 to 4 5</p>	83	6005	uint RWES
Fi Fi	<p><i>Output Digital (1 to 4)</i></p> <p>Output Function Instance Set the instance of the function selected above.</p>	1 to 4	1	<p>Instance 1</p> <p>Map 1 890 Map 2 1010</p> <p>Offset to next instance (Map 1 & Map 2) equals +30</p>	<p>0x6A (106)</p> <p>1 to 4 6</p>	84	6006	uint RWES
o.ty o.ty	<p><i>Output Process (3)</i></p> <p>Type Select whether the process output will operate in volts or milliamps.</p>	<p>uolt Volts (104)</p> <p>PPA Milliamps (112)</p>	Volts	<p>Instance 3</p> <p>Map 1 800 Map 2 920</p>	<p>0x76 (118)</p> <p>3 1</p>	95	18001	uint RWES
Fn Fn	<p><i>Output Process (3)</i></p> <p>Function Set the type of function that will drive this output.</p>	<p>oFF Off (62)</p> <p>r.PPt Retransmit (213)</p> <p>ALPP Alarm (6)</p>	Off	<p>Instance 3</p> <p>Map 1 802 Map 2 922</p>	<p>0x76 (118)</p> <p>3 2</p>	96	18002	uint RWES
r.Sr r.Sr	<p><i>Output Process (3)</i></p> <p>Retransmit Source Select the value that will be retransmitted.</p>	<p>A, Analog Input (142)</p>	Analog Input	<p>Instance 3</p> <p>Map 1 804 Map 2 924</p>	<p>0x76 (118)</p> <p>3 3</p>	97	18003	uint RWES
<p>* These parameters/prompts are available in these menus with firmware revisions 11.0 and above.</p> <p>** R: Read, W: Write, E: EEPROM, S: User Set</p>								

Setup Page

Display	Parameter Name Description	Range	Default	Modbus Relative Ad- dress	CIP - Class Instance Attribute hex (dec)	Pro- fibus Index	Param- eter ID	Data Type and Access **
<i>F</i> , Fi	<i>Output Process (3)</i> Function Instance Set the instance of the function select- ed above.	1 to 4	1	Instance 3 Map 1 Map 2 806 926	0x76 (118) 3 4	98	18004	uint RWES
<i>S.Lo</i> S.Lo	<i>Output Process (3)</i> Scale Low Set the scale low for process output in electrical units. This value; in volts or milliamps, will correspond to 0% PID power output or range low retrans- mit output.	-100.0 to 100.0	0.00	Instance 3 Map 1 Map 2 816 936	0x76 (118) 3 9	99	18009	float RWES
<i>S.h</i> , S.hi	<i>Output Process (3)</i> Scale High Set the scale high for process output in electrical units. This value; in volts or milliamps, will cor- respond to 100% PID power output or range high retrans- mit output.	-100.0 to 100.0	10.00	Instance 3 Map 1 Map 2 818 938	0x76 (118) 3 0x0A (10)	100	18010	float RWES
<i>r.Lo</i> r.Lo	<i>Output Process (3)</i> Range Low Set the minimum value of the re- transmit value range in process units. When the retransmit source is at this value, the retransmit output will be at its Scale Low value.	-1,999.000 to 9,999.000 °F or units -1,128.000 to 5,537.000 °C	0.0 °F or units -18 °C	Instance 3 Map 1 Map 2 820 940	0x76 (118) 3 0x0B (11)	101	18011	float RWES

* These parameters/prompts are available in these menus with firmware revisions 11.0 and above.

** R: Read, W: Write, E: EEPROM, S: User Set

Setup Page

Display	Parameter Name Description	Range	Default	Modbus Relative Address	CIP - Class Instance Attribute hex (dec)	Pro-fibus Index	Parameter ID	Data Type and Access **
r.h i r.hi	Output Process (3) Range High Set the maximum value of the re-transmit value range in process units. When the retransmit source is at this value, the retransmit output will be at its Scale High value.	-1,999.000 to 9,999.000°F or units -1,128.000 to 5,537.000°C	100.0°F or units 38.0°C	Instance 3 Map 1 822 Map 2 942	0x76 (118) 3 0x0C (12)	102	18012	float RWES
o.CA o.CA	Output Process (3) Calibration Offset Set an offset value for a process output.	-1,999.000 to 9,999.000°F or units -1,110.555 to 5,555.000°C	0.0°F or units 0.0°C	Instance 3 Map 1 812 Map 2 932	0x76 (118) 3 7	105	18007	float RWES

ALP7

SET

Alarm Menu

ALY A.ty	Alarm (1 to 4) Type Select whether the alarm trigger is a fixed value or will track the set point.	OFF Off (62) Pr.AL Process Alarm (76)	Off	Instance 1 Map 1 1508 Map 2 1908 Offset to next instance (Map 1 +50, Map 2 +60)	0x6D (109) 1 to 4 0xF (15)	20	9015	uint RWES
Sr.A Sr.A	Alarm (1 to 4) Alarm Source Select what will trigger this alarm.	AI Analog Input (142)	Analog Input	Instance 1 Map 1 1512 Map 2 1912 Offset to next instance (Map 1 +50, Map 2 +60)	0x6D (109) 1 to 4 0x11 (17)	21	9017	uint RWES

* These parameters/prompts are available in these menus with firmware revisions 11.0 and above.

** R: Read, W: Write, E: EEPROM, S: User Set

Setup Page

Display	Parameter Name Description	Range	Default	Modbus Relative Ad- dress	CIP - Class Instance Attribute hex (dec)	Pro- fibus Index	Param- eter ID	Data Type and Access **
A.h.y A.hy	Alarm (1 to 4) Hysteresis Set the hysteresis for an alarm. This determines how far into the safe region the process value needs to move before the alarm can be cleared.	0.001 to 9,999.000 °F or units 0.001 to 5,555.000 °C	1.0 °F or units 1.0 °C	Instance 1 Map 1 Map 2 1484 1884 Offset to next in- stance (Map 1 equals +50, Map 2 +60)	0x6D (109) 1 to 4 3	24	9003	float RWES
A.L.g A.Lg	Alarm (1 to 4) Logic Select what the output condition will be during the alarm state.	A.L.C Energize on alarm (17) A.L.o De-energize on alarm (66)	Close On Alarm	Instance 1 Map 1 Map 2 1488 1888 Offset to next in- stance (Map 1 +50, Map 2 +60)	0x6D (109) 1 to 4 5	25	9005	uint RWES
A.S.d A.Sd	Alarm (1 to 4) Sides Select which side or sides will trigger this alarm.	b.o.t.h Both (13) h.i.g.h High (37) L.o.w Low (53)	Both	Instance 1 Map 1 Map 2 1486 1886 Offset to next in- stance (Map 1 +50, Map 2 +60)	0x6D (109) 1 to 4 4	26	9004	uint RWES
A.L.o A.Lo	Alarm (1 to 4) Low Set Point Set the process value that will trigger a low alarm.	-1,999.000 to 9,999.000 °F or units -1,128.000 to 5,537.000 °C	32.0 °F or units 0.0 °C	Instance 1 Map 1 Map 2 1482 1882 Offset to next in- stance (Map 1 +50, Map 2 +60)	0x6D (109) 1 to 4 2	18	9002	float RWES
A.h.i A.hi	Alarm (1 to 4) High Set Point Set the process value that will trigger a high alarm.	-1,999.000 to 9,999.000 °F or units -1,128.000 to 5,537.000 °C	300.0 °F or units 150.0 °C	Instance 1 Map 1 Map 2 1480 1880 Offset to next in- stance (Map 1 +50, Map 2 +60)	0x6D (109) 1 to 4 1	19	9001	float RWES

* These parameters/prompts are available in these menus with firmware revisions 11.0 and above.

** R: Read, W: Write, E: EEPROM, S: User Set

Setup Page

Display	Parameter Name Description	Range	Default	Modbus Relative Address	CIP - Class Instance Attribute hex (dec)	Pro-fibus Index	Parameter ID	Data Type and Access **
RLA A.LA	Alarm (1 to 4) Latching Turn latching on or off. A latched alarm has to be turned off by the user.	nLAL Non-Latching (60) LAL Latching (49)	Non-Latching	Instance 1 Map 1 1492 Map 2 1892 Offset to next instance (Map 1 +50, Map 2 +60)	0x6D (109) 1 to 4 7	27	9007	uint RWES
RbL A.bL	Alarm (1 to 4) Blocking Select when an alarm will be blocked. After start-up and/or after the set point changes, the alarm will be blocked until the process value enters the normal range.	oFF Off (62) StAr Startup (88) StPt Set Point (85) both Both (13)	Off	Instance 1 Map 1 1494 Map 2 1894 Offset to next instance (Map 1 +50, Map 2 +60)	0x6D (109) 1 to 4 8	28	9008	uint RWES
RS , A.Si	Alarm (1 to 4) Silencing Turn silencing on to allow the user to disable this alarm.	oFF Off (62) on On (63)	Off	Instance 1 Map 1 1490 Map 2 1890 Offset to next instance (Map 1 equals +50, for Map 2 equals +60)	0x6D (109) 1 to 4 6	29	9006	uint RWES
RdSP A.dSP	Alarm (1 to 4) Display Display an alarm message when an alarm is active.	oFF Off (62) on On (63)	On	Instance 1 Map 1 1510 Map 2 1910 Offset to next instance (Map 1 equals +50, for Map 2 equals +60)	0x6D (109) 1 to 4 0x10 (16)	30	9016	uint RWES

* These parameters/prompts are available in these menus with firmware revisions 11.0 and above.

** R: Read, W: Write, E: EEPROM, S: User Set

Setup Page

Display	Parameter Name Description	Range	Default	Modbus Relative Address	CIP - Class Instance Attribute hex (dec)	Pro-fibus Index	Parameter ID	Data Type and Access **
<i>A.dL</i> A.dL	Alarm (1 to 4) Delay Time Set the span of time that the alarm will be delayed after the process value exceeds the alarm set point.	0 to 9,999 seconds	0	Instance 1 Map 1 1520 Map 2 1920 Offset to next instance (Map 1 equals +50, for Map 2 equals +60)	0x6D (109) 1 to 4 0x15 (21)	31	9021	uint RWES
<i>A.Clr</i> A.Clr	Alarm (1 to 4) Clear Alarm Write to this register to clear an alarm Note: If an alarm is set-up to latch when active <i>A.Clr</i> will appear on the display.	<i>CLr</i> Clear (0) <i>Ignr</i> Ignore (204)	----	Instance 1 Map 1 1504 Map 2 1904 Offset to next instance (Map1 1 equals +50, Map 2 equals +60)	0x6D (109) 1 to 4 0xD (13)	----	9013	uint W
<i>A.Sir</i> A.Sir	Alarm (1 to 4) Silence Alarm Write to this register to silence an alarm Note: If an alarm is setup to silence alarm when active <i>A.Sir</i> will appear on the display.	<i>Sil</i> Silence (1010)	----	Instance 1 Map 1 1506 Map 2 1906 Offset to next instance (Map1 1 equals +50, Map 2 equals +60)	0x6D (109) 1 to 4 0xE (14)	----	9014	uint W
<i>A.St</i> A.St	Alarm (1 to 4) Alarm State Current state of alarm	<i>Str</i> Startup (88) <i>nonE</i> None (61) <i>blo</i> Blocked (12) <i>ALL</i> Alarm low (8) <i>ALh</i> Alarm high (7) <i>ALe</i> Error (28)	----	Instance 1 Map 1 1496 Map 2 1896 Offset to next instance (Map1 1 equals +50, Map 2 equals +60)	0x6D (109) 1 to 4 9	----	9009	uint R

* These parameters/prompts are available in these menus with firmware revisions 11.0 and above.

** R: Read, W: Write, E: EEPROM, S: User Set

Setup Page

Display	Parameter Name Description	Range	Default	Modbus Relative Address	CIP - Class Instance Attribute hex (dec)	Pro-fibus Index	Parameter ID	Data Type and Access **
Function Key <i>FUn</i> <i>SEt</i>								
<i>LEu</i> LEv	Function Key (3 to 4) Active Level The Function Key will always power up in the low state. Pressing the Function Key will toggle the selected action.	<i>hi9h</i> High (37) <i>LoLu</i> Low (53)	High	Instance 3 Map 1 Map 2 1360 1600 Instance 4 Map 1 Map 2 1380 1620	0x6E (110) 3 to 4 1	137	10001	uint RWES
<i>Fn</i> Fn	Function Key (3 to 4) Action Function Program the EZ Key to trigger an action. Functions respond to a level state change or an edge level change. Note: The Limit Reset function is not available in firmware revision 11.0 and above.	<i>none</i> None (61) <i>uSrr</i> User Set Restore, edge triggered (227) <i>PLoE</i> Keypad Lock-out, level triggered (217) <i>ALrE</i> Alarm Reset, edge triggered (6) <i>SrL</i> Silence Alarms, edge triggered (108) <i>FAL</i> Force Alarm to occur, level triggered (218) <i>LrEr</i> Limit Reset, edge triggered (82)	None	Instance 3 Map 1 Map 2 1364 1604 Instance 4 Map 1 Map 2 1384 1624	0x6E (110) 3 to 4 3	138	10003	uint RWES
<i>Fi</i> Fi	Function Key (3 to 4) Function Instance Select which instance the EZ Key will affect. If only one instance is available, any selection will affect it.	0 to 40	0	Instance 3 Map 1 Map 2 1366 1606 Instance 4 Map 1 Map 2 1386 1626	0x96 (110) 3 to 4 4	139	10004	- - - -

* These parameters/prompts are available in these menus with firmware revisions 11.0 and above.

** R: Read, W: Write, E: EEPROM, S: User Set

Setup Page

Display	Parameter Name Description	Range	Default	Modbus Relative Address	CIP - Class Instance Attribute hex (dec)	Pro-fibus Index	Parameter ID	Data Type and Access **
9LbL 5Et Global Menu								
C_F C_F	Global Display Units Select which scale to use for temperature.	F °F (30) C °C (15)	°F	Instance 1 Map 1 1838 Map 2 2308	0x67 (103) 1 5	110	3005	uint RWES
AC.LF AC.LF	Global AC Line Frequency Set the frequency to the applied ac line power source.	50 50 Hz (3) 60 60 Hz (4)	60 Hz	Instance 1 Map 1 886 Map 2 1006	0x6A (106) 1 4	89	1034	uint RWES
C.LEd C.LEd	Global Communications LED Action Turns comms LED on or off for selected comms ports.	Con1 Comm port 1 (1189) Con2 Comm port 2 (1190) both Comm port 1 and 2 (13) oFF Off (62)	both	Instance 1 Map 1 1856 Map 2 2326	0x6A (103) 1 0x0E (14)	- - - -	3014	uint RWES
Zone Zone	Global Zone Turns Zone LED on or off based on selection.	oFF Off (62) on On (63)	On	Instance 1 Map 1 - - - - Map 2 2350	0x6A (103) 1 0x1A (26)	- - - -	3026	uint RWES
Chan Chan	Global Channel Turns Channel LED on or off based on selection.	oFF Off (62) on On (63)	On	Instance 1 Map 1 - - - - Map 2 2352	0x6A (103) 1 0x1B (27)	- - - -	3027	uint RWES
d.PrS d.PrS	Global Display Pairs Defines the number of Display Pairs.	1 to 10	2	Instance 1 Map 1 - - - - Map 2 2354	0x6A (103) 1 0x1C (28)	- - - -	3028	uint RWES
d.ti d.ti	Global Display Time Time delay in toggling between Display Pairs.	0 to 60	0	Instance 1 Map 1 - - - - Map 2 2356	0x6A (103) 1 0x1D (29)	- - - -	3029	uint RWES
USr.S USr.S	Global Save Settings As Save all of this controller's settings to the selected set.	5Et1 User Set 1 (101) 5Et2 User Set 2 (102) nonE None (61)	None	Instance 1 Map 1 26 Map 2 26	0x(101) 1 0xE (14)	118	1014	uint RWE

* These parameters/prompts are available in these menus with firmware revisions 11.0 and above.

** R: Read, W: Write, E: EEPROM, S: User Set

Setup Page

Display	Parameter Name Description	Range	Default	Modbus Relative Address	CIP - Class Instance Attribute hex (dec)	Pro-fibus Index	Parameter ID	Data Type and Access **
<i>USr.r</i> USr.r	Global Restore Settings From Replace all of this controller's settings with another set.	<i>Fcty</i> Factory (31) <i>none</i> None (61) <i>SEt 1</i> User Set 1 (101) <i>SEt 2</i> User Set 2 (102)	None	Instance 1 Map 1 Map 2 24 24	0x65 (101) 1 0xD (13)	117	1013	uint RWE
<i>CoM</i> <i>SEt</i> Communications Menu								
<i>PCoL</i> PCoL	Communications 1 Protocol Set the protocol of this controller to the protocol that this network is using.	<i>Std</i> Standard Bus (1286) <i>Mod</i> Modbus RTU (1057)	Modbus	Instance 1 Map 1 Map 2 2492 2972	0x96 (150) 1 7	- - - -	17009	uint RWE
Standard Bus								
<i>AdS</i> Ad.S	Communications 1 Standard Bus Address Set the network address of this controller. Each device on the network must have a unique address. The Zone Display on the front panel will display this number.	1 to 16	1	Instance 1 Map 1 Map 2 2480 2960	0x96 (150) 1 1	- - - -	17001	uint RWE
Modbus RTU								
<i>AdM</i> Ad.M	Communications (1 or 2) Modbus Address Set the network address of this controller. Each device on the network must have a unique address.	1 to 247	1	Instance 1 Map 1 Map 2 2482 2962 Instance 2 Map 1 Map 2 2500 2980	0x96 (150) 1 to 2 2	- - - -	17007	uint RWE
* These parameters/prompts are available in these menus with firmware revisions 11.0 and above. ** R: Read, W: Write, E: EEPROM, S: User Set								

Setup Page

Display	Parameter Name Description	Range	Default	Modbus Relative Address	CIP - Class Instance Attribute hex (dec)	Pro-fibus Index	Parameter ID	Data Type and Access **
bAUD bAUd	<i>Communications (1 or 2)</i> Baud Rate Set the speed of this controller's communications to match the speed of the Modbus serial network.	9600 9,600 (188) 192 19,200 (189) 384 38,400 (190)	9,600	Instance 1 Map 1 Map 2 2484 2964 Instance 2 Map 1 Map 2 2504 2984	0x96 (150) 1 to 2 3	- - - -	17002	uint RWE
PAR PAr	<i>Communications (1 or 2)</i> Parity Set the parity of this controller to match the parity of the Modbus serial network.	none None (61) Even Even (191) odd Odd (192)	None	Instance 1 Map 1 Map 2 2486 2966 Instance 2 Map 1 Map 2 2506 2986	0x96 (150) 1 to 2 4	- - - -	17003	uint RWE
C_F C_F	<i>Communications (1 or 2)</i> Display Units Select whether this communications channel will display in Celsius or Fahrenheit. Note: Applies to Modbus and Ethernet.	F Fahrenheit (30) C Celsius (15)	F	Instance 1 Map 1 Map 2 2490 2970	0x96 (150) 1 6	- - - -	17050	uint RWE
M.hL M.hL	<i>Communications (1 or 2)</i> Modbus Word Order Select the word order of the two 16-bit words in the floating-point values.	LoHi Low-High (1331) HiLo High-Low (1330)	Low-High	Instance 1 Map 1 Map 2 2488 2968 Instance 2 Map 1 Map 2 2508 2988	0x96 (150) 1 to 2 5	- - - -	17043	uint RWE
MAP Map	<i>Communications (1 or 2)</i> Data Map If set to 1 the control will use PM legacy mapping. If set to 2 the control will use new mapping to accommodate new functions.	1 to 2	1 if 9th digit of part number is a D or 1 otherwise, 2.	- - - -	- - - -	- - - -	17059	uint RWE

* These parameters/prompts are available in these menus with firmware revisions 11.0 and above.

** R: Read, W: Write, E: EEPROM, S: User Set

Setup Page

Display	Parameter Name Description	Range	Default	Modbus Relative Address	CIP - Class Instance Attribute hex (dec)	Pro-fibus Index	Parameter ID	Data Type and Access **
<i>nV.S</i> nV.S	<i>Communications (1 or 2)</i> Non-Volatile Save If set to Yes all values written to the control will be saved in EEPROM. The EEPROM allows for approximately one million writes.	<i>YES</i> Yes (106) <i>no</i> No (59)	Yes	<i>Instance 1</i> Map 1 Map 2 2494 2974	0x96 (150) 1 8	198	17051	uint RWE
no display	<i>Communications (1 or 2)</i> Tick Value increases at 1mS rate.	0 to 4,294,967,295	- - - -	<i>Instance 1</i> Map 1 Map 2 5020 8950	- - - -	- - - -	16006	un- signed 32-bit RWE
DeviceNet								
<i>Ad.d</i> Ad.d	<i>Communications (2)</i> DeviceNet™ Node Address Set the DeviceNet™ address for this gateway.	0 to 63	63	- - - -	- - - -	- - - -	17052	- - - -
<i>bAUd</i> bAUd	<i>Communications (2)</i> DeviceNet™ Baud Rate Set the DeviceNet speed for this gateway's communications to match the speed of the serial network.	<i>125</i> 125 kb (1351) <i>250</i> 250 kb (1352) <i>500</i> 500 kb (1353)	125	- - - -	- - - -	- - - -	17053	- - - -
<i>FC.E</i> FC.E	<i>Communications (2)</i> DeviceNet™ Quick Connect Enable Allows for immediate communication with the scanner upon power up.	<i>no</i> No (59) <i>YES</i> Yes (106)	No	- - - -	- - - -	- - - -	17054	- - - -
<i>Ao.nb</i> Ao.nb	<i>Communications (2)</i> CIP Implicit Assembly Output Member Quantity	1 to 20	20	- - - -	- - - -	- - - -	24009	- - - -
<i>Ai.nb</i> Ai.nb	<i>Communications (2)</i> CIP Implicit Assembly Input Member Quantity	1 to 20	20	- - - -	- - - -	- - - -	24010	- - - -

* These parameters/prompts are available in these menus with firmware revisions 11.0 and above.
** R: Read, W: Write, E: EEPROM, S: User Set

Setup Page

Display	Parameter Name Description	Range	Default	Modbus Relative Address	CIP - Class Instance Attribute hex (dec)	Profibus Index	Parameter ID	Data Type and Access **
C_F C_F	Communications (2) Display Units Select which scale to use for temperature passed over communications port 2.	F °F (30) C °C (15)	°F	Instance 2 Map 1 Map 2 - - - - 2990	0x96 (150) 2 6	199	17050	uint RWE
nUS nUS	Communications (2) Non-volatile Save If set to Yes all values written to the control will be saved in EEPROM. The EEPROM allows for approximately one million writes.	YES Yes (106) no No (59)	No	Instance 2 Map 1 Map 2 2514 2994	96 (150) 2 8	198	17051	uint RWE
Profibus DP								
P.Add P.Add	Communications (2) Profibus Node Address Set the Profibus address for this control.	0 to 126	126	- - - -	- - - -	- - - -	17060	- - - -
A.Loc A.Loc	Communications (2) Profibus Address Lock When set to yes will not allow address to be changed using software. Can be changed from front panel.	no No (59) YES Yes (106)	No	- - - -	- - - -	- - - -	17061	- - - -
Stat Stat	Communications Profibus DP Status Current Profibus status.	READY Ready (1662) RUNG Running (149)	- - - -	- - - -	- - - -	- - - -	17062	uint R
C_F C_F	Communications (2) Display Units Select which scale to use for temperature passed over communications port 2.	F °F (30) C °C (15)	°F	Instance 2 Map 1 Map 2 - - - - 2990	0x96 (150) 2 6	199	17050	uint RWE

* These parameters/prompts are available in these menus with firmware revisions 11.0 and above.

** R: Read, W: Write, E: EEPROM, S: User Set

Setup Page

Display	Parameter Name Description	Range	Default	Modbus Relative Address	CIP - Class Instance Attribute hex (dec)	Pro-fibus Index	Parameter ID	Data Type and Access **
nU.S nU.S	Communications (2) Non-volatile Save If set to Yes all values written to the control will be saved in EEPROM. The EEPROM allows for approximately one million writes.	YES Yes (106) no No (59)	No	Instance 2 Map 1 Map 2 2514 2994	96 (150) 2 8	198	17051	uint RWE
Modbus TCP or EtherNet/IP								
M.hL M.hL	Communications (2) Modbus Word Order Select the word order of the two 16-bit words in the floating-point values.	L o h , Low-High (1331) h i L o High-Low (1330)	Low-High	Instance 1 Map 1 Map 2 2488 2968 Instance 2 Map 1 Map 2 2508 2988	0x96 (150) 1 to 2 5	- - - -	17043	uint RWE
iP.M iP.M	Communications (2) IP Address Mode Select DHCP to let a DHCP server assign an address to this module.	d h C P DHCP (1281) F . A d d Fixed Address (1284)	DHCP	- - - -	- - - -	- - - -	17012	- - - -
Note: When changing IP address, the control power must be cycled for the new address to take effect.								
ip.F1 ip.F1	Communications (2) IP Fixed Address Part 1 Set the IP address of this module. Each device on the network must have a unique address.	0 to 255	169	- - - -	- - - -	- - - -	17014	- - - -
ip.F2 ip.F2	Communications (2) IP Fixed Address Part 2 Set the IP address of this module. Each device on the network must have a unique address.	0 to 255	254	- - - -	- - - -	- - - -	17015	- - - -
* These parameters/prompts are available in these menus with firmware revisions 11.0 and above. ** R: Read, W: Write, E: EEPROM, S: User Set								

Setup Page

Display	Parameter Name Description	Range	Default	Modbus Relative Ad- dress	CIP - Class Instance Attribute hex (dec)	Pro- fibus Index	Param- eter ID	Data Type and Access **
<i>ip.F3</i>	<i>Communications (2)</i> IP Fixed Address Part 3 Set the IP address of this module. Each device on the network must have a unique address.	0 to 255	1	----	----	----	17016	----
<i>ip.F4</i>	<i>Communications (2)</i> IP Fixed Address Part 4 Set the IP address of this module. Each device on the network must have a unique address.	0 to 255	1	----	----	----	17017	----
<i>ip.S1</i>	<i>Communications (2)</i> IP Fixed Subnet Part 1 Set the IP subnet mask for this mod- ule.	0 to 255	255	----	----	----	17020	----
<i>ip.S2</i>	<i>Communications (2)</i> IP Fixed Subnet Part 2 Set the IP subnet mask for this mod- ule.	0 to 255	255	----	----	----	17021	----
<i>ip.S3</i>	<i>Communications (2)</i> IP Fixed Subnet Part 3 Set the IP subnet mask for this mod- ule.	0 to 255	0	----	----	----	17022	----
<i>ip.S4</i>	<i>Communications (2)</i> IP Fixed Subnet Part 4 Set the IP subnet mask for this mod- ule.	0 to 255	0	----	----	----	17023	----
<i>ip.S5</i>	<i>Communications (2)</i> IP Fixed Subnet Part 5 Set the IP subnet mask for this mod- ule	0 to 255	0	----	----	----	17024	----

* These parameters/prompts are available in these menus with firmware revisions 11.0 and above.

** R: Read, W: Write, E: EEPROM, S: User Set

Setup Page

Display	Parameter Name Description	Range	Default	Modbus Relative Ad- dress	CIP - Class Instance Attribute hex (dec)	Pro- fibus Index	Param- eter ID	Data Type and Access **
.P.56 ip.S6	Communications (2) IP Fixed Subnet Part 6 Set the IP subnet mask for this mod- ule.	0 to 255	0	----	----	----	17025	----
.P.91 ip.g1	Communications (2) Fixed IP Gateway Part 1 Used for the pur- pose of sending and receiving messages from another net- work.	0 to 255	0	----	----	----	17026	----
.P.92 ip.g2	Communications (2) Fixed IP Gateway Part 2 Used for the pur- pose of sending and receiving messages from another net- work.	0 to 255	0	----	----	----	17027	----
.P.93 ip.g3	Communications (2) Fixed IP Gateway Part 3 Used for the pur- pose of sending and receiving messages from another net- work.	0 to 255	0	----	----	----	17028	----
.P.94 ip.g4	Communications (2) Fixed IP Gateway Part 4 Used for the pur- pose of sending and receiving messages from another net- work.	0 to 255	0	----	----	----	17029	----
.P.95 ip.g5	Communications (2) Fixed IP Gateway Part 5 Used for the pur- pose of sending and receiving messages from another net- work.	0 to 255	0	----	----	----	17030	----

* These parameters/prompts are available in these menus with firmware revisions 11.0 and above.

** R: Read, W: Write, E: EEPROM, S: User Set

Setup Page

Display	Parameter Name Description	Range	Default	Modbus Relative Address	CIP - Class Instance Attribute hex (dec)	Pro-fibus Index	Parameter ID	Data Type and Access **
IP.G6 ip.g6	Communications (2) Fixed IP Gateway Part 6 Used for the purpose of sending and receiving messages from another network.	0 to 255	0	- - - -	- - - -	- - - -	17031	- - - -
MB.E Mb.E	Communications (2) Modbus TCP Enable Activate Modbus TCP.	YES Yes (106) NO No (59)	Yes	- - - -	- - - -	- - - -	17041	- - - -
Ei.PE Ei.P.E	Communications (2) EtherNet/IP™ Enable Activate Ethernet/IP™.	YES Yes (106) NO No (59)	Yes	- - - -	- - - -	- - - -	17042	- - - -
Ao.nb Ao.nb	Communications (2) EtherNet/IP™ Output Assembly When using EtherNet/IP set the CIP Implicit Assembly Output Member Quantity	1 to 20	20	- - - -	- - - -	- - - -	24009	- - - -
Ai.nb Ai.nb	Communications (2) EtherNet/IP™ Input Assembly When using EtherNet/IP set the CIP Implicit Assembly Input Member Quantity	1 to 20	20	- - - -	- - - -	- - - -	24010	- - - -
C_F C_F	Communications (2) Display Units Select which scale to use for temperature passed over communications port 2.	F °F (30) C °C (15)	°F	Instance 2 Map 1 Map 2 - - - - 2990	0x96 (150) 2 6	199	17050	uint RWE

* These parameters/prompts are available in these menus with firmware revisions 11.0 and above.

** R: Read, W: Write, E: EEPROM, S: User Set

Setup Page

Display	Parameter Name Description	Range	Default	Modbus Relative Address	CIP - Class Instance Attribute hex (dec)	Pro-fibus Index	Parameter ID	Data Type and Access **
n4.5 nV.S	Communications (2) Non-volatile Save If set to Yes all values written to the control will be saved in EEPROM. The EEPROM allows for approximately one million writes.	YES Yes (106) no No (59)	No	Instance 2 Map 1 Map 2 2514 2994	96 (150) 2 8	198	17051	uint RWE













* These parameters/prompts are available in these menus with firmware revisions 11.0 and above.
 ** R: Read, W: Write, E: EEPROM, S: User Set

7

Chapter 7: Factory Page

Navigating the Factory Page

To navigate to the Factory Page follow the steps below:

1. From the Home Page, press and hold both the Advance  and Infinity  keys for six seconds.
2. Press the Up  or Down  key to view available menus.
3. Press the Advance Key  to enter the menu of choice.
4. If a sub-menu exists (more than one instance), press the Up  or Down  key to select and then press the Advance Key  to enter.
5. Press the Up  or Down  key to move through available menu prompts.
6. Press the Infinity Key  to move backwards through the levels: parameter to sub-menu, sub-menu to menu, menu to Home Page.
7. Press and hold the Infinity Key  for two seconds to return to the Home Page.

On the following pages, top level menus are identified with a yellow background color.

Note:

Some of these menus and parameters may not appear, depending on the controller's options. See model number information in the Appendix for more information. If there is only one instance of a menu, no sub-menus will appear.

Note:

Some of the listed parameters may not be visible. Parameter visibility is dependent upon controller part number.

CUSE

FCTY Custom Setup Menu

I

CUSE Custom Setup (1 to 20)

PAR Parameter

id Instance ID

LoC

FCTY Security Setting Menu

LoCo Operations Page

PASE Password Enabled

rLoC Read Lock

SLoC Write Security

LoCL Locked Access Level

roLL Rolling Password

PASu User Password

PASA Administrator Password

ULoC

FCTY Security Setting Menu

Code Public Key

PASS Password

diag

FCTY Diagnostics Menu

Pn Part Number

rEv Software Revision

SbLd Software Build Number

Sn Serial Number

dATE Date of Manufacture

.PAC IP Actual Address Mode

.PA1 IP Actual Address Part 1

.PA2 IP Actual Address Part 2

.PA3 IP Actual Address Part 3

.PA4 IP Actual Address Part 4

.P.A5 IP Actual Address Part 5

.P.A6 IP Actual Address Part 6

CAL

FCEY Calibration Menu

|

CAL Calibration (3)

PMU Electrical Measurement

EL 10 Electrical Input Offset

EL 15 Electrical Input Slope

EL 00 Electrical Output Offset

EL 05 Electrical Output Slope

Pn Part Number

Code Code

Factory Page

Display	Parameter Name Description	Range	Default	Modbus Relative Ad- dress	CIP Class Instance Attribute hex (dec)	Pro- fibus Index	Param- eter ID	Data Type and Access **
<div style="display: flex; justify-content: space-between; align-items: center;"> CUST FCTY </div> <p>Custom</p>								
PAR Par	<p><i>Custom</i> Parameter 1 to 20</p> <p>Select the parameters that will appear in the Home Page.</p> <p>The Parameter 1 value will appear in the upper display of the Home Page. It cannot be changed with the Up and Down Keys in the Home Page.</p> <p>The Parameter 2 value will appear in the lower display in the Home Page. It can be changed with the Up and Down Keys, if the parameter is a writable one.</p> <p>Scroll through the other Home Page parameters with the Advance Key .</p> <p>Note: Display Pairs affect the pairing of custom parameters on the Home page. For more information on Display Pairs see the section in this guide entitled "Modifying the Display Pairs".</p>	<div style="font-family: monospace; font-size: 0.8em;"> none None LLS Low Limit Set Point LHS High Limit Set Point LHY Limit Hysteresis LST Limit Status Pro Process CAL Calibration Offset CF Display Units USR Replace Settings From ALO Low Set Point AHI High Set Point AHY Hysteresis CUST Custom Menu CUST Custom Menu </div>	See: Home Page	- - - -	- - - -	- - - -	14005	uint RWES

** R: Read, W: Write, E: EEPROM, S: User Set

Factory Page

Display	Parameter Name Description	Range	Default	Modbus Relative Address	CIP Class Instance Attribute hex (dec)	Pro-fibus Index	Parameter ID	Data Type and Access **
iid	<i>Custom (1 to 20)</i> Instance ID Select which instance of the parameter will be selected.	1 to 4		-----	-----	-----	14003	uint RWES
LoC FCty Lock Menu								
LoC.o	Security Setting Operations Page Change the security level of the Operations Page.	1 to 3	2	Instance 1 Map 1 Map 2 1832 2302	0x67 (103) 1 2	-----	3002	uint RWE
LoC.P	Security Setting Password Enable Set to On to require a password for menu changes.	oFF Off oN On	Off	-----	-----	-----	3009	uint RWE
rLoC	Security Setting Read Lock Set the read security clearance level. The user can access the selected level and all lower levels. If the Set Lockout Security level is higher than the Read Lockout Security, the Read Lockout Security level takes priority.	1 to 5	5	Instance 1 Map 1 Map 2 1848 2318	0x67 (103) 1 0x0A (10)	-----	3010	uint RWE
** R: Read, W: Write, E: EEPROM, S: User Set								

Factory Page

Display	Parameter Name Description	Range	Default	Modbus Relative Ad- dress	CIP Class Instance Attribute hex (dec)	Pro- fibus Index	Param- eter ID	Data Type and Access **
SLoC SLoC	Security Setting Write Security Set the write security clearance level. The user can access the selected level and all lower levels. If the Set Lockout Security level is higher than the Read Lockout Security, the Read Lockout Security level takes priority.	0 to 5	5	Instance 1 Map 1 Map 2 1844 2314	0x67 (103) 1 0x0B (11)	- - - -	3011	uint RWE
LoC.L LoC.L	Security Setting Locked Access Level Determines user level menu visibility when Password Enable is set to on. See Features section under Password Security.	1 to 5	5	- - - -	- - - -	- - - -	3016	uint RWE
roLL roLL	Security Setting Rolling Password When power is cycled a new Public Key will be displayed and User Password changes.	oFF Off oN On	Off	- - - -	- - - -	- - - -	3019	uint RWE
PAS.u PAS.u	Security Setting User Password Used to acquire access to menus made available through the Locked Access Level setting.	10 to 999	63	- - - -	- - - -	- - - -	3017	uint RWE

** R: Read, W: Write, E: EEPROM, S: User Set

Factory Page

Display	Parameter Name Description	Range	Default	Modbus Relative Ad- dress	CIP Class Instance Attri- bute hex (dec)	Pro- fibus Index	Param- eter ID	Data Type and Access **
<i>PAS.A</i> PAS.A	Security Setting Administrator Password Used to acquire full access to all menus including disabling or changing passwords.	10 to 999	156	- - - -	- - - -	- - - -	3018	uint RWE
<i>ULoC</i> <i>FCTY</i> Unlock Menu								
<i>CodE</i> CodE	Security Setting Public Key If Rolling Password turned on, generates a random number when power is cycled. If Rolling Password is off fixed number will be displayed. The key can be used to gain access when password is not known.	Customer Specific	0	- - - -	- - - -	- - - -	3020	uint R
<i>PASS</i> PASS	Security Setting Password Enter the User or Administrator password to gain access. After valid password is supplied exit this menu and re-enter the Security Menu via the Factory Page.	-1999 to 9999	0	- - - -	- - - -	- - - -	3022	int RW

** R: Read, W: Write, E: EEPROM, S: User Set

Factory Page

Display	Parameter Name Description	Range	Default	Modbus Relative Ad- dress	CIP Class Instance Attrib- ute hex (dec)	Pro- fibus Index	Param- eter ID	Data Type and Access **
d.A9 Fcty Diagnostics Menu								
Pn Pn	Diagnostics Part Number Display this controller's part number.	15 characters	----	----	0x65 (101) 1 9	115	1009	string R
rEu rEu	Diagnostics Software Revi- sion Display this controller's firm- ware revision number.	1 to 10	----	Instance 1 Map 1 Map 2 4 4	0x65 (101) 1 3	116	1003	string R
S.bLd S.bLd	Diagnostics Software Build Number Display the firmware build number.	0 to 2,147,483,647	----	Instance 1 Map 1 Map 2 8 8	0x65 (101) 1 5	-- --	1005	dint R
Sn Sn	Diagnostics Serial Number Display the seri- al number.	0 to 2,147,483,647	----	Instance 1 Map 1 Map 2 12 12	0x65 (101) 1 0x20 (32)	-- --	1032	string R
dAtE dAtE	Diagnostics Date of Manu- facture Display the date code (YYWW). Where YY = year and WW= week.	0 to 2,147,483,647	----	Instance 1 Map 1 Map 2 14 14	0x65 (101) 1 8	-- --	1008	dint R
No Dis- play	Diagnostics Hardware ID Display the Hardware ID.	0 to 2,147,483,647	----	Instance 1 Map 1 Map 2 0 0	0x65 (101) 1 1	-- --	1001	dint R
No Dis- play	Diagnostics Firmware ID Display the Firmware ID.	0 to 2,147,483,647	----	Instance 1 Map 1 Map 2 2 2	0x65 (101) 1 2	-- --	1002	dint R
iP.AC iP.AC	Diagnostics IP Address Mode Actual address mode (DHCP or Fixed).	dhCP DHCP (1281) F.Add Fixed Address (1284)	DHCP	----	----	----	17013	----

** R: Read, W: Write, E: EEPROM, S: User Set

Factory Page

Display	Parameter Name Description	Range	Default	Modbus Relative Address	CIP Class Instance Attribute hex (dec)	Pro-fibus Index	Parameter ID	Data Type and Access **
.PA1 ip.A1	<i>Diagnostics</i> IP Actual Address Part 1 Actual IP address of this module. Note: Although it appears as if this can be changed here this is a read only parameter. Go to Setup Page and then the Com Menu to change.	0 to 255	----	----	----	----	17014	R
.PA2 ip.A2	<i>Diagnostics</i> IP Actual Address Part 2 Actual IP address of this module. Note: Although it appears as if this can be changed here this is a read only parameter. Go to Setup Page and then the Com Menu to change.	0 to 255	----	----	----	----	17015	R
.PA3 ip.A3	<i>Diagnostics</i> IP Actual Address Part 3 Actual IP address of this module. Note: Although it appears as if this can be changed here this is a read only parameter. Go to Setup Page and then the Com Menu to change.	0 to 255	----	----	----	----	17016	R

** R: Read, W: Write, E: EEPROM, S: User Set

Factory Page

Display	Parameter Name Description	Range	Default	Modbus Relative Address	CIP Instance Attribute hex (dec)	Pro-fibus Index	Parameter ID	Data Type and Access **
IP.A4 ip.A4	<i>Diagnostics</i> IP Actual Address Part 4 Actual IP address of this module. Note: Although it appears as if this can be changed here, this is a read only parameter. Go to Setup Page and then the Com Menu to change.	0 to 255	----	----	----	----	17017	R
CAL FACTY Calibration Menu								
Mv Mv	<i>Calibration</i> Electrical Measurement Read the raw electrical value for this input in the units corresponding to the Sensor Type (Setup Page, Analog Input Menu) setting.	-3.4e38 to 3.4e38	----	Instance 1 Map 1 Map 2 400 400	0x68 (104) 1 0x15 (21)	-- --	4021	float R
ELi.o ELi.o	<i>Calibration</i> Electrical Input Offset Change this value to calibrate the low end of the input range.	-1,999.000 to 9,999.000	0.0	Instance 1 Map 1 Map 2 378 378	0x68 (104) 1 0x0A (10)	-- --	4010	float RWES
ELi.S ELi.S	<i>Calibration</i> Electrical Input Slope Adjust this value to calibrate the slope of the input value.	-1,999.000 to 9,999.000	1.0	Instance 1 Map 1 Map 2 380 380	0x68 (104) 1 0xB (11)	-- --	4011	float RWES
** R: Read, W: Write, E: EEPROM, S: User Set								

Factory Page

Display	Parameter Name Description	Range	Default	Modbus Relative Address	CIP Class Instance Attribute hex (dec)	Pro-fibus Index	Parameter ID	Data Type and Access **
<i>ELo.o</i> ELo.o	<i>Calibration (3)</i> Electrical Output Offset Change this value to calibrate the low end of the output range.	-1,999.000 to 9,999.000	0.0	<i>Instance 3</i> Map 1 Map 2 808 928	0x76 (118) 3 5	- - - -	18005	float RWES
<i>ELo.S</i> ELo.S	<i>Calibration (3)</i> Electrical Output Slope Adjust this value to calibrate the slope of the output value.	-1,999.000 to 9,999.000	1.0	<i>Instance 3</i> Map 1 Map 2 810 930	0x76 (118) 3 6	- - - -	18006	float RWES
<i>Pn</i> Pn	<i>Calibration (1 to 2)</i> Part Number Displays current setting for control model number.	<i>FACTY</i> Factory <i>USER</i> User	- - - -	- - - -	- - - -	- - - -	- - - -	uint R
<i>CodE</i> CodE	<i>Calibration (1 to 3)</i> Public Key Changes the control to User or back to original model number as shown on the side of the control.	<i>250 1</i> User Settings <i>606</i> Factory model number	4999	- - - -	- - - -	- - - -	- - - -	uint RWES

** R: Read, W: Write, E: EEPROM, S: User Set

8

Chapter 8: Features

Changing PM Integrated Model Number to PM Express	92
Saving and Restoring Settings	94
Programming the Home Page	94
Inputs	94
Calibration Offset	94
Calibration	95
Filter Time Constant	97
Sensor Selection	97
Set Point Minimum and Maximum	97
Scale High and Scale Low	97
Range High and Range Low	98
Outputs	98
Retransmitting a Process Value or Set Point	98
Resetting a Tripped Limit	98
Alarms	99
Process Alarms	99
Set Points	99
Hysteresis	100
Latching	100
Silencing	100
Blocking	101
Using Lockout and Password Security	101
Using Lockout Method 1 (Read and Set Lock)	101
Using Lockout Method 2 (Password Enable)	103
Modbus - Using Programmable Memory Blocks	105
CIP - Communications Capabilities	106
CIP Implicit Assemblies	107
Profibus DP - (Decentralized Peripherals)	108
Software Configuration	108
Using EZ-ZONE Configurator Software	108

Changing PM Integrated Model Number to PM Express



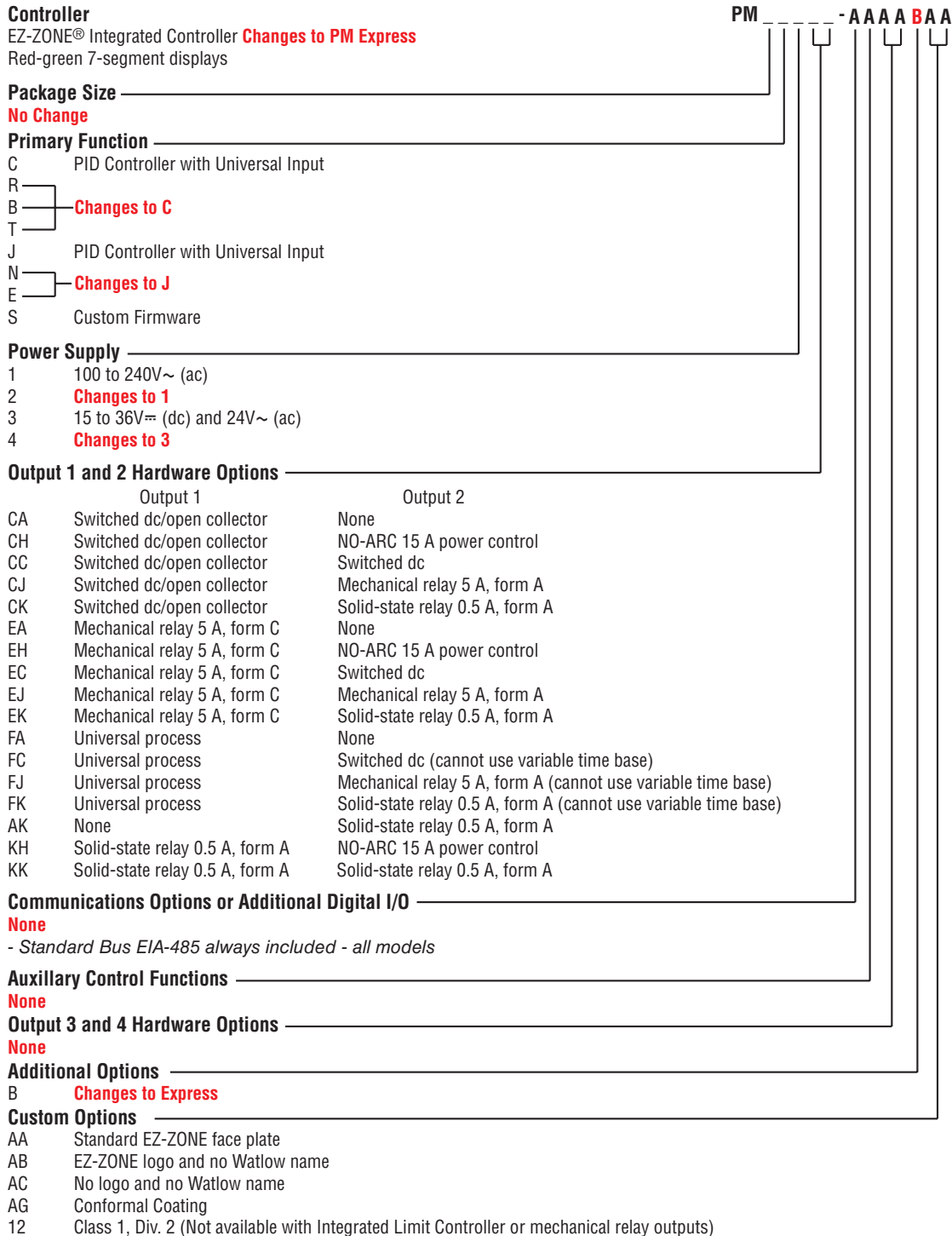

EZ-ZONE PM firmware revisions of 13 and above allow the user to switch between a PM Integrated control to a PM Express. Switching to a PM Express eliminates the complexity of the advanced PM Integrated control by allowing the user to operate with a simplified menu structure.

Note:

When switching from an integrated control to an Express version, optional PM hardware (even though installed) and firmware features not available in a PM Express will no longer work. To see exactly what is impacted by this change, compare the chart below to the ordering information page in this document.



How to Change the Controller Model Number

1. Enter Factory Page **FCLY**, Calibration Menu **CAL** via front panel by pressing the Infinity  or Reset Key and the Advance Key  together or using EZ-ZONE Configurator software.
2. Once there, use the Advance Key  to navigate to the Part Number **Pn** prompt. The top display will show factory **FCLY** indicating the factory model number as shown on the decal located on the side of the control is currently in effect.
3. Push the Advance Key , Public Key **Code** prompt will be displayed and the number **4999** in the top display.
4. Using the up or down Arrow Keys enter **2501** and push the Advance Key  to execute the change. The controller will reboot and the new controller model number is in effect. All previous settings are lost and the controller must be reprogrammed for the application. Be sure to label the controller with the new model number for future reference.

Note:





As noted above, when switching from a PM Standard to a PM Express version, optional hardware (even though installed) may no longer work. Also, all settings will be defaulted to the selected model when switched.

Note:

After switching the model number to a PM Express this document will no longer apply to the control. Click on the link that follows to acquire the latest version of the PM PID Express User's Guide. <http://www.watlow.com/en/Resources-And-Support/Technical-Library/User-Manuals>

Once there, simply enter express in the "Keyword" field to find the appropriate document.

How to Restore Original PM Factory Settings and Model Number

1. Enter Factory Page **FCLY**, Calibration Menu **CAL** via front panel by pressing the Infinity  or Reset Key and the Advance Key  together or using EZ-ZONE Configurator software.
2. Once there, use the Advance Key  to navigate to the Part Number **Pn** prompt. The upper display will show user **USER** indicating the user's selected model number is currently in effect.
3. Push the Advance Key  where the Public Key **Code** prompt will appear in the lower display and the number **4999** in the upper display.
4. Using the up or down arrow keys enter **606** and push the Advance Key  to execute the change. The controller will reboot and the new controller model number is in effect. All previous settings are lost and the controller must be reprogrammed for the application. Be sure to label the controller with the new model number for future reference.

Note:

When switching from a PM Express back to the original model number all original optional hardware will again be enabled for use (assuming all original hardware is still installed). Also, when executing this step the control will be factory defaulted back to the original model number (as shown on the side of the control) at zone address 1. This User's Guide would once again apply to this control.

Saving and Restoring Settings

Recording setup and operations parameter settings for future reference is very important. If you unintentionally change these, you will need to program the correct settings back into the controller to return the equipment to operational condition.

After you program the controller and verify proper operation, select Save Settings As **USR5** (Setup Page, Global Menu) to save the settings into either of two files (**SEET1** or **SEET2**) in the control memory.

Note:

Saving the settings overwrites any previously saved collection of settings. Be sure to document all the controller settings.

If the settings in the controller are altered a user can return the controller to one of three settings. If previously saved, **SEET1** or **SEET2** can be restored as well as the factory **FCTY** settings. Navigate to the Setup Page, Global Menu to find the Restore **USR** prompt. A digital input or the Function Key can also be configured to restore parameters.

Note:

When restoring factory defaults, I/O assemblies for Modbus, DeviceNet, Profibus and Ethernet along with the zone address will be overwritten when restoring factory defaults.

Programming the Home Page

Watlow's patented user-defined menu system improves operational efficiency. The user-defined Home Page provides you with a shortcut to monitor or change the parameter values that you use most often.

You can create your own Home Page with as many as 20 of the active parameters. When a parameter normally located in the Setup Page or Operations Page is placed in the Home Page, it is accessible through both. If you change a parameter in the Home Page, it is automatically changed in its original page. If you change a parameter in its original page it is automatically changed in the Home Page.

The default parameters will automatically appear in the Home Page.

Change the list of parameters in the Home Page from the Custom Menu **CUSE** (Factory Page)

Inputs

Calibration Offset

Calibration offset allows a device to compensate for an inaccurate sensor, lead resistance or other factors that affect the input value. A positive offset increases the input value, and a negative offset decreases the input value. The input offset value can be viewed or changed with Calibration Offset **ICR** (Operations Page, Analog Input Menu).

Calibration

Before performing any calibration procedure, verify that the displayed readings are not within published specifications by inputting a known value from a precision source to the analog input. Next, subtract the displayed value with the known value and compare this difference to the published accuracy range specification for that type of input.

Use of the Calibration Offset ΔR parameter found in the Operations Page $\alpha P E r$, Analog Input Menu R , shifts the readings across the entire displayed range by the offset value. Use this parameter to compensate for sensor error or sensor placement error. Typically this value is set to zero.

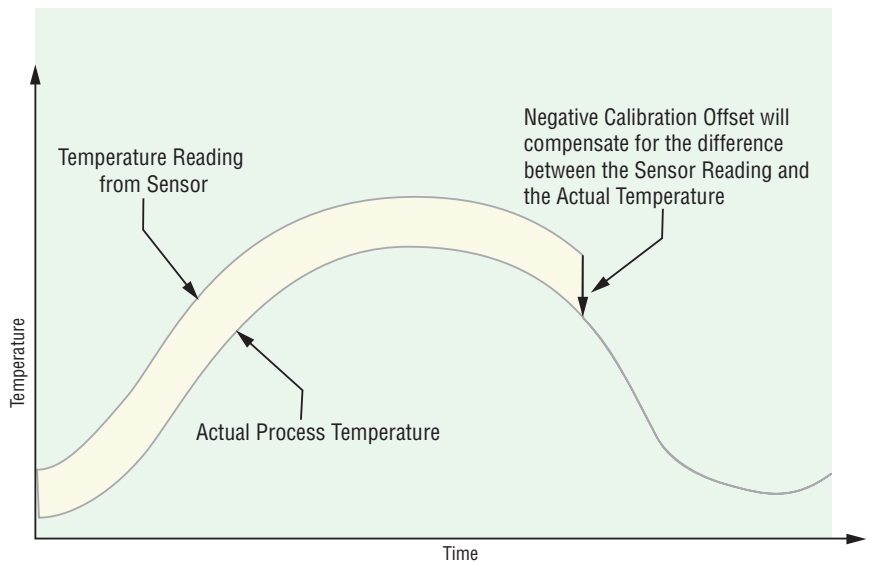

Equipment required while performing calibration:

Obtain a precision source for millivolts, volts, milliamperes or resistance depending on the sensor type to be calibrated. Use copper wire only to connect the precision source to the controller's input. Keep leads between the precision source and controller as short as possible to minimize error. In addition, a precision volt/ohm meter capable of reading values to 4 decimal places or better is recommended. Prior to calibration, connect this volt/ohm meter to the precision source to verify accuracy. Actual input values do NOT have to be exactly the recommended values, but it IS critical that the actual value of the signal connected to the controller be accurately known to at least four digits.

Calibration of Analog Inputs:

To calibrate an analog input, you will need to provide a source of two electrical signals or resistance values near the extremes of the range that the application is likely to utilize. See recommended values below:

Sensor Type	Precision Source Low	Precision Source High
thermocouple	0.000 mV	50.000 mV
millivolts	0.000 mV	50.000 mV
volts	0.000V	10.000V
milliamps	0.000 mA	20.000 mA
100 Ω RTD	50.00 Ω	350.0 Ω
1,000 Ω RTD	500.0 Ω	3,500 Ω
thermistor 5 k Ω	50.00	5,000
thermistor 10 k Ω	150.0	10,000
thermistor 20 k Ω	1,800	20,000
thermistor 40 k Ω	1,700	40,000
potentiometer	0.000	1,200

Note:

The user may only calibrate one sensor type. If the calibrator interferes with open thermocouple detection, set Sensor Type SEn in Setup Page SEt , Analog Input Menu Ai to millivolt mV instead of Thermocouple TC to avoid interference between the calibrator and open thermocouple detect circuit for the duration of the calibration process. Be sure to set sensor type back to the thermocouple type utilized.

1. Disconnect the sensor from the controller.
2. Record the Calibration Offset CA parameter value in the Operations Page $OPER$, Analog Input Menu Ai , then set value to zero.
3. Wire the precision source to the appropriate controller input terminals to be calibrated. Do not have any other wires connected to the input terminals. Please refer to the Install and Wiring section of this manual for the appropriate connections.
4. Ensure the controller sensor type is programmed to the appropriate Sensor Type SEn to be utilized in the Setup Page SEt , Analog Input Menu Ai .
5. Enter Factory Page $FACTY$, Calibration Menu CAL via front panel or EZ-ZONE Configurator Software.
6. Select the Calibration CAL input instance to be calibrated. This corresponds to the analog input to be calibrated.
7. Set Electrical Input Slope $EL.S$ to 1.000 and Electrical Input Offset $EL.O$ to 0.000 (this will cancel any prior user calibration values)
8. Input a Precision Source Low value. Read Electrical Measurement value mV of controller via EZ-Configurator or RUI. This will be referred to as Electrical Measured Low. Record low value _____
9. Input a Precision Source High value.
10. Read Electrical Measurement value mV of controller via EZ-Configurator or RUI. This will be referred to as Electrical Measured High. Record high value _____
11. Calculated Electrical Input Slope = (Precision High - Precision Low) / (Electrical Measured High - Electrical Measured Low) Calculated Slope value _____
12. Calculated Electrical Input Offset = Precision Low - (Electrical Input Slope * Measured Low) Calculated Offset value _____
13. Enter the calculated Electrical Input Slope $EL.S$ and Electrical Input Offset $EL.O$ into the controller.
14. Exit calibration menu.
15. Validate calibration process by utilizing a calibrator to the analog input.
16. Enter calibration offset as recorded in step 2 if required to compensate for sensor error.

Setting Electrical Input Slope $EL.S$ to 1.000 and Electrical Input Offset $EL.O$ to 0.000, restores factory calibration as shipped from factory.

Filter Time Constant

Filtering smooths an input signal by applying a first-order filter time constant to the signal. Filtering the displayed value makes it easier to monitor. Filtering the signal may improve the performance of PID control in a noisy or very dynamic system.

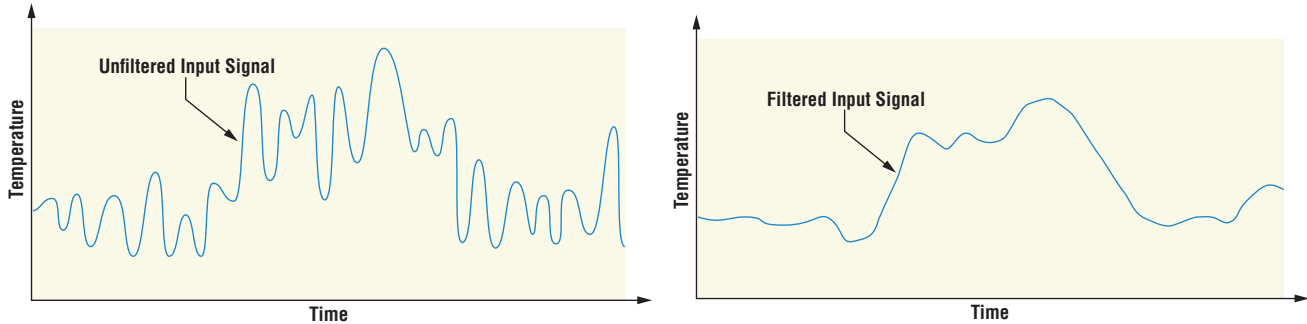

Adjust the filter time interval with Filter Time *F_{iL}* (Setup Page, Analog Input Menu). Example: With a filter value of 0.5 seconds, if the process input value instantly changes from 0 to 100 and remained at 100, the display will indicate 100 after five time constants of the filter value or 2.5 seconds.

Sensor Selection

You need to configure the controller to match the input device, which is normally a thermocouple, RTD or process transmitter.

Select the sensor type with Sensor Type *SE_n* (Setup Page, Analog Input Menu).

Set Point Minimum and Maximum

The controller has the ability to restrict the Set Points for the following modes of operation:

- For *closed loop control* use Minimum Set Point and Maximum Set Point found in the Setup Page, Loop Menu.
- For *Manual Power (open loop control)* use Minimum Power and Maximum Power found in the Setup Page, Loop Menu.

Scale High and Scale Low

When an analog input is selected as process voltage or process current input, you must choose the value of voltage or current to be the low and high ends. For example, when using a 4 to 20 mA input, the scale low value would be 4.00mA and the scale high value would be 20.00mA. Commonly used scale ranges are: 0 to 20mA, 4 to 20mA, 0 to 5V, 1 to 5V and 0 to 10V.

You can create a scale range representing other units for special applications. You can reverse scales from high values to low values for analog input signals that have a reversed action. For example, if 50 psi causes a 4 mA signal and 10 psi causes a 20mA signal.

Scale low and high low values do not have to match the bounds of the measurement range. These along with range low and high provide for process scaling and can include values not measurable by the controller. Regardless of scaling values, the measured value will be constrained by the electrical measurements of the hardware. Select the low and high values with Scale Low *SL_o* and Scale High *SH_i*. Select the displayed range with Range Low *RL_o* and Range High *RH_i* (Setup Page, Analog Input Menu).

Range High and Range Low

With a process input, you must choose a value to represent the low and high ends of the current or voltage range. Choosing these values allows the controller's display to be scaled into the actual working units of measurement. For example, the analog input from a humidity transmitter could represent 0 to 100 percent relative humidity as a process signal of 4 to 20mA. Low scale would be set to 0 to represent 4 mA and high scale set to 100 to represent 20 mA. The indication on the display would then represent percent humidity and range from 0 to 100 percent with an input of 4 to 20mA. Select the low and high values with Range Low `rLo` and Range High `rHi` (Setup Page, Analog Input Menu).

Outputs

Retransmitting a Process Value or Set Point

The retransmit feature allows a process output to provide an analog signal that represents the set point or process value. The signal may serve as a remote set point for another controller or as an input for a chart recorder documenting system performance over time.

In choosing the type of retransmit signal the operator must take into account the input impedance of the device to be retransmitted to and the required signal type, either voltage or milliamps. Typically applications might use the retransmit option to record one of the variables with a chart recorder or to generate a set point for other controls in a multi-zone application.

Output 3 can be ordered as process output. Select retransmit `rPr` as the Function `Fn` (Setup Page, Output Menu).

Set the output to volts `volt` or milliamps `mA` with Type `outY`. Select the signal to retransmit with Retransmit Source `rSr`. Set the range of the process output with Scale Low `SLo` and Scale High `SHi`. Scale the retransmit source to the process output with Range Low `rLo` and Range High `rHi`.

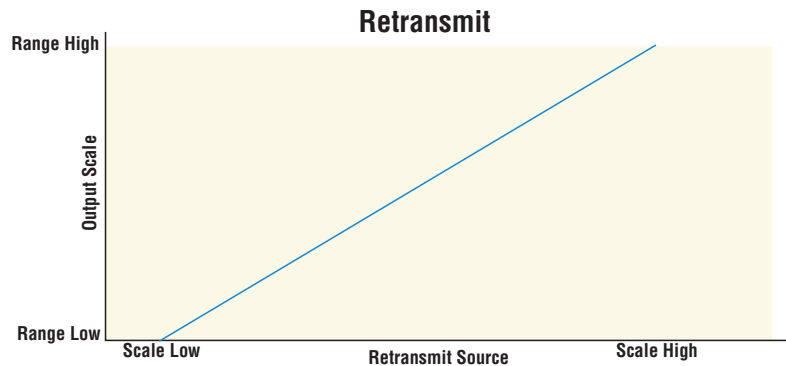

When the retransmit source is at the Range Low value, the retransmit output will be at its Scale Low value. When the retransmit source is at the Range High value, the retransmit output will be at its Scale High value.



Resetting a Tripped Limit

Output 2 will always be a Form A (normally open) Mechanical Relay and it will always be internally tied to the limit function. When the limit is in a safe state the internal coil for this relay will be energized, therefore the relay will be closed. When a condition occurs that causes the limit to trip, the internal coil will deenergize causing the relay to latch open. When the condition that caused the limit to trip has been resolved, the relay will remain latched open until manually reset. The process to reset a latched limit can be different from control to control and is dependent upon the controller firmware version.

To check the firmware revision of your control do one of the following:

1. Cycle power to the control while observing the number in the top display (this momentary numerical display reflects the current installed firmware version).
2. Navigate to the Factory Page by simultaneously pushing and holding the Advance Key  and the Reset Key  for approximately 8 seconds and then use the up or down arrow key to navigate to the Diagnostic Menu. Once there, push the Advance Key twice where the revision *rEu* will be shown in the lower display and the upper display will indicate the current firmware revision.

Prior to firmware release 11.0:

1. Push the Reset Key .
2. Configure a digital input with the Action Function set to Limit Reset (navigate to the Setup Page under the Digital I/O Menu).
3. Use a field bus protocol, i.e., Modbus, EtherNet/IP, etc..., where a value of zero would be written to the associated address (navigate to the Operations Page and look for Clear Limit under the Limit Menu to find appropriate address).
4. Cycle the power to the controller.

Firmware release 11.0 and above:

1. Push the Reset Key .
2. Follow the steps below:
 - 2a. Navigate to the Setup Page and then the Limit Menu
 - 2b. Set Source Function A to the desired device that will reset the limit (Digital I/O or Function Key)
 - 2c. Define the Source Instance
3. Use a field bus protocol, i.e., Modbus, EtherNet/IP, etc...where a value of zero would be written to the associated address (navigate to the Operations Page and look for Clear Limit under the Limit Menu to find appropriate address).
4. Cycle the power to the controller.

Alarms

Alarms are activated when the output level, process value or temperature leaves a defined range. A user can configure how and when an alarm is triggered, what action it takes and whether it turns off automatically when the alarm condition is over. Configure alarm outputs in the Setup Page before setting alarm set points. Alarms do not have to be assigned to an output. Alarms can be monitored and controlled through the front panel or by using software.

Process Alarms

A process alarm uses one or two absolute set points to define an alarm condition. Select the type with Type *RLY* (Setup Page, Alarm Menu).

Set Points

The high set point defines the process value or temperature that will trigger a high side alarm. The low set point defines the temperature that will trigger a low side alarm. View or change alarm set points with Low Set Point *RLo* and High Set Point *RHi* (Operations Page, Alarm Menu).

Hysteresis



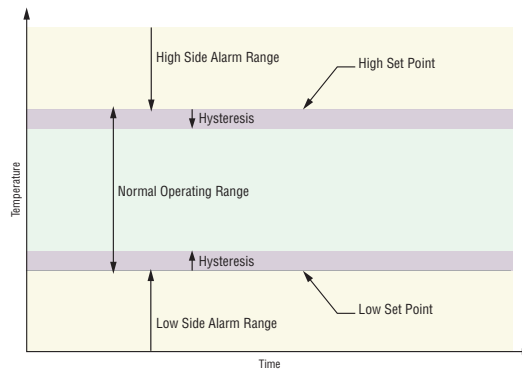

An alarm state is triggered when the process value reaches the high or low set point. Hysteresis defines how far the process must return into the normal operating range before the alarm can be cleared.

Hysteresis is a zone inside each alarm set point. This zone is defined by adding the hysteresis value to the low set point or subtracting the hysteresis value from the high set point. View or change hysteresis with Hysteresis *AHy* (Setup Page, Alarm Menu).



Alarm Set Points and Hysteresis

Latching

A latched alarm will remain active after the alarm condition has passed. It can only be deactivated by the user. An active message, such as an alarm message, will cause the display to toggle between the normal settings and the active message in the upper display and *Attn* in the lower display. Push the Advance Key  to display *!9nr* in the upper display and the message source in the lower display. Use the Up  or Down  keys to scroll through possible responses, such as Clear *CLr* or Silence *SIL*. Then push the Advance  or Infinity  key to execute the action.

See the Keys and Displays chapter and the Home Page chapter for more details. An alarm that is not latched (self-clearing) will deactivate automatically when the alarm condition has passed. Turn latching on or off with Latching *ALR* (Setup Page, Alarm Menu).

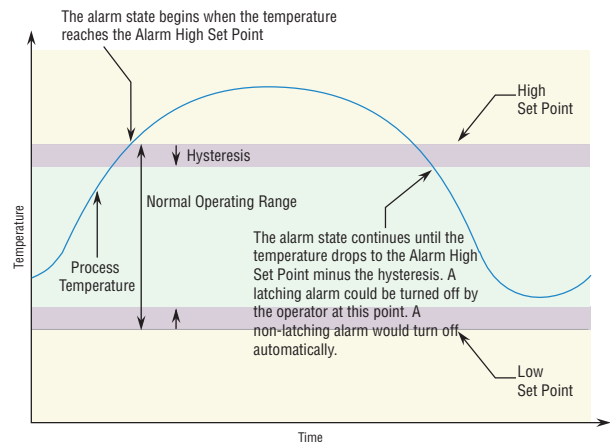





Alarm Response with Hysteresis

Silencing

If silencing is on the operator can disable the alarm output while the controller is in an alarm state. The process value or temperature has to enter the normal operating range beyond the hysteresis zone to activate the alarm output function again. An active message, such as an alarm message, will cause the display to toggle between the normal settings and the active message in the upper display and *Attn* in the lower display.

1. Push the Advance Key  to display *!9nr* in the upper display and the message source in the lower display.

2. Use the Up  and Down  keys to scroll through possible responses, such as Clear **CLr** or Silence **S,rL**. Then push the Advance  or Infinity  key to execute the action.

See the Keys and Displays chapter and the Home Page chapter for more details. Turn silencing on or off with Silencing **RS,r** (Setup Page, Alarm Menu).

Blocking

Blocking allows a system to warm up after it has been started up. With blocking on, an alarm is not triggered when the process temperature is initially lower than the low set point or higher than the high set point. The process temperature has to enter the normal operating range beyond the hysteresis zone to activate the alarm function. If the EZ-ZONE PM has an output that is functioning as a deviation alarm, the alarm is blocked when the set point is changed, until the process value re-enters the normal operating range. Turn blocking on or off with Blocking **AbL** (Setup Page, Alarm Menu).

Using Lockout and Password Security

If unintentional changes to parameter settings might raise safety concerns or lead to downtime, you can use the lockout feature to make them more secure. There are two methods of lockout that can be deployed, both of which are accessible from the Factory Page.

Method 1- Change the value of the Read Lock **rLoL** (1 to 5) and Set Lock **SLoL** (0 to 5) prompts where the higher the value or setting for each translates to a higher security clearance (greater access).

Method 2- Enable Password Security **PA5.E** and then modify the Lock Level **LoL.L** value which ranges from 1 to 5. See the section entitled [Using Lockout Method 2](#) for more detail.

Using Lockout Method 1 (Read and Set Lock)

All Pages have security levels assigned where two of those cannot be changed (Home and Setup). Defaults (factory settings) for each are shown below:

- Home Page = 1
- Operations Page = 2 (changeable to 1, 2 or 3)
- Setup Page = 4
- Profiling Page = 3 (changeable to 1, 2 or 3)
- Factory Page = 5*











* The Factory Page is always visible where all menus within it may or may not be visible/writable. For further detail see table "[Factory Page Menus](#)".

The table below represents the various levels of lockout for the Set Lockout Security prompt **SLoL** and the Read Lockout Security prompt **rLoL**. Looking at the table, "Y" equates to yes (can write/read) where "N" equates to no (cannot write/read). The colored cells simply differentiate one level from the next while also showing the level where read/write is enabled. As stated previously, the Set Lockout has 6 levels (0 to 5) of security where the Read Lockout has 5 (1 to 5). Therefore, level "0" applies to Set Lockout only.

Lockout Security <i>SLoC</i> and <i>rLoC</i>						
Pages	Security Level					
	0	1	2	3	4	5
Home Page (cannot be changed)	N	Y	Y	Y	Y	Y
Operations Page	N	N	Y	Y	Y	Y
Setup Page (cannot be changed)	N	N	N	N	Y	Y
Factory Page	Y	Y	Y	Y	Y	Y





Being able to change the page security level for the Operations and Profile pages allows a user to give access to the Profile Page while locking out the Operations Page. The following example shows how the Lockout feature may be used to accomplish this:

Changing Security Levels:

1. From the Home Page, press and hold the Infinity Key  and the Advance Key  for approximately six seconds. *CUSt* will appear in the upper display and *FCEY* will appear in the lower display.
2. Press the Up Key  until *LoC* appears in the upper display and *FCEY* will appear in the lower display.
3. Press the Advance Key  until Lock Operations prompt *LoCo* appears in the bottom display.
4. Press the Up Key  to change the default value from *2* to *3*.
5. Press the Advance Key  again and change the Lock Profiling prompt *LoCP* appears in the bottom display.
6. Press the Down Key  to change the default value from *3* to *2*.
7. Press the Advance Key  until Read Lock *rLoC* appears in the bottom display.
8. Press the Down Key  to change the default value from *5* to *2*.
9. Press the Advance Key  until Set Lock *SLoC* appears in the bottom display.
10. Press the Down Key  to change the default value from *5* to *4*.

With the above settings, the Home Page and the Profiling Page can be accessed, and all writable parameters can be written to. Due to the Read lock setting of 2, all pages with security levels greater than 2 will be locked out (inaccessible).

Another example of Method 1 lockout usage could be that an operator wants read access to all pages while allowing read/write access to the Home Page and the Lockout Menu only. To setup this scenario follow the steps below:

1. From the Home Page, press and hold the Infinity Key  and the Advance Key  for approximately six seconds. *CUSt* will appear in the upper display and *FCEY* will appear in the lower display.
2. Press the Up Key  until *LoC* appears in the upper display and *FCEY* will appear in the lower display.
3. Press the Advance Key  until Read Lock *rLoC* appears in the bottom display and change it to *5*.
4. Press the Advance Key  until Set Lock *SLoC* appears in the bottom display and change it to *1*.

Although the Factory Page is always visible, some menus within it can be restricted.

Lockout Security $SLoC$ and $rLoC$						
Factory Page Menus						
Menus	Security Level					
	0	1	2	3	4	5
Custom Menu	N	N	N	N	N	Y
Lockout Menu*	Y	Y	Y	Y	Y	Y
Diagnostic Menu**	N	Y	Y	Y	Y	Y
Calibration Menu	N	N	N	N	N	Y

* Using lockout Method 1 with $SLoC$ set to 0, all writable parameters within the control will be inhibited (not writable) with two exceptions, $SLoC$ and $rLoC$. As shown below, both of these parameters can always be seen and modified.

** Diagnostic Menu and all associated prompts are always visible and never writable

Lockout Security $SLoC$ and $rLoC$						
Factory Page Menu Parameters						
Parameters	Security Level					
	0	1	2	3	4	5
$LoC.o$	N	Y	Y	Y	Y	Y
$PAS.E$	N	Y	Y	Y	Y	Y
$rLoC$	Y	Y	Y	Y	Y	Y
$SLoC$	Y	Y	Y	Y	Y	Y

Note:

Using Method 1 Lockout all settings can be modified by anyone who knows how to find their way to the $SLoC$ and $rLoC$ parameters.



Using Lockout Method 2 (Password Enable)

It is sometimes desirable to apply a higher level of security to the control where a password would be required to access the control. If Password Enabled $PAS.E$ in the Factory Page under the LoC Menu is set to on, an overriding Password Security will be in effect. Without the appropriate password, specified menus will remain inaccessible. Page and Menu access is defined in the Locked Access Level $LoC.L$ prompt. On the other hand, a User with a password would have visibility restricted by the Read Lockout Security $rLoC$. As an example, with Password Enabled and the Locked Access Level $LoC.L$ set to 1 and $rLoC$ is set to 3, the available Pages for a User without a password would be limited to the Home and Factory Pages (locked level 1). If the User password is entered all pages would be accessible with the exception of the Setup Page as defined by level 3 access.

How to Enable Password Security

Follow the steps below:

1. From the Home Page, press and hold the Infinity Key ∞ and the Advance Key \rightarrow for approximately six seconds. $CUSt$ will appear in the upper display and $FCEY$ will appear in the lower display.

2. Press the Up Key  until **LoC** appears in the upper display and **FCEY** will appear in the lower display.
3. Press the Advance Key  until Password Enable **PASE** appears in the bottom display and change it to **5**.
4. Press the Up Key  to turn it on. Once on, four new prompts will appear:
 - a. Locked Access Level **LoCL**, (1 to 5) corresponding to the lockout table above.
 - b. Rolling Password **roLL**, will change the Customer Code every time power is cycled.
 - c. User Password **PASu**, which is needed for a User to acquire access to the control.
 - d. Administrator Password **PASa**, which is needed to acquire administrative access to the control.

The Administrator can either change the User and or the Administrator password or leave them in the default state. Once Password Security is enabled they will no longer be visible to anyone other than the Administrator. In other words the Lock Menu **LoC** is not available to a User. As can be seen in the formula that follows either the User or Administrator will need to know what those passwords are to acquire a higher level of access to the control. Back out of this menu by pushing the Infinity Key . Once out of the menu, the Password Security will be enabled.

How to Acquire Access to the Control









To acquire access to any inaccessible Pages or Menus, go to the Factory Page and enter the **ULoC** menu. Once there follow the steps below:

Note:

If Password Security (Password Enabled **PASE** is On) is enabled the two prompts mentioned below in the first step will not be visible. If the password is unknown, call the individual or company that originally setup the control.

1. Acquire either the User Password **PASu** or the Administrator Password **PASa**.
2. Press the Advance  key one time where the Code **Code** prompt will be visible.

Note:

- a. If the Rolling Password is off, press the Advance Key  one more time where the Password **PASS** prompt will be displayed. Proceed to either step 7a or 8a. Pushing the Up  or Down  arrow keys enter either the User or Administrator Password. Once entered, press and hold the Infinity  key for two seconds to return to the Home Page.
- b. If the Rolling Password **roLL** was turned on proceed on through steps 3 - 9.
3. Assuming the Code **Code** prompt (Public Key) is still visible on the face of the control simply push the Advance Key  to proceed to the Password **PASS** prompt. If not, find your way back to the Factory Page as described above.
4. Execute the calculation defined below (7b or 8b) for either the User or Administrator.
5. Enter the result of the calculation in the upper display play by using the Up  and Down  arrow keys or use EZ-ZONE Configurator Software.
6. Exit the Factory Page by pressing and holding the Infinity Key  for two seconds.

Formulas used by the User and the Administrator to calculate the Password follows:

Passwords equal:

7. User

- a. If Rolling Password `ROLL` is Off, Password `PASS` equals User Password `PAS.U`.
- b. If Rolling Password `ROLL` is On, Password `PASS` equals: $(PAS.U \times \text{code}) \text{ Mod } 929 + 70$

8. Administrator

- a. If Rolling Password `ROLL` is Off, Password `PASS` equals User Password `PAS.A`.
- b. If Rolling Password `ROLL` is On, Password `PASS` equals: $(PAS.A \times \text{code}) \text{ Mod } 997 + 1000$

Differences Between a User Without Password, User With Password and Administrator

- User **without** a password is restricted by the Locked Access Level `LoLL`.
- A User **with** a password is restricted by the Read Lockout Security `rLoE` never having access to the Lock Menu `LoE`.
- An Administrator is restricted according to the Read Lockout Security `rLoE` however, the Administrator has access to the Lock Menu where the Read Lockout can be changed.

Modbus - Using Programmable Memory Blocks

When using the Modbus RTU or Modbus TCP protocols, the PM control features a block of addresses that can be configured by the user to provide direct access to a list of 40 user configured parameters. This allows the user easy access to this customized list by reading from or writing to a contiguous block of registers.

To acquire a better understanding of the tables found in the back of this manual (See Appendix: [Modbus Programmable Memory Blocks](#)) please read through the text below which defines the column headers used.

Assembly Definition Addresses

- Fixed addresses used to define the parameter that will be stored in the “Working Addresses”, which may also be referred to as a pointer. The value stored in these addresses will reflect (point to) the Modbus address of a parameter within the PM control.

Assembly Working Addresses

- Fixed addresses directly related to their associated “Assembly Definition Addresses” (i.e., Assembly Working Addresses 200 & 201 will assume the parameter pointed to by Assembly Definition Addresses 40 & 41).

When the Modbus address of a target parameter is stored in an “Assembly Definition Address” its corresponding working address will return that parameter’s actual value. If it’s a writable parameter, writing to its working register will change the parameter’s actual value. As an example, Modbus register 360 represents the Analog Input Value (See Operations Page, Analog Input Menu). If the value 360 is loaded into Assembly Definition Address 90 and value 361 is loaded into Assembly Definition Address 91, the value sensed by Analog Input 1 will also be stored in Modbus registers 250 and 251. Notice that by default this parameter is also stored in working registers 240 and 241 as well.

Note:

When modifying the Modbus Assembly registers, single register writes (function 06) are not allowed. Multiple register writes (function 16) must be used to modify the assembly.

The table identified as “Assembly Definition Addresses and Assembly Working Addresses” (see Appendix: Modbus Programmable Memory Blocks) reflects the assemblies and their associated addresses.

CIP - Communications Capabilities

With the introduction of the Common Industrial Protocol (CIP) a user can now collect data, configure a device and control industrial devices. CIP is an open protocol at the application layer fully managed by the Open DeviceNet Vendors Association (ODVA, <http://www.odva.org>). Being that this is an open protocol there are many independent vendors offering a wide array of devices to the end user. CIP provides the ability to communicate utilizing both implicit messaging (real-time I/O messaging), and explicit messaging (information/configuration messaging). For implicit communications using a PLC, simply configure the PM assembly size into the I/O structure of the PLC (See: [CIP Implicit Assembly Structures](#)). The assembly structures can also be changed by the user. Explicit communications requires the use of specific addressing information. DeviceNet requires that the node address be specified where EtherNet/IP requires just the Class, Instance and Attribute.

- Node address or MAC ID (0 - 63, DeviceNet only)
- Class ID (1 to 255)
- Instance ID (0 to 255)
- Attribute ID (1 to 255)

EtherNet/IP and DeviceNet are both based on CIP and use the same addressing scheme. In the following menu pages notice the column header identified as CIP. There you will find the Class, Instance and Attribute in hexadecimal, (decimal in parenthesis) which makes up the addressing for both protocols. The Watlow implementation of CIP does not support connected explicit messages but fully supports unconnected explicit messaging.

Rockwell Automation (RA) developed the DF1 serial protocol within the framework of the PCCC application protocol. With the introduction of CIP, the PCCC protocol was encapsulated within it to enable continued communication over Ethernet to the legacy RA programmable controllers, e.g., SLC, Micrologic and PLC-5 controllers equipped with Ethernet capabilities. The Watlow implementation of CIP also supports the PCCC protocol.

EtherNet/IP (Industrial Protocol) is a network communication standard capable of handling large amounts of data at speeds of 10 Mbps or 100 Mbps, and at up to 1,500 bytes per packet. It makes use of standard off-the-shelf Ethernet chip sets and the currently installed physical media (hardware connections). DeviceNet was the first field bus offering of the ODVA group and has been around for many years. DeviceNet can communicate at 125, 250 and 500 kilobytes per second with a maximum limitation of 64 nodes (0 to 63) on the network.

Note:

If the control is brought back to the factory defaults (See Appendix: [CIP Implicit Assembly Structures](#)) the user configured assemblies will be overwritten.

Note:

The maximum number of implicit input/output members using *DeviceNet* is 200. When using EtherNet/IP the maximum is 100.

CIP Implicit Assemblies

Communications using CIP (EtherNet/IP and DeviceNet) can be accomplished with any PM Integrated control equipped with either DeviceNet or EtherNet/IP communications cards. As was already mentioned, reading or writing when using CIP can be accomplished via explicit and or implicit communications. Explicit communications are usually executed via a message instruction within the PLC but there are other ways to do this as well outside of the focus of this document.

Implicit communications is also commonly referred to as polled communications. When using implicit communications there is an I/O assembly that would be read or written to. The default assemblies and the assembly size is embedded into the firmware of the PM control. Watlow refers to these assemblies as the T to O (Target to Originator) and the O to T (Originator to Target) assemblies where the Target is always the EZ-ZONE PM controller and the Originator is the PLC or master on the network. The size of the O to T assembly is initially set to 40 (32-bit) members where the T to O assembly consists of 40 (32-bit) members. All assembly members are user configurable with the exception of the first T to O member. The first member of the T to O assembly is called the Device Status, it is unique and cannot be changed. If the module has been properly configured when viewing this 32-bit member in binary format bits 12 and 16 should always be set to 1 where all of the other bits should be 0. All other members that follow Device Status are user configurable. The Appendix of this User's Guide contains the PM implicit assemblies (See Appendix: [CIP Implicit Assembly Structures](#)).

Compact Assembly Class

Along with the standard implicit assembly where each module parameter (member) occupies one 32-bit assembly location, there is also a Compact Class assembly. The need for the Compact Class assembly members became apparent as the number of member instances grew with the EZ-ZONE family of controls. Because there is a limited number of implicit assembly members (40 input, 40 output), the Compact Class enables the user to modify the standard assembly offering to their liking while also achieving much better utilization of each bit within the 32-bit member. As an example, if a standard Implicit Assembly member were configured to monitor Alarm State 1, the entire 32-bit member would be consumed where just 7 bits out of the 32 represent: Startup (88), None (61), Blocked (12), Alarm Low (8), Alarm High (7) or Error (28). With Compact Class assembly member 12 (identified in this document as "[12 A, Alarm Read](#)") in use, the alarm states of all 4 alarms can be placed in one 32-bit assembly member using just 2 bits for each state. Bits 0 and 1 would represent Alarm State 1, bits 2 and 3 Alarm State 2, etc... Each pair of 2 bits can represent the following states: 00 = None, 01 = Alarm Low, 10 = Alarm High and 11 = Other. There is a variety of predefined Compact Class members that can be used (See Appendix: [Compact Class Assembly Structure](#)) to modify the default implicit assemblies.

Note:

As is the case with any available parameter within the PM control, the Compact Class members can also be read or written to individually via an explicit message as well.

Modifying Implicit Assembly Members

To change any given member of either assembly (T to O or O to T) simply write the new class, instance and attribute (CIA) to the member location of choice. As an example, if it were desired to change the 14th member of the T to O assembly from the default parameter (Cool Power) to the Compact Class 12th member (See Appendix: [Compact Class Assembly Structure](#)) write the value of 0x71, 0x01 and 0x0C (Class, Instance and Attribute respectively) to 0x77,

0x02 and 0x0D. Once the change is executed, reading this member location (as was discussed above) will return the Alarm States (1-4) to paired bits 0 through 7 where 00 = None, 01 = Alarm Low, 10 = Alarm High and 11 = Other. The CIP communications instance will always be instance 2.

Profibus DP - (Decentralized Peripherals)

This protocol is typically used to operate sensors and actuators via a centralized controller within industrialized production topologies. Data rates up to 12 Mbit/s on twisted pair cables and/or fiber optics are possible. This protocol is available in three functionally graded version; DP-V0, DP-V1 and DP-V2. It should be noted that Watlow products utilizing this protocol support DP-V0 and DP-V1 only.

DP-V0 - provides the basic functionality of DP, including cyclic data exchange, station, module and channel specific diagnostics and four different interrupt types for diagnostics and process interrupts.

Cyclic Data refers to input/output data that is pre-configured to pass from the Profibus-DP Class 1 Master and the Slave at a known rate. Cyclic data is expected on both the sender and the receiver end of the message.

Note:

To use DP-V0 (cyclic data transfer) first configure and then register the General Station Description (GSD) file. Watlow provides a software tool allowing for total customization of the data to be read and or written to. Acquire this software tool (Profibus GSD Editor) via the CD that shipped with the product or, as an alternative, point your browser to: <http://www.watlow.com/en/resources-and-support/Technical-Library/Software-and-Demos> and navigate to the bottom of the page and click on "Software and Demos" to download the software.

Using the GSD Editor a user can configure up to a maximum of 244 I/O bytes that can be read or written to from Zone 1 through 16. DP-V1 - contains enhancements geared towards process automation, in particular acyclic data communication for parameter assignment, operation, visualization and interrupt control of intelligent field devices, in conjunction with cyclic user data communication.

Acyclic Data is a message that can be sent and or received at any time where they typically have a lower priority then cyclic messages. This type of messaging is typically used for the purpose of configuration or performing some sort of a diagnostic function.

Software Configuration

Using EZ-ZONE Configurator Software

To enable a user to configure the PM control using a personal computer (PC), Watlow has provided free software for your use. If you have not yet obtained a copy of this software insert the CD (Controller Support Tools) into your CD drive and install the software. Alternatively, if you are viewing this document electronically and have a connection to the Internet simply click on the link below and download the software from the Watlow web site free of charge.

<http://www.watlow.com/en/resources-and-support/Technical-Library/Software-and-Demos>

Once the software is installed double click on the EZ-ZONE Configurator icon placed on your desktop during the installation process. If you cannot find the icon follow the steps below to run the software:

1. Move your mouse to the "Start" button
2. Place the mouse over "All Programs"
3. Navigate to the "Watlow" folder and then the sub-folder "EZ-ZONE Configurator"
4. Click on EZ-ZONE Configurator to run.

The first screen that will appear is shown below.

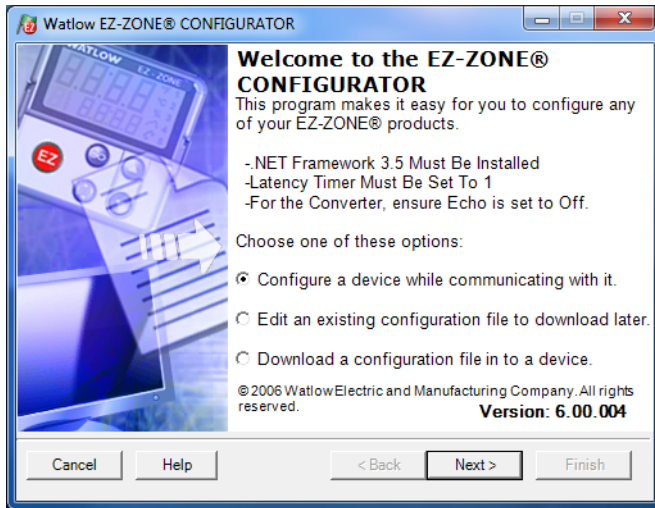

If the PC is already physically connected to the EZ-ZONE PM control click the next button to go on-line.

Note:

When establishing communications from PC to the EZ-ZONE PM controller, an interface converter will be required. The Standard Bus network uses EIA-485 as the interface. Most PCs today would require a USB to EIA-485 converter. However, some PCs may still be equipped with EIA-232 ports, therefore an EIA-232 to EIA-485 converter would be required.

As can be seen in the above screen shot the software provides the user with the option of downloading a previously saved configuration as well as the ability to create a configuration off-line to download later. The screen shots that follow will take the user on-line.

After clicking the next button above it is necessary to define the communications port that will be used on the PC as shown to the right. Clicking on the drop down will allow the user to select the appropriate communications port. This will be the port assigned to the EIA-485 to USB converter when it was connected to the PC. The "Advanced" button allows the user to determine how many devices to look for on the network (1 to 17).

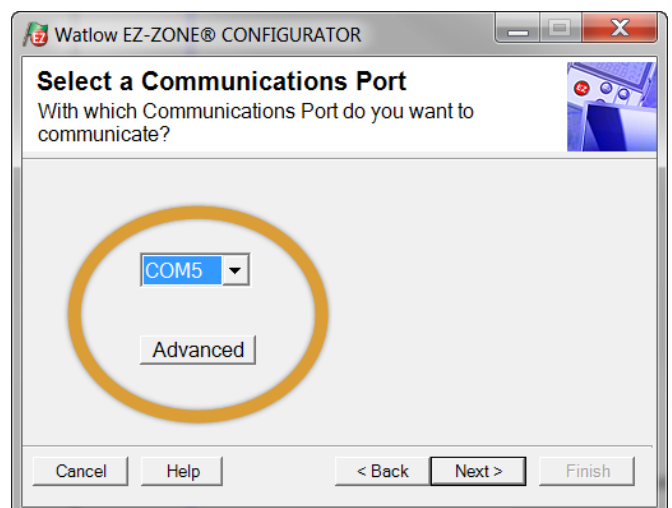

After clicking on the “Next” button, the software will scan the network for the zone addresses specified while showing the progress made (as shown in the graphic below. When complete the software will display all of the available devices found on the network as shown below.

Searching Network for Devices

Available Network Devices Displayed

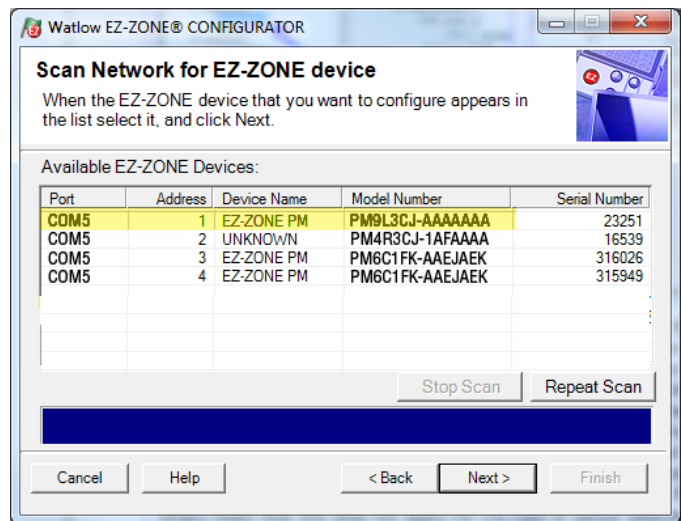
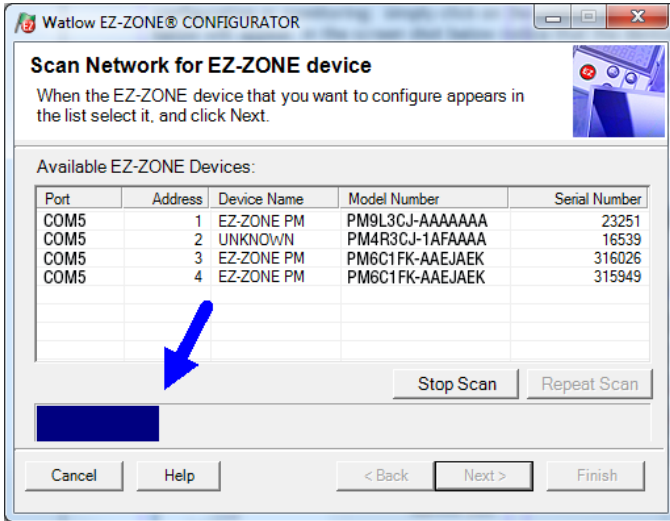

The PM9L is shown highlighted above to bring greater clarity to the controller in focus. Any EZ-ZONE device on the network will appear in this window and would be available for the purpose of configuration or monitoring; simply click on the control of choice. After doing so, the screen below will appear. In the screen shot below notice that the device part number is clearly displayed at the top of the page (yellow highlight added for emphasis). When multiple EZ-ZONE devices are on the network it is important that the part number be noted prior to configuring so as to avoid making unwanted configuration changes to another controller. Looking closely at the left hand column (Parameter Menus) notice that it displays all of the available menus and associated parameters within the controller. The menu structure as laid out within this software follows:

- Setup - Operations - Factory

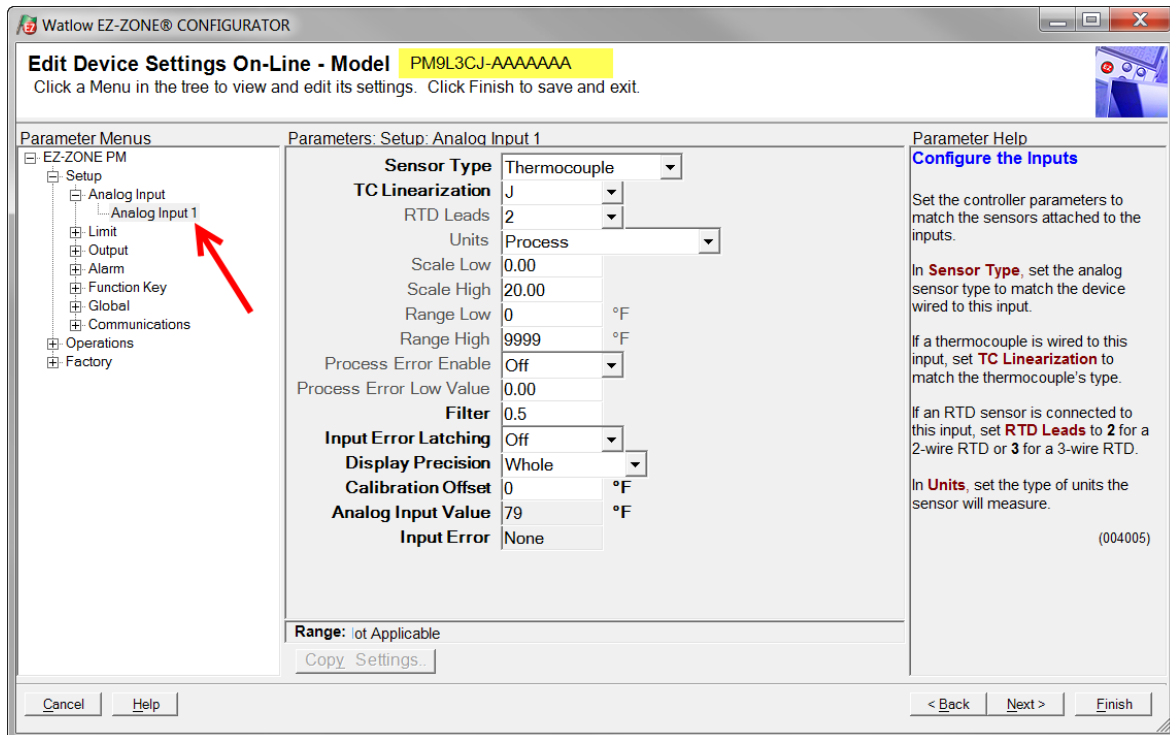

Navigating from one menu to the next is easy and clearly visible. Simply slide the scroll bar up or down to display the menu and parameter of choice. If there is a need to bring greater focus and clarity to the parameters of interest simply click on the negative symbol next to any of the Menu items. As an example, if it is desired to work within the Operations page click the negative sign next to Setup where the Setup Page will then collapse. Now click the plus sign next to Operations to find the menu items of choice without viewing unwanted menus and parameters. Once the focus is brought to an individual parameter (single click of mouse) as is the case for Analog Input 1 in the left column; all that can be setup related to that parameter will appear in the center column. The grayed out fields in the center column simply mean that this does not apply for the type of sensor selected. As an example, notice that when a thermocouple is selected, RTD Leads does not apply and is therefore grayed out. To speed up the process of configuration notice that at the bottom of the center column there is an option to copy settings. If Alarms 1 through 4 are to be configured the same, simply click on "Copy Settings" where a copy dialog box will appear allowing for quick duplication of all settings. Notice too, that by clicking on any of those items in the center column that context sensitive help will appear for that particular item in the right hand column. Lastly, when the configuration is complete, click the "Finish" button at the bottom right of the graphic on the previous page. The screen that follows this action can be seen above.

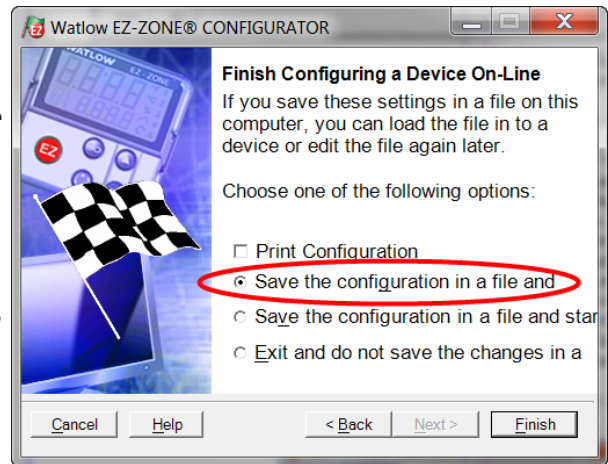

Although the PM controller now contains the configuration (because the previous discussion focused on doing the configuration on-line) it is suggested that after the configuration process is completed that the user save this file on the PC for future use. If for some reason someone inadvertently changed a setting without understanding the impact, it would be easy and perhaps faster to download a saved configuration back to the control versus trying to figure out what was changed. Of course, there is an option to exit without saving a copy to the local hard drive. After selecting Save above, click the "Finish" button once again. The screen below will then appear. When saving the configuration, note the location where the file will be placed (saved in) and enter the file name (File name) as well. The default path for saved files follows: Users\ "Username" \My Documents\ Watlow\EZ-Zone Configurator\Saved Configurations

The user can save the file to any folder of choice.

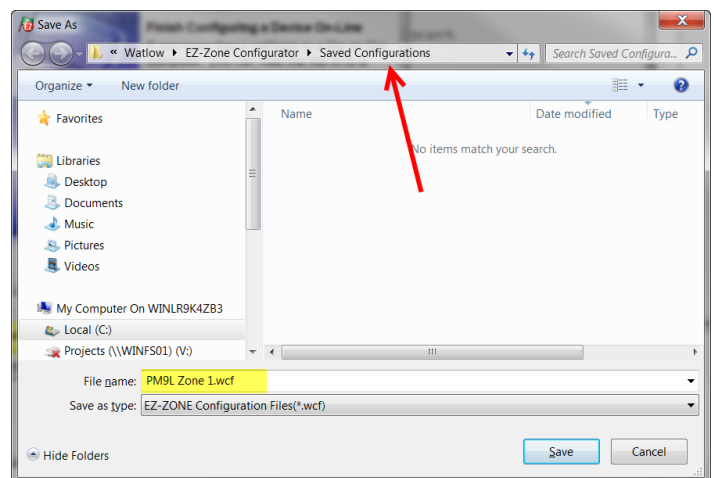

Chapter 9: Appendix

Troubleshooting Alarms, Errors and Control Issues

Indication	Description	Possible Cause(s)	Corrective Action
Alarm won't clear or reset	Alarm will not clear or reset with keypad or digital input	<ul style="list-style-type: none"> Latching is active Alarm set to incorrect output Alarm is set to incorrect source Sensor input is out of alarm set point range Alarm set point is incorrect Alarm is set to incorrect type Digital input function is incorrect 	<ul style="list-style-type: none"> Reset alarm when process is within range or disable latching Set output to correct alarm source instance Set alarm source to correct input instance Correct cause of sensor input out of alarm range Set alarm set point to correct trip point Set alarm to correct type: process, deviation or power Set digital input function and source instance
Alarm won't occur	Alarm will not activate output	<ul style="list-style-type: none"> Silencing is active Blocking is active Alarm is set to incorrect output Alarm is set to incorrect source Alarm set point is incorrect Alarm is set to incorrect type 	<ul style="list-style-type: none"> Disable silencing, if required Disable blocking, if required Set output to correct alarm source instance Set alarm source to correct input instance Set alarm set point to correct trip point Set alarm to correct type: process, deviation or power
Alarm Error <i>ALE 1</i> <i>ALE 2</i> <i>ALE 3</i> <i>ALE 4</i>	Alarm state cannot be determined due to lack of sensor input	<ul style="list-style-type: none"> Sensor improperly wired or open Incorrect setting of sensor type Calibration corrupt 	<ul style="list-style-type: none"> Correct wiring or replace sensor Match setting to sensor used Check calibration of controller

Indication	Description	Possible Cause(s)	Corrective Action
Alarm Low <i>ALL1</i> <i>ALL2</i> <i>ALL3</i> <i>ALL4</i>	Sensor input below low alarm set point	<ul style="list-style-type: none"> • Temperature is less than alarm set point • Alarm is set to latching and an alarm occurred in the past • Incorrect alarm set point • Incorrect alarm source 	<ul style="list-style-type: none"> • Check cause of under temperature • Clear latched alarm • Establish correct alarm set point • Set alarm source to proper setting
Alarm High <i>ALH1</i> <i>ALH2</i> <i>ALH3</i> <i>ALH4</i>	Sensor input above high alarm set point	<ul style="list-style-type: none"> • Temperature is greater than alarm set point • Alarm is set to latching and an alarm occurred in the past • Incorrect alarm set point • Incorrect alarm source 	<ul style="list-style-type: none"> • Check cause of over temperature • Clear latched alarm • Establish correct alarm set point • Set alarm source to proper setting
Error Input <i>Er.I1</i>	Sensor does not provide a valid signal to controller	<ul style="list-style-type: none"> • Sensor improperly wired or open • Incorrect setting of sensor type • Calibration corrupt 	<ul style="list-style-type: none"> • Correct wiring or replace sensor • Match setting to sensor used • Check calibration of controller
Ambient Error <i>Er.Ab</i>	Sensor does not provide a valid signal to controller	<ul style="list-style-type: none"> • Ambient error - cold junction circuitry not working 	<ul style="list-style-type: none"> • Return to factory for repair
Limit won't clear or reset	Limit will not clear or reset with keypad or digital input	<ul style="list-style-type: none"> • Sensor input is out of limit set point range • Limit set point is incorrect • Digital input function is incorrect 	<ul style="list-style-type: none"> • Correct cause of sensor input out of limit range • Set limit set point to correct trip point • Set digital input function and source instance
Limit Error <i>LE1</i>	Limit state cannot be determined due to lack of sensor input, limit will trip	<ul style="list-style-type: none"> • Sensor improperly wired or open • Incorrect setting of sensor type • Calibration corrupt 	<ul style="list-style-type: none"> • Correct wiring or replace sensor • Match setting to sensor used • Check calibration of controller
Limit Low <i>LL1</i>	Sensor input below low limit set point	<ul style="list-style-type: none"> • Temperature is less than limit set point • Limit outputs latch and require reset • Incorrect alarm set point 	<ul style="list-style-type: none"> • Check cause of under temperature • Clear limit • Establish correct limit set point

Indication	Description	Possible Cause(s)	Corrective Action
Limit High <i>L i h t</i>	Sensor input above high limit set point	<ul style="list-style-type: none"> • Temperature is greater than limit set point • Limit outputs latch and require reset • Incorrect alarm set point 	<ul style="list-style-type: none"> • Check cause of over temperature • Clear limit • Establish correct limit set point
No Display	No display indication or LED illumination	<ul style="list-style-type: none"> • Power to controller is off • Fuse open • Breaker tripped • Safety interlock switch open • Separate system limit control activated • Wiring error • Incorrect voltage to controller 	<ul style="list-style-type: none"> • Turn on power • Replace fuse • Reset breaker • Close interlock switch • Reset limit • Correct wiring issue • Apply correct voltage, check part number
No Serial Communication	Cannot establish serial communications with the controller	<ul style="list-style-type: none"> • Address parameter incorrect • Incorrect protocol selected • Baud rate incorrect • Parity incorrect • Wiring error • EIA-485 converter issue • Incorrect computer or PLC communications port • Incorrect software setup • Wires routed with power cables • Termination resistor may be required 	<ul style="list-style-type: none"> • Set unique addresses on network • Match protocol between devices • Match baud rate between devices • Match parity between devices • Correct wiring issue • Check settings or replace converter • Set correct communication port • Correct software setup to match controller • Route communications wires away from power wires • Place 120 Ω resistor across EIA-485 on last controller

Indication	Description	Possible Cause(s)	Corrective Action
Temperature runaway	Process value continues to increase or decrease past set point.	<ul style="list-style-type: none"> • Controller output incorrectly programmed • Thermocouple reverse wired • Controller output wired incorrectly • Short in heater • Power controller connection to controller defective • Controller output defective 	<ul style="list-style-type: none"> • Verify output function is correct (heat or cool) • Correct sensor wiring (red wire negative) • Verify and correct wiring • Replace heater • Replace or repair power controller • Replace or repair controller
Device Error <i>100</i> <i>rErr</i>	Controller displays internal malfunction message at power up.	<ul style="list-style-type: none"> • Controller defective • Sensor input over driven 	<ul style="list-style-type: none"> • Replace or repair controller • Check sensors for ground loops, reverse wiring or out of range values.
Menus inaccessible	Unable to access <i>SEt</i> , <i>oPEr</i> , <i>FctY</i> or <i>PrOF</i> menus or particular prompts in Home Page	<ul style="list-style-type: none"> • Security set to incorrect level • Digital input set to lock-out keypad • Custom parameters incorrect 	<ul style="list-style-type: none"> • Check <i>LoE</i> settings in Factory Page and enter appropriate password in <i>ULoE</i> setting in Factory Page • Change state of digital input • Change custom parameters in Factory Page
EZ-Key/s do not work	EZ-Key/s do not activate required function	<ul style="list-style-type: none"> • EZ-Key function incorrect • EZ-Key function instance not correct • Keypad malfunction 	<ul style="list-style-type: none"> • Verify EZ-Key function in the Setup Menu • Correct and change the function instance if not correct • Replace or repair controller
Displayed value to low <i>uALL</i>	Value to low to be displayed in 4 digit LED display <-1999	<ul style="list-style-type: none"> • Incorrect setup 	<ul style="list-style-type: none"> • Check scaling of source data
Displayed value to high <i>uALh</i>	Value to high to be displayed in 4 digit LED display >9999	<ul style="list-style-type: none"> • Incorrect setup 	<ul style="list-style-type: none"> • Check scaling of source data

Detection of and Rules Around Abnormal Sensor Conditions	
Inputs	Detection of Abnormal Conditions
Thermocouple	
Shorted	No direct detection, Open loop firmware detection.
Open	Yes, Parasitic pull-up
Reversed	Yes, firmware detection
Current Source	
Shorted	Range limiting only
Open	Range limiting only
Reversed	Range limiting only
Voltage Source	
Open	Range limiting only
Shorted	Range limiting only
Reversed	Range limiting only
RTD	
S1 open	Yes, pulled up.
S2 open	Not implemented.
S3 open	Yes, pulled up.
S1 short to S2	Yes, pulled up
S1 short to S3	Yes, pulled down to under range.
S2 shorted to S3	Not implemented, Possible, monitor S2 voltage.
S1 and S2 open	Yes, pulled down to under range.
S1 and S3 open	Yes, S1 pulled up.
S2 and S3 open	Yes pulled up.
Thermistor	
S1 open	Yes, pulled up to sensor over range.
S3 open	Yes, pulled up to sensor over range.
S1 short to S3	Yes, pulled down to sensor under range.
S1 and S3 open	Yes, S1 pulled up to sensor over range.

Modbus - Programmable Memory Blocks

The Modbus assembly or programmable memory blocks consists of 40 pointers to the parameters of your choosing starting at Modbus register 40 (shown on the following page). The pointers are 32-bits long and are stored in two sequential registers. As an example, if it is desired to move an alias to the Analog Input of the PM (register 360) into pointer registers 40 and 41, a single multi-write command (0x10 function) would be used writing 360 into register 40 and 361 into register 41.

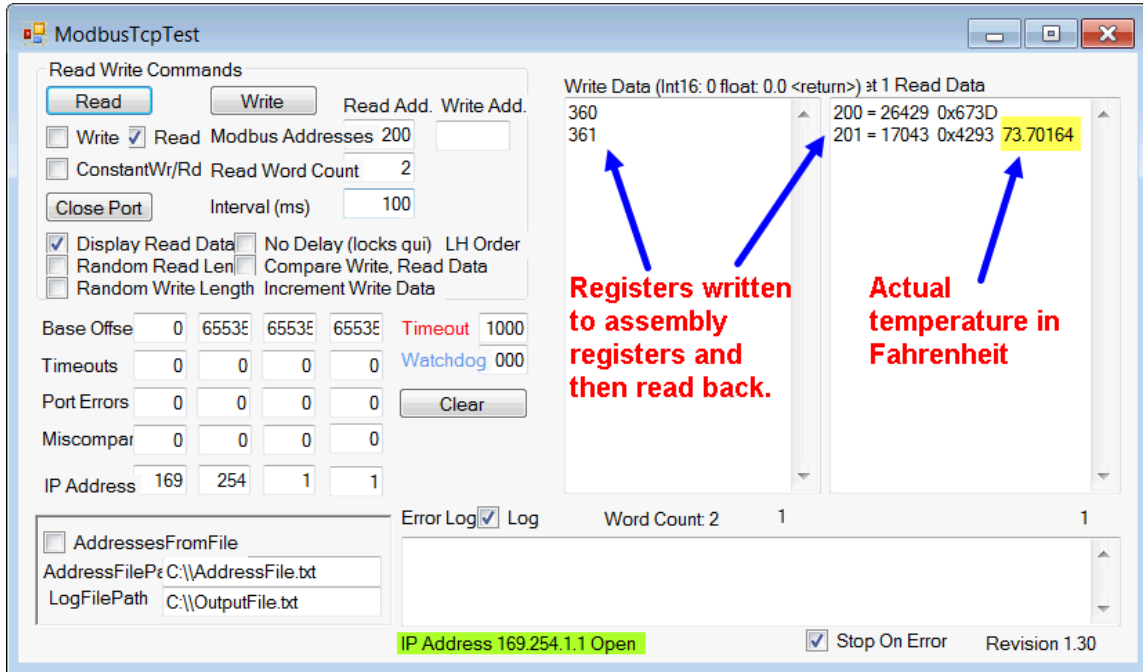

Once the parameters of choice have been defined and written to the specified pointer registers, the working registers will then represent the parameters written. In the example above, the 32-bit floating point analog input (360 and 361) was first written to registers 40 and 41 which in turn defines working registers 200 and 201 as Analog Input 1. As can be seen in the far right-hand column in the graphic above, reading back registers 200 and 201 the temperature, as detected by the first analog input is displayed.

The screen shot above was taken from a program that can be found on the Watlow Support Tools DVD (shipped with the product) as well as on the Watlow website. On the DVD, it can be found under "Utility Tools" and is identified as "Modbus TCP Diagnostic Program for EZ-ZONE PM, RM and ST". A similar program can be found here as well for Modbus RTU. If it is easier to go to the web to acquire this software, click on the link below and type "modbus" in the search field where both versions can be found and downloaded. <http://www.watlow.com/en/resources-and-support/Technical-Library/Software-and-Demos>

Modbus - Programmable Memory Blocks

Assembly Definition Addresses and Assembly Working Addresses

Assembly Definition Addresses	Assembly Working Addresses	Assembly Definition Addresses	Assembly Working Addresses
40 & 41	200 & 201	80 & 81	240 & 241
42 & 43	202 & 203	82 & 83	242 & 243
44 & 45	204 & 205	84 & 85	244 & 245
46 & 47	206 & 207	86 & 87	246 & 247
48 & 49	208 & 209	88 & 89	248 & 249
50 & 51	210 & 211	90 & 91	250 & 251
52 & 53	212 & 213	92 & 93	252 & 253
54 & 55	214 & 215	94 & 95	254 & 255
56 & 57	216 & 217	96 & 97	256 & 257
58 & 59	218 & 219	98 & 99	256 & 259
60 & 61	220 & 221	100 & 101	260 & 261
62 & 63	222 & 223	102 & 103	262 & 263
64 & 65	224 & 225	104 & 105	264 & 265
66 & 67	226 & 227	106 & 107	266 & 267
68 & 69	228 & 229	108 & 109	268 & 269
70 & 71	230 & 231	110 & 111	270 & 271
72 & 73	232 & 233	112 & 113	272 & 273
74 & 75	234 & 235	114 & 115	274 & 275
76 & 77	236 & 237	116 & 117	276 & 277
78 & 79	238 & 239	118 & 119	278 & 279

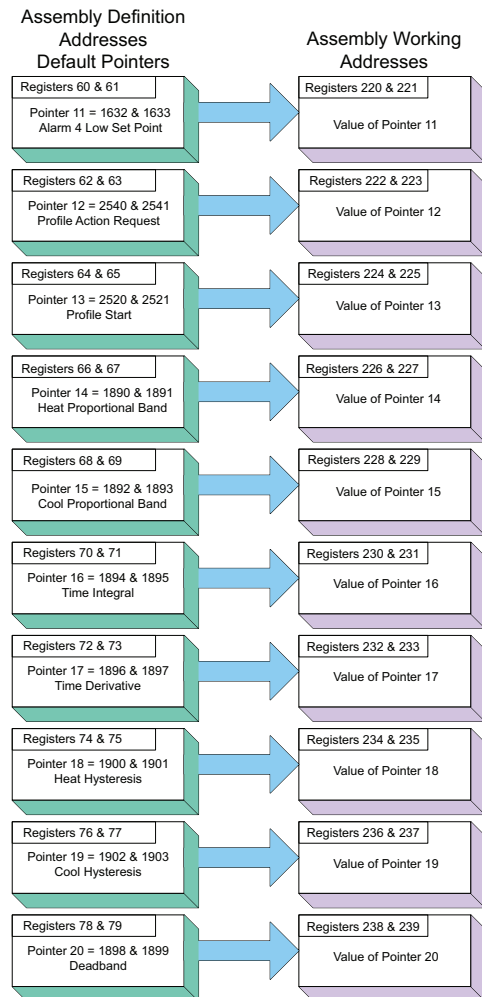
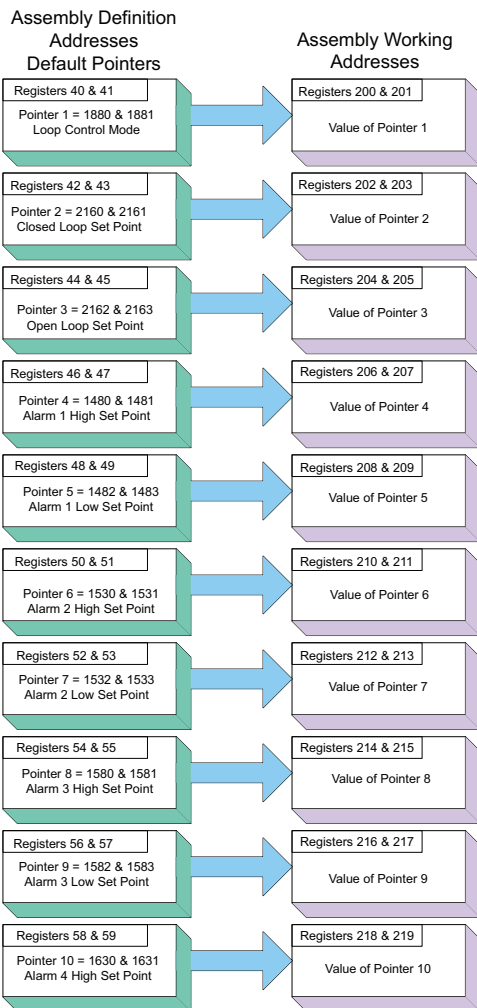

Modbus Default Assembly Structure 80-119

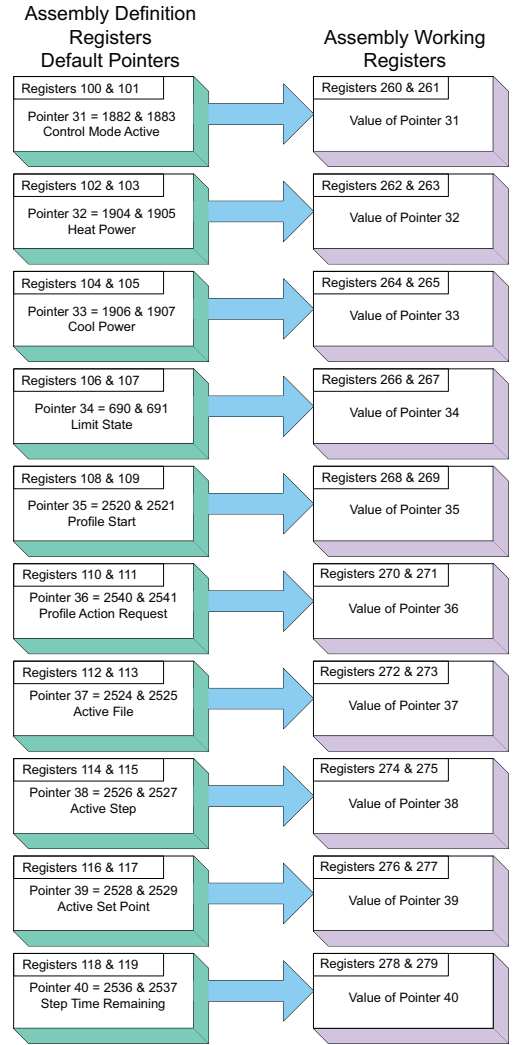
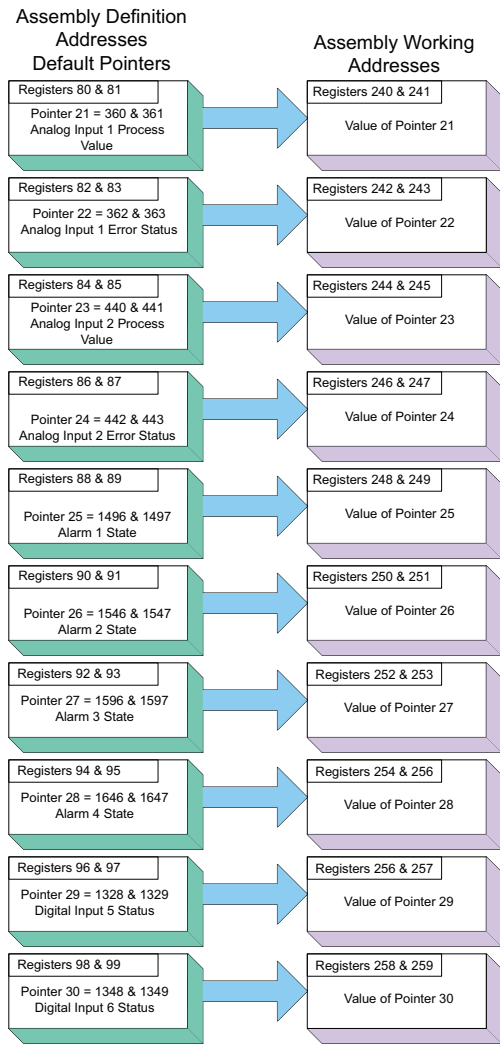

CIP Implicit Assembly Structures

CIP Implicit Assembly Originator (Master) to Target (PML)					
Assembly Members	Assembly Class, Instance, Attribute	ST Data Type	Parameter	Parameter Class, Instance, Attribute	PLC Data Type
1	0x77, 0x01, 0x01	DINT	Control Loop 1, User Control Mode	0x97, 0x01, 0x01	DINT
2	0x77, 0x01, 0x02	DINT	Closed Loop Set Point	0x6B, 0x01, 0x01	REAL
3	0x77, 0x01, 0x03	DINT	Open Loop Set Point	0x6B, 0x01, 0x02	REAL
4	0x77, 0x01, 0x04	DINT	Alarm 1 - Alarm High Set Point	0x6D, 0x01, 0x01	REAL
5	0x77, 0x01, 0x05	DINT	Alarm 1 - Alarm Low Set Point	0x6D, 0x01, 0x02	REAL
6	0x77, 0x01, 0x06	DINT	Alarm 2 - Alarm High Set Point	0x6D, 0x02, 0x01	REAL
7	0x77, 0x01, 0x07	DINT	Alarm 2 - Alarm Low Set Point	0x6D, 0x02, 0x02	REAL
8	0x77, 0x01, 0x08	DINT	Alarm 3 - Alarm High Set Point	0x6D, 0x03, 0x01	REAL
9	0x77, 0x01, 0x09	DINT	Alarm 3 - Alarm Low Set Point	0x6D, 0x03, 0x02	REAL
10	0x77, 0x01, 0x0A	DINT	Alarm 4 - Alarm High Set Point	0x6D, 0x04, 0x01	REAL
11	0x77, 0x01, 0x0B	DINT	Alarm 4 - Alarm Low Set Point	0x6D, 0x04, 0x02	REAL
12	0x77, 0x01, 0x0C	DINT	Profile Action Request	0x7A, 0x01, 0x0B	DINT
13	0x77, 0x01, 0x0D	DINT	Profile Start	0x7A, 0x01, 0x01	DINT
14	0x77, 0x01, 0x0E	DINT	Heat Proportional Band	0x97, 0x01, 0x06	REAL
15	0x77, 0x01, 0x0F	DINT	Cool Proportional Band	0x97, 0x01, 0x07	REAL
16	0x77, 0x01, 0x10	DINT	Time Integral	0x97, 0x01, 0x08	REAL
17	0x77, 0x01, 0x11	DINT	Time Derivative	0x97, 0x01, 0x09	REAL
18	0x77, 0x01, 0x12	DINT	Heat Hysteresis	0x97, 0x01, 0x0B	REAL
19	0x77, 0x01, 0x13	DINT	Cool Hysteresis	0x97, 0x01, 0x0C	REAL
20	0x77, 0x01, 0x14	DINT	Dead Band	0x97, 0x01, 0x0A	REAL
21	0x77, 0x02, 0x15	DINT	None Specified	----	----
22	0x77, 0x02, 0x16	DINT	None Specified	----	----
23	0x77, 0x02, 0x17	DINT	None Specified	----	----
24	0x77, 0x02, 0x18	DINT	None Specified	----	----
25	0x77, 0x02, 0x19	DINT	None Specified	----	----
26	0x77, 0x02, 0x1A	DINT	None Specified	----	----
27	0x77, 0x02, 0x1B	DINT	None Specified	----	----
28	0x77, 0x02, 0x1C	DINT	None Specified	----	----
29	0x77, 0x02, 0x1D	DINT	None Specified	----	----
30	0x77, 0x02, 0x1E	DINT	None Specified	----	----
31	0x77, 0x02, 0x1F	DINT	None Specified	----	----
32	0x77, 0x02, 0x20	DINT	None Specified	----	----
33	0x77, 0x02, 0x21	DINT	None Specified	----	----
34	0x77, 0x02, 0x22	DINT	None Specified	----	----
35	0x77, 0x02, 0x23	DINT	None Specified	----	----
36	0x77, 0x02, 0x24	DINT	None Specified	----	----
37	0x77, 0x02, 0x25	DINT	None Specified	----	----
38	0x77, 0x02, 0x26	DINT	None Specified	----	----
39	0x77, 0x02, 0x27	DINT	None Specified	----	----
40	0x77, 0x02, 0x28	DINT	None Specified	----	----

Note:

PM revision 15 and above firmware allows for 40 implicit members. Revisions below 15, allow for a maximum of 20.

**CIP Implicit Assembly
Target (PML) to Originator (Master)**

Assembly Members	Assembly Class, Instance, Attribute	ST Data Type	Parameter	Parameter Class, Instance, Attribute	PLC Data Type
- - - -	Cannot be changed	Binary	Device Status	None	BIN
1	0x77, 0x02, 0x01	DINT	Analog Input 1, Analog Input Value	0x68, 0x01, 0x01	REAL
2	0x77, 0x02, 0x02	DINT	Analog Input 1, Input Error	0x68, 0x01, 0x02	REAL
3	0x77, 0x02, 0x03	DINT	Analog Input 2, Analog Input Value	0x68, 0x02, 0x01	REAL
4	0x77, 0x02, 0x04	DINT	Analog Input 2, Input Error	0x68, 0x02, 0x02	REAL
5	0x77, 0x02, 0x05	DINT	Alarm 1, Alarm State	0x6D, 0x01, 0x09	DINT
6	0x77, 0x02, 0x06	DINT	Alarm 2, Alarm State	0x6D, 0x02, 0x09	DINT
7	0x77, 0x02, 0x07	DINT	Alarm 3, Alarm State	0x6D, 0x03, 0x09	DINT
8	0x77, 0x02, 0x08	DINT	Alarm 4, Alarm State	0x6D, 0x04, 0x09	DINT
9	0x77, 0x02, 0x09	DINT	Event Status 1	0x6E, 0x01, 0x05	DINT
10	0x77, 0x02, 0x0A	DINT	Event Status 2	0x6E, 0x02, 0x05	DINT
11	0x77, 0x02, 0x0B	DINT	Control Mode Active	0x97, 0x01, 0x02	DINT
12	0x77, 0x02, 0x0C	DINT	Heat Power	0x97, 0x01, 0x0D	REAL
13	0x77, 0x02, 0x0D	DINT	Cool Power	0x97, 0x01, 0x0E	REAL
14	0x77, 0x02, 0x0E	DINT	Limit State	0x70, 0x01, 0x06	DINT
15	0x77, 0x02, 0x0F	DINT	Profile Start	0x7A, 0x01, 0x01	DINT
16	0x77, 0x02, 0x10	DINT	Profile Action Request	0x7A, 0x01, 0x0B	DINT
17	0x77, 0x02, 0x11	DINT	Current Profile	0x7A, 0x01, 0x03	DINT
18	0x77, 0x02, 0x12	DINT	Current Step	0x7A, 0x01, 0x04	DINT
19	0x77, 0x02, 0x13	DINT	Active Set Point	0x7A, 0x01, 0x05	REAL
20	0x77, 0x02, 0x14	DINT	Step Time Remaining	0x7A, 0x01, 0x09	DINT
21	0x77, 0x02, 0x15	DINT	None Specified	- - - -	- - - -
22	0x77, 0x02, 0x16	DINT	None Specified	- - - -	- - - -
23	0x77, 0x02, 0x17	DINT	None Specified	- - - -	- - - -
24	0x77, 0x02, 0x18	DINT	None Specified	- - - -	- - - -
25	0x77, 0x02, 0x19	DINT	None Specified	- - - -	- - - -
26	0x77, 0x02, 0x1A	DINT	None Specified	- - - -	- - - -
27	0x77, 0x02, 0x1B	DINT	None Specified	- - - -	- - - -
28	0x77, 0x02, 0x1C	DINT	None Specified	- - - -	- - - -
29	0x77, 0x02, 0x1D	DINT	None Specified	- - - -	- - - -
30	0x77, 0x02, 0x1E	DINT	None Specified	- - - -	- - - -
31	0x77, 0x02, 0x1F	DINT	None Specified	- - - -	- - - -
32	0x77, 0x02, 0x20	DINT	None Specified	- - - -	- - - -
33	0x77, 0x02, 0x21	DINT	None Specified	- - - -	- - - -
34	0x77, 0x02, 0x22	DINT	None Specified	- - - -	- - - -
35	0x77, 0x02, 0x23	DINT	None Specified	- - - -	- - - -
36	0x77, 0x02, 0x24	DINT	None Specified	- - - -	- - - -
37	0x77, 0x02, 0x25	DINT	None Specified	- - - -	- - - -
38	0x77, 0x02, 0x26	DINT	None Specified	- - - -	- - - -
39	0x77, 0x02, 0x27	DINT	None Specified	- - - -	- - - -
40	0x77, 0x02, 0x28	DINT	None Specified	- - - -	- - - -

As can be seen on the previous page, the PML Implicit Assembly defaults (factory settings) to a populated assembly structure. If it is desired to modify any of the given assembly members there are many software tools available to do so. It is outside of the scope of this document to describe how to use those. What can be found in this document is the process to build the assembly structure. If viewing this document electronically simply click on the link below to read the section entitled "[Modifying Implicit Assembly Members](#)". Otherwise, turn back to the table of contents to find the above named section.

Compact Class Assembly Structure

On the next six pages, the 17 available members of the Compact Class are displayed. As an orientation to the format as displayed in this document, notice that each member begins with header identified as "Assembly" and below the header you will see the member number along with parameter information contained within. While looking at these illustrations keep in mind that each member is actually 32-bits in length. To better illustrate this information in this document, the following 6 pages present these members divided in half where the letter "A" in the page header and assembly number represents the most significant 16-bits where the letter "B" in the title and assembly number represents the least significant 16-bits of each member. In the event that these pages are printed out and then mixed up, simply match up the page headers placing them side by side. As an example, Compact Class 1 A through 7 A should be paired with Class 1 B through 7 B, left to right.

Assembly	Class, Instance, Attribute
1 A Analog Input Read	C = 0x71 (113) I = 1 to 4 A = 1

For further explanation as to what the Compact Class assembly is, navigate to the section entitled "[Compact Assembly Class](#)"

Compact Class 1 A through 7 A

		Instance i															
Assembly	Class, Instance, Attribute	31	30	29	28	27	26	25	24	23	22	21	20	19	18	17	16
1 A Analog Input Read	C = 0x71 (113) I = 1 to 4 A = 1	Filtered Analog Input Value															

Bits 16 to 31, Signed 16 bits with implied tenths precision (-32768.8 to 3276.7)

		Instance i															
Assembly	Class, Instance, Attribute	31	30	29	28	27	26	25	24	23	22	21	20	19	18	17	16
2 A Control Read/Write	C = 0x71 (113) I = 1 to 4 A = 2	Closed Loop Set Point															

Bits 16 to 31, Signed 16 bits with implied tenths precision (-32768.8 to 3276.7)

		Instance i + 1															
Assembly	Class, Instance, Attribute	31	30	29	28	27	26	25	24	23	22	21	20	19	18	17	16
3 A Control Read/Write	C = 0x71 (113) I = 1 to 4 A = 3	Closed Loop Set Point															

Bits 16 to 31, Signed 16 bits with implied tenths precision (-32768.8 to 3276.7)

		Instance i															
Assembly	Class, Instance, Attribute	31	30	29	28	27	26	25	24	23	22	21	20	19	18	17	16
4 A Control Read/Write	C = 0x71 (113) I = 1 to 4 A = 4	Heat Proportional Band															

Bits 16 to 31, Unsigned 16 bits with implied tenths precision (0 to 6553.5)

		Instance i															
Assembly	Class, Instance, Attribute	31	30	29	28	27	26	25	24	23	22	21	20	19	18	17	16
5 A Control Read/Write	C = 0x71 (113) I = 1 to 4 A = 5	Cool Proportional Band (instance i)															

Bits 16 to 31, Unsigned 16 bits with implied tenths precision (0 to 6553.5)

		Instance i + 1															
Assembly	Class, Instance, Attribute	31	30	29	28	27	26	25	24	23	22	21	20	19	18	17	16
6 A Limit Read	C = 0x71 (113) I = 1 to 4 A = 6	Limit State	Input Error Status	Analog Input Value													

Bits 16 to 28, Signed 16 bits whole (-4096 to 4095)

Bit 29, Analog Input Error Status (0 = None, 1 = Error)

Bits 30 and 31, Limit State (00 = None, 01 = Low Limit, 10 = Limit High, 11 = Other)

		Instance i + 1															
Assembly	Class, Instance, Attribute	31	30	29	28	27	26	25	24	23	22	21	20	19	18	17	16
7 A Limit Read/Write	C = 0x71 (113) I = 1 to 4 A = 7	Spare	Limit Clear	Clear Latched Error	Analog Input Value												

Bits 16 to 28, Signed 13 bits whole (-4096 to 4095)

Bit 29, Clear Latched Input Error (0 = Ignore, 1 = Clear)

Bits 30, Limit Clear (0 = Ignore, 1 = Clear)

Compact Class 1 B through 7 B

		Instance i														
Assembly	15	14	13	12	11	10	9	8	7	6	5	4	3	2	1	0
1 B	Input Error Status	Loop Error Status	Actual Control Mode	Tune Status	Control Loop Output Power											
Bits 0 to 10, Signed 10 bits with implied tenths precision (-100.0 to 100.0) Bit 11, Loop Tuning Status (0 = Off, 1 = Anything Else) Bits 12 and 13, Actual Control Mode (00 = Off, 01 = Manual, 10 = Auto) Bit 14, Loop Error Status (0 = None, 1 = Error) Bit 15, Analog Input Error (0 = None, 1 = Error)																

		Instance i														
Assembly	15	14	13	12	11	10	9	8	7	6	5	4	3	2	1	0
2 B	Spare	Open Loop Clear	Control Mode	Initiate Tune	Open Loop Set Point											
Bits 0 to 10, Signed 10 bits with implied tenths precision (-100.0 to 100.0) Bit 11, Initiate Tune (0 = No, 1 = Yes) Bits 12 and 13, Actual Control Mode (00 = Off, 01 = Manual, 10 = Auto) Bit 14, Open Loop Clear (0 = Ignore, 1 = Clear)																

		Instance i														
Assembly	15	14	13	12	11	10	9	8	7	6	5	4	3	2	1	0
3 B	Closed Loop Set Point															
Bits 0 to 15, Signed 16 bits with implied tenths precision (-3276.8 to 3276.8)																

		Instance i														
Assembly	15	14	13	12	11	10	9	8	7	6	5	4	3	2	1	0
4 B	Integral Time															
Bits 0 to 15, Unsigned 16 bits whole (0 to 65535)																

		Instance i														
Assembly	15	14	13	12	11	10	9	8	7	6	5	4	3	2	1	0
5 B	Derivative Time															
Bits 0 to 15, Unsigned 16 bits whole (0 to 65535)																

		Instance i														
Assembly	15	14	13	12	11	10	9	8	7	6	5	4	3	2	1	0
6 B	Limit State	Input Error Status	Analog Input Value													
Bits 0 to 12, Signed 13 bits whole (-4096 to 4095) Bits 13, Analog Input Error Status (0 = None, 1 = Error) Bit 14 and 15, Limit State (00 = None, 01 = Limit low, 10 = Limit high, 11 = Other)																

		Instance i														
Assembly	15	14	13	12	11	10	9	8	7	6	5	4	3	2	1	0
7 B	Spare	Limit Clear	Clear Latched Error	Limit Set Point High												
Bits 0 to 12, Signed 13 bits whole (-4096 to 4095) Bit 13, Clear Latched Input Error (0 = Ignore, 1 = Clear) Bit 14, Limit Clear (0 = Ignore, 1 = Clear)																

Compact Class 8 A through 13 A

Assembly	Class, Instance, Attribute	Instance i + 15		Instance i + 14		Instance i + 13		Instance i + 12		Instance i + 11		Instance i + 10		Instance i + 9		Instance i + 8	
		31	30	29	28	27	26	25	24	23	22	21	20	19	18	17	16
8 A Limit Read	C = 0x71 (113) I = 1 to 4 A = 8	Limit State		Limit State		Limit State		Limit State		Limit State		Limit State		Limit State		Limit State	

Bits 16 to 31, Paired bits representing the state of up to 16 limits (00 = None, 01 = Limit low,, 10 = Limit High)

Assembly	Class, Instance, Attribute	Instance i + 15		Instance i + 14		Instance i + 13		Instance i + 12		Instance i + 11		Instance i + 10		Instance i + 9		Instance i + 8	
		31	30	29	28	27	26	25	24	23	22	21	20	19	18	17	16
9 A Limit Read/Write	C = 0x71 (113) I = 1 to 4 A = 9	Spare	Limit Clear	Spare	Limit Clear	Spare	Limit Clear	Spare	Limit Clear	Spare	Limit Clear	Spare	Limit Clear	Spare	Limit Clear	Spare	Limit Clear

Bits 16 to 31, Paired bits representing the state of up to 16 limits (00 = None, 01 = Limit low,, 10 = Limit High)

Assembly	Class, Instance, Attribute	Instance i															
		31	30	29	28	27	26	25	24	23	22	21	20	19	18	17	16
10 A Limit Read/Write	C = 0x71 (113) I = 1 to 4 A = 0x0A (10)	Spare	Limit Clear	Clear Latched Error	Limit Set Point High												

Bits 16 to 28, Signed 13 bits whole (-4096 to 4095) - Bit 29, Clear Latched Input Error (0 = Ignore, 1 = Clear)

Bits 30, Limit Clear (0 = Ignore, 1 = Clear)

Assembly	Class, Instance, Attribute	Instance i + 1															
		31	30	29	28	27	26	25	24	23	22	21	20	19	18	17	16
11 A CT Read	C = 0x71 (113) I = 1 to 4 A = 0x0B (11)	Spare	Heater Error	Current Error	Current RMS												

Bits 16 to 28, Unsigned 11 bits (0 to 2047)

Bit 29, Current Error (00 = None, 01 = Low, 10 = High)

Bit 30, Heater Error (00 = None, 01 = Open, 10 = Shorted)

Assembly	Class, Instance, Attribute	Instance i + 15		Instance i + 14		Instance i + 13		Instance i + 12		Instance i + 11		Instance i + 10		Instance i + 9		Instance i + 8	
		31	30	29	28	27	26	25	24	23	22	21	20	19	18	17	16
12 A Alarm Read	C = 0x71 (113) I = 1 to 4 A = 0x0C (12)	Alarm State		Alarm State		Alarm State		Alarm State		Alarm State		Alarm State		Alarm State		Alarm State	

Bits 16 to 31, Paired bits reflecting the state of up to 16 alarms (00 = None, 01 = Alarm Low, 10 = Alarm High, 11 = Other)

Assembly	Class, Instance, Attribute	Instance i + 15		Instance i + 14		Instance i + 13		Instance i + 12		Instance i + 11		Instance i + 10		Instance i + 9		Instance i + 8	
		31	30	29	28	27	26	25	24	23	22	21	20	19	18	17	16
13 A Alarm Read/Write	C = 0x71 (113) I = 1 to 4 A = 0x0D (13)	Alarm Clear		Alarm Silence		Alarm Clear		Alarm Silence		Alarm Clear		Alarm Silence		Alarm Clear		Alarm Silence	

Bits 16 to 31, Paired bits reflecting the state of up to 16 alarms (0 = Ignore, 1 = Clear)

Compact Class 8 B through 13 B

	Instance i + 7		Instance i + 6		Instance i + 5		Instance i + 4		Instance i + 3		Instance i + 2		Instance i + 1		Instance i	
Assembly	15	14	13	12	11	10	9	8	7	6	5	4	3	2	1	0
8 B	Limit State		Limit State		Limit State		Limit State		Limit State		Limit State		Limit State		Limit State	

Bits 0 to 15, Paired bits representing the state of up to 16 limits (00 = None, 01 = Limit low., 10 = Limit High)

	Instance i + 7		Instance i + 6		Instance i + 5		Instance i + 4		Instance i + 3		Instance i + 2		Instance i + 1		Instance i	
Assembly	15	14	13	12	11	10	9	8	7	6	5	4	3	2	1	0
9 B	Spare	Limit Clear	Spare	Limit Clear	Spare	Limit Clear	Spare	Limit Clear	Spare	Limit Clear	Spare	Limit Clear	Spare	Limit Clear	Spare	Limit Clear

Bits 0, 2, 4, 6, 8, 10, 12 and 14, Limit Clear for instance i to instance i (0 = Ignore, 1 = Clear)

	Instance i															
Assembly	15	14	13	12	11	10	9	8	7	6	5	4	3	2	1	0
10 B	Spare				Limit Set Point Low											

Bits 0 to 12, Signed 13 bits whole (-4096 to 4095)

	Instance i															
Assembly	15	14	13	12	11	10	9	8	7	6	5	4	3	2	1	0
11 B	Spare	Heater Error	Current Error	Current RMS												

Bits 16 to 28, Unsigned 11 bits (0 to 2047)

Bit 29, Current Error (00 = None, 01 = Low, 10 = High)

Bit 30, Heater Error (00 = None, 01 = Open, 10 = Shorted)

	Instance i + 7		Instance i + 6		Instance i + 5		Instance i + 4		Instance i + 3		Instance i + 2		Instance i + 1		Instance i	
Assembly	15	14	13	12	11	10	9	8	7	6	5	4	3	2	1	0
12 B	Alarm State		Alarm State		Alarm State		Alarm State		Alarm State		Alarm State		Alarm State		Alarm State	

Bits 0 to 15, Paired bits reflecting the state of up to 16 alarms (00 = None, 01 = Alarm Low, 10 = Alarm High, 11 = Other)

	Instance i + 7		Instance i + 6		Instance i + 5		Instance i + 4		Instance i + 3		Instance i + 2		Instance i + 1		Instance i	
Assembly	15	14	13	12	11	10	9	8	7	6	5	4	3	2	1	0
13 B	Alarm Clear		Alarm Silence		Alarm Clear		Alarm Silence		Alarm Clear		Alarm Silence		Alarm Clear		Alarm Silence	

Bits 0 to 15, Paired bits reflecting the state of up to 16 alarms (0 = Ignore, 1 = Clear)

Compact Class 14 A through 19 A

		Instance i															
Assembly	Class, Instance, Attribute	31	30	29	28	27	26	25	24	23	22	21	20	19	18	17	16
14 A Alarm Read/Write	C = 0x71 (113) I = 1 to 4 A = 0x0E (14)	Alarm Clear	Alarm Set Point High														

Bits 16 to 30, Signed 15 bits with implied tenths precision (-1638.4 to 1638.3)

Bit 31, Alarm Clear (0 = Ignore, 1 = Clear)

		Instance i + 1															
Assembly	Class, Instance, Attribute	31	30	29	28	27	26	25	24	23	22	21	20	19	18	17	16
15 A Analog Input Read	C = 0x71 (113) I = 1 to 4 A = 0x0F (15)	Input Error Status	Filtered Analog Input Value														

Bits 16 to 30, Signed 15 bits with implied tenths precision (-1638.4 to 1638.3)

Bit 31, Analog Input Error (0 = None, 1 = Error)

		Instance i + 1															
Assembly	Class, Instance, Attribute	31	30	29	28	27	26	25	24	23	22	21	20	19	18	17	16
16 A Analog Input Read	C = 0x71 (113) I = 1 to 4 A = 0x10 (16)	Filtered Analog Input Value															

Bits 16 to 31, Signed 16 bits with implied tenths precision (-3276.8 to 3276.8)

		Instance i + 15		Instance i + 14		Instance i + 13		Instance i + 12		Instance i + 11		Instance i + 10		Instance i + 9		Instance i + 8	
Assembly	Class, Instance, Attribute	31	30	29	28	27	26	25	24	23	22	21	20	19	18	17	16
17 A Analog Input Read	C = 0x71 (113) I = 1 to 4 A = 0x11 (17)	Spare	Input Error Status	Spare	Input Error Status	Spare	Input Error Status	Spare	Input Error Status	Spare	Input Error Status	Spare	Input Error Status	Spare	Input Error Status	Spare	Input Error Status

Bits 16, 18, 20, 22, 24, 26, 28, 30, Analog Input Error Status (0 = None, 1 = Error)

Compact Class 14 B through 17 B

		Instance i															
Assembly		15	14	13	12	11	10	9	8	7	6	5	4	3	2	1	0
14 B	Alarm Silence	Alarm Set Point Low															
		Bits 0 to 14, Signed 15 bits with implied tenths precision (-1638.4 to 1638.3) Bit 15, Alarm Silence (0 = Ignore, 1 = Silence)															

		Instance i															
Assembly		15	14	13	12	11	10	9	8	7	6	5	4	3	2	1	0
15 B	Input Error Status	Filtered Analog Input Value															
		Bits 0 to 14, Signed 15 bits with implied tenths precision (-1638.4 to 1638.3) Bit 15, Analog Input Error (0 = None, 1 = Error)															

		Instance i															
Assembly		15	14	13	12	11	10	9	8	7	6	5	4	3	2	1	0
16 B		Filtered Analog Input Value															
		Bits 0 to 15, Signed 16 bits with implied tenths precision (-3276.8 to 3276.8)															

		Instance i + 7		Instance i + 6		Instance i + 5		Instance i + 4		Instance i + 3		Instance i + 2		Instance i + 1		Instance i	
Assembly		15	14	13	12	11	10	9	8	7	6	5	4	3	2	1	0
17 B	Spare	Input Error Status	Spare	Input Error Status	Spare	Input Error Status	Spare	Input Error Status	Spare	Input Error Status	Spare	Input Error Status	Spare	Input Error Status	Spare	Input Error Status	Input Error Status
		Bits 0, 2, 4, 6, 8, 10, 12, 14, Analog Input Error Status(0 = None, 1 = Error)															

PM Specifications

Line Voltage/Power (Minimum/Maximum Ratings)

- 85 to 264V~ (ac), 47 to 63Hz
- 20 to 28V~ (ac), 47 to 63Hz
- 12 to 40V= (dc)
- 14VA maximum power consumption (PM4, 8 & 9)
- 10VA maximum power consumption (PM6)
- Data retention upon power failure via non-volatile memory
- Compliant with SEMIF47-0200, Figure R1-1 voltage sag requirements @ 24V~ (ac) or higher

Environment

- 0 to 149°F (-18 to 65°C) operating temperature
- -40 to 185°F (-40 to 85°C) storage temperature
- 0 to 90% RH, non-condensing

Accuracy

- Calibration accuracy and sensor conformity: $\pm 0.1\%$ of span, $\pm 1^\circ\text{C}$ @ the calibrated ambient temperature and rated line voltage
- Types R, S, B; 0.2%
- Type T below -50°C ; 0.2%
- Calibration ambient temperature @ $77 \pm 5^\circ\text{F}$ ($25 \pm 3^\circ\text{C}$)
- Accuracy span :1000 °F (540°C) min.
- Temperature stability: $\pm 0.1^\circ\text{F}/^\circ\text{F}$ ($\pm 0.1^\circ\text{C}/^\circ\text{C}$) rise in ambient max.

Agency Approvals

- UL® Listed to UL® 61010-1 File E185611
- UL® Reviewed to CSA C22.2 No.61010-1-04
- UL® 50Type 4X, NEMA 4X indoor locations, IP65 front panel seal (indoor use only)
- FM Class 3545 File 3029084 temperature limit switches
- CE-See Declaration of Conformity RoHS and W.E.E.E. compliant
- ODVA-EtherNet/IP™ and DeviceNet Compliance
- CSA C22. No. 24 File 158031 Class 4813-023-02, CSA Approved

Isolated Serial Communications

- EIA232/485, Modbus® RTU
- EtherNet/IP™, DeviceNet™ (ODVA certified)
- Modbus TCP
- Profibus DP

Wiring Termination—Touch-Safe Terminals

- Input, power and controller output terminals are touch safe removable 3.30 to 0.0507 mm² (12 to 22 AWG)
- Wire strip length 7.6 mm (0.30 in.)
- Torque 0.56 Nm (5.0 in-lb)

Universal Input

- Thermocouple, grounded or ungrounded sensors
 - >20M Ω input impedance
- Max. 2k Ω source resistance
- 3 μ A open sensor detection
- RTD 2- or 3-wire, platinum, 100 Ω and 1k Ω @ 0 $^{\circ}$ C (32 $^{\circ}$ F) calibration to DIN curve (0.00385 $\Omega/\Omega/^{\circ}$ C)
- Process, 0-20mA @100 Ω , or 0-10V \rightleftharpoons (dc) @ 20k Ω input impedance; scalable, 0-50mV

Voltage Input Ranges

- Accuracy ± 10 mV ± 1 LSD at standard conditions
- Temperature stability ± 100 PPM/ $^{\circ}$ C maximum

Milliamp Input Ranges

- Accuracy ± 20 μ A ± 1 LSD at standard conditions
- Temperature stability ± 100 PPM/ $^{\circ}$ C maximum

Resolution Input Ranges

- 0 to 10V: 200 μ V nominal
- 0 to 20mA: 0.5mA nominal

- Potentiometer: 0 to 1.2k Ω
- Inverse scaling
- Current: input range is 0 to 50mA, 100 Ω input impedance
- Response time: 1 second max., accuracy ± 1 mA typical

Input Type	Max Error @ 25 Deg C	Accuracy Range Low	Accuracy Range High	Units
J	± 1.75	0	750	Deg C
K	± 2.45	-200	1250	Deg C
T	± 1.55	-200	350	Deg C
Input Type	Max Error @ 25 Deg C	Accuracy Range Low	Accuracy Range High	Units
N	± 2.25	0	1250	Deg C
E	± 2.10	-200	900	Deg C
R	± 3.9	0	1450	Deg C
S	± 3.9	0	1450	Deg C
B	± 2.66	870	1700	Deg C
C	± 3.32	0	2315	Deg C
D	± 3.32	0	2315	Deg C
F (PTII)	± 2.34	0	1343	Deg C
RTD, 100 ohm	± 2.00	-200	800	Deg C
RTD, 1000 ohm	± 2.00	-200	800	DegC
mV	± 0.05	-50	50	mV
Volts	± 0.01	0	10	Volts
mAdc	± 0.02	0	20	mAmps DC
mAac	± 5	0	50	mAmps AC

Operating Range			
Input Type	Range Low	Range High	Units
J	-210	1200	Deg C
K	-270	1371	Deg C
T	-270	400	Deg C
N	-270	1300	Deg C
E	-270	1000	Deg C
R	-50	1767	Deg C
S	-50	1767	Deg C
B	0	1816	Deg C
C	0	2315	Deg C
D	0	2315	Deg C
F (PTII)	0	1343	Deg C
RTD (100 ohm)	-200	800	Deg C
RTD (1000 ohm)	-200	800	Deg C
mV	0	50	mV
Volts	0	10	Volts
mAdc	0	20	mAmps DC
mAac	0	50	mAmps AC
Potentiometer, 1K range	0	1200	Ohms
Resistance, 5K range	0	5000	Ohms
Resistance, 10K range	0	10000	Ohms
Resistance, 20K range	0	20000	Ohms
Resistance, 40K range	0	40000	Ohms

Thermistor Input				
Input Type	Max Error @ 25 Deg C	Accuracy Range Low	Accuracy Range High	Units
Thermistor, 5K range	±5	0	5000	Ohms
Thermistor, 10K range	±10	0	10000	Ohms
Thermistor, 20K range	±20	0	20000	Ohms
Thermistor, 40K range	±40	0	40000	Ohms

- 0 to 40kΩ, 0 to 20kΩ, 0 to 10kΩ, 0 to 5kΩ
- 2.252kΩ and 10kΩ base at 25°C
- Linearization curves built in
- Third party Thermistor compatibility requirements

Base R @ 25C	Alpha Techniques	Beta THERM	YSI	Thermistor Curve
2.252K	Curve A	2.2K3A	004	A
10K	Curve A	10K3A	016	B
10K	Curve C	10K4A	006	C

2 Digital Input/Output Option - 2 DIO

- Digital input update rate 10Hz
 - *DC voltage*
 - Max. input 36V @ 3mA
 - Min. high state 3V at 0.25mA
 - Max. low state 2V
 - *Dry contact*
 - Min. open resistance 10k Ω
 - Max. closed resistance 50 Ω
 - Max. short circuit 13mA
- Digital output update rate 10Hz
 - SSR drive signal
 - Update rate 10 Hz
 - Maximum open circuit voltage is 22 to 25 $\overline{\text{V}}$ (dc)
 - PNP transistor source
 - Typical drive; 21mA @ 4.5V for DO5, and 11mA @ 4.5V for DO6
 - Current limit 24mA for Output 5 and 12mA Output 6
 - Output 5 capable of driving one 3 - pole DIN-A-MITE
 - Output 6 capable of driving one 1 - pole DIN-A-MITE

Output Hardware

- Switched DC
 - Maximum open circuit voltage is 22 to 25 $\overline{\text{V}}$ (dc)
 - 30mA max. per single output / 40mA max. total per paired outputs (3 & 4)
 - Typical drive; 4.5 $\overline{\text{V}}$ (dc) @ 30mA
 - Short circuit limited to <50mA
 - Use dc- and dc+ to drive external solid-state relay
 - 1-pole DIN-A-MITE: up to 4 in parallel or 4 in series
 - 2-pole DIN-A-MITE: up to 2 in parallel or 2 in series
 - 3-pole DIN-A-MITE: up to 2 in series
- Switched dc/open collector = 30 $\overline{\text{V}}$ (dc) max. @ 100mA max. current sink
- Solid State Relay (SSR), FormA, 0.5A @ 24V \sim (ac) min., 240V \sim (ac) max., 1A at 50 $^{\circ}$ F linear derating to 0.5A at 149 $^{\circ}$ F resistive, opto-isolated, without contact suppression, 120/240V \sim (ac) 20 VA pilot duty
 - Minimum holding current of 10mA
- Electromechanical relay, Form C, 5A, 24 to 240V \sim (ac) or 30 $\overline{\text{V}}$ (dc) max., resistive load, 100,000 cycles at rated load, 125 VA pilot duty at 120/240V \sim (ac), 25 VA at 24V \sim (ac)
- Electromechanical relay, Form A, 5A, 24 to 240V \sim (ac) or 30 $\overline{\text{V}}$ (dc) max., resistive load, 100,000 cycles at rated load, 125 VA pilot duty at 120/240V \sim (ac), 25 VA at 24V \sim (ac)
- NO-ARC relay, Form A, 15A, 24 to 240V \sim (ac), no $\overline{\text{V}}$ (dc), resistive load, 2 million cycles at rated load

- Universal process/retransmit, Output range selectable:

- 0 to 10V_{rms} (dc) into a min. 1kΩ load
- 0 to 20mA into max. 800Ω load

Resolution

- dc ranges: 2.5mV nominal
- mA ranges: 5μA nominal

Calibration Accuracy

- dc ranges: ±15mV
- mA ranges: ±30μA

Temperature Stability

- 100 ppm/°C

Operator Interface

- Dual 4 digit, 7 segment LED displays
- Advance, infinity, up and down keys, plus optional programmable EZ-KEY/s depending on model size
- Typical display update rate 1Hz
- RESET key substituted for infinity on all models including the limit control

Dimensions				
Size	Behind Panel (max.)	Width	Height	Display Character Height
1/32	101.6 mm (4.00 in)	53.3 mm (2.10 in)	30.9 mm (1.22 in)	Large: 7.62 mm (0.300 in) Small: 5.59 mm (0.220 in)
1/4	100.8 mm (3.97 in)	100.3 mm (3.95 in)	100.3 mm (3.95 in)	Large: 20.32 mm (0.800 in) Medium: 12.70 mm (0.500 in) Small: 10.16 mm (0.400 in)
1/16	101.6 mm (4.00 in)	53.3 mm (2.10 in)	53.3 mm (2.10 in)	Large: 10.16 mm (0.400 in) Small: 5.97 mm (0.235 in)
1/8 (H)	101.6 mm (4.00 in)	100.3 mm (3.95 in)	54.8 mm (2.16 in)	Large: 11.4 mm (0.450 in) Medium: 9.53 mm (0.375 in) Small: 7.62 mm (0.300 in)
1/8 (V)	101.6 mm (4.00 in)	54.8 mm (2.16 in)	100.3 mm (3.95 in)	Large: 11.4 mm (0.450 in) Medium: 9.53 mm (0.375 in) Small: 7.62 mm (0.300 in)

Weight	
1/32 DIN (PM3) • Controller: 127 g (4.5 oz.)	1/4 DIN (PM4) • Controller: 331 g (11.7 oz.)
1/8 DIN (PM8 and 9) • Controller: 284 g (10 oz.)	1/16 DIN (PM6) • Controller: 186 g (6.6 oz.)
User's Guide • User's Guide: 284.86 g (10.1 oz)	

Modbus® is a trademark of AEG Schneider Automation Inc.

EtherNet/IP™ is a trademark of ControlNet International Ltd. used under license by Open DeviceNet Vendor Association, Inc. (ODVA).

UL® is a registered trademark of Underwriters Laboratories Inc.

DeviceNet™ is a trademark of Open DeviceNet Vendors Association.

Note:

These specifications are subject to change without prior notice.

Ordering Information for Enhanced Limit Controller Models

Enhanced Limit Controller

EZ-ZONE® Enhanced Limit Models
 TRU-TUNE+® Adaptive Tune, red-green 7-segment displays

Package Size

- 6 Panel Mount 1/16 DIN
- 8 Panel Mount 1/8 DIN Vertical
- 9 Panel Mount 1/8 DIN Horizontal
- 4 Panel Mount 1/4 DIN

Primary Function

- L Limit Controller with Universal Input
- M Limit Controller with Thermistor
- D Custom Firmware

Power Supply, Digital Input/Output

- 1 100 to 240V~ (ac)
- 2 100 to 240V~ (ac) plus 2 Digital I/O points
- 3 24V~ (ac) and 15 to 36V[≡] (dc)
- 4 24V~ (ac) and 15 to 36V[≡] (dc), plus 2 Digital I/O points

Output 1 and 2 Hardware Options

Output 1		Output 2	
AJ	None		Mechanical relay 5 A, form A
CJ	Switched dc/open collector		Mechanical relay 5 A, form A
EJ	Mechanical relay 5 A, form C		Mechanical relay 5 A, form A

Communications Options

- A None
- 1 EIA 485 Modbus RTU®
- 2 Modbus RTU 232/485
- 3 EtherNet/IP™, Modbus TCP
- 5 DeviceNet
- 6 Profibus

- Standard Bus EIA-485 always included - all models

Future Options

- A None

Output 3 and 4 Hardware Options

Output 3		Output 4	
AA	None		None
AJ	None		Mechanical relay 5 A, form A
AK	None		Solid-State Relay 0.5 A, form A
CA	Switched dc/open collector		None
CC	Switched dc/open collector		Switched dc
CJ	Switched dc/open collector		Mechanical relay 5 A, form A
CK	Switched dc/open collector		Solid-State Relay 0.5 A, form A
EA	Mechanical relay 5 A, form C		None
EC	Mechanical relay 5 A, form C		Switched dc
EJ	Mechanical relay 5 A, form C		Mechanical relay 5 A, form A
EK	Mechanical relay 5 A, form C		Solid-State Relay 0.5 A, form A
FA	Universal Process		None
FC	Universal Process		Switched dc
FJ	Universal Process		Mechanical relay 5 A, form A
FK	Universal Process		Solid-State Relay 0.5 A, form A
KK	Solid-State Relay 0.5 A, form A		Solid-State Relay 0.5 A, form A

- PM6 only, if communications options 2 - 6 are ordered, option AA must be selected here.

Isolated Input Option

- A None
- D Isolated Input 1

Custom Options

- AA Standard EZ-ZONE face plate
- AB EZ-ZONE logo and no Watlow name
- AC No logo and no Watlow name
- AG conformal coating
- XX custom firmware, overlays, ...

Note:

The model of controller that you have is one of many possible models in the EZ-ZONE PM family of controllers. To view the others, visit our website (<http://www.watlow.com/en/resources-and-support/Technical-Library/User-Manuals>) and type EZ-ZONE into the Key-word field.

Ordering Information for Limit Controller Models

Limit Controller

EZ-ZONE® Limit Models
 TRU-TUNE+® Adaptive Tune, red-green 7-segment displays

Package Size

- 3 Panel Mount 1/32 DIN
- 6 Panel Mount 1/16 DIN
- 8 Panel Mount 1/8 DIN Vertical
- 9 Panel Mount 1/8 DIN Horizontal
- 4 Panel Mount 1/4 DIN

Primary Function

- L Limit Controller with Universal Input
- M Limit Controller with Thermistor
- D Custom Firmware

Power Supply, Digital Input/Output

- 1 100 to 240V~ (ac)
- 2 100 to 240V~ (ac) plus 2 Digital I/O points
- 3 24V~ (ac) and 15 to 36V= (dc)
- 4 24V~ (ac) and 15 to 36V= (dc), plus 2 Digital I/O points

Output 1 and 2 Hardware Options

Output 1		Output 2
AJ	None	Mechanical relay 5 A, form A
CJ	Switched dc/open collector	Mechanical relay 5 A, form A
EJ	Mechanical relay 5 A, form C	Mechanical relay 5 A, form A

Communications Options

- A None
 - 1 EIA 485 Modbus RTU®
- Standard Bus EIA-485 always included - all models*

Future Option

- AAA None

Isolated Input Option

- A None
- D Isolated Input 1

Custom Options

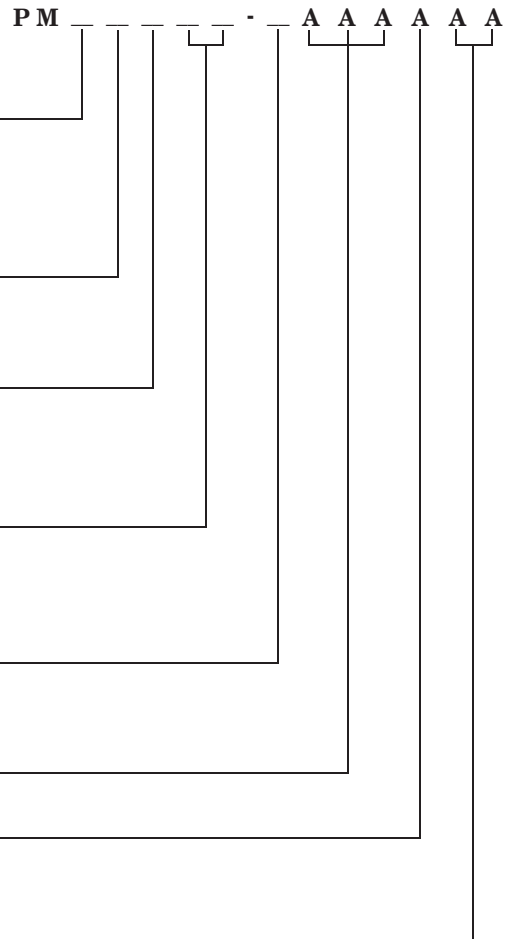

Note:

The model of controller that you have is one of many possible models in the EZ-ZONE PM family of controllers. To view the others, visit our website (<http://www.watlow.com/en/resources-and-support/Technical-Library/User-Manuals>) and type EZ-ZONE into the Keyword field.

Declaration of Conformity

Series EZ-ZONE[®] PM



WATLOW Electric Manufacturing Company

ISO 9001 since 1996.

1241 Bundy Blvd.
Winona, MN 55987 USA

Declares that the following product:

Designation: **Series EZ-ZONE[®] PM (Panel Mount)**

Model Numbers: PM (3, 6, 8, 9 or 4)(Any Letter or number) – (1, 2, 3 or 4)(A, C, E, F or K) (A, C, H, J or K)(Any letter or number) – (Any letter or number)(A, C, E, F or K)(A, C, H, J or K) (Any three letters or numbers)

Classification: Temperature control, Installation Category II, Pollution degree 2, IP65

Rated Voltage and Frequency: 100 to 240 V~ (ac 50/60 Hz) **or** 15 to 36 V=dc/ 24 V~ac 50/60 Hz

Rated Power Consumption: 10 VA maximum PM3, PM6 Models.
14 VA maximum PM8, PM9, PM4 Models

Meets the essential requirements of the following European Union Directives by using the relevant standards show below to indicate compliance.

2004/108/EC Electromagnetic Compatibility Directive

EN 61326-1	2013	Electrical equipment for measurement, control and laboratory use – EMC requirements (Industrial Immunity, Class B Emissions).
EN 61000-4-2	2009	Electrostatic Discharge Immunity
EN 61000-4-3	2010	Radiated Field Immunity 10V/M 80–1000 MHz, 3 V/M 1.4–2.7 GHz
EN 61000-4-4	2012	Electrical Fast-Transient / Burst Immunity
EN 61000-4-5	2006	Surge Immunity (Also compliant with IEC 61000-4-5 2014)
EN 61000-4-6	2014	Conducted Immunity
EN 61000-4-11	2004	Voltage Dips, Short Interruptions and Voltage Variations Immunity
EN 61000-3-2	2009	Harmonic Current Emissions (Also compliant with IEC 61000-3-2 2014)
EN 61000-3-3 ¹	2013	Voltage Fluctuations and Flicker
SEMI F47	2000	Specification for Semiconductor Sag Immunity Figure R1-1

¹For mechanical relay loads, cycle time may need to be extended up to 160 seconds to meet flicker requirements depending on load switched and source impedance.

2006/95/EC Low-Voltage Directive

EN 61010-1	2011²	Safety Requirements of electrical equipment for measurement, control and laboratory use. Part 1: General requirements
-------------------	-------------------------	------------------------------------------------------------------------------------------------------------------------------

² Compliance with 3rd Edition requirements with use of external surge suppressor installed on 230 Vac~ power line units. Recommend minimum 1000 V peak to maximum 2000 V peak, 70 joules or better part be used.

Compliant with 2011/65/EU RoHS2 Directive

Per 2012/19/EU W.E.E Directive  Please Recycle Properly.

Joe Millanes
Name of Authorized Representative

Winona, Minnesota, USA
Place of Issue

Director of Operations
Title of Authorized Representative

September 2014
Date of Issue

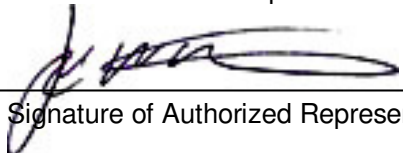
Signature of Authorized Representative

How to Reach Us

Corporate Headquarters

Watlow Electric Manufacturing Company
12001 Lackland Road
St. Louis, MO 63146
Sales: 1-800-WATLOW2
Manufacturing Support: 1-800-4WATLOW
Email: info@watlow.com
Website: www.watlow.com
From outside the USA and Canada:
Tel: +1 (314) 878-4600
Fax: +1 (314) 878-6814

Latin America

Watlow de México S.A. de C.V.
Av. Fundación No. 5
Col. Parques Industriales
Querétaro, Qro. CP-76130
Mexico
Tel: +52 442 217-6235
Fax: +52 442 217-6403

Asia and Pacific

Watlow Singapore Pte Ltd.
16 Ayer Rajah Crescent,
#06-03/04,
Singapore 139965
Tel: +65 6773 9488 Fax: +65 6778 0323
Email: info@watlow.com.sg Website: www.watlow.com.sg

Watlow Australia Pty., Ltd.
4/57 Sharps Road
Tullamarine, VIC 3043
Australia
Tel: +61 3 9335 6449
Fax: +61 3 9330 3566
Website: www.watlow.com

Watlow Electric Manufacturing Company (Shanghai) Co. Ltd.
Room 501, Building 10, KIC Plaza
290 Songhu Road, Yangpu District
Shanghai, China 200433
China
Phone:
Local: 4006 Watlow (4006 928569)
International: +86 21 3381 0188
Fax: +86 21 6106 1423
Email: vlee@watlow.cn
Website: www.watlow.cn

ワトロー・ジャパン株式会社
〒101-0047 東京都千代田区内神田1-14-4
四国ビル別館9階
Tel: 03-3518-6630 Fax: 03-3518-6632
Email: infoj@watlow.com Website: www.watlow.co.jp

Watlow Japan Ltd.
1-14-4 Uchikanda, Chiyoda-Ku
Tokyo 101-0047
Japan
Tel: +81-3-3518-6630 Fax: +81-3-3518-6632
Email: infoj@watlow.com Website: www.watlow.co.jp

Europe

Watlow France
Tour d'Asnières.
4 Avenue Laurent Cély
92600 Asnières sur Seine
France
Tél: + 33 (0)1 41 32 79 70
Télécopie: + 33(0)1 47 33 36 57
Email: info@watlow.fr
Website: www.watlow.fr

Watlow GmbH
Postfach 11 65, Lauchwasenstr. 1
D-76709 Kronau
Germany
Tel: +49 (0) 7253 9400-0
Fax: +49 (0) 7253 9400-900
Email: info@watlow.de
Website: www.watlow.de

Watlow Italy S.r.l.
Viale Italia 52/54
20094 Corsico MI
Italy
Tel: +39 024588841
Fax: +39 0245869954
Email: italyinfo@watlow.com
Website: www.watlow.it

Watlow Ibérica, S.L.U.
C/Marte 12, Posterior, Local 9
E-28850 Torrejón de Ardoz
Madrid - Spain
T. +34 91 675 12 92
F. +34 91 648 73 80
Email: info@watlow.es
Website: www.watlow.es

Watlow UK Ltd.
Linby Industrial Estate
Linby, Nottingham, NG15 8AA
United Kingdom
Telephone: (0) 115 964 0777
Fax: (0) 115 964 0071
Email: info@watlow.co.uk
Website: www.watlow.co.uk
From outside The United Kingdom:
Tel: +44 115 964 0777
Fax: +44 115 964 0071

Watlow Korea Co., Ltd.
#1406, E&C Dream Tower, 46, Yangpyeongdong-3ga
Yeongdeungpo-gu, Seoul 150-103
Republic of Korea
Tel: +82 (2) 2628-5770 Fax: +82 (2) 2628-5771
Website: www.watlow.co.kr

Watlow Malaysia Sdn Bhd
1F-17, IOI Business Park
No.1, Persiaran Puchong Jaya Selatan
Bandar Puchong Jaya
47100 Puchong, Selangor D.E.
Malaysia
Tel: +60 3 8076 8745 Fax: +60 3 8076 7186
Email: vlee@watlow.com
Website: www.watlow.com

瓦特龍電機股份有限公司
80143 高雄市前金區七賢二路189號 10樓之一
電話: 07-2885168 傳真: 07-2885568

Watlow Electric Taiwan Corporation
10F-1 No.189 Chi-Shen 2nd Road Kaohsiung 80143
Taiwan
Tel: +886-7-2885168 Fax: +886-7-2885568

Your Authorized Watlow Distributor

