

Operating Instructions Proline Promag W 10

Electromagnetic flowmeter
HART



Table of contents

1	About this document	6	8	Commissioning	62
	Document function	6		Post-installation check and post-connection check	62
	Associated documentation	6		IT security	62
	Symbols	7		Device-specific IT security	62
	Registered trademarks	9		Switching on the device	63
				Commissioning the device	64
2	Safety instructions	12	9	Operation	68
	Requirements for specialist personnel	12		Reading the device locking status	68
	Requirements for operating personnel	12		HistoROM data management	68
	Incoming acceptance and transport	12	10	Diagnostics and troubleshooting	70
	Adhesive labels, tags and engravings	12		General troubleshooting	70
	Environment and process	12		Diagnostic information via LED	71
	Occupational safety	12		Diagnostic information on local display	73
	Installation	12		Diagnostic information in FieldCare or DeviceCare	74
	Electrical connection	12		Changing the diagnostic information	75
	Surface temperature	13		Overview of diagnostic information	76
	Commissioning	13		Pending diagnostic events	79
	Modifications to the device	13		Diagnostic list	80
				Event logbook	80
				Device reset	82
3	Product information	16	11	Maintenance	84
	Measuring principle	16		Maintenance tasks	84
	Designated use	16		Services	84
	Incoming acceptance	16	12	Disposal	86
	Product identification	17		Removing the device	86
	Transport	19		Disposing of the device	86
	Checking the storage conditions	21	13	Technical data	88
	Recycling of packaging materials	21		Input	88
	Product design	22		Output	91
	Firmware history	24		Power supply	95
	Device history and compatibility	24		Cable specification	97
				Performance characteristics	100
				Environment	102
				Process	104
				Mechanical construction	109
				Local display	117
				Certificates and approvals	118
				Application packages	119
4	Installation	26	14	Dimensions in SI units	122
	Installation conditions	26		Compact version	122
	Device installation	31		Remote version	125
	Post-installation check	34		Fixed flange	130
				Lap joint flange	141
				Lap joint flange, stamped plate	144
				Accessories	145
5	Electrical connection	36			
	Connection conditions	36			
	Connecting cable connection	37			
	Connecting the transmitter	42			
	Ensuring potential equalization	44			
	Removing a cable	47			
	Hardware settings	47			
	Post-connection check	48			
6	Operation	50			
	Overview of the operating options	50			
	Local operation	50			
	SmartBlue App	55			
7	System integration	58			
	Device description files	58			
	Measured variables via HART protocol	58			

15	Dimensions in US units	148
	Compact version	148
	Remote version	151
	Fixed flange	156
	Lap joint flange	158
	Accessories	159
16	Accessories	162
	Device-specific accessories	162
	Communication-specific accessories	163
	Service-specific accessory	163
	System components	164
17	Appendix	166
	Screw tightening torques	167
	Examples for electric terminals	175

Index

1 About this document

Document function	6
Associated documentation	6
Symbols	7
Registered trademarks	9

Document function



These Operating Instructions provide all of the information that is required in various phases of the life cycle of the device:

- Incoming acceptance and product identification
- Storage and transport
- Installation and connection
- Commissioning and operation
- Diagnostics and troubleshooting
- Maintenance and disposal

Associated documentation

Technical Information	Overview of the device with the most important technical data.
Operating Instructions	All the information that is required in the various phases of the life cycle of the device: from product identification, incoming acceptance and storage, to mounting, connection, operation and commissioning through to troubleshooting, maintenance and disposal as well as the technical data and dimensions.
Sensor Brief Operating Instructions	Incoming acceptance, transport, storage and mounting of the device.
Transmitter Brief Operating Instructions	Electrical connection and commissioning of the device.
Description of Parameters	Detailed explanation of the menus and parameters.
Safety Instructions	Documents for the use of the device in hazardous areas.
Special Documentation	Documents with more detailed information on specific topics.
Installation Instructions	Installation of spare parts and accessories.

The related documentation is available online:

W@M Device Viewer	On the www.endress.com/deviceviewer website, enter the serial number of the device: nameplate → <i>Product identification</i> ,  17
Endress+Hauser Operations App	<ul style="list-style-type: none"> ▶ Scan the Data Matrix code: nameplate → <i>Product identification</i>,  17 ▶ Enter the serial number of the device: nameplate → <i>Product identification</i>,  17

Symbols

Warnings

DANGER

This symbol alerts you to an immediate dangerous situation. Failure to avoid the situation will result in a fatal or serious injury.

WARNING

This symbol alerts you to a potentially dangerous situation. Failure to avoid the situation may result in a fatal or serious injury.





CAUTION

This symbol alerts you to a potentially dangerous situation. Failure to avoid the situation may result in a minor or mild injury.





NOTICE

This symbol alerts you to a potentially harmful situation. Failure to avoid the situation may result in damage to the facility or to something in the facility's vicinity.



Electronics

-  Direct current
-  Alternating current
-  Direct current and alternating current
-  Protective earthing









Device communication





-  Bluetooth is enabled.
-  LED is off.
-  LED flashing.
-  LED lit.

Tools



-  Flat blade screwdriver
-  Hexagon wrench
-  Wrench

Types of information

-  Preferred procedures, processes or actions
-  Permitted procedures, processes or actions
-  Forbidden procedures, processes or actions
-  Additional information
-  Reference to documentation
-  Reference to page
-  Reference to graphic
-  Measure or individual action to be observed

-  Series of steps
-  Result of a step
-  Help in the event of a problem
-  Visual inspection
-  Write-protected parameter

Explosion protection

-  Hazardous area
-  Non-hazardous area

Registered trademarks

HART®

Registered trademark of the FieldComm Group, Austin, USA

Bluetooth®

The Bluetooth word mark and Bluetooth logos are registered trademarks of Bluetooth SIG. Inc. and any use of such marks by Endress+Hauser is under license. Other trademarks and trade names are those of their respective owners.

Apple®

Apple, the Apple logo, iPhone, and iPod touch are trademarks of Apple Inc., registered in the U.S. and other countries. App Store is a service mark of Apple Inc.

Android®

Android, Google Play and the Google Play logo are trademarks of Google Inc.

2 Safety instructions

Requirements for specialist personnel	12
Requirements for operating personnel	12
Incoming acceptance and transport	12
Adhesive labels, tags and engravings	12
Environment and process	12
Occupational safety	12
Installation	12
Electrical connection	12
Surface temperature	13
Commissioning	13
Modifications to the device	13

Requirements for specialist personnel

- ▶ Installation, electrical connection, commissioning, diagnostics and maintenance of the device must only be carried out by trained, specialist personnel authorized by the facility's owner-operator.
- ▶ Before commencing work, the trained, specialist personnel must carefully read, understand and adhere to the Operating Instructions, additional documentation and certificates.
- ▶ Comply with national regulations.

Requirements for operating personnel

- ▶ Operating personnel are authorized by the facility's owner-operator and are instructed according to the requirements of the task.
- ▶ Before commencing work, the operating personnel must carefully read, understand and adhere to the instructions provided in the Operating Instructions and additional documentation.

Incoming acceptance and transport

- ▶ Transport the device in a correct and appropriate manner.
- ▶ Do not remove protective covers or protective caps on the process connections.

Adhesive labels, tags and engravings

- ▶ Pay attention to all the safety instructions and symbols on the device.

Environment and process

- ▶ Only use the device for the measurement of appropriate media.
- ▶ Keep within the device-specific pressure range and temperature range.
- ▶ Protect the device from corrosion and the influence of environmental factors.

Occupational safety

- ▶ Wear the required protective equipment according to national regulations.
- ▶ Do not ground the welding unit by means of the device.
- ▶ Wear protective gloves if working on and with the device with wet hands.

Installation

- ▶ Do not remove protective covers or protective caps on the process connections until just before you install the sensor.
- ▶ Do not damage or remove the liner on the flange.
- ▶ Observe tightening torques.

Electrical connection

- ▶ Comply with national installation regulations and guidelines.
- ▶ Observe cable specifications and device specifications.
- ▶ Check the cable for damage.

- ▶ If using the device in hazardous areas, observe the "Safety Instructions" documentation.
- ▶ Provide (establish) potential equalization.
- ▶ Provide (establish) grounding.

Surface temperature

Media with elevated temperatures can cause the surfaces of the device to become hot. For this reason, note the following:

- ▶ Mount suitable touch protection.
- ▶ Wear suitable protective gloves.

Commissioning

- ▶ Operate the device only if it is in proper technical condition, free from errors and faults.
- ▶ Only put the device into operation once you have performed the post-installation check and post-connection check.

Modifications to the device

Modifications or repairs are not permitted and can pose a danger. For this reason, note the following:

- ▶ Only carry out modifications or repairs after consulting beforehand with an Endress+Hauser service organization.
- ▶ Only use original spare parts and original accessories from Endress+Hauser.
- ▶ Install original spare parts and original accessories according to the Installation Instructions.

3 Product information

Measuring principle	16
Designated use	16
Incoming acceptance	16
Product identification	17
Transport	19
Checking the storage conditions	21
Recycling of packaging materials	21
Product design	22
Firmware history	24
Device history and compatibility	24

Measuring principle

Electromagnetic flow measurement on the basis of *Faraday's law of magnetic induction*.

Designated use

The device is only suitable for flow measurement of liquids with a minimum conductivity of 5 $\mu\text{S}/\text{cm}$.

Depending on the version, the device measures potentially explosive, flammable, poisonous and oxidizing media.

Devices for use in a hazardous area, in hygienic applications, or where there is an increased risk due to process pressure, are labeled accordingly on the nameplate.

Non-designated use can compromise safety. The manufacturer is not liable for damage caused by improper or non-designated use.

Incoming acceptance

Is technical documentation provided with the device?	<input type="checkbox"/>
Does the scope of supply match the specifications on the delivery note?	<input type="checkbox"/>
Is the order code on the delivery note and nameplate identical?	<input type="checkbox"/>
Does the device bear any signs of damage from transportation?	<input type="checkbox"/>
Has an incorrect device been ordered or delivered or has the device been damaged in transit? Complaints or returns: www.services.endress.com/return-material	<input type="checkbox"/>

Product identification

Device name

The device comprises the following parts:

- Proline 10 transmitter
- Promag W sensor

Transmitter nameplate

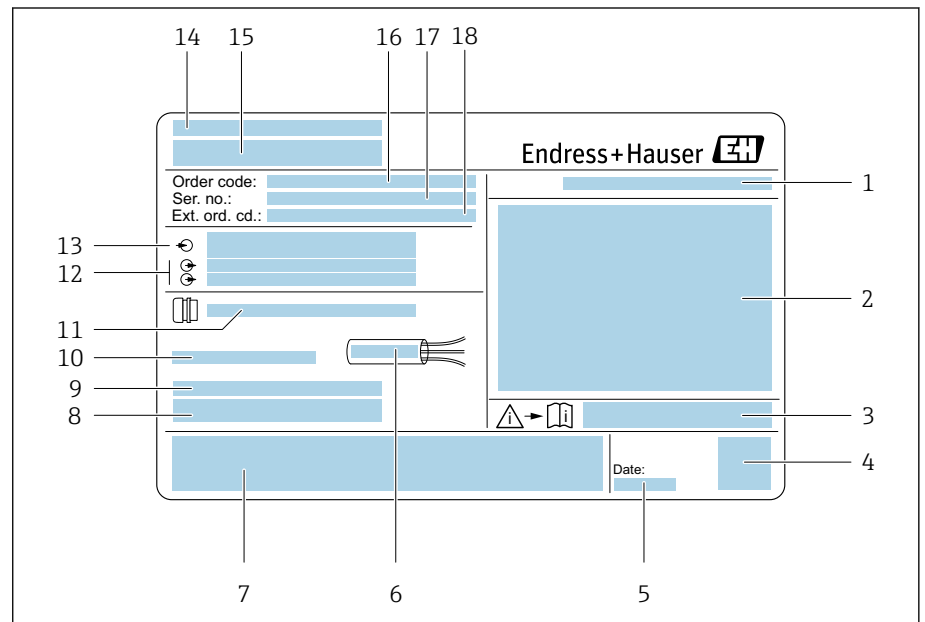

A0042943

1 Example of a transmitter nameplate

- 1 Degree of protection
- 2 Approvals for hazardous area, electrical connection data
- 3 Document number of safety-related supplementary documentation
- 4 Data Matrix code
- 5 Manufacturing date: year-month
- 6 Permitted temperature range for cable
- 7 CE mark and other approval marks
- 8 Firmware version (FW) and device revision (Dev.Rev.) from the factory
- 9 Additional information in the case of special products
- 10 Permitted ambient temperature (T_a)
- 11 Information on the cable entry
- 12 Available inputs and outputs: supply voltage
- 13 Electrical connection data: supply voltage and supply power
- 14 Place of manufacture
- 15 Transmitter name
- 16 Order code
- 17 Serial number
- 18 Extended order code

Sensor nameplate

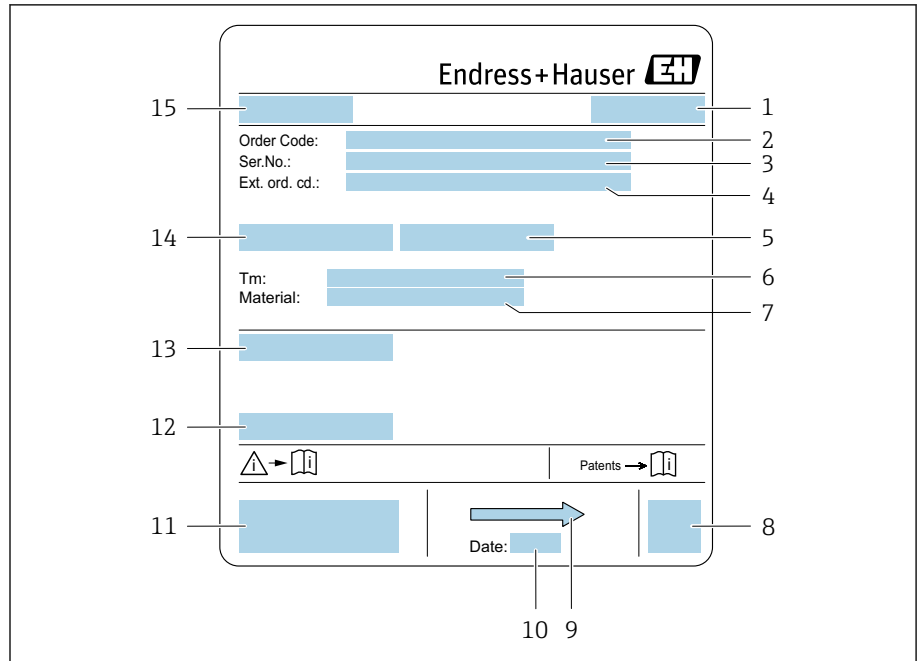

A0042987

2 Example of sensor nameplate

- 1 Place of manufacture
- 2 Order code
- 3 Serial number
- 4 Extended order code
- 5 Sensor test pressure
- 6 Medium temperature range
- 7 Material of coating and electrodes
- 8 Data Matrix code
- 9 Flow direction
- 10 Manufacturing date: year-month
- 11 CE mark, C-Tick
- 12 Permitted ambient temperature (T_a)
- 13 Degree of protection, e.g. IP, NEMA
- 14 Sensor nominal diameter
- 15 Sensor name

Transport

Protective packaging

Protective covers or protective caps are fitted on the process connections to protect against damage and dirt.

Transporting in the original packaging

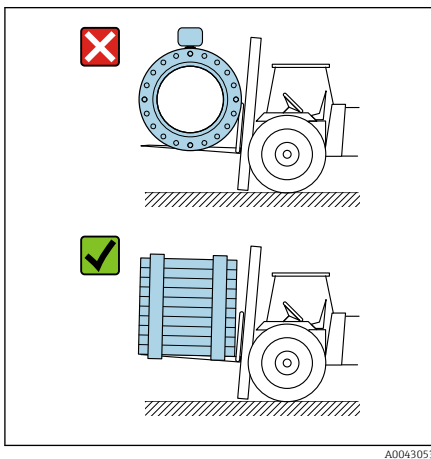

A0043053

NOTICE

Original packaging is missing!

Damage to the magnetic coil.

- ▶ Only lift and transport the device in the original packaging.

Transporting with lifting lugs

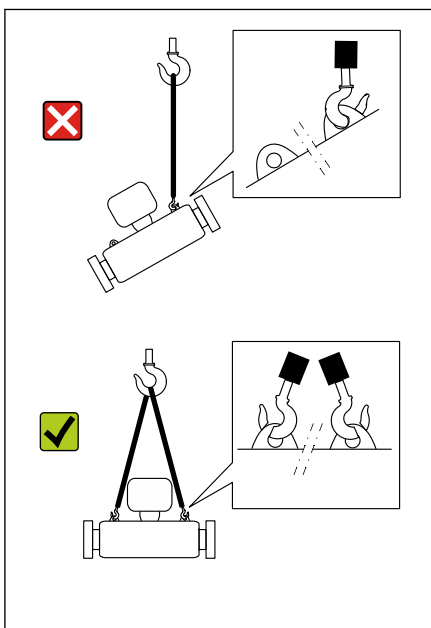

A0043058

⚠ DANGER

Potentially life-threatening hazard from suspended loads!

The device could fall.

- ▶ Secure the device against slipping and turning.
- ▶ Do not move suspended loads over people.
- ▶ Do not move suspended loads over unprotected areas.

NOTICE

Lifting equipment incorrectly attached!

Lifting equipment attached on one side only can damage the device.

- ▶ Attach lifting equipment to both lifting lugs.

Transporting without lifting lugs

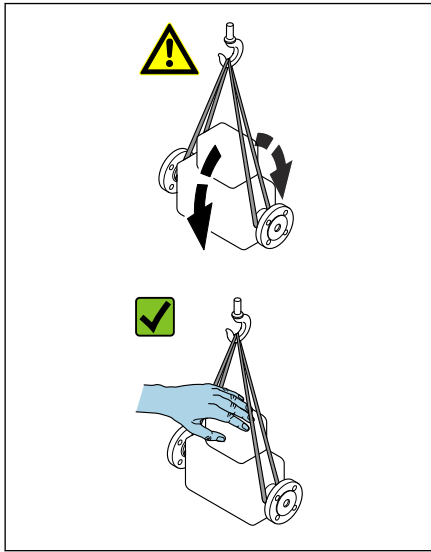

A0043054

⚠ DANGER

Potentially life-threatening hazard from suspended loads!

The device could fall.

- ▶ Secure the device against slipping and turning.
- ▶ Do not move suspended loads over people.
- ▶ Do not move suspended loads over unprotected areas.

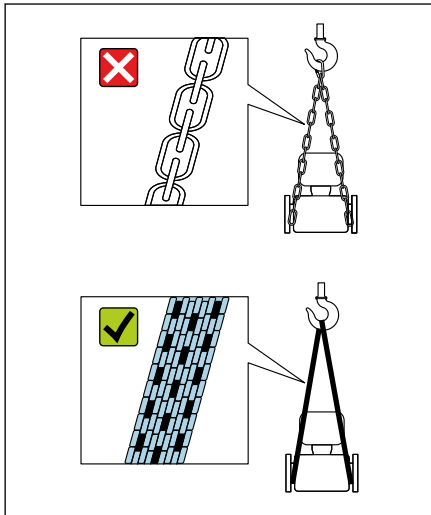

A0043055

NOTICE

Incorrect lifting equipment can damage the device!

The use of chains as hoists can damage the device.

- ▶ Use textile hoists.

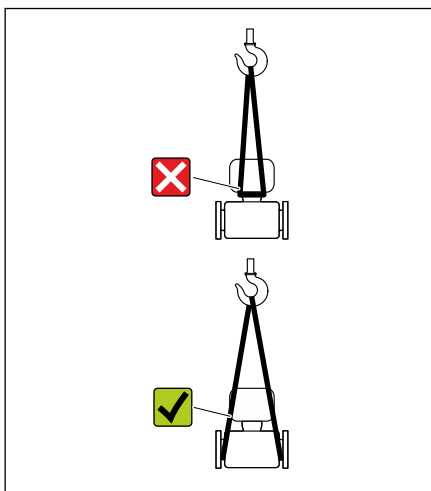

A0043056

NOTICE

Lifting equipment incorrectly attached!

Lifting equipment attached to unsuitable points can damage the device.

- ▶ Attach lifting equipment to both process connections of the device.

Checking the storage conditions

Are the protective covers or protection caps on the process connections?	<input type="checkbox"/>
Is the device in the original packaging?	<input type="checkbox"/>
Is the device protected against sunlight?	<input type="checkbox"/>
Is it guaranteed that the device is not stored outdoors?	<input type="checkbox"/>
Is the device stored in a dry and dust-free place?	<input type="checkbox"/>
Does the storage temperature match the device ambient temperature specified on the nameplate?	<input type="checkbox"/>
Is the possibility of moisture/condensation collecting on the device and original packaging as a result of variations in temperature ruled out?	<input type="checkbox"/>

Recycling of packaging materials

All packaging materials and packaging aids must be recycled as specified by national regulations.

- Stretch wrap: polymer in accordance with EU Directive 2002/95/EC (RoHS)
- Crate: wood in accordance with ISPM 15 standard, confirmed by IPPC logo
- Cardboard box: in accordance with European Packaging Directive 94/62/EC, confirmed by Resy symbol
- Disposable pallet: plastic or wood
- Packaging straps: plastic
- Adhesive strips: plastic
- Padding: paper

Product design

Compact version

The transmitter and sensor form a mechanical unit.

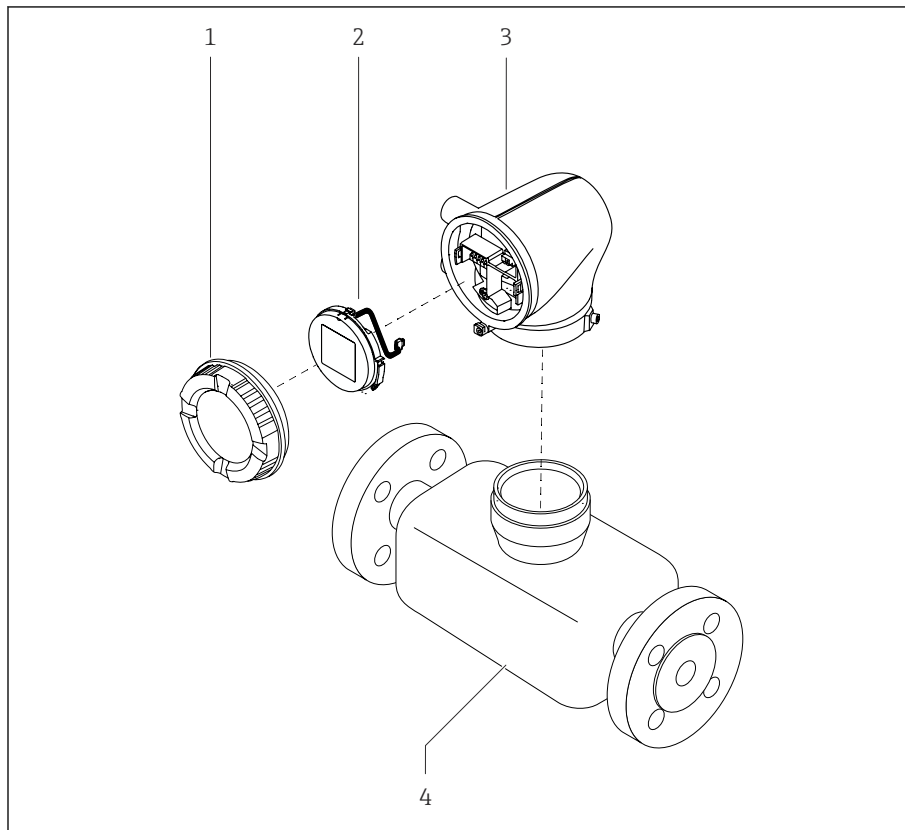

3 Main device components

- 1 Housing cover
- 2 Display module
- 3 Transmitter housing
- 4 Sensor

Remote version

The transmitter and sensor are installed in physically separate locations.

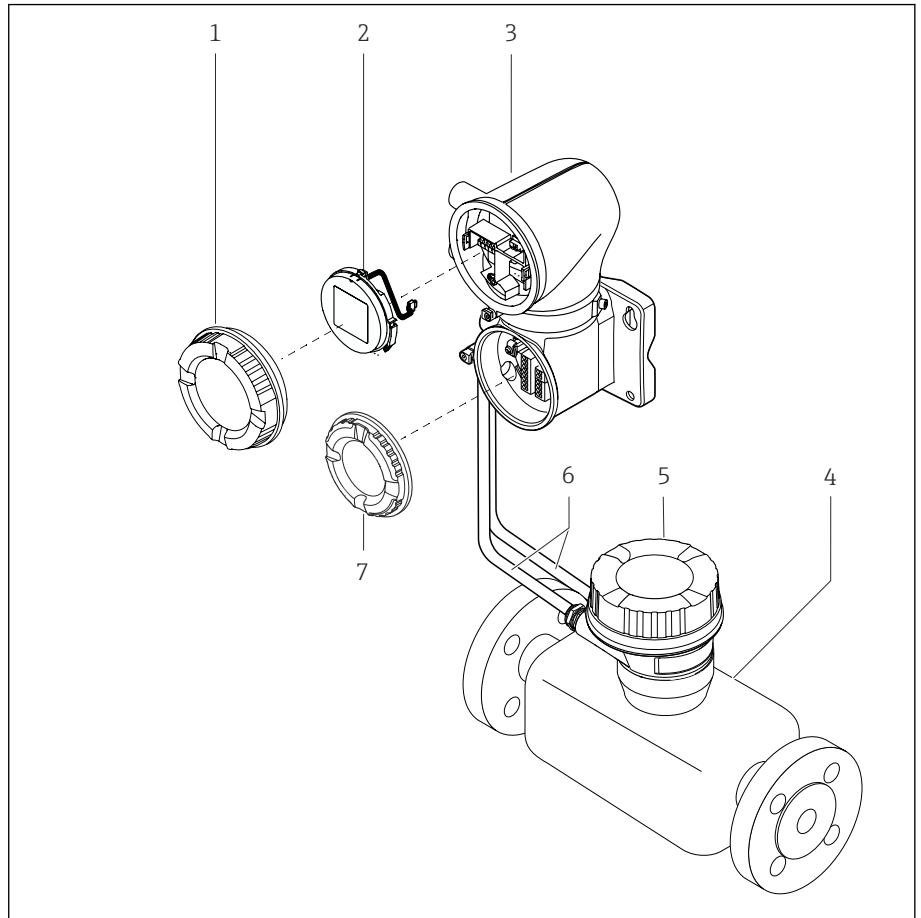

A0043524

4 Main device components

- 1 Housing cover
- 2 Display module
- 3 Transmitter housing
- 4 Sensor
- 5 Sensor connection housing
- 6 Connecting cable consisting of coil current cable and electrode cable
- 7 Connection compartment cover

Firmware history

List of firmware versions and changes since previous version

Firmware version 01.00.zz

Release date	2021-07-01	Original firmware
Version of the Operating Instructions	01.21	
Order code for "Firmware version"	Option 78	

Device history and compatibility

List of device models and changes since previous model

Device model A1

Release	2021-07-01	-
Version of the Operating Instructions	01.21	
Compatibility with previous model	-	

4 Installation

Installation conditions	26
Device installation	31
Post-installation check	34

Installation conditions

Flow direction

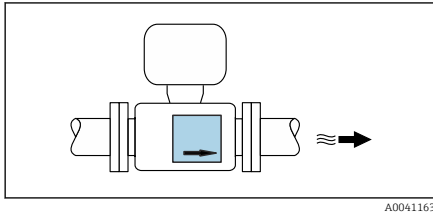

Install the device in the direction of flow.

i Note the direction of arrow on the nameplate.

Inlet runs and outlet runs

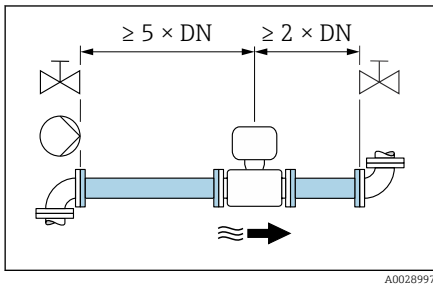

Ensure straight, undisturbed inlet and outlet runs.

i To avoid negative pressure and to comply with accuracy specifications, install the sensor upstream from assemblies that produce turbulence (e.g. valves, T-sections) and downstream from pumps → *Installation near pumps*, 28.

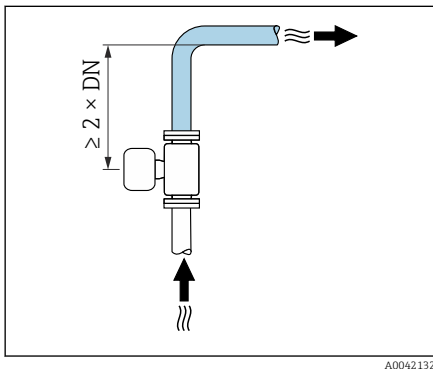

Keep a sufficient distance to the next pipe elbow.

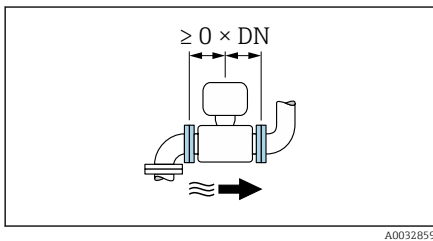

i Inlet and outlet runs do not need to be considered for devices with the order code for "Design", option H, I.

Orientations

Vertical orientation, upward direction of flow

For all applications.

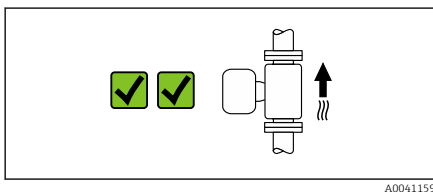

Horizontal orientation, transmitter at top

This orientation is suitable for the following applications:

- For low process temperatures in order to maintain the minimum ambient temperature for the transmitter.
- For empty pipe detection, even in the case of empty or partially filled measuring pipes.

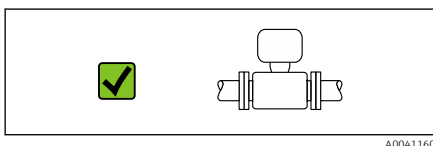

Mounting locations

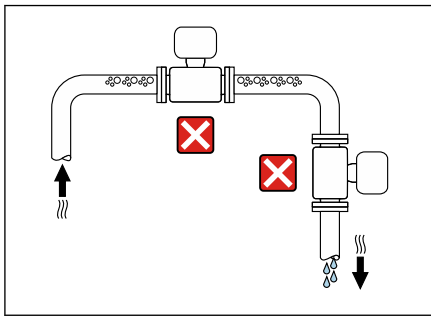

A0042131

- Do not install the device at the highest point of the pipe.
- Do not install the device upstream from a free pipe outlet in a down pipe.

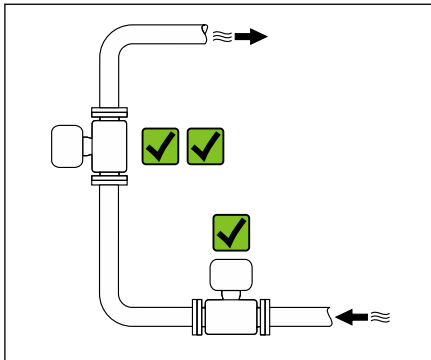

A0042317

Installation near control valves

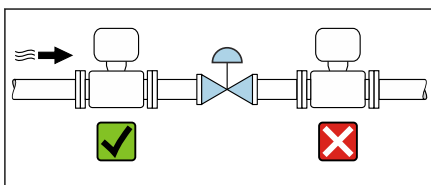

A0041091

Install the device in the direction of flow upstream from the control valve.

Installation upstream from a down pipe

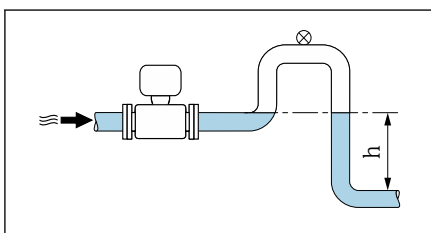

A0041089

NOTICE

Negative pressure in the measuring pipe can damage the liner!

- ▶ If installing upstream from down pipes with a length $h \geq 5 \text{ m}$ (16.4 ft): install a siphon with a vent valve downstream from the device.

i This arrangement prevents the flow of liquid stopping in the pipe and air entrainment.

Installation with partially filled pipes

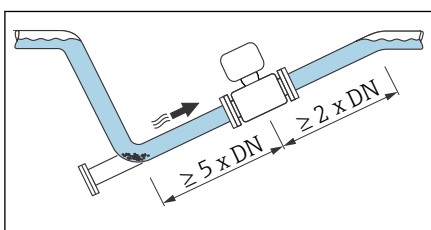

A0041088

- Partially filled pipes with a gradient require a drain-type configuration.
- The installation of a cleaning valve is recommended.

i Inlet and outlet runs do not need to be considered for devices with the order code for "Design", option H, I.

Installation near pumps

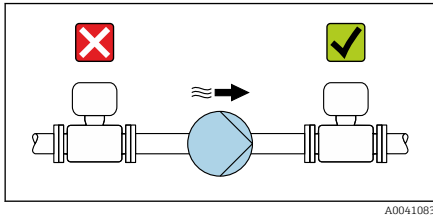

NOTICE

Negative pressure in the measuring pipe can damage the liner!

- ▶ Install the device in the direction of flow downstream from the pump.
- ▶ Install pulsation dampers if reciprocating, diaphragm or peristaltic pumps are used.

Installation of very heavy devices

Support is required with nominal diameters of DN ≥ 350 (14") and higher.

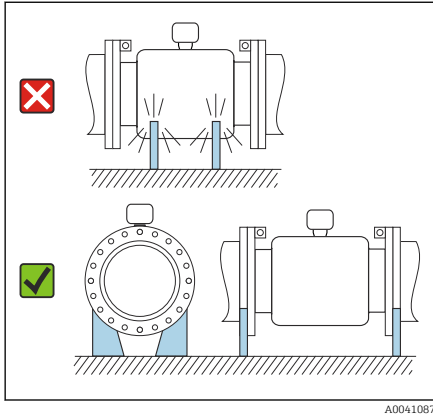

NOTICE

Damage to the device!

If incorrect support is provided, the sensor housing could buckle and the internal magnetic coils could be damaged.

- ▶ Only provide supports at the pipe flanges.

Pipe vibrations

A remote version is recommended in the event of strong pipe vibrations.

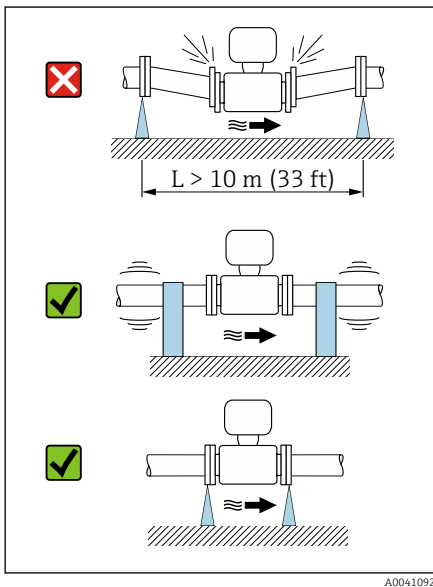

NOTICE

Pipe vibrations can damage the device!

- ▶ Do not expose the device to strong vibrations.
- ▶ Support the pipe and fix it in place.
- ▶ Support the device and fix it in place.
- ▶ Mount the sensor and transmitter separately.

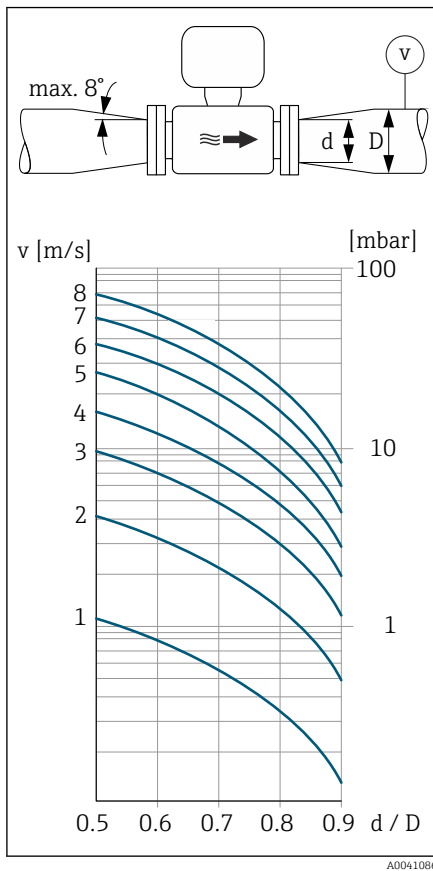

Adapters

Suitable adapters (double-flange reducers) can be used to install the sensor in larger-diameter pipes. The resulting higher rate of flow improves measuring accuracy with very slow-moving media.

i The nomogram shown here can be used to calculate the pressure loss caused by reducers and expanders. It only applies to liquids with a viscosity similar to that of water.

1. Calculate the ratio of the diameters d/D .
2. Determine the flow velocity after the reduction.
3. From the chart, determine the pressure loss as a function of the flow velocity v and the d/D ratio.

Seals

Note the following when installing seals:

- For liner with polyurethane: no seal is required.
- For "PTFE" liner: no seal is required.
- For liner with hard rubber: seal is **always** required.
- For DIN flanges: only install seals according to DIN EN 1514-1.

Thermal insulation

The sensor and pipe must be insulated in the event of very hot media. The insulation helps to slow energy loss and prevent injuries from accidental contact with hot pipes.

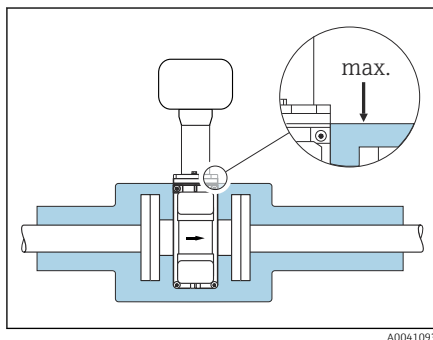

NOTICE

If the meter electronics overheat this can damage the device!

- ▶ Keep the housing support completely free (heat dissipation).
- ▶ Provide insulation but make sure it does not go beyond the upper edge of the two sensor half-shells.

Magnetism and static electricity

Do not install the device near magnetic fields, e.g. motors, pumps, transformers.

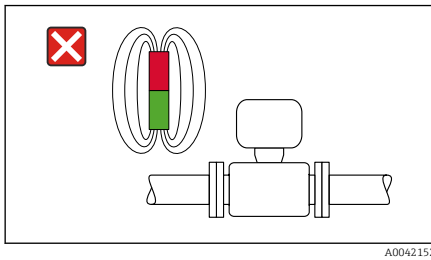

Outdoor use

- Avoid exposure to direct sunlight.
- Install in a location protected from sunlight.
- Avoid direct exposure to weather conditions.
- Use a weather protection cover → *Transmitter*, 162.

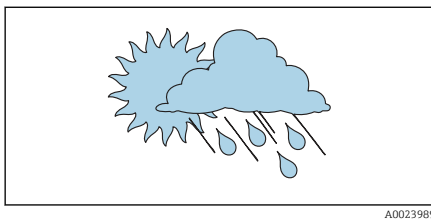

Immersion in water

i Only the remote version with IP68, type 6P, is suitable for immersion in water.

NOTICE

If the maximum water depth and operating duration are exceeded, this will damage the device!

- ▶ Observe the maximum water depth and operating duration.

Order code for "Sensor option", options CA, CB

Use of device under water at a maximum water depth of:

- 3 m (10 ft): permanent use
- 10 m (30 ft): max. 48 hours

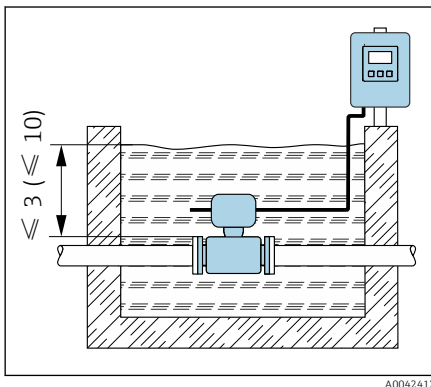

Use in buried applications

i Only the remote version with IP68 is suitable for use in buried applications.

Order code for "Sensor option", options CD, CE

The device can be used in buried applications without the need to implement additional precautionary measures on the device.

Installation is performed according to regional installation regulations.

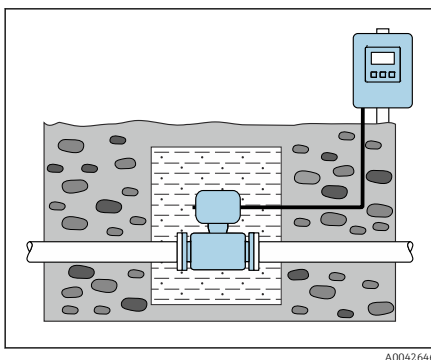

Device installation

Preparing the device

1. Remove the entire transportation packaging.
2. Remove protective covers or protective caps on the device.

Installing seals

⚠ WARNING

Improper process sealing can put staff at risk!

- ▶ Check whether the seals are clean and undamaged.

NOTICE

Incorrect installation can lead to incorrect measurement results!

- ▶ The internal diameter of the seal must be greater than or equal to that of the process connection and pipe.
- ▶ Fit the seals and measuring pipe centrally.
- ▶ Make sure that the seals do not protrude into the pipe cross-section.

NOTICE

Formation of an electrically conductive layer on the inside of the measuring pipe!

Measuring signal short circuit possible.

- ▶ Do not use electrically conductive sealing compounds such as graphite.

Installing the ground disks

- In the case of plastic pipes or pipes with an insulating liner, grounding is via ground disks.
- Observe the information for the use of ground disks → *Ensuring potential equalization*, ☰ 44.
- Ground disks can be ordered separately from Endress+Hauser → *Device-specific accessories*, ☰ 162.

Installing the sensor

1. Ensure that the direction of the arrow on the sensor matches the flow direction of the medium.
2. If using ground disks, comply with the Installation Instructions provided.
3. Observe tightening torques. Maximum or nominal screw tightening torques apply depending on the flange standard and flange size → *Screw tightening torques*, ☰ 167.
4. Install and turn the device or transmitter housing in such a way that the cable entries point down or to the side.

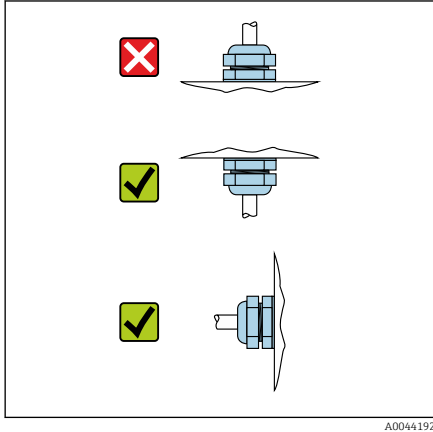

A0044192

Turning the transmitter housing

1. Loosen the fixing screws on both sides of the transmitter housing.
2. **NOTICE**
Overrotation of the transmitter housing!
Interior cables are damaged.
▶ Turn the transmitter housing a maximum of 180° in each direction.

Turn the transmitter housing to the desired position.
3. Tighten the screws in the logically reverse sequence.

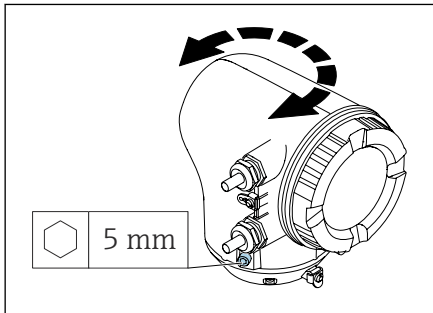

A0041095

Mounting the transmitter on the wall

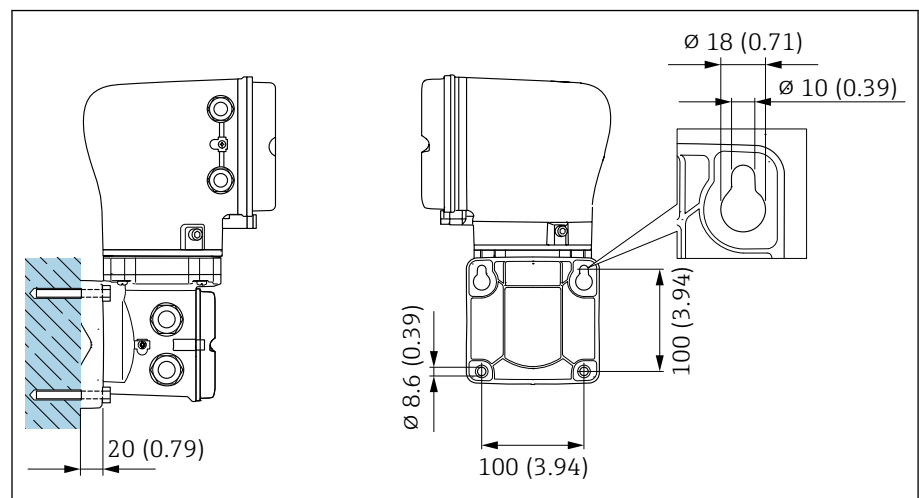

A0043473

☰ 5 Engineering unit mm (in)

NOTICE**Ambient temperature too high!**

If the electronics overheat this can damage the transmitter housing.

- ▶ Do not exceed the permissible temperature range for the ambient temperature.
- ▶ Use a weather protection cover → *Transmitter*, 162.
- ▶ Mount the device correctly.

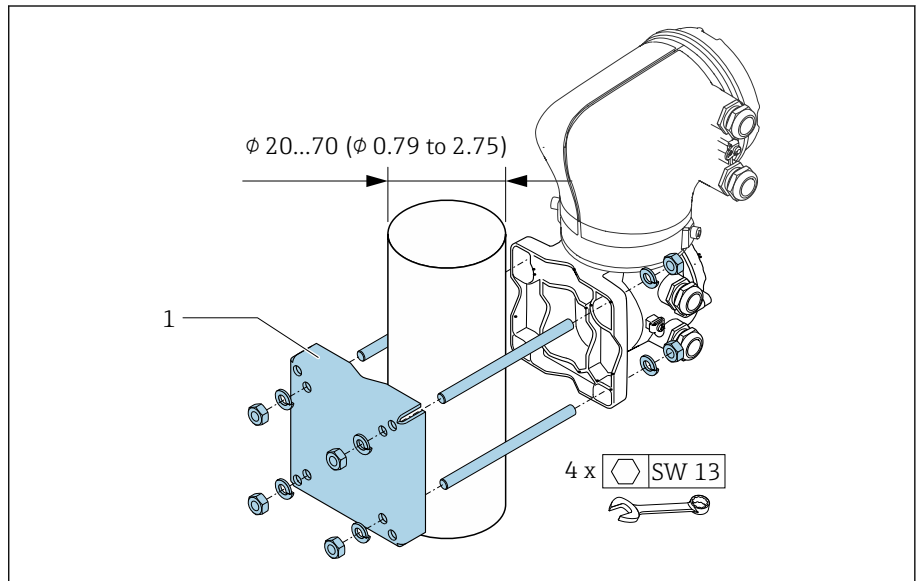
Mounting the transmitter on a post

6 Engineering unit mm (in)

A0043471

NOTICE**Ambient temperature too high!**

If the electronics overheat this can damage the transmitter housing.

- ▶ Do not exceed the permissible temperature range for the ambient temperature.
- ▶ Use a weather protection cover → *Transmitter*, 162.
- ▶ Mount the device correctly.

Post-installation check

Is the device undamaged (visual inspection)?	<input type="checkbox"/>
Does the device comply with the measuring point specifications? For example: <ul style="list-style-type: none">■ Process temperature■ Process pressure■ Ambient temperature■ Measuring range	<input type="checkbox"/>
Has the correct orientation been selected for the device?	<input type="checkbox"/>
Does the direction of the arrow on the device match the flow direction of the medium?	<input type="checkbox"/>
Is the device protected against precipitation and sunlight?	<input type="checkbox"/>
Are the screws tightened with the correct tightening torque?	<input type="checkbox"/>

5 Electrical connection

Connection conditions	36
Connecting cable connection	37
Connecting the transmitter	42
Ensuring potential equalization	44
Removing a cable	47
Hardware settings	47
Post-connection check	48

Connection conditions

Notes on the electrical connection

WARNING

Components carry voltage!

Incorrect work performed on the electrical connections can result in an electric shock.

- ▶ Have electrical connection work carried out by appropriately trained specialists only.
- ▶ Comply with applicable federal/national installation codes and regulations.
- ▶ Comply with national and local workplace safety regulations.
- ▶ Establish the connections in the correct order: always make sure to first connect the protective earth (PE) to the inner ground terminal.
- ▶ When using in hazardous areas, observe the "Safety Instructions" document.
- ▶ Ground the device carefully and provide potential equalization.
- ▶ Connect protective earthing to all outer ground terminals.

Additional protective measures

The following protective measures are required:

- Set up a disconnecting device (switch or power-circuit breaker) to easily disconnect the device from the supply voltage.
- In addition to the device fuse, include an overcurrent protection unit, with max. 10 A, in the facility installation.
- Plastic sealing plugs act as safeguards during transportation and must be replaced by suitable, individually approved installation material.
- Connection examples: → *Examples for electric terminals*,  175

Connecting cable connection

Preparing the connecting cable

Coil current cable

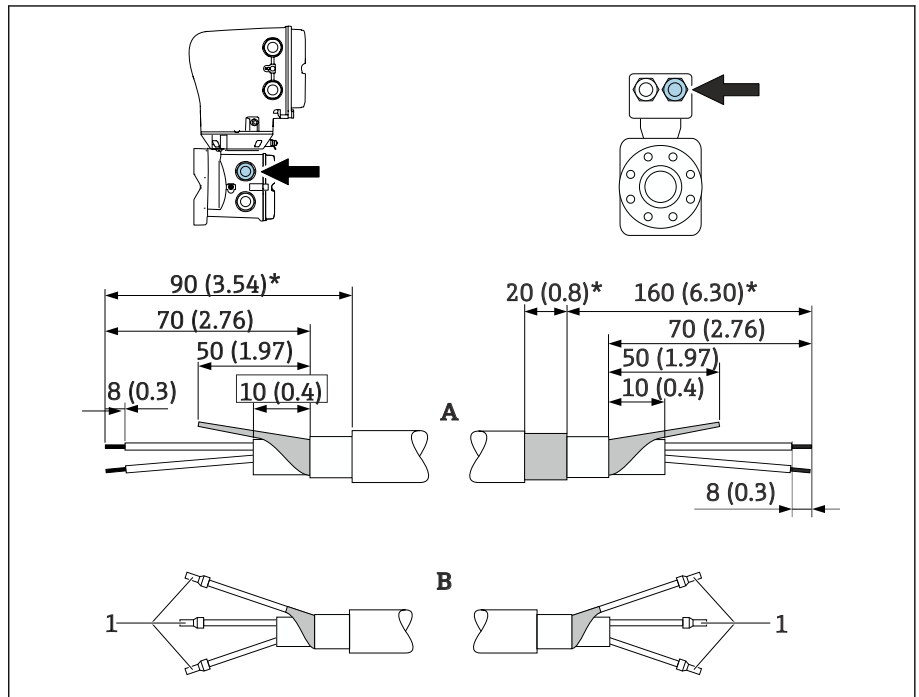

A0042278

1 Ferrules, red $\phi 1.0$ mm (0.04 in)

1. Insulate one core of the three-core cable at the level of the core reinforcement. Only 2 cores are required for the connection.
2. A: Terminate coil current cable, strip reinforced cables (*).
3. B: Fit ferrules over the strands and press in place.
4. Insulate the cable shield on the transmitter side, e.g. heat shrink tube.

Electrode cable

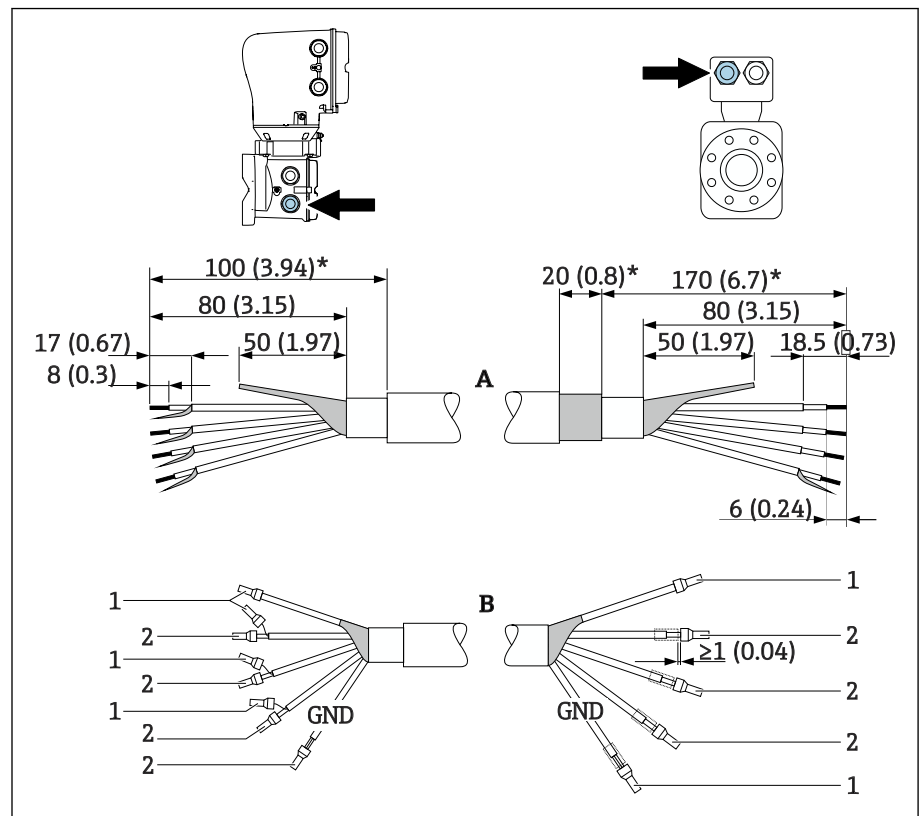

A0042424

- 1 Ferrules, red $\phi 1.0\text{ mm}$ (0.04 in)
 2 Ferrules, white $\phi 0.5\text{ mm}$ (0.02 in)

1. Make sure that the ferrules do not touch the cable shields on the sensor side. Minimum distance = 1 mm (exception: green "GND" cable)
2. A: Terminate electrode cable, strip reinforced cables (*).
3. B: Fit ferrules over the strands and press in place.
4. Insulate the cable shield on the transmitter side, e.g. heat shrink tube.

Attaching the connecting cable

Connecting cable terminal assignment

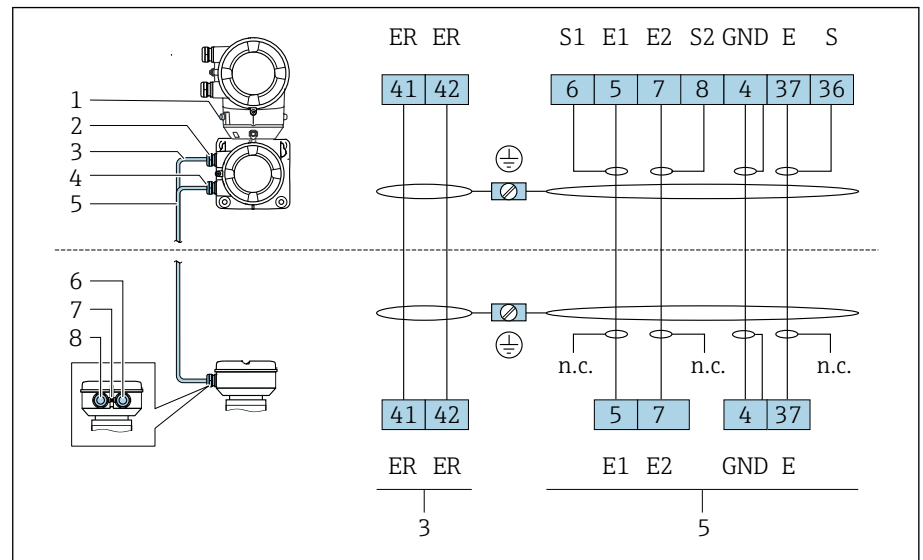

A0043474

- 1 Ground terminal, outer
- 2 Transmitter housing: cable entry for coil current cable
- 3 Coil current cable
- 4 Transmitter housing: cable entry for electrode cable
- 5 Electrode cable
- 6 Sensor connection housing: cable entry for electrode cable
- 7 Ground terminal, outer
- 8 Sensor connection housing: cable entry for coil current cable

Wiring the sensor connection housing

NOTICE

Incorrect wiring can damage the electronic components!

- ▶ Only connect sensors and transmitters with identical serial numbers.
- ▶ Connect the sensor connection housing and the transmitter housing to the potential equalization of the facility via the outer ground terminal.
- ▶ Connect the sensor and transmitter to the same potential.

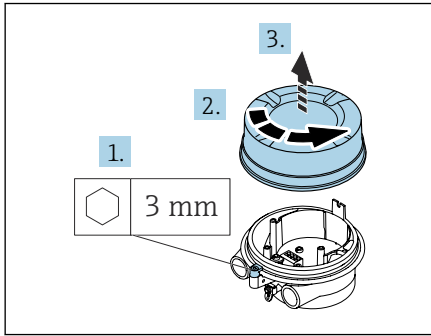

A0044138

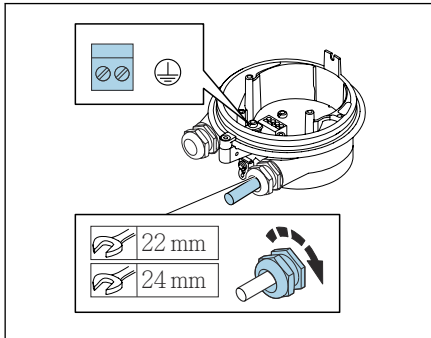

A0044139

1. Loosen the Allen key of the securing clamp.
2. Unscrew the connection compartment cover in the counterclockwise direction.

NOTICE

If the sealing ring is missing, the housing is not sealed tight!

Damage to the device.

- ▶ Do not remove the sealing ring from the cable entry.

3. Feed the coil current cable and electrode cable through the corresponding cable entry.
4. Adjust the cable lengths.
5. connect the cable shield to the inner ground terminal.
6. Strip the cable and cable ends.
7. Fit ferrules over the strands and press in place.
8. Connect the coil current cable and the electrode cable as per the terminal assignment.
9. Tighten the cable glands.
10. Screw on the connection compartment cover.
11. Fasten the securing clamp.

Wiring the transmitter housing

NOTICE

Incorrect wiring can damage the electronic components!

- ▶ Only connect sensors and transmitters with identical serial numbers.
- ▶ Connect the sensor connection housing and the transmitter housing to the potential equalization of the facility via the outer ground terminal.
- ▶ Connect the sensor and transmitter to the same potential.

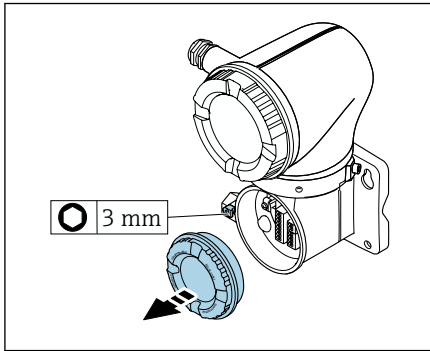

1. Loosen the Allen key of the securing clamp.
2. Unscrew the connection compartment cover in the counterclockwise direction.

NOTICE

If the sealing ring is missing, the housing is not sealed tight!

Damage to the device.

- ▶ Do not remove the sealing ring from the cable entry.

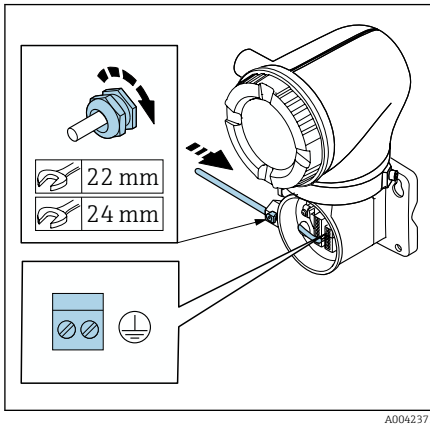

3. Feed the coil current cable and electrode cable through the corresponding cable entry.
4. Adjust the cable lengths.
5. Connect the cable shields to the inner ground terminal.
6. Strip the cable and cable ends.
7. Fit ferrules over the strands and press in place.
8. Connect the coil current cable and the electrode cable as per the terminal assignment.
9. Tighten the cable glands.
10. Screw on the connection compartment cover.
11. Fasten the securing clamp.

Connecting the transmitter

Transmitter terminal connections

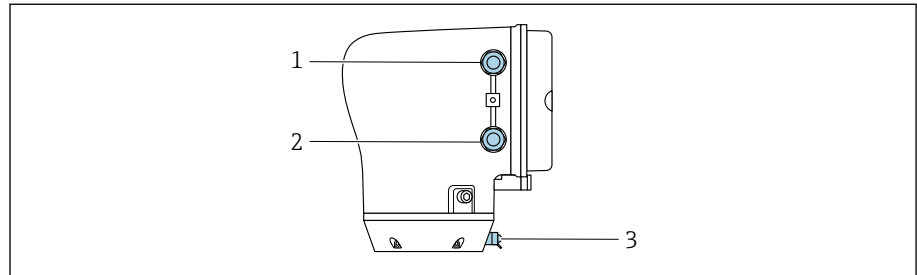

- 1 Cable entry for power supply cable: supply voltage
 2 Cable entry for signal cable
 3 Ground terminal, outer

A0045438

Terminal assignment

i The terminal assignment is documented on an adhesive label.

The following terminal assignment is available:

Current output 4 to 20 mA HART (active) and pulse/frequency/switch output

Supply voltage		Output 1				Output 2	
1 (+)	2 (-)	26 (+)	27 (-)	24 (+)	25 (-)	22 (+)	23 (-)
L/+	N/-	Current output 4 to 20 mA HART (active)		-		Pulse/frequency/switch output (passive)	

Current output 4 to 20 mA HART (passive) and pulse/frequency/switch output

Supply voltage		Output 1				Output 2	
1 (+)	2 (-)	26 (+)	27 (-)	24 (+)	25 (-)	22 (+)	23 (-)
L/+	N/-	-		Current output 4 to 20 mA HART (passive)		Pulse/frequency/switch output (passive)	

Wiring the transmitter

- i**
- Use a suitable cable gland for the power supply cable and signal cable.
 - Pay attention to the requirements for the power supply cable and signal cable → *Requirements for connecting cable*, 97 .
 - Use shielded cables for digital communication.

NOTICE

If the cable gland is incorrect, this compromises the sealing of the housing!
 Damage to the device.

- Use a suitable cable gland corresponding to the degree of protection.

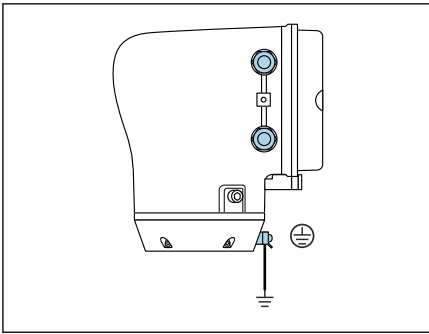

1. Ground the device carefully and provide potential equalization.
2. Connect protective earthing to the outer ground terminals.

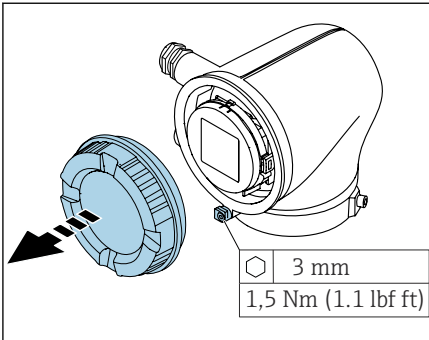

3. Loosen the Allen key of the securing clamp.
4. Unscrew the housing cover in the counterclockwise direction.

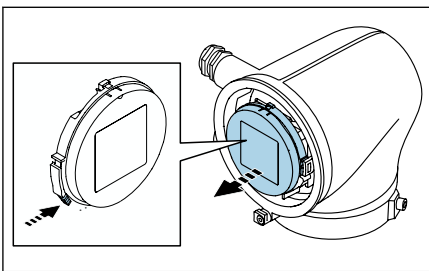

5. Press the tab of the display module holder.
6. Remove the display module from the display module holder.

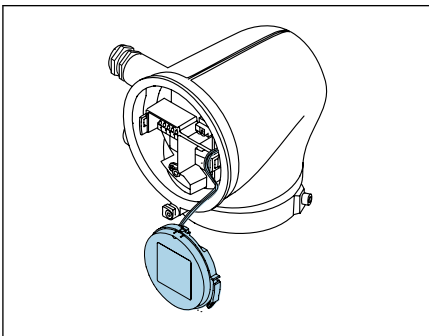

- i The cable must be in the tab for strain relief.
- 7. Let the display module hang down.

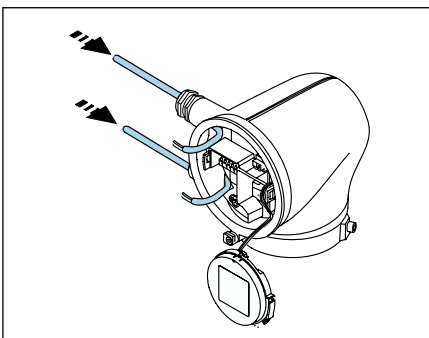

8. Remove dummy plug if present.

NOTICE

If the sealing ring is missing, the housing is not sealed tight!

Damage to the device.

- ▶ Do not remove the sealing ring from the cable entry.

9. Feed the power supply cable and signal cable through the corresponding cable entry.

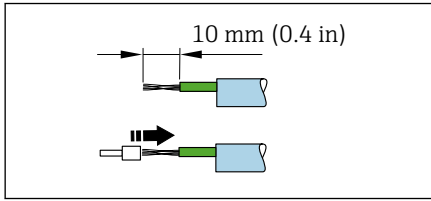

A0041357

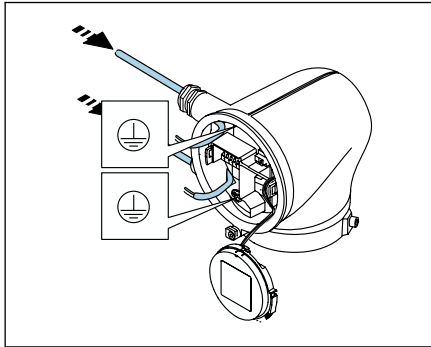

A0041358

10. Strip the cable and cable ends.
11. Fit ferrules over the strands and press in place.

- i** The terminal assignment is documented on an adhesive label.
12. Connect the protective ground (PE) to the inner ground terminal.
 13. Connect the power supply cable and signal cable as per the terminal assignment.
 14. Connect the cable shields to the inner ground terminal.
 15. Tighten the cable glands.
 16. Follow the sequence in the reverse order to reassemble.

Ensuring potential equalization

Introduction

Correct potential equalization (equipotential bonding) is a prerequisite for stable and reliable flow measurement. Inadequate or incorrect potential equalization can result in device failure and present a safety hazard.

The following requirements must be observed to ensure correct, trouble-free measurement:

- The principle that the medium, the sensor and the transmitter must be at the same electrical potential applies.
- Take in-company grounding guidelines, materials and the grounding conditions and potential conditions of the pipe into consideration.
- Any necessary potential equalization connections must be established by ground cables with a minimum cross-section of 6 mm² (0.0093 in²).
- In the case of remote device versions, the ground terminal in the example always refers to the sensor and not to the transmitter.

i You can order accessories such as ground cables and ground disks from Endress+Hauser → *Device-specific accessories*, 162

Abbreviations used

- PE (Protective Earth): potential at the protective earth terminals of the device
- P_p (Potential Pipe): potential of the pipe, measured at the flanges
- P_M (Potential Medium): potential of the medium

Connection examples for standard situations

Unlined and grounded metal pipe

- Potential equalization is via the measuring pipe.
- The medium is set to ground potential.

Starting conditions:

- Pipes are correctly grounded on both sides.
- Pipes are conductive and at the same electrical potential as the medium
- ▶ Connect the connection housing of the transmitter or sensor to ground potential by means of the ground terminal provided for this purpose.

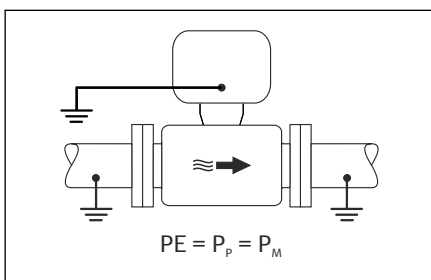

A0044854

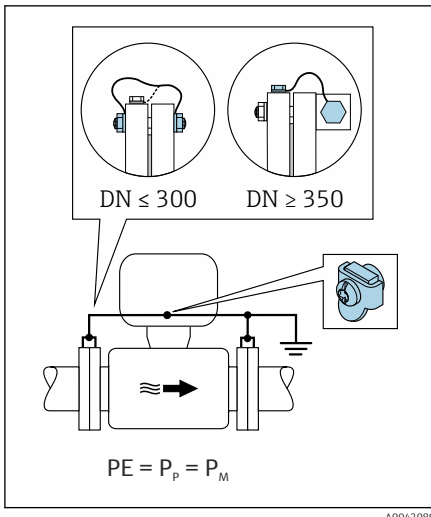

Unlined metal pipe

- Potential equalization is via the ground terminal and pipe flanges.
- The medium is set to ground potential.

Starting conditions:

- Pipes are not sufficiently grounded.
 - Pipes are conductive and at the same electrical potential as the medium
1. Connect both sensor flanges to the pipe flange via a ground cable and ground them.
 2. Connect the connection housing of the transmitter or sensor to ground potential by means of the ground terminal provided for this purpose.
 3. If DN ≤ 300 (12"): mount the ground cable directly on the conductive flange coating of the sensor with the flange screws.
 4. If DN ≥ 350 (14"): mount the ground cable directly on the metal transport bracket. Observe screw tightening torques: see the Brief Operating Instructions for the sensor.

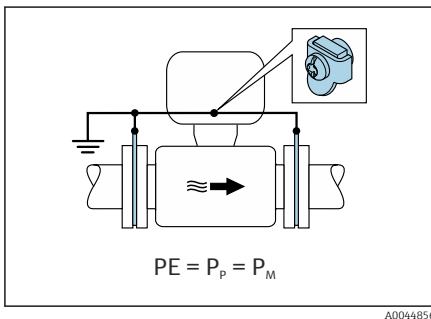

Plastic pipe or pipe with insulating liner

- Potential equalization is via the ground terminal and ground disks.
- The medium is set to ground potential.

Starting conditions:

- The pipe has an insulating effect.
- Low-impedance medium grounding close to the sensor is not guaranteed.
- Equalizing currents through the medium cannot be ruled out.

1. Connect the ground disks to the ground terminal of the connection housing of the transmitter or sensor via the ground cable.
2. Connect the connection to ground potential.

Connection example with the potential of medium not equal to protective earth without the "Measurement isolated from ground" option

In these cases, the medium potential can differ from the potential of the device.

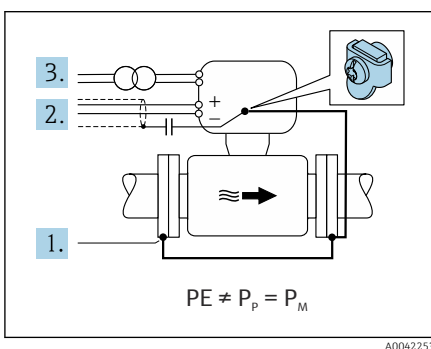

Metal, ungrounded pipe

The sensor and transmitter are installed in a way that provides electrical insulation from PE, e.g. applications for electrolytic processes or systems with cathodic protection.

Starting conditions:

- Unlined metal pipe
 - Pipes with an electrically conductive liner
1. Connect the pipe flanges and transmitter via the ground cable.
 2. Route the shielding of the signal lines via a capacitor (recommended value 1.5µF/50V).
 3. Device connected to power supply such that it is floating in relation to the protective earth (isolation transformer). This measure is not required in the case of 24V DC supply voltage without PE (= SELV power unit).

Connection examples with the potential of medium not equal to protective earth with the "Measurement isolated from ground" option

In these cases, the medium potential can differ from the potential of the device.

Introduction

The "Measurement isolated from ground" option enables the galvanic isolation of the measuring system from the device potential. This minimizes harmful equalizing currents caused by differences in potential between the medium and the device. The "Measurement isolated from ground" option is optionally available: order code for "Sensor option", option CV

Operating conditions for the use of the "Measurement isolated from ground" option

Device version	Compact version and remote version (length of connecting cable ≤ 10 m)
Differences in voltage between medium potential and device potential	As small as possible, usually in the mV range
Alternating voltage frequencies in the medium or at ground potential (PE)	Below typical power line frequency in the country

i To achieve the specified conductivity measuring accuracy, a conductivity calibration is recommended when the device is installed.

A full pipe adjustment is recommended when the device is installed.

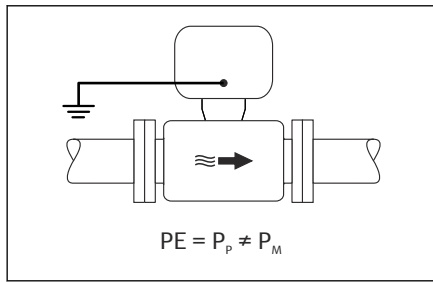

Plastic pipe

Sensor and transmitter are correctly grounded. A difference in potential can occur between the medium and protective earth. Potential equalization between P_M and PE via the reference electrode is minimized with the "Measurement isolated from ground" option.

Starting conditions:

- The pipe has an insulating effect.
- Equalizing currents through the medium cannot be ruled out.

1. Use the "Measurement isolated from ground" option, while observing the operating conditions for measurement isolated from ground.
2. Connect the connection housing of the transmitter or sensor to ground potential by means of the ground terminal provided for this purpose.

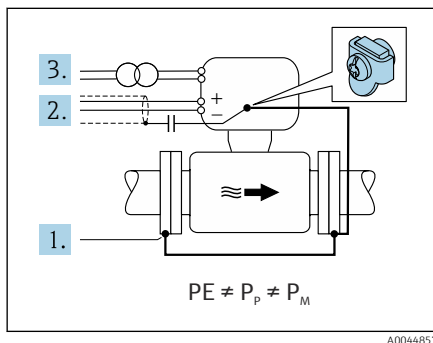

Metal, ungrounded pipe with insulating liner

The sensor and transmitter are installed in a way that provides electrical insulation from PE. The medium and pipe have different potentials. The "Measurement isolated from ground" option minimizes harmful equalizing currents between P_M and P_P via the reference electrode.

Starting conditions:

- Metal pipe with insulating liner
- Equalizing currents through the medium cannot be ruled out.

1. Connect the pipe flanges and transmitter via the ground cable.
2. Route the shielding of the signal cables via a capacitor (recommended value 1.5µF/50V).
3. Device connected to power supply such that it is floating in relation to the protective earth (isolation transformer). This measure is not required in the case of 24V DC supply voltage without PE (= SELV power unit).
4. Use the "Measurement isolated from ground" option, while observing the operating conditions for measurement isolated from ground.

Removing a cable

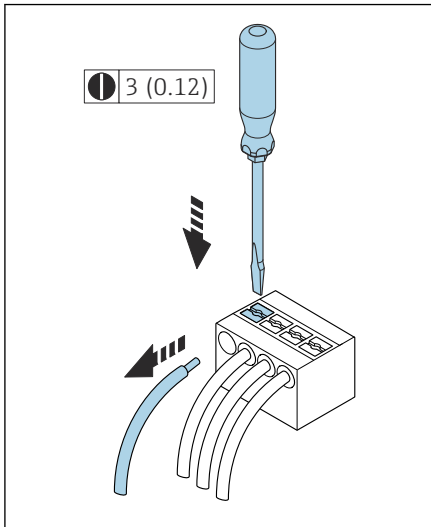

A0044725

7 Engineering unit mm (in)

1. Use a flat-blade screwdriver to press down on the slot between the two terminal holes and hold.
2. Remove the cable end from the terminal.

Hardware settings

Enabling write protection

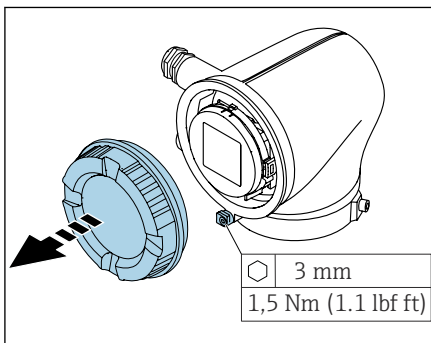

A0041094

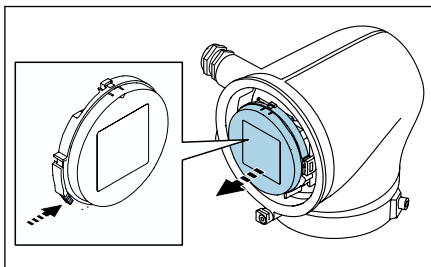

A0041330

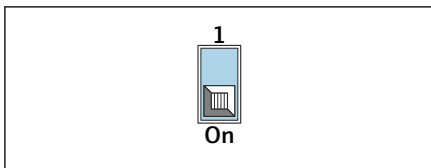

A0044412

1. Loosen the Allen key of the securing clamp.
2. Unscrew the housing cover in the counterclockwise direction.
3. Press the tab of the display module holder.
4. Remove the display module from the display module holder.
5. Set the write protection switch on the back of the display module to the **On** position.
 - ↳ Write protection is enabled.
6. Follow the sequence in the reverse order to reassemble.

Post-connection check

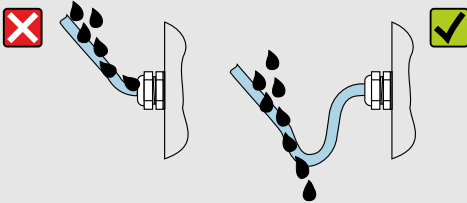
Only for remote version: Is the serial number on the nameplates of the connected sensor and transmitter identical?	<input type="checkbox"/>
Is the potential equalization established correctly?	<input type="checkbox"/>
Is the protective earthing established correctly?	<input type="checkbox"/>
Are the device and cable undamaged (visual check)?	<input type="checkbox"/>
Do the cables meet the requirements?	<input type="checkbox"/>
Is the terminal assignment correct?	<input type="checkbox"/>
Are all the cable glands installed, firmly tightened and leak-tight?	<input type="checkbox"/>
Are dummy plugs inserted in unused cable entries?	<input type="checkbox"/>
Are transportation plugs replaced by dummy plugs?	<input type="checkbox"/>
Are the housing screws and housing cover tightened?	<input type="checkbox"/>
Do the cables loop down before the cable gland ("water trap")? 	<input type="checkbox"/>
Does the supply voltage match the specifications on the transmitter nameplate?	<input type="checkbox"/>

A0042316

6 Operation

Overview of the operating options	50
Local operation	50
SmartBlue App	55

Overview of the operating options

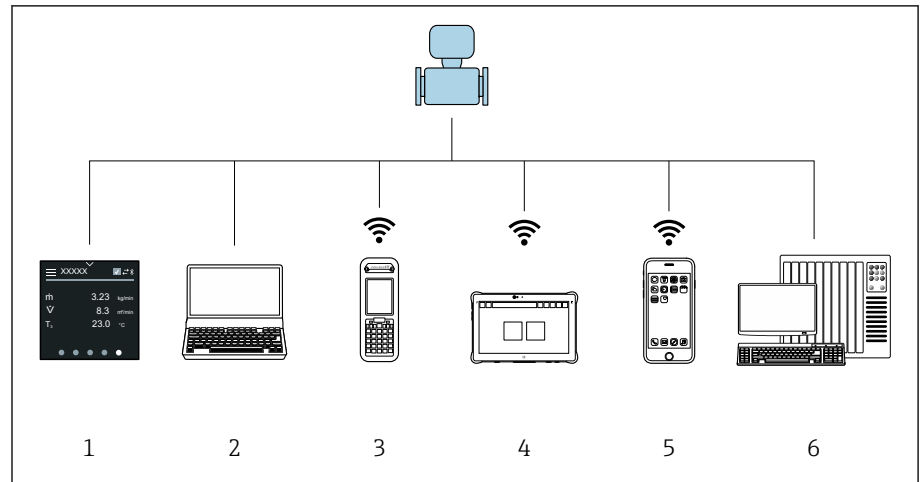

- 1 Local operation via touch screen
- 2 Computer with operating tool, e.g. FieldCare, DeviceCare, AMS Device Manager, SIMATIC PDM
- 3 Field Xpert SFX350 or SFX370 via Bluetooth, e.g. SmartBlue App
- 4 Field Xpert SMT70 via Bluetooth, e.g. SmartBlue App
- 5 Tablet or smartphone via Bluetooth, e.g. SmartBlue App
- 6 Automation system, e.g. PLC

Local operation

Unlocking local operation

Local operation must first be unlocked before the device can be operated via the touch screen. To unlock, draw the pattern "L" on the touch screen.

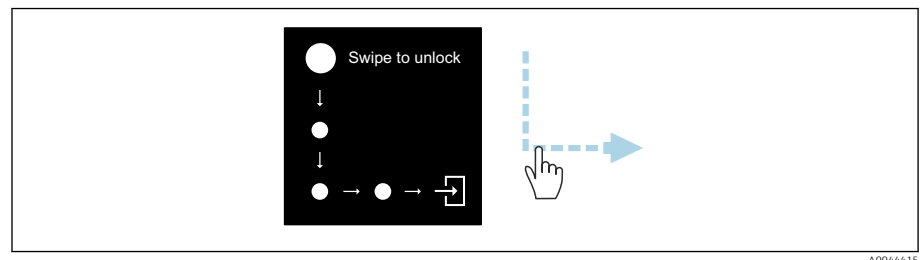

Navigation

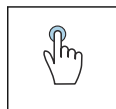

Tap

- Open menus.
- Select items in a list.
- Acknowledge buttons.
- Enter characters.

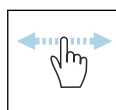

Swipe horizontally

Display next or previous page.

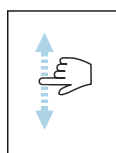

Swipe vertically

Display additional points in a list.

Operational display

During routine operation, the local display shows the operational display screen. The operational display consists of several windows which the user can toggle between.

i The operational display can be customized: see the description of parameters → *Main menu*, 52.

Operational display and navigation

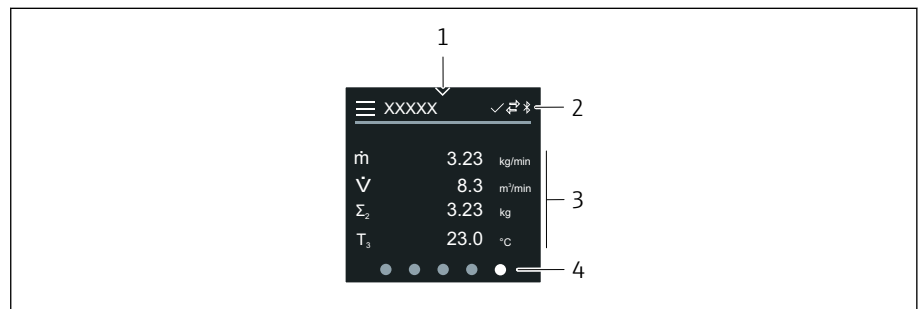

A0042992

- 1 Quick access
- 2 Status symbols, communication symbols and diagnostic symbols
- 3 Measured values
- 4 Rotating page display

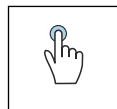

Tap

- Open the main menu.
- Open quick access.

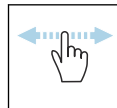

Swipe horizontally

Display next or previous page.

Symbols

- Open the main menu.
- Quick access
- Locking status
- Bluetooth is active.
- Device communication is enabled.
- Status signal: function check
- Status signal: maintenance required
- Status signal: out of specification
- Status signal: failure
- Status signal: diagnostics active.

Quick access

The Quick access menu contains a selection of specific device functions.

i Quick access is indicated by a triangle at the top of the local display in the middle.

Quick access and navigation

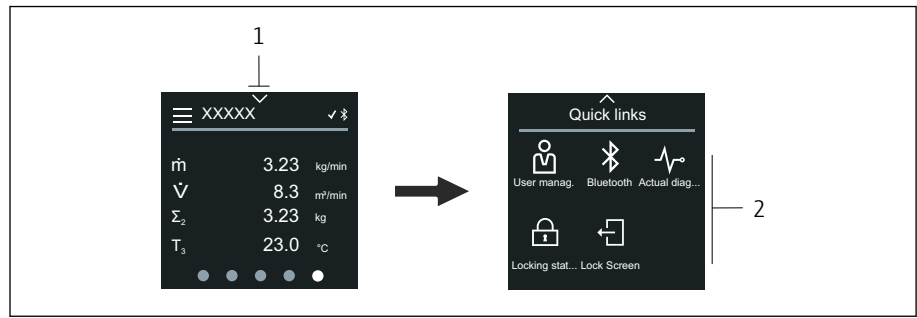

A0044208

- 1 Quick access
- 2 Quick access with specific device functions

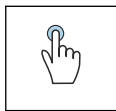

Tap

- Back to operational display.
- Open specific device functions.

Symbols

When a symbol is tapped, the local display shows the menu with the corresponding specific device functions.

- ⌘ Enable or disable Bluetooth.
- 🔑 Enter access code.
- 🔒 Write protection is enabled.
- ✕ Back to operational display.

Main menu

The main menu contains all the menus required for the commissioning, configuration and operation of the device.

Main menu and navigation

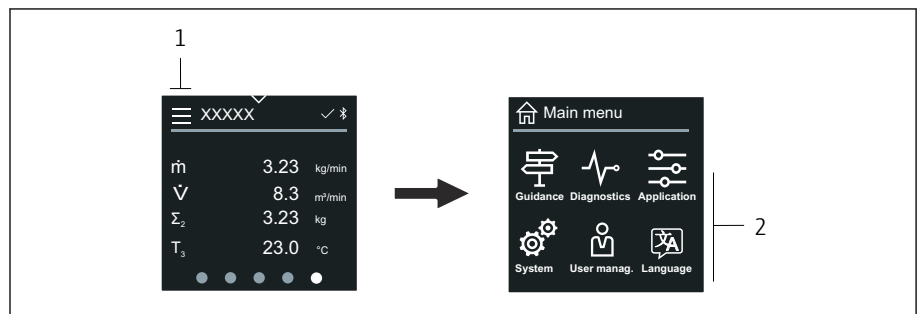

A0044213



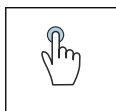



- 1 Open the main menu.
- 2 Open menus for the specific device functions.



Tap

- Back to operational display.
- Open menus.

Symbols

-  Back to operational display.
-  **Guidance** menu
Configuration of the device
-  **Diagnostics** menu
Troubleshooting and control of device behavior
-  **Application** menu
Application-specific adjustments
-  **System** menu
Device management and user administration
-  Set display language.

Submenus and navigation

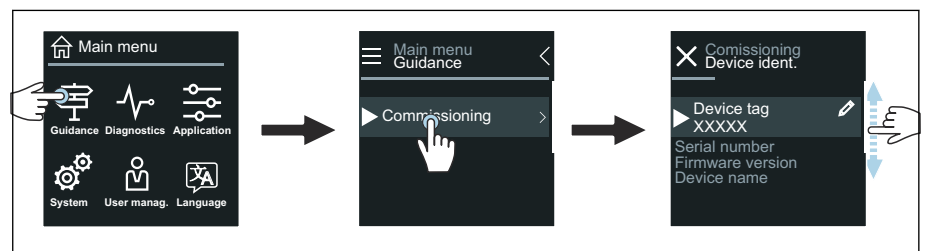

A0044219

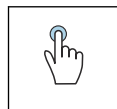

Tap

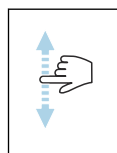

- Open the main menu.
- Open submenus or parameters.
- Select options.
- Skip items in list.



Swipe vertically

Select items in a list on a step-by-step basis.

Symbols

-  Return to previous menu.
-  Skip to bottom of list.
-  Skip to top of list.

Diagnostic information

Diagnostic information displays additional instructions or background information for diagnostic events.

Opening the diagnostic message

-  The diagnostic behavior is indicated on the top right of the local display by a diagnostics symbol. Tap the symbol or the "Help" button to open the diagnostic message.

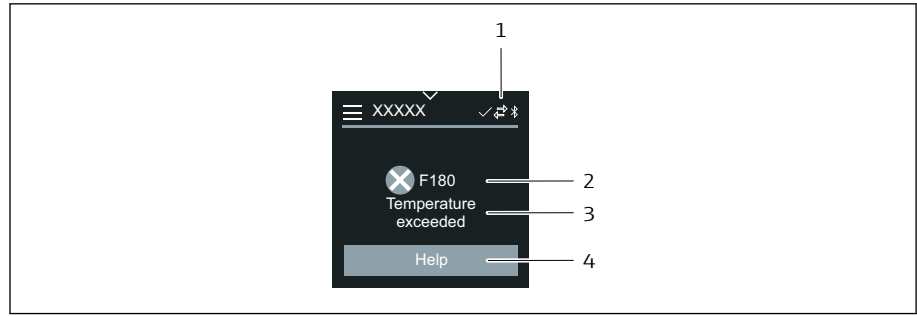

A0043008

- 1 Device status
- 2 Diagnostic behavior with diagnostic code
- 3 Short text
- 4 Open the troubleshooting measures.

Editing view

Editor and navigation

The text editor is used to enter characters.

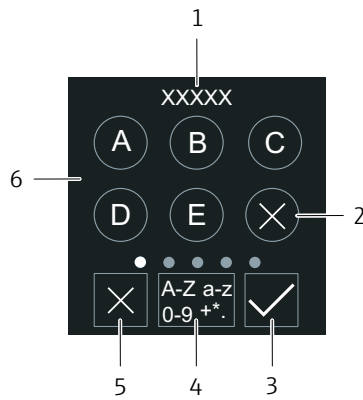

- 1 Entry display area
- 2 Delete character.
- 3 Confirm your entry.
- 4 Switch input field.
- 5 Cancel editor.
- 6 Input field

A0043020

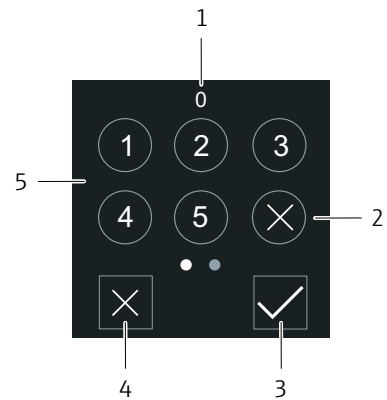

- 1 Entry display area
- 2 Delete character.
- 3 Confirm your entry.
- 4 Cancel editor.
- 5 Input field

A0043023

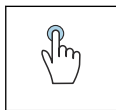

Tap

- Enter characters.
- Select next character set.

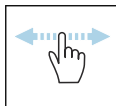

Swipe horizontally

Display next or previous page.

Input field

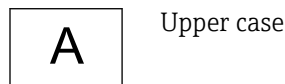

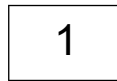

Numbers

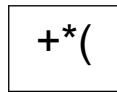

Special characters

Date

The device has a real-time clock for all log functions. The time can be configured here.

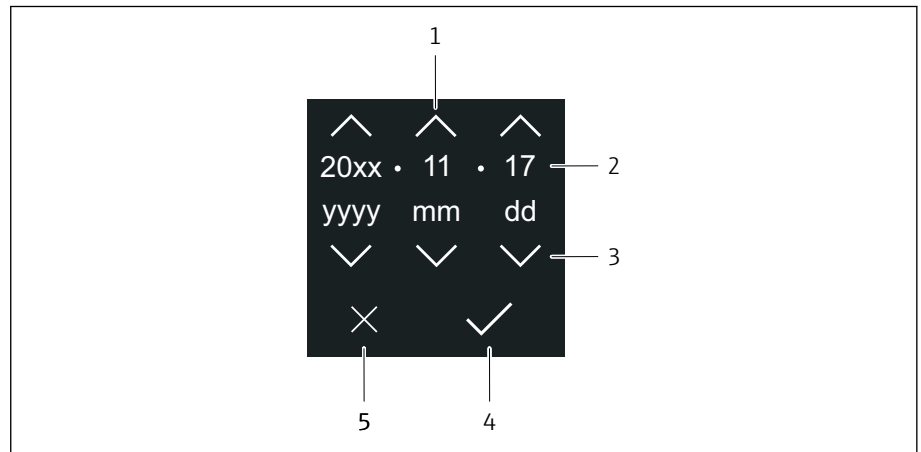

A0043043

- 1 Increase date by 1.
- 2 Actual value
- 3 Decrease date by 1.
- 4 Confirm settings.
- 5 Cancel editor.

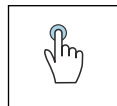



Tap

- Make settings.
- Confirm settings.
- Cancel editor.

SmartBlue App

The device has a Bluetooth interface and can be operated and configured using the SmartBlue App. The SmartBlue App must be downloaded onto a terminal device for this purpose. Any terminal device can be used.

- The range is 20 m (65.6 ft) under reference conditions.
- Incorrect operation by unauthorized persons is prevented by means of encrypted communication and password encryption.
- Bluetooth can be disabled.



Download	<p>Endress+Hauser SmartBlue App:</p> <ul style="list-style-type: none">▪ Google Playstore (Android)▪ iTunes Apple Shop (iOS devices) <div data-bbox="906 353 1284 488"></div>
Supported functions	<ul style="list-style-type: none">▪ Configuration of the device▪ Access to measured values, device status and diagnostic information

7 System integration

Device description files	58
Measured variables via HART protocol	58

Device description files

Version data

Firmware version	01.00.zz	<ul style="list-style-type: none"> On the title page of the Operating instructions On the transmitter nameplate → <i>Transmitter nameplate</i>,  17 System → Information → Device → Firmware version
Release date of firmware version	04.2021	-
Manufacturer ID	0x11	Application → Communication → Information → Manufacturer ID
Device type ID	0x71	Application → Communication → Information → Device ID
HART protocol revision	7	Application → Communication → Information → HART revision
Device revision	1	<ul style="list-style-type: none"> On the transmitter nameplate → <i>Transmitter nameplate</i>,  17 Diagnostics → Device information → Device revision

Operating tools

The suitable device description file for the individual operating tools is listed in the table below, along with information on where the file can be obtained.

Operating tool via HART protocol	Sources for obtaining device descriptions
FieldCare	<ul style="list-style-type: none"> www.endress.com → Downloads CD-ROM (contact Endress+Hauser) DVD (contact Endress+Hauser)
DeviceCare	<ul style="list-style-type: none"> www.endress.com → Downloads CD-ROM (contact Endress+Hauser) DVD (contact Endress+Hauser)
<ul style="list-style-type: none"> Field Xpert SFX350 Field Xpert SFX370 	Update function via handheld terminal
AMS Device Manager (Emerson Process Management)	www.endress.com → Downloads
SIMATIC PDM (Siemens)	www.endress.com → Downloads
Field Communicator 475 (Emerson Process Management)	Update function via handheld terminal

Measured variables via HART protocol

 Technical data → *Protocol-specific data*,  94

Dynamic variables

The following measured variables (HART device variables) are assigned to the dynamic variables at the factory:

Primary dynamic variable (PV)	Volume flow
Secondary dynamic variable (SV)	Totalizer 1
Tertiary dynamic variable (TV)	Totalizer 2
Quaternary dynamic variable (QV)	Totalizer 3

The assignment can be configured in the **Output** submenu.

Navigation

Application → Communication → Output

- Assign PV
- Assign SV
- Assign TV
- Assign QV



Assignment and available measured variables: Description of Device
Parameters → 6

Device variables

The device variables are permanently assigned. A maximum of 8 device variables can be transmitted.



- | | |
|---|------------------------|
| 0 | Volume flow |
| 1 | Mass flow |
| 2 | Conductivity |
| 5 | Flow velocity |
| 6 | Electronic temperature |
| 7 | Totalizer 1 |
| 8 | Totalizer 2 |
| 9 | Totalizer 3 |

8 Commissioning

Post-installation check and post-connection check	62
IT security	62
Device-specific IT security	62
Switching on the device	63
Commissioning the device	64

Post-installation check and post-connection check

Before commissioning the device, make sure that the post-installation and post-connection checks have been performed:

- Post-installation check → *Post-installation check*,  34
- Post-connection check → *Post-connection check*,  48

IT security

We only provide a warranty if the device is installed and used as described in the Operating Instructions. The device is equipped with security mechanisms to protect it against any inadvertent changes to the device settings.

IT security measures in line with operators' security standards and designed to provide additional protection for the device and device data transfer must be implemented by the operators themselves.

Device-specific IT security

Access via Bluetooth

Secure signal transmission via Bluetooth uses an encryption method tested by the Fraunhofer Institute.

- Without the SmartBlue App, the device is not visible via Bluetooth.
- Only one point-to-point connection is established between the device and a smartphone or tablet.

Access via the SmartBlue App

Two access levels (user roles) are defined for the device: the **Operator** user role and the **Maintenance** user role. The **Maintenance** user role is configured when the device leaves the factory.

If a user-specific access code is not defined (in the Enter access code parameter), the default setting **0000** continues to apply and the **Maintenance** user role is automatically enabled. The device's configuration data are not write-protected and can be edited at all times.

If a user-specific access code has been defined (in the Enter access code parameter), all the parameters are write-protected. The device is accessed with the **Operator** user role. When the user-specific access code is entered a second time, the **Maintenance** user role is enabled. All parameters can be written to.



For detailed information, see the "Description of Device Parameters" document pertaining to the device.

Protecting access via a password

There are a variety of ways to protect against write access to the device parameters:

- User-specific access code:
Protect write access to the device parameters via all the interfaces.
- Bluetooth key:
The password protects access and the connection between an operating unit, e.g. a smartphone or tablet, and the device via the Bluetooth interface.

General notes on the use of passwords

- The access code and Bluetooth key supplied with the device must be defined during commissioning.
- Follow the general rules for generating a secure password when defining and managing the access code and Bluetooth key.
- The user is responsible for the management and careful handling of the access code and Bluetooth key.

Write protection switch

The entire operating menu can be locked via the write protection switch. The values of the parameters cannot be changed. Write protection is disabled when the device leaves the factory.

Access authorization with write protection:

- Disabled: write access to the parameters
- Enabled: read-only access to the parameters

Write protection is enabled with the write protection switch on the back of the display module → *Hardware settings*,  47.



 The local display indicates that write protection is activated on the top right of the screen: .

Switching on the device

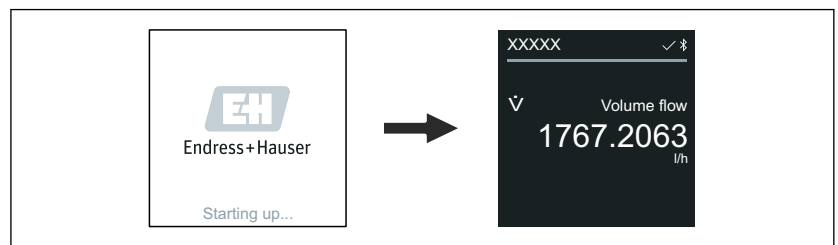
- ▶ Switch on the supply voltage for the device.
 - ↳ The local display switches from the start screen to the operational display.



A0042938

 If device startup is not successful, the device displays an error message to this effect → *Diagnostics and troubleshooting*,  70.

Commissioning the device

Local operation

 Detailed information on local operation: → *Operation*,  50

1. Via the "Menu" symbol, open the main menu.

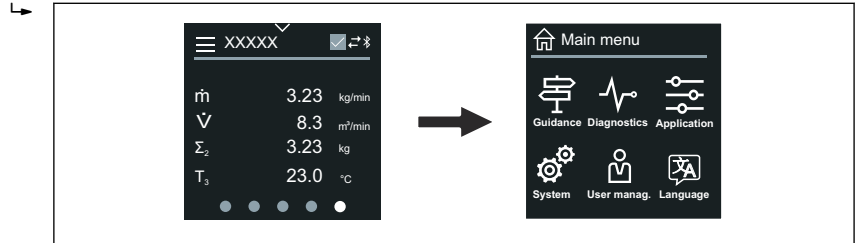

A0042939

2. Via the "Language" symbol, select the desired language.

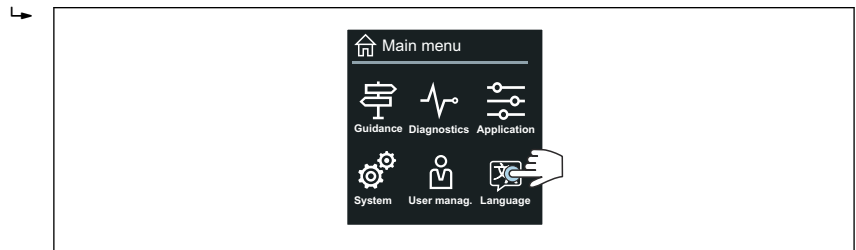

A0042940

3. Via the "Guidance" symbol, open the **Commissioning** wizard.

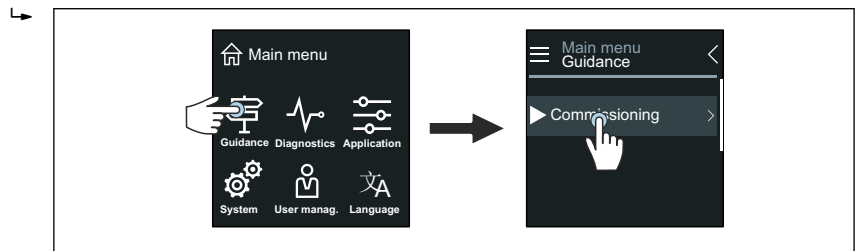

A0042941

4. Start the **Commissioning** wizard.

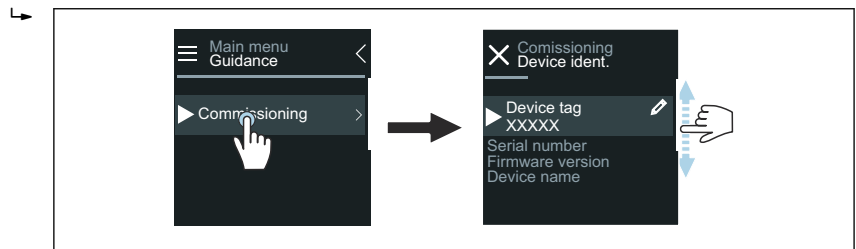

A0043018

5. Follow the instructions on the local display.
 - ↳ The **Commissioning** wizard goes through all the device parameters that are necessary to commission the device.

 For detailed information, see the "Description of Device Parameters" document pertaining to the device.

SmartBlue App

 Information on the SmartBlue App → *SmartBlue App*,  55.

Connecting the SmartBlue App to the device

1. Enable Bluetooth on the mobile handheld terminal, tablet or smartphone.
2. Start the SmartBlue App.
 - ↳ A Live List shows all the devices available.
3. Select the desired device.
 - ↳ The SmartBlue App shows the device login.
4. Under user name, enter **admin**.
5. Under password, enter the device's serial number. Serial number:
→ *Transmitter nameplate*, ⓘ 17.
6. Confirm your entries.
 - ↳ The SmartBlue App connects to the device and displays the main menu.

Opening the "Commissioning" wizard

1. Via the **Guidance** menu, open the **Commissioning** wizard.
2. Follow the instructions on the local display.
 - ↳ The **Commissioning** wizard goes through all the device parameters that are necessary to commission the device.

9 Operation

Reading the device locking status	68
HistoROM data management	68

Reading the device locking status

Indicates the write protection with the highest priority that is currently active.

Navigation

"System" menu → Device management → Locking status

Parameter overview with brief description

Parameter	Description	User interface
Locking status	Indicates the write protection with the highest priority that is currently active.	<ul style="list-style-type: none"> ▪ Hardware locked ▪ Temporarily locked

HistoROM data management

The device features HistoROM data management. Device data and process data can be saved, imported and exported with the HistoROM data management function, making operation and servicing far more reliable, secure and efficient.

Data backup

Automatic

The most important device data, e.g. the transmitter and sensor, are automatically saved in the S+T-DAT.

When the sensor is replaced, the customer-specific sensor data is adopted in the device. The device goes into operation immediately without any problems.

Manuell

The transmitter data (customer settings) must be saved manually.

Storage concept

	HistoROM backup	S+T-DAT
Available data	<ul style="list-style-type: none"> ▪ Event logbook, e.g. diagnostic events ▪ Parameter data record backup 	<ul style="list-style-type: none"> ▪ Sensor data, e.g. nominal diameter ▪ Serial number ▪ Calibration data ▪ Configuration of the device, e.g. software options
Storage location	On the sensor electronics module (ISEM)	In the sensor connector in the sensor neck

Data transfer

A parameter configuration can be transferred to another device using the export function of the operating tool. The parameter configuration can be duplicated or saved in an archive.

10 Diagnostics and troubleshooting

General troubleshooting	70
Diagnostic information via LED	71
Diagnostic information on local display	73
Diagnostic information in FieldCare or DeviceCare	74
Changing the diagnostic information	75
Overview of diagnostic information	76
Pending diagnostic events	79
Diagnostic list	80
Event logbook	80
Device reset	82

General troubleshooting

Local display

Error	Possible causes	Remedial action
Local display dark, no output signals	Supply voltage does not match that specified on the nameplate. The polarity of the supply voltage is wrong. No contact between cables and terminals. Terminals are not plugged into the electronics module correctly. Electronics module is defective.	Apply the correct supply voltage. Correct the polarity. <ul style="list-style-type: none"> ■ Check contact of cables. ■ Connect the cables to the terminals again. ■ Check the terminals. ■ Plug the terminals into the electronics module again. Order the appropriate spare part.
Local display is dark, but signal output is within the valid range.	Incorrect contrast setting of local display. Cable connector for the local display is not correctly connected. Local display is defective.	Adjust the contrast of the local display to ambient conditions. Plug in the cable connector correctly. Order the appropriate spare part.
Display alternates between error message and operational display	Diagnostic event has occurred.	Carry out appropriate troubleshooting measures.
Local display shows text in a foreign, incomprehensible language.	A foreign language is set.	Set the language of the local display.





Only for remote version

Error	Possible causes	Remedial action
Local display displays an error, no output signals	Cable connectors between the electronics module and local display are not plugged in correctly. Electrode cable and coil current cable are not plugged in correctly.	Plug in the cable connector correctly. Plug in the electrode cable and coil current cable correctly.

Output signal

Error	Possible causes	Remedial action
Signal output is outside the valid current range (< 3.5 mA or > 23 mA).	Electronics module is defective.	Order the appropriate spare part.
Local display shows the correct value, but signal output is incorrect, though in the valid range.	Configuration error	<ul style="list-style-type: none"> ■ Check parameter configuration. ■ Correct parameter configuration.
Device measures incorrectly.	<ul style="list-style-type: none"> ■ Configuration error ■ The device is being operated outside the application range. 	<ul style="list-style-type: none"> ■ Check parameter configuration. ■ Correct parameter configuration. ■ Observe limit values indicated.
No signal at frequency output	Device uses passive frequency output.	Wire the device correctly as described in the Operating Instructions .

Access and communication

Error	Possible causes	Remedial action
Not possible to write-access the parameter.	Write protection is enabled.	Set the write protection switch on the local display to the Off position.
	Current user role has limited access authorization.	<ol style="list-style-type: none"> 1. Check user role. 2. Enter correct customer-specific access code.
HART communication is not possible.	Load resistor missing or size is incorrect	<ul style="list-style-type: none"> ■ Load resistor must be at least 250 Ω. ■ Observe the maximum load → <i>Output signal</i>,  91. ■ → <i>Examples for electric terminals</i>,  175
	<ul style="list-style-type: none"> ■ Commubox is connected incorrectly. ■ Commubox is configured incorrectly. ■ Commubox driver is not installed correctly. ■ Wrong USB interface is configured on PC. 	Observe the documentation for the Commubox.  FXA195 HART: Document "Technical Information" TI00404F
Device communication is not possible.	Data transfer is active.	Wait until the data transfer or the current action is finished.
SmartBlue App does not show the device in the live list.	<ul style="list-style-type: none"> ■ Bluetooth is disabled on the device. ■ Bluetooth is disabled on the smartphone or tablet. 	<ol style="list-style-type: none"> 1. Check whether the Bluetooth symbol appears on the local display. 2. Enable Bluetooth on the device. 3. Enable Bluetooth on the smartphone or tablet.
Device cannot be operated with the SmartBlue App.	<ul style="list-style-type: none"> ■ Bluetooth connection is not available. ■ The device is already connected to another smartphone or tablet. ■ Incorrect password entered. ■ Password forgotten. 	<ol style="list-style-type: none"> 1. Check whether other devices are connected to the SmartBlue App. 2. Disconnect any other device connected to the SmartBlue App. <ol style="list-style-type: none"> 1. Enter correct password. 2. Contact Endress+Hauser service organization.
Login with user data is not possible with the SmartBlue App.	Device in operation for the first time.	<ol style="list-style-type: none"> 1. Enter the initial password (serial number of the device). 2. Change the initial password.
No connection via service interface	<ul style="list-style-type: none"> ■ Commubox driver is not installed correctly. ■ Wrong USB interface is configured on PC. 	Observe the documentation for the Commubox.  FXA291 HART: Document "Technical Information" TI00405C

Diagnostic information via LED

Only for devices with the order code for "Display; operation", option H

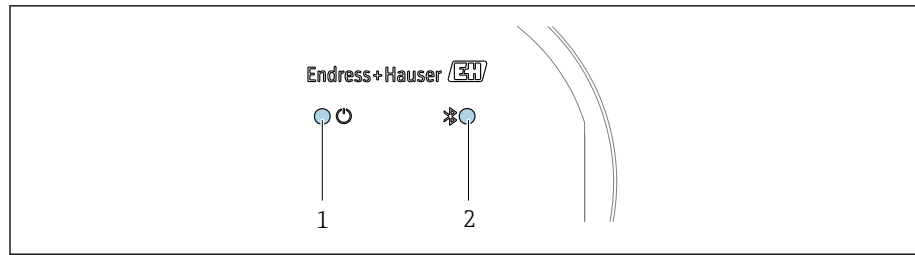

A0044231

- 1 Device status
2 Bluetooth

LED	Status	Meaning
1 Device status (normal operation)	Off	No power supply
	Permanently green	Device status is OK. No warning / failure / alarm
	Flashing red	Warning is active.
	Permanently red	Alarm is active.
2 Bluetooth	Off	Bluetooth is disabled.
	Permanently blue	Bluetooth is enabled.
	Flashing blue	Data transfer in progress.

Diagnostic information on local display

Diagnostic message

The local display alternates between displaying faults as a diagnostic message and displaying the operational display screen.

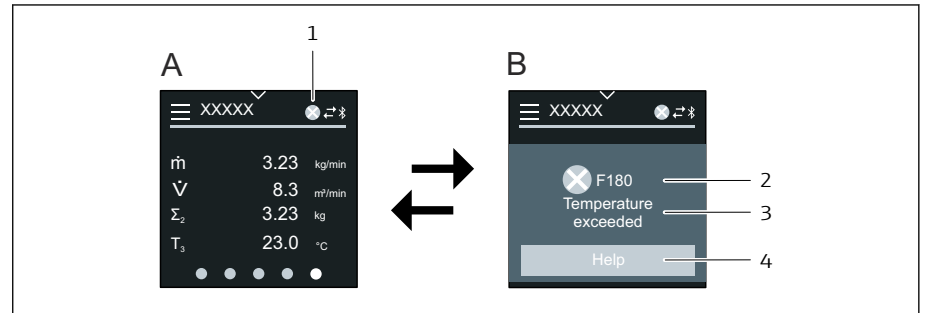

- A Operational display in alarm condition
- B Diagnostic message
- 1 Diagnostic behavior
- 2 Status signal
- 3 Diagnostic behavior with diagnostic code
- 4 Short text
- 5 Open information on remedial measures.

If two or more diagnostics events are pending simultaneously, the local display only shows the diagnostic message with the highest priority.

- i** Other diagnostic events that have occurred can be opened in the **Diagnostics** menu as follows:
 - Via parameters
 - Via submenus

Status signals

The status signals provide information on the state and reliability of the device by categorizing the cause of the diagnostic information (diagnostic event).

- i** The status signals are categorized according to NAMUR Recommendation NE 107: F = Failure, C = Function Check, S = Out of Specification, M = Maintenance Required, N = No Effect



Failure

- A device error has occurred.
- Measured value is no longer valid.



Function check

Device is in the service mode, e.g. during a simulation.

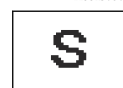

Out of specification

- Device is being operated outside the technical specification limits, e.g. outside the process temperature range.
- Device is being operated outside the configuration carried out by the user, e.g. max. flow in the 20 mA value parameter.



Maintenance required

- Maintenance is required.
- Measured value is still valid.

Diagnostic information

The fault can be identified using the diagnostic information. The short text displays a tip about the fault.

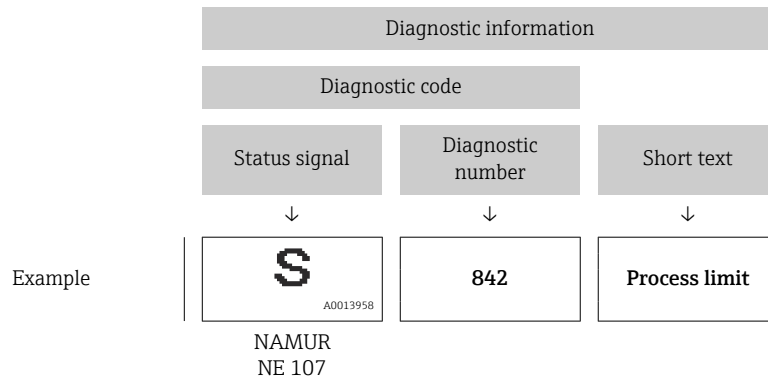
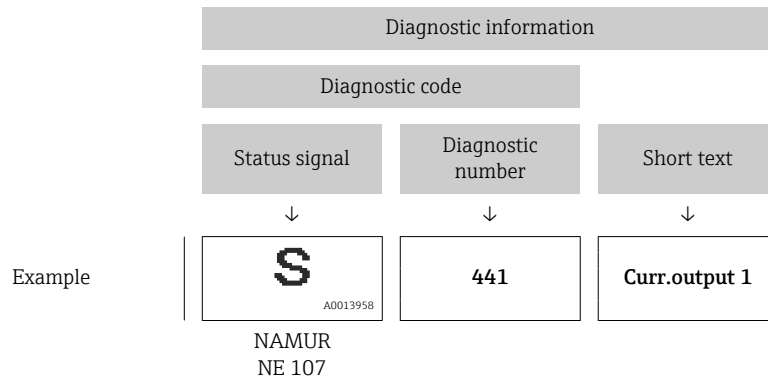

Diagnostic information in FieldCare or DeviceCare

Diagnostic options

After the connection has been established, the device shows faults on the home page.

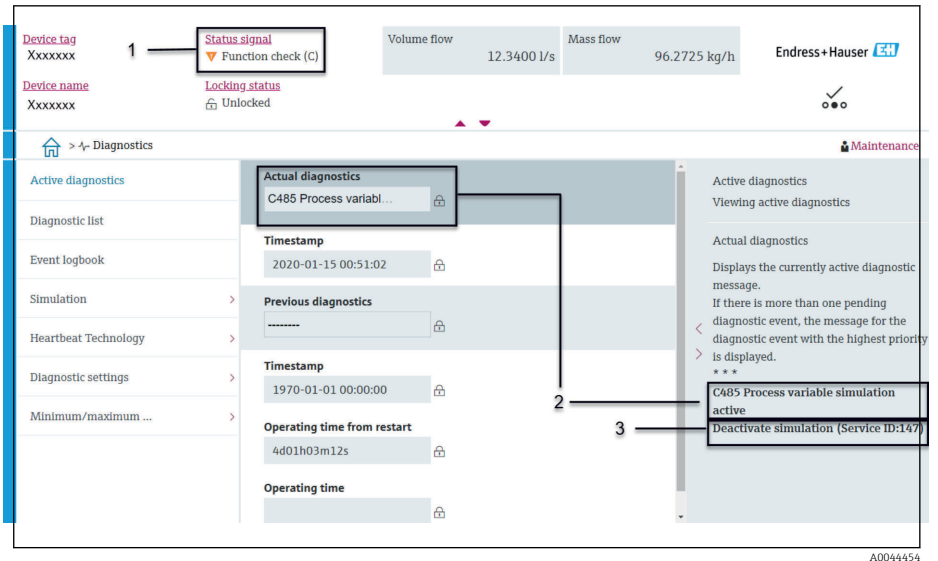

- 1 Status area with diagnostic behavior and status signal
- 2 Diagnostic code and short message
- 3 Troubleshooting measures with service ID

i Other diagnostic events that have occurred can be opened in the **Diagnostics** menu as follows:

- Via parameter
- Via submenus

Diagnostic information

The fault can be identified using the diagnostic information. The short text displays a tip about the fault. The corresponding symbol for the diagnostic behavior appears at the start.

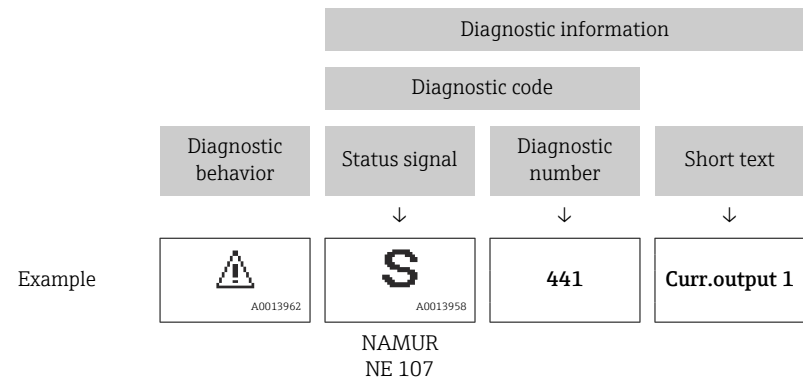

Changing the diagnostic information

Adapting the status signal

Each item of diagnostic information is assigned a specific status signal at the factory. The user can change the assignment for specific diagnostic information in the **"Diagnostic settings"** submenu.

Navigation path

Diagnostics → Diagnostic settings

Configuration of the device as per HART 7 Specification (Condensed Status), in accordance with NAMUR NE107.



Failure

- A device error has occurred.
- Measured value is no longer valid.

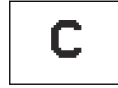

Function check

Device is in the service mode, e.g. during a simulation.



Out of specification

- Device is being operated outside the technical specification limits, e.g. outside the process temperature range.
- Device is being operated outside the configuration carried out by the user, e.g. max. flow in the 20 mA value parameter.



Maintenance required

- Maintenance is required.
- Measured value is still valid.

Adapting the diagnostic behavior

Each item of diagnostic information is assigned a specific diagnostic behavior at the factory. The user can change the assignment for specific diagnostic information in the **Diagnostic settings** submenu.

Navigation path

Diagnostics → Diagnostic settings

You can assign the following options to the diagnostic number as the diagnostic behavior:

Options	Description
Alarm	<ul style="list-style-type: none"> ▪ Device stops measurement. ▪ Signal outputs and totalizers assume a defined alarm condition. ▪ Diagnostic message is generated. ▪ Background lighting changes to red.
Warning	<ul style="list-style-type: none"> ▪ Device continues measuring. ▪ Signal outputs and totalizers are not affected. ▪ Diagnostic message is generated.
Logbook entry only	<ul style="list-style-type: none"> ▪ Device continues measuring. ▪ The local display shows the diagnostic message in the Event logbook submenu (Event list submenu) and does not alternate with the operational display.
Off	<ul style="list-style-type: none"> ▪ Diagnostic event is ignored. ▪ Diagnostic message is not generated and not entered.

Overview of diagnostic information

 The amount of diagnostic information and the number of measured variables affected increase if the device has one or more application packages.

Diagnostic number	Short text	Remedy instructions	Status signal [from the factory]	Diagnostic behavior [from the factory]
Diagnostic of sensor				
043	Sensor 1 short circuit detected	1. Check sensor cable and sensor 2. Execute Heartbeat Verification 3. Replace sensor cable or sensor	S	Warning ¹⁾
082	Data storage inconsistent	1. Check module connections 2. Contact service	F	Alarm
083	Memory content inconsistent	1. Restart device 2. Restore HistoROM S-DAT backup ('Device reset' parameter) 3. Replace HistoROM S-DAT	F	Alarm
168	Build-up detected	Clean measuring tube	M	Warning
169	Conductivity measurement failed	1. Check grounding conditions 2. Deactivate conductivity measurement	M	Warning
170	Coil resistance faulty	Check ambient and process temperature	F	Alarm
180	Temperature sensor defective	1. Check sensor connections 2. Replace sensor cable or sensor 3. Turn off temperature measurement	F	Warning
181	Sensor connection faulty	1. Check sensor cable and sensor 2. Execute Heartbeat Verification 3. Replace sensor cable or sensor	F	Alarm
Diagnostic of electronic				
201	Electronics faulty	1. Restart device 2. Contact service	F	Alarm
230	Date/time incorrect	1. Replace RTC buffer battery 2. Set date and time	M	Warning ¹⁾
231	Date/time not available	1. Replace display module or its cable 2. Set date and time	M	Warning ¹⁾
242	Firmware incompatible	1. Check firmware version 2. Flash or replace electronic module	F	Alarm
252	Module incompatible	1. Check electronic modules 2. Check if correct modules are available (e.g. NEx, Ex) 3. Replace electronic modules	F	Alarm
278	Display module defective	Replace display module	F	Alarm
283	Memory content inconsistent	1. Reset device 2. Contact service	F	Alarm
302	Device verification active	Device verification active, please wait.	C	Warning ¹⁾
311	Sensor electronics (ISEM) faulty	1. Do not reset device 2. Contact service	M	Warning

Diagnostic number	Short text	Remedy instructions	Status signal [from the factory]	Diagnostic behavior [from the factory]
331	Firmware update failed in module 1 to n	1. Update firmware of device 2. Restart device	F	Warning
372	Sensor electronics (ISEM) faulty	1. Restart device 2. Check if failure recurs 3. Replace sensor electronic module (ISEM)	F	Alarm
373	Sensor electronics (ISEM) faulty	Contact service	F	Alarm
376	Sensor electronics (ISEM) faulty	1. Replace sensor electronic module (ISEM) 2. Turn off diagnostic message	S	Warning ¹⁾
377	Sensor electronics (ISEM) faulty	1. Activate empty pipe detection 2. Check partial filled pipe and installation direction 3. Check sensor cabling 4. Deactivate diagnostics 377	S	Warning ¹⁾
378	Electronic module supply voltage faulty	Check supply voltage to the ISEM	F	Alarm
383	Memory content	1. Restart device 2. Delete T-DAT via 'Reset device' parameter 3. Replace T-DAT	F	Alarm
387	HistoROM data faulty	Contact service organization	F	Alarm
Diagnostic of configuration				
410	Data transfer failed	1. Check connection 2. Retry data transfer	F	Alarm
412	Processing download	Download active, please wait	C	Warning
431	Trim 1 required	Carry out trim	C	Warning
437	Configuration incompatible	1. Restart device 2. Contact service	F	Alarm
438	Dataset different	1. Check data set file 2. Check device configuration 3. Up- and download new configuration	M	Warning
441	Current output faulty	1. Check process 2. Check current output settings	S	Warning ¹⁾
442	Frequency output faulty	1. Check process 2. Check frequency output settings	S	Warning ¹⁾
443	Pulse output 1 faulty	1. Check process 2. Check pulse output settings	S	Warning ¹⁾
453	Flow override active	Deactivate flow override	C	Warning
484	Failure mode simulation active	Deactivate simulation	C	Alarm
485	Process variable simulation active	Deactivate simulation	C	Warning
491	Current output 1 simulation active	Deactivate simulation	C	Warning

Diagnostic number	Short text	Remedy instructions	Status signal [from the factory]	Diagnostic behavior [from the factory]
492	Frequency output simulation active	Deactivate simulation frequency output	C	Warning
493	Pulse output simulation active	Deactivate simulation pulse output	C	Warning
494	Switch output simulation active	Deactivate simulation switch output	C	Warning
495	Diagnostic event simulation active	Deactivate simulation	C	Warning
511	ISEM settings faulty	1. Check measuring period and integration time 2. Check sensor properties	C	Alarm
Diagnostic of process				
832	Sensor electronics temperature too high	Reduce ambient temperature	S	Warning ¹⁾
833	Sensor electronics temperature too low	Increase ambient temperature	S	Warning ¹⁾
834	Process temperature too high	Reduce process temperature	S	Warning ¹⁾
835	Process temperature too low	Increase process temperature	S	Warning ¹⁾
842	Process value above limit	1. Decrease process value 2. Check application 3. Check sensor	S	Warning ¹⁾
937	Sensor symmetry	1. Eliminate external magnetic field near sensor 2. Turn off diagnostic message	S	Warning ¹⁾
938	EMC interference	1. Check ambient conditions regarding EMC influence 2. Turn off diagnostic message	F	Alarm ¹⁾
944	Monitoring failed	Check process conditions for Heartbeat Monitoring	S	Warning
961	Electrode potential out of specification	1. Check process conditions 2. Check ambient conditions	S	Warning ¹⁾
962	Pipe empty	1. Perform full pipe adjustment 2. Perform empty pipe adjustment 3. Turn off empty pipe detection	S	Warning ¹⁾

1) Diagnostic behavior can be changed.

Pending diagnostic events

The **Active diagnostics** submenu displays the current diagnostic event and the last diagnostic event to occur.

Diagnostics → Active diagnostics

 The **Diagnostic list** submenu shows other diagnostic events that are pending.

Diagnostic list

The **Diagnostic list** submenu shows up to 5 currently pending diagnostic events with the related diagnostic information. If more than 5 diagnostic events are pending, the local display shows the diagnostic information with the highest priority.

Navigation path

Diagnostics → Diagnostic list

Event logbook

Reading out the event logbook

 The event logbook is only available via FieldCare or SmartBlue App (Bluetooth).



The **Event logbook** submenu shows a chronological overview of the event messages that have occurred.

Navigation path



Diagnostics menu → **Event logbook** submenu

Chronological display with a maximum of 20 event messages.

The event history includes the following entries:

- Diagnostic event → *Overview of diagnostic information*,  76
- Information event → *Overview of information events*,  80

In addition to the operation time of the event occurrence, each event is also assigned a symbol that indicates whether the event has occurred or has ended:

- Diagnostic event
 - : Occurrence of the event
 - : End of the event
- Information event
 - : Occurrence of the event

 Filter event messages:

Filtering the event logbook

The **Event logbook** submenu displays the category of event messages that were configured with the **Filter options** parameter.

Navigation path

Diagnostics → Event logbook → Filter options

Filter categories

- All
- Failure (F)
- Function check (C)
- Out of specification (S)
- Maintenance required (M)
- Information (I)

Overview of information events

The information event is only displayed in the event logbook.

Info number	Info name
I1000	----- (Device ok)
I1079	Sensor changed
I1089	Power on
I1090	Configuration reset
I1091	Configuration changed
I11036	Date/time set successfully
I11167	Date/time resynchronized
I1137	Display module replaced
I1151	History reset
I1155	Sensor electronics temperature reset
I1157	Memory error event list
I1256	Display: access status changed
I1335	Firmware changed
I1351	Empty pipe detection adjustment failure
I1353	Empty pipe detection adjustment ok
I1397	Fieldbus: access status changed
I1398	CDI: access status changed
I1443	Build-up thickness not determined
I1444	Device verification passed
I1445	Device verification failed
I1459	I/O module verification failed
I1461	Sensor verification failed
I1462	Sensor electronic module verific. failed
I1512	Download started
I1513	Download finished
I1514	Upload started
I1515	Upload finished
I1622	Calibration changed
I1624	All totalizers reset
I1625	Write protection activated
I1626	Write protection deactivated
I1629	CDI: login successful
I1632	Display: login failed
I1633	CDI: login failed
I1634	Reset to factory settings
I1635	Reset to delivery settings
I1649	Hardware write protection activated
I1650	Hardware write protection deactivated
I1712	New flash file received
I1725	Sensor electronic module (ISEM) changed

Device reset

The entire configuration, or a part of the configuration, can be reset to a defined state here.

Navigation path

System → Device management → Device reset

Options	Description
To delivery settings	Every parameter for which a customer-specific default setting was ordered is reset to the customer-specific value. All other parameters are reset to the factory setting.
Of customer settings	Visibility depends on order options or device settings
Restart device	The restart resets every parameter with data stored in volatile memory (RAM) to the factory setting (e.g. measured value data). The device configuration remains unchanged.
Restore S-DAT backup	Restore the data that is saved on the S-DAT. The data record is restored from the electronics memory to the S-DAT. Visibility depends on order options or device settings  The local display only displays this option in an alarm condition.

11 Maintenance

Maintenance tasks	84
Services	84

Maintenance tasks

The device is maintenance-free. Modifications or repairs may only be carried out following consultation with an Endress+Hauser service organization. It is recommended to examine the device regularly for corrosion, mechanical wear and damage.

Exterior cleaning

Permitted cleaning agents for the plastic housing:

- Commercially available mild household cleaners
- Methyl alcohol or isopropyl alcohol
- Mild soap solutions

Clean the device as follows:

- Use a dry or slightly damp lint-free cloth.
- Do not use sharp objects or aggressive cleaning agents.
- Do not use high-pressure steam.

Interior cleaning

No interior cleaning is required.

Services

Endress+Hauser offers a wide range of services for device maintenance, e.g. recalibration, maintenance service or device tests.

Endress+Hauser sales organizations can provide information about the services available.

12 Disposal

Removing the device	86
Disposing of the device	86

Removing the device

1. Disconnect the device from the supply voltage.
2. Remove all connecting cables.

⚠ WARNING

Process conditions can put staff at risk!

- ▶ Wear suitable protective equipment.
- ▶ Allow the device and pipe to cool.
- ▶ Empty the device and pipe so that they are unpressurized.
- ▶ Rinse the device and pipe if necessary.

3. Remove the device correctly.

Disposing of the device

⚠ WARNING

Dangerous media can endanger staff and the environment!

- ▶ Ensure that the device and all cavities are free of medium residues that are hazardous to health or the environment, e.g. substances that have permeated into crevices or diffused through plastic.



A0042336

If required by the Directive 2012/19/EU of the European Parliament and the Council of 4 July 2012 on waste electrical and electronic equipment (WEEE), the device is marked with the depicted symbol in order to minimize the disposal of WEEE as unsorted municipal waste.

- Do not dispose of devices bearing this marking as unsorted municipal waste. Instead, return them to Endress+Hauser for disposal under the applicable conditions.
- Observe applicable federal/national regulations.
- Ensure proper separation and reuse of the device components.
- Overview of installed materials: → *Materials*, 📄 114

13 Technical data

Input	88
Output	91
Power supply	95
Cable specification	97
Performance characteristics	100
Environment	102
Process	104
Mechanical construction	109
Local display	117
Certificates and approvals	118
Application packages	119

Input

Measured variable

Direct measured variables	<ul style="list-style-type: none"> ■ Volume flow (proportional to induced voltage) ■ Conductivity (order code for "Sensor Option", option CX)
Calculated measured variables	Mass flow

Operable flow range

Over 1000 : 1

Measuring range

Typically $v = 0.01$ to 10 m/s (0.03 to 33 ft/s) with the specified accuracy

Electrical conductivity: ≥ 5 $\mu\text{S/cm}$ for liquids in general

Flow characteristic values in SI units: DN 25 to 125 (1 to 4")

Nominal diameter		Recommended flow min./max. full scale value ($v \sim 0.3/10$ m/s)	Full scale value current output ($v \sim 2.5$ m/s)	Factory settings	
[mm]	[in]			Pulse value (~ 2 pulse/s)	Low flow cut off ($v \sim 0.04$ m/s)
		[dm ³ /min]	[dm ³ /min]	[dm ³]	[dm ³ /min]
25	1	9 to 300	75	0.5	1
32	–	15 to 500	125	1	2
40	1 ½	25 to 700	200	1.5	3
50	2	35 to 1100	300	2.5	5
65	–	60 to 2000	500	5	8
80	3	90 to 3000	750	5	12
100	4	145 to 4700	1200	10	20
125	–	220 to 7500	1850	15	30

Flow characteristic values in SI units: DN 150 to 2400 (6 to 90")

Nominal diameter		Recommended flow min./max. full scale value ($v \sim 0.3/10$ m/s)	Full scale value current output ($v \sim 2.5$ m/s)	Factory settings	
[mm]	[in]			Pulse value (~ 2 pulse/s)	Low flow cut off ($v \sim 0.04$ m/s)
		[m ³ /h]	[m ³ /h]	[m ³]	[m ³ /h]
150	6	20 to 600	150	0.025	2.5
200	8	35 to 1100	300	0.05	5
250	10	55 to 1700	500	0.05	7.5
300	12	80 to 2400	750	0.1	10
350	14	110 to 3300	1000	0.1	15
375	15	140 to 4200	1200	0.15	20
400	16	140 to 4200	1200	0.15	20
450	18	180 to 5400	1500	0.25	25

Nominal diameter		Recommended flow min./max. full scale value (v ~ 0.3/10 m/s)	Full scale value current output (v ~ 2.5 m/s)	Factory settings	
[mm]	[in]			[m ³ /h]	Pulse value (~ 2 pulse/s) [m ³]
500	20	220 to 6 600	2000	0.25	30
600	24	310 to 9 600	2500	0.3	40
700	28	420 to 13 500	3500	0.5	50
750	30	480 to 15 000	4000	0.5	60
800	32	550 to 18 000	4500	0.75	75
900	36	690 to 22 500	6000	0.75	100
1000	40	850 to 28 000	7000	1	125
-	42	950 to 30 000	8000	1	125
1200	48	1 250 to 40 000	10 000	1.5	150
-	54	1 550 to 50 000	13 000	1.5	200
1400	-	1 700 to 55 000	14 000	2	225
-	60	1 950 to 60 000	16 000	2	250
1600	-	2 200 to 70 000	18 000	2.5	300
-	66	2 500 to 80 000	20 500	2.5	325
1800	72	2 800 to 90 000	23 000	3	350
-	78	3 300 to 100 000	28 500	3.5	450
2000	-	3 400 to 110 000	28 500	3.5	450
-	84	3 700 to 125 000	31 000	4.5	500
2200	-	4 100 to 136 000	34 000	4.5	540
-	90	4 300 to 143 000	36 000	5	570
2400	-	4 800 to 162 000	40 000	5.5	650

Flow characteristic values in US units: 1 to 48" (DN 25 to 1200)

Nominal diameter		Recommended flow min./max. full scale value (v ~ 0.3/10 m/s)	Full scale value current output (v ~ 2.5 m/s)	Factory settings	
[in]	[mm]			[gal/min]	Pulse value (~ 2 pulse/s) [gal]
1	25	2.5 to 80	18	0.2	0.25
-	32	4 to 130	30	0.2	0.5
1 ½	40	7 to 185	50	0.5	0.75
2	50	10 to 300	75	0.5	1.25
-	65	16 to 500	130	1	2
3	80	24 to 800	200	2	2.5
4	100	40 to 1 250	300	2	4
-	125	60 to 1 950	450	5	7
6	150	90 to 2 650	600	5	12
8	200	155 to 4 850	1 200	10	15
10	250	250 to 7 500	1 500	15	30

Nominal diameter		Recommended flow min./max. full scale value (v ~ 0.3/10 m/s)	Full scale value current output (v ~ 2.5 m/s)	Factory settings	
[in]	[mm]			Pulse value (~ 2 pulse/s)	Low flow cut off (v ~ 0.04 m/s)
		[gal/min]	[gal/min]	[gal]	[gal/min]
12	300	350 to 10 600	2400	25	45
14	350	500 to 15 000	3600	30	60
15	375	600 to 19 000	4800	50	60
16	400	600 to 19 000	4800	50	60
18	450	800 to 24 000	6000	50	90
20	500	1000 to 30 000	7500	75	120
24	600	1400 to 44 000	10500	100	180
28	700	1900 to 60 000	13500	125	210
30	750	2 150 to 67 000	16500	150	270
32	800	2 450 to 80 000	19500	200	300
36	900	3 100 to 100 000	24000	225	360
40	1000	3 800 to 125 000	30000	250	480
42	-	4 200 to 135 000	33000	250	600
48	1200	5 500 to 175 000	42000	400	600

Flow characteristic values in US units: 54 to 90" (DN 1400 to 2400)

Nominal diameter		Recommended flow min./max. full scale value (v ~ 0.3/10 m/s)	Full scale value current output (v ~ 2.5 m/s)	Factory settings	
[in]	[mm]			Pulse value (~ 2 pulse/s)	Low flow cut off (v ~ 0.04 m/s)
		[Mgal/d]	[Mgal/d]	[Mgal]	[Mgal/d]
54	-	9 to 300	75	0.0005	1.3
-	1400	10 to 340	85	0.0005	1.3
60	-	12 to 380	95	0.0005	1.3
-	1600	13 to 450	110	0.0008	1.7
66	-	14 to 500	120	0.0008	2.2
72	1800	16 to 570	140	0.0008	2.6
78	-	18 to 650	175	0.0010	3.0
-	2000	20 to 700	175	0.0010	2.9
84	-	24 to 800	190	0.0011	3.2
-	2200	26 to 870	210	0.0012	3.4
90	-	27 to 910	220	0.0013	3.6
-	2400	31 to 1030	245	0.0014	4.1

Output

Output signal

Output versions

Order code for 020: output; input	Output version
Option B	<ul style="list-style-type: none"> ■ Current output 4 to 20 mA HART ■ Pulse/frequency/switch output

Current output 4 to 20 mA HART

Signal mode	Choose via terminal assignment: <ul style="list-style-type: none"> ■ Active ■ Passive
Current range	Can be set to: <ul style="list-style-type: none"> ■ 4 to 20 mA NAMUR ■ 4 to 20 mA US ■ 4 to 20 mA ■ Fixed current
Max. output current	21.5 mA
Open-circuit voltage	DC < 28.8 V (active)
Max. input voltage	DC 30 V (passive)
Max. load	400 Ω
Resolution	1 μA
Damping	Configurable: 0 to 999.9 s
Assignable measured variables	<ul style="list-style-type: none"> ■ Off ■ Volume flow ■ Mass flow ■ Flow velocity ■ Conductivity* ■ Electronic temperature ■ Noise* ■ Coil current shot time* ■ Reference electrode potential against PE* <p>* Visibility depends on order options or device settings</p>

Pulse/frequency/switch output

Function	Can be set to: <ul style="list-style-type: none"> ■ Pulse output ■ Frequency output ■ Switch output
Version	Open collector: Passive

Input values	<ul style="list-style-type: none"> ■ DC 10.4 to 30 V ■ Max. 140 mA
---------------------	--

Voltage drop	<ul style="list-style-type: none"> ■ ≤ DC 2 V @ 100 mA ■ ≤ DC 2.5 V @ max. input current
---------------------	--

Pulse output

Pulse width	Configurable: 0.05 to 2 000 ms
--------------------	--------------------------------

Max. pulse rate	10 000 Impulse/s
------------------------	------------------

Pulse value	Configurable
--------------------	--------------

Assignable measured variables	<ul style="list-style-type: none"> ■ Volume flow ■ Mass flow
--------------------------------------	--

Frequency output

Output frequency	Configurable: end value frequency 2 to 10 000 Hz ($f_{max} = 12\,500$ Hz)
-------------------------	--

Damping	Configurable: 0 to 999.9 s
----------------	----------------------------

Pulse/pause ratio	1:1
--------------------------	-----

Assignable measured variables	<ul style="list-style-type: none"> ■ Off ■ Volume flow ■ Mass flow ■ Flow velocity ■ Conductivity* ■ Electronic temperature ■ Noise* ■ Coil current shot time* ■ Reference electrode potential against PE* <p>* Visibility depends on order options or device settings</p>
--------------------------------------	---

Switch output

Switching behavior	Binary, conductive or non-conductive
---------------------------	--------------------------------------

Switching delay	Configurable: 0 to 100 s
------------------------	--------------------------

Number of switching cycles	Unlimited
Assignable functions	<ul style="list-style-type: none">■ Off■ On■ Diagnostic behavior:<ul style="list-style-type: none">■ Alarm■ Warning■ Warning and alarm■ Limit value:<ul style="list-style-type: none">■ Off■ Volume flow■ Mass flow■ Flow velocity■ Conductivity*■ Corrected conductivity*■ Totalizer 1...3■ Electronic temperature■ Flow direction monitoring■ Status<ul style="list-style-type: none">■ Empty pipe detection■ Low flow cut off <p>* Visibility depends on order options or device settings</p>

Signal on alarm

Output behavior in the event of a device alarm (failure mode)

HART

Device diagnostics	Device condition can be read out via HART Command 48
---------------------------	--

Current output 4 to 20 mA

4 to 20 mA	Selectable: <ul style="list-style-type: none"> ▪ Min. value: 3.59 mA ▪ Max. value: 21.5 mA ▪ Freely definable value between: 3.59 to 21.5 mA ▪ Actual value ▪ Last valid value
-------------------	---

Pulse/frequency/switch output

Pulse output	Selectable: <ul style="list-style-type: none"> ▪ Actual value ▪ No pulses
Frequency output	Selectable: <ul style="list-style-type: none"> ▪ Actual value ▪ 0 Hz ▪ Defined value: 0 to 12 500 Hz
Switch output	Selectable: <ul style="list-style-type: none"> ▪ Current status ▪ Open ▪ Closed

Low flow cut off

The switch points for low flow cut off are user-selectable.

Galvanic isolation

The outputs are galvanically isolated from one another and from earth.

Protocol-specific data

Bus structure	The HART signal overlays the 4 to 20 mA current output.
Manufacturer ID	0x11
Device type ID	0x71
HART protocol revision	7
Device description files (DTM, DD)	Information and files under: www.endress.com
HART load	At least 250 Ω
System integration	Measured variables via HART protocol

Power supply

Terminal assignment

 The terminal assignment is documented on an adhesive label.

The following terminal assignment is available:

Current output 4 to 20 mA HART (active) and pulse/frequency/switch output

Supply voltage		Output 1				Output 2	
1 (+)	2 (-)	26 (+)	27 (-)	24 (+)	25 (-)	22 (+)	23 (-)
L/+	N/-	Current output 4 to 20 mA HART (active)		-		Pulse/frequency/switch output (passive)	

Current output 4 to 20 mA HART (passive) and pulse/frequency/switch output

Supply voltage		Output 1				Output 2	
1 (+)	2 (-)	26 (+)	27 (-)	24 (+)	25 (-)	22 (+)	23 (-)
L/+	N/-	-		Current output 4 to 20 mA HART (passive)		Pulse/frequency/switch output (passive)	

Supply voltage

Order code for "Power supply"	Terminal voltage		Frequency range
Option D	DC 24 V	-20 to +30 %	-
Option E	AC 100 to 240 V	-15 to +10 %	50/60 Hz, ±5 Hz
Option I	DC 24 V	-20 to +30 %	-
	AC 100 to 240 V	-15 to +10 %	50/60 Hz, ±5 Hz
Option M non-hazardous area	DC 24 V	-20 to +30 %	-
	AC 100 to 240 V	-15 to +10 %	50/60 Hz, ±5 Hz

Power consumption

- Transmitter: max. 10 W (active power)
- Switch-on current: max. 36 A (< 5 ms) as per NAMUR Recommendation NE 21

Current consumption

- Max. 400 mA (24 V)
- Max. 200 mA (110 V, 50/60 Hz; 230 V, 50/60 Hz)

Power supply failure

- Totalizers stop at the last value measured.
- Device configuration remains unchanged.
- Error messages (incl. total operated hours) are stored.

Terminals

Spring terminals

- Suitable for strands and strands with ferrules.
- Conductor cross-section 0.2 to 2.5 mm² (24 to 12 AWG).

Cable entries

- Cable gland: M20 × 1.5 for cable Ø6 to 12 mm (0.24 to 0.47 in)
- Thread for cable entry:
 - NPT ½"
 - G ½", G ½" Ex d
 - M20

Cable specification

Requirements for connecting cable

Electrical safety

As per applicable national regulations.

Permitted temperature range

- Observe the installation guidelines that apply in the country of installation.
- The cables must be suitable for the minimum temperatures and maximum temperatures to be expected.

Power supply cable (incl. conductor for the inner ground terminal)

- A standard installation cable is sufficient.
- Provide grounding according to applicable national codes and regulations.

Signal cable

- Current output 4 to 20 mA HART:
A shielded cable is recommended, observe the grounding concept of the facility.
- Pulse/frequency/switch output:
Standard installation cable

Ground cable requirements

Copper wire: at least 6 mm² (0.0093 in²)

Connecting cable requirements

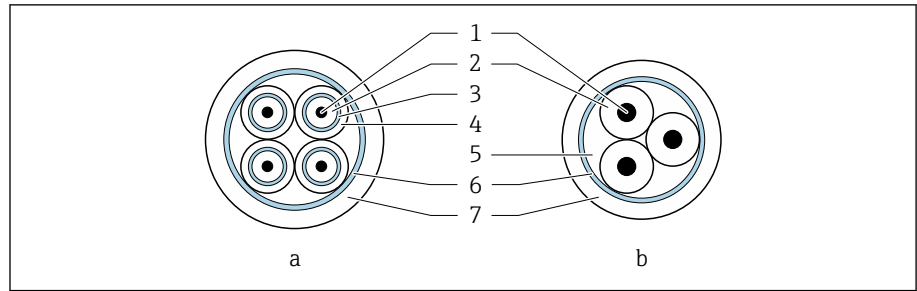

A0029151

8 Cable cross-section

- a Electrode cable
- b Coil current cable
- 1 Core
- 2 Core insulation
- 3 Core shield
- 4 Core jacket
- 5 Core reinforcement
- 6 Cable shield
- 7 Outer jacket

i Preterminated connecting cables

Two connecting cable versions can be ordered from Endress+Hauser for use with IP68 protection:

- Cable is already connected to the sensor.
- Cable is connected by the customer (incl. tools for sealing the connection compartment).

i Armored connecting cable

Armored connecting cables with additional, metal reinforcing braid can be ordered from Endress+Hauser. Armored connecting cables are used:

- When laying the cable directly in the ground
- Where there is a risk of damage from rodents
- If using the device below IP68 degree of protection

Electrode cable

Design	3×0.38 mm ² (20 AWG) with common, braided copper shield (∅ ~ 9.5 mm (0.37 in)) and individual shielded cores If using the empty pipe detection (EPD) function: 4×0.38 mm ² (20 AWG) with common, braided copper shield (∅ ~ 9.5 mm (0.37 in)) and individual shielded cores
Conductor resistance	≤ 50 Ω/km (0.015 Ω/ft)
Capacitance: core/shield	≤ 420 pF/m (128 pF/ft)
Cable length	Depending on the medium conductivity: maximum 200 m (656 ft)
Cable lengths (available for order)	5 m (15 ft), 10 m (30 ft), 20 m (60 ft) or variable length: maximum 200 m (656 ft) Armored cables: variable length up to maximum 200 m (656 ft)
Operating temperature	-20 to +80 °C (-4 to +176 °F)

Coil current cable

Design	3×0.38 mm ² (20 AWG) with common, braided copper shield (∅ ~ 9.5 mm (0.37 in)) and individual shielded cores
Conductor resistance	≤ 37 Ω/km (0.011 Ω/ft)
Capacitance: core/shield	≤ 120 pF/m (37 pF/ft)
Cable length	Depends on the medium conductivity, max. 200 m (656 ft)
Cable lengths (available for order)	5 m (15 ft), 10 m (30 ft), 20 m (60 ft) or variable length up to max. 200 m (656 ft) Armored cables: variable length up to max. 200 m (656 ft)
Operating temperature	-20 to +80 °C (-4 to +176 °F)
Test voltage for cable insulation	≤ AC 1 433 V r.m.s. 50/60 Hz or ≥ DC 2 026 V

Performance characteristics

Reference operating conditions

- Error limits based on ISO 20456:2017
- Water, typically: +15 to +45 °C (+59 to +113 °F); 0.5 to 7 bar (7.3 to 101 psi)
- Data as indicated in the calibration protocol
- Accuracy based on accredited calibration rigs according to ISO 17025

i To obtain measured errors, use the *Applicator* sizing tool → *Service-specific accessory*, 163

Maximum measured error

o. r. = of reading

Error limits under reference operating conditions

Volume flow

±0.5 % o. r. ±1 mm/s (±0.04 in/s)

i Fluctuations in the supply voltage do not have any effect within the specified range.

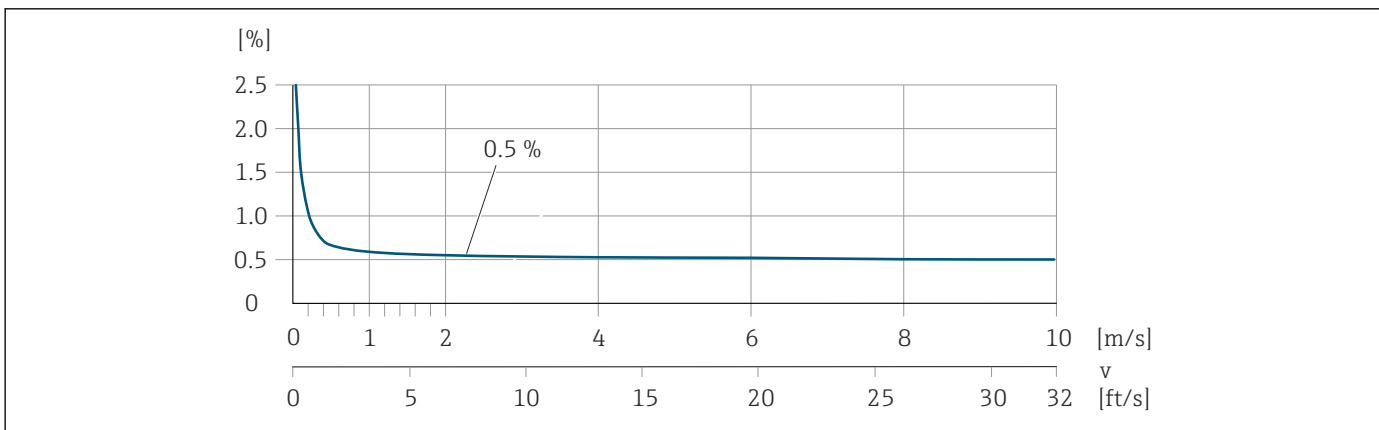

A0045827

Electrical conductivity

Max. measured error not specified.

Accuracy of outputs

Current output	±5 µA
Pulse/frequency output	Max. ±100 ppm o. r. (across the entire ambient temperature range)

Repeatability

Volume flow	Max. ±0.1 % o. r. ± 0.5 mm/s (0.02 in/s)
Electrical conductivity	Max. ±5 % o. r. (5 to 100 000 µS/cm)

Influence of ambient temperature

Current output	Temperature coefficient max. 1 $\mu\text{A}/^\circ\text{C}$
Pulse/frequency output	No additional effect. Is included in the accuracy.

Environment

Ambient temperature range

Transmitter	-40 to +60 °C (-40 to +140 °F)
Local display	-20 to +60 °C (-4 to +140 °F) The readability of the display may be impaired at temperatures outside the temperature range.
Sensor	<ul style="list-style-type: none"> ■ Process connection, carbon steel: -10 to +60 °C (+14 to +140 °F) ■ Process connection, stainless steel: -40 to +60 °C (-40 to +140 °F)
Liner	Do not exceed or fall below the permitted temperature range of the liner → <i>Medium temperature range</i> , ☰ 104.
	i Dependency of ambient temperature on medium temperature → <i>Medium temperature range</i> , ☰ 104

Storage temperature

The storage temperature corresponds to the ambient temperature range of the transmitter and sensor.

Atmosphere

According to IEC 60529: If a plastic housing is permanently exposed to certain steam and air mixtures, this can damage the housing.

i More Informationen: Endress+Hauser sales organizations.

Degree of protection

Transmitter	<ul style="list-style-type: none"> ■ IP66/67, type 4X enclosure ■ Open housing: IP20, type 1 enclosure 	
Sensor	IP66/67, type 4X enclosure	
Optional sensor Order code for "Sensor option", option CA	IP66/67, type 4X enclosure Fully welded, with protective coating as per EN ISO 12944 C5-M	For operation in corrosive environment
Order code for "Sensor option", Option CB, CC	IP68, type 6P enclosure Fully welded, with protective coating as per EN ISO 12944 C5-M and EN 60529	Use of device under water at a maximum water depth of: <ul style="list-style-type: none"> ■ 3 m (10 ft): permanent use ■ 10 m (30 ft): max. 48 hours
Order code for "Sensor option", option CE	IP68, type 6P enclosure Fully welded, with protective coating as per EN ISO 12944 Im1/Im2/Im3 and EN 60529	Use of device under water in saline water at a maximum water depth of: <ul style="list-style-type: none"> ■ 3 m (10 ft): permanent use ■ 10 m (30 ft): max. 48 hours ■ Use of device under water at a maximum water depth of: 10 m (30 ft): max. 48 hours ■ Use of device in buried applications

Vibration-resistance and shock-resistance

Compact version

Vibration, sinusoidal <ul style="list-style-type: none"> ▪ Following IEC 60068-2-6 ▪ 20 cycles per axis 	2 to 8.4 Hz	3.5 mm peak
	8.4 to 2 000 Hz	1 g peak
Vibration, broad-band random <ul style="list-style-type: none"> ▪ Following IEC 60068-2-64 ▪ 120 min per axis 	10 to 200 Hz	0.003 g ² /Hz
	200 to 2 000 Hz	0.001 g ² /Hz (1.54 g rms)
Shocks, half-sine <ul style="list-style-type: none"> ▪ Following IEC 60068-2-27 ▪ 3 positive and 3 negative shocks 	6 ms 30 g	

Shock

Due to rough handling according to IEC 60068-2-31.

Remote version (sensor)

Vibration, sinusoidal <ul style="list-style-type: none"> ▪ Following IEC 60068-2-6 ▪ 20 cycles per axis 	2 to 8.4 Hz	7.5 mm peak
	8.4 to 2 000 Hz	2 g peak
Vibration, broad-band random <ul style="list-style-type: none"> ▪ Following IEC 60068-2-6 ▪ 120 min per axis 	10 to 200 Hz	0.01 g ² /Hz
	200 to 2 000 Hz	0.003 g ² /Hz (2.7 g rms)
Shocks, half-sine <ul style="list-style-type: none"> ▪ Following IEC 60068-2-6 ▪ 3 positive and 3 negative shocks 	6 ms 50 g	

Shock

Due to rough handling according to IEC 60068-2-31.

Electromagnetic compatibility (EMC)

As per IEC/EN 61326 and NAMUR Recommendation NE 21.



For more information: Declaration of Conformity

Process

Medium temperature range

The medium temperature range depends on the liner.

Hard rubber	0 to +80 °C (+32 to +176 °F)
Polyurethane	-20 to +50 °C (-4 to +122 °F)
PTFE	<ul style="list-style-type: none"> ■ Process connection, carbon steel: -10 to +60 °C (+14 to +140 °F) ■ Process connection, stainless steel: -40 to +60 °C (-40 to +140 °F)

Conductivity

The necessary minimum conductivity is $\geq 5 \mu\text{S/cm}$.

i Note that in the case of the remote version, the minimum conductivity depends on the cable length.

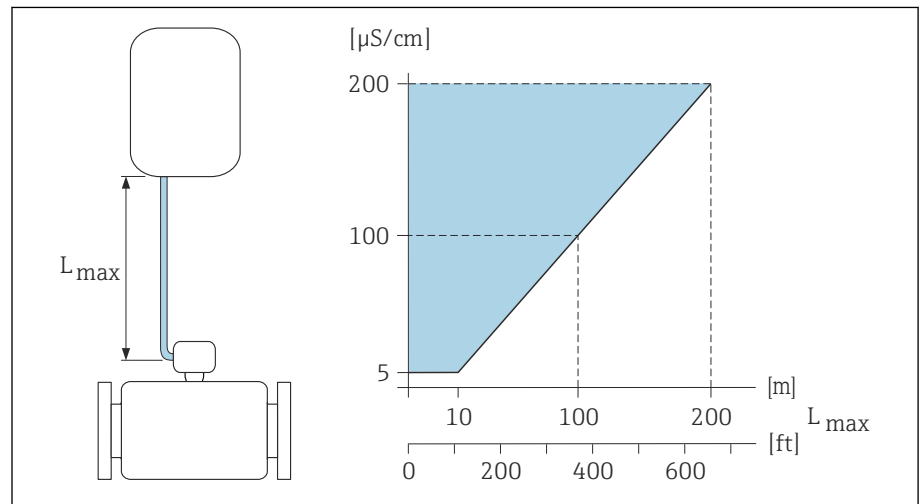

9 Permitted length of connecting cable

Colored area = permitted range

L_{max} = length of connecting cable in [m] ([ft])

[$\mu\text{S/cm}$] = medium conductivity

Flow limit

Pipe diameter and flow rate determine the nominal diameter of the sensor.

i The flow velocity is increased by reducing the sensor nominal diameter.

2 to 3 m/s (6.56 to 9.84 ft/s)	Optimum flow velocity
$v < 2 \text{ m/s}$ (6.56 ft/s)	For abrasive media, e.g. potter's clay, lime milk, ore slurry
$v > 2 \text{ m/s}$ (6.56 ft/s)	For media producing buildup, e.g. wastewater sludge

Pressure-temperature ratings

Maximum permitted medium pressure as a function of the medium temperature

The data relate to all pressure bearing parts of the device.

Fixed flange according to EN 1092-1

Stainless steel (-20 °C (-4 °F))
Carbon steel (-10 °C (14 °F))

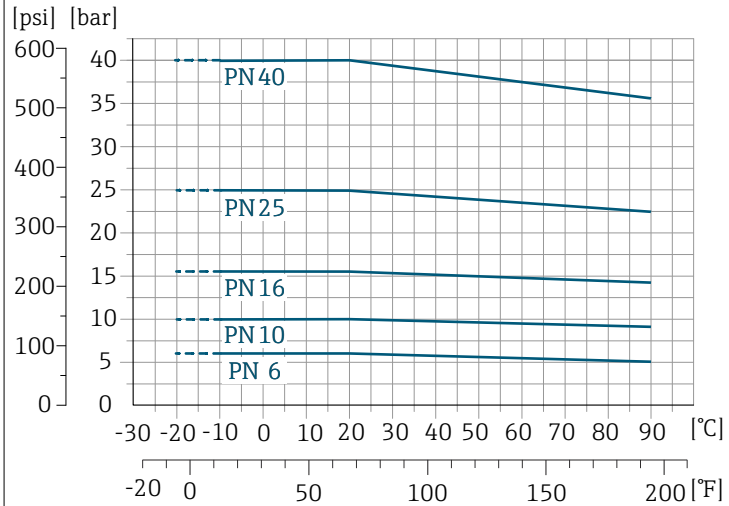

A0038122-EN

Fixed flange according to ASME B16.5

Stainless steel

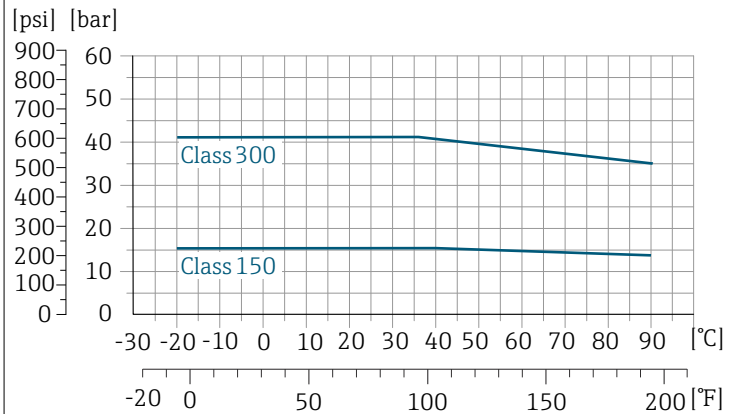

A0038123-EN

Carbon steel

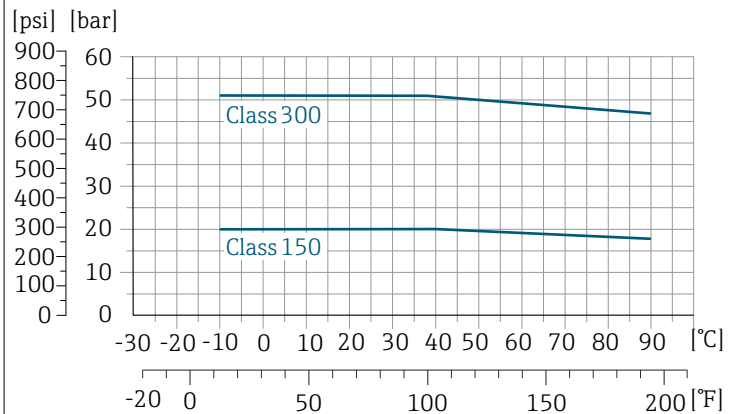

A0038121-EN

Fixed flange according to JIS B2220

Stainless steel (-20 °C (-4 °F))
 Carbon steel (-10 °C (14 °F))

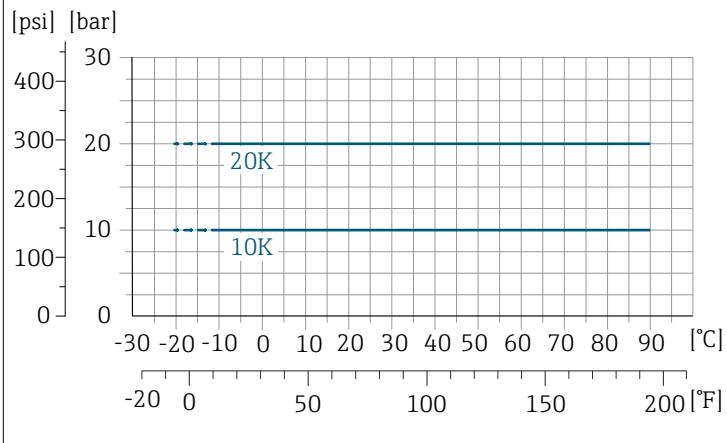

A0038124-EN

Fixed flange according to AWWA C207

Carbon steel

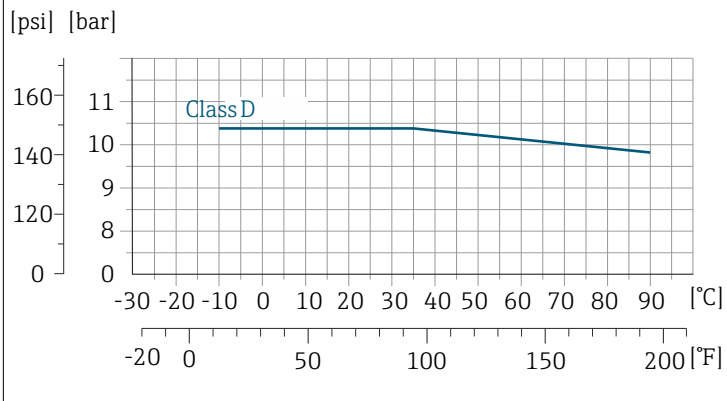

A0038126-EN

Fixed flange according to AS 2129

Carbon steel

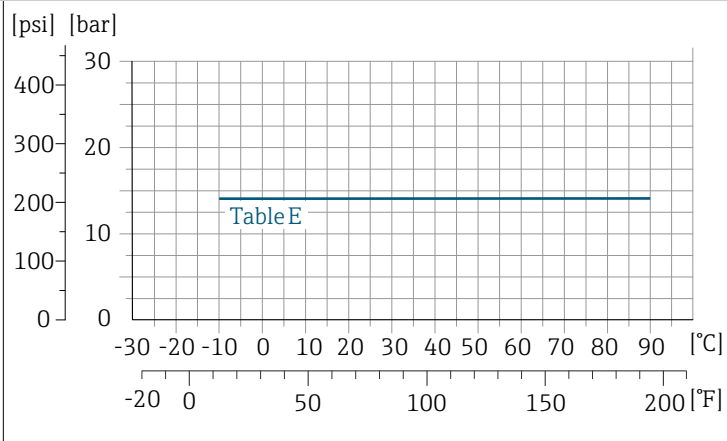

A0038127-EN

Fixed flange according to AS 4087

Carbon steel

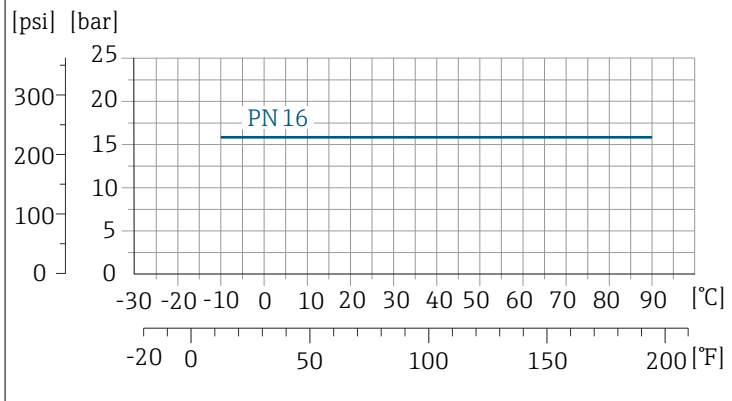

A0038128-EN

Lap joint flange/lap joint flange, stamped plate according to EN 1092-1 and ASME B16.5

Stainless steel (-20 °C (-4 °F))
Carbon steel (-10 °C (14 °F))

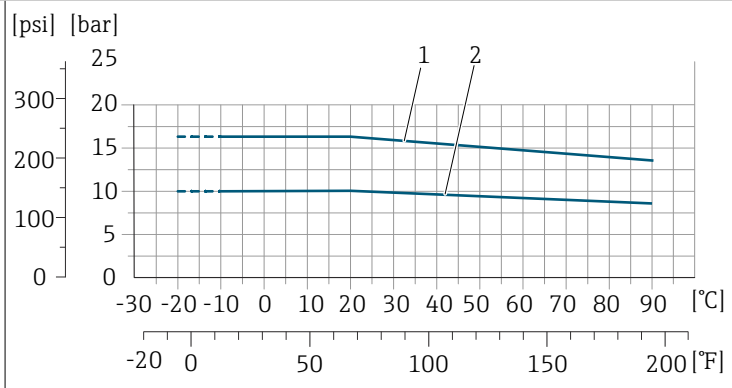

A0038129-EN

- 1 Lap joint flange PN16/Class150
- 2 Lap joint flange, stamped plate PN10, lap joint flange PN10

Pressure tightness

Limit values for the absolute pressure depending on the liner and medium temperature

PTFE	Nominal diameter		Absolute pressure in [mbar] ([psi])	
	[mm]	[in]	+25 °C (+77 °F)	+90 °C (+194 °F)
	25	1	0 (0)	0 (0)
	40	2	0 (0)	0 (0)
	50	2	0 (0)	0 (0)
	65	2 ½	0 (0)	40 (0.58)
	80	3	0 (0)	40 (0.58)
	100	4	0 (0)	135 (2.0)
	125	5	135 (2.0)	240 (3.5)
	150	6	135 (2.0)	240 (3.5)
	200	8	200 (2.9)	290 (4.2)
	250	10	330 (4.8)	400 (5.8)
	300	12	400 (5.8)	500 (7.3)

Hard rubber	+25 °C (+77 °F)	+50 °C (+122 °F)	+80 °C (+176 °F)
	0 (0)	0 (0)	0 (0)

Polyurethane	+25 °C (+77 °F)	+50 °C (+122 °F)
	0 (0)	0 (0)

Pressure loss

- No pressure loss: transmitter installed in a pipe with the same nominal diameter.
- Pressure loss information when adapters are used → *Adapters*,  29

Mechanical construction

Weight

All values refer to devices with flanges with a standard pressure rating. Weight data are guideline values. The weight may be lower than indicated depending on the pressure rating and design.

Transmitter remote version

Aluminum: 2.4 kg (5.3 lbs)

Sensor remote version

Aluminum sensor connection housing: see the information in the following table.

Weight in SI units

Order code for "Design", options D, E	Nominal diameter		EN (DIN), AS, JIS		ASME (Class 150)
	[mm]	[in]	Rating	[kg]	[kg]
	25	1	PN 40	10	5
	32	-	PN 40	11	-
	40	1 ½	PN 40	12	7
	50	2	PN 40	13	9
	65	-	PN 16	13	-
	80	3	PN 16	15	14
	100	4	PN 16	18	19
	125	-	PN 16	25	-
	150	6	PN 16	31	33
	200	8	PN 10	52	52
	250	10	PN 10	81	90
	300	12	PN 10	95	129
	350	14	PN 6	106	172
	375	15	PN 6	121	-
	400	16	PN 6	121	203

Order code for "Design", options G	Nominal diameter		EN (DIN) (PN 6)	ASME (Class 150), AWWA (Class D)
	[mm]	[in]	[kg]	[kg]
	450	18	161	255
	500	20	156	285
	600	24	208	405
	700	28	304	400
	-	30	-	460
	800	32	357	550
	900	36	485	800
	1000	40	589	900
	-	42	-	1 100
	1200	48	850	1 400
	-	54	850	2 200

Order code for "Design", options G	Nominal diameter		EN (DIN) (PN 6)	ASME (Class 150), AWWA (Class D)
	[mm]	[in]	[kg]	[kg]
	1400	-	1 300	-
	-	60	-	2 700
	1600	-	1 845	-
	-	66	-	3 700
	1800	72	2 357	4 100
	-	78	2 929	4 600
	2000	-	2 929	-

Order code for "Design", options F	Nominal diameter		EN (DIN) (PN16)	AS (PN 16)	ASME (Class 150), AWWA (Class D)
	[mm]	[in]	[kg]	[kg]	[kg]
	450	18	142	138	191
	500	20	182	186	228
	600	24	227	266	302
	700	28	291	369	266
	-	30	-	447	318
	800	32	353	524	383
	900	36	444	704	470
	1000	40	566	785	587
	-	42	-	-	670
	1200	48	843	1 229	901
	-	54	-	-	1 273
	1400	-	1 204	-	-
	-	60	-	-	1 594
	1600	-	1 845	-	-
	-	66	-	-	2 131
	1800	72	2 357	-	2 568
	-	78	2 929	-	3 113
	2000	-	2 929	-	3 113
	-	84	-	-	3 755
	2200	-	3 422	-	-
	-	90	-	-	4 797
	2400	-	4 094	-	-

Weight in US units

All values refer to devices with flanges with a standard pressure rating. Weight data are reference values. They may be lower than indicated depending on the pressure rating and design.

Transmitter remote version

- Polycarbonate: 3.1 lb
- Aluminum: 5.3 lb

Order code for "Design", options D, E	Nominal diameter		ASME (Class 150)
	[mm]	[in]	[lb]
	25	1	11
	32	-	-
	40	1 ½	15
	50	2	20
	65	-	-
	80	3	31
	100	4	42
	125	-	-
	150	6	73
	200	8	115
	250	10	198
	300	12	284
	350	14	379
	375	15	-
	400	16	448

Order code for "Design", options F	Nominal diameter		ASME (Class 150), AWWA (Class D)
	[mm]	[in]	[lb]
	450	18	421
	500	20	503
	600	24	666
	700	28	587
	-	30	701
	800	32	845
	900	36	1036
	1000	40	1294
	-	42	1477
	1200	48	1987
	-	54	2807
	1400	-	-
	-	60	3515
	1600	-	-
	-	66	4699
	1800	72	5662
	-	78	6864

Order code for "Design", options F	Nominal diameter		ASME (Class 150), AWWA (Class D)
	[mm]	[in]	[lb]
	2000	-	6864
	-	84	8280
	2200	-	-
	-	90	10577
	2400	-	-

Order code for "Design", options G	Nominal diameter		ASME (Class 150), AWWA (Class D)
	[mm]	[in]	[lb]
	450	18	562
	500	20	628
	600	24	893
	700	28	882
	-	30	1014
	800	32	1213
	900	36	1764
	1000	40	1984
	-	42	2426
	1200	48	3087
	-	54	4851
	1400	-	-
	-	60	5954
	1600	-	-
	-	66	8158
	1800	72	9040
	-	78	10143
	2000	-	-

Measuring pipe specification

Nominal diameter		Rating				Measuring pipe internal diameter					
		EN (DIN)	ASME AWWA	AS 2129 AS 4087	JIS	Hard rubber		Polyurethane		PTFE	
[mm]	[in]					[mm]	[in]	[mm]	[in]	[mm]	[in]
25	1	PN 40	Class 150	-	20K	-	-	24	0.94	25	0.98
32	-	PN 40	-	-	20K	-	-	32	1.26	34	1.34
40	1 ½	PN 40	Class 150	-	20K	-	-	38	1.50	40	1.57
50	2	PN 40	Class 150	Table E, PN 16	10K	50	1.97	50	1.97	52	2.05
65	-	PN 16	-	-	10K	66	2.60	66	2.60	68	2.68
80	3	PN 16	Class 150	Table E, PN 16	10K	79	3.11	79	3.11	80	3.15
100	4	PN 16	Class 150	Table E, PN 16	10K	102	4.02	102	4.02	104	4.09
125	-	PN 16	-	-	10K	127	5.00	127	5.00	130	5.12
150	6	PN 16	Class 150	Table E, PN 16	10K	156	6.14	156	6.14	156	6.14
200	8	PN 10	Class 150	Table E, PN 16	10K	204	8.03	204	8.03	202	7.95
250	10	PN 10	Class 150	Table E, PN 16	10K	258	10.2	258	10.2	256	10.08
300	12	PN 10	Class 150	Table E, PN 16	10K	309	12.2	309	12.2	306	12.05
350	14	PN 6	Class 150	Table E, PN 16	10K	337	13.3	342	13.5	-	-
375	15	-	-	PN 16	10K	389	15.3	-	-	-	-
400	16	PN 6	Class 150	Table E, PN 16	10K	387	15.2	392	15.4	-	-
450	18	PN 6	Class 150	-	10K	436	17.1	437	17.2	-	-
500	20	PN 6	Class 150	Table E, PN 16	10K	487	19.1	492	19.4	-	-
600	24	PN 6	Class 150	Table E, PN 16	10K	589	23.0	594	23.4	-	-
700	28	PN 6	Class D	Table E, PN 16	10K	688	27.1	692	27.2	-	-
750	30	-	Class D	Table E, PN 16	10K	737	29.1	742	29.2	-	-
800	32	PN 6	Class D	Table E, PN 16	-	788	31.0	794	31.3	-	-
900	36	PN 6	Class D	Table E, PN 16	-	889	35.0	891	35.1	-	-
1000	40	PN 6	Class D	Table E, PN 16	-	991	39.0	994	39.1	-	-
-	42	-	Class D	-	-	1043	41.1	1043	41.1	-	-
1200	48	PN 6	Class D	Table E, PN 16	-	1191	46.9	1197	47.1	-	-
-	54	-	Class D	-	-	1339	52.7	-	-	-	-
1400	-	PN 6	-	-	-	1402	55.2	-	-	-	-
-	60	-	Class D	-	-	1492	58.7	-	-	-	-
1600	-	PN 6	-	-	-	1600	63.0	-	-	-	-
-	66	-	Class D	-	-	1638	64.5	-	-	-	-
1800	72	PN 6	-	-	-	1786	70.3	-	-	-	-
-	78	-	Class D	-	-	1989	78.3	-	-	-	-
2000	-	PN 6	-	-	-	1989	78.3	-	-	-	-
-	84	-	Class D	-	-	2099	84.0	-	-	-	-
2200	-	PN 6	-	-	-	2194	87.8	-	-	-	-
-	90	-	Class D	-	-	2246	89.8	-	-	-	-
2400	-	PN 6	-	-	-	2391	94.1	-	-	-	-

Materials

Transmitter housing

Order code for "Housing" | Option A: aluminum, AlSi10Mg, coated

Window material | Glass

Sensor connection housing

- Aluminum, AlSi10Mg, coated
- Polycarbonate (in conjunction with order code for "Sensor option", options CA, CB, CC, CD, CE)

Cable glands and entries

Cable gland M20×1.5 | Plastic

Adapter for cable entry with female thread G ½" or NPT ½" | Nickel-plated brass

Connecting cable for remote version

- Electrode cable and coil current cable:
- PVC cable with copper shield
 - Reinforced cable: PVC cable with copper shield and additional steel wire braided jacket

Sensor housing

DN 25 to 300 (1 to 12") |

- Aluminum half-shell housing: aluminum, AlSi10Mg, coated
- Fully welded carbon steel housing with protective varnish

DN 350 to 2 400 (14 to 90") | Fully welded carbon steel housing with protective varnish

Measuring pipes

DN 25 to 600 (1 to 24") | Stainless steel: 1.4301, 1.4306, 304, 304L

DN 700 to 2 400 (28 to 90") | Stainless steel: 1.4301, 304

Liner

DN 25 to 300 (1 to 12") | PTFE

DN 25 to 1 200 (1 to 48") | Polyurethane

DN 50 to 2 400 (2 to 90") | Hard rubber

Electrodes

- Stainless steel: 1.4435 (316L)
- Alloy C22, 2.4602 (UNS N06022)
- Tantalum
- Platinum

Seals

As per DIN EN 1514-1, form IBC

Process connections	
EN 1092-1 (DIN 2501)	Fixed flange <ul style="list-style-type: none"> ■ Carbon steel: <ul style="list-style-type: none"> ■ DN ≤ 300: S235JRG2, S235JR+N, P245GH, A105, E250C ■ DN 350 to 2 400: P245GH, S235JRG2, A105, E250C ■ DN 350 to 600: P245GH, S235JRG2, A105, E250C ■ Stainless steel: <ul style="list-style-type: none"> ■ DN ≤ 300: 1.4404, 1.4571, F316L ■ DN 350 to 600: 1.4571, F316L, 1.4404 ■ DN 700 to 1 000: 1.4404, F316L Lap joint flange <ul style="list-style-type: none"> ■ Carbon steel DN ≤ 300: S235JRG2, A105, E250C ■ Stainless steel DN ≤ 300: 1.4306, 1.4404, 1.4571, F316L Lap joint flange, stamped plate <ul style="list-style-type: none"> ■ Carbon steel DN ≤ 300: S235JRG2 similar to S235JR+AR or 1.0038 ■ Stainless steel DN ≤ 300: 1.4301 similar to 304
ASME B16.5	<ul style="list-style-type: none"> ■ Carbon steel: A105 ■ Stainless steel: F316L
JIS B2220	<ul style="list-style-type: none"> ■ Carbon steel: A105, A350 LF2 ■ Stainless steel: F316L
AWWA C207	Carbon steel: A105, P265GH, A181 Class 70, E250C, S275JR
AS 2129	Carbon steel: A105, E250C, P235GH, P265GH, S235JRG2
AS 4087	Carbon steel: A105, P265GH, S275JR
Accessories	
Protective cover	Stainless steel, 1.4404 (316L)
Pipe mounting set	Stainless steel 1.4301 (304)
Wall mounting kit	Stainless steel 1.4301 (304)
Grounding rings	15 to 1 200 mm (½ to 48 in) <ul style="list-style-type: none"> ■ Stainless steel, 1.4435 (316L) ■ Alloy C22, 2.4602 (UNS N06022)

Fitted electrodes

Standard electrodes:

- Measuring electrodes
- Reference electrodes
- Empty pipe detection electrodes

Process connections

- EN 1092-1 (DIN 2501)
- ASME B16.5
- JIS B2220
- AS 2129 Table E
- AS 4087 PN 16
- AWWA C207 Class D

Surface roughness

All data relate to parts in contact with medium.

Electrodes with 1.4435 (316L); Alloy C22, 2.4602 (UNS N06022); tantalum:
< 0.5 μm (19.7 μin)

Local display

Operating concept

Operation method	<ul style="list-style-type: none"> Operation via local display with touch screen. Operation via SmartBlue App.
Menu structure	<p>Operator-oriented menu structure for user-specific tasks:</p> <ul style="list-style-type: none"> Diagnostics Application System Guidance Language
Commissioning	<ul style="list-style-type: none"> Commissioning via a guided menu (Commissioning wizard). Menu guidance with interactive help function for individual parameters.
Reliable operation	<ul style="list-style-type: none"> Operation in local language. Uniform operating philosophy in device and in the SmartBlue App. Write protection When electronics modules are replaced: configurations are transferred using the T-DAT Backup device memory. The device memory contains process data, device data and the event logbook. No reconfiguration is necessary.
Diagnostic behavior	<p>Efficient diagnostic behavior increases measurement availability:</p> <ul style="list-style-type: none"> Open troubleshooting measures via local display and SmartBlue App. Diverse simulation options. Logbook of events that have occurred.

Operating options

Local display	<p style="text-align: right;">A0042957</p> <p>Display elements:</p> <ul style="list-style-type: none"> LCD touch screen Depends on the orientation, automatic alignment of local display. Configuration of display format for measured variables and status variables. <p>Operating elements:</p> <ul style="list-style-type: none"> Touch screen Local display can also be accessed in the hazardous area.
SmartBlue App	<ul style="list-style-type: none"> The SmartBlue App allows the user to put devices into operation and operate them. Based on Bluetooth. No separate driver required. Available for mobile handheld terminals, tablets and smartphones. Suitable for convenient and secure access to devices in hard-to-reach locations or in hazardous areas. Can be used within a 20 m (65.6 ft) radius of the device. Encrypted and secure data transmission. No data loss during commissioning and maintenance. Diagnostic information and process information in real time.

Operating tools

Operating tools	Operating unit	Interface	Additional information
DeviceCare SFE100	<ul style="list-style-type: none"> ▪ Notebook ▪ PC ▪ Tablet with Microsoft Windows system 	<ul style="list-style-type: none"> ▪ CDI service interface ▪ Fieldbus protocol 	Innovation brochure IN01047S
FieldCare SFE500	<ul style="list-style-type: none"> ▪ Notebook ▪ PC ▪ Tablet with Microsoft Windows system 	<ul style="list-style-type: none"> ▪ CDI service interface ▪ Fieldbus protocol 	Operating Instructions BA00027S and BA00059S
SmartBlue App	<ul style="list-style-type: none"> ▪ Devices with iOS: iOS9.0 or higher ▪ Devices with Android: Android 4.4 KitKat or higher 	Bluetooth	Endress+HauserSmartBlue App: <ul style="list-style-type: none"> ▪ Google Playstore (Android) ▪ iTunes Apple Shop (iOS devices)
Device Xpert	Field Xpert SFX 100/350/370	HART fieldbus protocol	Operating Instructions BA01202S

Certificates and approvals

Non-Ex approval

- cCSAus
- EAC

Pressure Equipment Directive

- CRN
- PED Cat. II/III

Drinking water approval

- ACS
- KTW/W270
- NSF 61
- WRAS BS 6920

Pharmaceutical compatibility

- FDA
- USP Class VI
- TSE/BSE Certificate of Suitability

HART certification

The device is certified and registered by the FieldComm Group. The measuring system meets all the requirements of the following specifications:

- Certified according to HART 7
- The device can also be operated with certified devices of other manufacturers (interoperability).

Radio approval

The device has radio approvals.

Additional approvals

VDS (fire protection)

Other standards and guidelines

- IEC/EN 60529
Degrees of protection provided by enclosures (IP code)
- IEC/EN 60068-2-6
Environmental influences: Test procedure - Test Fc: vibrate (sinusoidal)
- IEC/EN 60068-2-31
Environmental influences: Test procedure - Test Ec: shocks due to rough handling, primarily for devices.
- IEC/EN 61010-1
Safety requirements for electrical equipment for measurement, control and laboratory use - general requirements.
- CAN/CSA-C22.2 No. 61010-1-12
Safety Requirements for Electrical Equipment for Measurement, Control and Laboratory Use - Part 1 General Requirements.
- IEC/EN 61326
Emission in accordance with Class A requirements. Electromagnetic compatibility (EMC requirements)
- ANSI/ISA-61010-1 (82.02.01)
Safety Requirements for Electrical Equipment for Measurement, Control and Laboratory Use - Part 1 General Requirements.
- NAMUR NE 21
Electromagnetic compatibility (EMC) of industrial process and laboratory control equipment.
- NAMUR NE 32
Data retention in the event of a power failure in field and control instruments with microprocessors.
- NAMUR NE 43
Standardization of the signal level for the breakdown information of digital transmitters with analog output signal.
- NAMUR NE 53
Software of field devices and signal-processing devices with digital electronics.
- NAMUR NE 105
Specifications for integrating fieldbus devices in engineering tools for field devices.
- NAMUR NE 107
Self-monitoring and diagnosis of field devices.
- NAMUR NE 131
Requirements for field devices for standard applications.
- ETSI EN 300 328
Guidelines for 2.4 GHz radio components
- EN 301489
Electromagnetic compatibility and radio spectrum matters (ERM).

Application packages

Use

Many different application packages are available to enhance the functionality of the device. Such packages might be needed to address safety aspects or specific application requirements.

The application packages can be ordered with the device or subsequently from Endress+Hauser. Detailed information on the relevant order code is available from your local Endress+Hauser sales organization or on the product page of the Endress+Hauser website: www.endress.com.

Heartbeat Verification + Monitoring

Heartbeat Verification

Availability depends on the product structure.

Meets the requirement for traceable verification to DIN ISO 9001:2008 Chapter 7.6 a) "Control of monitoring and measuring equipment":

- Functional testing in the installed state without interrupting the process.
- Traceable verification results on request, including a report.
- Simple testing process with local operation or other operating interfaces.
- Clear measuring point assessment (pass/fail) with high test coverage within the framework of manufacturer specifications.
- Extension of calibration intervals according to operator's risk assessment.

Heartbeat Monitoring

Availability depends on the product structure.

Heartbeat Monitoring continuously supplies data, which are characteristic of the measuring principle, to an external condition monitoring system for the purpose of preventive maintenance or process analysis. These data enable the operator to:

- Draw conclusions - using these data and other information - about the impact the process influences, e.g. corrosion, abrasion, formation of buildup, have on the measuring performance over time.
- Schedule servicing in time.
- Monitor the process quality or product quality, e.g. gas pockets.

14 Dimensions in SI units

Compact version	122
DN 25 to 300 (1 to 12")	122
DN 350 to 900 (14 to 36")	123
DN 1000 to 2400 (40 to 90")	124
Remote version	125
Transmitter remote version	125
Sensor connection housing	125
DN 25 to 300 (1 to 12") aluminum half-shell housing	126
DN 25 to 300 (1 to 12") fully welded housing	127
DN 350 to 900 (14 to 36")	128
DN 1000 to 2400 (40 to 90")	129
Fixed flange	130
Flange in accordance with EN 1092-1 (DIN 2501 / DIN 2512N): PN 10	130
Flange in accordance with EN 1092-1 (DIN 2501 / DIN 2512N): PN 16	131
Flange in accordance with EN 1092-1 (DIN 2501 / DIN 2512N): PN 25	132
Flange in accordance with EN 1092-1 (DIN 2501 / DIN 2512N): PN 40	133
Flange according to ASME B16.5, Class 150	134
Flange according to ASME B16.5, Class 300	135
Flange according to JIS B2220, 10K	136
Flange according to JIS B2220, 20K	137
Flange according to AWWA, Class D	138
Flange according to AS 2129, Tab. E	139
Flange according to AS 4087, PN 16	140
Lap joint flange	141
Lap joint flange in accordance with EN 1092-1 (DIN 2501 / DIN 2512N): PN 10	141
Lap joint flange in accordance with EN 1092-1 (DIN 2501 / DIN 2512N): PN 16	142
Lap joint flange according to ASME B16.5, Class 150	143
Lap joint flange, stamped plate	144
Lap joint flange, stamped plate in accordance with EN 1092-1 (DIN 2501 / DIN 2512N): PN 10	144
Accessories	145
Protective cover	145
Ground disks for flanges	145

Compact version

DN 25 to 300 (1 to 12")

Order code for "Housing", option A "Compact, aluminum, coated"

Sensor with aluminum half-shell housing

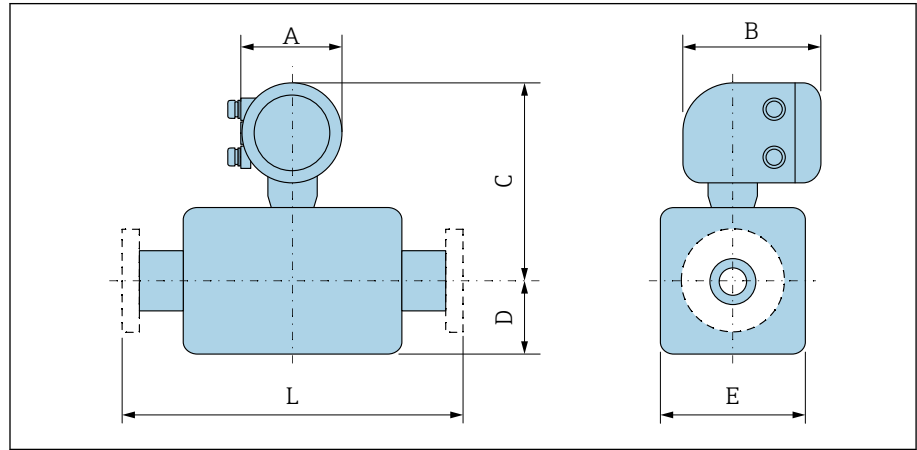

A0042708

DN		Order code for "Design"					
		Options D, E, H, I					
[mm]	[in]	A ¹⁾ [mm]	B [mm]	C ²⁾ [mm]	D ²⁾ [mm]	E ²⁾ [mm]	L [mm]
25	1	139	178	258	84	120	200
32	–	139	178	258	84	120	200
40	1 ½	139	178	258	84	120	200
50	2	139	178	258	84	120	200
65	–	139	178	283	109	180	200
80	3	139	178	283	109	180	200
100	4	139	178	283	109	180	250
125	–	139	178	323	150	260	250
150	6	139	178	323	150	260	300
200	8	139	178	348	180	324	350
250	10	139	178	373	205	400	450
300	12	139	178	398	230	460	500

1) Depending on the cable entry used: values up to + 30 mm

2) Reference values: dependent on the pressure rating, design and order option

DN 350 to 900 (14 to 36")

Order code for "Housing", option A "Compact, aluminum, coated"

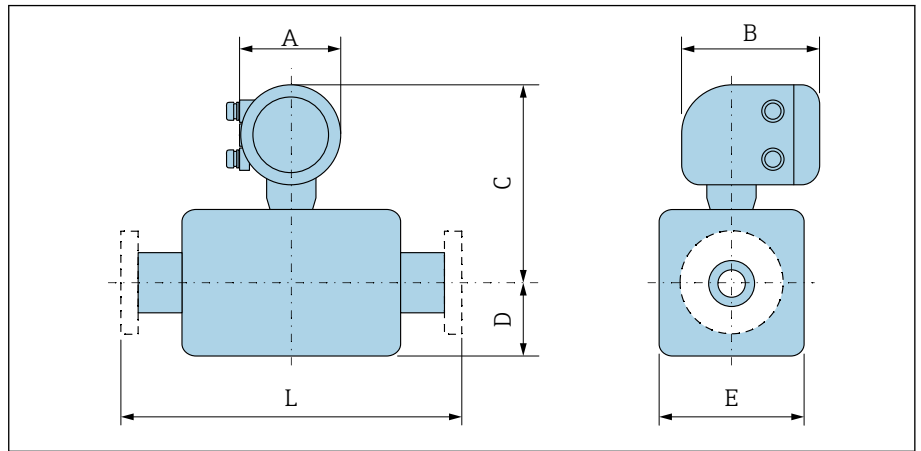

DN		A ¹⁾ [mm]	B [mm]	Order code for "Design"						L [mm]	
				Options E, F			Option G				
[mm]	[in]			C ²⁾ [mm]	D ²⁾ [mm]	E ²⁾ [mm]	C ²⁾ [mm]	D ²⁾ [mm]	E ²⁾ [mm]		
350	14	139	178	457	245	490	-	-	-		550
375	15	139	178	483	271	542	-	-	-		600
400	16	139	178	483	271	542	-	-	-		600
450	18	139	178	465	299	598	508	333	666	600 ³⁾	650 ⁴⁾
500	20	139	178	490	324	648	534	359	717	600 ³⁾	650 ⁴⁾
600	24	139	178	540	365	730	586	411	821	600 ³⁾	780 ⁴⁾
700	28	139	178	601	430	860	688	512	1024	700 ³⁾	910 ⁴⁾
750	30	139	178	639	467	934	688	512	1024	750 ³⁾	975 ⁴⁾
800	32	139	178	658	486	972	709	534	1065	800 ³⁾	1040 ⁴⁾
900	36	139	178	708	536	1072	786	610	1218	900 ³⁾	1170 ⁴⁾

- 1) Depending on the cable entry used: values up to + 30 mm
- 2) Reference values: dependent on the pressure rating, design and order option
- 3) Order code for "Design", option F "Fixed flange, short installation length"
- 4) Order code for "Design", option G "Fixed flange, long installation length"

DN 1000 to 2400 (40 to 90")

Order code for "Housing", option A "Compact, aluminum, coated"

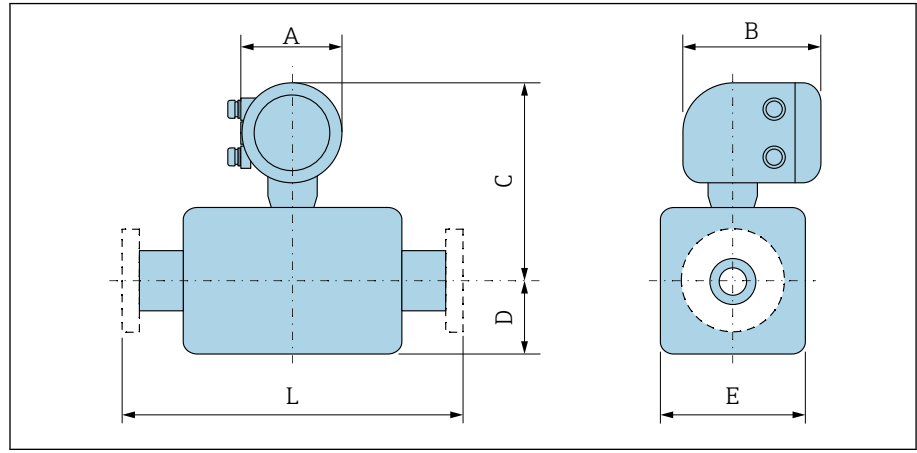

DN		A ¹⁾	B	C ²⁾	D ²⁾	E ²⁾	L	
[mm]	[in]	[mm]	[mm]	[mm]	[mm]	[mm]	[mm]	
1000	40	139	178	759	582	1164	1000 ³⁾	1300 ⁴⁾
-	42	139	178	795	618	1236	1050 ³⁾	1365 ⁴⁾
1200	48	139	178	873	696	1392	1200 ³⁾	1560 ⁴⁾
-	54	139	178	986	809	1617	1350 ³⁾	1755 ⁴⁾
1400	-	139	178	986	809	1617	1400 ³⁾	1820 ⁴⁾
-	60	139	178	1086	909	1817	1500 ³⁾	1950 ⁴⁾
1600	-	139	178	1086	909	1817	1600 ³⁾	2080 ⁴⁾
-	66	139	178	1137	960	1919	1650 ³⁾	2145 ⁴⁾
1800	72	139	178	1193	1016	2032	1800 ³⁾	2340 ⁴⁾
-	78	139	178	1305	1127	2254	2000 ³⁾	2600 ⁴⁾
2000	-	139	178	1305	1127	2254	2000 ³⁾	2600 ⁴⁾
-	84	139	178	1405	1227	2454	2150 ³⁾	
2200	-	139	178	1405	1227	2454	2200 ³⁾	
-	90	139	178	1510	1227	2664	2300 ³⁾	
2400	-	139	178	1510	1332	2664	2400 ³⁾	

- 1) Depending on the cable entry used: values up to + 30 mm
- 2) Reference values: dependent on the pressure rating, design and order option
- 3) Order code for "Design", option F "Fixed flange, short installation length"
- 4) Order code for "Design", option G "Fixed flange, long installation length"

Remote version

Transmitter remote version

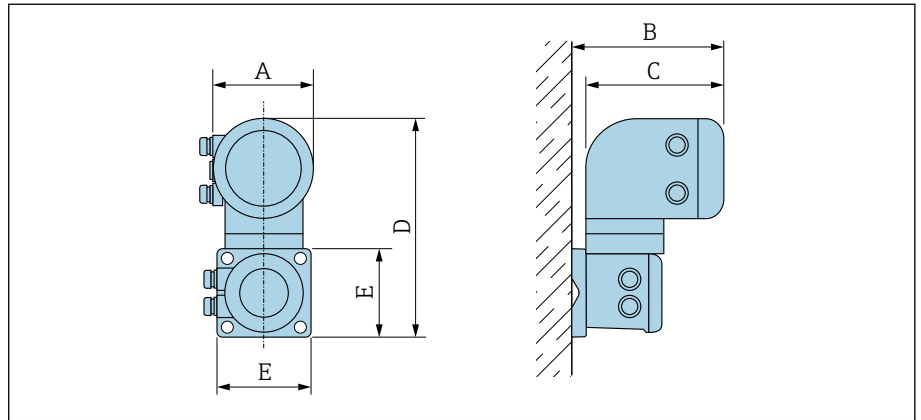

A0042715

Order code for "Housing"	A ¹⁾ [mm]	B [mm]	C [mm]	D [mm]	E [mm]
Option P "Remote, aluminum, coated"	139	185	178	309	130

1) Depending on the cable entry used: values up to + 30 mm

Sensor connection housing

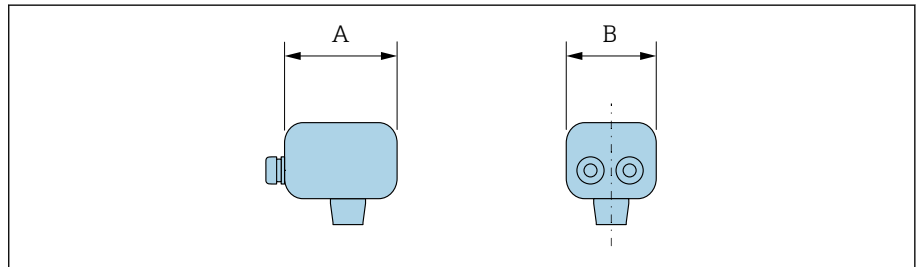

A0042716

Housing material	A ¹⁾ [mm]	B [mm]
Polycarbonate plastic ²⁾	113	112
Aluminum, coated	148	136

1) Depending on the cable entry used: values up to + 30 mm

2) In conjunction with order code for "Sensor option", options CA, CB, CC, CD, CE

DN 25 to 300 (1 to 12") aluminum half-shell housing

Sensor with aluminum half-shell housing.

Sensor connection housing: aluminum, AlSi10Mg, coated

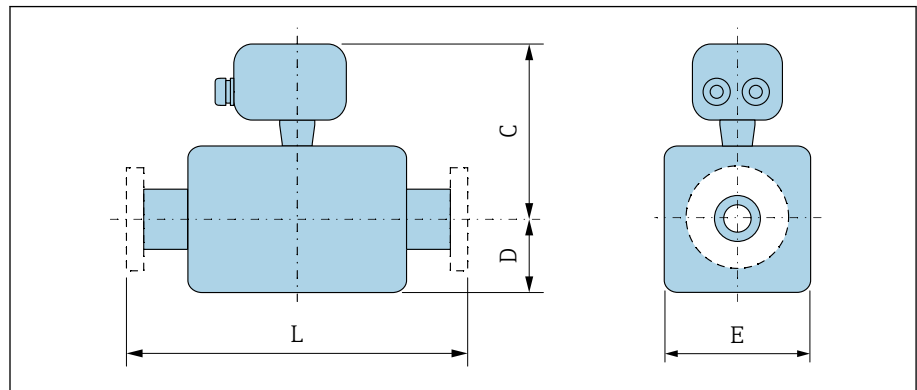

DN		Order code for "Design"			
		Options D, E, H, I			
[mm]	[in]	C ¹⁾ [mm]	D [mm]	E [mm]	L [mm]
25	1	197	84	120	200
32	–	197	84	120	200
40	1 ½	197	84	120	200
50	2	197	84	120	200
65	–	222	109	180	200
80	3	222	109	180	200
100	4	222	109	180	250
125	–	262	150	260	250
150	6	262	150	260	300
200	8	287	180	324	350
250	10	312	205	400	450
300	12	337	230	460	500

1) Reference values: dependent on the pressure rating, design and order option

DN 25 to 300 (1 to 12") fully welded housing

Sensor with fully welded carbon steel housing:

Order code for "Sensor option", options CA, CB, CC, CD, CE

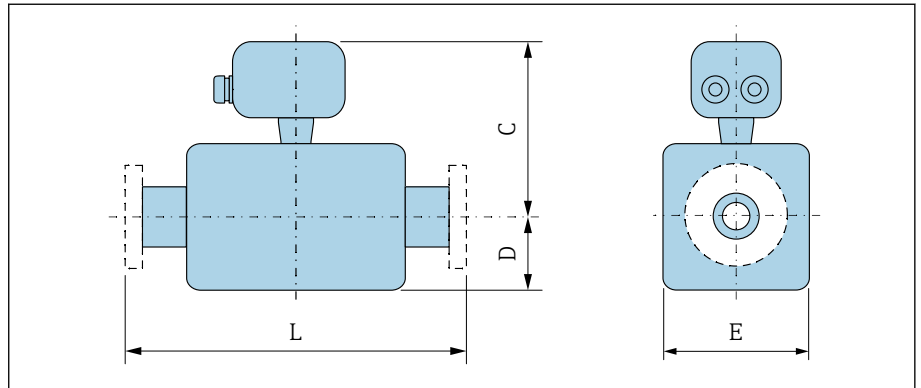

DN		Order code for "Design"			
		Options A, E			
[mm]	[in]	C ¹⁾ [mm]	D ¹⁾ [mm]	E ¹⁾ [mm]	L [mm]
25	1	189	70	140	200
32	-	189	70	140	200
40	1 ½	189	70	140	200
50	2	189	70	140	200
65	-	202	82	165	200
80	3	207	87	175	200
100	4	219	100	200	250
125	-	232	113	226	250
150	6	254	134	269	300
200	8	279	160	320	350
250	10	313	193	387	450
300	12	338	218	437	500

1) Reference values: dependent on the pressure rating, design and order option

DN 350 to 900 (14 to 36")

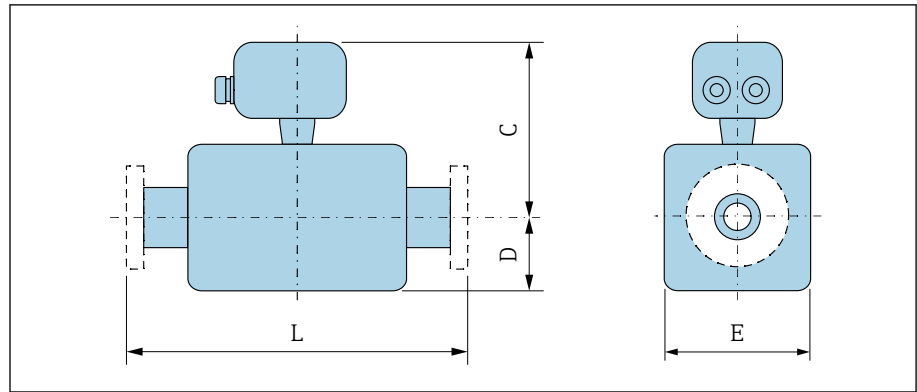

A0041519

DN		Order code for "Design"							L	
		Options E, F			Option G					
[mm]	[in]	C ¹⁾ [mm]	D ¹⁾ [mm]	E ¹⁾ [mm]	C ¹⁾ [mm]	D ¹⁾ [mm]	E ¹⁾ [mm]			
350	14	395	245	490	-	-	-	550		
375	15	421	271	542	-	-	-	600		
400	16	421	271	542	-	-	-	600		
450	18	403	299	598	446	333	666	600 ²⁾	650 ³⁾	
500	20	428	324	648	472	359	717	600 ²⁾	650 ³⁾	
600	24	478	365	730	524	411	821	600 ²⁾	780 ³⁾	
700	28	539	430	860	626	512	1024	700 ²⁾	910 ³⁾	
750	30	577	467	934	626	512	1024	750 ²⁾	975 ³⁾	
800	32	596	486	972	647	534	1065	800 ²⁾	1040 ³⁾	
900	36	646	536	1072	724	610	1218	900 ²⁾	1170 ³⁾	

- 1) Reference values: dependent on the pressure rating, design and order option
- 2) Order code for "Design", option F "Fixed flange, short installation length"
- 3) Order code for "Design", option G "Fixed flange, long installation length"

DN 1000 to 2400 (40 to 90")

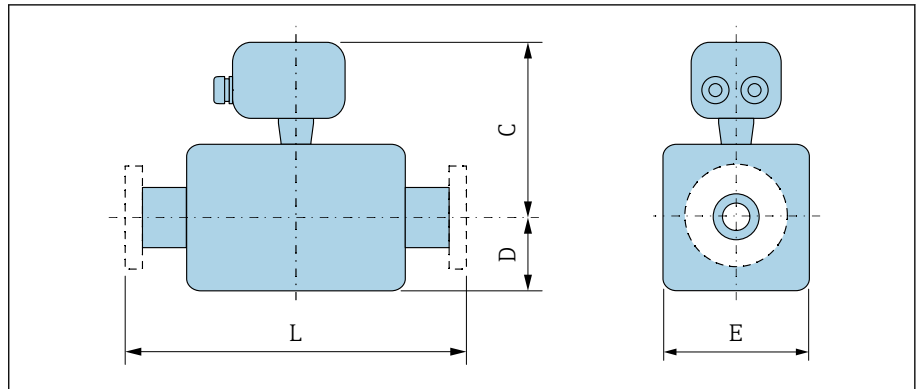

A0041519

DN		C ¹⁾	D ¹⁾	E ¹⁾	L	
[mm]	[in]	[mm]	[mm]	[mm]	[mm]	
1000	40	698	582	1164	1000 ²⁾	1300 ³⁾
-	42	734	618	1236	1050 ²⁾	1365 ³⁾
1200	48	812	696	1392	1200 ²⁾	1560 ³⁾
-	54	925	809	1617	1350 ²⁾	1755 ³⁾
1400	-	925	809	1617	1400 ²⁾	1820 ³⁾
-	60	1025	909	1817	1500 ²⁾	1950 ³⁾
1600	-	1025	909	1817	1600 ²⁾	2080 ³⁾
-	66	1076	960	1919	1650 ²⁾	2145 ³⁾
1800	72	1132	1016	2032	1800 ²⁾	2340 ³⁾
-	78	1244	1127	2254	2000 ²⁾	2600 ³⁾
2000	-	1244	1127	2254	2000 ²⁾	2600 ³⁾
-	84	1344	1227	2454	2150 ²⁾	
2200	-	1344	1227	2454	2200 ²⁾	
-	90	1449	1227	2664	2300 ²⁾	
2400	-	1449	1332	2664	2400 ²⁾	

- 1) Reference values: dependent on the pressure rating, design and order option
- 2) Order code for "Design", option F "Fixed flange, short installation length"
- 3) Order code for "Design", option G "Fixed flange, long installation length"

Fixed flange

Flange in accordance with EN 1092-1 (DIN 2501 / DIN 2512N): PN 10

- Carbon steel: order code for "Process connection", option D2K
- Stainless steel: order code for "Process connection", option D2S

Surface roughness: EN 1092-1 Form B1 (DIN 2526 Form C), Ra 6.3 to 12.5 µm

E: Internal diameter depends on the liner →  113

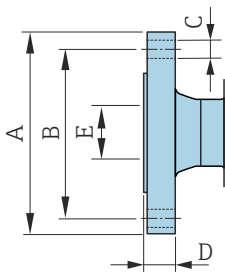

A0041915

DN [mm]	A [mm]	B [mm]	C [mm]	D [mm]
200	340	295	8 × Ø22	26
250	395	350	12 × Ø22	28
300	445	400	12 × Ø22	28
350	505	460	16 × Ø22	26
400	565	515	16 × Ø26	26
450	615	565	20 × Ø26	26
500	670	620	20 × Ø26	28
600	780	725	20 × Ø30	30
700	895	840	24 × Ø30	35
800	1015	950	24 × Ø33	38
900	1115	1050	28 × Ø33	38
1000	1230	1160	28 × Ø36	44
1200	1455	1380	32 × Ø39	55
1400	1675	1590	36 × Ø42	65
1600	1915	1820	40 × Ø48	75
1800	2115	2020	44 × Ø48	85
2000	2325	2230	48 × Ø48	90
2200	2550	2440	52 × Ø56	100
2400	2760	2650	56 × Ø56	110

Flange in accordance with EN 1092-1 (DIN 2501 / DIN 2512N): PN 16

- Carbon steel: order code for "Process connection", option D3K
- Stainless steel: order code for "Process connection", option D3S

Surface roughness: EN 1092-1 Form B1 (DIN 2526 Form C), Ra 6.3 to 12.5 µm

E: Internal diameter depends on the liner →  113

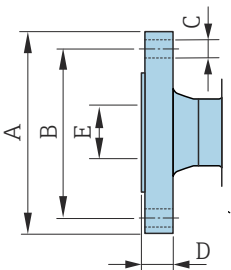

DN [mm]	A [mm]	B [mm]	C [mm]	D [mm]
65	185	145	8 × Ø18	20
80	200	160	8 × Ø18	20
100	220	180	8 × Ø18	22
125	250	210	8 × Ø18	24
150	285	240	8 × Ø22	24
200	340	295	12 × Ø22	26
250	405	355	12 × Ø26	32
300	460	410	12 × Ø26	32
350	520	470	16 × Ø26	30
400	580	525	16 × Ø30	32
450	640	585	20 × Ø30	34
500	715	650	20 × Ø33	36
600	840	770	20 × Ø36	40
700	910	840	24 × Ø36	40
800	1025	950	24 × Ø39	41
900	1125	1050	28 × Ø39	48
1000	1255	1170	28 × Ø42	59
1200	1485	1390	32 × Ø48	78
1400	1685	1590	36 × Ø48	84
1600	1930	1820	40 × Ø56	102
1800	2130	2020	44 × Ø56	110
2000	2345	2230	48 × Ø62	124

A0041915

**Flange in accordance with EN 1092-1 (DIN 2501 / DIN 2512N):
PN 25**

- Carbon steel: order code for "Process connection", option D4K
- Stainless steel: order code for "Process connection", option D4S

Surface roughness: EN 1092-1 Form B1 (DIN 2526 Form C), Ra 6.3 to 12.5 µm

E: Internal diameter depends on the liner →  113

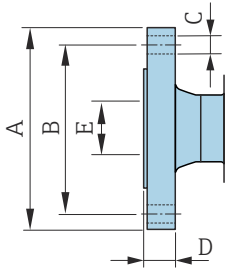

A0041915

DN [mm]	A [mm]	B [mm]	C [mm]	D [mm]
200	360	310	12 × Ø26	32
250	425	370	12 × Ø30	36
300	485	430	16 × Ø30	40
350	555	490	16 × Ø33	38
400	620	550	16 × Ø36	40
450	670	600	20 × Ø36	46
500	730	660	20 × Ø36	48
600	845	770	20 × Ø39	48
700	960	875	24 × Ø42	50
800	1085	990	24 × Ø48	53
900	1185	1090	28 × Ø48	57
1000	1320	1210	28 × Ø56	63

Flange in accordance with EN 1092-1 (DIN 2501 / DIN 2512N): PN 40

- Carbon steel: order code for "Process connection", option D5K
- Stainless steel: order code for "Process connection", option D5S

Surface roughness: EN 1092-1 Form B1 (DIN 2526 Form C), Ra 6.3 to 12.5 μm

E: Internal diameter depends on the liner →  113.

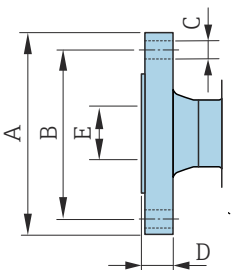

DN [mm]	A [mm]	B [mm]	C [mm]	D [mm]
25	115	85	4 × Ø14	16
32	140	100	4 × Ø18	18
40	150	110	4 × Ø18	18
50	165	125	4 × Ø18	20
65	185	145	8 × Ø18	24
80	200	160	8 × Ø18	26
100	235	190	8 × Ø22	26
125	270	220	8 × Ø26	28
150	300	250	8 × Ø26	30

A0041915

Flange according to ASME B16.5, Class 150

- Carbon steel: order code for "Process connection", option A1K
- Stainless steel: order code for "Process connection", option A1S

Surface roughness: Ra 6.3 to 12.5 µm

E: Internal diameter depends on the liner →  113

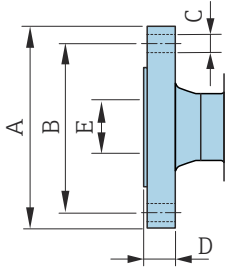

A0041915

DN [mm]	A [mm]	B [mm]	C [mm]	D [mm]
25	108	79.2	4 × Ø16	12.6
40	127	98.6	4 × Ø16	15.9
50	152.4	120.7	4 × Ø19.1	17.5
80	190.5	152.4	4 × Ø19.1	22.3
100	228.6	190.5	8 × Ø19.1	22.3
150	279.4	241.3	8 × Ø22.4	23.8
200	342.9	298.5	8 × Ø22.4	26.8
250	406.4	362	12 × Ø25.4	29.6
300	482.6	431.8	12 × Ø25.4	30.2
350	535	476.3	12 × Ø28.6	35.4
400	595	539.8	16 × Ø28.6	37
450	635	577.9	16 × Ø31.8	40.1
500	700	635	20 × Ø31.8	43.3
600	815	749.3	20 × Ø34.9	48.1

Flange according to ASME B16.5, Class 300

- Carbon steel: order code for "Process connection", option A2K
- Stainless steel: order code for "Process connection", option A2S

Surface roughness: Ra 6.3 to 12.5 μm

E: Internal diameter depends on the liner →  113

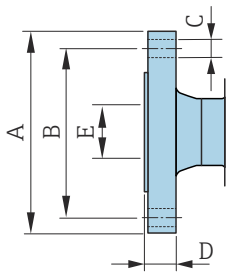

A0041915

DN [mm]	A [mm]	B [mm]	C [mm]	D [mm]
25	123.9	88.9	4 × Ø19.1	15.9
40	155.4	114.3	4 × Ø22.4	19
50	165.1	127	8 × Ø19.1	20.8
80	209.6	168.1	8 × Ø22.4	26.8
100	254	200.2	8 × Ø22.4	30.2
150	317.5	269.7	12 × Ø22.4	35

Flange according to JIS B2220, 10K

- Carbon steel: order code for "Process connection", option N3K
- Stainless steel: order code for "Process connection", option N3S

Surface roughness: Ra 6.3 to 12.5 μm

E: Internal diameter depends on the liner →  113

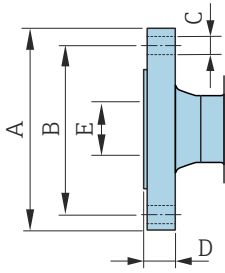

A0041915

DN [mm]	A [mm]	B [mm]	C [mm]	D [mm]
50	155	120	4 × Ø19	16
65	175	140	4 × Ø19	18
80	185	150	8 × Ø19	18
100	210	175	8 × Ø19	18
125	250	210	8 × Ø23	20
150	280	240	8 × Ø23	22
200	330	290	12 × Ø23	22
250	400	355	12 × Ø25	24
300	445	400	16 × Ø25	24

Flange according to JIS B2220, 20K

- Carbon steel: order code for "Process connection", option N4K
- Stainless steel: order code for "Process connection", option N4S

Surface roughness: Ra 6.3 to 12.5 μm

E: Internal diameter depends on the liner →  113

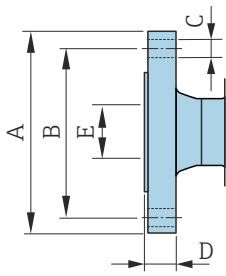

A0041915

DN [mm]	A [mm]	B [mm]	C [mm]	D [mm]
25	125	90	4 × Ø19	16
32	135	100	4 × Ø19	18
40	140	105	4 × Ø19	18
50	155	120	8 × Ø19	18
65	175	140	8 × Ø19	20
80	200	160	8 × Ø23	22
100	225	185	8 × Ø23	24
125	270	225	8 × Ø25	26
150	305	260	12 × Ø25	28
200	350	305	12 × Ø25	30
250	430	380	12 × Ø27	34
300	480	430	16 × Ø27	36

Flange according to AWWA, Class D

Order code for "Process connection", option W1K

Surface roughness: Ra 6.3 to 12.5 µm

E: Internal diameter depends on the liner →  113

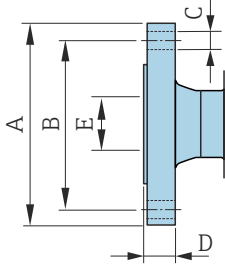

A0041915

DN	A		B	C	D
	[mm]	[in]			
700	927	28	863.6	28 × Ø35	33.4
750	984	30	914.4	28 × Ø35	35
800	1060	32	977.9	28 × Ø42	38.1
900	1168	36	1085.9	32 × Ø42	41.3
1000	1289	40	1200.2	36 × Ø42	41.3
-	1346	42	1257.3	36 × Ø42	44.5
1200	1511	48	1422.4	44 × Ø42	47.7
-	1683	54	1593.9	44 × Ø48	54
-	1855	60	1759	52 × Ø48	57.2
-	2032	66	1930.4	52 × Ø48	63.5
1800	2197	72	2095.5	60 × Ø48	66.7
-	2362	78	2260.6	64 × Ø54	69.9
-	2535	84	2425.7	64 × Ø54	73.1
-	2705	90	2717.8	68 × Ø60	76.2

Flange according to AS 2129, Tab. E

Order code for "Process connection", option M2K

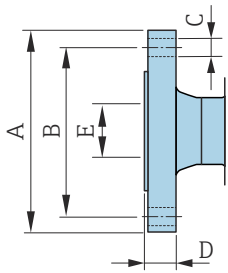
Surface roughness: Ra 6.3 to 12.5 μm E: Internal diameter depends on the liner \rightarrow 113.

A0041915

DN [mm]	A [mm]	B [mm]	C [mm]	D [mm]
80	185	146	4 × Ø18	12
100	215	178	8 × Ø18	13
150	280	235	8 × Ø22	17
200	335	292	8 × Ø22	19
250	405	356	12 × Ø22	22
300	455	406	12 × Ø26	25
350	525	470	12 × Ø26	30
400	580	521	12 × Ø26	32
450	640	584	16 × Ø26	35
500	705	641	16 × Ø26	38
600	825	756	16 × Ø33	48
700	910	845	20 × Ø33	51
750	995	927	20 × Ø36	54
800	1060	984	20 × Ø36	54
900	1175	1092	24 × Ø36	64
1000	1255	1175	24 × Ø39	67
1200	1490	1410	32 × Ø39	79

Flange according to AS 4087, PN 16

Order code for "Process connection", option M3K

Surface roughness: Ra 6.3 to 12.5 µm

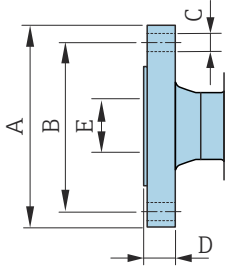
E: Internal diameter depends on the liner →  113

A0041915

DN [mm]	A [mm]	B [mm]	C [mm]	D [mm]
80	185	146	4 × Ø18	12
100	215	178	4 × Ø18	13
150	280	235	8 × Ø18	13
200	335	292	8 × Ø18	19
250	405	356	8 × Ø22	19
300	455	406	12 × Ø22	23
350	525	470	12 × Ø26	30
375	550	495	12 × Ø26	30
400	580	521	12 × Ø26	32
450	640	584	12 × Ø26	30
500	705	641	16 × Ø26	38
600	825	756	16 × Ø30	48
700	910	845	20 × Ø30	56
750	995	927	20 × Ø33	56
800	1060	984	20 × Ø36	56
900	1175	1092	24 × Ø36	66
1000	1255	1175	24 × Ø36	66
1200	1490	1410	32 × Ø36	76

Lap joint flange

Lap joint flange in accordance with EN 1092-1 (DIN 2501 / DIN 2512N): PN 10

- Carbon steel: order code for "Process connection", option D22
- Stainless steel: order code for "Process connection", option D24

Surface roughness (flange): Ra 6.3 to 12.5 μm

F: Internal diameter depends on the liner →  113

DN [mm]	A [mm]	B [mm]	C [mm]	D [mm]	E [mm]
200	340	295	8 × Ø22	24	264
250	395	350	12 × Ø22	26	317
300	445	400	12 × Ø22	26	367

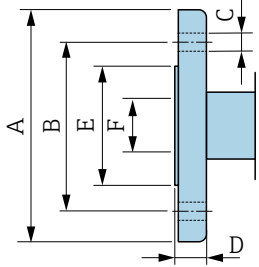

A0042254

Lap joint flange in accordance with EN 1092-1 (DIN 2501 / DIN 2512N): PN 16

- Carbon steel: order code for "Process connection", option D32
- Stainless steel: order code for "Process connection", option D34

Surface roughness (flange): Ra 6.3 to 12.5 µm

F: Internal diameter depends on the liner →  113

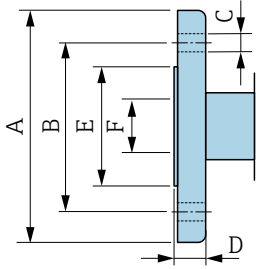

A0042254

DN [mm]	A [mm]	B [mm]	C [mm]	D [mm]	E [mm]
25	115	85	4 × Ø14	16	49
32	140	100	4 × Ø18	18	65
40	150	110	4 × Ø18	18	71
50	165	125	4 × Ø18	20	88
65	185	145	8 × Ø18	20	103
80	200	160	8 × Ø18	20	120
100	220	180	8 × Ø18	22	148
125	250	210	8 × Ø18	22	177
150	285	240	8 × Ø22	24	209
200	340	295	12 × Ø22	26	264
250	405	355	12 × Ø26	29	317
300	460	410	12 × Ø26	32	367

Lap joint flange according to ASME B16.5, Class 150

- Carbon steel: order code for "Process connection", option A12
- Stainless steel: order code for "Process connection", option A14

Surface roughness (flange): Ra 6.3 to 12.5 μm

F: Internal diameter depends on the liner →  113

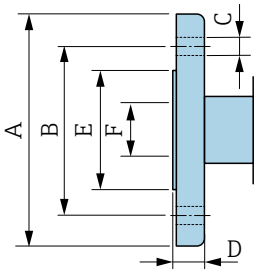

DN [mm]	A [mm]	B [mm]	C [mm]	D [mm]	E [mm]
25	110	80	4 × Ø16	14	49
40	125	98	4 × Ø16	17.5	71
50	150	121	4 × Ø19	19	88
80	190	152	4 × Ø19	24	120
100	230	190	8 × Ø19	24	148
150	280	241	8 × Ø23	25	209
200	345	298	8 × Ø23	29	264
250	405	362	12 × Ø25	30	317
300	485	432	12 × Ø25	32	378

A0042254

Lap joint flange, stamped plate

Lap joint flange, stamped plate in accordance with EN 1092-1 (DIN 2501 / DIN 2512N): PN 10

- Carbon steel: order code for "Process connection", option D21
- Stainless steel: order code for "Process connection", option D23

Surface roughness (flange): Ra 6.3 to 12.5 μm

F: Internal diameter depends on the liner →  113

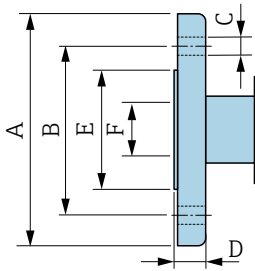

A0042254

DN [mm]	A [mm]	B [mm]	C [mm]	D [mm]	E [mm]
25	115	85	4 x \varnothing 13.5	16.5	49
32	140	100	4 x \varnothing 17.5	17	65
40	150	110	4 x \varnothing 17.5	16.5	71
50	165	125	4 x \varnothing 17.5	18.5	88
65	185	145	4 x \varnothing 17.5	20	103
80	200	160	8 x \varnothing 17.5	23.5	120
100	220	180	8 x \varnothing 17.5	24.5	148
125	250	210	8 x \varnothing 17.5	24	177
150	285	240	8 x \varnothing 21.5	25	209
200	340	295	8 x \varnothing 21.5	27.5	264
250	405	350	12 x \varnothing 21.5	30.5	317
300	445	400	12 x \varnothing 21.5	34.5	367

Accessories

Protective cover

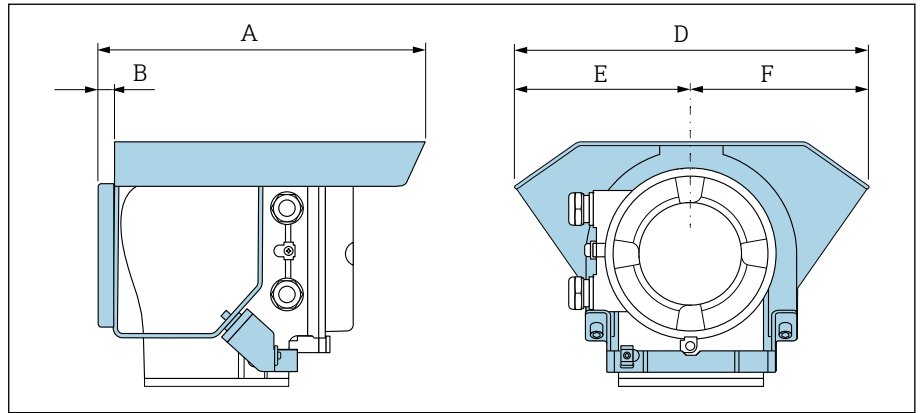

A0042332

A [mm]	B [mm]	D [mm]	E [mm]	F [mm]
257	12	280	140	140

Ground disks for flanges

DN 25 to 300 (1 to 12")		DN	Rating	A	B	C ¹⁾	D	E	F
		[mm]	[in]	[mm]	[mm]	[mm]	[mm]	[mm]	[mm]
	25	1"	2)	87.5	6.5	2	26	62	77.5
	32	1 ¼"	2)	94.5	6.5	2	35	80	87.5
	40	1 ½"	2)	103	6.5	2	41	82	101
	50	2"	2)	108	6.5	2	52	101	115.5
	65	2 ½"	2)	118	6.5	2	68	121	131.5
	80	3"	2)	135	6.5	2	80	131	154.5
	100	4"	2)	153	6.5	2	104	156	186.5
	125	5"	2)	160	6.5	2	130	187	206.5
	150	6"	2)	184	6.5	2	158	217	256
	200	8"	2)	205	6.5	2	206	267	288
	250	10"	2)	240	6.5	2	260	328	359
	300	12"	PN 10 PN 16 Cl. 150	273	6.5	2	312	375	413

A0042332

- 1) Material thickness
- 2) In the case of DN 25 to 250, ground disks can be used for all the flange standards/pressure ratings which can be supplied in the standard version.

DN		Rating	A	B	C ¹⁾	D	E	F
[mm]	[in]							
300	12"	PN 25 JIS 10K JIS 20K	268	9	2	310	375	404
350	14"	PN 6 PN 10 PN 16	365	9	2	343	420	479
375	15"	PN 16	395	9	2	393	461	523
400	16"	PN 6 PN 10 PN 16	395	9	2	393	470	542
450	18"	PN 6 PN 10 PN 16	417	9	2	439	525	583
500	20"	PN 6 PN 10 PN 16	460	9	2	493	575	650
600	24"	PN 6 PN 10 PN 16	522	9	2	593	676	766

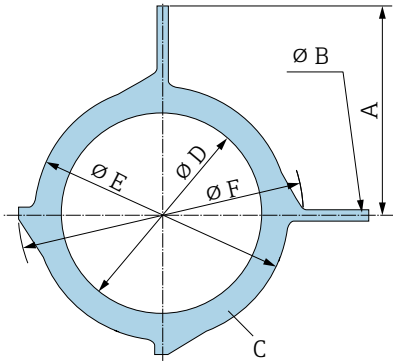

A0042323

1) Material thickness

DN		Rating	A	B	C ¹⁾	D	E
[mm]	[inch]						
700	28"	PN 6	18.11	6.4	2	697	786
		PN10	18.9			693	813
		PN16	19.29			687	807
		Cl, D	19.45			693	832
750	30"	Cl, D	20.59	6.4	2	743	833
800	32"	PN 6	520	6.4	2	799	893
		PN 10	540			795	920
		PN 16	550			789	914
		Cl, D	561			795	940
900	36"	PN 6	570	6.4	2	897	993
		PN 10	590			893	1020
		PN 16	595			886	1014
		Cl, D	615			893	1048
1000	40"	PN 6	620	6.4	2	999	1093
		PN 10	650			995	1127
		PN 16	660			988	1131
		Cl, D	675			995	1163
-	42"	PN 6	704	6.4	2	1044	1220
1200	48"	PN 6	733	6.4	2	1203	1310
		PN 10	760			1196	1344
		PN 16	786			1196	1385
		Cl, D	775			1188	1345

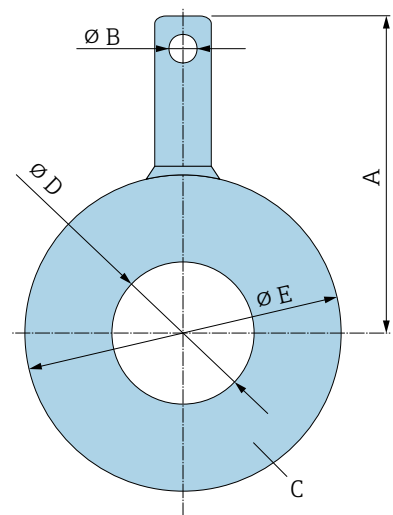

A0042324

1) Material thickness

15 Dimensions in US units

Compact version	148
DN 25 to 300 (1 to 12")	148
DN 350 to 900 (14 to 36")	149
DN 1000 to 2400 (40 to 90")	150
Remote version	151
Transmitter remote version	151
Sensor connection housing	151
DN 25 to 300 (1 to 12") aluminum half-shell housing	152
DN 25 to 300 (1 to 12") fully welded housing	153
DN 350 to 900 (14 to 36")	154
DN 1000 to 2400 (40 to 90")	155
Fixed flange	156
Flange according to ASME B16.5, Class 150	156
Flange according to ASME B16.5, Class 300	156
Flange according to AWWA, Cl. D	157
Lap joint flange	158
Lap joint flange according to ASME B16.5, Class 150	158
Accessories	159
Protective cover	159
Ground disks for flanges	159

Compact version

DN 25 to 300 (1 to 12")

Order code for "Housing", option A "Compact, aluminum, coated"

Sensor with aluminum half-shell housing

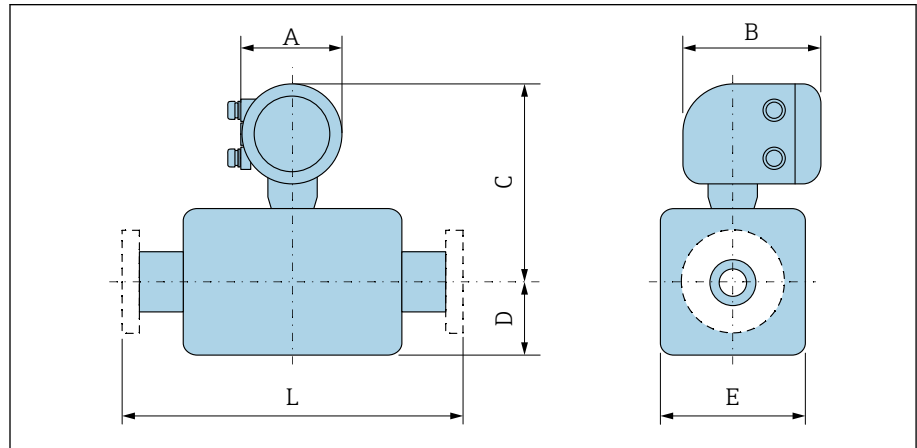

A0042708

DN		A ¹⁾ [in]	B [in]	Order code for "Design" Options D, E, H, I			L [in]
[mm]	[in]			C ²⁾ [in]	D ²⁾ [in]	E ²⁾ [in]	
25	1	5.47	7.01	10.16	3.31	4.72	7.87
32	-	5.47	7.01	10.16	3.31	4.72	7.87
40	1 ½	5.47	7.01	10.16	3.31	4.72	7.87
50	2	5.47	7.01	10.16	3.31	4.72	7.87
65	-	5.47	7.01	11.14	4.29	7.09	7.87
80	3	5.47	7.01	11.14	4.29	7.09	7.87
100	4	5.47	7.01	11.14	4.29	7.09	9.84
125	-	5.47	7.01	12.72	5.91	10.24	9.84
150	6	5.47	7.01	12.72	5.91	10.24	11.81
200	8	5.47	7.01	13.7	7.09	12.76	13.78
250	10	5.47	7.01	14.69	8.07	15.75	17.72
300	12	5.47	7.01	15.67	9.06	18.11	19.69

- 1) Depending on the cable entry used: values up to +1.18 in
- 2) Reference values: dependent on the pressure rating, design and order option

DN 350 to 900 (14 to 36")

Order code for "Housing", option A "Compact, aluminum, coated"

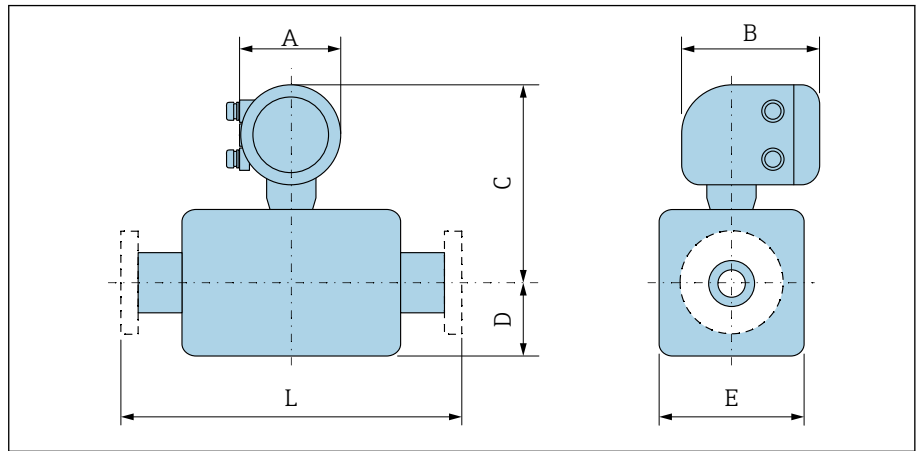

DN		A ¹⁾ [in]	B [in]	Order code for "Design"						L [in]	
				Options E, F			Option G				
[mm]	[in]			C ²⁾ [in]	D ²⁾ [in]	E ²⁾ [in]	C ²⁾ [in]	D ²⁾ [in]	E ²⁾ [in]		
350	14	5.47	7.01	17.99	9.65	19.29	-	-	-	21.65	
375	15	5.47	7.01	19.02	10.67	21.34	-	-	-	23.62	
400	16	5.47	7.01	19.02	10.67	21.34	-	-	-	23.62	
450	18	5.47	7.01	18.31	11.77	23.54	20	13.11	26.22	23.62 ³⁾	25.59 ⁴⁾
500	20	5.47	7.01	19.29	12.76	25.51	21.02	14.13	28.23	23.62	25.59
600	24	5.47	7.01	21.26	14.37	28.74	23.07	16.18	32.32	23.62	30.71
700	28	5.47	7.01	23.66	16.93	33.86	27.09	20.16	40.31	27.56	35.83
750	30	5.47	7.01	25.16	18.39	36.77	27.09	20.16	40.31	29.53	38.39
800	32	5.47	7.01	25.91	19.13	38.27	27.91	21.02	41.93	31.5	40.94
900	36	5.47	7.01	27.87	21.1	42.2	30.94	24.02	47.95	35.43	46.06

- 1) Depending on the cable entry used: values up to +1.18 in
- 2) Reference values: dependent on the pressure rating, design and order option
- 3) Order code for "Design", option F "Fixed flange, short installation length"
- 4) Order code for "Design", option G "Fixed flange, long installation length"

DN 1000 to 2400 (40 to 90")

Order code for "Housing", option A "Compact, aluminum, coated"

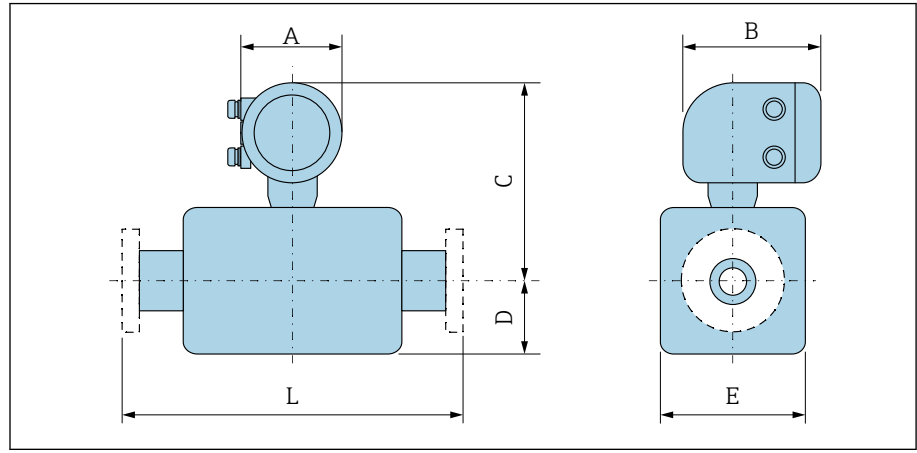

DN		A ¹⁾	B	C ²⁾	D ²⁾	E ²⁾	L	
[mm]	[in]	[in]	[in]	[in]	[in]	[in]	[in]	
1000	40	5.47	7.01	29.88	22.91	45.83	39.37 ³⁾	51.18 ⁴⁾
-	42	5.47	7.01	31.3	24.33	48.66	41.34	53.74
1200	48	5.47	7.01	34.37	27.4	54.8	47.24	61.42
-	54	5.47	7.01	38.82	31.85	63.66	53.15	69.09
1400	-	5.47	7.01	38.82	31.85	63.66	55.12	71.65
-	60	5.47	7.01	42.76	35.79	71.54	59.06	76.77
1600	-	5.47	7.01	42.76	35.79	71.54	62.99	81.89
-	66	5.47	7.01	44.76	37.8	75.55	64.96	84.45
1800	72	5.47	7.01	46.97	40	80	70.87	92.13
-	78	5.47	7.01	51.38	44.37	88.74	78.74	102.36
2000	-	5.47	7.01	51.38	44.37	88.74	78.74	102.36
-	84	5.47	7.01	55.31	48.31	96.61	84.65	
2200	-	5.47	7.01	55.31	48.31	96.61	86.61	
-	90	5.47	7.01	59.45	48.31	104.88	90.55	
2400	-	5.47	7.01	59.45	52.44	104.88	94.49	

- 1) Depending on the cable entry used: values up to +1.18 in
- 2) Reference values: dependent on the pressure rating, design and order option
- 3) Order code for "Design", option F "Fixed flange, short installation length"
- 4) Order code for "Design", option G "Fixed flange, long installation length"

Remote version

Transmitter remote version

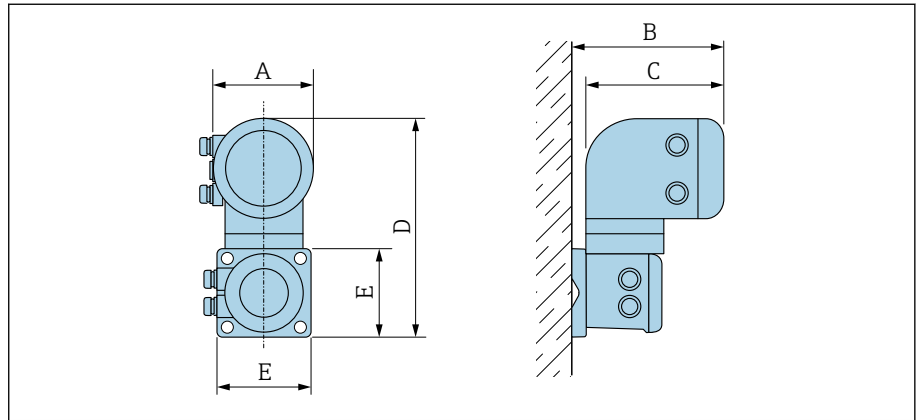

A0042715

Order code for "Housing"	A ¹⁾ [in]	B [in]	C [in]	D [in]	E [in]
Option P "Remote, aluminum, coated"	5.47	7.28	7.01	12.17	5.12

1) Depending on the cable entry used: values up to +1.18 in

Sensor connection housing

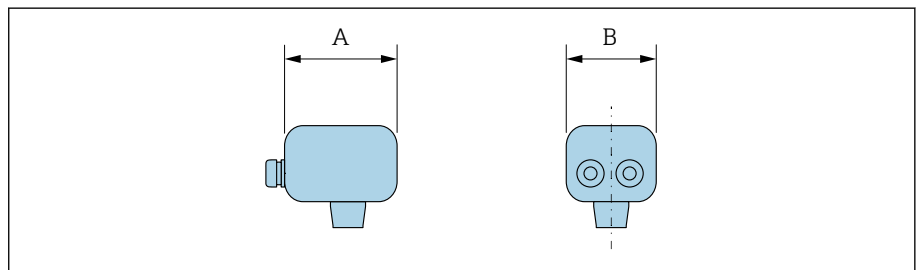

A0042716

Housing material	A ¹⁾ [in]	B [in]
Polycarbonate plastic ²⁾	4.45	4.41
Aluminum, coated	5.83	5.35

1) Depending on the cable entry used: values up to + 1.18 in

2) In conjunction with order code for "Sensor option", options CA, CB, CC, CD, CE

DN 25 to 300 (1 to 12") aluminum half-shell housing

Sensor with aluminum half-shell housing.

Sensor connection housing: aluminum, AlSi10Mg, coated

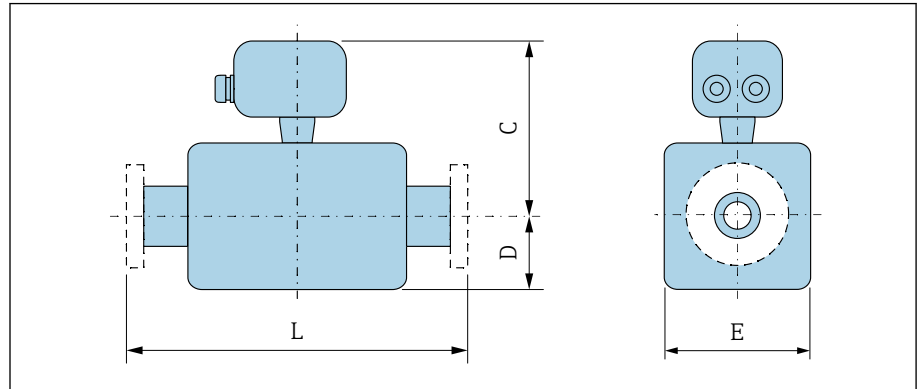

A0041519

DN		Order code for "Design"			
		Options D, E, H, I			
[mm]	[in]	C ¹⁾ [in]	D [in]	E [in]	L [in]
25	1	7.76	3.31	4.72	7.87
32	-	7.76	3.31	4.72	7.87
40	1 ½	7.76	3.31	4.72	7.87
50	2	7.76	3.31	4.72	7.87
65	-	8.74	4.29	7.09	7.87
80	3	8.74	4.29	7.09	7.87
100	4	8.74	4.29	7.09	9.84
125	-	10.31	5.91	10.24	9.84
150	6	10.31	5.91	10.24	11.81
200	8	11.3	7.09	12.76	13.78
250	10	12.28	8.07	15.75	17.72
300	12	13.27	9.06	18.11	19.69

1) Reference values: dependent on the pressure rating, design and order option

DN 25 to 300 (1 to 12") fully welded housing

Sensor with fully welded carbon steel housing:

Order code for "Sensor option", options CA, CB, CC, CD, CE

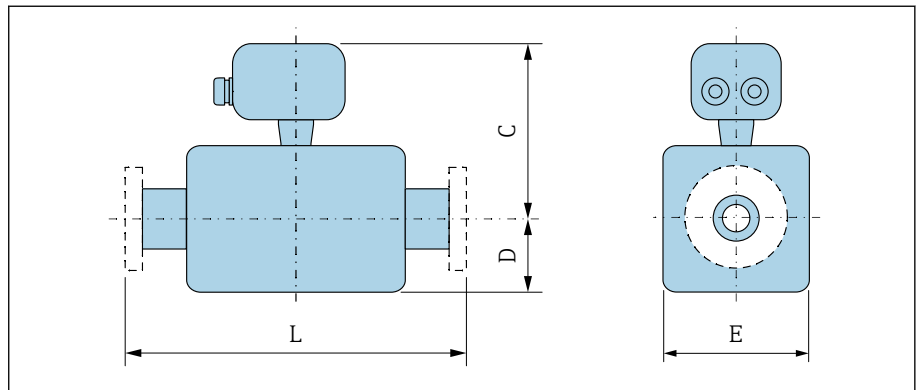

A0041519

DN		Order code for "Design"			
		Options A, E			
[mm]	[in]	C ¹⁾ [in]	D ¹⁾ [in]	E ¹⁾ [in]	L [in]
25	1	7.44	2.76	5.51	7.87
32	-	7.44	2.76	5.51	7.87
40	1 ½	7.44	2.76	5.51	7.87
50	2	7.44	2.76	5.51	7.87
65	-	7.95	3.23	6.5	7.87
80	3	8.15	3.43	6.89	7.87
100	4	8.62	3.94	7.87	9.84
125	-	9.13	4.45	8.9	9.84
150	6	10	5.28	10.59	11.81
200	8	10.98	6.3	12.6	13.78
250	10	12.32	7.6	15.24	17.72
300	12	13.31	8.58	17.2	19.69

1) Reference values: dependent on the pressure rating, design and order option

DN 350 to 900 (14 to 36")

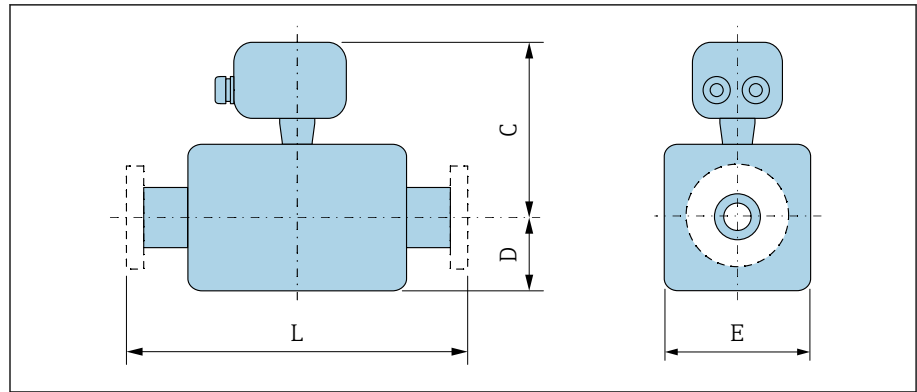

DN		Order code for "Design"							L	
		Options E, F			Option G					
[mm]	[in]	C ¹⁾ [in]	D [in]	E [in]	C [in]	D [in]	E [in]			
350	14	15.55	9.65	19.29	-	-	-	21.65		
375	15	16.57	10.67	21.34	-	-	-	23.62		
400	16	16.57	10.67	21.34	-	-	-	23.62		
450	18	15.87	11.77	23.54	17.56	13.11	26.22	23.62 ²⁾	25.59 ³⁾	
500	20	16.85	12.76	25.51	18.58	14.13	28.23	23.62	25.59	
600	24	18.82	14.37	28.74	20.63	16.18	32.32	23.62	30.71	
700	28	21.22	16.93	33.86	24.65	20.16	40.31	27.56	35.83	
750	30	22.72	18.39	36.77	24.65	20.16	40.31	29.53	38.39	
800	32	23.46	19.13	38.27	25.47	21.02	41.93	31.5	40.94	
900	36	25.43	21.1	42.2	28.5	24.02	47.95	35.43	46.06	

- 1) Reference values: dependent on the pressure rating, design and order option
- 2) Order code for "Design", option F "Fixed flange, short installation length"
- 3) Order code for "Design", option G "Fixed flange, long installation length"

DN 1000 to 2400 (40 to 90")

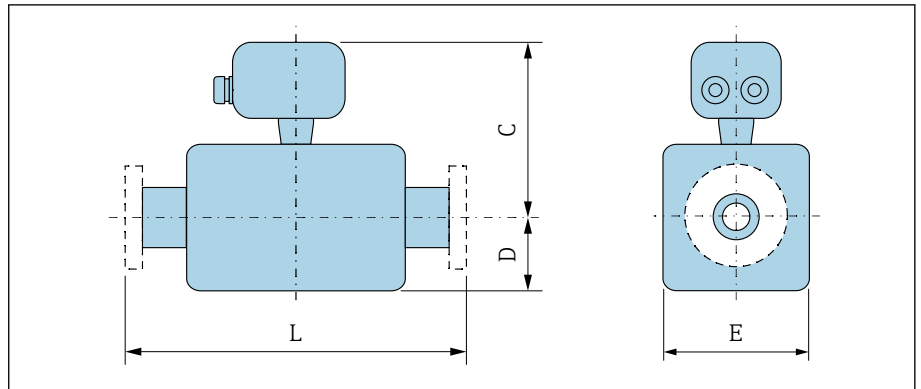

A0041519

DN		C ¹⁾	D ¹⁾	E ¹⁾	L	
[mm]	[in]	[in]	[in]	[in]	[in]	
1000	40	27.48	22.91	45.83	39.37 ²⁾	51.18 ³⁾
-	42	28.9	24.33	48.66	41.34	53.74
1200	48	31.97	27.4	54.8	47.24	61.42
-	54	36.42	31.85	63.66	53.15	69.09
1400	-	36.42	31.85	63.66	55.12	71.65
-	60	40.35	35.79	71.54	59.06	76.77
1600	-	40.35	35.79	71.54	62.99	81.89
-	66	42.36	37.8	75.55	64.96	84.45
1800	72	44.57	40	80	70.87	92.13
-	78	48.98	44.37	88.74	78.74	102.36
2000	-	48.98	44.37	88.74	78.74	102.36
-	84	52.91	48.31	96.61	84.65	
2200	-	52.91	48.31	96.61	86.61	
-	90	57.05	48.31	104.88	90.55	
2400	-	57.05	52.44	104.88	94.49	

- 1) Reference values: dependent on the pressure rating, design and order option
- 2) Order code for "Design", option F "Fixed flange, short installation length"
- 3) Order code for "Design", option G "Fixed flange, long installation length"

Fixed flange

Flange according to ASME B16.5, Class 150

- Carbon steel: order code for "Process connection", option A1K
- Stainless steel: order code for "Process connection", option A1S

Surface roughness: Ra 250 to 492 µin

E: Internal diameter depends on the liner →  113

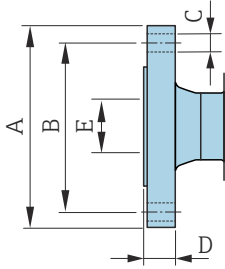

A0041915

DN [in]	A [in]	B [in]	C [in]	D [in]
1	4.25	3.12	4 × Ø0.63	0.5
1 ½	5	3.88	4 × Ø0.63	0.63
2	6	4.75	4 × Ø0.75	0.69
3	7.5	6	4 × Ø0.75	0.88
4	9	7.5	8 × Ø0.75	0.88
6	11	9.5	8 × Ø0.88	0.94
8	13.5	11.75	8 × Ø0.88	1.06
10	16	14.25	12 × Ø1	1.17
12	19	17	12 × Ø1	1.19
14	21.06	18.75	12 × Ø1.13	1.39
16	23.43	21.25	16 × Ø1.13	1.46
18	25	22.75	16 × Ø1.25	1.58
20	27.56	25	20 × Ø1.25	1.7
24	32.09	29.5	20 × Ø1.37	1.89

Flange according to ASME B16.5, Class 300

- Carbon steel: order code for "Process connection", option A2K
- Stainless steel: order code for "Process connection", option A2S

Surface roughness: Ra 250 to 492 µin

E: Internal diameter depends on the liner →  113

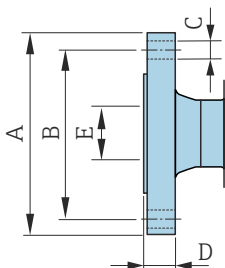

A0041915

DN [in]	A [in]	B [in]	C [in]	D [in]
1	4.88	3.5	4 × Ø0.75	0.63
1 ½	6.12	4.5	4 × Ø0.88	0.75
2	6.5	5	8 × Ø0.75	0.82
3	8.25	6.62	8 × Ø0.88	1.06
4	10	7.88	8 × Ø0.88	1.19
6	12.5	10.62	12 × Ø0.88	1.38

Flange according to AWWA, Cl. D

Order code for "Process connection", option W1K

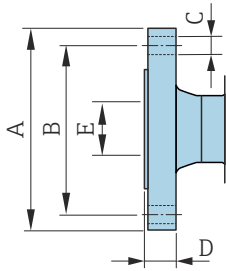
Surface roughness: Ra 250 to 492 μin E: Internal diameter depends on the liner →  113

A0041915

DN	A	B	C	D
[in]	[in]	[in]	[in]	[in]
28	36.5	34	28 × Ø1.38	1.31
30	38.74	36	28 × Ø1.38	1.38
32	41.73	38.5	28 × Ø1.65	1.5
36	45.98	42.75	32 × Ø1.65	1.63
40	50.75	47.25	36 × Ø1.65	1.63
42	52.99	49.5	36 × Ø1.65	1.75
48	59.49	56	44 × Ø1.65	1.88
54	66.26	62.75	44 × Ø1.89	2.13
60	73.03	69.25	52 × Ø1.89	2.25
66	80	76	52 × Ø1.89	2.5
72	86.5	82.5	60 × Ø1.89	2.63
78	92.99	89	64 × Ø2.13	2.75
84	99.8	95.5	64 × Ø2.13	2.88
90	106.5	107	68 × Ø2.36	3

Lap joint flange

Lap joint flange according to ASME B16.5, Class 150

- **Carbon steel:** order code for "Process connection", option A12
- **Stainless steel:** order code for "Process connection", option A14

Surface roughness (flange): Ra 248 to 492 µin

F: Internal diameter depends on the liner →  113

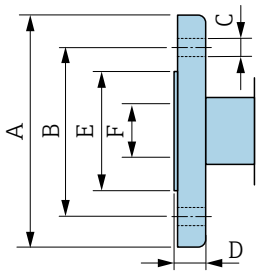

A0042254

DN [in]	A [in]	B [in]	C [in]	D [in]	E [in]
1	4.33	3.15	4 × Ø0.63	0.55	1.93
1 ½	4.92	3.86	4 × Ø0.63	0.69	2.8
2	5.91	4.76	4 × Ø0.75	0.75	3.46
3	7.48	5.98	4 × Ø0.75	0.94	4.72
4	9.06	7.48	8 × Ø0.75	0.94	5.83
6	11.02	9.49	8 × Ø0.91	0.98	8.23
8	13.58	11.73	8 × Ø0.91	1.14	10.39
10	15.94	14.25	12 × Ø0.98	1.18	12.48
12	19.09	17.01	12 × Ø0.98	1.26	14.88

Accessories

Protective cover

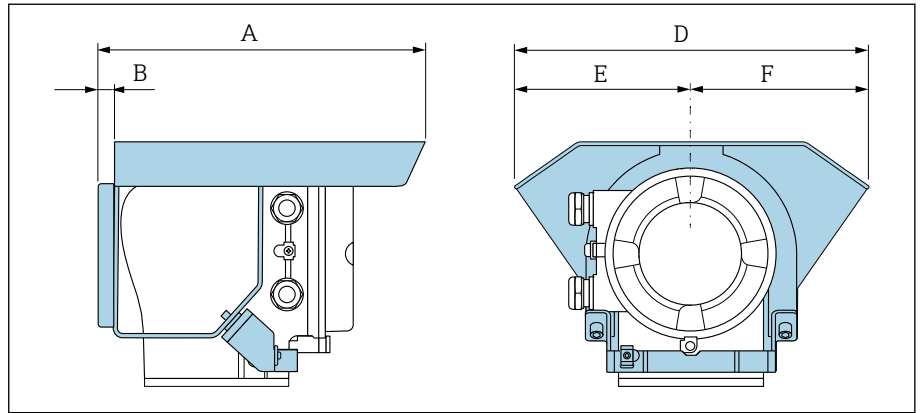

A0042332

A [in]	B [in]	D [in]	E [in]	F [in]
10.12	0.47	11.02	5.51	5.51

Ground disks for flanges

DN 25 to 300 (1 to 12")		DN	Rating	A	B	C ¹⁾	D	E	F
		[mm]	[in]	[in]	[in]	[in]	[in]	[in]	[in]
	25	1"	2)	3.44	0.26	0.08	1.02	2.44	3.05
	32	1 ¼"	2)	3.72	0.26	0.08	1.38	3.15	3.44
	40	1 ½"	2)	4.06	0.26	0.08	1.61	3.23	3.98
	50	2"	2)	4.25	0.26	0.08	2.05	3.98	4.55
	65	2 ½"	2)	4.65	0.26	0.08	2.68	4.76	5.18
	80	3"	2)	5.31	0.26	0.08	3.15	5.16	6.08
	100	4"	2)	6.02	0.26	0.08	4.09	6.14	7.34
	125	5"	2)	6.3	0.26	0.08	5.12	7.36	8.13
	150	6"	2)	7.24	0.26	0.08	6.22	8.54	10.08
	200	8"	2)	8.07	0.26	0.08	8.11	10.51	11.34
	250	10"	2)	9.45	0.26	0.08	10.24	12.91	14.13
	300	12"	PN 10 PN 16 Cl. 150	10.75	0.26	0.08	12.28	14.76	16.26

A0042322

- 1) Material thickness
- 2) In the case of DN 1" to 10", ground disks can be used for all the flange standards/pressure ratings which can be supplied in the standard version.

DN 300 to 600 (12 to 24")		DN	Rating	A	B	C ¹⁾	D	E	F
		[mm]	[in]	[in]	[in]	[in]	[in]	[in]	[in]
<p>A0042323</p>	300	12"	PN 25 JIS 10K JIS 20K	10.55	0.35	0.08	12.2	14.76	15.91
	350	14"	PN 6 PN 10 PN 16	14.37	0.35	0.08	13.5	16.54	18.86
	375	15"	PN 16	15.55	0.35	0.08	15.47	18.15	20.59
	400	16"	PN 6 PN 10 PN 16	15.55	0.35	0.08	15.47	18.5	21.34
	450	18"	PN 6 PN 10 PN 16	16.42	0.35	0.08	17.28	20.67	22.95
	500	20"	PN 6 PN 10 PN 16	18.11	0.35	0.08	19.41	22.64	25.59
	600	24"	PN 6 PN 10 PN 16	20.55	0.35	0.08	23.35	26.61	30.16

1) Material thickness

DN 700 to 1200 (28 to 48")		DN	Rating	A	B	C ¹⁾	D	E
		[mm]	[in]	[in]	[in]	[in]	[in]	[in]
<p>A0042324</p>	700	28"	PN 6 PN10 PN16 Cl, D	18.11 18.9 19.29 19.45	0.25	0.08	27.44 27.28 27.05 27.28	30.94 32.01 31.77 32.76
	750	30"	Cl, D	20.59	0.25	0.08	29.25	32.8
	800	32"	PN 6 PN 10 PN 16 Cl, D	20.47 21.26 21.65 22.09	0.25	0.08	31.46 31.3 31.06 31.3	35.16 36.22 35.98 37.01
	900	36"	PN 6 PN 10 PN 16 Cl, D	22.44 23.23 23.43 24.21	0.25	0.08	35.31 35.16 34.88 35.16	39.09 40.16 39.92 41.26
	1000	40"	PN 6 PN 10 PN 16 Cl, D	24.41 25.59 25.98 26.57	0.25	0.08	39.33 39.17 38.9 39.17	43.03 44.37 44.53 45.79
	-	42"	PN 6	27.72	0.25	0.08	41.1	48.03
	1200	48"	PN 6 PN 10 PN 16 Cl, D	28.86 29.92 30.94 30.51	0.25	0.08	47.36 47.09 47.09 46.77	51.57 52.91 54.53 52.95



1) Material thickness

16 Accessories

Device-specific accessories	162
Communication-specific accessories	163
Service-specific accessory	163
System components	164

Device-specific accessories







Transmitter

Accessories	Description	Order number
Proline 10 transmitter	 Installation Instructions EA01350D	5XBBXX-*...*
Protective cover	Protects the device from weather exposure:  Installation Instructions EA01351D	71502730
Connecting cable	Can be ordered with the device. The following cable lengths are available: order code for "Cable, sensor connection" <ul style="list-style-type: none"> ▪ 5 m (16 ft) ▪ 10 m (32 ft) ▪ 20 m (65 ft) ▪ User-configurable cable length (m or ft)  Max. cable length: 200 m (660 ft)	DK5013-*...*
Ground cable	1 ground cable set for potential equalization, consisting of 2 ground cables	



Sensor

Accessories	Description
Grounding rings	Ground medium in lined measuring pipes.  Installation Instructions EA00070D



Communication-specific accessories

Accessories	Description
Commubox FXA195 USB/HART modem	Intrinsically safe HART communication with FieldCare and FieldXpert  Technical Information TI00404F
Commubox FXA291	Connects the Endress+Hauser devices with the CDI interface (= Endress+Hauser Common Data Interface) to the USB interface of a personal computer or laptop.  Technical Information TI405C/07
HART Loop Converter HMX50	Is used to evaluate and convert dynamic HART process variables to analog current signals or limit values.  <ul style="list-style-type: none"> ▪ Technical Information TI00429F ▪ Operating Instructions BA00371F
Fieldgate FXA42	Transmission of measured values from connected 4 to 20 mA analog and digital devices.  <ul style="list-style-type: none"> ▪ Technical Information TI01297S ▪ Operating Instructions BA01778S ▪ Product page: www.endress.com/fxa42
Field Xpert SMT70	Tablet PC for the configuration of the device. Enables mobile Plant Asset Management to manage the devices with a digital communication interface. Suitable for Zone 2.  <ul style="list-style-type: none"> ▪ Technical Information TI01342S ▪ Operating Instructions BA01709S ▪ Product page: www.endress.com/smt70
Field Xpert SMT77	Tablet PC for the configuration of the device. Enables mobile Plant Asset Management to manage the devices with a digital communication interface. Suitable for Zone 1.  <ul style="list-style-type: none"> ▪ Technical Information TI01418S ▪ Operating Instructions BA01923S ▪ Product page: www.endress.com/smt77

Service-specific accessory

Accessories	Description	Order number
Applicator	Software for selecting and sizing Endress+Hauser devices.	https://portal.endress.com/webapp/applicator
W@M Life Cycle Management	<ul style="list-style-type: none"> ▪ Information platform with software applications and services ▪ Supports the entire life cycle of the facility. 	www.endress.com/lifecyclemanagement
FieldCare	FDT-based plant asset management software from Endress+Hauser. Management and configuration of Endress+Hauser devices.  Operating Instructions BA00027S and BA00059S	<ul style="list-style-type: none"> ▪ Device driver: www.endress.com → Download Area ▪ CD-ROM (contact Endress+Hauser) ▪ DVD (contact Endress+Hauser)
DeviceCare	Software for connecting and configuring Endress+Hauser devices.  Innovation brochure IN01047S	<ul style="list-style-type: none"> ▪ Device driver: www.endress.com → Download Area ▪ CD-ROM (contact Endress+Hauser) ▪ DVD (contact Endress+Hauser)

System components

Accessories	Description
Memograph M	Graphic data manager: <ul style="list-style-type: none">▪ Record measured values▪ Monitor limit values▪ Analyze measuring points  <ul style="list-style-type: none">▪ Technical Information TI00133R▪ Operating Instructions BA00247R
iTEMP	Temperature transmitter: <ul style="list-style-type: none">▪ Measure the absolute pressure and gauge pressure of gases, vapors and liquids▪ Read the medium temperature  "Fields of Activity" document FA00006T

17 Appendix

Screw tightening torques	167
Examples for electric terminals	175

Screw tightening torques

General information

Note the following for the screw tightening torques:

- Only for lubricated threads.
- Only for pipes that are free from tensile stress.
- Tighten the screws uniformly and in diagonally opposite sequence.
- Overtightening the screws will deform the sealing surface or damage the seal.
- Maximum or nominal screw tightening torques apply depending on the flange standard and size.

Max. screw tightening torques

EN 1092-1: DN 25 to 2 400	→ Max. screw tightening torques for EN 1092-1, ☰ 168
ASME B16.5	→ Max. screw tightening torques for ASME B16.5, ☰ 170
JIS B2220: DN 25 to 300	→ Max. screw tightening torques for JIS B2220, ☰ 170
AS 2129, Table E	→ Max. screw tightening torques for AS 2129, Table E, ☰ 171
AS 4087, PN 16	→ Max. screw tightening torques for AS 4087, PN 16, ☰ 171
AWWA C207, Class D	→ Max. screw tightening torques for AWWA C207, Class D, ☰ 172

Nominal screw tightening torques

EN 1092-1: DN 1 000 to 2 400	→ Nominal screw tightening torques for EN 1092-1; calculated according to EN 1591-1:2014 for flanges according to EN 1092-1:2013, ☰ 173
JIS B2220: DN 350 to 750	→ Nominal screw tightening torques for JIS B2220, ☰ 173

Maximum screw tightening torques

Max. screw tightening torques for EN 1092-1

Nominal diameter		Rating	Screws	Flange thickness	Max. screw tightening torque [Nm]		
[mm]	[in]	[bar]	[mm]	[mm]	HG	PUR	PTFE
25	1	PN 40	4×M12	18	–	15	26
32	–	PN 40	4×M16	18	–	24	41
40	1 ½	PN 40	4×M16	18	–	31	52
50	2	PN 40	4×M16	20	48	40	65
65 ¹⁾	–	PN 16	8×M16	18	32	27	44
65	–	PN 40	8×M16	22	32	27	44
80	3	PN 16	8×M16	20	40	34	53
		PN 40	8×M16	24	40	34	53
100	4	PN 16	8×M16	20	43	36	57
		PN 40	8×M20	24	59	50	79
125	–	PN 16	8×M16	22	56	48	75
		PN 40	8×M24	26	83	71	112
150	6	PN 16	8×M20	22	74	63	99
		PN 40	8×M24	28	104	88	137
200	8	PN 10	8×M20	24	106	91	141
		PN 16	12×M20	24	70	61	94
		PN 25	12×M24	30	104	92	139
250	10	PN 10	12×M20	26	82	71	110
		PN 16	12×M24	26	98	85	132
		PN 25	12×M27	32	150	134	201
300	12	PN 10	12×M20	26	94	81	126
		PN 16	12×M24	28	134	118	179
		PN 25	16×M27	34	153	138	204
350	14	PN 6	12×M20	22	111	120	–
		PN 10	16×M20	26	112	118	–
		PN 16	16×M24	30	152	165	–
		PN 25	16×M30	38	227	252	–
400	16	PN 6	16×M20	22	90	98	–
		PN 10	16×M24	26	151	167	–
		PN 16	16×M27	32	193	215	–
		PN 25	16×M33	40	289	326	–
450	18	PN 6	16×M20	22	112	126	–
		PN 10	20×M24	28	153	133	–
		PN 16	20×M27	40	198	196	–
		PN 25	20×M33	46	256	253	–
500	20	PN 6	20×M20	24	119	123	–
		PN 10	20×M24	28	155	171	–
		PN 16	20×M30	34	275	300	–
		PN 25	20×M33	48	317	360	–

Nominal diameter		Rating	Screws	Flange thickness	Max. screw tightening torque [Nm]		
[mm]	[in]	[bar]	[mm]	[mm]	HG	PUR	PTFE
600	24	PN 6	20×M24	30	139	147	-
		PN 10	20×M27	28	206	219	-
600	24	PN 16	20×M33	36	415	443	-
600	24	PN 25	20×M36	58	431	516	-
700	28	PN 6	24×M24	24	148	139	-
		PN 10	24×M27	30	246	246	-
		PN 16	24×M33	36	278	318	-
		PN 25	24×M39	46	449	507	-
800	32	PN 6	24×M27	24	206	182	-
		PN 10	24×M30	32	331	316	-
		PN 16	24×M36	38	369	385	-
		PN 25	24×M45	50	664	721	-
900	36	PN 6	24×M27	26	230	637	-
		PN 10	28×M30	34	316	307	-
		PN 16	28×M36	40	353	398	-
		PN 25	28×M45	54	690	716	-
1000	40	PN 6	28×M27	26	218	208	-
		PN 10	28×M33	34	402	405	-
		PN 16	28×M39	42	502	518	-
		PN 25	28×M52	58	970	971	-
1200	48	PN 6	32×M30	28	319	299	-
		PN 10	32×M36	38	564	568	-
		PN 16	32×M45	48	701	753	-
1400	-	PN 6	36×M33	32	430	-	-
		PN 10	36×M39	42	654	-	-
		PN 16	36×M45	52	729	-	-
1600	-	PN 6	40×M33	34	440	-	-
		PN 10	40×M45	46	946	-	-
		PN 16	40×M52	58	1007	-	-
1800	72	PN 6	44×M36	36	547	-	-
		PN 10	44×M45	50	961	-	-
		PN 16	44×M52	62	1108	-	-
2000	-	PN 6	48×M39	38	629	-	-
		PN 10	48×M45	54	1047	-	-
		PN 16	48×M56	66	1324	-	-
2200	-	PN 6	52×M39	42	698	-	-
		PN 10	52×M52	58	1217	-	-
2400	-	PN 6	56×M39	44	768	-	-
		PN 10	56×M52	62	1229	-	-

1) Sizing as per EN 1092-1 (not DIN 2501)

Max. screw tightening torques for ASME B16.5

Nominal diameter		Rating [psi]	Screws [in]	Max. screw tightening torque			
[mm]	[in]			HG		PUR	
				[Nm]	[lbf · ft]	[Nm]	[lbf · ft]
25	1	Class 150	4×½	–	–	7	5
25	1	Class 300	4×5/8	–	–	8	6
40	1 ½	Class 150	4×½	–	–	10	7
40	1 ½	Class 300	4×¾	–	–	15	11
50	2	Class 150	4×5/8	35	26	22	16
50	2	Class 300	8×5/8	18	13	11	8
80	3	Class 150	4×5/8	60	44	43	32
80	3	Class 300	8×¾	38	28	26	19
100	4	Class 150	8×5/8	42	31	31	23
100	4	Class 300	8×¾	58	43	40	30
150	6	Class 150	8×¾	79	58	59	44
150	6	Class 300	12×¾	70	52	51	38
200	8	Class 150	8×¾	107	79	80	59
250	10	Class 150	12×7/8	101	74	75	55
300	12	Class 150	12×7/8	133	98	103	76
350	14	Class 150	12×1	135	100	158	117
400	16	Class 150	16×1	128	94	150	111
450	18	Class 150	16×1 1/8	204	150	234	173
500	20	Class 150	20×1 1/8	183	135	217	160
600	24	Class 150	20×1 ¼	268	198	307	226

Max. screw tightening torques for JIS B2220

Nominal diameter [mm]	Rating [bar]	Screws [mm]	Max. screw tightening torque [Nm]	
			HG	PUR
25	10K	4×M16	–	19
25	20K	4×M16	–	19
32	10K	4×M16	–	22
32	20K	4×M16	–	22
40	10K	4×M16	–	24
40	20K	4×M16	–	24
50	10K	4×M16	40	33
50	20K	8×M16	20	17
65	10K	4×M16	55	45
65	20K	8×M16	28	23
80	10K	8×M16	29	23
80	20K	8×M20	42	35
100	10K	8×M16	35	29
100	20K	8×M20	56	48
125	10K	8×M20	60	51

Nominal diameter [mm]	Rating [bar]	Screws [mm]	Max. screw tightening torque [Nm]	
			HG	PUR
125	20K	8×M22	91	79
150	10K	8×M20	75	63
150	20K	12×M22	81	72
200	10K	12×M20	61	52
200	20K	12×M22	91	80
250	10K	12×M22	100	87
250	20K	12×M24	159	144
300	10K	16×M22	74	63
300	20K	16×M24	138	124

Max. screw tightening torques for AS 2129, Table E

Nominal diameter [mm]	Screws [mm]	Max. screw tightening torque [Nm]	
		HG	PUR
50	4×M16	32	-
80	4×M16	49	-
100	8×M16	38	-
150	8×M20	64	-
200	8×M20	96	-
250	12×M20	98	-
300	12×M24	123	-
350	12×M24	203	-
400	12×M24	226	-
450	16×M24	226	-
500	16×M24	271	-
600	16×M30	439	-
700	20×M30	355	-
750	20×M30	559	-
800	20×M30	631	-
900	24×M30	627	-
1000	24×M30	634	-
1200	32×M30	727	-

Max. screw tightening torques for AS 4087, PN 16

Nominal diameter [mm]	Screws [mm]	Max. screw tightening torque [Nm]	
		HG	PUR
50	4×M16	32	-
80	4×M16	49	-
100	4×M16	76	-
150	8×M20	52	-
200	8×M20	77	-
250	8×M20	147	-

Nominal diameter [mm]	Screws [mm]	Max. screw tightening torque [Nm]	
		HG	PUR
300	12×M24	103	-
350	12×M24	203	-
375	12×M24	137	-
400	12×M24	226	-
450	12×M24	301	-
500	16×M24	271	-
600	16×M27	393	-
700	20×M27	330	-
750	20×M30	529	-
800	20×M33	631	-
900	24×M33	627	-
1000	24×M33	595	-
1200	32×M33	703	-

Max. screw tightening torques for AWWA C207, Class D

Nominal diameter		Screws [in]	Max. screw tightening torque			
[mm]	[in]		HG		PUR	
			[Nm]	[lbf · ft]	[Nm]	[lbf · ft]
700	28	28×1 ¼	247	182	292	215
750	30	28×1 ¼	287	212	302	223
800	32	28×1 ½	394	291	422	311
900	36	32×1 ½	419	309	430	317
1000	40	36×1 ½	420	310	477	352
-	42	36×1 ½	528	389	518	382
-	48	44×1 ½	552	407	531	392
-	54	44×1 ¾	730	538	-	-
-	60	52×1 ¾	758	559	-	-
-	66	52×1 ¾	946	698	-	-
-	72	60×1 ¾	975	719	-	-
-	78	64×2	853	629	-	-
-	84	64×2	931	687	-	-
-	90	64×2 ¼	1048	773	-	-

Nominal screw tightening torques

Nominal screw tightening torques for EN 1092-1; calculated according to EN 1591-1:2014 for flanges according to EN 1092-1:2013

Nominal diameter		Rating	Screws	Flange thickness	Nominal screw tightening torque [Nm]		
[mm]	[in]	[bar]	[mm]	[mm]	HG	PUR	PTFE
1000	40	PN 6	28×M27	38	175	185	–
		PN 10	28×M33	44	350	360	–
		PN 16	28×M39	59	630	620	–
		PN 25	28×M52	63	1300	1290	–
1200	48	PN 6	32×M30	42	235	250	–
		PN 10	32×M36	55	470	480	–
		PN 16	32×M45	78	890	900	–
1400	–	PN 6	36×M33	56	300	–	–
		PN 10	36×M39	65	600	–	–
		PN 16	36×M45	84	1050	–	–
1600	–	PN 6	40×M33	63	340	–	–
		PN 10	40×M45	75	810	–	–
		PN 16	40×M52	102	1420	–	–
1800	72	PN 6	44×M36	69	430	–	–
		PN 10	44×M45	85	920	–	–
		PN 16	44×M52	110	1600	–	–
2000	–	PN 6	48×M39	74	530	–	–
		PN 10	48×M45	90	1040	–	–
		PN 16	48×M56	124	1900	–	–
2200	–	PN 6	52×M39	81	580	–	–
		PN 10	52×M52	100	1290	–	–
2400	–	PN 6	56×M39	87	650	–	–
		PN 10	56×M52	110	1410	–	–

Nominal screw tightening torques for JIS B2220

Nominal diameter [mm]	Rating [bar]	Screws [mm]	Nominal screw tightening torque [Nm]	
			HG	PUR
350	10K	16×M22	109	109
	20K	16×M30×3	217	217
400	10K	16×M24	163	163
	20K	16×M30×3	258	258
450	10K	16×M24	155	155
	20K	16×M30×3	272	272
500	10K	16×M24	183	183
	20K	16×M30×3	315	315
600	10K	16×M30	235	235
	20K	16×M36×3	381	381

Nominal diameter [mm]	Rating [bar]	Screws [mm]	Nominal screw tightening torque [Nm]	
			HG	PUR
700	10K	16×M30	300	300
750	10K	16×M30	339	339

Examples for electric terminals

Current output 4 to 20 mA HART (active)

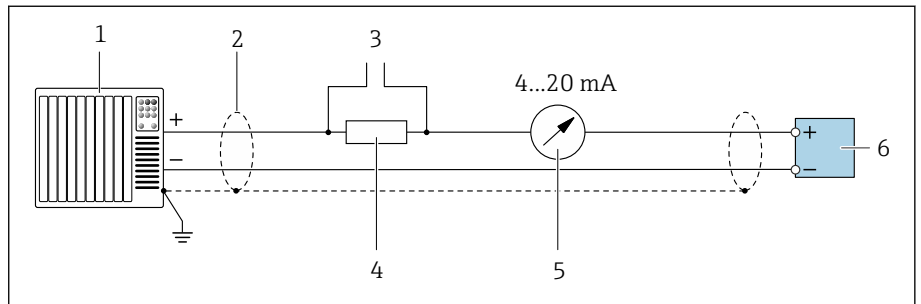

A0029055

- 1 Automation system with current input, e.g. PLC
- 2 Cable shield
- 3 Connection for HART operating devices
- 4 Resistor for HART communication ($\geq 250 \Omega$): observe max. load.
- 5 Analog display unit: observe max. load.
- 6 Transmitter

Current output 4 to 20 mA HART (passive)

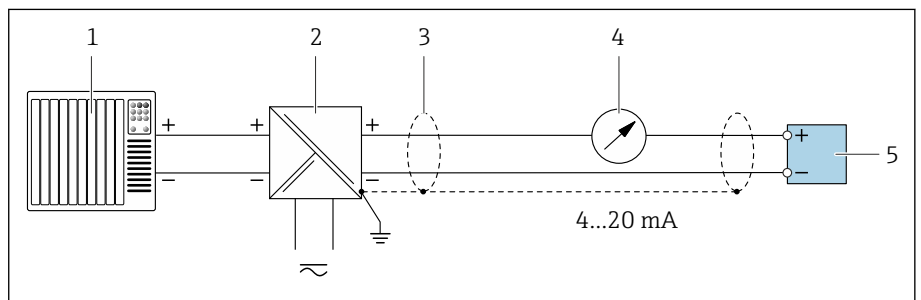

A0028762

- 1 Automation system with current input, e.g. PLC
- 2 Active barrier for supply voltage, e.g. RN221N
- 3 Cable shield
- 4 Analog display unit: observe max. load.
- 5 Transmitter

HART input (passive)

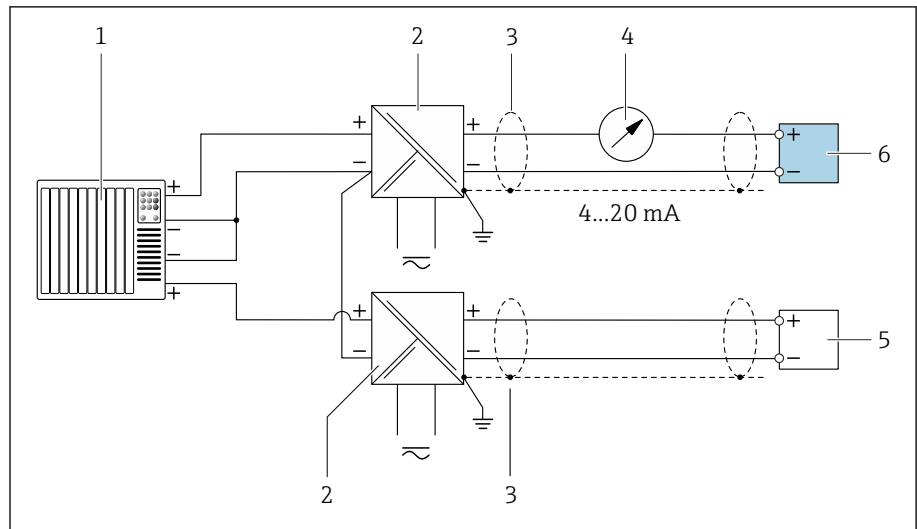

A0028763

10 Connection example for HART input with a common negative (passive)

- 1 Automation system with current input, e.g. PLC
- 2 Active barrier for supply voltage, e.g. RN22 1N
- 3 Cable shield
- 4 Analog display unit: observe max. load.
- 5 Pressure measuring device, e.g. Cerabar M, Cerabar S: observe requirements
- 6 Transmitter

Pulse/frequency output (passive)

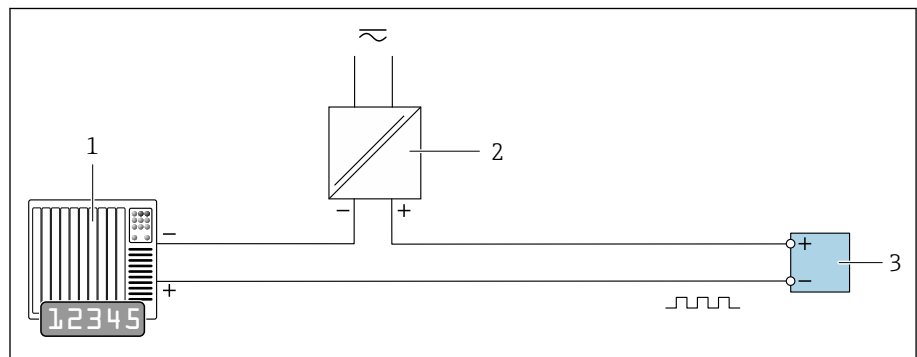

A0028761

- 1 Automation system with pulse output and frequency input, e.g. PLC
- 2 Supply voltage
- 3 Transmitter: observe input values.

Switch output (passive)

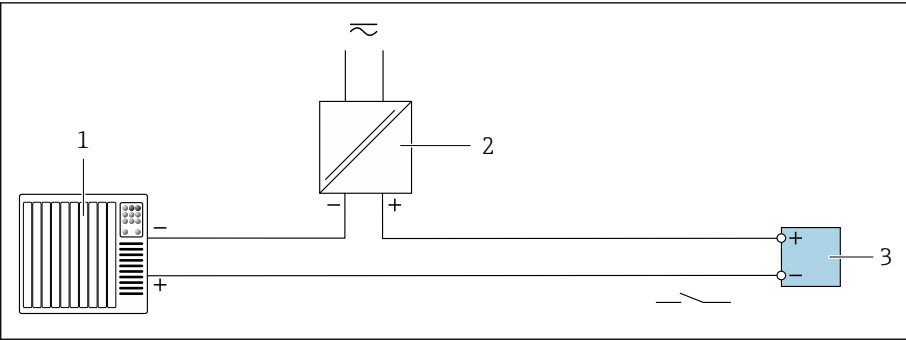

A0028760

- 1 Automation system with switch input, e.g. PLC
- 2 Supply voltage
- 3 Transmitter: observe input values.

Index

A

- Adapting the diagnostic behavior 76
- Ambient temperature
 - Influence 101
- Ambient temperature range 102
- Applicator 88
- Approvals 118

C

- Certificates 118
- Certificates and approvals 118
- Check
 - Connection 48
 - Installation 34
 - Received goods 16
- Checking the storage conditions (checklist) 21
- Checklist
 - Post-connection check 48
 - Post-installation check 34
- Commissioning 61, 62
 - see Commissioning wizard
 - see Via local operation
 - see Via SmartBlue App
- Switching on the device 63
- Commissioning the device 64
- Compatibility 24
- Conductivity 104
- Connecting cable terminal assignment
 - Sensor connection housing 39
- Connecting the connecting cable
 - Sensor connection housing 39
 - Transmitter connection housing 40

D

- Date of manufacture 17, 18
- Degree of protection 102
- Design
 - Device 22
- Designated use 16
- Device
 - Design 22
 - Disposal 86
 - Removal 86
- Device components 22
- Device description files 58
- Device history 24
- Device locking, status 68
- Device name
 - Sensor 18
 - Transmitter 17
- Device reset
 - Settings 82
- Device usage
 - see Designated use
- Diagnostic information
 - Design, description 74, 75

- DeviceCare 74
- FieldCare 74
- Light emitting diodes
 - LED 71
- Local display 73
- Overview 76
- Remedial measures 76
- Diagnostic information in FieldCare or DeviceCare 74
- Diagnostic information via LED 71
- Diagnostic list 80
- Diagnostic message 73
- Diagnostics
 - Symbols 73
- Display
 - Current diagnostic event 79
 - Previous diagnostic event 79
- Display values
 - For locking status 68
- Disposal 85
- Disposing of the device 86
- Drinking water approval 118

E

- Electromagnetic compatibility 103
- Electronics module 22
- Endress+Hauser services
 - Maintenance 84
- Environment
 - Ambient temperature 102
 - Storage temperature 102
 - Vibration-resistance and shock-resistance 103
- Error messages
 - see Diagnostic messages
- Event list 80
- Event logbook 80
- Extended order code
 - Sensor 18
 - Transmitter 17
- Exterior cleaning 84
 - Cleaning 84

F

- Filtering the event logbook 80
- Firmware history 24
- Fitted electrodes 115
- Flow limit 104

G

- Galvanic isolation 94
- General troubleshooting 70
- Ground disks for flanges
 - Dimensions 145, 159

H

- HART certification 118
- HART protocol
 - Device variables 58

- Dynamic variables 58
- I**
- Identify device 17
- Immersion in water 30
 - Installation conditions 30
- Incoming acceptance (checklist) 16
- Influence
 - Ambient temperature 101
- Influence of ambient temperature 101
- Input 88
- Interior cleaning 84
 - Cleaning 84
- L**
- Local display
 - see Diagnostic message
 - see In alarm condition
- Local operation 64
- Low flow cut off 94
- M**
- Magnetism 30
- Magnetism and static electricity 30
- Main electronics module 22
- Maintenance tasks 84
- Maximum measured error 100
- Measured variable
 - see Process variables
- Measured variables via HART protocol 58
- Measuring pipe specification 113
- Measuring principle 16
- Measuring range 88
- Medium temperature range 104
- N**
- Nameplate
 - Sensor 18
 - Transmitter 17
- Non-Ex approval 118
- O**
- Operable flow range 88
- Operation 49, 67
- Order code 17, 18
- Output 91
- Output signal 91
- Overview of diagnostic information 76
- P**
- Packaging disposal 21
- Pending diagnostic events 79
- Performance characteristics 100
- Pharmaceutical compatibility 118
- Post-connection check 62
- Post-connection check (checklist) 48
- Post-installation check 62
- Post-installation check (checklist) 34
- Post-installation check and post-connection check . . . 62
- Potential equalization 44
- Pressure Equipment Directive 118
- Pressure loss 108
- Pressure tightness 108
- Pressure-temperature ratings 105
- Process conditions
 - Conductivity 104
 - Flow limit 104
 - Medium temperature 104
 - Pressure loss 108
 - Pressure tightness 108
 - Pressure-temperature ratings 105
- Process connections 115
- Product design 22
- Product identification 17
- R**
- Radio approval 118
- Reading out the event logbook 80
- Reading the device locking status 68
- Recycling of packaging materials 21
- Reference operating conditions 100
- Registered trademarks 9
- Removing the device 86
- Repeatability 100
- S**
- Safety instructions 11
- Sensor nameplate 18
- Serial number 17, 18
- Services 84
- Signal on alarm 94
- SmartBlue App 64
 - Operating options 55
- Standards and guidelines 119
- Static electricity 30
- Status signals 73
- Storage 21
- Storage conditions 21
- Storage temperature 21, 102
- Storage temperature range 102
- Submenu
 - Device management 68
 - Event list 80
- Surface roughness 115
- Switching on the device 63
- System design
 - see Device design
- System integration 57
- T**
- Temperature range
 - Storage temperature 21
- Tool
 - Transport 19
- Transmitter nameplate 17
- Transport
 - Transporting the device 19
- Troubleshooting
 - General 70

U

- Use in buried applications 30
- Installation conditions 30

V

- Vibration-resistance and shock-resistance 103

W

- W@M Device Viewer 17
- Weight
 - Transport (notes) 19
- Wiring the sensor connection housing 39
- Wiring the transmitter housing 40



71510513

www.addresses.endress.com
