

Technical Information

Proline Promag W 400

Electromagnetic flowmeter



Versatile standard flowmeter for the water and wastewater industry

Application

- The bidirectional measuring principle is virtually independent of pressure, density, temperature and viscosity
- Ideal for water measurement, e.g. drinking water, utility water and industrial/municipal wastewater

Device properties

- International drinking water approvals
- Degree of protection IP68 (Type 6P enclosure)
- Approved for custody transfer to MI-001/OIML R49
- Transmitter housing made of durable polycarbonate or aluminum
- WLAN access
- Integrated data logger: measured values monitoring

Ihre Vorteile

- Reliable measurement at constant accuracy with 0 x DN inlet run and no pressure loss
- Flexible engineering – sensor with fixed or lap-joint process connections
- Application fitness – EN ISO 12944 corrosion protection for underground or underwater installation
- Improved plant availability – sensor compliant with industry-specific requirements
- Safe operation – no need to open the device due to display with touch control, background lighting
- Time-saving local operation without additional software and hardware – integrated web server
- Integrated verification – Heartbeat Technology

Table of contents





About this document	4	Electromagnetic compatibility (EMC)	43
Symbols	4		
Function and system design	5	Process	43
Measuring principle	5	Medium temperature range	43
Measuring system	6	Conductivity	44
Equipment architecture	7	Pressure-temperature ratings	44
Safety	7	Pressure tightness	47
		Flow limit	48
		Pressure loss	48
		System pressure	49
		Vibrations	49
Input	8	Custody transfer mode	50
Measured variable	8		
Measuring range	9	Mechanical construction	50
Operable flow range	12	Dimensions in SI units	50
Input signal	12	Dimensions in US units	68
		Weight	78
		Measuring tube specification	81
		Materials	83
		Fitted electrodes	85
		Process connections	86
		Surface roughness	86
Output	13	Human interface	86
Output signal	13	Operating concept	86
Signal on alarm	14	Languages	86
Low flow cut off	16	Local display	87
Galvanic isolation	16	Remote operation	87
Protocol-specific data	16	Service interface	89
		Supported operating tools	90
		HistoROM data management	92
Power supply	21	Certificates and approvals	93
Terminal assignment	21	CE mark	93
Pin assignment, device plug	23	RCM-tick symbol	93
Supply voltage	24	Ex approval	93
Power consumption	24	Drinking water approval	93
Current consumption	24	HART certification	93
Power supply failure	24	Certification PROFIBUS	93
Electrical connection	25	Modbus RS485 certification	93
Potential equalization	29	EtherNet/IP certification	93
terminals	30	Radio approval	93
Cable entries	31	Measuring instrument approval	93
Cable specification	31	Other standards and guidelines	93
		Ordering information	94
		Product generation index	94
Performance characteristics	33	Application packages	94
Reference operating conditions	33	Cleaning	95
Maximum measured error	33	Diagnostics functions	95
Repeatability	35	Heartbeat Technology	95
Influence of ambient temperature	35		
		Accessories	95
		Device-specific accessories	96
Installation	35		
Mounting location	36		
Orientation	37		
Inlet and outlet runs	38		
Adapters	38		
Length of connecting cable	39		
Mounting the transmitter housing	40		
Special mounting instructions	40		
Environment	41		
Ambient temperature range	41		
Storage temperature	42		
Atmosphere	42		
Degree of protection	42		
Vibration- and shock-resistance	42		
Mechanical load	43		

Communication-specific accessories	96
Service-specific accessories	97
System components	97
Supplementary documentation	98
Standard documentation	98
Supplementary device-dependent documentation	98
Registered trademarks	99





About this document

Symbols









Electrical symbols

Symbol	Meaning
	Direct current
	Alternating current
	Direct current and alternating current
	Ground connection A grounded terminal which, as far as the operator is concerned, is grounded via a grounding system.
	Protective Earth (PE) A terminal which must be connected to ground prior to establishing any other connections. The ground terminals are situated inside and outside the device: <ul style="list-style-type: none"> ▪ Inner ground terminal: Connects the protective earth to the mains supply. ▪ Outer ground terminal: Connects the device to the plant grounding system.



Communication symbols

Symbol	Meaning
	Wireless Local Area Network (WLAN) Communication via a wireless, local network.
	Bluetooth Wireless data transmission between devices over a short distance.
	LED Light emitting diode is off.
	LED Light emitting diode is on.
	LED Light emitting diode is flashing.

Symbols for certain types of information

Symbol	Meaning
	Permitted Procedures, processes or actions that are permitted.
	Preferred Procedures, processes or actions that are preferred.
	Forbidden Procedures, processes or actions that are forbidden.
	Tip Indicates additional information.
	Reference to documentation.
	Reference to page.
	Reference to graphic.
	Visual inspection.

Symbols in graphics

Symbol	Meaning
1, 2, 3, ...	Item numbers
1, 2, 3, ...	Series of steps
A, B, C, ...	Views
A-A, B-B, C-C, ...	Sections
	Hazardous area
	Safe area (non-hazardous area)
	Flow direction

Function and system design

Measuring principle

Following *Faraday's law of magnetic induction*, a voltage is induced in a conductor moving through a magnetic field.

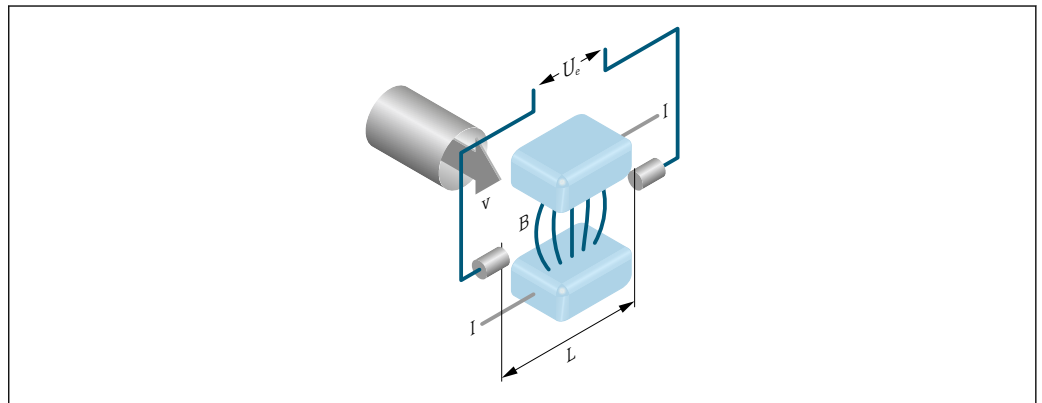

A0028962

- U_e* Induced voltage
- B* Magnetic induction (magnetic field)
- L* Electrode spacing
- I* Current
- v* Flow velocity

In the electromagnetic measuring principle, the flowing medium is the moving conductor. The voltage induced (U_e) is proportional to the flow velocity (v) and is supplied to the amplifier by means of two measuring electrodes. The flow volume (Q) is calculated via the pipe cross-section (A). The DC magnetic field is created through a switched direct current of alternating polarity.

Formulae for calculation

- Induced voltage $U_e = B \cdot L \cdot v$
- Volume flow $Q = A \cdot v$

Measuring system

The device consists of a transmitter and a sensor.



Two device versions are available:

- Compact version – transmitter and sensor form a mechanical unit.
- Remote version - transmitter and sensor are mounted in separate locations.

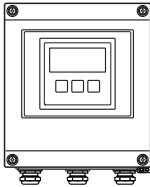
Transmitter

<p>Proline 400</p>  <p style="text-align: right; font-size: small;">A0017117</p>	<p>Device versions and materials</p> <ul style="list-style-type: none"> ■ Compact version: compact housing <ul style="list-style-type: none"> ■ Polycarbonate plastic ■ Aluminum, AlSi10Mg, coated ■ Remote version: wall-mount housing <ul style="list-style-type: none"> ■ Polycarbonate plastic ■ Aluminum, AlSi10Mg, coated <p>Configuration:</p> <ul style="list-style-type: none"> ■ External operation via four-line, illuminated local display with touch control and guided menus ("Make-it-run" wizards) for applications ■ Via operating tools (e.g. FieldCare) ■ Via Web browser (e.g. Microsoft Internet Explorer) ■ Also for device version with EtherNet/IP output: <ul style="list-style-type: none"> ■ Via Add-on Profile Level 3 for automation system from Rockwell Automation ■ Via Electronic Data Sheet (EDS) ■ Also for device version with PROFIBUS DP output: <ul style="list-style-type: none"> ■ Via PDM driver for Siemens automation system
--	--

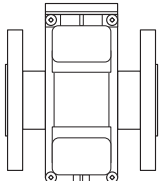
Sensor

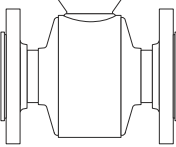
<p>Promag W</p> <p><i>Lap joint flange, lap joint flange, stamped plate or fixed flange with aluminum half-shell housing: DN 25 to 300 (1 to 12")</i></p>  <p style="text-align: right; font-size: small;">A0017040</p>	<ul style="list-style-type: none"> ■ Nominal diameter range: DN 25 to 2400 (1 to 90") ■ Materials →  83
<p><i>Fixed flange with fully welded housing made of carbon steel: DN 25 to 300 (1 to 12")</i></p>  <p style="text-align: right; font-size: small;">A0022673</p>	

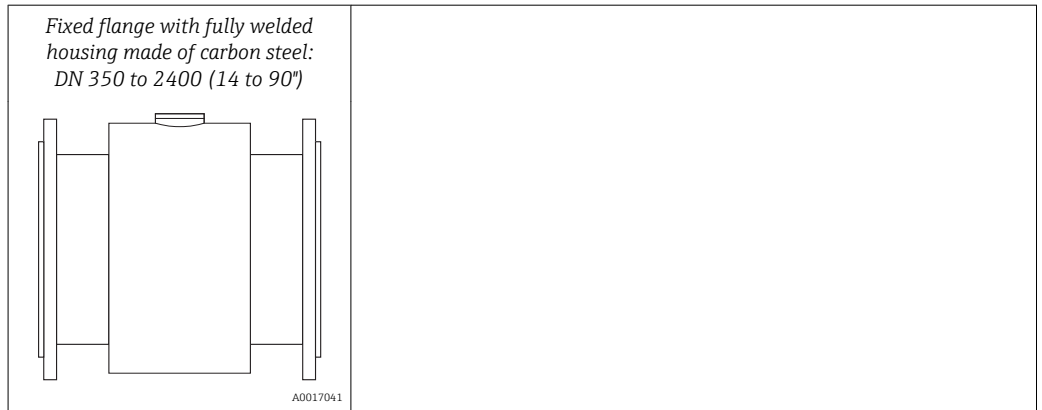

Equipment architecture

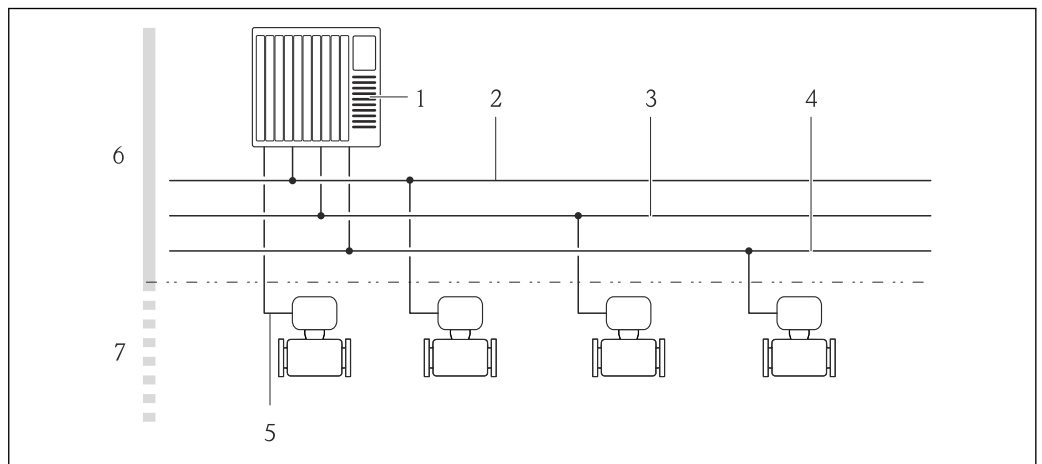

1 Possibilities for integrating measuring devices into a system

- 1 Control system (e.g. PLC)
- 2 EtherNet/IP
- 3 PROFIBUS DP
- 4 Modbus RS485
- 5 4-20 mA HART, pulse/frequency/switch output
- 6 Non-hazardous area
- 7 Non-hazardous area and Zone 2/Div. 2

Safety

IT security

Our warranty is valid only if the device is installed and used as described in the Operating Instructions. The device is equipped with security mechanisms to protect it against any inadvertent changes to the settings.

IT security measures, which provide additional protection for the device and associated data transfer, must be implemented by the operators themselves in line with their security standards.

Device-specific IT security

The device offers a range of specific functions to support protective measures on the operator's side. These functions can be configured by the user and guarantee greater in-operation safety if used correctly. An overview of the most important functions is provided in the following section.

Protecting access via hardware write protection

Write access to the device parameters via the local display or operating tool (e.g. FieldCare, DeviceCare) can be disabled via a write protection switch (DIP switch on the motherboard). When hardware write protection is enabled, only read access to the parameters is possible.

Hardware write protection is disabled when the device is delivered.

Protecting access via a password

Different passwords are available to protect write access to the device parameters or access to the device via the WLAN interface.

- **User-specific access code**
Protect write access to the device parameters via the local display, Web browser or operating tool (e.g. FieldCare, DeviceCare). Access authorization is clearly regulated through the use of a user-specific access code.
- **WLAN passphrase**
The network key protects a connection between an operating unit (e.g. notebook or tablet) and the device via the WLAN interface which can be ordered as an option.
- **Infrastructure mode**
When the device is operated in infrastructure mode, the WLAN passphrase corresponds to the WLAN passphrase configured on the operator side.

User-specific access code

Write access to the device parameters via the local display or operating tool (e.g. FieldCare, DeviceCare) can be protected by the modifiable, user-specific access code.

WLAN passphrase: Operation as WLAN access point

A connection between an operating unit (e.g. notebook or tablet) and the device via the WLAN interface, which can be ordered as an optional extra, is protected by the network key. The WLAN authentication of the network key complies with the IEEE 802.11 standard.

When the device is delivered, the network key is pre-defined depending on the device. It can be changed via the **WLAN settings** submenu in the **WLAN passphrase** parameter.

Infrastructure mode

A connection between the device and WLAN access point is protected by means of an SSID and passphrase on the system side. Please contact the relevant system administrator for access.

General notes on the use of passwords

- The access code and network key supplied with the device should be changed during commissioning.
- Follow the general rules for generating a secure password when defining and managing the access code or network key.
- The user is responsible for the management and careful handling of the access code and network key.

Access via Web server

The device can be operated and configured via a Web browser with the integrated Web server. The connection is via the service interface (CDI-RJ45) or the WLAN interface. For device versions with the EtherNet/IP and PROFINET communication protocols, the connection can also be established via the terminal connection for signal transmission with EtherNet/IP or PROFINET (RJ45 connector).

The Web server is enabled when the device is delivered. The Web server can be disabled if necessary (e.g. after commissioning) via the **Web server functionality** parameter.

The device and status information can be hidden on the login page. This prevents unauthorized access to the information.

 For detailed information on device parameters, see:
The "Description of Device Parameters" document →  98

Input

Measured variable

Direct measured variables

- Volume flow (proportional to induced voltage)
- Electrical conductivity

 In custody transfer: only volume flow

Calculated measured variables

Mass flow

Measuring range

Typically $v = 0.01$ to 10 m/s (0.03 to 33 ft/s) with the specified accuracy

Electrical conductivity: ≥ 5 $\mu\text{S/cm}$ for liquids in general

Flow characteristic values in SI units: DN 25 to 125 (1 to 4")

Nominal diameter		Recommended flow min./max. full scale value ($v \sim 0.3/10$ m/s) [dm ³ /min]	Factory settings		
[mm]	[in]		Full scale value current output ($v \sim 2.5$ m/s) [dm ³ /min]	Pulse value (~ 2 pulse/s) [dm ³]	Low flow cut off ($v \sim 0.04$ m/s) [dm ³ /min]
25	1	9 to 300	75	0.5	1
32	-	15 to 500	125	1	2
40	1 ½	25 to 700	200	1.5	3
50	2	35 to 1 100	300	2.5	5
65	-	60 to 2 000	500	5	8
80	3	90 to 3 000	750	5	12
100	4	145 to 4 700	1200	10	20
125	-	220 to 7 500	1850	15	30

Flow characteristic values in SI units: DN 150 to 2400 (6 to 90")

Nominal diameter		Recommended flow min./max. full scale value ($v \sim 0.3/10$ m/s) [m ³ /h]	Factory settings		
[mm]	[in]		Full scale value current output ($v \sim 2.5$ m/s) [m ³ /h]	Pulse value (~ 2 pulse/s) [m ³]	Low flow cut off ($v \sim 0.04$ m/s) [m ³ /h]
150	6	20 to 600	150	0.025	2.5
200	8	35 to 1 100	300	0.05	5
250	10	55 to 1 700	500	0.05	7.5
300	12	80 to 2 400	750	0.1	10
350	14	110 to 3 300	1000	0.1	15
375	15	140 to 4 200	1200	0.15	20
400	16	140 to 4 200	1200	0.15	20
450	18	180 to 5 400	1500	0.25	25
500	20	220 to 6 600	2000	0.25	30
600	24	310 to 9 600	2500	0.3	40
700	28	420 to 13 500	3500	0.5	50
750	30	480 to 15 000	4000	0.5	60
800	32	550 to 18 000	4500	0.75	75
900	36	690 to 22 500	6000	0.75	100
1000	40	850 to 28 000	7000	1	125
-	42	950 to 30 000	8000	1	125
1200	48	1 250 to 40 000	10000	1.5	150
-	54	1 550 to 50 000	13000	1.5	200
1400	-	1 700 to 55 000	14000	2	225
-	60	1 950 to 60 000	16000	2	250

Nominal diameter		Recommended flow min./max. full scale value (v ~ 0.3/10 m/s)	Factory settings		
[mm]	[in]		Full scale value current output (v ~ 2.5 m/s)	Pulse value (~ 2 pulse/s)	Low flow cut off (v ~ 0.04 m/s)
		[m ³ /h]	[m ³ /h]	[m ³]	[m ³ /h]
1600	-	2 200 to 70 000	18000	2.5	300
-	66	2 500 to 80 000	20500	2.5	325
1800	72	2 800 to 90 000	23000	3	350
-	78	3 300 to 100 000	28500	3.5	450
2000	-	3 400 to 110 000	28500	3.5	450
-	84	3 700 to 125 000	31000	4.5	500
2200	-	4 100 to 136 000	34000	4.5	540
-	90	4 300 to 143 000	36000	5	570
2400	-	4 800 to 162 000	40000	5.5	650

Flow characteristic values in SI units: DN 50 to 300 (2 to 12") for order code for "Design", option C "Fixed flange, without inlet/outlet runs"

Nominal diameter		Recommended flow min./max. full scale value (v ~ 0.12/5 m/s)	Factory settings		
[mm]	[in]		Full scale value current output (v ~ 2.5 m/s)	Pulse value (~ 4 pulse/s)	Low flow cut off (v ~ 0.01 m/s)
		[m ³ /h]	[m ³ /h]	[m ³]	[m ³ /h]
50	2	15 to 600 dm ³ /min	300 dm ³ /min	1.25 dm ³	1.25 dm ³ /min
65	-	25 to 1 000 dm ³ /min	500 dm ³ /min	2 dm ³	2 dm ³ /min
80	3	35 to 1 500 dm ³ /min	750 dm ³ /min	3 dm ³	3.25 dm ³ /min
100	4	60 to 2 400 dm ³ /min	1 200 dm ³ /min	5 dm ³	4.75 dm ³ /min
125	-	90 to 3 700 dm ³ /min	1 850 dm ³ /min	8 dm ³	7.5 dm ³ /min
150	6	145 to 5 400 dm ³ /min	2 500 dm ³ /min	10 dm ³	11 dm ³ /min
200	8	220 to 9 400 dm ³ /min	5 000 dm ³ /min	20 dm ³	19 dm ³ /min
250	10	20 to 850	500	0.03	1.75
300	12	35 to 1 300	750	0.05	2.75

Flow characteristic values in US units: 1 to 48" (DN 25 to 1200)

Nominal diameter		Recommended flow min./max. full scale value (v ~ 0.3/10 m/s)	Factory settings		
[in]	[mm]		Full scale value current output (v ~ 2.5 m/s)	Pulse value (~ 2 pulse/s)	Low flow cut off (v ~ 0.04 m/s)
		[gal/min]	[gal/min]	[gal]	[gal/min]
1	25	2.5 to 80	18	0.2	0.25
-	32	4 to 130	30	0.2	0.5
1 ½	40	7 to 185	50	0.5	0.75
2	50	10 to 300	75	0.5	1.25
-	65	16 to 500	130	1	2
3	80	24 to 800	200	2	2.5

Nominal diameter		Recommended flow min./max. full scale value (v ~ 0.3/10 m/s)	Factory settings		
			Full scale value current output (v ~ 2.5 m/s)	Pulse value (~ 2 pulse/s)	Low flow cut off (v ~ 0.04 m/s)
[in]	[mm]	[gal/min]	[gal/min]	[gal]	[gal/min]
4	100	40 to 1250	300	2	4
-	125	60 to 1950	450	5	7
6	150	90 to 2650	600	5	12
8	200	155 to 4850	1200	10	15
10	250	250 to 7500	1500	15	30
12	300	350 to 10600	2400	25	45
14	350	500 to 15000	3600	30	60
15	375	600 to 19000	4800	50	60
16	400	600 to 19000	4800	50	60
18	450	800 to 24000	6000	50	90
20	500	1000 to 30000	7500	75	120
24	600	1400 to 44000	10500	100	180
28	700	1900 to 60000	13500	125	210
30	750	2150 to 67000	16500	150	270
32	800	2450 to 80000	19500	200	300
36	900	3100 to 100000	24000	225	360
40	1000	3800 to 125000	30000	250	480
42	-	4200 to 135000	33000	250	600
48	1200	5500 to 175000	42000	400	600



Flow characteristic values in US units: 54 to 90" (DN 1400 to 2400)

Nominal diameter		Recommended flow min./max. full scale value (v ~ 0.3/10 m/s)	Factory settings		
			Full scale value current output (v ~ 2.5 m/s)	Pulse value (~ 2 pulse/s)	Low flow cut off (v ~ 0.04 m/s)
[in]	[mm]	[Mgal/d]	[Mgal/d]	[Mgal]	[Mgal/d]
54	-	9 to 300	75	0.0005	1.3
-	1400	10 to 340	85	0.0005	1.3
60	-	12 to 380	95	0.0005	1.3
-	1600	13 to 450	110	0.0008	1.7
66	-	14 to 500	120	0.0008	2.2
72	1800	16 to 570	140	0.0008	2.6
78	-	18 to 650	175	0.0010	3.0
-	2000	20 to 700	175	0.0010	2.9
84	-	24 to 800	190	0.0011	3.2
-	2200	26 to 870	210	0.0012	3.4
90	-	27 to 910	220	0.0013	3.6
-	2400	31 to 1030	245	0.0014	4.1

Flow characteristic values in US units: 2 to 12" (DN 50 to 300) for order code for "Design", option C
"Fixed flange, without inlet/outlet runs"

Nominal diameter		Recommended flow min./max. full scale value (v ~ 0.12/5 m/s)	Factory settings		
			Full scale value current output (v ~ 2.5 m/s)	Pulse value (~ 4 pulse/s)	Low flow cut off (v ~ 0.01 m/s)
[in]	[mm]	[gal/min]	[gal/min]	[gal]	[gal/min]
2	50	4 to 160	75	0.3	0.35
-	65	7 to 260	130	0.5	0.6
3	80	10 to 400	200	0.8	0.8
4	100	16 to 650	300	1.2	1.25
-	125	24 to 1000	450	1.8	2
6	150	40 to 1400	600	2.5	3
8	200	60 to 2 500	1200	5	5
10	250	90 to 3 700	1 500	6	8
12	300	155 to 5 700	2 400	9	12

Recommended measuring range

 Flow limit →  48

 For custody transfer, the applicable approval determines the permitted measuring range, the pulse value and the low flow cut off.

Operable flow range

Over 1000 : 1

 For custody transfer, the operable flow range is 100 : 1 to 630 : 1, depending on the nominal diameter. Further details are specified by the applicable approval.

Input signal

External measured values

 Various pressure transmitters and temperature measuring devices can be ordered from Endress +Hauser: see "Accessories" section →  97

It is recommended to read in external measured values to calculate the following measured variables:
Mass flow

HART protocol

The measured values are written from the automation system to the measuring device via the HART protocol. The pressure transmitter must support the following protocol-specific functions:

- HART protocol
- Burst mode

Digital communication

The measured values can be written from the automation system to the measuring via:

- PROFIBUS DP
- Modbus RS485
- EtherNet/IP

Status input

Maximum input values	<ul style="list-style-type: none"> ▪ DC 30 V ▪ 6 mA
Response time	Adjustable: 5 to 200 ms

Input signal level	<ul style="list-style-type: none"> ▪ Low signal: DC -3 to +5 V ▪ High signal: DC 12 to 30 V
Assignable functions	<ul style="list-style-type: none"> ▪ Off ▪ Reset totalizers 1-3 separately ▪ Reset all totalizers ▪ Flow override

Output

Output signal

Current output

Current output	Can be set as: <ul style="list-style-type: none"> ▪ 4-20 mA NAMUR ▪ 4-20 mA US ▪ 4-20 mA HART ▪ 0-20 mA
Maximum output values	<ul style="list-style-type: none"> ▪ DC 24 V (no flow) ▪ 22.5 mA
Load	0 to 700 Ω
Resolution	0.5 μA
Damping	Adjustable: 0.07 to 999 s
Assignable measured variables	<ul style="list-style-type: none"> ▪ Volume flow ▪ Mass flow ▪ Flow velocity ▪ Conductivity ▪ Electronic temperature

Pulse/frequency/switch output

Function	<ul style="list-style-type: none"> ▪ With the order code for "Output; Input", option H: output 2 can be set as a pulse or frequency output ▪ With the order code for "Output; Input", option I: output 2 and 3 can be set as a pulse, frequency or switch output ▪ With the order code for "Output; Input", option J: output 2 firmly assigned as certified pulse output
Version	Passive, open collector
Maximum input values	<ul style="list-style-type: none"> ▪ DC 30 V ▪ 250 mA
Voltage drop	For 25 mA: ≤ DC 2 V
Pulse output	
Pulse width	Adjustable: 0.05 to 2 000 ms
Maximum pulse rate	10 000 Impulse/s
Pulse value	Adjustable
Assignable measured variables	<ul style="list-style-type: none"> ▪ Volume flow ▪ Mass flow
Frequency output	
Output frequency	Adjustable: 0 to 12 500 Hz
Damping	Adjustable: 0 to 999 s
Pulse/pause ratio	1:1

Assignable measured variables	<ul style="list-style-type: none"> ▪ Volume flow ▪ Mass flow ▪ Conductivity ▪ Flow velocity ▪ Electronic temperature
Switch output	
Switching behavior	Binary, conductive or non-conductive
Switching delay	Adjustable: 0 to 100 s
Number of switching cycles	Unlimited
Assignable functions	<ul style="list-style-type: none"> ▪ Off ▪ On ▪ Diagnostic behavior ▪ Limit value: <ul style="list-style-type: none"> ▪ Off ▪ Volume flow ▪ Mass flow ▪ Conductivity ▪ Flow velocity ▪ Totalizer 1-3 ▪ Electronic temperature ▪ Flow direction monitoring ▪ Status <ul style="list-style-type: none"> ▪ Empty pipe detection ▪ Low flow cut off

PROFIBUS DP

Signal encoding	NRZ code
Data transfer	9.6 kBaud...12 MBaud

Modbus RS485

Physical interface	In accordance with EIA/TIA-485-A standard
Terminating resistor	Integrated, can be activated via DIP switch on the transmitter electronics module

EtherNet/IP

Standards	In accordance with IEEE 802.3
------------------	-------------------------------

Signal on alarm

Depending on the interface, failure information is displayed as follows:

Current output 4 to 20 mA

4 to 20 mA

Failure mode	<p>Choose from:</p> <ul style="list-style-type: none"> ▪ 4 to 20 mA in accordance with NAMUR recommendation NE 43 ▪ 4 to 20 mA in accordance with US ▪ Min. value: 3.59 mA ▪ Max. value: 22.5 mA ▪ Freely definable value between: 3.59 to 22.5 mA ▪ Actual value ▪ Last valid value
---------------------	---

0 to 20 mA

Failure mode	Choose from: <ul style="list-style-type: none"> ▪ Maximum alarm: 22 mA ▪ Freely definable value between: 0 to 22.5 mA
---------------------	---

HART current output

Device diagnostics	Device condition can be read out via HART Command 48
---------------------------	--

Pulse/frequency/switch output

Pulse output	
Failure mode	Choose from: <ul style="list-style-type: none"> ▪ Actual value ▪ No pulses
Frequency output	
Failure mode	Choose from: <ul style="list-style-type: none"> ▪ Actual value ▪ 0 Hz ▪ Defined value: 0 to 12 500 Hz
Switch output	
Failure mode	Choose from: <ul style="list-style-type: none"> ▪ Current status ▪ Open ▪ Closed

PROFIBUS DP

Status and alarm messages	Diagnostics in accordance with PROFIBUS PA Profile 3.02
----------------------------------	---

Modbus RS485

Failure mode	Choose from: <ul style="list-style-type: none"> ▪ NaN value instead of current value ▪ Last valid value
---------------------	---

EtherNet/IP

Device diagnostics	Device condition can be read out in Input Assembly
---------------------------	--

Local display

Plain text display	With information on cause and remedial measures
Backlight	Red backlighting indicates a device error.

 Status signal as per NAMUR recommendation NE 107

Interface/protocol

- Via digital communication:
 - HART protocol
 - PROFIBUS DP
 - Modbus RS485
 - EtherNet/IP
- Via service interface
 - CDI-RJ45 service interface
 - WLAN interface

Plain text display	With information on cause and remedial measures
---------------------------	---

 Additional information on remote operation →  87

Web browser

Plain text display	With information on cause and remedial measures
---------------------------	---

Light emitting diodes (LED)

Status information	<p>Status indicated by various light emitting diodes</p> <p>The following information is displayed depending on the device version:</p> <ul style="list-style-type: none"> ▪ Supply voltage active ▪ Data transmission active ▪ Device alarm/error has occurred ▪ EtherNet/IP network available ▪ EtherNet/IP connection established
---------------------------	---

Low flow cut off The switch points for low flow cut off are user-selectable.

Galvanic isolation The following connections are galvanically isolated from each other:

- Inputs
- Outputs
- Power supply

Protocol-specific data**HART**

Manufacturer ID	0x11
Device type ID	0x69
HART protocol revision	7
Device description files (DTM, DD)	Information and files under: www.endress.com
HART load	Min. 250 Ω

<p>Dynamic variables</p>	<p>Read out the dynamic variables: HART command 3 The measured variables can be freely assigned to the dynamic variables.</p> <p>Measured variables for PV (primary dynamic variable)</p> <ul style="list-style-type: none"> ▪ Off ▪ Volume flow ▪ Mass flow ▪ Conductivity ▪ Flow velocity ▪ Electronic temperature <p>Measured variables for SV, TV, QV (secondary, tertiary and quaternary dynamic variable)</p> <ul style="list-style-type: none"> ▪ Volume flow ▪ Mass flow ▪ Conductivity ▪ Flow velocity ▪ Electronic temperature ▪ Totalizer 1 ▪ Totalizer 2 ▪ Totalizer 3
<p>Device variables</p>	<p>Read out the device variables: HART command 9 The device variables are permanently assigned.</p> <p>A maximum of 8 device variables can be transmitted:</p> <ul style="list-style-type: none"> ▪ 0 = volume flow ▪ 1 = mass flow ▪ 2 = conductivity ▪ 3 = flow velocity ▪ 4 = electronic temperature ▪ 5 = totalizer 1 ▪ 6 = totalizer 2 ▪ 7 = totalizer 3

PROFIBUS DP

<p>Manufacturer ID</p>	<p>0x11</p>
<p>Ident number</p>	<p>0x1562</p>
<p>Profile version</p>	<p>3.02</p>
<p>Device description files (GSD, DTM, DD)</p>	<p>Information and files under:</p> <ul style="list-style-type: none"> ▪ www.endress.com ▪ www.profibus.org
<p>Output values (from measuring device to automation system)</p>	<p>Analog input 1 to 4</p> <ul style="list-style-type: none"> ▪ Mass flow ▪ Volume flow ▪ Flow velocity ▪ Conductivity ▪ Electronic temperature <p>Digital input 1 to 2</p> <ul style="list-style-type: none"> ▪ Empty pipe detection ▪ Low flow cut off ▪ Verification status <p>Totalizer 1 to 3</p> <ul style="list-style-type: none"> ▪ Mass flow ▪ Volume flow

Input values (from automation system to measuring device)	Analog output 1 (fixed assignment) External density Digital output 1 to 2 (fixed assignment) <ul style="list-style-type: none"> ▪ Digital output 1: switch positive zero return on/off ▪ Digital output 2: start verification Totalizer 1 to 3 <ul style="list-style-type: none"> ▪ Totalize ▪ Reset and hold ▪ Preset and hold ▪ Stop ▪ Operating mode configuration: <ul style="list-style-type: none"> ▪ Net flow total ▪ Forward flow total ▪ Reverse flow total
Supported functions	<ul style="list-style-type: none"> ▪ Identification & Maintenance Simplest device identification on the part of the control system and nameplate ▪ PROFIBUS upload/download Reading and writing parameters is up to ten times faster with PROFIBUS upload/download ▪ Condensed status Simplest and self-explanatory diagnostic information by categorizing diagnostic messages that occur
Configuration of the device address	<ul style="list-style-type: none"> ▪ DIP switches on the I/O electronics module ▪ Via operating tools (e.g. FieldCare)

Modbus RS485

Protocol	Modbus Applications Protocol Specification V1.1
Device type	Slave
Slave address range	1 to 247
Broadcast address range	0
Function codes	<ul style="list-style-type: none"> ▪ 03: Read holding register ▪ 04: Read input register ▪ 06: Write single registers ▪ 08: Diagnostics ▪ 16: Write multiple registers ▪ 23: Read/write multiple registers
Broadcast messages	Supported by the following function codes: <ul style="list-style-type: none"> ▪ 06: Write single registers ▪ 16: Write multiple registers ▪ 23: Read/write multiple registers
Supported baud rate	<ul style="list-style-type: none"> ▪ 1 200 BAUD ▪ 2 400 BAUD ▪ 4 800 BAUD ▪ 9 600 BAUD ▪ 19 200 BAUD ▪ 38 400 BAUD ▪ 57 600 BAUD ▪ 115 200 BAUD
Data transfer mode	<ul style="list-style-type: none"> ▪ ASCII ▪ RTU
Data access	Each device parameter can be accessed via Modbus RS485.  For detailed information on "Modbus RS485 register information", see the Description of Device Parameters → 98

EtherNet/IP

Protocol	<ul style="list-style-type: none"> ■ The CIP Networks Library Volume 1: Common Industrial Protocol ■ The CIP Networks Library Volume 2: EtherNet/IP Adaptation of CIP 		
Communication type	<ul style="list-style-type: none"> ■ 10Base-T ■ 100Base-TX 		
Device profile	Generic device (product type: 0x2B)		
Manufacturer ID	0x49E		
Device type ID	0x1067		
Baud rates	Automatic 10/100 Mbit with half-duplex and full-duplex detection		
Polarity	Auto-polarity for automatic correction of crossed Tx/D and Rx/D pairs		
Supported CIP connections	Max. 3 connections		
Explicit connections	Max. 6 connections		
I/O connections	Max. 6 connections (scanner)		
Configuration options for measuring device	<ul style="list-style-type: none"> ■ DIP switches on the electronics module for IP addressing ■ Manufacturer-specific software (FieldCare) ■ Custom Add-on Profile for Rockwell Automation control systems ■ Web browser ■ Electronic Data Sheet (EDS) integrated in the measuring device 		
Configuration of the EtherNet interface	<ul style="list-style-type: none"> ■ Speed: 10 MBit, 100 MBit, auto (factory setting) ■ Duplex: half-duplex, full-duplex, auto (factory setting) 		
Configuration of the device address	<ul style="list-style-type: none"> ■ DIP switches on the electronics module for IP addressing (last octet) ■ DHCP ■ Manufacturer-specific software (FieldCare) ■ Custom Add-on Profile for Rockwell Automation control systems ■ Web browser ■ EtherNet/IP tools, e.g. RSLinx (Rockwell Automation) 		
Device Level Ring (DLR)	No		
Fix Input			
RPI	5 ms to 10 s (factory setting: 20 ms)		
Exclusive Owner Multicast		Instance	Size [byte]
	Instance configuration:	0x68	398
	O → T configuration:	0x66	56
	T → O configuration:	0x64	32
Exclusive Owner Multicast		Instance	Size [byte]
	Instance configuration:	0x69	-
	O → T configuration:	0x66	56
	T → O configuration:	0x64	32
Input only Multicast		Instance	Size [byte]
	Instance configuration:	0x68	398
	O → T configuration:	0xC7	-
	T → O configuration:	0x64	32
Input only Multicast		Instance	Size [byte]
	Instance configuration:	0x69	-
	O → T configuration:	0xC7	-
	T → O configuration:	0x64	32

Input Assembly	<ul style="list-style-type: none"> ▪ Current device diagnostics ▪ Volume flow ▪ Mass flow ▪ Conductivity ▪ Totalizer 1 ▪ Totalizer 2 ▪ Totalizer 3 		
Configurable Input			
RPI	5 ms to 10 s (factory setting: 20 ms)		
Exclusive Owner Multicast		Instance	Size [byte]
	Instance configuration:	0x68	398
	O → T configuration:	0x66	56
	T → O configuration:	0x65	88
Exclusive Owner Multicast		Instance	Size [byte]
	Instance configuration:	0x69	-
	O → T configuration:	0x66	56
	T → O configuration:	0x65	88
Input only Multicast		Instance	Size [byte]
	Instance configuration:	0x68	398
	O → T configuration:	0xC7	-
	T → O configuration:	0x65	88
Input only Multicast		Instance	Size [byte]
	Instance configuration:	0x69	-
	O → T configuration:	0xC7	-
	T → O configuration:	0x65	88
Configurable Input Assembly	<ul style="list-style-type: none"> ▪ Volume flow ▪ Mass flow ▪ Electronic temperature ▪ Conductivity ▪ Totalizer 1 to 3 ▪ Flow velocity ▪ Volume flow unit ▪ Mass flow unit ▪ Temperature unit ▪ Conductivity unit ▪ Unit totalizer 1-3 ▪ Flow velocity unit ▪ Verification result ▪ Verification status <p> The range of options increases if the measuring device has one or more application packages.</p>		
Fix Output			
Output Assembly	<ul style="list-style-type: none"> ▪ Activation of reset totalizers 1-3 ▪ Activation of reference density compensation ▪ Reset totalizers 1-3 ▪ External density ▪ Density unit ▪ Activation verification ▪ Start verification 		

Configuration	
Configuration Assembly	<p>Only the most common configurations are listed below.</p> <ul style="list-style-type: none"> ■ Software write protection ■ Mass flow unit ■ Mass unit ■ Volume flow unit ■ Volume unit ■ Density unit ■ Conductivity ■ Temperature unit ■ Totalizer 1-3: <ul style="list-style-type: none"> ■ Assignment ■ Unit ■ Operating mode ■ Failure mode ■ Alarm delay

Power supply

Terminal assignment

Transmitter: 0-20 mA/4-20 mA HART

The sensor can be ordered with terminals.

Connection methods available		Possible options for order code "Electrical connection"
Outputs	Power supply	
Terminals	Terminals	<ul style="list-style-type: none"> ■ Option A: coupling M20x1 ■ Option B: thread M20x1 ■ Option C: thread G ½" ■ Option D: thread NPT ½"

Supply voltage

Order code "Power supply"	Terminal numbers	terminal voltage		Frequency range
Option L (wide range power unit)	1 (L+/L), 2 (L-/N)	DC 24 V	±25%	-
		AC 24 V	±25%	50/60 Hz, ±4 Hz
		AC 100 to 240 V	-15 to +10%	50/60 Hz, ±4 Hz

Signal transmission 0-20 mA/4-20 mA HART and additional outputs and inputs

Order code for "Output" and "Input"	Terminal numbers							
	Output 1		Output 2		Output 3		Input	
	26 (+)	27 (-)	24 (+)	25 (-)	22 (+)	23 (-)	20 (+)	21 (-)
Option H	<ul style="list-style-type: none"> ■ 4-20 mA HART (active) ■ 0-20 mA (active) 		Pulse/frequency output (passive)			Switch output (passive)		-
Option I	<ul style="list-style-type: none"> ■ 4-20 mA HART (active) ■ 0-20 mA (active) 		Pulse/frequency/switch output (passive)			Pulse/frequency/switch output (passive)		Status input
Option J	<ul style="list-style-type: none"> ■ 4-20 mA HART (active) ■ 0-20 mA (active) 		Permanently assigned: Pulse output adjusted (passive)			Pulse/frequency/switch output (passive)		Status input

Transmitter: PROFIBUS DP

The sensor can be ordered with terminals.

Connection methods available		Possible options for order code "Electrical connection"
Outputs	Power supply	
Terminals	Terminals	<ul style="list-style-type: none"> ▪ Option A: coupling M20x1 ▪ Option B: thread M20x1 ▪ Option C: thread G ½" ▪ Option D: thread NPT ½"

Supply voltage

Order code "Power supply"	Terminal numbers	terminal voltage		Frequency range
Option L (wide range power unit)	1 (L+/L), 2 (L-/N)	DC 24 V	±25%	–
		AC 24 V	±25%	50/60 Hz, ±4 Hz
		AC 100 to 240 V	–15 to +10%	50/60 Hz, ±4 Hz

PROFIBUS DP signal transmission

Order code for "Output" and "Input"	Terminal numbers	
	26 (RxD/TxD-P)	27 (RxD/TxD-N)
Option L	B	A
Order code for "Output": Option L: PROFIBUS DP, for use in non-hazardous areas and Zone 2/div. 2		

Transmitter: Modbus RS485

The sensor can be ordered with terminals.

Connection methods available		Possible options for order code "Electrical connection"
Outputs	Power supply	
Terminals	Terminals	<ul style="list-style-type: none"> ▪ Option A: coupling M20x1 ▪ Option B: thread M20x1 ▪ Option C: thread G ½" ▪ Option D: thread NPT ½"

Supply voltage

Order code "Power supply"	Terminal numbers	terminal voltage		Frequency range
Option L (wide range power unit)	1 (L+/L), 2 (L-/N)	DC 24 V	±25%	–
		AC 24 V	±25%	50/60 Hz, ±4 Hz
		AC 100 to 240 V	–15 to +10%	50/60 Hz, ±4 Hz

Signal transmission Modbus RS485

Order code for "Output" and "Input"	Terminal numbers	
	26 (+)	27 (-)
Option M	B	A

Transmitter: EtherNet/IP

The transmitter can be ordered with terminals or a device plug.

Connection methods available		Possible options for order code "Electrical connection"
Outputs	Power supply	
EtherNet/IP (RJ45 connector)	Terminals	Option D : thread NPT 1/2"
Device plug → 23	Terminals	<ul style="list-style-type: none"> ■ Option L: plug M12x1 + thread NPT 1/2" ■ Option N: plug M12x1 + coupling M20 ■ Option P: plug M12x1 + thread G 1/2" ■ Option U: plug M12x1 + thread M20

Supply voltage

Order code "Power supply"	Terminal numbers	terminal voltage		Frequency range
Option L (wide range power unit)	1 (L+/L), 2 (L-/N)	DC 24 V	±25%	-
		AC 24 V	±25%	50/60 Hz, ±4 Hz
		AC 100 to 240 V	-15 to +10%	50/60 Hz, ±4 Hz

EtherNet/IP signal transmission

Order code for "Output"	Connection via
Option N	EtherNet/IP: RJ45 or M12 connector

Remote version

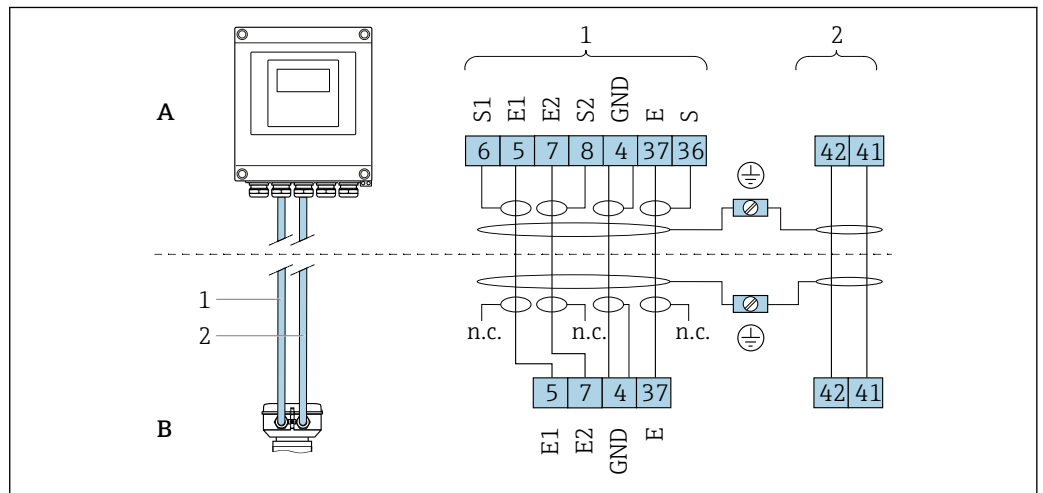

2 Remote version terminal assignment

- A Transmitter wall-mount housing
- B Sensor connection housing
- 1 Electrode cable
- 2 Coil current cable
- n.c. Not connected, insulated cable shields

Terminal No. and cable colors: 6/5 = brown; 7/8 = white; 4 = green; 36/37 = yellow

Pin assignment, device plug

Order codes for the M12x1 connectors, see the "Order code for electrical connection" column: EtherNet/IP → 23

EtherNet/IP

Device plug for signal transmission (device side)

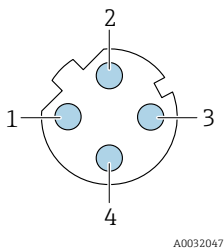
	Pin	Assignment		Coding	Plug/socket
	1	+	Tx	D	Socket
	2	+	Rx		
	3	-	Tx		
	4	-	Rx		



Recommended plug:

- Binder, series 763, part no. 99 3729 810 04
- Phoenix, part no. 1543223 SACC-M12MSD-4Q
- The device plug is not permitted in the hazardous area, Class I Division 2. The device plug may only be used in the non-hazardous area (General Purpose).

Supply voltage**Transmitter**

Order code for "Power supply"	terminal voltage		Frequency range
Option L	DC 24 V	±25%	–
	AC 24 V	±25%	50/60 Hz, ±4 Hz
	AC 100 to 240 V	–15 to +10%	50/60 Hz, ±4 Hz

Power consumption

Order code for "Output"	Maximum power consumption
Option H: 4-20mA HART, pulse/frequency/switch output, switch output	30 VA/8 W
Option I: 4-20mA HART, 2 x pulse/frequency/switch output, status input	30 VA/8 W
Option J: 4-20mA HART, certified pulse output, pulse/frequency/switch output, status input	30 VA/8 W
Option L: PROFIBUS DP	30 VA/8 W
Option M: Modbus RS485	30 VA/8 W
Option N: EtherNet/IP	30 VA/8 W

Current consumption**Transmitter**

Order code for "Power supply"	Maximum Current consumption	Maximum switch-on current
Option L: AC 100 to 240 V	145 mA	25 A (< 5 ms)
Option L: AC/DC 24 V	350 mA	27 A (< 5 ms)

Power supply failure

- Totalizers stop at the last value measured.
- Depending on the device version, the configuration is retained in the device memory or in the pluggable data memory (HistoROM DAT).
- Error messages (incl. total operated hours) are stored.

Electrical connection

Connecting the transmitter

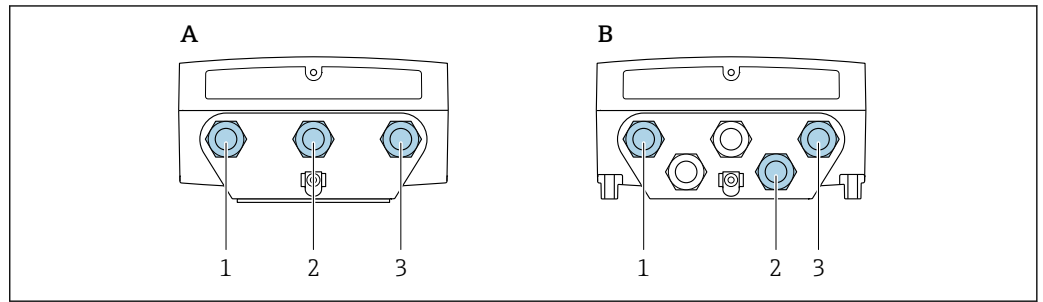

A0032041

3 Supply voltage and signal transmission connection

- A Compact version
- B Remote version wall-mount housing
- 1 Cable entry for supply voltage
- 2 Cable entry for signal transmission
- 3 Cable entry for signal transmission

Remote version connection

Connecting cable

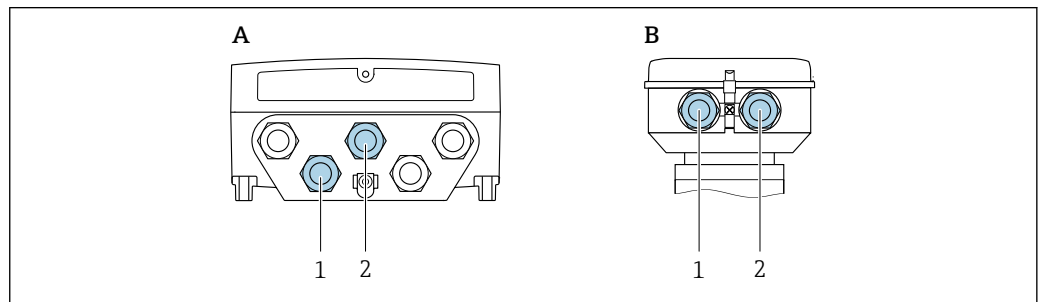

A0032042

4 Connecting cable connection: electrode and coil current cable

- A Transmitter wall-mount housing
- B Sensor connection housing
- 1 Electrode cable
- 2 Coil current cable

- Fix the cable run or route it in an armored conduit.
Cable movements can influence the measuring signal especially in the case of low fluid conductivities.
- Route the cable well clear of electrical machines and switching elements.
- Ensure potential equalization between sensor and transmitter .

Connection examples

Current output 4 to 20 mA HART

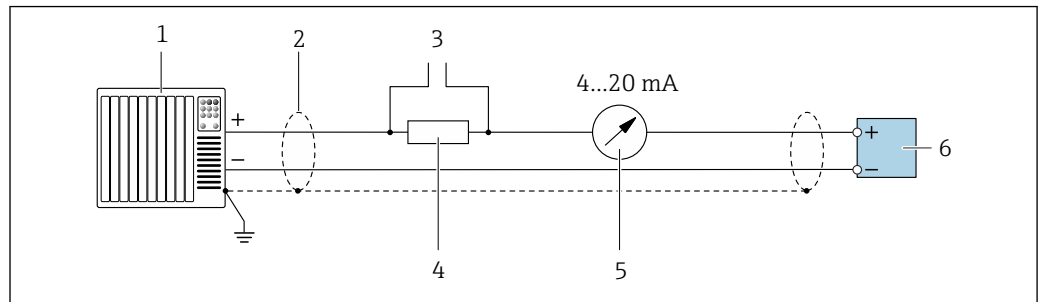

A0029055

5 Connection example for 4 to 20 mA HART current output (active)

- 1 Automation system with current input (e.g. PLC)
- 2 Cable shield provided at one end. The cable shield must be grounded at both ends to comply with EMC requirements; observe cable specifications → 31
- 3 Connection for HART operating devices → 87
- 4 Resistor for HART communication ($\geq 250 \Omega$); observe maximum load → 13
- 5 Analog display unit: observe maximum load → 13
- 6 Transmitter

Current output 4-20 mA

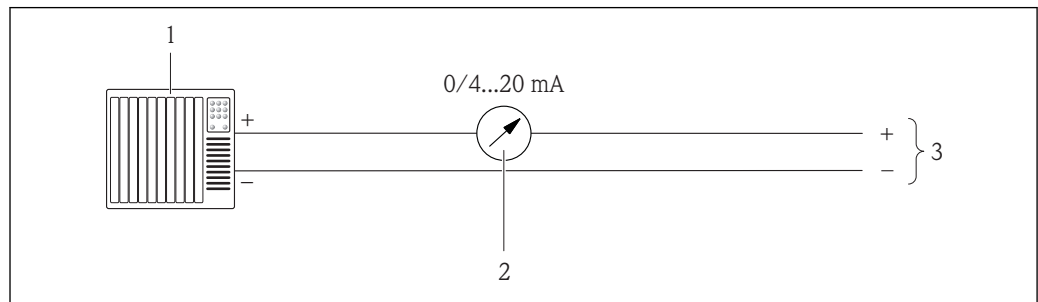

A0017162

6 Connection example for 0-20 mA current output (active) and 4-20 mA current output (active)

- 1 Automation system with current input (e.g. PLC)
- 2 Analog display unit: observe maximum load
- 3 Transmitter

Pulse/frequency output

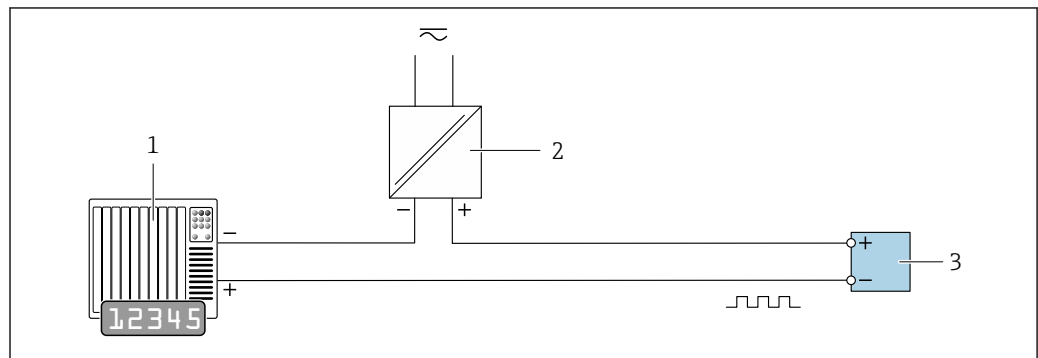

A0028761

7 Connection example for pulse/frequency output (passive)

- 1 Automation system with pulse/frequency input (e.g. PLC)
- 2 Power supply
- 3 Transmitter: Observe input values → 13

Switch output

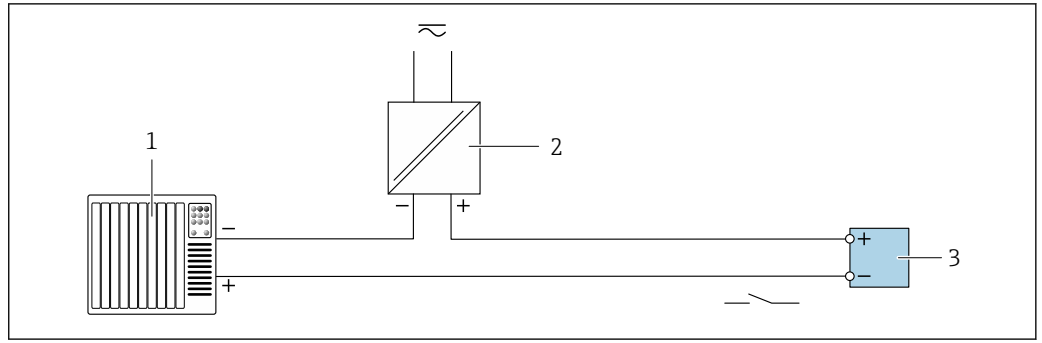

A0028760

8 Connection example for switch output (passive)

- 1 Automation system with switch input (e.g. PLC)
- 2 Power supply
- 3 Transmitter: Observe input values → 13

PROFIBUS DP

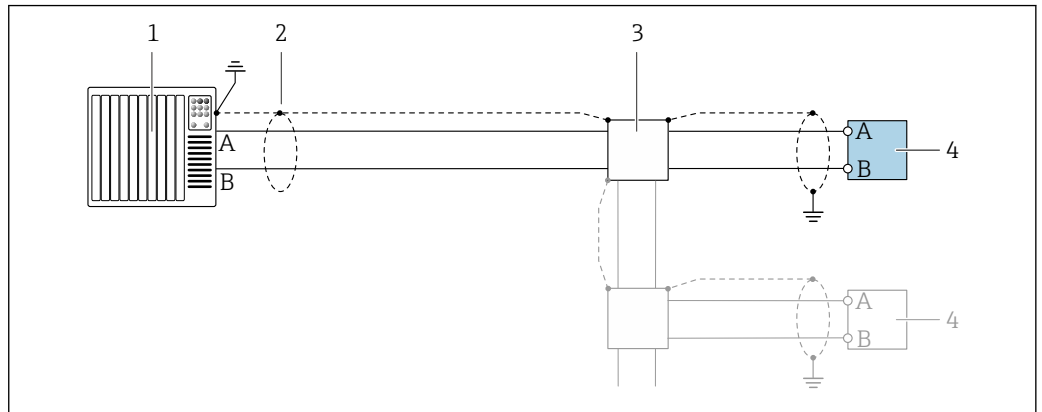

A0028765

9 Connection example for PROFIBUS DP, non-hazardous area and Zone 2/Div. 2

- 1 Control system (e.g. PLC)
- 2 Cable shield provided at one end. The cable shield must be grounded at both ends to comply with EMC requirements; observe cable specifications
- 3 Distribution box
- 4 Transmitter

i If baud rates > 1.5 MBaud an EMC cable entry must be used and the cable shield must continue as far as the terminal wherever possible.

Modbus RS485

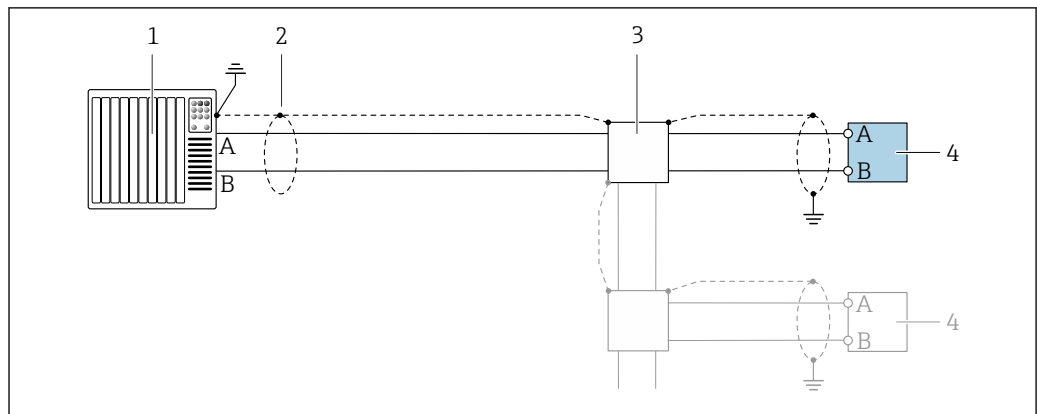

A0028765

10 Connection example for Modbus RS485, non-hazardous area and Zone 2/Div. 2

- 1 Control system (e.g. PLC)
- 2 Cable shield provided at one end. The cable shield must be grounded at both ends to comply with EMC requirements; observe cable specifications
- 3 Distribution box
- 4 Transmitter

EtherNet/IP

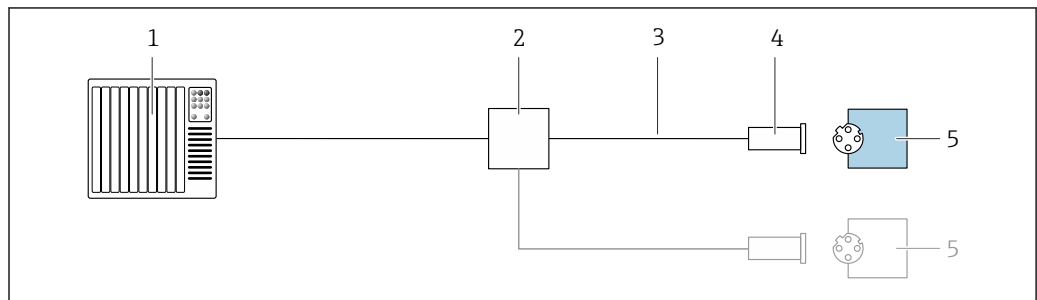

A0028767

11 Connection example for EtherNet/IP

- 1 Control system (e.g. PLC)
- 2 Ethernet switch
- 3 Observe cable specifications
- 4 Device plug
- 5 Transmitter

Status input

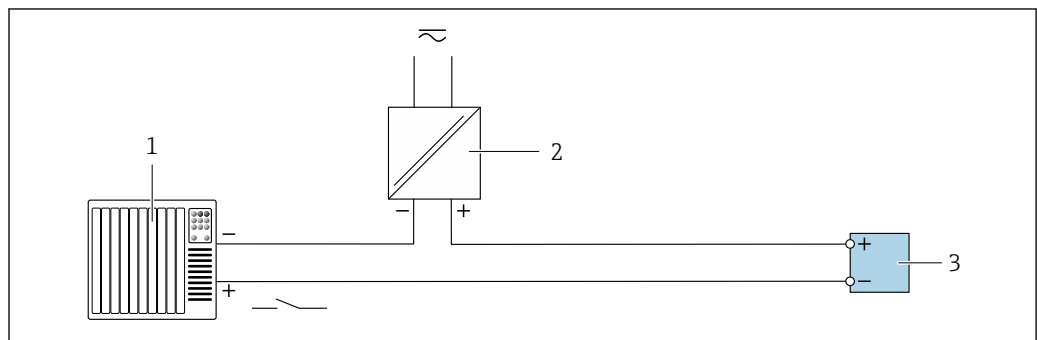

A0028764

12 Connection example for status input

- 1 Automation system with status output (e.g. PLC)
- 2 Power supply
- 3 Transmitter

Potential equalization

Requirements

Please consider the following to ensure correct measurement:

- Same electrical potential for the fluid and sensor
- Remote version: same electrical potential for the sensor and transmitter
- Company-internal grounding concepts
- Pipe material and grounding

Connection example, standard scenario

Metal, grounded pipe

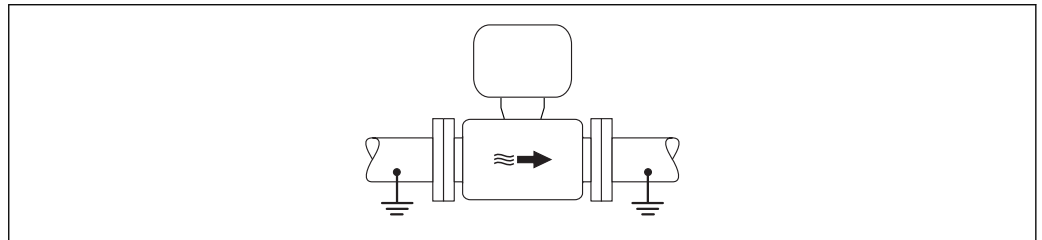

A0016315

13 Potential equalization via measuring tube

Connection example in special situations

Unlined and ungrounded metal pipe

This connection method also applies in situations where:

- The customary potential equalization is not used
- Equalizing currents are present

Ground cable	Copper wire, at least 6 mm ² (0.0093 in ²)
---------------------	---

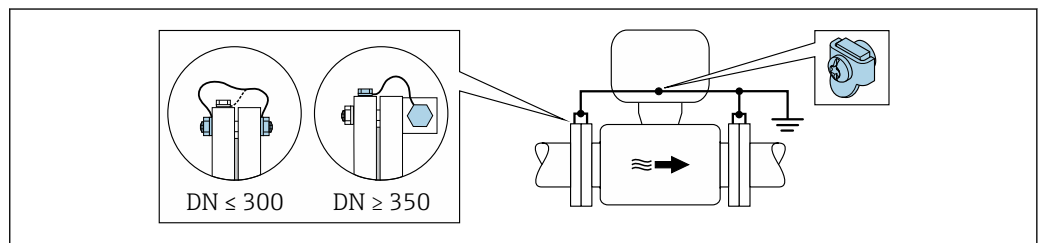

A0029338

14 Potential equalization via ground terminal and pipe flanges

Note the following when installing:

- Connect both sensor flanges to the pipe flange via a ground cable and ground them.
- Connect the connection housing of the transmitter or sensor to ground potential by means of the ground terminal provided for the purpose. To mount the ground cable:
 - If DN ≤ 300 (12"): Mount the ground cable directly on the conductive flange coating of the sensor with the flange screws.
 - If DN ≥ 350 (14"): Mount the ground cable directly on the metal transport bracket.

i For remote device versions, the ground terminal in the example always refers to the sensor and **not** to the transmitter.

i You can order the necessary ground cable from Endress+Hauser: .

Plastic pipe or pipe with insulating liner

This connection method also applies in situations where:

- The customary potential equalization is not used
- Equalizing currents are present

Ground cable	Copper wire, at least 6 mm ² (0.0093 in ²)
---------------------	---

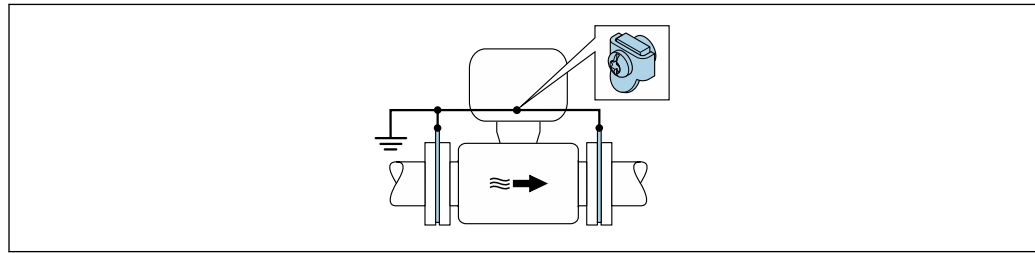

A0029339

15 Potential equalization via ground terminal and ground disks

Note the following when installing:

The ground disks must be connected to the ground terminal via the ground cable and be connected to ground potential.

For remote device versions, the ground terminal in the example always refers to the sensor and **not** to the transmitter.

The ground cable and ground disks can be ordered from Endress+Hauser → 96.

Pipe with a cathodic protection unit

This connection method is only used if the following two conditions are met:

- Metal pipe without liner or pipe with electrically conductive liner
- Cathodic protection is integrated in the personal protection equipment

Ground cable	Copper wire, at least 6 mm ² (0.0093 in ²)
---------------------	---

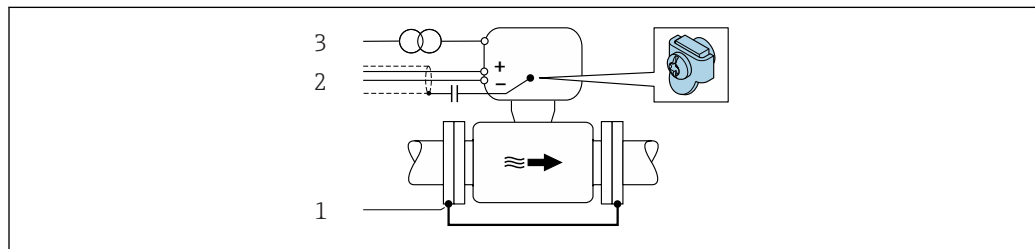

A0030377

1 Connection of the two flanges of the pipe via a ground cable

2 Signal line shielding via a capacitor

3 Measuring device connected to power supply such that it is floating in relation to the protective ground (isolation transformer)

Note the following when installing:

The sensor is installed in the pipe in a way that provides electrical insulation.

For remote device versions, the ground terminal in the example always refers to the sensor and **not** to the transmitter.

You can order the necessary ground cable from Endress+Hauser: .

terminals

Transmitter

- Supply voltage cable: plug-in spring terminals for wire cross-sections 0.5 to 2.5 mm² (20 to 14 AWG)
- Signal cable: plug-in spring terminals for wire cross-sections 0.5 to 2.5 mm² (20 to 14 AWG)
- Electrode cable: spring terminals for wire cross-sections 0.5 to 2.5 mm² (20 to 14 AWG)
- Coil current cable: spring terminals for wire cross-sections 0.5 to 2.5 mm² (20 to 14 AWG)

Sensor connection housing

Spring terminals for wire cross-sections 0.5 to 2.5 mm² (20 to 14 AWG)

Cable entries

Cable entry thread

- M20 x 1.5
- Via adapter:
 - NPT ½"
 - G ½"

Cable gland

- For standard cable: M20 × 1.5 with cable ϕ 6 to 12 mm (0.24 to 0.47 in)
- For reinforced cable: M20 × 1.5 with cable ϕ 9.5 to 16 mm (0.37 to 0.63 in)

 If metal cable entries are used, use a grounding plate.

Cable specification

Permitted temperature range

- The installation guidelines that apply in the country of installation must be observed.
- The cables must be suitable for the minimum and maximum temperatures to be expected.

Power supply cable

Standard installation cable is sufficient.

Signal cable

Current output 0/4 to 20 mA

Standard installation cable is sufficient.

Current output 4 to 20 mA HART

A shielded cable is recommended. Observe grounding concept of the plant.

Pulse/frequency/switch output

Standard installation cable is sufficient.

Status input

Standard installation cable is sufficient.

PROFIBUS DP

The IEC 61158 standard specifies two types of cable (A and B) for the bus line which can be used for every transmission rate. Cable type A is recommended.

Cable type	A
Characteristic impedance	135 to 165 Ω at a measuring frequency of 3 to 20 MHz
Cable capacitance	< 30 pF/m
Wire cross-section	> 0.34 mm ² (22 AWG)
Cable type	Twisted pairs
Loop resistance	\leq 110 Ω /km
Signal damping	Max. 9 dB over the entire length of the cable cross-section
Shield	Copper braided shielding or braided shielding with foil shield. When grounding the cable shield, observe the grounding concept of the plant.

 For further information on planning and installing PROFIBUS networks see:
 Operating Instructions "PROFIBUS DP/PA: Guidelines for planning and commissioning"
 (BA00034S)

Modbus RS485

The EIA/TIA-485 standard specifies two types of cable (A and B) for the bus line which can be used for every transmission rate. Cable type A is recommended.

Cable type	A
Characteristic impedance	135 to 165 Ω at a measuring frequency of 3 to 20 MHz
Cable capacitance	< 30 pF/m
Wire cross-section	> 0.34 mm ² (22 AWG)
Cable type	Twisted pairs
Loop resistance	\leq 110 Ω /km
Signal damping	Max. 9 dB over the entire length of the cable cross-section
Shield	Copper braided shielding or braided shielding with foil shield. When grounding the cable shield, observe the grounding concept of the plant.

EtherNet/IP

The standard ANSI/TIA/EIA-568-B.2 Annex specifies CAT 5 as the minimum category for a cable used for EtherNet/IP. CAT 5e and CAT 6 are recommended.



For more information on planning and installing EtherNet/IP networks, please refer to the "Media Planning and Installation Manual. EtherNet/IP" of ODVA Organization

Connecting cable for remote version

Electrode cable

Standard cable	3 \times 0.38 mm ² (20 AWG) with common, braided copper shield (ϕ ~9.5 mm (0.37 in)) and individual shielded cores
Cable for empty pipe detection (EPD)	4 \times 0.38 mm ² (20 AWG) with common, braided copper shield (ϕ ~9.5 mm (0.37 in)) and individual shielded cores
Conductor resistance	\leq 50 Ω /km (0.015 Ω /ft)
Capacitance: core/shield	\leq 420 pF/m (128 pF/ft)
Operating temperature	-20 to +80 $^{\circ}$ C (-4 to +176 $^{\circ}$ F)

Coil current cable

Standard cable	3 \times 0.75 mm ² (18 AWG) with common, braided copper shield (ϕ ~9 mm (0.35 in))
Conductor resistance	\leq 37 Ω /km (0.011 Ω /ft)
Capacitance: core/core, shield grounded	\leq 120 pF/m (37 pF/ft)
Operating temperature	-20 to +80 $^{\circ}$ C (-4 to +176 $^{\circ}$ F)
Test voltage for cable insulation	\leq AC 1433 V r.m.s. 50/60 Hz or \geq DC 2026 V

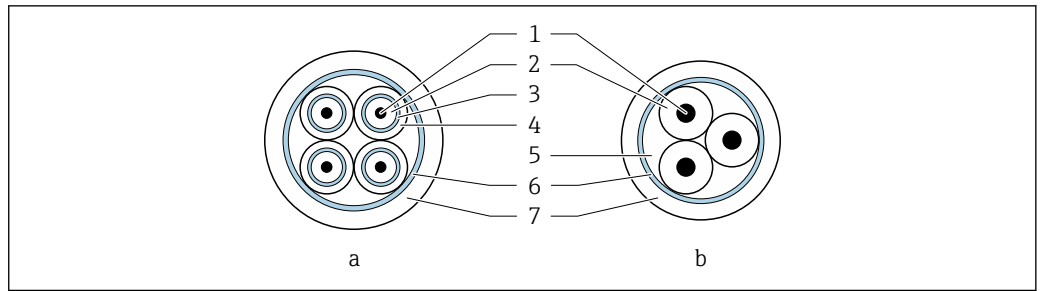

A0029151

16 Cable cross-section

- a Electrode cable
- b Coil current cable
- 1 Core
- 2 Core insulation
- 3 Core shield
- 4 Core jacket
- 5 Core reinforcement
- 6 Cable shield
- 7 Outer jacket



A connecting cable can be ordered from Endress+Hauser for IP68:

- Pre-terminated cables that are already connected to the sensor.
- Pre-terminated cables, where the cables are connected by the customer onsite (incl. tools for sealing the connection compartment)

Reinforced connecting cables

Reinforced connecting cables with an additional, reinforcing metal braid should be used:

- When laying the cable directly in the ground
- Where there is a risk of damage from rodents
- If using the device below IP68 degree of protection



Reinforced connecting cables with an additional, reinforcing metal braid can be ordered from Endress+Hauser .

Operation in areas with strong electrical interference

The measuring system meets the general safety requirements → 93 and EMC specifications → 43.

Grounding is by means of the ground terminal provided for the purpose inside the connection housing. The stripped and twisted lengths of cable shield to the ground terminal must be as short as possible.

Performance characteristics

Reference operating conditions

- Error limits following DIN EN 29104, in future ISO 20456
- Water, typically +15 to +45 °C (+59 to +113 °F); 0.5 to 7 bar (73 to 101 psi)
- Data as indicated in the calibration protocol
- Accuracy based on accredited calibration rigs according to ISO 17025

Maximum measured error

Error limits under reference operating conditions

Volume flow

- ±0.5 % o.r. ± 1 mm/s (0.04 in/s)
- Optional: ±0.2 % o.r. ± 2 mm/s (0.08 in/s)

Order code for "Design"	Installation <i>with</i> inlet and outlet runs max. measured error		Installation <i>without</i> inlet and outlet runs max. measured error
	0.5 %	0.2 %	0.5 %
Options A, B, D, E, F, G (standard)	✔	✔	not recommended
Options C, H, I (0 x DN)	✔	✔	✔

i Fluctuations in the supply voltage do not have any effect within the specified range.

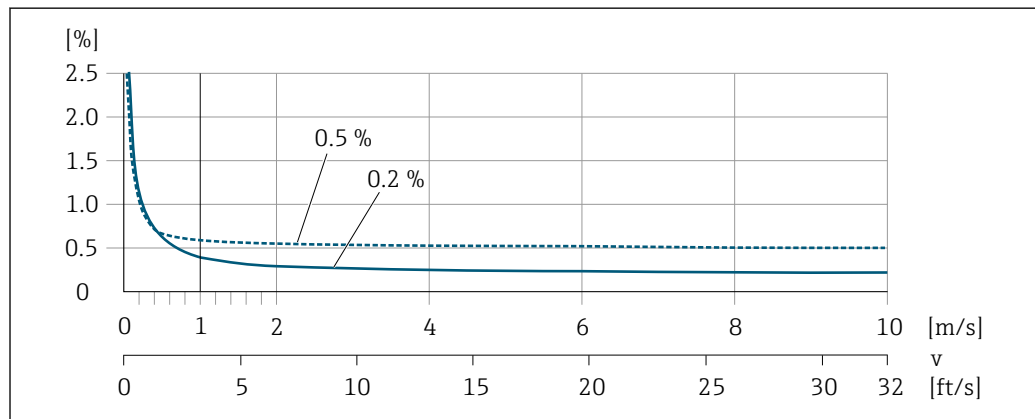

A0028974

17 Maximum measured error in % o.r.

Flat Spec

For Flat Spec in the range $v_{0.5}$ ($v_{0.2}$) up to v_{max} the measured error is constant.

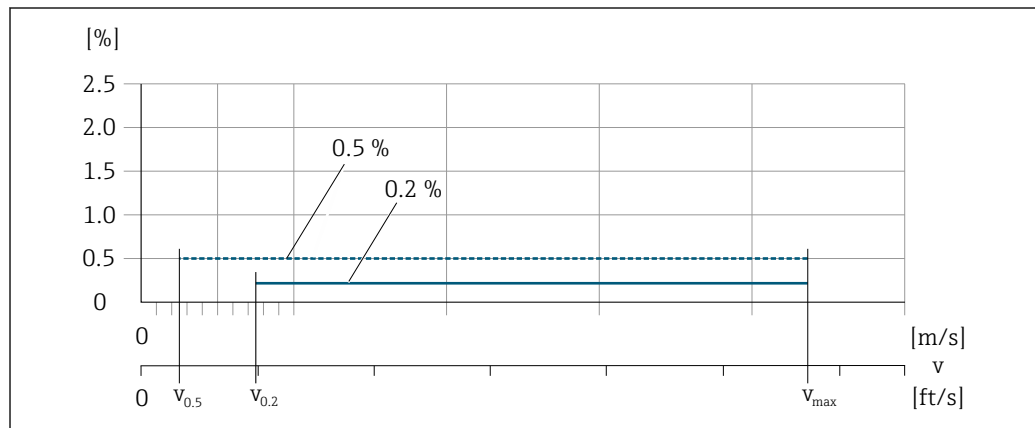

A0017051

18 Flat Spec in % o.r.

Flat Spec flow values 0.5 %

Nominal diameter		$v_{0.5}$		v_{max}	
[mm]	[in]	[m/s]	[ft/s]	[m/s]	[ft/s]
25 to 600	1 to 24	0.5	1.64	10	32
50 to 300 ¹⁾	2 to 12	0.25	0.82	5	16

1) Order code for "Design", option C

Flat Spec flow values 0.2 %

Nominal diameter		v _{0.2}		v _{max}	
[mm]	[in]	[m/s]	[ft/s]	[m/s]	[ft/s]
25 to 600	1 to 24	1.5	4.92	10	32
50 to 300 ¹⁾	2 to 12	0.6	1.97	4	13

1) Order code for "Design", option C

Electrical conductivity

Max. measured error not specified.

Accuracy of outputs

The outputs have the following base accuracy specifications.

Current output

Accuracy	Max. ±5 µA
-----------------	------------

Pulse/frequency output

o.r. = of reading

Accuracy	Max. ±50 ppm o.r. (over the entire ambient temperature range)
-----------------	---

Repeatability

o.r. = of reading

Volume flow

max. ±0.1 % o.r. ± 0.5 mm/s (0.02 in/s)

Electrical conductivity

Max. ±5 % o.r.

Influence of ambient temperature

Current output

o.r. = of reading

Temperature coefficient	Max. ±0.005 % o.r./°C
--------------------------------	-----------------------

Pulse/frequency output

Temperature coefficient	No additional effect. Included in accuracy.
--------------------------------	---

Installation

No special measures such as supports etc. are necessary. External forces are absorbed by the construction of the device.

Mounting location

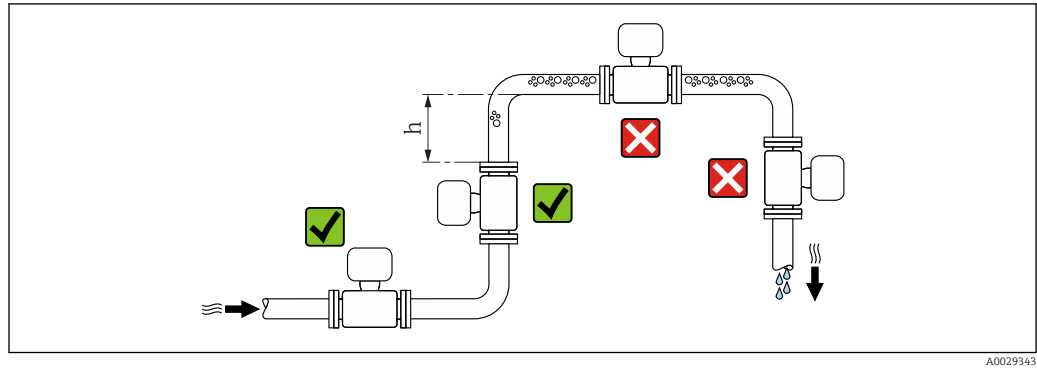

A0029343

Preferably install the sensor in an ascending pipe, and ensure a sufficient distance to the next pipe elbow: $h \geq 2 \times DN$.

i Distance $h \geq 2 \times DN$ not necessary with order code for "Design", option C, H, I.

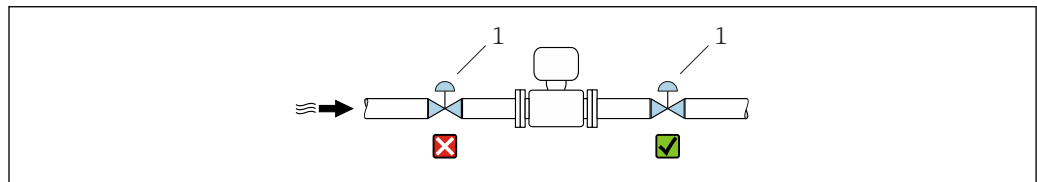

A0033017

19 Installation of the sensor after a control valve is not recommended

1 Control valve

Installation in down pipes

Install a siphon with a vent valve downstream of the sensor in down pipes whose length $h \geq 5 \text{ m}$ (16.4 ft). This precaution is to avoid low pressure and the consequent risk of damage to the measuring tube. This measure also prevents the system losing prime.

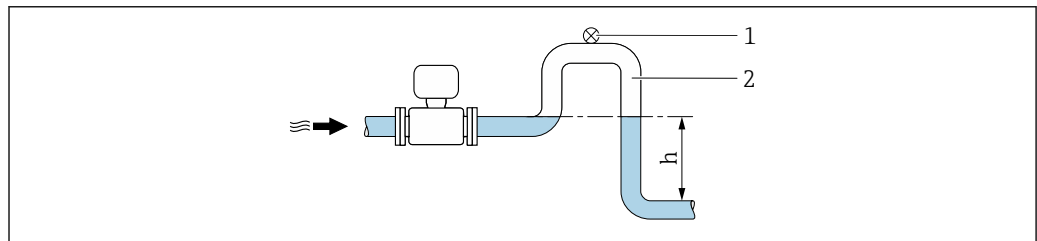

A0028981

20 Installation in a down pipe

1 Vent valve

2 Pipe siphon

h Length of down pipe

Installation in partially filled pipes

A partially filled pipe with a gradient necessitates a drain-type configuration.

i No inlet runs necessary with order code for "Design", option C, H, I

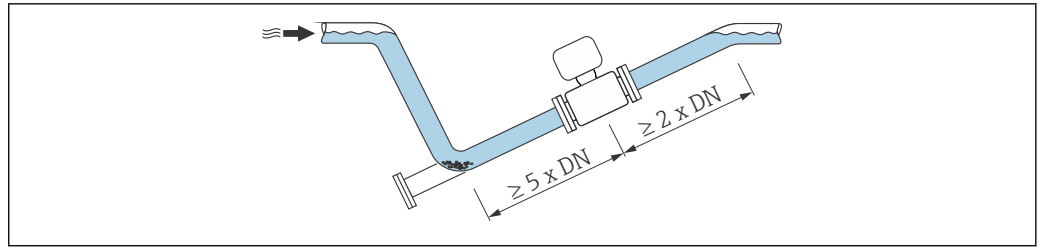

A0029257

For heavy sensors DN ≥ 350 (14")

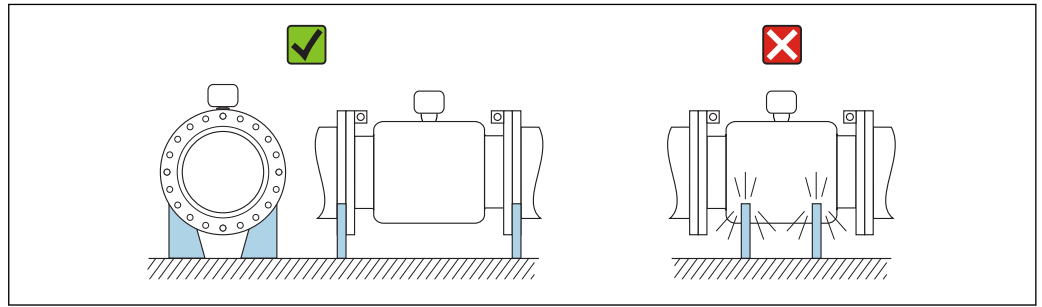

A0016276

Orientation

The direction of the arrow on the sensor nameplate helps you to install the sensor according to the flow direction (direction of medium flow through the piping).

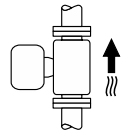
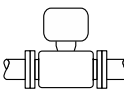
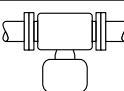
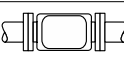
Orientation		Recommendation
A	Vertical orientation	 A0015591
B	Horizontal orientation, transmitter at top	 A0015589
C	Horizontal orientation, transmitter at bottom	 A0015590
D	Horizontal orientation, transmitter at side	 A0015592

- 1) Applications with low process temperatures may decrease the ambient temperature. To maintain the minimum ambient temperature for the transmitter, this orientation is recommended.
- 2) Applications with high process temperatures may increase the ambient temperature. To maintain the maximum ambient temperature for the transmitter, this orientation is recommended.
- 3) To prevent the electronics module from overheating in the case of a sharp rise in temperature (e.g. CIP or SIP processes), install the device with the transmitter component pointing downwards.
- 4) With the empty pipe detection function switched on: empty pipe detection only works if the transmitter housing is pointing upwards.

Horizontal

- Ideally, the measuring electrode plane should be horizontal. This prevents brief insulation of the measuring electrodes by entrained air bubbles.
- Empty pipe detection only works if the transmitter housing is pointing upwards as otherwise there is no guarantee that the empty pipe detection function will actually respond to a partially filled or empty measuring tube.

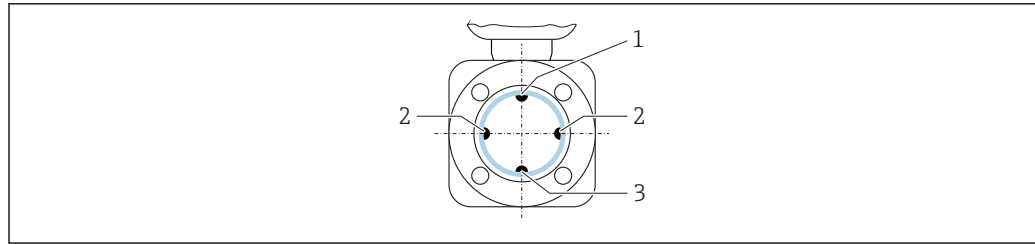

A0029344

- 1 EPD electrode for empty pipe detection
- 2 Measuring electrodes for signal detection
- 3 Reference electrode for potential equalization

Inlet and outlet runs

If possible, install the sensor upstream from fittings such as valves, T-pieces or elbows.

Observe the following inlet and outlet runs to comply with accuracy specifications:

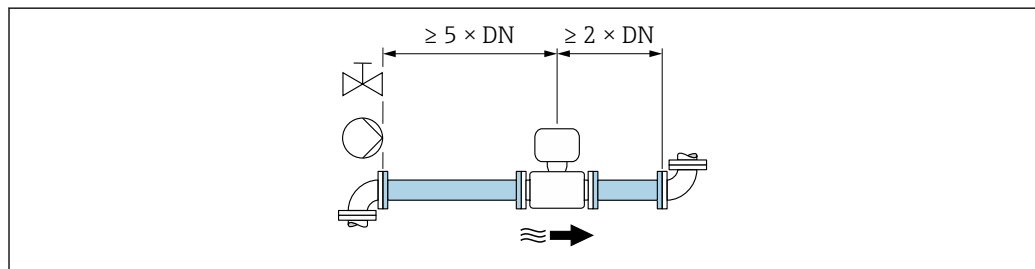

A0028997

For sensors with the order code for "Design", option C , H, I , no inlet or outlet runs need to be taken into account.

i To keep within the in-service maximum permissible errors for custody transfer no additional requirements apply with regard to the graphic illustrated above.

Adapters

Suitable adapters to DIN EN 545 (double-flange reducers) can be used to install the sensor in larger-diameter pipes. The resultant increase in the rate of flow improves measuring accuracy with very slow-moving fluids.

The nomogram shown here can be used to calculate the pressure loss caused by reducers and expanders:

- Calculate the ratio of the diameters d/D .
- From the nomogram read off the pressure loss as a function of flow velocity (downstream from the reduction) and the d/D ratio.

i The nomogram only applies to liquids with a viscosity similar to that of water.

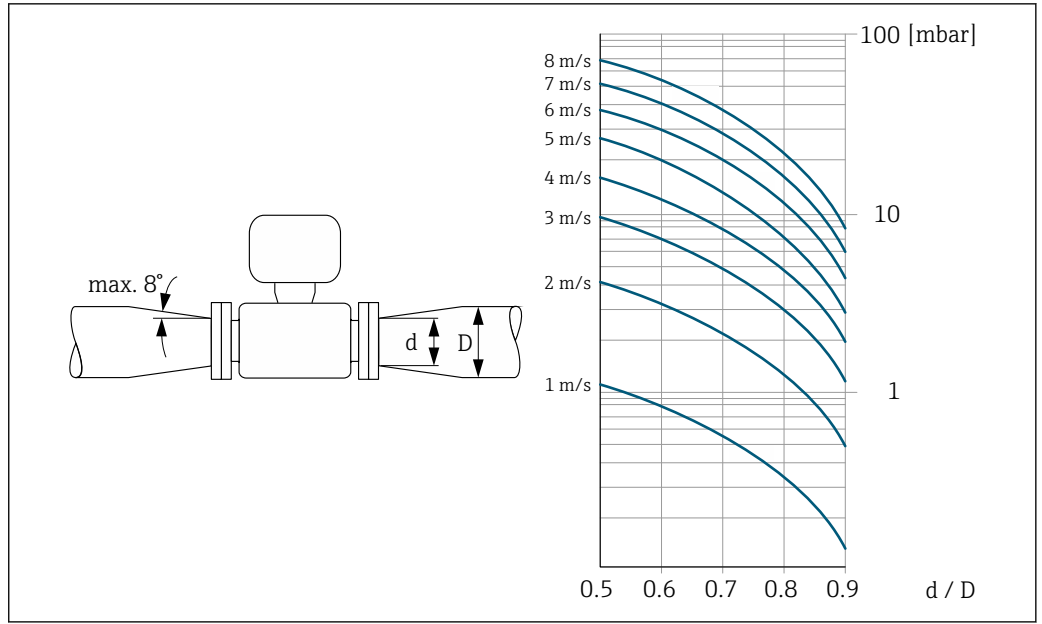

A0029002

Length of connecting cable

To obtain correct measurement results, observe the permitted connecting cable length of L_{max} . This length is determined by the conductivity of the fluid. If measuring liquids in general: 5 $\mu\text{S/cm}$

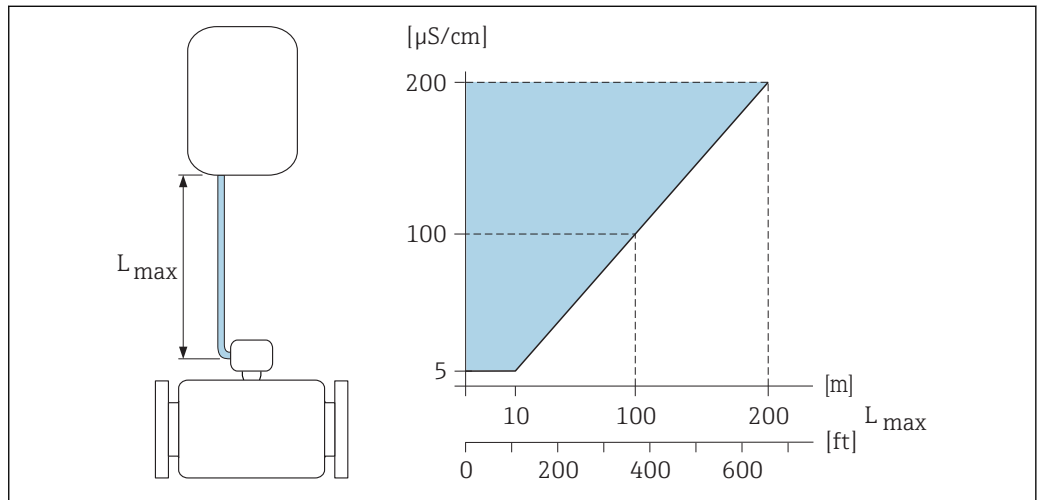

A0016539

21 Permitted length of connecting cable

Colored area = permitted range
 L_{max} = length of connecting cable in [m] ([ft])
 $\mu\text{S/cm}$ = fluid conductivity

Mounting the transmitter housing

Wall mounting

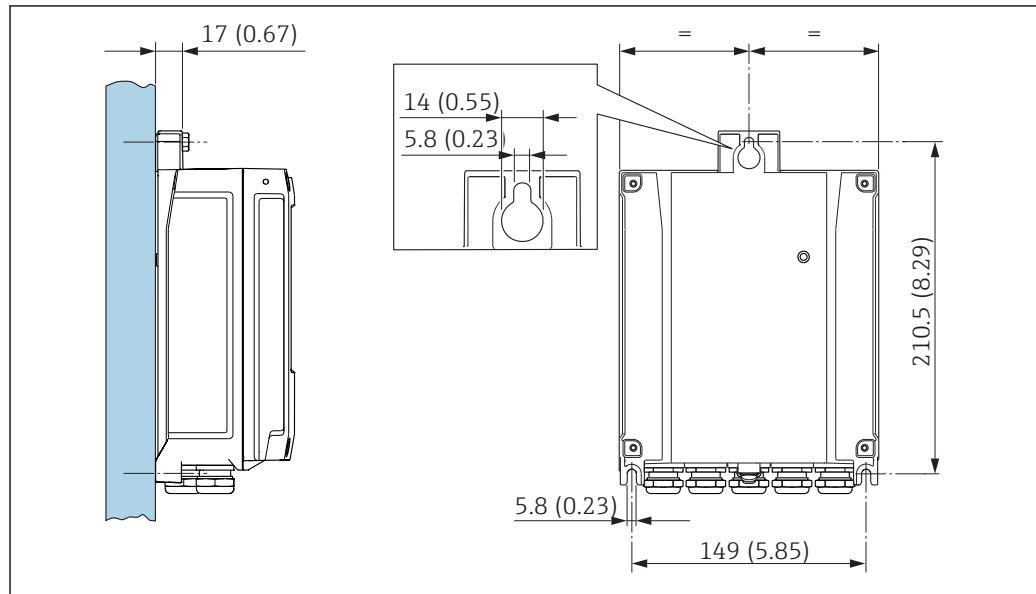

A0020523

22 Engineering unit mm (in)

Post mounting

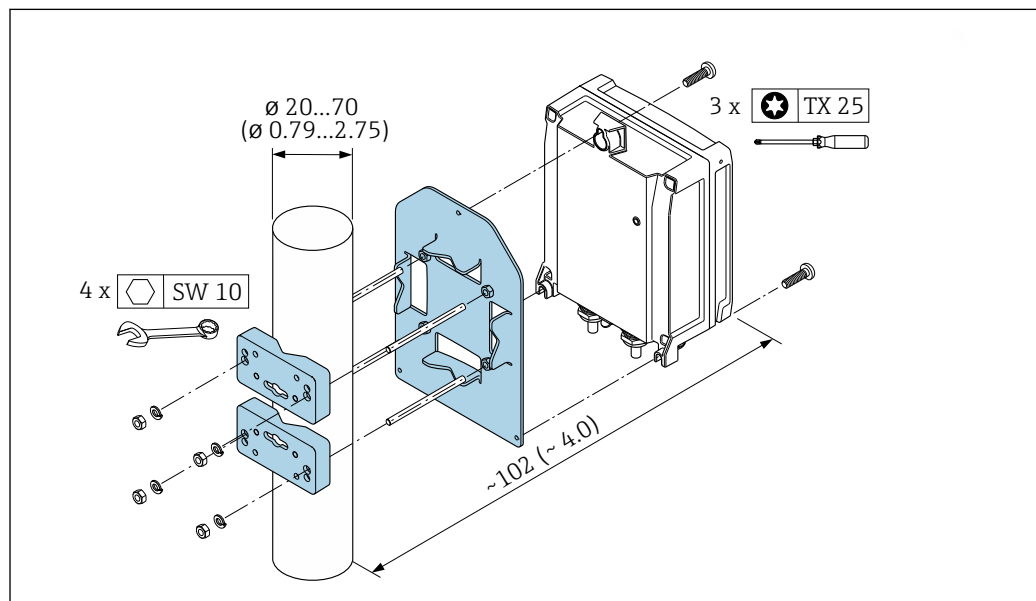

A0029051

23 Engineering unit mm (in)

Special mounting instructions

Display guard

To ensure that the optional display guard can be easily opened, maintain the following minimum head clearance: 350 mm (13.8 in)

Permanent immersion in water

A fully welded remote version with IP68 protection is optionally available for permanent immersion in water ≤ 3 m (10 ft) or in exceptional cases for use for up to 48 hours at ≤ 10 m (30 ft). The measuring device meets the requirements of corrosion categories C5-M and Im1/Im2/Im3. The fully welded design along with the connection compartment sealing system ensure that moisture cannot enter the measuring device.

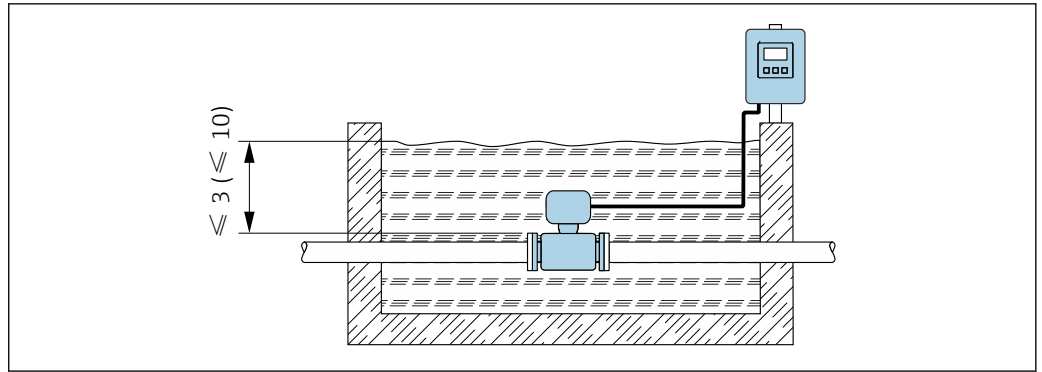

A0029320

24 Engineering unit in m(ft)

i Replacement of cable gland on connection housing

Buried applications

A remote version with IP68 protection is optionally available for buried applications. The measuring device satisfies the certified corrosion protection Im1/Im2/Im3 in accordance with EN ISO 12944. It can be used directly underground without the need for additional protective measures. The device is mounted in accordance with the usual regional installation regulations (e.g. EN DIN 1610).

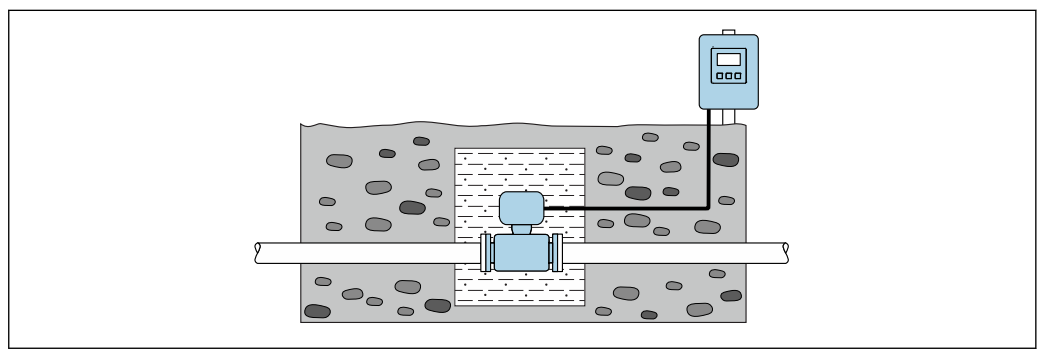



A0029321

Environment

Ambient temperature range	Transmitter	-40 to +60 °C (-40 to +140 °F)
	Local display	-20 to +60 °C (-4 to +140 °F), the readability of the display may be impaired at temperatures outside the temperature range.
	Sensor	<ul style="list-style-type: none"> ■ Process connection material, carbon steel: -10 to +60 °C (+14 to +140 °F) ■ Process connection material, stainless steel: -40 to +60 °C (-40 to +140 °F) <p>Mount the transmitter separately from the sensor if both the ambient and fluid temperatures are high.</p>
	Liner	Do not exceed or fall below the permitted temperature range of the liner .

- If operating outdoors:
- Install the measuring device in a shady location.
 - Avoid direct sunlight, particularly in warm climatic regions.
 - Avoid direct exposure to weather conditions.

- If the compact version of the device is insulated at low temperatures, the insulation must also include the device neck.
- Protect the display against impact.
- Protect the display from abrasion by sand in desert areas.

 Display guard available as an accessory →  96.

Temperature tables

 Observe the interdependencies between the permitted ambient and fluid temperatures when operating the device in hazardous areas.

 For detailed information on the temperature tables, see the separate document entitled "Safety Instructions" (XA) for the device.

Storage temperature

The storage temperature corresponds to the operating temperature range of the transmitter and the sensor →  41.

- Protect the measuring device against direct sunlight during storage in order to avoid unacceptably high surface temperatures.
- Select a storage location where moisture cannot collect in the measuring device as fungus or bacteria infestation can damage the liner.
- If protection caps or protective covers are mounted these should never be removed before installing the measuring device.

Atmosphere

If a plastic transmitter housing is permanently exposed to certain steam and air mixtures, this can damage the housing.

 In cases of doubt, please contact the Sales Center.

Degree of protection

Transmitter

- As standard: IP66/67, type 4X enclosure
- When housing is open: IP20, type 1 enclosure

Sensor

- As standard: IP66/67, type 4X enclosure
- Optionally available for compact and remote version:
IP66/67, type 4X enclosure; fully welded, with protective varnish EN ISO 12944 C5-M. Suitable for use in corrosive atmospheres.
- Optionally available for remote version:
 - IP68, type 6P enclosure; fully welded, with protective varnish as per EN ISO 12944 C5-M. Suitable for permanent immersion in water ≤ 3 m (10 ft) or up to 48 hours at depths ≤ 10 m (30 ft).
 - IP68, type 6P enclosure; fully welded, with protective varnish as per EN ISO 12944 Im1/Im2/Im3. Suitable for permanent immersion in saline water ≤ 3 m (10 ft) or up to 48 hours at depths ≤ 10 m (30 ft) or in buried applications.

Vibration- and shock-resistance

Vibration sinusoidal, in accordance with IEC 60068-2-6

Compact version; order code for "Housing", option A "Compact, alu, coated"

- 2 to 8.4 Hz, 3.5 mm peak
- 8.4 to 2 000 Hz, 1 g peak

Compact version; order code for "Housing", option M "Compact, polycarbonate"

- 2 to 8.4 Hz, 7.5 mm peak
- 8.4 to 2 000 Hz, 2 g peak

Remote version; order code for "Housing", option N "Remote, polycarbonate" and option P "Remote, alu, coated"

- 2 to 8.4 Hz, 7.5 mm peak
- 8.4 to 2 000 Hz, 2 g peak

Vibration broad-band random, according to IEC 60068-2-64

Compact version; order code for "Housing", option A "Compact, alu, coated"

- 10 to 200 Hz, 0.003 g²/Hz
- 200 to 2 000 Hz, 0.001 g²/Hz
- Total: 1.54 g rms

Compact version; order code for "Housing", option M "Compact, polycarbonate"

- 10 to 200 Hz, 0.01 g²/Hz
- 200 to 2 000 Hz, 0.003 g²/Hz
- Total: 2.70 g rms

Remote version; order code for "Housing", option N "Remote, polycarbonate" and option P "Remote, alu, coated"

- 10 to 200 Hz, 0.01 g²/Hz
- 200 to 2 000 Hz, 0.003 g²/Hz
- Total: 2.70 g rms

Shock half-sine, according to IEC 60068-2-27

- Compact version; order code for "Housing", option A "Compact, alu, coated"
6 ms 30 g
- Compact version; order code for "Housing", option M "Compact, polycarbonate"
6 ms 50 g
- Remote version; order code for "Housing", option N "Remote, polycarbonate" and option P "Remote, alu, coated"
6 ms 50 g

Rough handling shocks according to IEC 60068-2-31

Mechanical load

- Protect the transmitter housing against mechanical effects, such as shock or impact; the use of the remote version is sometimes preferable.
- Never use the transmitter housing as a ladder or climbing aid.

Electromagnetic compatibility (EMC)

- As per IEC/EN 61326 and NAMUR Recommendation 21 (NE 21)
- Complies with emission limits for industry as per EN 55011 (Class A)
- Device version with PROFIBUS DP: Complies with emission limits for industry as per EN 50170 Volume 2, IEC 61784



The following applies for PROFIBUS DP: If baud rates > 1.5 Mbaud, an EMC cable entry must be used and the cable shield must continue as far as the terminal wherever possible.



Details are provided in the Declaration of Conformity.

Process

Medium temperature range

- 0 to +80 °C (+32 to +176 °F) for hard rubber, DN 50 to 2400 (2 to 90")
- -20 to +50 °C (-4 to +122 °F) for polyurethane, DN 25 to 1200 (1 to 48")
- -20 to +90 °C (-4 to +194 °F) for PTFE, DN 25 to 300 (1 to 12")

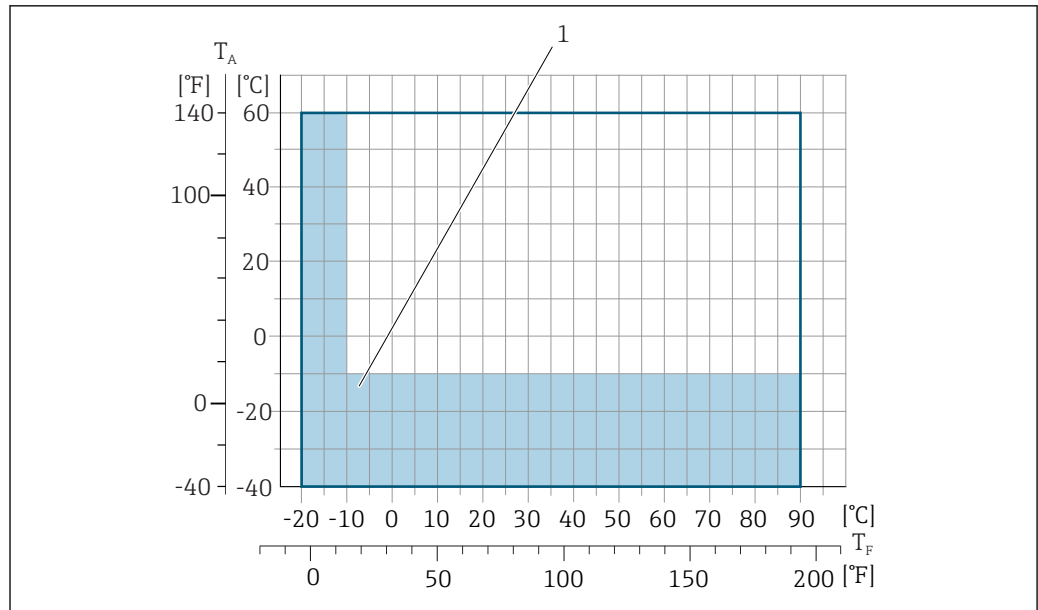

A0038130

T_A Ambient temperature range

T_F Medium temperature

1 Colored area: the ambient temperature range of -10 to -40 °C (+14 to -40 °F) and the fluid temperature range of -10 to -20 °C (+14 to -4 °F) applies to stainless flanges only

i The permitted fluid temperature in custody transfer is 0 to +50 °C (+32 to +122 °F).

Conductivity

≥ 5 μS/cm for liquids in general.

i Remote version

The necessary minimum conductivity also depends on the cable length → 39.

Pressure-temperature ratings

The following pressure/temperature diagrams apply to all pressure-bearing parts of the device and not just the process connection. The diagrams show the maximum permissible medium pressure depending on the specific medium temperature.

Process connection: fixed flange according to EN 1092-1 (DIN 2501)

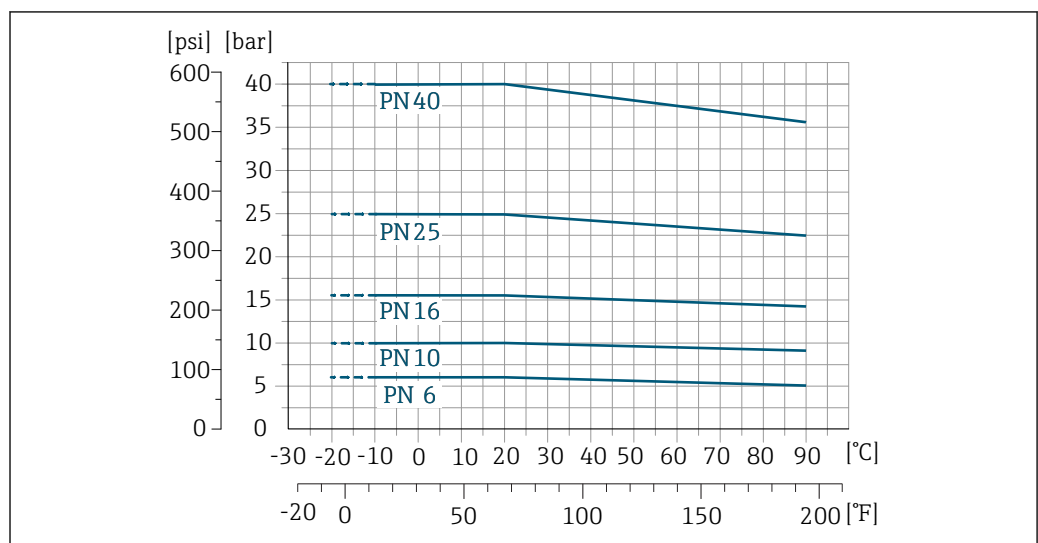

A0038122-EN

25 Process connection material: stainless steel (-20 °C (-4 °F)); carbon steel (-10 °C (14 °F))

Process connection: fixed flange according to ASME B16.5

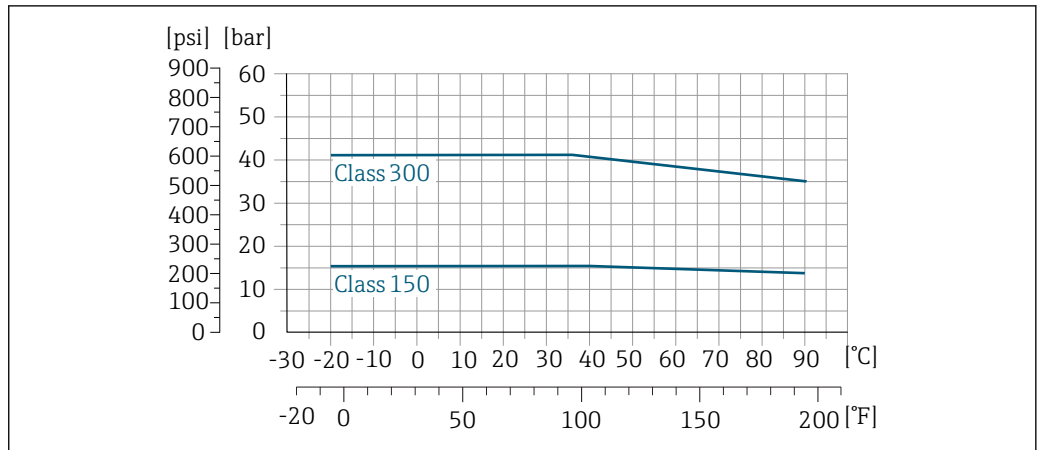

A0038123-EN

26 Process connection material: stainless steel

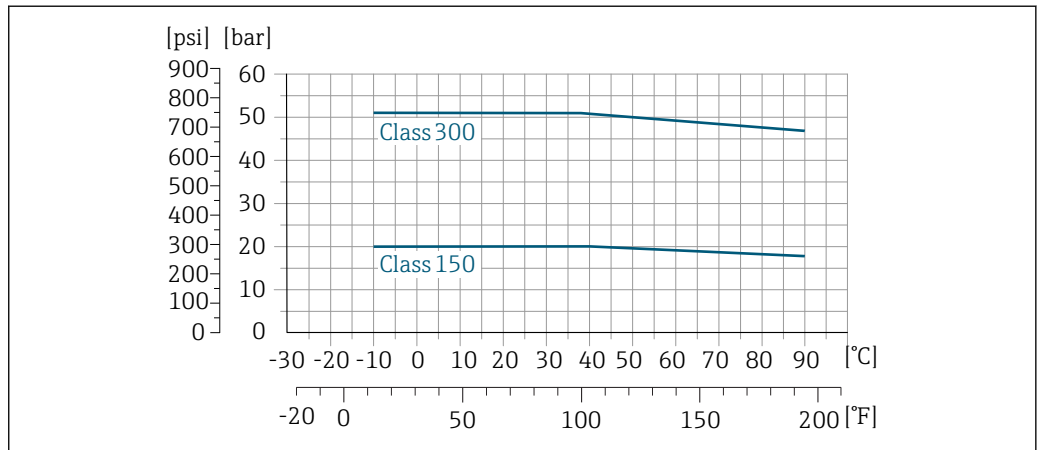

A0038124-EN

27 Process connection material: carbon steel

Process connection: fixed flange according to JIS B2220

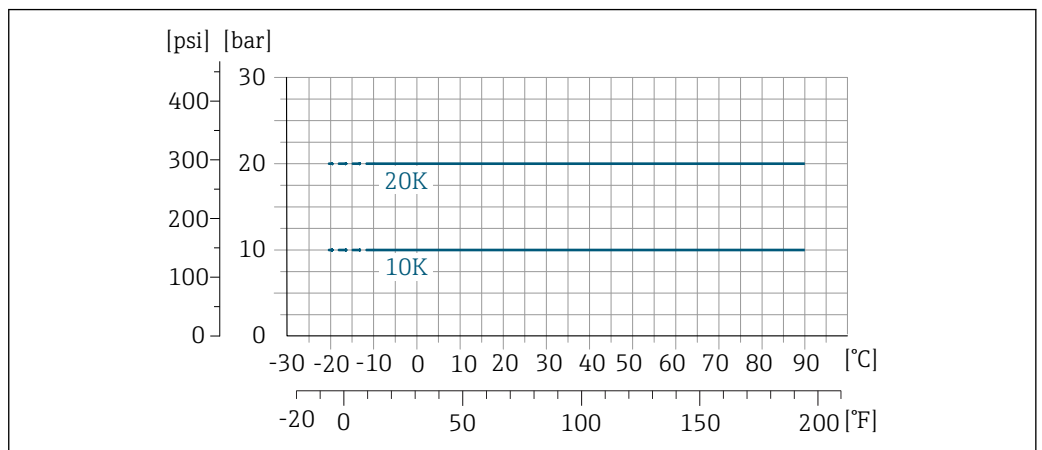

A0038124-EN

28 Process connection material: stainless steel (-20 °C (-4 °F)); carbon steel (-10 °C (14 °F))

Process connection: fixed flange according to AWWA C207

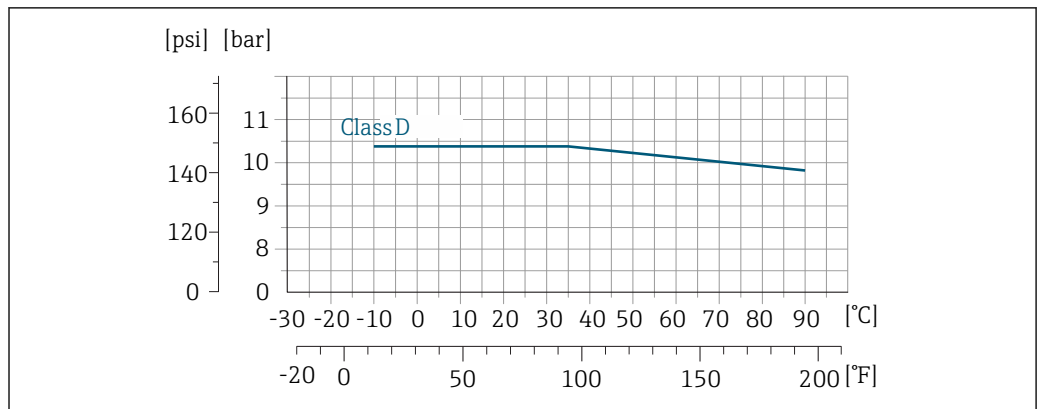

A0038126-EN

29 Process connection material: carbon steel

Process connection: fixed flange according to AS 2129

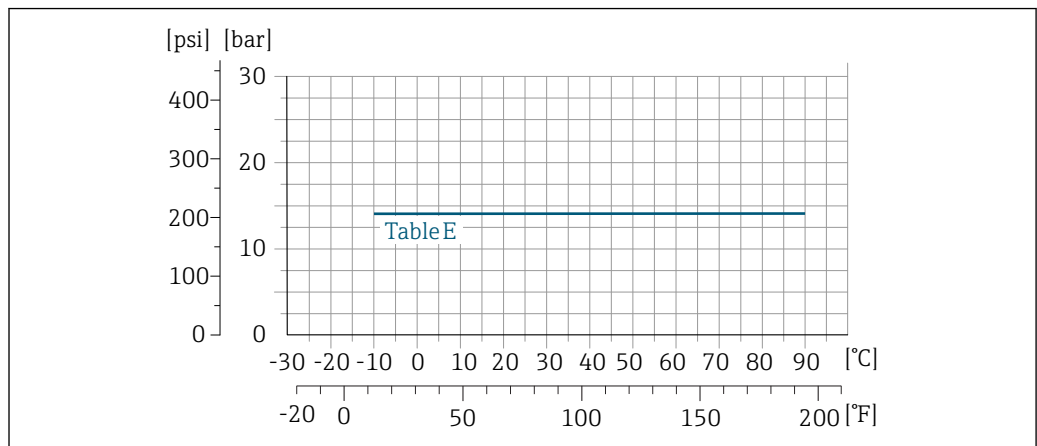

A0038127-EN

30 Process connection material: carbon steel

Process connection: fixed flange according to AS 4087

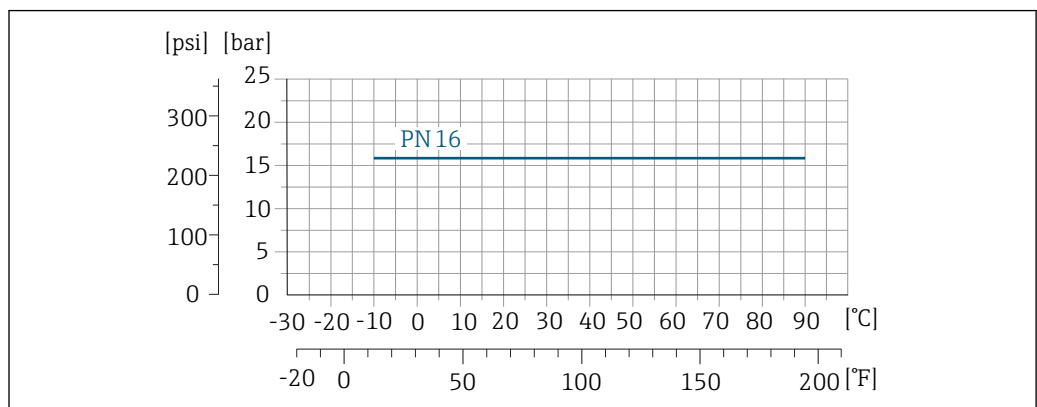

A0038128-EN

31 Process connection material: carbon steel

Process connection: lap joint flange/lap joint flange, stamped plate according to EN 1092-1 (DIN 2501) and ASME B16.5; DN 25 to 300 (1 to 12")

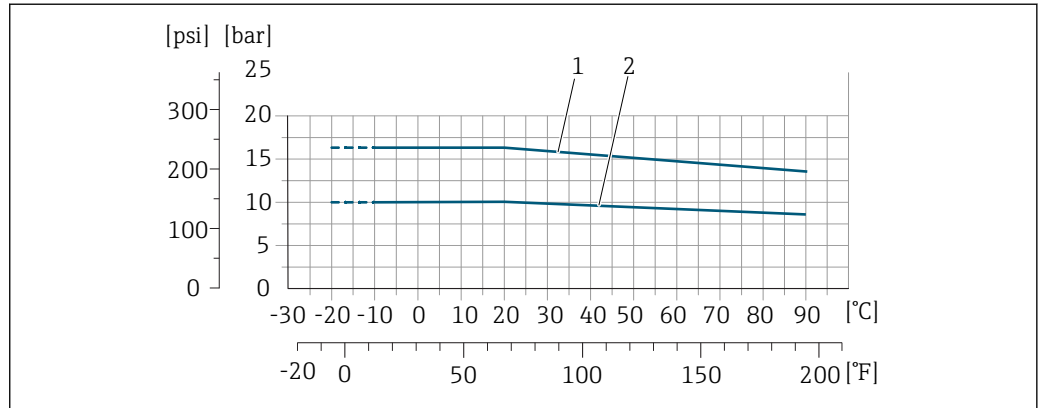

A0038129-EN

32 Process connection material: stainless steel (-20 °C (-4 °F)); carbon steel (-10 °C (14 °F))

1 Lap joint flange PN16/ Class150

2 Lap joint flange, stamped plate PN10, lap joint flange PN10

Pressure tightness

Liner: hard rubber

Nominal diameter		Limit values for absolute pressure in [mbar] ([psi]) for medium temperatures:		
[mm]	[in]	+25 °C (+77 °F)	+50 °C (+122 °F)	+80 °C (+176 °F)
50 ... 2400	2 ... 90	0 (0)	0 (0)	0 (0)

Liner: polyurethane

Nominal diameter		Limit values for absolute pressure in [mbar] ([psi]) for medium temperatures:	
[mm]	[in]	+25 °C (+77 °F)	+50 °C (+122 °F)
25 ... 1200	1 ... 48	0 (0)	0 (0)

Liner: PTFE

Nominal diameter		Limit values for absolute pressure in [mbar] ([psi]) for medium temperatures:	
[mm]	[in]	+25 °C (+77 °F)	+90 °C (+194 °F)
25	1	0 (0)	0 (0)
40	2	0 (0)	0 (0)
50	2	0 (0)	0 (0)
65	2 ½	0 (0)	40 (0.58)
80	3	0 (0)	40 (0.58)
100	4	0 (0)	135 (2.0)
125	5	135 (2.0)	240 (3.5)
150	6	135 (2.0)	240 (3.5)
200	8	200 (2.9)	290 (4.2)
250	10	330 (4.8)	400 (5.8)
300	12	400 (5.8)	500 (7.3)

Flow limit

The diameter of the pipe and the flow rate determine the nominal diameter of the sensor. The optimum velocity of flow is between 2 to 3 m/s (6.56 to 9.84 ft/s). Also match the velocity of flow (v) to the physical properties of the fluid:

- $v < 2$ m/s (6.56 ft/s): for abrasive fluids (e.g. potter's clay, lime milk, ore slurry)
- $v > 2$ m/s (6.56 ft/s): for fluids producing buildup (e.g. wastewater sludge)

i A necessary increase in the flow velocity can be achieved by reducing the sensor nominal diameter.

i For an overview of the full scale values for the measuring range, see the "Measuring range" section → [9](#)

i For custody transfer, the applicable approval determines the permitted measuring range.

Pressure loss

- No pressure loss occurs if the sensor is installed in a pipe with the same nominal diameter.
- Pressure losses for configurations incorporating adapters according to DIN EN 545 → [38](#)

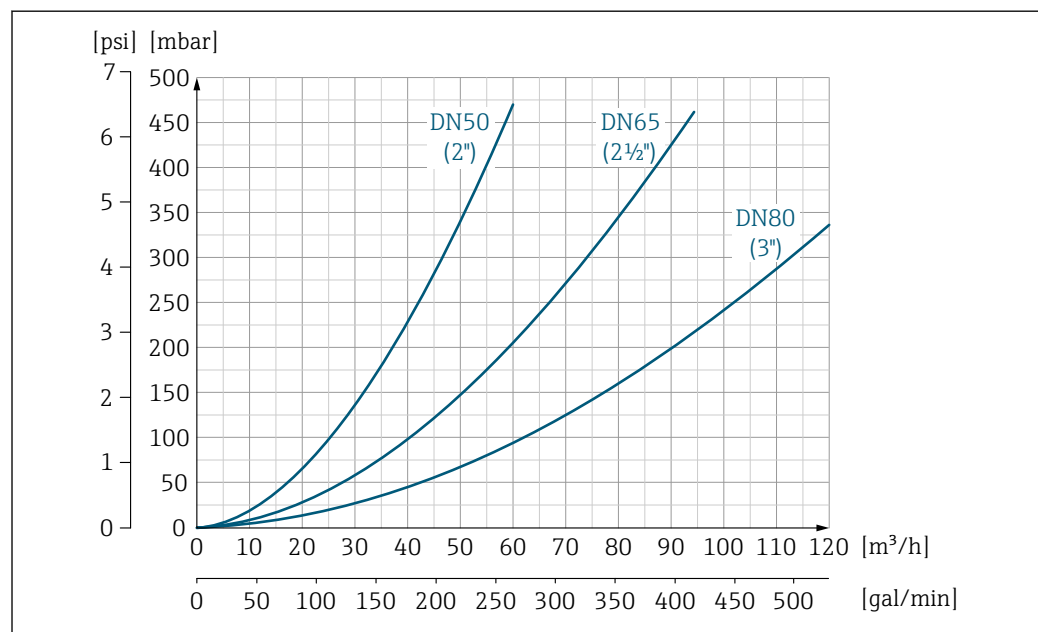

33 Pressure loss DN 50 to 80 (2 to 3") for order code for "Design", option C "fixed flange, without inlet/outlet runs"

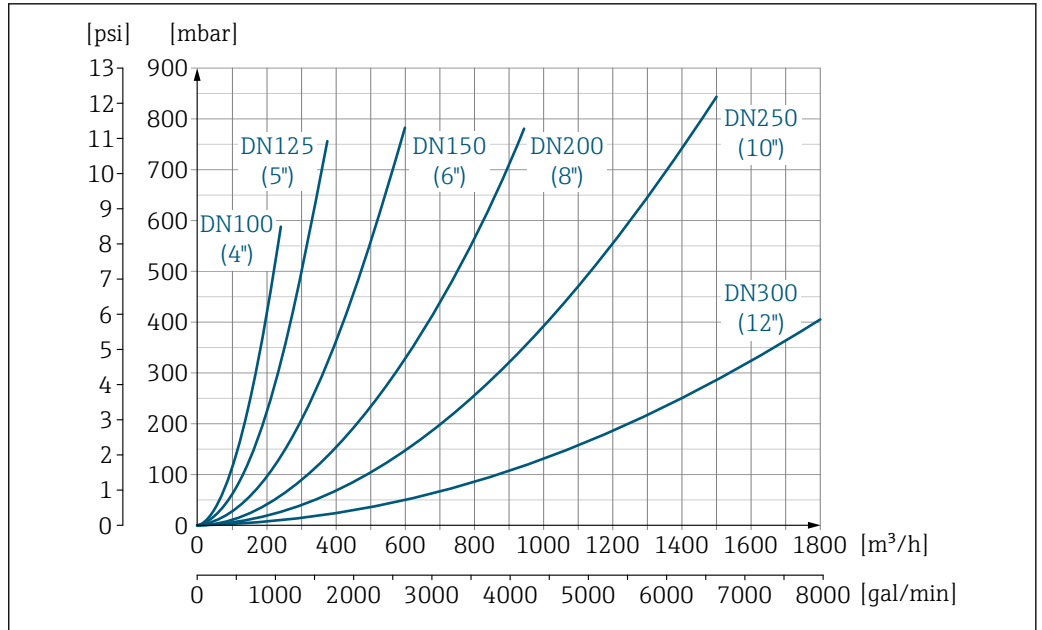

34 Pressure loss DN 100 to 300 (4 to 12") for order code for "Design", option C "fixed flange, without inlet/outlet runs"

System pressure

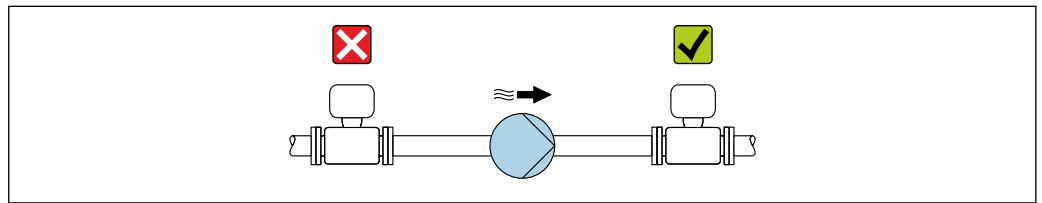

Never install the sensor on the pump suction side in order to avoid the risk of low pressure, and thus damage to the liner.

Furthermore, install pulse dampers if reciprocating, diaphragm or peristaltic pumps are used.

- Information on the liner's resistance to partial vacuum → 47
- Information on the shock resistance of the measuring system
- Information on the vibration resistance of the measuring system

Vibrations

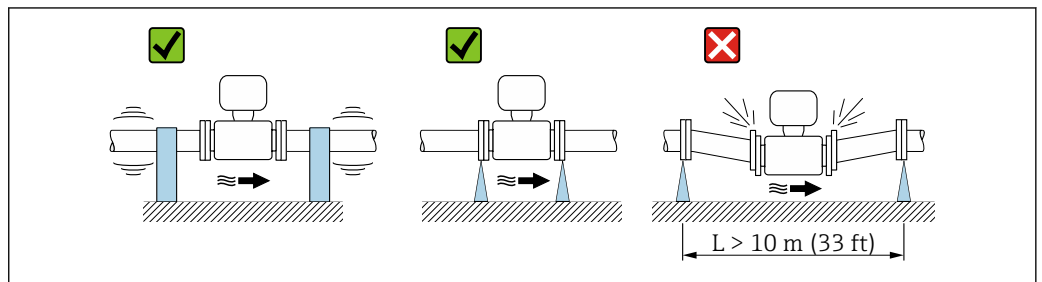

35 Measures to prevent vibration of the device

In the event of very strong vibrations, the pipe and sensor must be supported and fixed.

It is also advisable to mount the sensor and transmitter separately.

- Information on the shock resistance of the measuring system
- Information on the vibration resistance of the measuring system

Custody transfer mode

The measuring device is optionally tested in accordance with OIML R137 and has an EU type-examination certificate according to Measuring Instruments Directive 2014/32/EU for service subject to legal metrological control ("custody transfer") for cold water (Annex III).

The permitted fluid temperature in these applications is 0 to +50 °C (+32 to +122 °F).

The device is used with a legally controlled totalizer on the local display and optionally with legally controlled outputs.

Measuring devices subject to legal metrological control totalize in both directions, i.e. all the outputs consider flow components in the positive (forward) and negative (reverse) flow direction.

Generally a measuring device subject to legal metrological control is secured against tampering by seals on the transmitter or sensor. These seals may normally only be opened by a representative of the competent authority for legal metrology controls.

After putting the device into circulation or after sealing the device, operation is only possible to a limited extent.

Detailed ordering information is available from your local Endress+Hauser sales center for national approvals (outside Europe) as cold water meters based on OIML R49.

Mechanical construction

Dimensions in SI units

Compact version

Order code for "Housing", option A "Compact, aluminum, coated" or option M "Compact, polycarbonate"

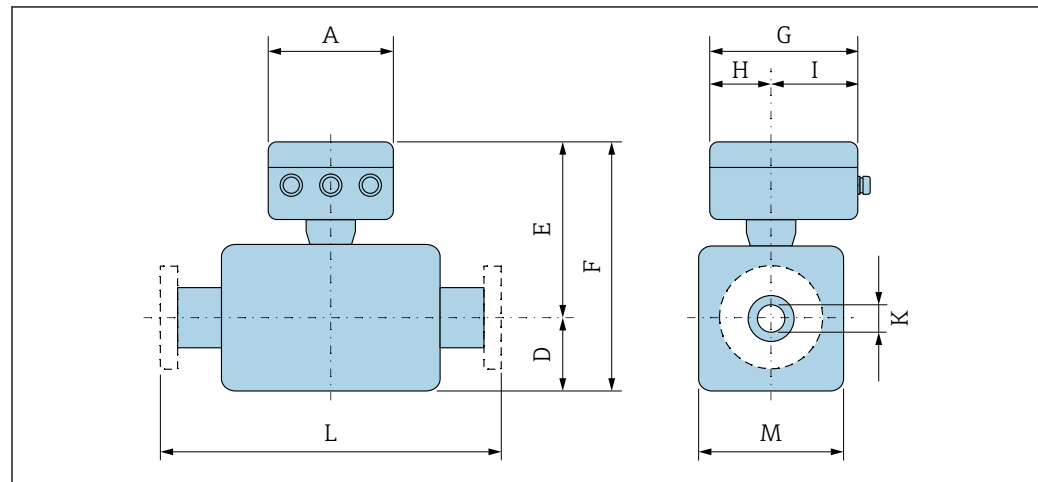

A0033790

A [mm]	G ¹⁾ [mm]	H [mm]	I ¹⁾ [mm]
167	193	90	103

1) Depending on the cable gland used: values up to + 30 mm

DN 25 to 300 (1 to 12"): sensor with aluminum half-shell housing

DN		Order code for "Design"								K	L
		Options A, D, E, H, I				Option C					
[mm]	[in]	D ¹⁾	E ^{1) 2)}	F ^{1) 2)}	M ¹⁾	D ¹⁾	E ^{1) 2)}	F ^{1) 2)}	M ¹⁾	[mm]	[mm]
25	1	84	201	285	120	-	-	-	-	³⁾	200
32	-	84	201	285	120	-	-	-	-	³⁾	200
40	1 ½	84	201	285	120	-	-	-	-	³⁾	200
50	2	84	201	285	120	84	201	285	120	³⁾	200
65	-	109	226	335	180	84	201	285	120	³⁾	200
80	3	109	226	335	180	84	201	285	120	³⁾	200
100	4	109	226	335	180	109	226	335	180	³⁾	250
125	-	150	266	416	260	109	226	335	180	³⁾	250
150	6	150	266	416	260	109	226	335	180	³⁾	300
200	8	180	291	471	324	150	266	416	260	³⁾	350
250	10	205	316	521	400	150	266	416	260	³⁾	450
300	12	230	341	571	460	180	291	471	324	³⁾	500

- 1) The dimensions are reference values. They may vary depending on the pressure rating, design and order option.
- 2) With order code for "Sensor option", option CG "Sensor extended neck for insulation": values + 110 mm
- 3) Depends on the liner → 81

DN 350 to 900 (14 to 36")

DN		Order code for "Design"								K	L	
		Options A, E, F				Option B, G						
[mm]	[in]	D ¹⁾	E ^{1) 2)}	F ^{1) 2)}	M ¹⁾	D ¹⁾	E ^{1) 2)}	F ^{1) 2)}	M ¹⁾	[mm]	[mm]	[mm]
350	14	245	412	658	490	-	-	-	-	³⁾	550	
375	15	271	438	709	542	-	-	-	-	³⁾	550	
400	16	271	438	709	542	-	-	-	-	³⁾	600	
450	18	299	466	765	598	333	450	783	666	³⁾	600 ⁴⁾	650 ⁵⁾
500	20	324	491	815	648	359	475	834	717	³⁾	600 ⁴⁾	650 ⁵⁾
600	24	365	542	907	730	411	528	939	821	³⁾	600 ⁴⁾	780 ⁵⁾
700	28	430	603	1033	860	512	630	1142	1024	³⁾	700 ⁴⁾	910 ⁵⁾
750	30	467	641	1108	934	512	630	1142	1024	³⁾	700 ⁴⁾	910 ⁵⁾
800	32	486	660	1146	972	534	650	1184	1065	³⁾	800 ⁴⁾	1040 ⁵⁾
900	36	536	710	1246	1072	610	727	1337	1218	³⁾	900 ⁴⁾	1170 ⁵⁾

- 1) The dimensions are reference values. They may be different than indicated, depending on the pressure rating, design and order code.
- 2) With order code for "Sensor option", option CG "Sensor extended neck for insulation": values + 110 mm
- 3) Depends on the liner → 81
- 4) Order code for "Design", option F "Fixed flange, short installation length"
- 5) Order code for "Design", option G "Fixed flange, long installation length"

DN 1000 to 2400 (40 to 90")

DN		D ¹⁾	E ^{1) 2)}	F ^{1) 2)}	K	L		M ¹⁾
[mm]	[in]	[mm]	[mm]	[mm]	[mm]	[mm]		[mm]
1000	40	686	803	1489	³⁾	1000 ⁴⁾	1300 ⁵⁾	1370
-	42	712	828	1540	³⁾	1050 ⁴⁾	1365 ⁵⁾	1420
1200	48	811	929	1740	³⁾	1200 ⁴⁾	1560 ⁵⁾	1620
-	54	912	1029	1941	³⁾	1350 ⁴⁾	1755 ⁵⁾	1820
1400	-	987	1104	2091	³⁾	1400 ⁴⁾	1820 ⁵⁾	1970
-	60	1011	1128	2139	³⁾	1500 ⁴⁾	1950 ⁵⁾	2018
1600	-	1056	1173	2229	³⁾	1600 ⁴⁾	2080 ⁵⁾	2108
-	66	1093	1209	2302	³⁾	1650 ⁴⁾	2145 ⁵⁾	2180
1800	72	1188	1304	2492	³⁾	1800 ⁴⁾	2340 ⁵⁾	2370
-	78	1238	1354	2592	³⁾	2000 ⁴⁾	2600 ⁵⁾	2470
2000	-	1238	1354	2592	³⁾	2000 ⁴⁾	2600 ⁵⁾	2470
-	84	1238	1354	2592	³⁾	2200 ⁴⁾		2470
2200	-	1227	1346	2573	³⁾	2200 ⁴⁾		2454
-	90	1227	1346	2573	³⁾	2400 ⁴⁾		2454
2400	-	1332	1451	2783	³⁾	2400 ⁴⁾		2664

- 1) The dimensions are reference values. They may be different than indicated, depending on the pressure rating, design and order code.
- 2) With order code for "Sensor option", option CG "Sensor extended neck for insulation": values + 110 mm
- 3) Depends on the liner → 81
- 4) Order code for "Design", option F "Fixed flange, short installation length"
- 5) Order code for "Design", option G "Fixed flange, long installation length"

Remote version

Transmitter remote version

Order code for "Housing", option N "Remote, polycarbonate" or option P "Remote, aluminum coated"

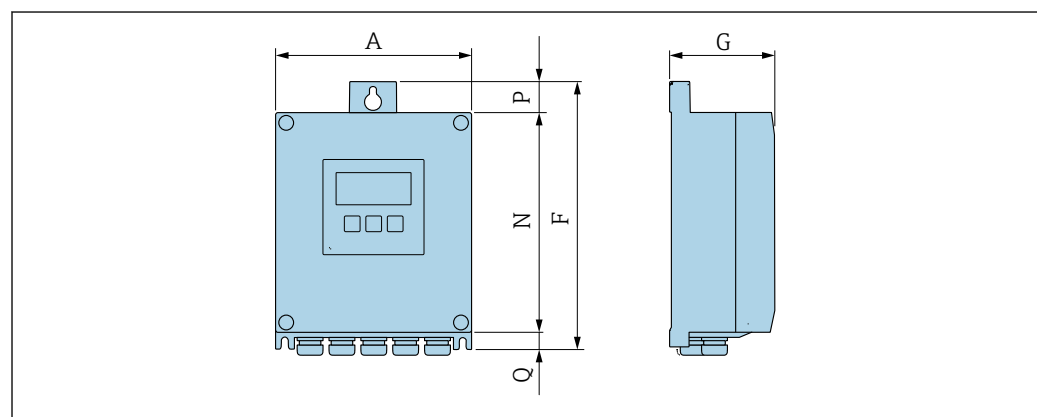

A0033789

A [mm]	F [mm]	G [mm]	N [mm]	P [mm]	Q [mm]
167	232	80	187	24	21

Sensor connection housing

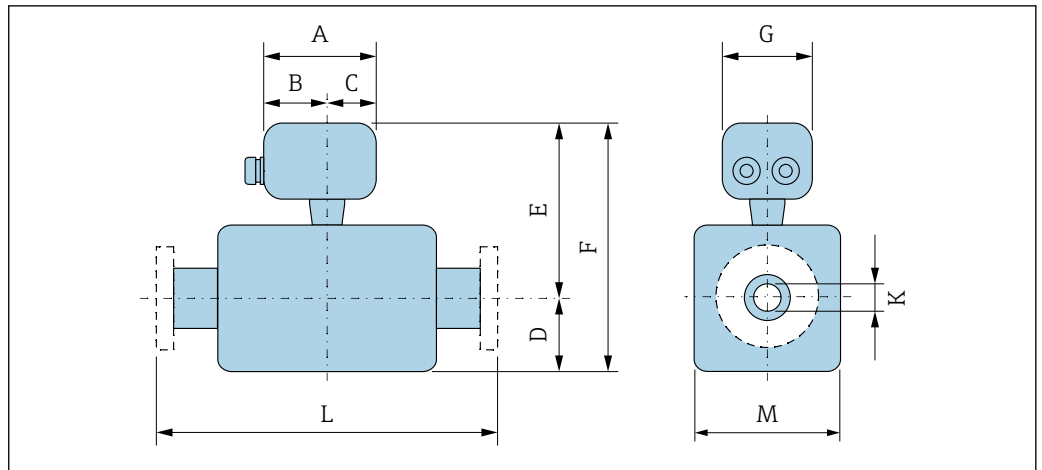

A0033784

Aluminum, coated

A [mm]	B [mm]	C [mm]	G [mm]
148	94	54	136

Polycarbonate (only in conjunction with order code for "Sensor option", options CA...CE)

A [mm]	B [mm]	C [mm]	G [mm]
113	62	51	112

DN 25 to 300 (1 to 12"): sensor with aluminum half-shell housing

DN		Order code for "Design"								K	L
[mm]	[in]	Options A, D, E, H, I				Option C				[mm]	[mm]
		D ¹⁾	E ¹⁾	F ¹⁾	M ¹⁾	D ¹⁾	E ¹⁾	F ¹⁾	M ¹⁾		
		[mm]	[mm]	[mm]	[mm]	[mm]	[mm]	[mm]	[mm]		
25	1	84	200	284	120	-	-	-	-	²⁾	200
32	-	84	200	284	120	-	-	-	-	²⁾	200
40	1 ½	84	200	284	120	-	-	-	-	²⁾	200
50	2	84	200	284	120	84	200	284	120	²⁾	200
65	-	109	225	334	180	84	200	284	120	²⁾	200
80	3	109	225	334	180	84	200	284	120	²⁾	200
100	4	109	225	334	180	109	225	334	180	²⁾	250
125	-	150	265	415	260	109	225	334	180	²⁾	250
150	6	150	265	415	260	109	225	334	180	²⁾	300
200	8	180	290	470	324	150	265	415	260	²⁾	350
250	10	205	315	520	400	150	265	415	260	²⁾	450
300	12	230	340	570	460	180	290	470	324	²⁾	500

- 1) The dimensions are reference values. They may vary depending on the pressure rating, design and order option.
- 2) Depends on the liner → 81

DN 25 to 300 (1 to 12"): sensor with fully welded carbon steel housing

DN		Order code for "Design"								K	L
		Options A, E				Option C					
		D ¹⁾	E ¹⁾	F ¹⁾	M ¹⁾	D ¹⁾	E ¹⁾	F ¹⁾	M ¹⁾		
[mm]	[in]	[mm]	[mm]	[mm]	[mm]	[mm]	[mm]	[mm]	[mm]	[mm]	[mm]
25	1	70	200	270	140	-	-	-	-	²⁾	200
32	-	70	200	270	140	-	-	-	-	²⁾	200
40	1 ½	70	200	270	140	-	-	-	-	²⁾	200
50	2	70	200	270	140	70	200	270	140	²⁾	200
65	-	82	225	307	165	70	200	270	140	²⁾	200
80	3	87	225	312	175	70	200	270	140	²⁾	200
100	4	100	225	325	200	82	225	307	165	²⁾	250
125	-	113	265	378	226	87	225	312	175	²⁾	250
150	6	134	265	399	269	100	225	325	200	²⁾	300
200	8	160	290	450	320	113	265	378	226	²⁾	350
250	10	193	315	508	387	134	265	399	269	²⁾	450
300	12	218	340	558	437	160	290	450	320	²⁾	500

- 1) The dimensions are reference values. They may vary depending on the pressure rating, design and order option.
 2) Depends on the liner →  81

DN 350 to 900 (14 to 36")

DN		Order code for "Design"								K	L	
		Options A, E, F				Option B, G						
		D ¹⁾	E ¹⁾	F ¹⁾	M ¹⁾	D ¹⁾	E ¹⁾	F ¹⁾	M ¹⁾			
[mm]	[in]	[mm]	[mm]	[mm]	[mm]	[mm]	[mm]	[mm]	[mm]	[mm]	[mm]	[mm]
350	14	245	350	595	490	-	-	-	-	²⁾	550	
375	15	271	375	646	542	-	-	-	-	²⁾	550	
400	16	271	375	646	542	-	-	-	-	²⁾	600	
450	18	299	403	702	598	333	447	780	666	²⁾	600 ³⁾	650 ⁴⁾
500	20	324	428	752	648	359	472	831	717	²⁾	600 ³⁾	650 ⁴⁾
600	24	365	479	844	730	411	525	936	821	²⁾	600 ³⁾	780 ⁴⁾
700	28	430	540	970	860	512	627	1139	1024	²⁾	700 ³⁾	910 ⁴⁾
750	30	467	578	1045	934	512	627	1139	1024	²⁾	700 ³⁾	910 ⁴⁾
800	32	486	597	1083	972	534	647	1181	1065	²⁾	800 ³⁾	1040 ⁴⁾
900	36	536	647	1183	1072	610	724	1334	1218	²⁾	900 ³⁾	1170 ⁴⁾

- 1) The dimensions are reference values. They may vary depending on the pressure rating, design and order option.
 2) Depends on the liner →  81
 3) Order code for "Design", option F "Fixed flange, short installation length"
 4) Order code for "Design", option G "Fixed flange, long installation length"

1000 ... 2400 (40 ... 90")

DN		D ¹⁾	E ¹⁾	F ¹⁾	K	L		M ¹⁾
[mm]	[in]	[mm]	[mm]	[mm]	[mm]	[mm]		[mm]
1000	40	686	800	1486	2)	1000 ³⁾	1300 ⁴⁾	1370
-	42	712	825	1537	2)	1050 ³⁾	1365 ⁴⁾	1420
1200	48	811	926	1737	2)	1200 ³⁾	1560 ⁴⁾	1620
-	54	912	1026	1938	2)	1350 ³⁾	1755 ⁴⁾	1820
1400	-	987	1101	2088	2)	1400 ³⁾	1820 ⁴⁾	1970
-	60	1011	1125	2136	2)	1500 ³⁾	1950 ⁴⁾	2018
1600	-	1056	1170	2226	2)	1600 ³⁾	2080 ⁴⁾	2108
-	66	1093	1206	2299	2)	1650 ³⁾	2145 ⁴⁾	2180
1800	72	1188	1301	2489	2)	1800 ³⁾	2340 ⁴⁾	2370
-	78	1238	1351	2589	2)	2000 ³⁾	2600 ⁴⁾	2470
2000	-	1238	1351	2589	2)	2000 ³⁾	2600 ⁴⁾	2470
-	84	1238	1351	2589	2)	2200 ³⁾		2470
2200	-	1227	1343	2570	2)	2200 ³⁾		2454
-	90	1227	1343	2570	2)	2400 ³⁾		2454
2400	-	1332	1448	2780	2)	2400 ³⁾		2664

- 1) The dimensions are reference values. They may be different than indicated, depending on the pressure rating, design and order code.
- 2) Internal diameter depends on liner, see measuring tube specification → 81
- 3) Order code for "Design", option F "Fixed flange, short installation length"
- 4) Order code for "Design", option G "Fixed flange, long installation length"

Flange connections

Fixed flange

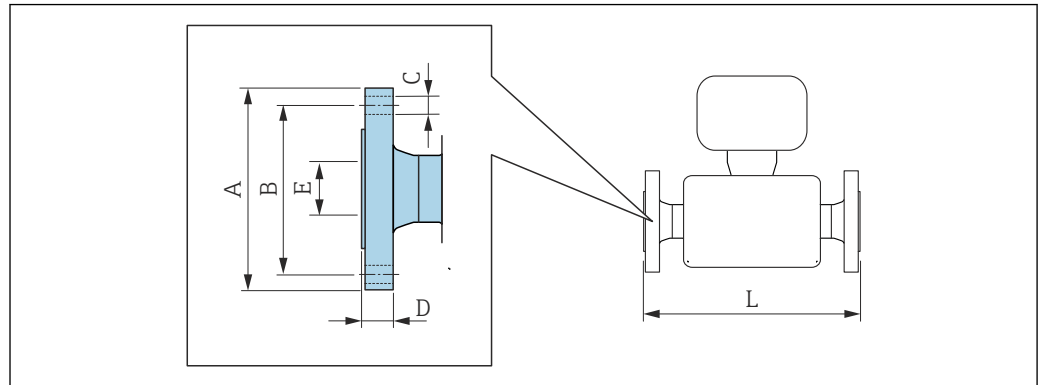

A0015621

Flange in accordance with EN 1092-1 (DIN 2501 / DIN 2512N): PN 6

Carbon steel: order code for "Process connection", option D1K

Stainless steel: order code for "Process connection", option D1S

DN [mm]	A [mm]	B [mm]	C [mm]	D [mm]	E [mm]	L [mm]
350	490	445	12 × Ø22	22	1)	2)
400	540	495	16 × Ø22	22		
450	595	565	20 × Ø26	26		
500	645	600	20 × Ø22	24		
600	755	705	20 × Ø26	30		
700	860	810	24 × Ø26	30		
800	975	920	24 × Ø30	30		
900	1075	1020	24 × Ø30	34		
1000	1175	1120	28 × Ø30	38		
1200	1405	1340	32 × Ø33	42		
1400	1630	1560	36 × Ø36	56		
1600	1830	1760	40 × Ø36	63		
1800	2045	1970	44 × Ø39	69		
2000	2265	2180	48 × Ø42	74		
2200	2475	2390	52 × Ø42	81		
2400	2685	2600	56 × Ø42	87		

Surface roughness (flange): EN 1092-1 Form B1 (DIN 2526 Form C), Ra 6.3 to 12.5 µm

1) Depends on the liner → 81

2) Total length is independent of the process connections. Length according to DVGW (German Technical and Scientific Association for Gas and Water) → 50 (compact version) → 53 (remote version)

Flange in accordance with EN 1092-1 (DIN 2501 / DIN 2512N): PN 10						
Carbon steel: order code for "Process connection", option D2K						
Stainless steel: order code for "Process connection", option D2S						
DN	A	B	C	D	E	L
[mm]	[mm]	[mm]	[mm]	[mm]	[mm]	[mm]
200	340	295	8 × Ø22	26	1)	2)
250	395	350	12 × Ø22	28		
300	445	400	12 × Ø22	28		
350	505	460	16 × Ø22	26		
400	565	515	16 × Ø26	26		
450	615	565	20 × Ø26	26		
500	670	620	20 × Ø26	28		
600	780	725	20 × Ø30	30		
700	895	840	24 × Ø30	35		
800	1015	950	24 × Ø33	38		
900	1115	1050	28 × Ø33	38		
1000	1230	1160	28 × Ø36	44		
1200	1455	1380	32 × Ø39	55		
1400	1675	1590	36 × Ø42	65		
1600	1915	1820	40 × Ø48	75		
1800	2115	2020	44 × Ø48	85		
2000	2325	2230	48 × Ø48	90		
2200	2550	2440	52 × Ø56	100		
2400	2760	2650	56 × Ø56	110		

Surface roughness (flange): EN 1092-1 Form B1 (DIN 2526 Form C), Ra 6.3 to 12.5 µm

- 1) Depends on the liner → 81
- 2) Total length is independent of the process connections. Length according to DVGW (German Technical and Scientific Association for Gas and Water) → 50 (compact version) → 53 (remote version)

Flange in accordance with EN 1092-1 (DIN 2501 / DIN 2512N): PN 16						
Carbon steel: order code for "Process connection", option D3K						
Stainless steel: order code for "Process connection", option D3S						
DN	A	B	C	D	E	L
[mm]	[mm]	[mm]	[mm]	[mm]	[mm]	[mm]
65	185	145	8 × Ø18	20	1)	2)
80	200	160	8 × Ø18	20		
100	220	180	8 × Ø18	22		
125	250	210	8 × Ø18	24		
150	285	240	8 × Ø22	24		
200	340	295	12 × Ø22	26		
250	405	355	12 × Ø26	32		
300	460	410	12 × Ø26	32		
350	520	470	16 × Ø26	30		
400	580	525	16 × Ø30	32		
450	640	585	20 × Ø30	34		
500	715	650	20 × Ø33	36		

Flange in accordance with EN 1092-1 (DIN 2501 / DIN 2512N): PN 16						
Carbon steel: order code for "Process connection", option D3K						
Stainless steel: order code for "Process connection", option D3S						
DN [mm]	A [mm]	B [mm]	C [mm]	D [mm]	E [mm]	L [mm]
600	840	770	20 × Ø36	40		
700	910	840	24 × Ø36	40		
800	1025	950	24 × Ø39	41		
900	1125	1050	28 × Ø39	48		
1000	1255	1170	28 × Ø42	59		
1200	1485	1390	32 × Ø48	78		
1400	1685	1590	36 × Ø48	84		
1600	1930	1820	40 × Ø56	102		
1800	2130	2020	44 × Ø56	110		
2000	2345	2230	48 × Ø62	124		
Surface roughness (flange): EN 1092-1 Form B1 (DIN 2526 Form C), Ra 6.3 to 12.5 µm						

- 1) Depends on the liner → 81
- 2) Total length is independent of the process connections. Length according to DVGW (German Technical and Scientific Association for Gas and Water) → 50 (compact version) → 53 (remote version)

Flange in accordance with EN 1092-1 (DIN 2501 / DIN 2512N): PN 25						
Carbon steel: order code for "Process connection", option D4K						
Stainless steel: order code for "Process connection", option D4S						
DN [mm]	A [mm]	B [mm]	C [mm]	D [mm]	E [mm]	L [mm]
200	360	310	12 × Ø26	32	1)	2)
250	425	370	12 × Ø30	36		
300	485	430	16 × Ø30	40		
350	555	490	16 × Ø33	38		
400	620	550	16 × Ø36	40		
450	670	600	20 × Ø36	46		
500	730	660	20 × Ø36	48		
600	845	770	20 × Ø39	48		
700	960	875	24 × Ø42	50		
800	1085	990	24 × Ø48	53		
900	1185	1090	28 × Ø48	57		
1000	1320	1210	28 × Ø56	63		
Surface roughness (flange): EN 1092-1 Form B1 (DIN 2526 Form C), Ra 6.3 to 12.5 µm						

- 1) Depends on the liner → 81
- 2) Total length is independent of the process connections. Length according to DVGW (German Technical and Scientific Association for Gas and Water) → 50 (compact version) → 53 (remote version)

Flange in accordance with EN 1092-1 (DIN 2501 / DIN 2512N): PN 40						
Carbon steel: order code for "Process connection", option D5K						
Stainless steel: order code for "Process connection", option D5S						
DN [mm]	A [mm]	B [mm]	C [mm]	D [mm]	E [mm]	L [mm]
25	115	85	4 × Ø14	16	1)	2)
32	140	100	4 × Ø18	18		
40	150	110	4 × Ø18	18		
50	165	125	4 × Ø18	20		
65	185	145	8 × Ø18	24		
80	200	160	8 × Ø18	26		
100	235	190	8 × Ø22	26		
125	270	220	8 × Ø26	28		
150	300	250	8 × Ø26	30		
Surface roughness (flange): EN 1092-1 Form B1 (DIN 2526 Form C), Ra 6.3 to 12.5 µm						

- 1) Depends on the liner → 81
- 2) Total length is independent of the process connections. Length according to DVGW (German Technical and Scientific Association for Gas and Water) → 50 (compact version) → 53 (remote version)

Flange according to ASME B16.5, Class 150									
Carbon steel: order code for "Process connection", option A1K									
Stainless steel: order code for "Process connection", option A1S									
DN		A	B	C	D	E	L		
[mm]	[in]	[mm]	[mm]	[mm]	[mm]	[mm]	[mm]		
25	1	108	79.2	4 × Ø16	12.6	1)	2)		
40	1 ½	127	98.6	4 × Ø16	15.9				
50	2	152.4	120.7	4 × Ø19.1	17.5				
80	3	190.5	152.4	4 × Ø19.1	22.3				
100	4	228.6	190.5	8 × Ø19.1	22.3				
150	6	279.4	241.3	8 × Ø22.4	23.8				
200	8	342.9	298.5	8 × Ø22.4	26.8				
250	10	406.4	362	12 × Ø25.4	29.6				
300	12	482.6	431.8	12 × Ø25.4	30.2				
350	14	535	476.3	12 × Ø28.6	35.4				
400	16	595	539.8	16 × Ø28.6	37				
450	18	635	577.9	16 × Ø31.8	40.1				
500	20	700	635	20 × Ø31.8	43.3				
600	24	815	749.3	20 × Ø34.9	48.1				
Surface roughness (flange): Ra 6.3 to 12.5 µm									

- 1) Depends on the liner → 81
- 2) Total length is independent of the process connections. Length according to DVGW (German Technical and Scientific Association for Gas and Water) → 50 (compact version) → 53 (remote version)

Flange according to ASME B16.5, Class 300							
Carbon steel: order code for "Process connection", option A2K							
Stainless steel: order code for "Process connection", option A2S							
DN		A	B	C	D	E	L
[mm]	[in]	[mm]	[mm]	[mm]	[mm]	[mm]	[mm]
25	1	123.9	88.9	4 × Ø19.1	15.9	1)	2)
40	1 ½	155.4	114.3	4 × Ø22.4	19		
50	2	165.1	127	8 × Ø19.1	20.8		
80	3	209.6	168.1	8 × Ø22.4	26.8		
100	4	254	200.2	8 × Ø22.4	30.2		
150	6	317.5	269.7	12 × Ø22.4	35		

Surface roughness (flange): Ra 6.3 to 12.5 µm

- 1) Depends on the liner → ☞ 81
 2) Total length is independent of the process connections. Length according to DVGW (German Technical and Scientific Association for Gas and Water) → ☞ 50 (compact version) → ☞ 53 (remote version)

Flange according to JIS B2220, 10K						
Carbon steel: order code for "Process connection", option N3K						
Stainless steel: order code for "Process connection", option N3S						
DN	A	B	C	D	E	L
[mm]	[mm]	[mm]	[mm]	[mm]	[mm]	[mm]
50	155	120	4 × Ø19	16	1)	2)
65	175	140	4 × Ø19	18		
80	185	150	8 × Ø19	18		
100	210	175	8 × Ø19	18		
125	250	210	8 × Ø23	20		
150	280	240	8 × Ø23	22		
200	330	290	12 × Ø23	22		
250	400	355	12 × Ø25	24		
300	445	400	16 × Ø25	24		

Surface roughness (flange): Ra 6.3 to 12.5 µm

- 1) Depends on the liner → ☞ 81
 2) Total length is independent of the process connections. Length according to DVGW (German Technical and Scientific Association for Gas and Water) → ☞ 50 (compact version) → ☞ 53 (remote version)

Flange according to JIS B2220, 20K						
Carbon steel: order code for "Process connection", option N4K						
Stainless steel: order code for "Process connection", option N4S						
DN	A	B	C	D	E	L
[mm]	[mm]	[mm]	[mm]	[mm]	[mm]	[mm]
25	125	90	4 × Ø19	16	1)	2)
32	135	100	4 × Ø19	18		
40	140	105	4 × Ø19	18		
50	155	120	8 × Ø19	18		
65	175	140	8 × Ø19	20		
80	200	160	8 × Ø23	22		
100	225	185	8 × Ø23	24		

Flange according to JIS B2220, 20K						
Carbon steel: order code for "Process connection", option N4K						
Stainless steel: order code for "Process connection", option N4S						
DN [mm]	A [mm]	B [mm]	C [mm]	D [mm]	E [mm]	L [mm]
125	270	225	8 × Ø25	26		
150	305	260	12 × Ø25	28		
200	350	305	12 × Ø25	30		
250	430	380	12 × Ø27	34		
300	480	430	16 × Ø27	36		
Surface roughness (flange): Ra 6.3 to 12.5 µm						

- 1) Depends on the liner → ☞ 81
- 2) Total length is independent of the process connections. Length according to DVGW (German Technical and Scientific Association for Gas and Water) → ☞ 50 (compact version) → ☞ 53 (remote version)

Flange according to AWWA, Class D							
Order code for "Process connection", option W1K							
DN		A	B	C	D	E	L
[mm]	[in]	[mm]	[mm]	[mm]	[mm]	[mm]	[mm]
700	28	927	863.6	28 × Ø35	33.4	1)	2)
750	30	984	914.4	28 × Ø35	35		
800	32	1060	977.9	28 × Ø42	38.1		
900	36	1168	1085.9	32 × Ø42	41.3		
1000	40	1289	1200.2	36 × Ø42	41.3		
-	42	1346	1257.3	36 × Ø42	44.5		
1200	48	1511	1422.4	44 × Ø42	47.7		
-	54	1683	1593.9	44 × Ø48	54		
-	60	1855	1759	52 × Ø48	57.2		
-	66	2032	1930.4	52 × Ø48	63.5		
1800	72	2197	2095.5	60 × Ø48	66.7		
-	78	2362	2260.6	64 × Ø54	69.9		
-	84	2535	2425.7	64 × Ø54	73.1		
-	90	2705	2717.8	68 × Ø60	76.2		
Surface roughness (flange): Ra 6.3 to 12.5 µm							

- 1) Depends on the liner → ☞ 81
- 2) Total length is independent of the process connections. Length according to DVGW (German Technical and Scientific Association for Gas and Water) → ☞ 50 (compact version) → ☞ 53 (remote version)

Flange according to AS 2129, Tab. E						
Order code for "Process connection", option M2K						
DN [mm]	A [mm]	B [mm]	C [mm]	D [mm]	E [mm]	L [mm]
80	185	146	4 × Ø18	12	1)	2)
100	215	178	8 × Ø18	13		
150	280	235	8 × Ø22	17		
200	335	292	8 × Ø22	19		
250	405	356	12 × Ø22	22		

Flange according to AS 2129, Tab. E						
<i>Order code for "Process connection", option M2K</i>						
DN [mm]	A [mm]	B [mm]	C [mm]	D [mm]	E [mm]	L [mm]
300	455	406	12 × Ø26	25		
350	525	470	12 × Ø26	30		
400	580	521	12 × Ø26	32		
450	640	584	16 × Ø26	35		
500	705	641	16 × Ø26	38		
600	825	756	16 × Ø33	48		
700	910	845	20 × Ø33	51		
750	995	927	20 × Ø36	54		
800	1060	984	20 × Ø36	54		
900	1175	1092	24 × Ø36	64		
1000	1255	1175	24 × Ø39	67		
1200	1490	1410	32 × Ø39	79		

Surface roughness (flange): Ra 6.3 to 12.5 µm

- 1) Depends on the liner → ☞ 81
- 2) Total length is independent of the process connections. Length according to DVGW (German Technical and Scientific Association for Gas and Water) → ☞ 50 (compact version) → ☞ 53 (remote version)

Flange according to AS 4087, PN 16						
<i>Order code for "Process connection", option M3K</i>						
DN [mm]	A [mm]	B [mm]	C [mm]	D [mm]	E [mm]	L [mm]
80	185	146	4 × Ø18	12	1)	2)
100	215	178	4 × Ø18	13		
150	280	235	8 × Ø18	13		
200	335	292	8 × Ø18	19		
250	405	356	8 × Ø22	19		
300	455	406	12 × Ø22	23		
350	525	470	12 × Ø26	30		
375	550	495	12 × Ø26	30		
400	580	521	12 × Ø26	32		
450	640	584	12 × Ø26	30		
500	705	641	16 × Ø26	38		
600	825	756	16 × Ø30	48		
700	910	845	20 × Ø30	56		
750	995	927	20 × Ø33	56		
800	1060	984	20 × Ø36	56		
900	1175	1092	24 × Ø36	66		
1000	1255	1175	24 × Ø36	66		

Flange according to AS 4087, PN 16
Order code for "Process connection", option M3K

DN [mm]	A [mm]	B [mm]	C [mm]	D [mm]	E [mm]	L [mm]
1200	1490	1410	32 × Ø36	76		

Surface roughness (flange): Ra 6.3 to 12.5 µm

- 1) Depends on the liner → 81
- 2) Total length is independent of the process connections. Length according to DVGW (German Technical and Scientific Association for Gas and Water) → 50 (compact version) → 53 (remote version)

Lap joint flange

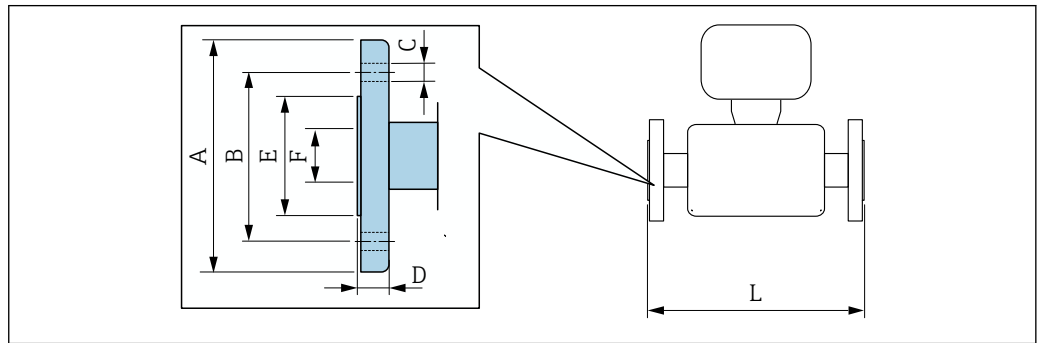

A0037862

Lap joint flange in accordance with EN 1092-1 (DIN 2501 / DIN 2512N): PN 10
Carbon steel: *order code for "Process connection", option D22*
Stainless steel: *order code for "Process connection", option D24*

DN		A	B	C	D	E	F	L
[mm]	[in]	[mm]	[mm]	[mm]	[mm]	[mm]	[mm]	[mm]
200	8	340	295	8 × Ø22	24	264	1)	2)
250	10	395	350	12 × Ø22	26	317		
300	12	445	400	12 × Ø22	26	367		

Surface roughness (flange): Ra 6.3 to 12.5 µm

- 1) Depends on the liner → 81
- 2) Total length is independent of the process connections. Length according to DVGW (German Technical and Scientific Association for Gas and Water) → 50 (compact version) → 53 (remote version)

Lap joint flange in accordance with EN 1092-1 (DIN 2501 / DIN 2512N): PN 16
Carbon steel: *order code for "Process connection", option D32*
Stainless steel: *order code for "Process connection", option D34*

DN		A	B	C	D	E	F	L
[mm]	[in]	[mm]	[mm]	[mm]	[mm]	[mm]	[mm]	[mm]
25	1	115	85	4 × Ø14	16	49	1)	2)
32	-	140	100	4 × Ø18	18	65		
40	1 ½	150	110	4 × Ø18	18	71		
50	2	165	125	4 × Ø18	20	88		
65	-	185	145	8 × Ø18	20	103		
80	3	200	160	8 × Ø18	20	120		
100	4	220	180	8 × Ø18	22	148		
125	-	250	210	8 × Ø18	22	177		

Lap joint flange in accordance with EN 1092-1 (DIN 2501 / DIN 2512N): PN 16
Carbon steel: order code for "Process connection", option D32
Stainless steel: order code for "Process connection", option D34

DN		A	B	C	D	E	F	L
[mm]	[in]	[mm]	[mm]	[mm]	[mm]	[mm]	[mm]	[mm]
150	6	285	240	8 × Ø22	24	209		
200	8	340	295	12 × Ø22	26	264		
250	10	405	355	12 × Ø26	29	317		
300	12	460	410	12 × Ø26	32	367		

Surface roughness (flange): Ra 6.3 to 12.5 µm

- 1) Depends on the liner → 81
- 2) Total length is independent of the process connections. Length according to DVGW (German Technical and Scientific Association for Gas and Water) → 50 (compact version) → 53 (remote version)

Lap joint flange according to ASME B16.5, Class 150
Carbon steel: order code for "Process connection", option A12
Stainless steel: order code for "Process connection", option A14

DN		A	B	C	D	E	F	L
[mm]	[in]	[mm]	[mm]	[mm]	[mm]	[mm]	[mm]	[mm]
25	1	110	80	4 × Ø16	14	49	1)	2)
40	1 ½	125	98	4 × Ø16	17.5	71		
50	2	150	121	4 × Ø19	19	88		
80	3	190	152	4 × Ø19	24	120		
100	4	230	190	8 × Ø19	24	148		
150	6	280	241	8 × Ø23	25	209		
200	8	345	298	8 × Ø23	29	264		
250	10	405	362	12 × Ø25	30	317		
300	12	485	432	12 × Ø25	32	378		

Surface roughness (flange): Ra 6.3 to 12.5 µm

- 1) Depends on the liner → 81
- 2) Total length is independent of the process connections. Length according to DVGW (German Technical and Scientific Association for Gas and Water) → 50 (compact version) → 53 (remote version)

Lap joint flange, stamped plate

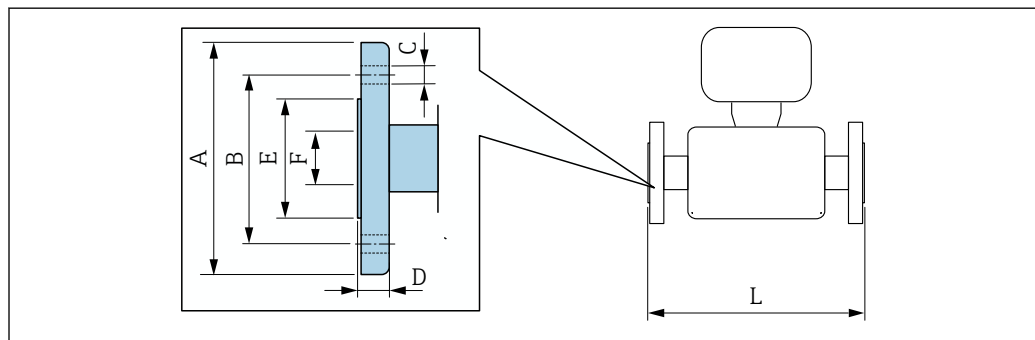

A0037862

Lap joint flange, stamped plate in accordance with EN 1092-1 (DIN 2501 / DIN 2512N): PN 10
Carbon steel: order code for "Process connection", option D21
Stainless steel: order code for "Process connection", option D23

DN [mm]	A [mm]	B [mm]	C [mm]	D [mm]	E [mm]	F [mm]	L [mm]
25	115	85	4 x Ø13.5	16.5	49	1)	2)
32	140	100	4 x Ø17.5	17	65		
40	150	110	4 x Ø17.5	16.5	71		
50	165	125	4 x Ø17.5	18.5	88		
65	185	145	4 x Ø17.5	20	103		
80	200	160	8 x Ø17.5	23.5	120		
100	220	180	8 x Ø17.5	24.5	148		
125	250	210	8 x Ø17.5	24	177		
150	285	240	8 x Ø21.5	25	209		
200	340	295	8 x Ø21.5	27.5	264		
250	405	350	12 x Ø21.5	30.5	317		
300	445	400	12 x Ø21.5	34.5	367		

Surface roughness (flange): Ra 6.3 to 12.5 µm

- 1) Depends on the liner → 81
- 2) Total length is independent of the process connections. Length according to DVGW (German Technical and Scientific Association for Gas and Water) → 50 (compact version) → 53 (remote version)

Accessories

Ground disks for flange connections

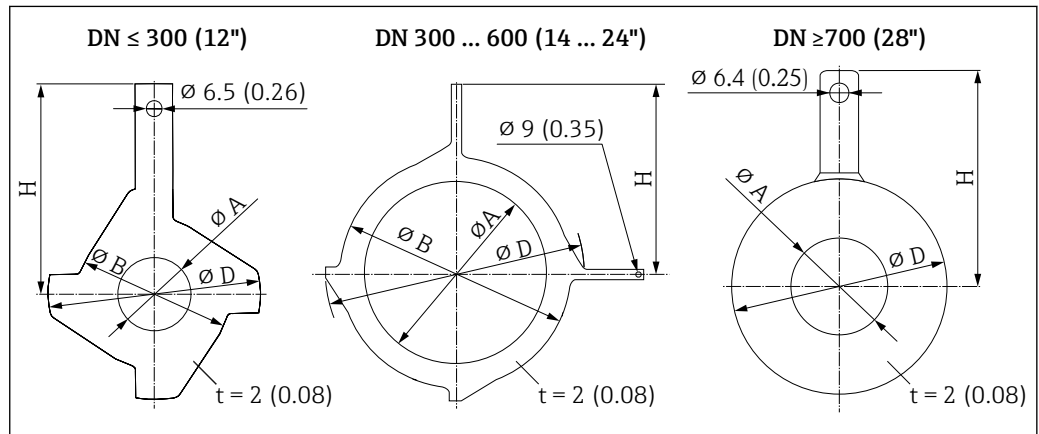

DN		Pressure rating	A		B		D		H	
[mm]	[inch]		[mm]	[inch]	[mm]	[inch]	[mm]	[inch]	[mm]	[inch]
25	1"	1)	26	1.02	62	2.44	77.5	3.05	87.5	3.44
32	1 ¼"	1)	35	1.38	80	3.15	87.5	3.44	94.5	3.72
40	1 ½"	1)	41	1.61	82	3.23	101	3.98	103	4.06
50	2"	1)	52	2.05	101	3.98	115.5	4.55	108	4.25
65	2 ½"	1)	68	2.68	121	4.76	131.5	5.18	118	4.65
80	3"	1)	80	3.15	131	5.16	154.5	6.08	135	5.31

DN		Pressure rating	A		B		D		H	
[mm]	[inch]		[mm]	[inch]	[mm]	[inch]	[mm]	[inch]	[mm]	[inch]
100	4"	1)	104	4.09	156	6.14	186.5	7.34	153	6.02
125	5"	1)	130	5.12	187	7.36	206.5	8.13	160	6.30
150	6"	1)	158	6.22	217	8.54	256	10.08	184	7.24
200	8"	1)	206	8.11	267	10.51	288	11.34	205	8.07
250	10"	1)	260	10.24	328	12.91	359	14.13	240	9.45
300	12"	PN 10 PN 16 Cl. 150	312	12.28	375	14.76	413	16.26	273	10.75
		PN 25 JIS 10K JIS 20K	310	12.20	375	14.76	404	15.91	268	10.55
350	14"	PN 6	343	13.50	420	16.54	479	18.86	365	14.37
		PN 10								
		PN 16								
375	15"	PN 16	393	15.5	461	18.2	523	20.6	395	15.6
400	16"	PN 6	393	15.5	470	18.50	542	21.34	395	15.55
		PN 10								
		PN 16								
450	18"	PN 6	439	17.28	525	20.67	583	22.95	417	16.42
		PN 10								
		PN 16								
500	20"	PN 6	493	19.41	575	22.64	650	25.59	460	18.11
		PN 10								
		PN 16								
600	24"	PN 6	593	23.35	676	26.61	766	30.16	522	20.55
		PN 10								
		PN 16								
700	28"	PN 6	697	27.44	-	-	786	30.94	460	18.11
		PN10	693	27.28	-	-	813	32.01	480	18.9
		PN16	687	27.05	-	-	807	31.77	490	19.29
		Cl, D	693	27.28	-	-	832	32.76	494	19.45
750	30"	Cl, D	743	29.25	-	-	833	32.8	523	20.59
800	32"	PN 6	799	31.46	-	-	893	35.16	520	20.47
		PN 10	795	31.3	-	-	920	36.22	540	21.26
		PN 16	789	31.06	-	-	914	35.98	550	21.65
		Cl, D	795	31.3	-	-	940	37.01	561	22.09
900	36"	PN 6	897	35.31	-	-	993	39.09	570	22.44
		PN 10	893	35.16	-	-	1020	40.16	590	23.23
		PN 16	886	34.88	-	-	1014	39.92	595	23.43
		Cl, D	893	35.16	-	-	1048	41.26	615	24.21
1000	40"	PN 6	999	39.33	-	-	1093	43.03	620	24.41
		PN 10	995	39.17	-	-	1127	44.37	650	25.59
		PN 16	988	38.9	-	-	1131	44.53	660	25.98

DN		Pressure rating	A		B		D		H	
[mm]	[inch]		[mm]	[inch]	[mm]	[inch]	[mm]	[inch]	[mm]	[inch]
		Cl, D	995	39.17	-	-	1163	45.79	675	26.57
-	42"	PN 6	1044	41.1	-	-	1220	48.03	704	27.72
1200	48"	PN 6	1203	47.36	-	-	1310	51.57	733	28.86
		PN 10	1196	47.09	-	-	1344	52.91	760	29.92
		PN 16	1196	47.09	-	-	1385	54.53	786	30.94
		Cl, D	1188	46.77	-	-	1345	52.95	775	30.51

- 1) In the case of DN 25 to 250, ground disks can be used for all the flange standards/pressure ratings which can be supplied in the standard version

Dimensions in US units

Compact version

Order code for "Housing", option A "Compact, aluminum, coated" or option M "Compact, polycarbonate"

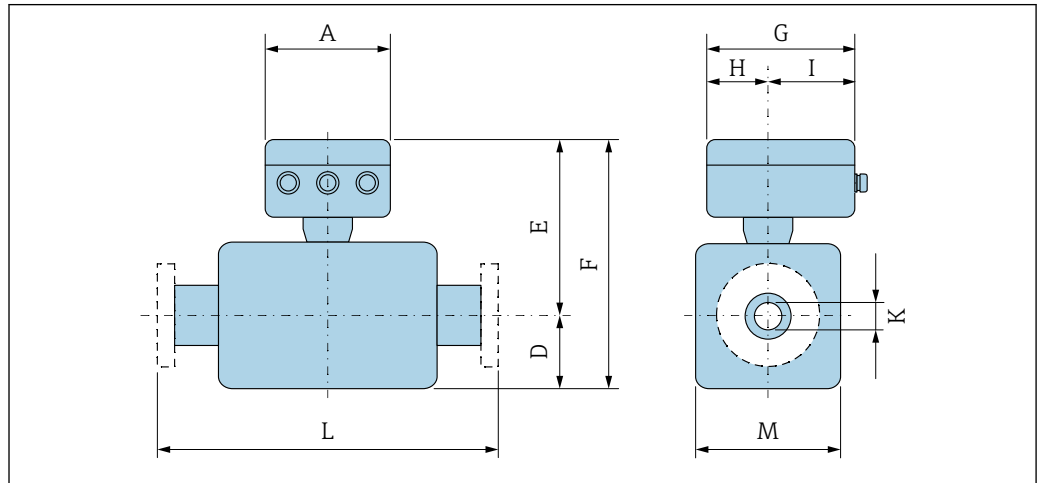

A0033790

A [in]	G ¹⁾ [in]	H [in]	I ¹⁾ [in]
6.57	7.60	3.54	4.06

1) Depending on the cable gland used: values up to + 1.18 in

DN 25 to 300 (1 to 12"): sensor with aluminum half-shell housing

DN		Order code for "Design"								K [in]	L [in]
		Options A, D, E, H, I				Option C					
[mm]	[in]	D ¹⁾ [in]	E ^{1) 2)} [in]	F ^{1) 2)} [in]	M ¹⁾ [in]	D ¹⁾ [in]	E ^{1) 2)} [in]	F ^{1) 2)} [in]	M ¹⁾ [in]	[in]	[in]
25	1	3.31	7.91	11.22	4.72	-	-	-	-	³⁾	7.87
32	-	3.31	7.91	11.22	4.72	-	-	-	-	³⁾	7.87
40	1 ½	3.31	7.91	11.22	4.72	-	-	-	-	³⁾	7.87
50	2	3.31	7.91	11.22	4.72	3.31	7.91	11.22	4.72	³⁾	7.87
65	-	4.29	8.9	13.19	7.09	3.31	7.91	11.22	4.72	³⁾	7.87
80	3	4.29	8.9	13.19	7.09	3.31	7.91	11.22	4.72	³⁾	7.87
100	4	4.29	8.9	13.19	7.09	4.29	8.9	13.19	7.09	³⁾	9.84
125	-	5.91	10.47	16.38	10.24	4.29	8.9	13.19	7.09	³⁾	9.84
150	6	5.91	10.47	16.38	10.24	4.29	8.9	13.19	7.09	³⁾	11.81
200	8	7.09	11.46	18.54	12.76	5.91	10.47	16.38	10.24	³⁾	13.78
250	10	8.07	12.44	20.51	15.75	5.91	10.47	16.38	10.24	³⁾	17.72
300	12	9.06	13.43	22.48	18.11	7.09	11.46	18.54	12.76	³⁾	19.69

1) The dimensions are reference values. They may vary depending on the pressure rating, design and order option.

2) With order code for "Sensor option", option CG "Sensor extended neck for insulation": values + 4.33 in

3) Depends on the liner → 81

DN 350 to 900 (14 to 36")

DN		Order code for "Design"								K	L	
		Options A, E, F				Option B, G						
		D ¹⁾	E ¹⁾²⁾	F ¹⁾²⁾	M ¹⁾	D ¹⁾	E ¹⁾²⁾	F ¹⁾²⁾	M ¹⁾			
[mm]	[in]	[mm]	[mm]	[mm]	[mm]	[mm]	[mm]	[mm]	[mm]	[mm]	[mm]	
350	14	9.65	16.2	25.91	19.29	-	-	-	-	3)	21.65	
375	15	10.67	17.24	27.91	21.34	-	-	-	-	3)	21.65	
400	16	10.67	17.24	27.91	21.34	-	-	-	-	3)	23.62	
450	18	11.77	18.35	30.12	23.54	13.11	17.72	30.83	26.22	3)	23.62 ⁴⁾	25.59 ⁵⁾
500	20	12.76	19.33	32.09	25.51	14.13	18.7	32.83	28.23	3)	23.62 ⁴⁾	25.59 ⁵⁾
600	24	14.37	21.34	35.71	28.74	16.18	20.79	36.97	32.32	3)	23.62 ⁴⁾	30.71 ⁵⁾
700	28	16.93	23.74	40.67	33.86	20.16	24.8	44.96	40.31	3)	27.56 ⁴⁾	35.83 ⁵⁾
750	30	18.39	25.24	43.62	36.77	20.16	24.8	44.96	40.31	3)	27.56 ⁴⁾	35.83 ⁵⁾
800	32	19.13	25.98	45.12	38.27	21.02	25.59	46.61	41.93	3)	31.5 ⁴⁾	40.94 ⁵⁾
900	36	21.1	27.95	49.06	42.2	24.02	28.62	52.64	47.95	3)	35.43 ⁴⁾	46.06 ⁵⁾

- 1) The dimensions are reference values. They may be different than indicated, depending on the pressure rating, design and order code.
- 2) With order code for "Sensor option", option CG "Sensor extended neck for insulation": values + 110 mm
- 3) Depends on the liner → 81
- 4) Order code for "Design", option F "Fixed flange, short installation length"
- 5) Order code for "Design", option G "Fixed flange, long installation length"

DN 1000 to 2400 (40 to 90")

DN		D ¹⁾	E ¹⁾²⁾	F ¹⁾²⁾	K	L		M ¹⁾
[mm]	[in]	[in]	[in]	[in]	[in]	[in]		[in]
1000	40	27.01	31.61	58.62	3)	39.37 ⁴⁾	51.18 ⁵⁾	53.94
-	42	28.03	32.6	60.63	3)	41.34 ⁴⁾	53.74 ⁵⁾	55.91
1200	48	31.93	36.57	68.5	3)	47.24 ⁴⁾	61.42 ⁵⁾	63.78
-	54	35.91	40.51	76.42	3)	53.15 ⁴⁾	69.09 ⁵⁾	71.65
1400	-	38.86	43.46	82.32	3)	55.12 ⁴⁾	71.65 ⁵⁾	77.56
-	60	39.8	44.41	84.21	3)	59.06 ⁴⁾	76.77 ⁵⁾	79.45
1600	-	41.57	46.18	87.76	3)	62.99 ⁴⁾	81.89 ⁵⁾	82.99
-	66	43.03	47.6	90.63	3)	64.96 ⁴⁾	84.45 ⁵⁾	85.83
1800	72	46.77	51.34	98.11	3)	70.87 ⁴⁾	92.13 ⁵⁾	93.31
-	78	48.74	53.31	102.05	3)	78.74 ⁴⁾	102.36 ⁵⁾	97.24
2000	-	48.74	53.31	102.05	3)	78.74 ⁴⁾	102.36 ⁵⁾	97.24
-	84	48.74	53.31	102.05	3)	86.61 ⁴⁾		97.24
2200	-	48.31	52.99	101.3	3)	86.61 ⁴⁾		96.61
-	90	48.31	52.99	101.3	3)	94.49 ⁴⁾		96.61
2400	-	52.44	57.13	109.57	3)	94.49 ⁴⁾		104.88

- 1) The dimensions are reference values. They may be different than indicated, depending on the pressure rating, design and order code.
- 2) With order code for "Sensor option", option CG "Sensor extended neck for insulation": values + 4.33 in
- 3) Depends on the liner → 81
- 4) Order code for "Design", option F "Fixed flange, short installation length"
- 5) Order code for "Design", option G "Fixed flange, long installation length"

Remote version

Transmitter remote version

Order code for "Housing", option N "Remote, polycarbonate" or option P "Remote, aluminum coated"

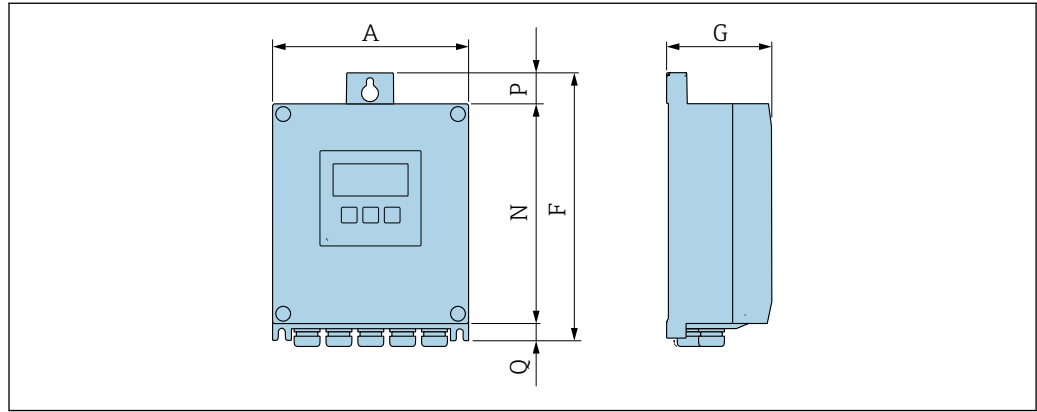

A0033789

A [in]	F [in]	G [in]	N [in]	P [in]	Q [in]
6.57	9.13	3.15	7.36	0.94	0.83

Sensor connection housing

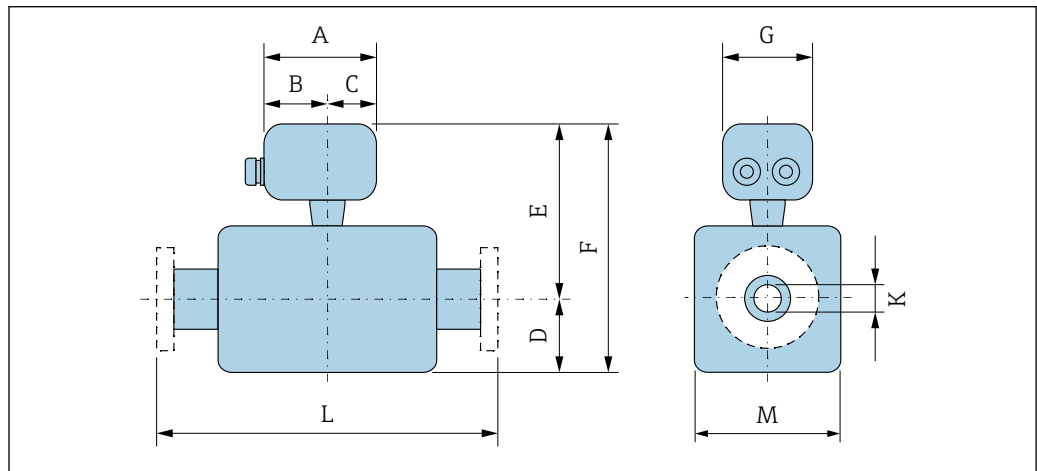

A0033784

Aluminum, coated

A [in]	B [in]	C [in]	G [in]
5.83	3.7	2.13	5.35

Polycarbonate (only in conjunction with order code for "Sensor option", options CA...CE)

A [in]	B [in]	C [in]	G [in]
4.45	2.44	2.01	4.41

DN 25 to 300 (1 to 12"): sensor with aluminum half-shell housing

DN		Order code for "Design"								K	L
[mm]	[in]	Options A, D, E, H, I				Option C				[in]	[in]
		D ¹⁾	E ¹⁾	F ¹⁾	M ¹⁾	D ¹⁾	E ¹⁾	F ¹⁾	M ¹⁾		
25	1	3.31	7.87	11.18	4.72	-	-	-	-	2)	7.87
32	-	3.31	7.87	11.18	4.72	-	-	-	-	2)	7.87
40	1 ½	3.31	7.87	11.18	4.72	-	-	-	-	2)	7.87
50	2	3.31	7.87	11.18	4.72	3.31	7.87	11.18	4.72	2)	7.87
65	-	4.29	8.86	13.15	7.09	3.31	7.87	11.18	4.72	2)	7.87
80	3	4.29	8.86	13.15	7.09	3.31	7.87	11.18	4.72	2)	7.87
100	4	4.29	8.86	13.15	7.09	4.29	8.86	13.15	7.09	2)	9.84
125	-	5.91	10.43	16.34	10.24	4.29	8.86	13.15	7.09	2)	9.84
150	6	5.91	10.43	16.34	10.24	4.29	8.86	13.15	7.09	2)	11.81
200	8	7.09	11.42	18.5	12.76	5.91	10.43	16.34	10.24	2)	13.78
250	10	8.07	12.4	20.47	15.75	5.91	10.43	16.34	10.24	2)	17.72
300	12	9.06	13.39	22.44	18.11	7.09	11.42	18.5	12.76	2)	19.69

- 1) The dimensions are reference values. They may vary depending on the pressure rating, design and order option.
- 2) Depends on the liner → 81

DN 25 to 300 (1 to 12"): sensor with fully welded carbon steel housing

DN		Order code for "Design"								K	L
[mm]	[in]	Options A, E				Option C				[in]	[in]
		D ¹⁾	E ¹⁾	F ¹⁾	M ¹⁾	D ¹⁾	E ¹⁾	F ¹⁾	M ¹⁾		
25	1	2.76	7.87	10.63	5.51	-	-	-	-	2)	7.87
32	-	2.76	7.87	10.63	5.51	-	-	-	-	2)	7.87
40	1 ½	2.76	7.87	10.63	5.51	-	-	-	-	2)	7.87
50	2	2.76	7.87	10.63	5.51	2.76	7.87	10.63	5.51	2)	7.87
65	-	3.23	8.86	12.09	6.5	2.76	7.87	10.63	5.51	2)	7.87
80	3	3.43	8.86	12.28	6.89	2.76	7.87	10.63	5.51	2)	7.87
100	4	3.94	8.86	12.8	7.87	3.23	8.86	12.09	6.5	2)	9.84
125	-	4.45	10.43	14.88	8.9	3.43	8.86	12.28	6.89	2)	9.84
150	6	5.28	10.43	15.71	10.59	3.94	8.86	12.8	7.87	2)	11.81
200	8	6.3	11.42	17.72	12.6	4.45	10.43	14.88	8.9	2)	13.78
250	10	7.6	12.4	20	15.24	5.28	10.43	15.71	10.59	2)	17.72
300	12	8.58	13.39	21.97	17.2	6.3	11.42	17.72	12.6	2)	19.69

- 1) The dimensions are reference values. They may vary depending on the pressure rating, design and order option.
- 2) Depends on the liner → 81

DN 350 to 900 (14 to 36")

DN		Order code for "Design"								K	L	
		Options A, E, F				Option B, G						
[mm]	[in]	D ¹⁾ [in]	E ¹⁾ [in]	F ¹⁾ [in]	M ¹⁾ [in]	D ¹⁾ [in]	E ¹⁾ [in]	F ¹⁾ [in]	M ¹⁾ [in]	[in]	[in]	
350	14	9.65	13.78	23.43	19.29	–	–	–	–	2)	21.65	
375	15	10.67	14.76	25.43	21.34	–	–	–	–	2)	21.65	
400	16	10.67	14.76	25.43	21.34	–	–	–	–	2)	23.62	
450	18	11.77	15.87	27.64	23.54	13.11	17.6	30.71	26.22	2)	23.62 ³⁾	25.59 ⁴⁾
500	20	12.76	16.85	29.61	25.51	14.13	18.58	32.72	28.23	2)	23.62 ³⁾	25.59 ⁴⁾
600	24	14.37	18.86	33.23	28.74	16.18	20.67	36.85	32.32	2)	23.62 ³⁾	30.71 ⁴⁾
700	28	16.93	21.26	38.19	33.86	20.16	24.69	44.84	40.31	2)	27.56 ³⁾	35.83 ⁴⁾
750	30	18.39	22.76	41.14	36.77	20.16	24.69	44.84	40.31	2)	27.56 ³⁾	35.83 ⁴⁾
800	32	19.13	23.5	42.64	38.27	21.02	25.47	46.5	41.93	2)	31.5 ³⁾	40.94 ⁴⁾
900	36	21.1	25.47	46.57	42.2	24.02	28.5	52.52	47.95	2)	35.43 ³⁾	46.06 ⁴⁾

- 1) The dimensions are reference values. They may vary depending on the pressure rating, design and order option.
- 2) Depends on the liner → 81
- 3) Order code for "Design", option F "Fixed flange, short installation length"
- 4) Order code for "Design", option G "Fixed flange, long installation length"

1000 ... 2400 (40 ... 90")

DN		D ¹⁾	E ¹⁾	F ¹⁾	K	L		M ¹⁾
[mm]	[in]	[in]	[in]	[in]	[in]	[in]		[in]
1000	40	27.01	31.5	58.5	2)	39.37 ³⁾	51.18 ⁴⁾	53.94
–	42	28.03	32.48	60.51	2)	41.34 ³⁾	53.74 ⁴⁾	55.91
1200	48	31.93	36.46	68.39	2)	47.24 ³⁾	61.42 ⁴⁾	63.78
–	54	35.91	40.39	76.3	2)	53.15 ³⁾	69.09 ⁴⁾	71.65
1400	–	38.86	43.35	82.2	2)	55.12 ³⁾	71.65 ⁴⁾	77.56
–	60	39.8	44.29	84.09	2)	59.06 ³⁾	76.77 ⁴⁾	79.45
1600	–	41.57	46.06	87.64	2)	62.99 ³⁾	81.89 ⁴⁾	82.99
–	66	43.03	47.48	90.51	2)	64.96 ³⁾	84.45 ⁴⁾	85.83
1800	72	46.77	51.22	97.99	2)	70.87 ³⁾	92.13 ⁴⁾	93.31
–	78	48.74	53.19	101.93	2)	78.74 ³⁾	102.36 ⁴⁾	97.24
2000	–	48.74	53.19	101.93	2)	78.74 ³⁾	102.36 ⁴⁾	97.24
–	84	48.74	53.19	101.93	2)	86.61 ³⁾		97.24
2200	–	48.31	52.87	101.18	2)	86.61 ³⁾		96.61
–	90	48.31	52.87	101.18	2)	94.49 ³⁾		96.61
2400	–	52.44	57.01	109.45	2)	94.49 ³⁾		104.88

- 1) The dimensions are reference values. They may be different than indicated, depending on the pressure rating, design and order code.
- 2) Internal diameter depends on liner, see measuring tube specification → 81
- 3) Order code for "Design", option F "Fixed flange, short installation length"
- 4) Order code for "Design", option G "Fixed flange, long installation length"

Flange connections

Fixed flange

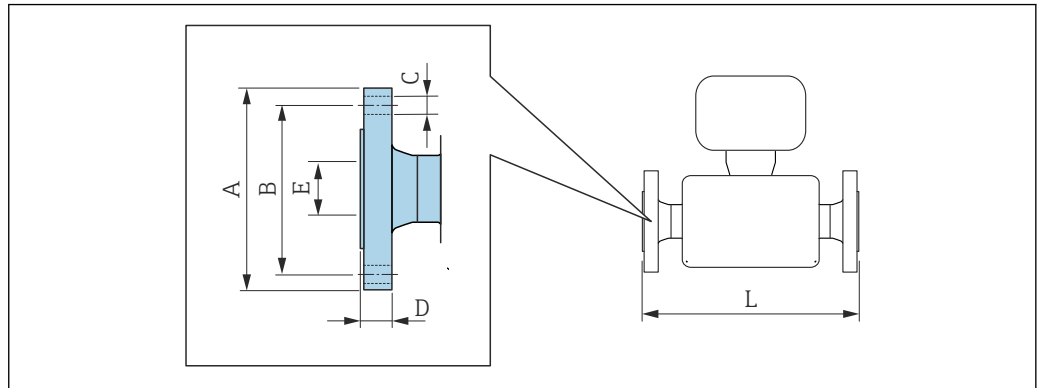

A0015621

Flange according to ASME B16.5, Class 150
Carbon steel: order code for "Process connection", option A1K
Stainless steel: order code for "Process connection", option A1S

DN		A	B	C	D	E	L
[mm]	[in]	[in]	[in]	[in]	[in]	[in]	[in]
25	1	4.25	3.12	4 × Ø0.63	0.5	1)	2)
40	1 ½	5	3.88	4 × Ø0.63	0.63		
50	2	6	4.75	4 × Ø0.75	0.69		
80	3	7.5	6	4 × Ø0.75	0.88		
100	4	9	7.5	8 × Ø0.75	0.88		
150	6	11	9.5	8 × Ø0.88	0.94		
200	8	13.5	11.75	8 × Ø0.88	1.06		
250	10	16	14.25	12 × Ø1	1.17		
300	12	19	17	12 × Ø1	1.19		
350	14	21.06	18.75	12 × Ø1.13	1.39		
400	16	23.43	21.25	16 × Ø1.13	1.46		
450	18	25	22.75	16 × Ø1.25	1.58		
500	20	27.56	25	20 × Ø1.25	1.7		
600	24	32.09	29.5	20 × Ø1.37	1.89		

Surface roughness (flange): Ra 250 to 492 µm

- 1) Depends on the liner → 81
- 2) Total length is independent of the process connections. Length according to DVGW (German Technical and Scientific Association for Gas and Water) → 68 (compact version) → 70 (remote version)

Flange according to ASME B16.5, Class 300
Carbon steel: order code for "Process connection", option A2K
Stainless steel: order code for "Process connection", option A2S

DN		A	B	C	D	E	L
[in]	[mm]	[in]	[in]	[in]	[in]	[in]	[in]
1	25	4.88	3.5	4 × Ø0.75	0.63	1)	2)
1 ½	40	6.12	4.5	4 × Ø0.88	0.75		
2	50	6.5	5	8 × Ø0.75	0.82		

Flange according to ASME B16.5, Class 300
Carbon steel: order code for "Process connection", option A2K
Stainless steel: order code for "Process connection", option A2S

DN		A	B	C	D	E	L
[in]	[mm]	[in]	[in]	[in]	[in]	[in]	[in]
3	80	8.25	6.62	8 × Ø0.88	1.06		
4	100	10	7.88	8 × Ø0.88	1.19		
6	150	12.5	10.62	12 × Ø0.88	1.38		

Surface roughness (flange): Ra 250 to 492 µm

- 1) Depends on the liner → 81
- 2) Total length is independent of the process connections. Length according to DVGW (German Technical and Scientific Association for Gas and Water) → 68 (compact version) → 70 (remote version)

Flange according to AWWA, Cl. D
Order code for "Process connection", option W1K

DN		A	B	C	D	E	L
[in]	[mm]	[in]	[in]	[in]	[in]	[in]	[in]
28	700	36.5	34	28 × Ø1.38	1.31	1)	2)
30	-	38.74	36	28 × Ø1.38	1.38		
32	800	41.73	38.5	28 × Ø1.65	1.5		
36	900	45.98	42.75	32 × Ø1.65	1.63		
40	1000	50.75	47.25	36 × Ø1.65	1.63		
42	-	52.99	49.5	36 × Ø1.65	1.75		
48	1200	59.49	56	44 × Ø1.65	1.88		
54	-	66.26	62.75	44 × Ø1.89	2.13		
60	-	73.03	69.25	52 × Ø1.89	2.25		
66	-	80	76	52 × Ø48	2.5		
72	1800	86.5	82.5	60 × Ø48	2.63		
78	-	92.99	89	64 × Ø54	2.75		
84	-	99.8	95.5	64 × Ø54	2.88		
90	-	106.5	107	68 × Ø60	3		

Surface roughness (flange): Ra 250 to 492 µm

- 1) Depends on the liner → 81
- 2) Total length is independent of the process connections. Length according to DVGW (German Technical and Scientific Association for Gas and Water) → 68 (compact version) → 70 (remote version)

Lap joint flange

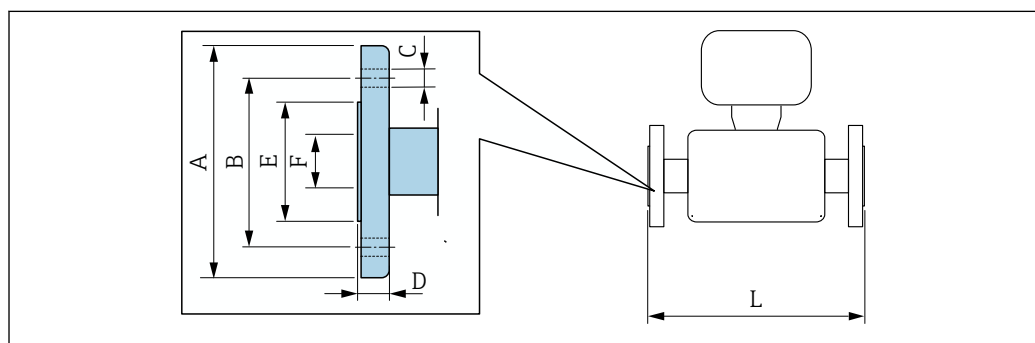

A0037862

Lap joint flange according to ASME B16.5, Class 150
Carbon steel: order code for "Process connection", option A12
Stainless steel: order code for "Process connection", option A14

DN		A	B	C	D	E	F	L
[mm]	[in]	[in]	[in]	[in]	[in]	[in]	[in]	[in]
25	1	4.33	3.15	4 × Ø0.63	0.55	1.93	1)	2)
40	1 ½	4.92	3.86	4 × Ø0.63	0.69	2.8		
50	2	5.91	4.76	4 × Ø0.75	0.75	3.46		
80	3	7.48	5.98	4 × Ø0.75	0.94	4.72		
100	4	9.06	7.48	8 × Ø0.75	0.94	5.83		
150	6	11.02	9.49	8 × Ø0.91	0.98	8.23		
200	8	13.58	11.73	8 × Ø0.91	1.14	10.39		
250	10	15.94	14.25	12 × Ø0.98	1.18	12.48		
300	12	19.09	17.01	12 × Ø0.98	1.26	14.88		

Surface roughness (flange): Ra 248 to 492 µin

- 1) Depends on the liner → 81
- 2) Total length is independent of the process connections. Length according to DVGW (German Technical and Scientific Association for Gas and Water) → 68 (compact version) → 70 (remote version)

Accessories

Ground disks for flange connections

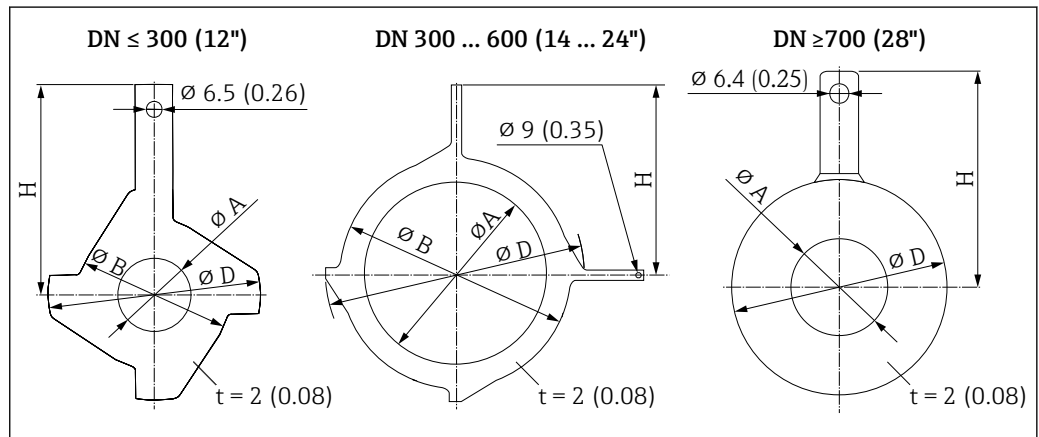

A0015442

DN		Pressure rating	A		B		D		H	
[mm]	[inch]		[mm]	[inch]	[mm]	[inch]	[mm]	[inch]	[mm]	[inch]
25	1"	1)	26	1.02	62	2.44	77.5	3.05	87.5	3.44
32	1 ¼"	1)	35	1.38	80	3.15	87.5	3.44	94.5	3.72
40	1 ½"	1)	41	1.61	82	3.23	101	3.98	103	4.06
50	2"	1)	52	2.05	101	3.98	115.5	4.55	108	4.25
65	2 ½"	1)	68	2.68	121	4.76	131.5	5.18	118	4.65
80	3"	1)	80	3.15	131	5.16	154.5	6.08	135	5.31
100	4"	1)	104	4.09	156	6.14	186.5	7.34	153	6.02
125	5"	1)	130	5.12	187	7.36	206.5	8.13	160	6.30

DN		Pressure rating	A		B		D		H	
[mm]	[inch]		[mm]	[inch]	[mm]	[inch]	[mm]	[inch]	[mm]	[inch]
150	6"	1)	158	6.22	217	8.54	256	10.08	184	7.24
200	8"	1)	206	8.11	267	10.51	288	11.34	205	8.07
250	10"	1)	260	10.24	328	12.91	359	14.13	240	9.45
300	12"	PN 10 PN 16 Cl. 150	312	12.28	375	14.76	413	16.26	273	10.75
		PN 25 JIS 10K JIS 20K	310	12.20	375	14.76	404	15.91	268	10.55
350	14"	PN 6	343	13.50	420	16.54	479	18.86	365	14.37
		PN 10								
		PN 16								
375	15"	PN 16	393	15.5	461	18.2	523	20.6	395	15.6
400	16"	PN 6	393	15.5	470	18.50	542	21.34	395	15.55
		PN 10								
		PN 16								
450	18"	PN 6	439	17.28	525	20.67	583	22.95	417	16.42
		PN 10								
		PN 16								
500	20"	PN 6	493	19.41	575	22.64	650	25.59	460	18.11
		PN 10								
		PN 16								
600	24"	PN 6	593	23.35	676	26.61	766	30.16	522	20.55
		PN 10								
		PN 16								
700	28"	PN 6	697	27.44	-	-	786	30.94	460	18.11
		PN10	693	27.28	-	-	813	32.01	480	18.9
		PN16	687	27.05	-	-	807	31.77	490	19.29
		Cl, D	693	27.28	-	-	832	32.76	494	19.45
750	30"	Cl, D	743	29.25	-	-	833	32.8	523	20.59
800	32"	PN 6	799	31.46	-	-	893	35.16	520	20.47
		PN 10	795	31.3	-	-	920	36.22	540	21.26
		PN 16	789	31.06	-	-	914	35.98	550	21.65
		Cl, D	795	31.3	-	-	940	37.01	561	22.09
900	36"	PN 6	897	35.31	-	-	993	39.09	570	22.44
		PN 10	893	35.16	-	-	1020	40.16	590	23.23
		PN 16	886	34.88	-	-	1014	39.92	595	23.43
		Cl, D	893	35.16	-	-	1048	41.26	615	24.21
1000	40"	PN 6	999	39.33	-	-	1093	43.03	620	24.41
		PN 10	995	39.17	-	-	1127	44.37	650	25.59
		PN 16	988	38.9	-	-	1131	44.53	660	25.98
		Cl, D	995	39.17	-	-	1163	45.79	675	26.57
-	42"	PN 6	1044	41.1	-	-	1220	48.03	704	27.72

DN		Pressure rating	A		B		D		H	
[mm]	[inch]		[mm]	[inch]	[mm]	[inch]	[mm]	[inch]	[mm]	[inch]
1200	48"	PN 6	1203	47.36	-	-	1310	51.57	733	28.86
		PN 10	1196	47.09	-	-	1344	52.91	760	29.92
		PN 16	1196	47.09	-	-	1385	54.53	786	30.94
		Cl, D	1188	46.77	-	-	1345	52.95	775	30.51

- 1) In the case of DN 25 to 250, ground disks can be used for all the flange standards/pressure ratings which can be supplied in the standard version

Weight

All values (weight exclusive of packaging material) refer to devices with flanges of the standard pressure rating.
The weight may be lower than indicated depending on the pressure rating and design.

Weight in SI units

Order code for "Design", options A, B, C, D, E DN 25 to 400, DN 1" to 16"				
Nominal diameter		Reference values		
		EN (DIN), AS, JIS		ASME (Class 150)
[mm]	[in]	Pressure rating	[kg]	[kg]
25	1	PN 40	10	5
32	-	PN 40	11	-
40	1 ½	PN 40	12	7
50	2	PN 40	13	9
65	-	PN 16	13	-
80	3	PN 16	15	14
100	4	PN 16	18	19
125	-	PN 16	25	-
150	6	PN 16	31	33
200	8	PN 10	52	52
250	10	PN 10	81	90
300	12	PN 10	95	129
350	14	PN 6	106	172
375	15	PN 6	121	-
400	16	PN 6	121	203

Order code for "Design", options A, F ≥ DN 450 (18")				
Nominal diameter		Reference values		
		EN (DIN) (PN16)	AS (PN 16)	ASME (Class 150), AWWA (Class D)
[mm]	[in]	[kg]	[kg]	[kg]
450	18	142	138	191
500	20	182	186	228
600	24	227	266	302
700	28	291	369	266
-	30	-	447	318
800	32	353	524	383
900	36	444	704	470
1000	40	566	785	587
-	42	-	-	670
1200	48	843	1229	901
-	54	-	-	1273
1400	-	1204	-	-
-	60	-	-	1594

Order code for "Design", options A, F ≥ DN 450 (18")				
Nominal diameter		Reference values		
		EN (DIN) (PN16)	AS (PN 16)	ASME (Class 150), AWWA (Class D)
[mm]	[in]	[kg]	[kg]	[kg]
1600	-	1845	-	-
-	66	-	-	2 131
1800	72	2 357	-	2 568
-	78	2 929	-	3 113
2000	-	2 929	-	3 113
-	84	-	-	3 755
2200	-	3 422	-	-
-	90	-	-	4 797
2400	-	4 094	-	-

Order code for "Design", options B, G ≥ DN 450 (18")				
Nominal diameter		Reference values		
		EN (DIN) (PN 6)	ASME (Class 150), AWWA (Class D)	
[mm]	[in]	[kg]	[kg]	
450	18	161	255	
500	20	156	285	
600	24	208	405	
700	28	304	400	
-	30	-	460	
800	32	357	550	
900	36	485	800	
1000	40	589	900	
-	42	-	1 100	
1200	48	850	1 400	
-	54	850	2 200	
1400	-	1 300	-	
-	60	-	2 700	
1600	-	1 845	-	
-	66	-	3 700	
1800	72	2 357	4 100	
-	78	2 929	4 600	
2000	-	2 929	-	

Weight in US units

Order code for "Design", options A, B, C, D, E DN 25 to 400, DN 1" to 16"		
Nominal diameter		Reference values ASME (Class 150)
[mm]	[in]	[lb]
25	1	11
32	-	-
40	1 ½	15
50	2	20
65	-	-
80	3	31
100	4	42
125	-	-
150	6	73
200	8	115
250	10	198
300	12	284
350	14	379
375	15	-
400	16	448

Order code for "Design", options A, F ≥ DN 450 (18")		
Nominal diameter		Reference values ASME (Class 150), AWWA (Class D)
[mm]	[in]	[lb]
450	18	421
500	20	503
600	24	666
700	28	587
-	30	701
800	32	845
900	36	1036
1000	40	1294
-	42	1477
1200	48	1987
-	54	2807
1400	-	-
-	60	3515
1600	-	-
-	66	4699
1800	72	5662
-	78	6864
2000	-	6864

Order code for "Design", options A, F ≥ DN 450 (18")		
Nominal diameter		Reference values ASME (Class 150), AWWA (Class D)
[mm]	[in]	[lb]
-	84	8280
2200	-	-
-	90	10 577
2400	-	-

Order code for "Design", options B, G ≥ DN 450 (18")		
Nominal diameter		Reference values ASME (Class 150), AWWA (Class D)
[mm]	[in]	[lb]
450	18	562
500	20	628
600	24	893
700	28	882
-	30	1014
800	32	1213
900	36	1764
1000	40	1984
-	42	2426
1200	48	3087
-	54	4851
1400	-	-
-	60	5954
1600	-	-
-	66	8158
1800	72	9040
-	78	10 143
2000	-	-

Measuring tube specification

Nominal diameter		EN (DIN)	Pressure rating			Measuring tube internal diameter					
			ASME AWWA	AS 2129 AS 4087	JIS	Hard rubber		Polyurethane		PTFE	
[mm]	[in]					[mm]	[in]	[mm]	[in]	[mm]	[in]
25	1	PN 40	Class 150	-	20K	-	-	24	0.94	25	0.98
32	-	PN 40	-	-	20K	-	-	32	1.26	34	1.34
40	1 ½	PN 40	Class 150	-	20K	-	-	38	1.50	40	1.57
50	2	PN 40	Class 150	Table E, PN 16	10K	50	1.97	50	1.97	52	2.05
50 ¹⁾	2	PN 40	Class 150	Table E, PN 16	10K	32	1.26	-	-	-	-
65	-	PN 16	-	-	10K	66	2.60	66	2.60	68	2.68

Nominal diameter		Pressure rating				Measuring tube internal diameter					
		EN (DIN)	ASME AWWA	AS 2129 AS 4087	JIS	Hard rubber		Polyurethane		PTFE	
[mm]	[in]					[mm]	[in]	[mm]	[in]	[mm]	[in]
65 ¹⁾	-	PN 16	-	-	10K	38	1.50	-	-	-	-
80	3	PN 16	Class 150	Table E, PN 16	10K	79	3.11	79	3.11	80	3.15
80 ¹⁾	3	PN 16	Class 150	Table E, PN 16	10K	50	1.97	-	-	-	-
100	4	PN 16	Class 150	Table E, PN 16	10K	102	4.02	102	4.02	104	4.09
100 ¹⁾	4	PN 16	Class 150	Table E, PN 16	10K	66	2.60	-	-	-	-
125	-	PN 16	-	-	10K	127	5.00	127	5.00	130	5.12
125 ¹⁾	-	PN 16	-	-	10K	79	3.11	-	-	-	-
150	6	PN 16	Class 150	Table E, PN 16	10K	156	6.14	156	6.14	156	6.14
150 ¹⁾	6	PN 16	Class 150	Table E, PN 16	10K	102	4.02	-	-	-	-
200	8	PN 10	Class 150	Table E, PN 16	10K	204	8.03	204	8.03	202	7.95
200 ¹⁾	8	PN 16	Class 150	Table E, PN 16	10K	127	5.00	-	-	-	-
250	10	PN 10	Class 150	Table E, PN 16	10K	258	10.2	258	10.2	256	10.08
250 ¹⁾	10	PN 16	Class 150	Table E, PN 16	10K	156	6.14	-	-	-	-
300	12	PN 10	Class 150	Table E, PN 16	10K	309	12.2	309	12.2	306	12.05
300 ¹⁾	12	PN 16	Class 150	Table E, PN 16	10K	204	8.03	-	-	-	-
350	14	PN 6	Class 150	Table E, PN 16	10K	337	13.3	342	13.5	-	-
375	15	-	-	PN 16	10K	389	15.3	-	-	-	-
400	16	PN 6	Class 150	Table E, PN 16	10K	387	15.2	392	15.4	-	-
450	18	PN 6	Class 150	-	10K	436	17.1	437	17.2	-	-
500	20	PN 6	Class 150	Table E, PN 16	10K	487	19.1	492	19.4	-	-
600	24	PN 6	Class 150	Table E, PN 16	10K	589	23.0	594	23.4	-	-
700	28	PN 6	Class D	Table E, PN 16	10K	688	27.1	692	27.2	-	-
750	30	-	Class D	Table E, PN 16	10K	737	29.1	742	29.2	-	-
800	32	PN 6	Class D	Table E, PN 16	-	788	31.0	794	31.3	-	-
900	36	PN 6	Class D	Table E, PN 16	-	889	35.0	891	35.1	-	-
1000	40	PN 6	Class D	Table E, PN 16	-	991	39.0	994	39.1	-	-
-	42	-	Class D	-	-	1043	41.1	1043	41.1	-	-
1200	48	PN 6	Class D	Table E, PN 16	-	1191	46.9	1197	47.1	-	-
-	54	-	Class D	-	-	1339	52.7	-	-	-	-
1400	-	PN 6	-	-	-	1402	55.2	-	-	-	-
-	60	-	Class D	-	-	1492	58.7	-	-	-	-
1600	-	PN 6	-	-	-	1600	63.0	-	-	-	-
-	66	-	Class D	-	-	1638	64.5	-	-	-	-
1800	72	PN 6	-	-	-	1786	70.3	-	-	-	-
-	78	-	Class D	-	-	1989	78.3	-	-	-	-
2000	-	PN 6	-	-	-	1989	78.3	-	-	-	-
-	84	-	Class D	-	-	2099	84.0	-	-	-	-
2200	-	PN 6	-	-	-	2194	87.8	-	-	-	-

Nominal diameter		Pressure rating				Measuring tube internal diameter					
		EN (DIN)	ASME AWWA	AS 2129 AS 4087	JIS	Hard rubber		Polyurethane		PTFE	
[mm]	[in]					[mm]	[in]	[mm]	[in]	[mm]	[in]
-	90	-	Class D	-	-	2246	89.8	-	-	-	-
2400	-	PN 6	-	-	-	2391	94.1	-	-	-	-

1) Order code for "Design", option C

Materials

Transmitter housing

Compact version

- Order code for "Housing", option **A** "Compact, alu, coated": Aluminum, AlSi10Mg, coated
- Order code for "Housing", option **M**: polycarbonate plastic
- Window material:
 - For order code for "Housing", option **A**: glass
 - For order code for "Housing", option **M**: plastic

Remote version (wall-mount housing)

- Order code for "Housing", option **P** "Remote, alu, coated": Aluminum, AlSi10Mg, coated
- Order code for "Housing", option **N**: polycarbonate plastic
- Window material:
 - For order code for "Housing", option **P**: glass
 - For order code for "Housing", option **N**: plastic

Sensor connection housing

- Aluminum, AlSi10Mg, coated
- Polycarbonate plastic (only in conjunction with order code for "Sensor option", options CA...CE)

Cable entries/cable glands

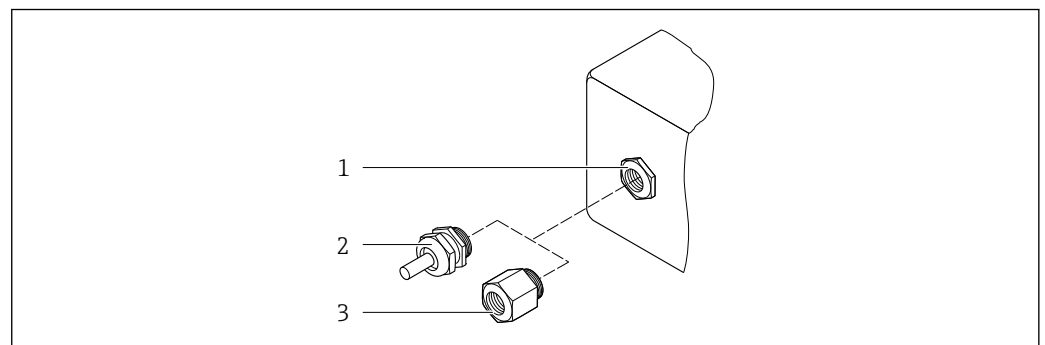

36 Possible cable entries/cable glands

- 1 Female thread M20 × 1.5
- 2 Cable gland M20 × 1.5
- 3 Adapter for cable entry with internal thread G ½" or NPT ½"

Compact and remote versions and sensor connection housing

Cable entry/cable gland	Material
Cable gland M20 × 1.5	Plastic
Remote version: cable gland M20 × 1.5 Option of reinforced connecting cable	<ul style="list-style-type: none"> ■ Sensor connection housing: Nickel-plated brass ■ Transmitter wall-mount housing: Plastic
Adapter for cable entry with internal thread G ½" or NPT ½"	Nickel-plated brass

Device plug

Electrical connection	Material
Plug M12x1	<ul style="list-style-type: none"> ■ Socket: Stainless steel, 1.4404 (316L) ■ Contact housing: Polyamide ■ Contacts: Gold-plated brass

Connecting cable for remote version

Electrode and coil current cable

- Standard cable: PVC cable with copper shield
- Reinforced cable: PVC cable with copper shield and additional steel wire braided jacket

Sensor housing

- DN 25 to 300 (1 to 12")
 - Aluminum half-shell housing, aluminum, AlSi10Mg, coated
 - Fully welded carbon steel housing with protective varnish
- DN 350 to 2400 (14 to 90")
 - Fully welded carbon steel housing with protective varnish

Measuring tubes

- DN 25 to 600 (1 to 24")
 - Stainless steel: 1.4301, 1.4306, 304, 304L
- DN 700 to 2400 (28 to 90")
 - Stainless steel: 1.4301, 304

Liner

- DN 25 to 300 (1 to 12"): PTFE
- DN 25 to 1200 (1 to 48"): polyurethane
- DN 50 to 2400 (2 to 90"): hard rubber

Electrodes

- Stainless steel, 1.4435 (316L)
- Alloy C22, 2.4602 (UNS N06022)
- Tantalum

Process connections

-  For flanges made of carbon steel:
 - DN ≤ 300 (12"): with Al/Zn protective coating or protective varnish
 - DN ≥ 350 (14"): protective varnish

-  All carbon steel lap joint flanges are supplied with a hot-dip galvanized finish.

EN 1092-1 (DIN 2501)

Fixed flange

- Carbon steel:
 - DN ≤ 300: S235JRG2, S235JR+N, P245GH, A105, E250C
 - DN 350 to 2400: P245GH, S235JRG2, A105, E250C
- Stainless steel:
 - DN ≤ 300: 1.4404, 1.4571, F316L
 - DN 350 to 600: 1.4571, F316L, 1.4404
 - DN 700 to 1000: 1.4404, F316L

Lap joint flange

- Carbon steel DN ≤ 300: S235JRG2, A105, E250C
- Stainless steel DN ≤ 300: 1.4306, 1.4404, 1.4571, F316L

Lap joint flange, stamped plate

- Carbon steel DN ≤ 300: S235JRG2 similar to S235JR+AR or 1.0038
- Stainless steel DN ≤ 300: 1.4301 similar to 304

ASME B16.5

Fixed flange, lap joint flange

- Carbon steel: A105
- Stainless steel: F316L

JIS B2220

- Carbon steel: A105, A350 LF2
- Stainless steel: F316L

AWWA C207

Carbon steel: A105, P265GH, A181 Class 70, E250C, S275JR

AS 2129

Carbon steel: A105, E250C, P235GH, P265GH, S235JRG2

AS 4087

Carbon steel: A105, P265GH, S275JR

Seals

As per DIN EN 1514-1, form IBC

Accessories

Display guard

Stainless steel, 1.4301 (304L)

Ground disks

- Stainless steel, 1.4435 (316L)
- Alloy C22, 2.4602 (UNS N06022)
- Tantalum

Fitted electrodes

Measurement, reference and empty pipe detection electrodes available as standard with:

- 1.4435 (316L)
- Alloy C22, 2.4602 (UNS N06022)
- Tantalum

Process connections

- EN 1092-1 (DIN 2501)
 - DN ≤ 300: fixed flange (PN 10/16/25/40) = Form A, lap joint flange (PN 10/16), lap joint flange, stamped plate (PN 10) = Form A
 - DN ≥ 350: fixed flange (PN 6/10/16/25) = flat face (Form B)
 - DN 450 to 2400: fixed flange (PN 6/10/16) = flat face (Form B)
- ASME B16.5
 - DN 350 to 2400 (14 to 90"): fixed flange (Class 150)
 - DN 25 to 600 (1 to 24"): lap joint flange (Class 150)
 - DN 25 to 150 (1 to 6"): fixed flange (Class 300)
- JIS B2220
 - DN 50 to 750: fixed flange (10K)
 - DN 25 to 600: fixed flange (20K)
- AWWA C207
 - DN 48 to 90": fixed flange (Class D)
- AS 2129
 - DN 50 to 1200: fixed flange (Table E)
- AS 4087
 - DN 50 to 1200: fixed flange (PN 16)



For information on the different materials used in the process connections → 84

Surface roughness

Electrodes with 1.4435 (316L); Alloy C22, 2.4602 (UNS N06022); tantalum:
 ≤ 0.3 to 0.5 μm (11.8 to 19.7 μin)
 (All data relate to parts in contact with fluid)

Human interface

Operating concept**Operator-oriented menu structure for user-specific tasks**

- Commissioning
- Operation
- Diagnostics
- Expert level

Fast and safe commissioning

- Guided menus ("Make-it-run" wizards) for applications
- Menu guidance with brief descriptions of the individual parameter functions
- Access to the device via Web server or SmartBlue App → 97
- WLAN access to the device via mobile handheld terminal, tablet or smart phone

Reliable operation

- Operation in local language
- Uniform operating philosophy applied to device and operating tools
- If replacing electronic modules, transfer the device configuration via the integrated memory (HistoROM backup) which contains the process and measuring device data and the event logbook. No need to reconfigure.

Efficient diagnostics increase measurement availability

- Troubleshooting measures can be called up via the device and in the operating tools
- Diverse simulation options, logbook for events that occur and optional line recorder functions

Languages

Can be operated in the following languages:

- Via local operation:
 - English, German, French, Spanish, Italian, Dutch, Portuguese, Polish, Russian, Turkish, Chinese, Japanese, Bahasa (Indonesian), Vietnamese, Czech, Swedish
- Via "FieldCare", "DeviceCare" operating tool:
 - English, German, French, Spanish, Italian, Chinese, Japanese
- Via Web browser (only available for device versions with HART, PROFIBUS DP and EtherNet/IP):
 - English, German, French, Spanish, Italian, Dutch, Portuguese, Polish, Russian, Turkish, Chinese, Japanese, Bahasa (Indonesian), Vietnamese, Czech, Swedish

Local display

Via display module

Features:

- Standard features 4-line, illuminated, graphic display; touch control
- Order code for "Display; operation", option BA "WLAN" = standard features plus access via Web browser

 Information about WLAN interface →  89

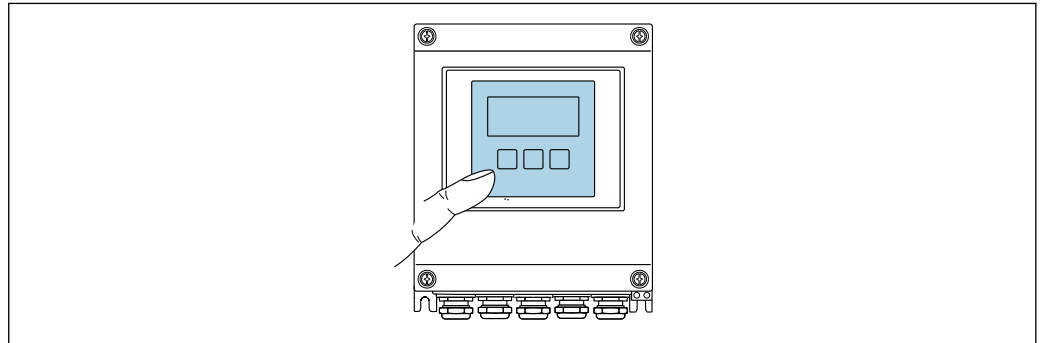



A0032074

 37 Operation with touch control

Display elements

- 4-line, illuminated, graphic display
- White background lighting; switches to red in event of device errors
- Format for displaying measured variables and status variables can be individually configured
- Permitted ambient temperature for the display: -20 to +60 °C (-4 to +140 °F)
The readability of the display may be impaired at temperatures outside the temperature range.

Operating elements

- External operation via touch control (3 optical keys) without opening the housing: , , 
- Operating elements also accessible in the various zones of the hazardous area

Remote operation

Via HART protocol

This communication interface is available in device versions with a HART output.

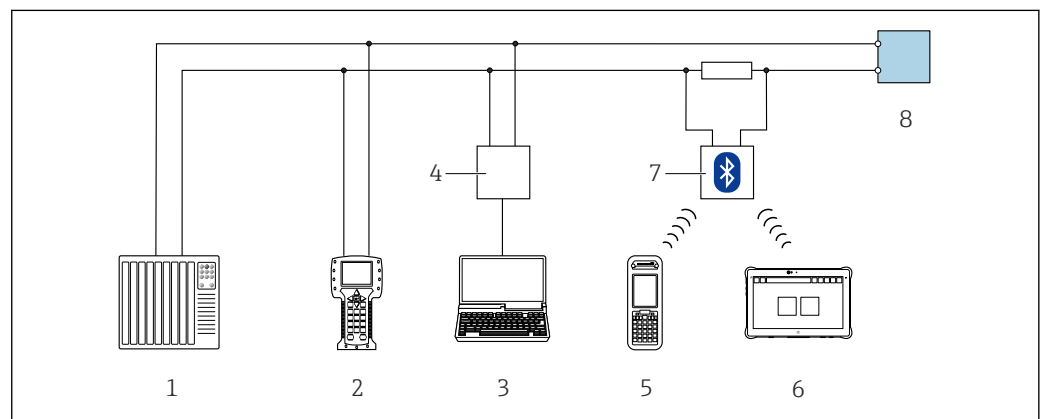

A0028747

 38 Options for remote operation via HART protocol

- 1 Control system (e.g. PLC)
- 2 Field Communicator 475
- 3 Computer with operating tool (e.g. FieldCare, AMS Device Manager, SIMATIC PDM)
- 4 Commubox FXA195 (USB)
- 5 Field Xpert SFX350 or SFX370
- 6 Field Xpert SMT70
- 7 VIATOR Bluetooth modem with connecting cable
- 8 Transmitter

Via PROFIBUS DP network

This communication interface is available in device versions with PROFIBUS DP.

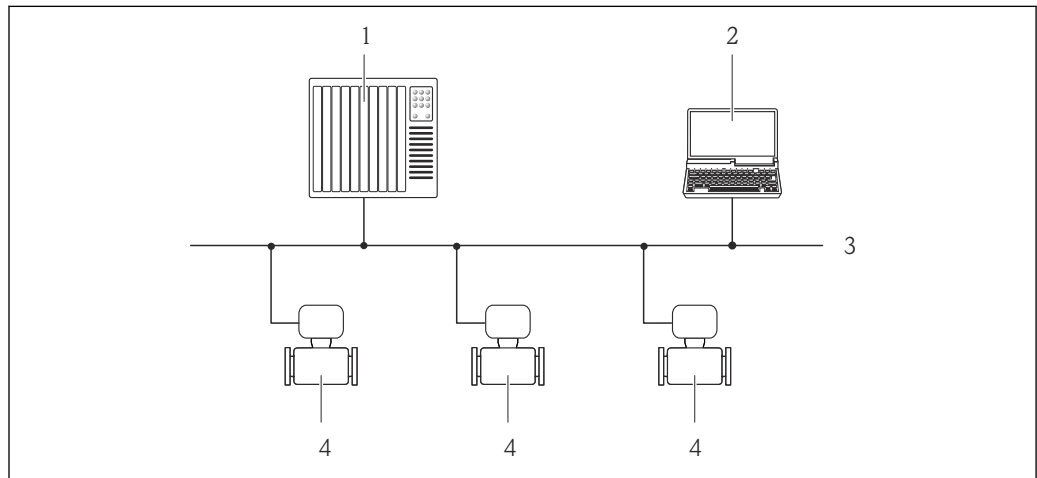

A0020903

39 Options for remote operation via PROFIBUS DP network

- 1 Automation system
- 2 Computer with PROFIBUS network card
- 3 PROFIBUS DP network
- 4 Measuring device

Via Modbus RS485 protocol

This communication interface is available in device versions with a Modbus-RS485 output.

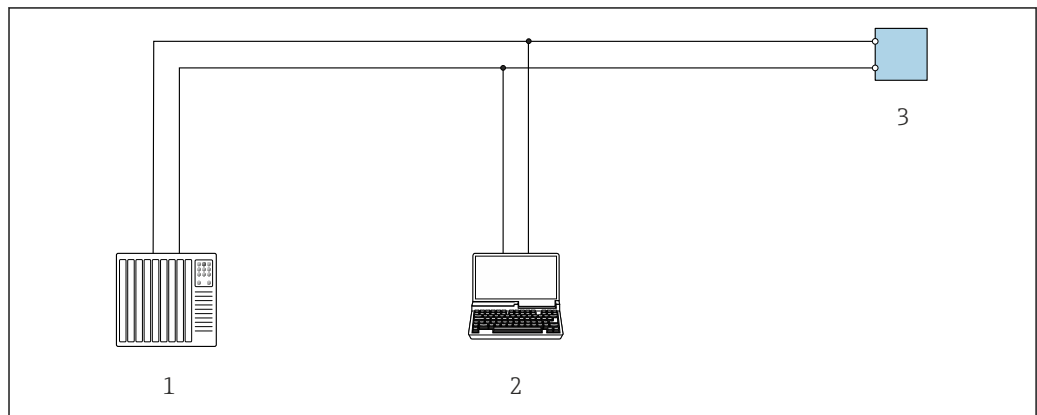

A0029437

40 Options for remote operation via Modbus-RS485 protocol (active)

- 1 Control system (e.g. PLC)
- 2 Computer with Web browser (e.g. Internet Explorer) for accessing the integrated device Web server or with operating tool (e.g. FieldCare, DeviceCare) with COM DTM "CDI Communication TCP/IP" or Modbus DTM
- 3 Transmitter

Via EtherNet/IP network

This communication interface is available in device versions with EtherNet/IP.

Star topology

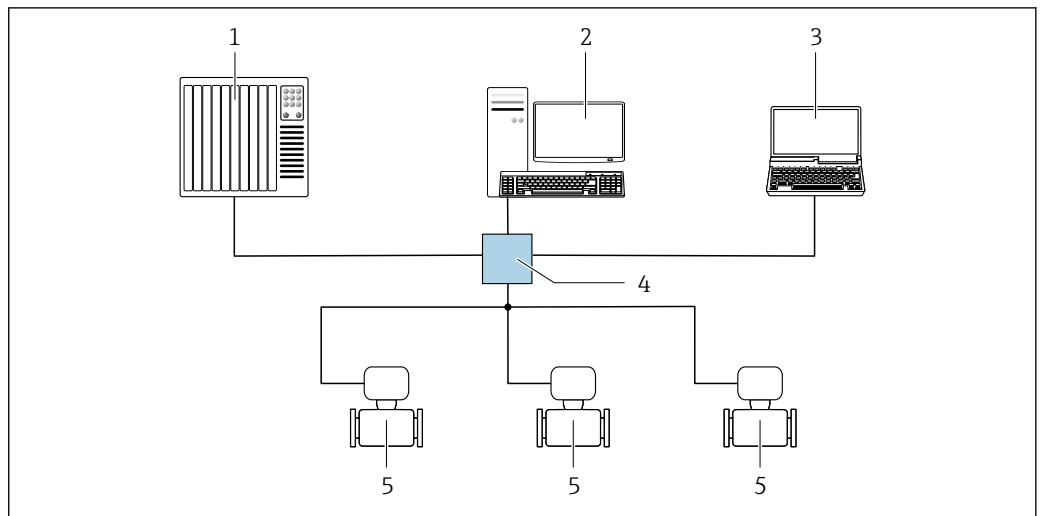

A0032078

41 Options for remote operation via EtherNet/IP network: star topology

- 1 Automation system, e.g. "RSLogix" (Rockwell Automation)
- 2 Workstation for measuring device operation: with Custom Add-On Profile for "RSLogix 5000" (Rockwell Automation) or with Electronic Data Sheet (EDS)
- 3 Computer with Web browser (e.g. Internet Explorer) for accessing the integrated device Web server or computer with operating tool (e.g. FieldCare, DeviceCare) with COM DTM "CDI Communication TCP/IP"
- 4 Ethernet switch
- 5 Measuring device

Service interface

Via service interface (CDI-RJ45)

This communication interface is present in the following device version:

- Order code for "Output", option H: 4-20/0-20 mA HART, pulse/frequency/switch output
- Order code for "Output", option I: 4-20/0-20 mA HART, pulse/frequency/switch output, status input
- Order code for "Output", option L: PROFIBUS DP
- Order code for "Output", option N: EtherNet/IP
- Order code for "Output", option M: Modbus RS485

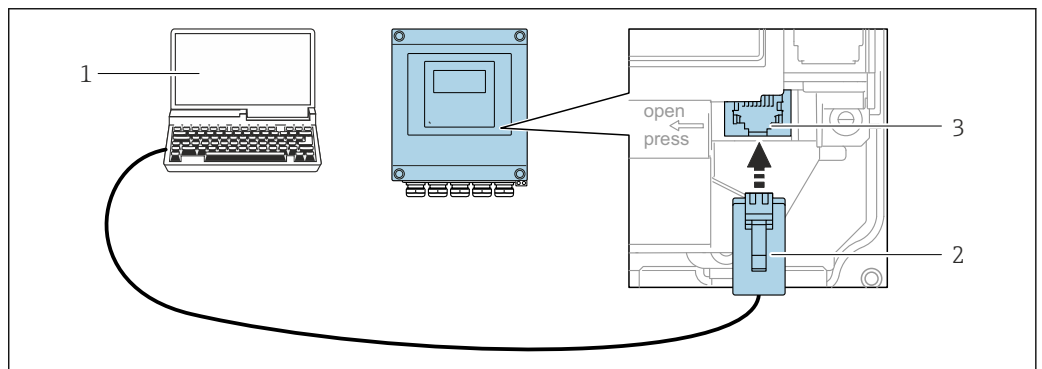

A0029163

42 Connection via service interface (CDI-RJ45)

- 1 Computer with Web browser (e.g. Microsoft Internet Explorer, Microsoft Edge) for accessing the integrated device Web server or with "FieldCare", "DeviceCare" operating tool with COM DTM "CDI Communication TCP/IP" or Modbus DTM
- 2 Standard Ethernet connecting cable with RJ45 plug
- 3 Service interface (CDI-RJ45) of the measuring device with access to the integrated Web server

Via WLAN interface

The optional WLAN interface is available on the following device version:

Order code for "Display", option BA "WLAN":
4-line, illuminated, graphic display; touch control + WLAN

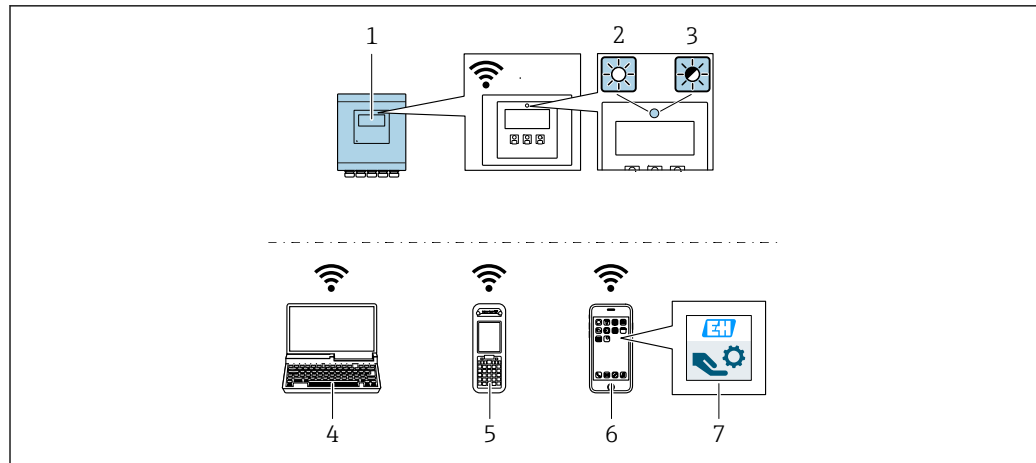



A0032079

- 1 Transmitter with integrated WLAN antenna
- 2 LED lit constantly: WLAN reception is enabled on measuring device
- 3 LED flashing: WLAN connection established between operating unit and measuring device
- 4 Computer with WLAN interface and Web browser (e.g. Microsoft Internet Explorer, Microsoft Edge) for accessing the integrated device Web server or with operating tool (e.g. FieldCare, DeviceCare)
- 5 Mobile handheld terminal with WLAN interface and Web browser (e.g. Microsoft Internet Explorer, Microsoft Edge) for accessing the integrated device Web server or operating tool (e.g. FieldCare, DeviceCare)
- 6 Smart phone or tablet (e.g. Field Xpert SMT70)
- 7 SmartBlue App

Function	WLAN: IEEE 802.11 b/g (2.4 GHz) <ul style="list-style-type: none"> ▪ Access point with DHCP server (default setting) ▪ Network
Encryption	WPA2-PSK AES-128 (in accordance with IEEE 802.11i)
Configurable WLAN channels	1 to 11
Degree of protection	IP67
Available antennas	<ul style="list-style-type: none"> ▪ Internal antenna ▪ External antenna (optional) In the event of poor transmission/reception conditions at the place of installation. Available as an accessory . <p> Only one antenna active in each case!</p>
Range	<ul style="list-style-type: none"> ▪ Internal antenna: typically 10 m (32 ft) ▪ External antenna: typically 50 m (164 ft)
Materials (external antenna)	<ul style="list-style-type: none"> ▪ Antenna: ASA plastic (acrylic ester-styrene-acrylonitrile) and nickel-plated brass ▪ Adapter: Stainless steel and nickel-plated brass ▪ Cable: Polyethylene ▪ Connector: Nickel-plated brass ▪ Angle bracket: Stainless steel

Supported operating tools

Different operating tools can be used for local or remote access to the measuring device. Depending on the operating tool used, access is possible with different operating units and via a variety of interfaces.

Supported operating tools	Operating unit	Interface	Additional information
Web browser	Notebook, PC or tablet with Web browser	<ul style="list-style-type: none"> ■ CDI-RJ45 service interface ■ WLAN interface ■ Ethernet-based fieldbus (EtherNet/IP) 	Special Documentation for device
DeviceCare SFE100	Notebook, PC or tablet with Microsoft Windows system	<ul style="list-style-type: none"> ■ CDI-RJ45 service interface ■ WLAN interface ■ Fieldbus protocol 	→  97
FieldCare SFE500	Notebook, PC or tablet with Microsoft Windows system	<ul style="list-style-type: none"> ■ CDI-RJ45 service interface ■ WLAN interface ■ Fieldbus protocol 	→  97
Device Xpert	Field Xpert SFX 100/350/370	HART and FOUNDATION Fieldbus fieldbus protocol	Operating Instructions BA01202S Device description files: Use update function of handheld terminal

 Other operating tools based on FDT technology with a device driver such as DTM/iDTM or DD/EDD can be used for device operation. These operating tools are available from the individual manufacturers. Integration into the following operating tools, among others, is supported:

- FactoryTalk AssetCentre (FTAC) by Rockwell Automation → www.rockwellautomation.com
- Process Device Manager (PDM) by Siemens → www.siemens.com
- Asset Management Solutions (AMS) by Emerson → www.emersonprocess.com
- FieldCommunicator 375/475 by Emerson → www.emersonprocess.com
- Field Device Manager (FDM) by Honeywell → www.honeywellprocess.com
- FieldMate by Yokogawa → www.yokogawa.com
- PACTWare → www.pactware.com

The associated device description files are available at: www.endress.com → Downloads

Web server

Thanks to the integrated Web server, the device can be operated and configured via a Web browser and via a service interface (CDI-RJ45) or via a WLAN interface. The structure of the operating menu is the same as for the local display. In addition to the measured values, status information on the device is also displayed and allows the user to monitor the status of the device. Furthermore the device data can be managed and the network parameters can be configured.

A device that has a WLAN interface (can be ordered as an option) is required for the WLAN connection: order code for "Display", option BA "WLAN": 4-line, illuminated; touch control + WLAN. The device acts as an Access Point and enables communication by computer or a mobile handheld terminal.

Supported functions

Data exchange between the operating unit (such as a notebook for example) and the measuring device:

- Upload the configuration from the measuring device (XML format, configuration backup)
- Save the configuration to the measuring device (XML format, restore configuration)
- Export event list (.csv file)
- Export parameter settings (.csv file or PDF file, document the measuring point configuration)
- Export the Heartbeat verification log (PDF file, only available with the "Heartbeat Verification" application package)
- Flash firmware version for device firmware upgrade, for instance
- Download driver for system integration
- Visualize up to 1000 saved measured values (only available with the **Extended HistoROM** application package →  95)

 Web server special documentation →  98

HistoROM data management The measuring device features HistoROM data management. HistoROM data management comprises both the storage and import/export of key device and process data, making operation and servicing far more reliable, secure and efficient.

Additional information on the data storage concept

There are different types of data storage units in which device data are stored and used by the device:

	Device memory	T-DAT	S-DAT
Available data	<ul style="list-style-type: none"> ▪ Device firmware package ▪ Driver for system integration e.g.: <ul style="list-style-type: none"> ▪ GSD for PROFIBUS DP ▪ EDS for EtherNet/IP 	<ul style="list-style-type: none"> ▪ Event history, such as diagnostic events ▪ Measured value memory ("Extended HistoROM" order option) ▪ Current parameter data record (used by firmware at run time) ▪ Maximum indicators (min/max values) ▪ Totalizer values 	<ul style="list-style-type: none"> ▪ Sensor data: diameter etc. ▪ Serial number ▪ User-specific access code (to use the "Maintenance" user role) ▪ Calibration data ▪ Device configuration (e.g. SW options, fixed I/O or multi I/O)
Storage location	Fixed on the user interface board in the connection compartment	Can be plugged into the user interface board in the connection compartment	In the sensor plug in the transmitter neck part

Data backup

Automatic

- The most important device data (sensor and transmitter) are automatically saved in the DAT modules
- If the transmitter or measuring device is replaced: once the T-DAT containing the previous device data has been exchanged, the new measuring device is ready for operation again immediately without any errors
- If the sensor is replaced: once the sensor has been replaced, new sensor data are transferred from the S-DAT in the measuring device and the measuring device is ready for operation again immediately without any errors

Data transfer

Manual

- Transfer of a device configuration to another device using the export function of the specific operating tool, e.g. with FieldCare, DeviceCare or Web server: to duplicate the configuration or to store in an archive (e.g. for backup purposes)
- Transmission of the drivers for system integration via Web server, e.g.:
 - GSD for PROFIBUS DP
 - EDS for EtherNet/IP

Event list

Automatic

- Chronological display of up to 20 event messages in the events list
- If the **Extended HistoROM** application package (order option) is enabled: up to 100 event messages are displayed in the events list along with a time stamp, plain text description and remedial measures
- The events list can be exported and displayed via a variety of interfaces and operating tools e.g. DeviceCare, FieldCare or Web server

Data logging

Manual



If the **Extended HistoROM** application package (order option) is enabled:

- Record up to 1 000 measured values via 1 to 4 channels
- User configurable recording interval
- Record up to 250 measured values via each of the 4 memory channels
- Export the measured value log via a variety of interfaces and operating tools e.g. FieldCare, DeviceCare or web server

Certificates and approvals



Currently available certificates and approvals can be called up via the product configurator.

CE mark	<p>The device meets the legal requirements of the applicable EU Directives. These are listed in the corresponding EU Declaration of Conformity along with the standards applied.</p> <p>Endress+Hauser confirms successful testing of the device by affixing to it the CE mark.</p>
RCM-tick symbol	<p>The measuring system meets the EMC requirements of the "Australian Communications and Media Authority (ACMA)".</p>
Ex approval	<p>The devices are certified for use in hazardous areas and the relevant safety instructions are provided in the separate "Control Drawing" document. Reference is made to this document on the nameplate.</p>
Drinking water approval	<ul style="list-style-type: none"> ■ ACS ■ KTW/W270 ■ NSF 61 ■ WRAS BS 6920
HART certification	<p>HART interface</p> <p>The measuring device is certified and registered by the FieldComm Group. The measuring system meets all the requirements of the following specifications:</p> <ul style="list-style-type: none"> ■ Certified according to HART 7 ■ The device can also be operated with certified devices of other manufacturers (interoperability)
Certification PROFIBUS	<p>PROFIBUS interface</p> <p>The measuring device is certified and registered by the PNO (PROFIBUS User Organization Organization). The measuring system meets all the requirements of the following specifications:</p> <ul style="list-style-type: none"> ■ Certified in accordance with PROFIBUS PA Profile 3.02 ■ The device can also be operated with certified devices of other manufacturers (interoperability)
Modbus RS485 certification	<p>The measuring device meets all the requirements of the MODBUS/TCP conformity test and has the "MODBUS/TCP Conformance Test Policy, Version 2.0". The measuring device has successfully passed all the test procedures carried out.</p>
EtherNet/IP certification	<p>The measuring device is certified and registered by the ODVA (Open Device Vendor Association). The measuring system meets all the requirements of the following specifications:</p> <ul style="list-style-type: none"> ■ Certified in accordance with the ODVA Conformance Test ■ EtherNet/IP Performance Test ■ EtherNet/IP PlugFest compliance ■ The device can also be operated with certified devices of other manufacturers (interoperability)
Radio approval	<p>The measuring device has radio approval.</p> <p> For detailed information regarding radio approval, see Special Documentation →  98</p>
Measuring instrument approval	<p>The measuring device is (optionally) approved as a cold water meter (MI-001) for volume measurement in service subject to legal metrological control in accordance with the European Measuring Instruments Directive 2014/32/EU (MID).</p> <p>The measuring device is qualified to OIML R49: 2013.</p>
Other standards and guidelines	<ul style="list-style-type: none"> ■ EN 60529 Degrees of protection provided by enclosures (IP code) ■ EN 61010-1 Safety requirements for electrical equipment for measurement, control and laboratory use - general requirements ■ IEC/EN 61326 Emission in accordance with Class A requirements. Electromagnetic compatibility (EMC requirements).

- ANSI/ISA-61010-1 (82.02.01)
Safety Requirements for Electrical Equipment for Measurement, Control and Laboratory Use - Part 1 General Requirements
- CAN/CSA-C22.2 No. 61010-1-12
Safety Requirements for Electrical Equipment for Measurement, Control and Laboratory Use - Part 1 General Requirements
- NAMUR NE 21
Electromagnetic compatibility (EMC) of industrial process and laboratory control equipment
- NAMUR NE 32
Data retention in the event of a power failure in field and control instruments with microprocessors
- NAMUR NE 43
Standardization of the signal level for the breakdown information of digital transmitters with analog output signal.
- NAMUR NE 53
Software of field devices and signal-processing devices with digital electronics
- NAMUR NE 105
Specifications for integrating fieldbus devices in engineering tools for field devices
- NAMUR NE 107
Self-monitoring and diagnosis of field devices
- NAMUR NE 131
Requirements for field devices for standard applications

Ordering information

Detailed ordering information is available from the following sources:

- In the Product Configurator on the Endress+Hauser website: www.endress.com -> Click "Corporate" -> Select your country -> Click "Products" -> Select the product using the filters and search field -> Open product page -> The "Configure" button to the right of the product image opens the Product Configurator.
- From your Endress+Hauser Sales Center: www.addresses.endress.com

Product Configurator - the tool for individual product configuration

- Up-to-the-minute configuration data
- Depending on the device: Direct input of measuring point-specific information such as measuring range or operating language
- Automatic verification of exclusion criteria
- Automatic creation of the order code and its breakdown in PDF or Excel output format
- Ability to order directly in the Endress+Hauser Online Shop

Product generation index

Release date	Product root	Modification
01.07.2012	5W4B	Original
01.11.2016	5W4C	<ul style="list-style-type: none"> ■ Web server: current version ■ Logbook: current concept, including Parameter Change ■ Upload/download: current concept ■ Heartbeat Technology: new hardware, diagnostics, events ■ Security concept: encrypted password transmission ■ WLAN ■ Custody transfer mode

 More information is available from your Sales Center or at:
www.service.endress.com → Downloads

Application packages

Many different application packages are available to enhance the functionality of the device. Such packages might be needed to address safety aspects or specific application requirements.

The application packages can be ordered with the device or subsequently from Endress+Hauser. Detailed information on the order code in question is available from your local Endress+Hauser sales center or on the product page of the Endress+Hauser website: www.endress.com.

Cleaning	Package	Description
	Electrode cleaning circuit (ECC)	The electrode cleaning circuit (ECC) function has been developed to have a solution for applications where magnetite (Fe ₃ O ₄) deposits frequently occur (e.g. hot water). Since magnetite is highly conductive this build up leads to measuring errors and ultimately to the loss of signal. The application package is designed to AVOID build up of highly conductive matter and thin layers (typical of magnetite).

Diagnostics functions	Package	Description
	Extended HistoROM	Comprises extended functions concerning the event log and the activation of the measured value memory. Event log: Memory volume is extended from 20 message entries (standard version) to up to 100 entries. Data logging (line recorder): <ul style="list-style-type: none"> ▪ Memory capacity for up to 1000 measured values is activated. ▪ 250 measured values can be output via each of the 4 memory channels. The recording interval can be defined and configured by the user. ▪ Measured value logs can be accessed via the local display or operating tool e.g. FieldCare, DeviceCare or Web server.



Heartbeat Technology	Package	Description
	Heartbeat Verification +Monitoring	<p>Heartbeat Verification Meets the requirement for traceable verification to DIN ISO 9001:2008 Chapter 7.6 a) "Control of monitoring and measuring equipment".</p> <ul style="list-style-type: none"> ▪ Functional testing in the installed state without interrupting the process. ▪ Traceable verification results on request, including a report. ▪ Simple testing process via local operation or other operating interfaces. ▪ Clear measuring point assessment (pass/fail) with high test coverage within the framework of manufacturer specifications. ▪ Extension of calibration intervals according to operator's risk assessment. <p>Heartbeat Monitoring Continuously supplies data, which are characteristic of the measuring principle, to an external condition monitoring system for the purpose of preventive maintenance or process analysis. These data enable the operator to:</p> <ul style="list-style-type: none"> ▪ Draw conclusions - using these data and other information - about the impact process influences (such as corrosion, abrasion, buildup etc.) have on the measuring performance over time. ▪ Schedule servicing in time. ▪ Monitor the process or product quality, e.g. gas pockets.

Accessories

Various accessories, which can be ordered with the device or subsequently from Endress+Hauser, are available for the device. Detailed information on the order code in question is available from your local Endress+Hauser sales center or on the product page of the Endress+Hauser website: www.endress.com.

Device-specific accessories





For the transmitter







Accessories	Description
Promag 400 transmitter	Transmitter for replacement or storage. Use the order code to define the following specifications: <ul style="list-style-type: none"> ▪ Approvals ▪ Output / input ▪ Display/operation ▪ Housing ▪ Software  For details, see Installation Instructions EA00104D
Display guard	Is used to protect the display against impact or scoring from sand in desert areas.  Order number: 71228792  Installation Instructions EA01093D
Connecting cable for remote version	Coil current and electrode cables, various lengths, reinforced cables available on request.
Ground cable	Set, consisting of two ground cables for potential equalization.
Post mounting kit	Post mounting kit for transmitter.
Compact → Remote conversion kit	For converting a compact device version to a remote device version.
Conversion kit Promag 50/53 → Promag 400	For converting a Promag with transmitter 50/53 to a Promag 400.

For the sensor



Accessories	Description
Ground disks	Are used to ground the medium in lined measuring tubes to ensure proper measurement.  For details, see Installation Instructions EA00070D

Communication-specific accessories



Accessories	Description
Commubox FXA195 HART	For intrinsically safe HART communication with FieldCare via the USB interface.  Technical Information TI00404F
Commubox FXA291	Connects Endress+Hauser field devices with a CDI interface (= Endress+Hauser Common Data Interface) and the USB port of a computer or laptop.  Technical Information TI405C/07
HART Loop Converter HMX50	Is used to evaluate and convert dynamic HART process variables to analog current signals or limit values.  <ul style="list-style-type: none"> ▪ Technical Information TI00429F ▪ Operating Instructions BA00371F
Wireless HART adapter SWA70	Is used for the wireless connection of field devices. The WirelessHART adapter can be easily integrated into field devices and existing infrastructures, offers data protection and transmission safety and can be operated in parallel with other wireless networks with minimum cabling complexity.  Operating Instructions BA00061S
Fieldgate FXA42	Is used to transmit the measured values of connected 4 to 20 mA analog measuring devices, as well as digital measuring devices  <ul style="list-style-type: none"> ▪ Technical Information TI01297S ▪ Operating Instructions BA01778S ▪ Product page: www.endress.com/fxa42

Field Xpert SMT70	<p>The Field Xpert SMT70 tablet PC for device configuration enables mobile plant asset management in hazardous and non-hazardous areas. It is suitable for commissioning and maintenance staff to manage field instruments with a digital communication interface and to record progress.</p> <p>This tablet PC is designed as an all-in-one solution with a preinstalled driver library and is an easy-to-use, touch-sensitive tool which can be used to manage field instruments throughout their entire life cycle.</p> <ul style="list-style-type: none">  Technical Information TI01342S  Operating Instructions BA01709S  Product page: www.endress.com/smt70
Field Xpert SMT77	<p>The Field Xpert SMT77 tablet PC for device configuration enables mobile plant asset management in areas categorized as Ex Zone 1.</p> <ul style="list-style-type: none">  Technical Information TI01418S  Operating Instructions BA01923S  Product page: www.endress.com/smt77

Service-specific accessories

Accessories	Description
Applicator	<p>Software for selecting and sizing Endress+Hauser measuring devices:</p> <ul style="list-style-type: none"> ▪ Choice of measuring devices for industrial requirements ▪ Calculation of all the necessary data for identifying the optimum flowmeter: e.g. nominal diameter, pressure loss, flow velocity and accuracy. ▪ Graphic illustration of the calculation results ▪ Determination of the partial order code, administration, documentation and access to all project-related data and parameters over the entire life cycle of a project. <p>Applicator is available:</p> <ul style="list-style-type: none"> ▪ Via the Internet: https://portal.endress.com/webapp/applicator ▪ As a downloadable DVD for local PC installation.
W@M	<p>W@M Life Cycle Management</p> <p>Improved productivity with information at your fingertips. Data relevant to a plant and its components is generated from the first stages of planning and during the asset's complete life cycle.</p> <p>W@M Life Cycle Management is an open and flexible information platform with online and on-site tools. Instant access for your staff to current, in-depth data shortens your plant's engineering time, speeds up procurement processes and increases plant uptime.</p> <p>Combined with the right services, W@M Life Cycle Management boosts productivity in every phase. For more information, visit www.endress.com/lifecyclemanagement</p>
FieldCare	<p>FDT-based plant asset management tool from Endress+Hauser. It can configure all smart field units in your system and helps you manage them. By using the status information, it is also a simple but effective way of checking their status and condition.</p> <ul style="list-style-type: none">  Operating Instructions BA00027S and BA00059S
DeviceCare	<p>Tool to connect and configure Endress+Hauser field devices.</p> <ul style="list-style-type: none">  Innovation brochure IN01047S
Commubox FXA291	<p>Connects Endress+Hauser field devices with a CDI interface (= Endress+Hauser Common Data Interface) and the USB port of a computer or laptop.</p> <ul style="list-style-type: none">  Technical Information TI00405C

System components

Accessories	Description
Memograph M graphic data manager	<p>The Memograph M graphic data manager provides information on all the relevant measured variables. Measured values are recorded correctly, limit values are monitored and measuring points analyzed. The data are stored in the 256 MB internal memory and also on a SD card or USB stick.</p> <ul style="list-style-type: none">  Technical Information TI00133R  Operating Instructions BA00247R

Supplementary documentation

-  For an overview of the scope of the associated Technical Documentation, refer to the following:
- *W@M Device Viewer* (www.endress.com/deviceviewer): Enter the serial number from nameplate
 - *Endress+Hauser Operations App*: Enter the serial number from the nameplate or scan the 2D matrix code (QR code) on the nameplate

Standard documentation

Brief Operating Instructions

Brief Operating Instructions for the sensor

Measuring device	Documentation code
Proline Promag W	KA01266D

Transmitter Brief Operating Instructions

Measuring device	Documentation code			
	HART	PROFIBUS DP	Modbus RS485	EtherNet/IP
Proline 400	KA01263D	KA01420D	KA01419D	KA01418D

Operating Instructions

Measuring device	Documentation code			
	HART	PROFIBUS DP	Modbus RS485	EtherNet/IP
Promag W 400	BA01063D	BA01234D	BA01231D	BA01214D

Description of device parameters

Measuring device	Documentation code			
	HART	PROFIBUS DP	Modbus RS485	EtherNet/IP
Promag 400	GP01043D	GP01044D	GP01045D	GP01046D

Supplementary device-dependent documentation

Special Documentation

Content	Documentation code
Heartbeat Technology	SD01847D
Display modules A309/A310	SD01793D
Information on Custody Transfer Measurement	SD02038D

Content	Documentation code			
	HART	PROFIBUS DP	Modbus RS485	EtherNet/IP
Web server	SD01811D	SD01813D	SD01812D	SD01814D

Installation Instructions

Content	Comment
Installation instructions for spare part sets and accessories	Documentation code: specified for each individual accessory →  96.

Registered trademarks

HART®

Registered trademark of the FieldComm Group, Austin, Texas, USA

PROFIBUS®

Registered trademark of the PROFIBUS User Organization, Karlsruhe, Germany

Modbus®

Registered trademark of SCHNEIDER AUTOMATION, INC.

EtherNet/IP™

Trademark of ODVA, Inc.

www.addresses.endress.com
