



Digital Indicating Controller

UTAdvanced

Digital Indicating Controller UT75A / UT55A / UT52A / UT35A / UT32A
Program Controller UP55A / UP35A / UP32A
Digital Indicator with Alarms UM33A



Reliable and secure line

Welcome new members: 2-loop and DIN rail models, and the UP32A

Program Controller

UP55A



UP35A



UP32A



UT75A



UT55A



UT52A



UT35A



UT32A



Digital Controller

UT32A-D
(Dual-loop type)



UT52A/MDL
UT55A/MDL
DIN Rail Mounting Controller



UT32A/MDL
UT35A/MDL
DIN Rail Mounting Controller



Configuration and Programming Software

UM33A

Digital Indicator with Alarms



LL50A



Tools and functions that go easy on your equipment

Operation and clear display that go easy on the user

A variety of functions, and easy-to-connect communication

Helpful ladder sequence control function

Reliability

- RoHS/WEEE
- NEMA4*/IP66 Front Panel

* Hose down test only.

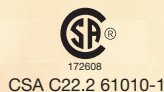

● Space saving options

- 1/8th DIN 2-loop controller (UT32A-D)
- CC-Link communication available in a 48 x 96 mm (1/8 DIN) size
- 1/8th DIN Program controller (UP32A)
- DIN rail mounting controller (/MDL option)

● More UP55A program patterns

- 99 program patterns (/AP option)

Tools and functions that go easy on your equipment

Setting and managing parameters

Easily edit settings from a PC while the unit is mounted on the controller board.

Settings are accessed through a dedicated adapter on the front panel. Maintenance of Ethernet-equipped controllers can be handled remotely.

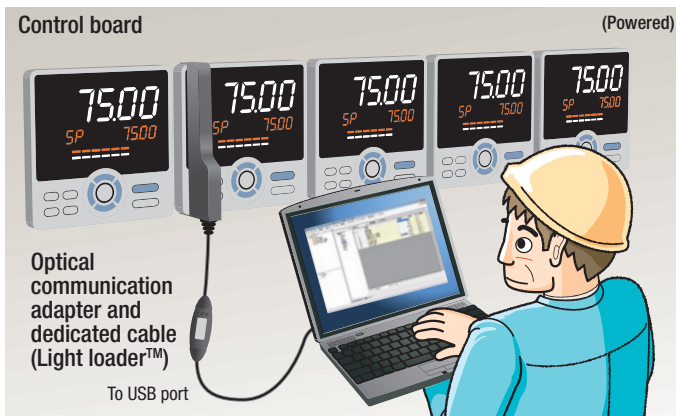

- Set up parameters
- Controller data read/write/compare
- Data management
- Print parameters and data, and create reports
- Configure user defaults

Set up right out of the box

No power cable required

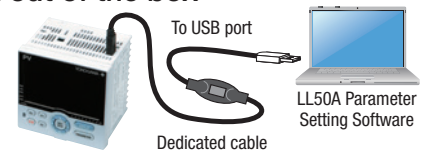

With DIN rail mountable controllers (/MDL option), used to perform maintenance when powered. Free software now available on the web for converting GREEN series parameters to UTAdvanced.

Can be supported with a single spare unit

Universal Input and Output

Supports different sensors, heaters, and actuators

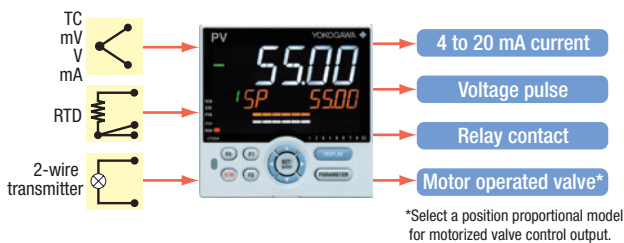

Universal Inputs

Universal Control Outputs

Gets you back home. Fast.

Shorter recovery time User defaults function

The LL50A lets you configure user default values.

Ever get lost in a maze of configuration changes? Now you can restore user-personalized default parameters. Recover quickly without disturbing operations.

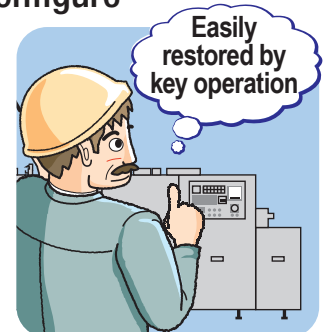

Save space on the panel and control board

Side-by-side close mounting on DIN rails in the board

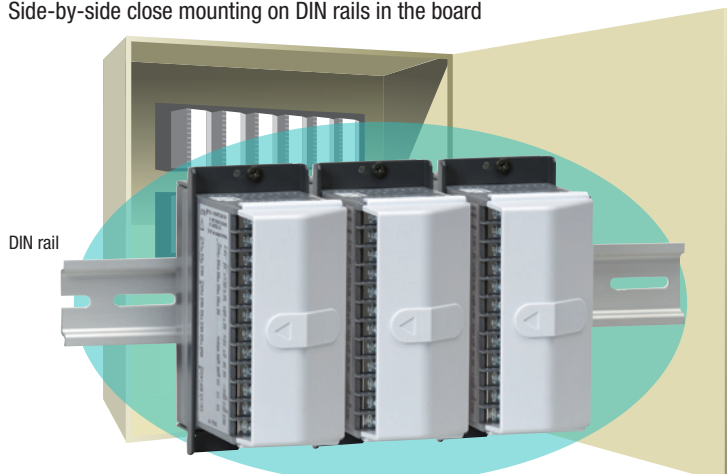

Status display (LED)

Green: Normal
Red: Abnormal



- Ambient temperature: -10 to 50 °C (0 to 50 °C with CC-Link installed)
- 2-loop control in a single unit (UT32A-D/MDL)
- Displays controller and I/O status

UT32A/MDL
UT52A/MDL
UT32A-D/MDL

Operation and clear display that go easy on the user

Bright & Easy to Read Active Color LCD Display

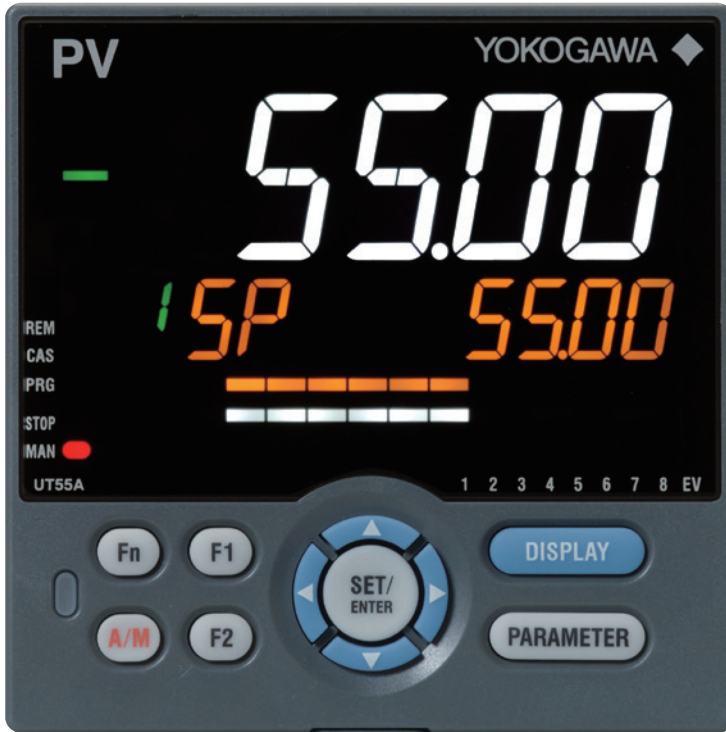

UT55A 1/4 DIN (96x96mm) size

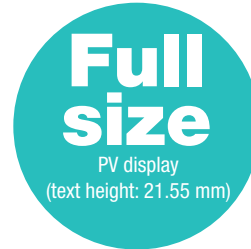

UT52A 1/8 DIN (48x96mm) size

Active Color PV Display

See the status of your process conditions **INSTANTLY!**

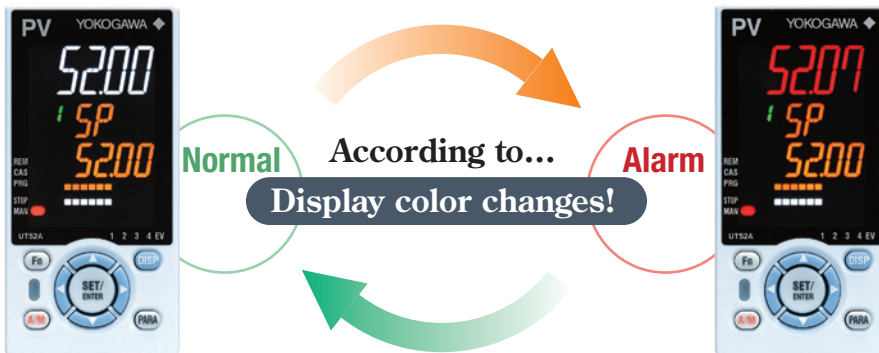

- Alarms
- Deviation values
- Measured values
- Contact input
- Choice of fixed white or red

Navigation guides and keys make it easy to operate



Fast one-touch operations

Programmable Function Keys

You can assign frequently used operations (start/stop, remote/local, etc.) and parameter entry screens (PID value, etc.) to function keys for one-touch availability.



UT series

A variety of functions, and easy-to-connect communication

Communication protocol

Connect to PLCs easily without programming!

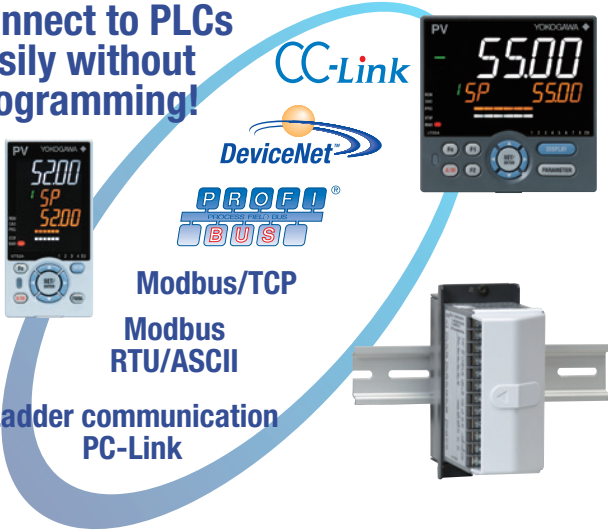

Open Network

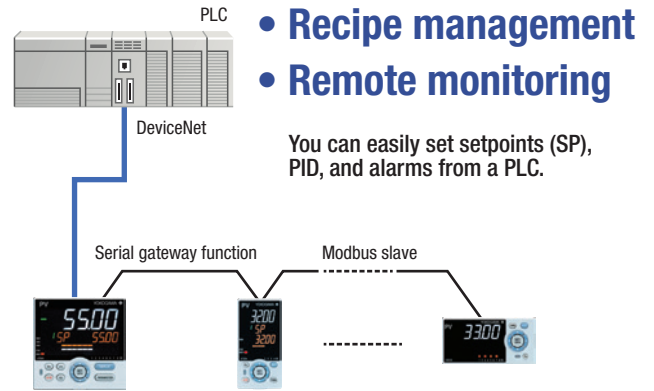

- Recipe management
- Remote monitoring

You can easily set setpoints (SP), PID, and alarms from a PLC.

UTAdvanced with RS-485 communication

Space-saving built-in CC-Link models

- UT52A, UT32A, UM33A, UT52A/MDL, UT32A/MDL

Modbus/TCP

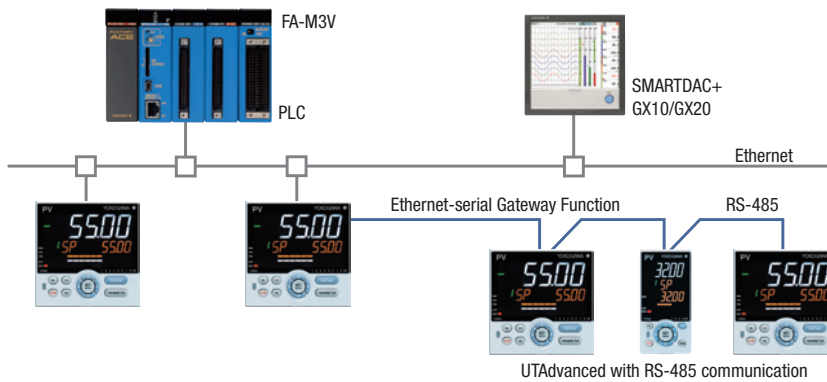

Modbus TCP, a protocol that allows the controller to connect to Ethernet network and have the ability to exchange data with the computers or devices on that network.

- Gateway function allows RS-485 Modbus devices to communicate via Ethernet.
- Physical layer: 10 BASE-T/100 BASE-TX
- Max. number of connection : 2

UTAdvanced with RS-485 communication

Peer to Peer

The use of the ladder sequence program makes it possible to exchange analog data and status data between communication-capable UTs.

Example: A UT in which an input error occurs sends a signal to another UT to enable that UT switch to MAN operation, thus shifting the whole system into a safe mode. In such a case, the safety mechanism can be built into the UTAdvanced and is not required in the host system.

* Create ladder sequence programs by the LL50A Parameter Setting software (sold separately).

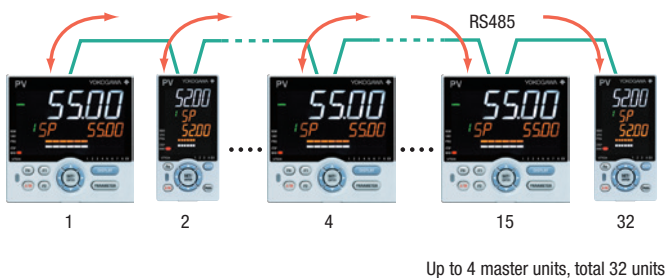

Coordinated operation

Coordinated operation: This function syncs operation of the slave with that of the master through Yokogawa's proprietary communication protocol.

- Finely adjust the temperature setting of the slave with the bias and ratio
- Upstream PLC or other device not needed for tuning
- No programming means fewer engineering manhours

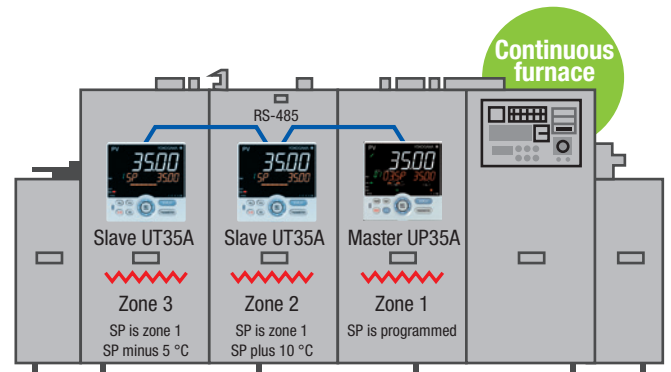

Helpful ladder sequence control function

Flexibly adapts to the customer's requirements

Using the UTAdvanced ladder sequence control function offers a low-cost alternative for applications typically dependent on compact units such as PLCs, timers, and relays. Plus, it saves wiring labor and space. The ladder sequence control function supports the customized specifications of your customers.

* Requires parameter setting software (sold separately).

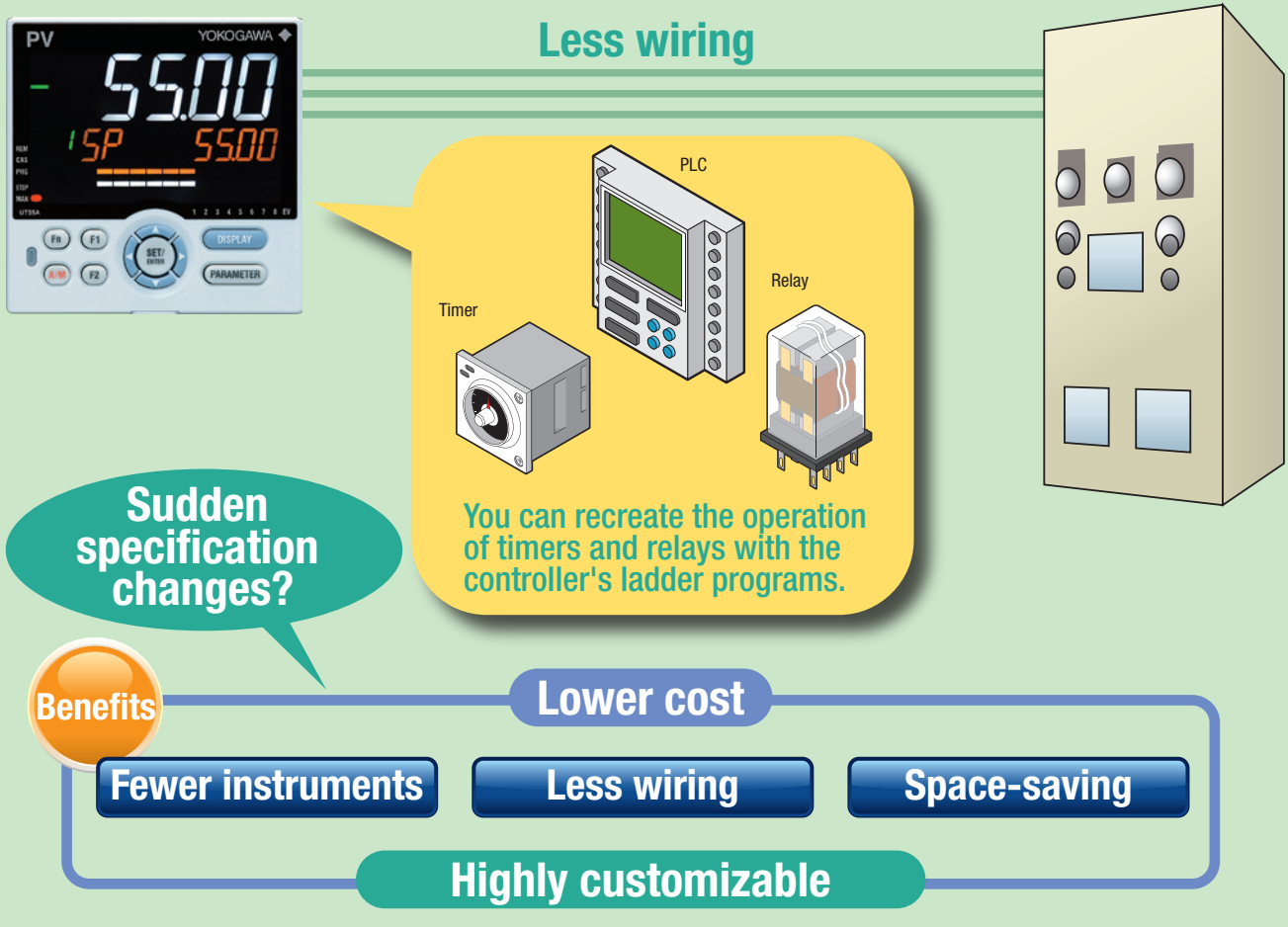

Example: Alarm annunciator

How it works

- Lamp blinks on alarm
- Lights while checking the active alarm
- Goes out while checking stopped alarm

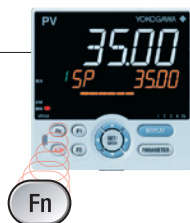

Check alarms with function keys

Time Chart

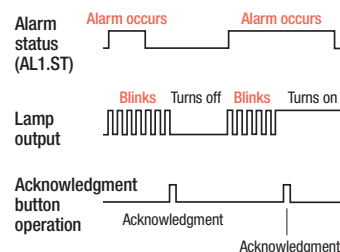

Alarm Ladder Sequence Program

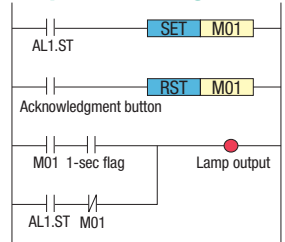

Example: On delay timer

How it works

- Hold down the F1 key for 5 sec. or longer to turn relay ON
- Release F1 key to turn relay OFF

Time Chart

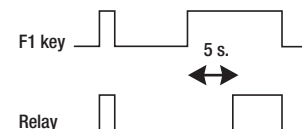

Program

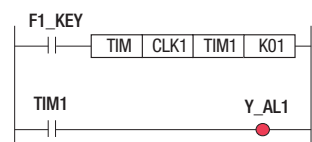





Product Line-up



Model		UT75A	UT55A	UT52A	UT35A
Size (W x H x D)		96×96×65mm		48×96×65mm	96×96×65mm
Weight		500 g or less			
DIN rail mountable (no display/keys)		No	Yes (option)		
Input sampling period (control scan period)		50, 100, 200ms			200ms
Number of analog inputs	PV input	1: Standard type 2: Dual-loop type	1		
	Aux. analog input	2 (max.)	3 (max.)	1 (max.)	1 (non-isolated)
PV input indication accuracy		±0.1 % of F.S.			
PV input type		TC : K, J, T, B, S, R, N, E, L, U, W, PL-2, PR20-40, W97Re3-W75Re25 RTD : JPt100, Pt100 mA : 4 to 20mA, 0 to 20mA mV, V : 1 to 5V, 0 to 10V, 0 to 2V, 0.4 to 2V, -10 to 20mV, 0 to 100mV			
Number of analog outputs	Control output	1 (max. 2)			
	Retransmission output	1			1 (only with 1 control output)
Control output type		Relay output : Contact rating (250VAC, 3A or 30 VDC, 3A)Normally open, 2 point (Heating/cooling output in UT52A/UT32A) Current output : 4 to 20mA, 0 to 20mA, 20 to 4mA, 20 to 0mA Voltage pulse output			
Retransmission output (aux. output)		4 to 20mA, 0 to 20mA, 20 to 4mA, 20 to 0mA			
Number of digital inputs	Standard	3	3	3	2
	Maximum	14	9	5	7
Number of digital outputs	Standard	3	3	3	3
	Maximum	8	18	5	8
Communication		RS485 Ethernet CC-Link PROFIBUS-DP DeviceNet		RS485 CC-Link	RS485 Ethernet CC-Link PROFIBUS-DP DeviceNet
Number of SP groups		20	8		4
Number of PID groups		16			
Number of alarm groups		8			
Number of ladder steps		1000	500		300
Number of ladder instructions		Basic instruction : 15 Application instruction : 111	Basic instruction : 13 Application instruction : 73		
Number of program patterns	Standard	1	None		
	Max. (option)				
Total number of segments	Standard	20			
	Max. (option)				
Power supply		100-240VAC or 24VAC/DC			
Power consumption (at 100 V AC)		18VA	15VA		18VA
Screw terminal size		M3.0			
24 V DC loop power supply		Yes (option)			
Heater burnout alarm		No	Yes (option) Excludes DIN rail mounting types		
Dust and waterproof level of front panel		NEMA4*/IP66 Front Panel Excludes DIN rail mounting types			
RoHS/WEEE		Compliant			
Safety and EMC standards					
GS (General Specifications)		GS 05P01B41-01EN	GS 05P01C31-01EN GS 05P01C81-01EN		GS 05P01D31-01EN GS 05P01D81-01EN



UT32A	UT32A-D	UP55A	UP35A	UP32A	UM33A
48×96×65mm		96×96×65mm		48×96×65mm	96×48×65mm
500 g or less					
Yes (option)			No		
200ms		100, 200ms	200ms		50, 100, 200ms
1	2	1			
1 (non-isolated)	None	3 (max.)	None		
±0.1 % of F.S.					
TC : K, J, T, B, S, R, N, E, L, U, W, PL-2, PR20-40, W97Re3-W75Re25					
RTD : JPt100, Pt100					
mA : 4 to 20mA, 0 to 20mA					
mV, V : 1 to 5V, 0 to 10V, 0 to 2V, 0.4 to 2V, -10 to 20mV, 0 to 100mV					
1 (max. 2)	2	1 (max. 2)			None
1 (only with 1 control output)	None	1	1 (only with 1 control output)		1
Relay output : Contact rating (250VAC, 3A or 30 VDC, 3A) Normally open (UT32A-D) Normally open, 2 point (Heating/cooling output in UP32A)					None
Current output : 4 to 20mA, 0 to 20mA, 20 to 4mA, 20 to 0mA					
Voltage pulse output					
4 to 20mA, 0 to 20mA, 20 to 4mA, 20 to 0mA	None	4 to 20mA, 0 to 20 mA, 20 to 4 mA, 20 to 0 mA			
2	3	8	3	3	2
4		9	8	5	
3	3	8	3	3	3
5		18	8	5	
RS485 CC-Link	RS485	RS485 Ethernet CC-Link PROFIBUS-DP DeviceNet		RS485 CC-Link	RS485 CC-Link
4		1			None
		8	4		8
300		500	300		None
Basic instruction : 13 Application instruction : 67					None
None		30	2		None
		99	4		
		300	20		
		600	40		
100-240VAC or 24VAC/DC					
15VA		18VA	15VA		
M3.0					
Yes (option)			No		
Yes (option)	Yes (option) Excludes DIN rail mounting types	Yes (option)			Yes (option)
NEMA4*/IP66 Front Panel Excludes DIN rail mounting types					
Compliant					
    					
GS 05P01D31-01EN GS 05P01D81-01EN	GS 05P08D31-01EN GS 05P08D81-01EN	GS 05P02C41-01EN	GS 05P02D41-01EN		GS 05P03D21-01EN

Product Line-up

Digital Indicating Controller UT55A/UT52A (Standard model)



Main Features

- Up to 4 analog inputs available
- 3 alarm relays with independent common terminals
- 500 steps of ladder logic control
- Simple operation
- Up to 18 DOs (various combinations available)

External Dimensions

Unit: mm

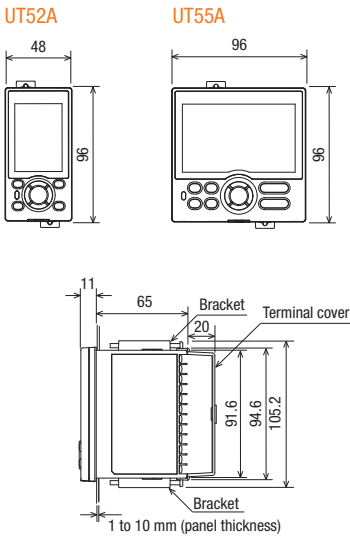

Model	Suffix code	Optional suffix code	Description
UT55A			Digital Indicating Controller (Power supply 100-240 V AC)(provided with retransmission output or 15 V DC loop power supply , 3 Dis, and 3 DOs)
Type 1:	-0		Standard type
Basic control	-1		Position proportional type
	-2		Heating/cooling type
Type 2:Functions	0		None
	1		Remote (1 additional aux. analog) input, 6 additional Dis, 5 additional DOs, and RS-485 communication (Max. 19.2 kbps, 2-wire/4-wire) ⁽¹⁾⁽²⁾
	2		Remote (1 additional aux. analog) input, 1 additional DI, and RS-485 communication (Max. 19.2 kbps, 2-wire/4-wire) ⁽²⁾
	3		5 additional Dis and 5 additional DOs
	4		Remote (1 additional aux. analog) input and 1 additional DI
	5		Remote (1 additional aux. analog) input, 6 additional Dis, and 5 additional DOs
	6		5 additional Dis, and 15 additional DOs ⁽¹⁾
	7		3 additional aux. analog inputs and 3 additional Dis
Type 3:	0		None
Open networks	1		RS-485 communication (Max. 38.4 kbps, 2-wire/4-wire)
	2		Ethernet communication (with serial gateway function)
	3		CC-Link communication (with Modbus master function)
	4		PROFIBUS-DP communication (with Modbus master function)
	5		DeviceNet communication (with Modbus master function)
Display language ⁽³⁾	-1		English (Default. Can be switched to other language by the setting.)
	-2		German (Default. Can be switched to other language by the setting.)
	-3		French (Default. Can be switched to other language by the setting.)
	-4		Spanish (Default. Can be switched to other language by the setting.)
Case color	0		White (Light gray)
	1		Black (Light charcoal gray)
Fixed code		-00	Always "-00"
Optional suffix codes		/DR	Additional direct input (TC & 3-wire/4-wire RTD) and current to Remote (1 additional aux. analog) input, 1 DI to be deleted ⁽⁴⁾
		/LP	24 V DC loop power supply ⁽⁵⁾
		/HA	Heater break alarm ⁽⁵⁾
		/DC	Power supply 24 V AC/DC
		/CT	Coating ⁽⁶⁾

- ¹: When the Type 2 code is "1" or "6", only "0" can be specified for the Type 3 code.
²: When the /LP option is specified, the RS-485 communication of the Type 2 code "1" or "2" is 2-wire system.
³: English, German, French, and Spanish are available for the guide display.
⁴: The /DR option can be specified when the Type 2 code is any of "1", "2", "4", "5", or "7".
⁵: The /LP option can be specified in the combination of Type 2 code (any of "0", "2", "3", or "4") and Type 3 code (any of "0" or "1"). Additionally the /LP option can be specified in the combination of Type 2 code "1" and Type 3 code "0".
⁶: The /HA option can be specified only when the Type 1 code is "-0".
⁷: When the /CT option is specified, the UT55A does not conform to the safety standards (UL and CSA) and CE marking (Products with /CT option are not intended for EEA-market).

Model	Suffix code	Optional suffix code	Description
UT52A			Digital Indicating Controller (Power supply 100-240 V AC)(provided with retransmission output or 15 V DC loop power supply , 3 Dis, and 3 DOs)
Type 1:	-0		Standard type
Basic control	-1		Position proportional type
	-2		Heating/cooling type
Type 2:	0		None
Functions	1		Remote (1 additional aux. analog) input, 1 additional DI, and RS-485 communication (Max. 38.4 kbps, 2-wire)
	2		Remote (1 additional aux. analog) input and 1 additional DI
	3		2 additional Dis, and 2 additional DOs
Type 3:	0		None
Open networks	3		CC-Link communication (with Modbus master function) ⁽¹⁾
Display language ⁽³⁾	-1		English (Default. Can be switched to other language by the setting.)
	-2		German (Default. Can be switched to other language by the setting.)
	-3		French (Default. Can be switched to other language by the setting.)
	-4		Spanish (Default. Can be switched to other language by the setting.)
Case color	0		White (Light gray)
	1		Black (Light charcoal gray)
Fixed code		-00	Always "-00"
Optional suffix codes		/DR	Additional direct input (TC & 3-wire/4-wire RTD) and current to Remote (1 additional aux. analog) input, 1 DI to be deleted ⁽³⁾
		/LP	24 V DC loop power supply ⁽⁴⁾
		/HA	Heater break alarm ⁽⁵⁾
		/DC	Power supply 24 V AC/DC
		/CT	Coating ⁽⁶⁾

- ¹: The Type 3 code "3" can be specified only when the Type 1 code is "-0" and the Type 2 code is "0".
²: English, German, French, and Spanish are available for the guide display.
³: The /DR option can be specified only when the Type 2 code is "2" and the Type 3 code is "0".
⁴: The /LP option can be specified only when the Type 1 code is "-0" or "-1". Furthermore both Type 2 and Type 3 codes should be "0".
⁵: The /HA option can be specified only when the Type 1 code is "-0" and the Type 3 code is "0".
⁶: When the /CT option is specified, the UT52A does not conform to the safety standards (UL and CSA) and CE marking (Products with /CT option are not intended for EEA-market).

Application examples

• Cascade control

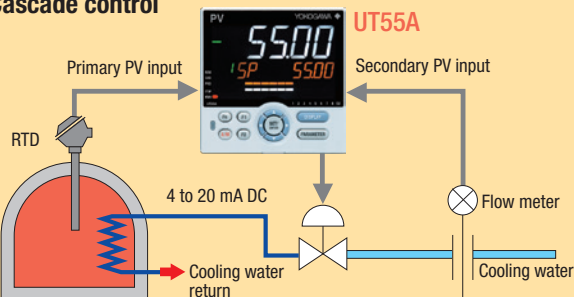

• Industrial furnace temperature control

Position proportional control for actuator motor

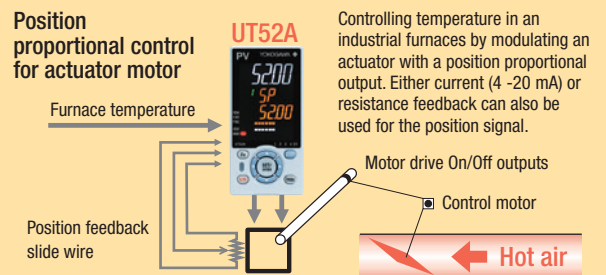

Digital Indicating Controller UT35A/UT32A (Standard model)



Main Features

- 4 target setpoints and PID sets available
- 3 alarm relays with independent common terminals
- 300 steps of ladder logic control
- Simple operation
- Up to 8 DOs (various combinations available)

External Dimensions

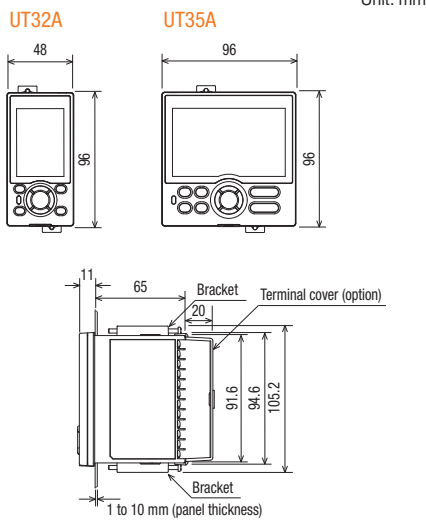

Model	Suffix code	Optional suffix code	Description
UT35A			Digital Indicating Controller (Power supply: 100-240 V AC)(provided with retransmission output or 15 V DC loop power supply, 2 DIs, and 3 DOs)
Type 1: Basic control	-0		Standard type
	-1		Position proportional type
	-2		Heating/cooling type
Type 2:Functions	0		None
	1		2 additional DIs, 2 additional DOs
	2		5 additional DIs, 5 additional DOs
Type 3: Open networks	0		None
	1		RS-485 communication (Max.38.4 kbps, 2-wire/4-wire)
	2		Ethernet communication (with serial gateway function)
	3		CC-Link communication (with Modbus master function)
	4		PROFIBUS-DP communication (with Modbus master function)
Display language ⁽²⁾	-1		English (Default. Can be switched to other language by the setting.)
	-2		German (Default. Can be switched to other language by the setting.)
	-3		French (Default. Can be switched to other language by the setting.)
	-4		Spanish (Default. Can be switched to other language by the setting.)
Case color	0		White (Light gray)
	1		Black (Light charcoal gray)
Fixed code		-00	Always "-00"
Optional suffix codes		/LP	24 V DC loop power supply ⁽²⁾
		/HA	Heater break alarm ⁽⁵⁾
		/DC	Power supply 24 V AC/DC
		/CT	Coating ⁽⁶⁾
		/CV	Terminal cover
		/RSP	Non-isolated remote input (please see the General Specifications GS 05P01D31-81EN.)

¹: English, German, French, and Spanish are available for the guide display.
²: The /LP option can be specified in the combination of Type 2 code (any of "0" or "1") and Type 3 code (any of "0" or "1").
³: The /HA option can be specified only when the Type 1 code is "-0" or "-2."
⁴: When the /CT option is specified, the UT35A does not conform to the safety standards (UL and CSA) and CE marking.

Model	Suffix code	Optional suffix code	Description
UT32A			Digital Indicating Controller (Power supply: 100-240 V AC) (provided with retransmission output or 15 V DC loop power supply, 2 DIs, and 3 DOs)
Type 1: Basic control	-0		Standard type
	-1		Position proportional type
	-2		Heating/cooling type
	-V		UT32A Digital Indicating Controller (Entry model)
	-C		(please see the General Specification GS 05P01F31-01EN.)
Type 2:Functions	0		None
	1		RS-485 communication (Max. 38.4 kbps, 2-wire/4-wire) ⁽¹⁾
	2		2 additional DIs and 2 additional DOs
Type 3: Open networks	0		None
	3		CC-Link communication (with Modbus master function) ⁽²⁾
Display language ⁽³⁾	-1		English (Default. Can be switched to other language by the setting.)
	-2		German (Default. Can be switched to other language by the setting.)
	-3		French (Default. Can be switched to other language by the setting.)
	-4		Spanish (Default. Can be switched to other language by the setting.)
Case color	0		White (Light gray)
	1		Black (Light charcoal gray)
Fixed code		-00	Always "-00"
Optional suffix codes		/LP	24 V DC loop power supply ⁽⁴⁾
		/HA	Heater break alarm ⁽⁵⁾
		/DC	Power supply 24 V AC/DC
		/CT	Coating ⁽⁶⁾
		/CV	Terminal cover
		/RSP	Non-isolated remote input (please see the General Specifications GS 05P01D31-81EN.)

¹: When the /LP option is specified, the RS-485 communication of the Type 2 code "1" is 2-wire system.
²: The type 3 code "3" can be specified only when the Type 1 code is "-0" and the Type 2 code is "0."
³: English, German, French, and Spanish are available for the guide display.
⁴: The /LP option can be specified in the combination of Type 1 code (any of "-0" or "-1"), Type 2 code (any of "0" or "1") and Type 3 code "0."
⁵: The /HA option can be specified in the combination of Type1 code "-0" or "-2," and Type 3 code "0."
⁶: When the /CT option is specified, the UT32A does not conform to the safety standards (UL and CSA) and CE marking (Products with /CT option are not intended for EEA-market).

Application examples

• Electric furnace

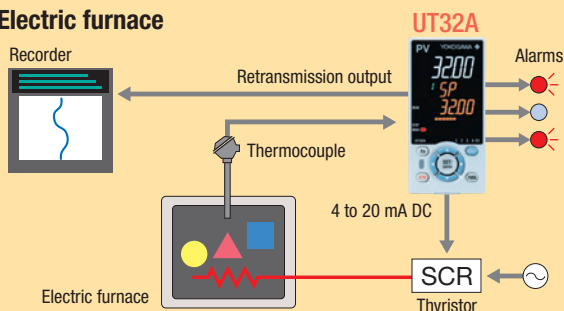

• Heating/cooling control

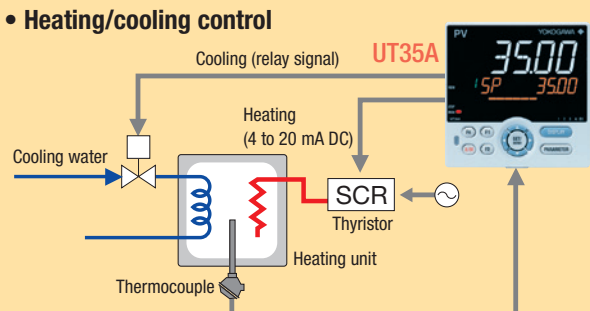

Product Line-up

DIN Rail Mounting Controller



Main Features

- DIN rail mounting
- Tidy appearance
- Up to 4 analog inputs available
- 3 alarm relays with independent common terminals
- 500 steps of ladder logic control
- Comes with a wealth of functions

External Dimensions

UT55A/UT35A (with option /MDL)

Unit: mm

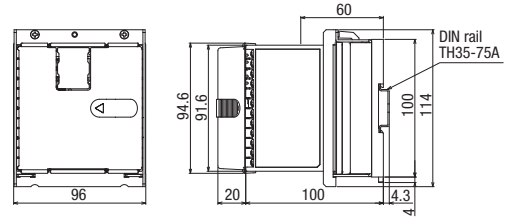

UT52A/UT32A (with option /MDL)

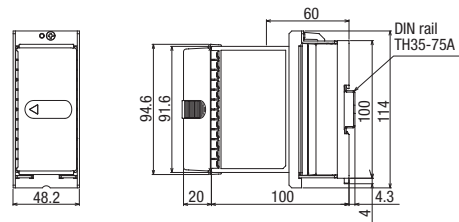

UT55A/UT52A: terminal cover comes standard
UT35A/UT32A: terminal cover sold separately

Model	Suffix code	Optional suffix code	Description
UT55A		/MDL (Required)	Digital Indicating Controller (Power supply 100-240 V AC) (provided with retransmission output or 15 V DC loop power supply, 3 Dis, and 3 DOs) (without the display parts and keys)
Type 1: Basic control	-0		Standard type
	-2		Heating/cooling type
Type 2: Functions	0		None
	2		Remote (1 additional aux. analog) input, 1 additional DI, and RS-485 communication (Max. 19.2 kbps, 2-wire or 2-wire/4-wire) ^{(*)1}
	3		5 additional Dis and 5 additional DOs
	4		Remote (1 additional aux. analog) input and 1 additional DI
	5		Remote (1 additional aux. analog) input, 6 additional Dis, and 5 additional DOs
	7		3 additional aux. analog inputs and 3 additional Dis
Type 3: Open networks	1		RS-485 communication (Max. 38.4 kbps, 2-wire/4-wire)
	2		Ethernet communication (with serial gateway function)
	3		CC-Link communication (with Modbus master function)
	4		PROFIBUS-DP communication (with Modbus master function)
	5		DeviceNet communication (with Modbus master function)
Fixed code	-1		Temperature unit: deg C & deg F
Case color	1		Black (Light charcoal gray)
Fixed code	-00		Always "-00"
Optional suffix codes		/MDL (Required)	Mount on DIN rail (without the display parts and keys) ^(**)
		/DC	Power supply 24 V AC/DC
		/LP	24 V DC loop power supply ^(**)
		/CT	Coating ^(**)

*1: When the /LP option is specified, the RS-485 communication of the Type 2 code "2" is 2-wire system.
*2: The /MDL option and /LP option can be specified in the combination of Type 2 code (any of "0", "2", "3", or "4") and Type 3 code "1".
*3: When the /CT option is specified, the UT55A does not conform to the safety standards (UL and CSA) and CE marking (Products with /CT option are not intended for EEA-market).

Model	Suffix code	Optional suffix code	Description
UT52A		/MDL (Required)	Digital Indicating Controller (Power supply 100-240 V AC) (provided with retransmission output or 15 V DC loop power supply, 3 Dis, and 3 DOs) (without the display parts and keys)
Type 1: Basic control	-0		Standard type
Type 2: Functions	0		None
	1		Remote (1 additional aux. analog) input, 1 additional DI, and RS-485 communication (Max. 38.4 kbps, 2-wire)
Type 3: Open networks	0		None
	3		CC-Link communication (with Modbus master function)
Fixed code	-1		Temperature unit: deg C & deg F
Case color	1		Black (Light charcoal gray)
Fixed code	-00		Always "-00"
Optional suffix codes		/MDL (Required)	Mount on DIN rail (without the display parts and keys) ^(**)
		/DC	Power supply 24 V AC/DC
		/CT	Coating ^(**)

*1: When the /MDL option is specified, the model and the suffix codes are as follows:
UT52A-010-11-00/x/MDL
UT52A-003-11-00/x/MDL
*2: When the /CT option is specified, the UT52A does not conform to the safety standards (UL and CSA) and CE marking (Products with /CT option are not intended for EEA-market).

Model	Suffix code	Optional suffix code	Description
UT35A		/MDL (Required)	Digital Indicating Controller (Power supply: 100-240 V AC) (provided with retransmission output or 15 V DC loop power supply, 2 Dis, and 3 DOs) (without the display parts and keys)
Type 1: Basic control	-0		Standard type
	-2		Heating/cooling type
Type 2: Functions	0		None
	2		5 additional Dis, 5 additional DOs
Type 3: Open networks	1		RS-485 communication (Max. 38.4 kbps, 2-wire/4-wire)
	2		Ethernet communication (with serial gateway function)
	3		CC-Link communication (with Modbus master function)
	4		PROFIBUS-DP communication (with Modbus master function)
	5		DeviceNet communication (with Modbus master function)
Fixed code	-1		Temperature unit: deg C & deg F
Case color	1		Black (Light charcoal gray)
Fixed code	-00		Always "-00"
Optional suffix codes		/MDL (Required)	Mount on DIN rail (without the display parts and keys) ^(**)
		/LP	24 V DC loop power supply ^(**)
		/DC	Power supply 24 V AC/DC
		/CT	Coating ^(**)
		/CV	Terminal cover

*1: The /MDL option and /LP option can be specified in the combination of Type 2 code "0" and Type 3 code "1".
*2: When the /CT option is specified, the UT35A does not conform to the safety standards (UL and CSA) and CE marking (Products with /CT option are not intended for EEA-market).

Model	Suffix code	Optional suffix code	Description
UT32A		/MDL (Required)	Digital Indicating Controller (Power supply: 100-240 V AC) (provided with retransmission output or 15 V DC loop power supply, 2 Dis, and 3 DOs) (without the display parts and keys)
Type 1: Basic control	-0		Standard type
	-2		Heating/cooling type
Type 2: Functions	0		None
	1		RS-485 communication (Max. 38.4 kbps, 2-wire/4-wire) ^(**)
Type 3: Open networks	0		None
	3		CC-Link communication (with Modbus master function)
Fixed code	-1		Temperature unit: deg C & deg F
Case color	1		Black (Light charcoal gray)
Fixed code	-00		Always "-00"
Optional suffix codes		/MDL (Required)	Mount on DIN rail (without the display parts and keys) ^(**) ^(**)
		/LP	24 V DC loop power supply ^(**)
		/HA	Heater break alarm ^(**)
		/DC	Power supply 24 V AC/DC
		/CT	Coating ^(**)
		/CV	Terminal cover

*1: When /LP option is specified, the RS-485 communication of the type 2 code "1" is 2-wire system.
*2: The /MDL option is specified, the model and suffix codes are as follows:
UT32A-010-11-00/x/MDL
UT32A-003-11-00/x/MDL
UT32A-210-11-00/x/MDL
*3: When /MDL option and /LP option is combined, "3" can not be specified for Type 3 code.
*4: The /HA option can be specified only in the combination of Type 2 code "1" and Type 3 code "0".
*5: When the /CT option is specified, the UT32A does not conform to the safety standards (UL and CSA) and CE marking (Products with /CT option are not intended for EEA-market).

Dual-loop Controller UT32A-D

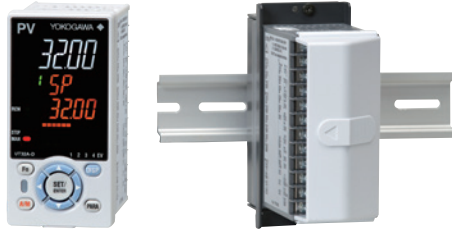

External Dimensions

Unit: mm

UT32A-D

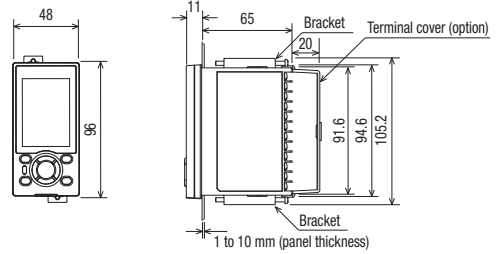

UT32A-D (with option /MDL)

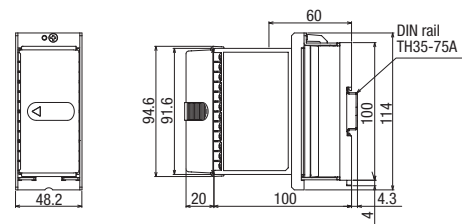

Main Features

- Dual-loop control
- Space-saving
- Simple operation
- Ladder sequence programs can be built
- 3 alarms available as standard

Panel mounting

Model	Suffix code	Optional suffix code	Description
UT32A			Digital Indicating Controller (Power supply: 100-240 V AC) (provided with 3 DIs and 3 DOs)
Type 1: Basic control	-D		Dual-loop type
Type 2: Functions	0		None
Type 3: Fixed code	1		RS-485 communication (Max. 38.4 kbps, 2-wire/4-wire)
Display language ^(*)	0		None
	-1		English (Default. Can be switched to other language by the setting.)
	-2		German (Default. Can be switched to other language by the setting.)
	-3		French (Default. Can be switched to other language by the setting.)
	-4		Spanish (Default. Can be switched to other language by the setting.)
Case color	0		White (Light gray)
	1		Black (Light charcoal gray)
Fixed code		-00	Always "-00"
Optional suffix codes		/HA	Heater break alarm ^(**)
		/DC	Power supply 24 V AC/DC
		/CT	Coating ^(***)
		/CV	Terminal cover

*1: English, German, French, and Spanish are available for the guide display.

*2: The /HA option can be specified when the Type 2 code is "0."

*3: When the /CT option is specified, the UT32A does not conform to the safety standards (UL and CSA) and CE marking (Products with /CT option are not intended for EEA-market).

DIN rail mounting

Model	Suffix code	Optional suffix code	Description
UT32A		/MDL (Required)	Digital Indicating Controller (Power supply: 100-240 V AC) (provided with 3 DIs, and 3 DOs) (without the display parts and keys)
Type 1: Basic control	-D		Dual-loop type
Type 2: Functions	1		RS-485 communication (Max. 38.4 kbps, 2-wire/4-wire)
Type 3: Fixed code	0		None
Fixed code	-1		Temperature unit: deg C & deg F
Case color	1		Black (Light charcoal gray)
Fixed code		-00	Always "-00"
Optional suffix codes		/MDL (Required)	Mount on DIN rail (without the display parts and keys)
		/DC	Power supply 24 V AC/DC
		/CT	Coating ^(**)
		/CV	Terminal cover

*1: When the /CT option is specified, the UT32A does not conform to the safety standards (UL and CSA) and CE marking (Products with /CT option are not intended for EEA-market).

Application examples

• Incubator control

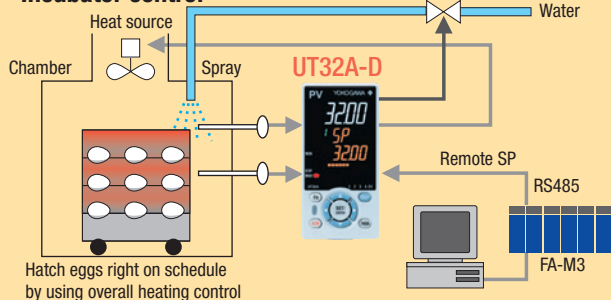

• Control of reflow furnaces

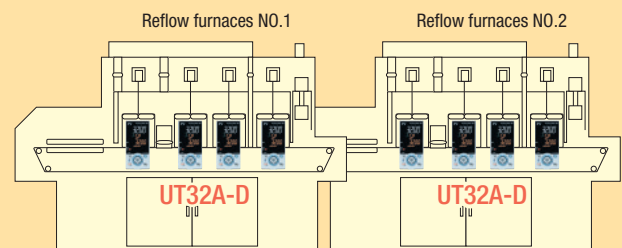

Product Line-up

Digital Indicating Controller UT75A



External Dimensions

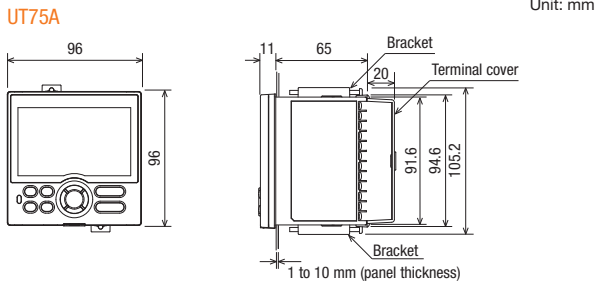

Model	Suffix code	Optional suffix code	Description
UT75A			Digital Indicating Controller (provided with retransmission output or 15 V DC loop power supply, 3 Dis, and 3 DOs) (Power supply 100-240 V AC)
Type 1:	-0		Standard type
Basic control	-1		Position proportional type
	-5		Dual-loop type
Type 2:Functions	0		5 additional Dis and 5 additional DOs
	1		Remote (1 additional aux. analog input, RS485 communication (Max.19.2 kbps, 2-wire), 1 additional DI, and 5 additional DOs)
	2		Remote (2 additional aux. analog inputs, RS485 communication (Max.19.2 kbps, 2-wire), 2 additional Dis)
	3		Remote (1 additional aux. analog input, 6 additional Dis, 5 additional DOs ⁽¹⁾)
Type 3:	0		None
Open networks	1		RS-485 communication (Max.38.4 kbps, 2-wire/4-wire) and 5 additional Dis
	2		Ethernet communication (with serial gateway function)
	3		CC-Link communication (with Modbus master function)
	4		PROFIBUS-DP communication (with Modbus master function)
	5		DeviceNet communication (with Modbus master function)
Display language ⁽²⁾	-1		English (Default. Can be switched to Spanish by the setting.)
	-2		German (Customized order)
	-3		French (Customized order)
	-4		Spanish (Default. Can be switched to English by the setting.)
Case color	0		White (Light gray)
	1		Black (Light charcoal gray)
Fixed code	-00		Always "-00"
Optional suffix codes	/DC		Power supply 24 V AC/DC
	/CP		Carbon potential calculation function ⁽³⁾
	/CT		Coating ⁽⁴⁾

¹: When Type 1 code is "-5", "3" cannot be specified for Type 2 code.
²: English and Spanish are available for the guide display.
 (German and French guide displays are customized. Contact our representatives for inquiries.)
³: Only when Type 2 code is "1", "2" or "3", the /CP option can be specified.
⁴: When the /CT option is specified, the UT75A does not conform to the safety standards (UL and CSA) and CE marking (Products with /CT option are not intended for EEA-market).

Enhancing Productivity by Managing a Variety of Recipes

Switching between 20 Recipes

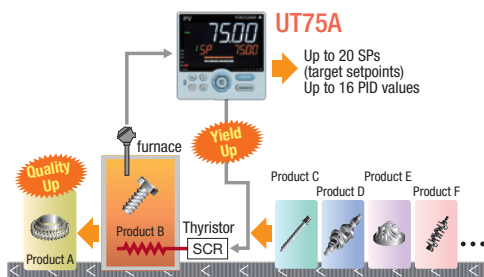

Program pattern operation

- Program pattern consists of up to 20 segments
- 2-loop program pattern can be operated

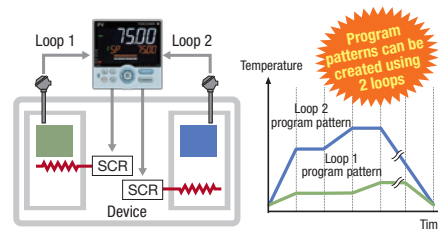

Easy to switch between recipes with a PLC

- Since CC-Link, Profibus, and DeviceNet are supported, it is easy to link to a PLC that manages recipes

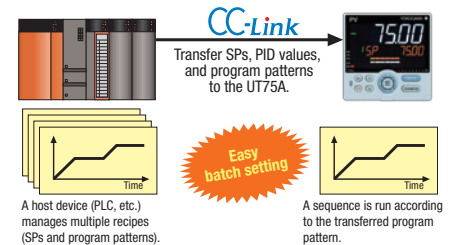

Application examples

2-loop control with a single controller

- 2-loop synchronous and independent operation is available
 - The start and stop instructions can be run synchronously or independently.
- Program pattern operation and constant value operation are available for 2-loop control
 - A sequence can be run by combining the program pattern operation and fixed-point operation.

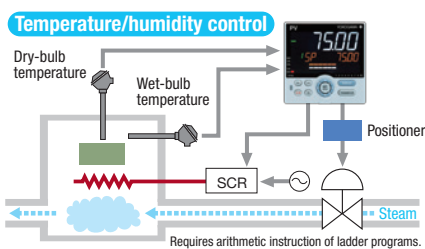

A variety of arithmetic instructions and large capacity ladder programs

- 15 basic instructions and 111 application instructions
- Ladder program capacity up to 1,000 steps

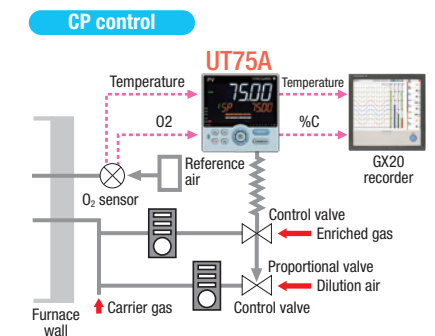
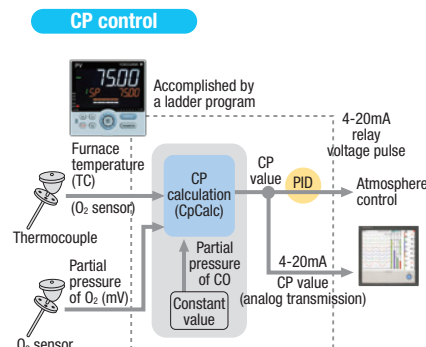

Program Controller UP55A (Standard model)



Main Features

- Up to 99 program patterns
- 8 PV events, 16 time events, and 8 alarms can be monitored simultaneously
- Ladder sequence programs can be built
- Simple operation
- Up to 9 DIs and 18 DOs (combinations available)

External Dimensions

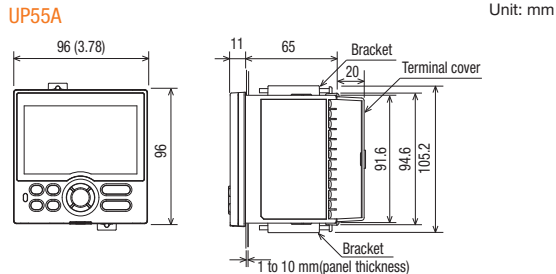

Model	Suffix code	Optional suffix code	Description	
UP55A			Program Controller (Power supply: 100-240 V AC) 30 program patterns / 300 program segments (99 program patterns / 600 program segments when the option /AP is specified. Max. 99 segments per pattern)(provided with retransmission output or 15 V DC loop power supply, 8 DIs, and 8 DOs)	
	Type 1:	-0	Standard type	
	Basic control	-1		Position proportional type
		-2		Heating/cooling type
				None
	Type 2:Functions	0		None
		1		Remote (1 additional aux. analog input, 1 additional DI)
		2		RS-485 communication (Max.19.2 kbps, 2-wire/4-wire)
		3		10 additional DOs ⁽¹⁾
		4		3 additional aux. analog inputs, 2 DIs and 5 DOs to be deleted
Type 3:	0		None	
	1		RS-485 communication (Max.38.4 kbps, 2-wire/4-wire)	
	2		Ethernet communication (with serial gateway function)	
	3		CC-Link communication (with Modbus master function)	
	4		PROFIBUS-DP communication (with Modbus master function)	
Open networks	5		DeviceNet communication (with Modbus master function)	
	-1		English (Default. Can be switched to other language by the setting.)	
	-2		German (Default. Can be switched to other language by the setting.)	
	-3		French (Default. Can be switched to other language by the setting.)	
	-4		Spanish (Default. Can be switched to other language by the setting.)	
Display language ⁽²⁾	0		White (Light gray)	
	1		Black (Light charcoal gray)	
Case color				
Fixed code			Always "-00"	
Optional suffix codes		/AP	69 additional patterns/300 additional segments	
		/DR	Additional direct input (TC and 3-wire/4-wire RTD) and current input to Remote (1 additional aux. analog input, 1 DI to be deleted) ⁽³⁾	
		/HA	Heater break alarm ⁽⁴⁾	
		/DC	Power supply 24 V AC/DC	
		/CT	Coating ⁽⁵⁾	

*1: When the Type 2 code is "3", only "0" can be specified for the Type 3 code.

*2: English, German, French, and Spanish are available for the guide display.

*3: The /DR option can be specified only when the Type 2 code is "1" or "4."

*4: The /HA option can be specified only when the Type 1 code is "0."

*5: When the /CT option is specified, the UP55A does not conform to the safety standards (UL and CSA) and CE marking (Products with /CT option are not intended for EEA-market).

Program Controller UP35A/UP32A (Standard model)



Main Features

- Up to 4 program patterns
- 2 PV events, 4 time events, and 2 alarms can be monitored simultaneously.
- Ladder sequence programs can be built
- Simple operation
- Up to 8 DIs and 8 DOs (combinations available)

External Dimensions

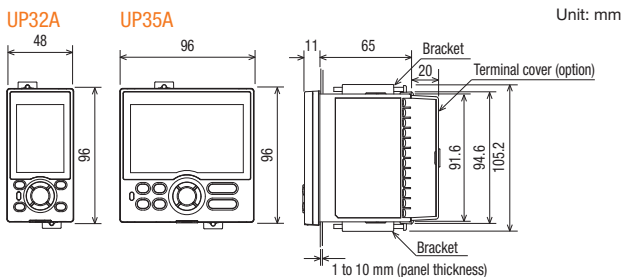

Model	Suffix code	Optional suffix code	Description	
UP35A			Program Controller (Power supply: 100-240 V AC) 2 program patterns/ 20 program segments (When the /AP option is specified, 4 program patterns/ 40 program segments, max. 20 segments per pattern.) (provided with retransmission output or 15 V DC loop power supply, 3 DIs, and 3 DOs)	
	Type 1:	-0	Standard type	
	Basic control	-1		Position proportional type
		-2		Heating/cooling type
				None
	Type 2:Functions	0		None
		1		5 additional DIs, 5 additional DOs
	Type 3:	0		None
		1		RS-485 communication (Max.38.4 kbps, 2-wire/4-wire)
		2		Ethernet communication (with serial gateway function)
3			CC-Link communication (with Modbus master function)	
4			PROFIBUS-DP communication (with Modbus master function)	
Open networks	5		DeviceNet communication (with Modbus master function)	
	-1		English (Default. Can be switched to other language by the setting.)	
	-2		German (Default. Can be switched to other language by the setting.)	
	-3		French (Default. Can be switched to other language by the setting.)	
	-4		Spanish (Default. Can be switched to other language by the setting.)	
Display language ⁽¹⁾	0		White (Light gray)	
	1		Black (Light charcoal gray)	
Case color				
Fixed code			Always "-00"	
Optional suffix codes		/AP	2 additional patterns/20 additional segments	
		/HA	Heater break alarm ⁽²⁾	
		/DC	Power supply 24 V AC/DC	
		/CT	Coating ⁽³⁾	
		/CV	Terminal Cover	

Model	Suffix code	Optional suffix code	Description	
UP32A			Program Controller (Power supply: 100-240 V AC) 2 program patterns/ 20 program segments (When the /AP option is specified, 4 program patterns/ 40 program segments, max. 20 segments per pattern.) (provided with retransmission output or 15 V DC loop power supply, 3 DIs, and 3 DOs)	
	Type 1:	-0	Standard type	
	Basic control	-1		Position proportional type
		-2		Heating/cooling type
				None
	Type 2:Functions	0		None
		1		RS-485 communication (Max.38.4 kbps, 2-wire/4-wire)
	Type 3:	0		None
		2		2 additional DIs, 2 additional DOs
		3		CC-Link communication (with Modbus master function) ⁽¹⁾
Open networks				
	-1		English (Default. Can be switched to other language by the setting.)	
	-2		German (Default. Can be switched to other language by the setting.)	
	-3		French (Default. Can be switched to other language by the setting.)	
	-4		Spanish (Default. Can be switched to other language by the setting.)	
Display language ⁽²⁾	0		White (Light gray)	
	1		Black (Light charcoal gray)	
Case color				
Fixed code			Always "-00"	
Optional suffix codes		/AP	2 additional patterns/20 additional segments	
		/HA	Heater break alarm ⁽³⁾	
		/DC	Power supply 24 V AC/DC	
		/CT	Coating ⁽⁴⁾	
		/CV	Terminal Cover	

UP35A *1: English, German, French, and Spanish are available for the guide display.

*2: The /HA option can be specified only when the Type 1 code is "-0" or "-2."

*3: When the /CT option is specified, the UP35A does not conform to the safety standards (UL and CSA) and CE marking (Products with /CT option are not intended for EEA-market).

UP32A *1: Type 3 code "3" can be specified only when both Type 1 and Type 2 code are "0".

*2: English, German, French, and Spanish are available for the guide display.

*3: The /HA option can be specified only when the Type 1 code is "-0" or "-2" and Type 3 code is "0".

*4: When the /CT option is specified, the UP32A does not conform to the safety standards (UL and CSA) and CE marking (Products with /CT option are not intended for EEA-market).

Product Line-up

Digital Indicator with Alarms UM33A



Main Features

- Up to 9 alarm outputs (including one Fail)
- Input correction function (PV bias, polygonal line approximation, polygonal line bias)
- 24 VDC sensor power supply available
- Simple operation
- CC-Link communication support

External Dimensions

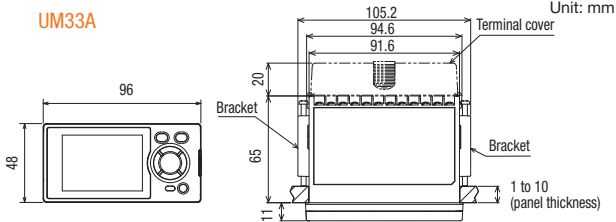

Model	Suffix code	Optional suffix code	Description
UM33A			Digital Indicator with Alarms (Power supply: 100-240 V AC) (provided with retransmission output or 15 V DC loop power supply, 2 DIs, and 3 DOs)
Type 1:Basic	-0		Standard type
	0		None
Type 2:Functions	1		1 additional DO (c-contact relay), RS-485 communication (Max.38.4 kbps, 2-wire/4-wire) ^{(*)1}
	2		1 additional DO (c-contact relay)
	3		6 additional DOs (c-contact relay; 1 point and open collector; 5 points)
Type 3:	0		None
Open networks	3		CC-Link communication (with Modbus master function) ^{(*)2}
Display language ^{(*)3}	-1		English (Default. Can be switched to other language by the setting.)
	-2		German (Default. Can be switched to other language by the setting.)
	-3		French (Default. Can be switched to other language by the setting.)
	-4		Spanish (Default. Can be switched to other language by the setting.)
Case color	0		White (Light gray)
	1		Black (Light charcoal gray)
Optional suffix codes	/LP		24 V DC loop power supply ^{(*)4}
	/DC		Power supply 24 V AC/DC
	/CT		Coating ^{(*)5}
	/CV		Terminal cover

*1: When /LP option is specified, the RS-485 communication of the Type 2 code "1" is 2-wire system.
 *2: Type 3 code "3" can be specified only when the Type 2 code is "0" or "2".
 *3: English, German, French, and Spanish are available for the guide display.
 *4: The /LP option can be specified only when the code for Type 2 code is any of "0", "1" or "2", and the Type 3 code is "0".
 *5: When the /CT option is specified, the UM33A does not conform to the safety standards (UL and CSA) and CE marking (Products with /CT option are not intended for EEA-market).

5 digits, 14-segment large LCD display with PV color changing function
 You can set the display to change colors during alarms.

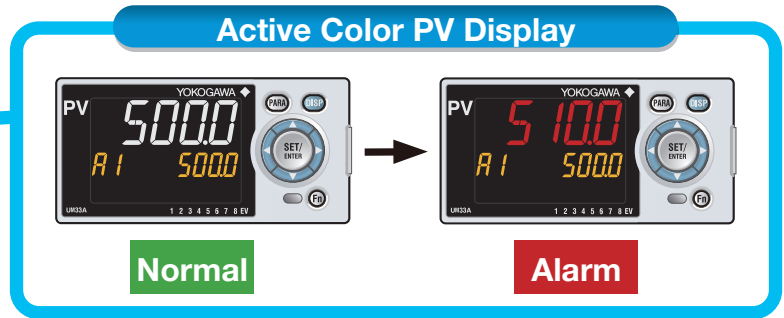
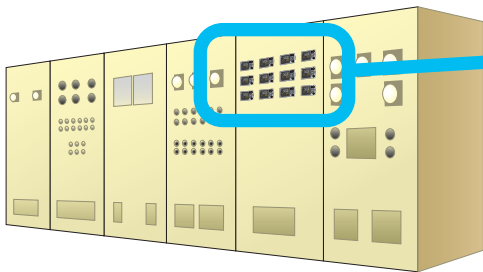

LL50A Parameter Setting Software

Parameter setting display

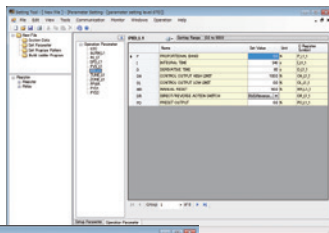

Program pattern creating display

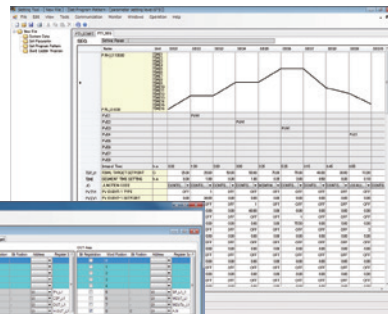

Tuning display

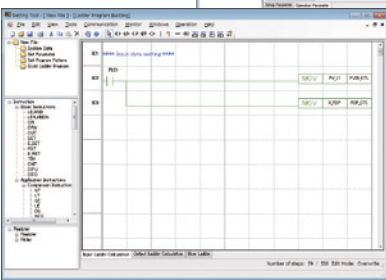

Ladder program building display

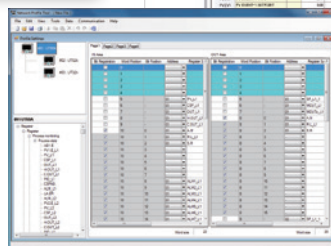

Network profile creating display

Model	Suffix code	Description
LL50A	-00	Parameter Setting Software with Ladder Program Building Function

Main Features

SUPER Function suppresses overshoot

SUPER

The field-proven SUPER function utilizes a built-in operator experience and fuzzy theory to deliver fine control and suppress overshoot.

- When wishing to suppress overshoot
- When wishing to reduce the startup time
- When load changes are significant
- When setpoint is changed frequently

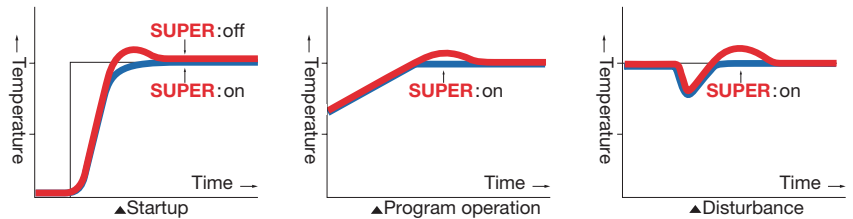

SUPER2 Function suppresses hunting

SUPER2

The new SUPER2 function utilizes a built-in operator experience and modern control theory to deliver fine control and suppress hunting.

- With frequent load fluctuations
- With frequent external disturbances that take time to normalize
- When hunting still occurs after setpoint (SP) changes even if PID constants are set

Effect 1: Material change or load change with the same PID.

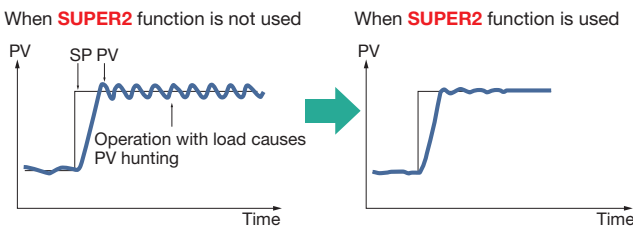

Effect 2: Setpoint (SP) change with the same PID.

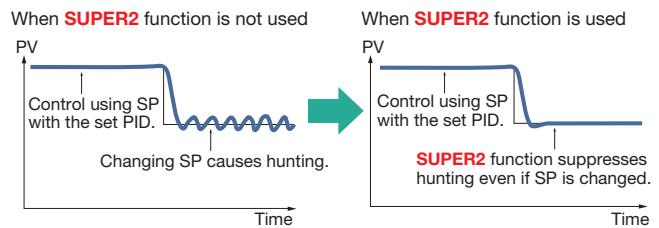

Auto-Tuning (AT) Function

Autotuning is a function that evaluates process characteristics to automatically set optimal values relative to a target value that determines a PID constant. To implement autotuning, you can configure the following conditions.

- Two types of algorithms to calculate PID constants are available for selection.
 - Normal: Fast-rising PID constant
 - Stable: Slow-rising PID constant
- High and low output limits can be set individually for control output values during AT runtime.

Quick Setting Function

Minimum parameters necessary for operation can be set.

Security Function

The password function can prevent inadvertent changes to the parameter settings. If a password is set, the password is required when moving to the Setup Parameter Setting Display. When the password is verified, can be changed to the Setup Parameter Setting Display.



Message Function

Using the message function and turning the contact input on/off, the message registered beforehand can be displayed on PV display by interrupt. The message is registered using LL50A Parameter Setting Software. The messages are limited to 20 alphanumeric characters. A maximum of four messages can be registered.



Operation Display



CLOSE VALVE

When the contact input is turned on, the scrolling message registered beforehand is displayed on PV Display.

Battery Free Memory Backup

Nonvolatile memory is used for memory parameters backup. Service life is improved because no batteries, backup capacitors, or other components are used.

Related Instruments

Temperature Controller TC10

Small Cubic Controller



- Compact size (48 x 48 mm (1/16 DIN), depth 48 mm + 14 mm (terminals))
- Universal Input
- 3 colors active display
- Serial Communication

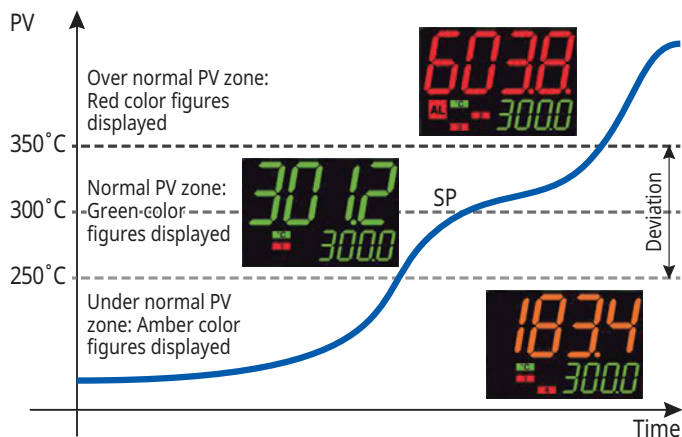

Application

Heating and cooling (two outputs model)

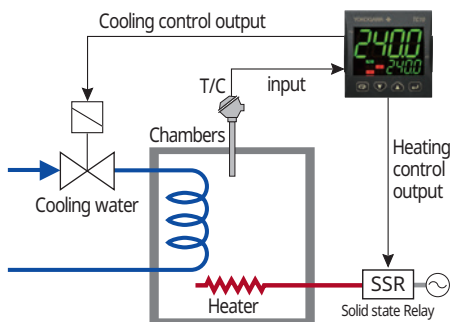

Alarm detection with active display

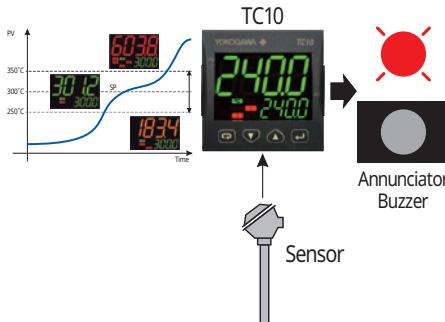

Monitoring and setting from external device

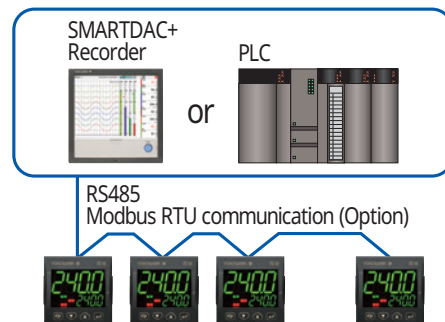

Model Code	Suffix codes										Description
TC10	-N	C				D		F	/		Temperature Controller with an universal input, one logic input, and one selectable I/O
Fixed code	-N										Always "-N"
Power supply	L										24 VAC/DC (Custom order)
	H										100 to 240 VAC
Fixed code		C									Always "C"
OUT1-3			R	N	N						Relay output for On/Off control
			R	R	R						Relay output with two alarm relays, or On/Off Heat/Cool control with one alarm
			V	N	N						DCV output for SSR
			V	R	R						DCV output for SSR with two alarm relays, or DCV and Relay output for Heat/Cool control with one alarm
			V	V	R						Two DCV outputs for SSR with one relay (Custom order)
IN/OUT4 (Fixed code)			A	R	R						Analog output with two alarm relays, or Analog output and Relay output for Heat/Cool control with one alarm
						D					Always "D" Selectable I/O (logic input / 12 V SSR drive output / 12 VDC 20 mA transmitter power supply)
Serial communication								S			RS485 Modbus
								N			None
Fixed code									F		Always "F"
Option code										/GK	Panel gasket for IP65

Data Logging Software GA10

Monitors and records data from a variety of instruments via networks



Broad support for data loggers, recorders, digital indicating controllers, signal conditioners, power monitors, and power meters. Even acquires data from Modbus devices.

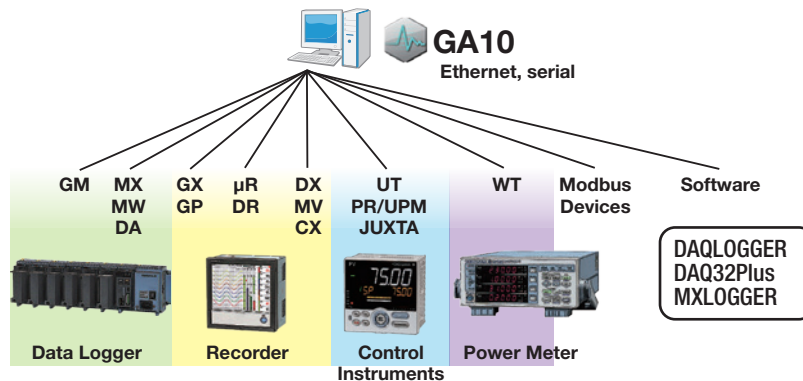

Specifications (Overview)

- Max. connectable units: 100
- Max. recording tags (channels): 2000
- Max. recording MATH tags (channels): 200
- Max connectable clients: Unlimited (verified with 32)
- Scan interval: 100 ms or higher (using PC time), or scan interval of instruments (using instrument time)

General Specifications: GS 04L65B01-01E

Paperless Recorder SMARTDAC+GX10/GX20

Read/write measured data on other instruments via Modbus protocol.

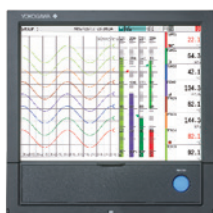
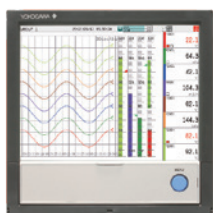

Cover color (BC option)

Modbus RTU (RS-422A/485 connection)

Modbus master

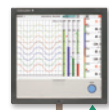

The data of slave units can be displayed and saved on the GX/GP using the Modbus RTU function*.

* Communication function option is required.

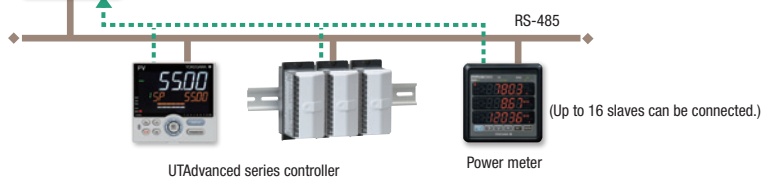

General Specifications: GS 04L51B01-01E

RS232C/RS485 Converter ML2

The ML2 is a plugin type converter with 2 ports (RS-232C and RS-485) that performs isolation of communication signals, level conversion, and active control of drivers.

- Built-in RS-485 line termination resistance of 220 Ω (optional)
- Select auto or manual RS-485 driver active control
- Change communication speeds from 300 to 38400 bps in 8 stages with a rotary switch
- Echo-back ON/OFF switch (2-wire types only)
- Switch between 2-wire and 4-wire on the RS-485 side



General Specifications: GS 77J04L02-01E

UTAdvanced

Find us on your favorite search engine

UTAdvanced

Search

www.UTAdvanced.com

Download user's manuals and specification documents here

STEP 1

UTAdvanced Y-Link

Search

STEP 2

keyword *

product category *

product series/model

document type

language

Search

All
Manual
Bulletin
GS
TI

ating Controllers

All

English

Choose a document type

Find answers to the most frequently asked questions.

FAQ : <http://www.yokogawa.com/ns/utadv/faq/>

3-Year Warranty

NOTICE

- Before operating the product, read the user's manual thoroughly for proper and safe operation.
- If this product is for use with a system requiring safeguards that directly involve personnel safety, please contact the Yokogawa sales offices.

UTAdvanced, Light loader and SMARTDAC+ are registered trademarks or trademarks of Yokogawa Electric Corporation.
Microsoft and Windows are registered trademarks or trademarks of Microsoft Corporation in the United States and other countries.
Other company names and product names appearing in this document are registered trademarks or trademarks of their respective holders.

YOKOGAWA ELECTRIC CORPORATION

Control Instruments Business Division

E-mail: ns@cs.jp.yokogawa.com

<http://www.yokogawa.com/>

YOKOGAWA CORPORATION OF AMERICA

YOKOGAWA EUROPE B.V.

YOKOGAWA ENGINEERING ASIA PTE. LTD.

<http://www.yokogawa.com/us/>

<http://www.yokogawa.com/eu/>

<http://www.yokogawa.com/sg/>

Sign up for our free e-mail newsletter
www.yokogawa.com/ns/

Subject to change without notice.
All Rights Reserved. Copyright© 2015, Yokogawa Electric Corporation

KP-S-1E

Printed in Japan, 801(KP)
[Ed : 02/b]