
**User's
Manual**

UTAdvanced

Functional
Enhancement

**UM33A
Digital Indicator with Alarms
User's Manual**

IM 05P03D21-01EN

vigilantplant[®]

Product Registration

Thank you for purchasing YOKOGAWA products.

YOKOGAWA provides registered users with a variety of information and services. Please allow us to serve you best by completing the product registration form accessible from our homepage.

<http://www.yokogawa.com/ns/reg/>

Introduction

Thank you for purchasing the UM33A digital indicator with alarms (hereinafter referred to as UM33A).

This manual describes how to use UM33A functions other than UM33A's communication function and ladder sequence function. Please read through this user's manual carefully before using the product.

Note that the manuals for the UM33A comprise the following six documents:

• Printed manual

Manual Name	Manual Number	Description
UM33A Operation Guide	IM 05P03D21-11EN	This manual describes the basic operation method.
Precautions on the Use of the UTAdvanced Series	IM 05P01A01-11EN	This manual is always delivered even if 'without manuals' was selected.

• Electronic manuals

Manual Name	Manual Number	Description
UM33A Operation Guide	IM 05P03D21-11EN	This is identical to the printed manual.
UM33A User's Manual	IM 05P03D21-01EN	This manual. It describes the usage of all functions except the ladder sequence and communication functions.
UTAdvanced Series Communication Interface (RS-485, Ethernet) User's Manual	IM 05P07A01-01EN	This manual describes how to use UM33A in Ethernet and serial communications. For communication wiring, see the Operation Guide or User's Manual.
LL50A Parameter Setting Software Installation Manual	IM 05P05A01-01EN	This manual describes how to install and uninstall the LL50A.
LL50A Parameter Setting Software User's Manual	IM 05P05A01-02EN	This manual describes how to use the LL50A, ladder sequence function, peer-to-peer communication, and network profile creating function.
Precautions on the Use of the UTAdvanced Series	IM 05P01A01-11EN	This manual is always delivered even if 'without manuals' was selected.

* User's Manual can be downloaded from a website.

 <http://www.yokogawa.com/ns/ut/im/>

• General Specifications

General Specification Name	GS Number
UM33A Digital Indicator with Alarms	GS 05P03D21-01EN
LL50A Parameter Setting Software	GS 05P01A01-01EN

* The last two characters of the manual number and general specification number indicate the language in which the manual is written.

• Authorised Representative in the EEA

Authorised Representative in the EEA

Yokogawa Europe BV. (Address: Euroweg 2 , 3825 HD Amersfoort, The Netherlands) is the Authorised Representative of Yokogawa Electric Corporation for this Product in the EEA.

Target Readers

This guide is intended for the following personnel;

- Engineers responsible for installation, wiring, and maintenance of the equipment.
- Personnel responsible for normal daily operation of the equipment.

Notice

- The contents of this manual are subject to change without notice as a result of continuing improvements to the instrument's performance and functions.
- Every effort has been made to ensure accuracy in the preparation of this manual. Should any errors or omissions come to your attention, however, please inform Yokogawa Electric's sales office or sales representative.
- Under no circumstances may the contents of this manual, in part or in whole, be transcribed or copied without our permission.

Trademarks

- Our product names or brand names mentioned in this manual are the trademarks or registered trademarks of Yokogawa Electric Corporation (hereinafter referred to as YOKOGAWA).
- Microsoft, MS-DOS, Windows, Windows XP, Windows Vista, and Windows 7 are either registered trademarks or trademarks of Microsoft Corporation in the United States and/or other countries.
- Adobe, Acrobat, and Postscript are either registered trademarks or trademarks of Adobe Systems Incorporated.
- Ethernet is a registered trademark of XEROX Corporation in the United States.
- Modbus is a registered trademark of Schneider Electric.
- CC-Link is a registered trademark of CC-Link Partner Association (CLPA.)
- We do not use the TM or ® mark to indicate these trademarks or registered trademarks in this user's manual.
- All other product names mentioned in this user's manual are trademarks or registered trademarks of their respective companies.

Safety Precautions

This instrument is a product of Installation Category II of IEC/EN/CSA/UL61010-1, IEC/EN61010-2-201, IEC/EN61010-2-030 Safety Standards and Class A of EN61326-1, EN55011 (EMC Standards).



CAUTION

This instrument is an EMC class A product. In a domestic environment, this product may cause radio interference in which case the user needs to take adequate measures.

The instrument is a product rated Measurement Category O (other).

* Measurement Category O (other)

This category applies to electric equipment that measures a circuit connected to a low-voltage facility and receives power from stationary equipment such as electric switchboards.

To use the instrument properly and safely, observe the safety precautions described in this user's manual when operating it. Use of the instrument in a manner not prescribed herein may compromise protection features inherent in the device. We assume no liability for or warranty on a fault caused by users' failure to observe these instructions.

This instrument is designed to be used within the scope of Measurement Category O (other) and is dedicated for indoor use.

Notes on the User's Manual

- This user's manual should be readily accessible to the end users so it can be referred to easily. It should be kept in a safe place.
- Read the information contained in this manual thoroughly before operating the product.
- The purpose of this user's manual is not to warrant that the product is well suited to any particular purpose, but rather to describe the functional details of the product.

Safety, Protection, and Modification of the Product

The following symbols are used in the product and user's manuals to indicate safety precautions:



"Handle with Care" (This symbol is attached to the part(s) of the product to indicate that the user's manual should be referred to in order to protect the operator and the instrument from harm.)



AC



AC/DC



The equipment wholly protected by double insulation or reinforced insulation.



Functional grounding terminal (Do not use this terminal as a protective grounding terminal.)

- In order to protect the system controlled by this product and the product itself, and to ensure safe operation, observe the safety precautions described in this user's manual. Use of the instrument in a manner not prescribed herein may compromise the product's functions and the protection features inherent in the device. We assume no liability for safety, or responsibility for the product's quality, performance or functionality should users fail to observe these instructions when operating the product.
- Installation of protection and/or safety circuits with respect to a lightning protector; protective equipment for the system controlled by the product and the product itself; foolproof or failsafe design of a process or line using the system controlled by the product or the product itself; and/or the design and installation of other protective and safety circuits are to be appropriately implemented as the customer deems necessary.
- Be sure to use the spare parts approved by YOKOGAWA when replacing parts or consumables.
- This product is not designed or manufactured to be used in critical applications that directly affect or threaten human lives. Such applications include nuclear power equipment, devices using radioactivity, railway facilities, aviation equipment, air navigation facilities, aviation facilities, and medical equipment. If so used, it is the user's responsibility to include in the system additional equipment and devices that ensure personnel safety.
- Modification of the product is strictly prohibited.
- This product is intended to be handled by skilled/trained personnel for electric devices.
- This product is UL Recognized Component. In order to comply with UL standards, end-products are necessary to be designed by those who have knowledge of the requirements.



WARNING

- **Power Supply**
Ensure that the instrument's supply voltage matches the voltage of the power supply before turning ON the power.
- **Do Not Use in an Explosive Atmosphere**
Do not operate the instrument in locations with combustible or explosive gases or steam. Operation in such environments constitutes an extreme safety hazard. Use of the instrument in environments with high concentrations of corrosive gas (H₂S, SO_x, etc.) for extended periods of time may cause a failure.
- **Do Not Remove Internal Unit**
The internal unit should not be removed by anyone other than YOKOGAWA's service personnel. There are dangerous high voltage parts inside. Additionally, do not replace the fuse by yourself.
- **Damage to the Protective Construction**
Operation of the instrument in a manner not specified in this user's manual may damage its protective construction.

Warning and Disclaimer

- YOKOGAWA makes no warranties regarding the product except those stated in the WARRANTY that is provided separately.
- The product is provided on an "as is" basis. YOKOGAWA assumes no liability to any person or entity for any loss or damage, direct or indirect, arising from the use of the product or from any unpredictable defect of the product.

Notes on Software

- YOKOGAWA makes no warranties, either expressed or implied, with respect to the software's merchantability or suitability for any particular purpose, except as specified in the terms of the separately provided warranty.
- This software may be used on one specific machine only.
- To use the software on another machine, the software must be purchased again separately.
- It is strictly prohibited to reproduce the product except for backup purposes.
- Store the software CD-ROM (the original medium) in a safe place.
- All reverse-engineering operations, such as reverse compilation or the reverse assembly of the product are strictly prohibited.
- No part of the product's software may be transferred, converted, or sublet for use by any third party, without prior written consent from YOKOGAWA.

Handling Precautions for the Main Unit

- The instrument comprises many plastic components. To clean it, wipe it with a soft, dry cloth. Do not use organic solvents such as benzene or thinner for cleaning, as discoloration or deformation may result.
- Keep electrically charged objects away from the signal terminals. Not doing so may cause the instrument to fail.
- Do not apply volatile chemicals to the display area, operation keys, etc. Do not leave the instrument in contact with rubber or PVC products for extended periods. Doing so may result in failure.
- If the equipment emits smoke or abnormal smells or makes unusual noises, turn OFF the instrument's power immediately and unplug the device. In such an event, contact your sales representative.

Checking the Contents of the Package

Unpack the box and check the contents before using the product. If the product is different from that which you have ordered, if any parts or accessories are missing, or if the product appears to be damaged, contact your sales representative.

UM33A Main Unit

The UM33A main units have nameplates affixed to the side of the case.

Check the model and suffix codes inscribed on the nameplate to confirm that the product received is that which was ordered.

No. (Instrument number)

When contacting your sales representative, inform them of this number, too.

Note

The last digit of the display code (-x0) has been changed into the case color code.

Model and Suffix Codes of UM33A

Model	Suffix code	Optional suffix code	Description
UM33A			Digital Indicator with Alarms (Power supply: 100-240 V AC) (provided with retransmission output or 15 V DC loop power supply, 2 DIs, and 3 DOs)
Type 1: Basic	-0		Standard type
Type 2: Functions	0		None
	1		1 additional DO (c-contact relay), RS-485 communication (Max.38.4 kbps, 2-wire/4-wire) (*1)
	2		1 additional DO (c-contact relay)
	3		6 additional DOs (c-contact relay; 1 point and open collector; 5 points)
Type 3: Open networks	0		None
			CC-Link communication (with Modbus master function) (*2)
Display language (*3)	-1		English (Default. Can be switched to other language by the setting.)
	-2		German (Default. Can be switched to other language by the setting.)
	-3		French (Default. Can be switched to other language by the setting.)
	-4		Spanish (Default. Can be switched to other language by the setting.)
Case color	0		White (Light gray)
	1		Black (Light charcoal gray)
Optional suffix codes		/LP	24 V DC loop power supply (*4)
		/DC	Power supply 24 V AC/DC
		/CT	Coating (*5)
		/CV	Terminal cover

*1: When /LP option is specified, the RS-485 communication of the Type 2 code "1" is 2-wire system.

*2: Type 3 code "3" can be specified only when the Type 2 code is "0" or "2".

*3: English, German, French, and Spanish are available for the guide display.

*4: The /LP option can be specified only when the code for Type 2 code is any of "0", "1" or "2", and the Type 3 code is "0".

*5: When the /CT option is specified, the UM33A does not conform to the safety standards (UL and CSA) and CE marking (Products with /CT option are not intended for EEA-market).

Coating Treatment

(1) HumiSeal coating treatment

Apply HumiSeal coating to the printed circuit board assembly.

Do not apply HumiSeal coating to the following parts: connector, gold-plated contact area, relay part, RJC device, and in the vicinity of the push switch/LED lamp.

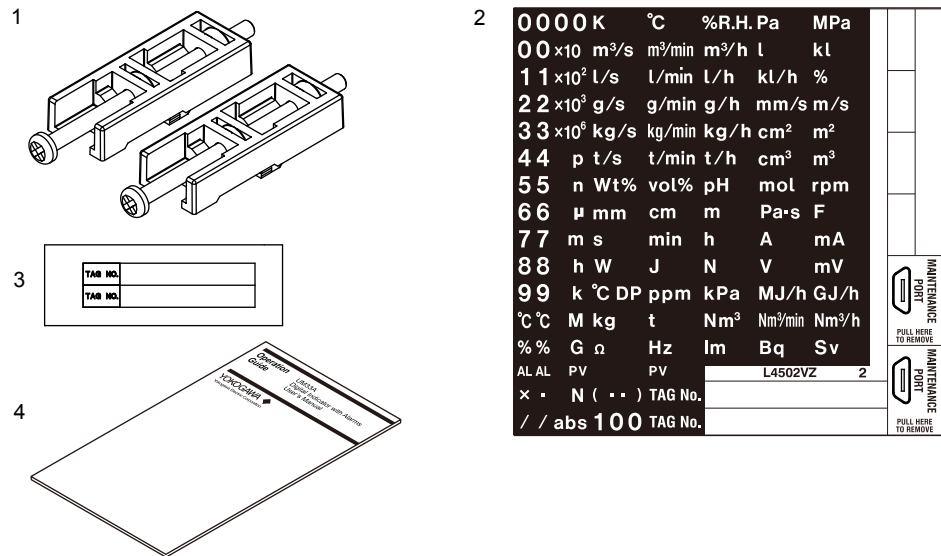
(2) Apply terminal coating to the gold-plated contact area on the printed circuit board.

Notes

- There are two treatments as described above, but we do not guarantee their effectiveness. We do not supply any test data on these treatments.
- Do not apply any treatment to the screw terminal area on the back side of the instrument.

Accessories

The product is provided with the following accessories according to the model and suffix codes. Check that none of them are missing or damaged.



No.	Product Name	Quantity	Remark
1	Brackets	2	Part number: L4502TP (For fixing the right and left parts)
2	Unit label	1	Part number: L4502VZ
3	Tag label	1	Part number: L4502VE (Only when ordered.)
4	Operation Guide	1	A3 size, x 4

How to use the unit label

- Affixing the unit label**
Affix the unit label to the front panel. If necessary, combine with unit prefixes. Affix it so that the LCD area is not blocked.
- Maintenance port seals**
Maintenance port seals (two spares) are available. Use them if the seal affixed to the UTAdvanced controller loses its adhesiveness.
- TAG No. labels**
TAG No. labels (two pieces) are available. Use them if necessary.

Accessory (sold separately)

The following lists an accessory sold separately.

- LL50A Parameter Setting Software

Model	Suffix code	Description
LL50A	-00	Parameter Setting Software

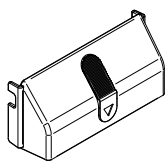
- External Precision Resistor

Model	Suffix code	Description
X010	See the General Specifications (*)	Resistance Module

*: Necessary to input the current signal to the voltage input terminal.

- Terminal cover

For UM33A, Model: UTAP002



- Brackets

Part number L4502TP (2 pieces for fixing the right and left parts)

- User's Manual (A4 size)

* User's Manual can be downloaded from a website.

Symbols Used in This Manual



This symbol is used on the instrument. It indicates the possibility of injury to the user or damage to the instrument, and signifies that the user must refer to the user's manual for special instructions. The same symbol is used in the user's manual on pages that the user needs to refer to, together with the term "WARNING" or "CAUTION."

WARNING

Calls attention to actions or conditions that could cause serious or fatal injury to the user, and indicates precautions that should be taken to prevent such occurrences.

CAUTION

Calls attention to actions or conditions that could cause injury to the user or damage to the instrument or property and indicates precautions that should be taken to prevent such occurrences.

Note

Identifies important information required to operate the instrument.



Indicates related operations or explanations for the user's reference.



Indicates a character string displayed on the display.

Setting Display

Indicates a setting display and describes the keystrokes required to display the relevant setting display.

Setting Details

Provides the descriptions of settings.

Description

Describes restrictions etc. regarding a relevant operation.

How to Use This Manual

For the communication functions, see the Communication Interface manual. This user's manual is organized into Chapters 1 to 17 as shown below.

Chapter	Title and Description
1	Introduction to Functions Describes the main functions of the UM33A.
2	UM33A Operating Procedures Describes the flow from unpacking to regular operations.
3	Part Names Describes part names and functions on the front panel.
4	Basic Operation Describes basic operation of the UM33A.
5	Quick Setting Function Describes the minimum necessary settings for operation.
6	Monitoring of Regular Operations Describes monitoring displays of regular operations and operation.
7	Input (PV) Functions Describes PV input.
8	Functions Provides function block diagrams.
9	Alarm Functions Describes alarm output and status output.
10	Output (Retransmission) Functions Describes output functions.
11	Contact Input/Output Functions Describes contact input/output functions.
12	Display, Key, and Security Functions Describes display, user function key and security functions.
13	Parameter Initialization Describes the initialization to factory default values and to user default values.
14	Power Failure Recovery Processing/Power Frequency Setting/Other Settings Describes operations performed after momentary power interruption and power failures.
15	Troubleshooting, Maintenance, and Inspections Describes troubleshooting, maintenance, periodic inspections, and disposal.
16	Installation and Wiring Describes installation and wiring.
17	Parameters Provides parameter maps.
GS	Specifications Provides the UM33A specifications.

Contents

Introduction.....	i
Target Readers.....	i
Notice	ii
Trademarks	ii
Safety Precautions	ii
Handling Precautions for the Main Unit.....	iv
Checking the Contents of the Package.....	v
Model and Suffix Codes of UM33A.....	v
Symbols Used in This Manual.....	viii
How to Use This Manual	ix
Chapter 1 Introduction to Functions	
1.1 Quick Setting Function	1-1
1.2 Input/Output Function.....	1-2
1.3 Display and Key Functions.....	1-4
1.4 Communication Functions.....	1-5
1.5 Definition of Main Symbols and Terms	1-7
Chapter 2 UM33A Operating Procedures	
2.1 UM33A Operating Procedures	2-1
Chapter 3 Part Names	
3.1 Names and Functions of Display Parts	3-1
3.2 Names and Functions of Keys	3-2
3.3 List of Display Symbols	3-4
3.4 Brief Description of Setting Details (Parameters)	3-6
Chapter 4 Basic Operation	
4.1 Overview of Display Switch and Operation Keys	4-1
4.2 How to Set Parameters	4-4
Chapter 5 Quick Setting Function	
5.1 Setting Using Quick Setting Function.....	5-1
5.2 Restarting Quick Setting Function.....	5-6
Chapter 6 Monitoring of Regular Operations	
6.1 Monitoring of Operation Displays	6-1
6.1.1 Operation Display Transitions.....	6-1
6.2 Setting Alarm Setpoint.....	6-3
6.3 Releasing On-State (Latch) of Alarm Output.....	6-4
6.4 Confirmation of PV peak and bottom value.....	6-5
Chapter 7 Input (PV) Functions	
7.1 Setting Functions of PV Input.....	7-1
7.1.1 Setting Input Type, Unit, Range, Scale, and Decimal Point Position.....	7-1
7.1.2 Setting Burnout Detection for Input.....	7-4
7.1.3 Setting Reference Junction Compensation (RJC) or External Reference Junction Compensation (ERJC)	7-5
7.1.4 Correcting Input Value	7-6
(1) Setting Bias and Filter	7-6
(2) Setting Square Root Extraction and Low Signal Cutoff Point.....	7-7



	(3) Setting 10-segment Linearizer.....	7-8
7.2	Setting Input Sampling Period.....	7-10
Chapter 8 Functions		
8.1	Function Block Diagrams	8-1
Chapter 9 Alarm Functions		
9.1	Setting Alarm Type	9-1
9.2	Setting Number of Alarm Groups to Use	9-7
9.3	Setting Hysteresis to Alarm Operation	9-8
9.4	Delaying Alarm Output (Alarm Delay Timer)	9-9
Chapter 10 Retransmission Output Functions		
10.1	Setting Retransmission Output Terminal, Type, and Scales.....	10-1
10.2	Setting 10-segment Linearizer for Output	10-2
10.3	Changing Current Output Range.....	10-4
10.4	Setting Split Computation Output Function	10-5
10.5	Using 15 V DC Loop Power Supply	10-6
Chapter 11 Contact Input/Output Functions		
11.1	Setting Contact Input Function.....	11-1
	11.1.1 Setting Contact Input Function	11-1
	11.1.2 Changing Contact Type of Contact Input.....	11-3
11.2	Setting Contact Output Function	11-4
	11.2.1 Setting Function of Contact Output.....	11-4
	11.2.2 Changing Contact Type of Contact Output	11-7
Chapter 12 Display, Key, and Security Functions		
12.1	Setting Display Functions.....	12-1
	12.1.1 Setting Active Color PV Display Function	12-1
	12.1.2 Masking Arbitrary Display Value in Operation Display	12-3
	12.1.3 Registering SELECT Display (Up to 5 Displays)	12-4
	12.1.4 Changing Event Display	12-5
	12.1.5 Masking Least Significant Digit of PV Display	12-6
	12.1.6 Setting Economy Mode.....	12-7
	12.1.7 Selecting the Initial Operation Display that Appears at Power ON	12-7
	12.1.8 Setting Message Function	12-8
	12.1.9 Switching Guide Display Language	12-8
	12.1.10 Changing Guide Scroll Speed	12-9
	12.1.11 Turning Guide Display ON/OFF.....	12-9
	12.1.12 Setting Automatic Return to Operation Display	12-9
	12.1.13 Setting Brightness Adjustment of LCD and Display Update Cycle	12-10
12.2	Assigning Function to User Function Key	12-11
12.3	Setting Security Functions.....	12-13
	12.3.1 Setting or Clearing the Password	12-13
	12.3.2 Setting Parameter Display Level	12-13
	12.3.3 Locking (Hiding) Parameter Menu Display	12-14
	12.3.4 Key Lock.....	12-15
	12.3.5 Setting Display/Non-display of Operation Display	12-15
	12.3.6 Prohibiting Writing via Communication	12-15
12.4	Confirmation of Key and I/O Condition and Version.....	12-16
	12.4.1 Confirmation of Key and I/O Condition	12-16
	12.4.2 Confirmation of Version	12-18

Chapter 13 Parameter Initialization

13.1 Initializing Parameter Settings to Factory Default Values..... 13-1
 13.2 Registering and Initializing User Default Values..... 13-2
 13.2.1 Registering as User Setting (Default) Values..... 13-2
 13.2.2 Initializing to User Setting (Default) Values..... 13-2

Chapter 14 Power Failure Recovery Processing / Power Frequency Setting / Other Settings

14.1 Remedies if Power Failure Occurs during Operations 14-1
 14.2 Power Frequency Setting 14-2
 14.3 Setting Time between Powering on Indicator and Starting Monitor (Restart Timer)..... 14-3

Chapter 15 Troubleshooting, Maintenance, and Inspections

15.1 Troubleshooting..... 15-1
 15.1.1 Troubleshooting Flowchart..... 15-1
 15.1.2 Errors at Power On 15-2
 15.1.3 Errors during Operation 15-4
 15.2 Maintenance 15-9
 15.2.1 Cleaning..... 15-9
 15.2.2 Packaging when Shipping the Product for Repair 15-9
 15.2.3 Replacing Parts 15-9
 15.3 Periodic Maintenance 15-10
 15.4 Disposal..... 15-11

Chapter 16 Installation and Wiring

16.1 Installation Location..... 16-1
 16.2 Mounting Method..... 16-3
 16.3 External Dimensions and Panel Cutout Dimensions 16-4
 16.4 Wiring 16-5
 16.4.1 Important Information on Wiring 16-5
 16.4.2 PV Input Wiring 16-7
 16.4.3 Contact Input Wiring 16-8
 16.4.4 Contact Output Wiring 16-9
 16.4.5 Retransmission Output Wiring 16-11
 16.4.6 15 V DC Loop Power Supply Wiring 16-11
 16.4.7 24 V DC Loop Power Supply Wiring 16-11
 16.4.8 RS-485 Communication Interface Wiring 16-12
 16.4.9 CC-Link Communication Interface Wiring..... 16-14
 16.4.10 Power Supply Wiring 16-16
 16.5 Attaching and Detaching Terminal Cover 16-17

Chapter 17 Parameters

17.1 Parameter Map..... 17-1
 17.2 List of Parameters 17-6
 17.2.1 Operation Parameters 17-6
 17.2.2 Setup Parameters..... 17-8

Appendix Input and Output Table

Appendix 1 Input and Output Table..... App-1

Revision Information



1.1 Quick Setting Function

The Quick setting function is a function to easily set the basic function of the indicator.

Buy and Unpacking



Check the contents.

Installation and Wiring

Installation and Wiring: Chapter 16
Install and wire a indicator, and then turn on the power.

Setup



Q: What should I do to perform operate immediately?
First, I want to set the input and output.

A: Use the Quick setting function to perform the setup easily.
Quick setting function: Chapter 5

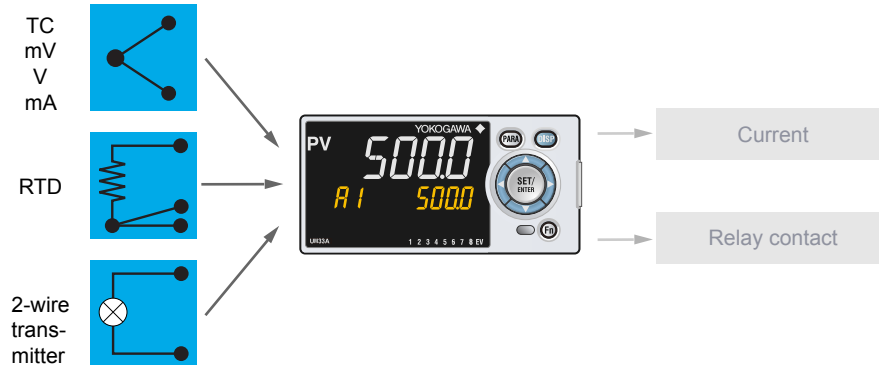
Operation

1.2 Input/Output Function

PV Input (equipped as standard)

PV input is a universal input to arbitrarily set the type and range for the thermocouple (TC), resistance-temperature detector (RTD), and DC voltage/current.

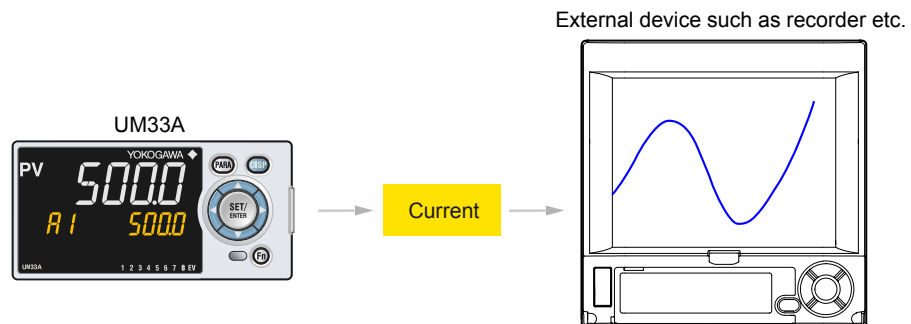
▶ [Chapter 7 Input \(PV\) Functions](#)



Retransmission Output (equipped as standard)

Retransmission output outputs a PV input value (PV), alarm output value (ALM) and the like as an analog signal to, for example, the recorder.

▶ [Chapter 11 Contact Input/Output Functions](#)



Contact Input

Two contact inputs are incorporated in UM33A. The PV peak value and PV bottom value can be reset, and the alarm latch can be released.

▶ [Chapter 11 Contact Input/Output Functions](#)

Contact Output

Up to 9 contact outputs can be incorporated. Contact output can output events such as alarms.

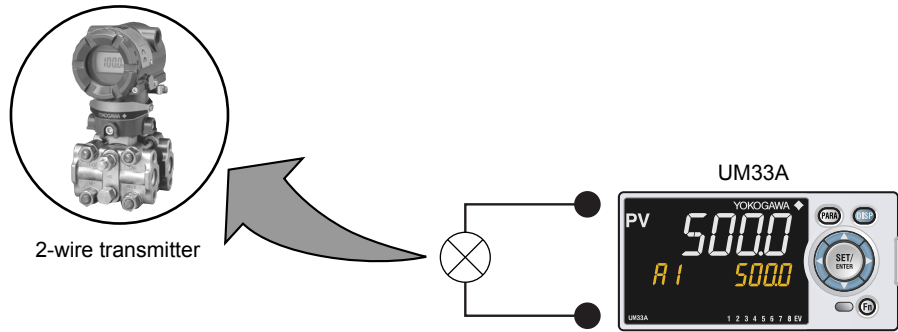
For details, see the table of Model and Suffix Codes.

▶ [Chapter 9 Alarm Functions](#)

24 V DC Loop Power Supply (optional suffix code: /LP)

24 V DC loop power supply can be supplied to 2-wire transmitter.

- ▶ [16.4.7 24 V DC Loop Power Supply Wiring](#)



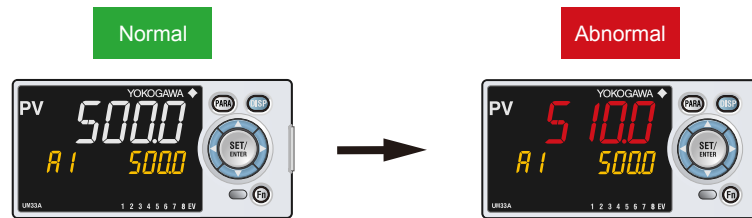
1.3 Display and Key Functions

Employing a 14-segment, active color LCD greatly increases the monitoring and operating capabilities.

Active Color PV Display (display color change)

The active color PV display function changes the PV display color (red or white) when abnormality occurs in PV etc.

▶ [12.1.1 Setting Active Color PV Display Function](#)



Guide Display

The guide is displayed on PV display when setting parameters. This guide can be turned on/off with the Fn key.



Multilingual Guide Display

English, German, French, or Spanish can be displayed in Guide display.

▶ [12.1.9 Switching Guide Display Language](#)

Parameter Display Level

To intended use of the operator, the display level of the parameter can be set.

▶ [Chapter 17 Parameters](#)

User Function Keys

The UM33A has a user function key (Fn).

Assign a function to a user function key to use it as an exclusive key.

▶ [12.2 Assigning Function to User Function Key](#)

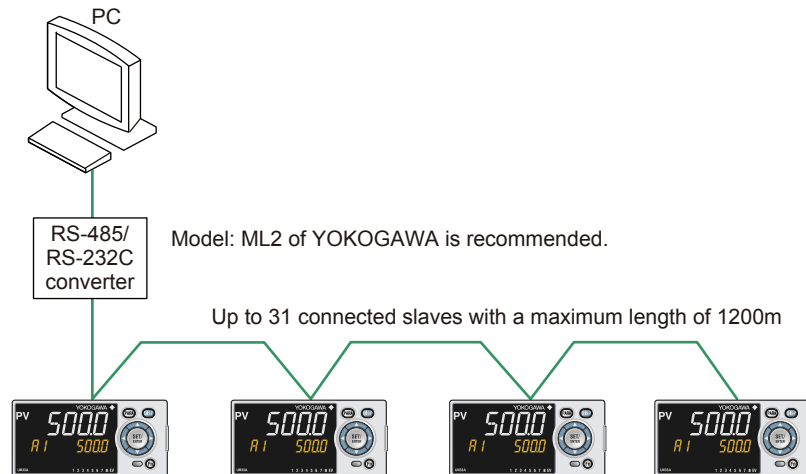
1.4 Communication Functions

The UM33A can use RS-485 communication by specifying the suffix code.

▶ [UTAdvanced Series Communication Interface \(RS-485, Ethernet\) User's Manual](#)

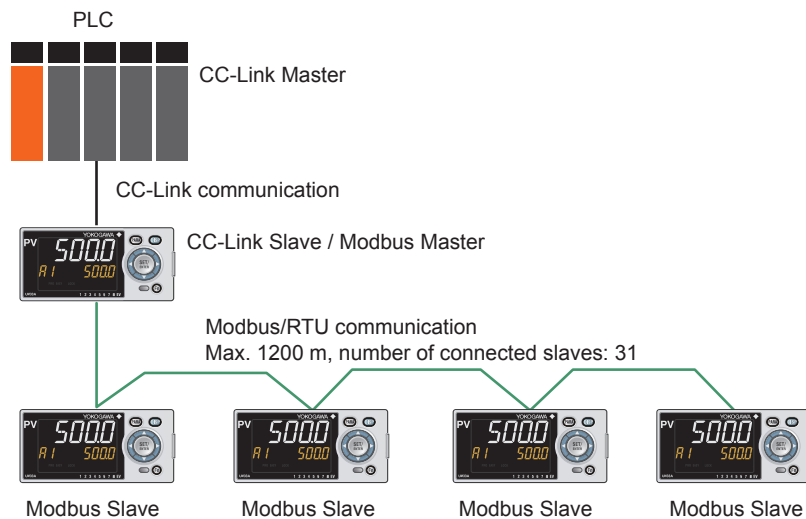
RS-485 Communication (Modbus communication, PC link communication, and Ladder communication)

The UM33A can communicate with PCs, PLCs, touch panels, and other devices.



CC-Link Communication

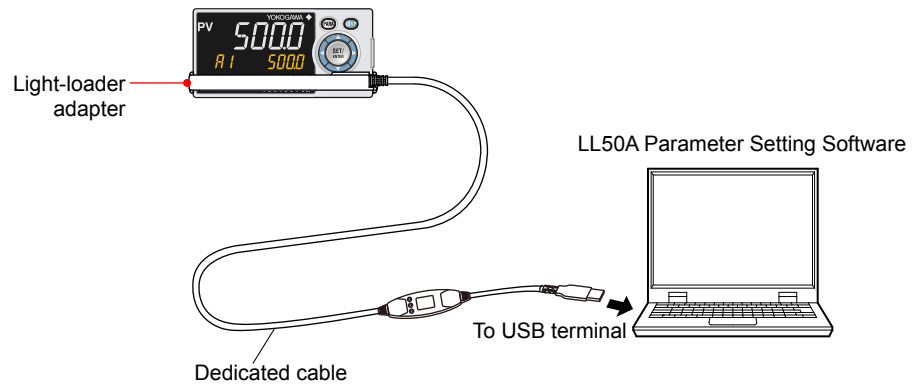
The UM33A can be used as the slave devices for CC-Link communication. Read-out of PV, operation or alarm status, and SP setting can be done by accessing the remote I/O on the master unit of CC-Link.



Light-loader Communication

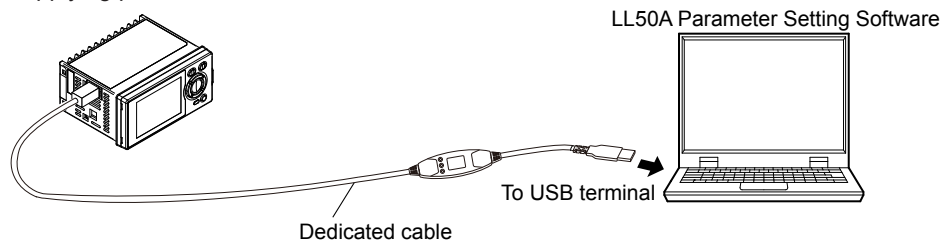
Use the LL50A to set parameters. Attach the adapter to the front of the indicator to communicate.

▶ [Light-loader function: LL50A Parameter Setting Software User's Manual](#)



Maintenance Port Communication (Power supply is not required for the UM33A)

Maintenance port is used to connect with the dedicated cable when using LL50A Parameter Setting Software (sold separately). The parameters can be set without supplying power to the UM33A.



CAUTION

When using the maintenance port, do not supply power to the indicator. Otherwise, the indicator does not work normally.
If power is supplied to the indicator while the cable is connected, or the cable is connected to the indicator already turned on, unplug the cable and turn on the indicator again. The indicator returns to the normal condition.

1.5 Definition of Main Symbols and Terms

Main Symbol

PV: Measured input value
A1 to A8: Alarm setpoint

PEAK: PV peak value
BOTM: PV bottom values

▶ [16.4 Wiring](#)

Engineering Units

Input range (scale): the PV range low limit is set to 0%, and the high limit is set to 100% for conversion.

Input range (scale) span: the PV range span is set to 100% for conversion.

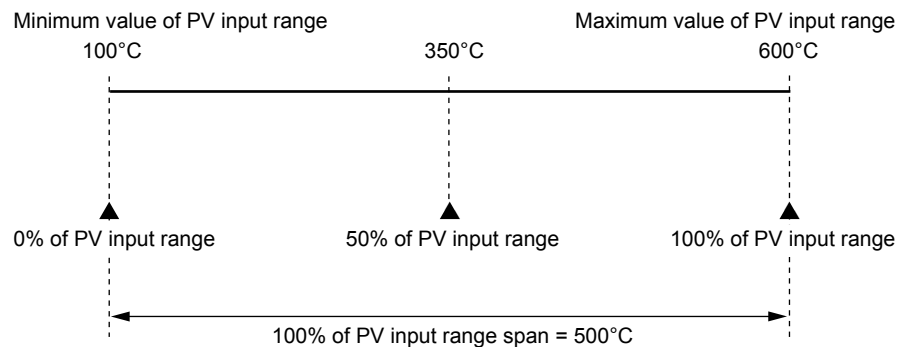
In this manual, the parameter setting range is described as the “input range” and “input range span.” This means that engineering units are required to be set. Set a temperature for temperature input.

The following describes a conversion example.

When the PV input range is 100 to 600°C, 0% of the PV range is equivalent to 100°C, 50% of the PV range is equivalent to 350°C, and 100% of the PV range is equivalent to 600°C.

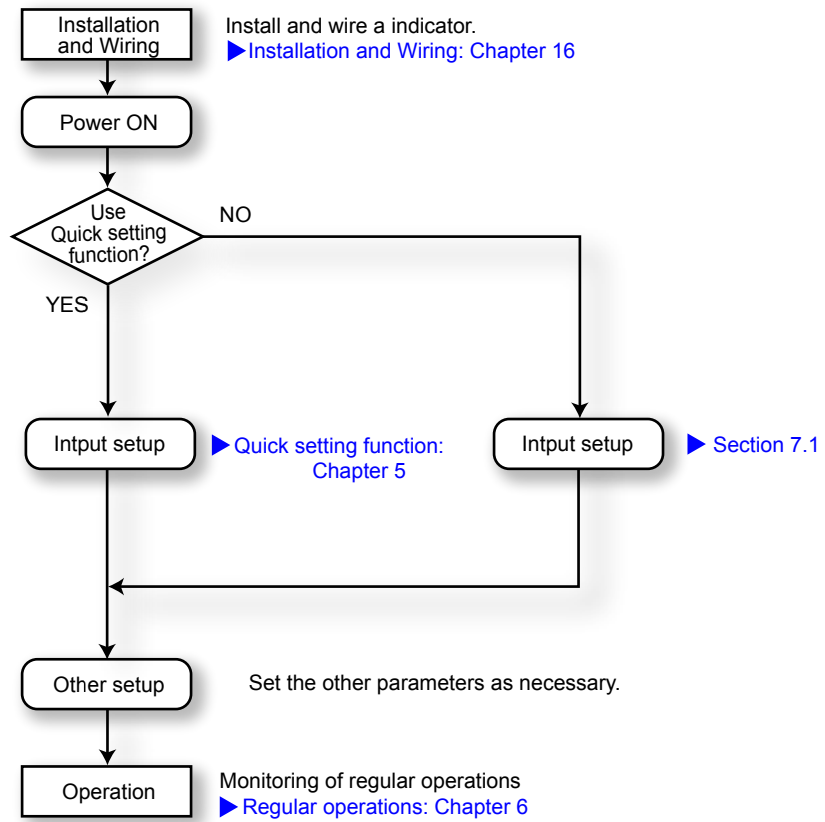
100% of the PV range span is equivalent to 500°C.

20% of the PV range span is equivalent to 100°C.

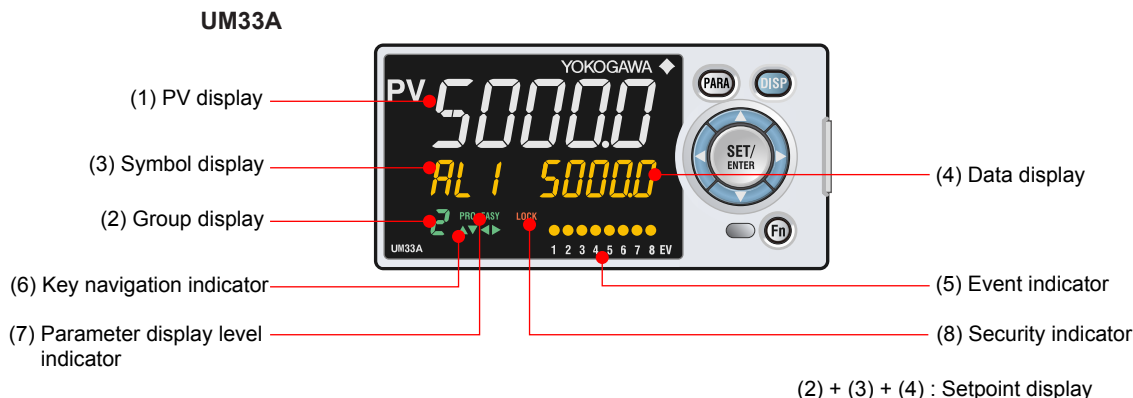


The above applies to the scale for voltage and current input.

2.1 UM33A Operating Procedures



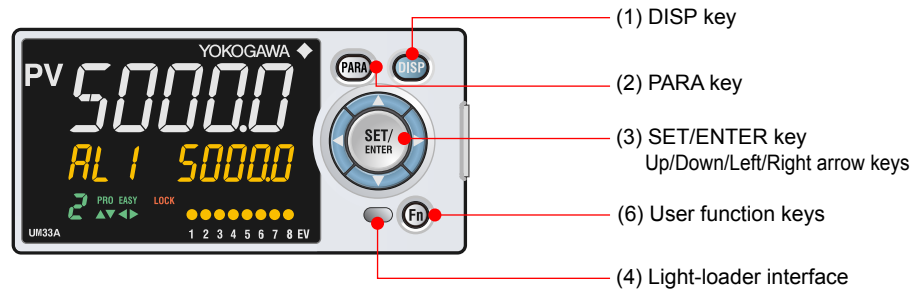
3.1 Names and Functions of Display Parts



No. in figure	Name	Description												
(1)	PV display (white or red)	Displays PV. Displays an error code if an error occurs. Displays the scrolling guide in the Menu Display and Parameter Setting Display when the guide display ON/OFF is set to ON.												
(2)	Group display (green)	Displays a group number.												
(3)	Symbol display (orange)	Displays a parameter symbol.												
(4)	Data display (orange)	Displays a parameter setpoint and menu symbol.												
(5)	Event indicator (orange)	Lit when the alarms 1 to 8 occur. Event displays other than alarms can be set by the parameter.												
(6)	Key navigation indicator (green)	Lit or blinks when the Up/Down or Left/Right arrow key operation is possible.												
(7)	Parameter display level indicator (green)	Displays the setting conditions of the parameter display level function. <table border="1" style="width: 100%; border-collapse: collapse;"> <thead> <tr> <th style="background-color: #d9ead3;">Parameter display level</th> <th style="background-color: #d9ead3;">EASY</th> <th style="background-color: #d9ead3;">PRO</th> </tr> </thead> <tbody> <tr> <td>Easy setting mode</td> <td>Lit</td> <td>Unlit</td> </tr> <tr> <td>Standard setting mode</td> <td>Unlit</td> <td>Unlit</td> </tr> <tr> <td>Professional setting mode</td> <td>Unlit</td> <td>Lit</td> </tr> </tbody> </table>	Parameter display level	EASY	PRO	Easy setting mode	Lit	Unlit	Standard setting mode	Unlit	Unlit	Professional setting mode	Unlit	Lit
Parameter display level	EASY	PRO												
Easy setting mode	Lit	Unlit												
Standard setting mode	Unlit	Unlit												
Professional setting mode	Unlit	Lit												
(8)	Security indicator (red)	Lit if a password is set. The setup parameter settings are locked.												

3.2 Names and Functions of Keys

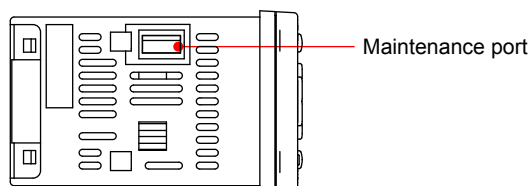
UM33A



No. in figure	Name	Description
(1)	DISP key	Used to switch the Operation Displays. Press the key in the Operation Display to switch the provided Select Displays. Press the key in the Menu Display or Parameter Setting Display to return to the Operation Display.
(2)	PARA key	Hold down the key for 3 seconds to move to the Operation Parameter Setting Display. Hold down the key and the Left arrow key simultaneously for 3 seconds to move to the Setup Parameter Setting Display. Press the key in the Parameter Setting Display to return to the Menu Display. Press the key once to cancel the parameter setting (setpoint is blinking).
(3)	SET/ENTER key Up/Down/ Left/Right arrow keys	SET/ENTER key Press the key in the Menu Display to move to the Parameter Setting Display of the Menu. Press the key in the Parameter Setting Display to transfer to the parameter setting mode (setpoint is blinking), and the parameter can be changed. Press the key during parameter setting mode to register the setpoint. Up/Down/Left/Right arrow keys Press the Left/Right arrow keys in the Menu Display to switch the Displays. Press the Up/Down arrow keys in the Parameter Setting Display to switch the Displays. Press the Up/Down arrow keys during parameter setting mode (setpoint is blinking) to change a setpoint. Press the Left/Right arrow keys during parameter setting mode (setpoint is blinking) to move between digits according to the parameter.
(4)	Light-loader interface	It is the communication interface to the adapter cable when setting and storing parameters via PC. The LL50A Parameter Setting Software (sold separately) is required.
(5)	User function keys	The UM33A has Fn key. The user can assign a function to the key. The function is set by the parameter.

Maintenance Port (Power supply is not required for the UM33A).

The maintenance port is used to connect with the dedicated cable when using LL50A Parameter Setting Software (sold separately). The parameters can be set without supplying power to the UM33A.

**CAUTION**

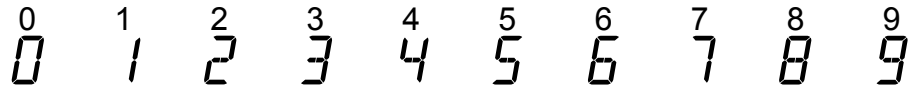
When using the maintenance port, do not supply power to the indicator. Otherwise, the indicator does not work normally.

If power is supplied to the indicator while the cable is connected, or the cable is connected to the indicator already turned on, unplug the cable and turn on the indicator again. The indicator returns to the normal condition.

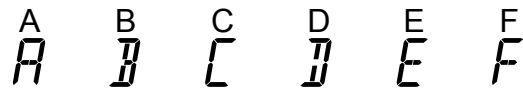
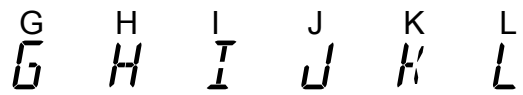
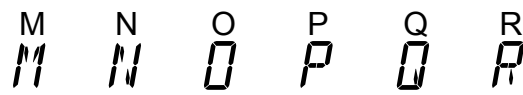


3.3 List of Display Symbols

The following shows the parameter symbols, menu symbols, alphanumeric of guide, and symbols which are displayed on the UM33A.

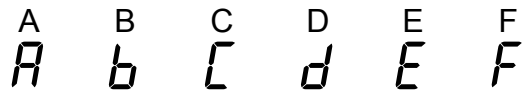


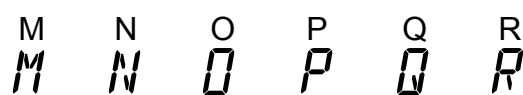
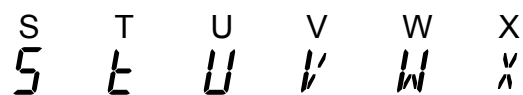

Figure (common to all display area)

0 1 2 3 4 5 6 7 8 9


PV display (14 segments): Alphabet

A B C D E F

 G H I J K L

 M N O P Q R

 S T U V W X

 Y Z


Symbol display and Data display (11 segments): Alphabet

A B C D E F

 C (lower-case)

 G H I J K L

 M N O P Q R

 S T U V W X

 Y Z


PV display (14 segments): Symbol

Space



-



/



'



,




3.4 Brief Description of Setting Details (Parameters)

This manual describes the Setting Details as follows in addition to the functional Description.

Setting Details

(Display Example)

Parameter symbol	Name	Display level	Setting range	Menu symbol
A1 to A8	Alarm-1 to -8 setpoint	EASY	Set a display value of setpoint of PV alarm, or velocity alarm. -19999 to 30000 (Set a value within the input range.) Decimal point position depends on the input type	AL 


(1) Parameter symbol: Symbol displayed on Symbol display on the front panel.

(2) Name: Parameter name

(3) Display level: Indicates the parameter display level.

(4) Setting range: Parameter setting range

(5) Menu symbol: Indicates the menu to which the parameter belongs.

: Operation parameter

: Setup parameter

Parameter Display Level

Display level		Description
EASY	Easy setting mode: The minimum necessary parameters are displayed.	Corresponding parameters are displayed in all modes.
STD	Standard setting mode: The wider range of parameters than those shown in Easy setting mode are displayed.	Corresponding parameters are displayed only in Standard setting mode and Professional setting mode. Parameter display level indicators "EASY" and "PRO" are unlit in Standard setting mode. *: "STD" is the symbol used in this manual only.
PRO	Professional setting mode: All parameters are displayed.	Corresponding parameters are displayed only in Professional setting mode.

Note

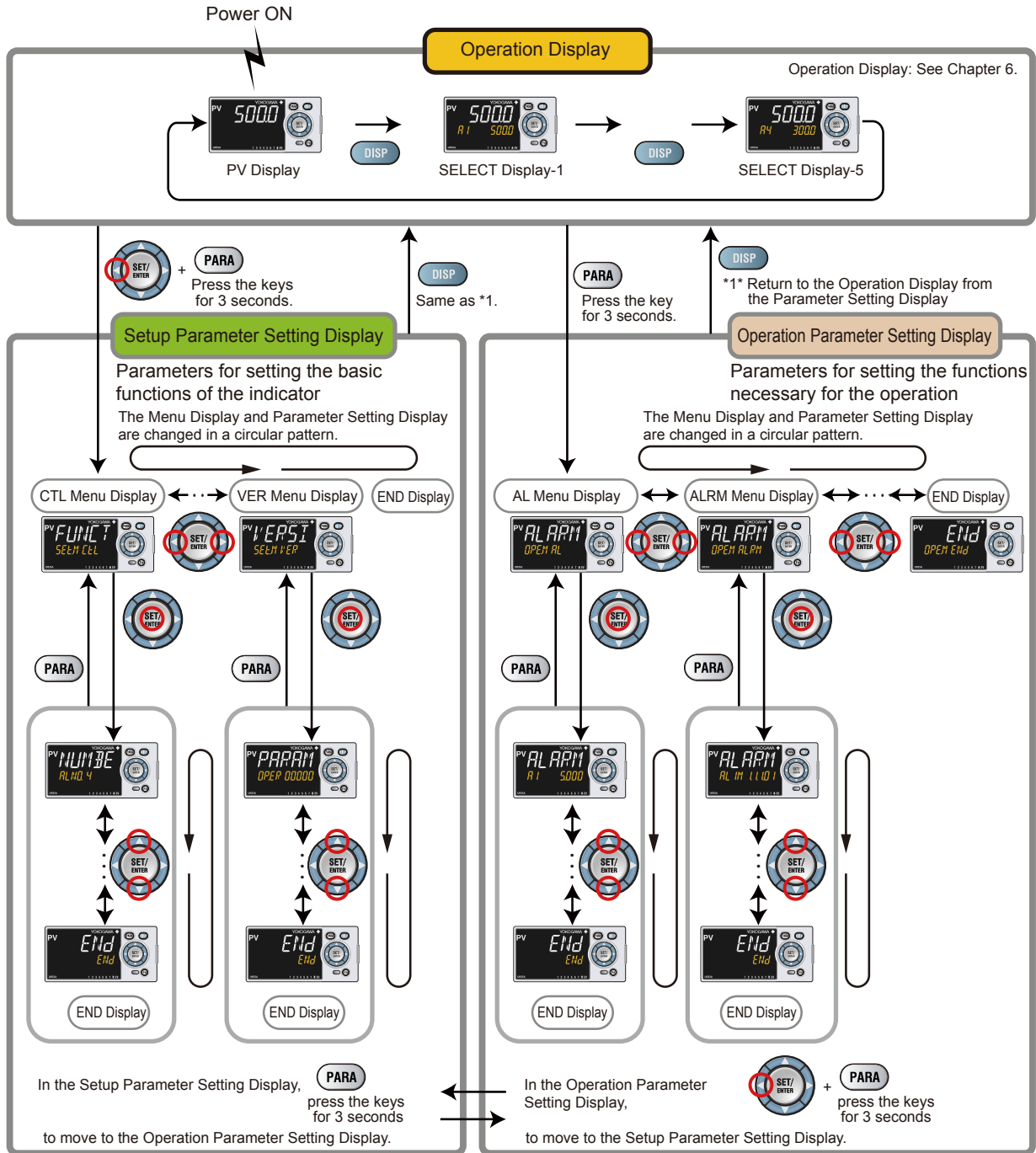
For more intelligible display operation of parameters and the references, see Chapter 17, "Parameter Map."

4.1 Overview of Display Switch and Operation Keys

The following shows the transition of Operation Display, Operation Parameter Setting Display, and Setup Parameter Setting Display.

The "Operation Parameter Setting Display" has the parameters for setting the functions necessary for the operation.




The "Setup Parameter Setting Display" has the parameters for setting the basic functions of the indicator.



4.1 Overview of Display Switch and Operation Keys

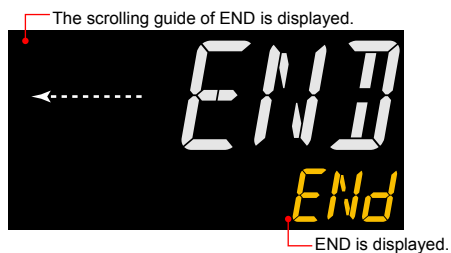
The display pattern of the UM33A is as follows; the Menu Display and Parameter Setting Display.

For the Operation Display, see Chapter 6, "Monitoring of Regular Operations."

Display	Description
<p>Menu Display</p>	<p>The Menu Display is segmented by the function. The scrolling guide for the menu is displayed on PV display. The guide display can be turned on/off with the Fn key.</p> <p>Menu Display of Operation Parameter The scrolling guide for the menu is displayed.</p>  <p>Menu Display of Setup Parameter The scrolling guide for the menu is displayed.</p> 
<p>Parameter Setting Display</p>	<p>The following is the Display for displaying and setting a parameter. The parameters have three types of display levels; Easy setting mode, Standard setting mode, and Professional setting mode. The parameters to be displayed can be limited according to the setting of the parameter display level. The scrolling guide for the parameter is displayed on PV display. The guide display can be turned on/off with the Fn key.</p> <p>Parameter Setting Display (Example of Operation Parameter Setting Display) The scrolling guide for the parameter is displayed.</p> 

Display Shown at the End (the Lowest Level) of the Parameter Setting Display

As shown in the figure below, the END Display is shown to indicate the end of the Menu Display and Parameter Setting Display. There are no setting items.

**Basic Key Operation Sequence**

- **To move to the Setup Parameter Setting Display**

Hold down the PARA key and the Left arrow key simultaneously for 3 seconds.



- **To move to the Operation Parameter Setting Display**

Hold down the PARA key for 3 seconds.



Hold down the key for 3 seconds.

- **To move to the Operation Display**

Press the DISP key once.

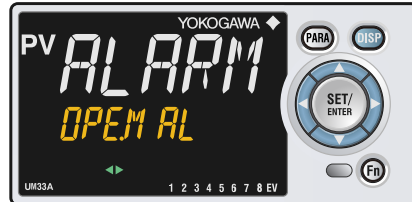


4.2 How to Set Parameters

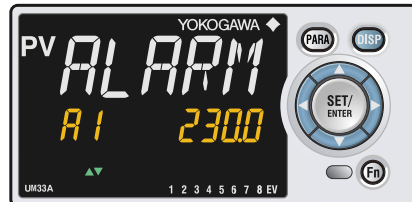
The following operating procedure describes an example of setting alarm setpoint (A2).

Operation

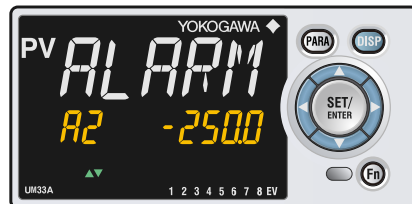
1. Hold down the **PARA** key for 3 seconds in the Operation Display to call up the **[AL]** Menu Display.



2. Press the **SET/ENTER** key to display the **[A1]** Parameter Setting Display.



3. Press the **Down arrow** key to display the **[A2]** Parameter Setting Display.



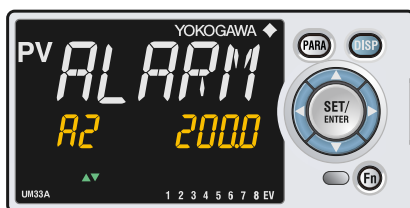
4. Press the **SET/ENTER** key to blink the setpoint.



5. Press the **Up** or **Down arrow** key to change the setpoint.
(Change the setpoint using the Up/Down arrow keys to increase and decrease the value and the Left/Right arrow keys to move between digits.)



6. Press the **SET/ENTER** key to register the setpoint (the setpoint stops blinking).



7. Press the **SET/ENTER** key to register the setpoint (the setpoint stops blinking).
8. Press the **PARA** key once to return to the Menu Display. Press the **DISP** key once to return to the Operation Display.

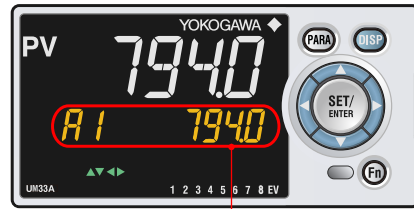
This completes the setting procedure.

How to Cancel Parameter Setting

To cancel parameter setting when a parameter is being set (setpoint is blinking), press the **PARA** key once.

How to Set Parameter Setpoint

Numeric Value Setting



1. Display the Parameter Setting Display.



2. Press the SET/ENTER key to move to the setting mode (the setpoint blinks).



3. Press the Left arrow key to move one digit to the left. (Press the Right arrow key to move one digit to the right.)

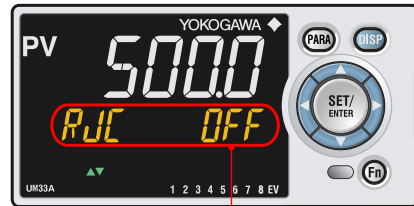


4. Press the Up or Down arrow key to change the setpoint. Press the Up arrow key when 9 is displayed to move one digit to the left. Press the Down arrow key when 0 is displayed to move one digit to the right.



5. Press the SET/ENTER key to register the setpoint.

Selection Data Setting



1. Display the Parameter Setting Display.



2. Press the SET/ENTER key to move to the setting mode (the setpoint blinks).

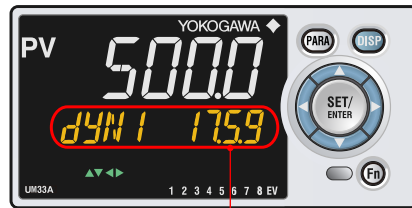


3. Press the Up arrow key to change the setpoint (press the Down arrow key to change the setpoint).





4. Press the SET/ENTER key to register the setpoint.


Time (minute.second) Setting





Example of 17 minutes 59 seconds

- 

1. Display the Parameter Setting Display.
- 

2. Press the SET/ENTER key to move to the setting mode (the setpoint blinks).
- 

3. Press the Left arrow key to move one digit to the left. (press the Right arrow key to move one digit to the right.)
- 

4. Press the Up or Down arrow key to change the setpoint. Press the Up arrow key when 5 is displayed to move one digit to the left. Press the Down arrow key when 0 is displayed to move one digit to the right.
- 

5. Press the SET/ENTER key to register the setpoint.

5.1 Setting Using Quick Setting Function

Description

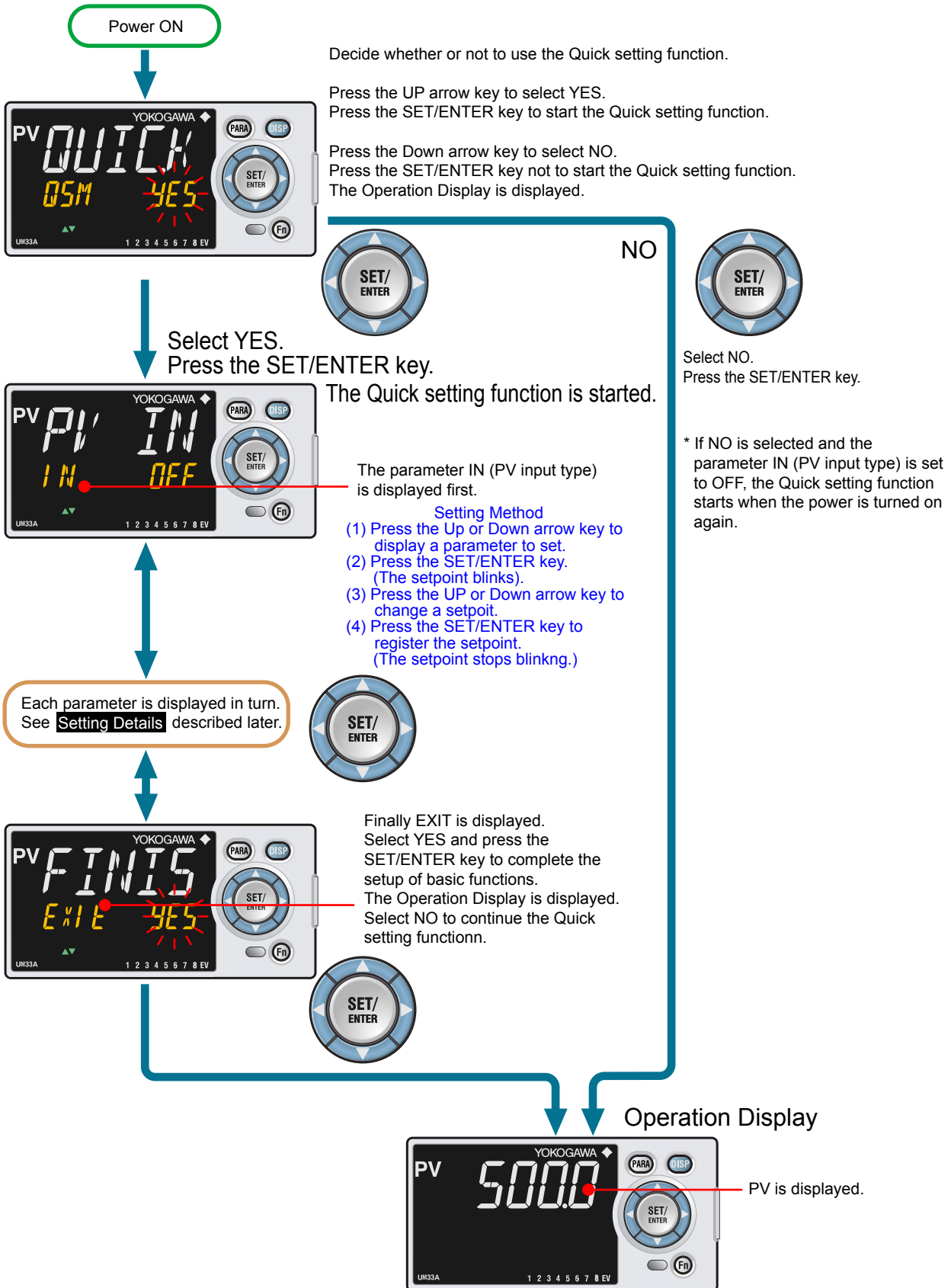
The Quick setting function is a function to easily set the basic function of the indicator. The Quick setting function starts when the power is turned on after wiring.

The following lists the items to set using the Quick setting function.

- (1) Input function (PV input, range, scale (at voltage/current input), etc.)

5.1 Setting Using Quick Setting Function

Flowchart of Quick Setting Function



Setting Example

Set the following parameters to set to thermocouple Type K (range: 0.0 to 500.0°C). No need to change the parameters other than the following parameters.

Set QSM = YES to enter the quick setting mode.

- (1) Set IN = K1.
- (2) Set UNIT = C (initial value).
- (3) Set RH = 500.0
- (4) Set RL = 0.0.

Set EXIT = YES to quit the quick setting mode.
The Operation Display is shown.

5.1 Setting Using Quick Setting Function

Setting Details

Input Function

Parameter symbol	Name	Display level	Setting range	Menu symbol
IN	PV input type	EASY	OFF: Disable K1: -270.0 to 1370.0 °C / -450.0 to 2500.0 °F K2: -270.0 to 1000.0 °C / -450.0 to 2300.0 °F K3: -200.0 to 500.0 °C / -200.0 to 1000.0 °F J: -200.0 to 1200.0 °C / -300.0 to 2300.0 °F T1: -270.0 to 400.0 °C / -450.0 to 750.0 °F T2: 0.0 to 400.0 °C / -200.0 to 750.0 °F B: 0.0 to 1800.0 °C / 32 to 3300 °F S: 0.0 to 1700.0 °C / 32 to 3100 °F R: 0.0 to 1700.0 °C / 32 to 3100 °F N: -200.0 to 1300.0 °C / -300.0 to 2400.0 °F E: -270.0 to 1000.0 °C / -450.0 to 1800.0 °F L: -200.0 to 900.0 °C / -300.0 to 1600.0 °F U1: -200.0 to 400.0 °C / -300.0 to 750.0 °F U2: 0.0 to 400.0 °C / -200.0 to 1000.0 °F W: 0.0 to 2300.0 °C / 32 to 4200 °F PL2: 0.0 to 1390.0 °C / 32.0 to 2500.0 °F P2040: 0.0 to 1900.0 °C / 32 to 3400 °F WRE: 0.0 to 2000.0 °C / 32 to 3600 °F JPT1: -200.0 to 500.0 °C / -300.0 to 1000.0 °F JPT2: -150.0 to 150.0 °C / -200.0 to 300.0 °F PT1: -200.0 to 850.0 °C / -300.0 to 1560.0 °F PT2: -200.0 to 500.0 °C / -300.0 to 1000.0 °F PT3: -150.0 to 150.0 °C / -200.0 to 300.0 °F 0.4-2V: 0.400 to 2.000 V 1-5V: 1.000 to 5.000 V 4-20: 4.00 to 20.00 mA 0-2V: 0.000 to 2.000 V 0-10V: 0.00 to 10.00 V 0-20 : 0.00 to 20.00 mA -1020: -10.00 to 20.00 mV 0-100: 0.0 to 100.0 mV	PV Set
UNIT	PV input unit	EASY	-: No unit C: Degree Celsius -: No unit - -: No unit - - -: No unit F: Degree Fahrenheit	
RH	Maximum value of PV input range	EASY	Depends on the input type. - For temperature input - Set the temperature range that is actually displayed. (RL<RH) - For voltage / current input - Set the range of a voltage / current signal that is applied.	
RL	Minimum value of PV input range	EASY	The scale across which the voltage / current signal is actually displayed should be set using the maximum value of input scale (SH) and minimum value of input scale (SL). (Input is always 0% when RL=RH.)	

Note1: W:W-5% Re/W-26% Re(Hoskins Mfg. Co.). ASTM E988
 WRE: W97Re3-W75Re25

Input Function (Continued)

Parameter symbol	Name	Display level	Setting range	Menu symbol
SDP	PV input scale decimal point position	EASY	0: No decimal place 1: One decimal place 2: Two decimal places 3: Three decimal places 4: Four decimal places	PV Set
SH	Maximum value of PV input scale	EASY	-19999 to 30000, (SL<SH), SH - SL ≤ 30000	
SL	Minimum value of PV input scale	EASY		

▶ Input setting: 7.1 Setting Functions of PV Input

5.2 Restarting Quick Setting Function

Once functions have been built using the Quick setting function, the Quick setting function does not start even when the power is turned on. The following methods can be used to restart the Quick setting function.

- Set the parameter QSM (Quick setting mode) to ON and turn on the power again.
- Set the parameter IN (PV input type) to OFF and turn on the power again.

CAUTION

The parameters related to the range or scale are initialized if the PV input type is changed.

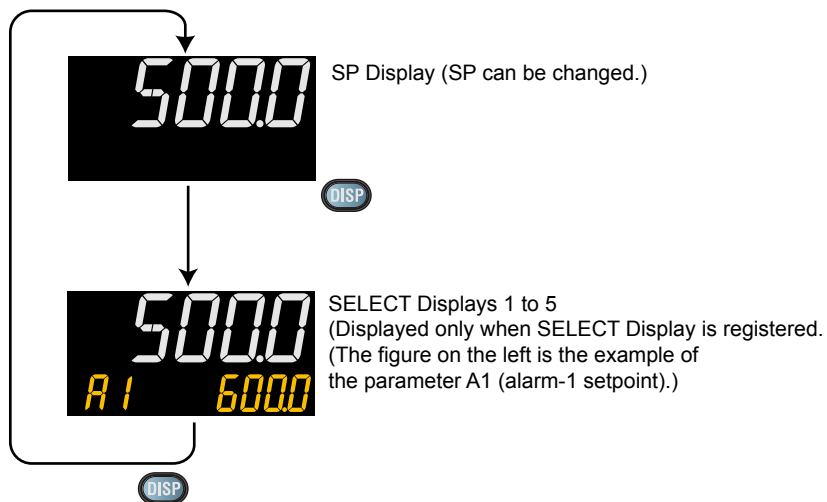
Setting Details

Parameter symbol	Name	Display level	Setting range	Menu symbol
IN	PV input type	EASY	OFF: Disable	PV Set
QSM	Quick setting mode	EASY	OFF: Disable ON: Enable	SYS Set

6.1 Monitoring of Operation Displays

6.1.1 Operation Display Transitions

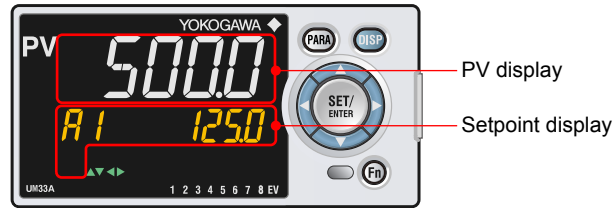
- ▶ Registration of SELECT Display: 12.1.3 Registering SELECT Display (Up to 5 displays)



6.1 Monitoring of Operation Displays

Details of the Operation Display

The following is the Operation Display types and each display and operation description.

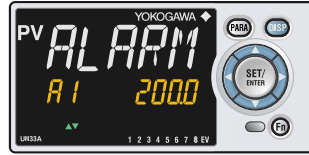


Operation Display	Display and operation description
PV Display	PV display: Displays measured input value (PV). (Setpoint display shows nothing.)
SELECT Display	<p>SELECT Display is for registering frequently-used parameters from Parameter Setting Display, and for displaying them on Operation Display so that the parameter settings can be easily changed in normal operation.</p> <p>PV display: Displays measured input value (PV). Setpoint display: Displays and changes the registered parameter.</p> <p>The following is the display example when the parameter A1 (alarm-1 setpoint) is registered.</p> <p>Symbol PV input</p>

6.2 Setting Alarm Setpoint

Setting Display

Parameter Setting Display



Operation Display > **PARAM** key for **3 seconds** (to [AL] Menu Display) > **SET/ENTER** key (The setting parameter is displayed.) > **Down arrow** key (The setting parameter is displayed.)

Setting Details

Parameter symbol	Name	Display level	Setting range	Menu symbol
A1 to A8	Alarm-1 to -8 setpoint	EASY	Set a display value of setpoint of PV alarm or velocity alarm. -19999 to 30000 (Set a value within the input range.) Decimal point position depends on the input type	AL Ope
ALNO.	Number of alarms	PRO	0 to 8	CTL Set

Description

Each alarm type has eight alarm setpoints.

Alarm-related parameter	Number of settings
Alarm type	8 (number of settings)
PV velocity alarm time setpoint	8 (number of settings)
Alarm hysteresis	8 (number of settings)
Alarm delay timer	8 (number of settings)
Alarm setpoint	8 (number of settings)

▶ Alarm type: [Chapter 9 Alarm Functions](#)

6.3 Releasing On-State (Latch) of Alarm Output

Description

Alarm latch can be released by any of the following.

- (1) User function key
- (2) Communication
- (3) Contact input

For the switching operation by using the above, the last switching operation is performed.

Releasing the alarm latch function releases all of the latched alarm outputs.

By factory default, the function is not assigned to the user function key. Assign and use the function in accordance with the reference sections below.

- ▶ [Release by user function key: 12.2 Assigning Function to User Function Key](#)
- ▶ [Release by contact input: 11.1 Setting Contact Input Function](#)
- ▶ [Release via communication: UTAdvanced Series Communication Interface User's Manual](#)

6.4 Confirmation of PV peak and bottom value

Description

Displays the maximum value and minimum value of PV input during operation.
This parameter is not to be set.

Setting Details

Parameter symbol	Name	Display level	Setting range	Menu symbol
PEAK	PV peak value	EASY	Display only -100.0 to 100.0% of PV input range span (EUS)	PVS Ope
BOTM	PV bottom value	EASY		

- ▶ [PV peak and bottom values reset: 11.1 Setting Contact Input Function](#)

7.1 Setting Functions of PV Input

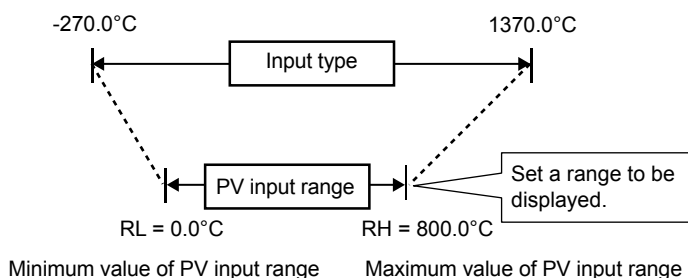
7.1.1 Setting Input Type, Unit, Range, Scale, and Decimal Point Position

Description

The figure below describes the case of PV input.

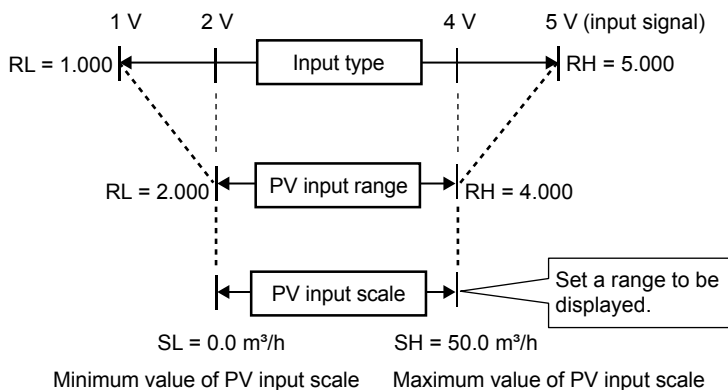
Example of Temperature Input

The figure below is an example of setting Type K thermocouple and a measurement range of 0.0 to 800.0 °C.



Example of Voltage and Current Inputs

The figure below is an example of setting 2-4 V DC and a scale of 0.0 to 50.0 m³/h.



When using 1-5 V DC signal as is, set RH = 5.000 V, RL = 1.000 V, SDP=1, and SH = 50.0, and SL=0.0.

7.1 Setting Functions of PV Input

Setting Details

Parameter symbol	Name	Display level	Setting range	Menu symbol
IN	PV input type	EASY	OFF: Disable K1: -270.0 to 1370.0 °C / -450.0 to 2500.0 °F K2: -270.0 to 1000.0 °C / -450.0 to 2300.0 °F K3: -200.0 to 500.0 °C / -200.0 to 1000.0 °F J: -200.0 to 1200.0 °C / -300.0 to 2300.0 °F T1: -270.0 to 400.0 °C / -450.0 to 750.0 °F T2: 0.0 to 400.0 °C / -200.0 to 750.0 °F B: 0.0 to 1800.0 °C / 32 to 3300 °F S: 0.0 to 1700.0 °C / 32 to 3100 °F R: 0.0 to 1700.0 °C / 32 to 3100 °F N: -200.0 to 1300.0 °C / -300.0 to 2400.0 °F E: -270.0 to 1000.0 °C / -450.0 to 1800.0 °F L: -200.0 to 900.0 °C / -300.0 to 1600.0 °F U1: -200.0 to 400.0 °C / -300.0 to 750.0 °F U2: 0.0 to 400.0 °C / -200.0 to 1000.0 °F W: 0.0 to 2300.0 °C / 32 to 4200 °F (Note1) PL2: 0.0 to 1390.0 °C / 32.0 to 2500.0 °F P2040: 0.0 to 1900.0 °C / 32 to 3400 °F WRE: 0.0 to 2000.0 °C / 32 to 3600 °F JPT1: -200.0 to 500.0 °C / -300.0 to 1000.0 °F JPT2: -150.0 to 150.0 °C / -200.0 to 300.0 °F PT1: -200.0 to 850.0 °C / -300.0 to 1560.0 °F PT2: -200.0 to 500.0 °C / -300.0 to 1000.0 °F PT3: -150.0 to 150.0 °C / -200.0 to 300.0 °F 0.4-2V: 0.400 to 2.000 V 1-5V: 1.000 to 5.000 V 4-20: 4.00 to 20.00 mA 0-2V: 0.000 to 2.000 V 0-10V: 0.00 to 10.00 V 0-20 : 0.00 to 20.00 mA -1020: -10.00 to 20.00 mV 0-100: 0.0 to 100.0 mV	PV Set
UNIT	PV input unit	EASY	-: No unit C: Degree Celsius -: No unit --: No unit ---: No unit F: Degree Fahrenheit	PV Set
RH (Physical quantity)	Maximum value of PV input range	EASY	Depends on the input type. - For temperature input - Set the temperature range that is actually displayed. (RL<RH) - For voltage / current input - Set the range of a voltage / current signal that is applied. The scale across which the voltage / current signal is actually displayed should be set using the maximum value of input scale (SH) and minimum value of input scale (SL). (Input is always 0% when RL = RH.)	PV Set
RL (Physical quantity)	Minimum value of PV input range	EASY	Same as RH	PV Set

Note1: W: W-5% Re/W-26% Re(Hoskins Mfg. Co.). ASTM E988
 WRE: W97Re3-W75Re25

(Continued)

Parameter symbol	Name	Display level	Setting range	Menu symbol
SDP (Scaling)	PV input scale decimal point position (for voltage / current input)	EASY	0: No decimal place 1: One decimal place 2: Two decimal places 3: Three decimal places 4: Four decimal places	PV Set
SH (Scaling)	Maximum value of PV input scale (for voltage / current input)	EASY	-19999 to 30000, (SL<SH), SH - SL ≤ 30000	PV Set
SL (Scaling)	Minimum value of PV input scale (for voltage / current input)	EASY	-19999 to 30000, (SL<SH), SH - SL ≤ 30000	PV Set

When changing the PV decimal point position or the digit of the indicated value, can be set by the following parameters.

Example: PV input type= K1 (-270.0 to 1370.0°C), the digit is without decimal point for "0 to 1000°C".

P.UNI=C
P.DP=0
P.RH=1000
P.RL=0

Parameter symbol	Name	Display level	Setting range	Menu symbol
P.UNI	Display PV input unit	STD	-: No unit C: Degree Celsius - -: No unit - - -: No unit F: Degree Fahrenheit	MPV Set
P.DP	Display PV input decimal point position		0: No decimal place 1: One decimal place 2: Two decimal places 3: Three decimal places 4: Four decimal places	
P.RH	Maximum value of display PV input range		-19999 to 30000, (P.RL<P.RH), P.RH - P.RL ≤ 30000	
P.RL	Minimum value of display PV input range			

7.1.2 Setting Burnout Detection for Input

Description

The input value when input burnout occurs can be determined.
 The input value is 105.0% of the input range when the upscale is set, and -5.0% of the input range when the downscale is set.
 Burnout detection is activated for TC, RTD, and standard signal (0.4–2 V, 1–5 V or 4–20 mA).
 For standard signal, burnout is determined to have occurred if it is 0.1 V or less for the range of 0.4–2 V and 1–5V, or if it is 0.4 mA or less for the range of 4–20 mA.

Setting Details

Parameter symbol	Name	Display level	Setting range	Menu symbol
BSL	PV input burnout action	STD	OFF: Disable UP: Upscale DOWN: Downscale	PV Set

7.1.3 Setting Reference Junction Compensation (RJC) or External Reference Junction Compensation (ERJC)

Description

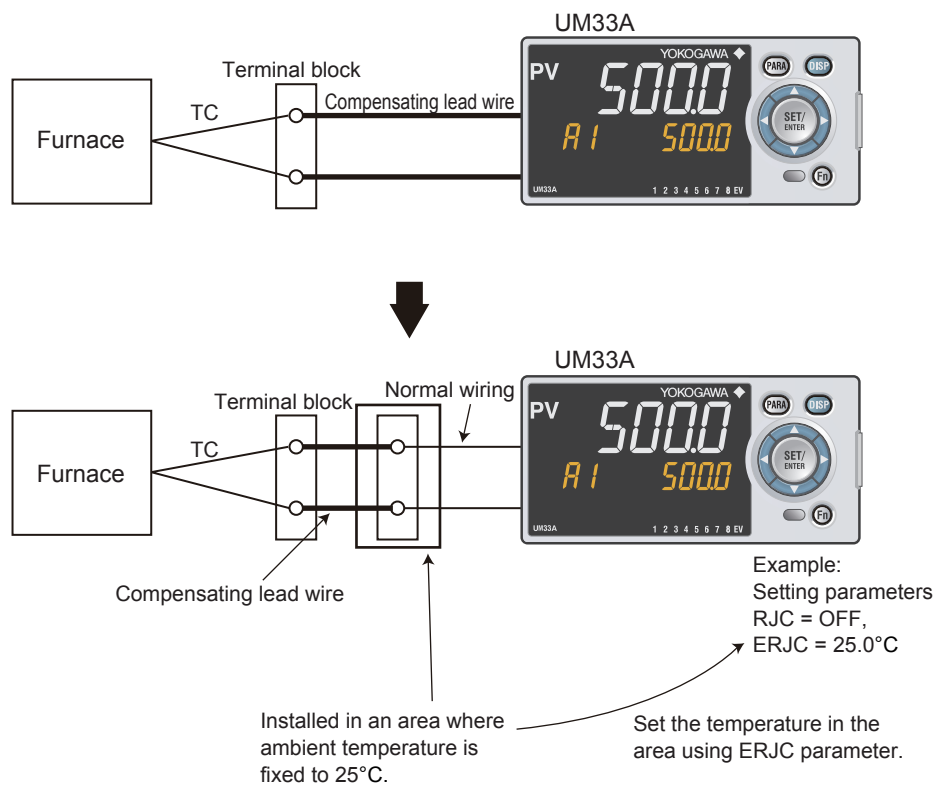
Reference Junction Compensation (RJC)

When TC input is selected, presence/absence of input reference junction compensation can be set.

Usually input values are compensated with the RJC function provided for the indicator. However, if it is necessary to rigorously compensate the values with a device other than the function of the indicator, for example with a zero-compensator, the RJC function of the indicator can be turned off.

External Reference Junction Compensation (ERJC)

For TC input, a temperature compensation value for external device can be set. The external RJC can be used only when RJC = OFF.



Setting Details

Parameter symbol	Name	Display level	Setting range	Menu symbol
RJC	PV input reference junction compensation	PRO	OFF: RJC OFF ON: RJC ON	PV Set
ERJC	PV input external RJC setpoint	PRO	-10.0 to 60.0°C	PV Set

7.1.4 Correcting Input Value

(1) Setting Bias and Filter

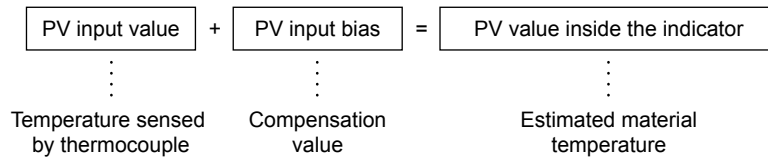
Description

PV Input Bias

The PV input bias allows bias to be summed with input to develop a measured value for display use inside the indicator.

This function can also be used for fine adjustment to compensate for small inter-instrument differences in measurement reading that can occur even if all are within the specified instrument accuracies.

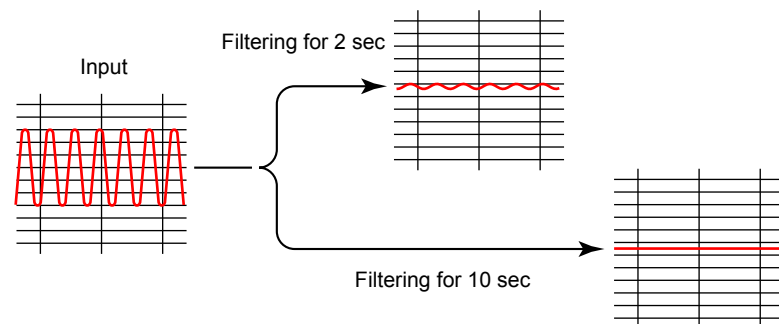
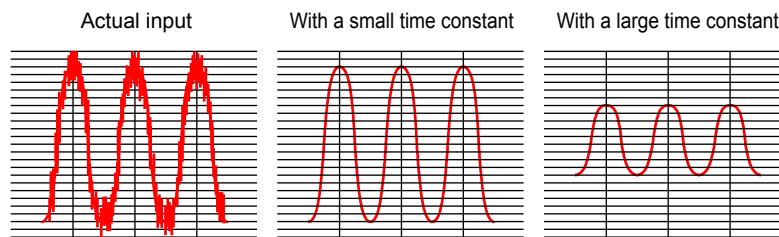
PV input bias is used for normal operation.



PV Input Filter

If input noise or variations cause the low-order display digits to fluctuate so that the displayed value is difficult to read, a digital filter can be inserted to smooth operation. This filter provides a first-order lag calculation, which can remove more noise the larger the time constant becomes. However, an excessively large time constant will distort the waveform.

PV input filter is used for normal operation.



Analog Input Bias

Analog input bias is used to correct sensor-input characteristics, compensating lead wire errors, and so on.

Analog Input Filter

The analog input filter is used to remove noise from an input signal. This filter provides a first-order lag calculation, which can remove more noise the larger the time constant becomes. However, an excessively large time constant will distort the waveform.

Setting Details

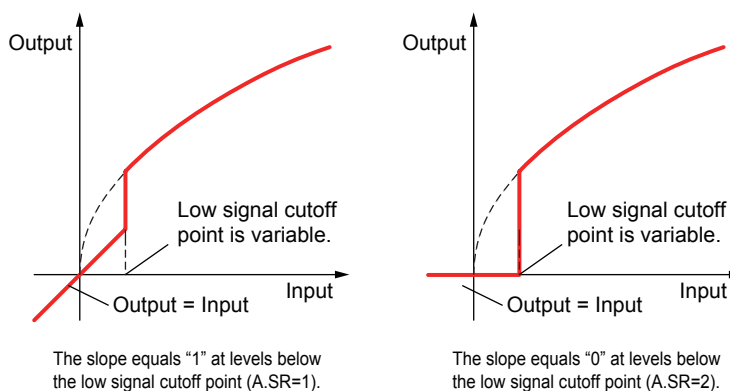
Parameter symbol	Name	Display level	Setting range	Menu symbol
BS	PV input bias	EASY	-100.0 to 100.0% of PV input range span (EUS)	PVS Ope
FL	PV input filter	EASY	OFF, 1 to 120 s	

Parameter symbol	Name	Display level	Setting range	Menu symbol
A.BS	PV analog input bias	STD	-100.0 to 100.0% of each input range span (EUS)	PV Set
A.FL	PV analog input filter	STD	OFF, 1 to 120 s	PV Set

(2) Setting Square Root Extraction and Low Signal Cutoff Point

Description

This calculation is used to convert, for example, a differential pressure signal from a throttling flow meter such as an orifice and nozzle into a flow-rate signal. There is no hysteresis for low signal cutoff point.



Setting Details

Parameter symbol	Name	Display level	Setting range	Menu symbol
A.SR	PV analog input square root extraction	PRO	OFF: No square root extraction. 1: Compute the square root. (The slope equals "1.") 2: Compute the square root. (The slope equals "0.")	PV Set
A.LC	PV analog input low signal cutoff	PRO	0.0 to 5.0%	PV Set

Note 1: Each parameter is displayed when the input type is voltage or current.

(3) Setting 10-segment Linearizer

Description

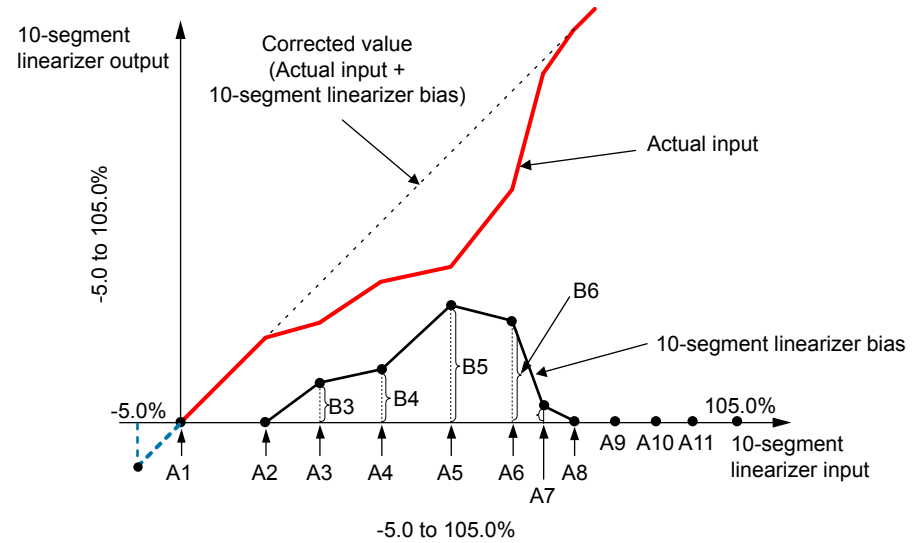
The 10-segment linearizer can be used for PV input and retransmission output.

- ▶ [Function block diagram: 8.1 Function block diagram](#)
- ▶ [Output Linearizer: 10.2 Setting 10-segment Linearizer for Output](#)

10-segment Linearizer Bias

This function is used to correct an input signal affected by sensor deterioration. The corrected values are obtained by adding the corresponding bias values to each of the 11 points of optionally set input values.

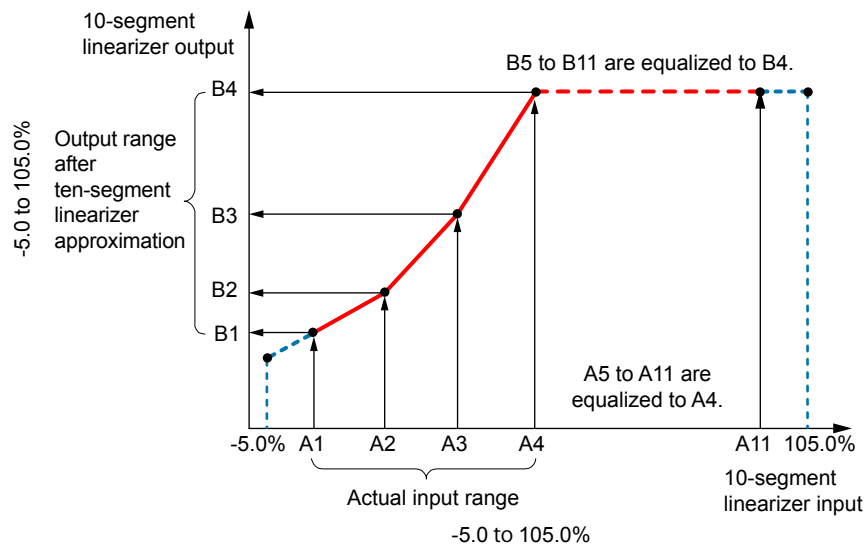
When 10-segment linearizer input is A1 or less, B1 is to be added. When 10-segment linearizer input is A11 or more, B11 is to be added.




10-segment Linearizer Approximation

This function is used when the input signal and the required measurement signal have a non-linear relationship, for example, when trying to obtain the volume from a sphere tank level. As shown in the figure below, the output values can be optionally set to 11 points of the optionally set input values.

When the 10-segment linearizer input is A1 or less, the value of extended line between B1 and B2 is output. Moreover, when the input is A11 or more, the value of extended line between B10 and B11 is output.



Setting Details

Parameter symbol	Name	Display level	Setting range	Menu symbol
A1 to A11	10-segment linearizer input	PRO	-66.7 to 105.0% of input range (EU)	PYS1 
B1 to B11	10-segment linearizer output	PRO	10-segment linearizer bias: -66.7 to 105.0% of input range span (EUS) 10-segment linearizer approximation: -66.7 to 105.0% of input range (EU)	
PMD	10-segment linearizer mode	PRO	0: 10-segment linearizer bias 1: 10-segment linearizer approximation	

Note1: When each parameter is displayed, the group number (1 to 4) is displayed on Group display.

Parameters are set in the following order.

- (1) The PV input is set by the parameter in PYS1 menu.
 - ▶ [Where the 10-segment linearizer function is used; Function block diagrams in 8.1 Function block diagram](#)
- (2) PMD: Specifies whether to use it as a 10-segment linearizer bias or a 10-segment linearizer approximation.
- (3) A1 to A11, B1 to B11: Sets the 10-segment linearizer input and 10-segment linearizer output.
PV input: PV input range or PV input range span

Note

- Set the 10-segment linearizer so that it increases monotonically.

7.2 Setting Input Sampling Period

Setting Details

Parameter symbol	Name	Display level	Setting range	Menu symbol
SMP	Input sampling period	STD	50: 50 ms 100: 100 ms 200: 200 ms	CTL Set

8.1 Function Block Diagrams

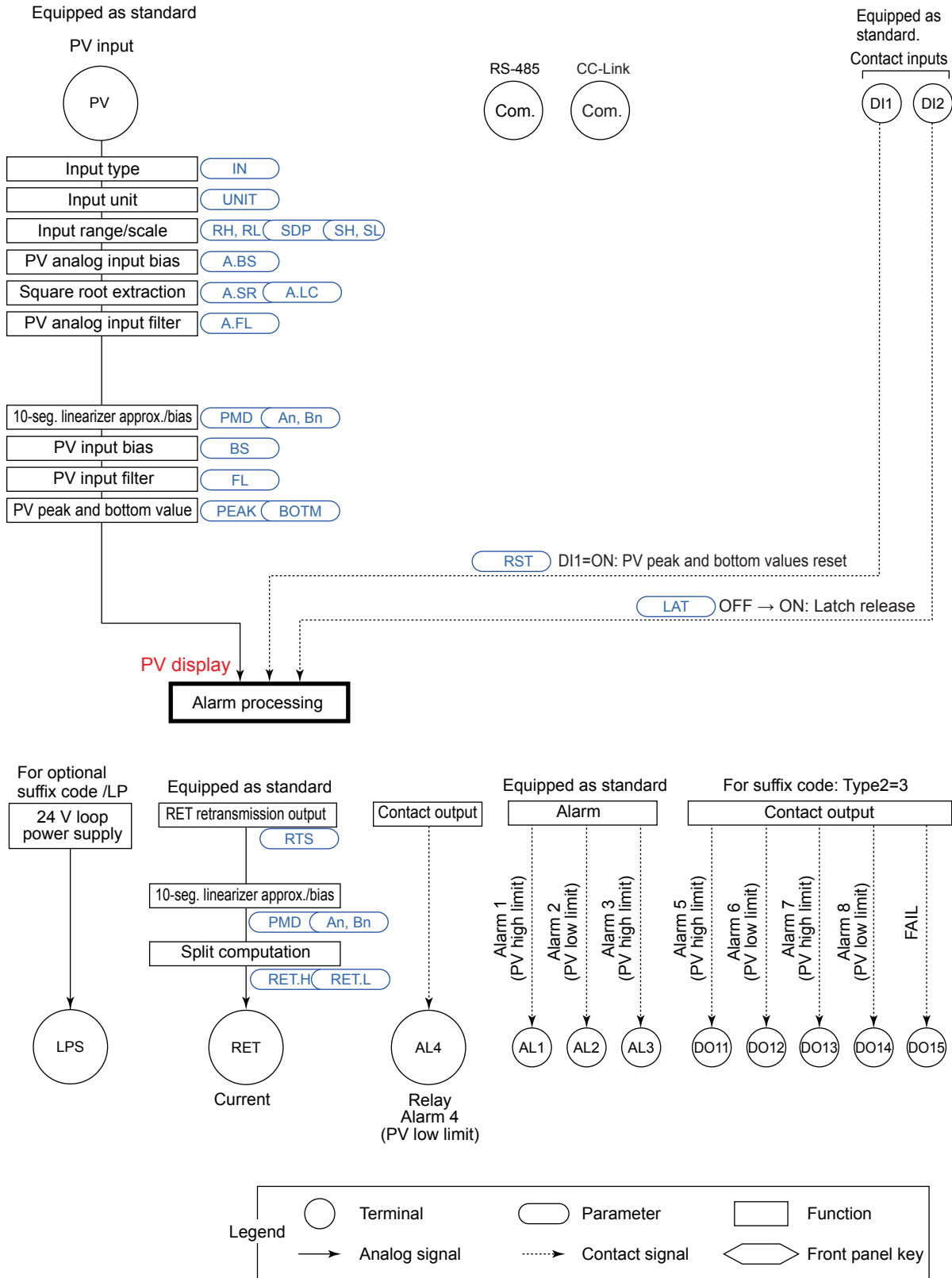
Description

The Function block diagram describes only the basic functions.
Parameter symbols in the Function block diagram describe representative parameters.

For the functions and parameters which are not described in Function block diagram, see the following.

- ▶ [Contact input assignment: 11.1 Setting Contact Input Function](#)
- ▶ [Contact output assignment: 11.2 Setting Contact Output Function](#)
- ▶ [Analog output range change: 10.3 Changing Current Output Range](#)

8.1 Function Block Diagrams



9.1 Setting Alarm Type

Description

The alarm-related parameters consist of the alarm type (type, stand-by action, energized/de-energized, and latch function), PV velocity alarm time setpoint, alarm hysteresis, alarm (On-/Off-) delay timer, and alarm setpoint.

Alarm-related parameter	Number of settings
Alarm type	8 (number of settings)
PV velocity alarm time setpoint	8 (number of settings)
Alarm hysteresis	8 (number of settings)
Alarm (on-/off-) delay timer	8 (number of settings)
Alarm setpoint	8 (number of settings)

- ▶ Alarm hysteresis: [9.3 Setting Hysteresis to Alarm Operation](#)
- ▶ Alarm delay timer: [9.4 Delaying Alarm Output \(Alarm Delay Timer\)](#)
- ▶ Alarm setpoint: [6.2 Setting Alarm Setpoint](#)

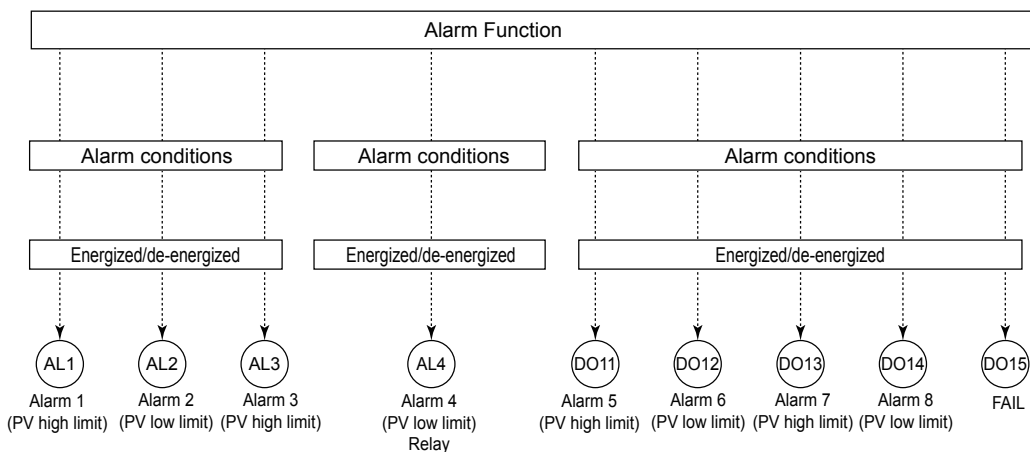
Alarm output can be assigned to the unused contact output.

- ▶ Contact output: [11.2.1 Setting Function of Contact Output](#)

Energized/de-energized of alarm output can be changed.

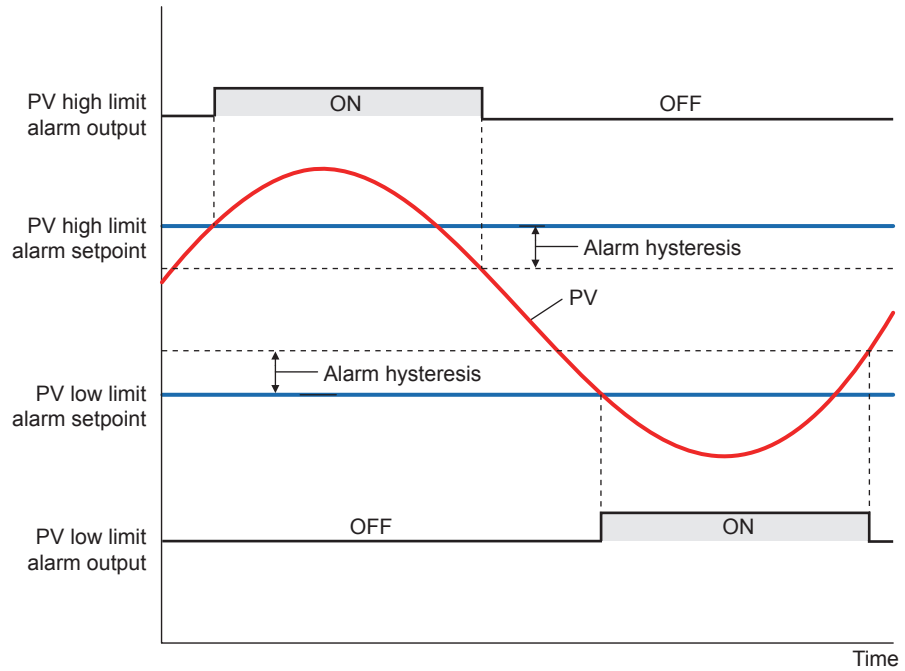
- ▶ Energized/de-energized: [11.2.2 Changing Contact Type of Contact Output](#)

To read the conditions of alarms, outputs, or latches via communication, see Communication Interface User's Manual.



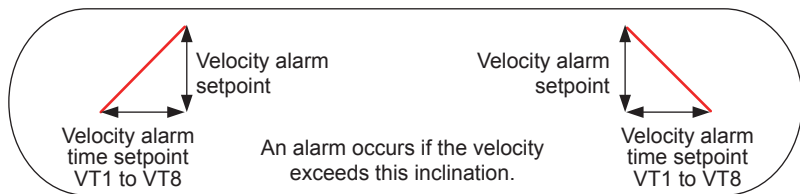
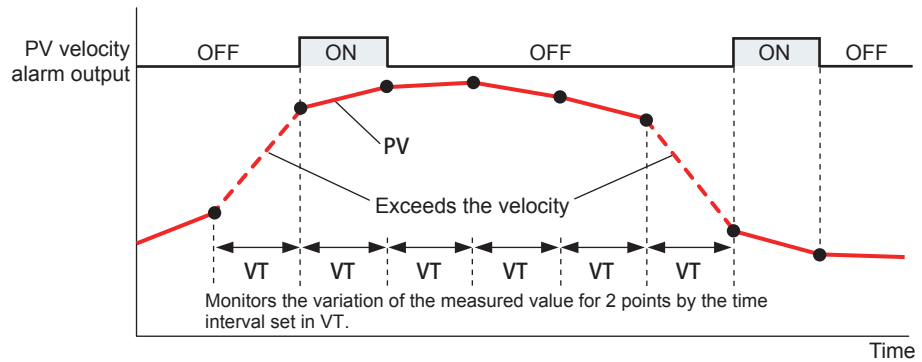
* See "Appendix 1 Input and Output Table of Model and Suffix Codes" for presence/absence of the terminals DO11 to DO15.

PV High Limit Alarm and PV Low Limit Alarm



Contact type in the figure above: Energized when an event occurs (factory default).

PV Velocity Alarm



Contact type in the figure above: Energized when an event occurs (factory default).

The PV velocity alarm function does not work the alarm hysteresis, the stand-by action and the alarm delay timer functions.

Fault diagnosis Alarm

The function outputs an alarm signal in the following cases.

The corresponding event (EV) lamp is lit and the contact output turns on (when the contact type is energized).

- Burnout of PV input, RSP remote input, or auxiliary analog input
- ADC failure of PV input, RSP remote input, or auxiliary analog input
- Reference junction compensation (RJC) error of PV input, RSP remote input

The fault diagnosis alarm does not work the stand-by action functions.

FAIL output

When the FAIL condition is caused (faulty MCU or system data error), DO (alarm output) turned off regardless of contact type.

The FAIL output does not work the alarm latch, the energized/de-energized and the stand-by action functions.

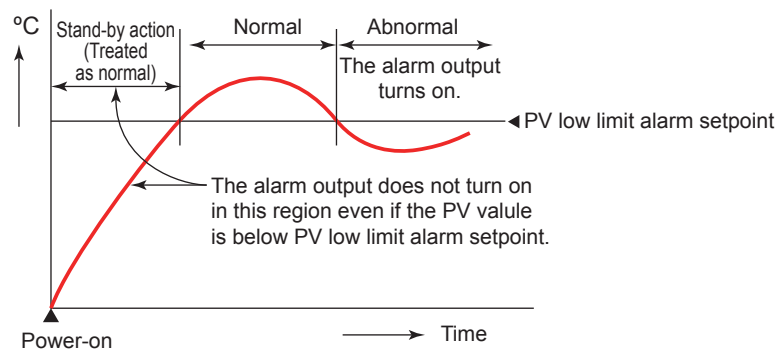
Stand-by Action

The stand-by action is a function for ignoring the alarm condition and keeps the alarm off until the alarm condition is removed. Once the alarm condition is removed, the stand-by action is cancelled.

It is effective in the following cases where;

- The power is turned on
- The alarm type is changed
- Forced stand-by via communication

The following shows the behavior of an alarm with the stand-by action at power ON.



Alarm Latch Function

The alarm latch function is a function for keeping the alarm output (keeping the alarm output on) after entering the alarm condition (alarm output is turned on) until an order to release the alarm latch is received.

The alarm latch function has the following four types of action.

Latch 1

Cancels the alarm output when an order to release the alarm latch is received. (Alarm output OFF.)
 However, an order to release the alarm latch is ignored if the order is received during alarm condition.

Latch 2

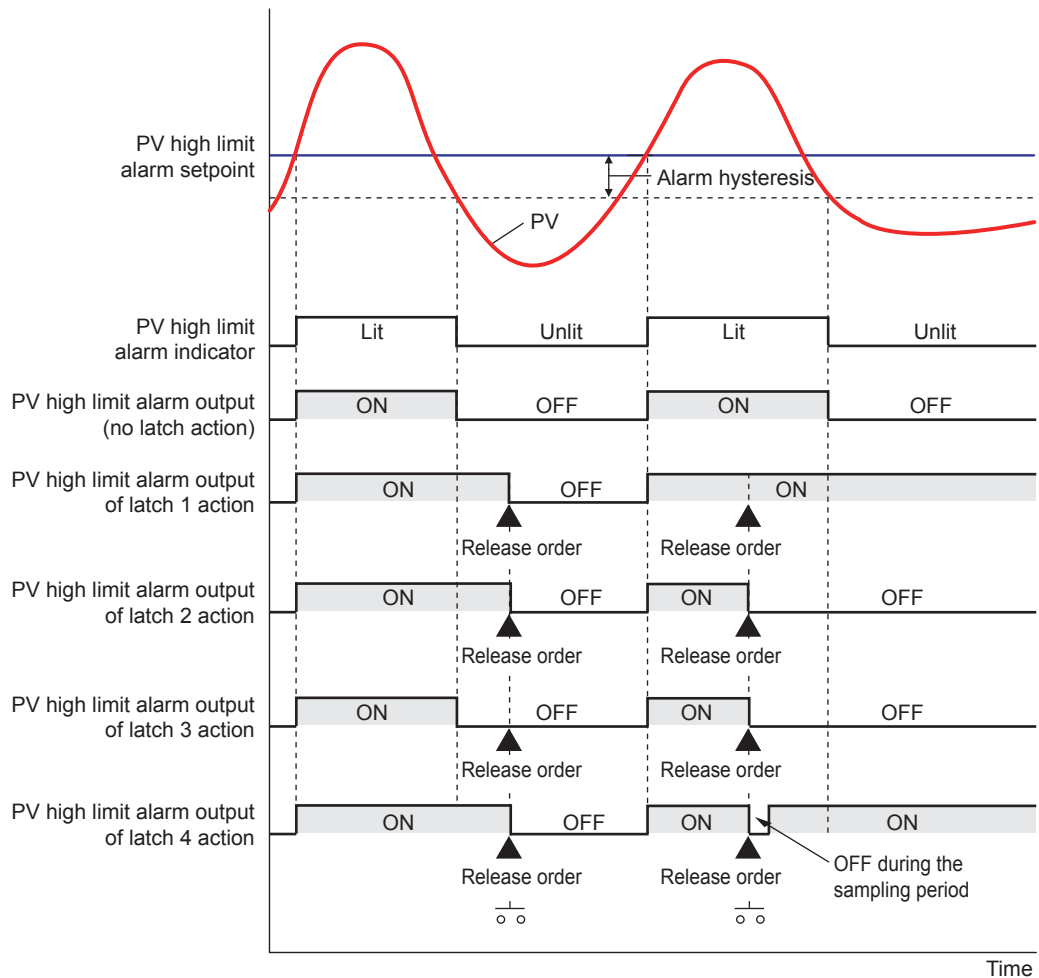
Always forces cancelling of the alarm output when an order to release the alarm latch is received. (Alarm output OFF)

Latch 3

Cancels the alarm output when an order to release the alarm latch is received or when the alarm condition is removed. (Alarm output OFF.)

Latch 4

Cancels the alarm output when an order to release the alarm latch is received. (Alarm output OFF.)
 However, cancels the alarm output for the duration of the input sampling period if an order to release the alarm latch is received during alarm condition. (Alarm output OFF)



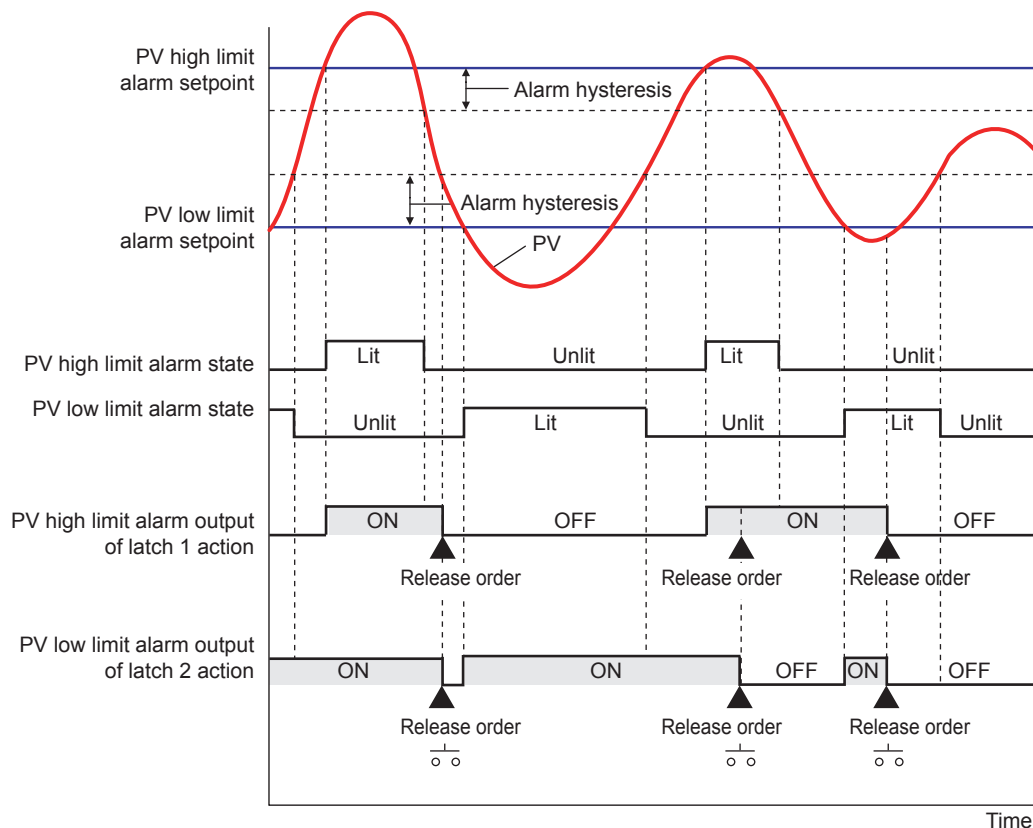
Contact type in the figure above: Energized when an event occurs (factory default).

Release of Alarm Latch

The alarm latch function can be cancelled by the user function key, via communication, or by contact input.

Cancelling the alarm latch function cancels all latched alarm outputs.

- ▶ Release by user function key: [12.2 Assigning Function to User Function Key and A/M key](#)
- ▶ Release by contact input: [11.1.1 Setting Contact Input Function](#)
- ▶ Release via communication: [UTAdvanced Series Communication Interface User's Manual](#)



Contact type in the figure above: Energized when an event occurs (factory default).

Operation of Alarm Output and Display Lamp (EV)

The contact output and display lamp (EV) are usually output and displayed according to the setpoint of the alarm type. However, the alarm conditions (operations) of the normal action, and latch action can be assigned to the contact output and display lamp (EV), regardless of the setpoint of the alarm type. (Two operations can be assigned simultaneously.)

- ▶ Display lamp action: [12.1 Setting Display Functions](#)
- ▶ Contact output action: [11.2.1 Setting Function of Contact Output](#)

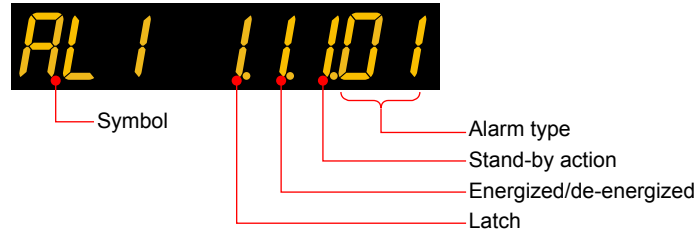
9.1 Setting Alarm Type

Setting Details

Parameter symbol	Name	Display level	Setting range	Menu symbol
AL1 to AL8	Alarm-1 to -8 type	EASY	See the table below.	ALRM Ope
VT1 to VT8	PV velocity alarm time setpoint 1 to 8	EASY	00.01 to 99.59 (minute.second)	

Note1: The initial values of the parameters AL1 to AL8 and VT1 to VT8 are "8".
The number of alarms can be changed using the parameter ALNO.

The following shows the example of setting PV high limit (01), With stand-by action (1), De-energized (1), and Latch 1 action (1).



Name	Latch action (Note 1)	Energized (0) / de-energized (1)	Stand-by action Without (0) / with (1)	Alarm type
Disable	- (Note 2)	- (Note 2)	- (Note 2)	00
PV high limit	0 / 1 / 2 / 3 / 4	0 / 1	0 / 1	01
PV low limit	0 / 1 / 2 / 3 / 4	0 / 1	0 / 1	02
PV velocity	0 / 1 / 2 / 3 / 4	0 / 1	- (Note 2)	29
Fault diagnosis	0 / 1 / 2 / 3 / 4	0 / 1	- (Note 2)	30
FAIL	- (Note 2)	- (Note 2)	- (Note 2)	31

Note 1: 0: No latch function, 1: Latch 1, 2: Latch 2, 3: Latch 3, 4: Latch 4
Note 2: -: Alarm function doesn't work even if any value is set.

9.2 Setting Number of Alarm Groups to Use

Description

Up to eight alarm groups of alarm type, alarm hysteresis, alarm (On-/Off-) delay timer, and alarm setpoint are available.

Unused alarm parameters can be hidden and their functions can be turned off.

When ALNO. = 4, for example, only the four groups of alarm type, PV velocity alarm time setpoint, alarm hysteresis, alarm delay timer, and alarm setpoint are displayed.

If the number of alarms is set to zero, alarm setpoint parameters, alarm type parameters, and menu are not displayed.

Setting Details

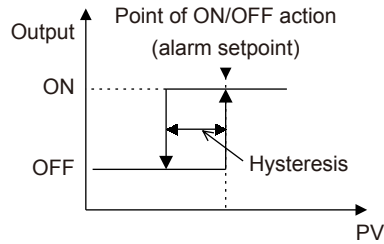
Parameter symbol	Name	Display level	Setting range	Menu symbol
ALNO.	Number of alarm groups	PRO	0 to 8	CTL Set

9.3 Setting Hysteresis to Alarm Operation

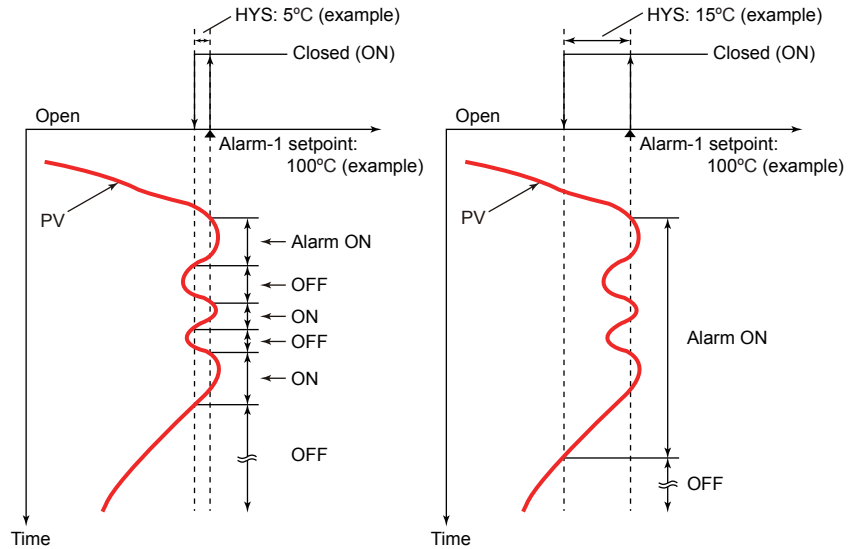
Description

If the On/Off switch of the alarm output is too busy, you can alleviate the busyness by increasing the alarm hysteresis.

Hysteresis for PV High Limit Alarm



When Setting Hysteresis of 5°C and 15°C for PV High Limit Alarm



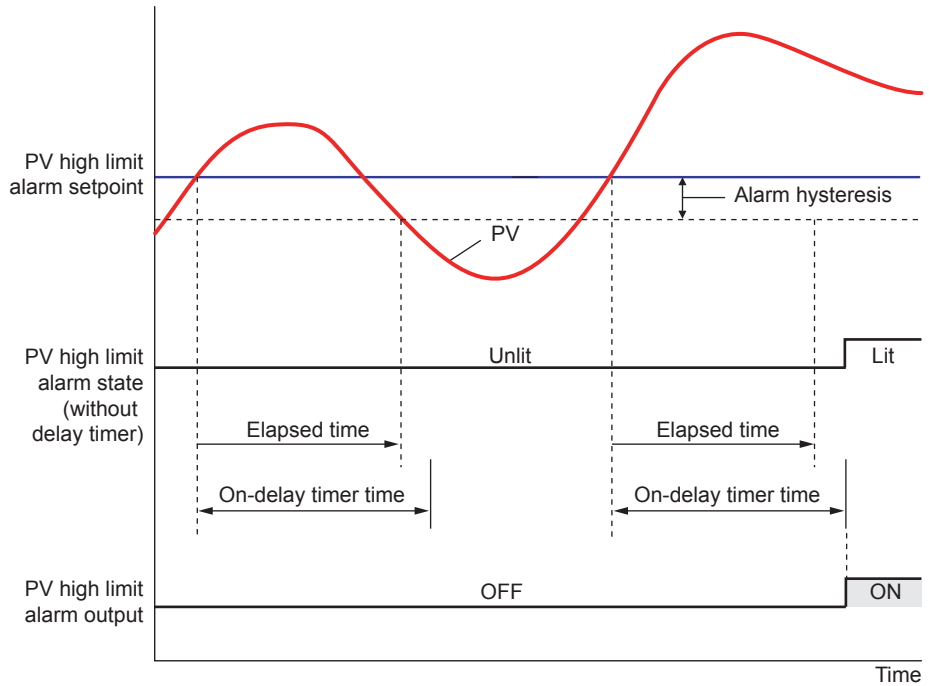
Setting Details

Parameter symbol	Name	Display level	Setting range	Menu symbol
HY1 to HY8	Alarm-1 to -8 hysteresis	EASY	Sets the hysteresis setpoint as a display value. -19999 to 30000 (set it within the input range) The decimal point position depends on the input type.	ALRM Ope

9.4 Delaying Alarm Output (Alarm Delay Timer)

Description

The alarm on-delay timer is a function for turning on the alarm when the alarm condition occurs, and the timer starts and the set time elapses. The timer is reset if the alarm condition is removed while the timer is running. No alarm is generated. The figure below shows the example of the On-delay timer



Contact type in the figure above: Energized when an event occurs (factory default).

The alarm Off-delay timer is a function for turning off the alarm when the alarm condition is removed (normal condition), and the timer starts and the set time elapses. The timer is reset if the alarm condition occurs again while the timer is running. The alarm is not cancelled.

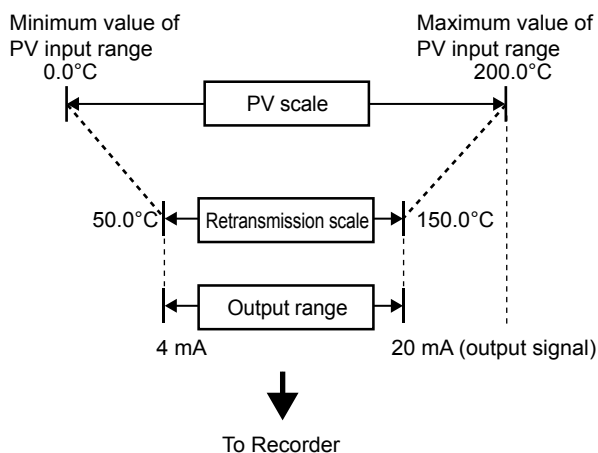
Setting Details

Parameter symbol	Name	Display level	Setting range	Menu symbol
DYN1 to DYN8	Alarm-1 to -8 On-delay timer	STD	0.00 to 99.59 (minute.second)	ALRM Ope
DYF1 to DYF8	Alarm-1 to -8 Off-delay timer	PRO		

10.1 Setting Retransmission Output Terminal, Type, and Scales

Description

▶ Current output range: 10.3 Changing Current Output Range



Setting Details

Parameter symbol	Name	Display level	Setting range	Menu symbol
RTS	Retransmission out type of RET	EASY	OFF: Disable PV1: PV LPS: 15 V DC loop power supply	OUT Set
RTH	Maximum value of retransmission output scale of RET	STD	When RTS = PV1 RTL + 1 digit to 30000 -19999 to RTH - 1 digit	
RTL	Minimum value of retransmission output scale of RET	STD	Decimal point position: When RTS=PV1 decimal point position is same as that of PV input.	

Parameters and Corresponding Terminals

RTS, RTH, RTL	RET terminal
---------------	--------------

10.2 Setting 10-segment Linearizer for Output

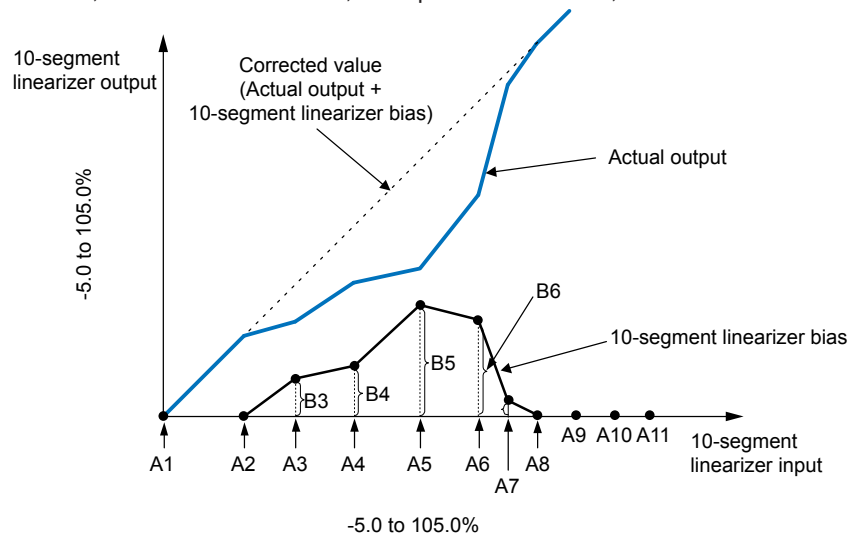
Description

The 10-segment linearizer can be used for PV input and retransmission output.

- ▶ [Function block diagram: 8.1 Function block diagram](#)
- ▶ [10-segment linearizer input: 7.1.4 \(3\) Setting 10-segment Linearizer](#)

10-segment Linearizer Biasing

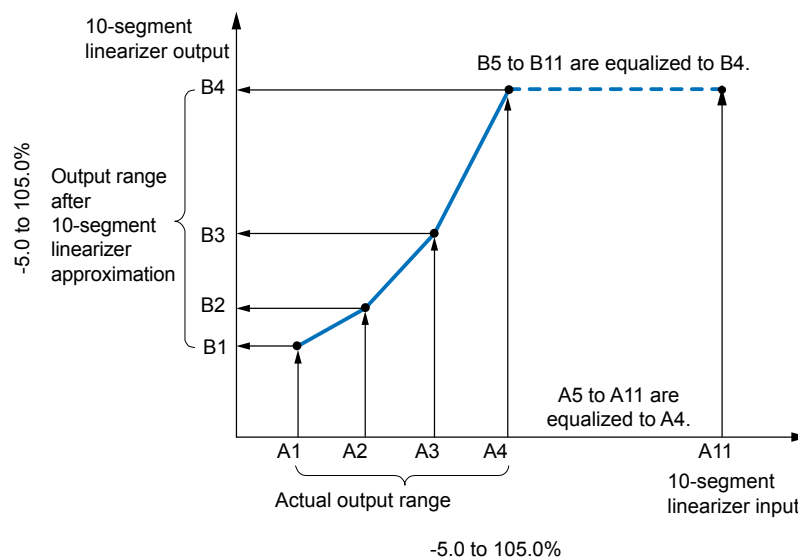
This function is used to correct the output by adding the corresponding bias values to each of the 11 points of optionally set input values. When the 10-segment linearizer input is A1 or less, B1 is added. Moreover, the input is A11 or more, B11 is added.



10-segment Linearizer Approximation

This function is used to correct the output.

As shown in the figure below, the output values can be optionally set to 11 points of the optionally set input values. When the 10-segment linearizer input is A1 or less, the value of extended line between B1 and B2 is output. Moreover, when the input is A11 or more, the value of extended line between B10 and B11 is output.



Setting Details

Parameter symbol	Name	Display level	Setting range	Menu symbol
A1 to A11	10-segment linearizer input	PRO	Output linearizer: -5.0 to 105.0%	PYS2 Ope
B1 to B11	10-segment linearizer output	PRO	Output linearizer: -5.0 to 105.0%	
PMD	10-segment linearizer mode	PRO	0: 10-segment linearizer bias 1: 10-segment linearizer approximation	

Note1: The group number 2 is displayed on Group display while each parameter is displayed.

Set it in the following orders.

- (1) The RET analog output is set by the parameter in PYS2 menu.
Setpoint RET functions before output to RET terminal.
- (2) PMD: Specifies whether to use it as a 10-segment linearizer bias or a 10-segment linearizer approximation.
- (3) A1 to A11, B1 to B11: Sets the 10-segment linearizer input and 10-segment linearizer output.

Note


- Set the 10-segment linearizer so that it increases monotonically.

10.3 Changing Current Output Range

Description

The analog output type can be selected from among 4 to 20, 0 to 20, 20 to 4, or 20 to 0 mA.

Setting Details

Parameter symbol	Name	Display level	Setting range	Menu symbol
RET.A	RET current output range	STD	4-20: 4 to 20 mA, 0-20: 0 to 20 mA, 20-4: 20 to 4 mA, 20-0: 20 to 0 mA	OUT 

Parameters and Corresponding Terminals

RET.A	RET terminal
-------	--------------

10.4 Setting Split Computation Output Function

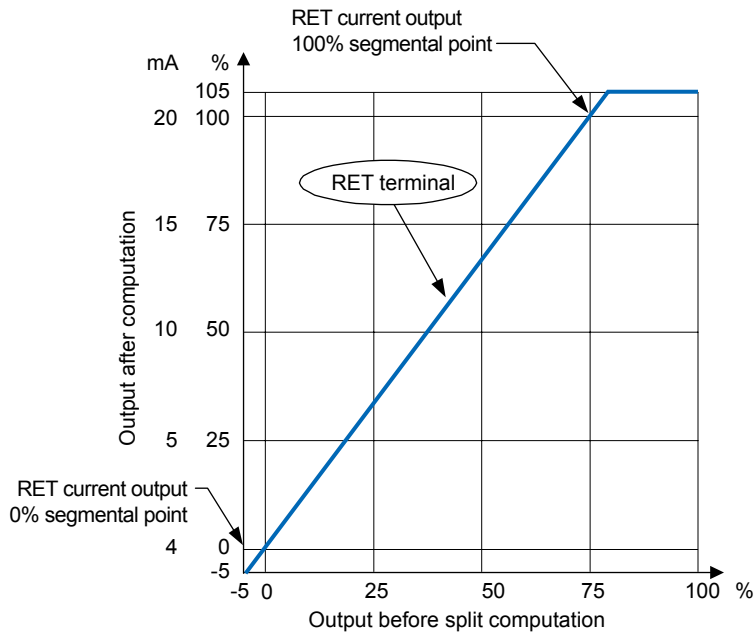
Description

The split computation output can be output by setting the breaking points for two points. The current output range can be changed.

▶ [Current output range: 10.3 Changing Current Output Range](#)

Setting Example

	RET terminal
Retransmission output type	RTS=PV1
Current output 100% segmental point	RET.H=75.0%
Current output 0% segmental point	RET.L=0.0%
Current output range	RET.A=4-20



Setting Details

Parameter symbol	Name	Display level	Setting range	Menu symbol
RET.H	100% segmental point of RET current output	PRO	-100.0 to 200.0%	OUT Set
RET.L	0% segmental point of RET current output	PRO		

Parameters and Corresponding Terminals

RET.H, RET.L	RET terminal
--------------	--------------

10.5 Using 15 V DC Loop Power Supply

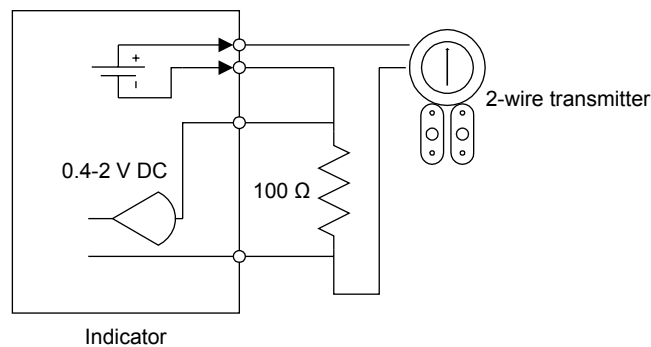
Description

The 15 V DC loop power supply is a function to supply DC power (14.5 to 18.0 V DC (21 mA DC)) to a 2-wire transmitter.

The loop power supply block is isolated from the indicator's internal circuitry. In addition, the block is equipped with a current limiting circuit. Therefore, accidental short-circuits that may occur in the field do not adversely affect the rest of the indicator's internal circuitry.

Note that the loop power supply function cannot be used for digital communication where the supply voltage is superposed on the signal line.

The following shows the examples of loop power supply connection to a 2-wire transmitter.



Setting Details

Parameter symbol	Name	Display level	Setting range	Menu symbol
RTS	Retransmission output type of RET	EASY	OFF: Disable PV1: PV LPS: 15 V DC loop power supply	OUT Set

Parameters and Corresponding Terminals

RTS	RET/OUT2 terminal
-----	-------------------

11.1 Setting Contact Input Function

11.1.1 Setting Contact Input Function

Description

The contact input function works by setting the contact input number (I relay) to functions such as the operation mode.

This explanation assumes that the contact type is energized. (The function is executed when the contact is turned on)

PV peak and bottom values reset (RST)

PV peak and bottom values can be released using contact input. (Switch by the status)

▶ [PV peak values and PV bottom values: 6.4 Confirmation of PV peak and bottom value](#)

Contact status	Operation	Remark
ON	PV peak and bottom values reset	–
OFF	Maintains the current operation status	–

Latch Release (LAT)

Latch can be released using contact input. (Switch by the rising edge)

Contact status	Operation	Remark
OFF→ON	Releases the latch	–
ON→OFF	Maintains the current operation status	–

Releasing the latch function releases all latched contact (alarm) outputs.

LCD Backlight ON/OFF Switch (LCD)

LCD backlight ON/OFF can be switched using contact input. (Switch by the rising edge and the falling edge)

Contact status	Operation	Remark
OFF→ON	Turns off the LCD backlight	–
ON→OFF	Turns on the LCD backlight	–

PV Red/White Switch (PVRW)

PV color can be switched using contact input. (Switch by the status)

Contact status	Operation	Remark
ON	Red color	–
OFF	White color	–

Set "10" to the parameter PCMD.

Message Display Interruption 1 to 4 (MG 1 to 4)

The message set using LL50A Parameter Setting Software can be interrupt-displayed on PV display using contact input. The messages are limited to 20 alphanumeric characters. A maximum of four displays can be registered. (Switch by the rising edge)

▶ [Message: LL50A Parameter Setting Software User's Manual](#)

Contact status	Operation	Remark
OFF→ON	Interrupt-displays the message	Pressing the DISP key erases the message.
ON→OFF	Displays the current PV	–

11.1 Setting Contact Input Function

Contact Action

Type	Operation	Description
Status		Receiving a contact input signal changes the status to the specified operation, and a release changes the status back to the original action.
Rising edge	<p>Rising edge</p> <p>Detection time: Input sampling period + 5</p>	Receiving an OFF-to-ON contact input signal changes the status to the specified operation. The minimum detection time is the input sampling period + 50 ms. Pulse width is 50 ms or more.
Falling edge	<p>Falling edge</p> <p>Detection time: Input sampling period + 5</p>	Receiving an ON-to-OFF contact input signal changes the status to the specified operation. The minimum detection time is the input sampling period + 50 ms. Pulse width is 50 ms or more.

Setting Details

Parameter symbol	Name	Display level	Setting range	Menu symbol
RST	PV peak and bottom values reset	STD	See the following section, "UM33A DI and Setpoint".	DI.SL Set
LAT	Latch release	STD		
LCD	LCD backlight ON/OFF switch	STD		
PVRW	PV red/white switch	STD		
MG1	Message display interruption 1	PRO		
MG2	Message display interruption 2	PRO		
MG3	Message display interruption 3	PRO		
MG4	Message display interruption 4	PRO		

UM33A DI and Setpoint (I relay number)

DI equipped as standard

DI symbol	Setpoint
DI1	5025
DI2	5026

11.1.2 Changing Contact Type of Contact Input

Description

The contact type can set the action direction of contact input assigned to the function.

Setting Details

Contact Input Equipped as Standard

Parameter symbol	Name	Display level	Setting range	Menu symbol
DI1.D	DI1 contact type	PRO	0: The assigned function is enabled when the contact input is closed. 1: The assigned function is enabled when the contact input is opened.	DI.D Set
DI2.D	DI2 contact type	PRO		

▶ [Terminal arrangement: 16.4 Wiring](#)

11.2 Setting Contact Output Function

11.2.1 Setting Function of Contact Output

Description

The contact output function works by setting a status such as an alarm to the contact output.

This explanation assumes that the contact type is energized. (The contact is turned on when an event occurs.)

Setting Details

Contact Output Equipped as Standard

Parameter symbol	Name	Display level	Setting range	Menu symbol
AL1.S	AL1 function selection	STD	See the following section.	ALM Set
AL2.S	AL2 function selection	STD		
AL3.S	AL3 function selection	STD		

Additional Relay Contact Output

Parameter symbol	Name	Display level	Setting range	Menu symbol
AL4.S	AL4 function selection	STD	See the following section.	ALM Set

Additional Contact Output

Parameter symbol	Name	Display level	Setting range	Menu symbol
DO1.S	DO11 function selection	STD	See the following section.	DO Set
DO2.S	DO12 function selection	STD		
DO3.S	DO13 function selection	STD		
DO4.S	DO14 function selection	STD		
DO5.S	DO15 function selection	STD		

Refer to the table below for presence/absence of UM33A contact output.

Terminal area	Suffix code: Type 2			
	0	1	2	3
ALM4 (101-103)	–	AL4	AL4	AL4
E1-terminal area	–	–	–	DO11 to DO15

▶ [Terminal arrangement: 16.4 Wiring](#)

Alarm Status

The alarm status can be output to the contact output. (The setpoints below are I relay numbers.)

► [I relay: UTAdvanced Series Communication Interface \(RS-485, Ethernet\) User's Manual](#)

Setpoint		Function
Alarm status	Alarm output status	
4321	4353	Alarm 1
4322	4354	Alarm 2
4323	4355	Alarm 3
4325	4357	Alarm 4
4326	4358	Alarm 5
4327	4359	Alarm 6
4329	4361	Alarm 7
4330	4362	Alarm 8

- Alarm status: The internal alarm status is turned on when an alarm occurs and turned off in normal condition
- Alarm output status: Contact output status when an alarm occurs (ON in alarm condition and OFF in normal condition)

However, the output status depends on the settings of energized/de-energized of alarm, latch action, and contact type.

The above assumes that the contact type is energized. (Then contact is turned on when an event occurs.)

To output the normal alarm to the contact output, assign the alarm output status.

► [Alarm action: 9.1 Setting Alarm Type](#)

Alarm Latch Status

The alarm latch status can be output to another contact output irrespective of the setting of alarm-1 to -8 type (AL1 to AL8). (The setpoints below are I relay numbers.)

► [I relay: UTAdvanced Series Communication Interface \(RS-485, Ethernet\) User's Manual](#)

Setpoint				Function
Alarm output latch 1 status	Alarm output latch 2 status	Alarm output latch 3 status	Alarm output latch 4 status	
4385	4417	4449	4481	Alarm 1
4386	4418	4450	4482	Alarm 2
4387	4419	4451	4483	Alarm 3
4389	4421	4453	4485	Alarm 4
4390	4422	4454	4486	Alarm 5
4391	4423	4455	4487	Alarm 6
4393	4425	4457	4489	Alarm 7
4394	4426	4458	4490	Alarm 8

- Alarm output latch 1, 2, 3, and 4 status: ON in the latch status of the contact output when an alarm occurs and OFF in the latch release status of the contact output in normal condition

However, the output status depends on the settings of contact type.

► [Alarm latch action: 9.1 Setting Alarm Type](#)

11.2 Setting Contact Output Function

Key and Display Status

The key and display status can be output to the contact output. (The setpoints below are I relay numbers.)

Setpoint	Function	Contact status	
		ON	OFF
4705	PARA key	Key is pressed	Key is not pressed
4706	DISP key		
4707	Right arrow key		
4708	Down arrow key		
4709	SET/ENTER key		
4710	Up arrow key		
4711	Left key		
4715	Fn key		

Operation Mode and Status

Setpoint	Function	Contact status	
		ON	OFF
4256	FAIL output	Normal status	FAIL status

System Error Status

Setpoint	Function	Contact status	
		ON	OFF
4769	Message display interruption 1 status	With interruption	Without interruption
4770	Message display interruption 2 status	With interruption	Without interruption
4771	Message display interruption 3 status	With interruption	Without interruption
4773	Message display interruption 4 status	With interruption	Without interruption
5457	Power ON → Initialization status	During operation	Initializing the system

Error Status

Setpoint	Function	Contact status	
		ON	OFF
4065	PV input ADC error	Error occurs	Normal
4073	PV input burnout error		
4070	PV input RJC error		
4097	PV input burnout error		
4101	PV input over-scale		
4102	PV input under-scale		

System Error Status

Setpoint	Function	Contact status	
		ON	OFF
4001	System data error	Error occurs	Normal
4002	Calibration value error		
4003	User (parameter) default value error		
4005	Setup parameter error		
4006	Operation parameter error		
4009	Faulty FRAM		


11.2.2 Changing Contact Type of Contact Output

Description


The contact type can set the action direction of contact output assigned to the function.

Setting Details


Contact Output Equipped as Standard

Parameter symbol	Name	Display level	Setting range	Menu symbol
AL1.D	AL1 contact type	PRO	0: When the event of assigned function occurs, the contact output is closed. 1: When the event of assigned function occurs, the contact output is opened.	ALM 
AL2.D	AL2 contact type	PRO		
AL3.D	AL3 contact type	PRO		

Additional Relay Contact Output

Parameter symbol	Name	Display level	Setting range	Menu symbol
AL4.D	AL4 contact type	PRO	0: When the event of assigned function occurs, the NO (normally open) terminal is closed. 1: When the event of assigned function occurs, the NC (normally closed) terminal is closed.	ALM 

Additional Contact Output

Parameter symbol	Name	Display level	Setting range	Menu symbol
DO1.D	DO11 contact type	PRO	0: When the event of assigned function occurs, the contact output is closed. 1: When the event of assigned function occurs, the contact output is opened.	DO 
DO2.D	DO12 contact type	PRO		
DO3.D	DO13 contact type	PRO		
DO4.D	DO14 contact type	PRO		
DO5.D	DO15 contact type	PRO		

Refer to the table below for presence/absence of UM33A contact output.

Terminal area	Suffix code: Type 2			
	0	1	2	3
ALM4 (101-103)	–	AL4	AL4	AL4
E1-terminal area	–	–	–	DO11 to DO15

► Terminal arrangement: 16.4 Wiring

12.1 Setting Display Functions

12.1.1 Setting Active Color PV Display Function

The active color PV display function changes the PV display color when an event occurs.

Description

Link to Alarm

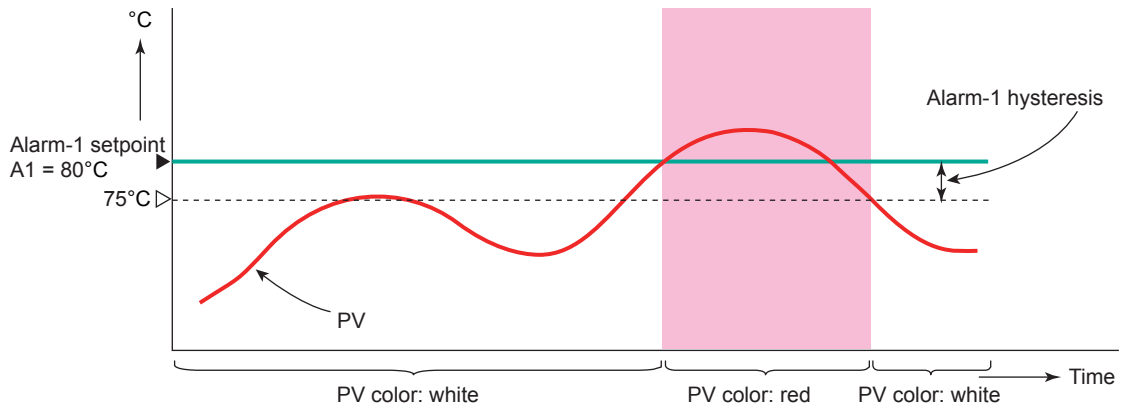
The PV display color changes by linking to the alarm 1 or alarm 2.

The following is an example of operation linking to alarm 1.

Set the alarm-1 type to "PV high limit alarm" and alarm-1 setpoint to "80°C."

When the active color PV display switch is set to "2," PV display color changes from white to red if PV exceeds the alarm-1 setpoint.

The red-to-white switching action can be set.



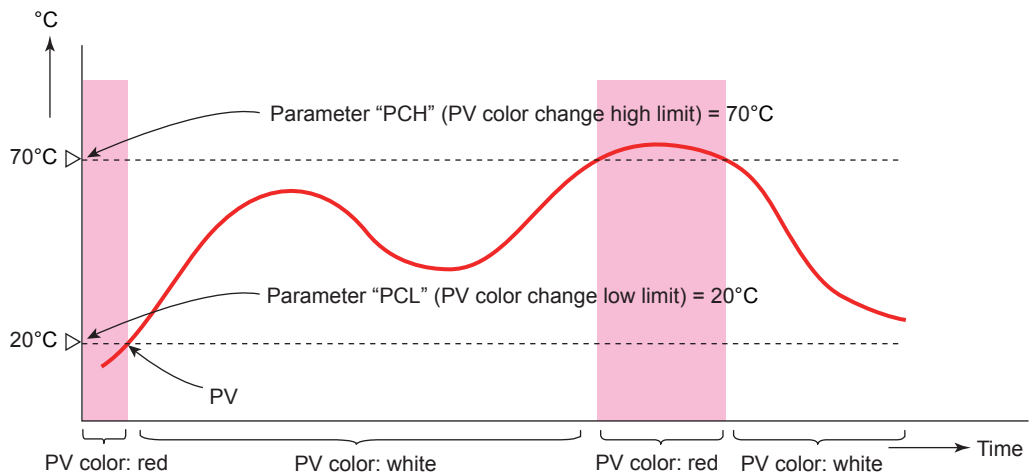
Link to PV

The PV display color changes by linking to PV.

Set the PV color change high limit to "70°C" and the PV color change low limit to "20°C."

PV display color changes from white to red if PV is out of the range.

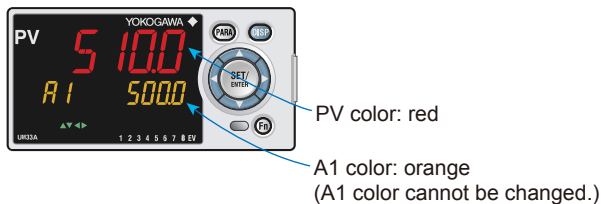
The red-to-white switching action can be set. There is no hysteresis.



12.1 Setting Display Functions

Use in Fixed Color

PV display color can be fixed in red. It can also be fixed in white.



Link to DI

The PV display color changes by linking to DI (ON/OFF).

The following is an example for changing the display color by a state of DI1.

Set the parameter PCMD=10, and PVRW=5025.

PV display color is red when DI1=ON, and is white when DI1=OFF.

PVRW: PV red/white switch (Menu: DI.SL)

Setting Details

Parameter symbol	Name	Display level	Setting range	Menu symbol
PCMD	Active color PV display switch	EASY	0: Fixed in white 1: Fixed in red 2: Link to alarm 1 (Alarm OFF: white, Alarm ON: red) 3: Link to alarm 1 (Alarm OFF: red, Alarm ON: white) 4: Link to alarm 1 or 2 (Alarm OFF: white, Alarm ON: red) 5: Link to alarm 1 or 2 (Alarm OFF: red, Alarm ON: white) 6: PV limit (Within range: white, Out of range: red) 7: PV limit (Within range: red, Out of range: white) 10: Link to DI (ON: red, OFF: white)	DISP Set
PCH	PV color change high limit	EASY	Set a display value when in PV limit.	
PCL	PV color change low limit	EASY	-19999 to 30000 (Set a value within the input range.) Decimal point position depends on the input type.	

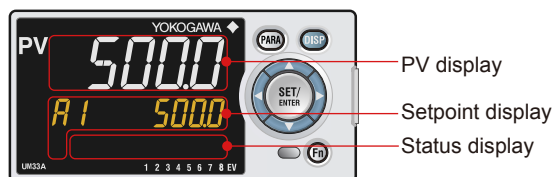
12.1.2 Masking Arbitrary Display Value in Operation Display

Description

Display/non-display of the PV display, Setpoint display, and Status display in the Operation Display can be set.

Items that you do not want to display can be set to non-display. For example, if PV display is set to non-display, the following items are not displayed: PV on the PV display, the scrolling guide in the Menu Display and Parameter Setting Display.

When an error at power-on or hardware malfunction error occurs, Operation display cannot be set to non-display.



Setting Details

Parameter symbol	Name	Display level	Setting range	Menu symbol
PV.D	PV display area ON/OFF	PRO	OFF: Nondisplay ON: Display	DISP Set
SP.D	Setpoint display area ON/OFF	PRO		
STS.D	Status display area ON/OFF	PRO		

12.1 Setting Display Functions

12.1.3 Registering SELECT Display (Up to 5 Displays)

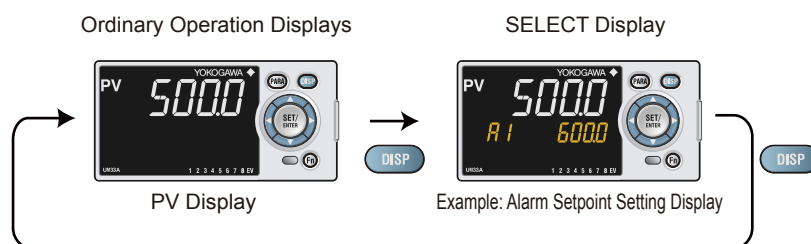
Description

Registering frequently changed-operation parameters (except for the operation mode) in the SELECT Display of the Operation Displays will allow you to change parameter settings easily. A maximum of five Displays can be registered. Set the D register number of the parameter you wish to register for the registration to the SELECT Display.

However, the parameters in the following menu cannot be set:

CTL, PV, MPV, OUT, R485, KEY, DISP, CSEL, KLOC, MLOC, DI.SL, DI.D, ALM, DO, I/O, SYS, INIT, VER, and LVL.

When each parameter is displayed, the terminal area (E1 to E4) is displayed on Group display according to the suffix code and optional suffix code.



Setting Details

Parameter symbol	Name	Display level	Setting range	Menu symbol
CS1 to CS5	SELECT Display-1 to -5 registration	STD	OFF: No registration D register number (2301 to 5000)	CSEL Set

For D register numbers, see sections 10.4.2 and 10.4.3 in the UTAdvanced Series Communication Interface User's Manual.

D Resistor Number	Category	Description	Reference in Communication Interface User's Manual
2301 to 2400	Operation Parameters	Alarm setpoint setting	Section 10.4.2
2801 to 2900		Alarm function settings	
2901 to 3000		PV-related settings	
4801 to 5000	10-segment Linearizer Setting Parameters	10-segment linearizer setting	Section 10.4.3

12.1.4 Changing Event Display

Description

The UM33A has four event (EV) lamps.
The alarms 1 to 8 are assigned to EV1 to EV8.

Setting Details

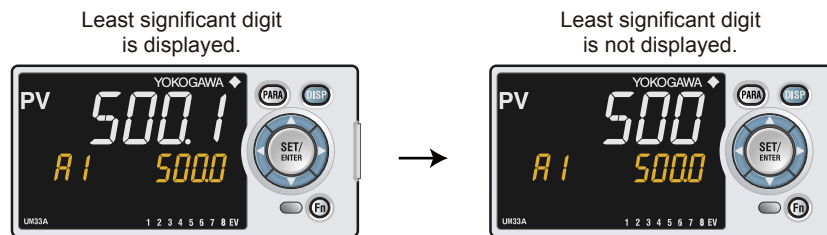
Parameter symbol	Name	Display level	Setting range	Menu symbol
EV1 to EV8	EV1 to EV8 display condition registration	PRO	Setting range: 4001 to 6304 OFF: Disable 4321: Link to alarm 1 (Lit when the alarm occurs) 4322: Link to alarm 2 (Lit when the alarm occurs) 4323: Link to alarm 3 (Lit when the alarm occurs) 4325: Link to alarm 4 (Lit when the alarm occurs) 4326: Link to alarm 5 (Lit when the alarm occurs) 4327: Link to alarm 6 (Lit when the alarm occurs) 4329: Link to alarm 7 (Lit when the alarm occurs) 4330: Link to alarm 8 (Lit when the alarm occurs) 4529: Heater break alarm 1 (Lit when the alarm occurs) 4530: Heater break alarm 2 (Lit when the alarm occurs) 5025 to 5026: Link to DI1-DI2 (Lit when the contact is closed) 5153 to 5155: Link to AL1-AL3 (Lit when the contact is closed) 5156: Link to AL4 (Lit when the contact is closed) 5169 to 5173: Link to DO11-DO15 (E1-terminal area) (Lit when the contact is closed) For other functions, see the UTAdvanced Series Communication Interface User's Manual.	DISP Set

Relay Number	Description	Reference in Communication Interface User's Manual
4001 to 4064	System error	Section 11.3.1
4065 to 4128	Input error	
4129 to 4192	Free area	
4256	FAIL output	
4257 to 4320	Free area	
4321 to 4384	Alarm	
4385 to 4528	Alarm latch	
4641 to 4704	Free area	
4705 to 4768	Key	
4769 to 4832	Display	
4833 to 5024	Free area	
5025 to 5152	Input relay	Section 11.3.2
5153 to 5280	Output relay	

12.1.5 Masking Least Significant Digit of PV Display

Description

With and without least significant digit of the PV in the Operation Display can be set. If the least significant digit is set to none, the value in the least significant can be truncated or rounded. The internal value is not changed depending on whether with or without least significant digit (the value is for display only). This parameter does not function for the PV without decimal point.



The following shows the example of with and without least significant digit

PV display		
With least significant digit	Without least significant digit	
	Rounding	Rounding-off
1499.9	1499	1500
1500.4	1500	1500
1999.9	1999	2000
2000.4	2000	2000
3000.0	3000	3000
3000.9	3000	3001
3001.0	3001	3001

Setting Details

Parameter symbol	Name	Display level	Setting range	Menu symbol
MLSD	Least significant digital mask of PV display	STD	OFF: With least significant digit ON: Without least significant digit	DISP Set
MKTP	Method for least significant digital mask of PV display	STD	0: Rounding 1: Rounding-off	DISP Set

12.1.6 Setting Economy Mode

Description

The LCD backlight ON/OFF can be set in the following methods.
Setting the LCD backlight to OFF saves energy.

User Function Keys

The LCD backlight ON/OFF switch can be assigned to the user function key.

▶ [User function key: 12.2 Assigning Function to User Function Key](#)

Backlight OFF timer

The backlight OFF timer sets the economy mode parameter to ON.

If no keys are pressed for 30 minutes, the LCD backlight goes off automatically.

The backlight OFF can be set to turn off the backlight for the whole display or a display other than the PV display.

To turn on the LCD backlight, press any key.

Contact Input


The LCD backlight ON/OFF switch can be assigned to the contact input

▶ [Contact input: 11.1 Setting Contact Input Function](#)

In the following cases, the LCD backlight does not go off.

- when an alarm occurs
- When an error at power-on or a hardware malfunction error occurs

Setting Details


Parameter symbol	Name	Display level	Setting range	Menu symbol
ECO	Economy mode	STD	OFF: Disable 1: Economy mode ON (All indications except PV display OFF) 2: Economy mode ON (All indications OFF) 3: Brightness 10 % (all indications)	DISP 

12.1.7 Selecting the Initial Operation Display that Appears at Power ON

Description

The initial Operation Display that appears when the power is turned on can be set.

Setting Details

Parameter symbol	Name	Display level	Setting range	Menu symbol
HOME	Home Operation Display setting	PRO	PV: PV Analog Input Display CS1 to CS5: SELECT Display 1 to 5	DISP 

12.1.8 Setting Message Function

Description

Using the message function and turning the contact input on/off, the message registered beforehand can be displayed on PV display by interrupt.

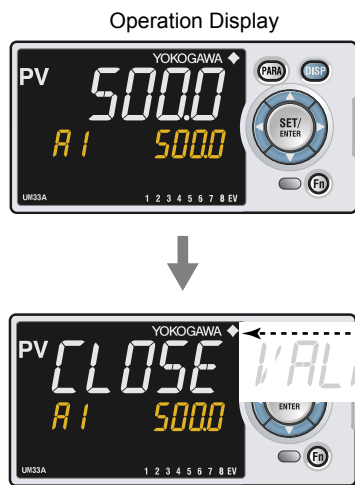
The message is registered using LL50A Parameter Setting Software.

The messages are limited to 20 alphanumeric characters. A maximum of four messages can be registered.

If a number of messages occur simultaneously, the priority is as follows:

(high) MG1>MG2>MG3>MG4 (low)

- ▶ [Message registration: LL50A Parameter Setting Software User's Manual](#)
- ▶ [Registration of contact input: 11.1.1 Setting Contact Input Function](#)
- ▶ [Registration symbols: 3.3 List of Display Symbols](#)



When the contact input is turned on, the scrolling message registered beforehand is displayed on PV Display.

12.1.9 Switching Guide Display Language

Description

The guide display language that appears when the parameter or the menu is displayed can be switched.

Setting Details

Parameter symbol	Name	Display level	Setting range	Menu symbol
LANG	Guide display language	EASY	ENG: English FRA: French GER: German SPA: Spanish	SYS Set

12.1.10 Changing Guide Scroll Speed

Description

The scroll speed can be changed when the guide for the parameter or menu is displayed.

Setting Details

Parameter symbol	Name	Display level	Setting range	Menu symbol
SPD	Scroll speed	PRO	(Slow) 1 to 8 (Quick)	DISP Set

12.1.11 Turning Guide Display ON/OFF

Description

The guide display that appears when the parameter or the menu is displayed can be switched.

The guide display can be turned on and off by the Fn key in the Menu Display and Parameter Setting Display.

Setting Details

Parameter symbol	Name	Display level	Setting range	Menu symbol
GUID	Guide display ON/OFF	STD	OFF: Nondisplay ON: Display	DISP Set

12.1.12 Setting Automatic Return to Operation Display

Description

The Display will automatically revert to the Operation Display if no keys are pressed for 5 minutes in Menu Display or Parameter Setting Display.

Setting Details

Parameter symbol	Name	Display level	Setting range	Menu symbol
OP.JP	Automatic return to Operation Display	PRO	ON: Automatically returned to the Operation Display. OFF: Not automatically returned to the Operation Display.	DISP Set


12.1 Setting Display Functions

12.1.13 Setting Brightness Adjustment of LCD and Display Update Cycle

Description

The brightness for PV, Setpoint, Bar-graph, and Status indicator can be adjusted. Brightness ranges for each display can be set. The LCD has a characteristic that the display action becomes late at the low temperature. This can be solved by adjusting the display update cycle (D.CYC).

Setting Details

Parameter symbol	Name	Display level	Setting range	Menu symbol
BRI	Brightness	EASY	(Dark) 1 to 5 (Bright)	DISP 
B.PVW	White brightness adjustment of PV display	PRO	Adjusts the white brightness of PV display. (Dark) -4 to 4 (Bright)	
B.PVR	Red brightness adjustment of PV display	PRO	Adjusts the red brightness of PV display. (Dark) -4 to 4 (Bright)	
B.SP	Brightness adjustment of Setpoint display	PRO	Adjusts the brightness of SP display. (Dark) -4 to 4 (Bright)	
B.STS	Brightness adjustment of Status indicator	PRO	Adjusts the brightness of Status indicator. (Dark) -4 to 4 (Bright)	
D.CYC	Display update cycle	PRO	1: 100 ms 2: 200 ms 3: 500 ms 4: 1 s 5: 2 s	

12.2 Assigning Function to User Function Key

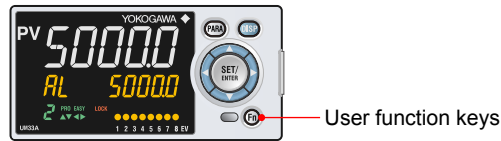
Description

The UM33A has three user function keys on the front panel. The UM33A has one user function key.

Various functions (operation mode switch etc.) can be assigned to the user function key. Press the user function key to perform the assigned function.

The User function key is available only on the Operation Display.

The assigned function does not work on the Parameter Setting Display. However, the Fn key can be used to turn on/off the guide display.



Setting Details

Parameter symbol	Name	Display level	Setting range	Menu symbol
Fn	User function key action setting	EASY	See the table below	KEY Set

Setpoint	Function	Action
OFF	Unassigned	–
LTUP	LCD brightness UP	The current brightness gradually increases every time the function key is pressed.
LTDN	LCD brightness DOWN	The current brightness gradually decreases every time the function key is pressed.
BRI	Adjust LCD brightness	The current brightness gradually increases every time the function key is pressed. Pressing the function key after reaching the maximum brightness changes to the minimum brightness. Thereafter, minimum brightness→maximum brightness→maximum brightness is repeated.
LCD	LCD Backlight ON/OFF switch	The LCD backlight turns on and off every time the user function key is pressed.
LAT	Latch release	Latch 1 to latch 4 are released every time the user function key is pressed.
AL	Alarm setpoint setting	When the user function key is pressed while the Operation Display is shown, the first parameter (A1) of the Alarm setpoint setting menu appears and the setting change becomes possible. As with the operation to change the parameter setpoint, the sequence is A1→A2→A3→...→A1→.... Pressing the function key again, or pressing the DISP key returns to the initial Operation Display. The PARA key does not switch to the Menu Display.
RST	PV peak and bottom values reset	PV peak and bottom values are reset every time the user function key is pressed.

Status of user function key

The status of the user function key can be identified by communication.

“1” can be read while the user function key is held down, and “0” can be read when the user function key is released. (Initial value: 0)

▶ Reading via communication: [UTAdvanced Series Communication Interface User's Manual](#)

12.2 Assigning Function to User Function Key

Fn key operation in the Parameter Setting Display

In the Menu Display and Parameter Setting Display, the guide is displayed on PV display. At this time, use the Fn key to turn on and off the guide display on PV display. A measured input value (PV) is displayed in the ON state.

12.3 Setting Security Functions

12.3.1 Setting or Clearing the Password

Description

The password function can prevent inadvertent changes to the parameter settings. If a password is set, the checking is required when moving to the Setup Parameter Setting Display. When the password is verified, can be changed to the Setup Parameter Setting Display. The parameters in the following menu can be set only when the password is verified.

CTL, PV, MPV, OUT, R485, KEY, DISP, CSEL, KLOC, MLOC, DI.SL, DI.D, ALM, DO, I/O, SYS, INIT, VER, and LVL.

Always remember your password when using the password function.

To clear the password, set parameter PASS to "0."

Setting Details

Parameter symbol	Name	Display level	Setting range	Menu symbol
PASS	Password setting	EASY	0 (No password) to 65535	SYS Set

12.3.2 Setting Parameter Display Level

Description

Parameter display level can be set according to the setting level.

▶ [Parameter display level: Chapter 17 Parameters](#)

Setting Details

Parameter symbol	Name	Display level	Setting range	Menu symbol
LEVL	Parameter display level	EASY	EASY: Easy setting mode STD: Standard setting mode PRO: Professional setting mode	LVL Set


12.3 Setting Security Functions

12.3.3 Locking (Hiding) Parameter Menu Display

Description

The parameter menu display lock function hides the following Parameter Menu Displays.

Setting Details


Parameter symbol	Name	Display level	Setting range	Menu symbol
CTL	[CTL] menu lock	PRO	OFF: Display ON: Nondisplay	MLOC 
PV	[PV] menu lock	PRO		
MPV	[MPV] menu lock	PRO		
OUT	[OUT] menu lock	PRO		
R485	[R485] menu lock	PRO		
CC-L	[CC-L] menu lock	PRO		
KEY	[KEY] menu lock	PRO		
DISP	[DISP] menu lock	PRO		
CSEL	[CSEL] menu lock	PRO		
KLOC	[KLOC] menu lock	PRO		
DI.SL	[DI.SL] menu lock	PRO		
DI.D	[DI.D] menu lock	PRO		
ALM	[ALM] menu lock	PRO		
DO	[DO] menu lock	PRO		
I/O	[I/O] menu lock	PRO		
SYS	[SYS] menu lock	PRO		
INIT	[INIT] menu lock	PRO		
VER	[VER] menu lock	PRO		
LVL	[LVL] menu lock	PRO		
AL	[AL] menu lock	PRO		
ALRM	[ALRM] menu lock	PRO		
PVS	[PVS] menu lock	PRO		
PYS1	[PYS1] menu lock	PRO		
PYS2	[PYS2] menu lock	PRO		

12.3.4 Key Lock

Description

The key lock function locks the key on the front panel to prohibit key operation. It can prohibit the operation mode switch or parameter setting change.

Setting Details

Parameter symbol	Name	Display level	Setting range	Menu symbol
DATA	Front panel parameter data key lock	STD	OFF: Unlock ON: Lock (when Operation Display only)	KLOCK 


12.3.5 Setting Display/Non-display of Operation Display

Description

Display/non-display of the Operation Display can be set.

▶ [Operation Display: Chapter 6 Monitoring of Regular Operations](#)

Setting Details


Parameter symbol	Name	Display level	Setting range	Menu symbol
U.PV	PV Analog Input Display lock	PRO	OFF: Display ON: Nondisplay	KLOC 

12.3.6 Prohibiting Writing via Communication

Description

Writing data to each register via all communication methods can be permitted or prohibited. However, writing data via light-loader (front) or maintenance port (side) is possible using LL50A Parameter Setting Software.

Setting Details

Parameter symbol	Name	Display level	Setting range	Menu symbol
COM.W	Communication write enable/disable	STD	OFF: Enable ON: Disable	KLOC 

Displayed only in cases where the communication is specified.

12.4 Confirmation of Key and I/O Condition and Version

12.4.1 Confirmation of Key and I/O Condition

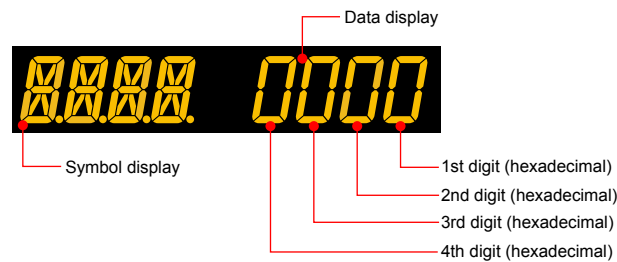
Description

Can be confirm the Key and I/O condition.

Setting Details

Parameter symbol	Name	Display level	Setting range	Menu symbol
KEY	Key status	PRO	Read only.	I/O Set
X000	DI1-DI2 status (equipped as standard)	PRO		
Y000	AL1-AL4 status (equipped as standard)	PRO		
Y100	DO11-DO15 status (E1-terminal area)	PRO		

Key confirmation parameters are displayed in hexadecimal.
When the error occurs, "1" is set on the bit of corresponding error , and the bit data is displayed in hexadecimal.



Parameter KEY

Displayed digit	bit	Description
1st digit	0	PARA key (0: OFF, 1: ON)
	1	DISP key (0: OFF, 1: ON)
	2	RIGHT arrow key (0: OFF, 1: ON)
	3	DOWN arrow key (0: OFF, 1: ON)
2nd digit	4	SET/ENTER key (0: OFF, 1: ON)
	5	UP arrow key (0: OFF, 1: ON)
	6	LEFT arrow key (0: OFF, 1: ON)
	7	—
3rd digit	8	—
	9	—
	10	Fn key (0: OFF, 1: ON)
	11	—
4th digit	12	—
	13	—
	14	—
	15	—

Parameter X000

Displayed digit	bit	Description
1st digit	0	DI1 status (0: OFF, 1: ON)
	1	DI2 status (0: OFF, 1: ON)
	2	—
	3	—
2nd digit	4	—
	5	—
	6	—
	7	—
3rd digit	8	—
	9	—
	10	—
4th digit	11	—
	12	—
	13	—
	14	—
	15	—

Parameter Y000

Displayed digit	bit	Description
1st digit	0	AL1 status (0: OFF, 1: ON)
	1	AL2 status (0: OFF, 1: ON)
	2	AL3 status (0: OFF, 1: ON)
	3	—
2nd digit	4	—
	5	—
	6	—
	7	—
3rd digit	8	—
	9	—
	10	—
4th digit	11	—
	12	—
	13	—
	14	—
	15	—

Parameter Y100

Displayed digit	bit	Description
1st digit	0	DO11 status (0: OFF, 1: ON)
	1	DO12 status (0: OFF, 1: ON)
	2	DO13 status (0: OFF, 1: ON)
	3	DO14 status (0: OFF, 1: ON)
2nd digit	4	DO15 status (0: OFF, 1: ON)
	5	—
	6	—
	7	—
3rd digit	8	—
	9	—
	10	—
4th digit	11	—
	12	—
	13	—
	14	—
	15	—

12.4 Confirmation of Key and I/O Condition and Version

12.4.2 Confirmation of Version

Description

Can be confirm the version of the indicator.

Setting Details

Parameter symbol	Name	Display level	Setting range	Menu symbol
MCU	MCU version	EASY	Read only.	VER Set
DCU	DCU version	EASY		
ECU1	ECU-1 version (E1-terminal area)	EASY		
PARA	Parameter version	EASY		
H.VER	Product version	EASY		
SER1	Serial number 1	EASY		
SER2	Serial number 2	EASY		

13.1 Initializing Parameter Settings to Factory Default Values

Description

Parameter settings can be initialized to the factory default values. Use the key or LL50A Parameter Setting Software to execute it.

Note

The user setting values (defaults) are not initialized even if the parameter setting values are initialized to the factory default values.

Setting Details

Parameter symbol	Name	Display level	Setting range	Menu symbol
F.DEF	Initialization to factory default value	PRO	-12345: Initialization, automatically returned to "0" after initialization.	INIT Set

13.2 Registering and Initializing User Default Values

13.2.1 Registering as User Setting (Default) Values

Description

The user default values can be registered as parameter default values.
Use the LL50A Parameter Setting Software to register user setting (default) values.

CAUTION

Before registering the user default value, make sure that the user setting value is set to the parameter.

13.2.2 Initializing to User Setting (Default) Values

Description

Parameter settings can be initialized to the user setting (default) values.
Use the LL50A Parameter Setting Software to execute it.

Setting Details

Parameter symbol	Name	Display level	Setting range	Menu symbol
U.DEF	Initialization to user default value	PRO	12345: Initialization, automatically returned to "0" after initialization.	INIT Set

14.1 Remedies if Power Failure Occurs during Operations

Description

All functions of the indicator cannot be operated for about 10 seconds after recovery. However, the case of instantaneous power failure is excepted.

- 100–240 V AC: Instantaneous power failure of 20 ms or less
- 24 V AC/DC: Instantaneous power failure of 1 ms

A power failure is not detected. Normal operation continues.

The following shows effects caused in “settings” and “operation status.”

Alarm action	Does not continue. Alarm with stand-by function will enter stand-by status. Alarm latch will be initialized.
Setting parameter	Set contents of each parameter are retained.

The PV peak value and PV bottom value will be reset.

14.2 Power Frequency Setting

Description

The power frequency can be set by automatic detection or manually. However, when the /DC option is specified, only manual setting is available. Set the range to the commercial frequency of the installation location.

Setting Details

Parameter symbol	Name	Display level	Setting range	Menu symbol
FREQ	Power frequency	EASY	AUTO 60: 60 Hz 50: 50 Hz	SYS Set

14.3 Setting Time between Powering on Indicator and Starting Monitor (Restart Timer)

Description

The time between power on and the instant where indicator starts monitor can be set.

Operation start time = Operating time of indicator initialization after power on.

Setting Details

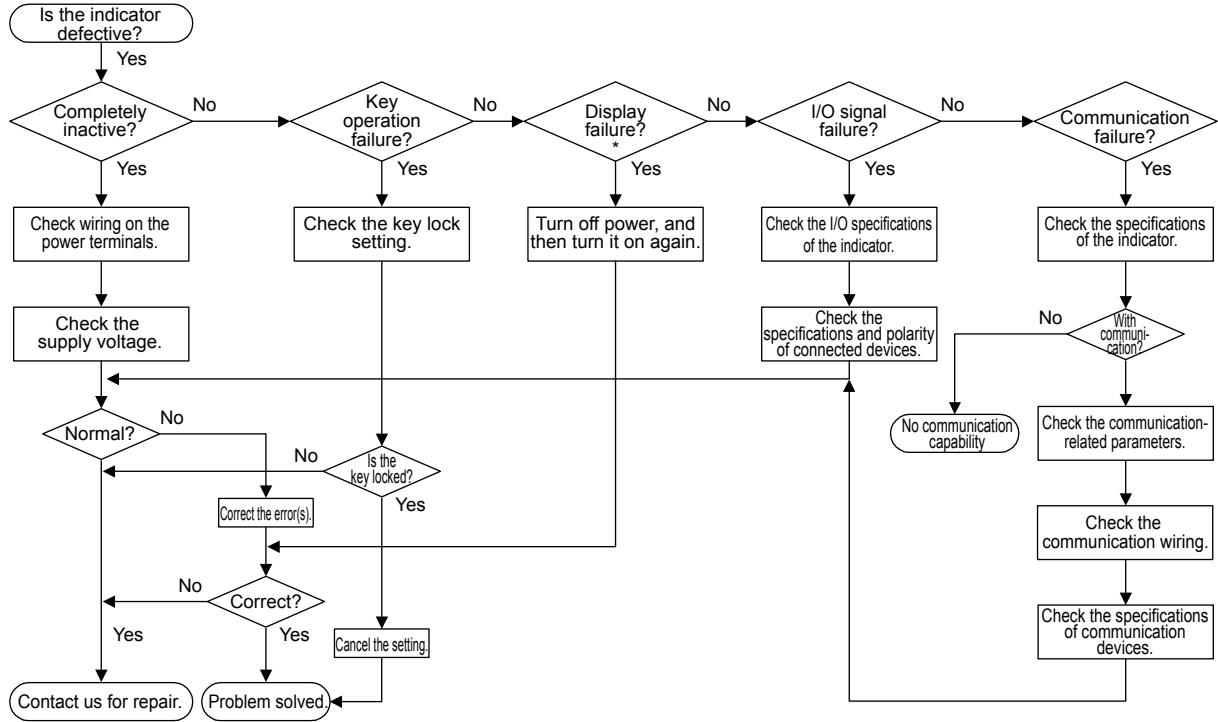
Parameter symbol	Name	Display level	Setting range	Menu symbol
R.TM	Restart Timer	STD	0 to 10 s	SYS Set

15.1 Troubleshooting

15.1.1 Troubleshooting Flowchart

If the Operation Display does not appear after turning on the indicator's power, follow the measures in the procedure below.

If a problem appears complicated, contact our sales representative.



*: The LCD (a liquid crystal display) is used for a display portion of this product. The LCD has a characteristic that the display action becomes late at the low temperature. Additionally, the luminance and contrast degradation are caused due to aged deterioration. However, the function is not affected.

15.1 Troubleshooting

15.1.2 Errors at Power On

The errors shown below may occur in the fault diagnosis when the power is turned on.

PV display (Operation Display)	Setpint display (Operation Display)	Status indicator (Operation Display)	Parameter that displays error details	Error description	Cause and diagnosis	Remedy	
Indication off	Indication off	—	—	Faulty MCU RAM / MCU ROM	MCU RAM / MCU ROM are failed.	Faulty. Contact us for repair.	
ERR	SYS -----	—	—	System data error	System data is corrupted.	Faulty. Contact us for repair.	
	PAR 0004 (for user default value error only)			Setup parameter (PA.ER)	User (parameter) default value error	User parameter is corrupted. Initialized to factory default value.	Check and reconfigure the initialized parameters. Error indication is erased when the power is turned on again.
	PAR 0010 (for setup parameter error only)				Setup parameter error	Setup parameter data is corrupted. Initialized to factory default value.	
	PAR 0020 (for operation parameter error only)				Operation parameter error	Operation parameter data is corrupted. Initialized to user default value.	
	PAR 0400 (for control parameter error only)				Control parameter error	Control parameter data is corrupted. Initialized to user default value.	
	SLOT 0001				Setup parameter (OP.ER)	Non responding hardware of extended function (E1-terminal areas)	
Normal indication	Normal indication	Rightmost decimal point on PV display blinks.	Setup parameter (PA.ER)	Calibration value error	Initialized to calibrated default value because of corrupted factory default value.	Faulty. Contact us for repair.	
		Right most decimal point on Symbol display blinks.		Faulty FRAM	Writing (storing) data to FRAM is impossible.		
Normal indication	0.000 00000 (Decimal point on the left of the Symbol display blinks)	—	Setup parameter (OP.ER)	User profile error	User profile is corrupted.	Download the user profile again.	

Errors at Power On (Input/output Action)

Error description	PV input	Retransmission output	Alarm action	Analog output (retransmission output)	Contact input	Contact (alarm) output	Communication
Faulty MCU RAM Faulty MCU ROM	Undefined	Undefined	Stopped	0% or less	OFF	OFF	Stopped
System data error	Undefined	Undefined	Stopped	0% or less	OFF	OFF	Normal action
User (parameter) default value error	Normal action	Normal action	Normal action	Normal action	Normal action	Normal action	Normal action
Setup parameter error							
Operation parameter error							
Control parameter error							
Non responding hardware of extended function (E1-terminal areas)	Undefined	Normal action	Normal action	Normal action	Normal action	Normal action	Normal action
Calibration value error	Normal action (out of accuracy)	Normal action	Normal action	Normal action (out of accuracy)	Normal action	Normal action	Normal action
Faulty FRAM	Normal action			Normal action			
User profile error	Normal action	Normal action	Normal action	Normal action	Normal action	Normal action	CC-Link communication is disabled

15.1 Troubleshooting

15.1.3 Errors during Operation

Errors during Operation (1)

The errors shown below may occur during operation.

PV display (Operation Display)	Setpoint display (Operation Display)	Status indicator (Operation Display)	Parameter that displays error details	Error description	Cause and diagnosis	Remedy
AD.ERR	Normal indication	–	Setup parameter (AD1.E)	Analog input terminal ADC error • PV input	Analog input terminal AD value error	Faulty Contact us for repair.
RJC.E (Displays RJC.E and PV alternately.)	Normal indication	–	Setup parameter (AD1.E)	Universal input terminal RJC error • PV input	Universal input terminal RJC error	Faulty Contact us for repair. Set the parameter RJC to OFF to erase error indication.
B.OUT	Normal indication	–	Setup parameter (AD1.E)	Analog input terminal burnout error • PV input	Analog input terminal sensor burnout	Check wiring and sensor. Error indication is erased in normal operation.
			Setup parameter (PV1.E)	PV input burnout error)	Burnout of analog input connected to PV	Check wiring and sensor of connected analog input terminal. Error indication is erased in normal operation.
OVER- OVER	Normal indication	–	Setup parameter (PV1.E)	PV input over-scale PV input under-scale (PV values out of -5 to 105%)	PV input is out of -5 to 105%. Also occurs when the data out of range which is the ladder computation result is input.	Check analog input value or ladder program.

Errors during Operation (Input/output Action)

Error description	PV input	Retransmission output	Alarm action	Analog output (retransmission output)	Contact input	Contact (alarm) output	Communication
Analog input terminal ADC error • PV input	105%	Normal action	Normal action	Normal action	Normal action	Normal action	Normal action
Universal input terminal RJC error • PV input	Normal action (without reference junction compensation)	Normal action	Normal action	Normal action	Normal action	Normal action	Normal action
Analog input terminal burnout error • PV input	Depends on the parameter BSL. Upscale: 105% Downscale: -5%	Normal action	Normal action	Normal action	Normal action	Normal action	Normal action
PV input burnout error	Depends on the setting of the parameter BSL. Upscale: 105% Downscale: -5%						
PV input over-scale PV input under-scale (PV values out of -5 to 105%)	Normal action	Normal action	Normal action	Normal action	Normal action	Normal action	Normal action

Errors during Operation (2)

The errors shown below may occur during operation.

PV display (Operation Display)	Setpoint display (Operation Display)	Status indicator (Operation Display)	Parameter that displays error details	Error description	Cause and diagnosis	Remedy
Normal indication	0.000 00000 (Decimal point on the left of the Symbol display blinks)	–	Setup parameter (OP.ER)	Communication error (RS-485 communication)	Framing parity error Buffer overflow Inter-character time-out Checksum error (PC link communication with checksum) CRC check error (Modbus/RTU) LRC check error (Modbus/ASCII)	Check the communication parameters. Recovery at normal receipt. Hold down any key to stop blinking.
Normal indication	0.000 00000 (Decimal point on the left of the Symbol display blinks)	–	Setup parameter (OP.ER)	User profile error	User profile is corrupted.	Download the user profile again.
Normal indication	Normal indication	Rightmost decimal point on Symbol display blinks.	Setup parameter (PA.ER)	Faulty FRAM	Writing (storing) data to FRAM is impossible.	Faulty. Contact us for repair.
Undefined	Undefined	–	–	Faulty MCU	MCU is corrupted.	Faulty Contact us for repair.
Undefined	Undefined	–	–	Faulty DCU (ROM/RAM error, corrupted)	DCU is corrupted.	Faulty Contact us for repair.

Errors during Operation (Input/output Action)

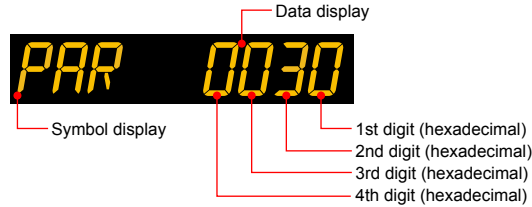
Error description	PV input	Retransmission output	Alarm action	Analog output (retransmission output)	Contact input	Contact (alarm) output	Communication
Communication error (RS485 communication)	Normal action	Normal action	Normal action	Normal action	Normal action	Normal action	Normal action
User profile error	Normal action	Normal action	Normal action	Normal action	Normal action	Normal action	CC-Link communication is disabled
Faulty FRAM	Normal action	Normal action	Normal action	Normal action	Normal action	Normal action	Normal action
Faulty MCU	Undefined	Undefined	Stopped	0% or less	OFF	OFF	Stopped
Faulty DCU (ROM/RAM error, corrupted)	Undefined	Undefined	Stopped	0% or less	OFF	OFF	Stopped

Hexadecimal Display on Setpoint Display (Operation Display)

Some error codes are displayed in hexadecimal.

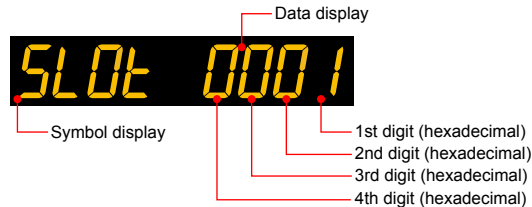
When the error occurs, "1" is set on the bit of corresponding error, and the bit data is displayed in hexadecimal.

If the setup parameter error or the operation parameter errors occur, it is displayed as follows:



Displayed digit	bit	Description
1st digit	0	System data error
	1	Calibration value error
	2	User (parameter) default value error
	3	–
2nd digit	4	Setup parameter error
	5	Operation parameter error
	6	–
	7	–
3rd digit	8	Faulty FRAM
	9	–
	10	Control parameter error
	11	–
4th digit	12	–
	13	–
	14	–
	15	–

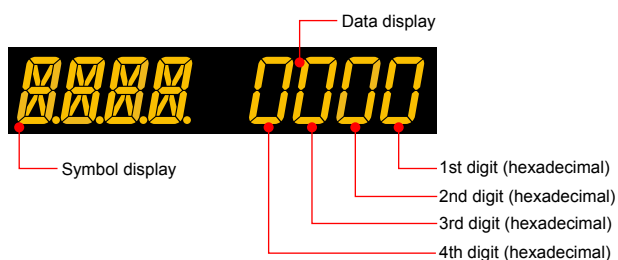
If the hardware in E1-terminal area does not respond, it is displayed as follows:



Displayed digit	bit	Description
1st digit	0	Non responding hardware in E1-terminal area
	1	–
	2	–
	3	–
2nd digit	4	–
	5	–
	6	–
	7	–
3rd digit	8	Communication error in E1-terminal area
	9	–
	10	–
	11	–
4th digit	12	–
	13	–
	14	–
	15	–

Hexadecimal Display of the Parameter which Shows the Error Details

Error confirmation parameters are displayed in hexadecimal.
When the error occurs, "1" is set on the bit of corresponding error.



Parameter PA.ER

Displayed digit	bit	Description
1st digit	0	System data error
	1	Calibration value error
	2	User (parameter) default value error
	3	–
2nd digit	4	Setup parameter error
	5	Operation parameter error
	6	–
	7	–
3rd digit	8	Faulty FRAM
	9	–
	10	Control parameter error
	11	–
4th digit	12	–
	13	–
	14	–
	15	–

Parameter OP.ER

Displayed digit	bit	Description
1st digit	0	Non responding hardware in E1-terminal area
	1	–
	2	–
	3	–
2nd digit	4	–
	5	–
	6	–
	7	–
3rd digit	8	Communication error in E1-terminal area
	9	–
	10	–
	11	–
4th digit	12	–
	13	–
	14	–
	15	–

15.1 Troubleshooting

Parameter AD1.E

Displayed digit	bit	Description
1st digit	0	ADC error of PV input
	1	–
	2	–
	3	–
2nd digit	4	–
	5	RJC error of PV input
	6	–
	7	–
3rd digit	8	PV input burnout error
	9	–
	10	–
	11	–
4th digit	12	–
	13	–
	14	–
	15	–

Parameter PV1.E

Displayed digit	bit	Description
1st digit	0	PV input burnout error
	1	–
	2	–
	3	–
2nd digit	4	PV input over-scale
	5	PV input under-scale
	6	–
	7	–
3rd digit	8	–
	9	–
	10	–
	11	–
4th digit	12	–
	13	–
	14	–
	15	–

15.2 Maintenance

15.2.1 Cleaning

The front panel and operation keys should be gently wiped with a cloth soaked with water and squeezed firmly.

CAUTION

In order to prevent LCD from static electricity damage, do not wipe with dry cloth. (When LCD is electrified, it returns to normal in several minutes.)
Do not use alcohol, benzene, or any other solvents.

15.2.2 Packaging when Shipping the Product for Repair

Should the instrument break down and need to be shipped to our sales representative for repair, handle it as noted below:

CAUTION

Write down the settings of parameters for a repair request.

WARNING

Prior to shipping the instrument, put it into an antistatic bag and repackage it using the original internal packaging materials and packaging container.

15.2.3 Replacing Parts

Do not replace any parts inside the unit.

15.3 Periodic Maintenance

Check the operating condition periodically to use this instrument with good condition.

15.4 Disposal

When disposing of this instrument, arrange for appropriate disposal as industrial waste according to the rules of a country, the area, or a local government.

16.1 Installation Location

The instrument should be installed in indoor locations meeting the following conditions:

- Instrumented panel

This instrument is designed to be mounted in an instrumented panel. Mount the instrument in a location where its terminals will not inadvertently be touched.

- Well ventilated locations

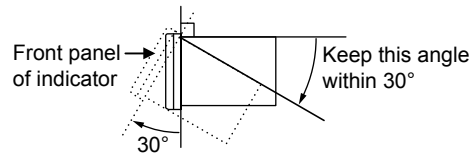
Mount the instrument in well ventilated locations to prevent the instrument's internal temperature from rising. However, make sure that the terminal portions are not exposed to wind. Exposure to wind may cause the temperature sensor accuracy to deteriorate. To mount multiple indicators, see the external dimensions/panel cutout dimensions which follow. If mounting other instruments adjacent to the instrument, comply with these panel cutout dimensions to provide sufficient clearance between the instruments.

- Locations with little mechanical vibration

Install the instrument in a location subject to little mechanical vibration.

- Horizontal location

Mount the instrument horizontally and ensure that it is level, with no inclination to the right or left.



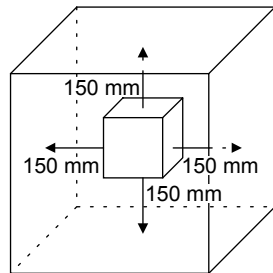
Note

If the instrument is moved from a location with low temperature and low humidity to a place with high temperature and high humidity, or if the temperature changes rapidly, condensation will result. Moreover, in the case of thermocouple inputs, measurement errors will result. To avoid such a situation, leave the instrument in the new environment under ambient conditions for more than 1 hour prior to using it.

16.1 Installation Location

Do not mount the instrument in the following locations:

- Outdoors
- Locations subject to direct sunlight, ultrared rays, ultraviolet rays, or close to a heater
Install the instrument in a location with stable temperatures that remain close to an average temperature of 23°C. Do not mount it in locations subject to direct sunlight or close to a heater. Doing so adversely affects the instrument and LCD.
- Locations with substantial amounts of oily fumes, steam, moisture, dust, or corrosive gases
The presence of oily fumes, steam, moisture, dust, or corrosive gases adversely affects the instrument. Do not mount the instrument in locations subject to any of these substances.
- Areas near electromagnetic field generating sources
Do not place magnets or tools that generate magnetism near the instrument. If the instrument is used in locations close to a strong electromagnetic field generating source, the magnetic field may cause measurement errors.
- Locations where the display is difficult to see
The instrument uses an LCD for the display unit, and this can be difficult to see from extremely oblique angles. Mount the instrument in a location where it can be seen as much as possible from the front.
- Areas close to flammable articles
Absolutely do not place the instrument directly on flammable surfaces. If such a circumstance is unavoidable and the instrument must be placed close to a flammable item, provide a shield for it made of 1.43 mm thick plated steel or 1.6 mm thick unplated steel with a space of at least 150 mm between it and the instrument on the top, bottom and sides.



- Areas subject to being splashed with water

16.2 Mounting Method



WARNING

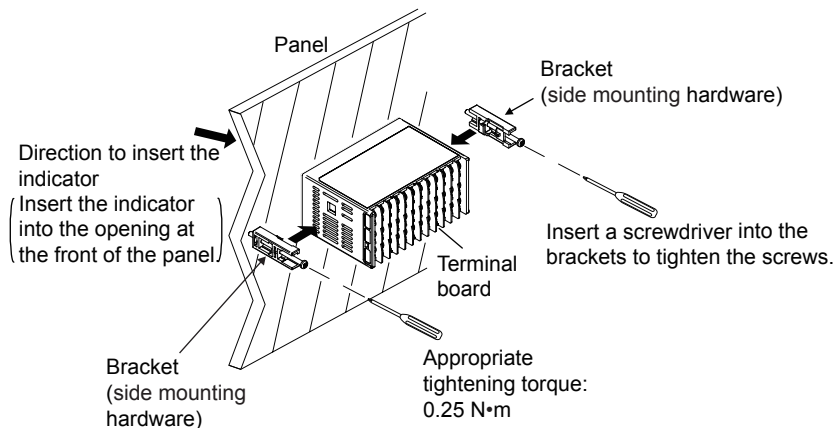
Be sure to turn OFF the power supply to the indicator before installing it on the panel to avoid an electric shock.

Mounting the Instrument Main Unit

Provide an instrumented panel steel sheet of 1 to 10 mm thickness.

After opening the mounting hole on the panel, follow the procedures below to install the indicator:

1. Insert the indicator into the opening from the front of the panel so that the terminal board on the rear is at the far side.
2. Set the brackets in place on the right and left of the indicator as shown in the figure below, then tighten the screws of the brackets. Take care not to overtighten them.



To uninstall the indicator, perform the procedure in the reverse order.

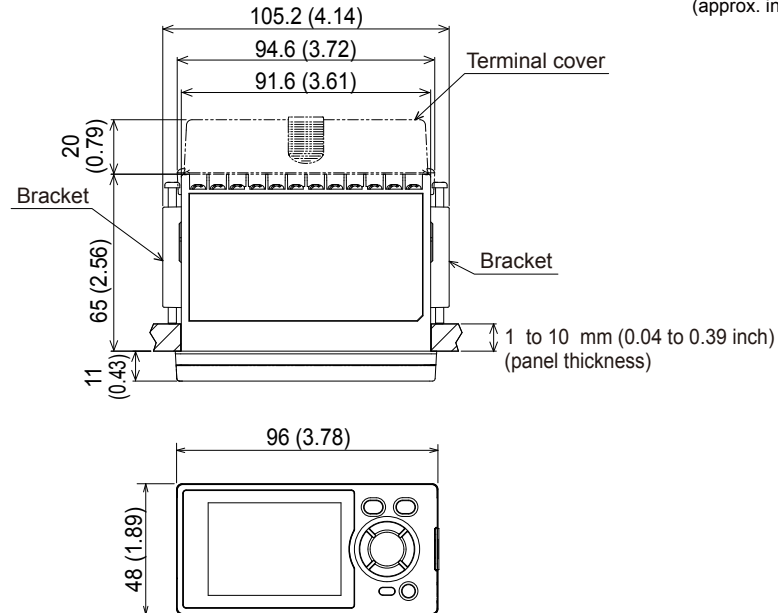
CAUTION

- 1) Tighten the screws with appropriate tightening torque within 0.25 N·m. Otherwise it may cause the case deformation or the bracket damage.
- 2) Make sure that foreign materials do not enter the inside of the instrument through the case's slit holes.

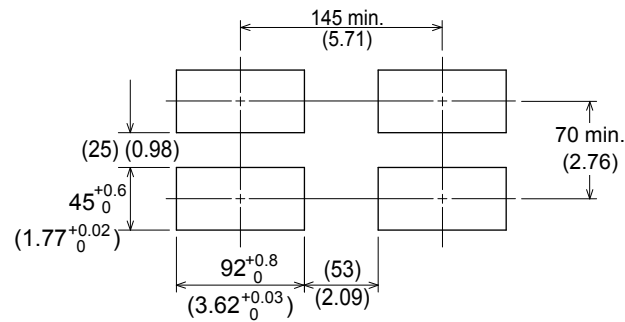
16.3 External Dimensions and Panel Cutout Dimensions

UM33A

Unit: mm
(approx. inch)



General mounting



Normal tolerance:
±(value of JIS B 0401-1998 tolerance class IT18)/2

16.4 Wiring

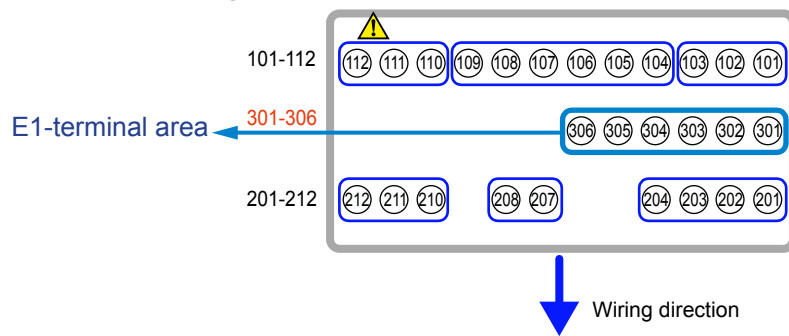
16.4.1 Important Information on Wiring



WARNING

- 1) Be sure to turn OFF the power supply to the indicator before wiring to avoid an electric shock. Use a tester or similar device to ensure that no power is being supplied to a cable to be connected.
- 2) Wiring work must be carried out by a person with basic electrical knowledge and practical experience.
- 3) For the wiring cable, the temperature rating is 75 °C or more.

Terminal Block Diagram



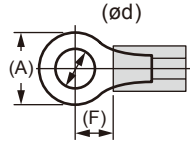
CAUTION

- When connecting two or more crimp-on terminal lugs to the single terminal block, bend the crimp-on terminal lugs before tightening the screw.
- Note that the wiring of two or more crimp-on terminal lugs to the single high-voltage terminal of the power supply and relay, etc. does not comply with the safety standard.

CAUTION

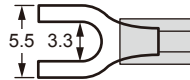
Do not use an unassigned terminal as the relay terminal.

Recommended Crimp-on Terminal Lugs



Recommended tightening torque: 0.6 N·m
 Applicable wire size: Power supply wiring 1.25 mm² or more

Applicable terminal lug	Applicable wire size mm ² (AWG#)	(ød)	(A)	(F)
M3	0.25 to 1.65 (22 to 16)	3.3	5.5	4.2



Cable Specifications

Purpose	Name and Manufacturer
Power supply, relay contact output	600 V Grade heat-resistant PVC insulated wires, JIS C 3317(HIV), 0.9 to 2.0 mm ²
Thermocouple	Shielded compensating lead wire JISC1610 For thermocouple input (PV input and remote input with direct input), shielded compensating lead wire of cross-sectional area less than or equal to 0.75 mm ² is recommended. If the cross-sectional area is wide, the reference junction compensation error may be large.
RTD	Shielded wire (three/four conductors) UL2482 (Hitachi Cable)
Other signals (other than contact input/output)	Shielded wires
Other signals (contact input/output)	Non shielded wires
RS485 communication	Shielded wires
CC-Link communication	Dedicated cable for CC-Link (Shielded three-wires)

Recommended tightening torque: 0.5 to 0.6 N·m

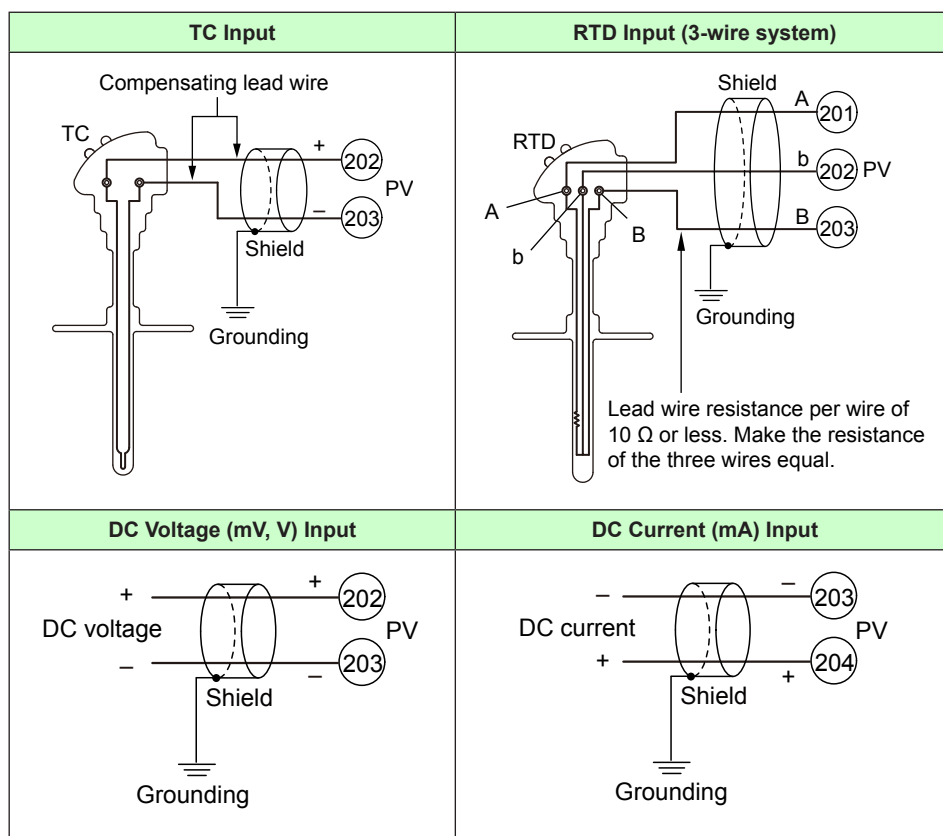
Note

Communication wires of cross-sectional area less than or equal to 0.34 mm² may not be secured firmly to the terminals.
 Check that the wire is firmly connected to the terminal by folding the conductor of the wire connected to the crimp-on lug.
 Recommended length of the stripped wire: 7 mm

16.4.2 PV Input Wiring

CAUTION

- 1) Be careful of polarity when wiring inputs. Reversed polarity can damage the UT.
- 2) Keep the PV input signal line as far away as possible from the power supply circuit and ground circuit.
- 3) For TC input, use shielded compensating lead wires for wiring. For RTD input, use shielded wires that have low conductor resistance and cause no significant differences in resistance between the three wires.
- 4) If there is a risk of external lightning surges, use a lightning arrester etc.

**Use**

PV input is used for PV input.

16.4.3 Contact Input Wiring

CAUTION

- 1) Use a no-voltage contact (relay contact etc.) for external contacts.
- 2) Use a no-voltage contact which has ample switching capacity for the terminal's OFF voltage (approx. 5V) and ON current (approx 1mA).
- 3) When using a transistor contact, the voltage at both terminals must be 2 V or less when the contact is ON and the leakage current must be 100 μ A or less when it is OFF.
- 4) If there is a risk of external lightning surges, use a lightning arrester etc.

Contact Input Equipped as Standard

No-voltage contact	Transistor contact
<p>DI</p> <p>210 DI2</p> <p>211 DI1</p> <p>212 COM</p> <p>Contact rating: 12 V DC, 10 mA or more</p>	<p>DI</p> <p>210 DI2 +5 V</p> <p>211 DI1 +5 V</p> <p>212 COM</p> <p>Contact rating: 12 V DC, 10 mA or more</p>

The following table shows the initial status.

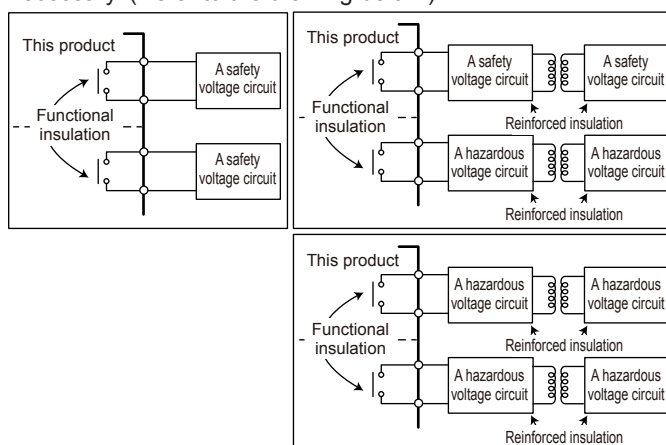
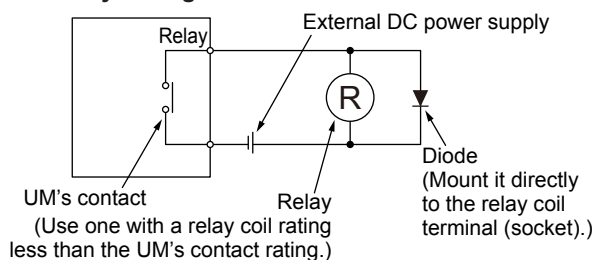
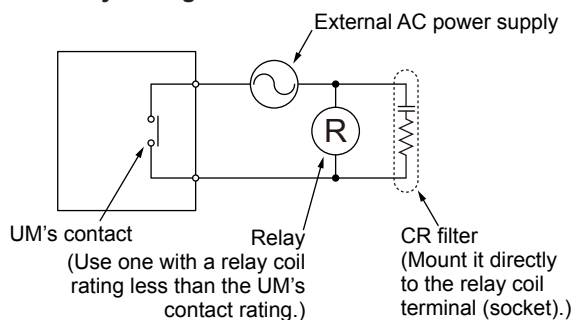
► [Contact input function registration: 11.1 Setting Contact Input Function](#)

DI1	DI2
OFF → ON: PV peak and bottom values reset	OFF → ON: Latch release

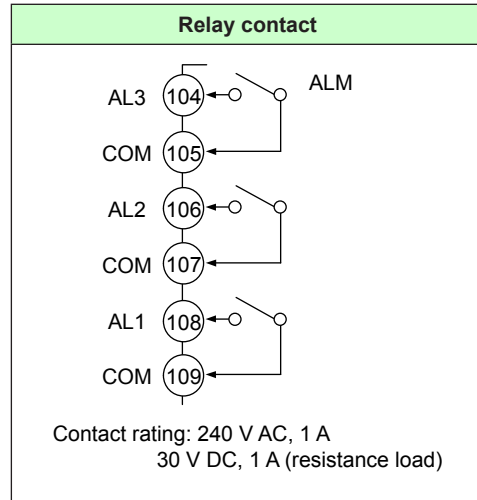
16.4.4 Contact Output Wiring

CAUTION

- 1) Use an auxiliary relay for load-switching if the contact rating is exceeded.
- 2) Connect a bleeder resistor when a small current is used, so that a current exceeding 1 mA can be supplied.
- 3) The output relay has a limited service life. Be sure to connect a CR filter (for AC) or diode (for DC) to the load.
- 4) The use of inductance (L) loads such as auxiliary relays, motors and solenoid valves causes malfunction or relay failure; always insert a CR filter for use with alternating current or a diode for use with direct current, as a spark-removal surge suppression circuit, into the line in parallel with the load.
- 5) If there is a risk of external lightning surges, use a lightning arrester etc.
- 6) The alarm output should always be used with a load of 1 mA or more.
- 7) Since the insulation provided to each relay output terminal is Functional insulation, provide Reinforced insulation to the external of the device as necessary. (Refer to the drawing below.)

**DC Relay Wiring****AC Relay Wiring**

Contact Output Equipped as Standard

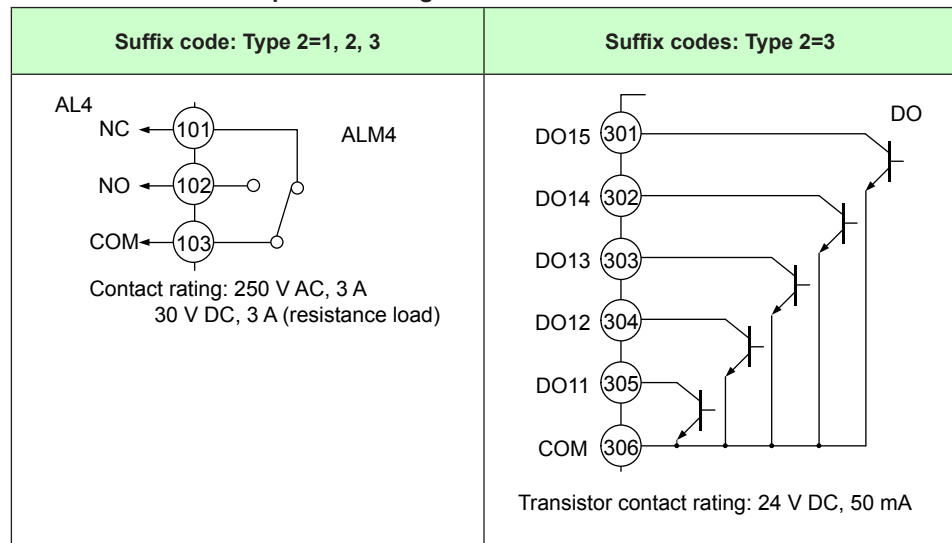


Factory default: Function is not assigned to the additional contact outputs.

▶ [Contact output function registration: 11.2 Setting Contact Output Function](#)

AL1 terminal	AL2 terminal	AL3 terminal
Alarm 1 (PV high limit)	Alarm 2 (PV low limit)	Alarm 3 (PV high limit)

Additional Contact Output According to the UM33A Suffix Codes



Factory default: Function is not assigned to the additional contact outputs.

▶ [Contact output function registration: 11.2 Setting Contact Output Function](#)

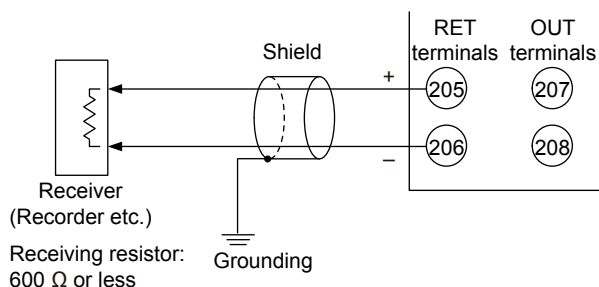
AL4 terminal
Alarm 4 (PV low limit)

DO11 terminal	DO12 terminal	DO13 terminal	DO14 terminal	DO15 terminal
Alarm 5 (PV low limit)	Alarm 6 (PV high limit)	Alarm 7 (PV low limit)	Alarm 8 (PV high limit)	FAIL

16.4.5 Retransmission Output Wiring

When retransmission output is not used for retransmission output, it can be used for 15 V DC loop power supply.

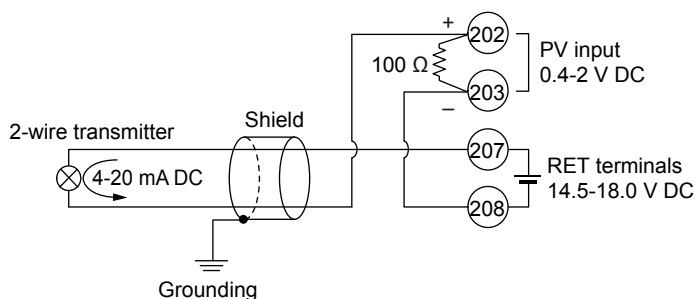
The current output range can be changed.



16.4.6 15 V DC Loop Power Supply Wiring

This can be used when it is not used for retransmission output.

The indicator is equipped with a non-isolated loop power supply (14.5 to 18.0 V DC) for connecting a 2-wire transmitter.

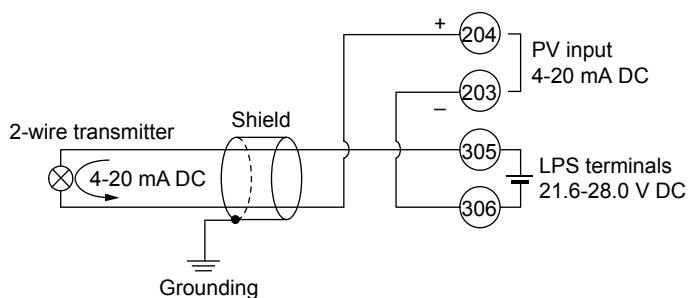


OUT terminal and OUT2 terminal also can be used.

16.4.7 24 V DC Loop Power Supply Wiring

This can be used when the optional suffix code /LP is specified.

The indicator with the optional suffix code /LP is equipped with an isolated loop power supply (21.6 to 28.0 V DC) for connecting a 2-wire transmitter.



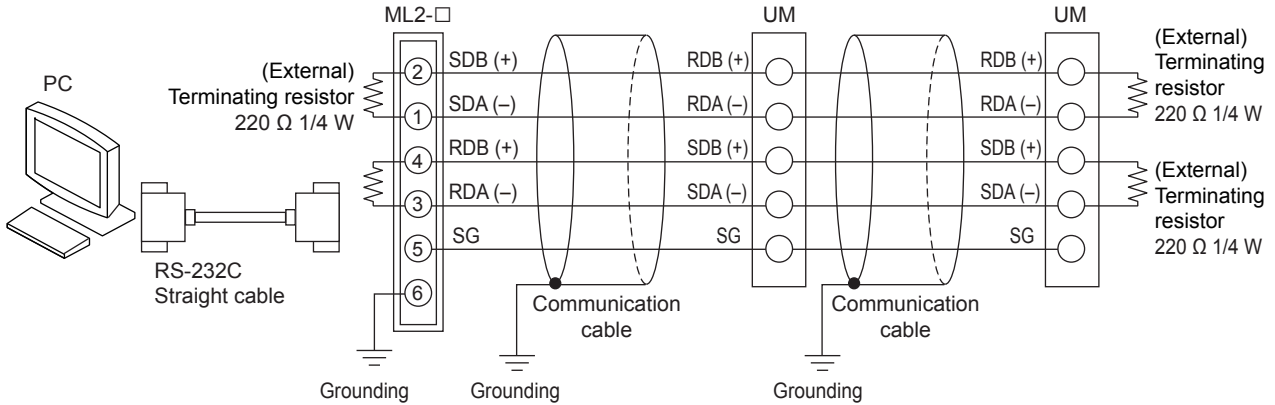
16.4.8 RS-485 Communication Interface Wiring

Wire as follows for Modbus communication, PC link communication, or ladder communication. Up to 32 UTAdvanced series controllers can be connected.

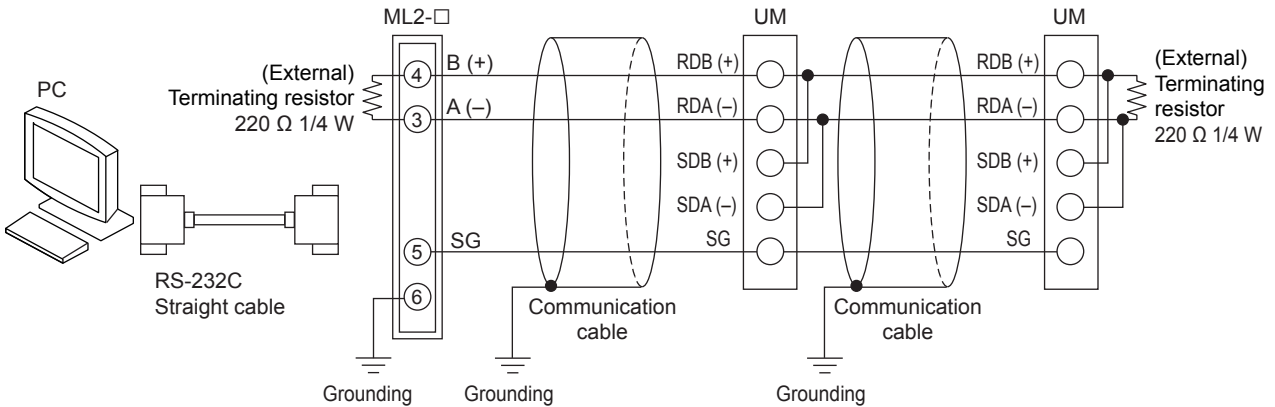
Always connect a terminating resistor to the station at the end of the communication line.

► [Details of communication parameter settings and communication functions: UTAdvanced Series Communication Interface \(RS-485, Ethernet\) User's Manual](#)

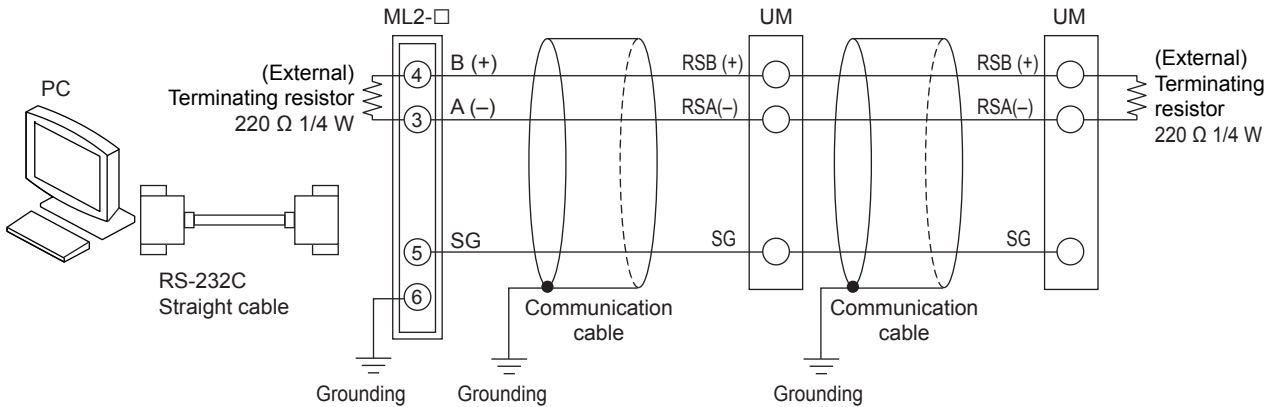
4-wire Wiring



2-wire Wiring of 4-wire Terminal



2-wire Wiring



Terminal symbol above.	4-wire Wiring Applicable to suffix code: Type 2 = 1; however, without optional suffix code /LP
RDB (+)	304
RDA (-)	305
SDB (+)	301
SDA (-)	302
SG	303

Terminal symbol above.	2-wire Wiring Applicable to suffix code: Type 2 = 1, and with optional suffix code /LP
RSB (+)	301
RSA (-)	302
SG	303

Note

ML2-x indicates a converter of YOKOGAWA. Other than this, RS232C/RS485 converters can also be used. If another converter is to be used, check the electrical specifications of the converter before using it.

16.4.9 CC-Link Communication Interface Wiring

Multiple wiring (multi-drop) of connector

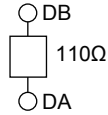
Multiple wiring of the UTAdvanced connector with other devices is possible within the following multi-wire connection capacity range.

Multi-wire connection capacity (Two wires with the same cross-sectional area)

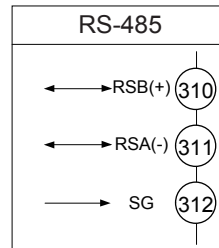
- Single wire 0.2 to 1.0 mm²/twisted wire 0.2 to 1.5 mm²
- Twisted wire with bar terminal (without plastic sleeve) 0.25 to 1.0 mm²
- Twisted wire with twin bar terminals (with plastic sleeve) 0.5 to 1.5 mm²

CC-L
(Suffix code 3=3)

If the UM is located at the end of a segment for the CC-Link communication wiring, terminating resistors are separately needed. These are to be prepared by users. (110 Ω: 1 pc.)



FG: Flame ground	301
SLD: Shield	302
DG: TX/RX signal ground	303
DB: RX/TX signal - signal	304
DA: RX/TX signal + signal	305
Not used	306
CHK(red) (Lit: User profile error/Adress error, Unlit: Normal)	307
L ERR(red) (Lit: Communication failure(CRC error), Unlit: Normal)	308
L RUN(green) (Lit: Normal, Unlit: No carrier detected/Communication timeout)	309



Up to 32 UTAdvanced series (Modbus/RTU slave) controllers can be connected.

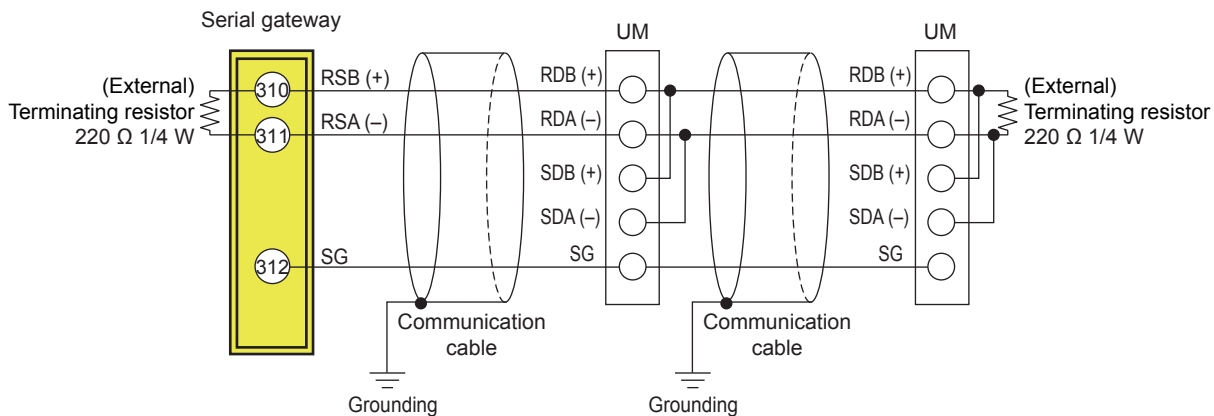
Note

Use FG as an exclusive ground. Be sure to ground using a low grounding resistance.

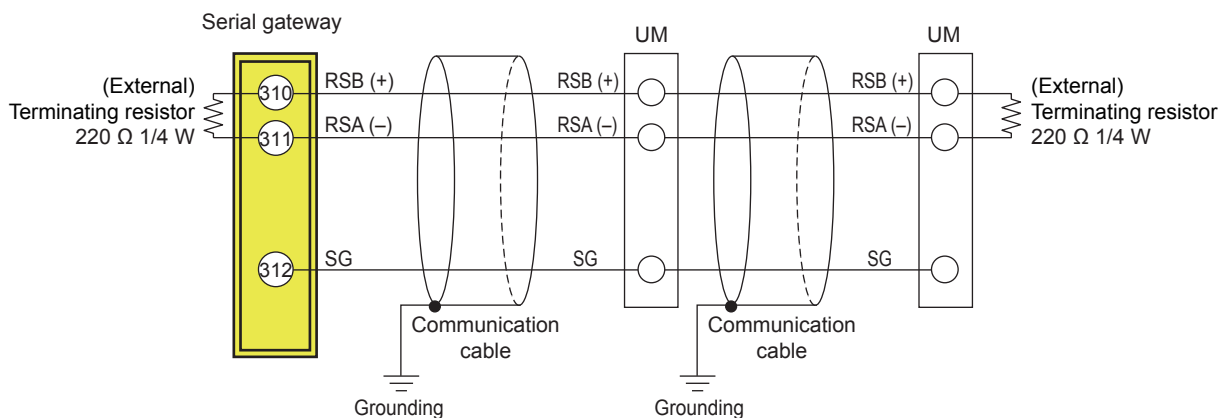
Modbus master wiring

RS-485 communication wiring for the serial gateway function is as follows.
Up to 32 UTAdvanced series controllers can be connected.

2-wire Wiring of 4-wire Terminal



2-wire Wiring



16.4.10 Power Supply Wiring

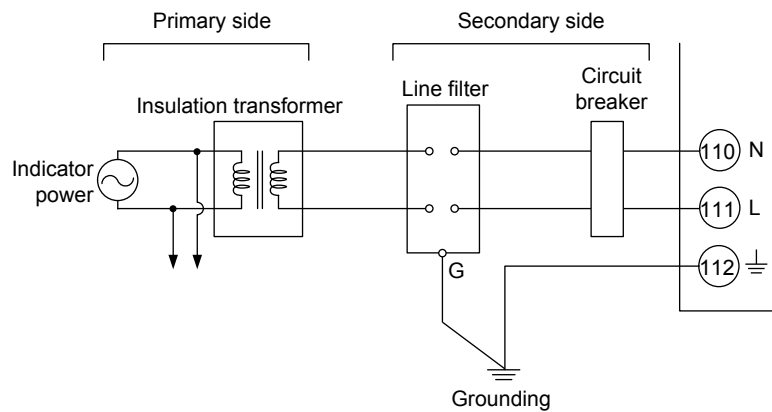


WARNING

- 1) Wiring work must be carried out by a person with basic electrical knowledge and practical experience.
- 2) Be sure to turn OFF the power supply to the indicator before wiring to avoid an electric shock. Use a tester or similar device to ensure that no power is being supplied to a cable to be connected.
- 3) As a safety measure, always install a circuit breaker (an IEC 60947-compatible product, 5 A, 100 V or 220 V AC) in an easily accessible location near the instrument. Moreover, provide indication that the switch is a device for turning off the power to the instrument.
- 4) Install the power cable keeping a distance of more than 1 cm from other signal wires.
- 5) The power cable is required to meet the IEC standards concerned or the requirements of the area in which the instrument is being installed.
- 6) Wiring should be installed to conform to NEC (National Electrical Code: ANSI/NFPA-70) or the wiring construction standards in countries or regions where wiring will be installed.

CAUTION

- 1) Provide electricity from a single-phase power supply. If the power is noisy, install an isolation transformer on the primary side, and use a line filter on the secondary side. When measures against noise are taken, do not install the primary and secondary power cables close to each other.
- 2) If there is a risk of external lightning surges, use a lightning arrester etc.



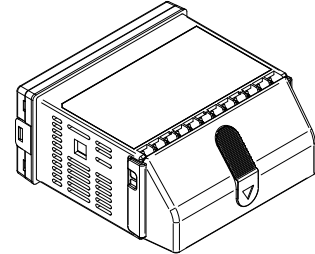
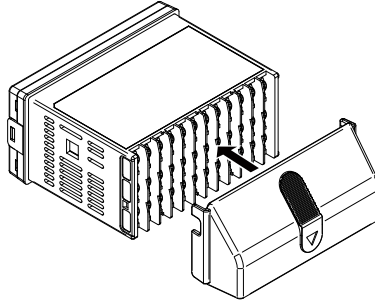
16.5 Attaching and Detaching Terminal Cover

After completing the wiring, the terminal cover is recommended to use for the instrument.

Attaching Method

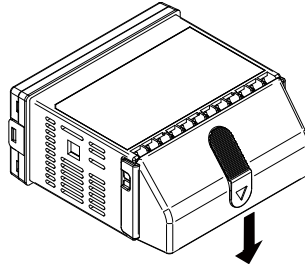
(1) Attach the terminal cover to the rear panel of the main unit horizontally.

(2) The following figure is a mounting image.



Detaching Method

(1) Slide the terminal cover to the direction of the printed arrow.



17.1 Parameter Map

Brief Description of Parameter Map

Group Display

"1 to 2" appearing in the parameter map are displayed on Group display (7 segments, 1 digit) while the parameter of PYS1 and PYS2 menu is displayed.

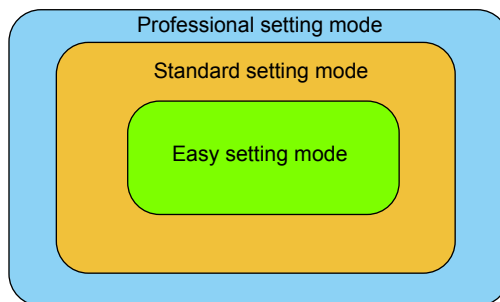
1: indicates the PYS1 parameter

2: indicates the PYS2 parameter

Parameter Display Level

The marks below appearing next to the menu symbol and parameter symbol in the parameter map indicate the display/non-display level.

Mark	Display	Display level	Description
None	EASY	Easy setting mode: Displays the minimum parameters.	Corresponding parameters are displayed in all modes.
Ⓢ	STD	Standard setting mode: Displays a wider range of parameters than displayed in the Easy setting mode.	Corresponding parameters are displayed only in Standard setting mode and Professional setting mode. Parameter display level indicators "EASY" and "PRO" are unlit in Standard setting mode. *: "STD" is the symbol used in this manual only.
Ⓟ	PRO	Professional setting mode: Displays all parameters.	Corresponding parameters are displayed only in Professional setting mode.



► [Display level: 12.3.2 Setting Parameter Display Level](#)

E1:

"E1" appearing in the parameter map indicates that the parameter is in E1-terminal area.

► [E1: 16.4 Wiring \(Terminal Block Diagram\)](#)

Function of Each Menu

The parameters in the menu of the following table indicate the parameters to set the functions necessary for operation. The symbol in parentheses are shown on Group display.

Menu symbol	Function
AL	Alarm Setpoint Setting
ALRM	Alarm function
PVS	PV-related function
PYS1 (1)	10-segment linearizer 1
PYS2 (2)	10-segment linearizer 2

The parameters in the menu of the following table indicate the parameters to set the basic functions of the indicator.

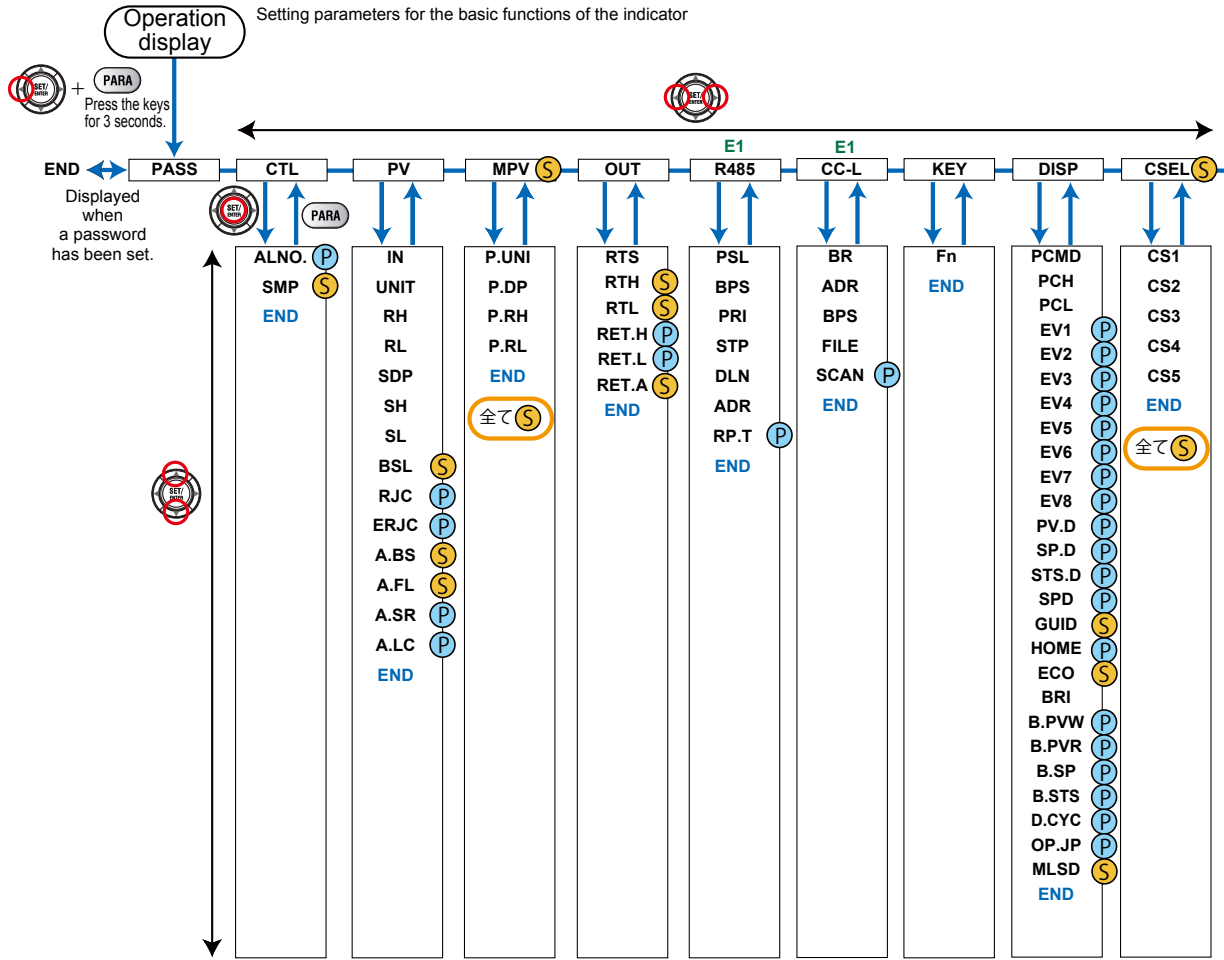
Menu symbol	Functions
PASS	Password setting (Displayed only when the password has been sent.)

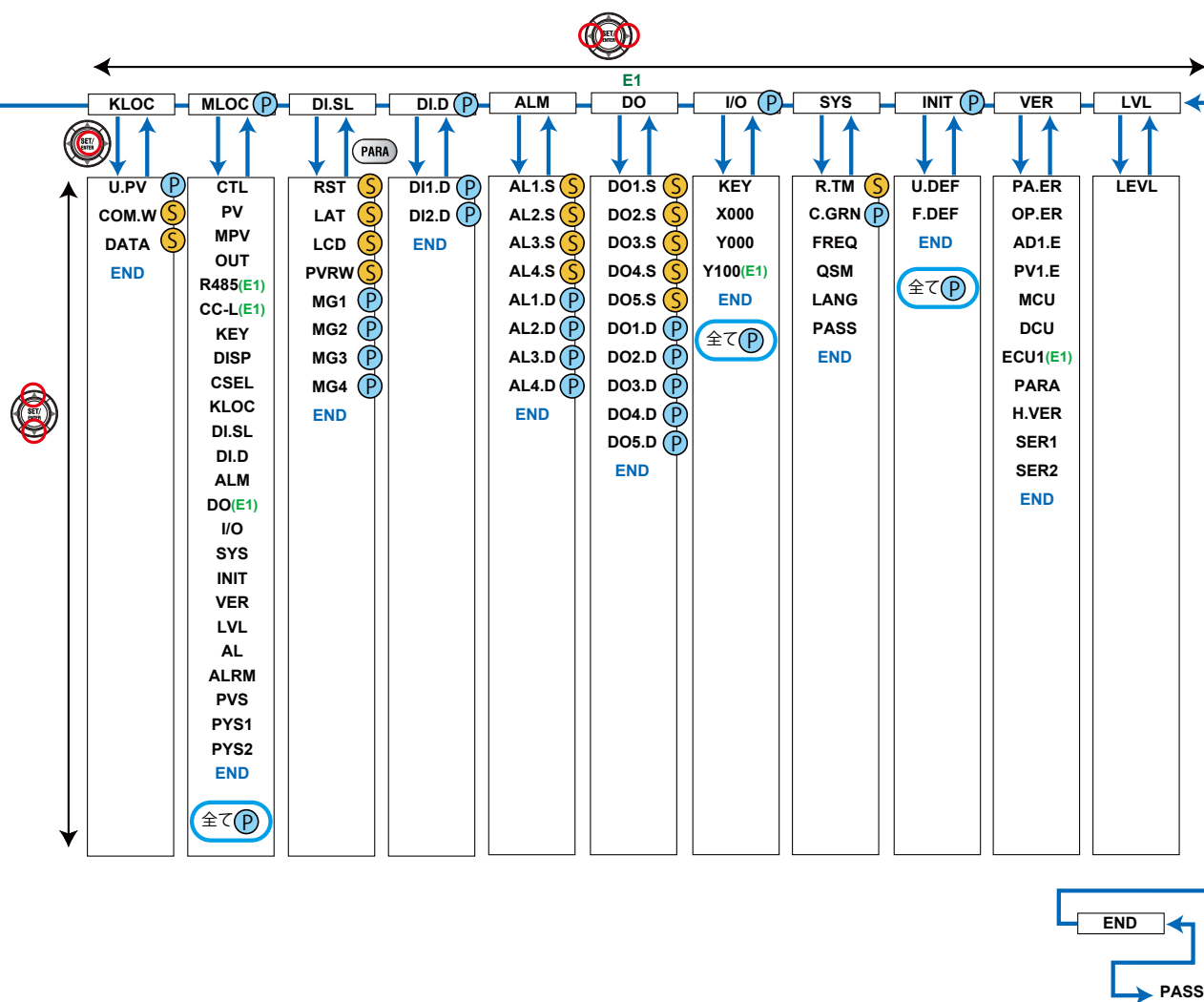
Menu symbol	Functions
CTL	Number of alarms, sampling period
PV	PV input type, range, scale, etc
MPV	Input range, etc
OUT	Retransmission output type, scale, etc
R485	RS-485 communication (E1-terminal area)
CC-L	CC-Link communication (E1-terminal area)
KEY	Function of User function key
DISP	Display functions
CSEL	SELECT Display registration
KLOC	Key lock
MLOC	Parameter menu lock
DI.SL	Contact input function
DI.D	Contact input type (equipped as standard)
ALM	Alarm output function, contact output type (equipped as standard)
DO	Contact output function, contact output type (E1-terminal area)
I/O	Input / output data display
SYS	Restart timer, guide display language, password setting, etc
INIT	Initialization of parameter
VER	Error status, version, serial numbe
LVL	Parameter display level

Note

Some parameters are not displayed according to the setting such as input and output.

17.1 Parameter Map





17.2 List of Parameters

17.2.1 Operation Parameters

Alarm Setpoint Setting Menu (Menu: AL)

Parameter symbol	Name	Display level	Setting range	Initial value
A1 to A4	Alarm-1 to -4 setpoint	EASY	Set a display value of setpoint of PV alarm or velocity alarm. -19999 to 30000 (Set a value within the input range.) Decimal point position depends on the input type.	0

Alarm Function Setting Menu (Menu: ALRM)

Parameter symbol	Name	Display level	Setting range	Initial value
AL1 to AL8	Alarm-1 to -8 type	EASY	Set a 5-digit value in the following order. [Latch action (0/1/2/3/4)] + [Energized (0) or De-energized (1)] + [Without (0) or With (1) Stand-by action] + [Alarm type: 2 digits (see below)] For latch action, see chapter 9. Alarm type: 2 digits 00: Disable 01: PV high limit 02: PV low limit 29: PV velocity 30: Fault diagnosis 31: FAIL	AL1, AL3, AL5, AL7: Latch action (0) Energized (0) Without Stand-by action (0) PV high limit (01) AL2, AL4, AL6, AL8: Latch action (0) Energized (0) Without Stand-by action (0) PV low limit (02)
VT1 to VT8	PV velocity alarm time setpoint 1 to 8	EASY	0.01 to 99.59 (minute.second)	1.00
HY1 to HY8	Alarm-1 to -8 hysteresis	EASY	Set a display value of setpoint of hysteresis. -19999 to 30000 (Set a value within the input range.) Decimal point position depends on the input type. When the decimal point position for the input type is set to "1", the initial value of the hysteresis is "1.0".	10
DYN1 to DYN8	Alarm-1 to -8 On-delay timer	STD	0.00 to 99.59 (minute.second)	0.00
DYF1 to DYF8	Alarm-1 to -8 Off-delay timer	PRO		0.00

PV-related Setting Menu (Menu: PVS)

Parameter symbol	Name	Display level	Setting range	Initial value
BS	PV input bias	EASY	-100.0 to 100.0% of PV input range span (EUS)	0.0 % of PV input range span
FL	PV input filter	EASY	OFF, 1 to 120 s	OFF
PEAK	PV peak value	EASY	Read only	-
BOTM	PV bottom value	EASY	-5.0 to 105.0% of PV input range (EU)	-

10-segment Linearizer Setting Menu (Menu: PYS1 and PYS2)

Parameter symbol	Name	Display level	Setting range	Initial value
A1 to A11	10-segment linearizer input 1 to 11	PRO	-66.7 to 105.0% of input range (EU) Output linearizer: -5.0 to 105.0%	0.0%
B1 to B11	10-segment linearizer output 1 to 11	PRO	10-segment linearizer bias: -66.7 to 105.0% of input range span (EUS) 10-segment linearizer approximation: -66.7 to 105.0% of input range (EU) Output linearizer: -5.0 to 105.0%	0.0%
PMD	10-segment linearizer mode	PRO	0: 10-segment linearizer bias 1: 10-segment linearizer approximation	0

10-segment linearizer parameters are four groups, the group number (1 or 2) is displayed on Group display.

17.2.2 Setup Parameters

Function Setting Menu (Menu: CTL)

Parameter symbol	Name	Display level	Setting range	Initial value
ALNO.	Number of alarms	PRO	0 to 8	8
SMP	Input sampling period	STD	50: 50 ms (Note) 100: 100 ms 200: 200 ms	50

PV Input Setting Menu (Menu: PV)

Parameter symbol	Name	Display level	Setting range	Initial value
IN	PV input type	EASY	OFF: Disable K1: -270.0 to 1370.0 (°C) / -450.0 to 2500.0 (°F) K2: -270.0 to 1000.0 (°C) / -450.0 to 2300.0 (°F) K3: -200.0 to 500.0 (°C) / -200.0 to 1000.0 (°F) J: -200.0 to 1200.0 (°C) / -300.0 to 2300.0 (°F) T1: -270.0 to 400.0 (°C) / -450.0 to 750.0 (°F) T2: 0.0 to 400.0 (°C) / -200.0 to 750.0 (°F) B: 0.0 to 1800.0 (°C) / 32 to 3300 (°F) S: 0.0 to 1700.0 (°C) / 32 to 3100 (°F) R: 0.0 to 1700.0 (°C) / 32 to 3100 (°F) N: -200.0 to 1300.0 (°C) / -300.0 to 2400.0 (°F) E: -270.0 to 1000.0 (°C) / -450.0 to 1800.0 (°F) L: -200.0 to 900.0 (°C) / -300.0 to 1600.0 (°F) U1: -200.0 to 400.0 (°C) / -300.0 to 750.0 (°F) U2: 0.0 to 400.0 (°C) / -200.0 to 1000.0 (°F) W: 0.0 to 2300.0 (°C) / 32 to 4200 (°F) PL2: 0.0 to 1390.0 (°C) / 32.0 to 2500.0 (°F) P2040: 0.0 to 1900.0 (°C) / 32 to 3400 (°F) WRE: 0.0 to 2000.0 (°C) / 32 to 3600 (°F) JPT1: -200.0 to 500.0 (°C) / -300.0 to 1000.0 (°F) JPT2: -150.00 to 150.00 (°C) / -200.0 to 300.0 (°F) PT1: -200.0 to 850.0 (°C) / -300.0 to 1560.0 (°F) PT2: -200.0 to 500.0 (°C) / -300.0 to 1000.0 (°F) PT3: -150.00 to 150.00 (°C) / -200.0 to 300.0 (°F) 0.4-2V: 0.400 to 2.000 V 1-5V: 1.000 to 5.000 V 4-20: 4.00 to 20.00 mA 0-2V: 0.000 to 2.000 V 0-10V: 0.00 to 10.00 V 0-20: 0.00 to 20.00 mA -1020: -10.00 to 20.00 mV 0-100: 0.0 to 100.0 mV Note: W: W-5% Re/W-26% Re (Hoskins Mfg. Co.), ASTM E988 WRE: W97Re3-W75Re25	OFF
UNIT	PV input unit	EASY	-: No unit C: Degree Celsius -: No unit --: No unit ---: No unit F: Degree Fahrenheit	C
RH	Maximum value of PV input range	EASY	Depends on the input type. - For temperature input - Set the temperature range that is actually displayed. (RL<RH) - For voltage / current input - Set the range of a voltage / current signal that is applied.	Depends on the input type
RL	Minimum value of PV input range	EASY	The scale across which the voltage / current signal is actually displayed should be set using the maximum value of input scale (SH) and minimum value of input scale (SL). (Input is always 0% when RL = RH.)	Depends on the input type

PV Input Setting Menu (Menu: PV) (Continued from previous page)

Parameter symbol	Name	Display level	Setting range	Initial value
SDP	PV input scale decimal point position (for voltage / current input)	EASY	0: No decimal place 1: One decimal place 2: Two decimal places 3: Three decimal places 4: Four decimal places	Depends on the input type
SH	Maximum value of PV input scale (for voltage / current input)	EASY	-19999 to 30000, (SL<SH), SH - SL ≤ 30000	Depends on the input type
SL	Minimum value of PV input scale (for voltage / current input)	EASY		Depends on the input type
BSL	PV input burnout action	STD	OFF: Disable UP: Upscale DOWN: Downscale	Depends on the input type
RJC	PV input reference junction compensation	PRO	OFF: RJC OFF ON: RJC ON	ON
ERJC	PV input external RJC setpoint	PRO	-10.0 to 60.0 (°C)	0.0
A.BS	PV analog input bias	STD	-100.0 to 100.0% of PV input range span (EUS)	0.0 % of PV input range span
A.FL	PV analog input filter	STD	OFF, 1 to 120 s	OFF
A.SR	PV analog input square root extraction	PRO	OFF: No square root extraction. 1: Compute the square root. (The slope equals "1.") 2: Compute the square root. (The slope equals "0.")	OFF
A.LC	PV analog input low signal cutoff	PRO	0.0 to 5.0%	1.0%

Input Range Setting Menu (Menu: MPV)

Parameter symbol	Name	Display level	Setting range	Initial value
P.UNI	Display PV input unit	STD	-: No unit C: Degree Celsius -: No unit --: No unit ---: No unit F: Degree Fahrenheit	Same as PV input unit
P.DP	Display PV input decimal point position	STD	0: No decimal place 1: One decimal place 2: Two decimal places 3: Three decimal places 4: Four decimal places	Depends on the input type
P.RH	Maximum value of display PV input range	STD	-19999 to 30000, (P.RL<P.RH), P.RH - P.RL ≤ 30000	Depends on the input type
P.RL	Minimum value of display PV input range	STD		Depends on the input type

17.2 List of Parameters

Output Setting Menu (Menu: OUT)

Parameter symbol	Name	Display level	Setting range	Initial value
RTS	Retransmission output type of RET	EASY	OFF: Disable PV1: PV LPS: 15 V DC loop power supply	PV1
RTH	Maximum value of retransmission output scale of RET	STD	When RTS = PV1 RTL + 1 digit to 30000 -19999 to RTH - 1 digit	100 % of PV input range
RTL	Minimum value of retransmission output scale of RET	STD	Decimal point position: When RTS=PV1, decimal point position is same as that of PV input.	0 % of PV input range
RET.H	100% segmental point of RET current output	PRO	-100.0 to 200.0%	100.0%
RET.L	0% segmental point of RET current output	PRO		0.0%
RET.A	RET current output range	STD	4-20: 4 to 20 mA 0-20: 0 to 20 mA 20-4: 20 to 4 mA 20-0: 20 to 0 mA	4-20

RS-485 Communication Setting Menu (Menu: R485) (E1 terminal area)

Parameter symbol	Name	Display level	Setting range	Initial value
PSL	Protocol selection	EASY	PCL: PC link communication PCLSM: PC link communication (with checksum) LADR: Ladder communication MBASC: Modbus (ASCII) MBRTU: Modbus (RTU)	MBRTU
BPS	Baud rate	EASY	600: 600 bps 1200: 1200 bps 2400: 2400 bps 4800: 4800 bps 9600: 9600 bps 19200: 19.2k bps 38400: 38.4k bps	19200
PRI	Parity	EASY	NONE: None EVEN: Even ODD: Odd	EVEN
STP	Stop bit	EASY	1: 1 bit, 2: 2 bits	1
DLN	Data length	EASY	7: 7 bits, 8: 8 bits	8
ADR	Address	EASY	1 to 99	1
RP.T	Minimum response time	PRO	0 to 10 (x10ms)	0

CC-Link Communication Setting Menu (Menu: CC-L) (E1 terminal area)

Parameter symbol	Name	Display level	Setting range	Initial value
BR	Baud rate	EASY	156K: 156k bps 625K: 625k bps 2.5M: 2.5M bps 5M: 5M bps 10M: 10M bps	10M
ADR	Address	EASY	1 to 64	1
BPS	Baud rate	EASY	9600: 9600 bps 19200: 19.2k bps 38400: 38.4k bps	38400
FILE	Profile number	EASY	0, 31 to 34 (0, 31: Ver 1.10; 32 to 34: Ver 2.00)	0
SCAN	Automatic rescan time	PRO	OFF 1M: 1 minute 10M: 10 minutes 30M: 30 minutes 60M: 60 minutes	OFF

When each parameter is displayed, the terminal area (E1) is displayed on Group display.

Key Action Setting Menu (Menu: KEY)

Parameter symbol	Name	Display level	Setting range	Initial value
Fn	User function key-n action setting	EASY	OFF: Disable LTUP: LCD brightness UP LTDN: LCD brightness DOWN BRI: Adjust LCD brightness LCD: LCD backlight ON/OFF switch LAT: Latch release AL: Alarm Setpoint Setting RST: PV peak and bottom values reset	RST

17.2 List of Parameters

Display Function Setting Menu (Menu: DISP)

Parameter symbol	Name	Display level	Setting range	Initial value
PCMD	Active color PV display switch	EASY	0: Fixed in white 1: Fixed in red 2: Link to alarm 1 (Alarm OFF: white, Alarm ON: red) 3: Link to alarm 1 (Alarm OFF: red, Alarm ON: white) 4: Link to alarm 1 or 2 (Alarm OFF: white, Alarm ON: red) 5: Link to alarm 1 or 2 (Alarm OFF: red, Alarm ON: white) 6: PV limit (Within range: white, Out of range: red) 7: PV limit (Within range: red, Out of range: white) 10: Link to DI (ON: red, OFF: white)	0
PCH	PV color change high limit	EASY	Set a display value when in PV limit. -19999 to 30000 (Set a value within the input range.)	0
PCL	PV color change low limit	EASY	Decimal point position depends on the input type.	0
EV1 to EV8	EV1 to EV8 display condition registration	PRO	Setting range: 4001 to 5344 OFF: Disable 4321: Link to alarm 1 (Lit when the alarm occurs) 4322: Link to alarm 2 (Lit when the alarm occurs) 4323: Link to alarm 3 (Lit when the alarm occurs) 4325: Link to alarm 4 (Lit when the alarm occurs) 4326: Link to alarm 5 (Lit when the alarm occurs) 4327: Link to alarm 6 (Lit when the alarm occurs) 4329: Link to alarm 7 (Lit when the alarm occurs) 4330: Link to alarm 8 (Lit when the alarm occurs) 5025 to 5026: Link to DI1-DI2 (Lit when the contact is closed) 5153 to 5155: Link to AL1-AL3 (Lit when the contact is closed) 5156: Link to AL4 (Lit when the contact is closed) 5169 to 5173: Link to DO11-DO15 (E1-terminal area) (Lit when the contact is closed) For other functions, see the UTAdvanced Series Communication Interface User's Manual.	EV1: 4321 EV2: 4322 EV3: 4323 EV4: 4325
PV.D	PV display area ON/OFF	PRO		ON
SP.D	Setpoint display area ON/OFF	PRO	OFF: Nondisplay, ON: Display	ON
STS.D	Status display area ON/OFF	PRO		ON

Display Function Setting Menu (Menu: DISP) (Continued from previous page)

Parameter symbol	Name	Display level	Setting range	Initial value
SPD	Scroll speed	PRO	(Slow) 1 to 8 (Quick)	4
GUID	Guide display ON/OFF	STD	OFF: Nondisplay ON: Display	ON
HOME	Home Operation Display setting	PRO	PV: Valve Position Display CS1 to CS5: SELECT Display 1 to 5	PV
ECO	Economy mode	STD	OFF: Disable 1: Economy mode ON (All indications except PV display OFF) 2: Economy mode ON (All indications OFF) 3: Brightness 10 % (All indications)	OFF
BRI	Brightness	EASY	(Dark) 1 to 5 (Bright)	3
B.PVW	White brightness adjustment of PV display	PRO	Adjusts the white brightness of PV display. (Dark) -4 to 4 (Bright)	0
B.PVR	Red brightness adjustment of PV display	PRO	Adjusts the red brightness of PV display. (Dark) -4 to 4 (Bright)	0
B.SP	Brightness adjustment of SP display	PRO	Adjusts the brightness of SP display. (Dark) -4 to 4 (Bright)	0
B.STS	Brightness adjustment of Status indicator	PRO	Adjusts the brightness of Status indicator. (Dark) -4 to 4 (Bright)	0
D.CYC	Display update cycle	PRO	1: 100 ms 2: 200 ms 3: 500 ms 4: 1 s 5: 2 s	2
OP.JP	Autoreturn to operation display	PRO	Automatically returned to the Operation Display when there has been no keystroke operation for 5 minutes. OFF, ON	ON
MLSD	Least significant digital mask of PV display	STD	OFF: With least significant digit ON: Without least significant digit	OFF
MKTP	Method for least significant digital mask of PV display	STD	0: Rounding 1: Rounding-off	0

SELECT Display Setting Menu (Menu: CSEL)

Parameter symbol	Name	Display level	Setting range	Initial value
CS1 to CS5	SELECT Display-1 to -5registration	STD	OFF, 2301 to 5000	OFF

Key Lock Setting Menu (Menu: KLOC)

Parameter symbol	Name	Display level	Setting range	Initial value
U.PV	PV Analog Input Display lock	PRO	OFF: Display ON: Nondisplay	OFF
COM.W	Communication write enable/disable	STD	OFF: Enable ON: Disable	OFF
DATA	Front panel parameter data key lock	STD	OFF: Unlock ON: Lock (when Operation Display only)	OFF

17.2 List of Parameters

Menu Lock Setting Menu (Menu: MLOC)

Parameter symbol	Name	Display level	Setting range	Initial value
CTL	[CTL] menu lock	PRO	OFF: Display ON: Nondisplay	OFF
PV	[PV] menu lock	PRO		
MPV	[MPV] menu lock	PRO		
OUT	[OUT] menu lock	PRO		
R485	[R485] menu lock	PRO		
CC-L	[CC-L] menu lock	PRO		
KEY	[KEY] menu lock	PRO		
DISP	[DISP] menu lock	PRO		
CSEL	[CSEL] menu lock	PRO		
KLOC	[KLOC] menu lock	PRO		
DI.SL	[DI.SL] menu lock	PRO		
DI.D	[DI.D] menu lock	PRO		
ALM	[ALM] menu lock	PRO		
DO	[DO] menu lock	PRO		
I/O	[I/O] menu lock	PRO		
SYS	[SYS] menu lock	PRO		
INIT	[INIT] menu lock	PRO	OFF: Display ON: Nondisplay	OFF
VER	[VER] menu lock	PRO		
LVL	[LVL] menu lock	PRO		
AL	[AL] menu lock	PRO		
ALRM	[ALRM] menu lock	PRO		
PVS	[PVS] menu lock	PRO		
PYS1	[PYS1] menu lock	PRO		
PYS2	[PYS2] menu lock	PRO		

DI Function Registration Menu (Menu: DI.SL)

Parameter symbol	Name	Display level	Setting range	Initial value
RST	PV peak and bottom values reset	STD	Set an I relay number of contact input. Set "OFF" to disable the function. Standard terminals DI1: 5025, DI2: 5026	5025
LAT	Latch release	STD		5026
LCD	LCD backlight ON/OFF switch	STD		OFF
PVRW	PV red/white switch	STD		OFF
MG1	Message display interruption 1	PRO		OFF
MG2	Message display interruption 2	PRO		OFF
MG3	Message display interruption 3	PRO		OFF
MG4	Message display interruption 4	PRO		OFF

DI1-DI2 Contact Type Setting Menu (Menu: DI.D)

Parameter symbol	Name	Display level	Setting range	Initial value
DI1.D	DI1 contact type	PRO	0: The assigned function is enabled when the contact input is closed.	0
DI2.D	DI2 contact type	PRO	1: The assigned function is enabled when the contact input is opened.	0

AL1-AL4 Function Registration Menu (Menu: ALM)

Parameter symbol	Name	Display level	Setting range	Initial value
AL1.S	AL1 function selection	STD	Set an I relay number. Setting range: 4001 to 6000	4353
AL2.S	AL2 function selection	STD	No function: OFF	4354
AL3.S	AL3 function selection	STD	Alarm 1: 4353 Alarm 2: 4354 Alarm 3: 4355	4355
AL4.S	AL4 function selection	STD	Alarm 4: 4357 Alarm 5: 4358 Alarm 6: 4359 Alarm 7: 4361 Alarm 8: 4362 FAIL (Normally ON) output: 4256	4357
AL1.D	AL1 contact type	PRO	0: When the event of assigned function occurs, the contact output is closed.	0
AL2.D	AL2 contact type	PRO		0
AL3.D	AL3 contact type	PRO	1: When the event of assigned function occurs, the contact output is opened.	0
AL4.D	AL4 contact type	PRO		0

DO Setting Menu (Menu: DO) (E1 and E4 terminal area)

Parameter symbol	Name	Display level	Setting range	Initial value
DO1.S	DO11 function selection	STD	Same as AL1.S. Set "OFF" to disable the function.	4358
DO2.S	DO12 function selection	STD		4359
DO3.S	DO13 function selection	STD		4361
DO4.S	DO14 function selection	STD		4362
DO5.S	DO15 function selection	STD		4256
DO1.D	DO11 contact type	PRO	0: When the event of assigned function occurs, the contact output is closed.	0
DO2.D	DO12 contact type	PRO		0
DO3.D	DO13 contact type	PRO	1: When the event of assigned function occurs, the contact output is opened.	0
DO4.D	DO14 contact type	PRO		0
DO5.D	DO15 contact type	PRO		0

I/O Display Menu (Menu: I/O)

Parameter symbol	Name	Display level	Read only
KEY	Key status	PRO	See Chapter 12.
X000	DI1-DI2 status (equipped as standard)	PRO	
Y000	AL1-AL4 status (equipped as standard)	PRO	
Y100	DO11-DO15 status (E1-terminal area)	PRO	

17.2 List of Parameters

System Setting Menu (Menu: SYS)

Parameter symbol	Name	Display level	Setting range	Initial value
R.TM	Restart timer	STD	0 to 10 s	0
C.GRN	Response as GREEN Series	PRO	OFF: Works as UM33A in communication of device information response or broadcasting. ON: Works as GREEN Series in communication of device information response or broadcasting.	OFF
FREQ	Power frequency	EASY	AUTO 60: 60 Hz 50: 50 Hz	AUTO
QSM	Quick setting mode	EASY	OFF: Disable ON: Enable	ON
LANG	Guide display language	EASY	ENG: English FRA: French GER: German SPA: Spanish	Depends on the Model and Suffix Codes
PASS	Password setting	EASY	0 (No password) to 65535 Once a password is set, you can no longer choose not to set a password.	0

Initialization Menu (Menu: INIT)

Parameter symbol	Name	Display level	Setting range	Initial value
U.DEF	Initialization to user default value	PRO	12345: Initialization, automatically returned to "0" after initialization.	0
F.DEF	Initialization to factory default value	PRO	-12345: Initialization, automatically returned to "0" after initialization.	0

Error and Version Confirmation Menu (Menu: VER)

Parameter symbol	Name	Display level	Read only
PA.ER	Parameter error status	EASY	See Chapter 15.
OP.ER	Option error status	EASY	
AD1.E	A/D converter error status 1	EASY	
PV1.E	PV input error status	EASY	
MCU	MCU version	EASY	See Chapter 12.
DCU	DCU version	EASY	
ECU1	ECU-1 version (E1 terminal area)	EASY	
PARA	Parameter version	EASY	
H.VER	Product version	EASY	
SER1	Serial number 1	EASY	
SER2	Serial number 2	EASY	

Parameter Display Level Menu (Menu: LVL)

Parameter symbol	Name	Display level	Setting range	Initial value
LEVL	Parameter display level	EASY	EASY: Easy setting mode STD: Standard setting mode PRO: Professional setting mode	STD

General Specifications

UM33A
Digital Indicator with Alarms



GS 05P03D21-01EN

Overview

The UM33A digital indicator with Alarms employ an easy-to-read, 14-segment large color LCD display, along with navigation keys, thus greatly increasing the monitoring and operating capabilities. The short depth of the controller helps save instrument panel space. Also supporting the CC-Link communication.



Features

- A 14-segment, active (PV display color changing function) color LCD display is employed. Two five-digit, high-resolution displays are possible. Alphabet letters can be displayed in an easy-to-read manner. The guide display shows parameter names.
- Easy to operate
Navigation keys (SET/ENTER and Up/Down/Left/Right arrow keys) are employed to facilitate making settings.
- 65 mm depth
The small depth enables the mounting in a thin and small instrumented panel.
- Embedded CC-Link communication
Supporting easy connection with Mitsubishi Electric Corporation PLCs.
- Quick setting function
Setting only the minimum necessary parameters for operation is possible.
- Equipped with retransmission output
- LL50A Parameter Setting Software (sold separately)
The parameters of UTAdvanced digital indicating controller can be built from a PC using this software. It makes data management even easier.
- Dust-proof and drip-proof
IP66 (for front panel) (Not applicable to side-by-side close mounting.)
NEMA4 (Hose-down test only)



Alarm Functions

- Types of Alarm

Measured value alarm	PV (measured value) high/low limit alarm PV rate-of-change alarm
Other alarms	Self-diagnosis alarm FAIL

- Alarm Functions

Alarm output action	Alarm stand-by action Alarm latch (forced reset) function Alarm hysteresis Alarm ON/OFF delay timer
Number of alarm settings	8
Number of alarm output points	Up to 9 (differs by model code)

Functional Specifications

Signal Computation Function

Measured input computation:
Bias addition (-100.0 to 100.0% of PV input range span.), first-order lag filter (time constant off, 1 to 120 s.), and 10-segment linearizer approximation/bias
Contact input: Retains and displays maximum and minimum readings from measured variable.
Resets the maximum and minimum readings.

Contact I/O Function

This function allows for allocating the input error condition, operation condition, alarm condition or other conditions to the contact input and contact output.

Contact input	PV peak and bottom values reset
	Latch release (ACK)
	LCD backlight ON/OFF switch
	PV red/white switch
Contact output	Message interrupt displays 1 through 4
	Alarms 1 through 8 Status output

Communication Function

	Function	Method	Interface	Targets	Max connection	Communication Data
Modbus (RTU/ASCII)	A standard industry protocol allowing communications between the controller and devices such as PCs, PLCs, and DCSs.	Slave	RS-485	PLC and others, UT55A/UT52A/UT35A/UT32A/UP55A/UP35A/UM33A ^(*)	31 units	PV, ALM etc
PC link	The proprietary Yokogawa protocol allowing communications to PCs, PLCs and touch panels.					
Ladder	A protocol to communicate to PLCs.					
CC-Link	Used for communication between PLCs and remote I/O, enabling highspeed data transmission.	Slave		PLC and others	Number of nodes: 42 (Remote device)	
		Modbus master function		UT75A/UT55A/UT52A/UT35A/UT32A/UP55A/UP35A/UP32A/UM33A	31 Units (Main Controller is included.)	

*1: UT digital indication controllers can be connected.

Physical Interface

RS-485

Standard: EIA RS-485
 Communication method: Two-wire half-duplex or four-wire half-duplex, start-stop synchronization, and non-procedural
 Baud rate: 600,1200,2400,4800,9600,19200 or 38400bps
 Maximum communication distance: 1200m
 Terminating resistor: 220Ω (External)

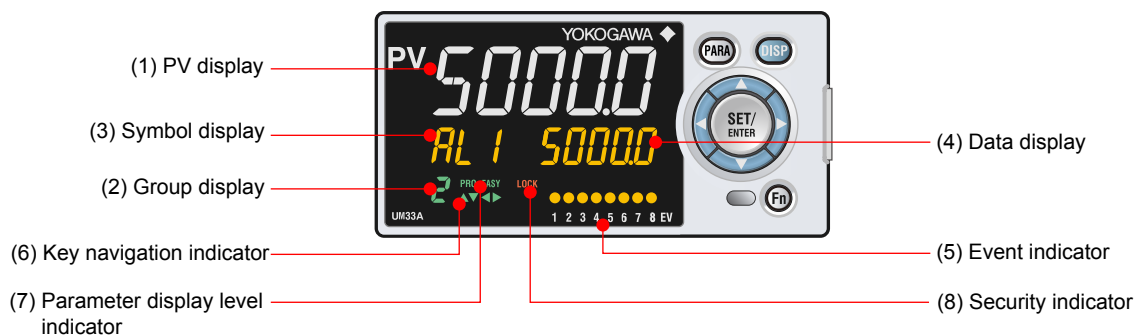
CC-Link

Supported version : Remote device (Ver.1.10, Ver.2.00)
 Baud rate : 156k, 625k, 2.5M, 5M, 10M bps
 Transmission distance : 1.2km (156k bps), 600m (625k bps), 200m (2.5M bps), 150m (5M bps), 100m (10M bps)
 When using optical repeater : 7.6 km (156k) to 4.3 km (10M)

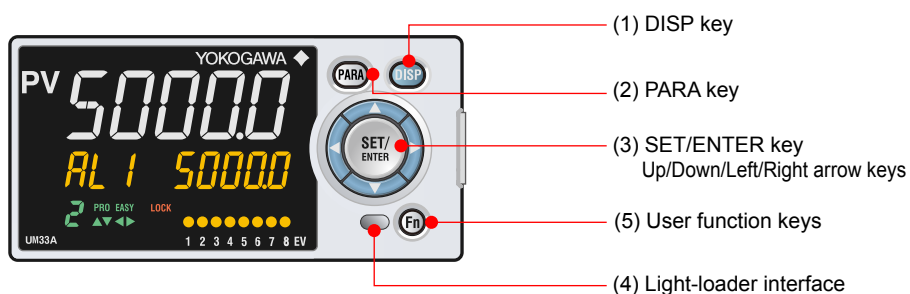
■ Hardware Specifications

Display Specifications

- PV display: 5-digit, 14-segment active color LCD (white/red)
- Character height: 14.2 mm
- Data display: 5-digit, 11-segment color LCD (orange)
- Bar graph display: 12-segment color LCD (orange)



Names of Display Parts



Universal Input Specifications

- Number of inputs: 1
- Input type, instrument range, and measurement accuracy: See the table below.

Input Type		Instrument Range (°C)	Instrument Range (°F)	Accuracy
Thermo-couple	K	-270.0 to 1370.0°C	-450.0 to 2500.0°F	±0.1% of instrument range ±1 digit for 0°C or more
		-270.0 to 1000.0°C	-450.0 to 2300.0°F	±0.2% of instrument range ±1 digit for less than 0°C
	J	-270.0 to 500.0°C	-200.0 to 1000.0°F	±2% of instrument range ±1 digit for less than -200.0°C of thermocouple K
		-200.0 to 1200.0°C	-300.0 to 2300.0°F	±1% of instrument range ±1 digit for less than -200.0°C of thermocouple T
	T	-270.0 to 400.0°C	-450.0 to 750.0°F	±1% of instrument range ±1 digit for less than -200.0°C of thermocouple T
		0.0 to 400.0°C	-200.0 to 750.0°F	±0.15% of instrument range ±1 digit for 400°C or more
	B	0.0 to 1800.0°C	32 to 3300°F	±5% of instrument range ±1 digit for less than 400°C
	S	0.0 to 1700.0°C	32 to 3100°F	±0.15% of instrument range ±1 digit
	R	0.0 to 1700.0°C	32 to 3100°F	
	N	-200.0 to 1300.0°C	-300.0 to 2400.0°F	±0.1% of instrument range ±1 digit
	E	-270.0 to 1000.0°C	-450.0 to 1800.0°F	±0.25% of instrument range ±1 digit for less than 0°C
	L	-200.0 to 900.0°C	-300.0 to 1600.0°F	±0.1% of instrument range ±1 digit for 0°C or more
		-200.0 to 400.0°C	-300.0 to 750.0°F	±0.2% of instrument range ±1 digit for less than 0°C
	U	0.0 to 400.0°C	-200.0 to 1000.0°F	±1.5% of instrument range ±1 digit for less than -200.0°C of thermocouple E.
0.0 to 2300.0°C		32 to 4200°F	±0.2% of instrument range ±1 digit (Note 2)	
Platinel 2	0.0 to 1390.0°C	32.0 to 2500.0°F	±0.1% of instrument range ±1 digit	
PR20-40	0.0 to 1900.0°C	32 to 3400°F	±0.5% of instrument range ±1 digit for 800°C or more Accuracy is not guaranteed for less than 800°C.	
W97Re3-W75Re25	0.0 to 2000.0°C	32 to 3600°F	±0.2% of instrument range ±1 digit	
RTD	JPt100	-200.0 to 500.0°C	-300.0 to 1000.0°F	±0.1% of instrument range ±1 digit (Note 1)
		-150.00 to 150.00°C	-200.0 to 300.0°F	±0.1% of instrument range ±1 digit
	Pt100	-200.0 to 850.0°C	-300.0 to 1560.0°F	±0.1% of instrument range ±1 digit (Note 1)
		-200.0 to 500.0°C	-300.0 to 1000.0°F	
Standard signal	0.400 to 2.000 V		±0.1% of instrument range ±1 digit	
	1.000 to 5.000 V			
	4.00 to 20.00 mA			
DC voltage/current	0.000 to 2.000 V		±0.1% of instrument range ±1 digit	
	0.00 to 10.00 V			
	0.00 to 20.00 mA			
	-10.00 to 20.00 mV			
	0.0 to 100.0 mV			

The accuracy is that in the standard operating conditions: 23±2°C, 55±10%RH, and power frequency at 50/60 Hz.

Note 1: ±0.3°C ±1 digit in the range between 0 and 100°C, ±0.5°C ±1 digit in the range between -100 and 200°C.

Note 2: W: W-5% Re/W-26% Re(Hoskins Mfg.Co.). ASTM E988

- Input sampling period: Select from among 50, 100, and 200 ms
- Burnout detection: Functions at TC, RTD, and standard signal
Upscale, downscale, and off can be specified.
For standard signal, burnout is determined to have occurred if it is 0.1 V or 0.4 mA or less.
- Input bias current: 0.05 µA (for TC or RTD)
- Measurement current (RTD): About 0.16 mA
- Input resistance:
TC or mV input: 1 MΩ or more
V input: About 1 MΩ
mA input: About 250 Ω
- Allowable signal source resistance:
TC or mV input: 250 Ω or less
Effects of signal source resistance: 0.1 µV/Ω or less
DC voltage input: 2 kΩ or less
Effects of signal source resistance: About 0.01%/100 Ω
- Allowable wiring resistance:
RTD input: Max. 150 Ω/wire (The conductor resistance between the three wires shall be equal.)
Wiring resistance effect: ±0.1°C/10 Ω
- Allowable input voltage/current:
TC, mV, mA or RTD input: ±10 V DC
V input: ±20 V DC
mA input: ±40 mA
- Noise rejection ratio:
Normal mode: 40 dB or more (50/60 Hz)
Common mode: 120 dB or more (50/60 Hz)
For 100-240 V AC, the power frequency can be set manually. Automatic detection is also available.
For 24 V AC/DC, the power frequency can be set manually.
- Reference junction compensation error:
±1.0°C (15 to 35°C)
±1.5°C (-10 to 15°C, 35 to 50°C)
- Applicable standards: JIS/IEC/DIN (ITS-90) for TC and RTD

Contact Input Specifications

- Number of inputs: 2 points
- Input type: No-voltage contact input or transistor contact input
- Input contact rating: 12 V DC, 10 mA or more
Use a contact of a minimum on-current of 1 mA or less
- ON/OFF detection:
No-voltage contact input:
Contact resistance of 1 k Ω or less is determined as "ON" and contact resistance of 50 k Ω or more as "OFF."
Transistor contact input:
Input voltage of 2 V or less is determined as "ON" and leakage current must not exceed 100 μ A when "OFF."
- Minimum status detection hold time: Input sampling period +50 ms
- Use: Event input

Retransmission Output Specifications

- Number of outputs: Retransmission output; 1, shared with 15 V DC loop power supply
- Current output: 4 to 20 mA DC or 0 to 20 mA DC/load resistance of 600 Ω or less
- Current output accuracy (conversion accuracy from PV display on the set scale): $\pm 0.1\%$ of span ($\pm 5\%$ of span for 1 mA or less.)

The accuracy is that in the standard operating conditions: 23 \pm 2 $^{\circ}$ C, 55 \pm 10%RH, and power frequency at 50/60 Hz.

This is not conversion accuracy through input and output but the performance of transmission output itself.

15 V DC Loop Power Supply Specifications

(Shared with retransmission output)

- Power supply: 14.5 to 18.0 V DC
- Maximum power supply: About 21 mA (with short-circuit current limiting circuit)

Step Response Time Specifications

Within 500 ms (when the input sampling period is 50 ms or 100 ms)

Within 1 s (when the input sampling period is 200 ms)
(63% of analog output response time when a step change of 10 to 90% of input span is applied)

Relay Contact Output Specifications

- Contact type and number of outputs:
Alarm-1 to -3 output: contact point 1a; 3 points (common is independent)
Alarm-4 output: contact point 1c; 1 point
- Contact rating:
Contact point 1a (alarm-1 to -3 output): 240 V AC, 1 A or 30 V DC, 1 A (resistance load)
Contact point 1c (alarm-4 output): 250 V AC, 3 A or 30 V DC, 3 A (resistance load)
- Use: Alarm output, FAIL output, etc.
 - *: The alarm-1 to -3 output should always be used with a load of 1 mA or more.
The alarm-4 output should always be used with a load of 10 mA or more.

Transistor Contact Output Specifications

- Number of outputs: See the table of Model and Suffix Codes.
- Output type: Open collector (SINK current)
- Output contact rating: Max. 24 V DC, 50 mA
- Output time resolution: Min. 50 ms
- Use: Alarm output, FAIL output, etc.

24 V DC Loop Power Supply Specifications

- Use: Power is supplied to a 2-wire transmitter.
- Power supply: 21.6 to 28.0 V DC
- Rated current: 4 to 20 mA DC
- Maximum power supply: About 30 mA (with short circuit current limiting circuit)

Safety and EMC Standards

- Safety:
Compliant with IEC/EN 61010-1 (CE), IEC/EN 61010-2-201 (CE), IEC/EN 61010-2-030 (CE), approved by CAN/CSA C22.2 No. 61010-1 (CSA), approved by UL 61010-1.

Installation category: II

Pollution degree: 2

Measurement category: I (CAT I) (UL, CSA)
O (Other) (CE)

Rated measurement input voltage: Max. 10 V DC

Rated transient overvoltage: 1500 V (*)

*: This is a reference safety standard value for measurement category I of CSA/UL 61010-1, and for measurement category O of IEC/EN 61010-2-030. This value is not necessarily a guarantee of instrument performance.

- EMC standards:
Compliant with
CE marking
EN 61326-1 Class A, Table 2 (For use in industrial locations),
EN 61326-2-3
*: The instrument continues to operate at a measurement accuracy of within $\pm 20\%$ of the range during testing.
EN 55011 Class A, Group 1
EN 61000-3-2 Class A
EN 61000-3-3
EMC Regulatory Arrangement in Australia and New Zealand
EN 55011 Class A, Group 1
- KC marking: Electromagnetic wave interference prevention standard, electromagnetic wave protection standard compliance

Construction, Installation, and Wiring

- Dust-proof and drip-proof: IP66 (for front panel)/NEMA4 *
*: Hose-down test only
- Material: Polycarbonate (Flame retardancy: UL94V-0)
- Case color: White (Light gray) or Black (Light Charcoal gray)
- Weight: 0.5 kg or less
- External dimensions (mm): 96 (W) \times 48 (H) \times 65 (depth from the panel face)
(Depth except the projection on the rear panel)
- Installation: Direct panel mounting; mounting bracket, one each for left and right mounting
- Panel cutout dimensions (mm): 92 $^{+0.8/0}$ (W) \times 45 $^{+0.6/0}$ (H)
- Mounting attitude: Up to 30 degrees above the horizontal. No downward titling allowed.
- Wiring: M3 screw terminal with square washer (for signal wiring and power wiring)

Power Supply Specifications and Isolation

- Power supply:
 - Rated voltage: 100 – 240 V AC (+10%/-15%), 50/60 Hz
 - 24 V AC/DC (+10%/-15%) (for /DC option)
- Power consumption: 15 VA (DC: 7 VA, AC: 11 VA if /DC option is specified)
- Data backup: Nonvolatile memory
- Power holdup time: 20 ms (for 100 V AC drive)
- Withstanding voltage
 - Between primary terminals and secondary terminals: 2300 V AC for 1 minute (UL, CSA)
 - Between primary terminals and secondary terminals: 3000 V AC for 1 minute (CE)
 - Between primary terminals: 1500 V AC for 1 minute
 - Between secondary terminals: 500 V AC for 1 minute

(Primary terminals: Power (*) and relay output terminals; Secondary terminals: Analog I/O signal terminals, contact input terminals, communication terminals, and functional grounding terminals.)
- (*): Power terminals for 24V AC/DC models are the secondary terminals.
- Insulation resistance
 - Between power supply terminals and a grounding terminal: 20 MΩ or more at 500 V DC
- Isolation specifications

PV (universal) input terminals	Internal circuits	Power supply
Retransmission (analog) output terminals (not isolated between the analog output terminals)		
Alarm-4 relay (contact point c) output terminals		
Alarm-1 relay (contact point a) output terminals		
Alarm-2 relay (contact point a) output terminals		
Alarm-3 relay (contact point a) output terminals		
Contact input terminals (All) RS-485 communication terminals		
24 V DC loop power supply terminals		
CC-Link communication terminals		
Contact output (transistor) terminals		

The circuits divided by lines are insulated mutually.

Environmental Conditions

Normal Operating Conditions

- Ambient temperature: -10 to 50°C
 - If the CC-Link option is specified, 0 to 40 °C for UM33A.
- Ambient humidity: 20 to 90% RH (no condensation allowed)
- Magnetic field: 400 A/m or less
- Continuous vibration at 5 to 9 Hz: Half amplitude of 1.5 mm or less, 1oct/min for 90 minutes each in the three axis directions
 - Continuous vibration at 9 to 150 Hz: 4.9 m/s² or less, 1oct/min for 90 minutes each in the three axis directions
- Short-period vibration: 14.7 m/s², 15 seconds or less
- Shock: 98 m/s² or less, 11 ms

- Altitude: 2000 m or less above sea level
- Warm-up time: 30 minutes or more after the power is turned on
- Startup time: Within 10 seconds

*: The LCD (a liquid crystal display) is used for a display portion of this product.
The LCD has a characteristic that the display action becomes late at the low temperature.

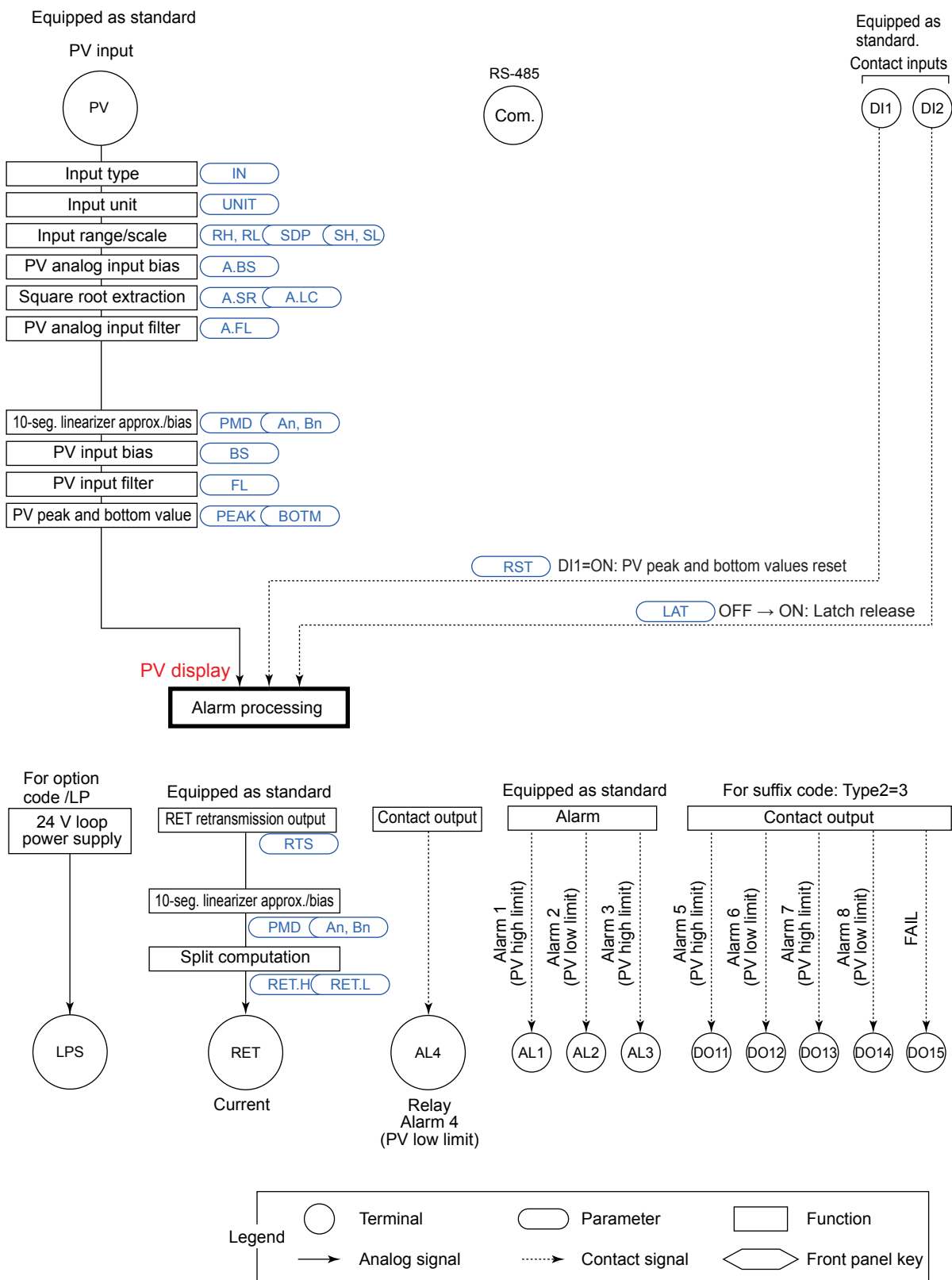
Transportation and Storage Conditions

- Temperature: -25 to 70°C
- Temperature change rate: 20°C/h or less
- Humidity: 5 to 95% RH (no condensation allowed)

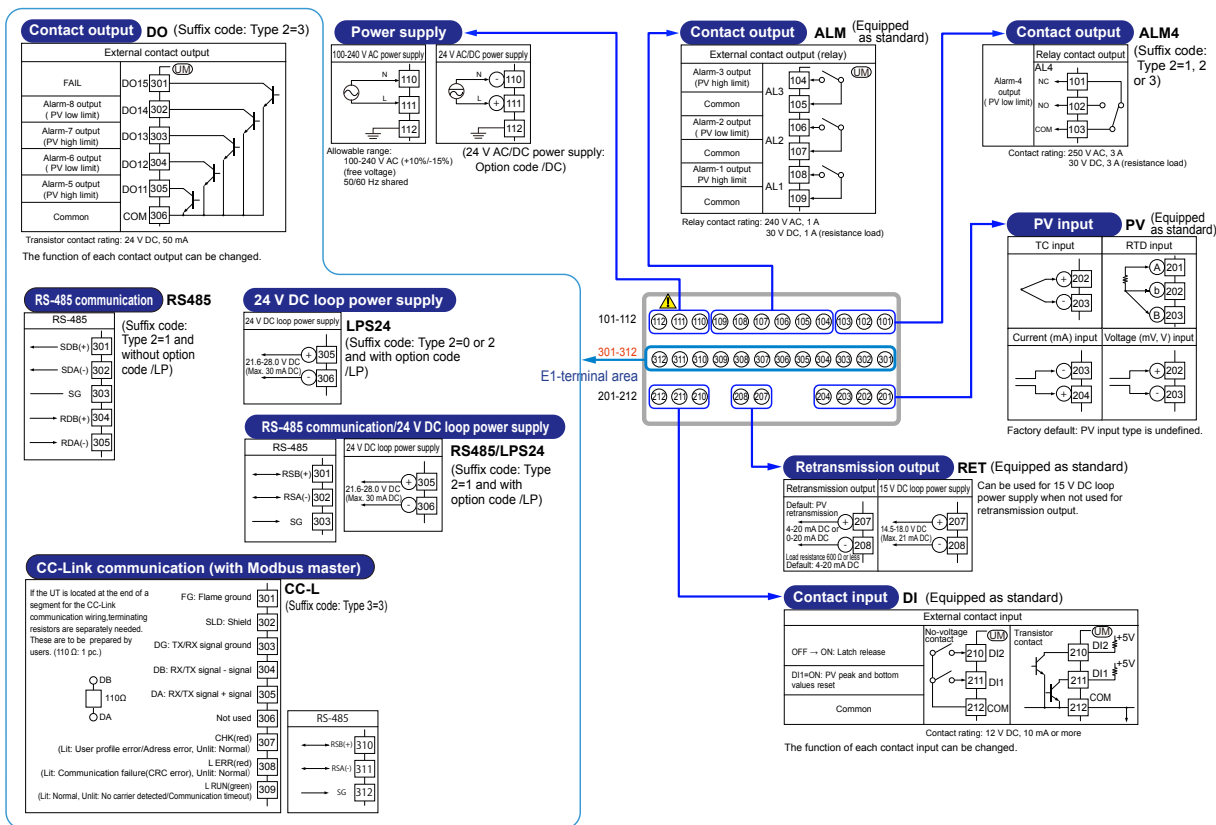
Effects of Operating Conditions

- Effect of ambient temperature:
 - Voltage or TC input: $\pm 1 \mu\text{V}/^\circ\text{C}$ or $\pm 0.01\%$ of F.S./°C, whichever is larger
 - Current input: $\pm 0.01\%$ of F.S./°C
 - RTD input: $\pm 0.05^\circ\text{C}/^\circ\text{C}$ (ambient temperature) or less
 - Analog output: $\pm 0.02\%$ of F.S./°C or less
 - Effect of power supply voltage fluctuation
 - Analog input: $\pm 0.05\%$ of F.S. or less
 - Analog output: $\pm 0.05\%$ of F.S. or less
- (Each within rated voltage range)

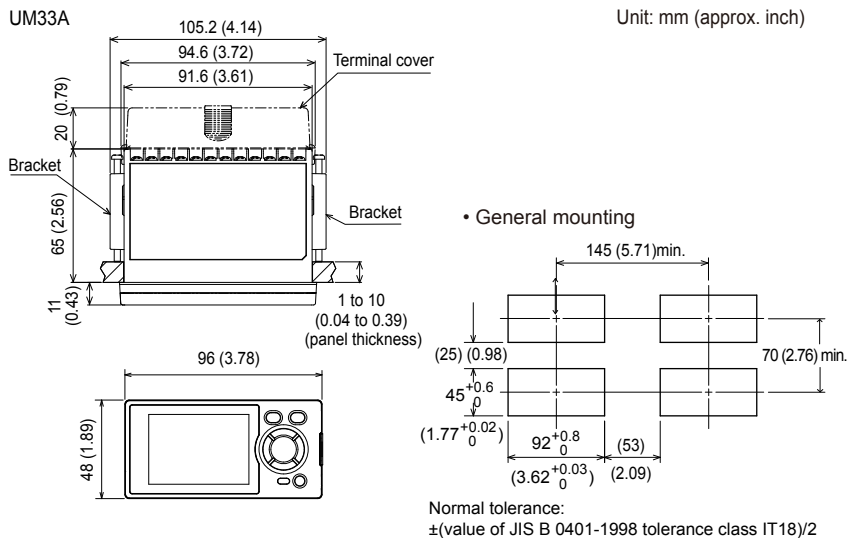
Block Diagram



Terminal Arrangement



External Dimensions and Panel Cutout Dimensions



■ Model and Suffix Code

Model	Suffix code	Option code	Description
UM33A			Digital Indicator with Alarms (Power supply: 100-240 V AC) (provided with retransmission output or 15 V DC loop power supply, 2 DIs, and 3 DOs)
Type 1: Basic	-0		Standard type
Type 2: Functions	0		None
	1		1 additional DO (c-contact relay), RS-485 communication (Max.38.4 kbps, 2-wire/4-wire) ^{(*)1}
	2		1 additional DO (c-contact relay)
	3		6 additional DOs (c-contact relay; 1 point and open collector; 5 points)
Type 3: Open networks	0		None
	3		CC-Link communication (with Modbus master function) ^{(*)2}
Display language ^{(*)3}	-1		English (Default. Can be switched to other language by the setting.)
	-2		German (Default. Can be switched to other language by the setting.)
	-3		French (Default. Can be switched to other language by the setting.)
	-4		Spanish (Default. Can be switched to other language by the setting.)
Case color	0		White (Light gray)
	1		Black (Light charcoal gray)
Option codes		/LP	24 V DC loop power supply ^{(*)4}
		/DC	Power supply 24 V AC/DC
		/CT	Coating ^{(*)5}
		/CV	Terminal cover

*1: When /LP option is specified, the RS-485 communication of the Type 2 code "1" is 2-wire system.

*2: Type 3 code "3" can be specified only when the Type 2 code is "0" or "2".

*3: English, German, French, and Spanish are available for the guide display.

*4: The /LP option can be specified only when the code for Type 2 code is any of "0", "1" or "2", and the Type 3 code is "0".

*5: When the /CT option is specified, the UM33A does not conform to the safety standards (UL and CSA) and CE marking (Products with /CT option are not intended for EEA-market).

■ Items to be specified when ordering

Model and suffix codes, whether User's Manual and QIC required.

■ Standard accessories

Brackets (mounting hardware), Unit label, Operation Guide

■ Special Order Items

Model code	Suffix code	Description
LL50A	-00	Parameter Setting Software
X010	See the General Specifications (*)	Resistance Module

*: Necessary to input the current signal to the voltage input terminal.

Name	Model
Terminal cover	UTAP002
User's Manual (CD)	UTAP003

User's Manual

Product user's manuals can be downloaded or viewed at the following URL. To view the user's manual, you need to use Adobe Reader 7 or later by Adobe Systems.

URL: <http://www.yokogawa.com/ns/ut/im/>

Revision Information

- Title : UM33A Digital Indicator with Alarms User's Manual
- Manual No. : IM 05P03D21-01EN

Aug. 2010/1st Edition

Newly published

Jan. 2011/2nd Edition

UL approved and error correction

Mar. 2015/3rd Edition

Functional Enhancement

Mar. 2016/4th Edition

Safety standard IEC/EN 61010-2-201 conformity and error correction.

- Written by Yokogawa Electric Corporation
 - Published by Yokogawa Electric Corporation
2-9-32 Nakacho, Musashino-shi, Tokyo 180-8750, JAPAN
-

Blank Page



YOKOGAWA ELECTRIC CORPORATION**Headquarters**

2-9-32, Nakacho, Musashino-shi, Tokyo, 180-8750 JAPAN
Phone : 81-422-52-5555

Branch Sales Offices

Osaka, Nagoya, Hiroshima, Kurashiki, Fukuoka, Kitakyusyu

YOKOGAWA CORPORATION OF AMERICA**Head Office**

12530 West Airport Blvd, Sugar Land, Texas 77478, USA
Phone : 1-281-340-3800 Fax : 1-281-340-3838

Georgia Office

2 Dart Road, Newnan, Georgia 30265, USA
Phone : 1-800-888-6400/ 1-770-253-7000 Fax : 1-770-254-0928

YOKOGAWA AMERICA DO SUL LTDA.

Praca Acapulco, 31 - Santo Amaro, São Paulo/SP, BRAZIL, CEP-04675-190
Phone : 55-11-5681-2400 Fax : 55-11-5681-4434

YOKOGAWA EUROPE B. V.

Euroweg 2, 3825 HD Amersfoort, THE NETHERLANDS
Phone : 31-88-4641000 Fax : 31-88-4641111

YOKOGAWA ELECTRIC CIS LTD.

Grokholskiy per 13 Building 2, 4th Floor 129090, Moscow, RUSSIA
Phone : 7-495-737-7868 Fax : 7-495-737-7869

YOKOGAWA CHINA CO., LTD.

3F Tower D Cartelo Crocodile Building, No.568 West Tianshan Road,
Shanghai 200335, CHINA
Phone : 86-21-62396262 Fax : 86-21-62387866

YOKOGAWA ELECTRIC KOREA CO., LTD.

(Yokogawa B/D, Yangpyeong-dong 4-Ga), 21, Seonyu-ro 45-gil, Yeongdeungpo-gu,
Seoul, 150-866, KOREA
Phone : 82-2-2628-6000 Fax : 82-2-2628-6400

YOKOGAWA ENGINEERING ASIA PTE. LTD.

5 Bedok South Road, Singapore 469270, SINGAPORE
Phone : 65-6241-9933 Fax : 65-6241-2606

YOKOGAWA INDIA LTD.

Plot No.96, Electronic City Complex, Hosur Road, Bangalore - 560 100, INDIA
Phone : 91-80-4158-6000 Fax : 91-80-2852-1442

YOKOGAWA AUSTRALIA PTY. LTD.

Tower A, 112-118 Talavera Road, Macquarie Park NSW 2113, AUSTRALIA
Phone : 61-2-8870-1100 Fax : 61-2-8870-1111

YOKOGAWA MIDDLE EAST & AFRICA B.S.C.(C)

P.O. Box 10070, Manama, Building 577, Road 2516, Busaiteen 225, Muharraq,
Kingdom of BAHRAIN
Phone : 973-17358100 Fax : 973-17336100

Apr. '15