

8081 MULTIMETER

INPUTS

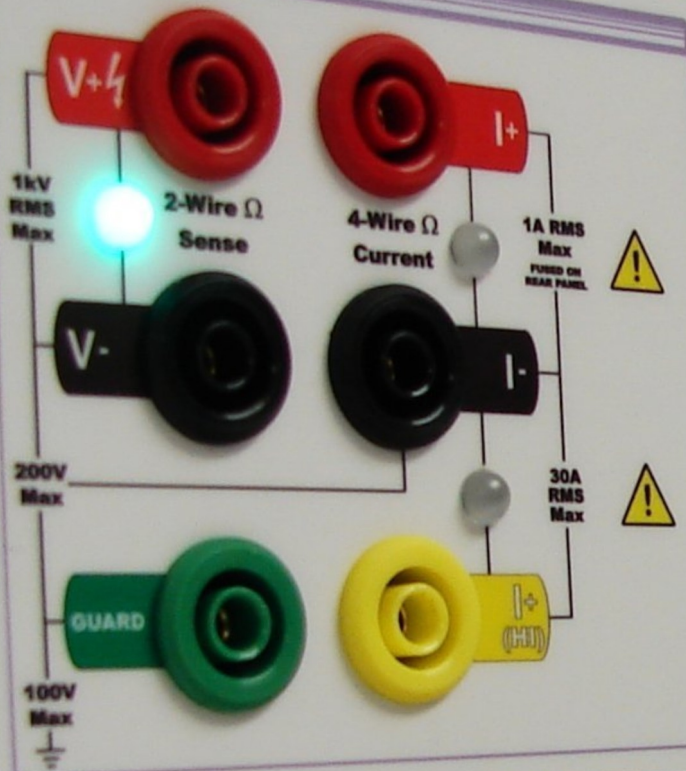

1000.000

DCV	ACDCV	ACV	Ω 2WIRE	FREQ	HOLD	
DCI	ACDCI	ACI	Ω 4WIRE	USER	RANGE UP	RANGE AUTO
					RANGE DOWN	CONFIG

8000 SERIES

OPERATION MANUAL

TRANSMILLE

SOLUTIONS IN CALIBRATION

8000 Series

Precision Digital Multimeter

Operation Manual

IMPORTANT NOTICE

**THIS PRODUCT
WILL
REQUIRE AN
UNLOCK CODE
AFTER THE EVALUATION
PERIOD HAS EXPIRED.**

(60 Days After Invoice Date)

**AFTER THE EVALUATION PERIOD HAS EXPIRED THE OPERATION
OF THE PRODUCT IS LOCKED AND THE DISPLAY SHOWS A
NUMBER WHICH MUST BE QUOTED TO TRANSMILLE TO RECEIVE
THE UNLOCK CODE**

**THE UNLOCK CODE IS AVAILALBLE
FROM TRANSMILLE
ONLY AFTER PAYMENT
HAS BEEN RECEIVED.**

(This code is only entered once in the life of the instrument.)

**Please contact Transmille or use the form in the
back of the manual to obtain the code.**

**Transmille Ltd.
Staplehurst , Kent.
Tel: 44 (0)1580 890700 : Fax 44 (0)1580 890711
EMail: sales@transmille.com**

DECLARATION OF CONFORMITY

Manufacturer's Name: Transmille Ltd.
 Manufacturer's Address: Unit 4, Select Business Centre
 Lodge Road
 Staplehurst
 TN12 0QW

Declares, that the product

Product Name: Multimeter
 Model Number: 8071 / 8081
 Product Options: This declaration covers all options of the above product(s)

Conforms with the following European Directives:

The product herewith complies with the requirements of the Low Voltage Directive 73/73EEC and the EMC Directive 89/336/EEC (including 93/68/EEC) and carries the CE Marking accordingly

Conforms with the following product standards:

EMC

EN 61326-1:1997+A1:1998 • EN55011:1991 (Group 1 : Class A)

Standard

IEC 61000-4-2:1995+A1:1998 / EN 61000-4-2:1995
 IEC 61000-4-3:1995 / EN 61000-4-3:1995
 IEC 61000-4-4:1995 / EN 61000-4-4:1995
 IEC 61000-4-5:1995 / EN 61000-4-5:1995
 IEC 61000-4-6:1996 / EN 61000-4-6:1996
 IEC 61000-4-11:1994 / EN 61000-4-11:1994

Limit

4kV CD, 8kV AD
 3 V/m, 80-1000 MHz
 0.5kV signal lines, 1kV power lines
 0.5kV line-line, 1kV line-ground
 3V, 0.15-80 MHz / cycle, 100%
 Dips: 30% 10ms; 60% 100ms
 Interrupt > 95% @5000ms

Date : 27/02/2009

Revision No: 1.00

Managing Director

TABLE OF CONTENTS

8000 SERIES MULTIMETER INTRODUCTION	6
MAIN FEATURES	6
ACCURACY AND FUNCTIONALITY	7
MULTI PRODUCT MULTIMETER.....	7
EXPANDABLE RANGE OF PRESSURE MODULES	7
MULTI INTERFACE SUPPORT.....	8
PREPARING THE MULTIMETER FOR USE	9
INITIAL INSPECTION	9
LIFTING AND CARRYING THE MULTIMETER	9
POSITIONING THE MULTIMETER.	10
REAR PANEL CONNECTIONS AND CONTROLS.....	11
SETTING AND CHECKING THE LINE VOLTAGE.	12
POWER LINE INLET FUSE AND RATING.....	12
CONNECTING TO A COMPUTER	13
POWERING UP THE MULTIMETER.....	15
OUTPUT CONNECTIONS	16
INPUT OVERLOADS	17
SAFETY WARNINGS	18
INTRODUCTION TO OPERATION	18
CONTROLS & FUNCTIONS	19
PREPARING THE MULTIMETER FOR USE.....	20
CONNECTIONS FOR VOLTAGE MEASUREMENT TO 1kV	21
CONNECTIONS FOR LOW CURRENT MEASUREMENT TO 1A.....	21
CONNECTIONS FOR LOW CURRENT MEASUREMENT TO 30A.....	21
CONNECTIONS FOR 2 WIRE RESISTANCE MEASUREMENT	22
CONNECTIONS FOR 4 WIRE RESISTANCE MEASUREMENT	22
ELECTROMETER INPUT : HIGH RESISTANCE MEASUREMENT	23
ELECTROMETER INPUT : LOW CURRENT MEASUREMENT	23
FRONT PANEL CONTROLS AND INDICATORS	24
FRONT PANEL SECTIONS	24
INPUT TERMINALS & INDICATOR LEDs.....	24
FUNCTION KEYS	25
RANGE & READBACK CONTROLS.....	25
INPUT & MENU CONTROLS	25
MENU DIAL.....	26
ELECTROMETER I/O TERMINALS.....	26
FRONT PANEL KEYBOARD.....	26
DUAL DISPLAY	27
OPERATING THE MULTIMETER	28
SELECTING A RANGE	28
SETTINGS MENU MAP	29
SETTINGS MENU DESCRIPTIONS.....	30
CONFIGURATION MENU MAP	31
CONFIGURATION MENU DESCRIPTIONS.....	32
USER MENU MAP (PART 1)	33
USER MENU MAP(PART 2)	34
USER MENU DESCRIPTIONS	35

USING THE 8081 – BEST MEASUREMENT PRACTICE	36
<i>Nulling or Zero</i>	36
<i>Zeroing the Voltage ranges</i>	36
<i>Understanding thermal EMF voltages</i>	37
<i>Zeroing Current Ranges</i>	38
<i>2-Wire null method (all ranges) [Except Electrometer]</i>	38
<i>4-Wire null methods (10kOhm and below)</i>	38
8000 SERIES FUNCTIONS	39
DC VOLTAGE	39
AC VOLTAGE	40
DC CURRENT	41
DC CURRENT (ELECTROMETER MODE) (OPTION)	42
AC CURRENT	43
2-WIRE RESISTANCE	44
2-WIRE RESISTANCE (ELECTROMETER MODE) (OPTION)	45
4-WIRE RESISTANCE	46
FREQUENCY	47
THERMOCOUPLE MEASUREMENT : CONNECTION DIAGRAMS (OPTION)	48
THERMOCOUPLE MEASUREMENT : MULTIMETER SETUP (OPTION)	49
PRT MEASUREMENT : CONNECTION DIAGRAMS (OPTION)	50
PRT MEASUREMENT : MULTIMETER SETUP (OPTION)	51
GUIDE TO SETTING UP A PRT PROBE	52
PRESSURE MEASUREMENT : CONNECTION DIAGRAM (OPTION)	53
PRESSURE MEASUREMENT : MULTIMETER SETUP (OPTION)	54
SHUNT MEASUREMENT : CONNECTION DIAGRAM (OPTION)	55
SHUNT MEASUREMENT : MULTIMETER SETUP (OPTION)	56
DC POWER / DUAL INPUT V/30A (OPTION)	57
USING THE MATH FUNCTIONS	58
REMOTE PROGRAMMING	59
PROGRAMMING COMMANDS OVERVIEW	60
COMMAND RESPONSE CODES	60
SCPI	61
GENERAL	62
SETUP	63
CALIBRATION	64
CALIBRATION	65
CALIBRATION OVERVIEW	65
ENTERING CALIBRATION MODE	65
EXAMPLE 1 : DC VOLTAGE 10V RANGE	67
EXAMPLE 2 : AC VOLTAGE 10V RANGE	67
GENERAL MAINTENANCE	68
ELECTRICAL SAFETY TESTS	68
CLEANING THE EXTERNAL CASE	68
GUARANTEE AND SERVICE	69

8000 Series Multimeter Introduction

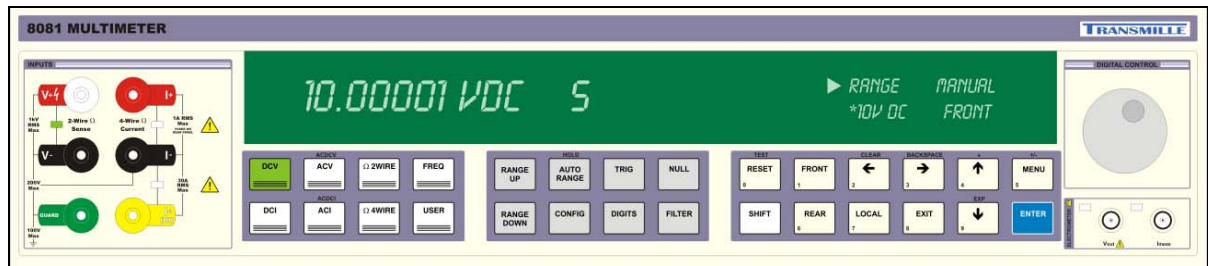

The 8000 series range of multimeters offer maximised capabilities from a highly accurate 4ppm / 9ppm advanced design. Utilising the precision electronics to their fullest extent, the 8000 Series provides high performance core functionality combined with advanced operation modes in a single instrument.

Main Features

- AC/DC Volts to 1025V
- AC/DC Current to 30 Amps
- DC Low Current Measurement (Option)
- 2 and 4 Wire Resistance
- High Resistance Measurement to 1 TOhm (Option)
- Frequency
- Temperature Measurement (PRT / ITS90 / SPRT Co-efficient storage modes) (Option)
- Pressure Module Support : Measurement to 100Bar (Option)

- RS232 Serial Interface
- USB Interface
- GPIB (IEEE488)
- Ethernet (LAN) Interface

Accuracy And Functionality

The 8000 Series multimeters are available in 2 accuracy grades - the 8081 / 8080 4ppm model and the 8071 of 9ppm model. The appearance of these units is the same, however the model is indicated on the front & rear panel and shown on the display on power up.

Multi Product Multimeter

Designed to provide an accurate cost effective portable instrument for the calibration of a wide range of signal sources including pressure, temperature and more. The 8000 series multimeter is equally suitable for use in the standards laboratory or for on site calibration work with a fast warm up time combined with low weight and optional soft / hard carry cases. The multi – interface design allows direct connection to desktop or laptop PCs via RS232, USB, GPIB or Ethernet.

Expandable Range of Pressure Modules

A range of pressure modules are available for support of pressure measurement (optional pressure hand pump also available) – see www.transmille.com for further information.

Multi Interface Support

All functions and ranges of the series 8000 multimeter are fully programmable over the multiple interfaces. The support of RS232, USB and Ethernet saves the cost of fitting GPIB cards to the PC, and also allows easy connection to portable PC's, reducing the set up time for on site calibration. GPIB is also available where use of this type of interface is already implemented.

Preparing the Multimeter For Use

Initial Inspection

After shipment the multimeter should be inspected for any signs of external damage. Should external damage be found contact the carrier immediately. Do not connect a damaged instrument to the line power as this may result in internal damage. Please keep the original box as this can be used when returning the multimeter for service and recalibration.

Lifting and carrying the Multimeter

The multimeter can be carried easily by one person by supporting from underneath (Note : observe all normal practices for health and safety when carrying). A custom carry case with shoulder strap is available if the multimeter is to be regularly transported - see options list. The multimeter should always be placed down on a firm flat surface on its base feet. Avoid knocking or banging the multimeter and always place down smoothly.

**WARNING****DO NOT DROP THE MULTIMETER AS THIS MAY CAUSE INTERNAL DAMAGE.**

Positioning the Multimeter.

The multimeter can be used free standing on a bench or mounted in a standard 19" rack enclosure. The multimeter can be operated at any angle, the two front feet have tilt legs for bench operation. A 2" (5cm) space behind the instrument is also required for line and interface connections.

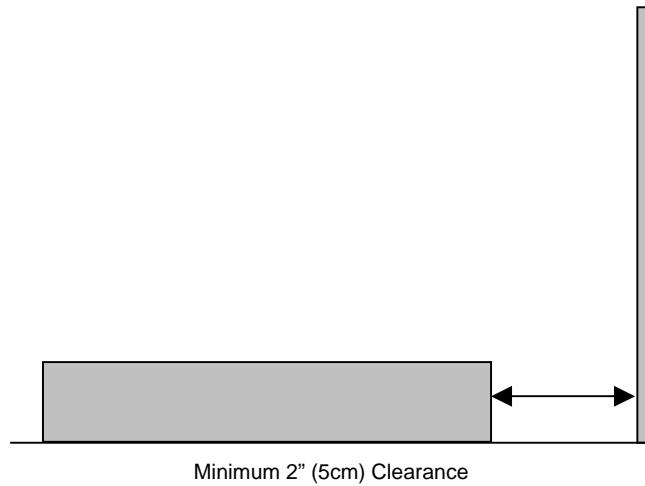

Rear Panel Connections and controls

Connections on the rear panel are for Line Power via a 3 Pin IEC connector incorporating the Line fuse and on-off switch -note the mains inlet is filtered.

The multiple interface connections are available including RS232, USB, GPIB and Ethernet (LAN) These interfaces are optically isolated from the multimeter input.

On 8081 units a set of rear panel terminals are fitted as standard, including voltage, current (to 1A) and a guard terminal. The 1 A range + and – fuses are located below the current terminals (1A Q.B.). This set of rear terminals is an option on other models

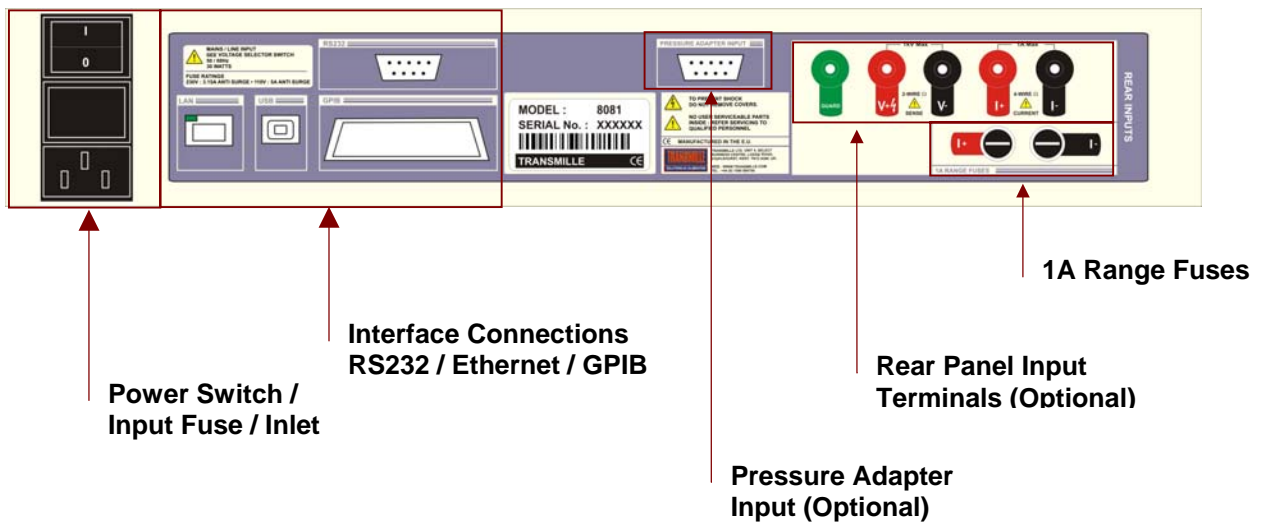

Setting and checking the Line Voltage.

**WARNING**

THE LINE POWER CORD MUST HAVE AN EARTH CONDUCTOR TO AVOID RISK OF SHOCK. THIS INSTRUMENT MUST BE CORRECTLY EARTHED.

The multimeter has been designed to work from either 100-120 Volt line supply or 200 - 240 Volt line supply. Check Supply voltage as marked on the rear panel before connecting to power line. Connecting the multimeter to the wrong supply will cause internal damage to the instrument.

Power Line Inlet Fuse and rating

The Power line inlet fuse is located directly above the power inlet. The correct fuse for is 1A Anti-surge for 230V operation and 1A Anti surge for 110V Operation

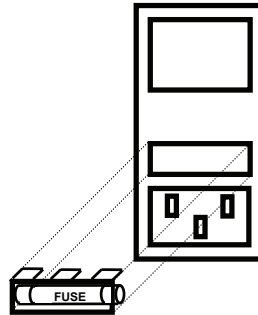

Connecting to a computer

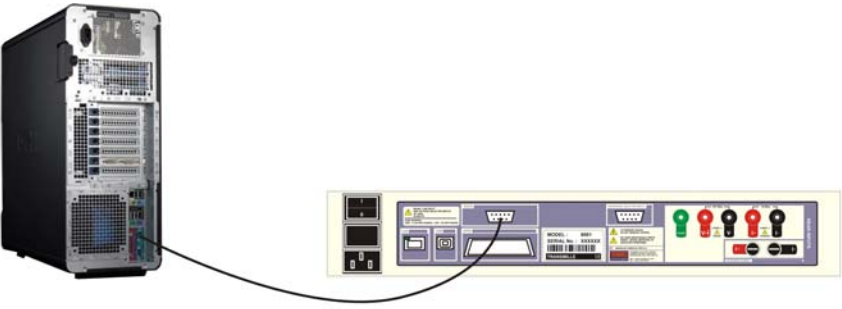
RS232 Interface	
Connection	 <p style="text-align: center;">8000 Series to PC RS232 Connection</p>
Configuration	BAUD RATE : 9600 PARITY : NONE DATA BITS : 8 STOP BITS : 1
Cable Type	Male to Female Serial Cable Straight Through Pin Connection (Not Null MODEM)
Software Driver	N/A

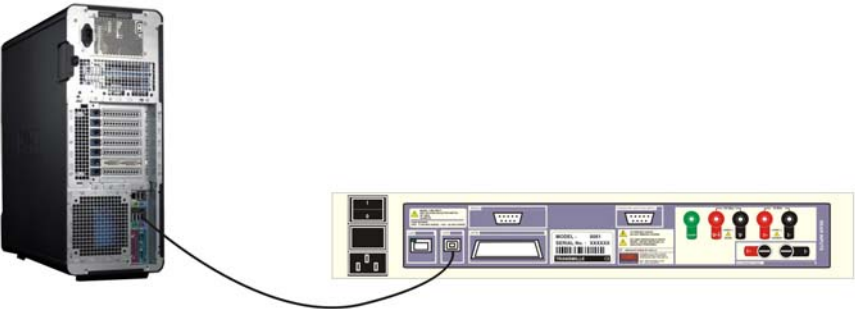
USB Interface	
Connection	 <p style="text-align: center;">8000 Series to PC USB Connection</p>
Configuration	N/A
Cable Type	USB 'A' Type connector to USB 'B' Connector
Software Driver	FTDI USB Driver (Supplied)

Ethernet (LAN) Interface

Connection

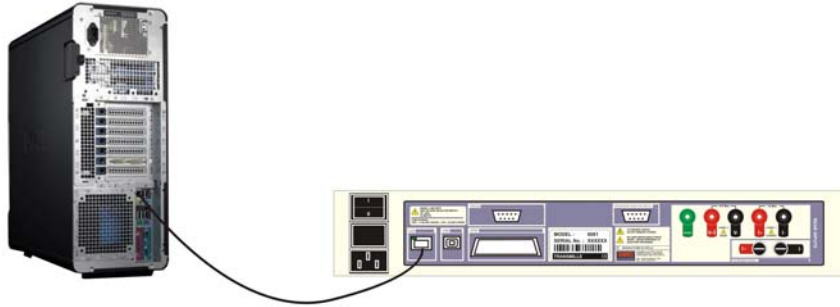

8000 Series to PC Ethernet (Lan) Connection

Configuration

8000 Series Menu Setup :

Press **MENU**

Press **→** until **ETHERNET** is displayed

Press **↓**

For automatic IP Address (DHCP Host required) Select **ENABLE DHCP**

*To set a manual IP Address Select **SET IP** and enter IP Address in xxx.xxx.xxx.xxx format.

* For further information consult your network administrator.

Cable Type

100BaseT Ethernet Cable (Standard Network Cable)

Software Driver

N/A

GPIB Interface

Connection

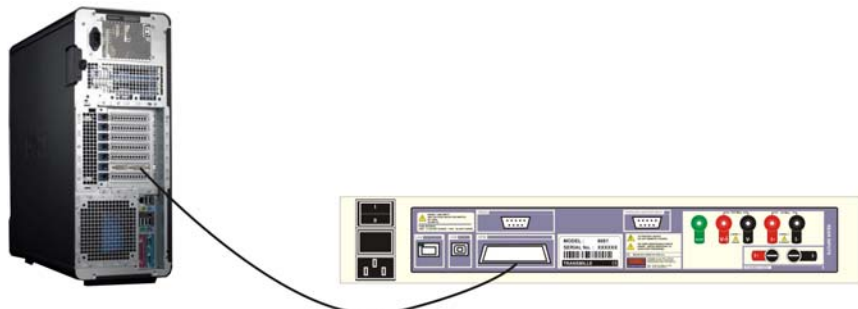

**8000 Series to PC GPIB Connection
(Internal PC GPIB Card / PC USB-> GPIB Converter Lead required)**

Configuration

N/A

Cable Type

GPIB Interface Cable

Software Driver

National Instruments GPIB Device Driver or Similar (Card Specific)

Powering up the multimeter

After connecting line power, the multimeter can be switched on with the line power switch above the mains inlet socket on the rear panel.

The front panel displays will illuminate and indicate if the instrument is in evaluation mode for a period of 5 seconds, giving the user a chance to unlock the instrument. The start-up sequence will operate internal circuits indicating initial power up during which time the processor performs a self test of the instrument - the display will then switch to measurement display mode.

TRANSMILLE LTD.



EVALUATION 60 DAYS



0.0000mV D.C.

Allow the multimeter to warm up for 3 hours to obtain 90% of full specifications.

Output Connections

⚠ WARNING
THE LINE POWER CORD MUST HAVE AN EARTH CONDUCTOR TO AVOID RISK OF SHOCK. THIS INSTRUMENT MUST BE CORRECTLY EARTHED.

Input sockets are all 4mm safety type, the voltage pairs contacts are low thermal gold plated for minimum thermal EMF.

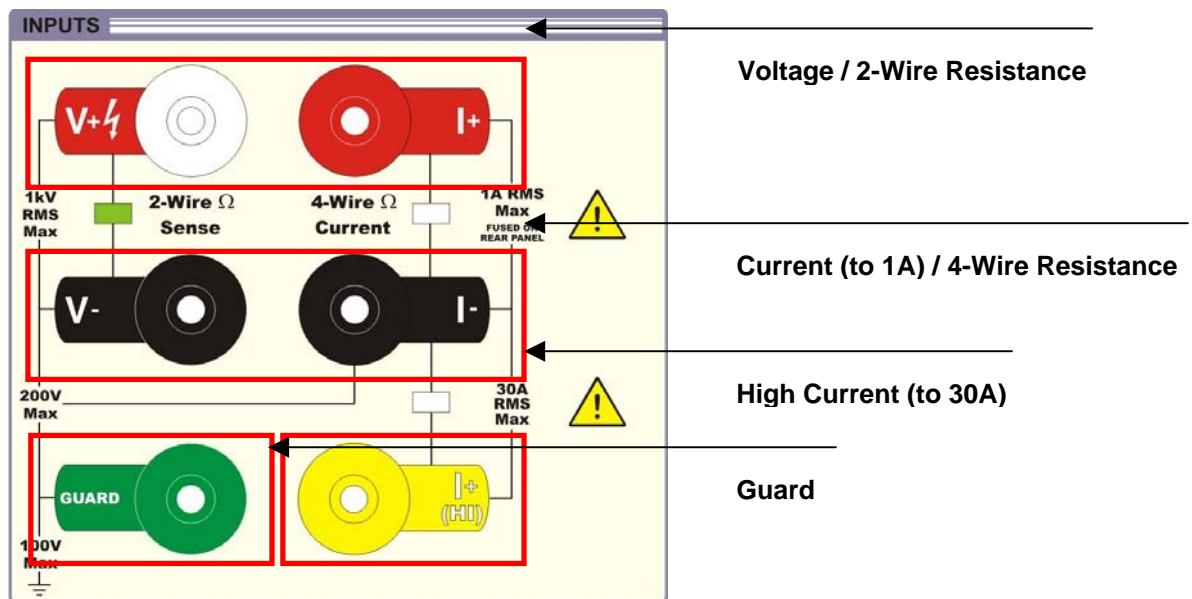

It is recommended that the voltage and low current leads be high quality screened cable with gold plated 4mm plugs fitted. The cable must be able to withstand 1025 volts AC and have an insulation resistance greater than 1 TOhm to avoid introducing any shunting effect on the high resistance ranges.

Poor quality test leads will introduce noise, thermal emf and leakage errors on low voltage & current ranges and also unstable readings on resistance and capacitance outputs (see measurement techniques). Special test leads are available from Transmille, see accessories.

**WARNING****OBSERVE ALL MAXIMUM INPUT RATINGS WHEN PERFORMING MEASUREMENTS**

Input Overloads

If the multimeter is unable to measure the input due to over range, the display will indicate

OVER-RANGE.

Operation

Safety Warnings

**WARNING :**

THE INFORMATION IN THIS SECTION IS INTENDED ONLY FOR QUALIFIED PERSONNEL. THE USER MUST AT ALL TIMES BE ADEQUATELY PROTECTED FROM ELECTRIC SHOCK. QUALIFIED PERSONNEL MUST ENSURE THAT OPERATORS OF THE EQUIPMENT ARE ADEQUATELY INSULATED FROM CONNECTION POINTS.



A SOFT CARRY-CASE AND A HARD TRANSIT CASE ARE AVAILABLE FOR REGULAR TRANSPORTATION OF THE MULTIMETER.





Introduction to Operation

All functions of the 8000 Series Multimeter can be controlled from the front panel or controlled remotely by a computer over the remote interface. The front panel controls are 'locked out', but local control may be resumed by selecting the **LOCAL** key - it must be remembered that this action may disrupt any computer program controlling the multimeter.

Controls & Functions

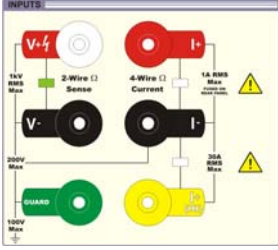
To familiarise yourself with the 8000 Series multimeters, it is advised to learn a selection of the basic operations of the front panel controls before use.

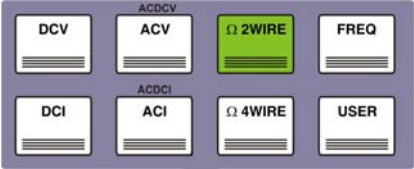
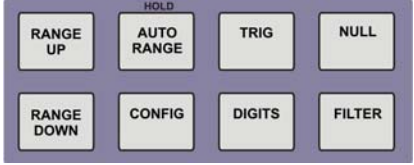
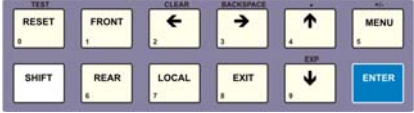
The front panel consists of the following sections :

Dual Display	
Input terminals and Indicator LEDs	
Digital Control Dial	
Function Keys	
Range & Readback Controls	
Input & Menu Controls	
Electrometer I/O Terminals	

The front panel keys are grouped into related sections, with certain keys providing 'shift' functions as printed above the relevant key. To perform a shifted function, simply click the **SHIFT** key which will illuminate in blue. Press one of the keys with the required function labelled above it and this function will be selected. For example to select the ACDCV function press **SHIFT ACV**.

If the **SHIFT** button is pressed by mistake, simply press it again to de-select it.

Preparing the Multimeter For Use

The multimeter front panel displays and function buttons will illuminate, with the function selected remaining lit once the start up sequence is complete.

If the multimeter does not power up as expected check the following :

- **Check AC power is connected to the multimeter**
Ensure AC power is supplied via the mains lead and the Off/ On switch is switch to the I (on) position
- **Verify the line voltage selection on the rear power inlet is correct**
Check voltage selector on the mains inlet
- **Check the line input fuse is OK and does not require replacement.**
This can be performed using the continuity function on a basic hand held multimeter.

Connections for Voltage Measurement to 1kV

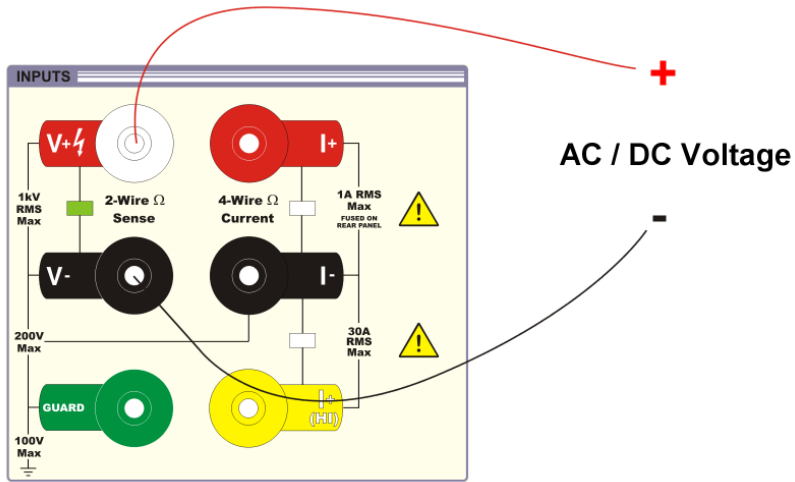

Connections for Low Current Measurement to 1A

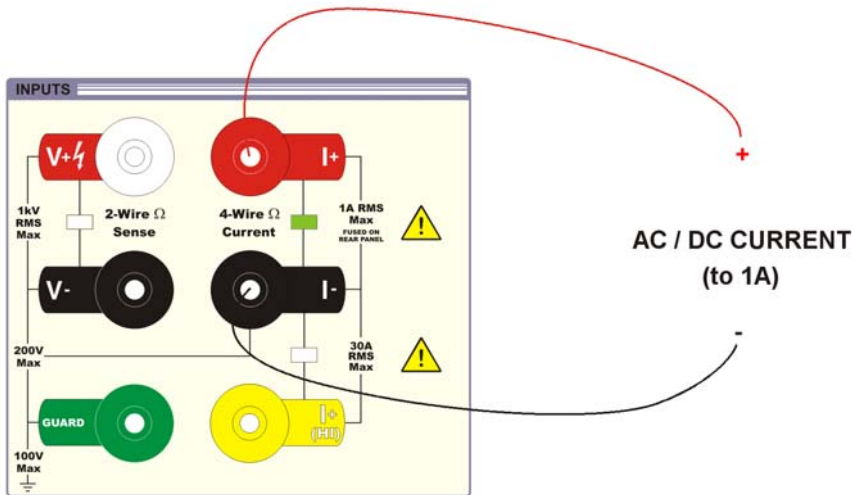

Connections for Low Current Measurement to 30A

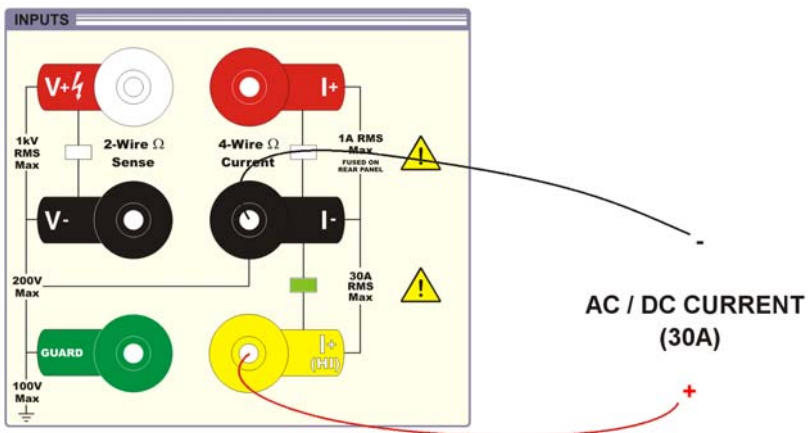

Connections for 2 Wire Resistance Measurement

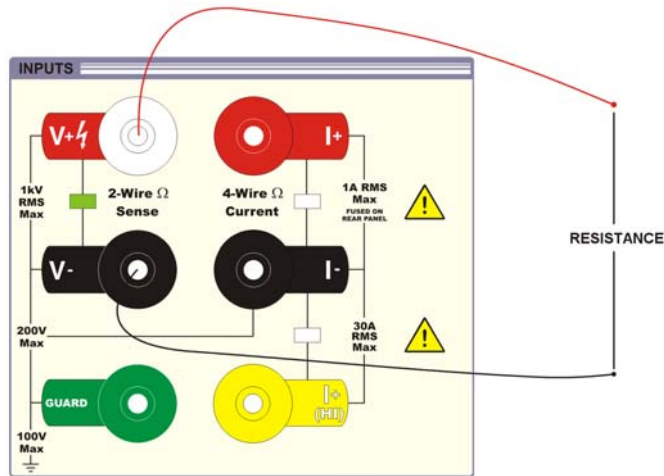

Connections for 4 Wire Resistance Measurement

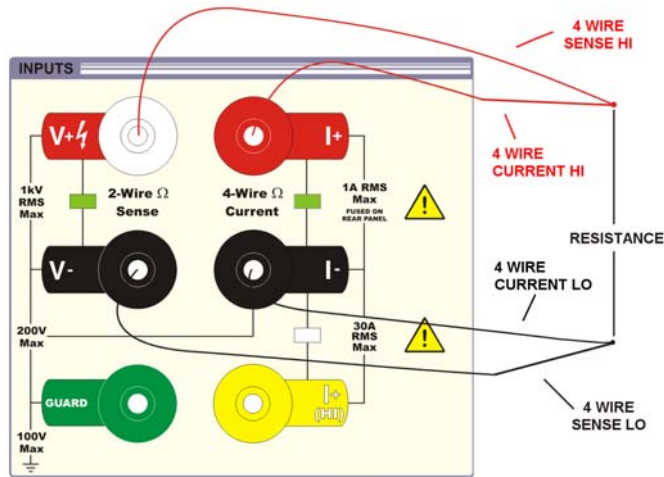

Electrometer Input : High Resistance Measurement

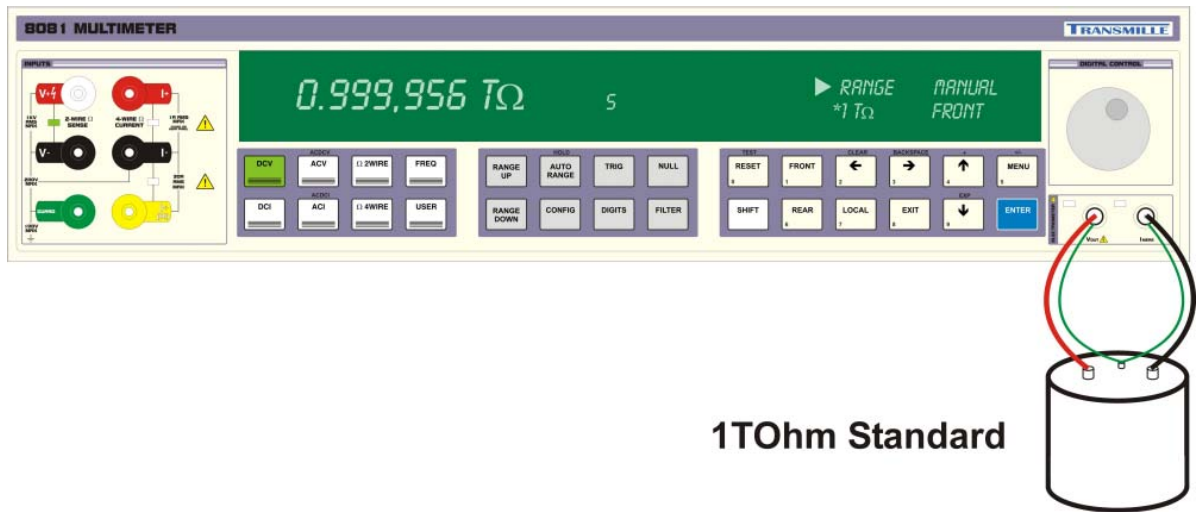

Electrometer Input : Low Current Measurement

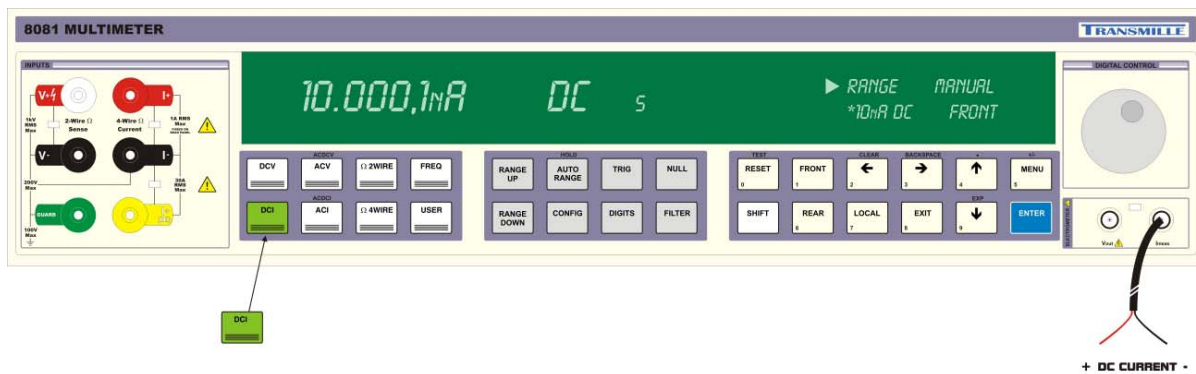

Front Panel Controls and Indicators

Front Panel Sections

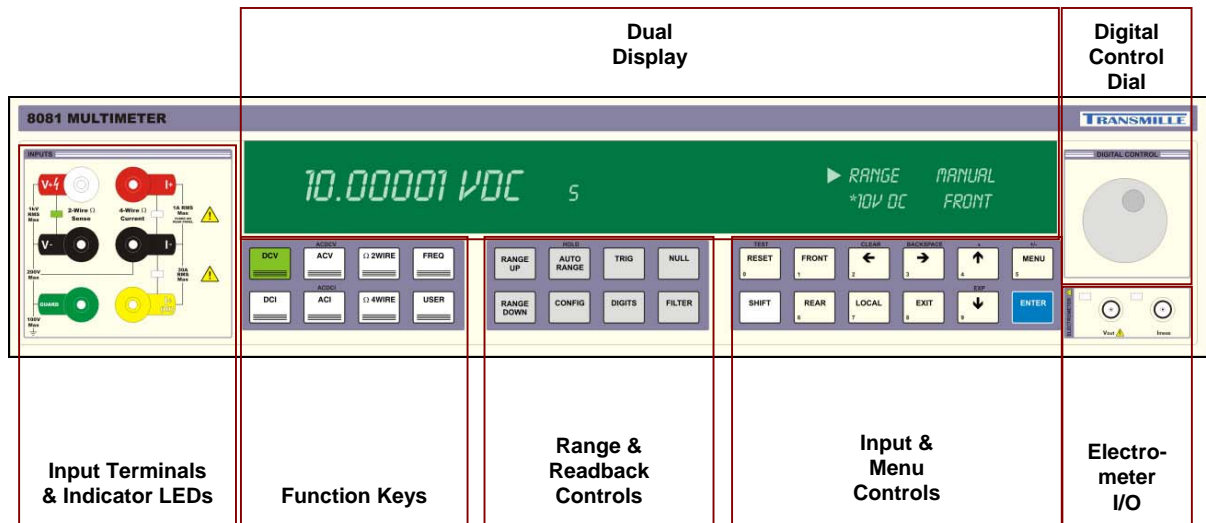

Input Terminals & Indicator LEDs

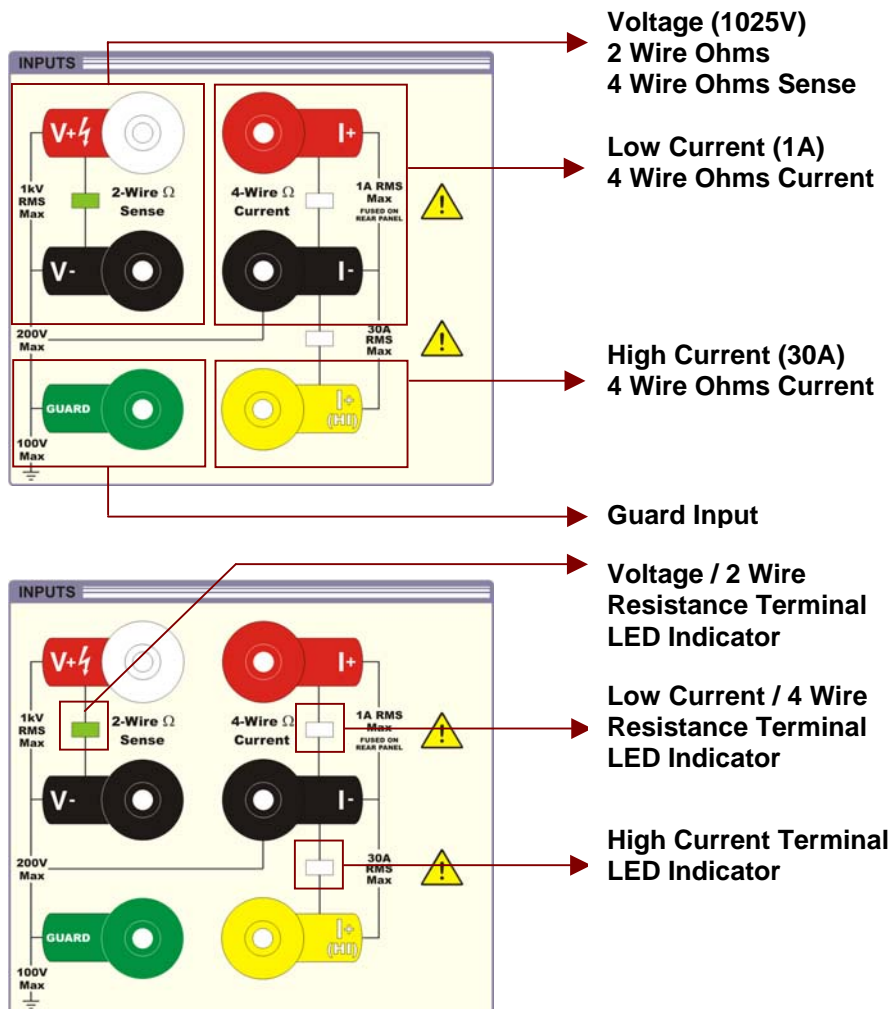

Function Keys

	DCV	DC Voltage
	ACV	AC Voltage
	ACDCV	ACDC Voltage (Coupled)
	Ω 2WIRE	2 Wire Resistance
	FREQ	Frequency
	DCI	DC Current
	ACI	AC Current
	ACDCI	ACDC Current (Coupled)
	Ω 4WIRE	4 Wire Resistance
	USER	User Defined Function

Range & Readback Controls

	RANGE UP	Select Next Range Up
	RANGE DOWN	Select Next Range Down
	AUTO RANGE	Set Auto Range Mode
	CONFIG	Enter Configuration Menu
	TRIG	Select Trigger Setting
	DIGITS	Select Number of Digits
	NULL	Set Null Point
	FILTER	Select Filter Setting

Input & Menu Controls

	RESET 0	Reset Multimeter / Numeric Entry 0
	SHIFT	Select Button Shift Function
	FRONT 1	Activate Front Inputs Numeric Entry 1
	REAR 6	Activate Rear Inputs Numeric Entry 6
	← 2	Menu Left Select Numeric Entry 2
	LOCAL 7	Set to Local Control Numeric Entry 7
	→ 3	Menu Right Select Numeric Entry 3
	EXIT 8	Exit Menu Numeric Entry 8
	↑ 4	Menu Up Select Numeric Entry 4
	↓ 9	Menu Down Select Numeric Entry 9
MENU 5	Enter Menu Numeric Entry 5	
ENTER	Confirm Menu Select	

Menu Dial

	<p>Multi Purpose Use – Context Specific :</p> <p>Range Up / Down Menu Navigation Menu Item Selection Numeric Increment / Decrement</p>
---	---

Electrometer I/O Terminals

	Vout	Voltage <i>output</i> for Electrometer high resistance measurement function
	Imeas	Current measurement <i>input</i> for Electrometer function

Front panel Keyboard

The front panel of the 8000 Series Multimeter utilises a high quality custom rubber keyboard with tactile feel buttons and integral dual display window.



IMPORTANT NOTE

THE FRONT PANEL KEY BUTTONS ARE FOR USE WITH FINGERS ONLY - DO NOT PRESS THE KEY WITH HARD OR SHARP OBJECTS E.G. BALL-POINT PENS, PENCILS, SCREWDRIVERS ETC. REPEATED ACTIONS LIKE THIS WILL ALMOST CERTAINLY CAUSE THE KEYBOARD TO FAIL. (THIS WILL NOT BE COVERED UNDER WARRANTY). CARE SHOULD ALSO BE TAKEN WHEN TRANSPORTING THE INSTRUMENT, DO NOT PLACE TEST LEADS ON TOP OF THE PANEL WHICH MAY GET PUSHED INTO THE DISPLAY AREA OR KEYS WHICH CAN ALSO CAUSE DAMAGE.

Dual Display



The 8000 Series multimeters incorporate clear, bright dual vacuum fluorescent displays to present the user with a large amount of information in an easy to read configuration. The main display shows the reading, function selected and various indicators depending on the mode of operation (for example, an 's' to indicate a sample being taken).

The secondary two line display shows additional settings related to the modes selected, including FILTER, RANGE, TERMINAL SELECTION. In addition the secondary display is also available to display menu options and settings.

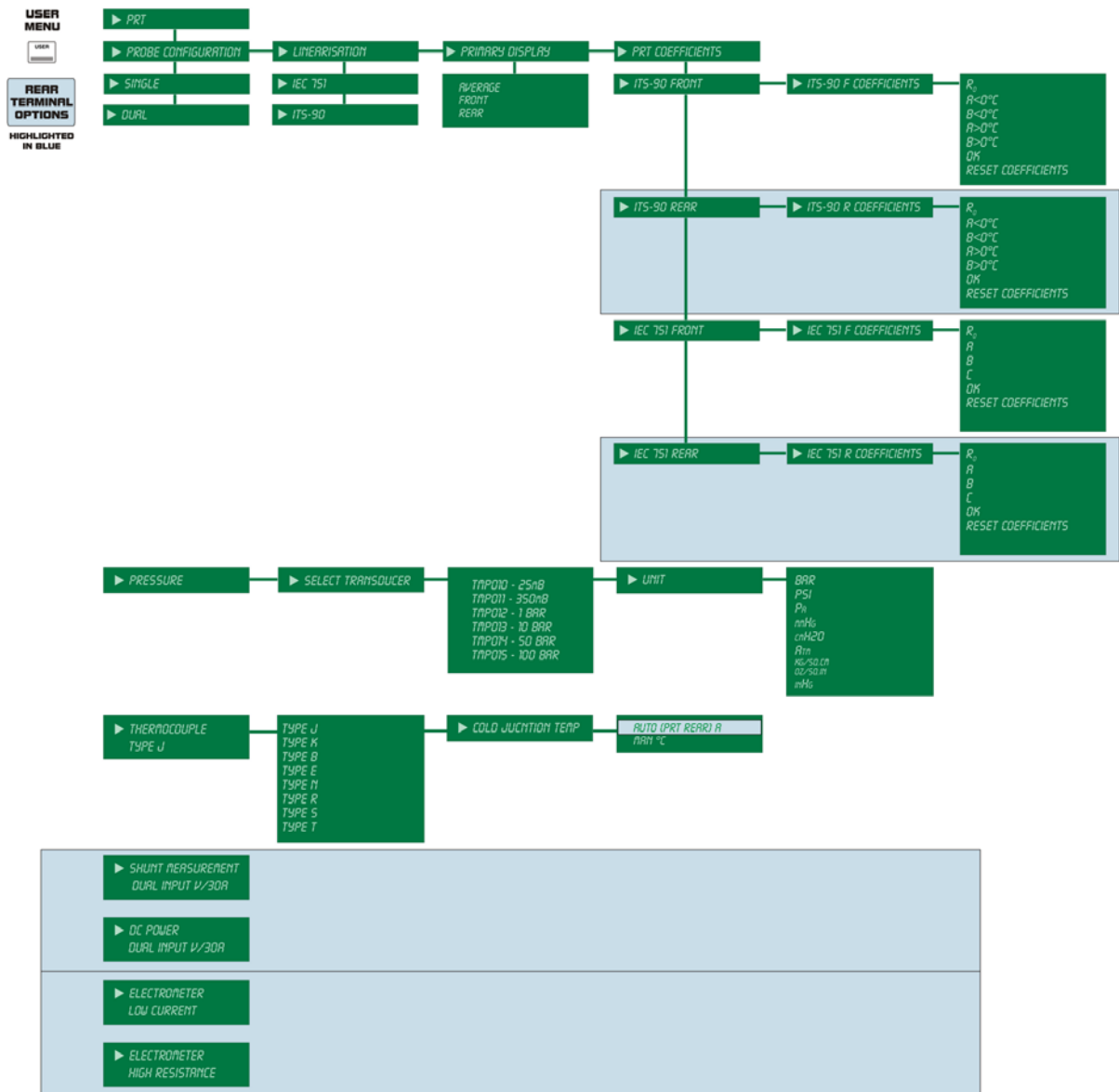

Example Menu : User Menu

Operating the multimeter

Selecting a Range

Range selection can be set to automatic **AUTORANGE** mode or a manual range can be set using **MANUAL RANGING**.

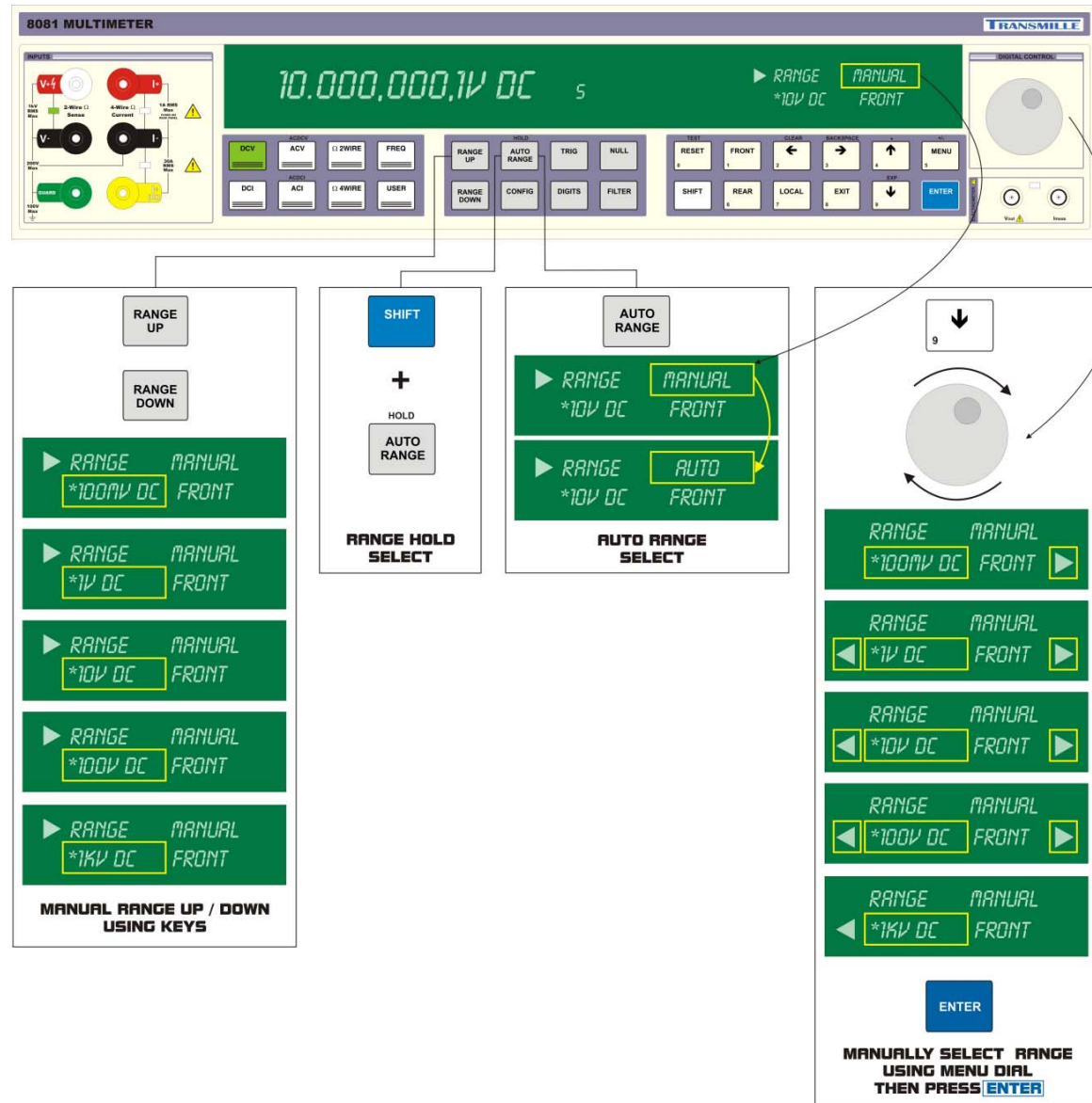





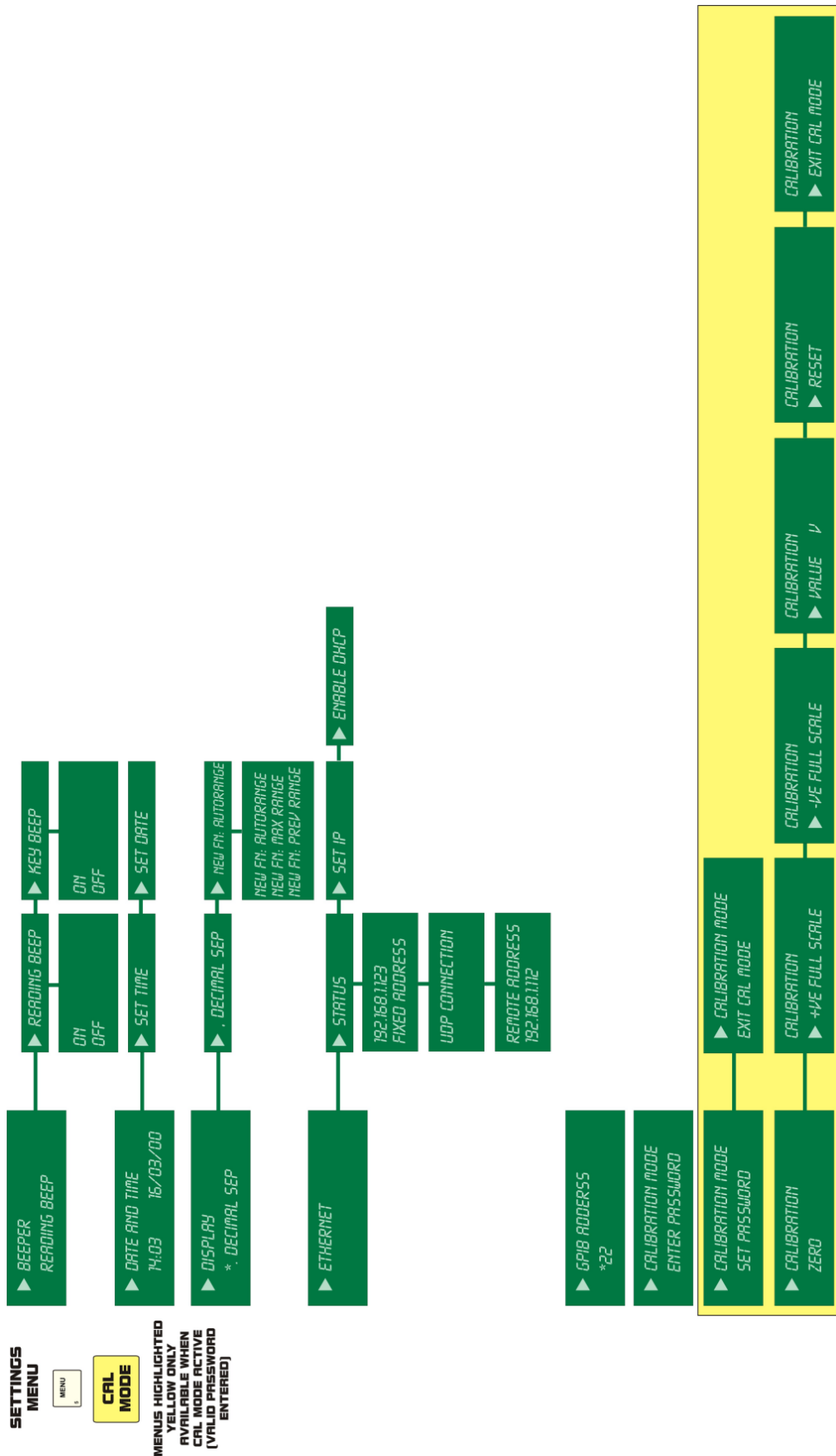

- If the input signal is greater than the range full scale the multimeter will indicate overrange
- For frequency measurements, ranging is automatic.

Settings Menu Map

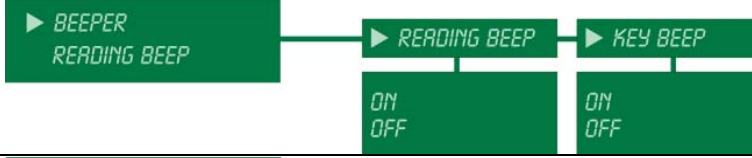

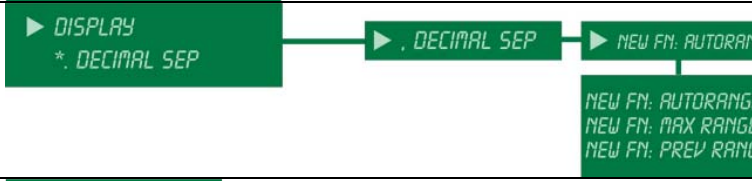
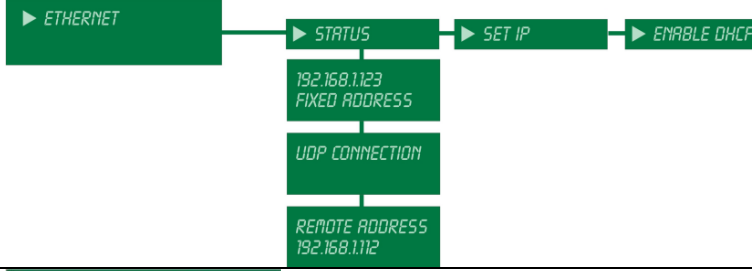
MENUS HIGHLIGHTED
YELLOW ONLY
AVAILABLE WHEN
CAL MODE ACTIVE
(VALID PASSWORD
ENTERED)

Settings Menu Descriptions

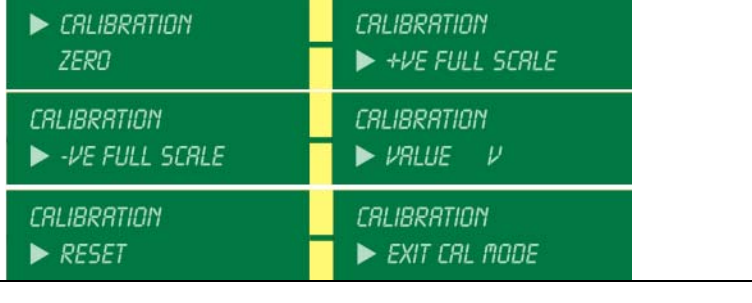
Menu Item	Description of Use
	Set reading and key beep modes on or off
	View / Set current date and time
	Set decimal separator type (. or,) and function default Ranging behaviour
	Set up Ethernet interface / view Ethernet status
	Set GPIB address
	Enter calibration mode (enter password) to gain access to calibration menu
	Set new password for calibration mode or exit calibration mode Only available if cal mode active
	Calibration menu for adjustment of ± full scales, zero or value dependant on range selected. Only available if cal mode active

Configuration Menu Map

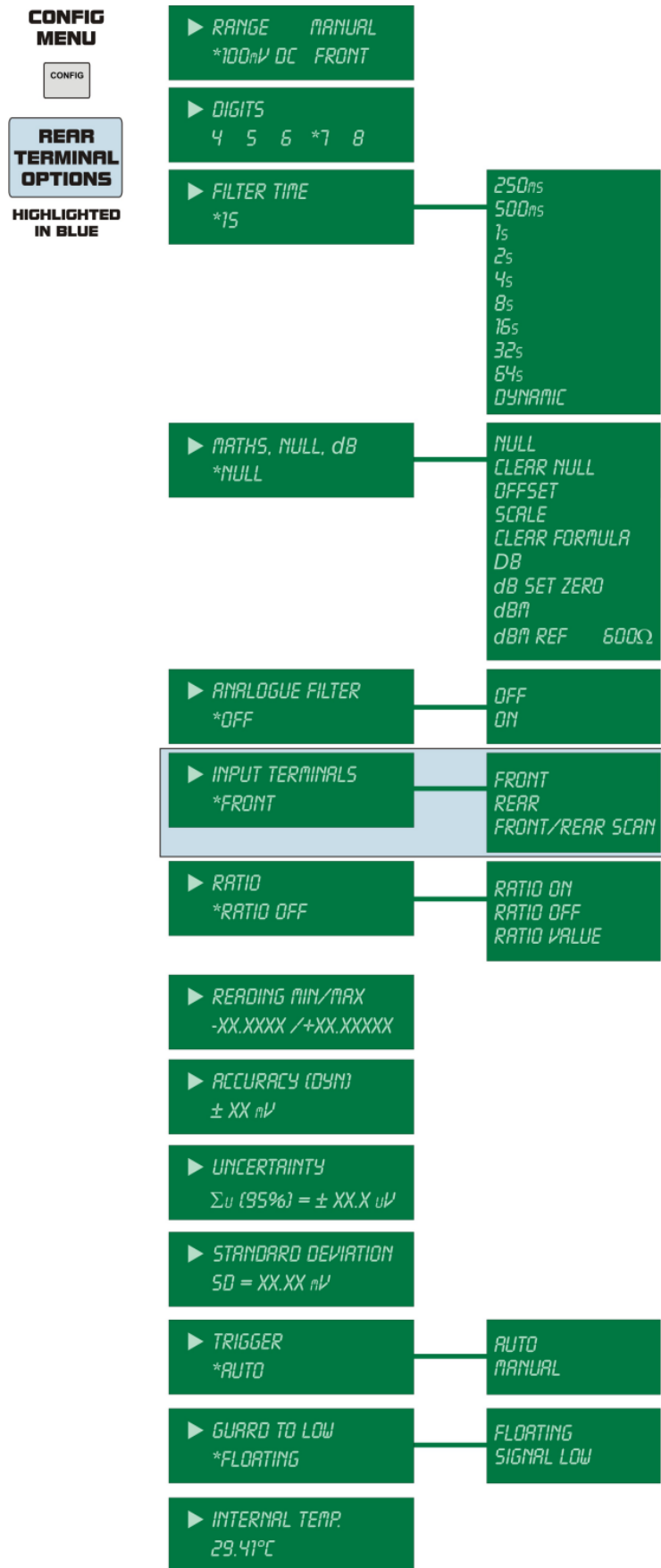

Configuration Menu Descriptions

Menu Item	Description of Use	
▶ RANGE MANUAL *100mV DC FRONT	Displays function, range and terminal settings.	
▶ DIGITS 4 5 6 *7 8	View / set number of digits	
▶ FILTER TIME *15	250nS 500nS 15 25 45 85 165 325 645 DYNAMIC	View / set filter time or select Dynamic for intelligent filter selection
▶ MATHS, NULL, dB *NULL	NULL CLEAR NULL OFFSET SCALE CLEAR FORMULA dB dB SET ZERO dBm dBm REF 600Ω	Set maths functions
▶ ANALOGUE FILTER *OFF	OFF ON	View / set analogue filter
▶ INPUT TERMINALS *FRONT	FRONT REAR FRONT/REAR SCAN	View / set input terminal settings Available with Rear Terminal Option only
▶ RATIO *RATIO OFF	RATIO OFF RATIO ON RATIO VALUE	View / set Ratio settings
▶ READING MIN/MAX -XX.XXXX /+XX.XXXXX		View Minimum / maximum readings
▶ ACCURACY (DYN) ± XX nV		View automatically calculated accuracy for the selected function / range / reading
▶ UNCERTAINTY Σu (95%) = ± XX.X nV		View automatically calculated uncertainty for the selected function / range / reading
▶ STANDARD DEVIATION SD = XX.XX nV		View automatically calculated standard deviation
▶ TRIGGER *AUTO	AUTO MANUAL	View / set the trigger mode
▶ GUARD TO LOW *FLOATING	FLOATING SIGNAL LOW	View / set the guard to low setting
▶ INTERNAL TEMP. 29.41°C		View internal temperature

User Menu Map (Part 1)

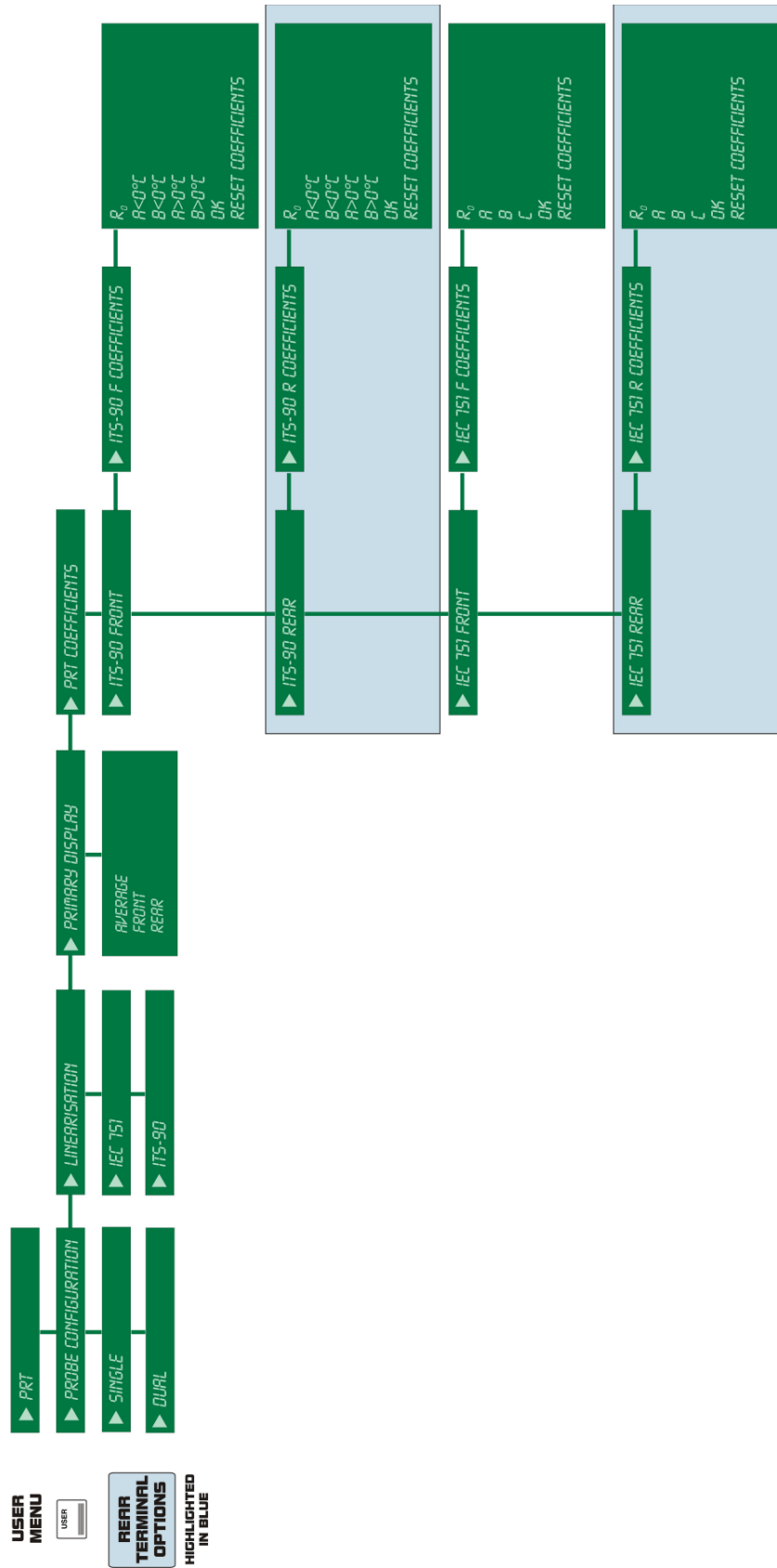

USER MENU
 USER
REAR TERMINAL OPTIONS
 HIGHLIGHTED IN BLUE

User Menu Map(Part 2)

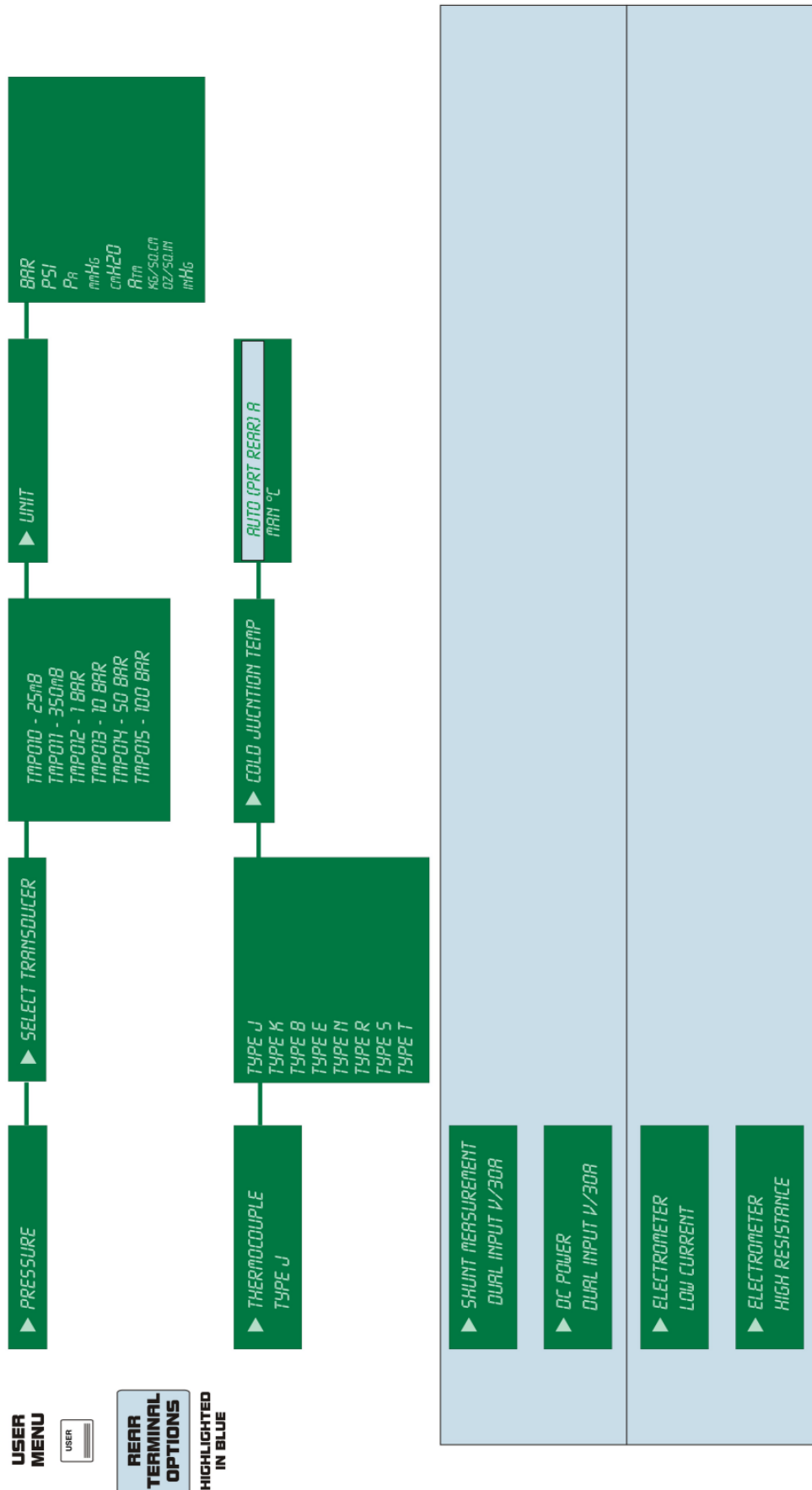

User Menu Descriptions

Menu Item	Description of Use
	<p>Configure probe inputs for PRT measurement</p> <p>Rear input configuration available with Rear Terminal Option only</p>
	<p>Configure pressure modules for pressure measurement</p>
	<p>Configure thermocouple type and cold junction compensation for thermocouple measurement</p>
	<p>Configure dual input voltage and current input mode for shunt measurement</p>
	<p>Configure dual input voltage and current input mode for DC power measurement</p>
	<p>Select electrometer low current measurement mode.</p>
	<p>Select electrometer high resistance measurement mode.</p>

Using the 8081 – Best measurement practice.

The 8000 series DMM offers several easy to use features to help the user make high accuracy measurements. The following information gives advice on using these features and how to avoid common errors.

Nulling or Zero

It is always good measurement practice on DC Voltage, DC Current and Resistance ranges to 'zero' the range first before making a reading. By zeroing the range first, any small errors due to thermal emf voltages and input amplifier input offsets can be removed from the measurement. Thermal and zero offsets change with time making it necessary to re-zero the system from time to time as required.

With the 8000 series each range has two zeroes stored, one for the front panel inputs, and one for the rear panel inputs. It is therefore important to remember to zero both the front and rear inputs in ratio measurements to obtain accurate comparison measurements whenever both front and rear inputs are being used.

The 8000 series DMM stores the zero offset in non-volatile memory so the last zero is saved even if the DMM is switched off.

When autorange is selected all ranges on that function will be zeroed.

Zeroing the Voltage ranges.

System Zero Vs DMM zero -It is often normal to null the DMM by shorting the DMM's input terminals together. It may be better short the connecting leads together at the measurement end, to give a system zero. In this way any thermal EMF voltages from the connecting leads will also be removed from the measurement.

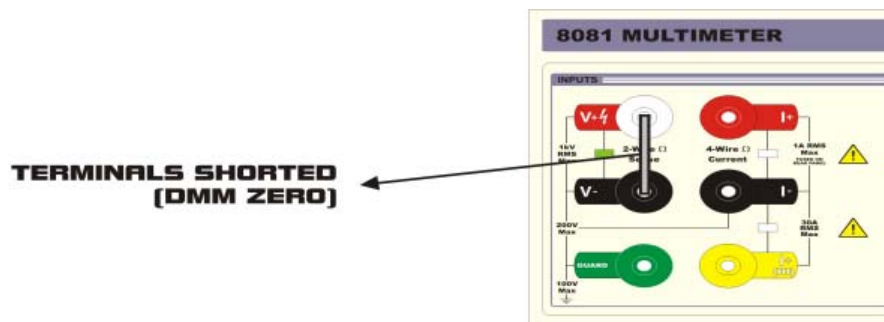

Diagram : DMM Zero

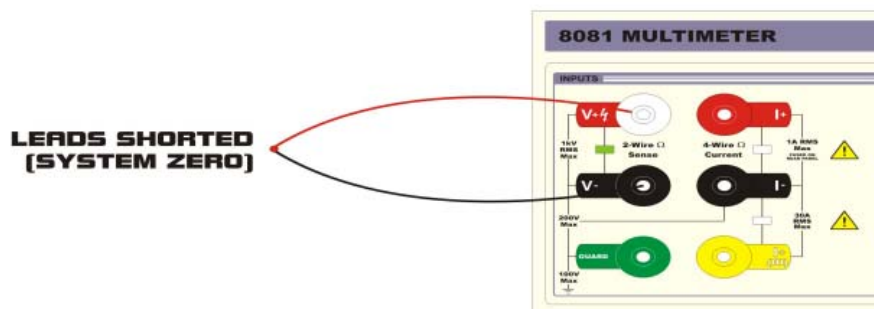

Diagram : System Zero (Recommended)

Understanding thermal EMF voltages.

Thermal EMF voltages are generated wherever there is a metal to metal junction, an electrical connection between two different metals. The voltage generated is dependant on the metals and the temperature of the junction. Voltages up to many 10's of micro volts can easily be generated by a simple banana plug connection, each connection being effectively a thermocouple.

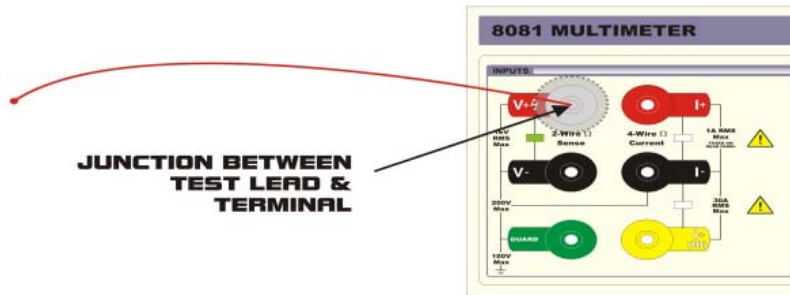
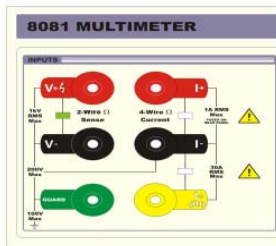
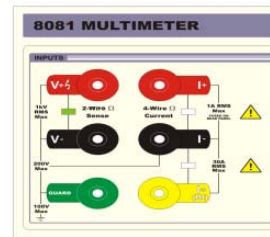

Diagram : Metal to metal junction between test lead and terminal

For low level DC voltage measurements these thermally generated EMF voltages are the primary source's of error. To avoid such errors it is best to use copper-to-copper connection, avoiding nickel-plated brass plugs, use gold plated copper plugs where possible. Avoid temperature gradient's from any source, soldering iron close to test leads, air condition's unit blowing cold/hot air across test leads etc. Even a test lead, which has been previously passing a high current, will be warm and give errors.



GOLD PLATED COPPER TO GOLD PLATED COPPER TO AVOID THERMALLY GENERATED EMFs



AVOID LEADS PREVIOUSLY HEATED BY HIGH CURRENT

Diagram : Gold plated copper to gold plated copper to avoid thermally generated EMFs

Diagram : Leads previously heated by high current

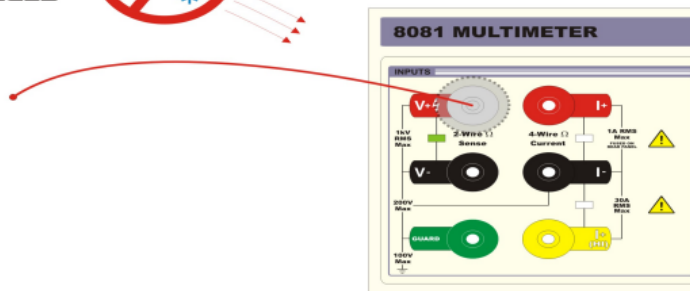

Diagram : Avoid hot/cold temperature sources when taking measurements

Note that thermal EMF do not only effect voltage measurements but also resistance measurements.

Zeroing Current Ranges

Current ranges are easily zeroed by simply open circuiting the terminals and nulling the range

CURRENT TERMINALS LEFT OPEN CIRCUIT FOR CURRENT RANGE NULL

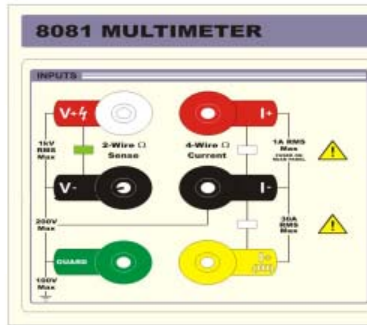

Diagram : Current Null using open circuit terminals

2-Wire null method (all ranges) [Except Electrometer]

The recommended method is to short together the ‘measurement’ end of the test leads and zeroing the DMM. Using this technique the resistance of the test leads will also be zeroed out.

LEADS SHORTED AT MEASUREMENT END

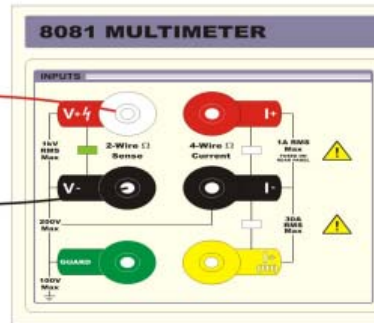
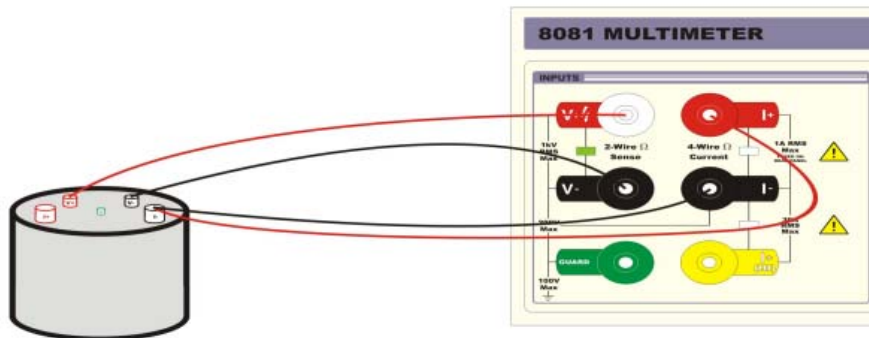

Diagram : 2-Wire resistance Null shorting test leads at measurement end

4-Wire null methods (10kOhm and below)

It is recommend to connect the voltage sense test leads to the voltage sense terminals of the resistor, and short together at the negative current terminal of the resistor the measurement current leads. With this connection there is no current flowing in the resistor and therefore can be no voltage across it - the DMM can then be zeroed. This will remove all thermal EMF voltages in the test leads. To make a measurement simply connect the positive measurement current lead to the positive current terminal on the resistor.



CURRENT LEADS SHORTED AT RESISTOR END

Diagram : 4-Wire resistance Null shorting current leads at measurement end

8000 Series Functions

DC Voltage

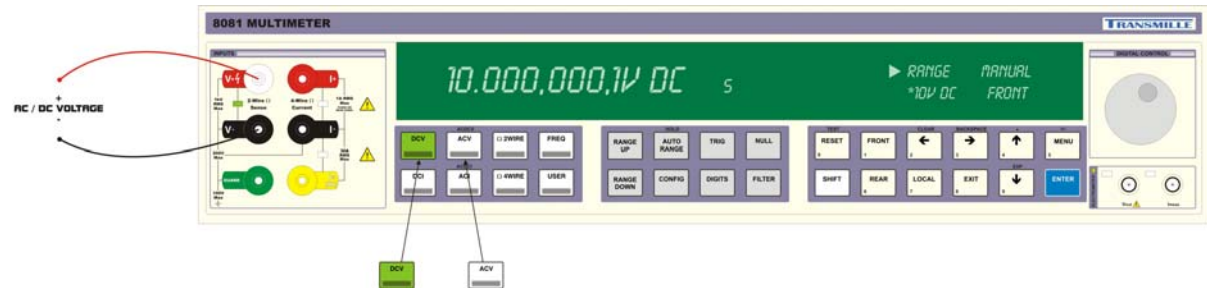

Press **DCV** to enter the DCV measurement mode – the status display will indicate the settings and range information.

Status Display Section	Description
▶ RANGE eg. *10V DC	Display / Selection of DC Voltage range – Use menu dial or RANGE UP RANGE DOWN buttons to change range. Selected range indicated by a *
MANUAL	Ranging mode : AUTO or MANUAL
FRONT	FRONT or REAR terminals in use

Additional Settings	Description
DIGITS	Set measurement resolution
FILTER TIME	Set FILTER TIME : 250ms to 64s Dynamic Mode for Automatic filter setting based on measurement stability
ANALOGUE FILTER	Set ANALOGUE FILTER mode : ON / OFF
INPUT TERMINALS	Set INPUT TERMINALS to use : FRONT / REAR
RATIO	Set RATIO mode : ON / VALUE / OFF
READING MIN / MAX	Display READING MIN / MAX measurement data for the selected function / range
TRIGGER	TRIGGER mode : AUTO / MANUAL
GUARD TO LOW	Set GUARD TO LOW mode : FLOATING / SIGNAL LOW
MATHS, NULL, dB	Set NULL : Store zero offset value Clear NULL : Clear zero offset value Set OFFSET : Add a user entered value to the measurement Set SCALE : Multiply measurement by a user entered value Clear FORMULA : Clear the formula entered (SCALE & OFFSET) See dB function for use of Set dB, dB SET ZERO & dBm REF 600 Ohms
INTERNAL TEMPERATURE	Displays the internal temperature

AC Voltage

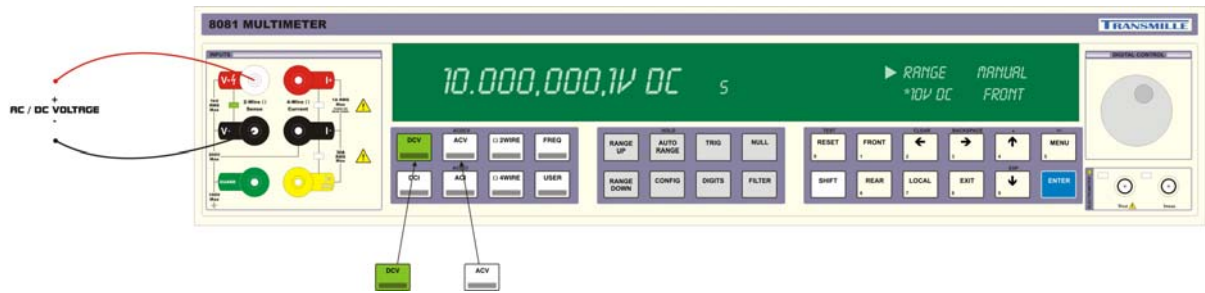

Press **ACV** to enter the ACV measurement mode – the status display will indicate the settings and range information.

Press **FREQ** to enter the FREQUENCY measurement mode (1Hz resolution) : **ACV** and **FREQ** will both illuminate.

Press **FREQ** to switch back to **ACV** display

Status Display Section	Description
▶ RANGE eg. *10V AC	Display / Selection of AC Voltage range – Use menu dial or RANGE UP RANGE DOWN buttons to change range. Selected range indicated by a *
MANUAL	Ranging mode : AUTO or MANUAL
FRONT	FRONT or REAR terminals in use

Additional Settings	Description
DIGITS	Set measurement resolution
FILTER TIME	Set FILTER TIME : 250ms to 64s Dynamic Mode for Automatic filter setting based on measurement stability
ANALOGUE FILTER	Set ANALOGUE FILTER mode : ON / OFF
INPUT TERMINALS	Set INPUT TERMINALS to use : FRONT / REAR
RATIO	Set RATIO mode : ON / VALUE / OFF
READING MIN / MAX	Display READING MIN / MAX measurement data for the selected function / range
TRIGGER	TRIGGER mode : AUTO / MANUAL
GUARD TO LOW	Set GUARD TO LOW mode : FLOATING / SIGNAL LOW
MATHS, NULL, dB	Set NULL : Store zero offset value Clear NULL : Clear zero offset value Set OFFSET : Add a user entered value to the measurement Set SCALE : Multiply measurement by a user entered value Clear FORMULA : Clear the formula entered (SCALE & OFFSET) See dB function for use of Set dB, dB SET ZERO & dBm REF 600 Ohms
FREQUENCY	Displays the measurement frequency value
INTERNAL TEMPERATURE	Displays the internal temperature

DC Current

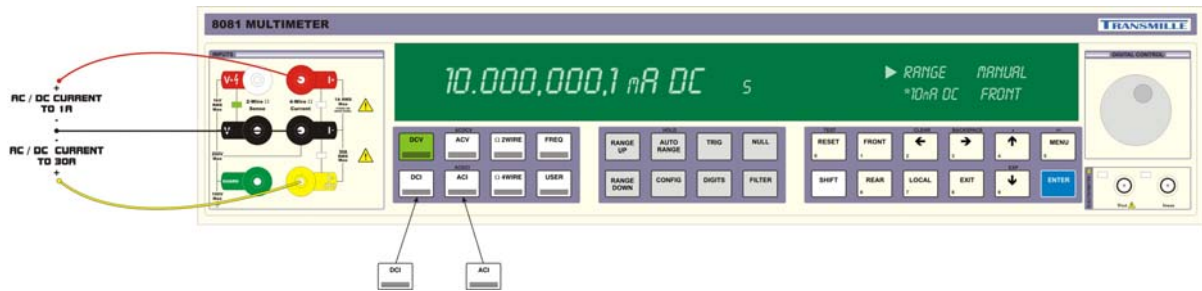

Press **DCI** to enter the DCI measurement mode – the status display will indicate the settings and range information.

Status Display Section	Description
▶ RANGE eg. *10mA DC	Display / Selection of DC Current range – Use menu dial or RANGE UP RANGE DOWN buttons to change range. Selected range indicated by a *
MANUAL	Ranging mode : AUTO or MANUAL
FRONT	FRONT or REAR terminals in use (Rear to 1A Max.)

Additional Settings	Description
DIGITS	Set measurement resolution
FILTER TIME	Set FILTER TIME : 250ms to 64s Dynamic Mode for Automatic filter setting based on measurement stability
ANALOGUE FILTER	Set ANALOGUE FILTER mode : ON / OFF
INPUT TERMINALS	Set INPUT TERMINALS to use : FRONT / REAR
RATIO	Set RATIO mode : ON / VALUE / OFF
READING MIN / MAX	Display READING MIN / MAX measurement data for the selected function / range
TRIGGER	TRIGGER mode : AUTO / MANUAL
GUARD TO LOW	Set GUARD TO LOW mode : FLOATING / SIGNAL LOW
MATHS, NULL, dB	Set NULL : Store zero offset value Clear NULL : Clear zero offset value Set OFFSET : Add a user entered value to the measurement Set SCALE : Multiply measurement by a user entered value Clear FORMULA : Clear the formula entered (SCALE & OFFSET) See dB function for use of Set dB, dB SET ZERO & dBm REF 600 Ohms
INTERNAL TEMPERATURE	Displays the internal temperature

DC Current (Electrometer Mode) (Option)

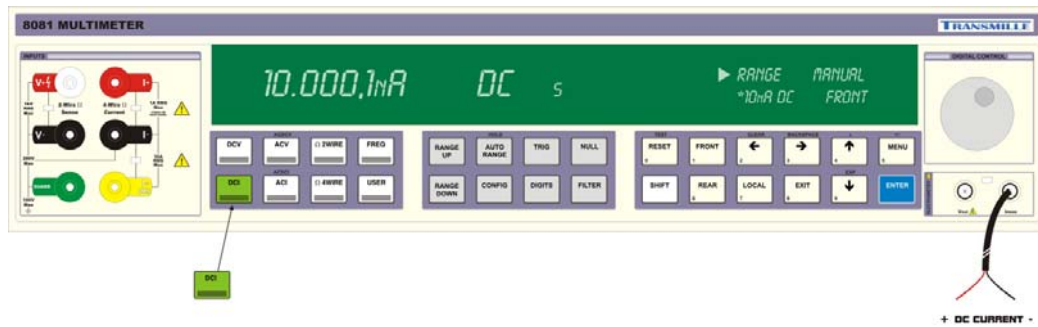

Press **DCI** to enter the DCI measurement mode – the status display will indicate the settings and range information.

Selecting ranges 10nA , 100nA, 1uA, 10uA will activate the electrometer mode. Inputs are measured from the IMeas BNC terminal on the right hand side of the multimeter. An LED indicates the BNC terminal set is active.

Status Display Section	Description
▶ RANGE eg. *10mA DC	Display / Selection of DC Current range – Use menu dial or RANGE UP / RANGE DOWN buttons to change range. Selected range indicated by a *
MANUAL	Ranging mode : AUTO or MANUAL
FRONT	FRONT or REAR terminals in use (Rear to 1A Max.)

Additional Settings	Description
DIGITS	Set measurement resolution
FILTER TIME	Set FILTER TIME : 250ms to 64s Dynamic Mode for Automatic filter setting based on measurement stability
ANALOGUE FILTER	Set ANALOGUE FILTER mode : ON / OFF
READING MIN / MAX	Display READING MIN / MAX measurement data for the selected function / range
TRIGGER	TRIGGER mode : AUTO / MANUAL
GUARD TO LOW	Set GUARD TO LOW mode : FLOATING / SIGNAL LOW
MATHS, NULL, dB	Set NULL : Store zero offset value Clear NULL : Clear zero offset value Set OFFSET : Add a user entered value to the measurement Set SCALE : Multiply measurement by a user entered value Clear FORMULA : Clear the formula entered (SCALE & OFFSET) See dB function for use of Set dB, dB SET ZERO & dBm REF 600 Ohms
INTERNAL TEMPERATURE	Displays the internal temperature

AC Current

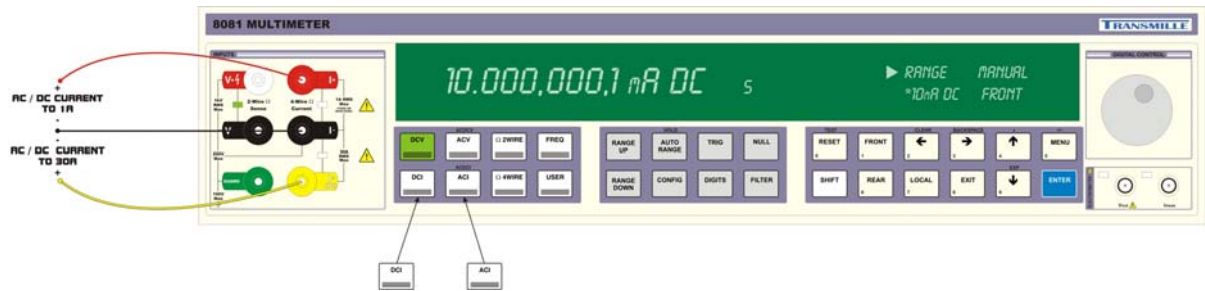

Press **ACI** to enter the ACI measurement mode – the status display will indicate the settings and range information.

Press **FREQ** to enter the FREQUENCY measurement mode (1Hz resolution) : **ACV** and **FREQ** will both illuminate.

Press **FREQ** to switch back to **ACV** display

Status Display Section	Description
▶ RANGE eg. *10mA AC	Display / Selection of AC Current range – Use menu dial or RANGE UP RANGE DOWN buttons to change range. Selected range indicated by a *
MANUAL	Ranging mode : AUTO or MANUAL
FRONT	FRONT or REAR terminals in use (Rear to 1A Max.)

Additional Settings	Description
DIGITS	Set measurement resolution
FILTER TIME	Set FILTER TIME : 250ms to 64s Dynamic Mode for Automatic filter setting based on measurement stability
ANALOGUE FILTER	Set ANALOGUE FILTER mode : ON / OFF
INPUT TERMINALS	Set INPUT TERMINALS to use : FRONT / REAR
RATIO	Set RATIO mode : ON / VALUE / OFF
READING MIN / MAX	Display READING MIN / MAX measurement data for the selected function / range
TRIGGER	TRIGGER mode : AUTO / MANUAL
GUARD TO LOW	Set GUARD TO LOW mode : FLOATING / SIGNAL LOW
MATHS, NULL, dB	Set NULL : Store zero offset value Clear NULL : Clear zero offset value Set OFFSET : Add a user entered value to the measurement Set SCALE : Multiply measurement by a user entered value Clear FORMULA : Clear the formula entered (SCALE & OFFSET) See dB function for use of Set dB, dB SET ZERO & dBm REF 600 Ohms
FREQUENCY	Displays the measurement frequency value
INTERNAL TEMPERATURE	Displays the internal temperature

2-Wire Resistance

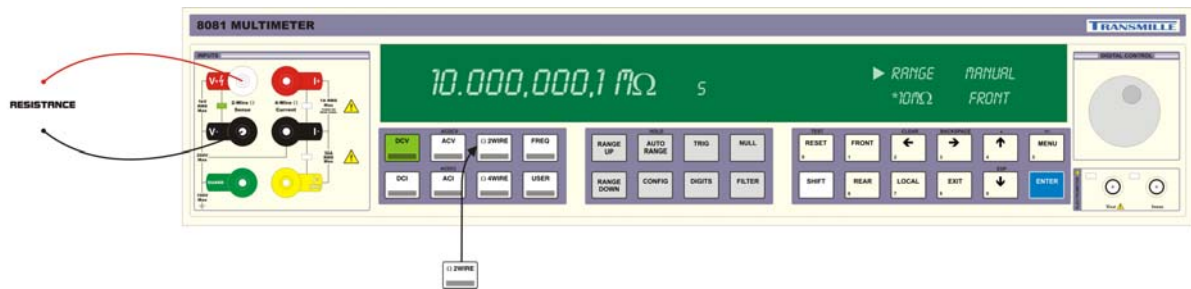

Press **Ω 2WIRE** to enter the Ω 2WIRE measurement mode – the status display will indicate the settings and range information.

Status Display Section	Description
► RANGE eg. *10m Ω DC	Display / Selection of 2-Wire Resistance range – Use menu dial or RANGE UP RANGE DOWN buttons to change range. Selected range indicated by a *
MANUAL	Ranging mode : AUTO or MANUAL
FRONT	FRONT or REAR terminals in use

Additional Settings	Description
DIGITS	Set measurement resolution
FILTER TIME	Set FILTER TIME : 250ms to 64s Dynamic Mode for Automatic filter setting based on measurement stability
ANALOGUE FILTER	Set ANALOGUE FILTER mode : ON / OFF
INPUT TERMINALS	Set INPUT TERMINALS to use : FRONT / REAR
RATIO	Set RATIO mode : ON / VALUE / OFF
READING MIN / MAX	Display READING MIN / MAX measurement data for the selected function / range
TRIGGER	AUTO / MANUAL
GUARD TO LOW	Set GUARD TO LOW mode : FLOATING / SIGNAL LOW
MATHS, NULL, dB	Set NULL : Store zero offset value Clear NULL : Clear zero offset value Set OFFSET : Add a user entered value to the measurement Set SCALE : Multiply measurement by a user entered value Clear FORMULA : Clear the formula entered (SCALE & OFFSET) See dB function for use of Set dB, dB SET ZERO & dBm REF 600 Ohms
OHMS LOW CURRENT	Reduced measurement current to reduce power dissipation / self heating during measurement OFF / ON
OHMS COMPENSATION	Compensates for thermal voltages which may be present at the measurement terminal connection OFF / ON
POWER / CURRENT	Displays the power dissipation / current flowing for the specific range & measurement
INTERNAL TEMPERATURE	Displays the internal temperature

2-Wire Resistance (Electrometer Mode) (Option)

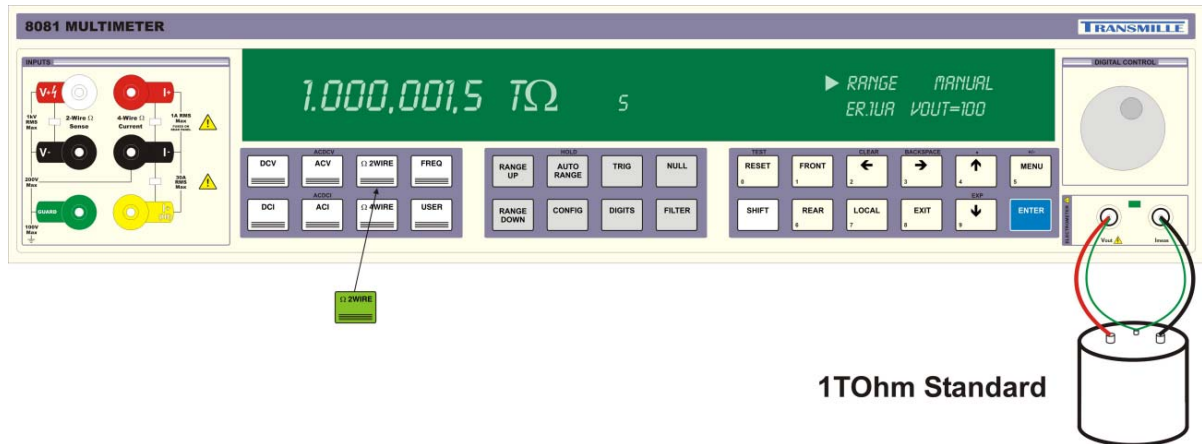

Press **Ω 2WIRE** to enter the Ω 2WIRE measurement mode – the status display will indicate the settings and range information.

Selecting ranges above 10 MOhms will activate electrometer mode - this is displayed in terms of current (100uA, 10uA, 1uA, 100nA, 10nA). Inputs are measured from the I Meas BNC terminal on the right hand side of the multimeter. An LED indicates the BNC terminal set is active.

Voltage output on electrometer terminals is configurable from status menu (using menu dial) from 50V to 300V in 50V steps.

Status Display Section	Description
▶ RANGE eg. *10m Ω DC	Display / Selection of 2-Wire Resistance range – Use menu dial or RANGE UP RANGE DOWN buttons to change range. Selected range indicated by a *
MANUAL	Ranging mode : AUTO or MANUAL
FRONT	FRONT or REAR terminals in use

Additional Settings	Description
DIGITS	Set measurement resolution
FILTER TIME	Set FILTER TIME : 250ms to 64s Dynamic Mode for filter setting based on measurement stability
ANALOGUE FILTER	Set ANALOGUE FILTER mode : ON / OFF
READING MIN / MAX	Display READING MIN / MAX measurement
TRIGGER	AUTO / MANUAL
GUARD TO LOW	Set GUARD TO LOW mode : FLOATING / SIGNAL LOW
MATHS, NULL, dB	Set NULL : Store zero offset value Clear NULL : Clear zero offset value Set OFFSET : Add a user entered value to the measurement Set SCALE : Multiply measurement by a user entered value Clear FORMULA : Clear the formula entered (SCALE & OFFSET) See dB function for use of Set dB, dB SET ZERO & dBm REF 600 Ohms
POWER / CURRENT	Displays the power dissipation / current flowing for the specific range & measurement
TEST VOLTAGE	Select Test Voltage 50V • 100V • 150V • 200V • 250V • 300V for the specific range & measurement
INTERNAL TEMPERATURE	Displays the internal temperature

4-Wire Resistance

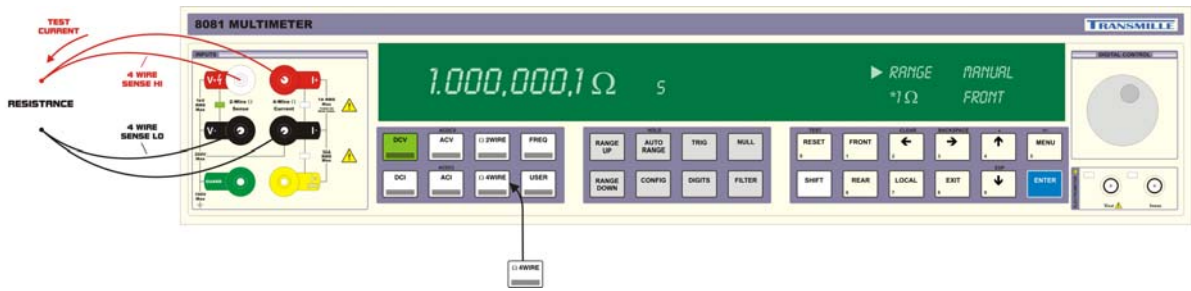

Press **Ω 4WIRE** to enter the Ω 4WIRE measurement mode – the status display will indicate the settings and range information.

Status Display Section	Description
▶ RANGE eg. *1Ω DC	Display / Selection of 4-Wire Resistance range – Use menu dial or RANGE UP RANGE DOWN buttons to change range. Selected range indicated by a *
MANUAL	Ranging mode : AUTO or MANUAL
FRONT	FRONT or REAR terminals in use

Additional Settings	Description
DIGITS	Set measurement resolution
FILTER TIME	Set FILTER TIME : 250ms to 64s Dynamic Mode for Automatic filter setting based on measurement stability
ANALOGUE FILTER	Set ANALOGUE FILTER mode : ON / OFF
INPUT TERMINALS	Set INPUT TERMINALS to use : FRONT / REAR
RATIO	Set RATIO mode : ON / VALUE / OFF
READING MIN / MAX	Display READING MIN / MAX measurement data for the selected function / range
TRIGGER	AUTO / MANUAL
GUARD TO LOW	Set GUARD TO LOW mode : FLOATING / SIGNAL LOW
MATHS, NULL, dB	Set NULL : Store zero offset value Clear NULL : Clear zero offset value Set OFFSET : Add a user entered value to the measurement Set SCALE : Multiply measurement by a user entered value Clear FORMULA : Clear the formula entered (SCALE & OFFSET) See dB function for use of Set dB, dB SET ZERO & dBm REF 600 Ohms
OHMS LOW CURRENT	Reduced measurement current to reduce power dissipation / self heating during measurement OFF / ON
OHMS COMPENSATION	Compensates for thermal voltages which may be present at the measurement terminal connection OFF / ON
POWER / CURRENT	Displays the power dissipation / current flowing for the specific range & measurement
INTERNAL TEMPERATURE	Displays the internal temperature

Frequency

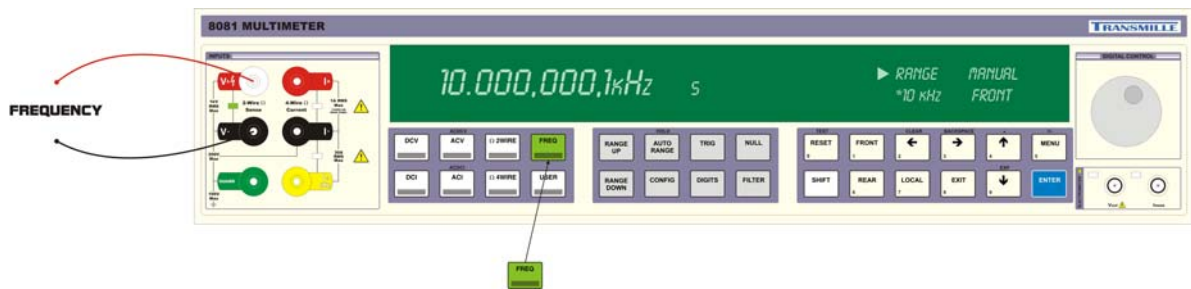

Press **FREQ** to enter the FREQUENCY measurement mode (.1Hz resolution) : **ACV** and **FREQ** will both illuminate.

Status Display Section	Description
▶ RANGE eg. *1V	Display / Selection of AC Voltage range – Use menu dial or RANGE UP RANGE DOWN buttons to change range. Selected range indicated by a *
MANUAL	Ranging mode : AUTO or MANUAL
FRONT	FRONT or REAR terminals in use

Additional Settings	Description
DIGITS	Set measurement resolution
FILTER TIME	Set FILTER TIME : 250ms to 64s Dynamic Mode for Automatic filter setting based on measurement stability
ANALOGUE FILTER	Set ANALOGUE FILTER mode : ON / OFF
INPUT TERMINALS	Set INPUT TERMINALS to use : FRONT / REAR
RATIO	Set RATIO mode : ON / VALUE / OFF
READING MIN / MAX	Display READING MIN / MAX measurement data for the selected function / range
TRIGGER	AUTO / MANUAL
GUARD TO LOW	Set GUARD TO LOW mode : FLOATING / SIGNAL LOW
MATHS, NULL, dB	Set NULL : Store zero offset value Clear NULL : Clear zero offset value Set OFFSET : Add a user entered value to the measurement Set SCALE : Multiply measurement by a user entered value Clear FORMULA : Clear the formula entered (SCALE & OFFSET) See dB function for use of Set dB, dB SET ZERO & dBm REF 600 Ohms
OHMS LOW CURRENT	Reduced measurement current to reduce power dissipation / self heating during measurement OFF / ON
OHMS COMPENSATION	Compensates for thermal voltages which may be present at the measurement terminal connection OFF / ON
POWER / CURRENT	Displays the power dissipation / current flowing for the specific range & measurement
INTERNAL TEMPERATURE	Displays the internal temperature

Thermocouple Measurement : Connection Diagrams (Option)

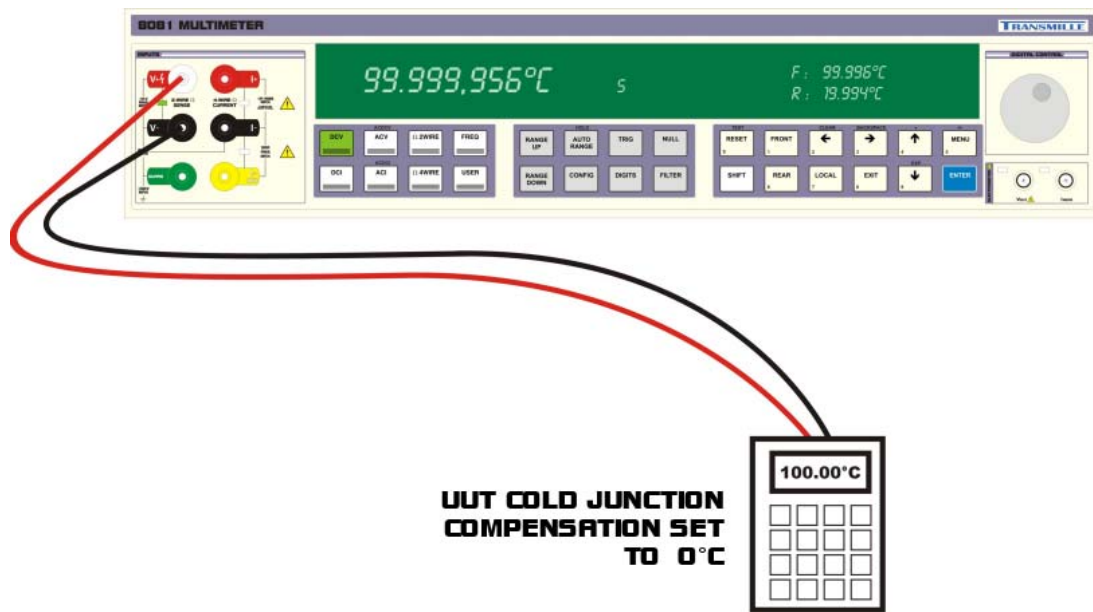

Configuration A
Process control calibrator connection.

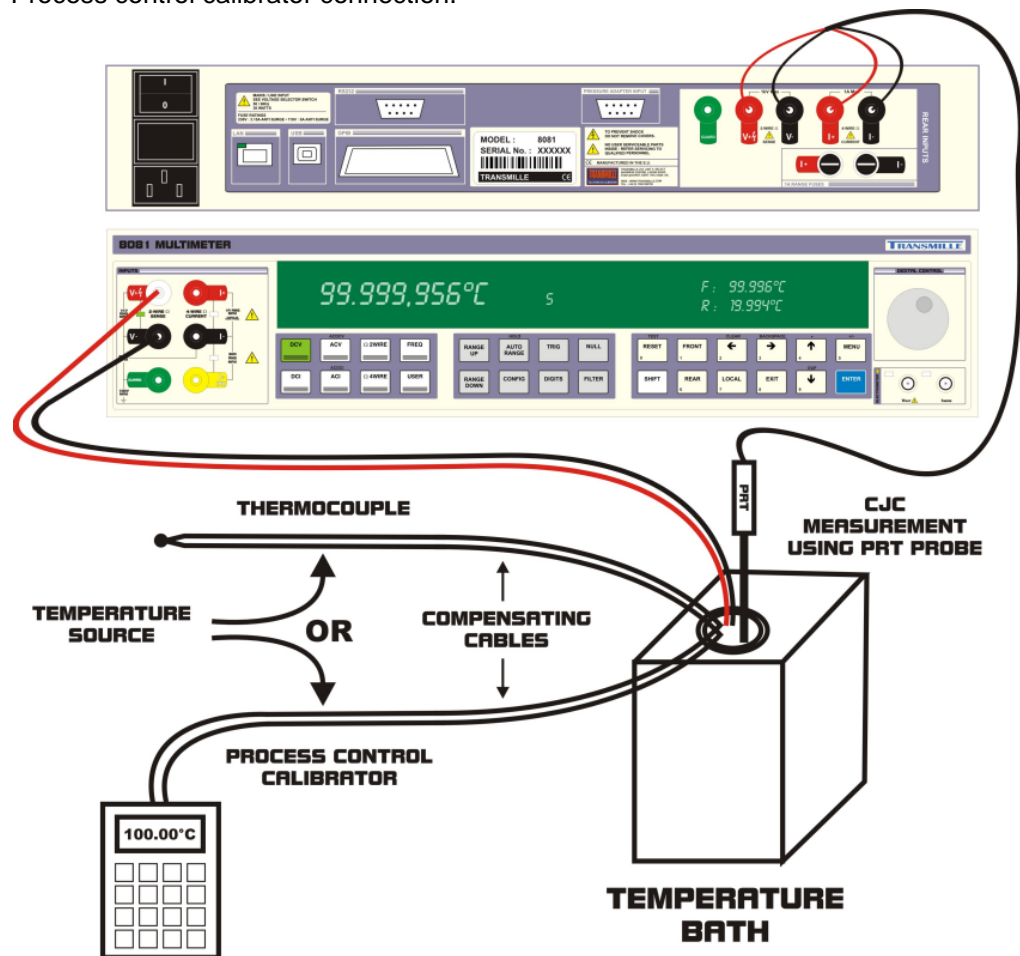

Configuration B (Requires Rear Terminal Option)
Process Control Calibrator / Thermocouple Connection with Cold Junction Compensation using external PRT probe in bath.

Thermocouple Measurement : Multimeter Setup (Option)

Press **SHIFT** then **DCV** to select thermocouple measurement.

Select the thermocouple **Type J** **Type K** **Type B** **Type E** **Type N** **Type R** **Type S** **Type T** using **←** **→** buttons or menu dial

Select cold junction compensation mode using **←** **→** buttons or menu dial

Auto (PRT Rear) A : Uses the PRT Rear Probe A coefficients - connect to rear panel terminals

Man °C : User measured and entered cold junction temperature value

Additional Settings	Description
DIGITS	Set measurement resolution
FILTER TIME	Set FILTER TIME : 250ms to 64s Dynamic Mode for Automatic filter setting based on measurement stability
ANALOGUE FILTER	Set ANALOGUE FILTER mode : ON / OFF
INPUT TERMINALS	Set INPUT TERMINALS to use : FRONT / REAR
RATIO	Set RATIO mode : ON / VALUE / OFF
READING MIN / MAX	Display READING MIN / MAX measurement data for the selected function / range
TRIGGER	AUTO / MANUAL
GUARD TO LOW	Set GUARD TO LOW mode : FLOATING / SIGNAL LOW
INTERNAL TEMPERATURE	Displays the internal temperature

PRT Measurement : Connection Diagrams (Option)

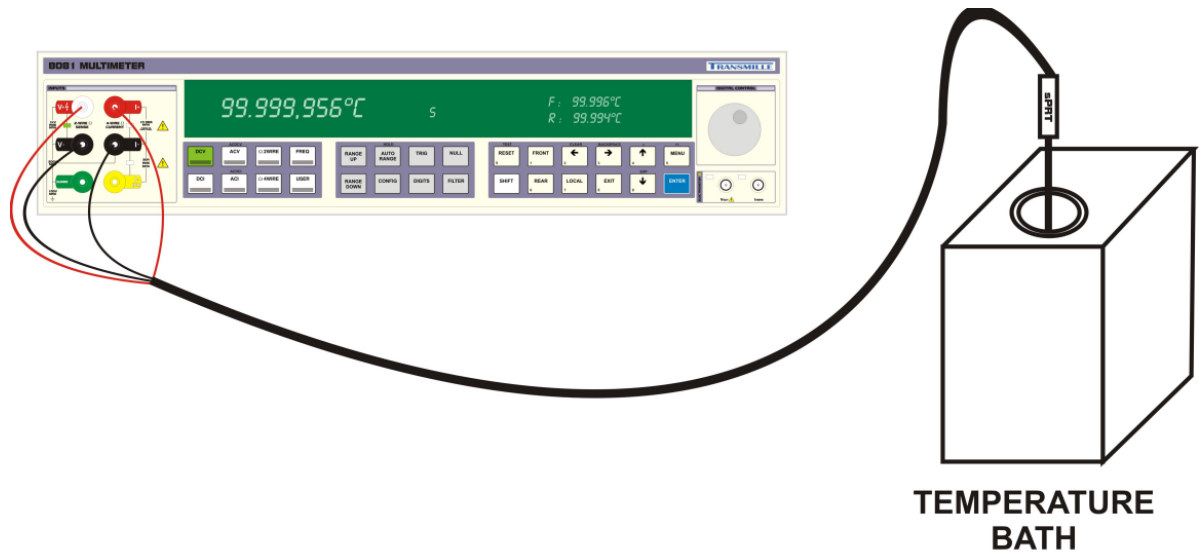

Configuration A
Single probe measurement

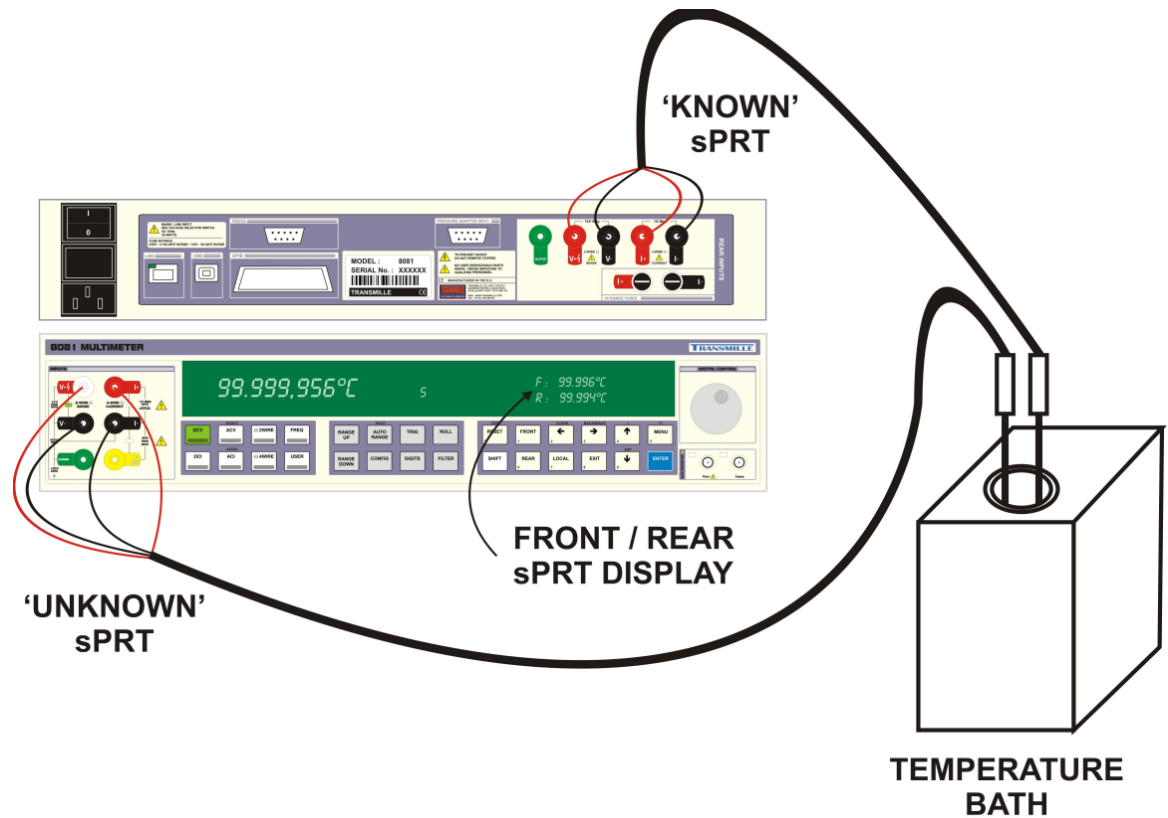

Configuration B
Dual probe configuration with ratio comparison of known and unknown probes

PRT Measurement : Multimeter Setup (Option)

Press **SHIFT** then **Ω 4WIRE** to select PRT measurement.

Select **PROBE CONFIGURATION** **SINGLE** **DUAL**

Select **LINEARISATION** **IEC 751** **ITS-90**

Select **PRIMARY DISPLAY** **AVERAGE** **FRONT** **REAR**

Select **PRT Coefficients** **ITS-90 Front** **ITS-90 Rear** **IEC 751 Front** **IEC 751 Rear**

ITS-90 Front Coefficients		ITS-90 Rear Coefficients	
R ₀	100	R ₀	100
a<0°C	0	a<0°C	0
b<0°C	0	b<0°C	0
a>0°C	0	a>0°C	0
b>0°C	0	b>0°C	0
OK		OK	
Reset coefficients		Reset coefficients	

IEC 751 Front Coefficients		IEC 751 Rear Coefficients	
R ₀	100	R ₀	100
A	3.908299e-3	A	3.908299e-3
B	-5.774999e-7	B	-5.774999e-7
C	-4.183e-12	C	-4.183e-12
OK		OK	
Reset coefficients		Reset coefficients	

OK	Saves coefficients as entered
Reset Coefficients	Reset coefficient data back to defaults

Additional Settings	Description
DIGITS	Set measurement resolution
FILTER TIME	Set FILTER TIME : 250ms to 64s Dynamic Mode for Automatic filter (reading stability based)
ANALOGUE FILTER	Set ANALOGUE FILTER mode : ON / OFF
INPUT TERMINALS	Set INPUT TERMINALS to use : FRONT / REAR
RATIO	Set RATIO mode : ON / VALUE / OFF
READING MIN / MAX	Display READING MIN / MAX measurement data
TRIGGER	AUTO / MANUAL
GUARD TO LOW	Set GUARD TO LOW mode : FLOATING / SIGNAL LOW
INTERNAL TEMPERATURE	Displays the internal temperature

Guide to setting up a PRT probe

1. Use digital control dial to choose

Probe Configuration → **PRT Coefficients** → **Primary Display** → **PRT Coefficients**

2. Select Linearisation / Coefficient location **ITS-90 Front** **ITS-90 Rear** **IEC 751 Front** **IEC 751 Rear**

3. Enter Coefficient data (examples shown below) :

ITS-90 Front Coefficients		ITS-90 Rear Coefficients	
R ₀	100	R ₀	100
a<0°C	0	a<0°C	0
b<0°C	0	b<0°C	0
a>0°C	0	a>0°C	0
b>0°C	0	b>0°C	0
OK		OK	
Reset		Reset	

IEC 751 Front Coefficients		IEC 751 Rear Coefficients	
R ₀	100	R ₀	100
A	3.908299e-3	A	3.908299e-3
B	-5.774999e-7	B	-5.774999e-7
C	-4.183e-12	C	-4.183e-12
OK		OK	
Reset		Reset	

Coefficient data entry example : 3.908299e-3

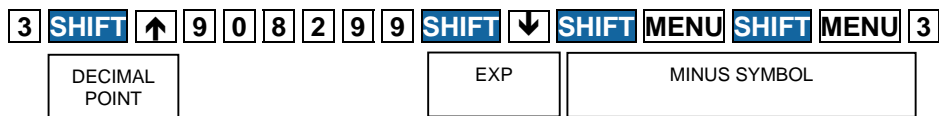

4. Select **PROBE CONFIGURATION**

SINGLE

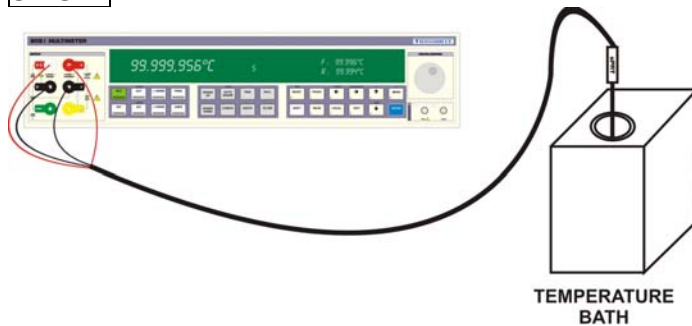

DUAL

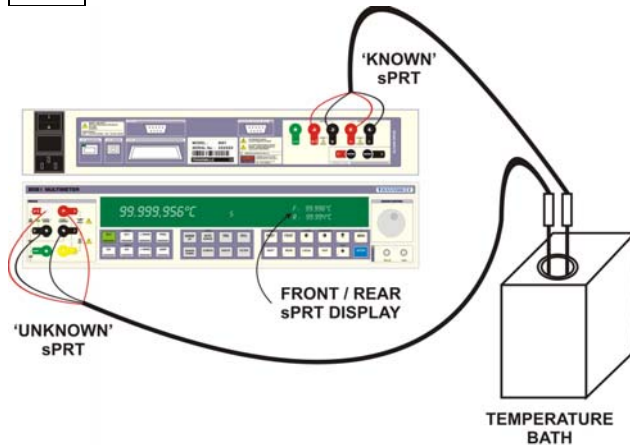

5. Select **PRIMARY DISPLAY** **AVERAGE** **FRONT** **REAR** as required

Pressure Measurement : Connection Diagram (Option)

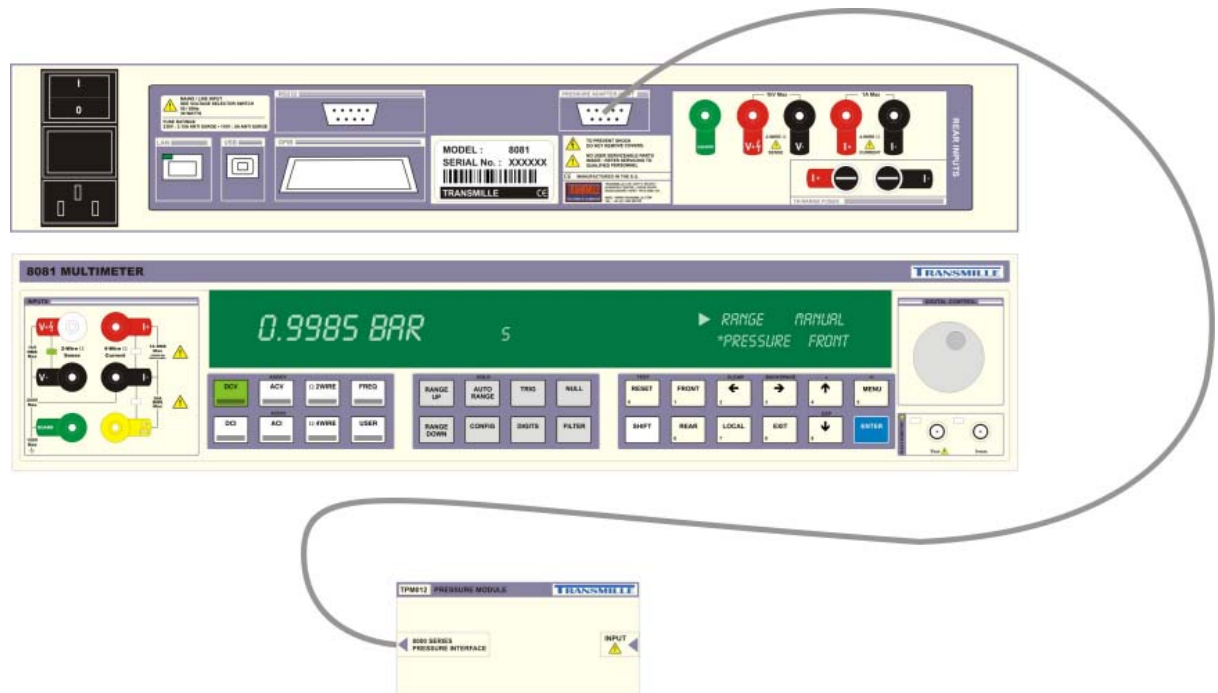

Pressure module connection

Pressure Measurement : Multimeter Setup (Option)

Press **SHIFT** then **USER** to select PRESSURE measurement.

Select **SELECT TRANSDUCER** **TPMxx**

Select **UNIT** **BAR** **PSI** **Pa** **mmHg** **cmH2O** **Atm** **kg/sq.cm** **oz/sq.in** **inHg**

Additional Settings	Description
DIGITS	Set measurement resolution
FILTER TIME	Set FILTER TIME : 250ms to 64s Dynamic Mode for Automatic filter setting based on measurement stability
ANALOGUE FILTER	Set ANALOGUE FILTER mode : ON / OFF
INPUT TERMINALS	Set INPUT TERMINALS to use : FRONT / REAR
RATIO	Set RATIO mode : ON / VALUE / OFF
READING MIN / MAX	Display READING MIN / MAX measurement data for the selected function / range
TRIGGER	AUTO / MANUAL
GUARD TO LOW	Set GUARD TO LOW mode : FLOATING / SIGNAL LOW
MATHS, NULL, dB	Set NULL : Store zero offset value Clear NULL : Clear zero offset value Set OFFSET : Add a user entered value to the measurement Set SCALE : Multiply measurement by a user entered value Clear FORMULA : Clear the formula entered (SCALE & OFFSET) See dB function for use of Set dB, dB SET ZERO & dBm REF 600 Ohms
INTERNAL TEMPERATURE	Displays the internal temperature

Shunt Measurement : Connection Diagram (Option)

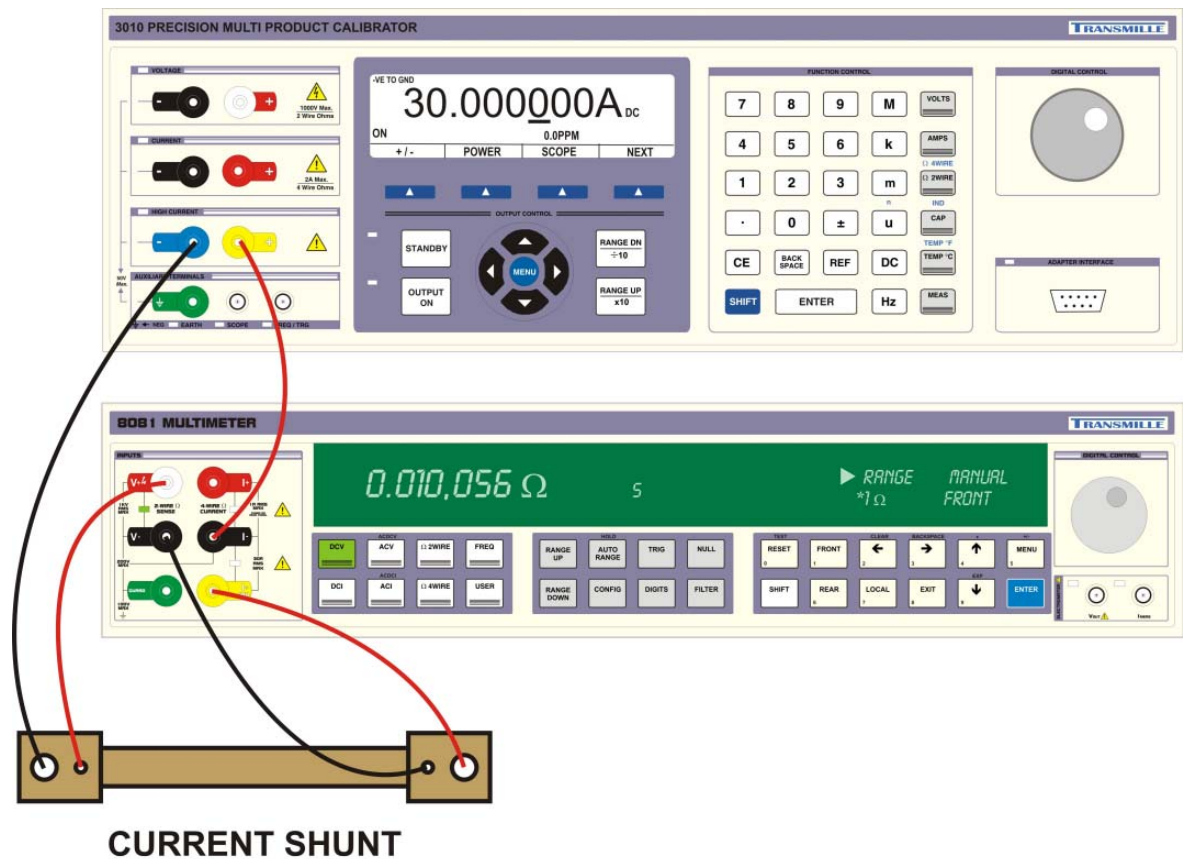

Example shunt measurement configuration using 3000 Series multi product calibrator as current source

Shunt Measurement : Multimeter Setup (Option)

The precision shunt measurement function allows accurate measurement of current shunts by monitoring the current supplied to the shunt and voltage measured across the shunt. By monitoring both the current and voltage the 8000 Series can provide an accurate measurement of the current shunt connected.

The diagram shows the connection configuration required, using a 3000 Series to provide the 30A current source and both the current and voltage measured by the 8000 Series. When SHUNT MEASUREMENT mode is selected, the 8000 Series will automatically switch between voltage and current measurement terminals in a continuous cycle until shunt mode is exited.

Press **USER** then press **→** until **SHUNT MEASUREMENT** is displayed

Press **ENTER** to select **SHUNT MEASUREMENT**

The secondary display can be used to display the separate Voltage and Current readings by using the menu dial to scroll to this display.

Additional Settings	Description
DIGITS	Set measurement resolution
FILTER TIME	Set FILTER TIME : 250ms to 64s Dynamic Mode for Automatic filter setting based on measurement stability
ANALOGUE FILTER	Set ANALOGUE FILTER mode : ON / OFF
INPUT TERMINALS	Set INPUT TERMINALS to use : FRONT / REAR
READING MIN / MAX	Display READING MIN / MAX measurement data for the selected function / range
TRIGGER	AUTO / MANUAL
VOLTAGE / CURRENT DISPLAY	Displays the measured VOLTAGE and CURRENT separately as well as the calculated WATTS on the main display
GUARD TO LOW	Set GUARD TO LOW mode : FLOATING / SIGNAL LOW
INTERNAL TEMPERATURE	Displays the internal temperature

DC Power / Dual Input V/30A (Option)

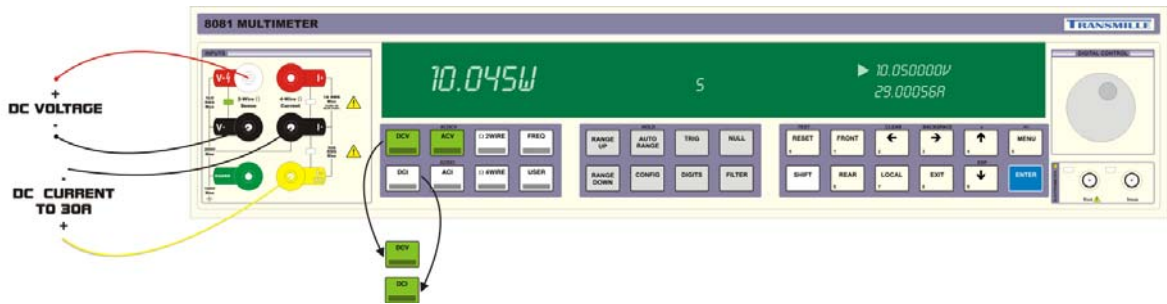

The DC Power / Dual Input V/30A function allows the 8000 Series to automatically switch between the voltage and current inputs and display a calculated value in Watts.

Press **USER** then press **→** until **DC POWER DUAL INPUT V/30A** is displayed

Press **ENTER** to select **DC POWER DUAL INPUT V/30A**

The 8000 Series will automatically switch between the Voltage and High Current Terminals, separately measuring both inputs and displaying a calculated value in Watts on the main display.

The secondary display can be used to display the separate Voltage and Current readings by using the menu dial to scroll to this display.

Additional Settings	Description
DIGITS	Set measurement resolution
FILTER TIME	Set FILTER TIME : 250ms to 64s Dynamic Mode for Automatic filter setting based on measurement stability
ANALOGUE FILTER	Set ANALOGUE FILTER mode : ON / OFF
INPUT TERMINALS	Set INPUT TERMINALS to use : FRONT / REAR
READING MIN / MAX	Display READING MIN / MAX measurement data for the selected function / range
TRIGGER	AUTO / MANUAL
GUARD TO LOW	Set GUARD TO LOW mode : FLOATING / SIGNAL LOW
VOLTAGE / CURRENT DISPLAY	Displays the measured Voltage and Current separately as well as the calculated Watts on the main display
INTERNAL TEMPERATURE	Displays the internal temperature

Using the Math Functions

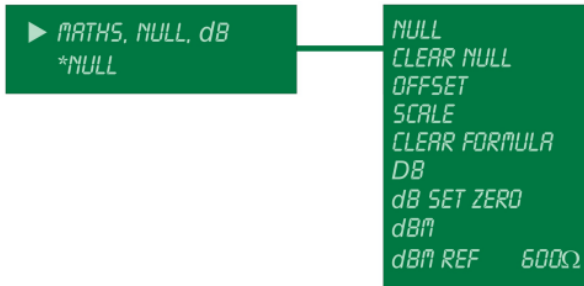

Status Display Section	Description
CLEAR NULL	Clear stored null (zero reference point)
NULL	Store latest input value as zero reference point
OFFSET	<p>Offset measured input using entered offset value</p> <p style="text-align: center;">$MX+C$</p> <p>Offset is the addition value (C) in the $MX+C$ formula</p> <p>eg. If C=0.1, then a 10V input reads 10.1V eg. If C=5, then a 10V input reads 15V</p> <p>Note : M on right hand of display indicates formula active</p> <p style="text-align: center;">10.000,000,1V DC M s</p>
SCALE	<p>Scale measured input using entered scale value</p> <p style="text-align: center;">$MX+C$</p> <p>Scale is the multiplier (x) in the $MX+C$ formula</p> <p>eg. If X=0.5, then a 10V input reads 5V eg. If X=5, then a 10V input reads 50V</p> <p>Note : M on right hand of display indicates formula active</p> <p style="text-align: center;">10.000,000,1V DC M s</p>
CLEAR FORMULA	Clear any OFFSET or SCALE settings
dB	Turns on dB measurement mode
dB SET ZERO	Store latest input value as zero dB reference point
dBm	Turns on dBm measurement mode
dBm REF	Set dBm reference point (default = 600Ω)

Remote Programming



WARNING

THE 8000 SERIES MULTIMETERS CAN MEASURE HIGH VOLTAGES UP TO 1025V AND CURRENT UP TO 30A AND MUST BE PROGRAMMED WITH DUE CAUTION.

ANY PROGRAMS SHOULD BE EXTENSIVELY TESTED TO MAINTAIN SAFE OPERATION AND INCLUDE SAFEGUARD'S SUCH AS ERROR CATCHMENT AND HANDLING TO ENSURE THAT ANY COMMANDS SENT TO THE MULTIMETER PERFORM AS EXPECTED AND ANY THAT DO NOT ARE SAFELY HANDLED TO ENSURE USER SAFETY.

WITHIN THE 8000 SERIES COMMAND LANGUAGE, RESPONSE CODES ARE INCLUDED TO DETERMINE THE OPERATIONAL STATE OF THE MULTIMETER. THESE RESPONSE CODES CAN ALSO BE USED TO DETERMINE WHETHER A COMMAND WAS RECEIVED CORRECTLY AND IN ENSURING SAFE OPERATION OF THE MULTIMETER.

Programming Commands Overview

The 8000 series is controlled by a set of simple high level commands which can be used either individually or as part of a command sequence to setup the 8000 Series multimeter to the required state.

The commands can be joined together using the / (forward slash) character.

The required terminator for the commands to be detected by the multimeter is a carriage return (ASCII character 13) and should be the last character sent on a command line

For Example :

Command1/Command2 <CR>

Where each command is represented as Commandx
(x being the command number)

and the carriage return (ASCII character 13) is represented by <CR>

All Commands are subject to change or removal.

All commands followed by Carriage Return or Line Feed (ASCII 13 or 10) or both.

Command Response Codes	
Commands (excluding Reading commands) response codes	
Successful command	*0<cr><lf>
Correct command with an incorrect input signal	*2<cr><lf>
Correct commands with incorrect parameters	*3<cr><lf>
Unauthorised command	*6<cr><lf>
Command with incorrect range	*7<cr><lf>
Unrecognised command	*9<cr><lf>

SCPI

Command words are separated by a colon. A space is required between the command words and the parameters. Command words are not case sensitive.

Command	Format	Parameters
Transmit Reading	READ?	
	*TRG	
Select AC Voltage Range	RANGE:AC:VOLTAGE<space> <value> RANGE:AC:VOLT<space> <value>	value = 0.01 to 1000
Select DC Voltage Range	RANGE:DC:VOLTAGE<space> <value> RANGE:DC:VOLT <space><value>	value = 0.1 to 1000
Select AC Current Range	RANGE:AC:CURRENT <space><value> RANGE:AC:CURR<space> <value>	value = 10^{-4} to 30
Select DC Current Range	RANGE:DC:CURRENT <space><value> RANGE:DC:CURR<space> <value>	value = 10^{-8} to 30
Select 4-Wire Resistance	RANGE:FRES<space> <value> RANGE:FRESISTANCE<space> <value>	value=1 to 10^7
Select 4-Wire Resistance Low measurement current	RANGE:FRES:LOWI<space> <value> RANGE:FRESISTANCE:LOWI<space> <value>	value=100 to 10,000
Select 2-Wire Resistance	RANGE:RES <space><value> RANGE:RESISTANCE <space><value>	value=1 to 10^{12}
Select 2-Wire Resistance Low measurement current	RANGE:RES:LOWI<space> <value> RANGE:RESISTANCE:LOWI<space> <value>	value=100 to 10,000
		value may be modified by SI Prefixes: n, u, m, k, M, G, T. Exponent notation should be used for numbers less than 10^{-7} (1.0E-7)
Identification String	*IDN?	

Example Commands (where <CR> denotes Carriage Return (ASCII 13)) :

Required Output	Range Command	Output Value	Command Separator	Filter Command	Terminator (Carriage Return)
1V DC @ 2s Filter	RANGE:DC:VOLT	1	/	F4	<CR>
10V AC @ 4s Filter	RANGE:AC:VOLT	10	/	F5	<CR>
100mA DC @ 500ms Filter	RANGE:DC:CUR R	0.1	/	F2	<CR>

General

Command	Format	Parameters
Transmit Next Reading	T	
Transmit Currently Displayed Reading	t	
Use Rear Terminals	r	
Use Front Terminals	f	
Set Range	R<Range Number>	Range Number = 1 to 70
Set Filter Range	F<Filter Range>	Filter Range = 1 to 9 for filter times 250ms,500ms,1s,2s,4s,8s, 16s,32s,64s Filter Range
Dynamic Filter	FD<n>	ON: n=1 OFF: n=0
Set Digits	D<Digits>	Digits = 4 to 8
Show Status	s	
Set Null	n	
Clear Null	N	
Display Date	a	
Version Information	v	
Internal Temperature	TEMP?	
Thermocouple	RANGE:THERMOCOUPLE:<TC_TYPE> <space><cold_junction> where TC_TYPE = {B,E,J,K,N,R,S,T}	<cold_junction> = {-273 to 1800}°C or {AUTO,A,a}
PRT (ITS 90 Linearisation)	RANGE:PRT:ITS<space> <probe>	probe = {{f,front},{r,rear},{d,dual}}
PRT (IEC751 Linearisation)	RANGE:PRT:IEC<space> <probe> RANGE:PRT<space> <probe>	probe = {{f,front},{r,rear},{d,dual}}
Electrometer Voltage	ELECTROMETER:VOLTAGE <space><voltage>	voltage = {50,100,150,200,250,300}

Setup

Command	Format	Parameters
Display Brightness	B<Display><Brightness>	Display = {1,2} Brightness = {0,1,2,3}
Enter Password	k<Password>	Password = 1 to 10 digits User-changeable Calibration Password Fixed Setup Password Fixed Cal Password
Set Password	K<Password>	Password = 1 to 10 digits
Leave Password-protected mode	k0	
Set GPIB Address	COMMUNICATE:GPIB:ADDRESS <space><address>	Address = {1-30}
Set Date (Requires System Password or Unlocked Instrument)	A<Date>	Date = DDMMYY

Calibration

Command	Format	Parameters
Enter Password	k<Password>	Password = 1 to 10 digits
Set Password	K<Password>	Requires calibration mode to be active

If a command includes a value which cannot be set due to, for example, the value being higher than the range maximum, the multimeter will reject the command and stay set as it is (the multimeter will return a *9 code).

The multimeter will respond to the commands sent with the response codes as detailed at the beginning of this section. These codes can be used to ensure that potentially hazardous conditions are clearly indicated to the operator and to maintain control of these outputs. This allows the multimeter to be returned to a safe state once the testing required has been completed.

This functionality is employed within the ProCal calibration software from Transmille to allow safe operation of the multimeter. Commands that change the calibration memory require the correct calibration password to be sent.

Command	Format	Parameters
Set positive Cal Factor	CP	Input signal limits 70-130%
Set negative Cal Factor	CN	Input signal limits 70-130%
Set zero Cal Factor Set AC 20% Cal Factor	CZ	DC: Input signal limits -5 to 5%, value=0 AC: Input signal limits 5 to 30%, Value=20%
Calibrate to Value	CV <value>	value = value of input signal in current range units Positive value sets positive cal factor Negative value sets negative cal factor Value Limits: 50-150% of range Input signal limits: 50-150% (Except AC 1kV 10-150%) (AC 30A 10-150%)
Calibrate Zero Factor to Value	CA <value>	value = value of input signal in current range units Value Limits: -5 to 50% of range Input signal limits: -5 to 50%
Set electrometer voltage output calibration factor (adjusts voltage output) Stored once. Calibrate at 300V	CALIBRATE:ELOUTPUT <space> <value>	value = measured electrometer voltage output limits: [Electrometer Voltage] ±25V
Set electrometer correction calibration factor (adjusts resistance calculation) Stored for each voltage setting	CALIBRATE:ELMEASURED <space> <value>	value = measured electrometer voltage output limits: [Electrometer Voltage] ±25V
Read back electrometer correction calibration factor	CALIBRATE:ELMEASURED <space> ?	

Calibration

Calibration Overview

To adjust the 8000 Series multimeter the multimeter can either be connected to a computer via the available interfaces. Calibration constants stored within the multimeter can then be adjusted using the built-in menus via the 8000 Series front panel. To prevent unauthorised access to calibration menus, a password is required before access is granted. Adjustment can be completed without disassembly of the multimeter.

**WARNING**

**The information in this section is intended only for qualified personnel.
The user must at all times be adequately protected from electric shock.**

Each function e.g. DC voltage, AC Current, Resistance etc. has several ranges. Each range has one or more calibration constants. See table below.

The 8000 Series allows any calibration constant to be adjusted independently of any other, therefore it is possible to adjust a single range without needing to adjust any other points. Altering the calibration constants directly changes the multimeter measurement. Adjusting the multimeter simply involves changing the constant until the output reads correctly.

Entering Calibration Mode

Press **MENU**

Press 

Enter password (default = Model Number, ie. 8081 or 8071)

Press **ENTER**

Multimeter will display **CAL PASSWORD OK** if successful

The calibration menus will change depending on the selected function :

Function	Menus Available	Notes
DC Voltage DC Current	Calibration Zero Calibration +ve Full Scale Calibration -ve Full Scale Value <range units> Reset	Set zero calibration point Set +FS calibration point Set -FS calibration point Calibrate FS to set value Reset range to default points
AC Voltage AC Current	Calibration 20% FS Calibration +ve Full Scale Value <range units> Reset	Set 20% FS calibration point Set +FS calibration point Calibrate FS to set value Reset range to default points
		<p>Frequency Response points* :</p> <p>1kHz (Reference Frequency)**</p> <p>10Hz 23Hz 40Hz 56Hz 106Hz 206Hz 2kHz 1kHz** 10kHz 20kHz 35kHz 50kHz 75kHz 100kHz 200kHz 400kHz 700kHz 1MHz</p> <p>* Max. Frequency dependant on range</p> <p>** 1kHz reference frequency point MUST be set up first</p>
Resistance 2 Wire Resistance 4 Wire	Calibration Zero Calibration +ve Full Scale Value <range units> Reset	Set zero calibration point Set +FS calibration point Calibrate FS to set value Reset range to default points

Example 1 : DC Voltage 10V Range

Calibration Point	Actions
DC Voltage ZERO	Apply low thermal shorting link Select Calibration Zero Press ENTER
DC Voltage +ve Full Scale	Apply +10V signal Select +ve Full Scale Press ENTER
DC Voltage -ve Full Scale	Apply -10V signal Select -ve Full Scale Press ENTER

Example 2 : AC Voltage 10V Range

Calibration Point	Actions	Frequency Points
AC Voltage 20% FS	Apply 20% FS signal (2V) Select 20% Full Scale Press ENTER	
AC Voltage +ve Full Scale	Apply +10V signal Select +ve Full Scale Press ENTER	Frequency Response points* : 1kHz (Reference Frequency)** 10Hz 23Hz 40Hz 56Hz 106Hz 206Hz 2kHz 1kHz** 10kHz 20kHz 35kHz 50kHz 75kHz 100kHz 200kHz 400kHz 700kHz 1MHz
		* Max. Frequency dependant on range ** 1kHz reference frequency point MUST be set up first



Linearity is inherent within the design of the D to A in the multimeter and does not require adjustment.

General Maintenance

**WARNING**

**The information in this section is intended only for qualified personnel.
The user must at all times be adequately protected from electric shock.**

The 8000 series multimeters maintenance requirements are listed below. Please note that the multimeter does not require any regular internal servicing or adjustment.

- 1) Electrical Safety Checks on Line power lead and case**
- 2) Cleaning the external case**

Electrical Safety Tests

These can be carried out as frequently as required. Earth bond and insulation can be tested as a class 1 standard. Flash testing is not recommended due to the possibility of damage to internal components.

Cleaning the external case

Use a damp cloth with a mild water based cleaner for the outside case and front panel. Do not use alcohol based cleaners or solvents and do not spill or allow liquid to enter the case.

Guarantee and service

Transmille Ltd. guarantees this instrument to be free from defects under normal use and service for a period of 1 year from purchase. This guarantee applies only to the original purchaser and does not cover fuses, or any instrument which, in Transmille's opinion, has been modified, misused or subjected to abnormal handling or operating conditions.

Transmille's obligation under this guarantee is limited to replacement or repair of an instrument which is returned to Transmille within the warranty period. If Transmille determines that the fault has been caused by the purchaser, Transmille will contact the purchaser before proceeding with any repair.

To obtain repair under this guarantee the purchaser must send the instrument in its original packaging (carriage prepaid) and a description of the fault to Transmille at the address shown below. The instrument will be repaired at the factory and returned to the purchaser, carriage prepaid.

Note :

TRANSMILLE ASSUMES NO RESPONSIBILITY FOR DAMAGE IN TRANSIT

THIS GUARANTEE IS THE PURCHASER'S SOLE AND EXCLUSIVE GUARANTEE AND IS IN LEIU OF ANY OTHER GUARANTEE, EXPRESSED OR IMPLIED. TRANSMILLE SHALL NOT BE LIABLE FOR ANY INCIDENTAL, INDIRECT, SPECIAL OR CONSEQUENTIAL DAMAGES OR LOSS.



Transmille Ltd.
Unit 4, Select Business Centre
Lodge Road
Staplehurst
Kent
TN12 0QW
United Kingdom

Tel : +44 0 1580 890700
Fax : +44 0 1580 890711

E-Mail : sales@transmille.com
Web : www.transmille.com



Transmille Ltd.
Unit 4, Select Business Centre
Lodge Road
Staplehurst
Kent.
TN12 0QW
United Kingdom.

Tel : +44 0 1580 890700
Fax : +44 0 1580 890711

Email : sales@transmille.com
Web : www.transmille.com

8000 Series Fax Back Form

Your 8000 Series Precision Multimeter is fitted with a *security system* which requires a *security code* to be entered to allow continued operation of the unit beyond the 65 Day evaluation period.

Please complete the following details :

Company Name : _____

Contact Name : _____

Address : _____

Country : _____

Tel. : _____

Fax : _____

Instrument Model : 8000 Series Multimeter

Serial Number : _____

Please Fax This Form To : +44 (0) 1580 890711

On receipt of this fax Transmille will, on receipt of payment for the multimeter, send details of the security code with details on how to enter this code.