

# TOS/TOM/TOL

## Analog and non-indicating type, set temperature by dial

### ■ Features

- Non-indicating type
- Setting temperature by Dial
- Includes burn out function
- Universal power : TOS



**⚠ Please read "Caution for your safety" in operation manual before using.**



### ■ Ordering information

**T O S - B 4 R P 4 C**

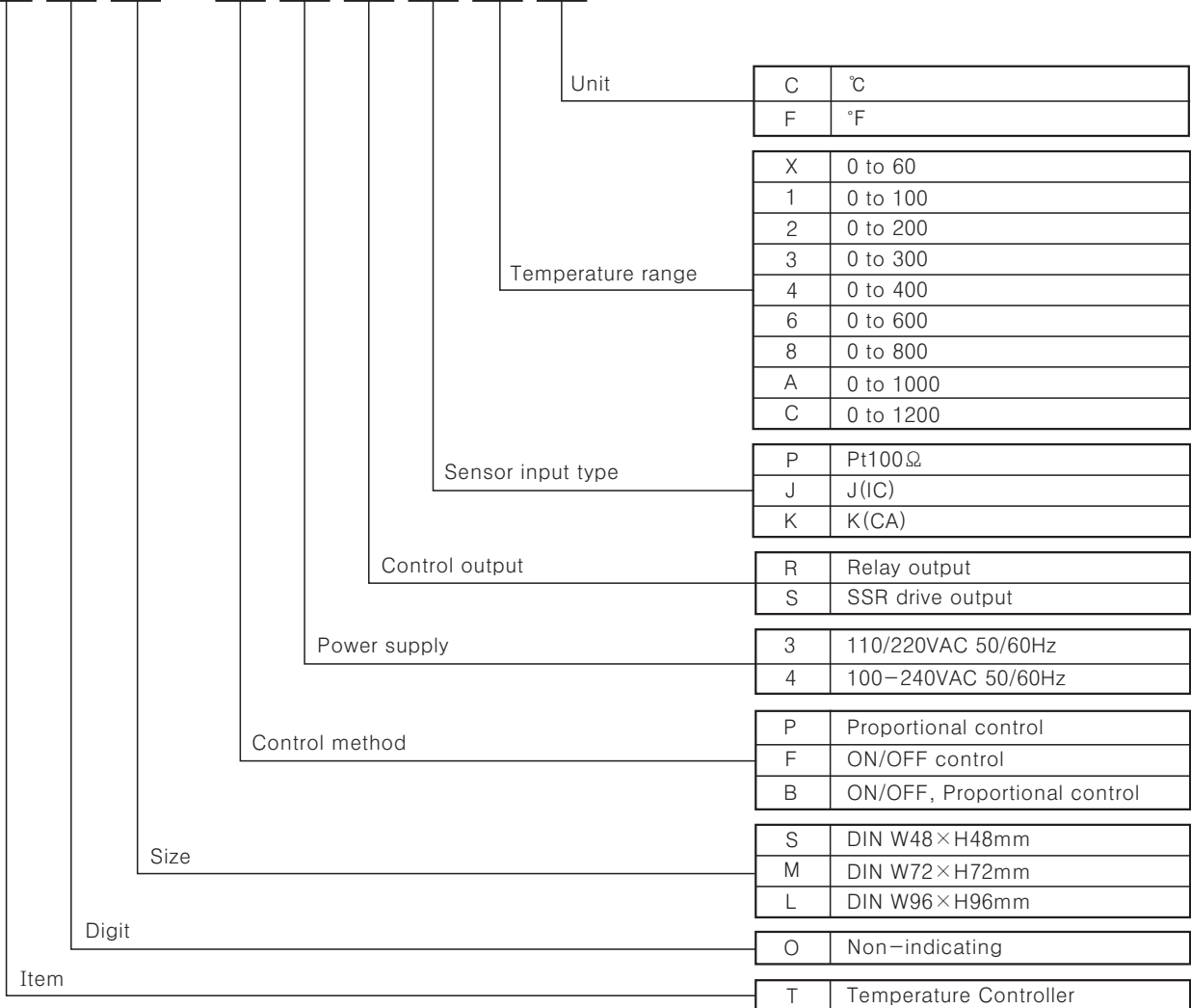

※ See H-104 about sensor temperature range for selection.

# Analog Setting Non-Indicating Type

## Temperature range for each sensor

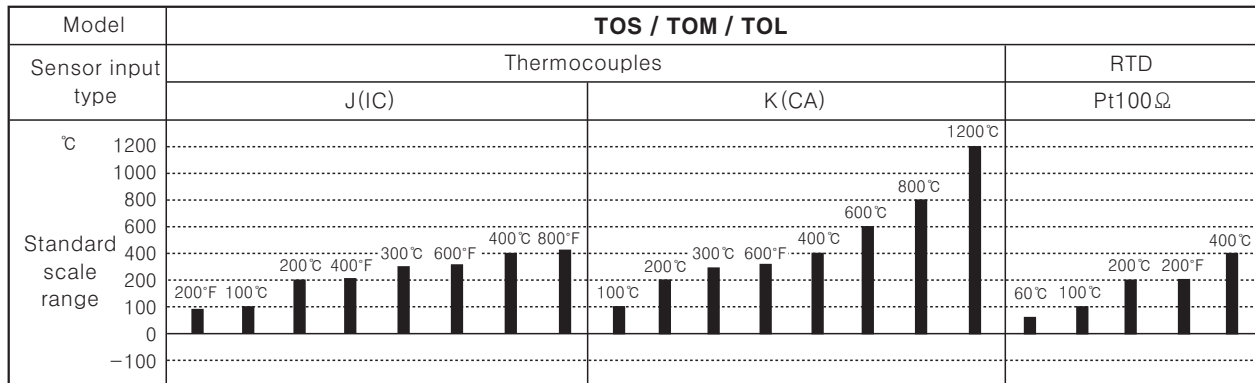

## Specifications

Model	TOS	TOM	TOL
Power supply	100-240VAC 50/60Hz	110/220VAC 50/60Hz	
Allowable voltage range	90 to 110% of rated voltage		
Power consumption	2.2VA	3VA	
Display method	LED ON	LED ON/OFF	
Setting type	Dial setting		
Setting accuracy	F · S ±2%		
Sensor input	Thermocouples : K(CA), J(IC) / RTD : Pt100Ω		
Input line resistance	Thermocouples : Max. 100Ω, RTD : Max. 5Ω per a wire		
Control method	ON/OFF	Hysteresis : F · S 0.5 ±0.2% fixed	
	Proportional	Proportional band : F · S 3% fixed, Period : 20sec. fixed	
Control output	<ul style="list-style-type: none"> <li>Relay output : 250VAC 2A 1c</li> <li>SSR drive output : 12VDC ±3V Load 20mA Max.</li> </ul>	<ul style="list-style-type: none"> <li>Relay output : 250VAC 3A 1c</li> <li>SSR drive output : 12VDC ±3V 20mA max.</li> </ul>	
Self-diagnosis	Built-in burn out function		
Insulation resistance	Min. 100MΩ (at 500VDC megger)		
Dielectric strength	2000VAC 50/60Hz for 1 minute		
Noise strength	±1kV the square wave noise (pulse width : 1μs) by the noise simulator		
Vibration	Mechanical	0.75mm amplitude at frequency of 10 to 55Hz in each of X, Y, Z directions for 1 hour	
	Malfunction	0.5mm amplitude at frequency of 10 to 55Hz in each of X, Y, Z directions for 10 minutes	
Shock	Mechanical	300m/s <sup>2</sup> (Approx. 30G) 3 times at X, Y, Z direction	
	Malfunction	100m/s <sup>2</sup> (Approx. 10G) 3 times at X, Y, Z direction	
Relay life cycle	Mechanical	Min. 10,000,000 times	
	Electrical	Min. 100,000 times (250VAC 3A at resistive load)	
Ambient temperature	-10 to 50°C (at non-freezing status)		
Storage temperature	-20 to 60°C (at non-freezing status)		
Ambient humidity	35 to 85%RH		
Approval		_____	_____
Unit weight	Approx. 104g	Approx. 419g	Approx. 426g

\*F.S is same with sensor measuring temperature range.

Ex) In case of using temperature is from 0 to 800°C, Full scale is "800".

(A)	Photo electric sensor
(B)	Fiber optic sensor
(C)	Door/Area sensor
(D)	Proximity sensor
(E)	Pressure sensor
(F)	Rotary encoder
(G)	Connector/Socket
(H)	Temp. controller
(I)	SSR/Power controller
(J)	Counter
(K)	Timer
(L)	Panel meter
(M)	Tacho/Speed/Pulse meter
(N)	Display unit
(O)	Sensor controller
(P)	Switching power supply
(Q)	Stepping motor & Driver & Controller
(R)	Graphic/Logic panel
(S)	Field network device
(T)	Production stoppage models & replacement

# TOS/TOM/TOL

## Connections

※RTD(Resistance Temperature Detector) : Pt 100Ω(3-wire type) ※ Thermocouple : K, J, R

### ●TOS

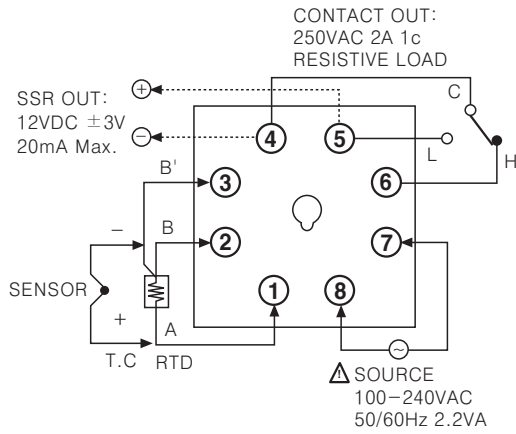

### ●TOM

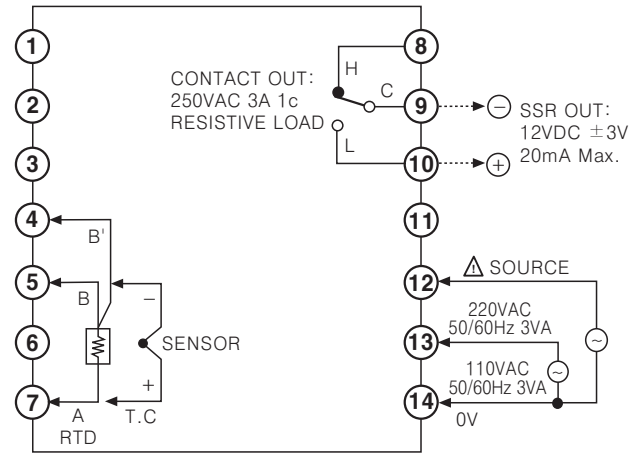

### ●TOL

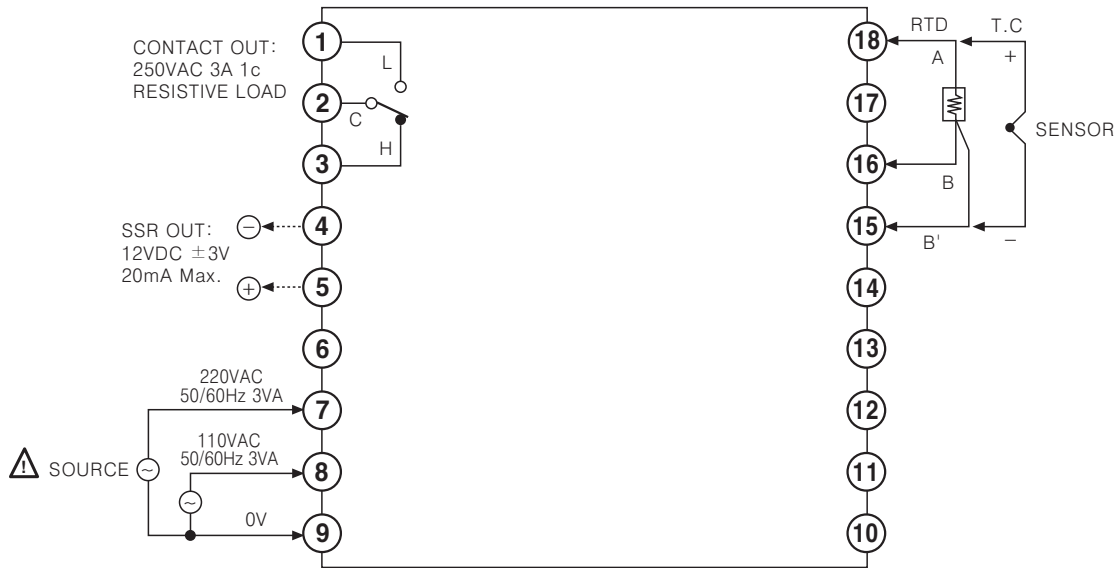

## Dimensions

### ●TOS

#### ●Bracket

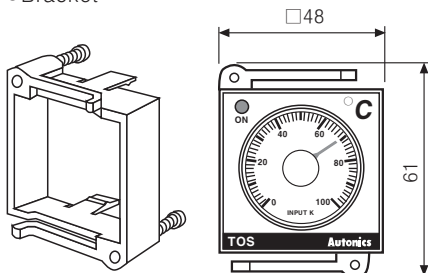

#### ●Panel cut-out

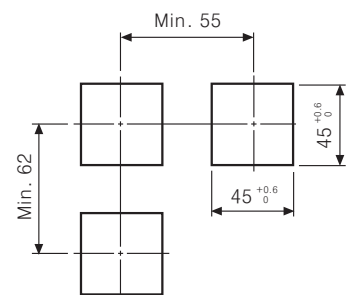

※Socket : PG-08, PS-08(Sold separately)

(Unit:mm)

# Analog Setting Non-Indicating Type

## Dimensions

### ●TOM

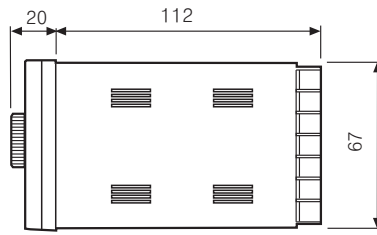
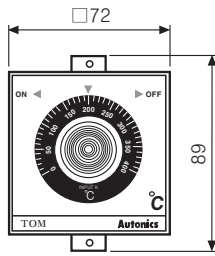

### ●Panel cut-out

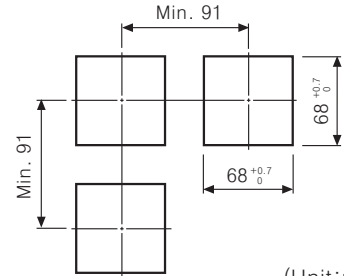

(Unit:mm)

### ●TOL

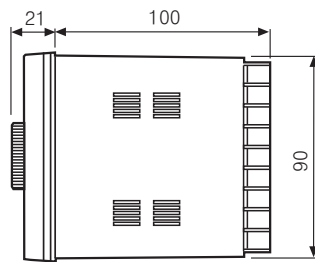
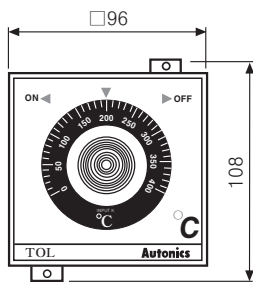

### ●Panel cut-out

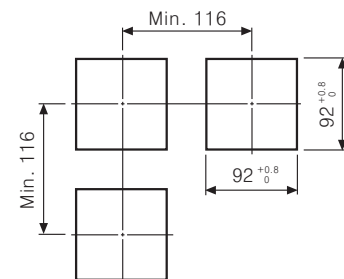

(Unit:mm)

## Proper usage

### ◎Application of temperature controller and load connection

#### ●SSR output

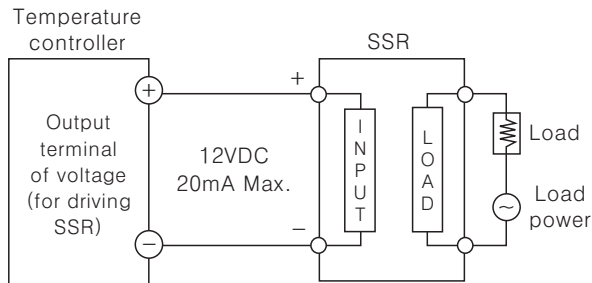

#### ●Relay output

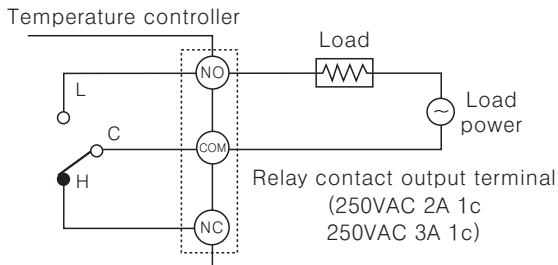

### ◎Normal/Reverse operation

Reverse operation executes to output ON when processing value is lower than setting value, and it is used for heating.

Normal operation is executed conversely and used for cooling.

(This item runs as a reverse operation.)

※Refer to H-130 for ◎Caution for using and ◎Simple "Error" diagnosis.

### ◎How to select ON/OFF or proportional by plug pin

Factory specification is proportional control. When using ON/OFF control, transfer the switch of control method from P to F after detaching the case from its body.

Note) Several models require to change control method by jump line or solder.

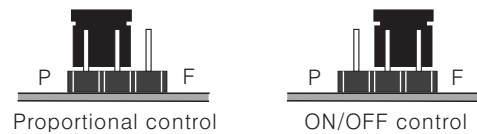

### ◎Case detachment

#### ●TOM, TOL

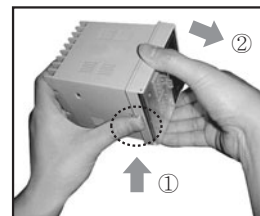

Pressing the front guide of Lock toward ① and squeeze and pull toward ②, it is detached.

#### ●TOS

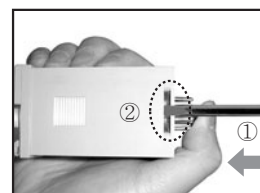

Pressing Pin plug ①, raise it up with a driver as ② and it is detached.

(A) Photo electric sensor

(B) Fiber optic sensor

(C) Door/Area sensor

(D) Proximity sensor

(E) Pressure sensor

(F) Rotary encoder

(G) Connector/Socket

(H) Temp. controller

(I) SSR/Power controller

(J) Counter

(K) Timer

(L) Panel meter

(M) Tacho/Speed/Pulse meter

(N) Display unit

(O) Sensor controller

(P) Switching power supply

(Q) Stepping motor & Driver & Controller

(R) Graphic/Logic panel

(S) Field network device

(T) Production stoppage models & replacement