



# THC Series Temperature and Humidity Controller

## Specification and Operating Instructions

### • Dependent ON/OFF control

If  $rh8=ono$  and  $rh0=dEP$ , output 3 works as in Independent ON/OFF control, but output 4 works as follows:  
If  $ch3=dir$ , output 4 will connect when  $HS \geq Sh1+Sh2+rh2$  and will disconnect when  $HS \leq Sh1+Sh2$ .

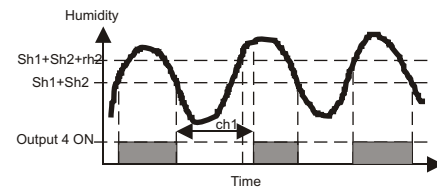

If  $ch3=inv$ , output 4 will connect when  $HS \leq Sh1+Sh2-rh2$  and will disconnect when  $HS \geq Sh1+Sh2$ .  
 $ch1$  is the minimum stop time.

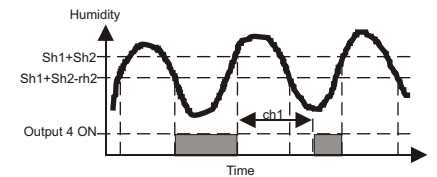

### • Neutral zone control

If  $rh8 = NEu$  output 3 connects when  $HS \geq Sh1+rh3$  and disconnects when  $HS \leq Sh1$ , while output 4 connects when  $HS \leq Sh1-rh3$  and disconnects when  $HS \geq Sh1$ .

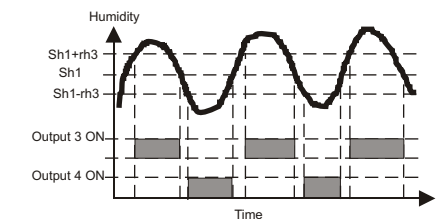

### • Control with probe errors

If reading of humidity probe fails the output 3 works following 10 minutes cycles, with a percentage of connection time given by  $Ch4$ . Output 4 is carried out in the same way with parameter  $Ch5$ .

### • Humidity alarms

If  $HS \geq Sh1+Ah1$ , the controller will indicate maximum humidity alarm for (AHH) and the alarm will remain activated until  $HS \leq Sh1+Ah1-Ah0$ .

If  $HS \leq Sh1-Ah2$ , the controller will activate minimum humidity alarm for (ALH), and it will remain activated until  $HS \geq Sh1-Ah2-Ah0$ .

Program  $Ah3$  to indicate the alarm check time between alarm event and indication of an alarm event. The alarm is indicated by a message on the display and activating the alarm output if present (alarm can be silenced pressing UP+DOWN keys or CLEAR in the IR remote control).

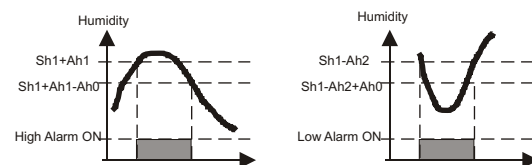

### • Probe options

If the probe is not placed in the exact point to control, use a standard hygrometer to determine the offset and set it by  $Ph0$ . Set  $Ph1$  to select if the decimal point is shown or not in the display.  
Set  $Ph2$  to set the probe type (0-1V, CRPH03 or 4-20mA).  
If a 4-20mA probe is used, use  $Ph3$  to set the humidity value for 4mA and  $Ph4$  to set the value for 20mA.

### General parameters

$H1, H2, H3$  are general parameters that can be accessed from both temperature and humidity parameters.  
Setting  $H1$  to YES the set points ( $St1, St2, Sh1, Sh2$ ) cannot be changed. To unblock this protection, press SET T or SET H for 8 seconds and introduce the code in the same way as is done when entering parameters.  
 $H2$  sets the communication address for the controller.  
 $H3$  sets the access code to parameters.

### Led indication and display messages

The four **OUT** leds indicate the of the four outputs (when the correspondent led is ON the output is connected and when the led is OFF the output is disconnected).

In normal operation, the left display will show the temperature measured by probe 1 and the right display the relative humidity. In order to display the temperature measured by probe 2 press SET T + UP keys.

In case of alarm or error, the following messages can be shown:

- Err = Memory reading error
- ErrP = Error in the temperature probe 2
- AHt = High temperature alarm (probe 1)
- ALt = Low temperature alarm (probe 1)
- AHh = High humidity alarm
- ALh = Low humidity alarm
- ooo = Open Probe Error
- --- = Short Circuit Probe Error

### Maintenance, cleaning and repair

After final installation of the unit, no routine maintenance is required.

Clean the surface of the display controller with a soft and damp cloth. Never use abrasive detergents, petrol, alcohol or solvents.

All repairs must be made by authorised personnel.



### Wiring Diagram

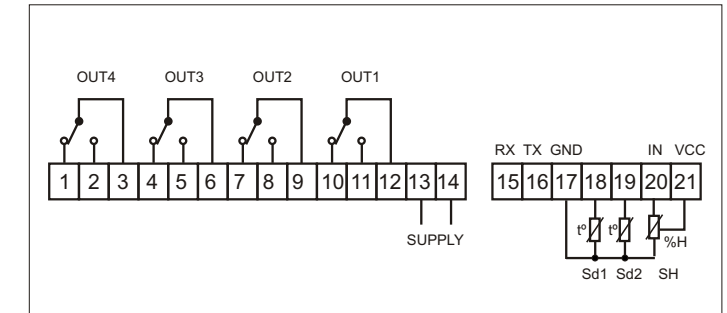

### Description

The THC is a temperature and humidity digital controller. The temperature control can be ON-OFF, neutral zone and refrigeration modes. It is possible to set a second temperature probe for defrosting control. Humidity control can be ON-OFF and neutral zone modes. The humidity probe can be 0-1V, 0-3V THC-P and 4-20mA types.

### Model references

The model reference is given by: THC-YZ

Each suffix can take the following values:

Y	Supply Voltage	1=115VAC, 2=230VAC
Z	Temp. Units	0=°F, 1=°C

### Installation

**NOTE:** Unit must be mounted away from vibration, impacts, water and corrosive gases.

- Cut hole in panel 131 x 101 mm (5.15 x 3.97 inches).
- Remove the rear cover to wire the unit.
- The wiring diagram is shown in the unit label.
- Apply silicone (or rubber gasket) around the perimeter of the hole to prevent leakage.
- Insert the unit in the panel hole.
- Replace the rear cover.
- Place removable fitting clips from the back of the unit it is secured to the panel.
- Fit the clip in the panel and then press to fit the other side in the unit.

Temperature Probe 1 (Sd1) in terminals 18 - 17  
Temperature Probe 2 (Sd2) in terminals 19 - 17  
Humidity Probe (SH) in terminals 20-21-17

• Note: DO NOT INSTALL PROBE CABLES NEAR POWER CABLES.

### Technical Data

<b>Supply voltages</b>	115 VAC10%, 230 VAC10%
<b>Supply powers</b>	7VA (230V)
<b>Storage temperature</b>	-20°C to 80°C (-4 to 176°F)
<b>Operating temperature</b>	0°C to 70°C (32 to 158°F)
<b>Temperature probe</b>	PTC1000 (25°C - 1000 Ohm)
<b>Temperature probe range</b>	-50°C to 150°C (-58 to 302°F)
<b>Temperature accuracy</b>	Better than 0,5% of full scale
<b>Temperature resolution</b>	0.1° (3 digits)
<b>Humidity probe</b>	0-1V, 0-3V THC-P, 4-20mA
<b>Humidity probe range</b>	0 to 100% RH
<b>Humidity accuracy</b>	Better than 5% of full scale
<b>Humidity resolution</b>	1% (3 digits)
<b>Displays</b>	3-digit and sign (x2)
<b>Outputs</b>	SPDT relay 250Vac 8A RL
<b>Dimensions</b>	134x105x61mm (5.3x4.1x2.4 in)
<b>Front Protection</b>	IP65

LOVE CONTROLS DIVISION  
DWYER INSTRUMENTS, INC.  
P.O. BOX 338 - MICHIGAN CITY,  
INDIANA 46361, U.S.A.

Phone: 219/879-8000 www.love-controls.com  
Fax: 219/872-9057 e-mail:love@love-controls.com  
Lit-By Fax: 888/891-4963

LOVE CONTROLS DIVISION  
DWYER INSTRUMENTS, INC.  
P.O. BOX 338 - MICHIGAN CITY,  
INDIANA 46361, U.S.A.

Phone: 219/879-8000 www.love-controls.com  
Fax: 219/872-9057 e-mail:love@love-controls.com  
Lit-By Fax: 888/891-4963

## List of temperature parameters

	Description	Units	Range
St1	Temperature set point 1	Degrees	rt4 to rt6
St2	Temperature set point 2	Degrees	rt5 to rt7
rt0	St1 and St2 dependency	Range	Ind / dEP
rt1	Differential for St1	Degrees	0.1 to 20.0
rt2	Differential for St2	Degrees	0.1 to 20.0
rt3	Band differential	Degrees	0.1 to 20.0
rt4	Minimum value for St1	Degrees	-99.9 to rt6
rt5	Minimum value for St2	Degrees	-99.9 to rt7
rt6	Maximum value for St1	Degrees	rt4 to 302
rt7	Maximum value for St2	Degrees	rt5 to 302
rt8	Operation mode	Range	ono/rEF/nEU
dt0	Defrosting type	Range	fRES/InV
dt1	Max. defrosting temperature	Degrees	-99.9 to 302
dt2	Max. defrosting time	Minutes	0 to 240
dt3	Defrosting interval time	hh:mm	0.0 to 18.0
dt4	Defrosting displayed temp.	Range	off/on/-d-
At0	Alarm differentials	Degrees	0.1 to 20.0
At1	Maximum probe 1 alarm	Degrees	0.1 to 99.9
At2	Minimum probe 1 alarm	Degrees	0.1 to 99.9
At3	Alarm check time	hh:mm	0.0 to 18.0
ct0	Minimum stop time output 1	Minutes	0 to 240
ct1	Minimum stop time output 2	Minutes	0 to 240
ct2	Operation output 1	Range	Dir/Inv
ct3	Operation output 2	Range	Dir/Inv
ct4	Default operation output 1	%ON	0 to 100
ct5	Default operation output 2	%ON	0 to 100
ct6	Continuous cycle time	Minutes	0 to 240
Pt0	Temp. probe adjustment	Degrees	-20.0 to 20.0
Pt1	Decimal point	Option	no/yES
Pt2	Temperature units	Range	°C/°F
Pt3	Number of temp. probes	Range	1 / 2
H0	Set default settings	Command	
H1	Keypad protection	Option	no/yES
H2	Communication setup	Numeric	0 to 999
H3	Access code to parameters	Numeric	0 to 999

## Temperature parameter programming

**Set Points (St1, St2) are the only parameters the user can access without code protection.**

- Press SET T. Current value of St1 appears flashing and led OUT 1 flashes.
- The value can be modified with the UP and DOWN arrows.
- Press SET again to confirm St1. Current value of St2 appears flashing and led OUT 2 flashes.
- The value can be modified with the UP and DOWN arrows.
- Press SET to enter St2 value and exit.

**Access to all code protected parameters.**

- Press SET T for 8 secs. The access code value 0 is shown on the display (unit comes with code set at 0 from factory).
- Select the correct code with the UP and DOWN arrows.
- Press SET T to enter the code. If the code is correct, the first parameter label is shown on the display (St1).
- Move to the desired parameter with the UP and DOWN.
- Press SET T to view the value on the display.
- The value can be modified with the UP and DOWN arrows.
- Press SET to enter the value.
- Repeat until all necessary parameters are modified.
- Press SET and DOWN at the same time to quit programming or wait one minute and the display will automatically exit programming mode.

*\*The keyboard code can be reset to ZERO by turning off the controller and turning it on again while keeping the SET T key depressed.*

### Set default settings

- Access parameter H0 as explained. 0 will appear.
- Press SET T or SET H for 8 seconds. Pro will appear on the display if the Set Point is correct and Epr will appear if it is not correct.
- Press SETT+DOWN or SETH+DOWN to exit or wait 1 minute.

## Temperature control process

### • Independent ON/OFF control

If rt8=ono and rt0=Ind, each output is associated to a particular Set. If ct2=dir, output 1 will connect when  $TS1 \geq St1+rt1$  (where TS1 is the temperature of probe 1) and will disconnect when  $TS1 \leq St1$ .

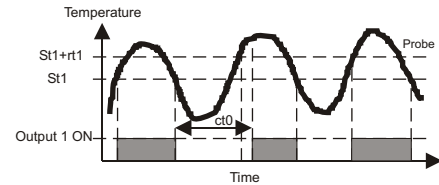

ct0 is the minimum stop time. Once the output is disconnected, it is not connected again until ct0 minutes later.

If ct2=Inv, output 1 will connect when  $TS1 \leq St1-rt1$  and will disconnect when  $TS1 \geq St1$ .

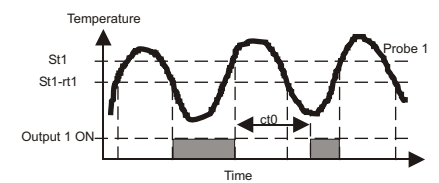

The output 2 is handled in the same manner but controlled by St2, using rt2 as differential, ct3 as indicator of direct or reverse connection, and ct1 as minimum stop time.

### • Dependent ON/OFF control

If rt8=ono and rt0=dEP, output 1 works as in Independent ON/OFF control, but output 2 works as follows: If ct3=dir, output 2 will connect when  $TS1 \geq St1+St2+rt2$  (where TS1 is the temperature of probe 1) and will disconnect when  $TS1 \leq St1+St2$ .

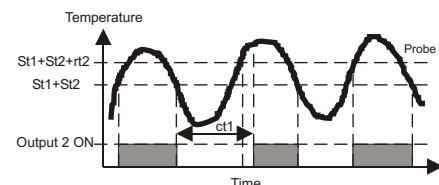

ct1 is the minimum stop time.

If ct3=Inv, output 2 will connect when  $TS1 \leq St1+St2-rt2$  and will disconnect when  $TS1 \geq St1+St2$ .

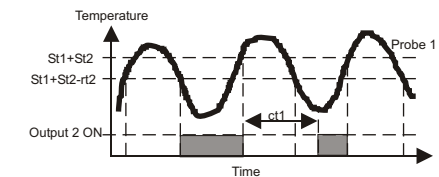

### • Cooling control

If rt8=rEF the temperature is regulated by output 1 as in ON/OFF control, while defrosting is triggered by output 2.

Three defrosting methods are available:

1. Switch off the compressor (dt0=re)
2. Switch off the compressor and connect a heat resistor to output 2 (dt0=re)
3. Switch on the compressor and connect an electro-valve to output 2 to reverse the cycle (dt0=in)

Defrosting is performed at time periods indicated by dt3. If dt3 is zero, no defrosting is performed periodically. Defrosting is deactivated when TS2 (temperature of probe 2) reaches dt1 value or when the maximum defrosting time dt2 is reached.

Defrosting can also be activated and deactivated from the keypad, pressing the UP arrow for 8 seconds, or IR remote control. Defrosting can not be activated if a continuous cold cycle is activated, unit is in auxiliary adjustment mode,  $TS2 \geq dt1$  or  $dt2=0$ . With dt4 parameter we can choose that during the defrosting and one hour after a message -d- is displayed until the temperature raises the initial defrosting temperature. It is also possible to show the initial temperature during the defrosting or to show the actual temperature all the time.

### • Continuous cold cycle

A continuous cold cycle maintains the compressor (output 1) in operation for a period of time given by ct6. These cycles are activated from the keypad, keeping the DOWN arrow pressed for 8 seconds, and end when the time is finished or an order is given from the keypad (pressing DOWN for 8 seconds again). The cycle will not commence if the unit is in heat control mode or in auxiliary adjusting mode (due to memory failure) or if defrosting is activated.

### • Neutral zone control

If rt8 = NEU output 1 connects when  $TS1 \geq St1+rt3$  and disconnects when  $TS1 \leq St1$ , while output 2 connects when  $TS1 \leq St1-rt3$  and disconnects when  $TS1 \geq St1$ .

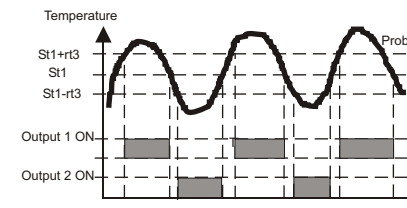

### • Control with probe errors

If reading of probe 1 fails the output 1 works following 10 minutes cycles, with a percentage of connection time given by Ct4. Output 2 is carried out in the same way with parameter Ct5. If reading of probe 2 fails, the defrosting ends by time.

### • Temperature alarms

If  $TS1 \geq St1+At1$ , the thermostat will indicate maximum temperature alarm for probe1 (Aht) and the alarm will remain activated until temperature  $TS1 \leq St1+At1-At0$ .

If  $TS1 \leq St1-At2$ , the thermostat will activate minimum temperature alarm for probe 1 (ALt), and it will remain activated until temperature  $TS1 \geq St1-At2-At0$ .

Program At3 to indicate the alarm check time between alarm event and indication of an alarm event. The alarm is indicated by a message on the display and activating the alarm output if present (alarm can be silenced pressing SETT+DOWN keys or CLEAR in the IR remote control).

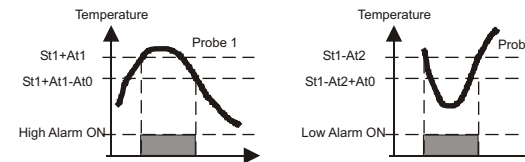

### • Probe options

Set Pt1 to select if the decimal point is shown or not in the display.

Set Pt2 to set temperature units (Celsius of Fahrenheit).

If the probe is not placed in the exact point to control, use a standard thermometer to determine the offset and set it by Pt0.

Set Pt3 to select if 1 or 2 temperature probes are used.

## List of humidity parameters

	Description	Units	Range
Sh1	Humidity set point 1	%RH	rh4 to rh6
Sh2	Humidity set point 2	%RH	rh5 to rh7
rh0	Sh1 and Sh2 dependency	Range	Ind / dEP
rh1	Differential for Sh1	%RH	0.1 to 30.0
rh2	Differential for Sh2	%RH	0.1 to 30.0
rh3	Band differential	%RH	0.1 to 30.0
rh4	Minimum value for Sh1	%RH	0 to rh6
rh5	Minimum value for Sh2	%RH	0 to rh7
rh6	Maximum value for Sh1	%RH	rh4 to 100
rh7	Maximum value for Sh2	%RH	rh5 to 100
rh8	Operation mode	Range	ono/nEU
Ah0	Alarm differential	%RH	0.1 to 20.0
Ah1	Maximum probe alarm	%RH	0.1 to 99.9
Ah2	Minimum probe alarm	%RH	0.1 to 99.9
Ah3	Alarm check time	hh:mm	0.0 to 18.0
ch0	Minimum stop time output 3	Minutes	0 to 240
ch1	Minimum stop time output 4	Minutes	0 to 240
ch2	Operation output 3	Range	Dir/Inv
ch3	Operation output 4	Range	Dir/Inv
ch4	Default operation output 3	%ON	0 to 100
ch5	Default operation output 4	%ON	0 to 100
Ph0	Hum. probe adjustment	%RH	-20 to 20
Ph1	Decimal point	Option	no/yES
Ph2	Humidity Probe type	Range	1V/3V/420
Ph3	Value for 4mA	%RH	0.0 to 100
Ph4	Value for 20mA	%RH	0.0 to 100
H0	Set default settings	Command	
H1	Keypad protection	Option	NO/YES
H2	Communication setup	Numeric	0 to 999
H3	Access code to parameters	Numeric	0 to 999

## Humidity parameter programming

Follow the same steps as when adjusting temperature parameters but using the SET H key.

## Humidity control process

### • Independent ON/OFF control

If rh8=ono and rh0=Ind, each output is associated to a particular Set.

If ch2=dir, output 3 will connect when  $HS \geq Sh1+rh1$  (where HS is the humidity measured) and will disconnect when  $HS \leq Sh1$ .

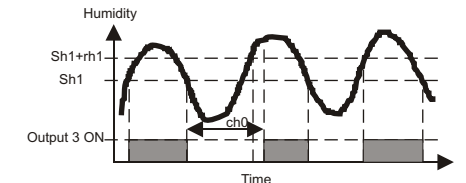

ch0 is the minimum stop time. Once the output is disconnected, it is not connected again until ch0 minutes later.

If ch2=Inv, output 3 will connect when  $HS \leq Sh1-rh1$  and will disconnect when  $HS \geq Sh1$ .

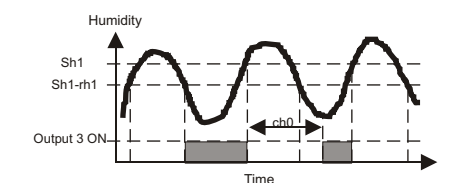

The output 4 is handled in the same manner but controlled by Sh2, using rh2 as differential, ch3 as indicator of direct or reverse connection, and ch1 as minimum stop time.