



# setraFLEX

## Installation & Operation Guide

**Setra Systems, Inc.**

159 Swanson Road, Boxborough, MA 01719

800.257.3872 • [www.setra.com](http://www.setra.com)



© 2018 Setra Systems, Inc.

BACnet is a registered trademark of the American Society of Heating, Refrigerating, and Air-Conditioning Engineers (ASHRAE).

The material in this document is for information purposes only and is subject to change without notice. Setra Systems assumes no responsibility for any errors or for consequential damages that may result from the use or misrepresentation of any of the material in this publication.

# Table of Contents

1.0 Introduction .....	4
1.1 Intended Use .....	4
1.2 Home Screen .....	5
1.3 BACnet Networking .....	8
2.0 Rough-in Installation .....	8
2.1 Required Parts to be Supplied by the Installer .....	8
2.2 Parts Included with Your Order .....	8
2.3 Unboxing the Unit .....	9
2.4 Installation Overview .....	10
3.0 Operation .....	16
3.1 Initial Unit Setup .....	16
3.2 Device Configuration .....	16
3.3 Network .....	17
3.4 Inputs/Outputs .....	17
3.5 Control .....	22
3.6 Room .....	28
3.7 Room Remote Duplicate Display .....	30
3.8 Room Profile .....	31
3.9 Display .....	32
3.10 Alarms .....	33
3.11 Security .....	34
3.12 Diagnostics .....	34
3.13 Maintenance .....	36
4.0 Troubleshooting .....	39
5.0 Returns .....	40
6.0 Warranty and Limitation of Liability .....	40
7.0 Support .....	44



### 1.0 Introduction

The Setra FLEX™ provides a flexible room environmental control and monitoring solution in a simple-to-use package. An attractive flush-mount faceplate is complemented by an intuitive graphical display to meet any architectural requirement. The unit supports 3 rooms, monitoring up to 6 parameters for each room. An optional differential pressure sensor can be either factory-installed in the unit or ordered separately and installed above the ceiling. Integration with building automation systems is made easy through either BACnet/IP or BACnet MS/TP network protocols.

The modular design permits the unit to fit in a variety of wall thicknesses, from as little as 50 mm (1.97") to 88.9 mm (3.5"). Either on-board or external sensors are high accuracy 0.25% of full-scale differential pressure transducers.

FLEX software comes in two configurations; monitor-only (RM = room monitor), or monitor and control (RC = room controller). Model RM will not have any control features enabled for use. Model RC will have both monitor and control features enabled, offering either Proportional-Integral (PI) loop control or network command of VAV boxes, venturi valves, hydronic reheat valves, or other equipment that responds to voltage or milliamp signals or network commands, respectively.

FLEX is fully-configurable on-site via simple menu commands via the touch-screen, and requires no

programming. FLEX can also be configured over the BACnet network once basic network communications is established. A third option for configuration is to use the USB cloning feature, which permits the configuration from a single master unit to be used as a template for all subsequent units. Two levels of password protection and a faceplate lock provide security from unauthorized use or tampering.

### 1.1 Intended Use

FLEX is designed to monitor and control critical environments, such as hospital operating rooms, isolation rooms, compounding pharmacies, and other spaces that require room pressure control and directional airflow. Additional critical environments include laboratories, vivariums, pharmaceutical manufacturing, clean rooms, or any enclosed space where managed room pressure (positive or negative) is desired. Up to 3 rooms are supported by 1 FLEX unit.

FLEX RM will monitor and provide both visual and audible alarms on any of 6 configured room parameters, such as pressure, temperature, relative humidity, air changes per hour (ACH), plus 2 user-defined parameters. FLEX RC contains all the functionality of FLEX RM, but adds PI control or network control of HVAC equipment.

## 1.2 Home Screen

The FLEX home screen is the view that will be continuously displayed to the end-user, ensuring room environmental conditions are clearly visible to indicate personal safety. The screen is designed to display key room parameters, and enable touch-screen operation when changes in room conditions are needed, when additional information is desired, or if alarms need to be acknowledged. Elements of the screen are described below.



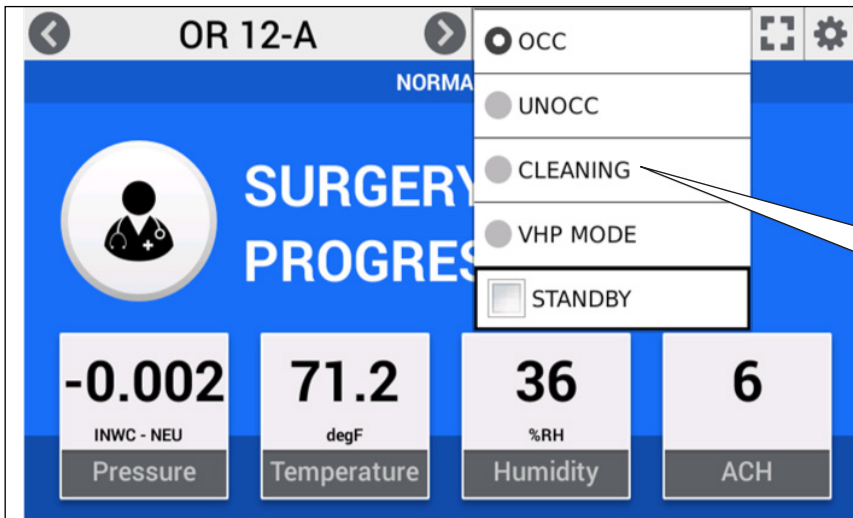

Room profiles. Define room conditions and their related monitor and control setpoints. Text is user-defined

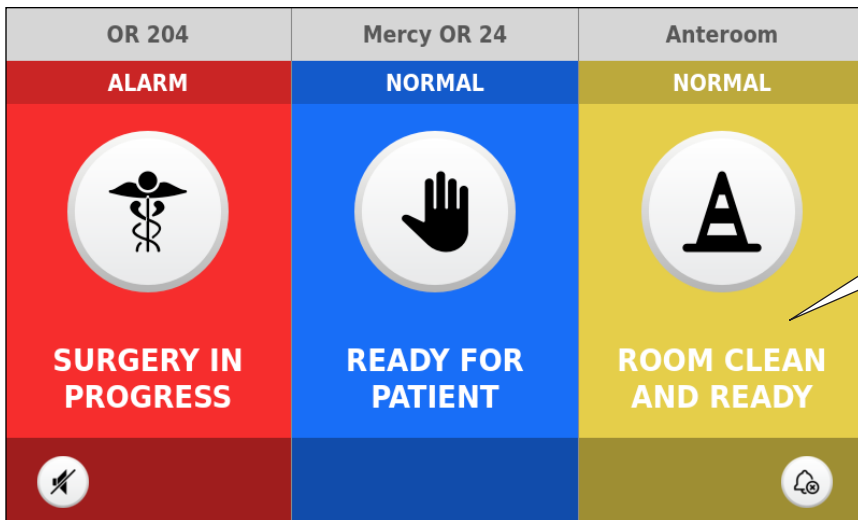

Full screen mode shows all rooms configured on a single screen, and any alarm or door conditions that are active, including an ability to silence or acknowledge.

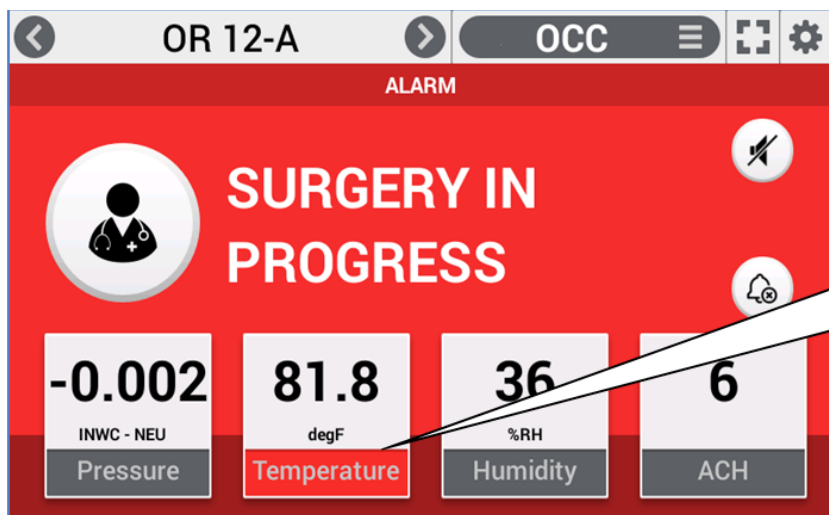

If a badge is in alarm, its background will turn red, as will the main screen

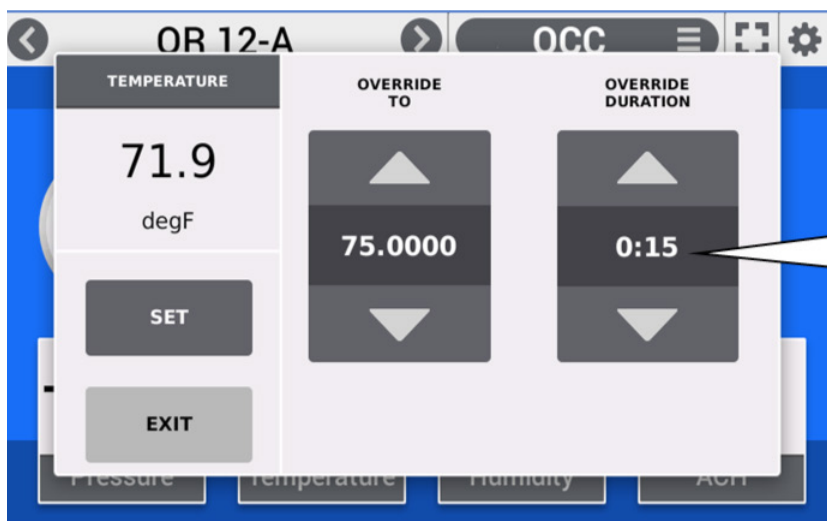

FLEX RC enables setpoint control and override duration. Press the badge that has been set up for control to access this pop-up screen

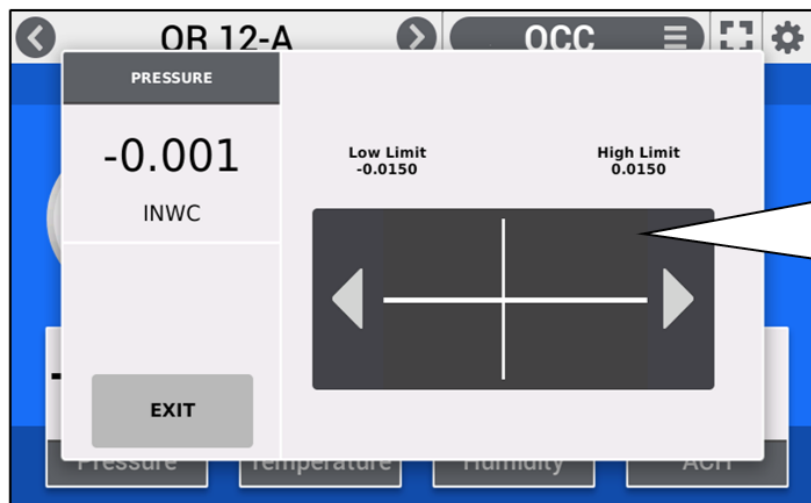

FLEX RM, or using FLEX RC with no control enabled, will show where each badge's sensor reading is within defined alarm thresholds. Press the badge to access this pop-up screen.

## 1.3 BACnet Networking

FLEX communicates on BACnet networks, an ASHRAE/ANSI standard building automation protocol. FLEX supports both BACnet MS/TP and BACnet/IP, allowing either protocol to be field-selected for installation. Connection to the network is then achieved using either 3-wire RS-485 connector or the RJ-45 Ethernet jack on the rear of the FLEX housing.

FLEX contains approximately 470 BACnet objects with read/write properties. Nearly all functionality that can be set or configured using the FLEX touch-screen can also be achieved by reading or writing BACnet objects over the network. Exceptions include password changes, firmware upgrades, and restore to factory defaults.

For more information on BACnet, refer to Section 4 – BACnet Integration.

## 2.0 Rough-in Installation

For FLEX to be installed correctly, the rough-in phase of the project must be completed properly. This section will outline the specific considerations the General Contractor must pay attention to so that the final wiring and commissioning will go smoothly.

During rough-in installation there are several options for installation, depending on whether FLEX was ordered with on-board or external pressure transducers (or no pressure sensors at all). Field wiring will be the same, regardless of pressure sensor presence or location.

### 2.1 Required Parts to be Supplied by the Installer

The following is a list of parts required and supplied by the installer for Setra FLEX RM or FLEX RC:

- Triple-gang electrical box (typically called a “masonry” box) available from most electrical supply houses
- Single-deep metal box – used only if FLEX has no on-board pressure sensor
- Garvin TB-325, Madison MSB3G, or equivalent
- Double-deep metal box – used with FLEX ordered with on-board pressure sensor
- Garvin TB-335-G, RACO 697, Appleton M3-350, or equivalent
- Power (18 AWG recommended) and signal wire (22 AWG recommended), as needed.
- 0.25" (6 mm) O.D. flame retardant polyethylene control tubing (such as CPChem UL 1820) to run from the room(s) Pressure Pickup Ports to the FLEX monitor or external sensors. Maximum 250 feet (76.2 meters) length.
- Pressure tubing T-connectors

- EMT conduit (if required by local code)
- 24 VAC transformer, capacity VA rated for number of FLEX units powered
- 250 ohm resistors, if wiring inputs for 4-20 mA current loops
- Door switch SPDT or SPST normally-open, as required
- Remote pressure transducers, Setra Model 264 or 267, as needed
- Single-gang electrical box, one per Pressure Pickup Port

### 2.2 Parts Included with Your Order

The following parts are included with your order:

- Setra FLEX main unit
- On-board pressure transducer (if on-board specified on order)
- External pressure transducers (if external specified on order)
- Integral FLEX faceplate
- Pressure Pickup Ports, quantity specified in original order
- 0.25" O.D. final connection tubing with integrated springs and attached brass barbed couplings, quantity 2
- Mounting screws, 6-32 x 1/2 Phillips head, quantity 5
- Mating electrical connectors, Phoenix Contact MC plug kit adapting I/O screw terminals to FLEX unit.



### 2.3 Unboxing the unit

Setra FLEX comes packaged with pink security tape holding the display and base unit together for handling and wiring. Keep this tape in place until the unit is ready to be mounted in the wall.



With the pink security tape still in place, hold the unit to the rough-in mounting box and make final wiring and plumbing connections.

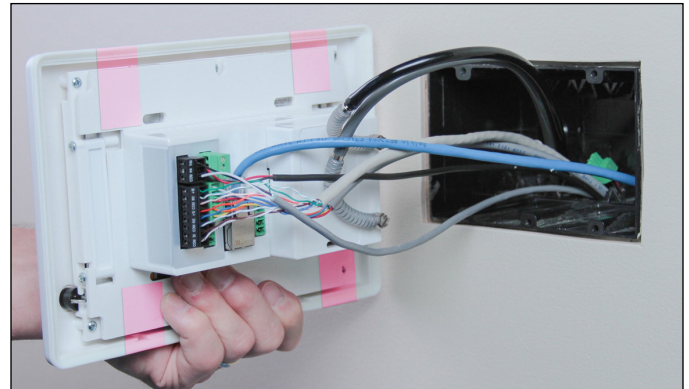

Now remove the pink security tape, and let the display hang below the base unit. With the final connections in place, push the FLEX unit into the rough-in box, taking care not to crimp tubing or damage wires.



Secure the FLEX base unit into the electrical box with the four (4) mounting screws provided. Allow the FLEX display to hang below the mounting box, taking care so that the display does not get damaged by tools.



## 2.4 Installation Overview

Each FLEX unit comes complete per order specifications to provide a full room environment monitoring solution for pressure, temperature, relative humidity, air change rate, and two user-defined parameters. Support for up to 3 rooms is included with each FLEX product. Installation proceeds via the steps noted below, with variations depending on order configuration.

1. Install 3-gang electrical box for FLEX main unit. Box depth requirement varies depending on whether an on-board sensor is factory-installed.
2. Install 1-gang electrical box for each Pressure Pickup Port, either horizontal ceiling-mounted or vertically mounted high on a wall surface.
3. Ensure electrical boxes are level and flush to the finished wall surface.

**Note: Surface mount adapter boxes are available for installation where cutting into the wall is not possible (Setra P/N 229973 for FLEX units without on-board pressure sensor; Setra P/N 229971 for FLEX units with on-board pressure sensor).**

### With On-board Pressure Sensing

- Install room-side and reference-side Pressure Pickup Ports, which sense and transmit pressure measurement to the FLEX unit.
- Run tubing to FLEX electrical box, being careful not to crimp tubing in conduit or within walls.
- Run all wiring and network connections to the FLEX electrical box

### With External Pressure Sensing

- Install room-side and reference-side Pressure Pickup Ports, which sense and transmit pressure measurement to the FLEX unit.
- Mount external transducers (Setra model 264 or 267) in a NEMA enclosure or other suitable location that enables convenient access for commissioning and servicing.
- Run tubing to external transducers, being careful not to crimp tubing anywhere across the run.
- Run external transducer output signal wires, remaining wiring and network connection to the FLEX electrical box.

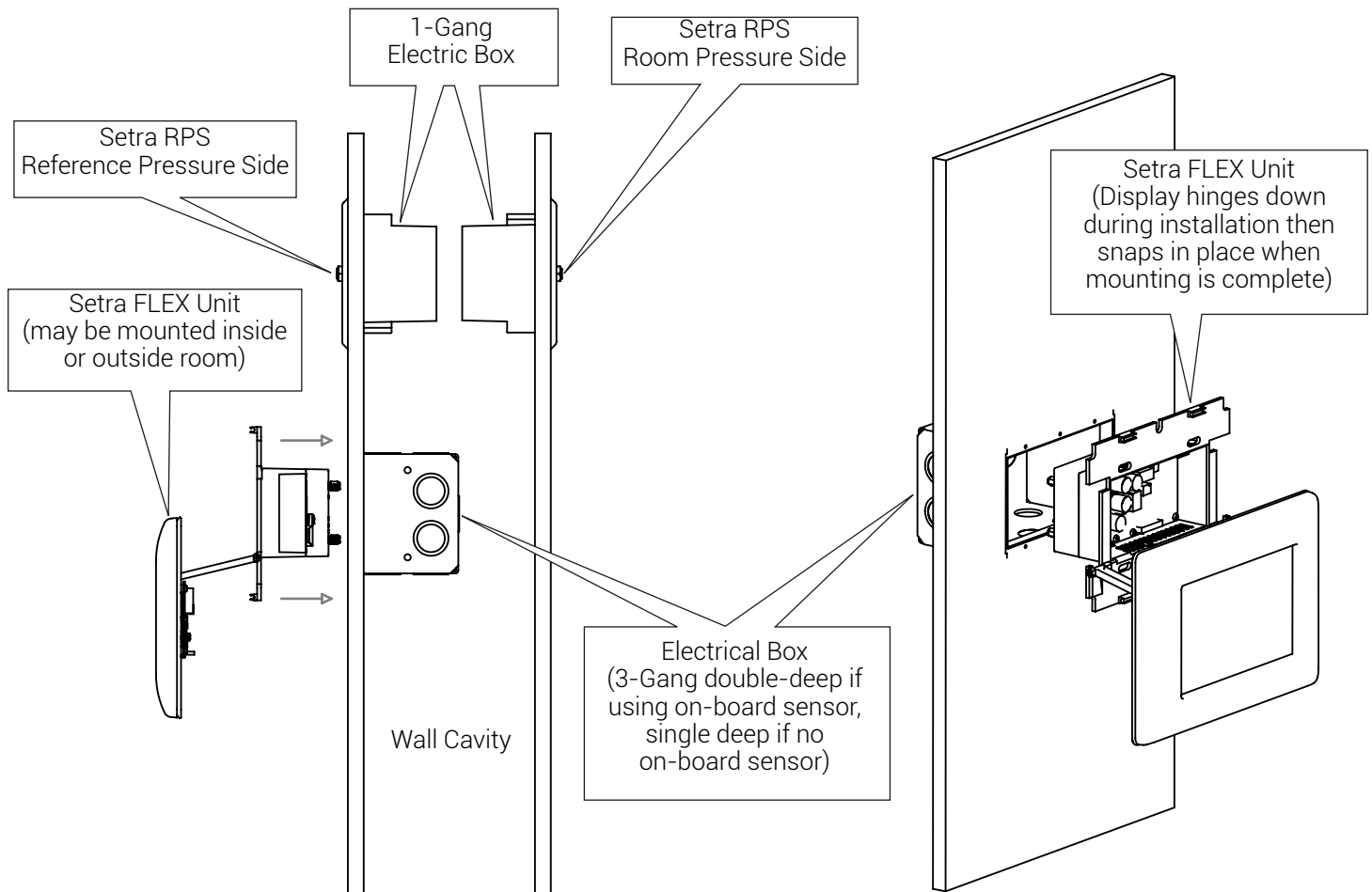

### Network-only Mapping BACnet Objects

FLEX is able to take any sensor input as a network variable by binding BACnet objects from third-party BAS controllers (or any BACnet source). This network access to sensors can be used in addition to, or in lieu of hard-wiring sensors to the FLEX unit. For example, a pressure sensor wired to a third-party controller may map the pressure output signal to a BACnet object in that controller. This BACnet object may then be mapped to FLEX via configuration settings. In a similar manner, variables from temperature, relative humidity, air changes per hour, and other variables can be mapped to FLEX for display and alarming on the home screen. The end-user can choose up to six networked sensors to show on the display.

### Plumbing

For either on-board or external sensors, typically a Pressure Pickup Port is installed in the primary monitored room and another one is installed in the reference area (typically a hallway). 0.25" nylon tubing is typically used to bring the pressure signal from this point of measurement to the pressure fittings on the back of the pressure sensor. A single reference area may be used to serve several rooms, as long as the reference area is in the intended adjacent space for the differential pressure reading. In this manner, tubing from a single Pressure Pickup Port can have several "T" junctions for additional tubing runs to the LOW side of each sensor (one, two, or three sensors supported by FLEX).

Installing a single gang electrical box anywhere inside the room, typically high on the wall or flush-mounted to the ceiling is appropriate. This will be used for the room pressure signal (room pressure port is labeled HIGH and reference port is labeled LOW). Run 0.25" tubing from this electrical box to the on-board or external sensor used with FLEX.

Attach pressure tubing as follows for final connections:

- Install the supplied silicone tube (with integrated external spring) and attached barbed tube adapter onto the end of the 0.25" field tubing.
- For the ROOM side, push the open end of the soft silicone tubing onto the on-board or external sensor HIGH port.
- For the REFERENCE side, push the open end of the soft silicone tubing onto the on-board or external sensor LOW port.

### Location of Pressure Pickup Ports

Caution should be taken to locate Pressure Pickup Ports at least six (6) feet from air turbulence that may originate from air supply diffusers, slot diffusers, mobile equipment cooling fans, or other devices that may exhaust air in the direction of the ports. Air velocity blowing directly on these ports can cause inaccurate pressure measurement.

### Surface Mounting on Wall

For installations where inserting the unit into the wall is not possible, mount the optional adapter box to allow installation of the Setra FLEX unit (Setra P/N 229973 for FLEX units without on-board pressure sensor. Setra P/N 229971 for FLEX units with on-board pressure sensor).

- Align the adapter box appropriately, mark and drill four holes for plastic sheet rock anchors using a 3/16" diameter drill bit.
- Gently tap the sheet rock anchors into place
- Align adapter box to sheet rock anchors and fasten adapter box to wall using four screws (provide in the optional adapter box kit).
- Mount the Setra FLEX unit onto the adapter box

# Setra FLEX Operating Instructions

## Considerations to Avoid Kinked or Damaged Tubing

Pull tubing runs in a manner that protects the tubing from being damaged, cut, or crimped. Any break or bend in the tubing may affect the integrity of the pressure signal. DO NOT TIGHTEN STRAIN RELIEFS at the electrical boxes so that they crimp the tubing. Leave the strain reliefs open enough so that the tubing can slide in and out of the box with a few inches of play. Prior to use, tape the open ends of the tubes closed to prevent contamination during construction.

During final installation of the Pressure Pickup Ports, use the included clear spring-wound adapters between the nylon wall tubing and the back of the Pressure Pickup Port, (as shown below). This will ensure when the port is mounted to the wall that the tubing assembly does not crimp inside the electrical box. Careful observation should be made of how the tubing gets pushed back into the wall for final faceplate mounting.

In a similar manner, mount remaining Pressure Pickup Ports and the FLEX unit if using an on-board sensor.



## Use of External Pressure Sensors

If FLEX is being used exclusively with external pressure sensors, or in combination with an on-board sensor, the external sensors require no tubing runs to the FLEX unit itself. Instead, the external sensors will be separately mounted, plumbed and wired. Only the wire for the analog output of that sensor(s) will be run to the FLEX unit.

## Wiring the FLEX Main Unit

The back of the FLEX unit has terminal blocks labeled with their function. Universal inputs, marked "UI" will be configured for either Analog Inputs or Digital Inputs in the FLEX configuration setup.

### Power

The 3-pin power connection for FLEX is labeled "PWR" on the rear of the unit.

1. Pull off the removable PWR terminal block
2. Connect the 24 VAC lines to L1 and L2
3. Connect a ground wire to the ground terminal (if provided)
4. Push the removable terminal block back into the PWR connection

FLEX operates at 18-30 VAC, 50/60 Hz, and consumes 10 W nominal, 13 W maximum.

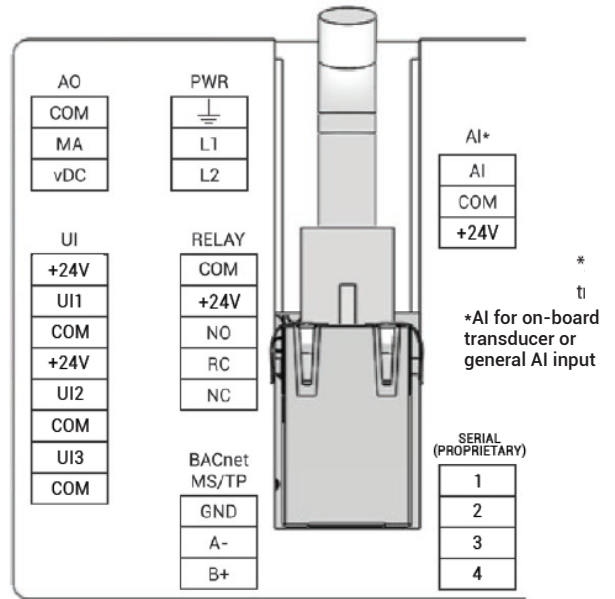

## BACnet MS/TP Detail

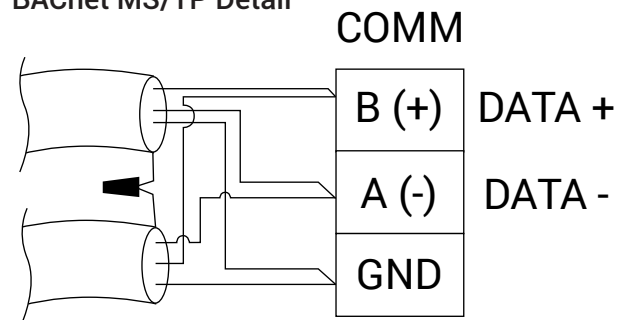

If live power is already turning on FLEX, power can be removed from FLEX by removing the J3 jumper on the unit. This can be done by hand (pictured below), or carefully with non-conductive pliers. Normally, FLEX is continuously powered and this jumper does not need to be accessed.

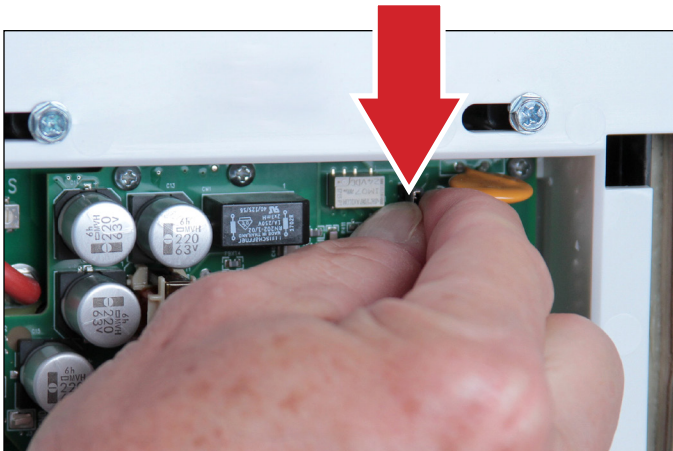

### Universal Inputs (3) and Analog Input (1)

There are three (3) Universal Inputs (UI) on the FLEX main unit, and one Analog Input (AI). The AI is used for the on-board pressure sensor. If the factory-installed pressure sensor is present, the AI is unavailable for other wired sensors. The UI can be configured in software as either Digital Inputs (DI) or AI.

### Using the Universal Inputs as Analog Inputs

When the UI are configured as AI, sensors that output a voltage or milliamp (mA) signal can be used. Supported signals are 0-5 V, 0-10 V, and 4-20 mA. These sensors can be for temperature, relative humidity, CO<sub>2</sub>, lumens, etc.

Two 24 VDC excitation terminals are available on the UI to power up to two pressure sensors or other desired devices. One 24 VDC excitation terminal is available on the AI (provided the on-board sensor is not present). These terminals can source 90 mA maximum combined. They are labeled "+24V" on the terminals. Connect this to the positive excitation terminal of the desired sensor.

### Using the Universal Inputs as Digital Inputs

Any of the UI terminals can be configured as DI, and then configured accordingly in FLEX setup screens. It is common for a DI to be used as a door-open indicator, fan status, pressure switch across filter, duct static pressure switch, or other type of dry contact. Normally-open (NO) or Normally-closed (NC) states are supported.

When the DI is configured for door-open indication, FLEX will display a round door indicator on the home screen (shown below).

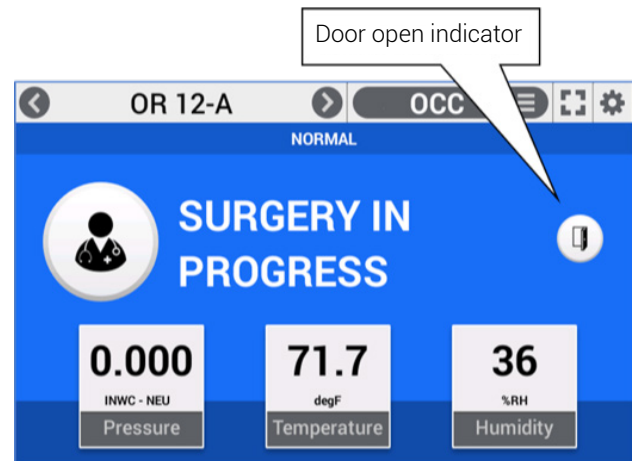

### Milliamp Loops Require Field-installed 250 Ohm Resistor

For 4-20 mA loops, it is required that a 250 ohm resistor be field-installed between the terminals labeled UI/AI and COM. FLEX will be measuring the voltage across this resistor as 1-5 VDC corresponding to 4-20 mA.

# Setra FLEX Operating Instructions

## External Pressure Transducers

### (Setra Models 264 or 267)

The figure below shows an external pressure transducer (such as Setra Model 264 or 267) with either a voltage or mA output signal, and correct wiring. Either configuration can be wired to the FLEX on-board I/O.

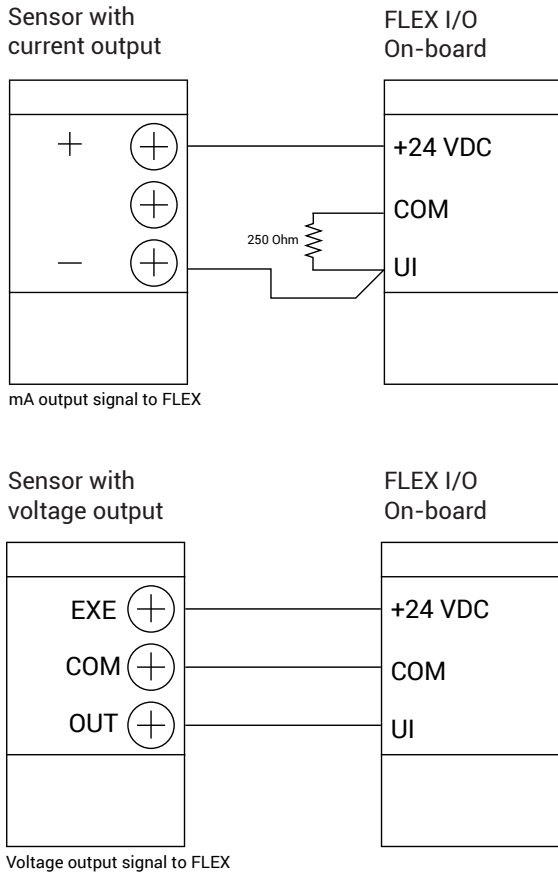

### Analog Output (1)

If using the Analog Output (AO) for voltage output, connect to the terminals labeled VDC and COM. If using the AO for mA output, connect to the terminals labeled MA and COM. The AO generates a 0-5 VDC, 0-10 VDC, or 4-20 mA output signal, as configured. This can be used for a Proportional-Integral (PI) control loop to modulate reheat valves or other analog driven devices, as a pressure output signal, or to mirror an input signal.

### Relay (1)

On-board FLEX is a Single-pole Double-throw (SPDT) dry contact labeled RELAY. When an alarm occurs the NO and COM internal contacts will be closed. During no alarm conditions the NC and COM are shorted. This relay can also drive a Setra Remote Annunciator (SRAN). The RELAY may also be configured to change the state of a remote third-party device. Match the state for the desired application.

### BACnet MS/TP

Setra FLEX is an isolated device on an MS/TP network. BACnet MS/TP recommended wiring is 22 AWG stranded wire in a shielded cable. A positive, negative, GND, and shield should be run. This can be two twisted pairs in a cable with a common cable shield. One twisted pair is used for communications, and the second twisted pair can be used for communications ground and the shield wire can be connected to the other device shield wires.

BACnet hardware is implemented as isolated RS485. Wire to the terminal labeled BACnet MS/TP. Connect positive to B+, negative to A-, and ground wires to GND. Connect shields of incoming and outgoing cables together using a wire nut. If using 3-wire, connect shield returns to GND.

### BACnet/IP

Connect standard Ethernet cable with RJ-45 connectors between the Setra FLEX unit and your network switch.

## Completing the Installation

1. Connect all the electrical connectors matching the wiring connector with the mates on the back of the unit. Some connectors are color-coded and keyed to prevent mis-wiring.
2. Connect any remaining pressure signals to HIGH and LOW ports on pressure sensors, utilizing the clear tubing with integrated external springs to prevent crimping.
3. As you push the Setra FLEX unit into the electrical box, push the black nylon tubing (if on-board sensor is used) into the conduit tube or into the wall cavity. The supplied clear tubing should be the only tubing in the electrical box after the unit is slid in as far as it will go.
4. When wiring is complete, push the FLEX unit into the enclosure and secure with four (4) mounting screws.
5. Leaving FLEX display in its lowered position on hinges, apply power so the FLEX unit starts operation.
6. When the FLEX initial configuration screen appears, swing the display and faceplate housing up and press in place so that security rollers lock the display firmly in place tight against the wall surface.



All FLEX units with on-board sensors, and external transducers should be powered and operational for 30 minutes for warmup time and to ensure acclimated conditions are met for one-time pressure sensing stabilization. If necessary, after the 30 minute warmup, units can be re-zeroed if no room pressure is present (open door, or no airflow, or disconnect pressure tubes).

## 2.6 Servicing FLEX

In the event the FLEX unit needs to be recalibrated or removed for service, security holes at the bottom of the faceplate enable the display to be pulled back from the wall surface. Slide a terminal screw driver gently into the holes until it stops. Then rotate the screw driver blade 90 degrees to unattach the faceplate snaps. Repeat for both holes.

## 3.0 Operation

Once FLEX is installed and powered-up, configuration and operation can begin. Note, FLEX can be configured via three methods: 1) the touch screen interface, 2) USB cloning from another device, or 3) over the BACnet network (once the unit being configured is on the network). This section describes configuration via the touch screen interface.

### 3.1 Initial Unit Setup

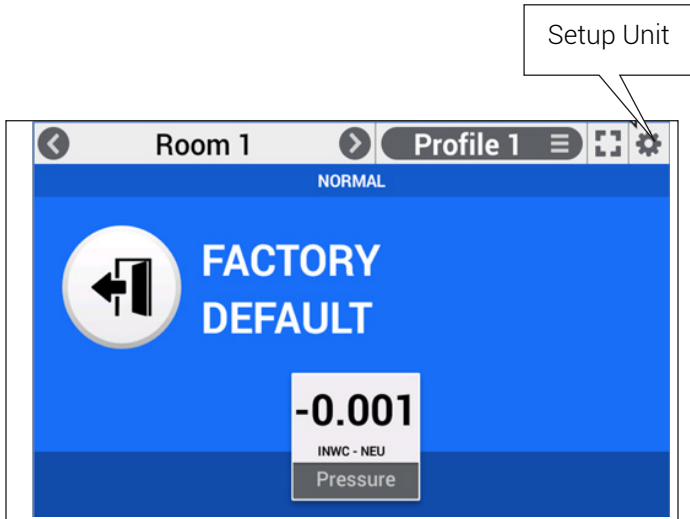

Select the Tools icon, which looks like a cog wheel on the top-right of the Home screen. The Settings screen will appear.

The Settings menu includes several functions:

- Device Configuration, which sets all the parameters of Home screen and FLEX unit functionality
- Diagnostics, which performs system, network, and I/O tests on the unit
- Maintenance, which allows pressure sensor calibration, USB cloning, date and time setup, and other software functions
- About, which shows the unit model, serial number, calibration date, and other system information

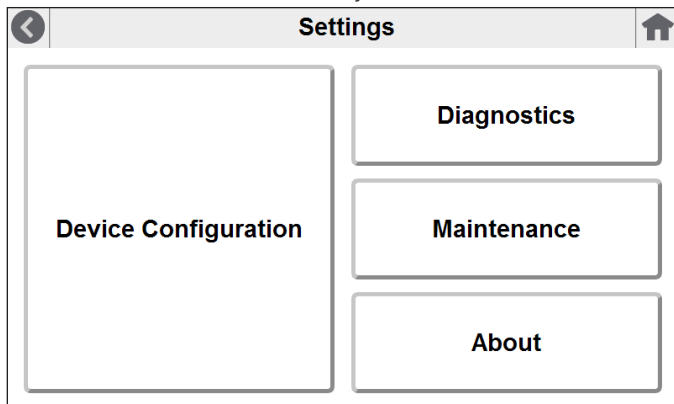

### 3.2 Device Configuration

The Device Configuration menu is the series of menus that define all the operating parameters of the FLEX unit. There are seven menu areas:

1. **Network**, where BACnet/IP or BACnet MS/TP network information is defined and tested
2. **Inputs/Outputs**, where on-board or external hard-wired sensor points are defined
3. **Room**, where room name, profiles, and badges present are setup
4. **Room Profile**, where Profile pull-down menus are defined, including icons, on-screen text, and monitor and controls presets are configured
5. **Display**, where performance, timing, and other visual aspect of the Home screen are defined
6. **Alarms**, for alarm general parameters, volume, and mute timing
7. **Security**, which defines Supervisor and Operator passcodes, if used

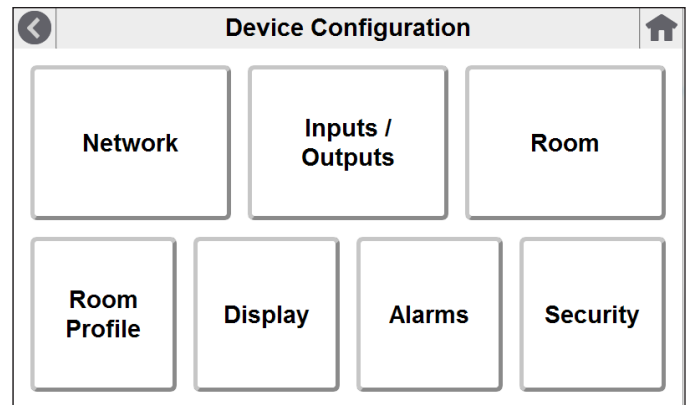



### 3.3 Network

The Network settings area is where FLEX is setup for network communications on a BACnet network. Either BACnet/IP or BACnet MS/TP can be chosen, but not both. Configure the area desired by selecting the appropriate tab.

**Note: after initial network setup is completed, FLEX can be fully configured over the BACnet network. Visit [Setra.com](http://Setra.com) for a FLEX BACnet points list.**

If enabling BACnet/IP, move the Disabled slider to the RIGHT so the feature becomes Enabled. Then fill in the parameters as needed for the network. IP Address supports either addresses obtained via Dynamic Host Control Protocol (DHCP) or static IP addresses. If the DHCP server is active on the IP network, then it will automatically assign an IP address to the FLEX. One can assign a static IP address by checking the "Static?" check-box and fill in the desired IP address in the field.

**Note: FLEX does not have capability to detect duplicate IP addresses. The installer must be aware of which IP addresses are available and unused on the subnet.**

If enabling BACnet MS/TP, move the Disabled slider to the RIGHT so the feature becomes Enabled. Then fill in the parameters as needed for the MS/TP network.

#### Updating the BACnet Network

Selecting the Update tab will update the network settings and reboot so FLEX can communicate effectively on the network with the new settings.

**Note: It is extremely important to use the "UPDATE" tab after every change (single or multiple) to ensure changes take effect. FLEX will restart application when "UPDATE" tab is selected. Failure to select "UPDATE" will result in changes not taking effect.**

### 3.4 Inputs / Outputs

The Inputs / Outputs settings area is where FLEX is configured for hard-wired sensors, on physical input on the back of FLEX.

#### Input Settings

The FLEX main unit supports 4 inputs and 2 outputs.

# Setra FLEX Operating Instructions

Inputs that are on-board the FLEX main unit are labelled "On-Board AI-1" and "On-Board UI-1 to 3," for Analog Input (AI) and Universal Inputs (UI) respectively. Note, if FLEX is using a factory-installed pressure transducer, then the input "On-Board AI-1" is not available, as it is occupied by the on-board sensor snapped to the back of the unit.

Select the desired input to be configured. Then define the type of signal output from the sensor, milliamps (mA), DC voltage (VDC), or contact (Digital). Selecting "None" means the input is not used, and FLEX will not attempt to read a transient input signal from that input.

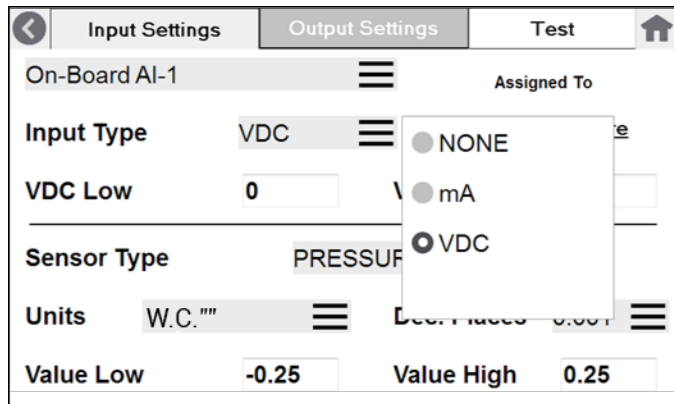

Choose the Sensor Type being used. Pre-selections are available for Pressure, Temperature, Humidity, and Air Changes per Hour (ACH). A User Defined selection can also be chosen if the sensor is not one of the ones on the pre-selected list.

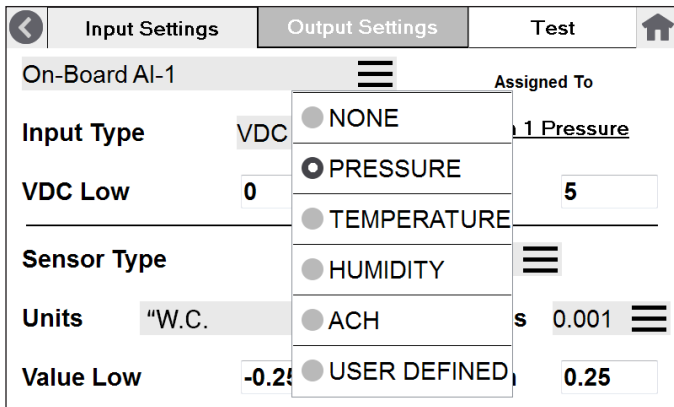

When the Sensor Type is chosen, the input signal can then be scaled using Low and High signal values that match the full-scale range of the applicable sensor. In the example below, these are "mA Low" and "mA High." This scaling of the input allows the sensor's output signal to be scaled to the desired reading on the Home screen. Select the Engineering Units "Eng Units" and define the full-scale range of the sensor in the appropriate units of measure.

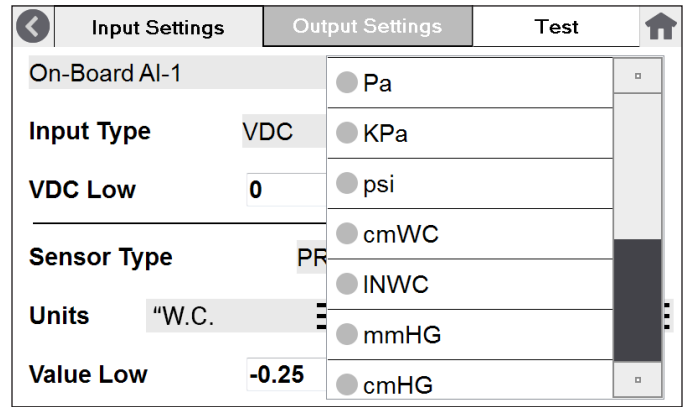

When "Digital" is chosen for Input Type, DOOR can be selected as an option. This applies to a door contact. Selecting Normal Polarity means switch open equals door open, and switch closed means door closed. Selecting Reverse Polarity means switch open equals door closed, and switch closed means door open. Choose the Polarity that generates the desired results from the door switch being used.

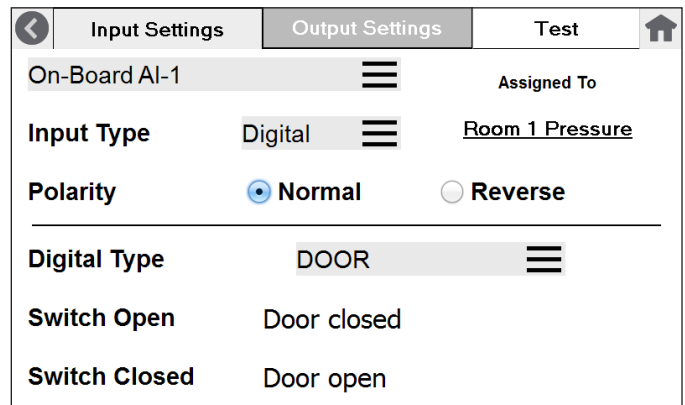

### Output Settings

An external device can be connected to a FLEX-RC unit: at the back of the main unit The FLEX main unit supports 1 analog output and 1 relay output.

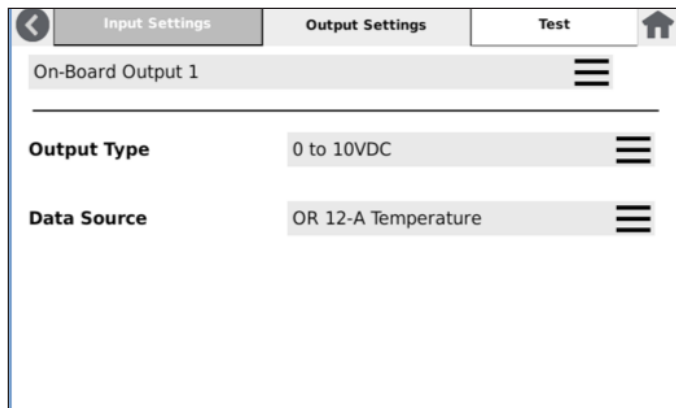

Outputs that are on-board the FLEX main unit are labeled "On-Board" Outputs and Relays.

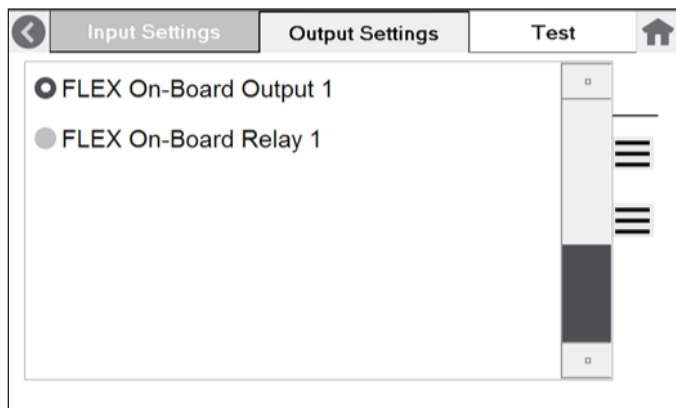

Select the desired Output or Relay to be configured. Then define the type of signal FLEX will generate to the destination controller or equipment.

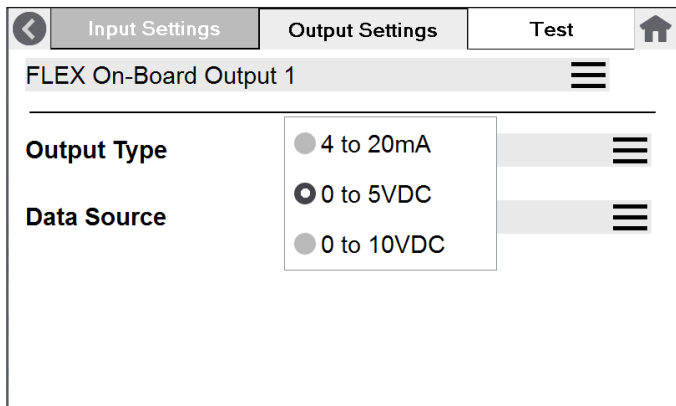

Choose the Data Source from which to obtain this signal value. This can be any of the FLEX three (3) rooms, and any of the six (6) parameters at each room. If this is a Control application, choose one of the four (4) Control Loops available in FLEX-RC. Examples appear below:

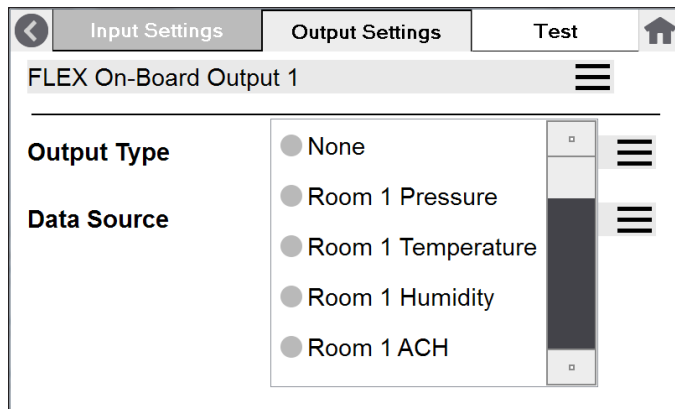

Data Source can be selected as one of the following:

- **None** – the Output Type has been defined, but no data source is feeding a signal
- **Room 1 Pressure** – the Output is driving a signal from Room 1 Pressure badge
- **Room 1 Temperature** – the Output is driving a signal from Room 1 Temperature badge
- **Room 1 Humidity** – the Output is driving a signal from Room 1 Humidity badge
- **Room 1 ACH** – the Output is driving a signal from Room 1 Air Changes per Hour (ACH) badge
- **Room 1 User Defined** – the Output is driving a signal from Room 1's first User Defined badge
- **Room 1 User Defined** – the Output is driving a signal from Room 1's second User Defined badge
- **Room 2 Pressure** – the Output is driving a signal from Room 2 Pressure badge
- **Room 2 Temperature** – the Output is driving a signal from Room 2 Temperature badge
- **Room 2 Humidity** – the Output is driving a signal from Room 2 Humidity badge
- **Room 2 ACH** – the Output is driving a signal from Room 2 Air Changes per Hour (ACH) badge
- **Room 2 User Defined** – the Output is driving a signal from Room 2's first User Defined badge
- **Room 2 User Defined** – the Output is driving a signal from Room 2's second User Defined badge

(CONTINUED ON NEXT PAGE)

# Setra FLEX Operating Instructions

(CONTINUED FROM PREVIOUS PAGE)

- **Room 3 Pressure** – the Output is driving a signal from Room 3 Pressure badge
- **Room 3 Temperature** – the Output is driving a signal from Room 3 Temperature badge
- **Room 3 Humidity** – the Output is driving a signal from Room 3 Humidity badge
- **Room 3 ACH** – the Output is driving a signal from Room 3 Air Changes per Hour (ACH) badge
- **Room 3 User Defined** – the Output is driving a signal from Room 3's first User Defined badge
- **Room 3 User Defined** – the Output is driving a signal from Room 1's second User Defined badge
- **Control Loop 1** – the Output signal is being controlled by Control Loop 1's PI algorithm
- **Control Loop 2** – the Output signal is being controlled by Control Loop 2's PI algorithm
- **Control Loop 3** – the Output signal is being controlled by Control Loop 3's PI algorithm
- **Control Loop 4** – the Output signal is being controlled by Control Loop 4's PI algorithm

## Relay Settings

There is one relay contact available on the back of the FLEX unit. When "On-Board Relay" is selected, the Output Type available is either "Normally Closed" or "Normally Open."

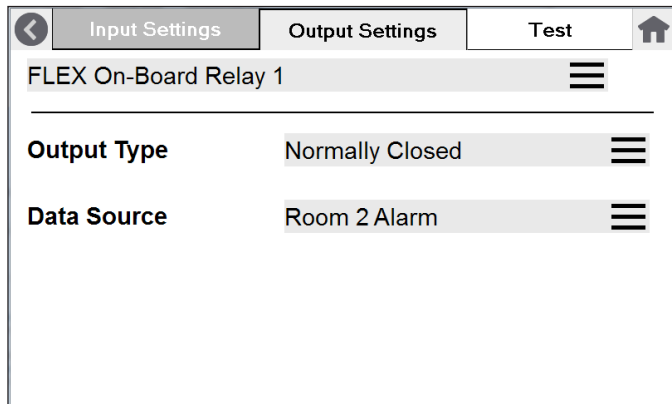

Choose the Data Source that will drive the relay. Examples appear below:

Data Source can be selected as one of the following:

- **None** – the Relay has no Data Source driving it
- **Room 1 Alarm** – the Relay changes state when an alarm occurs in Room 1
- **Room 2 Alarm** – the Relay changes state when an alarm occurs in Room 2
- **Room 3 Alarm** – the Relay changes state when an alarm occurs in Room 3

- **Master Alarm** – the Relay changes state when any alarm occurs in any room and on any parameter

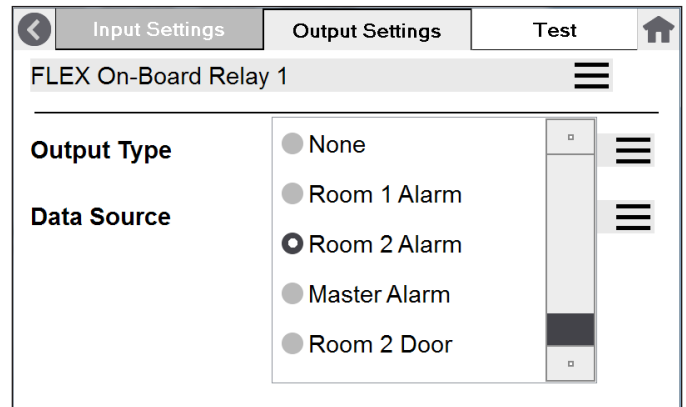

- **Room 1 Door** – the Relay changes state when the Door contact changes state in Room 1
- **Room 2 Door** – the Relay changes state when the Door contact changes state in Room 2
- **Room 3 Door** – the Relay changes state when the Door contact changes state in Room 3

### Testing the Inputs / Outputs

Selecting the Test tab accesses the Diagnostics menu.

Functions available for network testing are:

- I/O Testing
- Send WHOIS & Display IAM Messages
- Control Loop Testing
- View Log
- Network Testing

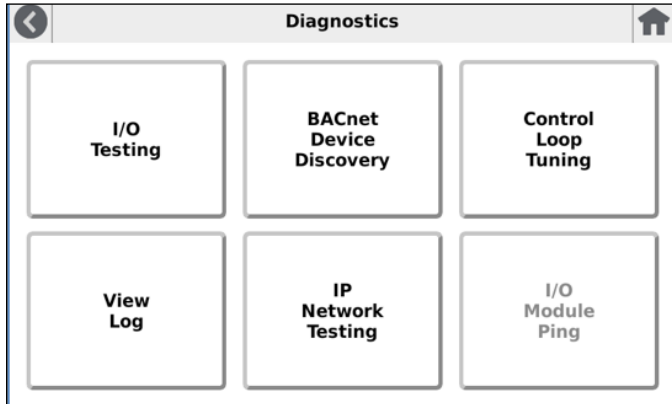

Selecting the I/O Testing shows the screen where Inputs and Outputs can be selected.

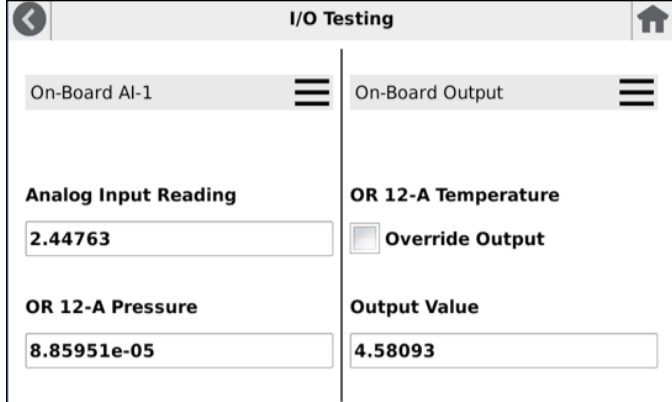

Choose the Input desired from the pull-down menu, and the input value will be displayed if a sensor is properly connected. Choose the Output desired from the pull-down menu, and the output value will be displayed if properly configured or looped from an input.

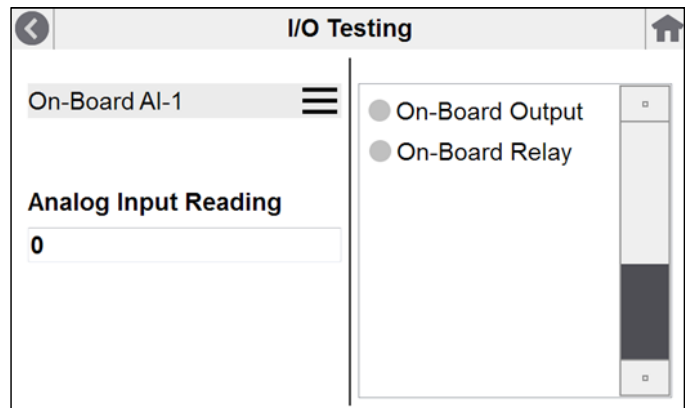
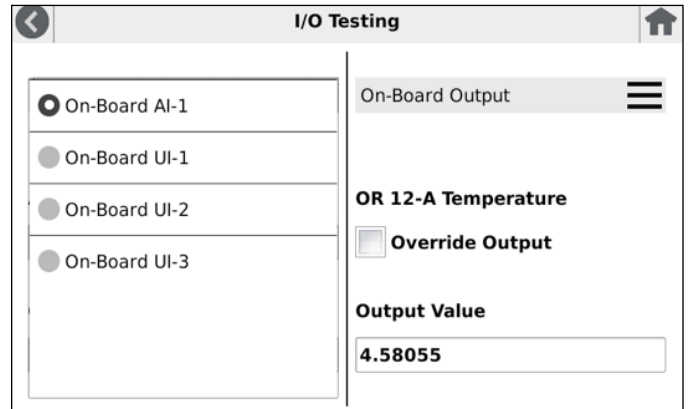

### 3.5 Control (FLEX-RC only)

FLEX-RC contains software that permits control of external equipment, such as VAV dampers, venturi valves, and hydronic reheat valves. Each badge on the FLEX home screen is capable of having Control enabled for that parameter. The badge shows the present value of the parameter, and Control is behind-the-scenes maintaining that value.

This section will guide you through the setup and configuration of enabling the use of Control on home screen badges. There are two methods of Control in FLEX-RC:

- BACnet Setpoint Overrides
- Proportional-Integral (PI) Loop Control

BACnet Setpoint Overrides simply writes new setpoint values over the BACnet network to third-party controllers that are controlling the equipment. PI Loop Control is an algorithm internal to FLEX-RC that actively modulates equipment that is wired to FLEX Inputs and Outputs.

If your systems includes third-party controllers that are either integral to, or responsible for controlling external equipment, BACnet Setpoint Overrides may be the best method of FLEX Control for your application. Alternatively, if you wish to save the cost of these third-party controllers, you can choose to have FLEX PI Loop Control drive this equipment directly through wired points to FLEX itself.

#### 3.5.1 Setpoint Control Setup

From the Home screen, access **Setup->Device Configuration->Room**, and select the Room tab and desired Parameter to control. Ensure the Parameter is Enabled, which places the badge on the Home screen.

There are four (4) available Control sets in FLEX, called **Control Assignments**. Each Control Assignment is dedicated to driving a piece of equipment via BACnet Setpoint Override or PI Loop Control. These can mix-and-match. That is, some Control Assignments can use PI Loop Control, and other Control Assignments can use BACnet Setpoint Override. A total of four (4) are available.

To begin defining the first piece of equipment to control, select which of the four (4) **Control Assignments** you wish to use. The Setpoint Control Setup screen appears. Note, if a **Control Assignment** number is already in use, it will not be available to select.

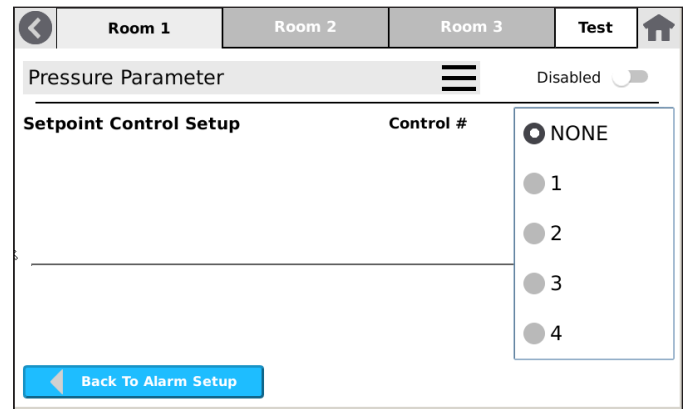

On the Setpoint Control Setup screen there are two active sets of Setpoints and Limits for each of the four Control Assignment that can be stored in FLEX. These are called **Control Preset A** and **Control Preset B**. These are used for the configurable Room Profiles on the Home screen.

Control Preset A or B have the desired **Set Point**, and any **Low Limit** or **High Limit** that may be required for end-user control in the application.

**Example #1**

In the example on the screen below, Control Assignment #1 is dedicated to controlling a hydronic reheat valve. The desired FLEX configuration is to define Occupied and Unoccupied room temperatures, intended to deliver energy savings when the room is not in use. Control Preset A is going to be the Occupied state, and Control Preset B is going to be the Unoccupied state.

Set Control Preset A as follows:

- Set Point to 72°F
- Low Limit 65°F
- High Limit 78°F

This means when Room Profile "Occupied" is selected, the room will be controlled to maintain 72°F temperature. If the end-user chooses to override the temperature, they cannot select a temperature lower than 65°F or a temperature higher than 78°F. FLEX limits the range in this manner if:

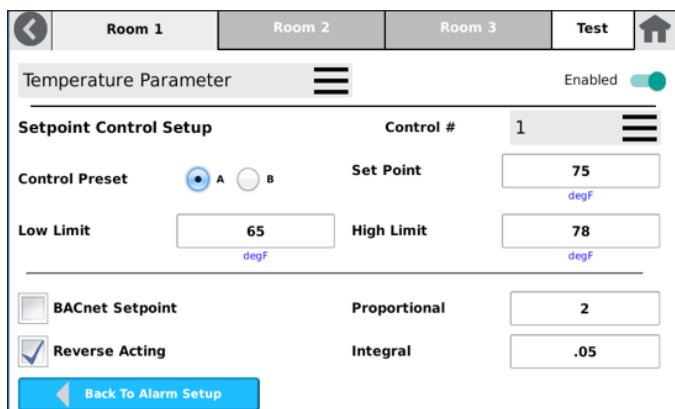

Set Control Preset B (not shown) as follows:

- Set Point to 78°F
- Low Limit 72°F
- High Limit 80°F

This means when Room Profile "Unoccupied" is selected, the room will be controlled to maintain 78°F (warm climate) temperature. If the end-user wants to lower the temperature via override, they cannot select a temperature lower than 72°F or a temperature higher than 80°F. FLEX limits the range in this manner if desired.

Low Limit and High Limit should be set to the physical limitations of the devices used.

**Example #2**

A ventilation VAV damper or valve actuator can also be controlled, enabling differential pressure regulation in a room.

Control Assignment #2 is dedicated to controlling an actuator. The desired FLEX configuration is to define Isolation and Non-Isolation room pressures, intended to manage room differential pressure alarms when the room is not in use. Control Preset A is going to be the Isolation state, and Control Preset B is going to be the Non-Isolation (or normal patient room use) state.

Set Control Preset A as follows:

- Set Point to 0.01"WC
- Low Limit 0.01"WC
- High Limit 0.01"WC

This means when Room Profile "Isolation" is selected, the room ventilation will be controlled to maintain 0.01"WC differential pressure. If the end-user tries to override the pressure, they cannot change anything. FLEX limits the range in this manner.

Set Control Preset B as follows:

- Set Point to 0.00"WC
- Low Limit 0.00"WC
- High Limit 0.01"WC

This means when Room Profile "Non-Isolation" is selected, the VAV control will not try to modulate airflow to achieve any differential pressure, with the door open or closed. If the user chooses to close the door and modulate pressure override to 0.01"WC, that is permitted.

## 3.5.2 Choosing Control Type – BACnet Setpoint Override or PI Loop Control

In the lower section of the **Room** screen is the choice for using FLEX Control as either **BACnet Setpoint Override** or **PI Loop Control**. Depending on the selection made, parameters then change to match the function.

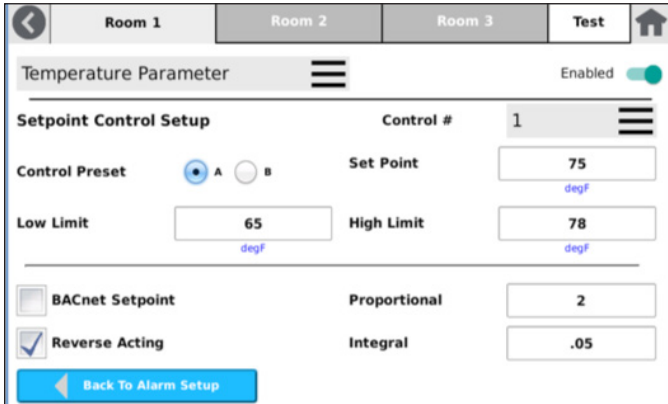

## 3.5.3 Configuring PI Loop Control

Access the **Room** configuration screen. For PI Loop Control to function, a wired Input must provide the signal and value of the operating parameter, such as room temperature or VAV actuator position. And a wired Output must drive the control signal to the equipment.

On the **Inputs/Outputs** screen, select the Input desired, configure the Input Type and voltage range, the Sensor Type, Units, significant digits for display (Dec. Places), and the full scale range of the sensor as Value Low and Value High.

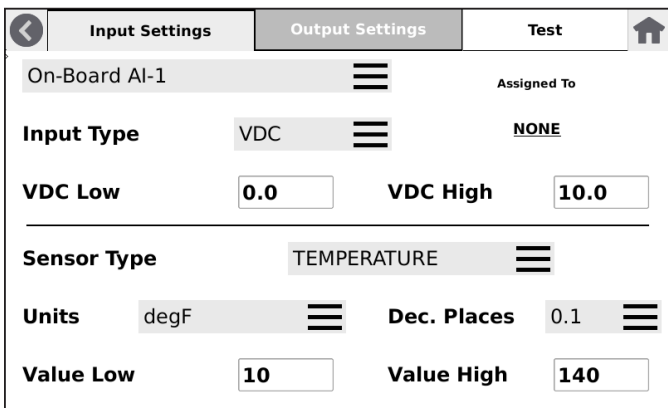

Next, in the Room configuration, for the desired Room to control, select the parameter to control. The example below shows **Temperature Parameter**. Choose the Data Source where the Temperature Parameter originates from. In this case, Temperature is coming from Universal Input #1. Make sure the Parameter is Enabled using the slider.

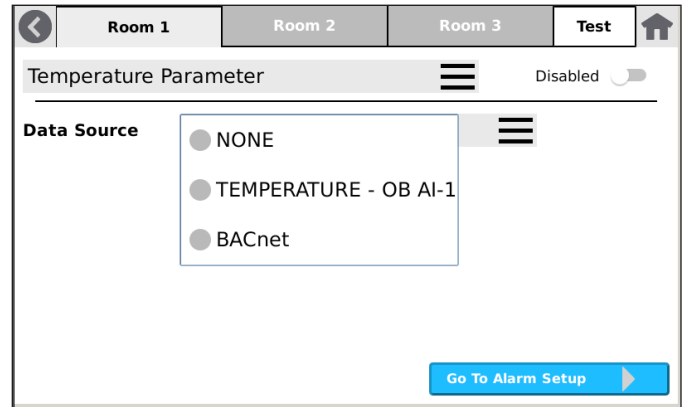

Next, from the **Inputs/Outputs** screen, select the **Output Settings** tab and choose which Output is going to drive the control signal to the equipment. In the example below, the selection is to use **FLEX On-Board Output 1**, which is a 0-10 VDC control signal. And the **Control Assignment** used is Control Loop 2 (or Control #2).

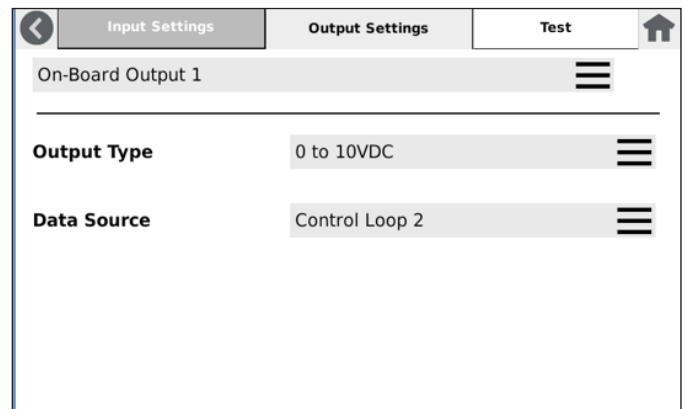

With the **Data Source** defined for a **Control Assignment**, return to the **Room** setup and the parameter being configured. Press **Go To Alarm Setup**, and then **Go To Control Setup**.



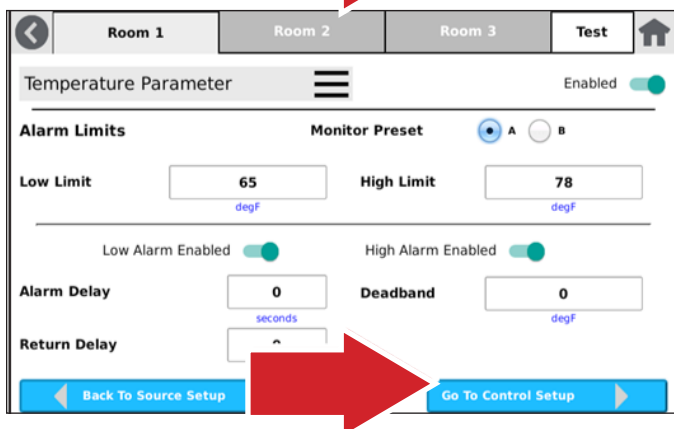
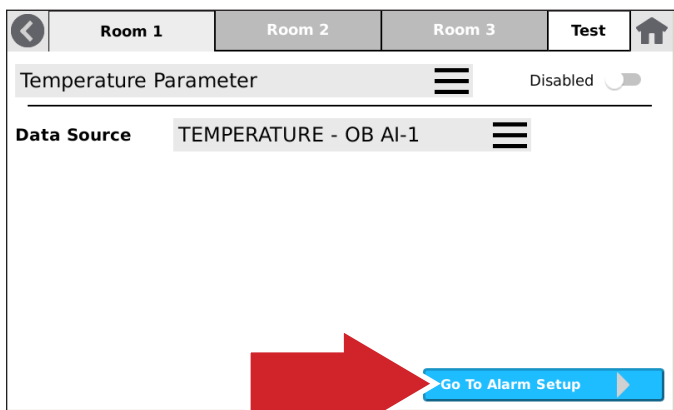

On the **Setpoint Control Setup** screen, choose the Control Assignment to be **Control #2**, which matches what was defined for **FLEX On-Board Output 1**, the Output controlling the equipment.

To use **PI Loop Control** with a Control Assignment, unselect the **BACnet Setpoint** check-box. **Proportional and Integral** selections appear to the right. These will be used for Loop Tuning the equipment operation. **Reverse Acting** also appears. Choose this if the target equipment motor operates in this manner.

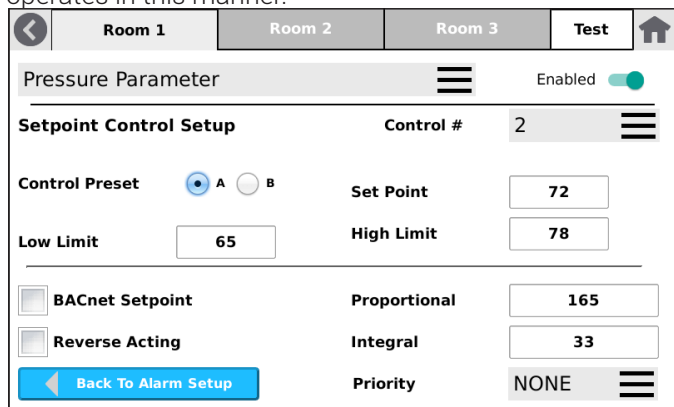

Perform similar actions for **Control Preset B**, if desired.

When the Control Assignment is setup with initial parameters, it can then be tested to verify operation as intended. Press the **Test** tab to access the **Control Loop Testing** tile, and the **Control Loop Tuning** screen.

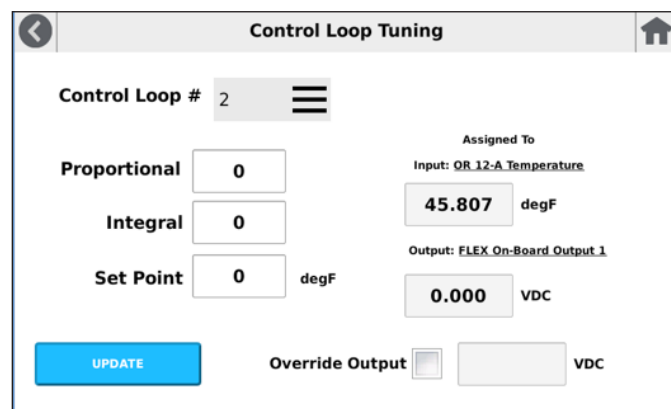
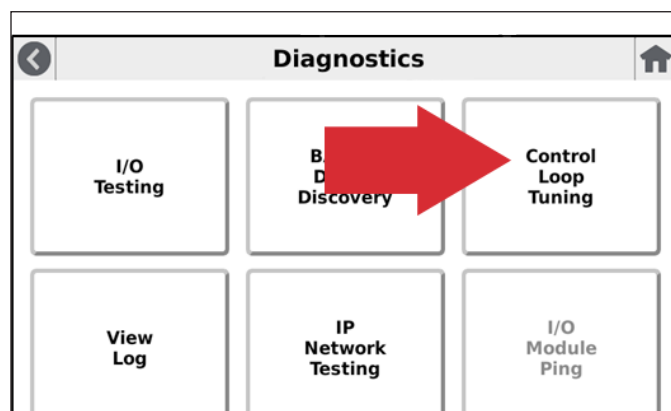
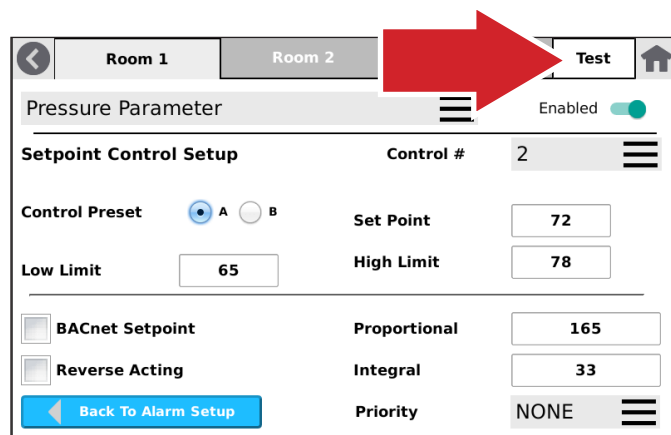

### 3.5.4 Control Loop Testing

# Setra FLEX Operating Instructions

Select the Control Assignment desired from the **Control Loop** pull-down. The left side of the screen are the configured values, and the right side of the screen are the actual real-time values being read from the assigned Input and Output. **Proportional, Integral, and Set Point** values can be changed as needed, with **UPDATE** applied to test equipment performance. Continue Loop Tuning as needed until proper performance is achieved.

There is also an ability to **Override Output** in order to test the behavior of a VAV damper or hydronic valve.

### 3.5.5 Using PI Loop Control – Home Screen

When PI Loop Control is fully configured and operational, the parameter's badge on the Home screen will permit Control operation. Pressing the badge will bring up the parameter override screen.

The values can be modified using **UP** or **DOWN** arrows, or by pressing the number in the middle of the **UP** or **DOWN** arrows and using keyboard entry. Use **SET**, to make the new values take effect. If **SET** is not used, and **EXIT** is pressed instead, no change is made.

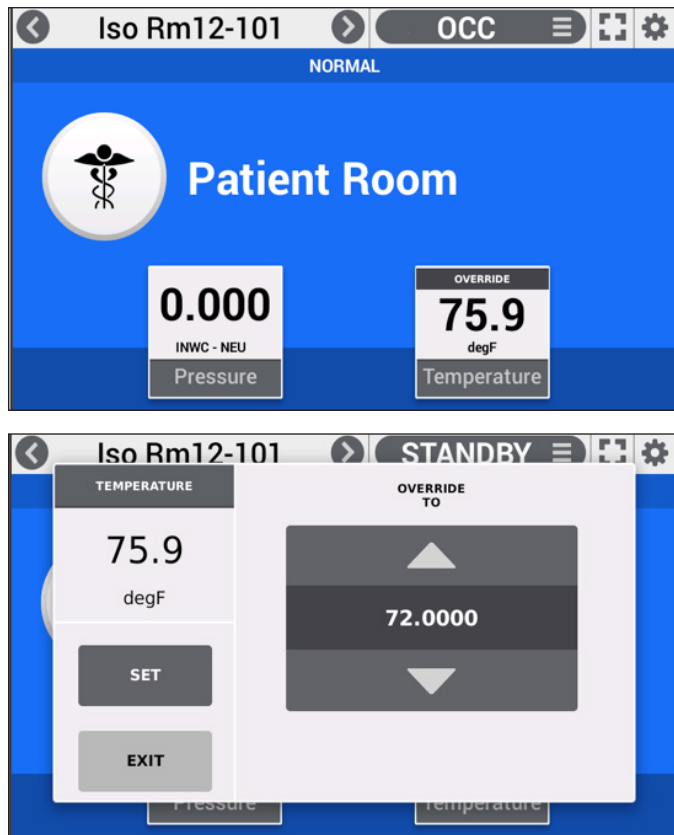

### 3.5.6 Configuring BACnet Setpoint Overrides

Access the **Room** configuration screen. To use BACnet Setpoint Overrides with a Control Assignment, use the **BACnet Setpoint** check-box for the desired parameter. BACnet network selections appear to the right.

**Device Inst.** and **Object Inst.** are the BACnet Device Instances and Object Instances of the BACnet Analog Values (AVs) to be controlled. Press the field selection box to bring up keyboard entry to change these values for the controller on your network.

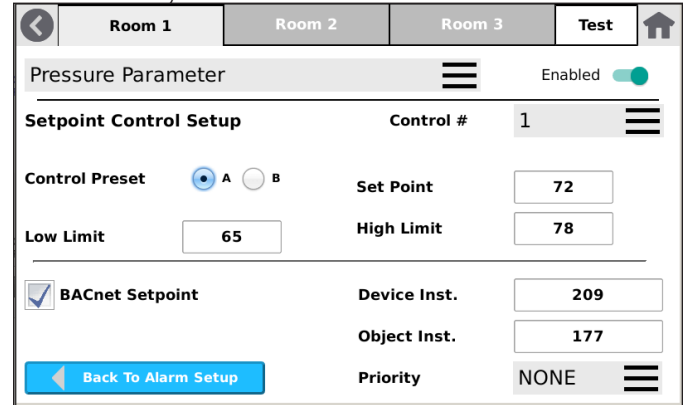

**Priority** is an optional field for setting the BACnet Write Priority Level, or it can be set to **NONE**. Some third-party controllers will have an AV with a BACnet Priority Array. If this is the case, you will need to select a Priority in FLEX that is higher than the Priority in the third-party controller for any changes in Setpoint to take effect. FLEX will restore the original Setpoint and AV Priority Level to the third-party controller if FLEX **Override** is cancelled, or when **Override Duration** expires.

**Priority** can also be set to **NONE**. This is used in third-party controllers that may not support AVs with Priority Arrays, and only have an ability to set Present Value. FLEX will set the AV state to "Out of Service" to enable the Setpoint Write function to take effect. FLEX will restore the original Setpoint and AV state to "In Service" if FLEX **Override** is canceled, or when **Override Duration** expires.

### 3.5.7 Using BACnet Setpoint Overrides – Home Screen

When BACnet Setpoints Override is fully configured and operational, the parameter's badge on the Home screen will permit Control operation. Pressing the badge will bring up the parameter override screen.

There are several elements on this screen:

- Top-left – the present parameter value
- SET – the function which applies the desired changes on this screen
- EXIT – the function that exits the screen, whether SET has been applied or not
- OVERRIDE TO – the new setpoint requested by the user. Use arrows or press value for keyboard entry.
- OVERRIDE DURATION – the requested time for the override period to run. Increments by 15 minutes. Use arrows or press value for keyboard entry. When pressing down-arrow from 0:15, "HOLD" appears, indicating permanent Override Duration (until user accesses the function again to change it). When a time duration is applied, and Override Duration expires, original setpoint is restored.
- CANCEL OVERRIDE – at any time the user may cancel the Override To value, and the original setpoint is restored.

The values can be modified using **UP** or **DOWN** arrows, or by pressing the number in the middle of the **UP** or **DOWN** arrows and using keyboard entry. Use **SET**, to make the new values take effect. If **SET** is not used, and **EXIT** is pressed instead, no change is made.

**OVERRIDE DURATION** is only available when using Control via BACnet Setpoint Override.



When Override is applied, the badge will indicate "OVERRIDE" until the Override Duration expires or if Cancel Override is applied.

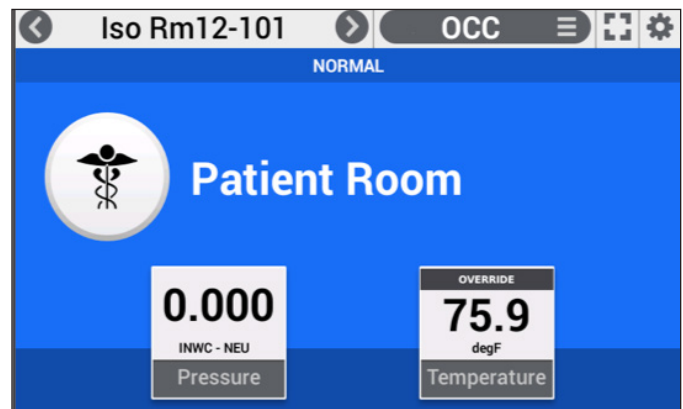

## 3.6 Room

The **Room** settings area is where FLEX has definitions for everything that is seen on that room's Home screen. These include whether the room is shown on the Home screen, name, default Profile, the number of Badges on the screen, and where the data shown on Badges originates from. **Room** is where all the alarm thresholds get set for each Badge, and whether that Badge has just elements of monitoring, or whether it can also do control functions.

Select from the tabs at the top of the screen which room to configure.

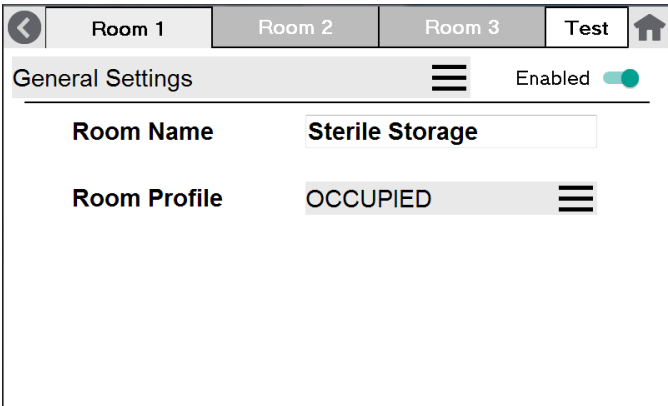

Choose a Room Setting to work on. Examples appear below:

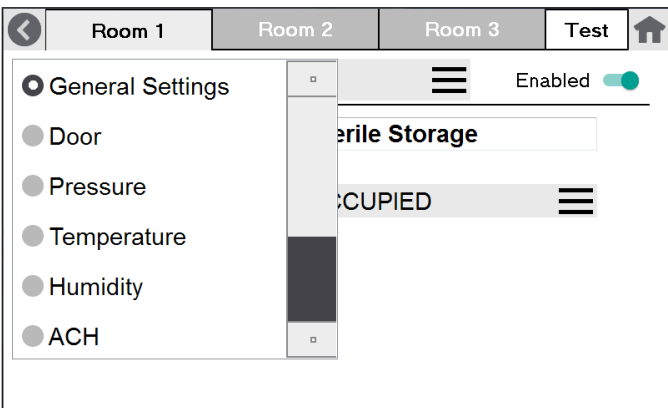

Using the pull-down just under the tabs, select from:

- **General Settings** – which defines whether the room is displayed on the Home screen (Enabled or Disabled), the room name, and default Profile. Note, Profiles should be setup before choosing a default profile at this stage.
- **Door** – which defines whether a Door Input is Enabled or Disabled, and the source of information to trigger the Home Screen “Door” icon, which shows that a door is open.
- **Pressure** – which defines whether the Pressure Badge is present on the room's Home screen (Enabled = present, Disabled = not shown), the source of data (an Input, or the network), alarming parameters, and control parameters (FLEX-RC only).
- **Temperature** – which defines whether the Temperature Badge is present on the room's Home screen (Enabled = present, Disabled = not shown), the source of data (an Input, or the network), alarming parameters, and control parameters (FLEX-RC only).
- **Humidity** – which defines whether the Humidity Badge is present on the room's Home screen (Enabled = present, Disabled = not shown), the source of data (an Input, or the network), alarming parameters, and control parameters (FLEX-RC only).
- **ACH** – which defines whether the ACH (Air Changes per Hour) Badge is present on the room's Home screen (Enabled = present, Disabled = not shown), the source of data (an Input, or the network), alarming parameters, and control parameters (FLEX-RC only). Room dimensions can be entered when the **Input Type** is volumetric flow. FLEX will then compute ACH based on these two parameters.
- **User Defined 1** – which defines whether the first User Defined Badge is present on the room's Home screen (Enabled = present, Disabled = not shown), the source of data (an Input, or the network), alarming parameters, and control parameters (FLEX-RC only). Note, the User Defined Badge may scroll off the screen left or right, depending on the number of Badges configured. Swipe the screen left or right to access them.
- **User Defined 2** – which defines whether the second User Defined Badge is present on the room's Home screen (Enabled = present, Disabled = not shown), the source of data (an Input, or the network), alarming parameters, and control parameters (FLEX-RC only). Note, the User Defined Badge may scroll off the screen left or right, depending on the number of Badges configured. Swipe the screen left or right to access them.

### General Settings

This setting defines whether the room is displayed on the Home screen (Enabled or Disabled), the room name, and default Profile. Note, Profiles should be setup before choosing a default profile at this stage.

Enabling Room 1 will cause the room to appear alone, or

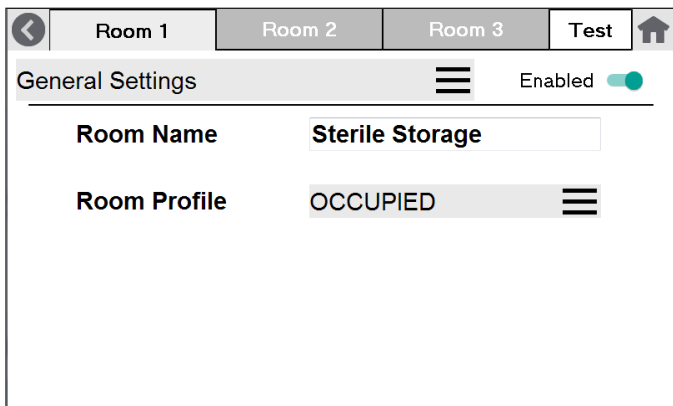

in rotation on the Home screen. Disabling the room will cause the Home screen to not display Room 1 at all. To change the Room Name, press anywhere in the name field, and a pop-up keyboard appears. Press **Enter** after typing to exit.

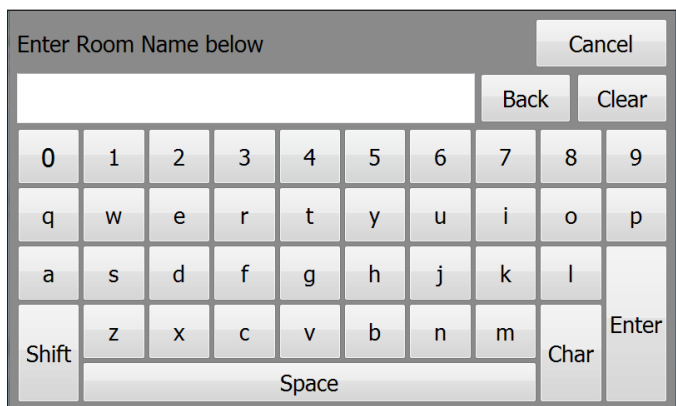

### Door

This defines whether the door Input is Enabled or Disabled, and if Enabled, the Data Source that drives its state. The Data Source may be None, or an Input. When Enabled and configured with a Data Source, the Door Input drives the state of the DOOR icon on the right side of the Home screen.

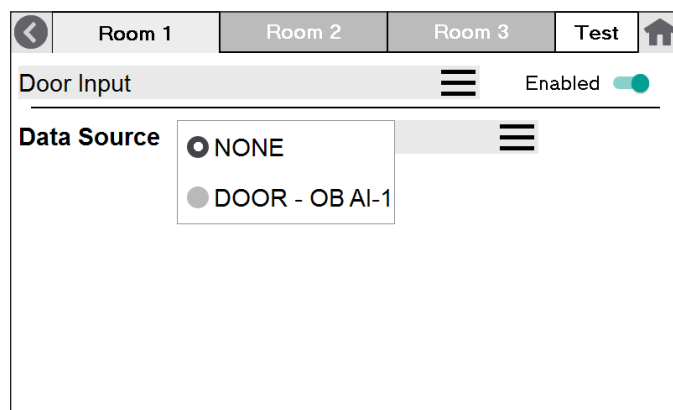

### Pressure, Temperature, Humidity, ACH, and User-Defined Badges

This defines whether the Pressure (Temperature, Humidity, ACH, and User Defined) Badge is present on the room's Home screen (Enabled = present, Disabled = not shown), the source of data (an Input, or the network), alarming parameters, and control parameters (FLEX-RC only).

The bottom-right button **Go To Alarm Setup** permits access to alarm and control parameters. The functions Pressure, Temperature, Humidity, ACH, and User Defined Badge configurations all have similar menus.

**Note: When using an air velocity sensor for ACH calculation, the input must be scaled to convert to volumetric flow. To do this, scale the low and high input values for 4-20mA, 0-5V, or 0-10V by multiplying by the cross-sectional area of the duct where the air velocity sensor is installed. Ensure that any difference in time (e.g. minutes, seconds) or distance (e.g. meters, centimeters, feet) are accounted for.**

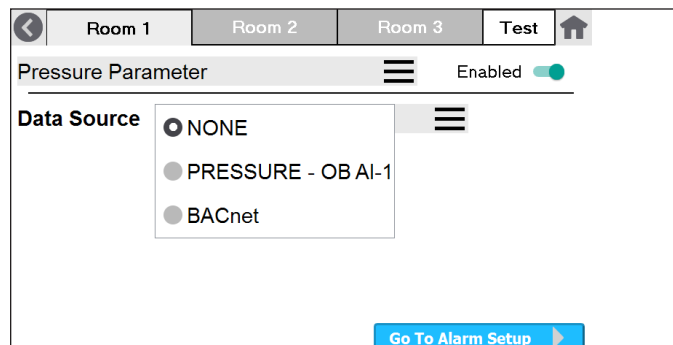
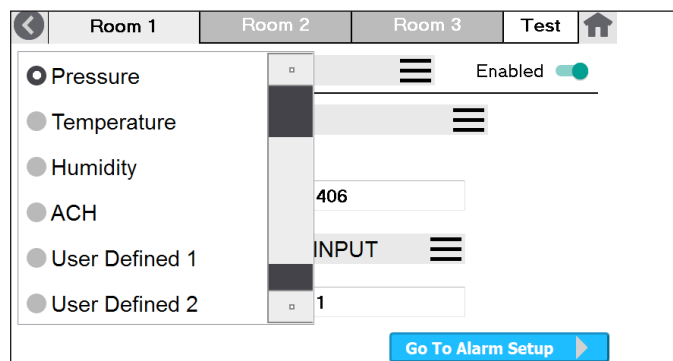

## Setra FLEX Operating Instructions

Choosing **BACnet** as the Data Source enables the user to define the Device Instance, Object Type, and Object Instance. This maps any BACnet network variable to the Room 1 Pressure Badge. The value will then come across the network and be displayed and updated on the Home screen.

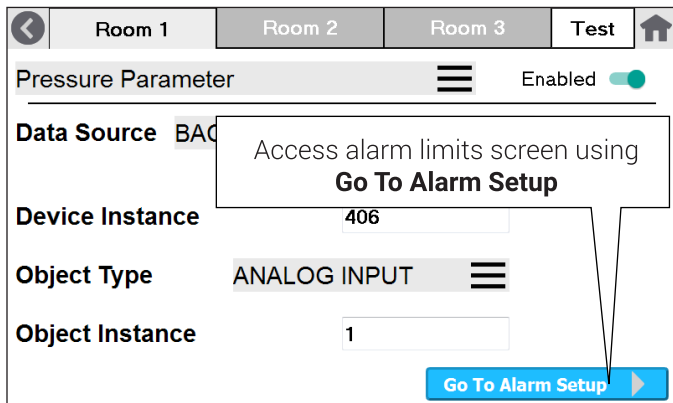

### 3.7 Room Remote Duplicate Display

**Duplicate Display** is a way to use two or more FLEX units to monitor a single room. The FLEX units exist and coordinate information together on a network for the purpose of showing different parameters on different units, which is desirable for some applications. This is typically done with a primary unit *inside* a room, and a secondary unit *outside* the room, or vice versa. For example, FLEX inside the room may show pressure, temperature, humidity, and air change rate, and have audible alarming turned off. The second "Duplicate Display" FLEX outside the room may show only pressure, and be configured with audible alarming enabled. There are many Duplicate Display scenarios that can be configured in FLEX.

#### Configuring Room Duplicate Display

1. First, decide what information and configuration you want at each unit, similar to the example above. Document the design intention.
2. The primary FLEX unit will be the unit where any sensors are wired or configured with mapped BACnet objects from where the sensors originate.
3. Fully configure the primary FLEX unit, so it is operational with all the sensors and configuration parameters desired.
4. Clone the primary FLEX configuration onto a USB drive using the procedure documented in the **Copy to USB** section.
5. If desired, **Copy From USB** to the FLEX Duplicate Display unit. In some cases, Copy From USB may make configuration faster. In other cases, there may be too many configuration items to change between the primary FLEX and Duplicate Display. Use manual, or Copy From USB, depending on what makes the most sense for your application.

6. At the Duplicate Display, which is secondary (tertiary, or more), there will be no sensors directly wired or mapped via BACnet. Instead, you will map parameters from the primary FLEX unit.

(a) For the desired Parameter on the secondary unit, set the **Data Source** to BACnet.

(b) Set the **Device Instance** to match the Device Instance on the primary unit.

(c) Set the **Object Type** to match the Object Type on the primary unit.

(d) Set the **Object Instance** to match the Object Instance on the primary unit.

7. Continue for any other badges desired at the Duplicate Display.

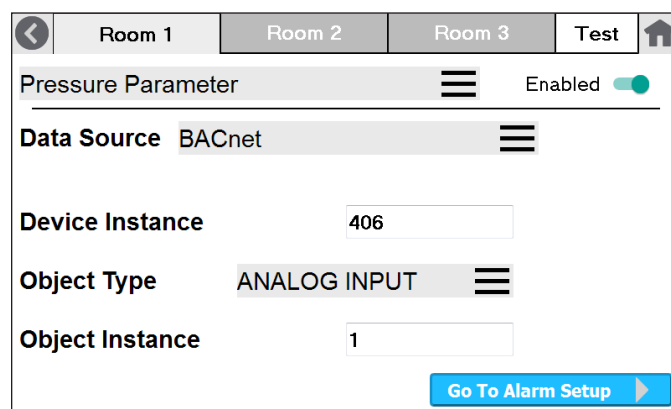

#### Configuring Other Parameters on the Duplicate Display

Other than mapped BACnet objects from the primary FLEX to home screen badges on the secondary FLEX, the configuration of the Duplicate Display can be different from the primary unit. You may choose to enable or disable audible alarms, have different Room Profiles, or different home screen icons or colors.

**CAUTION: Alarm thresholds and values should be identical in each of multiple FLEX units that are monitoring a single room, so there is no confusion about when the room is in alarm state.**

### Setting Alarm Thresholds

There are two (2) sets of Alarm Limits that are of general use in FLEX for each Badge. These are called "Monitor Preset A and B." **Monitor Preset A** establishes one full set of Alarm Limits and thresholds, noted on the screen below. **Monitor Preset B** establishes another full second set of Alarm Limits and thresholds. These sets A and B can be used with different room Profiles, such as OCCUPIED and UNOCCUPIED states, where the user may desire different Alarm Limits.

For example: OCCUPIED may have thresholds for 0.03" WC Pressure, 68 °F Temperature, and 20 ACH. But UNOCCUPIED would not need those higher thresholds, and may only need thresholds 0.01" WC Pressure, 75 °F Temperature, and 8 ACH.

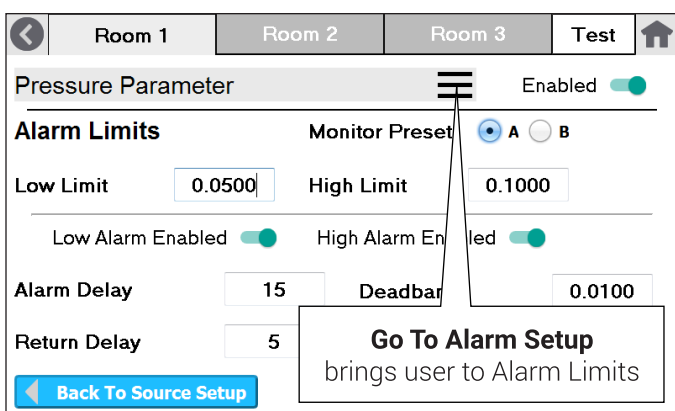

Decide whether you will need one or two sets of Alarm Limits, and use only **Monitor Preset A**, or whether you will need a second set, **Monitor Preset B**. Set parameters for one, or both. When the radio button for **Monitor Preset B** is pressed, all new Alarm Limits can be entered on that screen.

Low Limit is the low threshold for alarming. High Limit is the high threshold for alarming. For a Positive room you may not need a High Limit. If this is the case, change the state of High Alarm Enabled to **Disabled**. For a Negative room, you may not need a Low Limit. If this is the case, change the state of Low Alarm Enabled to **Disabled**.

**Alarm Delay** is the time between when a parameter value falls beyond an alarm condition (trigger) and when an audible, visual, or output alarm condition occurs. Use **Alarm Delay** when time is needed for door entry and personnel access. **Return to Normal Delay** is just the opposite. When a parameter value comes out of alarm and now falls within normal range, the audible, visual, and output alarm condition will persist for this period of time until the condition is cleared.

**Deadband** is a value that is added or subtracted to a limit when determining if a parameter has returned to a normal state. For example. Given a pressure parameter with a low alarm limits of 0.1"WC, and deadband of 0.01"WC, if the pressure falls below 0.1"WC and goes into an alarm, the pressure must then return to a value greater than 0.11"WC to trigger the alarm state change from alarm to normal.

### 3.8 Room Profile

The **Room Profile Setup** menu is where the functions of the Home screen Profiles pull-down menu are defined. There are four (4) fully configurable Room Profiles, and one fixed Profile called **Standby** which is not configurable, and therefore not shown on this menu.

Choose a **Profile**, 1-4. Set the name for each Profile in **Profile Name**. The pop-up keyboard appears for entry. Set the **Banner Text** for this Profile, or none, which will appear on the Home screen in the center of the display to the right of the **Banner Icon**.

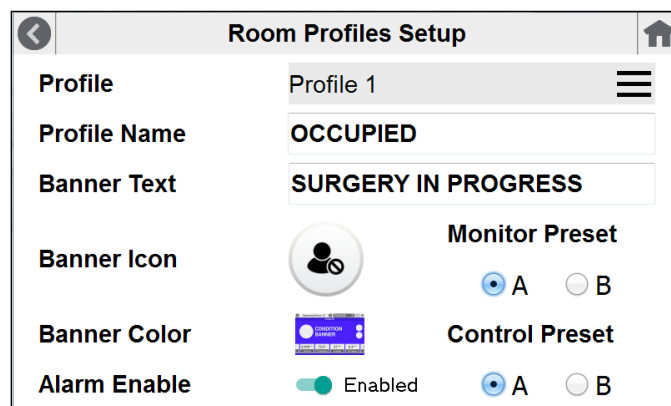

Choose the **Banner Icon** for this Profile from the list of 32 pre-defined icons.

Choose a **Banner Color** for this Profile from the six (6) Background Colors available.

**Alarm Enable** is a global function for this Profile. If Alarm Enable is **Enabled**, then all the Alarm Limits defined for each Badge on the Home screen are active and working as intended. If Alarm Enable is **Disabled**, then all alarms are disabled when the Room is operating with that Profile.

# Setra FLEX Operating Instructions

Choose **Monitor Preset A or B** for this Profile. Refer to the Monitor Presets defined in Alarm Limits for each Badge in **Room** setup.



**Room** setup. This Monitor Preset will then apply to all the Badges for that Room when running this Profile.



Choose **Control Preset A or B** for this Profile. Refer to the Control Presets defined in Control Loop Setup for each Badge in **Room** setup. This Control Preset will then apply to all the Badges for that Room when running this Profile.

## 3.9 Display

The Display Settings menu is where the behavior of the Home screen is defined.

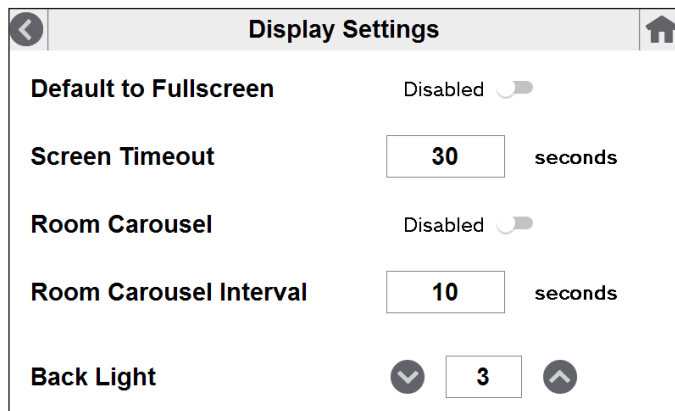

**Default to Fullscreen** is a mode where all Rooms are shown on one screen. When Default to Fullscreen is **Disabled**, each Room is shown on the Home screen with

its' appropriate Badges and Profiles. Fullscreen mode can be accessed manually using the Fullscreen icon on the top-right part of the screen.

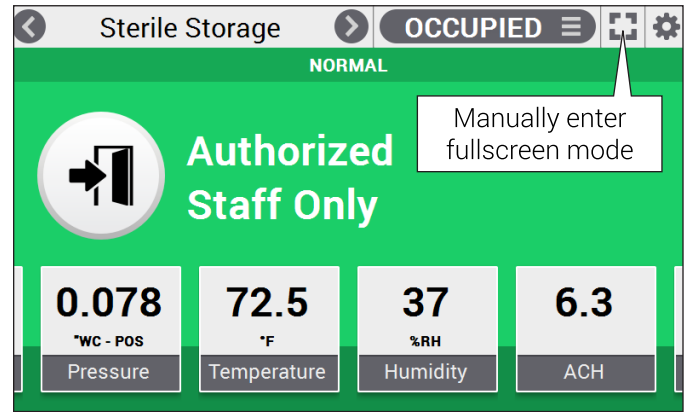

When Default to Fullscreen is **Enabled**, the Home screen is in Fullscreen mode all the time. Each individual Room and Badges can be viewed by touching any of the rooms.

After the **Screen Timeout** duration, Fullscreen mode goes back into effect.

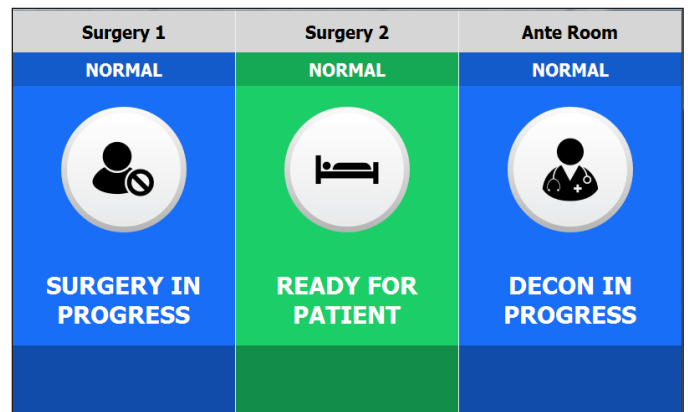

**Screen Timeout** is duration of time of screen inactivity before the screen reverts back to the Home screen (or Fullscreen, if so configured). This applies to inactivity on Setup screens, accessing Fullscreen mode manually, accessing badges, and other transient features.

**Room Carousel** is a feature that causes multi-room displays to transition from one room to another, in sequence, based on timing defined by **Room Carousel Interval**. If **Disabled**, the room selected will continue to be displayed on the Home screen until a touch change is made.

**Back Light** is the lumens intensity of the Home screen display and all other screens. Changing the Back Light slider to more or less bright is a way of managing the light intensity of FLEX displays in customer nighttime and daytime applications. Move the slider to the optimum setting for 24-hour conditions, or change the lumens intensity via BMS control over BACnet on a schedule.



### 3.10 Alarms

The **Alarms Settings** menu is where global alarm functions are defined. These settings apply to all alarm behaviors.

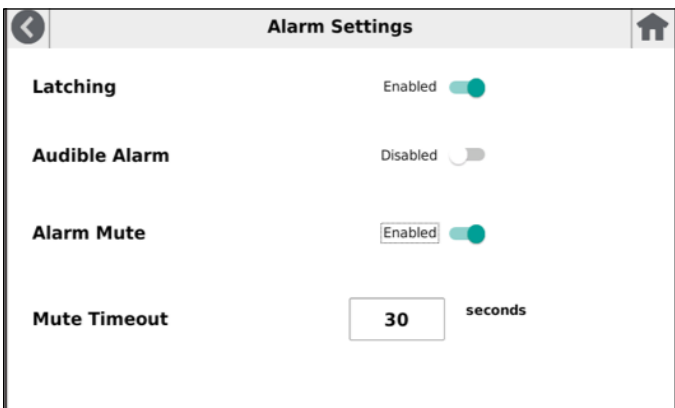

Latch alarm indicator. Press to acknowledge and reset.

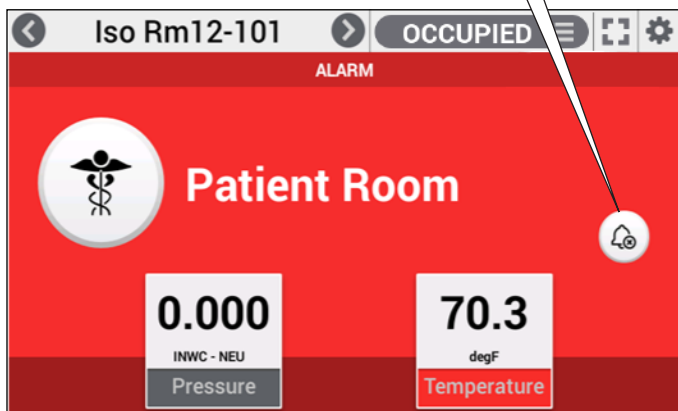

**Latching** is an alarm function that causes an alarm condition to persist even when the Badge parameters have returned to normal operating ranges. A Latched alarm must be acknowledged at the FLEX touch screen interface itself to be cleared. This function is useful when it is important for staff to be physically present at the room to observe the alarm condition and respond to it.

Audible alarm indicator. Press to silence.

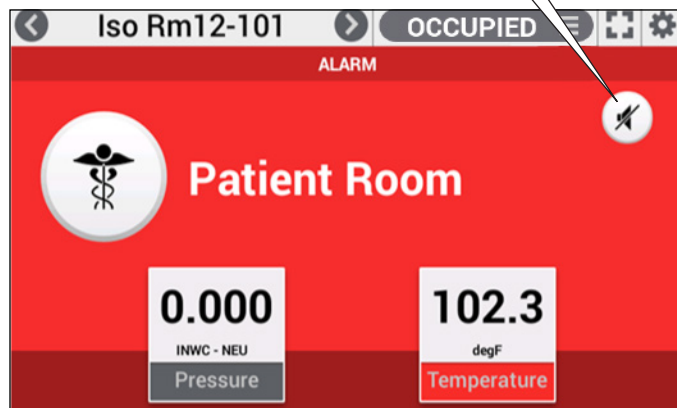

**Audible Alarm** Enabled causes an alarm condition to sound the audible alarm behind the FLEX faceplate. When Disabled, FLEX will still announce the alarm via a relay, visibly on the FLEX screen, and over the network to a BACnet object. The relay is configurable, and may not always announce when in alarm. Audible Alarms also need not be annoying. If Audible Alarms are desired, set the Alarm volume as low as needed for the customer's environment.

**Alarm Volume** is a 3-level adjustment for the audible alarm. Press up or down arrows to increase or decrease the setting. When up or down arrows are pressed, the buzzer will beep briefly to provide a sample of the level. If Audible Alarms are desired, test several settings on this parameter to optimize an appropriate volume for the environment where FLEX is installed.

**Mute Timeout** is the amount of time an acknowledged alarm will be silent. When an audible alarm occurs, an operator may approach the FLEX unit and silence the alarm by pressing the Mute Sound icon on the right side of the screen. At that time, **Mute Timeout** begins a countdown function from the number of seconds configured. When Mute Timeout gets to zero, and if the alarm condition persists, the audible alarm will sound again. This number should be optimized to a time that long enough so it is not annoying to staff, but short enough to ensure the alarm condition is dealt with responsibly.

## 3.11 Security

The **Security Settings** menu defines password access to FLEX functions at the touch screen. If **Password Security is Disabled**, anyone can access any function of the FLEX unit via the touch screen with full, unrestricted access. When **Enabled**, Supervisor Passcodes and Operator Passcodes are enforced at the Home and Setup Screens. When a user attempts to access any functions from the **Home screen** (e.g. changing setpoint), the **Operator Passcode** is requested via keypad interface. When a user attempts to access any functions from the **Setup screen** (e.g. I/O or network configuration), the **Supervisor Passcode** is requested via keypad interface. Security Enabled is highly recommended to prevent unauthorized or accidental tampering of FLEX operations.

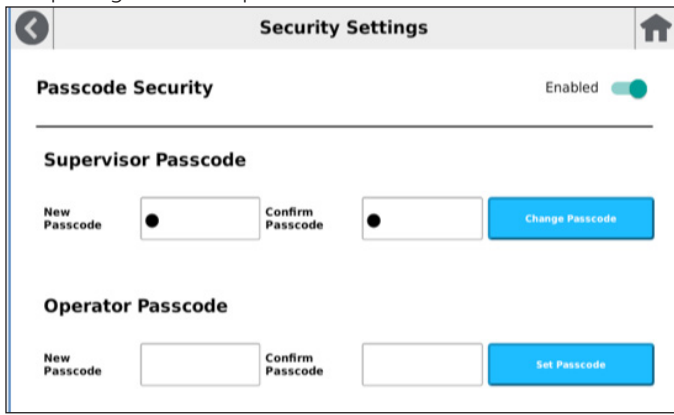

Note: If the Supervisor Passcode is set and forgotten, the only recovery method is to perform a factory reset of the unit that will result in all configuration setting being lost. To perform a factory reset, press and hold push button on the display circuit board for 150 seconds.

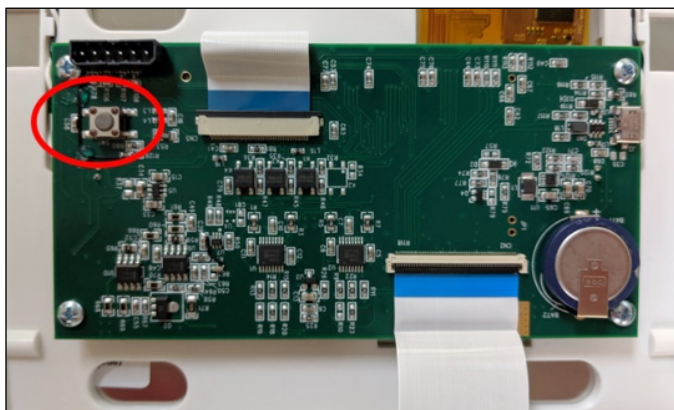

## 3.12 Diagnostics

The Diagnostics menu performs system, network, and I/O tests on the unit. Functions available are:

- I/O Testing
- Send WHOIS & Display IAM Messages
- Control Loop Testing

- View Log
- Network Testing
- I/O Module Ping

### I/O Testing

Selecting the I/O Testing shows the screen where Inputs and Outputs can be selected.

Choose the Input desired from the pull-down menu, and the input value will be displayed if a sensor is properly connected. Choose the Output desired from the pull-down menu, and the output value will be displayed if properly configured or looped from an input.

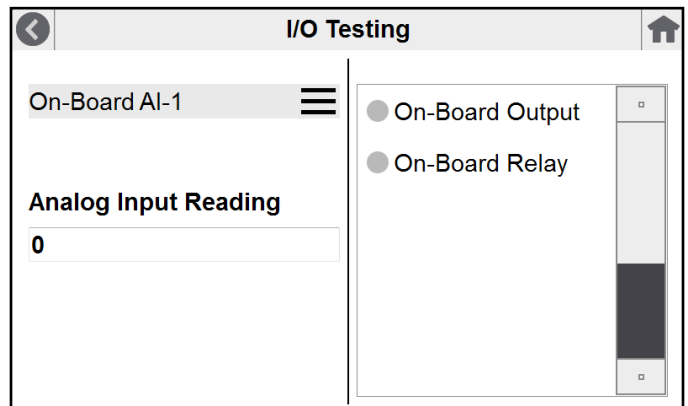
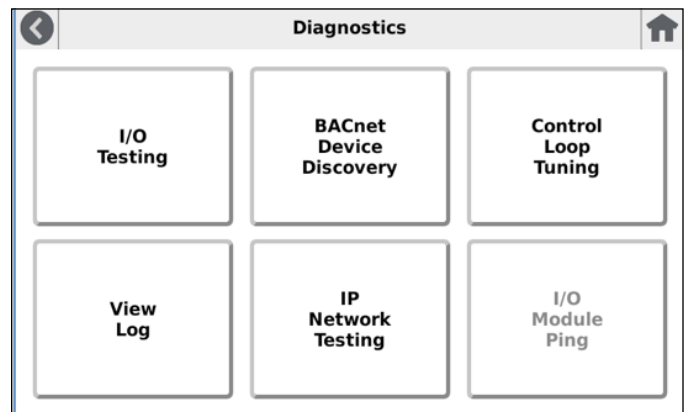
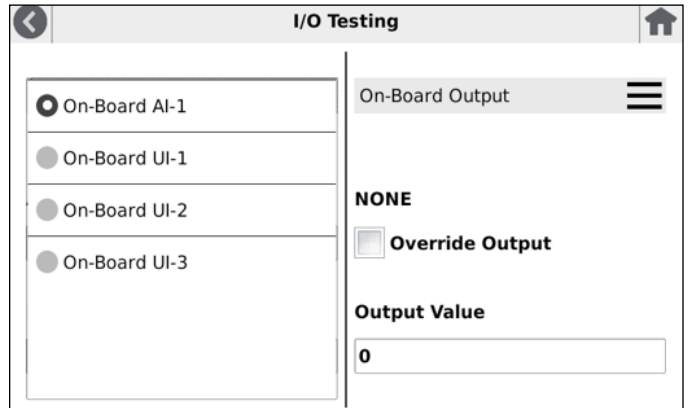

### Send WHOIS & Display IAM Messages

When first entering this screen, the user should see a list of all devices that replied to FLEX with an I-Am message.

For Who-Is page, the user enters a range of device IDs to search for. When selecting the Send Who-Is button, it clears the I-Am list and issues a new Who-Is request over the BACnet network. As I-Am responses come in, they are then posted to the screen.

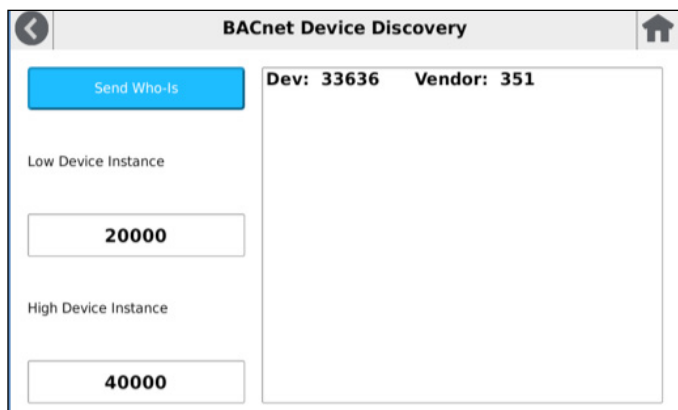

### View Log

The log file in FLEX is designed to capture significant events related to FLEX performance, changes in state, and configuration changes. These events are listed below.

- Transitions to ALARM or to NORMAL for any of the 6 parameters on each of the 3 rooms
- Door open or close for any of the 3 rooms
- Successful and unsuccessful password entry
- Room profile selection change
- Access to Pressure Calibration menu
- Copy from USB successful
- Update firmware
- Reset to factory defaults
- Config – any change to Alarm Settings page
- Config – any change to Security Settings page
- Pressure Calibration menu – log whenever zero or span adjustments are made, or if the user adjustment is reset
- Reset to factory defaults
- Application launch

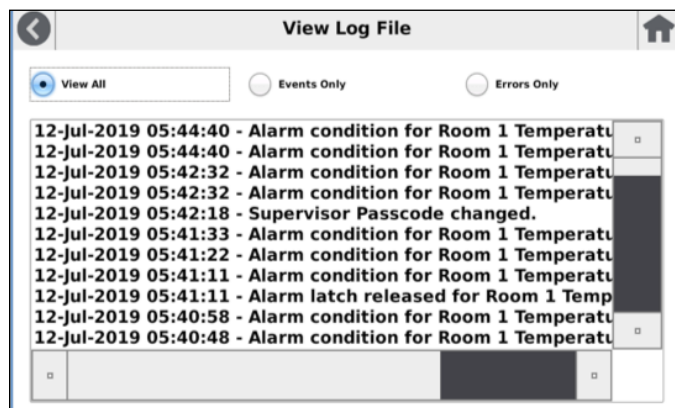

- System errors, such as failure to work with a specific piece of hardware or BACnet. These include:
  - RP-A response timed out
  - Settings file write errors
  - Copy To/From USB errors
  - Reset to factory default errors
  - Firmware update failures
  - ADC errors
  - DAC errors
  - Backlight errors
  - Buzzer errors
  - I/O module COM errors
  - Relay errors

## Network Testing

The Network Testing page provides two key pieces of information: whether or not the network is online, and the IP address assigned to FLEX. The field to the right of the Ping button is available to enter an IP address, where Ping can then be used to test if that address is online or not. Ping is configured to try seven (7) times and report the ping statistics.

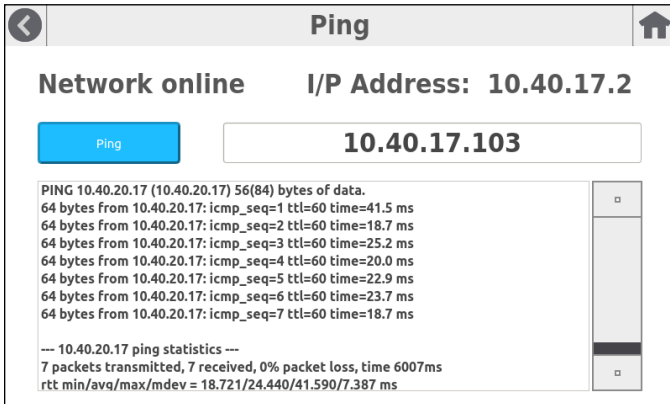

## 3.13 Maintenance

The Maintenance menu provides several functions that help ensure FLEX is configured and operating accurately and with proper parameters. Maintenance functions are as follows:

- Calibration of the pressure sensor, provided FLEX is configured with an on-board pressure transducer from Setra (integrated on the back of the FLEX unit).
- Copy From or Copy To a USB thumb drive. This permits FLEX configurations to be copied to USB for the purpose of replicating the configuration on other devices, or units that may be replaced in the field
- Reset To Factory Default – restores the unit's original factory configuration.
- Date and Time – allows manual or BACnet setting of date/time and customization of home screen date/time display
- Update Application – in the event new application software containing new features and bug fixes is available from Setra
- Software Update – in the event a full firmware update is required for the unit

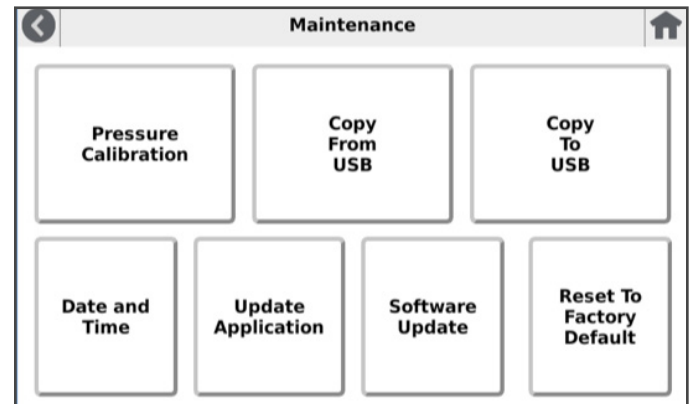

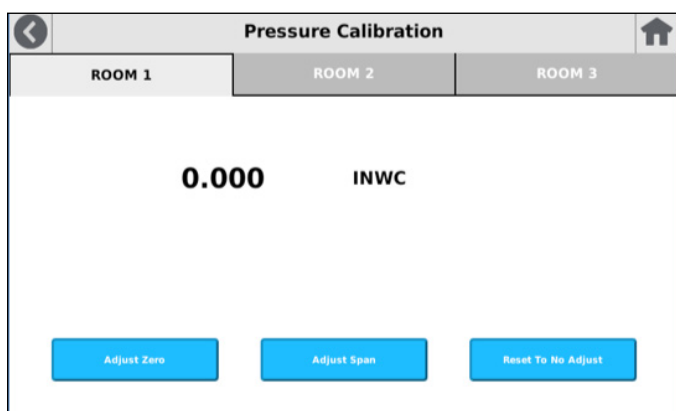

1. Select the Room tab desired for recalibration. The indicated pressure is shown.
2. Remove the two pressure tubes shown above
3. Connect tubing from the calibrator to the low and high ports identified on the FLEX unit
4. Apply full range pressure. For example  $\pm 0.1$ " WC range uses 0.1" WC pressure.
5. When pressure reaches full range, press **Adjust Span**.
6. The output at full range must be within 10% of the factory calibration to allow readjustment.

### Pressure Calibration

Pressure Calibration is the function used to ensure accurate and reliable pressure sensing occurs continuously in the room environment. From **Maintenance**, select the large **Pressure Calibration** button.

Three room tabs appear, including the live value of the room pressure being sensed at the time of menu access. **Adjust Zero** can be used for either an on-board sensor or external sensor. To access the on-board sensor, remove the FLEX display from the wall surface and swing the faceplate down below the base unit mounted in the wall. Remove the pressure tubes from the HIGH and LOW side of the sensor. Apply the zero function. Repeat for any external sensors (such as Setra 264 or Setra 267) that may be connected to other rooms.

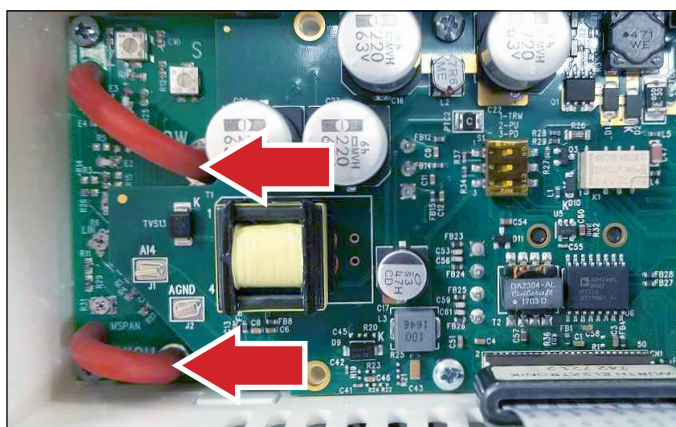

**Adjust Span** is used for calibration of the internal or external pressure transducer sensor and testing operation of hardware circuitry. Calibration using **Adjust Span** is only required for highly accurate measurement needs such as those needed to comply with federally mandated regulations. Calibration should only be performed by qualified personnel, using a pressure calibrator such as the Setra MicroCal or equivalent.

**Reset to No Adjust** permits the user to discard any changes that may be unintentional, leaving the unit as it was before any Adjust Zero or Adjust Span modifications.

## Copy To USB

The Copy To USB function is used to capture a FLEX configuration on a USB thumb drive. This function is useful to store configurations on a personal computer, where a controlled inventory of one or more units can be maintained. In the event that a FLEX unit needs to be replaced, the proper configuration file can be retrieved and loaded. Copy To USB is also helpful for commissioning new installations. A single FLEX unit can be setup, and then the USB configuration can be "cloned," or copied to many other units to get most of the configuration in with little touch-screen labor. Once copied, the "cloned" unit then only needs room-specific parameters setup, such as room name, IP address, and other unique parameters.

To initiate the Copy To USB function, enter the file name you wish to use. This should be a name that makes sense to your organization, such as "FLEX-Floor3Room123-122517." In this example the file name itself indicates it is a Setra FLEX unit, the location, and the date the configuration was captured.

When the USB is connected, press COPY. All other FLEX configurations that may reside on the USB drive are shown in the status window.

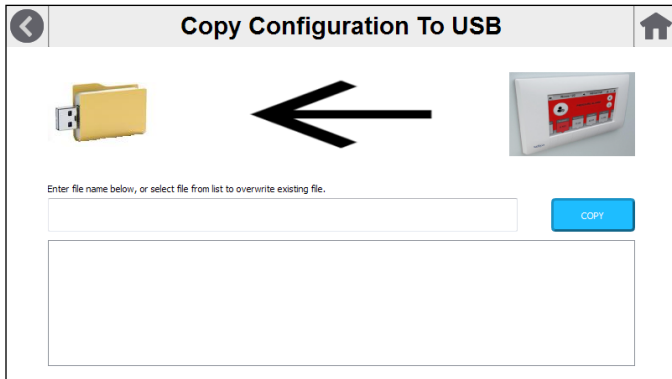

## Copy From USB

The Copy From USB function is used to copy a FLEX configuration from a USB thumb drive to a target FLEX unit. A FLEX configuration previously captured is then "cloned," or copied to many other units to get most of the configuration in with little touch-screen labor. Once copied, the "cloned" unit then only needs room-specific parameters setup, such as room name, IP address, and other unique parameters.

To initiate the Copy From USB function, select the file name you wish to use from the list in the window. Press COPY.

## Date and Time

The Date and Time allows the unit date and time to be manually set or sourced via BACnet. The display of the date and time on the home screen can also be customized.

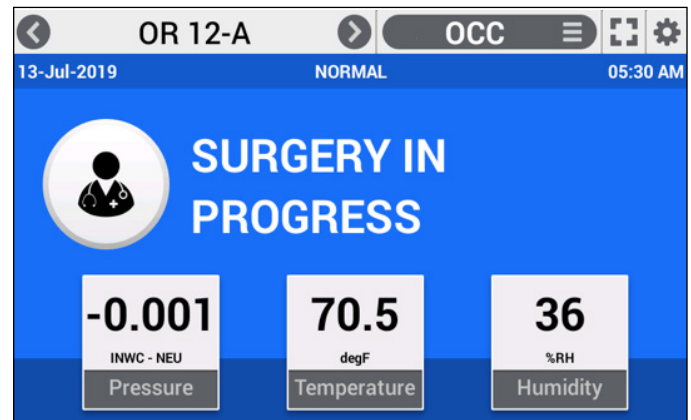
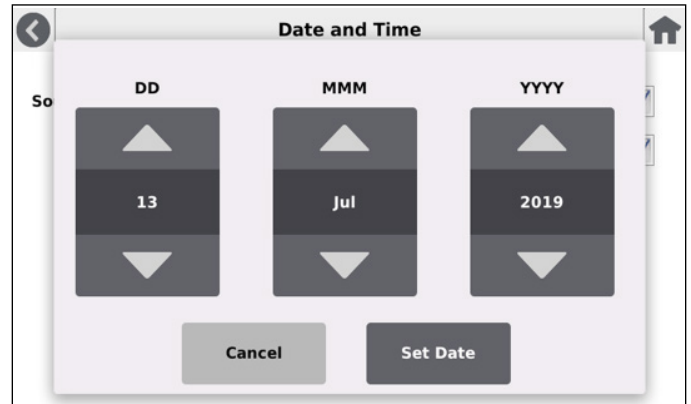
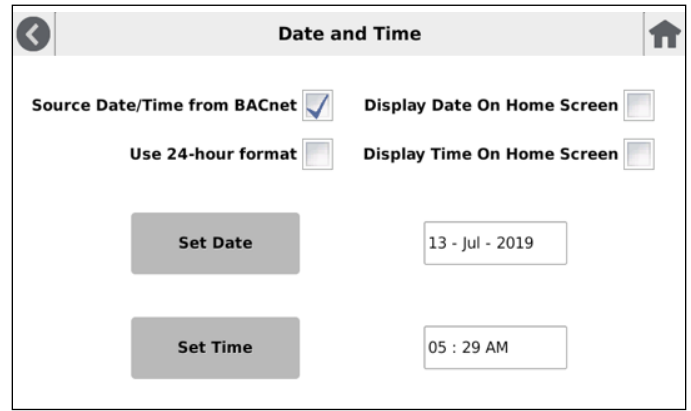

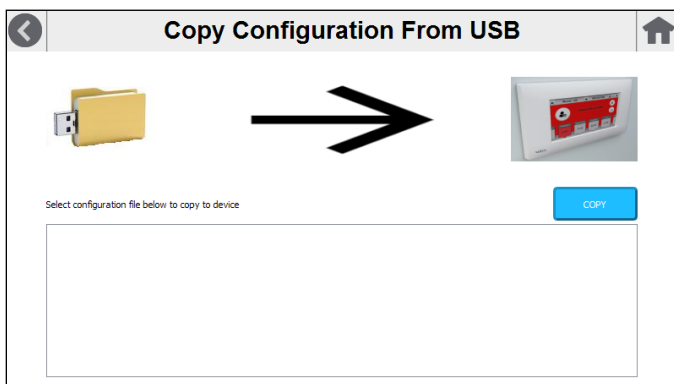

Note: Before proceeding with any firmware update function, first Copy to USB the current configuration of any units you plan to update. It will be necessary to restore the configuration after the firmware update is successful. Additionally, manually not any and all configuration settings in case the old configuration file is incompatible with the updated firmware.

Load the firmware on a USB thumb drive, connect it to FLEX, select Software Update, and press OK. When complete, restore the configuration using Copy From USB or manually from notes.

The Update Application function is necessary only if Setra has issued a software revision to the FLEX unit that impacts a customer installation (e.g. new functionality or bug fix needed). If all functions in use are operating as designed, there is never a need to update FLEX application software.

In the event Update Application is required, obtain the software revision from Setra.com or your authorized Setra distributor.

**NOTE: before proceeding with any application update function, first Copy To USB the current configuration of any units you plan to update. It will be necessary to restore this configuration after the firmware update is successful.**

Load the firmware on a USB thumb drive, connect it to FLEX, and press UPDATE. When complete, restore the configuration using Copy From USB.

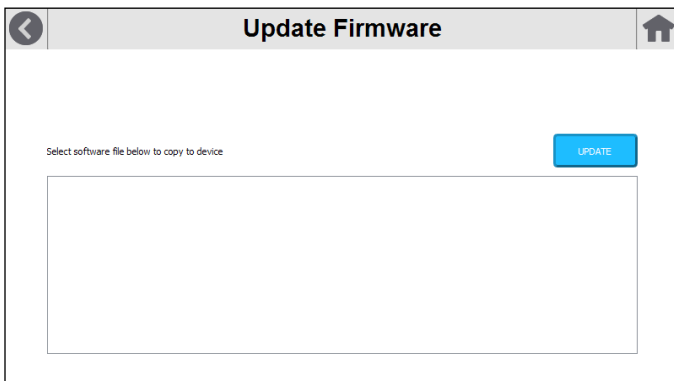

### Software Update

The software update function is necessary only if explicitly instructed by Setra (e.g. to resolve firmware-level issues with a specific installation). If all functions in use are operating as designed, there is never a need to update FLEX firmware. In the event Software Update is required, obtain the software revision from Setra.com or your authorized Setra distributor.

**Reset To Factory Default**

The function Reset To Factory Default is used in the event a FLEX unit must be put into a known state for either service or configuration reload. This helps establish a baseline of original functionality from which to build the specific configuration for a given application. New configurations can then be added by either touch-screen entry, Copy From USB, or over the BACnet network.

Selecting NO will cause FLEX to remain in its current state of configuration. Selecting YES will cause FLEX to erase all configuration information and restore the FLEX unit to its original factory configuration. Once YES is selected, this function cannot be reversed or undone.

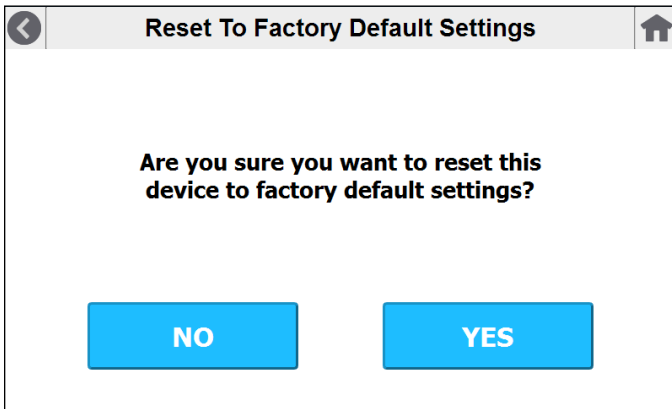

An alternative way to reset the unit to factory default settings is to press and hold the physical reset button on the display circuit board for 150 seconds. For units where a Supervisor Passcode is set and forgotten, this is the only method to recover access to the configuration settings on the unit.

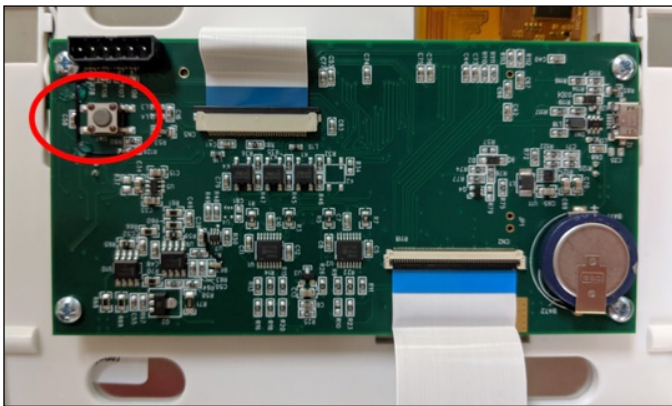

Caution: Resetting a unit to factory default, either via the configuration menu or via the physical reset button, will result in all configuration settings being erase.

**About**

The About box shows the FLEX Model Number of the unit as purchased from the factory. This will match any Setra order information, as well as a sticker on the inside

of the FLEX housing (behind the touch screen). The Serial Number can be used for any service that may be required. Calibration Date shows when the unit was calibrated at the Setra factory. Firmware Revision is the software version from the factory or any firmware updates loaded. Technical Support is a field that can be entered by the end-user if a Setra distributor chooses to have something different from Setra.com.

**4.0 Troubleshooting**

There are circumstances where values may not appear on badges. "..." indicates that the badge is not configured properly, or the badge has been configured for BACnet but has not been properly set to a valid source. Dashes "----" indicates that the badge has been configured to appear on the home screen, is waiting for a valid response from the source.

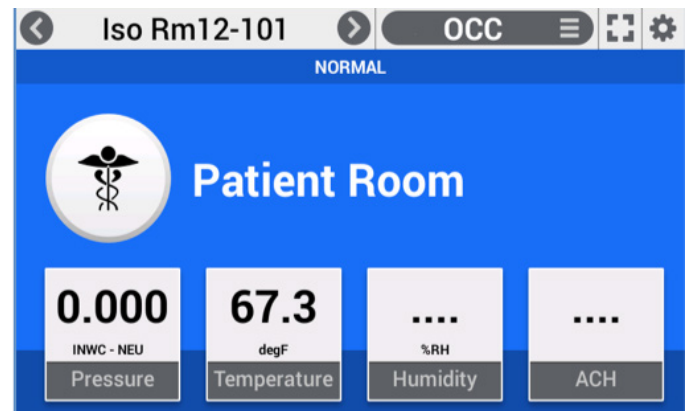
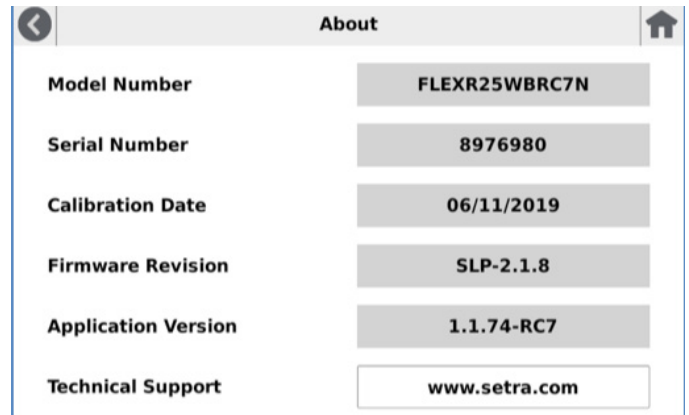



### 5.0 Returns

When returning a product to Setra Systems, the material should be carefully packaged and shipped prepaid to:

**Setra Systems, Inc.  
159 Swanson Road  
Boxborough, MA 01719-1304  
Attn: Repair Department**

To assure prompt handling, please refer to return instructions on our Web site at:

**<https://www.setra.com/support/service>**

### 6.0 Warranty and Limitation of Liability

SETRA warrants its products to be free from defects in materials and workmanship, subject to the following terms and conditions: Without charge, SETRA will repair or replace products found to be defective in materials or workmanship within the warranty period; provided that:

- a) the product has not been subjected to abuse, neglect, accident, incorrect wiring not our own, improper installation or servicing, or use in violation of instructions furnished by SETRA;
- b) the product has not been repaired or altered by anyone except SETRA or its authorized service agencies;
- c) the serial number or date code has not been removed, defaced, or otherwise changed; and
- d) examination discloses, in the judgment of SETRA, the defect in materials or workmanship developed under normal installation, use and service;
- e) SETRA is notified in advance of and the product is returned to SETRA transportation prepaid.

Unless otherwise specified in a manual or warranty card, or agreed to in writing and signed by a SETRA officer, SETRA pressure, humidity, and acceleration products shall be warranted for one year from date of sale.

The foregoing warranty is in lieu of all warranties, express, implied or statutory, including but not limited to, any implied warranty of merchantability for a particular purpose.

SETRA's liability for breach of warranty is limited to repair or replacement, or if the goods cannot be repaired or replaced, to a refund of the purchase price. In no instance shall SETRA be liable for incidental or consequential damages arising from a breach of warranty, or from the use or installation of its products. No representative or person is authorized to give any warranty other than as set out above or to assume for SETRA any other liability in connection with the sale of its products.

For all CE technical questions, contact Setra Systems, USA. EU customers may contact our EU representative Hengstler GmbH, Uhlandstr 49, 78554 Aldingen, Germany (Tel: +49-7424-890; Fax: +49-7424-89500).

This product uses Open Source Software developed by the open source community. To obtain a copy of our Open Source Attribution, please follow the link on our website [www.Setra.com](http://www.Setra.com) under the Flex listing. Certain open source licenses require Setra to make available the source code corresponding to the binaries distributed under that license. Recipients who would like to receive a copy of such source code, should contact customer support (see Section 7.0) for application ordering instructions and cost details.



### Safety Precautions

This product conforms to UL 61010-1/61010-2-201 and CSA CSA22.2 No. 61010-1/61010-2-201 safety standards Pollution Degree 2, and Measurement Category 2.

To ensure the safe operation and service of the device, follow these instructions closely. Failure to observe warnings can result in severe personal injury or permanent damage to the device.

- This product is for indoors use only
- Use a Class-2 transformer of the appropriate size to supply power to the device
- Relay shall only be used to switch load up to 30VDC 2A
- Temperature inside enclosure may exceed 60°C under normal operation. Select appropriate cable or wire rating for connection. Avoid touching electronics components with bare hands to prevent personal injury
- All wiring must conform to national and local codes and regulations
- Observe ESD general practice. Wear ESD wrist strap to install and service the device

## 7.0 Support

### Setra FLEX Quickstart Guide

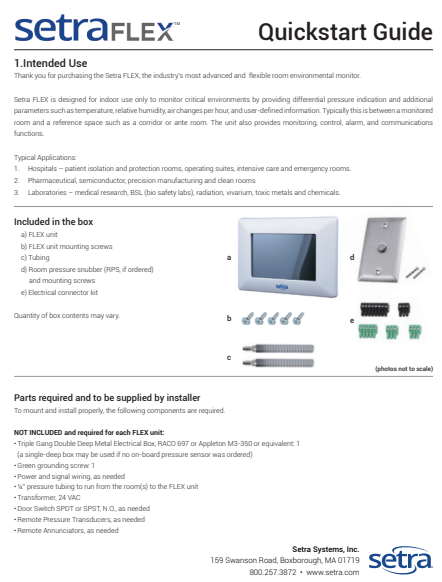

**setraFLEX™ Quickstart Guide**

**1. Intended Use**  
Thank you for purchasing the Setra FLEX, the industry's most advanced and flexible room environmental monitor.

Setra FLEX is designed for indoor use only to monitor critical environments by providing differential pressure indication and additional parameters such as temperature, relative humidity, air changes per hour, and user-defined information. Typically this is between a monitored room and a reference space such as a corridor or ante room. The unit also provides monitoring, control, alarm, and communications functions.

**Typical Applications:**

- Hospital – patient isolation and protection rooms, operating suites, intensive care and emergency rooms.
- Pharmaceutical, semiconductor, precision manufacturing and clean rooms
- Laboratories – medical research, BSL (bio safety labs), radiation, vivarium, toxic metals and chemicals.

**Included in the box**

- FLEX unit
- FLEX unit mounting screws
- Tubing
- Room pressure snubber (RPS, if ordered) and mounting screws
- Electrical connector kit

Quantity of box contents may vary.

**Parts required and to be supplied by installer**  
To mount and install properly, the following components are required.

**NOT INCLUDED and required for each FLEX unit:**

- Triple Gang Double Deep Metal Electrical Box, RA20 6BT or Appleton MS-350 or equivalent 1 (a single deep box may be used if no on-board pressure sensor was ordered)
- Green grounding screw 1
- Power and signal wiring, as needed
- ¼" pressure tubing to run from the room(s) to the FLEX unit
- Transformer, 24 VAC
- Door Switch SPDT or SPST, N.O., as needed
- Remote Pressure Transducers, as needed
- Remote Annunciators, as needed

Setra Systems, Inc.  
159 Swanson Road, Boxborough, MA 01719  
800.257.3872 • www.setra.com

### Setra FLEX Data Sheet



**setra**

The Setra FLEX™ provides a flexible room environmental control and monitoring solution in a simple to use package. An attractive flush mount footprint is complemented by an intuitive graphical display to meet any architectural requirement. The unit supports 3 rooms, monitoring up to 6 parameters for each room. If additional I/O is required, an expansion I/O module enables the monitoring and control for more complicated applications. An optional differential pressure sensor can be either factory installed in the unit or ordered separately and installed above the ceiling. Integration with building automation systems is made easy through other DACHESIP™ or DACHES M3/MT™ network protocols.

**Modular Design**

A modular hardware design enables the FLEX monitor to fit in various wall thicknesses found around the globe. For applications which require the monitor to fit in wall depths less than 50mm, the FLEX can be ordered with an external pressure sensor. When mounting in a three-gang electrical box, the FLEX can be ordered with an integrated on-board sensor. Sufficient on-board I/O provides connectivity for most common equipment and sensor applications. If additional connections are required, or if more advanced I/O applications demand it, the expansion I/O module can be ordered as an accessory. A high accuracy 0.25% differential pressure transducer is used in all pressure sensing options. A project specific touch screen provides simple functionality and allows for use with medical gloves. The faceplate is attached to the unit body enabling both tamper resistant operation and easy opening for pressure calibration.

**Setra FLEX-RM and FLEX-RC**

FLEX software is designed to suit any application, with the ability to support up to 3 rooms. FLEX RM (Room Monitor) provides monitoring only for those applications where no control from the touch screen is needed. FLEX RC (Room Controller) offers monitoring plus 71 loop or network control of VAV boxes, venturi valves, or hydraulic reheat valves. Software is pre-installed with configuration and network integration done using simple-step screens. There is no programming required. When completed, configuration settings on one unit can be cloned to other devices using a standard USB transfer device, thereby shortening commissioning time. Units can also be configured remotely over a DACHES network.

The FLEX monitor is both a controller and monitor, with audible and visual alarming on all room environmental parameters. The FLEX monitor enables users to save energy by choosing from two 7x control loops and two monitoring sets for any of four room modes, such as occupied and unoccupied.

**setraFLEX Environmental Monitor**

- Supports 3 Rooms, 6 Parameters Each
- 77 Programmable Cognitive Touch Screens
- DACHESIP & DACHES M3/MT
- Flush Mount to Wall
- Mounts in Standard Electrical Boxes
- Full Touch Response with Medical Gloves
- No Programming Required
- 8 Inputs & 8 Outputs On-board
- 8 Inputs & 8 Outputs Expansion I/O Module
- On-board or External Pressure Transducer
- High Accuracy 0.25% Sensor Standard
- Monitor and Control Pressure, Temperature, Humidity, Air Change Rate and 2 User Defined Parameters
- Customizable Screen Profiles
- 4 Levels of Password Security
- User Defined On-Screen Text and Icons
- Configuration Options Help Reduce Hardware Alarms
- 50mm Wall Depth when Sensor is Mounted Remotely
- Cloning Features Reduces Time Required for Multi-Unit Installation
- Remote duplicate display shows parameters inside and outside of rooms

800.257.3872 | www.setra.com

## Technical Support



800.257.3872



www.setra.com



techsupport@setra.com



**Setra Systems, Inc.**

159 Swanson Road, Boxborough, MA 01719

800.257.3872 • [www.setra.com](http://www.setra.com)

