

AUTO PRO™

Manual

45.4 °C

Noncontact Temperature Measurement



- Infrared Thermometer for Automotive Diagnostics
- Infrarot-Thermometer für die Fahrzeugdiagnose
- Termômetro Infravermelho para Diagnósticos Automotivos
- Termómetro Infrarrojo para Diagnóstico Automotriz
- Thermomètre infrarouge pour le diagnostic automobile

Worldwide Headquarters

Raytek Corporation

1201 Shaffer Rd. PO Box 1820
Santa Cruz, CA 95061-1820 USA
Tel: 1 800 866 5478
1 831 458 1110
Fax: 1 831 425 4561
solutions@raytek.com

Raytek China Company

Beijing, China
Tel: 86 10 6439 2255
Fax: 86 10 6437 0285
info@raytek.com.cn

Raytek Japan, Inc.

Osaka, Japan
Tel: 81 6 4390 5015
Fax: 81 6 4390 5016
info@raytekjapan.co.jp

South American Headquarters

Raytek do Brasil

Sorocaba, SP Brasil
Tel: 55 15 32176046
Fax: 55 15 32175694
info@raytek.com.br

European Headquarters

Raytek GmbH

Berlin, Germany
Tel: 49 30 4 78 00 80
Fax: 49 30 4 71 02 51
raytek@raytek.de

Raytek UK Ltd.

Milton Keynes, United Kingdom
Tel: 44 1908 630800
Fax: 44 1908 630900
ukinfo@raytek.com

Raytek France

Palaiseau, France
Tel: 33 1 64 53 15 40
Fax: 33 1 64 53 15 44
info@raytek.fr

Worldwide Service

Raytek offers services including emergency repairs and calibration. For more information, contact your local office or e-mail: support@raytek.com

www.raytek.com

for up-to-the-minute features

The Raytek logo consists of a stylized 'R' symbol followed by the word 'Raytek' in a bold, sans-serif font, with a registered trademark symbol (®) to the upper right.

Specifications	
Temperature Range	-32 to 535°C (-25 to 999°F)
Accuracy for target temperatures (assumes ambient temperature of 23°C (73°F))	-32 to -26°C (-25 to -15°F): ±3°C (±5°F) -26 to -18°C (-15 to 0°F): ±2.5°C (±4°F) -18 to 23°C (0 to 73°F): ±2°C (±3°F) 23° to 510°C (73° to 950°F): ±1% of reading or ±1°C (±2°F), whichever is greater Above 510°C (950°F): ±1.5% of reading
Distance to Spot (D:S)	Optimized for use at 8 inches Approximately 16:1 at focus point
Temperature Display	°C or °F selectable
Display Resolution	0.2°C (0.5°F)
Repeatability	±0.5% or ≤ ±1°C (±2°F), whichever is greater
Response Time	500 mSec (95% of reading)
Spectral Response	8-14µm
Emissivity	Pre-set at 0.95
Ambient Operating Temp.	0 to 50°C (32 to 120°F)
Relative Humidity	10-90% RH noncondensing, at 30 to 50°C (86 to 122°F)
Storage Temperature	-20 to 60°C (-13 to 158°F) without battery
Weight/Dimensions	360g (12oz) 205 x 160 x 55mm (8x6x2 in)
Power	9V Alkaline or NiCd Battery
Typical Battery Life (Alkaline)	4 hrs w/laser, flashlight & backlight on 20 hrs w/laser, flashlight & backlight off
Laser (Class II)	SmartSight™ dual laser sighting system Laser turns off above 40° C (104°F) ambient temperature
Typical Distance to Target	200 mm-600 mm (8 inches to 2 feet)
MAX Temp. Display	✓
Display Hold (7 seconds)	✓
LCD Backlit	✓
Tripod Mounting	0.25" 20 UNC threading
Removable base magnet	✓
Work area illumination	Bright white LED (7100 millicandela)
Additional Options/Accessories	Nylon Holster NIST Calibration Certificate

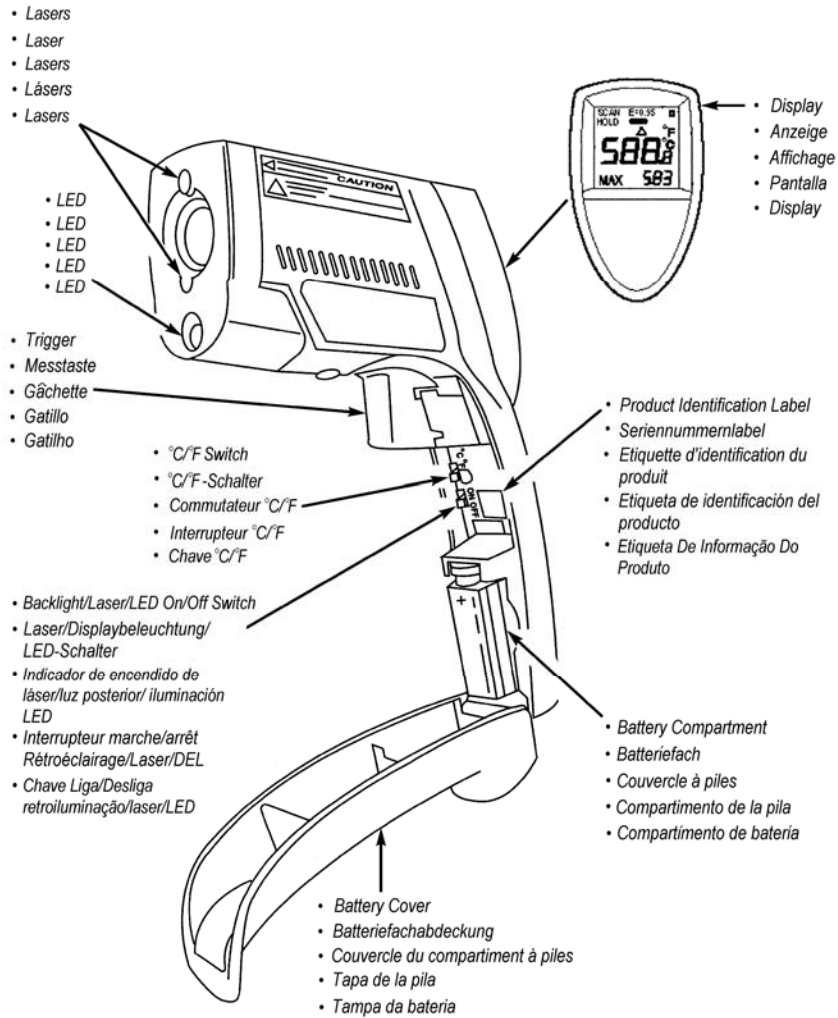

INTRODUCTION

Product Identification Label

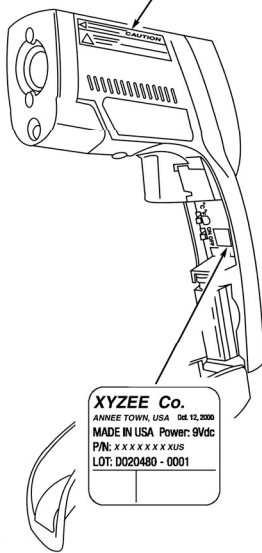
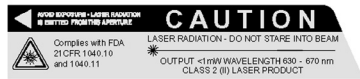

Warning:
Do not point lasers directly at eye or indirectly off reflective surfaces.

- Cautions:**
All models should be protected from the following:
- ◆ EMF (Electro-Magnetic Fields) from engine components closer than 125 mm (5 inches).
 - ◆ Static electricity
 - ◆ Thermal shock (caused by large or abrupt ambient temperature changes—allow 30 minutes for unit to stabilize before use)
 - ◆ Do not leave the unit on or near objects of high temperature

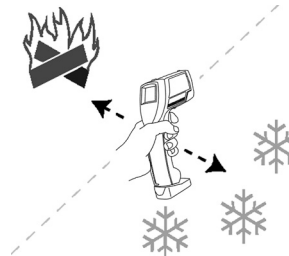

Features

- Your thermometer includes:
- Dual laser sighting
 - LED Flashlight
 - Wide temperature range
 - MAX temperature display
 - Back-lit graphic display
 - Tripod mount
 - Removable magnetic Base
 - Durable, ergonomic construction

Options/Accessories

- Nylon Holster
- N.I.S.T./DKD Certification

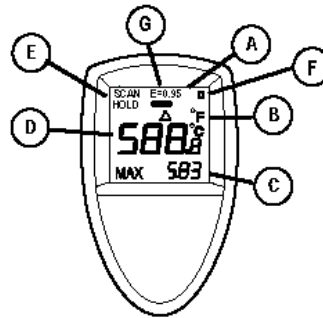

Display

- A) Low battery indicator (comes on when battery is low)
- B) °C/°F symbol
- C) Maximum temperature value (continuously updated while the unit is on)
- D) Temperature display
- E) Scan/Hold indicator

F) Laser/Backlight/LED on indicator

G) Emissivity indicator

In the scan mode, the backlit LCD displays both the current temperature (D) and maximum temperature (C) in Celsius or Fahrenheit (B). The unit will hold the last reading for 7 seconds after the trigger is released; the word HOLD appears (E). The presence of the battery icon (A) indicates a low battery. The presence of a light bulb (F) will indicate backlight and LED flashlight are on. When trigger is pulled triangular icon will be present indicating laser is on.

Introduction

We are confident you will find many uses for your handheld non-contact thermometer. Compact, rugged, and easy to use—just aim, pull the trigger, and read the temperature in less than a second. You can safely measure surface temperatures of hot, hazardous, or hard-to-reach objects without contact.

How it Works

Infrared thermometers measure the surface temperature of an object. The unit's optics sense energy emitted, reflected, and transmitted energy, which are collected and focused onto a detector. The unit's electronics translate the information into a temperature reading displayed on the unit. The lasers are used for aiming purposes only.

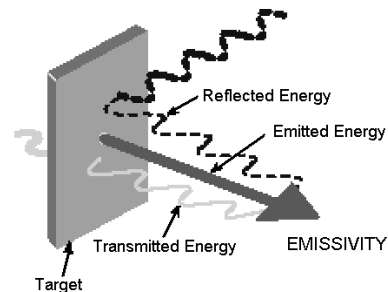

How to Operate the Unit

Measurement: Quick Start

To measure an object, point the unit at an object, and pull the trigger. Try to merge the 2 laser dots on your target into one dot. When using the lasers, use them only for aiming. When sighting an object, merge the 2 lasers into one for optimum temperature reading. For more detailed operating instructions, see "How to Accurately Measure Temperature."

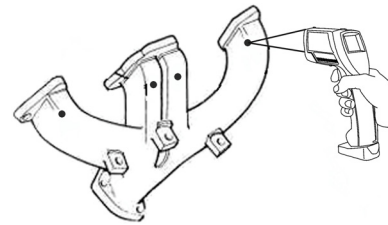

Switching °C and °F; Changing the Battery; Laser/Backlight/LED On/Off

Before opening the unit's handle to access the battery and controls, use a Phillips head screwdriver to remove the base magnet. To open the unit's handle, push the button near the trigger on the underside of the unit, and pull the handle down and forward.

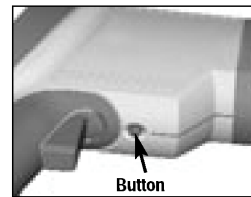

To select °C or °F, slide the top switch (A) up for Celsius and down for Fahrenheit. To activate the lasers, backlight and LED flashlight, slide the lower switch (B) down. Dual lasers and LED flashlight will turn on when the trigger is pulled. The lasers and LED flashlight will turn off when the trigger is released. The backlight will remain on for 7 seconds after the trigger is released.

To change the 9V battery, attach the battery to the battery snaps with the positive side toward the rear of the battery compartment.

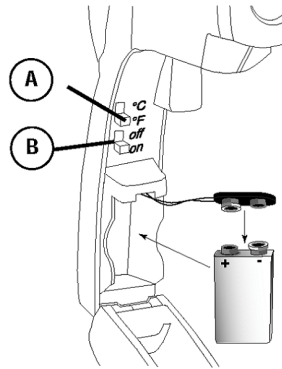

How to Accurately Measure Temperature

Laser Sighting

Laser sighting consists of 2 lasers. These lasers are aimed at different angles. The point at which the two laser points intersect (thermometer focused) is 8 inches (200 mm). This is also the optimum measuring distance.

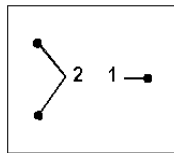

To sight object being measured, press trigger to turn on laser sight. Only one laser point should be seen when at optimum measuring distance (1). If two laser points are visible (2), adjust distance of unit from object being measured. If it is not possible to adjust the distance, see Distance & Spot Size information.

Distance & Spot Size

The relationship between distance and spot size is 16:1 at the focus point (200mm: 13mm or 8

inches: 0.5 inch). As the distance (D) from the object decreases or increases, the spot size (S) of the area measured by the unit becomes larger. The spot sizes indicate 90%-encircled energy.

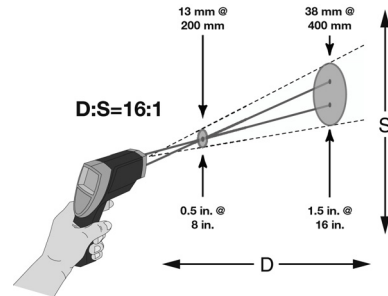

Emissivity

Emissivity is a term used to describe the energy-emitting characteristics of materials. Most organic materials and painted or oxidized surfaces have an emissivity of 0.95 (pre-set in the unit). Inaccurate readings can result from measuring shiny or polished metal surfaces. To compensate, cover the surface to be measured with masking tape or flat black paint. Allow time for the tape or paint to reach the same temperature as the material underneath it. Measure the temperature of the tape or painted surface.

Locating a Hot or Cold Spot

To find a hot or cold spot, aim the thermometer outside the area of interest. Then scan across the area with an up and down motion until you locate the hot or cold spot.

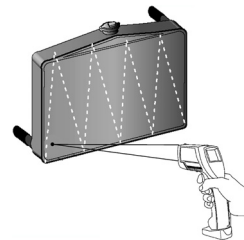

ENGLISH

LED Illumination

An LED is located on the front of the unit. When the trigger is pulled, notice a bright LED illuminates the area including and around the area being measured for convenience unless switched off.

Magnetic Base

A removable magnetic base is attached to the bottom of unit, below the handle. The magnetic base allows the unit to be attached to any ferrous metal surface. The magnet's surface has been engineered not to scratch finishes by recessing the actual magnets. However, metal shavings and debris can be inadvertently picked up by the magnetic, and if not removed and cleaned, can damage the finish of a surface. The magnetic base is attached to the unit using a Phillips head screw and can easily be removed using a screwdriver.

Reminders

- Not recommended for use when measuring shiny or polished metal surfaces (stainless steel, aluminum, etc.). See "Emissivity" for measuring these surfaces.
- The unit cannot measure through transparent surfaces such as glass or plastic. It will measure the surface temperature of these materials instead.
- Steam, dust, smoke, or other particles can prevent accurate measurement by obstructing the unit's optics.
- The thermometer can be pointed using the sighting guides on top of the unit whenever it is difficult to see the laser sighting system.

Maintenance

Lens Cleaning: Blow off loose particles using clean compressed air. Gently brush remaining debris away with a soft brush. Carefully wipe the surface with a moist cotton swab. The swab may be moistened with water.

Note: Do not use solvents to clean the plastic lens.

Cleaning the housing: Use soap and water on a damp sponge or soft cloth.

Note: Do not submerge the unit in water.



CE Certification

This instrument conforms to the following standards:

- EN61326-1 EMC
- EN61010-1
- EN60825-1 Safety

Tests were conducted using a frequency range of 80–1000 MHz with the instrument in three orientations.

Note: Between 165 MHz and 880 MHz at 3V/m, the instrument may not meet its stated accuracy.

Troubleshooting

Code	Problem	Action
--- (on display)	Target temperature is over or under range	Select target within specifications
 Battery icon	Low battery	Check and/or replace battery
Blank display	Possible dead battery	Check and/or replace battery
Laser doesn't work	(1) Low or dead battery (2) Laser turned off (3) Ambient temperature above 40°C (104°F)	(1) Replace battery (2) Turn laser on (3) Use in area with lower ambient temperature
ERR	Possible damage by EMF	Contact your distributor

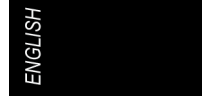

APPLICATIONS

TABLE OF CONTENTS

A/C-HEATER SYSTEM 7

BEARINGS, BUSHINGS, CV JOINTS & UNIVERSAL JOINTS..... 8

BRAKES..... 9

COOLING SYSTEM..... 11

ENGINE PERFORMANCE 13

HEATED SEATS..... 15

REAR WINDOW DEFROSTER..... 16

TIRE PRESSURES & WHEEL ALIGNMENT ... 16

A/C-Heater System

A/C System – Cooling

NOTE: Before and after performing repairs on the A/C refrigerant system, discharge/charge refrigerant using approved refrigerant recovery/recycling equipment.

When A/C is on and set at maximum cooling, air temperature from instrument panel ducts should be a minimum of 15°C (25°F) cooler than ambient temperature. To verify A/C outlet temperature, start vehicle and set A/C to coldest setting using dash vents. Set A/C controls to MAX-A/C or re-circulate position. Test-drive vehicle if possible. If test is to be performed in service bay, place a large fan in front of the vehicle to ensure A/C condenser has sufficient airflow for an accurate temperature reading. If vehicle is stationary, raise idle and allow A/C system to stabilize before measuring outlet

temperature. Ensure windows are rolled up and doors are closed.

CAUTION: To avoid thermal-shock of IR thermometer, DO NOT hold unit directly in the flow of the A/C outlet when measuring A/C duct surface temperature or measuring other components near A/C ducts. Hold unit off to one side when measuring to avoid direct contact with cold airflow.

Using the IR thermometer, measure A/C outlet temperature. If outlet temperature is at 15°C (25°F) cooler than ambient temperature, A/C system is cooling sufficiently. If outlet temperature is less than 15°C (25°F) cooler than ambient temperature, check for the following:

- Restricted liquid line to evaporator (check for ice on liquid line to evaporator).
- Restricted expansion valve or orifice tube (check for ice on expansion valve or orifice tube).

Measure temperature of condenser to check for cold spots. If cold spots are found, this will indicate a restriction in the condenser. Parallel flow condensers will normally have an even temperature drop from one side to the other while serpentine condensers will show a drop in temperature from top to bottom.

If A/C compressor is cycling on and off with less "on" time than normal, check for low refrigerant charge. If A/C compressor is not operating at all, diagnose and repair A/C system using appropriate service information.

Automatic A/C System

On many vehicles with automatic A/C systems, sensors are used to determine ambient (outside) and cabin (in-car) temperatures to control functions of the A/C-Heater system. Often, along with these sensors, the A/C system may have the ability to display current ambient and in-car temperature provided by these sensors, on the A/C controls. Most ambient temperature sensors are mounted outside the passenger

A/C-Heater System (Cont.)

compartment, near the front of the vehicle. Most in-car temperature sensors are mounted on the instrument panel. See manufacturer's information to identify exact location of sensors, if equipped. To verify correct operation of sensors, use the IR thermometer to measure ambient temperature near the ambient temperature sensor and in-car temperature near the in-car temperature sensor. Compare readings to A/C control. If the measured and displayed temperatures are not approximately the same, a problem with the sensor or A/C system may exist.

Heater System

WARNING: Engine coolant can reach temperatures exceeding 125°C (260°F). Allow engine to cool before performing repairs on heater system or serious injury may occur.

Heater systems on most vehicles are connected directly to the engine cooling system using the engine water pump and coolant system pressure to provide coolant to the heater core. On other vehicles a separate water pump is used to circulate water for the heater system. A heater control valve, controlled by the A/C system, is used in some applications to stop flow of coolant into heater core to prolong heater core life and to aid in cooling the passenger compartment when A/C is in use. When trouble shooting heater cores, ensure A/C system is off and heater control valve is open as to not stop flow of coolant to heater core. Inspect coolant level and top off as necessary to ensure air will not be trapped in heater core during testing. Ensure vehicle is at operating temperature, approximately 85-105°C (190-220°F). Verify operating temperature has been reached by measuring temperature at upper radiator hose near the thermostat housing. If vehicle does not reach operating temperature, trouble shoot the cooling system first.

Using the IR thermometer, measure inlet and outlet hose temperature near firewall. The temperature reading of the inlet hose should be approximately 10°C (20°F) hotter than the outlet

hose. If the outlet hose is not hot or the temperature differential between the inlet and the outlet hose is greater than 10°C (20°F), coolant is not flowing through the heater core. Check for the following:

- Plugged/Restricted heater core.
- Heater control valve not opening.

Bearings, Bushings, CV Joints & Universal Joints

Bearings, bushings, CV joints and universal joints all have friction surfaces that require proper clearance and lubrication to operate properly. Some of these components are sealed and do not require service while some are equipped with fittings to allow regular maintenance. Following manufacturers recommended maintenance intervals is key to ensuring proper operation of all friction surfaces.

Bearings & Bushings – Including Trailers

Most bearing and bushing problems can be related with a growl noise or metal-on-metal contact. Once a noise is heard, damage has occurred. A bearing or bushing that has deteriorated this far can possibly damage the component it has been designed to protect. To prevent this type of damage, whenever possible, perform a through visual inspection to check for damaged or leaking seals. On wheel bearings, check for uneven wear of brake pads or excessive axial movement of wheels. Bearings and bushings can be checked before damage occurs. To check for deteriorating wheel bearings, test-drive vehicle a short distance. Stop vehicle, place in Park (auto trans) or neutral (manual trans) and set parking brake. Using the IR thermometer, measure temperatures at all wheel bearings and/or hubs. The bearing or hub with a higher temperature as compared to other bearings/hubs will indicate potential bearing failure. Verify that a brake drag is not causing the difference in temperature. Inspect components and repair as necessary.

Bearings, Bushings, CV Joints & Universal Joints (Cont.)

NOTE: *It is advised to check all wheel bearings/hubs at the same time to ensure all are in good working order.*

On other items such as alternator bearings, differential pinion bearings or distributor bushings that do not have a like component to compare temperature readings measure temperature of component away from bearing/bushing area. Then measure bearing/bushing area. When operating properly, temperature should not change significantly between the component and the bearing/bushing area. If temperature increases at the bearing/bushing area, inspect the bearing/bushing and repair as necessary. On components such as alternators, check for brown residue expelling from bearings indicating bearing deterioration.

CV Joints & Universal Joints

CV joints and universal joints operate typically the same as bearings. Lubrication and clearance are key to proper operation. On a CV joint, a noise or symptom is usually not heard until damage is done. On a universal joint, often a squeak or a vibration will indicate a marginal component. To prevent this type of damage, whenever possible, perform a thorough visual inspection to check for damaged/torn boots or leaking seals.

To trouble shoot CV joints and universal joints, test-drive vehicle a short distance. Stop vehicle, place in Park (auto trans) or neutral (manual trans) and set parking brake.

Using the IR thermometer, measure temperatures at all CV joints or universal joints. The CV joint or universal joint with excessive temperature as compared to other CV/universal joints will indicate potential bearing failure. Remove, inspect and repair as necessary.

Brakes

Familiarity with the different types of braking systems can aid in choosing the correct path of diagnosis. High temperature at one brake does not mean that is the brake with the problem. If another brake is not operating properly, then the brake that is hotter may be having to work harder to stop the vehicle. See appropriate service for information to verify type of braking system for vehicle.

NOTE: *Before trouble shooting brakes, ensure all tires are properly inflated to manufacturer's specification. Ensure tire size on vehicle is the same across the front or rear and that bias-ply and radial tires are not mixed.*

CAUTION: *Both front or rear brakes should be serviced at the same time to ensure brakes are at optimum operating condition.*

Front/Rear Split Brake Systems

On vehicles equipped with front/rear split brake systems, each circuit of the master cylinder operates either the front or rear brakes.

See Fig 1.

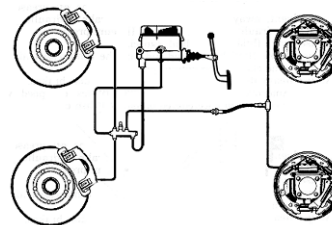

Fig. 1: Front/Rear Split Brake System

The front brakes will normally have higher temperatures than rear brakes when working properly. Normal temperature differential between front and rear brakes is 30°C (50°F). This procedure checks operation of front and rear brakes on these systems and applies to vehicles with disc/disc, drum/drum or disc/drum brake configuration.

Brakes (Cont.)

To obtain an accurate temperature reading, test drive vehicle in a low-traffic area, preferably on a straight, level section of roadway. Operate vehicle to 50 KM/H (30 MPH) and bring to a complete stop 5 times. Stop vehicle, place in Park (auto trans) or neutral (manual trans) and set parking brake. Using the IR thermometer, measure temperature of front and rear brakes. See Figs. 2 & 3.

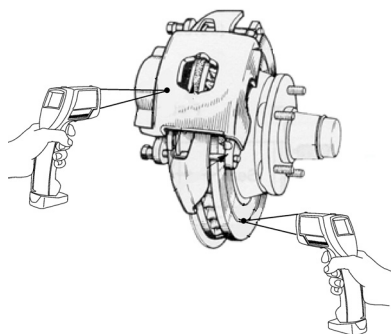

Fig. 2: Measuring Disc Brake Temperatures

If temperature differential between front and rear brakes is greater than 30°C (50°F), rear brakes may not be working effectively. Check the following:

- Front brake adjustment too tight (disc brakes - front).
- Rear brake adjustment too loose (disc brakes - rear).
- Emergency brake adjustment.
- Combination valve malfunction.
- Master cylinder malfunction (check for loss of brake fluid without a visible fluid leak).
- Leaking calipers or wheel cylinders.
- Master cylinder overfilled.
- Brake line or hose restriction.

If temperature differential is less than 30°C (50°F), or rear brake temperature is hotter than front brakes, front brakes may not be working effectively. Check the following:

- Front brake adjustment too loose (disc brakes - front).

- Rear brake adjustment too tight (drum brakes - rear).
- Emergency brake adjustment too tight.
- Combination valve malfunction.
- Master cylinder malfunction.
- Leaking calipers or wheel cylinders.
- Brake line or hose restriction.

Some vehicles also have a load-sensing valve near the rear brakes. Check this valve for proper operation where applicable.

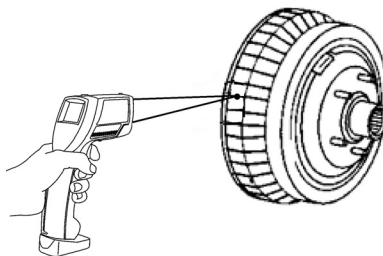

Fig. 3: Measuring Drum Brake Temperatures

Diagonal Split Brake Systems

Diagonal split brake systems differ from front/rear split systems in that each circuit of the master cylinder operates one front brake and the diagonally opposite rear brake. See Fig. 4. As in front/rear split brake systems; diagonal split brake systems front brakes will normally have higher temperatures than rear brakes when working properly. Normal temperature differential between front and rear brakes is 30°C (50°F). Diagonal split brake system symptoms are often related with a brake pull. This is when the vehicle pulls to left or right when the brakes are applied. This procedure trouble shoots operation of the diagonal split brake system and applies to vehicles with disc/disc or disc/drum brake configuration.

To obtain an accurate temperature reading, test drive vehicle in a low-traffic area, preferably on a straight, level section of roadway. Operate

Brakes (Cont.)

vehicle to 50 KM/H (30 MPH) and bring to a complete stop 5 times. Stop vehicle, place in Park (auto trans) or neutral (manual trans) and set parking brake. Using the IR thermometer, measure temperature of each front and each rear brake. See Figs. 2 & 3. If the temperature reading of one brake on the front of the vehicle is 3°C (5°F) greater than the other front brake and the diagonally opposite brake on the rear is also 3°C (5°F) greater than the other rear brake, check for the following:

- Master cylinder malfunction (check for loss of brake fluid without a visible fluid leak).
- Master cylinder overfilled.
- Leaking calipers or wheel cylinders.
- Brake line restriction.
- Combination valve malfunction.

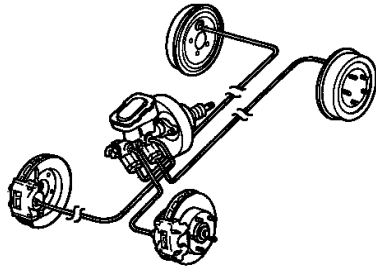

Fig. 4: Diagonal Split Brake System

Some vehicles also have a load-sensing valve near the rear brakes. Check this valve for proper operation where applicable. If temperature differential is greater than 3°C (5°F) only between the two front brakes or the two rear brakes, check for conditions associated with brake drag at one or more brakes.

Brake Drag/Pull (Left/Right)

Vehicle may pull to one side when brakes are applied. One wheel may lock up under braking. Uneven brake pad/shoe wear or glazed surface may accompany condition. Heat damage to rotor/drum may also exist. This procedure applies to vehicles with disc/disc, drum/drum or disc/drum brake configuration and also to front/rear and diagonal split brake systems.

To obtain an accurate temperature reading, test-drive vehicle in a low-traffic area, preferably on a straight, level section of roadway. Operate vehicle to 50 KM/H (30 MPH) and bring to a complete stop 5 times. Make sure brake symptom is duplicated. Stop vehicle, place in Park (auto trans) or neutral (manual trans) and set parking brake. Using the IR thermometer, measure temperature of all brake rotors/drums. See Figs. 2 & 3. If temperature differential of one brake is greater than 3°C (5°F) compared to the other brake on the same axle, check for the following at all brakes:

- Binding caliper hardware (disc brakes).
- Frozen caliper (disc brakes).
- Leaking calipers or wheel cylinders.
- Broken, loose or missing brake hardware.
- Brake adjustment (drum brakes).
- Worn or damaged backing plates (drum brakes).
- Wheel bearing adjustment.
- Leaking bearing or axle seals (contaminated pads/shoes).
- Brake hose restriction.

On drum brakes, check that automatic brake adjusters operate properly. If temperature differential between brakes is small or non-existent, worn suspension components or alignment of vehicle may be causing pull.

Cooling System

WARNING: Engine coolant can reach temperatures exceeding 125°C (260°F). Allow engine to cool before performing repairs on cooling system or serious injury may occur.

Each vehicle has its own optimum operating temperature and a threshold beyond that to allow vehicle operation without causing damage to engine components. A cooling system may be operating fine and have no visible signs of trouble, yet for some reason the vehicle may be running hot, have a fluctuating temperature or possibly overheating. The task is to be able to trouble shoot and repair the cooling system

Cooling System (Cont.)

before the vehicle overheats and to prevent damage to engine.

Note: Before trouble shooting cooling system, ensure coolant leaks DO NOT exist and cooling fans operate properly.

Radiator Trouble Shooting

Radiators are hard to trouble shoot visually. The radiator will either leak or not leak. You may be able to pull the radiator cap off and look inside at the ends of the passages. The cap may look new and the seal good. Unless there is excessive damage or corrosion, the radiator may not be considered suspect.

Internally there are many passages that can be blocked or restricted, causing cool spots that decrease the radiators flow and effectiveness at lowering the temperature of the coolant to the engine.

CAUTION: On vehicles with mechanical fans, use care not to place tools or hands into moving blades to prevent injury. On vehicles with electric fans, be cautious when working near because the fan may turn on at any time.

To trouble shoot for radiator blockage, start engine and run until normal operating temperature of 85-105°C (190-220°F) is reached and temperature stabilizes. For vehicles equipped with electric cooling fans, ensure fans cycle on and off three times prior to checking temperatures.

Using the IR thermometer, measure radiator surface temperature. On vehicles equipped with a cross flow radiator, measure temperature from inlet side (hose from thermostat) to outlet side (hose from water pump inlet). Temperature should decrease evenly from inlet side to outlet side. On vehicles equipped with a down flow radiator, measure temperature from top to bottom. Temperature should decrease evenly from top to bottom. Also measure temperature at various points across radiator fins. If there is a drop in temperature at one section, this indicates

a blockage or restricted flow. Also check for bent fins restricting airflow.

Thermostat Opening Temperature

As an engine reaches normal operating temperature, approximately 85-105°C (190-220°F) on most vehicles, the thermostat should open and allow coolant to flow through the radiator. Using the IR thermometer, measure the temperature of the upper radiator hose near the thermostat housing as engine reaches operating temperature. When the thermostat opens at the specified temperature, the temperature of the upper radiator hose should quickly increase. If temperature at upper radiator hose near the thermostat housing does not increase, check for the following:

- Stuck closed thermostat causing coolant not to flow (engine temperature will be high).
- Stuck open thermostat, causing coolant to flow constantly and not increase in temperature.
- Air in cooling system (possibly from not being properly bled).

If temperature remains low and does not reach normal operating temperature, check for the following:

- Stuck open thermostat, causing coolant to flow constantly and not increase in temperature.
- Missing thermostat.
- Thermostat with opening temperature too low for vehicle.

If temperature of upper radiator hose fluctuates up and down, check for the following:

- Weak thermostat spring.
- Air in cooling system (possibly from not being properly bled).

A fluctuating temperature gauge may accompany fluctuating temperature at upper radiator hose.

Engine Performance

Engine Misfire Trouble Shooting – Gasoline

A gasoline engine may idle rough or have an intermittent misfire. Lack of fuel, lack of spark or lack of cylinder pressure (compression) can cause misfires. In a gasoline engine, any of these three problems means no combustion in that cylinder. No heat coming from the exhaust port will indicate lack of combustion. A lean fuel condition will cause a higher combustion temperature. Individual exhaust temperature will be easier to obtain on vehicles equipped with separate exhaust pipes for each port. On exhaust manifolds, heat transfer will occur and make it difficult to identify changes in temperature between ports. The best results on a manifold will be observed when the vehicle is first started and the engine is cold. On newer vehicles, if a cylinder is not operating effectively, the check engine light may turn on and a Diagnostic Trouble Code (DTC) will be set.

To locate a misfiring cylinder using the IR thermometer, start engine and allow the idle to stabilize. Measure temperature at each exhaust port, noting changes in temperature. See Fig. 5. If any cylinders show a significantly lower temperature than other cylinders, check that cylinder for the following:

- Malfunctioning ignition supply to affected cylinder.
- Malfunctioning fuel supply to affected cylinder (rich condition).
- Excessively low cylinder pressure (compression).

If any cylinders show a significantly higher temperature than other cylinders, check for a fuel restriction to affected cylinder causing a lean misfire. Most likely cause is a dirty fuel injector or vacuum leak.

If any cylinders indicate a noticeable, but not significantly lower or higher temperature than other cylinders, this could be an indication of poor cylinder performance. This check may warn of other mechanical problems. Check for the following:

- Worn spark plugs or wires.
- Malfunctioning fuel supply to affected cylinder (rich/lean condition).
- Low cylinder pressure (compression).
- Carbon buildup.

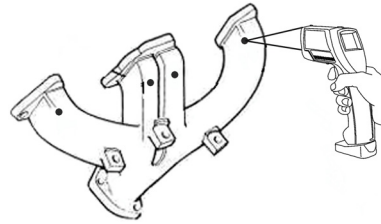

Fig. 5: Measuring Exhaust Port Temperatures

Engine Misfire Trouble Shooting – Diesel

A diesel engine may be hard to start, lack power or idle rough in all climates and at all operating temperatures. The engine may have a cylinder that is misfiring.

To locate a misfiring cylinder using the IR thermometer, start engine and run until engine reaches normal operating temperature. Run engine at a fast idle and measure temperature at each exhaust port, noting changes in temperature. See Fig. 5. A weak cylinder can be identified as having a temperature less than surrounding cylinders of 55°C (100°F) or more. If a weak cylinder is found, check that cylinder for the following:

- Malfunctioning fuel injectors or fuel injector pump.
- Excessively low cylinder pressure (compression).

Engine Temperature Sensors

Emission controls on most computer-controlled vehicles rely on many sensor inputs, allowing proper control of spark and fuel supply in all climate and driving conditions. Engine Coolant Temperature (ECT) sensor and Intake Air Temperature (IAT) sensor (if equipped) inputs can be verified using the IR thermometer. To

Engine Performance (Cont.)

verify ECT and IAT sensor inputs, a scan tool or other data device with proper software installed will need to be connected to the vehicle to enable viewing of the actual ECT and IAT sensor temperature readings.

Start engine and run until normal operating temperature of 85-105°C (190-220°F) is reached and temperature stabilizes. For vehicles equipped with electric cooling fans, ensure fans cycle on and off three times prior to checking temperatures.

To verify ECT sensor temperature, monitor ECT sensor temperature reading on scan tool. On most vehicles the ECT sensor is threaded into the cooling system, near the thermostat.

Measure temperature where ECT sensor threads into engine. Compare temperature readings. If temperature readings are not approximately the same, check for the following before diagnosing:

- Damaged ECT sensor, connector or wiring.
- Air in cooling system (possibly from not being properly bled).

To verify IAT sensor temperature, turn engine off and ignition on. Monitor IAT sensor temperature reading on scan tool. On some vehicles the IAT sensor may be threaded into the intake air ducting before the throttle body. On other vehicles it may be threaded directly into the intake manifold after the throttle body. After engine reaches operating temperature, it may be difficult to verify IAT sensor temperature when threaded into the intake manifold. On vehicles where the IAT is threaded into the intake air ducting, remove ducting to access IAT sensor without disconnecting IAT sensor. Measure air temperature around IAT sensor. Compare temperature readings. If temperature readings are not approximately the same, check for the following before diagnosing:

- Contaminated or damaged IAT sensor, connector or wiring.
- Damaged intake air ducting.

Catalytic Converter - Efficiency

An engine may run fine yet fail an emissions test. The catalytic converter efficiency can be checked. Start engine and test drive vehicle until

normal operating temperature of 85-105°C (190-220°F) is reached and temperature stabilizes. On some vehicles the catalytic converter temperatures will lower and become insufficient for testing purposes if the vehicle is left idling for a prolonged period of time. For vehicles equipped with electric cooling fans, ensure fans cycle on and off three times prior to testing catalytic converter. During test, hold throttle to keep engine running at 1000 RPM.

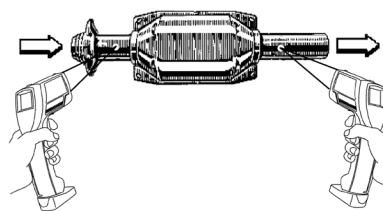

Fig. 6: Measuring Converter Inlet & Outlet Temperatures

Using the IR thermometer, measure the inlet and outlet temperatures of the converter. See Fig. 6. Compare inlet temperature to outlet temperature. On vehicles equipped with 2-way catalytic converters, temperature differential will be 55°C (100°F) or more. On vehicles equipped with 3-way catalytic converters, temperature differential will be 20°C (30°F) or more. The outlet temperature will be hotter when the converter is operating properly. If temperature differential between converter inlet and outlet are less than specified or the application, then the converter needs to be inspected further. Before replacing the catalytic converter, determine cause of failure. Catalytic converters are designed to last the life of the vehicle. If vehicle has high mileage of over 240,000 kilometers (150,000 miles) it is probably just expired. If the vehicle has low mileage of less 240,000 kilometers (150,000 miles) then check for the following:

- Ignition system malfunction (misfire).
- Fuel system malfunction (over-lean or over-rich condition).
- Emission system operation (O₂, air injection, etc).

Engine Performance (Cont.)

- Engine coolant in combustion chamber (leaking/blown head gasket).
- Excessive oil getting past rings or valve guides.

Trouble shoot and repair problem and retest before replacing catalytic converter.

Catalytic Converter – Plugged

CAUTION: *If a vehicle is operated with a plugged catalytic converter for any length of time, possible engine damage may result.*

If a catalytic converter is exposed to a rough running or improperly maintained engine for extended periods of time, the end result could be a plugged converter or exhaust system.

Symptoms of a plugged catalytic converter will be lack of power, engine temperature increasing as vehicle is driven, and if the converter has been plugged for a while, the exhaust manifold gaskets will blow out.

To check for a plugged converter, start engine and test drive until normal operating temperature of 85-105°C (190-220°F) is reached and temperature stabilizes. On some vehicles the catalytic converter temperatures will lower and become insufficient for testing purposes if the vehicle is left idling for a prolonged period of time. For vehicles equipped with electric cooling fans, ensure fans cycle on and off three times prior to testing catalytic converter. During test, hold throttle to keep engine running at 1000 RPM.

Using the IR thermometer, measure the inlet and outlet temperatures of the converter. Compare inlet temperature to outlet temperature. When a converter is plugged, the converter outlet temperature will be cooler than the inlet temperature. In some cases, the catalyst inside of the converter will break apart and end up plugging the exhaust in the muffler. In this case, the inlet and outlet temperatures of the converter will be close as with an expired converter. If this is the case, the converter and muffler will need to

be removed, inspected and repaired as necessary.

Before replacing the catalytic converter, determine cause of failure as to not damage new converter.

Heated Seats

Some vehicles are equipped with heated seats as an option. Some heated seats have 2-position LOW/HIGH heating capabilities. Vehicle may also be equipped with rear heated seats.

On most vehicles, seat temperature will reach 35°C (98°F) when in LOW position and approximately 45°C (110°F), when in HIGH position. Internal temperature sensors will ensure heated seats will operate at these temperatures as closely as possible. Seat temperature may vary by manufacturer. See appropriate service information for exact operating temperatures for vehicle being serviced.

Before checking heated seat temperatures, verify if vehicle is equipped with heated seat cushions, heated seat backs or both heated seat cushions and seat backs. If possible, park vehicle out of sunlight and allow cabin (in-car) temperature to stabilize.

Using the IR thermometer, measure heated seat cushion and/or seat back surface with all heated seats off. Measure other seats to get a general temperature reading of seat surfaces.

Temperature should be close between all seats. If surface temperature is noticeably hotter, heated seat may be stuck on. Next, turn ignition on and set heated seat switch to LOW position and allow 5 minutes for seat temperature to stabilize. Measure heated seat cushion and/or seat back surface again. Verify that LOW temperature reading is close to 35°C (98°F). Next, set heated seat switch to HIGH position and allow 5 minutes for seat temperature to stabilize. Measure heated seat cushion and/or seat back surface again. Verify that HIGH temperature reading is close 45°C (110°F). If temperature readings are hotter or cooler, diagnose heated seat system using appropriate service information.

Rear Window Defroster

Locating Broken Grid Lines

Rear window defroster uses heat through voltage to defrost the rear window using metal strips attached to the inside of the rear window. To visually locate broken grid lines is difficult. To trouble shoot defroster system grid lines turn ignition on and activate rear window defroster. Using the IR thermometer, measure temperature across each defroster grid line from left to right from inside of window. Temperature should increase from left to right on grid line as temperature is measured. If temperature remains constant across grid line, check for a loose ground for defroster grid. Temperature drops will indicate location of broken grid lines. See Fig. 7. If defroster does not turn on or temperature does not increase, problem may be in voltage supply circuit, relay or defroster switch. See appropriate service information to diagnose and repair.

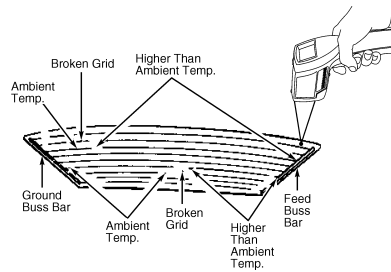

Fig. 7: Locating Broken Grid Lines

Tire Pressures & Wheel Alignment

NOTE: Before trouble shooting tire pressures or alignment, ensure all tires are properly inflated to manufacturer's specification. Ensure tire size on vehicle is the same across the front or rear and that bias-ply and radial tires are not mixed.

Tire temperatures can tell you how well the tire is using the tread surface and the road surface to maintain control. The objective is to get the tire to work effectively across the entire face of the tire. This can be maximized for most vehicles by adjusting tire pressures and alignment.

Tire Temperatures/Pressures

CAUTION: Some vehicles are equipped with tire pressure monitoring systems. If air pressure is adjusted, system may set a warning light. Check manufacturer's information before adjusting air pressure beyond factory specifications.

Optimum tire temperature should be little to no temperature differential across the tire tread. On a vehicle such as a taxi or a truck, this procedure may not be suitable because of the varying loads impressed upon the tires.

Tire manufacturers recommend tire temperature differential for passenger car tires across the tread should be less than 10°C (20°F). Before test drive, ensure tires are properly inflated to manufacturer's specifications. To obtain an accurate temperature reading, test drive vehicle in a low-traffic area, preferably on a straight, level section of roadway. Operate vehicle at a safe speed and bring to a complete stop. Try to avoid any sharp turns or movements during test drive. Stop vehicle, place in Park (auto trans) or neutral (manual trans) and set parking brake. Using the IR thermometer, measure temperature at inside, center and outside of tire tread surface. See Fig. 8.

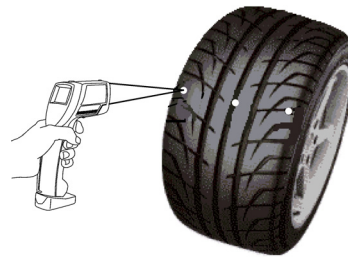

Fig. 8: Measuring Tire Temperatures

Tire Pressures & Wheel Alignment (Cont.)

If the center temperature is higher than the inside and outside temperatures, the tire is probably over inflated. Try reducing pressure in 2-psi (14 kPa) increments and recheck. If the middle temperature is lower than the inside and outside temperatures, the tire is probably under inflated. Try increasing pressure in 2-psi (14 kPa) increments and recheck.

Wheel Alignment

Temperatures can be used to determine condition of alignment before tread wear is evident. Before attempting to trouble shoot wheel alignment using tire temperature readings, ensure tires are properly inflated to manufacturer's specifications. On many vehicles, front and rear suspension alignment can be adjusted. See appropriate service information to verify if vehicle is equipped with front and rear alignment adjustments.

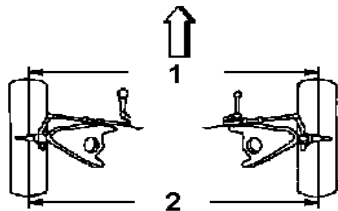

Fig. 9: Identifying Toe

The following are alignment conditions that can be diagnosed using tire temperatures.

- Toe-In - This is when the distance between the front (1) centerline of the tires is shorter than the distance between the rear (2) centerline of the tires. See Fig. 9.
- Toe-Out - This is when the distance between the rear (2) centerline of the tires is shorter than the distance between the front (1) centerline of the tires. See Fig. 9.
- Negative Camber - This is when the top of the tire leans in toward the vehicle (1). See Fig. 10.

- Positive Camber - This is when the top of the tire leans away from the vehicle (2). See Fig. 10.
- Caster - Caster will not cause tire tread wear or increase tire temperatures. Caster can cause a pull.

To obtain an accurate temperature reading, test drive vehicle in a low-traffic area, preferably on a straight, level section of roadway. Operate vehicle at a safe speed and bring to a complete stop. Try to avoid any sharp turns or movements during test drive. Stop vehicle, place in Park (auto trans) or neutral (manual trans) and set parking brake.

Using the IR thermometer, measure temperature at inside, center and outside of tire tread surface on all tires. See Fig. 8.

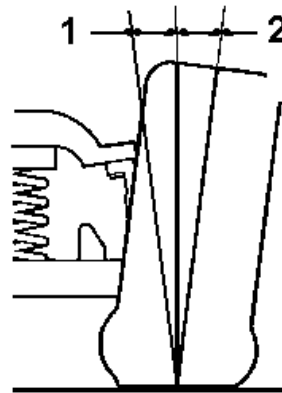

Fig. 10: Identifying Camber (Positive Camber Shown)

If tire temperatures are higher on the inside of both tires, check for the following:

- Excessive toe-out condition.
- Excessive negative camber at both wheels.
- Ride height too low (causing excessive negative camber).
- Excessive play in steering or suspension components (tie-rod ends, ball joints, bushings, etc.).

Tire Pressures & Wheel Alignment (Cont.)

- Bent steering or suspension components.
- Collapsed springs.
- Bent axle or axle housing (solid front/rear axle vehicles).

If tire temperatures are hotter on the outside of both tires, check for the following:

- Excessive toe-in condition.
- Excessive positive camber at both wheels.
- Ride height too high (causing excessive positive camber).
- Bent steering or suspension components.
- Bent axle or axle housing (solid front/rear axle vehicles).

If tire temperature on one tire is hotter on the inside only, check for the following:

- Excessive amount of negative camber at that wheel.
- Excessive play in steering or suspension components (tie-rod ends, ball joints, bushings, etc.).
- Bent or damaged steering or suspension components.
- Collapsed spring.
- Bent axle or axle housing (solid front/rear axle vehicles).

If tire temperature on one tire is hotter on the outside only, check for the following:

- Excessive amount of positive camber at that wheel.
- Excessive play in steering or suspension components (tie-rod ends, ball joints, bushings, etc.).
- Bent or damaged steering or suspension components.
- Bent axle or axle housing (solid front/rear axle vehicles).