

# Model SRPM Room Pressure Monitor Installation and Operating Manual

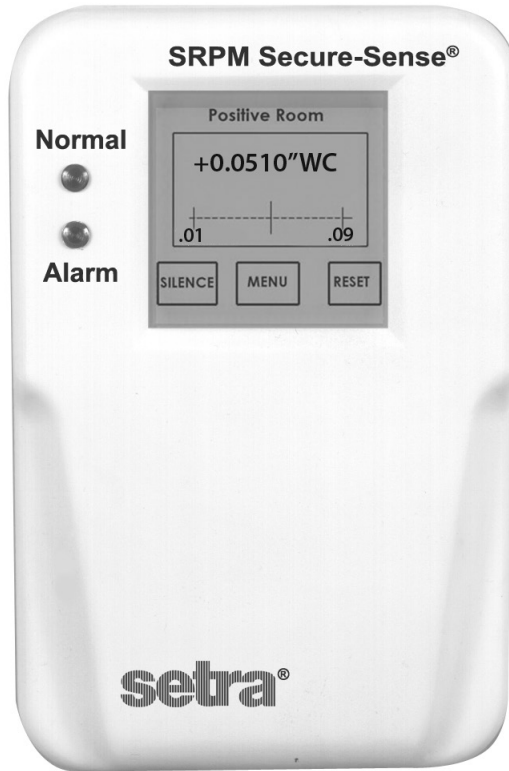

# Setra SRPM Room Pressure Monitor

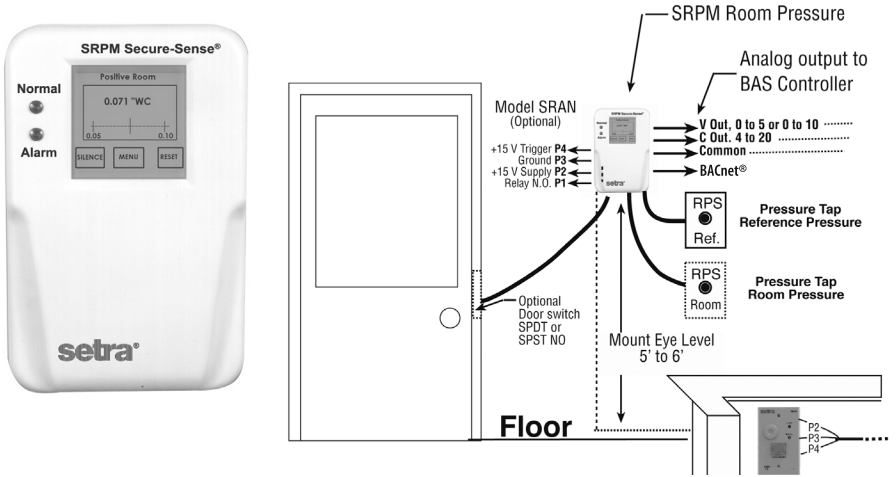

**The Setra SRPM Room Pressure Monitor** is designed for critical low differential pressure applications that require stringent pressure monitoring and alarming. The SRPM can be configured to monitor positive, negative or neutral pressure in protected environments and hospital isolation rooms per CDC guidelines. The SRPM is a complete system that includes a backlit RGB LCD display with a graphic user interface, which enables access to pressure, security, calibration, and alarm setup. The touch-screen displays menus that guide the user through setup, as well as setting up password protection. Red and green LED's and a local audible alarm (with time delay feature) alert personnel to system status. The SRPM has a NEMA 1 (IP20) rated fire retardant plastic housing for indoor applications. True differential pressure is displayed with a resolution of .0001". Setra's patented very low pressure capacitance sensor is dead ended and avoids the potential for cross contamination of the room and reference space as well as eliminating drift that results from fouling of flow based sensors, which by nature have a flow path connecting the protected and reference spaces. Additionally there are 2 levels of password protection available as well as optional BACnet MSTP communications.

## Table of Contents

1.0 Intended Use .....	4
1.1 Specifications .....	4
1.2 SRPM Function .....	5
2.0 Parts .....	6
2.1 SRPM Included parts.....	6
2.2 SRAN Included parts.....	6
2.3 RPS included parts.....	6
2.4 Parts required and to be supplied by installer .....	6
3.0 Installation .....	7
3.1 Wiring (Rough in).....	7
3.2 Plumbing .....	9
3.3 Wiring (Finish) .....	10
3.3.1 Alarm Relay .....	10
3.3.2 Remote Annunciator .....	10
3.3.3 Door status input .....	11
3.3.4 Analog Output.....	11
3.3.5 BACnet .....	12
4.0 Startup and Operation .....	13
4.1 Menu Tree .....	13
4.2 Power Up.....	13
4.3 Monitoring Screen .....	13
4.4 Main Menu.....	14
4.5 Setup Unit.....	15
4.6 Setup Room.....	17
4.7 Setup Alarms .....	18
4.8 Self Test.....	19
4.9 Calibration .....	20
4.10 BACnet Setup Screen .....	21
5.0 Remote Annunciator .....	23
6.0 Maintenance .....	24
7.0 Agency Electrical Standards.....	25
8.0 Wiring and Plumbing Overview .....	26
9.0 Menu Tree .....	27

## 1.0 INTENDED USE

The SRPM is designed to monitor critical environments by providing differential pressure indication. Typically this is between a monitored room and a reference space such as a corridor or ante room. The unit also provides monitoring, alarm and communications functions.

Installation must be indoors, Pollution Degree 2, Installation Category II. Failure to install per these instructions may impair the safety of the unit.

Typical Applications:

1. **Hospitals** – patient isolation and protection rooms, operating suites, intensive care, and emergency rooms.
2. Pharmaceutical, semiconductor, precision manufacturing, and clean rooms.
3. **Laboratories** – medical research, BSL (Bio safety labs), radiation, vivarium, toxic metals and chemicals. Indoor use only.

1.1 SPECIFICATIONS	
Service	Air or nonconductive, nonexplosive gas
Accuracy	±0.5% F.S., ±0.25% FS optional
Operating Temperature Limits	32 to 120°F (0 to 50°C)
Operating Humidity Limits	5 to 95% Relative humidity (non condensing)
Altitude	2000 meters (max)
Thermal Effects	±0.03% F.S./ °F (± 0.05% F.S./ °C)
Overpressure	±15" W.C.
Supply Voltage	Code V1 and V2 85-265 VAC, 50-60 Hz Code A1 and A2 18-32 VAC, 50-60 Hz
Power Consumption (Voltage Output)	5 W.
Output	Selectable 4-20 mA (2-wire), 0-5 VDC (3-wire), or 0-10 VDC (3-wire)
Loop Resistance (4-20mA Output)	0-510 OHMS
Electrical Connection	Removable terminal block
Pressure Fittings	Barbed fittings for 1/4" O.D. tubing
Housing	Fire retardant plastic (NEMA 1, IP20 rated for indoor applications)
Mounting	Mounts to customer supplied 4" plaster ring (mounts to 2-gang electrical box)
Dimensions	8½ H x 5.4½ W x 1.8½ D (20.3 H x 13.7 W x 4.1
Weight (approx.)	1.5 lbs (680 g)
Agency Approval	CE, CAN/CSA-C22.2 NO. 61010-1-04
Communications	BACnet MSTP ASC, optional, see setra.com for detailed PICS statement

## 1.2 SRPM FUNCTION

The SRPM senses very low differential pressure using high accuracy capacitive sensor technology. The pressure difference for these applications is the difference in static pressure between a critical environment room and its surrounding reference area (usually a hallway or another room). Maintaining and monitoring a static room pressure difference ensures that the critical environment room is either protected or isolated from a surrounding environment. Protection strategy requires a net positive room static pressure difference, while isolation requires a net negative static pressure difference. The SRPM can be programmed to monitor either positive or negative room static pressure. Low pressure sensing technology is coupled with multifunctional alarming and simple touchscreen user interface with password security protection. The BACnet communication option allows the device to communicate with other BACnet devices to allow the supervisory system to change configuration setups and monitor alarms in an open network.

**User Interface:** LCD Display 128 x 128 COG module, with custom RGB LED backlight and custom 4-wire resistive touch screen

**RGB Backlight.** The SRPM indicates the status of the room being monitored using visual backlight color.

Color	Status
Green	Room Pressure is within alarm limits
Yellow	Door is open. (Door input must be enabled)
Red	Room Pressure is outside alarm limits and alarm delay period has been exceeded and room is not in "No Isolation" mode.

**Visual Feedback:** LEDs, green for normal, red for alarm

**Audible Feedback:** Beeper will sound when pressure is out of range and alarm delay has timed out. Volume can be adjusted between 1 to 4 in relative sound levels up to the maximum level specification of the beeper of 85 dB at 4". Audible alarm can also be disabled.

**Quick Room Mode Change:** Sometimes the room needs to be changed quickly from in use (Occupied) to out of use (No Isolation). This is accomplished by using 2 levels of password protection. The Operator level allows access to change room modes but no other changes. The Supervisor Level allows full access to all menus. In No Isolation mode no alarms are generated even if the pressure is outside limits. To change modes see page 22, Room Mode Change, for directions to change modes.

## 2.0 PARTS

### 2.1 SRPM (Setra Room Pressure Monitor) INCLUDED

#### PARTS

Quantity

- 1 SRPM assembly
- 2 Barbed Couplings, with Silicone Tubing
- 4 6-32 x 1/2" Mounting Screws for connecting the SRPM Base to the plaster ring



### 2.2 SRAN (Setra Remote Annunciator) INCLUDED

#### PARTS

Quantity

- 1 Annunciator Assembly



### 2.3 RPS (Room Pressure Snubber) INCLUDED PARTS

Quantity

- 1 Room pressure snubber Assembly



### 2.4 Parts required and to be supplied by installer

#### MOUNTING AND WIRING

To mount and install properly, the following components are required:

#### NOT INCLUDED and required for each SRPM

Quantity

- 1 2-Gang Metal Electrical Box with Grounding Stud
- 1 4 inch Metal Plaster Ring
- 1 Door Switch SPDT or SPST, N.O., as needed

#### NOT INCLUDED and required for each remote annunciator and room pressure snubber

Quantity

- 1 1-Gang Electrical Box
- 1/4 " tubing as required to connect between the RPS (Room Pressure Snubbers) and the SRPM

### 3.0 INSTALLATION (See Section 8.0 for overview)



For 120/240 VAC Version, only

CAUTION: Do not open or remove SRPM cover (tool required) with input power applied unless performed by a licensed electrician. "Hazardous Live" voltage is present at connector J3 when power is applied. Please observe the warning symbol (▲) near the J3 power connector.

The SRPM is designed to be mounted on a standard double gang metal electrical box using a 4 x 4 inch plaster ring adaptor. After the rough in wiring and plumbing is performed remove the cover and mount the baseplate to the plaster ring adaptor using the supplied 6-32 x 1/2" long mounting screws. Note: The plaster ring external mounting face needs to be positioned flush to recessed, relative to the surface of the wall. Also note the orientation of the 4 mounting screws in the plaster ring, as the plaster ring is rotated 90° from conventional mounting.

Note: In the following wiring sections, abbreviations are used (e.g. J1, P3). Please see section 8.0 for complete wiring diagrams with abbreviations.

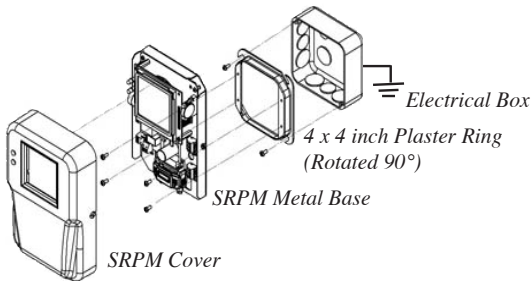

### 3.1 WIRING ELECTRICAL BOX (ROUGH IN)

Layout the system in terms of wiring: power, annunciator, analog output, BACnet, relay output and plumbing to connect to the monitored spaces (pressure taps).

Bring all power, earth ground, signal, communications and analog output wiring into the 4x4 electrical box.

Bring 1/4" O.D. tubing for 3/6" Barb fitting into box.

In order to conform to the CSA safety standard the electrical installer must comply with the following earth ground instructions:

1. Pre-wire the electrical box with power (24 VAC or 120/240 VAC), and provide earth grounding to the electrical box. The safety ground path consists of four 6-32 x 1/2" metal screws that connect the SRPM metal base to the 4½ x 4½ metal plaster ring. The plaster ring must be grounded to the 4½ x 4½ electrical box by 2 metal mounting screws. The 4½ x 4½ electrical box must be connected to the building earth ground. In addition, the marked ground wire included in 120/240 VAC version, should

be connected to the electrical box earth ground connection. It is also highly recommended to use armored cable (Type AC) for all the wiring in applications where high levels of radio interference may be present.

2. For the 120/240 VAC version only, a switch or circuit-breaker should be included in the building installation. It is advised to indicate the location of the switch or circuit-breaker by means of a label on or nearby the installed device. The disconnection switch or circuit-breaker should disconnect all current-carrying conductors. Any line-connected single-pole switch should be connected to a terminal intended for connection to the ungrounded conductor of the supply circuit.

Power leads, analog output, door status, and annunciator wiring should be 14 to 22 AWG stranded wire.

BACnet suggested wiring is 22 AWG stranded wire in a shielded cable, a +, -, Gnd (S) and shield should be run. This can be 2 twisted pairs with a separate cable shield. One twisted pair is used for communications, the second twisted pair can be used for communications ground and the shield wire can be connected to the other device shield wires. For CE compliance, a properly grounded shielding cable is required.



### 3.2 PLUMBING (ATTACHING PRESSURE TUBING)

**Warning:** Always attach tubing to the SRPM header and then place Header onto SRPM. This will prevent overpressure from crimped or collapsed tubes.

Use the following procedure for all room types: positive, negative or neutral:

Typically a Room Pressure Snubber (RPS) is installed in the monitored room. Often stiff nylon 1/4" tubing is used for running pressure signals from the SRPM to the monitored spaces. To prevent buckling and collapse of this stiff tubing inside the electrical box, use the supplied soft silicone tubing and tubing adaptors to transition from the field tubing to the pressure fittings on the SRPM.

Attach pressure tubing as follows:

1. Connect the 1/4 inch O. D. tubing running from the RPS (or other pressure connection from the **monitored** space) to the 2-gang electrical box for the SRPM. Install one of the supplied 1/4 inch male to male barbed tube adaptors onto the end of the tube then push the 4" length silicone tube (supplied) onto the other end. Thread the tubes, with installed adaptor, through the conduit opening at the bottom of the electrical box.
2. Next push the open end of the silicone tubing onto the SRPM pressure tube header (H1) port labeled "+". Note: The header is an Electro-Pneumatic (EP) assembly. "+" indicates (Positive) pressure, and "-" indicates negative or reference pressure.
3. For the most pressure stable operation, an RPS installed in the reference pressure area is also recommended. In this case, install the RPS in a hallway or reference space. Attach the tube to the SRPM in the same way as for the + port, except attach the tube to the "-" port on the pressure tube header. Tighten swivel fittings on the SRPM Header H1 assembly if they become loose, 9 in lb. max. Verify that the tubes are not buckled, which could close off pressure signal at end of installation.

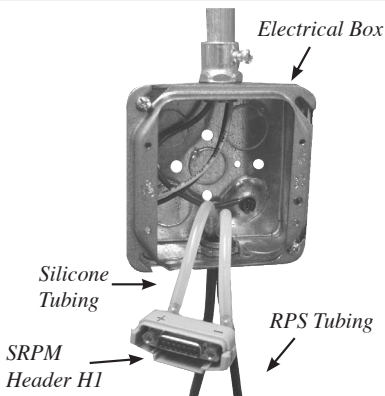

Plumbing inside Electrical Box



RPS Room Pressure Snubber

### 3.3 WIRING, FINISH

#### 3.3.1 ALARM RELAY OUTPUT

The Single Pole Single Throw (SPST) relay output can be used for remote signaling of alarm condition. A form “C” contact rated at 1A is available. Connect to J4, P1 and P4 (See Section 8.0 for Diagram of J4). This relay can be used as a dry contact for remote indication or can drive an SRAN remote annunciator.

#### 3.3.2 OPTIONAL REMOTE ANNUNCIATOR WIRING

##### Setra SRAN wiring

In the figure below, the SRAN remote annunciator connector is at left, and the SRPM connector is at right:

On J4 of the SRPM, jumper P1 to P2, this will connect the internal 15V supply to the common of the internal alarm relay. Connect P2 to A1 (Located on Remote Annunciator), this supplies 15V exc. to the Annunciator for powering the circuit during normal conditions. Connect P3 of J4 to A2 of SRAN J1, this is the 15V power return. Finally connect P4 of SRPM J4 to A3 terminal of SRAN J1, this is the alarm trigger.

When an alarm occurs and after the programmed alarm delay times out the internal relay will supply 15 V to the Annunciator circuit to actuate the audible beeper and the red LED.

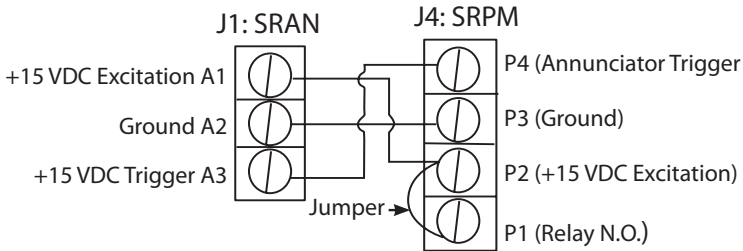

##### Non-Setra Remote Annunciator

The SRPM can drive other annunciators that are powered by a 15V supply, 50 mA max current draw., and accept a 15V trigger (wire as above).

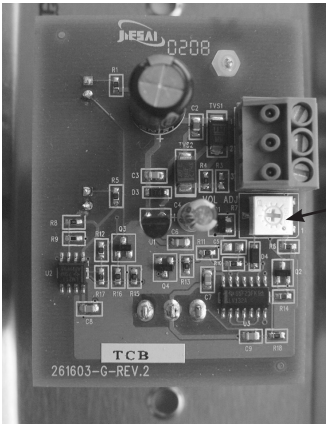

*Audible Alarm  
Potentiometer*

The volume control on the Annunciator is a potentiometer that can be adjusted from 0 to 85 dB. Using a small flat bladed screwdriver, rotate potentiometer (remote annunciator PC board) clockwise to *increase* volume and counterclockwise to *decrease* volume.

### 3.3.3 DOOR STATUS SWITCH WIRING

Install the door switch into the door jamb. Wire to the normally open (N.O.) side of the door jamb contact switch. The SRPM will indicate the status of door position. A contact closure indicates that the door is closed. This is a low voltage circuit (5 VDC). Run 2 wires from the door switch to connector J6 on the SRPM (See Section 8.0). The door input status function is enabled in the SETUP ALARMS menu screen, section 4.7

### 3.3.4 ANALOG OUTPUT

The SRPM can be configured to have either current (4 to 20 mA) or voltage (0 to 5 or 0 to 10 VDC) outputs. Voltage output--pin 1, Current output--pin 2, Common--pin 3. *Note: No external excitation is required.*

*Note 1: No external excitation is required.*

*Note 2: Electro-pneumatic header (page 9) must be connected.*

*Note 3: For CE compliance a properly grounded shielding cable is required.*

#### Current Output

The SRPM supplies it's own loop power, do not wire in a separate power supply.

#### Voltage Output

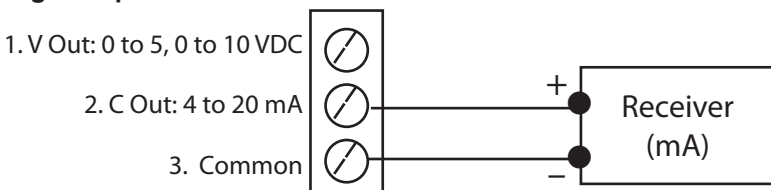

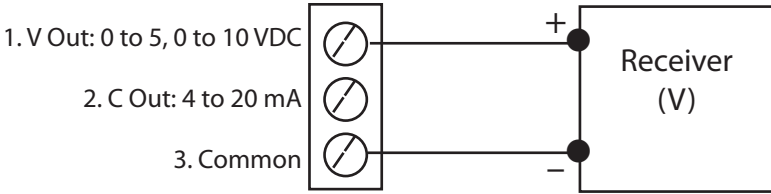

### 3.3.5 BACnet

BACnet hardware is implemented as isolated RS485. Wire to Connector J2, labeled RS-485. Connect tx line to +, rx to – and ground wires to S. Connect Shields together with wire nut.

Hardware configuration is done using a 5 position dip switch (S1) located in the upper right hand section of the PCBA as well as through the touch screen interface, see Section 4.4. and 4.9.

Position	Function
1	MAC address enable
2	N/C Not Connected
3	Pull Up Resistor
4	Termination Resistor
5	Pull Down Resistor

Use a small flat blade screwdriver or pen to push the switch to the right to turn that function on, otherwise it is off.

There is a BACnet setup screen that is enabled by pushing position 1 switch to the “on” position. After configuration the switch must be moved to the “off” position.

## 4.0 STARTUP AND OPERATION

The SRPM is designed with as an easy to use, intuitive, touch screen interface. In its normal (default) state the Monitoring Screen displays the actual room static pressure, also a slider bar shows the actual pressure relative to the alarm limits. The RGB backlight is used to indicate the condition of the room. The buttons at the bottom of the screen give you access to the functions that can be performed.

### 4.1 MENU TREE See section 9.0

### 4.2 POWER-UP



Apply power and observe the welcome screen and subsequent transition to the pressure monitor screen. The actual room static pressure is shown as a number in the center of the LCD and visually as a moving bar indicator operating between the preset alarm units. The vertical bar is an indicator of the pressure.

### 4.3 MONITORING SCREEN

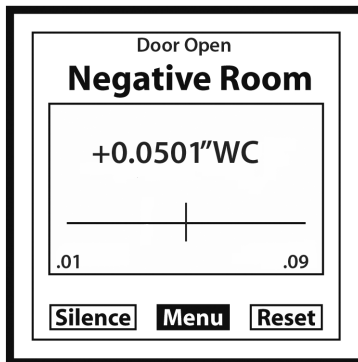

BUTTON	DESCRIPTION
Silence	Shuts off Alarm
Menu	Access to Main Menu Functions
Reset	Resets the unit in "Latched" mode.

The following screens are configuration screens, they can be configured so that Password protection is required to make changes. If no entry is made to the screen the unit will return to the default screen after approx. 1 minute.

#### 4.4 MAIN MENU SCREEN

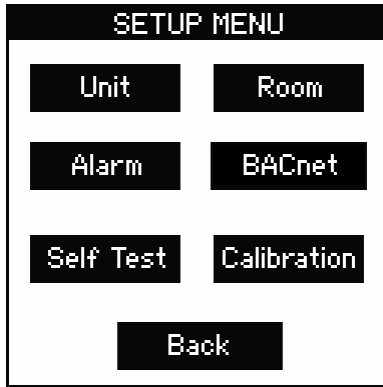

BUTTON	DESCRIPTION
Unit	Setup Supervisor password, output, engineering units, and display averaging.
Room	Set up high and low pressure limits to monitor a positive, negative, or neutral room. Operator password setup.
Alarm	Setup latch alarm, audible alarm, door alarm input, mute time out, alarm delay, and volume.
BACnet	Configuration of BACnet Communications
Self Test	Identifies product model and software version, and serial #. Verifies memory and performs alarm test.
Calibration	Perform zero and span calibration.
Back	Returns to monitoring screen.

## 4.5 SETUP UNIT OPERATION

SETUP UNIT		
Supervisor Password	Yes	No Change
Analog Output	4-20	0-5 0-10
Eng. Unit	"WC	Pa cmWC
Display Averaging	32	Secs
Save & Exit		Cancel

**ENTERING DATA** Press (or tap) button to select an output or engineering unit. Selected button background will change from clear to black.

### PASSWORD PROTECTION

Lightly pressing (or tapping) the “Yes” button activates Supervisor password protection. With Supervisor password protection enabled, operators can not access menu screens to update setup. Pressing “No” disables password protection. Pressing “Change” will open “Password Setting Screen”. To change the password, enter the present password (numeric value), followed by the new password in the “New Password” and “Confirm New Password” entry boxes, then press save. Be careful to store password for future reference.

### Analog Output

Select : 4-20, 0-5, or 0-10

### Eng. Unit

Select: “WC, Pa, cmWC

### DISPLAY AVERAGING

Lightly pressing (or tapping) the “Display Averaging” box activates the “Data Entry Screen”). Enter from 0 to 60 seconds. Display averaging affects the analog output. Increase the display averaging time to smooth out the pressure readings, this will also reduce the display update rate.

Press Save and Exit.

### DATA ENTRY SCREEN

Enter numbers by pressing each key in sequence until the desired character is displayed in the data entry box above the keypad. (Note: The cursor will blink for one to two seconds then stop and display the character.) Erase any mistakes by using the “Back Space” key. When finished entering data, press the “Enter” key to return to SETUP UNIT screen.

*Note: Use the eraser end of a pencil or back-end of a pen to press (or tap) box on screen to increase accuracy of inputs.*

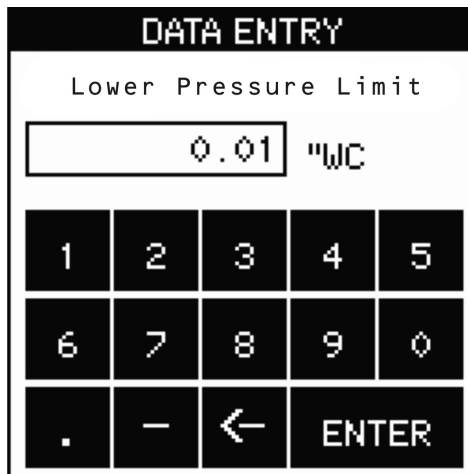



## 4.6 SETUP ROOM SCREEN

SETUP ROOM		
Room Type	Positive Room	
Lower Limit	Upper Limit	
+0.0000	+0.9000	
Operator Password		
Yes	No	Change
Save & Exit		Cancel

### SETUP ROOM OPERATION

Setup alarm limits for “protective” positive room static pressure, “isolating” negative room static pressure or neutral (where the limits can be – to +).

### ENTERING DATA

Press lightly or tap in the Lower Limit data entry box. Enter the lower limit pressure. Enter the Upper Limit pressure. The Room type box will change depending on the lower and upper limits. If both entries are positive, the room will be a Positive Room. If both are negative, the room will be a Negative Room and if the Lower Limit is negative and the Upper Limit is positive the room will be a Neutral Room.

### OPERATOR PASSWORD

The operator can only change the room from Occupied to No Isolation and vice versa.

Lightly pressing (or tapping) the “Yes” button activates Operator password protection. With Operator password protection enabled, room Occupied/No Isolation status can not be changed without entering a valid Operator password. Pressing “No” disables password protection. Pressing “Change” will open “Password Setting Screen”. To change the password, enter the present password, followed by the new password in the “New Password” and “Confirm New Password” entry boxes, then press save. Be careful to save the operator password for future reference.

## 4.7 SETUP ALARMS SCREEN

ALARM SETUP		
Latch Alarm	Yes	No
Audible Alarm	Yes	No
Door Alarm Input	Yes	No
Mute Time Out	34	Secs
Alarm Delay	23	Secs
Volume 1	Up	Down
Save & Exit		Cancel

From this screen the user can access the following:

- Latched Alarm requires the pressure to return to normal and the alarm to be acknowledged before the alarm can be silenced and reset.
- Enable the audible alarm by selecting “Yes” or use visual only alarm by selecting “No”.
- Provide a “door open” warning visual indication. When a door jamb contact switch is used and this button is activated by pressing “Yes”, the door status “open” condition is indicated by the touch screen display turning from green to yellow, and door open indicated on the monitoring (default) screen.
- Set the time (in seconds) that the alarm can be silenced in the latched alarm mode before the alarm resumes. This assumes that the room static pressure is still outside the normal or set operating limits. The Mute Time Out can be set from 0 to 9999 seconds.
- Set the Alarm Delay (in seconds) from the time that the room pressure goes out of the preset limits until the alarm activates. The alarm delay may be set from 0 to 9999 seconds.
- Set the alarm volume or sound level. Using the Up and Down keys, the volume can be set at level 1-4. Level 4 alarm volume is the loudest and corresponds to a sound level of 85 dB at a distance of 4 inches.

### ALARM SETUP OPERATION

Lightly press (or tap) button to select “Yes” or “No” for Latch Alarm, Audible Alarm, or Door Alarm Inputs. Selected box background will change from clear to black when selected.

### MUTE TIME OUT/ALARM DELAY

Pressing (or tapping) the “Mute Time Out” or “Alarm Delay” box activates the Data Entry screen to set the time delay duration.

## 4.8 SELF TEST SCREEN



### Self Test Operation

This screen identifies the Product Model Part Number and Software Version. User can also perform a Self Test of the unit to verify that the data in protected area of the EEPROM memory hasn't been corrupted and also test the alarm to verify the sound level and alarm setup.

Press "Self Test" button to initiate EEPROM memory checksum test sequence.

Press "Alarm Test" to test beeper, visual Red LED Alarm, and relay output. This can be used to verify the system in alarm mode.

Press "Cancel Test" to stop the alarm test.

Press "Exit" to return to Main Menu.

## 4.9 CALIBRATION SCREEN



### CALIBRATION

To re-zero the device, disconnect the pneumatic tubing from Header H1 so that room pressures are not applied to the pressure sensor and lightly press (or tap) the “Zero” button. If a sufficiently accurate Pressure Calibrator is available, apply a steady full-scale pressure signal to the “+” on the header fitting and press (or tap) the “Span” button. Reconnect the room pressure tube and calibration is complete. Calibration must be within  $\pm 5\%$  of original calibration for this to occur otherwise an error message will occur.

The original factory pressure calibration can be restored, if desired, by pushing the “Restore Factory Setting” button.

#### 4.10 BACnet Setup Screen

BACnet Setup

MAC Address

Device Inst.

Baud Rate

#### BACnet Setup

To setup up BACnet communications, the MAC address enable switch (S1 [See Section 8]) on the dip switch must be enabled by pushing it to the right.

Set MAC address, input the address of the device.

Select Device Instance by inputting the device instance into the data entry box.

Select baud rate by pressing the correct baud rate button, 9600 to 76800.

Save and Exit to save settings or Cancel to cancel setting changes. Once complete disable the BACnet setup by moving the dip switch position 1 to “off” (left) position.

If the unit will be at the end of the line, the pull up resistor can be enabled by pushing position 3 to “on”.

The termination resistor can be inserted by pushing position 4 switch “on”. The pull down resistor can be enabled by turning position 5 to “on”.

**Save and Exit. After the unit returns to the main menu screen disconnect the power to the unit, then re-connect to boot up with the proper MAC address and Device Instance.**

Position	Function
----------	----------

Position	Function
1	MAC address enable
2	Not Used
3	Pull Up Resistor
4	Termination Resistor
5	Pull Down Resistor

See Setra website for information on Points list and PICS and BIBBS statements.

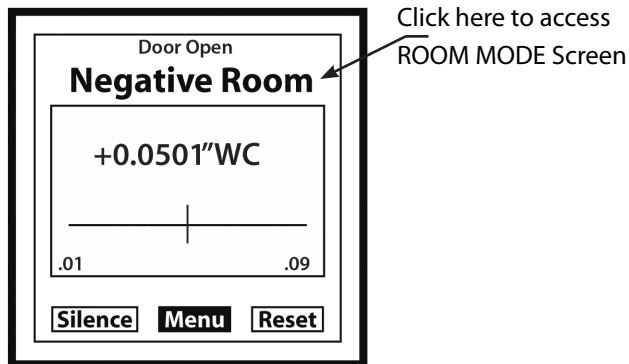

### PRESSURE MONITORING SCREENS

At completion of setup, the main display will be the pressure monitoring screen, which displays the actual room static pressure. The room static pressure is shown as a number on the LCD as well as a “Moving Bar” indicator operating between the preset pressure limits. Normal room pressure conditions within the preset pressure limits are verified by a green colored screen. When the door is opened under conditions within the preset pressure limits, the screen turns to yellow. Room static pressure outside of the preset limits is indicated by a Red screen after the alarm’s time delay expires.

### CHANGING ROOM MODES

The SRPM can quickly be changed from active monitor and alarming to No Isolation (or unoccupied). To do this touch the room mode indicator at the top of the pressure monitoring screen (see above).

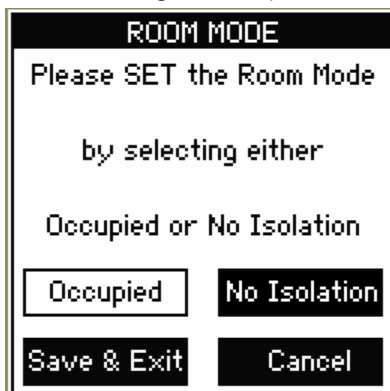

### OCCUPIED/NO ISOLATION

Use these buttons to quickly change the room to Occupied (Standby) or No Isolation status. If No Isolation is used there will be no alarms generated if the room is outside pressure limits. Press Save and Exit.

## 5.0 REMOTE ANNUNCIATOR

The Remote Annunciator provides remote indication of room status.



Green LED	Visual indication of normal room condition.
Red LED	Visual indication of a breach in room pressure protection.
Audible Alarm	Beeper sounds to indicate breach in room pressure protection.
Acknowledge Switch	Press to silence beeper.

### OPERATION

Under normal conditions, the green LED remains on. When an alarmed condition occurs (i.e., room pressure falls outside preset range), a signal is triggered by the SRPM, the green LED shuts off, the red LED flashes, and the audible alarm sounds. The acknowledge button can be pressed to momentarily turn-off the audible alarm and the red LED will continue to flash until the alarmed condition is corrected. When the alarmed condition is corrected the annunciator will reset itself. The green LED will turn on, and the red LED and audible alarm will shut-off. If the SRPM reaches the mute time out limit it will re-sound the alarm.

## **6.0 MAINTENANCE**

The SRPM is designed to operate in an indoor environment, monitoring clean, dry air.

Upon final installation of the SRPM Room Pressure Monitor, no routine maintenance is required. A periodic check of system calibration is recommended. The SRPM is not field serviceable and should be returned if repair is needed (field repair should not be attempted and may void warranty). Be sure to include a brief description of the problem plus any relevant application notes. Contact customer service to receive a return goods authorization number before shipping.

### **CLEANING Important**

Do not blow into the pressure tubing or fittings with mouth, compressed air, or canned air. Such actions may permanently damage the pressure sensor. Do not clean or wash-down the SRPM with industrial cleaners or solvents. The housing may be wiped down with soap and water or isopropyl alcohol. The LCD may only be cleaned with isopropyl alcohol. Do not immerse unit.



## 7.0 AGENCY ELECTRICAL STANDARDS

This device falls into CSA “Pollution Degree 2” for PCB insulation and CSA “Installation Category 2”.

The SRPM meets the following requirements:

**CSA Standard C22.2 No 0-M 91:** General Requirements - Canadian electrical code, Part 1

**CAN/CSA C22.2 No. 0.4-04:** Bonding of Electrical Equipment

**CAN/CSA-C22.2 No. 61010-1-04:** Safety requirements for electrical equipment for measurement, control and laboratory Use Part-1: General Requirements

**ANSI/UL61010-1 (Third Edition):** Safety requirements for electrical equipment for measurement, control and laboratory use Part 1: General Requirements.

## 8.0 LOCATION OF COMPONENTS AND ACCESSORIES

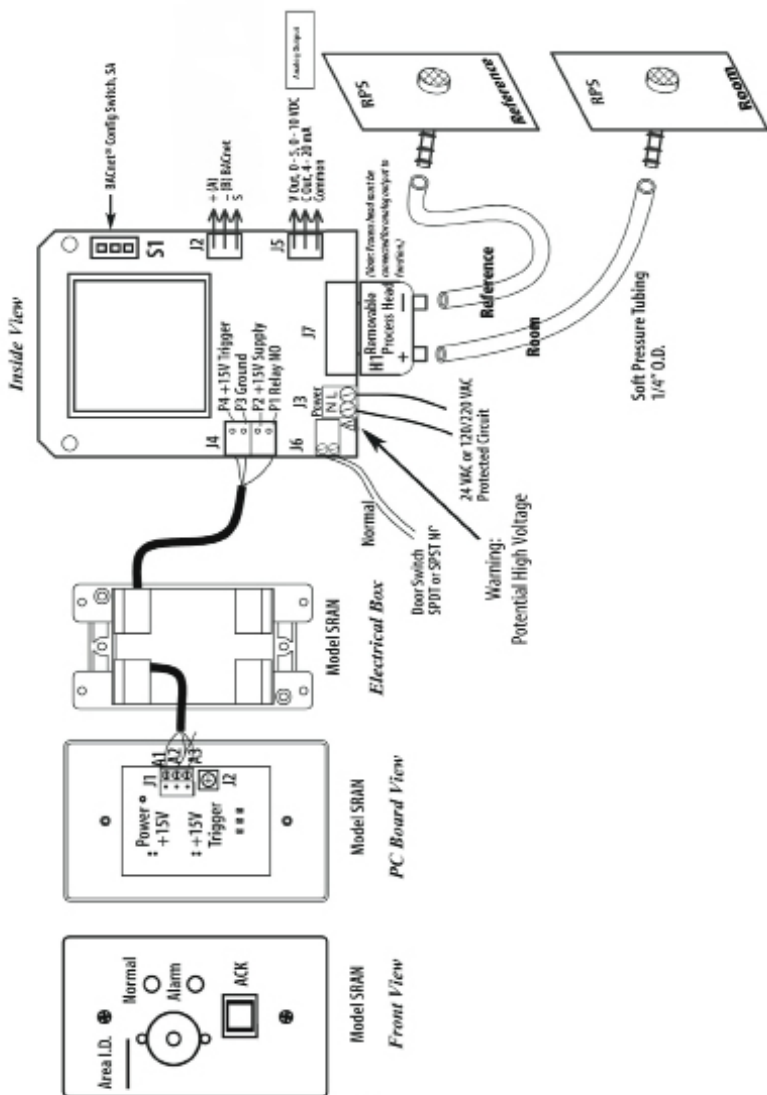

26

# 9.0 MENU TREE

## 9.0 MENU TREE

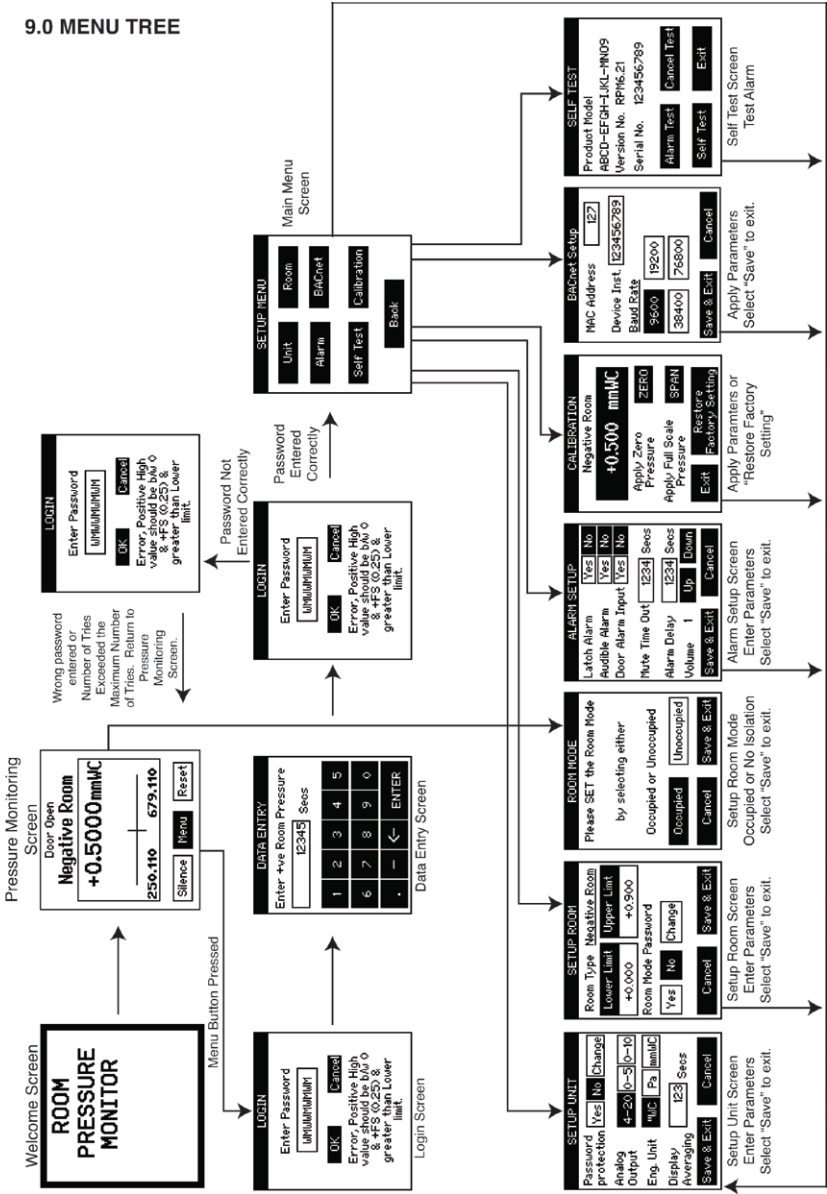

## 10.0 RETURNING PRODUCTS FOR REPAIR

Before returning the unit for repair, please contact a Setra application engineer (800-257-3872, 978-263-1400) to review information relative to your application . Many times only minor field adjustments may be necessary. When returning a product to Setra, the unit should be carefully packaged and shipped prepaid to:

**Setra Systems, Inc.**  
**159 Swanson Road**  
**Boxborough, MA 01719-1304**  
**Attn: Repair Department**

To assure prompt handling, please refer to return instructions on our Web site at: [http://www.setra.com/tra/repairs/cal\\_rep.htm](http://www.setra.com/tra/repairs/cal_rep.htm).

Allow approximately 3 weeks after receipt at Setra for the repair and return of the unit. Non-warranty repairs will not be made without customer approval and a purchase order to cover repair charges.

### Calibration Services

Setra maintains a complete calibration facility that is traceable to the National Institute of Standards & Technology (NIST). If you would like to recalibrate or recertify your Setra pressure transducers or transmitters, please call our Repair Department at 800-257-3872 (978-263-1400) for scheduling.

## 11.0 WARRANTY AND LIMITATIONS OF LIABILITY

Setra warrants its products to be free from defects in materials and workmanship, subject to the following terms and conditions:

Without charge, Setra will repair or replace products to be found to be defective in materials or workmanship within the warranty period; provided that:

- a.) the product has not been subjected to abuse, neglect, accident, incorrect wiring not our own, improper installation or servicing, or use in violation of instructions furnished by Setra;
- b.) the product has not been repaired or altered by anyone except SETRA or its authorized service agencies;
- c) the serial number or product code has not been removed, defaced, or otherwise changed; and
- d) examination discloses, in the judgement of SETRA, the defect in materials or workmanship developed under normal installation, use and service;
- e) SETRA is notified in advance of and the product is returned to SETRA transportation prepaid.

Unless otherwise specified in a manual or warranty card, or agreed to in a writing signed by a SETRA officer, SETRA pressure and acceleration products shall be warranted for one year from date of sale.

The foregoing warranty is in lieu of all warranties, express, implied or statutory, including but not limited to, any implied warranty of merchantability for a particular purpose.

SETRA's liability for breach of warranty is limited to repair or replacement, or if the goods cannot be repaired or replaced, to a refund of the purchase price. SETRA's liability for all other breaches is limited to a refund of the purchase price. In no instance shall SETRA be liable for incidental or consequential damages arising from a breach of warranty, or from the use or installation of its products.

No representative or person is authorized to give any warranty other than as set out above or to assume for SETRA any other liability in connection with the sale of its products.

For all CE technical questions, contact Setra Systems, USA. EU customers may contact our EU representative Hengstler GmbH, Uhlandstr 49, 78554 Aldingen, Germany (Tel: +49-7424-890; Fax: +49-7424-89500).

---

159 Swanson Road, Boxborough, MA 01719  
Tel: 800-257-3872 Fax: 978-264-0292  
Email: [sales@setra.com](mailto:sales@setra.com) Web: [www.setra.com](http://www.setra.com)

