

Pyxis[®]

SP-350P Fluorescent Polymer Handheld User Manual



Water Professionals Deserve Better Tools.
www.pyxis-lab.com

Fluorescent Polymer Handheld User Manual

October 12, 2020
Rev. 2.00

Pyxis Lab, Inc.
1729 Majestic Dr. Suite 5
Lafayette, CO 80026 USA
www.pyxis-lab.com

Table of Contents

1	Introduction	3
1.1	Main Features	3
2	Specifications	3
3	Unpacking Instrument	4
3.1	Standard Accessories	4
3.2	Optional Accessories	4
4	Installation	4
4.1	Battery Installation	4
5	Instrument Overview	5
5.1	Control Keys	6
5.2	Main Module On/Off	6
6	Measurement	6
6.1	Fluorescent Polymer Measurement	6
6.2	High Color and Turbidity Warning	6
7	Calibration	7
7.1	Fluorescent Polymer Calibration (Two-Point with Zero)	7
8	Device Information and Diagnosis	8
8.1	Sample Cell Cleanliness Check	9
8.2	Bluetooth Connection to Devices	10
8.3	Factory Reset	10
9	Use with uPyxis® Mobile App	11
9.1	Download uPyxis® Mobile App	11
9.2	Connecting to uPyxis® Mobile App	11
9.3	Setting Screen	12
9.4	System Screen	13
10	Use with uPyxis® Desktop App	13
10.1	Install uPyxis® Desktop App	13
10.2	Connecting to uPyxis® Desktop App	14
10.3	System Screen	15
10.4	Datalog Screen	16
10.5	Setting Screen	16
11	Device Maintenance and Precaution	17
11.1	Maintenance Best Practices and Quick Tips	17
11.2	Methods to Cleaning the SP-350P	17
11.3	Storage	18
12	Regulatory Approval	18

Warranty Information

Confidentiality

The information contained in this manual may be confidential and proprietary and is the property of Pyxis Lab, Inc. Information disclosed herein shall not be used to manufacture, construct, or otherwise reproduce the goods described. Information disclosed herein shall not be disclosed to others or made public in any manner without the express written consent of Pyxis Lab, Inc.

Standard Limited Warranty

Pyxis Lab warrants its products for defects in materials and workmanship. Pyxis Lab will, at its option, repair or replace instrument components that prove to be defective with new or remanufactured components (i.e., equivalent to new). The warranty set forth is exclusive and no other warranty, whether written or oral, is expressed or implied.

Warranty Term

The Pyxis warranty term is thirteen (13) months ex-works. In no event shall the standard limited warranty coverage extend beyond thirteen (13) months from original shipment date.

Warranty Service

Damaged or dysfunctional instruments may be returned to Pyxis for repair or replacement. In some instances, replacement instruments may be available for short duration loan or lease.

Pyxis warrants that any labor services provided shall conform to the reasonable standards of technical competency and performance effective at the time of delivery. All service interventions are to be reviewed and authorized as correct and complete at the completion of the service by a customer representative, or designate. Pyxis warrants these services for 30 days after the authorization and will correct any qualifying deficiency in labor provided that the labor service deficiency is exactly related to the originating event. No other remedy, other than the provision of labor services, may be applicable.

Repair components (parts and materials), but not consumables, provided during a repair, or purchased individually, are warranted for 90 days ex-works for materials and workmanship. In no event will the incorporation of a warranted repair component into an instrument extend the whole instrument's warranty beyond its original term.

Warranty Shipping

A Repair Authorization (RA) Number must be obtained from Pyxis Technical Support before any product can be returned to the factory. Pyxis will pay freight charges to ship replacement or repaired products to the customer. The customer shall pay freight charges for returning products to Pyxis. Any product returned to the factory without an RA number will be returned to the customer. To receive an RMA you can generate a request on our website at <https://pyxis-lab.com/request-tech-support/>.

Pyxis Technical Support

Contact Pyxis Technical Support at +1 (866) 203-8397, service@pyxis-lab.com, or by filling out a request for support at <https://pyxis-lab.com/request-tech-support/>.

1 Introduction

The Pyxis SP-350P is a uniquely designed handheld multimeter that measures Fluorescent Polymer. It is a cuvette-less device. Less than 5 mL water sample is needed to fill the sample cell for proper measurement.

1.1 Main Features

The Pyxis SP-350P analyzer measures the concentration of Fluorescent Polymer of a water sample and includes the following features:

- Pre-calibrated for measuring Fluorescent Polymer in the range of 0 to 20 ppm. The Fluorescent Polymer measurement is automatically compensated for sample color and turbidity interference.
- Fluorescent Polymer can be calibrated with three standards (0, 10 and 20 ppm) through a user-friendly, menu-driven procedure.
- No sample cuvette is required and as such variations associated with the cuvette are eliminated.
- Large color graphic screen that can be read in direct sunlight.

2 Specifications

Table 1. SP-350P Specifications

Item	Specification*
Part Number (P/N)	50228
Fluorescent Polymer Range [†]	0.1–20 ppm
Fluorescent Polymer Accuracy	±1% or ±0.1 ppm
Excitation Wavelength	410 nm
Emission Wavelength	450 nm
Wavelength Accuracy	±1 nm
Calibration Solution Point	0, 10, and 20 ppm
Temperature Range	40–106 °F (4–41 °C)
Display	320×240 TFT-LCD, visible under direct sunlight
Power Supply	4 AA alkaline batteries
Typical Battery Life	3,200 readings
Dimension (L × W × H)	6.69 × 3.15 × 1.77 inch (170 × 80 × 45 mm)
Weight [‡]	0.88 lbs (400 g)
Enclosure Rating	IP67
Regulation	CE/RoHS

* With Pyxis's continuous improvement policy, these specifications are subject to change without notice.

[†] The Fluorescent Polymer concentration scale is based on the polymer containing 0.25 mole % fluorescent monomer.

[‡] Batteries excluded

3 Unpacking Instrument

Remove the instrument and accessories from the shipping container and inspect each item for any damage that may have occurred during shipment. Verify that all items listed on the packing slip are included. If any items are missing or damaged, please contact Pyxis Customer Service at service@pyxislab.com.

3.1 Standard Accessories

- Four (4) AA alkaline batteries
- Bluetooth/USB Adapter for Desktop P/N: MA-NEB
- User Manual available online at <https://pyxis-lab.com/support/>

3.2 Optional Accessories

The following optional accessories can be ordered from Pyxis Customer Service (order@pyxis-lab.com) or Pyxis eStore at <https://pyxis-lab.com/shop/>.

Table 2. Optional Accessories

Accessory Name	Part Number (P/N)
Pyxis Carrying Case for Handheld Devices	50725
Pyxis 10 ppm Fluorescent Polymer + 100 ppb PTSA Combined Standard — 500 mL	21055
Pyxis 10 ppm Fluorescent Polymer Calibration Standard — 500 mL	21054
Pyxis 20 ppm Fluorescent Polymer Calibration Standard — 500 mL	21053
Pyxis Handheld Cleaning Kit	SER-02

4 Installation

4.1 Battery Installation

The SP-350P is powered by four alkaline batteries. Typical battery life lasts for 3,200 measurements or 10 months. When the battery capacity is critically low, the SP-350P will display a "LOW BATTERY" warning for 5 seconds and then automatically turn off.

NOTE Do not use rechargeable nickel cadmium (NiCad) or lithium batteries.

Replace the batteries to resume operation of the SP-350P after the battery warning. The SP-350P will automatically turn on in the measurement mode after new batteries are installation.

The SP-350P battery compartment, shown in Figure 1, is on the back side of the instrument. Batteries are held in place by a cover secured with two Phillips-head screws.

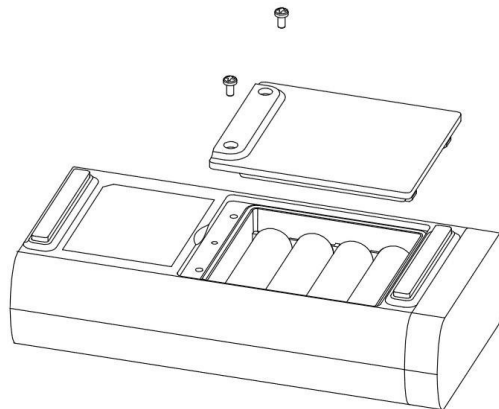

Figure 1. The SP-350P battery compartment

Install batteries using the following steps:

1. Remove the battery compartment cover by loosening the two screws.
2. Remove old batteries and dispose of them properly.
3. Following the positive and negative terminal signs in the compartment bottom, snap four new AA alkaline batteries firmly into the battery holder.
4. Replace the battery compartment cover and ensure that the sealing O-ring is lying flat on the battery holder.
5. Fasten the two screws.

NOTE Failure to properly seat the O-ring may result in water damage to the SP-350P.

5 Instrument Overview



Figure 2.

5.1 Control Keys

The SP-350P has three control keys, as shown in Figure 2. The left (<), right (>), and ok (OK) keys are used to launch actions indicated on the LCD display directly above the keys. The labels above the keys indicate the function associated with each key and functions can be changed in different operation modes.

5.2 Main Module On/Off

To turn on the SP-350P: Press (OK) momentarily and release.

To turn off the SP-350P: Press and hold (OK) for about three seconds. Release (OK) when the LCD display turns off. The SP-350P turns itself off after 60 seconds without user interaction detected. This is done to conserve battery life.

**NOTE* This auto-time off setting may be customized by the user as desired through the uPyxis® Mobile or Desktop App.*

6 Measurement

6.1 Fluorescent Polymer Measurement

When powered on, the SP-350P will be in the Fluorescent Polymer measurement mode. The water sample can be transferred to the sample cell using a pipette or filled directly from a faucet, sample bottle, or sample valve.

**NOTE* Special care should be taken when pouring the sample into the cell to avoid air bubble entrainment, which can interfere with reading accuracy.*

Before beginning a measurement, use the sample water to rinse the sample cell at least three times. Allow 5–10 seconds for the SP-350P to stabilize (Figure 2). For a sample containing 10 ppm Fluorescent Polymer, the measured Fluorescent Polymer should be stabilized within the range of 9.8–10.2 ppm.

**NOTE* The time required to reach a stable reading may be slightly longer if the water sample temperature is significantly different than the environmental temperature at which the SP-350P had been equilibrated (stored).*

The SP-350P does not need to be turned off between measurements of two samples. Rinsing the sample cell several times between samples is recommended. Ambient light does not affect the measurement. The sample cell does not need to be covered during the measurement.

6.2 High Color and Turbidity Warning

The SP-350P has extra channels to measure sample turbidity and color which are used to automatically compensate for any interference caused by these contaminants as high as 40–60 NTU. If the sample turbidity and color values determined are too high, a measurement warning will be displayed. In such a case, the user should pre-filter the sample for a Fluorescent Polymer measurement within the compensation capability of the SP-350P.

7 Calibration

7.1 Fluorescent Polymer Calibration (Two-Point with Zero)

1. Rinse the main module sample cell three times with DI water. Fill the sample cell with DI water.

NOTE In emergency, “non-Fluorescent Polymer” water, such as city water, may be used, but re-calibrate using DI water for the zero step as soon as it is available.

2. Power on the SP-350P by pressing **OK** . Allow 5–10 seconds for the SP-350P to stabilize.
3. The unit is actively reading and displaying Fluorescent Polymer. The values will be very low if DI water is used; Fluorescent Polymer value should be near zero. A low non-zero value (e.g. 0.1 or 0.2, etc.) is not problematic.
4. Press **Calibration** (**<** or **>**) to launch the **CALIBRATION** screen (Figure 3).
5. Press **Zero** (**<**) to start the zero (blank) calibration.
6. If the calibration succeeds, a checkmark (**✓**) and instructions for the slope calibration will appear (Figure 4).
7. Rinse the sample cell three times with the desired Fluorescent Polymer standard. Fill the sample cell with the desired Fluorescent Polymer standard.
8. Press **Cycle** (**<**) to cycle between the Fluorescent Polymer standards 10 and 20 (it repeats). Ensure the value selected matches the desired Fluorescent Polymer standard in the sample cell.
9. Press **Slope** (**>**) to start the slope calibration.
10. If the calibration succeeds, a checkmark (**✓**), a “**Calibration Success**” message will appear (Figure 5). Otherwise, a warning message is displayed.
11. Calibration is now complete. Press **Exit** (**OK**) to return to measurement mode.

NOTE If **Exit** is pressed before the second checkmark appears, the calibration will not be completed and must be re-done.

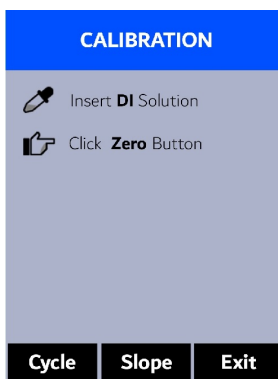

Figure 3.

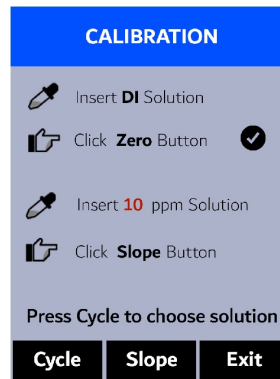

Figure 4.

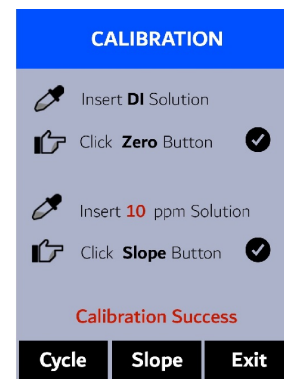

Figure 5.

8 Device Information and Diagnosis

The **DEVICE INFORMATION** screen is launched when **Info** (OK) is pressed in the measurement mode. This screen contains the device serial number, software version, and hardware version (Figure 6). The battery life as a percentage and the MAC addresses for main module also shown.

Press **Diagnosis** (◀ or ▶) to launch the **SYSTEM DIAGNOSIS** screen where raw measurement data are displayed (Figure 7). The information has no use for normal operation, but instead is used for device troubleshooting. Provide an image of both the **DEVICE INFORMATION** screen and the **SYSTEM DIAGNOSIS** screen when you contact Pyxis (service@pyxis-lab.com) for troubleshooting your device or call +1 (866) 203-8397.

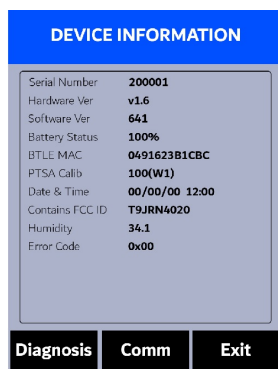

Figure 6.



Figure 7.

8.1 Sample Cell Cleanliness Check

The SP-350P is designed to provide reliable and accurate measurement on HST. Heavy fouling will prevent the light from reaching the sensor, resulting in inaccurate readings. It is suggested that the SP-350P be checked for fouling and cleaned on a monthly basis. Heavily contaminated waters may require more frequent cleanings. Cleaner water sources with less contamination may not require cleaning for several months. The SP-350P is designed to carry out a Cleanliness Check as described below:

1. Power on the SP-350P by pressing **OK**.
2. Press **Info** (**OK**) to launch the **DEVICE INFORMATION** screen.
3. Press **Diagnosis** (**<** or **>**) to launch the **SYSTEM DIAGNOSIS** screen.
4. Allow 5–10 seconds for the message in the top-right corner of the display change from **Starting BTLE...** to **BTLE Started**.
5. Press **Cleanliness** (**<**). An instruction prompt appears to ask the user to put DI water into the sample cell (Figure 8).
6. Pour DI water into the sample cell.
7. Press **Confirm** (**<**, **>**, or **OK**). The instruction prompt will disappear and the SP-350P displays a countdown toward the bottom of the display.
8. Once the Cleanliness Check is completed a **Clean** message (Figure 9) or **Sample cell fouled** message (Figure 10) will appear towards the bottom of the display.
9. Cleanliness check is now complete. Press **Exit** (**OK**) to return to measurement mode.

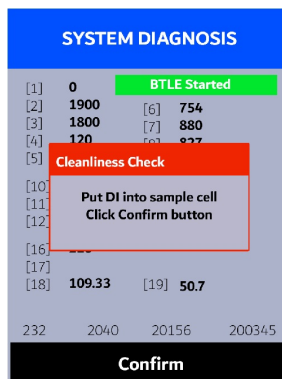

Figure 8.



Figure 9.

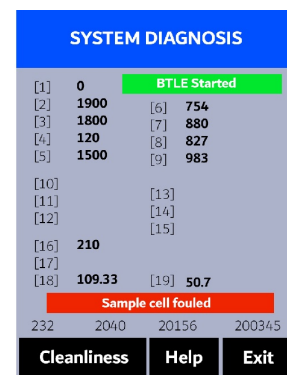

Figure 10.

8.2 Bluetooth Connection to Devices

The SP-350P uses a built-in Bluetooth Low Energy Connection (BTLE) to connect wirelessly to a smart phone via the **uPyxis®** Mobile App or to a computer via the included Bluetooth Adapter (P/N: MA-NEB) and the **uPyxis®** Desktop App. To allow the SP-350P to connect via Bluetooth with other devices follow the steps below:

1. Power on the SP-350P by pressing **OK**.
2. Press **Info** (**OK**) to launch the **DEVICE INFORMATION** screen.
3. Press **Diagnosis** (**<** or **>**) to launch the **SYSTEM DIAGNOSIS** screen.
4. Allow 5–10 seconds for the message in the top-right corner of the display change from **Starting BTLE...** to **BTLE Started** (Figure 7).
5. Choose to connect via one of two options:
 - (a) The **uPyxis®** Mobile App (see the **Use with uPyxis® Mobile App** section), or
 - (b) The **uPyxis®** Desktop App (see the **Use with uPyxis® Desktop App** section).

8.3 Factory Reset

Use the following steps to restore all device parameters to factory default:

1. Power on the SP-350P by pressing **OK**.
2. Press **Info** (**OK**) to launch the **DEVICE INFORMATION** screen.
3. Press **Diagnosis** (**<** or **>**) to launch the **SYSTEM DIAGNOSIS** screen.
4. Allow 5–10 seconds for the message in the top-right corner of the display change from **Starting BTLE...** to **BTLE Started**.
5. Press **Help** (**>**) to launch the **HELP** screen (Figure 11).
6. Press **Factory Reset** (**<** or **>**). The display updates as shown in Figure 12 appear and the user can choose one of three options:
 - (a) Press **OK** to start the factory reset, or
 - (b) Press **Cancel** (**<**) to return to the **HELP** screen, or
 - (c) Press **Exit** (**>**) to abandon the factory reset entirely.
7. After a successful factory reset, the message “Factory reset done.” will appear on the display.
8. Press **Exit** (**OK**) to return to measurement mode.

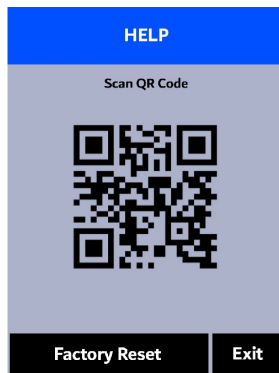

Figure 11.



Figure 12.

9 Use with uPyxis® Mobile App

9.1 Download uPyxis® Mobile App

Download uPyxis® Mobile App from [Apple App Store](#) or [Google Play](#).



Figure 13.

9.2 Connecting to uPyxis® Mobile App

Turn on Bluetooth on your mobile phone (**Do not pair the phone Bluetooth to the SP-350P**). Open uPyxis® Mobile App. Ensure that the SP-350P is discoverable by following the steps in the **Bluetooth Connection to Devices** section. Once the app is open, the app will start to search for the SP-350P. When the uPyxis® Mobile App connects to the SP-350P, then press on the **SP-350P**.

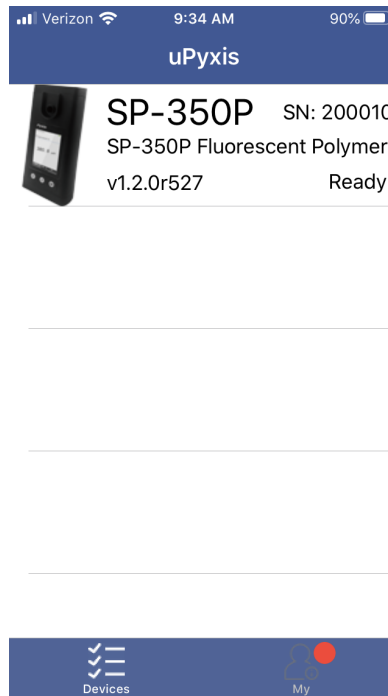

Figure 14.

9.3 Setting Screen

When connected, the uPyxis® Mobile App will default to the **Setting** screen. From the **Setting** screen, the user can set the **Power off time** and **Screen off time** in seconds.

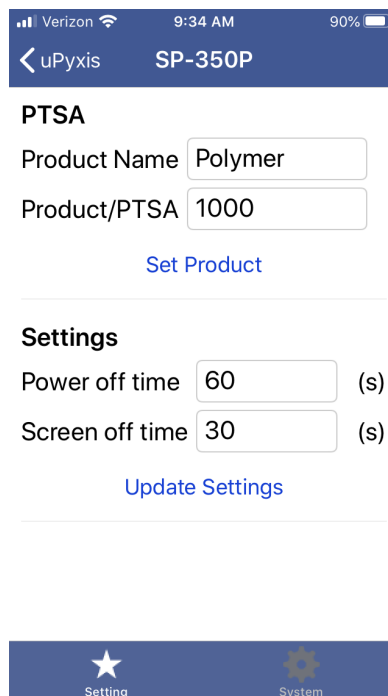

Figure 15.

9.4 System Screen

From the **System** screen, users can change the **Device Name**, find the **Serial Number**, **Hardware Version**, and **Firmware Version**, as well as update the firmware of the SP-350P by pressing **Check Update**. If a firmware update is available, press **Get Firmware**. Once the new firmware is downloaded, press **Upgrade Firmware**.

NOTE *The firmware update process takes some time and will require the SP-350P to stay within range (approximately 10 ft without obstructions) for the entire duration of the update.*

Once the update is complete, the SP-350P will reboot which will disconnect the SP-350P from the **uPyxis®** Mobile App.



Figure 16.

10 Use with uPyxis® Desktop App

10.1 Install uPyxis® Desktop App

Download the latest version of **uPyxis®** Desktop software package from: <https://pyxis-lab.com/upyxis/> this setup package will download and install the Microsoft.Net Framework 4.5 (if not previously installed on the PC), the USB driver for the USB-Bluetooth adapter (MA-NEB), the USB-RS485 adapter (MA-485), and the main **uPyxis®** Desktop application. Double click the **uPyxis.Setup.exe** file to install.

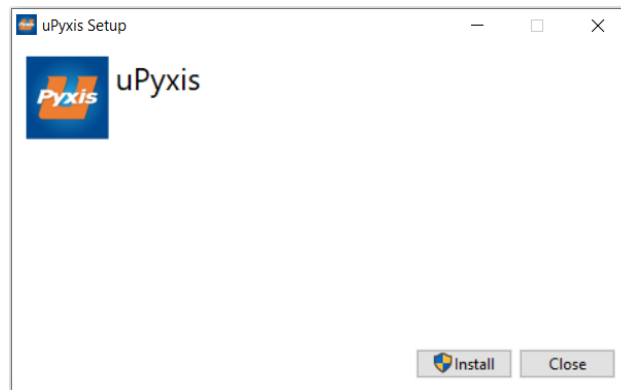

Figure 17.

Click **Install** to start the installation process. Follow the screen instructions to complete the USB driver and uPyxis installation.

10.2 Connecting to uPyxis® Desktop App

Ensure that the SP-350P is discoverable by following the steps in the **Bluetooth Connection to Devices** section. Once the app is open, to find your device, click on **Device**, then **Connect via Bluetooth...**

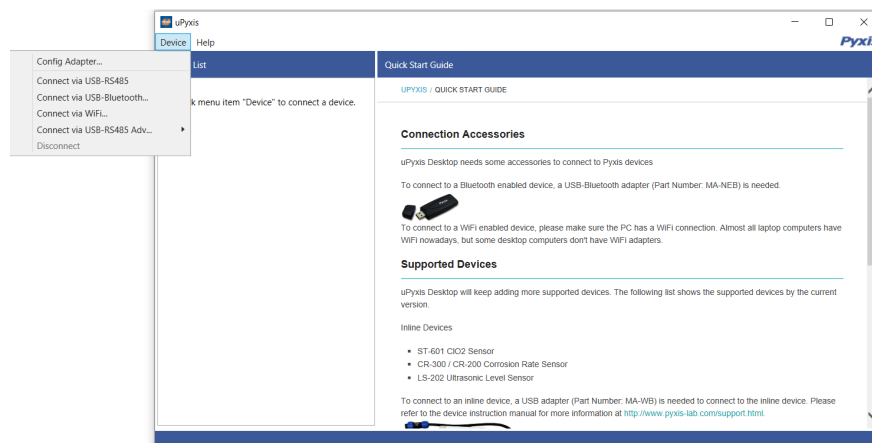

Figure 18.

10.3 System Screen

Once connected to the device, a picture of the device will appear on the top-left corner of the window and the **uPyxis**® Desktop App will default to the **System** screen. From the **System** screen, users can upgrade the firmware by selecting an appropriate firmware file (contact service@pyxis-lab.com for these firmware files) and clicking **Upgrade Firmware**.

NOTE *The firmware update process takes some time and will require the SP-350P to stay within range (approximately 10 ft without obstructions) for the entire duration of the update.*

Once the update is complete, the SP-350P will reboot which will disconnect the SP-350P from the **uPyxis**® Mobile App.

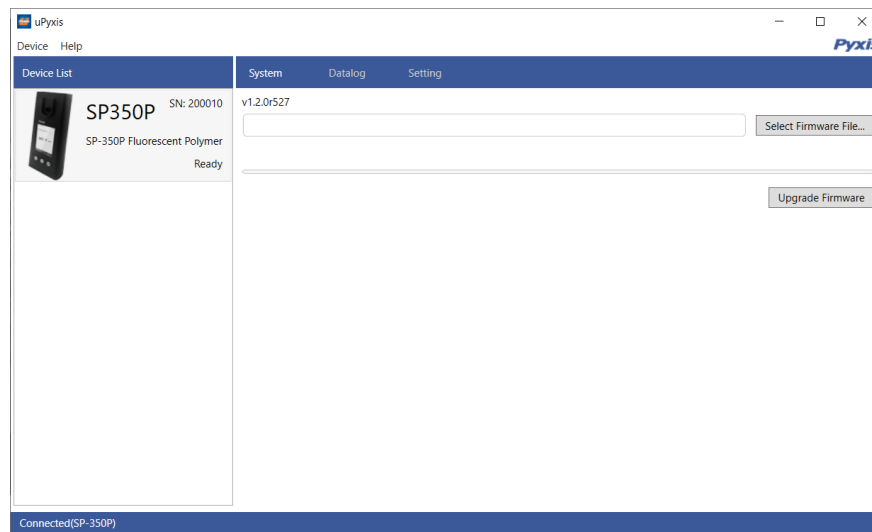

Figure 19.

10.4 Datalog Screen

From the **Datalog** screen, the user can view, delete, and export the internal log files of the SP-350P by clicking **Read Datalog List** and selecting the desired datalog (these are separated by month). The SP-350P will then populate any relevant log event from the selected datalog which can be viewed in more detail by clicking **Read Datalog**, deleted by clicking **Delete**, or exported by clicking **Export as .CSV File**.

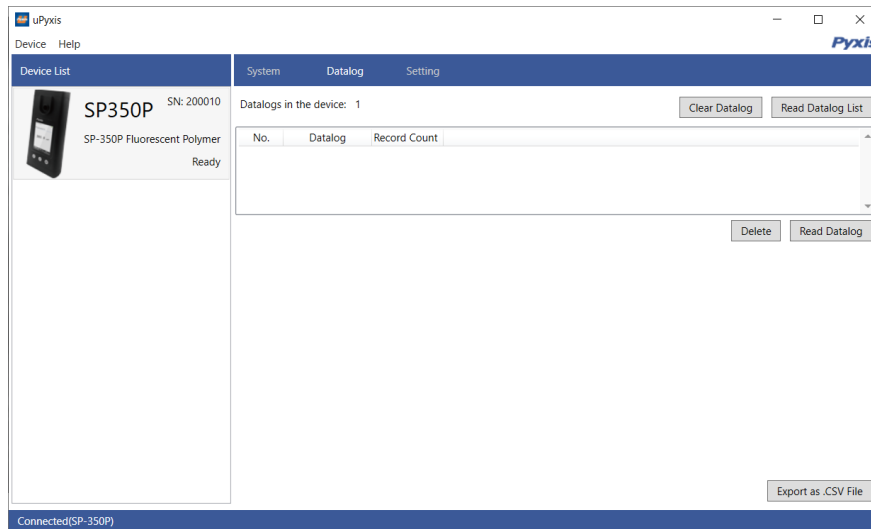

Figure 20.

10.5 Setting Screen

From the **Setting** screen, the user can set the **Power off time** and **Screen off time** in seconds.

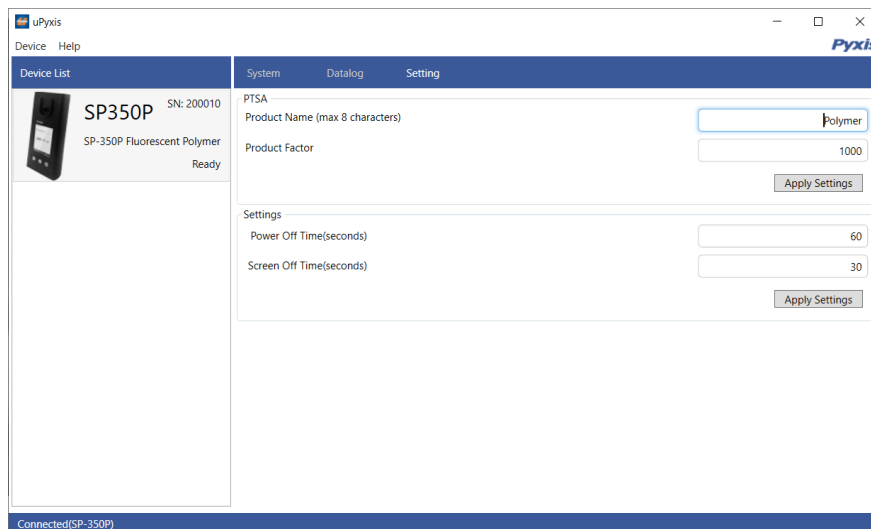

Figure 21.

11 Device Maintenance and Precaution

11.1 Maintenance Best Practices and Quick Tips

For greatly increased working life and ease of use of the SP-350P follow the list of maintenance best practices and quick tips below:

- Rinse the sample cell at least three times with the desired solution before turning on.
- After a successful calibration, the unit does not automatically return to the measurement mode. If Exit is held down too long the unit will power down rather than returning to the measurement mode.
- After returning to measurement mode after calibration, rinse several times with the first sample. The unit will continue to read the sample values without any further key presses if it has not powered off. If there are no key presses for 20 seconds the screen will darken, and after another 20 seconds without key activity will power down. The press of any key while the screen is dark will reset the timer and the screen will re-light. (This press will not step along the calibration process; the next press needed will still be required in the sequence).
- Always rinse the unit with clean water after use and dry by clean tissue or paper towel.

11.2 Methods to Cleaning the SP-350P

A light deposit on quartz glass inside the conductivity cell can be cleaned by a Q-tip. Aged heavy deposition, especially iron oxide deposited, can be removed using a cleaning solution that is capable of removing iron, such as the Pyxis Handheld Device Cleaning Solution Kit (P/N: SER-02) available from Pyxis online eStore/Catalog <https://pyxis-lab.com/product/handheld-device-cleaning-kit/>.



Figure 22. Handheld Device Cleaning Solution Kit

To clean the SP-350P pour cleaning solution into the sample cell for 10 minutes. Rinse the sample cell with distilled water and use the Cleanliness Check (see the **Sample Cell Cleanliness Check** section) to confirm that the SP-350P is clean. Repeat the process as needed until the Cleanliness Check shows **Clean**.

11.3 Storage

Do not expose the SP-350P to an extreme high or low temperature condition such as leaving the SP-350P inside an unattended automobile.

12 Regulatory Approval

United States

The SP-350P sensor has been tested and found to comply with the limits for a Class B digital device, pursuant to part 15 of the FCC Rules. These limits are designed to provide reasonable protection against harmful interference in a residential installation. This equipment generates, uses and can radiate radio frequency energy, and if not installed and used in accordance with the instructions, may cause harmful interference to radio communications. However, there is no guarantee that interference will not occur in an installation. If this equipment does cause harmful interference to radio or television reception, which can be determined by turning the equipment off and on, the user is encouraged to try to correct the interference by one or more of the following measures:

- Reorient or relocate the receiving antenna.
- Increase the separation between the equipment and receiver.
- Connect the equipment into an outlet on a circuit different from that to which the receiver is connected.
- Consult the dealer or an experienced radio/TV technician for help

Canada

This device complies with Industry Canada license exempt RSS standard(s). Operation is subject to the following two conditions: (1) this device may not cause interference, and (2) this device must accept any interference, including interference that may cause undesired operation of the device. Le présent appareil est conforme aux CNR d'Industrie Canada applicables aux appareils radio exempts de licence. L'exploitation est autorisée aux deux conditions suivantes: (1) l'appareil ne doit pas produire de brouillage, et (2) l'utilisateur de l'appareil doit accepter tout brouillage radioélectrique subi, même si le brouillage est susceptible

13 Contact Us

Pyxis Lab, Inc

1729 Majestic Dr. Suite 5

Lafayette, CO 80026 USA

www.pyxis-lab.com

Phone: +1 (866) 203-8397

Email: service@pyxis-lab.com