

# Operating Instructions

## **Proline Promass S 100**

### **PROFINET**

Coriolis flowmeter

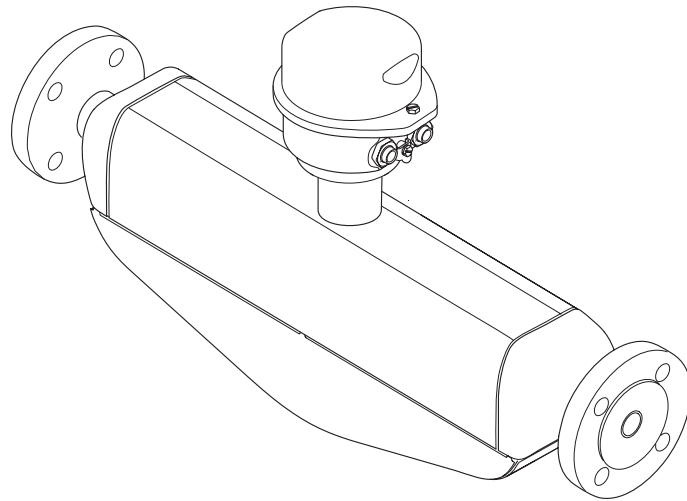

- Make sure the document is stored in a safe place such that it is always available when working on or with the device.
- To avoid danger to individuals or the facility, read the "Basic safety instructions" section carefully, as well as all other safety instructions in the document that are specific to working procedures.
- The manufacturer reserves the right to modify technical data without prior notice. Your Endress+Hauser Sales Center will supply you with current information and updates to these instructions.

## Table of contents

<b>1</b>	<b>Document information</b> . . . . .	<b>6</b>	6.2	Mounting the measuring device . . . . .	25
1.1	Document function . . . . .	6	6.2.1	Required tools . . . . .	25
1.2	Symbols used . . . . .	6	6.2.2	Preparing the measuring device . . . . .	25
1.2.1	Safety symbols . . . . .	6	6.2.3	Mounting the measuring device . . . . .	25
1.2.2	Electrical symbols . . . . .	6	6.2.4	Turning the display module . . . . .	25
1.2.3	Tool symbols . . . . .	6	6.3	Post-installation check . . . . .	26
1.2.4	Symbols for certain types of information . . . . .	7	<b>7</b>	<b>Electrical connection</b> . . . . .	<b>28</b>
1.2.5	Symbols in graphics . . . . .	7	7.1	Connection conditions . . . . .	28
1.3	Documentation . . . . .	7	7.1.1	Required tools . . . . .	28
1.3.1	Standard documentation . . . . .	8	7.1.2	Requirements for connecting cable . . . . .	28
1.3.2	Supplementary device-dependent documentation . . . . .	8	7.1.3	Terminal assignment . . . . .	29
1.4	Registered trademarks . . . . .	8	7.1.4	Pin assignment, device plug . . . . .	30
<b>2</b>	<b>Basic safety instructions</b> . . . . .	<b>9</b>	7.1.5	Preparing the measuring device . . . . .	30
2.1	Requirements for the personnel . . . . .	9	7.2	Connecting the measuring device . . . . .	30
2.2	Designated use . . . . .	9	7.2.1	Connecting the transmitter . . . . .	31
2.3	Workplace safety . . . . .	10	7.2.2	Ensuring potential equalization . . . . .	32
2.4	Operational safety . . . . .	10	7.3	Special connection instructions . . . . .	32
2.5	Product safety . . . . .	10	7.3.1	Connection examples . . . . .	32
2.6	IT security . . . . .	11	7.4	Hardware settings . . . . .	33
<b>3</b>	<b>Product description</b> . . . . .	<b>12</b>	7.4.1	Setting the device name . . . . .	33
3.1	Product design . . . . .	12	7.5	Ensuring the degree of protection . . . . .	34
3.1.1	Device version with PROFINET communication type . . . . .	12	7.6	Post-connection check . . . . .	35
<b>4</b>	<b>Incoming acceptance and product identification</b> . . . . .	<b>13</b>	<b>8</b>	<b>Operation options</b> . . . . .	<b>36</b>
4.1	Incoming acceptance . . . . .	13	8.1	Overview of operating options . . . . .	36
4.2	Product identification . . . . .	13	8.2	Structure and function of the operating menu . . . . .	37
4.2.1	Transmitter nameplate . . . . .	14	8.2.1	Structure of the operating menu . . . . .	37
4.2.2	Sensor nameplate . . . . .	15	8.2.2	Operating philosophy . . . . .	38
4.2.3	Symbols on measuring device . . . . .	16	8.3	Access to the operating menu via the Web browser . . . . .	38
<b>5</b>	<b>Storage and transport</b> . . . . .	<b>17</b>	8.3.1	Function range . . . . .	38
5.1	Storage conditions . . . . .	17	8.3.2	Prerequisites . . . . .	39
5.2	Transporting the product . . . . .	17	8.3.3	Establishing a connection . . . . .	39
5.2.1	Measuring devices without lifting lugs . . . . .	17	8.3.4	Logging on . . . . .	40
5.2.2	Measuring devices with lifting lugs . . . . .	18	8.3.5	User interface . . . . .	41
5.2.3	Transporting with a fork lift . . . . .	18	8.3.6	Disabling the Web server . . . . .	42
5.3	Packaging disposal . . . . .	18	8.3.7	Logging out . . . . .	42
<b>6</b>	<b>Installation</b> . . . . .	<b>19</b>	8.4	Access to the operating menu via the operating tool . . . . .	43
6.1	Installation conditions . . . . .	19	8.4.1	Connecting the operating tool . . . . .	43
6.1.1	Mounting position . . . . .	19	8.4.2	FieldCare . . . . .	44
6.1.2	Requirements from environment and process . . . . .	21	8.4.3	DeviceCare . . . . .	45
6.1.3	Special mounting instructions . . . . .	24	<b>9</b>	<b>System integration</b> . . . . .	<b>46</b>
			9.1	Overview of device description files . . . . .	46
			9.1.1	Current version data for the device . . . . .	46
			9.1.2	Operating tools . . . . .	46
			9.2	Device master file (GSD) . . . . .	47
			9.2.1	File name of the device master file (GSD) . . . . .	47
			9.3	Cyclic data transmission . . . . .	47
			9.3.1	Overview of the modules . . . . .	47

9.3.2	Description of the modules . . . . .	47	12.5	Adapting the diagnostic information . . . . .	83
9.3.3	Status coding . . . . .	53	12.5.1	Adapting the diagnostic behavior . . . . .	83
9.3.4	Factory setting . . . . .	54	12.6	Overview of diagnostic information . . . . .	86
<b>10</b>	<b>Commissioning . . . . .</b>	<b>55</b>	12.6.1	Diagnostic of sensor . . . . .	86
10.1	Function check . . . . .	55	12.6.2	Diagnostic of electronic . . . . .	90
10.2	Identifying the device in the PROFINET network . . . . .	55	12.6.3	Diagnostic of configuration . . . . .	95
10.3	Startup parameterization . . . . .	55	12.6.4	Diagnostic of process . . . . .	99
10.4	Establishing a connection via FieldCare . . . . .	55	12.7	Pending diagnostic events . . . . .	107
10.5	Setting the operating language . . . . .	55	12.8	Diagnostic list . . . . .	107
10.6	Configuring the measuring device . . . . .	55	12.9	Event logbook . . . . .	107
10.6.1	Defining the tag name . . . . .	56	12.9.1	Event history . . . . .	107
10.6.2	Setting the system units . . . . .	56	12.9.2	Filtering the event logbook . . . . .	108
10.6.3	Displaying the communication interface . . . . .	58	12.9.3	Overview of information events . . . . .	108
10.6.4	Selecting and setting the medium . . . . .	59	12.10	Resetting the measuring device . . . . .	109
10.6.5	Configuring the low flow cut off . . . . .	61	12.10.1	Function scope of the "Device reset" parameter . . . . .	110
10.6.6	Configuring the partial filled pipe detection . . . . .	62	12.11	Device information . . . . .	110
10.7	Advanced settings . . . . .	63	12.12	Firmware history . . . . .	112
10.7.1	Calculated values . . . . .	63	<b>13</b>	<b>Maintenance . . . . .</b>	<b>113</b>
10.7.2	Carrying out a sensor adjustment . . . . .	64	13.1	Maintenance tasks . . . . .	113
10.7.3	Configuring the totalizer . . . . .	65	13.1.1	Exterior cleaning . . . . .	113
10.7.4	Carrying out additional display configurations . . . . .	67	13.1.2	Interior cleaning . . . . .	113
10.8	Simulation . . . . .	70	13.2	Measuring and test equipment . . . . .	113
10.9	Protecting settings from unauthorized access . . . . .	71	13.3	Endress+Hauser services . . . . .	113
10.9.1	Write protection via access code . . . . .	71	<b>14</b>	<b>Repair . . . . .</b>	<b>114</b>
10.9.2	Write protection via write protection switch . . . . .	72	14.1	General notes . . . . .	114
10.9.3	Write protection via startup parameterization . . . . .	72	14.2	Spare parts . . . . .	114
<b>11</b>	<b>Operation . . . . .</b>	<b>73</b>	14.3	Endress+Hauser services . . . . .	114
11.1	Reading the device locking status . . . . .	73	14.4	Return . . . . .	114
11.2	Adjusting the operating language . . . . .	73	14.5	Disposal . . . . .	115
11.3	Configuring the display . . . . .	73	14.5.1	Removing the measuring device . . . . .	115
11.4	Reading measured values . . . . .	73	14.5.2	Disposing of the measuring device . . . . .	115
11.4.1	Process variables . . . . .	73	<b>15</b>	<b>Accessories . . . . .</b>	<b>116</b>
11.4.2	Totalizer . . . . .	75	15.1	Device-specific accessories . . . . .	116
11.5	Adapting the measuring device to the process conditions . . . . .	76	15.1.1	For the sensor . . . . .	116
11.6	Performing a totalizer reset . . . . .	76	15.2	Service-specific accessories . . . . .	116
<b>12</b>	<b>Diagnostics and troubleshooting . . . . .</b>	<b>78</b>	15.3	System components . . . . .	117
12.1	General troubleshooting . . . . .	78	<b>16</b>	<b>Technical data . . . . .</b>	<b>118</b>
12.2	Diagnostic information via light emitting diodes . . . . .	79	16.1	Application . . . . .	118
12.2.1	Transmitter . . . . .	79	16.2	Function and system design . . . . .	118
12.3	Diagnostic information in the Web browser . . . . .	80	16.3	Input . . . . .	119
12.3.1	Diagnostic options . . . . .	80	16.4	Output . . . . .	120
12.3.2	Calling up remedy information . . . . .	82	16.5	Power supply . . . . .	124
12.4	Diagnostic information in FieldCare . . . . .	82	16.6	Performance characteristics . . . . .	125
12.4.1	Diagnostic options . . . . .	82	16.7	Installation . . . . .	128
12.4.2	Calling up remedy information . . . . .	83	16.8	Environment . . . . .	129
			16.9	Process . . . . .	129
			16.10	Mechanical construction . . . . .	132
			16.11	Operability . . . . .	134
			16.12	Certificates and approvals . . . . .	136
			16.13	Application packages . . . . .	137
			16.14	Accessories . . . . .	138

16.15 Supplementary documentation . . . . . 138

**Index . . . . . 140**





# 1 Document information

## 1.1 Document function







These Operating Instructions contain all the information that is required in various phases of the life cycle of the device: from product identification, incoming acceptance and storage, to mounting, connection, operation and commissioning through to troubleshooting, maintenance and disposal.

## 1.2 Symbols used



### 1.2.1 Safety symbols

Symbol	Meaning
	<b>DANGER!</b> This symbol alerts you to a dangerous situation. Failure to avoid this situation will result in serious or fatal injury.
	<b>WARNING!</b> This symbol alerts you to a dangerous situation. Failure to avoid this situation can result in serious or fatal injury.
	<b>CAUTION!</b> This symbol alerts you to a dangerous situation. Failure to avoid this situation can result in minor or medium injury.
	<b>NOTE!</b> This symbol contains information on procedures and other facts which do not result in personal injury.











### 1.2.2 Electrical symbols

Symbol	Meaning	Symbol	Meaning
	Direct current		Alternating current
	Direct current and alternating current		<b>Ground connection</b> A grounded terminal which, as far as the operator is concerned, is grounded via a grounding system.
	<b>Protective ground connection</b> A terminal which must be connected to ground prior to establishing any other connections.		<b>Equipotential connection</b> A connection that has to be connected to the plant grounding system: This may be a potential equalization line or a star grounding system depending on national or company codes of practice.





### 1.2.3 Tool symbols

Symbol	Meaning
	Allen key
	Open-ended wrench

### 1.2.4 Symbols for certain types of information

Symbol	Meaning
	<b>Permitted</b> Procedures, processes or actions that are permitted.
	<b>Preferred</b> Procedures, processes or actions that are preferred.
	<b>Forbidden</b> Procedures, processes or actions that are forbidden.
	<b>Tip</b> Indicates additional information.
	Reference to documentation
	Reference to page
	Reference to graphic
	Series of steps
	Result of a step
	Help in the event of a problem
	Visual inspection

### 1.2.5 Symbols in graphics

Symbol	Meaning	Symbol	Meaning
1, 2, 3,...	Item numbers		Series of steps
A, B, C, ...	Views	A-A, B-B, C-C, ...	Sections
	Hazardous area		Safe area (non-hazardous area)
	Flow direction		

## 1.3 Documentation

 For an overview of the scope of the associated Technical Documentation, refer to the following:

- The *W@M Device Viewer* : Enter the serial number from the nameplate ([www.endress.com/deviceviewer](http://www.endress.com/deviceviewer))
- The *Endress+Hauser Operations App*: Enter the serial number from the nameplate or scan the 2-D matrix code (QR code) on the nameplate.

 For a detailed list of the individual documents along with the documentation code

### 1.3.1 Standard documentation

Document type	Purpose and content of the document
Technical Information	<b>Planning aid for your device</b> The document contains all the technical data on the device and provides an overview of the accessories and other products that can be ordered for the device.
Brief Operating Instructions	<b>Guide that takes you quickly to the 1st measured value</b> The Brief Operating Instructions contain all the essential information from incoming acceptance to initial commissioning.

### 1.3.2 Supplementary device-dependent documentation

Additional documents are supplied depending on the device version ordered: Always comply strictly with the instructions in the supplementary documentation. The supplementary documentation is an integral part of the device documentation.

## 1.4 Registered trademarks

#### **PROFINET®**

Registered trademark of the PROFIBUS User Organization, Karlsruhe, Germany

#### **Microsoft®**

Registered trademark of the Microsoft Corporation, Redmond, Washington, USA

#### **TRI-CLAMP®**

Registered trademark of Ladish & Co., Inc., Kenosha, USA

#### **Applicator®, FieldCare®, DeviceCare®, Field Xpert™, HistoROM®, TMB®, Heartbeat Technology™**

Registered or registration-pending trademarks of the Endress+Hauser Group



## 2 Basic safety instructions

### 2.1 Requirements for the personnel

The personnel for installation, commissioning, diagnostics and maintenance must fulfill the following requirements:

- ▶ Trained, qualified specialists must have a relevant qualification for this specific function and task
- ▶ Are authorized by the plant owner/operator
- ▶ Are familiar with federal/national regulations
- ▶ Before beginning work, the specialist staff must have read and understood the instructions in the Operating Instructions and supplementary documentation as well as in the certificates (depending on the application)
- ▶ Following instructions and basic conditions

The operating personnel must fulfill the following requirements:

- ▶ Being instructed and authorized according to the requirements of the task by the facility's owner-operator
- ▶ Following the instructions in these Operating Instructions

### 2.2 Designated use

#### Application and media

The measuring device described in these Instructions is intended only for flow measurement of liquids and gases.

Depending on the version ordered, the measuring device can also measure potentially explosive, flammable, poisonous and oxidizing media.

Measuring devices for use in hazardous areas, in hygienic applications or in applications where there is an increased risk due to process pressure, are labeled accordingly on the nameplate.

To ensure that the measuring device remains in proper condition for the operation time:

- ▶ Only use the measuring device in full compliance with the data on the nameplate and the general conditions listed in the Operating Instructions and supplementary documentation.
- ▶ Check the nameplate to verify if the device ordered can be put to its intended use in the approval-related area (e.g. explosion protection, pressure vessel safety).
- ▶ Use the measuring device only for media against which the process-wetted materials are adequately resistant.
- ▶ If the measuring device is not operated at atmospheric temperature, compliance with the relevant basic conditions specified in the associated device documentation is absolutely essential: "Documentation" section →  7.
- ▶ Protect the measuring device permanently against corrosion from environmental influences.

#### Incorrect use

Non-designated use can compromise safety. The manufacturer is not liable for damage caused by improper or non-designated use.

#### **WARNING**

**Danger of breakage of the measuring tube due to corrosive or abrasive fluids or from environmental conditions.**

Housing breakage due to mechanical overload possible!

- ▶ Verify the compatibility of the process fluid with the measuring tube material.
- ▶ Ensure the resistance of all fluid-wetted materials in the process.
- ▶ Keep within the specified pressure and temperature range.

Verification for borderline cases:

- ▶ For special fluids and fluids for cleaning, Endress+Hauser is glad to provide assistance in verifying the corrosion resistance of fluid-wetted materials, but does not accept any warranty or liability as minute changes in the temperature, concentration or level of contamination in the process can alter the corrosion resistance properties.

#### **Residual risks**

The external surface temperature of the housing can increase by max. 20 K due to the power consumption of the electronic components. Hot process fluids passing through the measuring device will further increase the surface temperature of the housing. The surface of the sensor, in particular, can reach temperatures which are close to the fluid temperature.

Possible burn hazard due to fluid temperatures!

- ▶ For elevated fluid temperature, ensure protection against contact to prevent burns.

## **2.3 Workplace safety**

For work on and with the device:

- ▶ Wear the required personal protective equipment according to federal/national regulations.

For welding work on the piping:

- ▶ Do not ground the welding unit via the measuring device.

If working on and with the device with wet hands:

- ▶ It is recommended to wear gloves on account of the higher risk of electric shock.

## **2.4 Operational safety**

Risk of injury.

- ▶ Operate the device in proper technical condition and fail-safe condition only.
- ▶ The operator is responsible for interference-free operation of the device.

#### **Conversions to the device**

Unauthorized modifications to the device are not permitted and can lead to unforeseeable dangers.

- ▶ If, despite this, modifications are required, consult with Endress+Hauser.

#### **Repair**

To ensure continued operational safety and reliability,

- ▶ Carry out repairs on the device only if they are expressly permitted.
- ▶ Observe federal/national regulations pertaining to repair of an electrical device.
- ▶ Use original spare parts and accessories from Endress+Hauser only.

## **2.5 Product safety**

This measuring device is designed in accordance with good engineering practice to meet state-of-the-art safety requirements, has been tested, and left the factory in a condition in which it is safe to operate.

It meets general safety standards and legal requirements. It also complies with the EC directives listed in the device-specific EC Declaration of Conformity. Endress+Hauser confirms this by affixing the CE mark to the device.

## **2.6 IT security**

We only provide a warranty if the device is installed and used as described in the Operating Instructions. The device is equipped with security mechanisms to protect it against any inadvertent changes to the device settings.

IT security measures in line with operators' security standards and designed to provide additional protection for the device and device data transfer must be implemented by the operators themselves.

## 3 Product description

The device consists of a transmitter and a sensor.

The device is available as a compact version:

The transmitter and sensor form a mechanical unit.

### 3.1 Product design

#### 3.1.1 Device version with PROFINET communication type

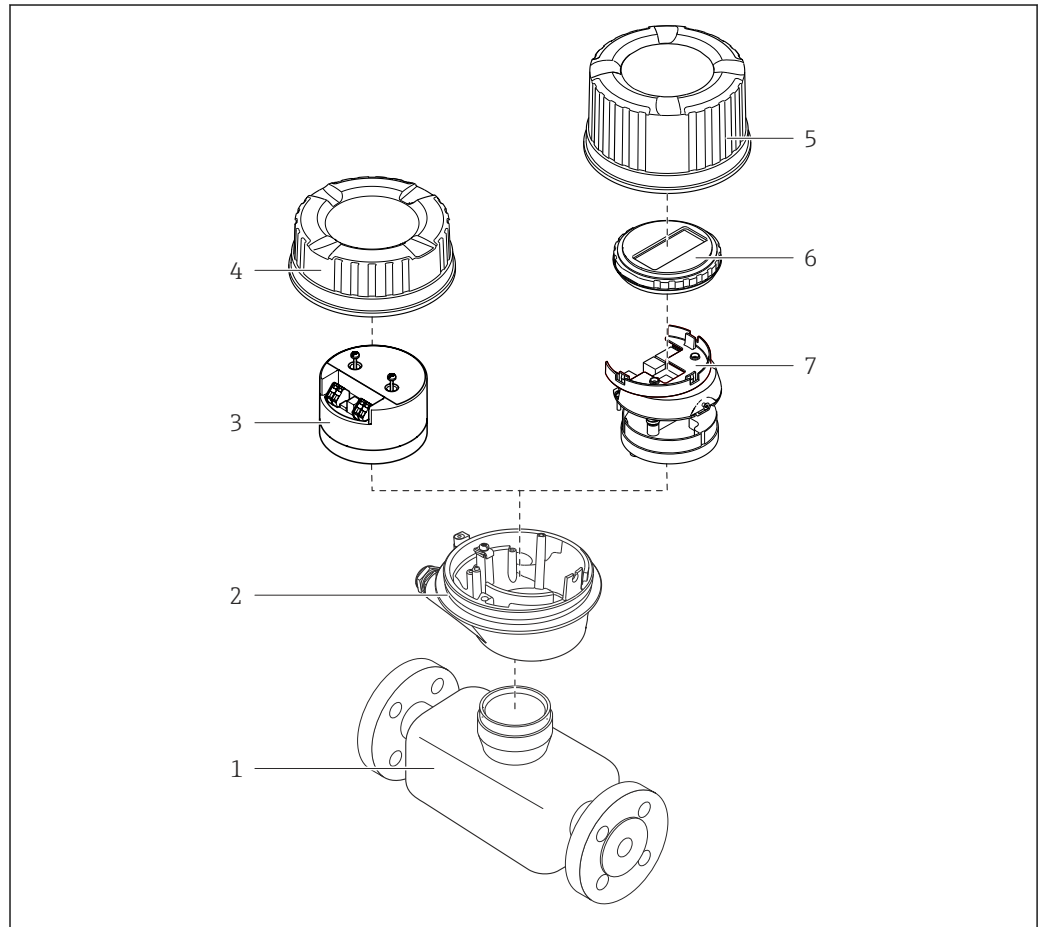

A0023153

1 Important components of a measuring device

- 1 Sensor
- 2 Transmitter housing
- 3 Main electronics module
- 4 Transmitter housing cover
- 5 Transmitter housing cover (version for optional onsite display)
- 6 Onsite display (optional)
- 7 Main electronics module (with bracket for optional onsite display)

## 4 Incoming acceptance and product identification

### 4.1 Incoming acceptance

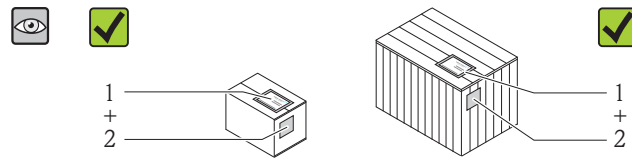

Are the order codes on the delivery note (1) and the product sticker (2) identical?

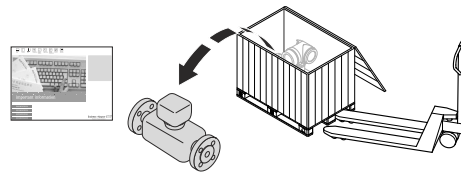

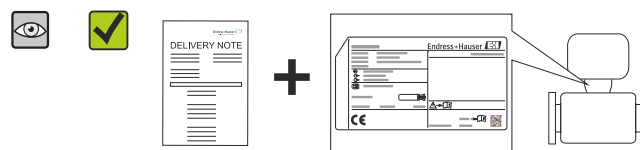

Are the goods undamaged?

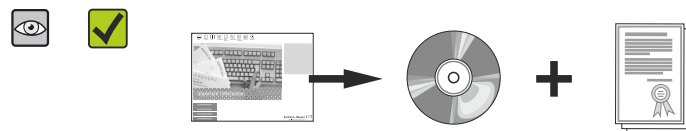

Do the nameplate data match the ordering information on the delivery note?



Is the CD-ROM with the Technical Documentation (depends on device version) and documents present?

-  If one of the conditions is not satisfied, contact your Endress+Hauser Sales Center.
- Depending on the device version, the CD-ROM might not be part of the delivery! The Technical Documentation is available via the Internet or via the *Endress+Hauser Operations App*, see the "Product identification" section →  14.

### 4.2 Product identification

The following options are available for identification of the measuring device:

- Nameplate specifications
- Order code with breakdown of the device features on the delivery note
- Enter serial numbers from nameplates in *W@M Device Viewer* ([www.endress.com/deviceviewer](http://www.endress.com/deviceviewer)): All information about the measuring device is displayed.
- Enter the serial number from the nameplates into the *Endress+Hauser Operations App* or scan the 2-D matrix code (QR code) on the nameplate with the *Endress+Hauser Operations App*: all the information for the measuring device is displayed.

For an overview of the scope of the associated Technical Documentation, refer to the following:

- The chapters "Additional standard documentation on the device" → 8 and "Supplementary device-dependent documentation" → 8
- The *W@M Device Viewer*: Enter the serial number from the nameplate ([www.endress.com/deviceviewer](http://www.endress.com/deviceviewer))
- The *Endress+Hauser Operations App*: Enter the serial number from the nameplate or scan the 2-D matrix code (QR code) on the nameplate.

#### 4.2.1 Transmitter nameplate

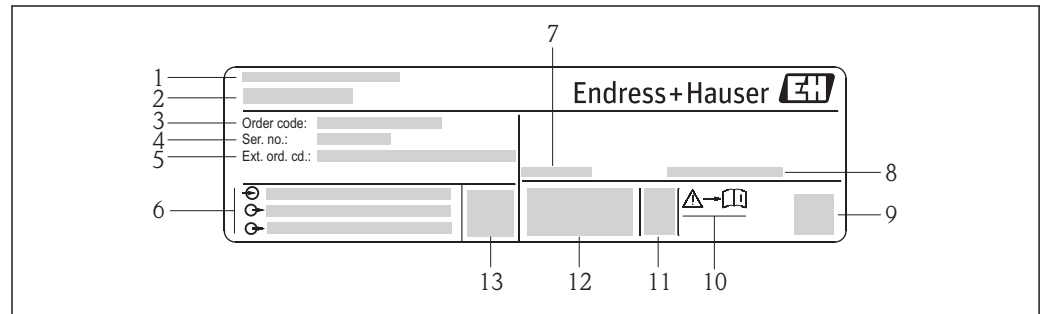

A0017520

2 Example of a transmitter nameplate

- 1 Manufacturing location
- 2 Name of the transmitter
- 3 Order code
- 4 Serial number (Ser. no.)
- 5 Extended order code (Ext. ord. cd.)
- 6 Electrical connection data, e.g. available inputs and outputs, supply voltage
- 7 Permitted ambient temperature ( $T_a$ )
- 8 Degree of protection
- 9 2-D matrix code
- 10 Document number of safety-related supplementary documentation
- 11 Manufacturing date: year-month
- 12 CE mark, C-Tick
- 13 Firmware version (FW)

## 4.2.2 Sensor nameplate

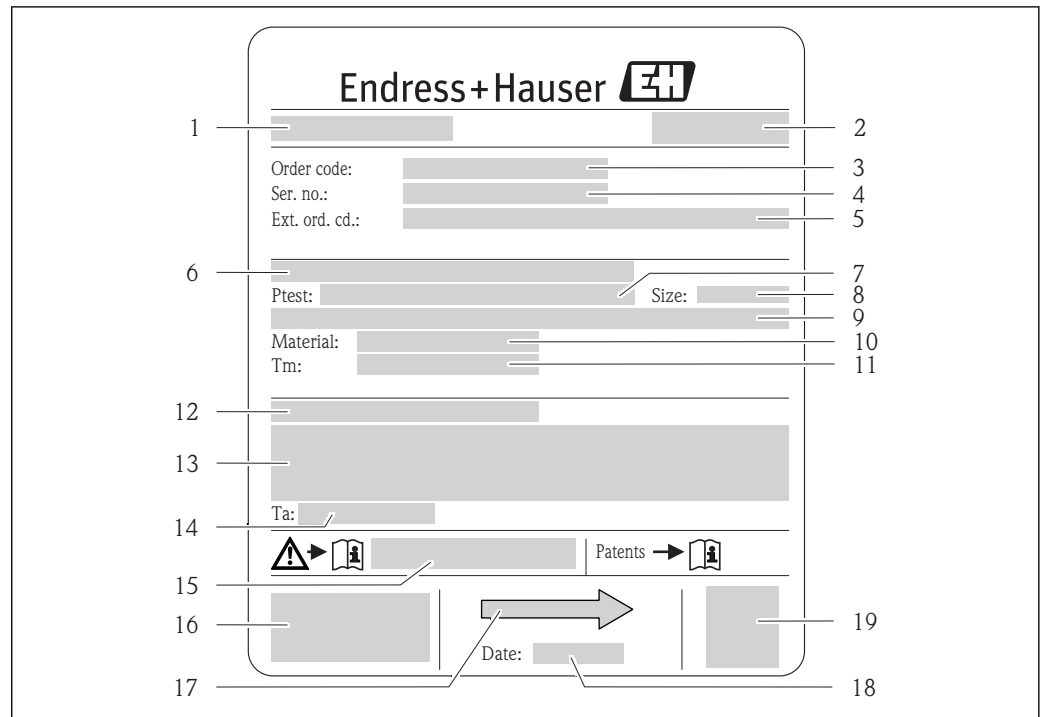

A0017923

 3 Example of a sensor nameplate

- 1 Name of the sensor
- 2 Manufacturing location
- 3 Order code
- 4 Serial number (ser. no.)
- 5 Extended order code (ext. ord. cd.)
- 6 Flange nominal diameter/nominal pressure
- 7 Test pressure of the sensor
- 8 Nominal diameter of sensor
- 9 Sensor-specific data: e.g. pressure range of secondary containment, wide-range density specification (special density calibration)
- 10 Material of measuring tube and manifold
- 11 Medium temperature range
- 12 Degree of protection
- 13 Approval information for explosion protection and Pressure Equipment Directive
- 14 Permitted ambient temperature (T<sub>a</sub>)
- 15 Document number of safety-related supplementary documentation
- 16 CE mark, C-Tick
- 17 Flow direction
- 18 Manufacturing date: year-month
- 19 2-D matrix code



### Order code

The measuring device is reordered using the order code.

#### Extended order code

- The device type (product root) and basic specifications (mandatory features) are always listed.
- Of the optional specifications (optional features), only the safety and approval-related specifications are listed (e.g. LA). If other optional specifications are also ordered, these are indicated collectively using the # placeholder symbol (e.g. #LA#).
- If the ordered optional specifications do not include any safety and approval-related specifications, they are indicated by the + placeholder symbol (e.g. XXXXXX-ABCDE+).

### 4.2.3 Symbols on measuring device

Symbol	Meaning
	<b>WARNING!</b> This symbol alerts you to a dangerous situation. Failure to avoid this situation can result in serious or fatal injury.
	<b>Reference to documentation</b> Refers to the corresponding device documentation.
	<b>Protective ground connection</b> A terminal which must be connected to ground prior to establishing any other connections.



## 5 Storage and transport

### 5.1 Storage conditions

Observe the following notes for storage:

- Store in the original packaging to ensure protection from shock.
- Do not remove protective covers or protective caps installed on process connections. They prevent mechanical damage to the sealing surfaces and contamination in the measuring tube.
- Protect from direct sunlight to avoid unacceptably high surface temperatures.
- Store in a dry and dust-free place.
- Do not store outdoors.

Storage temperature:  $-40$  to  $+80$  °C ( $-40$  to  $+176$  °F),

Order code for "Test, Certificate", option JM:  $-50$  to  $+60$  °C ( $-58$  to  $+140$  °F), preferably at  $+20$  °C ( $+68$  °F)

### 5.2 Transporting the product

Transport the measuring device to the measuring point in the original packaging.

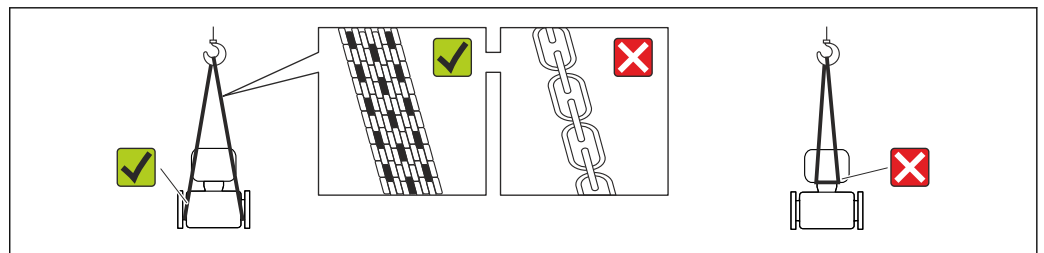

A0015604

- i** Do not remove protective covers or caps installed on process connections. They prevent mechanical damage to the sealing surfaces and contamination in the measuring tube.

#### 5.2.1 Measuring devices without lifting lugs

##### **⚠ WARNING**

**Center of gravity of the measuring device is higher than the suspension points of the webbing slings.**

Risk of injury if the measuring device slips.

- ▶ Secure the measuring device against slipping or turning.
- ▶ Observe the weight specified on the packaging (stick-on label).

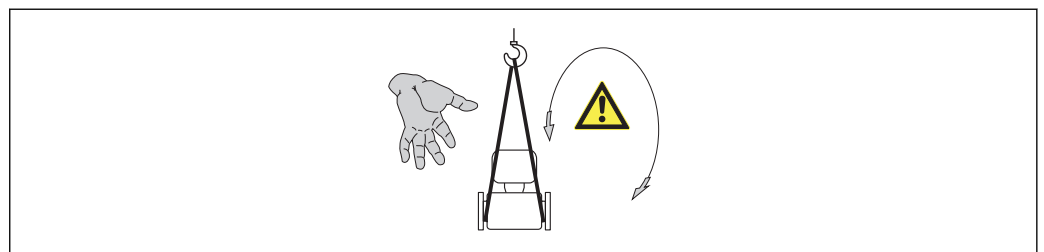

A0015606

## 5.2.2 Measuring devices with lifting lugs

### **⚠ CAUTION**

#### Special transportation instructions for devices with lifting lugs

- ▶ Only use the lifting lugs fitted on the device or flanges to transport the device.
- ▶ The device must always be secured at two lifting lugs at least.

## 5.2.3 Transporting with a fork lift

If transporting in wood crates, the floor structure enables the crates to be lifted lengthwise or at both sides using a forklift.

## 5.3 Packaging disposal

All packaging materials are environmentally friendly and 100% recyclable:

- Measuring device secondary packaging: polymer stretch film that conforms to EC Directive 2002/95/EC (RoHS).
- Packaging:
  - Wood crate, treated in accordance with ISPM 15 standard, which is confirmed by the affixed IPPC logo.
  - or
  - Carton in accordance with European Packaging Directive 94/62EC; recyclability is confirmed by the affixed RESY symbol.
- Seaworthy packaging (optional): Wood crate, treated in accordance with ISPM 15 standard, which is confirmed by the affixed IPPC logo.
- Carrying and mounting hardware:
  - Disposable plastic pallet
  - Plastic straps
  - Plastic adhesive strips
- Dunnage: Paper cushion

## 6 Installation

### 6.1 Installation conditions

No special measures such as supports are necessary. External forces are absorbed by the construction of the device.

#### 6.1.1 Mounting position

##### Mounting location

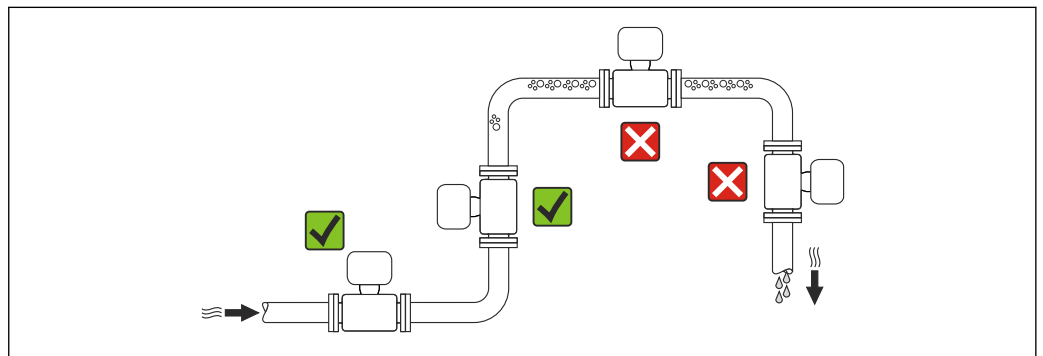

A0023344

To prevent measuring errors arising from accumulation of gas bubbles in the measuring tube, avoid the following mounting locations in the pipe:

- Highest point of a pipeline.
- Directly upstream of a free pipe outlet in a down pipe.

##### Installation in down pipes

However, the following installation suggestion allows for installation in an open vertical pipeline. Pipe restrictions or the use of an orifice with a smaller cross-section than the nominal diameter prevent the sensor running empty while measurement is in progress.

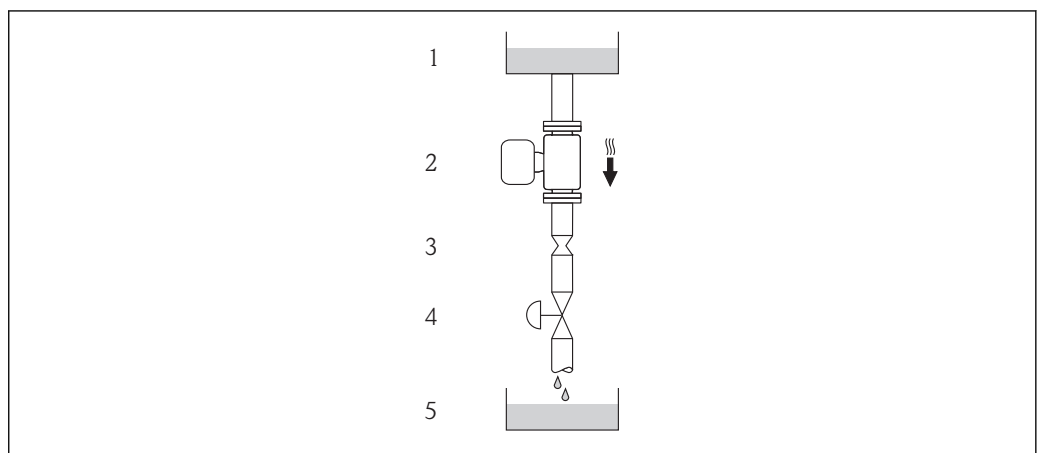

A0015596

4 Installation in a down pipe (e.g. for batching applications)

- 1 Supply tank
- 2 Sensor
- 3 Orifice plate, pipe restriction
- 4 Valve
- 5 Batching tank

DN		Ø orifice plate, pipe restriction	
[mm]	[in]	[mm]	[in]
8	3/8	6	0.24
15	1/2	10	0.40
25	1	14	0.55
40	1 1/2	22	0.87
50	2	28	1.10

**Orientation**

The direction of the arrow on the sensor nameplate helps you to install the sensor according to the flow direction (direction of medium flow through the piping).

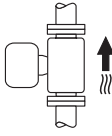
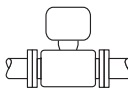
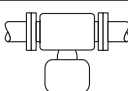
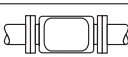
Orientation			Recommendation
<b>A</b>	Vertical orientation	 A0015591	✓✓
<b>B</b>	Horizontal orientation, transmitter head up	 A0015589	✓✓ <sup>1)</sup> Exceptions: → ☒ 5, ☒ 20
<b>C</b>	Horizontal orientation, transmitter head down	 A0015590	✓✓ <sup>2)</sup> Exceptions: → ☒ 5, ☒ 20
<b>D</b>	Horizontal orientation, transmitter head at side	 A0015592	✓✓

- 1) Applications with low process temperatures may decrease the ambient temperature. To maintain the minimum ambient temperature for the transmitter, this orientation is recommended.
- 2) Applications with high process temperatures may increase the ambient temperature. To maintain the maximum ambient temperature for the transmitter, this orientation is recommended.

If a sensor is installed horizontally with a curved measuring tube, match the position of the sensor to the fluid properties.

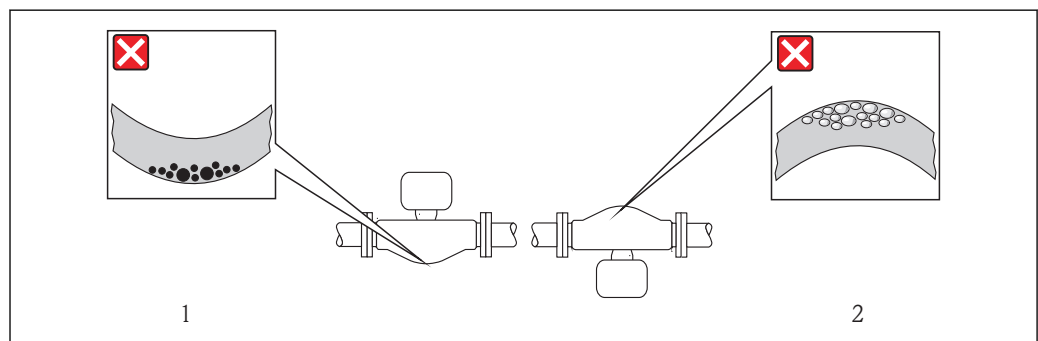

☒ 5 Orientation of sensor with curved measuring tube

- 1 Avoid this orientation for fluids with entrained solids: Risk of solids accumulating.
- 2 Avoid this orientation for outgassing fluids: Risk of gas accumulating.

### Inlet and outlet runs

No special precautions need to be taken for fittings which create turbulence, such as valves, elbows or T-pieces, as long as no cavitation occurs → 21.



### Installation dimensions

 For the dimensions and installation lengths of the device, see the "Technical Information" document, "Mechanical construction" section

## 6.1.2 Requirements from environment and process

### Ambient temperature range

<b>Measuring device</b>	Non-Ex	-40 to +60 °C (-40 to +140 °F)
	Ex na, NI version	-40 to +60 °C (-40 to +140 °F)
	Ex ia, IS version	<ul style="list-style-type: none"> <li>■ -40 to +60 °C (-40 to +140 °F)</li> <li>■ -50 to +60 °C (-58 to +140 °F) (order code for "Test, certificate", option JM)</li> </ul>
<b>Readability of the local display</b>		-20 to +60 °C (-4 to +140 °F) The readability of the display may be impaired at temperatures outside the temperature range.

- ▶ If operating outdoors:  
Avoid direct sunlight, particularly in warm climatic regions.

### System pressure

It is important that cavitation does not occur, or that gases entrained in the liquids do not outgas.

Cavitation is caused if the pressure drops below the vapor pressure:

- In liquids that have a low boiling point (e.g. hydrocarbons, solvents, liquefied gases)
- In suction lines
- ▶ Ensure the system pressure is sufficiently high to prevent cavitation and outgassing.

For this reason, the following mounting locations are recommended:

- At the lowest point in a vertical pipe
- Downstream from pumps (no danger of vacuum)

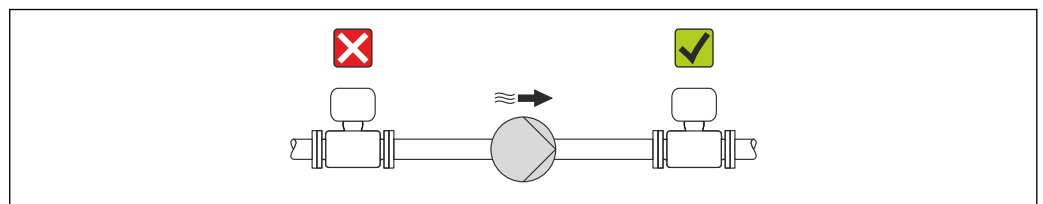

**Thermal insulation**

In the case of some fluids, it is important that the heat radiated from the sensor to the transmitter is kept to a minimum. A wide range of materials can be used for the required insulation.

**NOTICE**

**Electronics overheating on account of thermal insulation!**

- ▶ Observe maximum permitted insulation height of the transmitter neck so that the transmitter head is completely free.

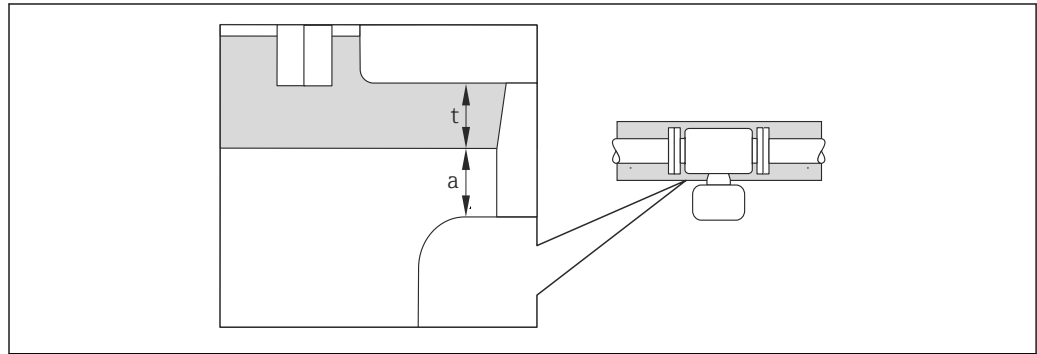

A0019919

- a Minimum distance to insulation
- t maximum Insulation thickness

The minimum distance between the transmitter housing and the insulation is 10 mm (0.39 in) so that the transmitter head remains completely exposed.

**Maximum recommended insulation thickness**

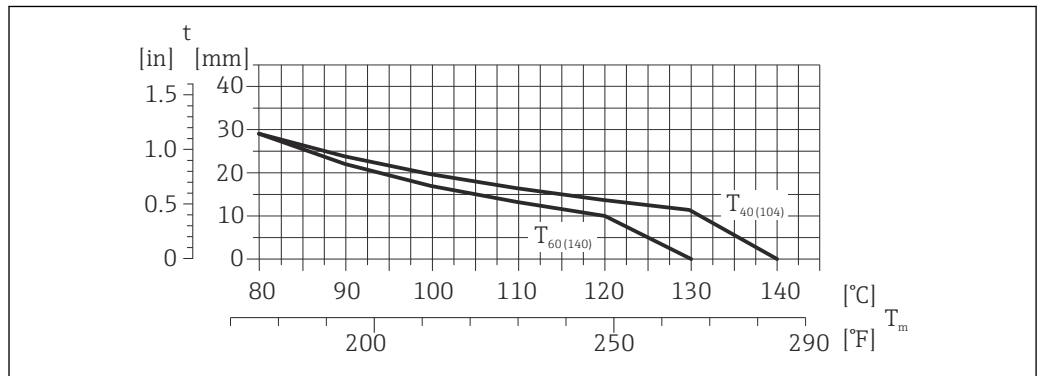

A0023173

6 Maximum recommended insulation thickness depending on the temperature of the medium and the ambient temperature

- t Insulation thickness
- $T_m$  Medium temperature
- $T_{40(104)}$  Maximum recommended insulation thickness at an ambient temperature of  $T_a = 40^\circ\text{C}$  (104 °F)
- $T_{60(140)}$  Maximum recommended insulation thickness at an ambient temperature of  $T_a = 60^\circ\text{C}$  (140 °F)

**Maximum recommended insulation thickness for the extended temperature range and insulation**

For the extension neck for insulation version, order code for "Sensor option", option CG:

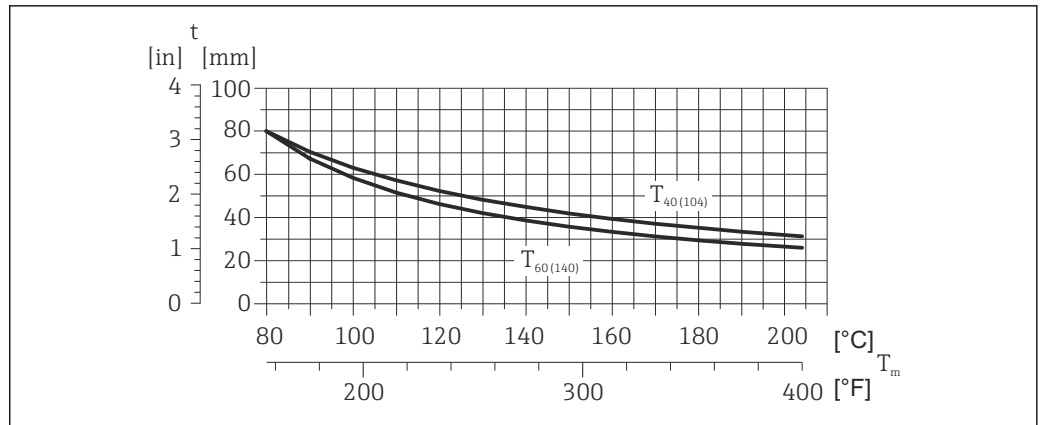

7 Maximum recommended insulation thickness depending on the temperature of the medium and the ambient temperature

$t$  Insulation thickness

$T_m$  Medium temperature

$T_{40(104)}$  Maximum recommended insulation thickness at an ambient temperature of  $T_a = 40\text{ °C}$  ( $104\text{ °F}$ )

$T_{60(140)}$  Maximum recommended insulation thickness at an ambient temperature of  $T_a = 60\text{ °C}$  ( $140\text{ °F}$ )

#### NOTICE

##### Danger of overheating with insulation

- ▶ Ensure that the temperature at the lower end of the transmitter housing does not exceed  $80\text{ °C}$  ( $176\text{ °F}$ )

#### NOTICE

##### The insulation can also be thicker than the maximum recommended insulation thickness.

Prerequisite:

- ▶ Ensure that convection takes place on a sufficiently large scale at the transmitter neck.
- ▶ Ensure that a sufficiently large area of the housing support remains exposed. The uncovered part serves as a radiator and protects the electronics from overheating and excessive cooling.

#### Heating

#### NOTICE

##### Electronics can overheat due to elevated ambient temperature!

- ▶ Observe maximum permitted ambient temperature for the transmitter .
- ▶ Depending on the fluid temperature, take the device orientation requirements into account .

#### NOTICE

##### Danger of overheating when heating

- ▶ Ensure that the temperature at the lower end of the transmitter housing does not exceed  $80\text{ °C}$  ( $176\text{ °F}$ )
- ▶ Ensure that convection takes place on a sufficiently large scale at the transmitter neck.
- ▶ Ensure that a sufficiently large area of the housing support remains exposed. The uncovered part serves as a radiator and protects the electronics from overheating and excessive cooling.

*Heating options*

If a fluid requires that no heat loss should occur at the sensor, users can avail of the following heating options:

- Electrical heating, e.g. with electric band heaters
- Via pipes carrying hot water or steam
- Via heating jackets

*Using an electrical trace heating system*

If heating is regulated via phase angle control or pulse packages, magnetic fields can affect the measured values (= for values that are greater than the values approved by the EN standard (sine 30 A/m)).

For this reason, the sensor must be magnetically shielded: the housing can be shielded with tin plates or electric sheets without a privileged direction (e.g. V330-35A).

The sheet must have the following properties:

- Relative magnetic permeability  $\mu_r \geq 300$
- Plate thickness  $d \geq 0.35 \text{ mm}$  ( $d \geq 0.014 \text{ in}$ )

**Vibrations**

The high oscillation frequency of the measuring tubes ensures that the correct operation of the measuring system is not influenced by plant vibrations.

**6.1.3 Special mounting instructions**

**Securing with mounting clamp in the case of hygiene connections**

It is not necessary to provide additional support for the sensor for operational performance purposes. If, however, additional support is required for installation purposes, the following dimensions must be observed.

Use mounting clamp with lining between clamp and measuring instrument.

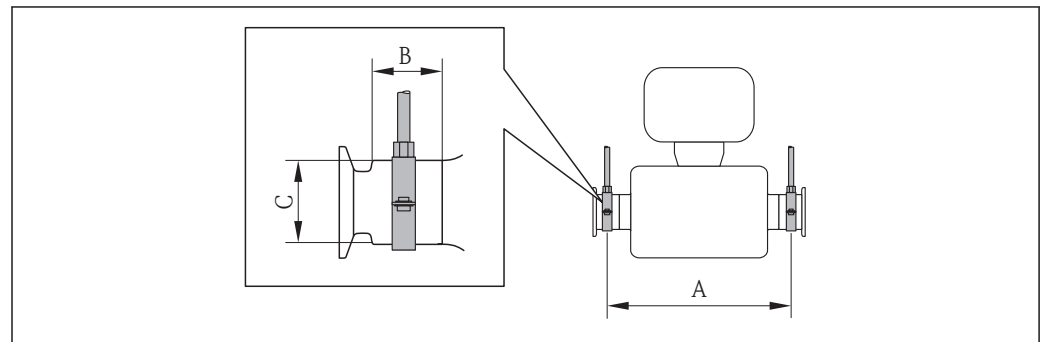

A0016588

DN		A		B		C	
[mm]	[in]	[mm]	[in]	[mm]	[in]	[mm]	[in]
8	3/8	298	11.73	33	1.3	28	1.1
15	1/2	402	15.83	33	1.3	28	1.1
25	1	542	21.34	33	1.3	38	1.5
40	1 1/2	658	25.91	36.5	1.44	56	2.2
50	2	772	30.39	44.1	1.74	75	2.95



### Zero point adjustment

All measuring devices are calibrated in accordance with state-of-the-art technology. Calibration takes place under reference conditions → 125. Therefore, a zero point adjustment in the field is generally not required.

Experience shows that zero point adjustment is advisable only in special cases:

- To achieve maximum measuring accuracy even with low flow rates
- Under extreme process or operating conditions (e.g. very high process temperatures or very high-viscosity fluids).

## 6.2 Mounting the measuring device

### 6.2.1 Required tools

#### For sensor

For flanges and other process connections: Corresponding mounting tools

### 6.2.2 Preparing the measuring device

1. Remove all remaining transport packaging.
2. Remove any protective covers or protective caps present from the sensor.
3. Remove stick-on label on the electronics compartment cover.

### 6.2.3 Mounting the measuring device

#### **⚠ WARNING**

#### Danger due to improper process sealing!

- ▶ Ensure that the inside diameters of the gaskets are greater than or equal to that of the process connections and piping.
  - ▶ Ensure that the gaskets are clean and undamaged.
  - ▶ Install the gaskets correctly.
1. Ensure that the direction of the arrow on the nameplate of the sensor matches the flow direction of the fluid.
  2. Install the measuring device or turn the transmitter housing so that the cable entries do not point upwards.

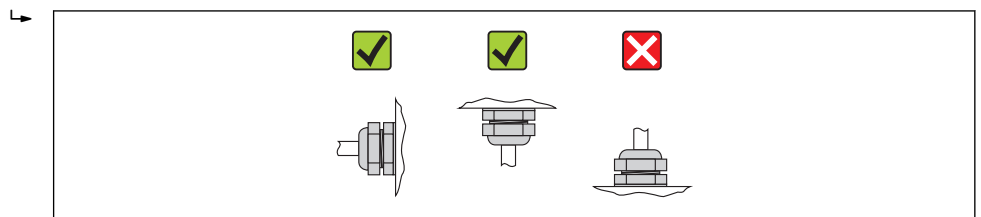

A0013964

### 6.2.4 Turning the display module

The local display is only available with the following device version:  
Order code for "Display; Operation", option **B**: 4-line; lit, via communication

The display module can be turned to optimize display readability.

**Aluminum housing version, AlSi10Mg, coated**

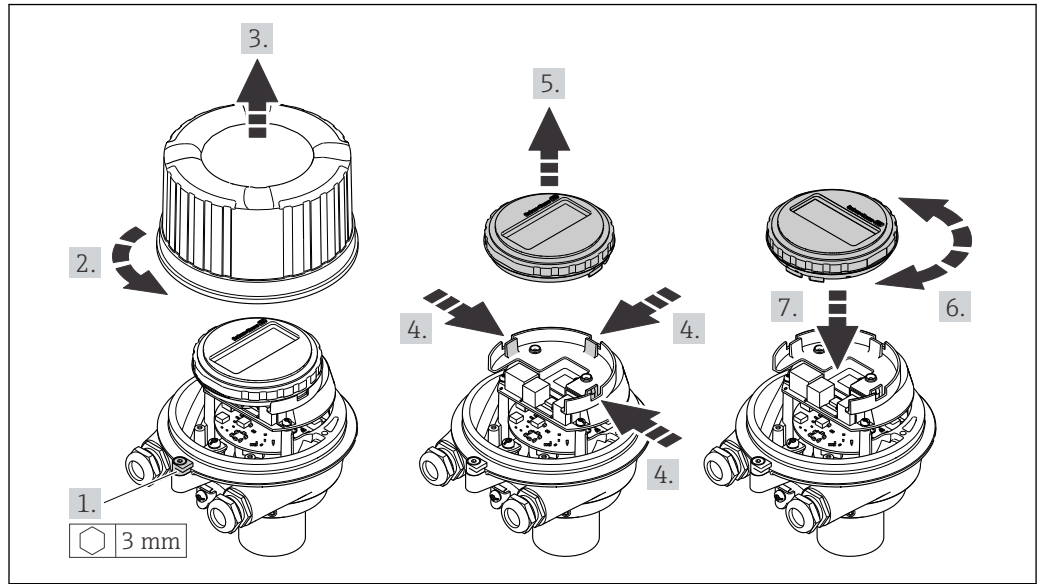

A0023192

**Compact and ultra-compact housing version, hygienic, stainless**

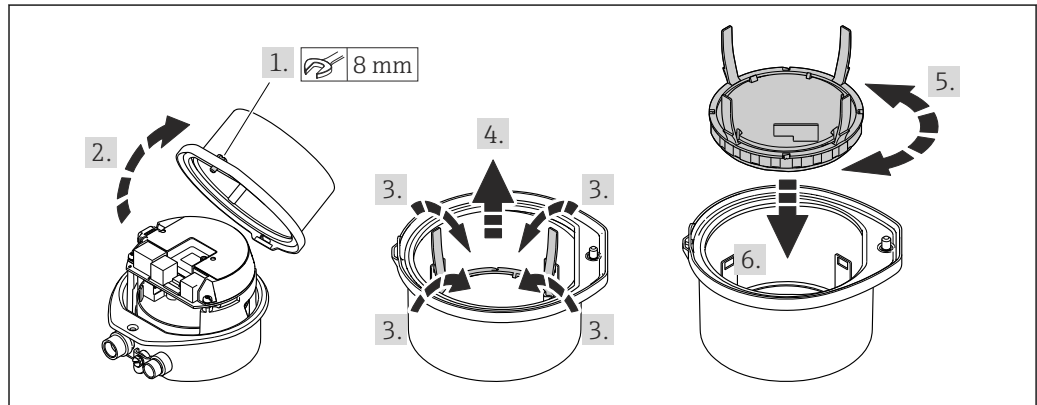

A0023195

**6.3 Post-installation check**

Is the device undamaged (visual inspection)?	<input type="checkbox"/>
Does the measuring device conform to the measuring point specifications? For example: <ul style="list-style-type: none"> <li>■ Process temperature → 129</li> <li>■ Process pressure (refer to the chapter on "Pressure-temperature ratings" of the "Technical Information" document)</li> <li>■ Ambient temperature</li> <li>■ Measuring range</li> </ul>	<input type="checkbox"/>
Has the correct orientation for the sensor been selected ? <ul style="list-style-type: none"> <li>■ According to sensor type</li> <li>■ According to medium temperature</li> <li>■ According to medium properties (outgassing, with entrained solids)</li> </ul>	<input type="checkbox"/>
Does the arrow on the sensor nameplate match the direction of flow of the fluid through the piping → 20?	<input type="checkbox"/>
Are the measuring point identification and labeling correct (visual inspection)?	<input type="checkbox"/>

---

Is the device adequately protected from precipitation and direct sunlight?	<input type="checkbox"/>
Are the securing screw and securing clamp tightened securely?	<input type="checkbox"/>

## 7 Electrical connection

 The measuring device does not have an internal circuit breaker. For this reason, assign the measuring device a switch or power-circuit breaker so that the power supply line can be easily disconnected from the mains.

### 7.1 Connection conditions

#### 7.1.1 Required tools

- For cable entries: Use corresponding tools
- For securing clamp (on aluminum housing): Allen screw 3 mm
- For securing screw (for stainless steel housing): open-ended wrench 8 mm
- Wire stripper
- When using stranded cables: crimping tool for ferrule

#### 7.1.2 Requirements for connecting cable

The connecting cables provided by the customer must fulfill the following requirements.

##### Electrical safety

In accordance with applicable federal/national regulations.

##### Permitted temperature range

- $-40\text{ °C}$  ( $-40\text{ °F}$ ) to  $+80\text{ °C}$  ( $+176\text{ °F}$ )
- Minimum requirement: cable temperature range  $\geq$  ambient temperature  $+20\text{ K}$

##### Power supply cable

Standard installation cable is sufficient.

##### Signal cable

*PROFINET*

Standard IEC 61156-6 specifies CAT 5 as the minimum category for a cable used for PROFINET. CAT 5e and CAT 6 are recommended.

 For more information on planning and installing PROFINET networks, see: "PROFINET Cabling and Interconnection Technology", Guideline for PROFINET

##### Cable diameter

- Cable glands supplied:  
M20  $\times$  1.5 with cable  $\phi$  6 to 12 mm (0.24 to 0.47 in)
- Spring terminals:  
Wire cross-sections 0.5 to 2.5 mm<sup>2</sup> (20 to 14 AWG)

### 7.1.3 Terminal assignment

#### Transmitter

PROFINET connection version

Order code for "Output", option **R**

Depending on the housing version, the transmitters can be ordered with terminals or device plugs.

Order code for "Housing"	Connection methods available		Possible options for order code "Electrical connection"
	Output	Power supply	
Options <b>A, B</b>	Device plugs → 30	Terminals	<ul style="list-style-type: none"> <li>▪ Option <b>L</b>: plug M12x1 + thread NPT 1/2"</li> <li>▪ Option <b>N</b>: plug M12x1 + coupling M20</li> <li>▪ Option <b>P</b>: plug M12x1 + thread G 1/2"</li> <li>▪ Option <b>U</b>: plug M12x1 + thread M20</li> </ul>
Options <b>A, B, C</b>	Device plugs → 30	Device plugs → 30	Option <b>Q</b> : 2 x plug M12x1
Order code for "Housing": <ul style="list-style-type: none"> <li>▪ Option <b>A</b>: compact, coated aluminum</li> <li>▪ Option <b>B</b>: compact, hygienic, stainless</li> <li>▪ Option <b>C</b>: ultra-compact, hygienic, stainless</li> </ul>			

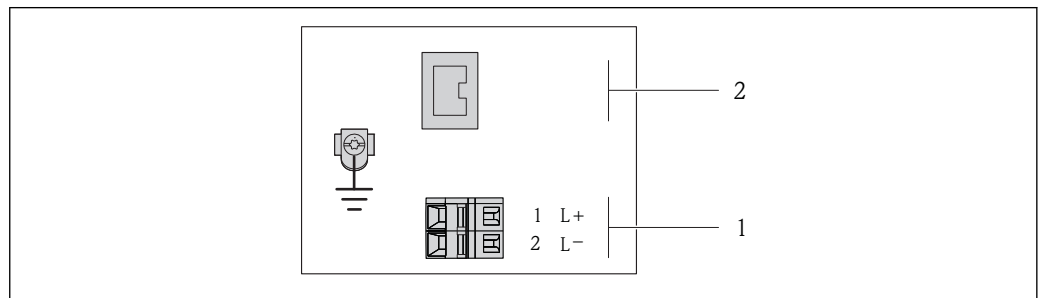

A0017054

8 PROFINET terminal assignment

- 1 Power supply: DC 24 V
- 2 PROFINET

Order code for "Output"	Terminal number		Output Device plug M12x1
	Power supply 2 (L-)	1 (L+)	
Option <b>R</b>	DC 24 V		PROFINET
Order code for "Output": Option <b>R</b> : PROFINET			

### 7.1.4 Pin assignment, device plug

#### Supply voltage

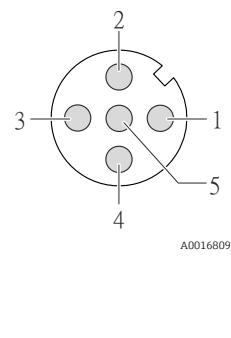
	Pin	Assignment	
	1	L+	DC 24 V
	2		Not assigned
	3		Not assigned
	4	L-	DC 24 V
	5		Grounding/shielding
Coding		Plug/socket	
A		Plug	

#### Device plug for signal transmission (device side)

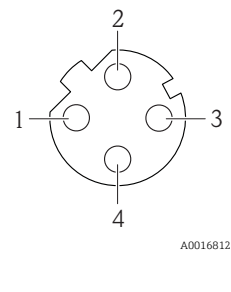
	Pin	Assignment	
	1	+	TD +
	2	+	RD +
	3	-	TD -
	4	-	RD -
	Coding		Plug/socket
D		Socket	

### 7.1.5 Preparing the measuring device

1. Remove dummy plug if present.
2. **NOTICE**  
**Insufficient sealing of the housing!**  
 Operational reliability of the measuring device could be compromised.  
 ► Use suitable cable glands corresponding to the degree of protection.  
  
 If measuring device is delivered without cable glands:  
 Provide suitable cable gland for corresponding connecting cable .
3. If measuring device is delivered with cable glands:  
 Observe cable specification .

## 7.2 Connecting the measuring device

### **NOTICE**

#### **Limitation of electrical safety due to incorrect connection!**

- Have electrical connection work carried out by correspondingly trained specialists only.
- Observe applicable federal/national installation codes and regulations.
- Comply with local workplace safety regulations.
- For use in potentially explosive atmospheres, observe the information in the device-specific Ex documentation.

### 7.2.1 Connecting the transmitter

The connection of the transmitter depends on the following order codes:

- Housing version: compact or ultra-compact
- Connection version: device plug or terminals

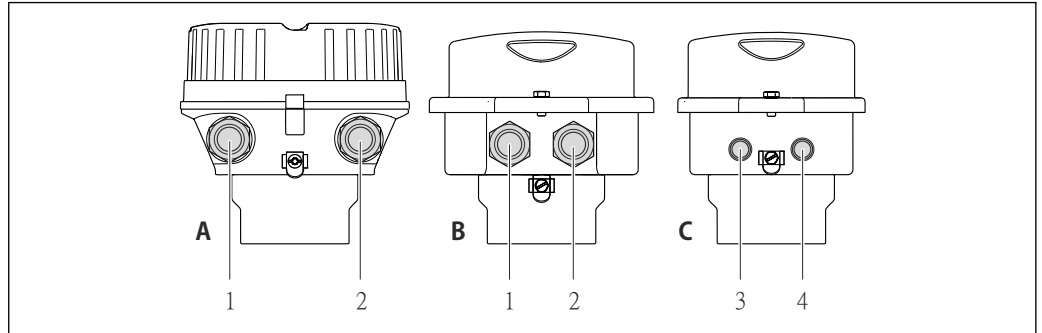

A0016924

9 Housing versions and connection versions

- A Housing version: compact, aluminum coated
- B Housing version: compact hygienic, stainless
- 1 Cable entry or device plug for signal transmission
- 2 Cable entry or device plug for supply voltage
- C Housing version: ultra-compact, hygienic, stainless:
- 3 Device plug for signal transmission
- 4 Device plug for supply voltage

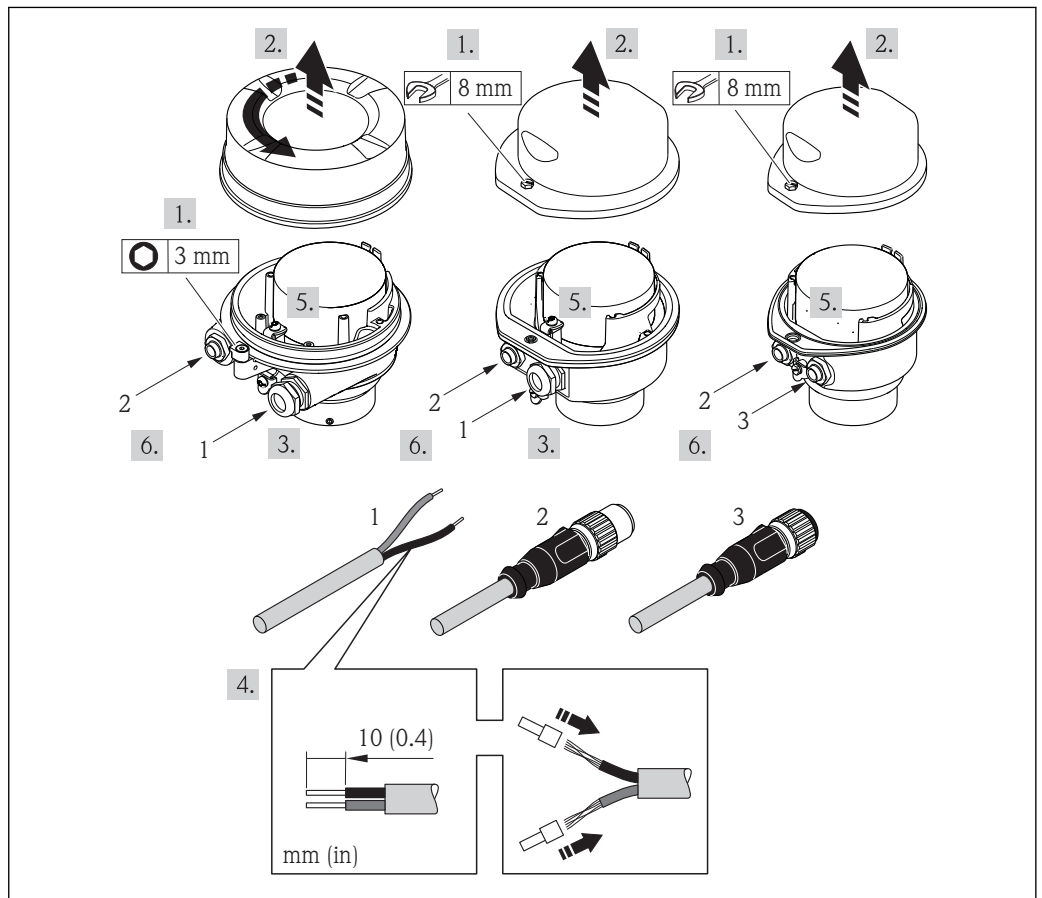

A0017844

10 Device versions with connection examples

- 1 Cable
- 2 Device plug for signal transmission
- 3 Device plug for supply voltage

For device version with device plug: follow step 6 only.

1. Depending on the housing version, loosen the securing clamp or fixing screw of the housing cover.
2. Push the cable through the cable entry . To ensure tight sealing, do not remove the sealing ring from the cable entry.
3. Strip the cable and cable ends. In the case of stranded cables, also fit ferrules.
4. Connect the cable in accordance with the terminal assignment or the device plug pin assignment .
5. Depending on the device version, tighten the cable glands or plug in the device plug and tighten .

6. **⚠ WARNING**

**Housing degree of protection may be voided due to insufficient sealing of the housing.**

- ▶ Screw in the screw without using any lubricant. The threads on the cover are coated with a dry lubricant.

Reverse the removal procedure to reassemble the transmitter.

## 7.2.2 Ensuring potential equalization

### Requirements

Please consider the following to ensure correct measurement:

- Same electrical potential for the fluid and sensor
- Company-internal grounding concepts

 For devices intended for use in hazardous locations, please observe the guidelines in the Ex documentation (XA).

## 7.3 Special connection instructions

### 7.3.1 Connection examples

#### PROFINET

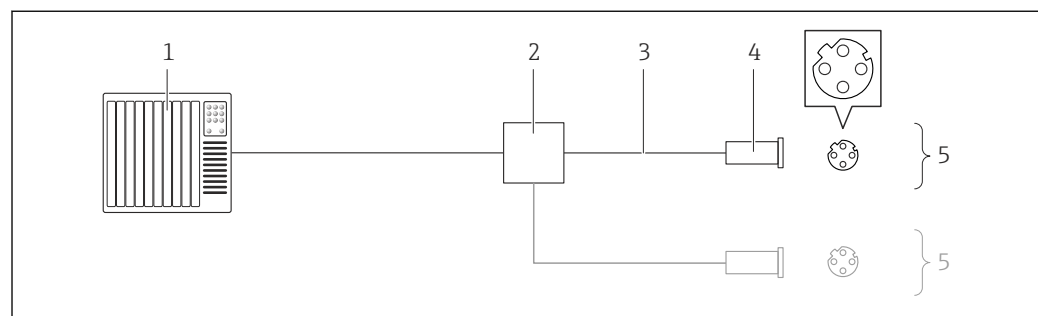

 11 Connecting cable for PROFINET

- 1 Control system (e.g. PLC)
- 2 Ethernet switch
- 3 Observe cable specifications
- 4 Connector
- 5 Transmitter



## 7.4 Hardware settings

### 7.4.1 Setting the device name

A measuring point can be quickly identified within a plant on the basis of the tag name. The tag name is equivalent to the device name (name of station of the PROFINET specification). The factory-assigned device name can be changed using the DIP switches or the automation system.

Example of device name (factory setting): eh-promass100-xxxxx

<b>eh</b>	Endress+Hauser
<b>promass</b>	Instrument family
<b>100</b>	Transmitter
<b>xxxxx</b>	Serial number of the device

The device name currently used is displayed in "Setup" menu → Name of station .

#### Setting the device name using the DIP switches

The last part of the device name can be set using DIP switches 1-8. The address range is between 1 and 254 (factory setting: serial number of the device →  14)

#### Overview of the DIP switches

DIP switches	Bit	Description
1	1	Configurable part of the device name
2	2	
3	4	
4	8	
5	16	
6	32	
7	64	
8	128	
9	–	Enable hardware write protection
10	–	Default IP address: use 192.168.1.212

Example: set the device name eh-promass100-065

DIP switches	ON/OFF	Bit
1	ON	1
2...6	OFF	–
7	ON	64
8	OFF	–

#### Setting the device name

Risk of electric shock when opening the transmitter housing.

- ▶ Disconnect the device from the power supply before opening the transmitter housing.

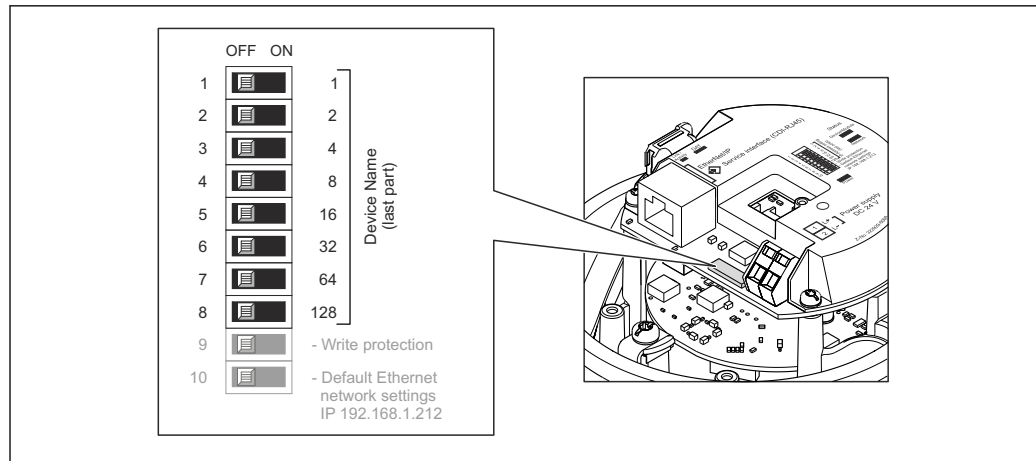

1. Depending on the housing version, loosen the securing clamp or fixing screw of the housing cover.
2. Depending on the housing version, unscrew or open the housing cover and disconnect the local display from the main electronics module where necessary → 135.
3. Set the desired device name using the corresponding DIP switches on the I/O electronics module.
4. Reverse the removal procedure to reassemble the transmitter.
5. Reconnect the device to the power supply. The configured device address is used once the device is restarted.

**i** If the device is reset via the PROFINET interface, it is not possible to reset the device name to the factory setting. The value 0 is used instead of the device name.

### Setting the device name via the automation system

DIP switches 1-8 must all be set to **OFF** (factory setting) or all be set to **ON** to be able to set the device name via the automation system.

The complete device name (name of station) can be changed individually via the automation system.

- i** The serial number used as part of the device name in the factory setting is not saved. It is not possible to reset the device name to the factory setting with the serial number. The value 0 is used instead of the serial number.
- When assigning the device name via the automation system, enter the device name in lower-case letters.

## 7.5 Ensuring the degree of protection

The measuring device fulfills all the requirements for the IP66/67 degree of protection, Type 4X enclosure.

To guarantee IP66/67 degree of protection, Type 4X enclosure, carry out the following steps after the electrical connection:

1. Check that the housing seals are clean and fitted correctly. Dry, clean or replace the seals if necessary.
2. Tighten all housing screws and screw covers.
3. Firmly tighten the cable glands.

- 4. To ensure that moisture does not enter the cable entry, route the cable so that it loops down before the cable entry ("water trap").

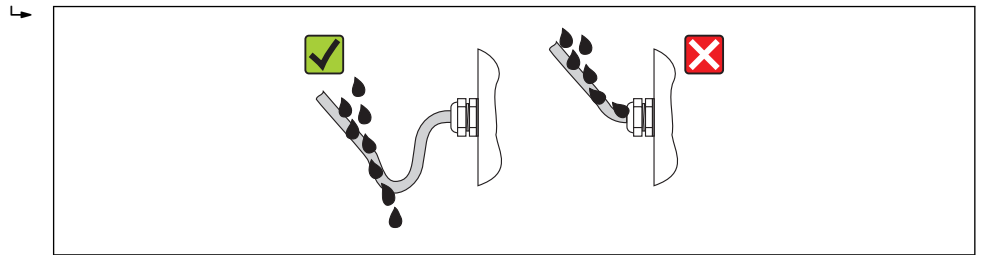

A0013960

- 5. Insert dummy plugs into unused cable entries.

### 7.6 Post-connection check

Are cables or the device undamaged (visual inspection)?	<input type="checkbox"/>
Do the cables comply with the requirements ?	<input type="checkbox"/>
Do the cables have adequate strain relief?	<input type="checkbox"/>
Are all the cable glands installed, firmly tightened and leak-tight? Cable run with "water trap" → 34 ?	<input type="checkbox"/>
Depending on the device version: are all the device plugs firmly tightened → 31?	<input type="checkbox"/>
Does the supply voltage match the specifications on the transmitter nameplate ?	<input type="checkbox"/>
Is the terminal assignment or the pin assignment of the device plug correct?	<input type="checkbox"/>
If supply voltage is present, is the power LED on the electronics module of the transmitter lit green ?	<input type="checkbox"/>
Depending on the device version, is the securing clamp or fixing screw firmly tightened?	<input type="checkbox"/>

## 8 Operation options

### 8.1 Overview of operating options

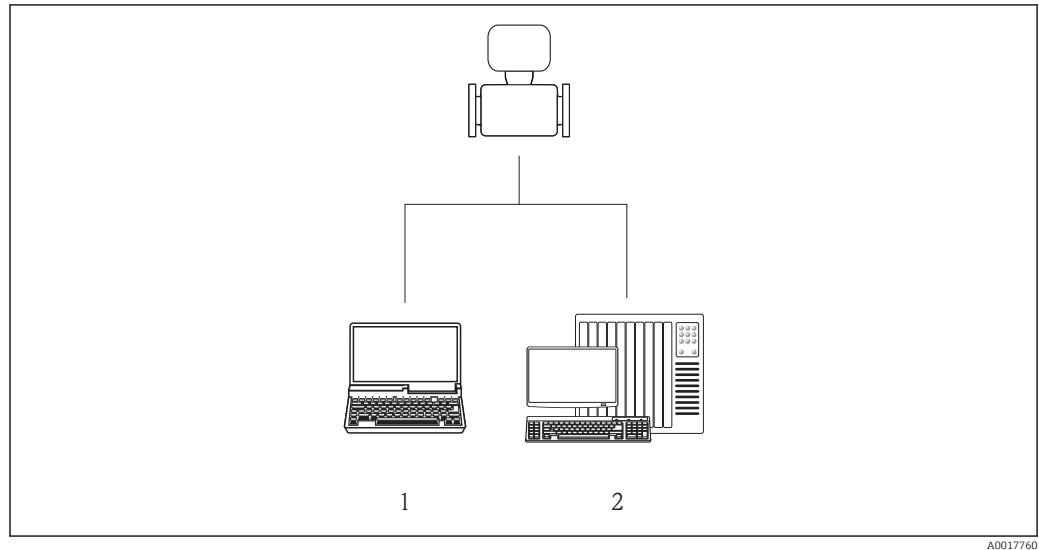

- 1 Computer with Web browser (e.g. Internet Explorer) or with "FieldCare" operating tool  
2 Automation system, e.g. Siemens S7-300 or S7-1500 with Step7 or TIA portal and latest GSD file.

A0017760

## 8.2 Structure and function of the operating menu

### 8.2.1 Structure of the operating menu

 For an overview of the operating menu with menus and parameters

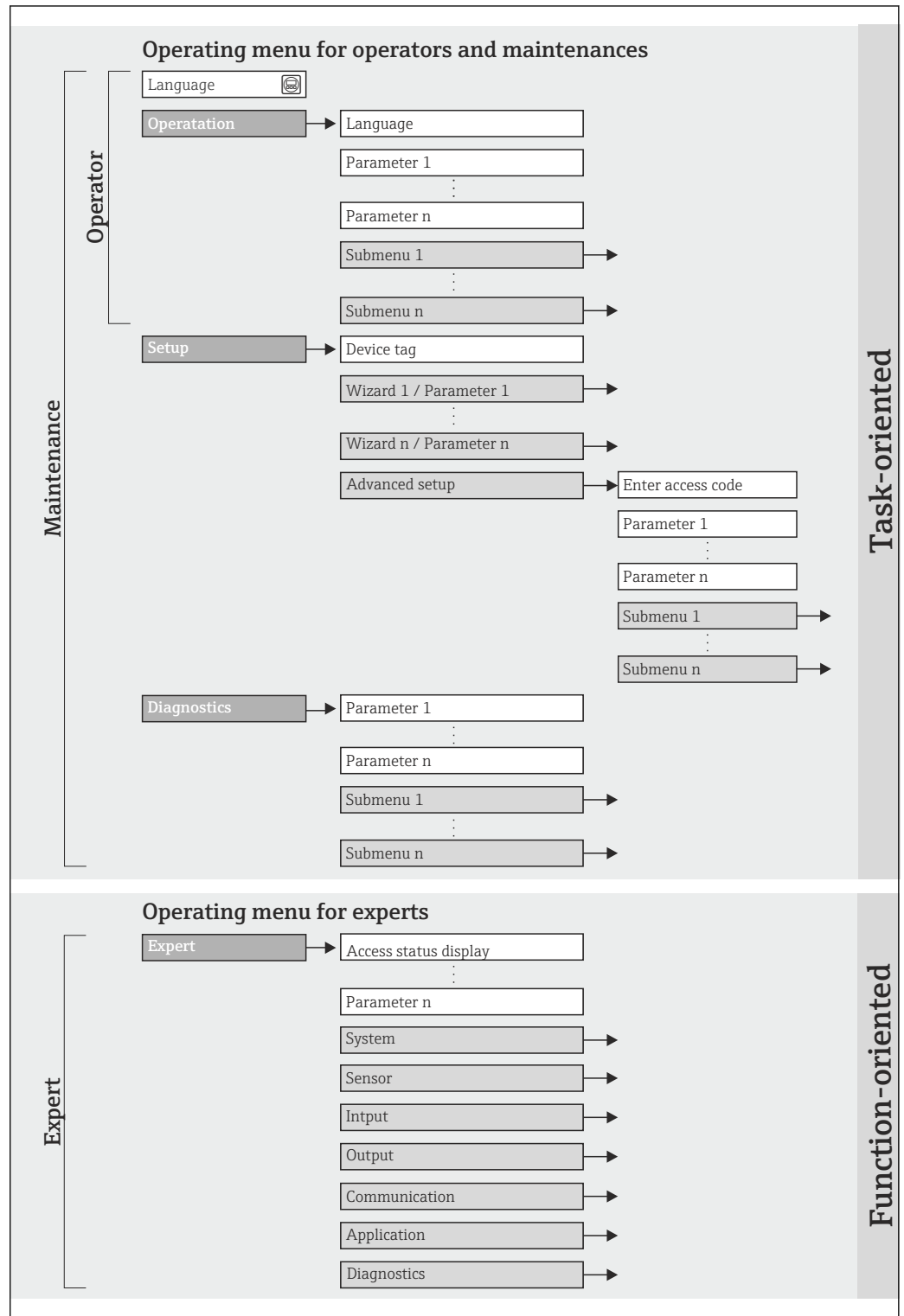

 12 Schematic structure of the operating menu

A0018237-EN

### 8.2.2 Operating philosophy

The individual parts of the operating menu are assigned to certain user roles (operator, maintenance etc.). Each user role contains typical tasks within the device lifecycle.

Menu/parameter		User role and tasks	Content/meaning
Language	task-oriented	<b>Role "Operator", "Maintenance"</b> Tasks during operation: <ul style="list-style-type: none"> <li>▪ Configuring the operational display</li> <li>▪ Reading measured values</li> </ul>	Defining the operating language
Operation			<ul style="list-style-type: none"> <li>▪ Configuring the operational display (e.g. display format, display contrast)</li> <li>▪ Resetting and controlling totalizers</li> </ul>
Setup		<b>"Maintenance" role</b> Commissioning: <ul style="list-style-type: none"> <li>▪ Configuration of the measurement</li> <li>▪ Configuration of the inputs and outputs</li> </ul>	Advanced setup <ul style="list-style-type: none"> <li>▪ For more customized configuration of the measurement (adaptation to special measuring conditions)</li> <li>▪ Configuration of totalizers</li> <li>▪ Administration (define access code, reset measuring device)</li> </ul>
Diagnostics		<b>"Maintenance" role</b> Fault elimination: <ul style="list-style-type: none"> <li>▪ Diagnostics and elimination of process and device errors</li> <li>▪ Measured value simulation</li> </ul>	Contains all parameters for error detection and analyzing process and device errors: <ul style="list-style-type: none"> <li>▪ Diagnostic list Contains up to 5 currently pending diagnostic messages.</li> <li>▪ Event logbook Contains up to 20 event messages that have occurred.</li> <li>▪ Device information Contains information for identifying the device.</li> <li>▪ Measured values Contains all current measured values.</li> <li>▪ Heartbeat The functionality of the device is checked on demand and the verification results are documented.</li> <li>▪ Simulation Is used to simulate measured values or output values.</li> </ul>
Expert	function-oriented	Tasks that require detailed knowledge of the function of the device: <ul style="list-style-type: none"> <li>▪ Commissioning measurements under difficult conditions</li> <li>▪ Optimal adaptation of the measurement to difficult conditions</li> <li>▪ Detailed configuration of the communication interface</li> <li>▪ Error diagnostics in difficult cases</li> </ul>	Contains all the parameters of the device and makes it possible to access these parameters directly using an access code. The structure of this menu is based on the function blocks of the device: <ul style="list-style-type: none"> <li>▪ System Contains all higher-order device parameters which do not concern the measurement or the communication interface.</li> <li>▪ Sensor Configuration of the measurement.</li> <li>▪ Application Configuration of the functions that go beyond the actual measurement (e.g. totalizer).</li> <li>▪ Diagnostics Error detection and analysis of process and device errors and for device simulation and Heartbeat Technology.</li> </ul>

## 8.3 Access to the operating menu via the Web browser

### 8.3.1 Function range

Thanks to the integrated Web server the device can be operated and configured via a Web browser. In addition to the measured values, status information on the device is also displayed and allows the user to monitor the status of the device. Furthermore the device data can be managed and the network parameters can be configured.



For additional information about the Web server, see Special Documentation SD01458D

### 8.3.2 Prerequisites



#### Computer hardware

Interface	The computer must have an RJ45 interface.
Connecting cable	Standard Ethernet cable with RJ45 connector.
Screen	Recommended size: ≥12" (depends on the screen resolution)  Web server operation is not optimized for touch screens!



#### Computer software

Recommended operating systems	Microsoft Windows 7 or higher.  Microsoft Windows XP is supported.
Web browsers supported	<ul style="list-style-type: none"> <li>▪ Microsoft Internet Explorer 8 or higher</li> <li>▪ Mozilla Firefox</li> <li>▪ Google Chrome</li> </ul>

#### Computer settings



User rights	User rights are required for TCP/IP and proxy server settings (for changes to the IP address, subnet mask etc.).
Proxy server settings of the Web browser	The Web browser setting <i>Use proxy server for LAN</i> must be <b>disabled</b> .
JavaScript	JavaScript must be enabled.  If JavaScript cannot be enabled: enter <code>http://XXX.XXX.X.XXX/basic.html</code> in the address line of the Web browser, e.g. <code>http://192.168.1.212/basic.html</code> . A fully functional but simplified version of the operating menu structure starts in the Web browser.  When installing a new firmware version: To enable correct data display, clear the temporary memory (cache) of the Web browser under <b>Internet options</b> .

#### Measuring device

Web server	Web server must be enabled; factory setting: ON  For information on enabling the Web server →  42
------------	--

### 8.3.3 Establishing a connection

#### Configuring the Internet protocol of the computer

1. Via DIP switch 10, enable the default IP address 192.168.1.212 →  33.
2. Switch on the measuring device and connect to the computer via the cable →  43.
3. Configure the properties of the Internet protocol (TCP/IP) as defined in the table:

IP address	192.168.1.212
Subnet mask	255.255.255.0
Default gateway	192.168.1.212 or leave cells empty

### Starting the Web browser

- ▶ Start the Web browser on the computer.

The login page appears.

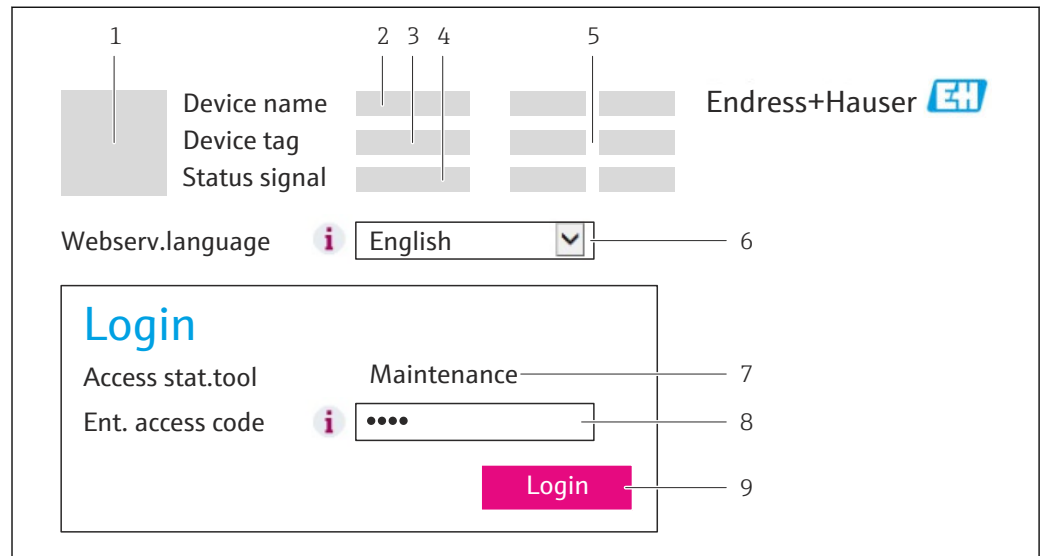

A0017362

- 1 Picture of device
- 2 Device name
- 3 Device tag
- 4 Status signal
- 5 Current measured values
- 6 Operating language
- 7 User role
- 8 Access code
- 9 Login

**i** If a login page does not appear, or if the page is incomplete → 78

### 8.3.4 Logging on

1. Select the preferred operating language for the Web browser.
2. Enter the access code.
3. Press **OK** to confirm your entry.

<b>Access code</b>	0000 (factory setting); can be changed by customer
--------------------	--

**i** If no action is performed for 10 minutes, the Web browser automatically returns to the login page.



### 8.3.5 User interface

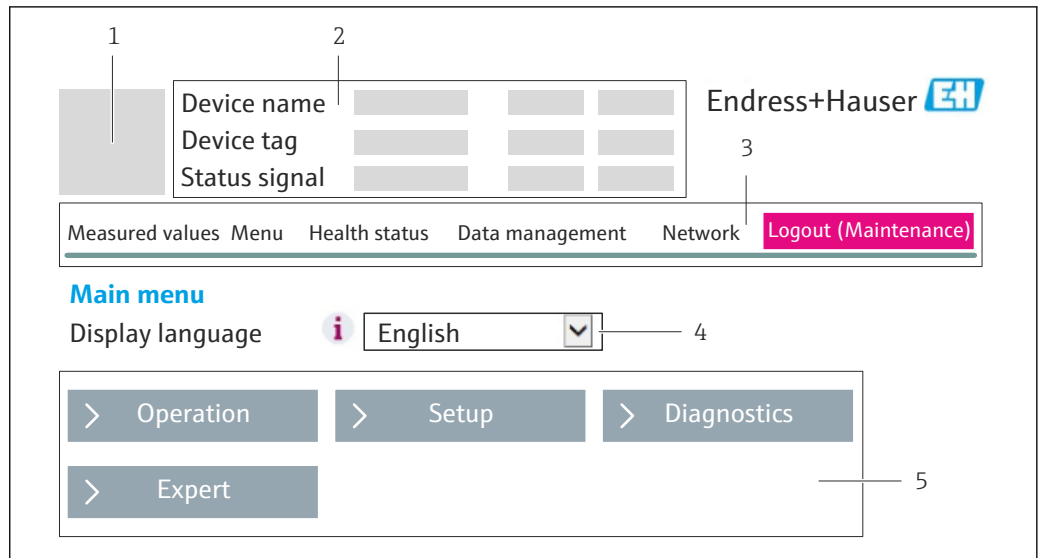

- 1 Picture of device
- 2 Header
- 3 Function row
- 4 Operating language
- 5 Navigation area

#### Header

The following information appears in the header:

- Device tag
- Device status with status signal → 81
- Current measured values

#### Function row

Functions	Meaning
Measured values	The measured values of the device are displayed
Menu	Access to the operating menu structure of the device, same as for the operating tool
Device status	Displays the diagnostic messages currently pending, listed in order of priority
Data management	Data exchange between PC and measuring device: <ul style="list-style-type: none"> <li>■ Upload the configuration from the device (XML format, create configuration back-up)</li> <li>■ Save the configuration to the device (XML format, restore configuration)</li> <li>■ Export the event list (.csv file)</li> <li>■ Export parameter settings (.csv file, create documentation of the measuring point configuration)</li> <li>■ Export the Heartbeat verification log (PDF file, only available with the "Heartbeat Verification" application package)</li> </ul>
Network configuration	Configuration and checking of all the parameters required for establishing the connection to the device: <ul style="list-style-type: none"> <li>■ Network settings (e.g. IP address, MAC address)</li> <li>■ Device information (e.g. serial number, firmware version)</li> </ul>
Logout	End the operation and call up the login page

### Working area

Depending on the selected function and the related submenus, various actions can be performed in this area:

- Configuring parameters
- Reading measured values
- Calling up help text
- Starting an upload/download

### Navigation area

If a function is selected in the function bar, the submenus of the function open in the navigation area. The user can now navigate through the menu structure.

## 8.3.6 Disabling the Web server

The Web server of the measuring device can be switched on and off as required using the **Web server functionality** parameter.

Possible selection:

- Off
  - The Web server is completely disabled.
  - Port 80 is blocked.
- HTML Off
  - The HTML version of the Web server is not available.
- On
  - The complete Web server functionality is available.
  - JavaScript is used.
  - The password is transmitted as an encrypted password.
  - Any change to the password is also transmitted in encrypted format.

### Navigation

"Expert" menu → Communication → Web server

### Parameter overview with brief description

Parameter	Description	Selection	Factory setting
Web server functionality	Switch the Web server on and off.	<ul style="list-style-type: none"> <li>■ Off</li> <li>■ HTML Off</li> <li>■ On</li> </ul>	On

### Enabling the Web server

If the Web server is disabled it can only be re-enabled with the **Web server functionality** parameter via the following operating options:

- Via the FieldCare operating tool
- Via the DeviceCare operating tool

## 8.3.7 Logging out

 Before logging out, perform a data backup via the **Data management** function (upload configuration from device) if necessary.

1. Select the **Logout** entry in the function row.
  - ↳ The home page with the Login box appears.
2. Close the Web browser.
3. Reset the modified properties of the Internet protocol (TCP/IP) if they are no longer needed →  39.

## 8.4 Access to the operating menu via the operating tool

### 8.4.1 Connecting the operating tool

#### Via PROFINET network

This communication interface is available in device versions with PROFINET.

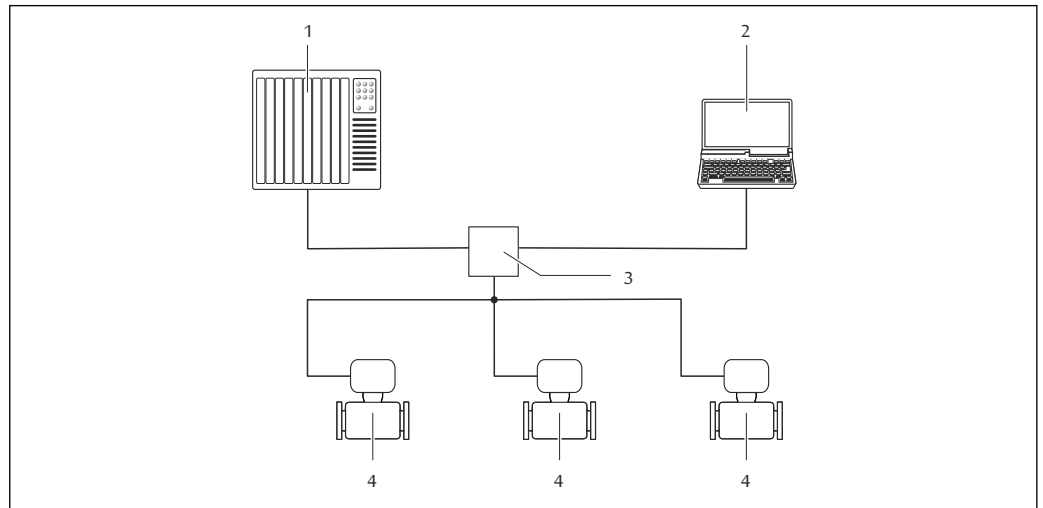

A0026545

13 Options for remote operation via PROFINET network

- 1 Automation system, e.g. Simatic S7 (Siemens)
- 2 Computer with Web browser (e.g. Internet Explorer) for accessing the integrated device Web server or with "FieldCare" operating tool with COM DTM "CDI Communication TCP/IP"
- 3 Switch, e.g. Scalance X204 (Siemens)
- 4 Measuring device

#### Via service interface (CDI-RJ45)

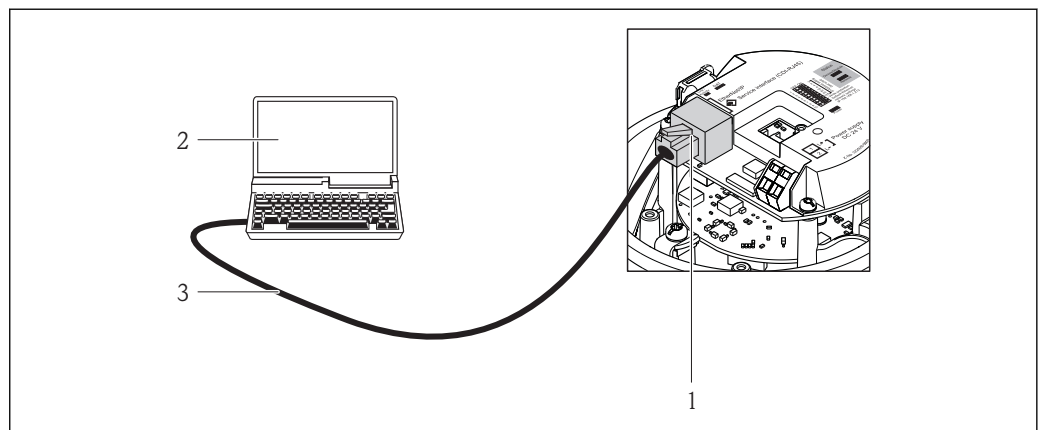

A0016940

14 Connection for order code for "Output", option R: PROFINET

- 1 Service interface (CDI -RJ45) and PROFINET interface of the measuring device with access to the integrated Web server
- 2 Computer with Web browser (e.g. Internet Explorer) for accessing the integrated device Web server or with "FieldCare" operating tool with COM DTM "CDI Communication TCP/IP"
- 3 Standard Ethernet connecting cable with RJ45 connector

## 8.4.2 FieldCare

### Function scope

FDT-based plant asset management tool from Endress+Hauser. It can configure all smart field devices in a system and helps you manage them. By using the status information, it is also a simple but effective way of checking their status and condition.

Access is via:

Service interface CDI-RJ45 →  43

Typical functions:

- Configuring parameters of transmitters
- Loading and saving device data (upload/download)
- Documentation of the measuring point
- Visualization of the measured value memory (line recorder) and event logbook



For additional information about FieldCare, see Operating Instructions BA00027S and BA00059S

### Source for device description files

See information →  46

### Establishing a connection

1. Start FieldCare and launch the project.
2. In the network: Add a device.
  - ↳ The **Add device** window opens.
3. Select the **CDI Communication TCP/IP** option from the list and press **OK** to confirm.
4. Right-click **CDI Communication TCP/IP** and select the **Add device** option in the context menu that opens.
5. Select the desired device from the list and press **OK** to confirm.
  - ↳ The **CDI Communication TCP/IP (Configuration)** window opens.
6. Enter the device address in the **IP address** field and press **Enter** to confirm: 192.168.1.212 (factory setting); if the IP address is not known .
7. Establish the online connection to the device.



For additional information, see Operating Instructions BA00027S and BA00059S

## User interface

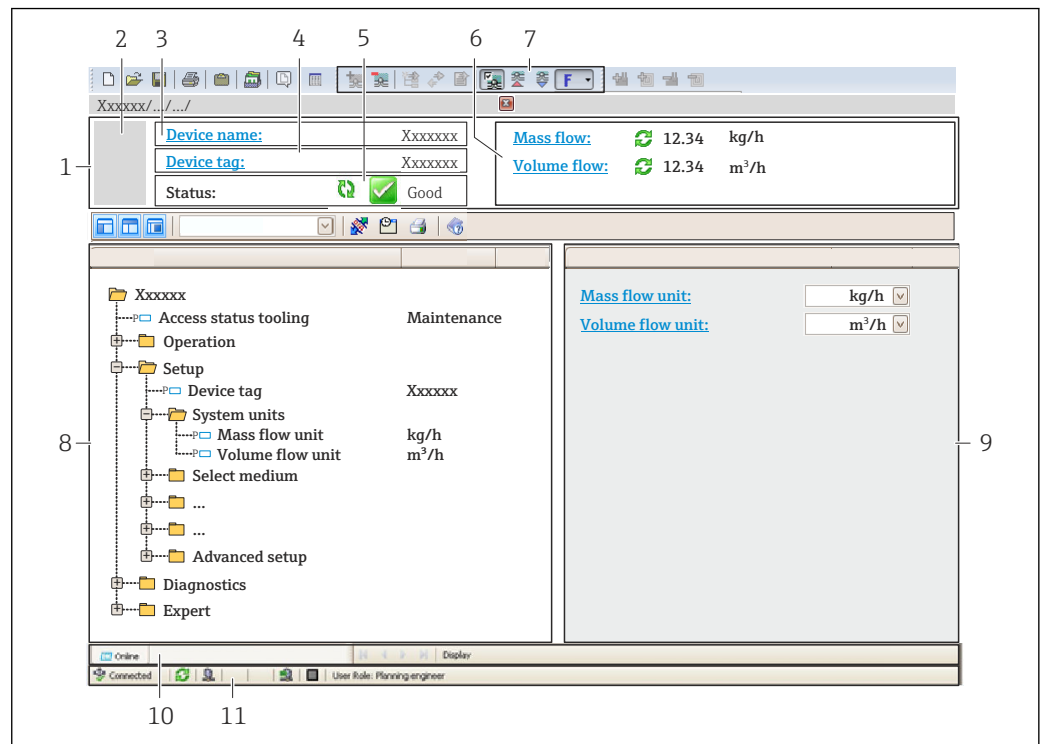

A0021051-EN

- 1 Header
- 2 Picture of device
- 3 Device name
- 4 Tag name
- 5 Status area with status signal → 81
- 6 Display area for current measured values
- 7 Edit toolbar with additional functions such as save/restore, event list and create documentation
- 8 Navigation area with operating menu structure
- 9 Working area
- 10 Range of action
- 11 Status area

### 8.4.3 DeviceCare

#### Function scope

Tool to connect and configure Endress+Hauser field devices.

The fastest way to configure Endress+Hauser field devices is with the dedicated "DeviceCare" tool. Together with the device type managers (DTMs) it presents a convenient, comprehensive solution.



For details, see Innovation Brochure IN01047S

#### Source for device description files

See information → 46

## 9 System integration

### 9.1 Overview of device description files

#### 9.1.1 Current version data for the device

Firmware version	01.00.zz	<ul style="list-style-type: none"> <li>▪ On the title page of the Operating instructions</li> <li>▪ On the transmitter nameplate →  14</li> <li>▪ Firmware version "Diagnostics" menu → Device information → Firmware version</li> </ul>
Release date of firmware version	12.2015	–
Manufacturer ID	0x11	Manufacturer ID "Diagnostics" menu → Device information → Manufacturer ID
Device ID	0x844A	Device ID "Expert" menu → Communication → PROFINET configuration → PROFINET information → Device ID
Device type ID	Promass 100	Device Type "Expert" menu → Communication → PROFINET configuration → PROFINET information → Device Type
Device revision	1	Device revision "Expert" menu → Communication → PROFINET configuration → PROFINET information → Device revision
PROFINET version	2.3.x	–

 For an overview of the different firmware versions for the device →  112

#### 9.1.2 Operating tools

The suitable device description file for the individual operating tools is listed in the table below, along with information on where the file can be acquired.

Operating tool via Service interface (CDI)	Sources for obtaining device descriptions
FieldCare	<ul style="list-style-type: none"> <li>▪ <a href="http://www.endress.com">www.endress.com</a> → Download Area</li> <li>▪ CD-ROM (contact Endress+Hauser)</li> <li>▪ DVD (contact Endress+Hauser)</li> </ul>
DeviceCare	<ul style="list-style-type: none"> <li>▪ <a href="http://www.endress.com">www.endress.com</a> → Download Area</li> <li>▪ CD-ROM (contact Endress+Hauser)</li> <li>▪ DVD (contact Endress+Hauser)</li> </ul>

## 9.2 Device master file (GSD)

In order to integrate field devices into a bus system, the PROFINET system needs a description of the device parameters, such as output data, input data, data format and data volume.

These data are available in the device master file (GSD) which is provided to the automation system when the communication system is commissioned. In addition device bit maps, which appear as icons in the network structure, can also be integrated.

The device master file (GSD) is in XML format, and the file is created in the GSDML description markup language.

### 9.2.1 File name of the device master file (GSD)

Example of the name of a device master file:







GSDML-V2.3.x-EH-PROMASS 100-yyyymmdd.xml

<b>GSDML</b>	Description language
<b>V2.3.x</b>	Version of the PROFINET specification
<b>EH</b>	Endress+Hauser
<b>Promass</b>	Instrument family
<b>100</b>	Transmitter
<b>yyyymmdd</b>	Date of issue (yyyy: year, mm: month, dd: day)
<b>.xml</b>	File name extension (XML file)

## 9.3 Cyclic data transmission

### 9.3.1 Overview of the modules

The following tables shows which modules are available to the measuring device for cyclic data exchange. Cyclic data exchange is performed with an automation system.

Measuring device		Slot	Direction Data flow	Control system
Module				
Analog Input module →  48		1 to 14	→	PROFINET
Digital Input module →  48		1 to 14	→	
Diagnose Input module →  49		1 to 14	→	
Analog Output module →  51		18, 19, 20	←	
Digital Output module →  52		21, 22	←	
Totalizer 1 to 3 →  49		15...17	← →	
Heartbeat Verification module →  52		23	← →	

### 9.3.2 Description of the modules

-  The data structure is described from the perspective of the automation system:
- Input data: Are sent from the measuring device to the automation system.
  - Output data: Are sent from the automation system to the measuring device.

## Analog Input module

Transmit input variables from the measuring device to the automation system.

Analog Input modules cyclically transmit the selected input variables, along with the status, from the measuring device to the automation system. The input variable is depicted in the first four bytes in the form of a floating point number as per the IEEE 754 standard. The fifth byte contains status information pertaining to the input variable.

*Selection: input variable*

Slot	Input variables
1...14	<ul style="list-style-type: none"> <li>▪ Mass flow</li> <li>▪ Volume flow</li> <li>▪ Corrected volume flow</li> <li>▪ Target mass flow <sup>1)</sup></li> <li>▪ Carrier mass flow <sup>1)</sup></li> <li>▪ Density</li> <li>▪ Reference density</li> <li>▪ Concentration <sup>1)</sup></li> <li>▪ Temperature</li> <li>▪ Carrier tube temperature <sup>2)</sup></li> <li>▪ Electronic temperature</li> <li>▪ Oscillation frequency</li> <li>▪ Oscillation amplitude</li> <li>▪ Frequency fluctuation</li> <li>▪ Oscillation damping</li> <li>▪ Tube damping fluctuation</li> <li>▪ Signal asymmetry</li> <li>▪ Exciter current</li> </ul>

1) Only available with the Concentration application package

2) Only available with the Heartbeat Verification application package

*Data structure*

*Input data of Analog Input*

Byte 1	Byte 2	Byte 3	Byte 4	Byte 5
Measured value: floating point number (IEEE 754)				Status <sup>1)</sup>

1) Status coding →  53

## Discrete Input module

Transmit discrete input values from the measuring device to the automation system.

Discrete input values are used by the measuring device to transmit the state of device functions to the automation system.

Discrete Input modules cyclically transmit discrete input values, along with the status, from the measuring device to the automation system. The discrete input value is depicted in the first byte. The second byte contains standardized status information pertaining to the input value.

*Selection: device function*

Slot	Device function	Status (meaning)
1...14	Empty pipe detection	<ul style="list-style-type: none"> <li>▪ 0 (device function not active)</li> <li>▪ 1 (device function active)</li> </ul>
	Low flow cut off	



*Data structure*

*Input data of Discrete Input*

Byte 1	Byte 2
Discrete Input	Status <sup>1)</sup>

1) Status coding →  53

**Diagnose Input module**



Transmit discrete input values (diagnostic information) from the measuring device to the automation system.

Diagnostic information is used by the measuring device to transmit the device status to the automation system.

Diagnose Input modules transmit discrete input values from the measuring device to the automation system. The first two bytes contain the information regarding the diagnostic information number (→  86). The third byte provides the status.

*Selection: device function*

Slot	Device function	Status (meaning)
1...14	Last diagnostics	Diagnostic information number (→  86) and status
	Current diagnosis	

 Information about pending diagnostic information →  107.

*Data structure*

*Input data of Diagnose Input*

Byte 1	Byte 2	Byte 3	Byte 4
Diagnostic information number		Status	Value 0

*Status*

Coding (hex)	Status
0x00	No device error is present.
0x01	Failure (F): A device error is present. The measured value is no longer valid.
0x02	Function check (C): The device is in service mode (e.g. during a simulation).
0x04	Maintenance required (M): Maintenance is required. The measured value is still valid.
0x08	Out of specification (S): The device is being operated outside its technical specification limits (e.g. process temperature range).

**Totalizer module**

The Totalizer module consists of the Totalizer Value, Totalizer Control and Totalizer Mode submodules.

*Totalizer Value submodule*

Transmit transmitter value from the device to the automation system.

Totalizer modules cyclically transmit a selected totalizer value, along with the status, from the measuring device to the automation system via the Totalizer Value submodule. The totalizer value is depicted in the first four bytes in the form of a floating point number as per the IEEE 754 standard. The fifth byte contains status information pertaining to the totalizer value.

*Selection: input variable*

Slot	Sub-slot	Input variable
15...17	1	<ul style="list-style-type: none"> <li>■ Mass flow</li> <li>■ Volume flow</li> <li>■ Corrected volume flow</li> <li>■ Target mass flow <sup>1)</sup></li> <li>■ Carrier mass flow <sup>1)</sup></li> </ul>

1) Only available with the Concentration application package

*Data structure of input data (Totalizer Value submodule)*

Byte 1	Byte 2	Byte 3	Byte 4	Byte 5
Measured value: floating point number (IEEE 754)				Status <sup>1)</sup>

1) Status coding →  53

*Totalizer Control submodule*

Control the totalizer via the automation system.

*Selection: control totalizer*

Slot	Sub-slot	Value	Control totalizer
15...17	2	0	Totalize
		1	Reset + hold
		2	Preset + hold
		3	Reset + totalize
		4	Preset + totalize
		5	Hold

*Data structure of output data (Totalizer Control submodule)*

Byte 1
Control variable

*Totalizer Mode submodule*

Configure the totalizer via the automation system.

*Selection: totalizer configuration*

Slot	Sub-slot	Value	Control totalizer
15...17	3	0	Balancing
		1	Balance the positive flow
		2	Balance the negative flow

*Data structure of output data (Totalizer Mode submodule)*

Byte 1
Configuration variable

**Analog Output module**

Transmit compensation values from the automation system to the measuring device.

Analog Output modules cyclically transmit compensation values, along with the status and the associated unit, from the automation system to the measuring device. The compensation value is depicted in the first four bytes in the form of a floating point number as per the IEEE 754 standard. The fifth byte contains standardized status information pertaining to the compensation value. The unit is transmitted in the sixth and seventh byte.

*Assigned compensation values*

 The configuration is performed via: "Expert" menu → Sensor → External compensation

Slot	Compensation value
18	External pressure
19	External temperature
20	External reference density

*Available units*

Pressure		Temperature		Density	
Unit code	Unit	Unit code	Unit	Unit code	Unit
1610	Pa a	1001	°C	32840	kg/Nm <sup>3</sup>
1616	kPa a	1002	°F	32841	kg/Nl
1614	MPa a	1000	K	32842	g/Scm <sub>3</sub>
1137	bar	1003	°R	32843	kg/Scm <sub>3</sub>
1611	Pa g			32844	lb/Sft <sub>3</sub>
1617	kPa g				
1615	MPa g				
32797	bar g				
1142	psi a				
1143	psi g				

*Data structure**Output data of Analog Output*

Byte 1	Byte 2	Byte 3	Byte 4	Byte 5	Byte 6	Byte 7
Measured value: floating point number (IEEE 754)				Status <sup>1)</sup>	Unit code	

1) Status coding → 53

*Failsafe mode*

A failsafe mode can be defined for using the compensation values.

If the status is GOOD or UNCERTAIN, the compensation values transmitted by the automation system are used. If the status is BAD, the failsafe mode is activated for the use of the compensation values.

Parameters are available per compensation value to define the failsafe mode: "Expert" menu → Sensor → External compensation

*Fail safe type parameter*

- Fail safe value option: The value defined in the Fail safe value parameter is used.
- Fallback value option: The last valid value is used.
- Off option: The failsafe mode is disabled.

*Fail safe value parameter*

Use this parameter to enter the compensation value which is used if the Fail safe value option is selected in the Fail safe type parameter.

**Digital Output module**

Transmit discrete output values from the automation system to the measuring device.

Discrete output values are used by the automation system to enable and disable device functions.

Digital Output modules cyclically transmit discrete output values, along with the status, from the automation system to the measuring device. The discrete output value is transmitted in the first byte. The second byte contains status information pertaining to the output value.

*Assigned device functions*

Slot	Device function	Status (meaning)
21	Flow override	<ul style="list-style-type: none"> <li>■ 0 (disable device function)</li> <li>■ 1 (enable device function)</li> </ul>
22	Zero point adjustment	

*Data structure**Output data of Discrete Output*

Byte 1	Byte 2
Discrete Output	Status <sup>1)</sup> <sup>2)</sup>

1) Status coding → 53

2) If the status is BAD, the control variable is not adopted.

**Heartbeat Verification module**

Receive discrete output values from the automation system and transmit discrete input values from the measuring device to the automation system.

The Heartbeat Verification module receives discrete output data from the automation system and transmits discrete input data from the measuring device to the automation system.

The discrete output value is provided by the automation system in order to start Heartbeat Verification. The discrete input value is depicted in the first byte. The second byte contains status information pertaining to the input value.

The discrete input value is used by the measuring device to transmit the status of the Heartbeat Verification device functions to the automation system. The module cyclically transmits the discrete input value, along with the status, to the automation system. The discrete input value is depicted in the first byte. The second byte contains status information pertaining to the input value.

 Only available with the Heartbeat Verification application package.

*Assigned device functions*

Slot	Device function	Bit	Verification status
23	Status verification (input data)	0	Verification has not been performed
		1	Verification has failed
		2	Currently performing verification
		3	Verification terminated
	Verification result (input data)	<b>Bit</b>	<b>Verification result</b>
		4	Verification has failed
		5	Verification performed successfully
		6	Verification has not been performed
	Start verification (output data)	7	-
		<b>Verification control</b>	
			A change in the status from 0 to 1 starts the verification

*Data structure*

*Output data of the Heartbeat Verification module*

Byte 1
Discrete Output

*Input data of the Heartbeat Verification module*

Byte 1	Byte 2
Discrete Input	Status <sup>1)</sup>

1) Status coding →  53

### 9.3.3 Status coding

Status	Coding (hex)	Meaning
BAD - Maintenance alarm	0x24	A measured value is not available because a device error has occurred.
BAD - Process related	0x28	A measured value is not available because the process conditions are not within the device's technical specification limits.

Status	Coding (hex)	Meaning
BAD - Function check	0x3C	A function check is active (e.g. cleaning or calibration)
UNCERTAIN - Initial value	0x4F	A pre-defined value is output until a correct measured value is available again or until remedial measures have been carried out that change this status.
UNCERTAIN - Maintenance demanded	0x68	Signs of wear and tear have been detected on the measuring device. Short-term maintenance is needed to ensure that the measuring device remains operational. The measured value might be invalid. The use of the measured value depends on the application.
UNCERTAIN - Process related	0x78	The process conditions are not within the device's technical specification limits. This could have a negative impact on the quality and accuracy of the measured value. The use of the measured value depends on the application.
GOOD - OK	0x80	No error has been diagnosed.
GOOD - Maintenance demanded	0xA8	The measured value is valid. It is highly advisable to service the device in the near future.
GOOD - Function check	0xBC	The measured value is valid. The measuring device is performing an internal function check. The function check does not have any noticeable effect on the process.

### 9.3.4 Factory setting

The slots are already assigned in the automation system for initial commissioning.



#### Assigned slots

Slot	Factory setting
1	Mass flow
2	Volume flow
3	Corrected volume flow
4	Density
5	Reference density
6	Temperature
7...12	-
15	Totalizer 1
16	Totalizer 2
17	Totalizer 3

## 10 Commissioning

### 10.1 Function check

Before commissioning the measuring device:



- ▶ Make sure that the post-installation and post-connection checks have been performed.
- "Post-installation check" checklist →  26
- "Post-connection check" checklist →  35

### 10.2 Identifying the device in the PROFINET network



A device can be quickly identified within a plant using the PROFINET flash function. If the PROFINET flash function is activated in the automation system, the LED indicating the network status flashes →  80 and the red backlight of the onsite display is switched on.

### 10.3 Startup parameterization

By activating the startup parameterization function (NSU: Normal Startup Unit), the configuration of the most important measuring device parameters is taken from the automation system.

 Configurations taken from the automation system →  124.

### 10.4 Establishing a connection via FieldCare

- For FieldCare connection →  43
- For establishing a connection via FieldCare →  44
- For FieldCare user interface →  45

### 10.5 Setting the operating language

Factory setting: English or ordered local language

The operating language can be set in FieldCare, DeviceCare or via the Web server:  
"Operation" menu → Display language

### 10.6 Configuring the measuring device

The **Setup** menu with its submenus contains all the parameters needed for standard operation.

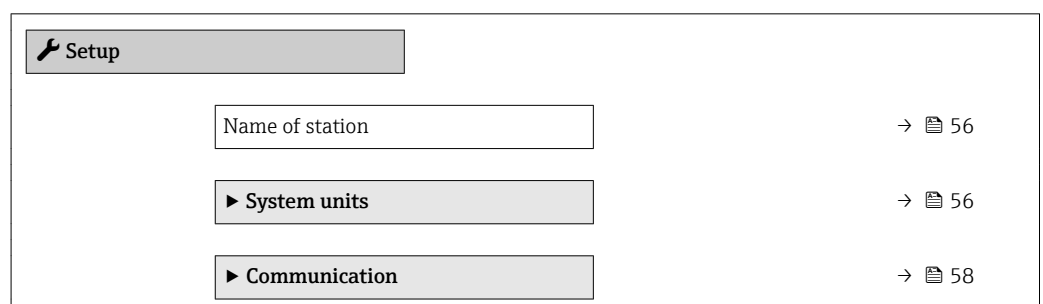

▶ Medium selection	→ 59
▶ Low flow cut off	→ 61
▶ Partially filled pipe detection	→ 62
▶ Advanced setup	→ 63

### 10.6.1 Defining the tag name

A measuring point can be quickly identified within a plant on the basis of the tag name. The tag name is equivalent to the device name (name of station) of the PROFINET specification (data length: 255 bytes)

The device name can be changed via DIP switches or the automation system → 33.

The device name currently used is displayed in the **Name of station** parameter.

#### Navigation

"Setup" menu → Name of station

#### Parameter overview with brief description

Parameter	Description	User interface	Factory setting
Name of station	Name of the measuring point.	Max. 32 characters such as letters and numbers.	EH-PROMASS100 serial number of the device

### 10.6.2 Setting the system units

In the **System units** submenu the units of all the measured values can be set.

 Depending on the device version, not all submenus and parameters are available in every device. The selection can vary depending on the order code.

#### Navigation

"Setup" menu → Advanced setup → System units → Mass flow unit

▶ System units
Mass flow unit
Mass unit
Volume flow unit
Volume unit
Corrected volume flow unit
Corrected volume unit
Density unit



<div style="border: 1px solid black; width: 200px; margin: 0 auto; padding: 2px;">Reference density unit</div> <div style="border: 1px solid black; width: 200px; margin: 10px auto; padding: 2px;">Temperature unit</div> <div style="border: 1px solid black; width: 200px; margin: 10px auto; padding: 2px;">Pressure unit</div>
---

**Parameter overview with brief description**

Parameter	Description	Selection	Factory setting
Mass flow unit	Select mass flow unit. <i>Result</i> The selected unit applies for: <ul style="list-style-type: none"> <li>▪ Output</li> <li>▪ Low flow cut off</li> <li>▪ Simulation process variable</li> </ul>	Unit choose list	Country-specific: <ul style="list-style-type: none"> <li>▪ kg/h</li> <li>▪ lb/min</li> </ul>
Mass unit	Select mass unit.	Unit choose list	Country-specific: <ul style="list-style-type: none"> <li>▪ kg</li> <li>▪ lb</li> </ul>
Volume flow unit	Select volume flow unit. <i>Result</i> The selected unit applies for: <ul style="list-style-type: none"> <li>▪ Output</li> <li>▪ Low flow cut off</li> <li>▪ Simulation process variable</li> </ul>	Unit choose list	Country-specific: <ul style="list-style-type: none"> <li>▪ l/h</li> <li>▪ gal/min (us)</li> </ul>
Volume unit	Select volume unit.	Unit choose list	Country-specific: <ul style="list-style-type: none"> <li>▪ l</li> <li>▪ gal (us)</li> </ul>
Corrected volume flow unit	Select corrected volume flow unit. <i>Result</i> The selected unit applies for: Corrected volume flow	Unit choose list	Country-specific: <ul style="list-style-type: none"> <li>▪ NI/h</li> <li>▪ Sft<sup>3</sup>/min</li> </ul>
Corrected volume unit	Select corrected volume unit.	Unit choose list	Country-specific: <ul style="list-style-type: none"> <li>▪ NI</li> <li>▪ Sft<sup>3</sup></li> </ul>
Density unit	Select density unit. <i>Result</i> The selected unit applies for: <ul style="list-style-type: none"> <li>▪ Output</li> <li>▪ Simulation process variable</li> <li>▪ Density adjustment (<b>Expert</b> menu)</li> </ul>	Unit choose list	Country-specific: <ul style="list-style-type: none"> <li>▪ kg/l</li> <li>▪ lb/ft<sup>3</sup></li> </ul>
Reference density unit	Select reference density unit.	Unit choose list	Country-dependent <ul style="list-style-type: none"> <li>▪ kg/NI</li> <li>▪ lb/Sft<sup>3</sup></li> </ul>

Parameter	Description	Selection	Factory setting
Temperature unit	Select temperature unit. <i>Result</i> The selected unit applies for: <ul style="list-style-type: none"> <li>▪ Maximum value</li> <li>▪ Minimum value</li> <li>▪ Maximum value</li> <li>▪ Minimum value</li> <li>▪ Maximum value</li> <li>▪ Minimum value</li> <li>▪ External temperature</li> <li>▪ Reference temperature</li> <li>▪ Temperature</li> </ul>	Unit choose list	Country-specific: <ul style="list-style-type: none"> <li>▪ °C</li> <li>▪ °F</li> </ul>
Pressure unit	Select process pressure unit. <i>Result</i> The unit is taken from: <ul style="list-style-type: none"> <li>▪ Pressure value</li> <li>▪ External pressure</li> <li>▪ Pressure value</li> </ul>	Unit choose list	Country-specific: <ul style="list-style-type: none"> <li>▪ bar a</li> <li>▪ psi a</li> </ul>

### 10.6.3 Displaying the communication interface

The **Communication** submenu shows all the current parameter settings for selecting and configuring the communication interface.

#### Navigation

"Setup" menu → Communication

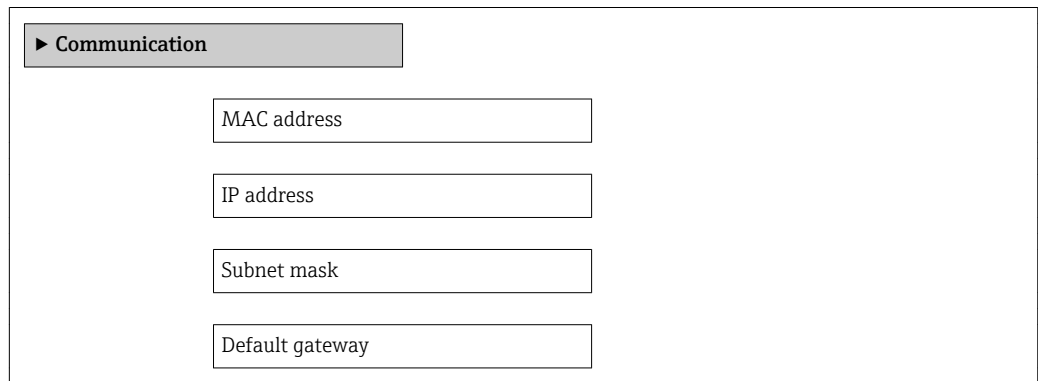

#### Parameter overview with brief description

Parameter	Description	User interface	Factory setting
MAC address	Displays the MAC address of the measuring device.  MAC = Media Access Control	Unique 12-digit character string comprising letters and numbers, e.g.: 00:07:05:10:01:5F	Each measuring device is given an individual address.
IP address	Displays the IP address of the Web server of the measuring device.	4 octet: 0 to 255 (in the particular octet)	0.0.0.0
Subnet mask	Displays the subnet mask.	4 octet: 0 to 255 (in the particular octet)	0.0.0.0
Default gateway	Displays the default gateway.	4 octet: 0 to 255 (in the particular octet)	0.0.0.0

### 10.6.4 Selecting and setting the medium

The **Medium selection** submenu contains parameters that have to be configured for selecting and setting the medium.

#### Navigation

"Setup" menu → Medium selection

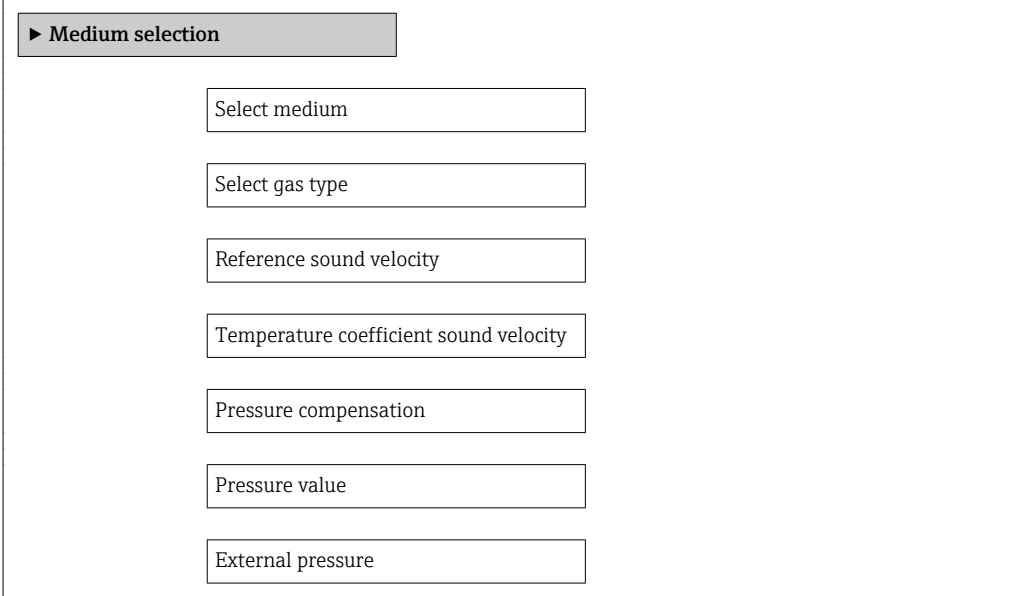

The image shows a screenshot of a software interface for the 'Medium selection' submenu. At the top left, there is a grey header bar with a right-pointing triangle and the text 'Medium selection'. Below this header, there are seven rectangular input fields, each containing a parameter name. The parameters are listed vertically from top to bottom: 'Select medium', 'Select gas type', 'Reference sound velocity', 'Temperature coefficient sound velocity', 'Pressure compensation', 'Pressure value', and 'External pressure'.

## Parameter overview with brief description

Parameter	Prerequisite	Description	Selection / User entry	Factory setting
Select medium	–	Select medium type.	<ul style="list-style-type: none"> <li>▪ Liquid</li> <li>▪ Gas</li> </ul>	Liquid
Select gas type	The <b>Gas</b> option is selected in the <b>Select medium</b> parameter.	Select measured gas type.	<ul style="list-style-type: none"> <li>▪ Air</li> <li>▪ Ammonia NH<sub>3</sub></li> <li>▪ Argon Ar</li> <li>▪ Sulfur hexafluoride SF<sub>6</sub></li> <li>▪ Oxygen O<sub>2</sub></li> <li>▪ Ozone O<sub>3</sub></li> <li>▪ Nitrogen oxide NO<sub>x</sub></li> <li>▪ Nitrogen N<sub>2</sub></li> <li>▪ Nitrous oxide N<sub>2</sub>O</li> <li>▪ Methane CH<sub>4</sub></li> <li>▪ Hydrogen H<sub>2</sub></li> <li>▪ Helium He</li> <li>▪ Hydrogen chloride HCl</li> <li>▪ Hydrogen sulfide H<sub>2</sub>S</li> <li>▪ Ethylene C<sub>2</sub>H<sub>4</sub></li> <li>▪ Carbon dioxide CO<sub>2</sub></li> <li>▪ Carbon monoxide CO</li> <li>▪ Chlorine Cl<sub>2</sub></li> <li>▪ Butane C<sub>4</sub>H<sub>10</sub></li> <li>▪ Propane C<sub>3</sub>H<sub>8</sub></li> <li>▪ Propylene C<sub>3</sub>H<sub>6</sub></li> <li>▪ Ethane C<sub>2</sub>H<sub>6</sub></li> <li>▪ Others</li> </ul>	Methane CH <sub>4</sub>
Reference sound velocity	The <b>Others</b> option is selected in the <b>Select gas type</b> parameter.	Enter sound velocity of gas at 0 °C (32 °F).	1 to 99 999.9999 m/s	0 m/s
Temperature coefficient sound velocity	The <b>Others</b> option is selected in the <b>Select gas type</b> parameter.	Enter temperature coefficient for the gas sound velocity.	Positive floating-point number	0 (m/s)/K
Pressure compensation	The <b>Gas</b> option is selected in the <b>Select medium</b> parameter.	Select pressure compensation type.	<ul style="list-style-type: none"> <li>▪ Off</li> <li>▪ Fixed value</li> <li>▪ External value</li> </ul>	Off
Pressure value	The <b>Fixed value</b> option is selected in the <b>Pressure compensation</b> parameter.	Enter process pressure to be used for pressure correction.	Positive floating-point number	0 bar
External pressure	The <b>External value</b> option is selected in the <b>Pressure compensation</b> parameter.	Shows the external, fixed process pressure value.	Positive floating-point number	0 bar

### 10.6.5 Configuring the low flow cut off

The **Low flow cut off** submenu contains parameters that must be configured for the configuration of low flow cut off.

#### Navigation

"Setup" menu → Low flow cut off

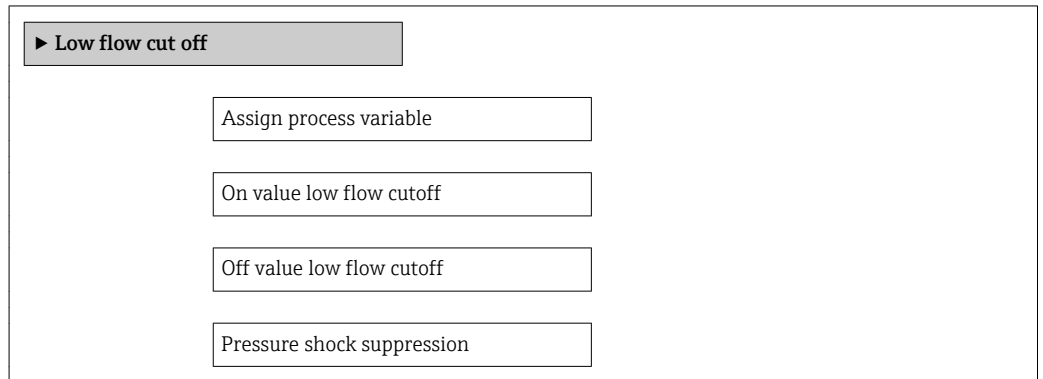

#### Parameter overview with brief description

Parameter	Prerequisite	Description	Selection / User entry	Factory setting
Assign process variable	–	Select process variable for low flow cut off.	<ul style="list-style-type: none"> <li>■ Off</li> <li>■ Mass flow</li> <li>■ Volume flow</li> <li>■ Corrected volume flow</li> </ul>	Mass flow
On value low flow cutoff	One of the following options is selected in the <b>Assign process variable</b> parameter (→ 61): <ul style="list-style-type: none"> <li>■ Mass flow</li> <li>■ Volume flow</li> <li>■ Corrected volume flow</li> </ul>	Enter on value for low flow cut off.	Positive floating-point number	Depends on country and nominal diameter
Off value low flow cutoff	One of the following options is selected in the <b>Assign process variable</b> parameter (→ 61): <ul style="list-style-type: none"> <li>■ Mass flow</li> <li>■ Volume flow</li> <li>■ Corrected volume flow</li> </ul>	Enter off value for low flow cut off.	0 to 100.0 %	50 %
Pressure shock suppression	One of the following options is selected in the <b>Assign process variable</b> parameter (→ 61): <ul style="list-style-type: none"> <li>■ Mass flow</li> <li>■ Volume flow</li> <li>■ Corrected volume flow</li> </ul>	Enter time frame for signal suppression (= active pressure shock suppression).	0 to 100 s	0 s

### 10.6.6 Configuring the partial filled pipe detection

The **Partially filled pipe detection** submenu contains parameters that have to be set for configuring empty pipe detection.

#### Navigation

"Setup" menu → Partially filled pipe detection

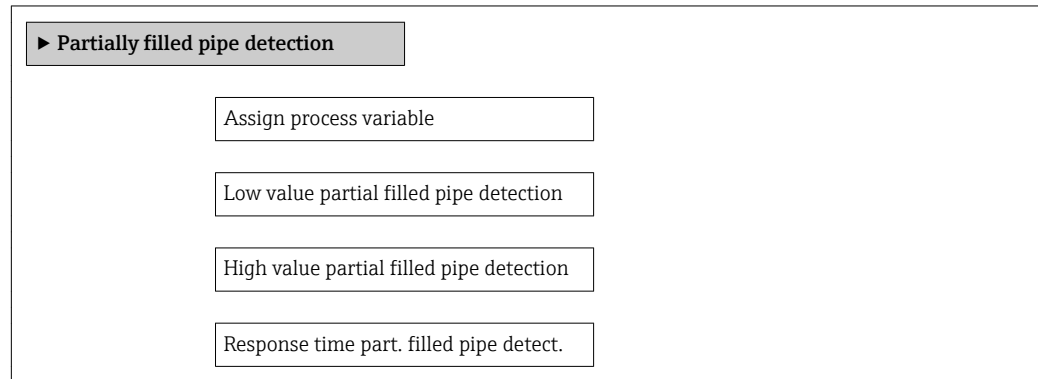

#### Parameter overview with brief description

Parameter	Prerequisite	Description	Selection / User entry	Factory setting
Assign process variable	–	Select process variable for partially filled pipe detection.	<ul style="list-style-type: none"> <li>▪ Off</li> <li>▪ Density</li> <li>▪ Reference density</li> </ul>	Off
Low value partial filled pipe detection	One of the following options is selected in the <b>Assign process variable</b> parameter: <ul style="list-style-type: none"> <li>▪ Density</li> <li>▪ Reference density</li> </ul>	Enter lower limit value for deactivating partially filled pipe detection.	Signed floating-point number	200
High value partial filled pipe detection	One of the following options is selected in the <b>Assign process variable</b> parameter: <ul style="list-style-type: none"> <li>▪ Density</li> <li>▪ Reference density</li> </ul>	Enter upper limit value for deactivating partially filled pipe detection.	Signed floating-point number	6 000
Response time part. filled pipe detect.	One of the following options is selected in the <b>Assign process variable</b> parameter: <ul style="list-style-type: none"> <li>▪ Density</li> <li>▪ Reference density</li> </ul>	Enter time before diagnostic message is displayed for partially filled pipe detection.	0 to 100 s	1 s

## 10.7 Advanced settings

The **Advanced setup** submenu together with its submenus contains parameters for specific settings.

 The number of submenus can vary depending on the device version, e.g. viscosity is available only with the Promass I.

### Navigation

"Setup" menu → Advanced setup

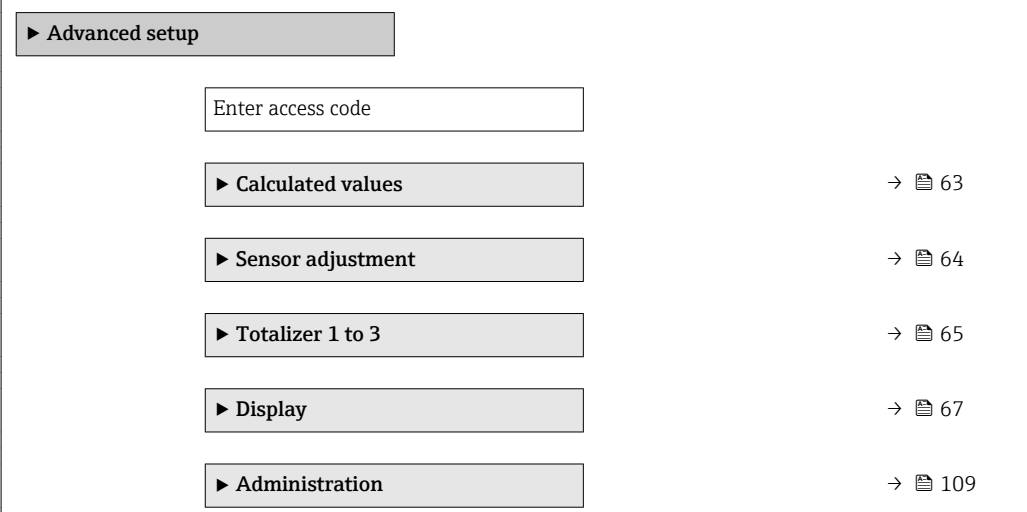

► **Advanced setup**

Enter access code

► **Calculated values** → 63

► **Sensor adjustment** → 64

► **Totalizer 1 to 3** → 65

► **Display** → 67

► **Administration** → 109

### 10.7.1 Calculated values

The **Calculated values** submenu contains parameters for calculating the corrected volume flow.

### Navigation

"Setup" menu → Advanced setup → Calculated values

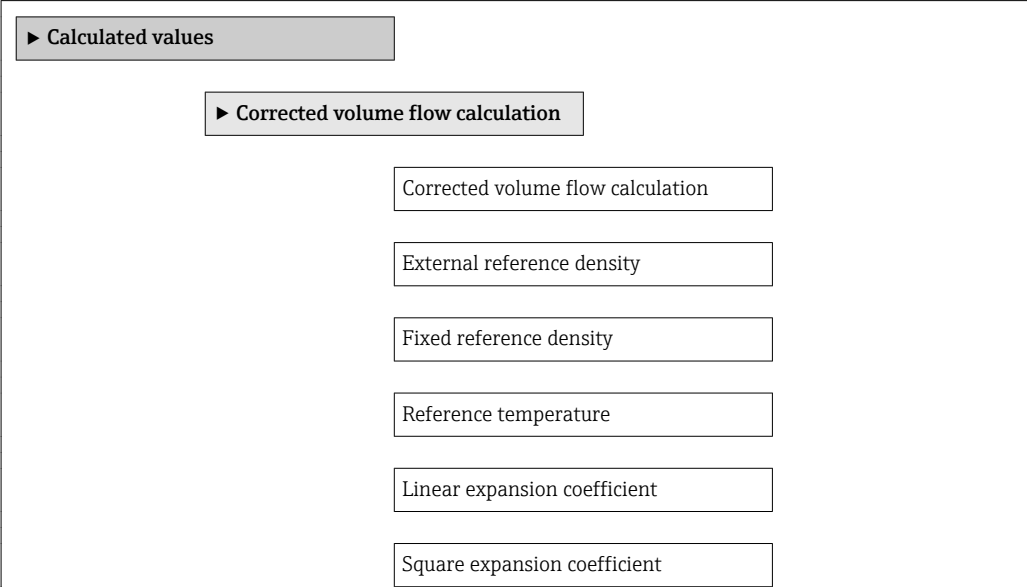

► **Calculated values**

► **Corrected volume flow calculation**

Corrected volume flow calculation

External reference density

Fixed reference density

Reference temperature

Linear expansion coefficient

Square expansion coefficient

## Parameter overview with brief description

Parameter	Prerequisite	Description	Selection / User entry	Factory setting
Corrected volume flow calculation	–	Select reference density for calculating the corrected volume flow.	<ul style="list-style-type: none"> <li>■ Fixed reference density</li> <li>■ Calculated reference density</li> <li>■ Reference density by API table 53</li> <li>■ External reference density</li> </ul>	Calculated reference density
External reference density	–	Shows external reference density.	Floating point number with sign	0 kg/Nl
Fixed reference density	In the <b>Corrected volume flow calculation</b> parameter the <b>Fixed reference density</b> option is selected.	Enter fixed value for reference density.	Positive floating-point number	1 kg/Nl
Reference temperature	In the <b>Corrected volume flow calculation</b> parameter the <b>Calculated reference density</b> option is selected.	Enter reference temperature for calculating the reference density.	–273.15 to 99 999 °C	Country-specific: <ul style="list-style-type: none"> <li>■ +20 °C</li> <li>■ +68 °F</li> </ul>
Linear expansion coefficient	In the <b>Corrected volume flow calculation</b> parameter the <b>Calculated reference density</b> option is selected.	Enter linear, medium-specific expansion coefficient for calculating the reference density.	Signed floating-point number	0.0
Square expansion coefficient	–	For media with a non-linear expansion pattern: enter the quadratic, medium-specific expansion coefficient for calculating the reference density.	Signed floating-point number	0.0

## 10.7.2 Carrying out a sensor adjustment

The **Sensor adjustment** submenu contains parameters that pertain to the functionality of the sensor.

## Navigation

"Setup" menu → Advanced setup → Sensor adjustment

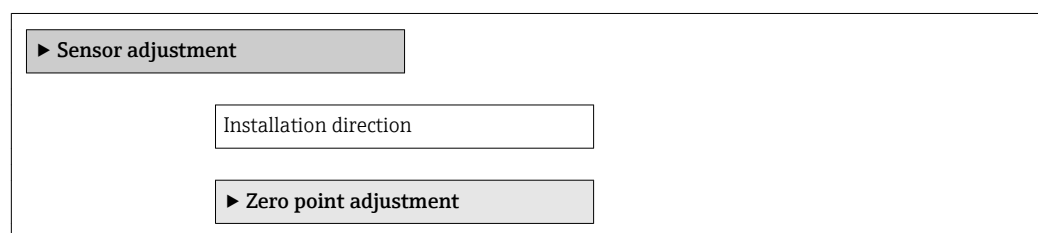

## Parameter overview with brief description

Parameter	Description	Selection	Factory setting
Installation direction	Set sign of flow direction to match the direction of the arrow on the sensor.	<ul style="list-style-type: none"> <li>■ Flow in arrow direction</li> <li>■ Flow against arrow direction</li> </ul>	Flow in arrow direction



### Zero point adjustment

All measuring devices are calibrated in accordance with state-of-the-art technology. Calibration takes place under reference conditions →  125. Therefore, a zero point adjustment in the field is generally not required.

Experience shows that zero point adjustment is advisable only in special cases:

- To achieve maximum measuring accuracy even with low flow rates
- Under extreme process or operating conditions (e.g. very high process temperatures or very high-viscosity fluids).

### Navigation

"Setup" menu → Advanced setup → Sensor adjustment → Zero point adjustment

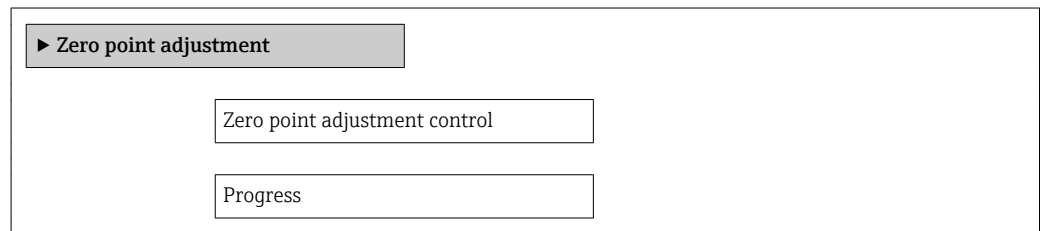

### Parameter overview with brief description

Parameter	Description	Selection / User interface	Factory setting
Zero point adjustment control	Start zero point adjustment.	<ul style="list-style-type: none"> <li>▪ Cancel</li> <li>▪ Busy</li> <li>▪ Zero point adjust failure</li> <li>▪ Start</li> </ul>	Cancel
Progress	Shows the progress of the process.	0 to 100 %	-

## 10.7.3 Configuring the totalizer

In the "Totalizer 1 to 3" submenu the individual totalizer can be configured.

### Navigation

"Setup" menu → Advanced setup → Totalizer 1 to 3

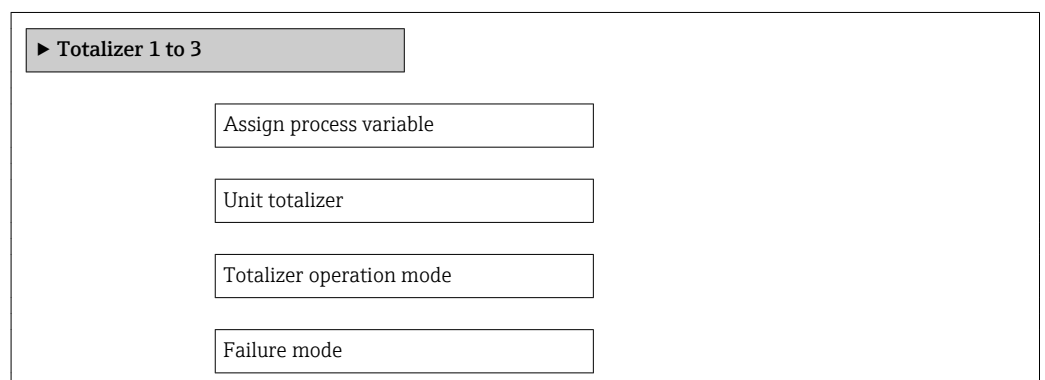

## Parameter overview with brief description

Parameter	Prerequisite	Description	Selection	Factory setting
Assign process variable	–	Select process variable for totalizer.	<ul style="list-style-type: none"> <li>■ Volume flow</li> <li>■ Mass flow</li> <li>■ Corrected volume flow</li> <li>■ Total mass flow</li> <li>■ Condensate mass flow</li> <li>■ Energy flow</li> <li>■ Heat flow difference</li> </ul>	Volume flow
Unit totalizer	One of the following options is selected in the <b>Assign process variable</b> parameter: <ul style="list-style-type: none"> <li>■ Mass flow</li> <li>■ Volume flow</li> <li>■ Corrected volume flow</li> <li>■ Target mass flow *</li> <li>■ Carrier mass flow *</li> </ul>	Select the unit for the process variable of the totalizer.	Unit choose list	Country-specific: <ul style="list-style-type: none"> <li>■ kg</li> <li>■ lb</li> </ul>
Totalizer operation mode	In the <b>Assign process variable</b> parameter, one of the following options is selected: <ul style="list-style-type: none"> <li>■ Mass flow</li> <li>■ Volume flow</li> <li>■ Corrected volume flow</li> <li>■ Target mass flow *</li> <li>■ Carrier mass flow *</li> </ul>	Select totalizer calculation mode.	<ul style="list-style-type: none"> <li>■ Net flow total</li> <li>■ Forward flow total</li> <li>■ Reverse flow total</li> <li>■ Last valid value</li> </ul>	Net flow total
Failure mode	In the <b>Assign process variable</b> parameter, one of the following options is selected: <ul style="list-style-type: none"> <li>■ Mass flow</li> <li>■ Volume flow</li> <li>■ Corrected volume flow</li> <li>■ Target mass flow *</li> <li>■ Carrier mass flow *</li> </ul>	Define the totalizer behavior in the event of a device alarm.	<ul style="list-style-type: none"> <li>■ Stop</li> <li>■ Actual value</li> <li>■ Last valid value</li> </ul>	Actual value

\* Visibility depends on order options or device settings

### 10.7.4 Carrying out additional display configurations

In the **Display** submenu you can set all the parameters associated with the configuration of the local display.

#### Navigation

"Setup" menu → Advanced setup → Display

► Display

Format display

Value 1 display

0% bargraph value 1

100% bargraph value 1

Decimal places 1

Value 2 display

Decimal places 2

Value 3 display

0% bargraph value 3

100% bargraph value 3

Decimal places 3

Value 4 display

Decimal places 4

Display language

Display interval

Display damping

Header

Header text

Separator

Backlight

## Parameter overview with brief description

Parameter	Prerequisite	Description	Selection / User entry	Factory setting
Format display	A local display is provided.	Select how measured values are shown on the display.	<ul style="list-style-type: none"> <li>▪ 1 value, max. size</li> <li>▪ 1 bargraph + 1 value</li> <li>▪ 2 values</li> <li>▪ 1 value large + 2 values</li> <li>▪ 4 values</li> </ul>	1 value, max. size
Value 1 display	A local display is provided.	<p>Select the measured value that is shown on the local display.</p> <p> Depending on the device version, not all options are available in this parameter. The selection can vary depending on the sensor, e.g. viscosity is available only with the Promass I.</p>	<ul style="list-style-type: none"> <li>▪ Mass flow</li> <li>▪ Volume flow</li> <li>▪ Corrected volume flow</li> <li>▪ Target mass flow *</li> <li>▪ Carrier mass flow *</li> <li>▪ Density</li> <li>▪ Reference density *</li> <li>▪ Concentration *</li> <li>▪ Temperature</li> <li>▪ Carrier pipe temperature *</li> <li>▪ Electronic temperature</li> <li>▪ Oscillation frequency 0</li> <li>▪ Oscillation amplitude 0 *</li> <li>▪ Frequency fluctuation 0</li> <li>▪ Oscillation damping 0</li> <li>▪ Tube damping fluctuation 0</li> <li>▪ Signal asymmetry</li> <li>▪ Exciter current 0</li> <li>▪ None</li> <li>▪ Totalizer 1</li> <li>▪ Totalizer 2</li> <li>▪ Totalizer 3</li> </ul>	Mass flow
0% bargraph value 1	A local display is provided.	Enter 0% value for bar graph display.	Signed floating-point number	Country-specific: <ul style="list-style-type: none"> <li>▪ 0 kg/h</li> <li>▪ 0 lb/min</li> </ul>
100% bargraph value 1	A local display is provided.	Enter 100% value for bar graph display.	Signed floating-point number	Depends on country and nominal diameter
Decimal places 1	A measured value is specified in the <b>Value 1 display</b> parameter.	Select the number of decimal places for the display value.	<ul style="list-style-type: none"> <li>▪ x</li> <li>▪ x.x</li> <li>▪ x.xx</li> <li>▪ x.xxx</li> <li>▪ x.xxxx</li> </ul>	x.xx
Value 2 display	A local display is provided.	Select the measured value that is shown on the local display.	Picklist, see <b>Value 1 display</b> parameter	None
Decimal places 2	A measured value is specified in the <b>Value 2 display</b> parameter.	Select the number of decimal places for the display value.	<ul style="list-style-type: none"> <li>▪ x</li> <li>▪ x.x</li> <li>▪ x.xx</li> <li>▪ x.xxx</li> <li>▪ x.xxxx</li> </ul>	x.xx
Value 3 display	A local display is provided.	Select the measured value that is shown on the local display.	Picklist, see <b>Value 1 display</b> parameter	None
0% bargraph value 3	A selection has been made in the <b>Value 3 display</b> parameter.	Enter 0% value for bar graph display.	Signed floating-point number	Country-specific: <ul style="list-style-type: none"> <li>▪ 0 kg/h</li> <li>▪ 0 lb/min</li> </ul>

Parameter	Prerequisite	Description	Selection / User entry	Factory setting
100% bargraph value 3	A selection was made in the <b>Value 3 display</b> parameter.	Enter 100% value for bar graph display.	Signed floating-point number	0
Decimal places 3	A measured value is specified in the <b>Value 3 display</b> parameter.	Select the number of decimal places for the display value.	<ul style="list-style-type: none"> <li>■ x</li> <li>■ x.x</li> <li>■ x.xx</li> <li>■ x.xxx</li> <li>■ x.xxxx</li> </ul>	x.xx
Value 4 display	A local display is provided.	Select the measured value that is shown on the local display.	Picklist, see <b>Value 1 display</b> parameter	None
Decimal places 4	A measured value is specified in the <b>Value 4 display</b> parameter.	Select the number of decimal places for the display value.	<ul style="list-style-type: none"> <li>■ x</li> <li>■ x.x</li> <li>■ x.xx</li> <li>■ x.xxx</li> <li>■ x.xxxx</li> </ul>	x.xx
Display language	A local display is provided.	Set display language.	<ul style="list-style-type: none"> <li>■ English</li> <li>■ Deutsch *</li> <li>■ Français *</li> <li>■ Español *</li> <li>■ Italiano *</li> <li>■ Nederlands *</li> <li>■ Portuguesa *</li> <li>■ Polski *</li> <li>■ русский язык (Russian) *</li> <li>■ Svenska *</li> <li>■ Türkçe *</li> <li>■ 中文 (Chinese) *</li> <li>■ 日本語 (Japanese) *</li> <li>■ 한국어 (Korean) *</li> <li>■ Bahasa Indonesia *</li> <li>■ tiếng Việt (Vietnamese) *</li> <li>■ čeština (Czech) *</li> </ul>	English (alternatively, the ordered language is preset in the device)
Display interval	A local display is provided.	Set time measured values are shown on display if display alternates between values.	1 to 10 s	5 s
Display damping	A local display is provided.	Set display reaction time to fluctuations in the measured value.	0.0 to 999.9 s	0.0 s
Header	A local display is provided.	Select header contents on local display.	<ul style="list-style-type: none"> <li>■ Device tag</li> <li>■ Free text</li> </ul>	Device tag
Header text	The <b>Free text</b> option is selected in the <b>Header</b> parameter.	Enter display header text.	Max. 12 characters such as letters, numbers or special characters (e.g. @, %, /)	-----
Separator	A local display is provided.	Select decimal separator for displaying numerical values.	<ul style="list-style-type: none"> <li>■ . (point)</li> <li>■ , (comma)</li> </ul>	. (point)
Backlight	Order code for "Display; operation", option E "SD03 4-line, illum.; touch control + data backup function"	Switch the local display backlight on and off.	<ul style="list-style-type: none"> <li>■ Disable</li> <li>■ Enable</li> </ul>	Enable

\* Visibility depends on order options or device settings

## 10.8 Simulation

The **Simulation** submenu enables you to simulate, without a real flow situation, various process variables in the process and the device alarm mode and to verify downstream signal chains (switching valves or closed-control loops).

### Navigation

"Diagnostics" menu → Simulation

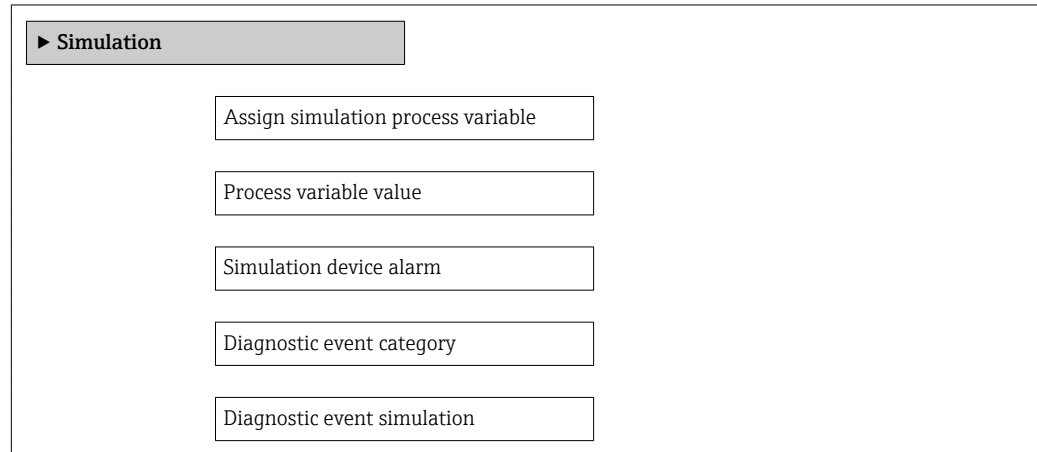

### Parameter overview with brief description



Parameter	Prerequisite	Description	Selection / User entry	Factory setting
Assign simulation process variable	–	Select a process variable for the simulation process that is activated.	<ul style="list-style-type: none"> <li>▪ Off</li> <li>▪ Mass flow</li> <li>▪ Volume flow</li> <li>▪ Corrected volume flow</li> <li>▪ Density</li> <li>▪ Reference density</li> <li>▪ Temperature</li> <li>▪ Concentration *</li> <li>▪ Target mass flow *</li> <li>▪ Carrier mass flow *</li> </ul>	Off
Process variable value	One of the following options is selected in the <b>Assign simulation process variable</b> parameter (→ 70): <ul style="list-style-type: none"> <li>▪ Mass flow</li> <li>▪ Volume flow</li> <li>▪ Corrected volume flow</li> <li>▪ Density</li> <li>▪ Reference density</li> <li>▪ Temperature</li> <li>▪ Concentration *</li> <li>▪ Target mass flow *</li> <li>▪ Carrier mass flow *</li> </ul>	Enter the simulation value for the selected process variable.	Depends on the process variable selected	0
Simulation device alarm	–	Switch the device alarm on and off.	<ul style="list-style-type: none"> <li>▪ Off</li> <li>▪ On</li> </ul>	Off

Parameter	Prerequisite	Description	Selection / User entry	Factory setting
Diagnostic event category	–	Select a diagnostic event category.	<ul style="list-style-type: none"> <li>■ Sensor</li> <li>■ Electronics</li> <li>■ Configuration</li> <li>■ Process</li> </ul>	Process
Diagnostic event simulation	–	Select a diagnostic event to simulate this event.	<ul style="list-style-type: none"> <li>■ Off</li> <li>■ Diagnostic event picklist (depends on the category selected)</li> </ul>	Off

\* Visibility depends on order options or device settings

## 10.9 Protecting settings from unauthorized access

The following options exist for protecting the configuration of the measuring device from unintentional modification after commissioning:

- Write protection via access code for Web browser →  71
- Write protection via write protection switch →  72
- Write protection via startup parameterization →  55

### 10.9.1 Write protection via access code

With the customer-specific access code, access to the measuring device via the Web browser is protected, as are the parameters for the measuring device configuration.

#### Navigation

"Setup" menu → Advanced setup → Administration → Define access code

▶ Define access code

#### Defining the access code via the Web browser

1. Navigate to the **"Enter access code"** parameter.
2. Max. Define a max. 4-digit numeric code as an access code.
3. Enter the access code again to confirm the code.
  - ↳ The Web browser switches to the login page.

 If no action is performed for 10 minutes, the Web browser automatically returns to the login page.

 The user role with which the user is currently logged on via the Web browser is indicated by the **Access status tooling** parameter.

Navigation path: "Operation" menu → Access status tooling

## 10.9.2 Write protection via write protection switch

The write protection switch makes it possible to block write access to the entire operating menu with the exception of the following parameters:

- External pressure
- External temperature
- Reference density
- All parameters for configuring the totalizer

The parameter values are now read only and cannot be edited any more:

- Via service interface (CDI-RJ45)
- Via PROFINET

1. Depending on the housing version, loosen the securing clamp or fixing screw of the housing cover.
2. Depending on the housing version, unscrew or open the housing cover and disconnect the local display from the main electronics module where necessary  
→  135.

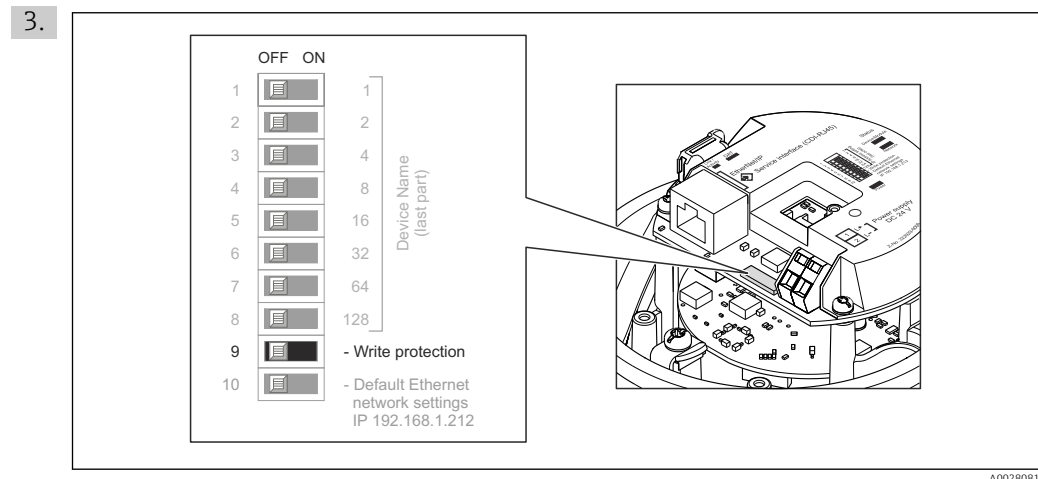

Setting the write protection switch on the main electronics module to the **ON** position enables the hardware write protection. Setting the write protection switch on the main electronics module to the **OFF** position (factory setting) disables the hardware write protection.



- ↳ If hardware write protection is enabled: the **Locking status** parameter displays the **Hardware locked** option ; if disabled, the **Locking status** parameter does not display any option .

4. Reverse the removal procedure to reassemble the transmitter.

## 10.9.3 Write protection via startup parameterization

Software write protection can be enabled via startup parameterization. If software write protection is enabled, device configuration can only be performed via the PROFINET controller. In this case, write access is **no longer** possible via:

- Acyclic PROFINET communication
- Service interface
- Web server

-  Startup parameterization settings →  124.



# 11 Operation

## 11.1 Reading the device locking status

Device active write protection: **Locking status** parameter

### Navigation



"Operation" menu → Locking status

*Function scope of "Locking status" parameter*

Options	Description
Hardware locked	The write protection switch (DIP switch) for hardware locking is activated on the I/O electronic module. This prevents write access to the parameters .
Temporarily locked	Write access to the parameters is temporarily locked on account of internal processes running in the device (e.g. data upload/download, reset etc.). Once the internal processing has been completed, the parameters can be changed once again.

## 11.2 Adjusting the operating language

Information →  55

 For information on the operating languages supported by the measuring device  
→  136

## 11.3 Configuring the display

Advanced settings for the local display →  67

## 11.4 Reading measured values

With the **Measured values** submenu, it is possible to read all the measured values.

### 11.4.1 Process variables

The **Process variables** submenu contains all the parameters needed to display the current measured values for every process variable.

### Navigation

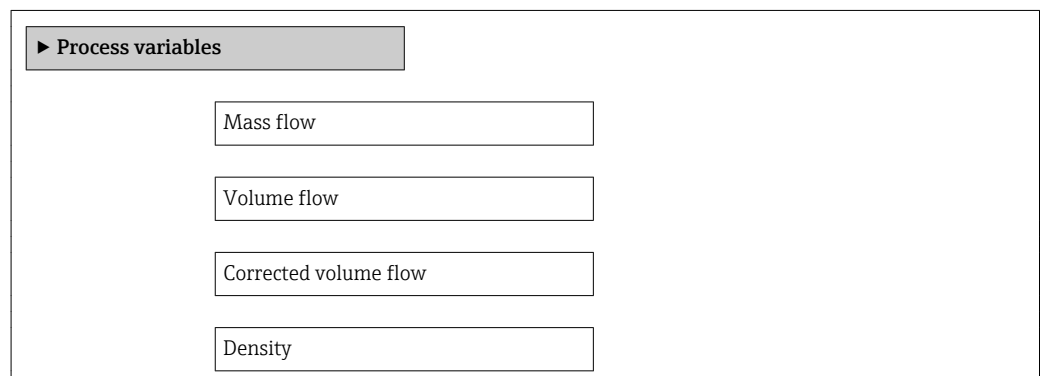

"Diagnostics" menu → Measured values → Process variables



Reference density
Temperature
Pressure value
Concentration
Target mass flow
Carrier mass flow

### Parameter overview with brief description

Parameter	Prerequisite	Description	User interface
Mass flow	–	Displays the mass flow currently measured. <i>Dependency</i> The unit is taken from the <b>Mass flow unit</b> parameter	Signed floating-point number
Volume flow	–	Displays the volume flow currently calculated. <i>Dependency</i> The unit is taken from the <b>Volume flow unit</b> parameter	Signed floating-point number
Corrected volume flow	–	Displays the corrected volume flow currently calculated. <i>Dependency</i> The unit is taken from the <b>Corrected volume flow unit</b> parameter	Signed floating-point number
Density	–	Shows the density currently measured. <i>Dependency</i> The unit is taken from the <b>Density unit</b> parameter	Signed floating-point number
Reference density	–	Displays the reference density currently calculated. <i>Dependency</i> The unit is taken from the <b>Reference density unit</b> parameter	Signed floating-point number
Temperature	–	Shows the medium temperature currently measured. <i>Dependency</i> The unit is taken from the <b>Temperature unit</b> parameter	Signed floating-point number
Pressure value	–	Displays either a fixed or external pressure value. <i>Dependency</i> The unit is taken from the <b>Pressure unit</b> parameter.	Signed floating-point number

Parameter	Prerequisite	Description	User interface
Concentration	<p>For the following order code: "Application package", option ED "Concentration"</p> <p> The software options currently enabled are displayed in the <b>Software option overview</b> parameter.</p>	<p>Displays the concentration currently calculated.</p> <p><i>Dependency</i> The unit is taken from the <b>Concentration unit</b> parameter.</p>	Signed floating-point number
Target mass flow	<p>With the following conditions:</p> <ul style="list-style-type: none"> <li>Order code for "Application package", option ED "Concentration"</li> <li>The <b>WT-%</b> option or the <b>User conc.</b> option is selected in the <b>Concentration unit</b> parameter.</li> </ul> <p> The software options currently enabled are displayed in the <b>Software option overview</b> parameter.</p>	<p>Displays the target fluid mass flow currently measured.</p> <p><i>Dependency</i> The unit is taken from the <b>Mass flow unit</b> parameter.</p>	Signed floating-point number
Carrier mass flow	<p>With the following conditions:</p> <ul style="list-style-type: none"> <li>Order code for "Application package", option ED "Concentration"</li> <li>The <b>WT-%</b> option or the <b>User conc.</b> option is selected in the <b>Concentration unit</b> parameter.</li> </ul> <p> The software options currently enabled are displayed in the <b>Software option overview</b> parameter.</p>	<p>Displays the carrier fluid mass flow currently measured.</p> <p><i>Dependency</i> The unit is taken from the <b>Mass flow unit</b> parameter.</p>	Signed floating-point number

### 11.4.2 Totalizer

The **Totalizer** submenu contains all the parameters needed to display the current measured values for every totalizer.

#### Navigation

"Diagnostics" menu → Measured values → Totalizer 1 to 3

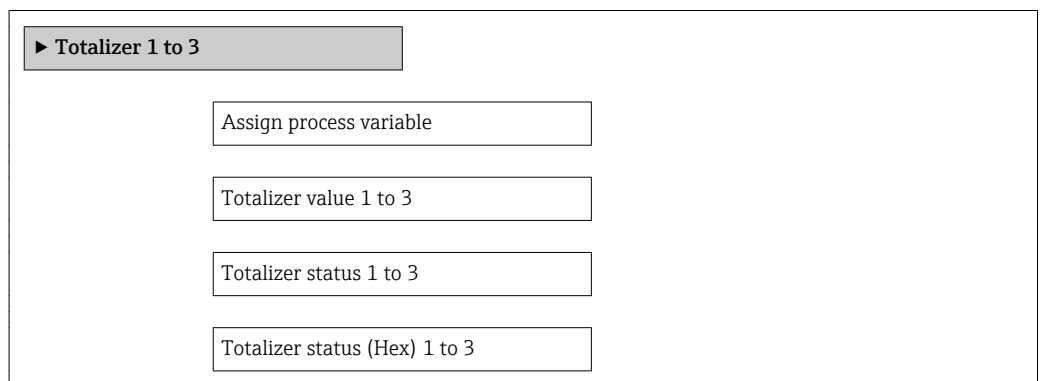

**Parameter overview with brief description**

Parameter	Prerequisite	Description	Selection / User entry / User interface	Factory setting
Assign process variable	–	Select process variable for totalizer.	<ul style="list-style-type: none"> <li>▪ Volume flow</li> <li>▪ Mass flow</li> <li>▪ Corrected volume flow</li> <li>▪ Total mass flow</li> <li>▪ Condensate mass flow</li> <li>▪ Energy flow</li> <li>▪ Heat flow difference</li> </ul>	Volume flow
Totalizer value 1 to 3	In the <b>Assign process variable</b> parameter one of the following options is selected: <ul style="list-style-type: none"> <li>▪ Volume flow</li> <li>▪ Mass flow</li> <li>▪ Corrected volume flow</li> <li>▪ Total mass flow</li> <li>▪ Condensate mass flow</li> <li>▪ Energy flow</li> <li>▪ Heat flow difference</li> </ul>	Displays the current totalizer counter value.	Signed floating-point number	0 m <sup>3</sup>
Totalizer status 1 to 3	–	Displays the current totalizer status.	<ul style="list-style-type: none"> <li>▪ Good</li> <li>▪ Uncertain</li> <li>▪ Bad</li> </ul>	–
Totalizer status (Hex) 1 to 3	In <b>Target mode</b> parameter, the <b>Auto</b> option is selected.	Displays the current status value (hex) of the totalizer.	0 to 0xFF	–

## 11.5 Adapting the measuring device to the process conditions

The following are available for this purpose:

- Basic settings using the **Setup** menu →  55
- Advanced settings using the **Advanced setup** submenu →  63

## 11.6 Performing a totalizer reset

The totalizers are reset in the **Operation** submenu:

- Control Totalizer
- Reset all totalizers

*Function scope of the "Control Totalizer" parameter*

Options	Description
Totalize	The totalizer is started.
Reset + hold	The totaling process is stopped and the totalizer is reset to 0.
Preset + hold	The totaling process is stopped and the totalizer is set to its defined start value from the <b>Preset value</b> parameter.
Reset + totalize	The totalizer is reset to 0 and the totaling process is restarted.
Preset + totalize	The totalizer is set to the defined start value from the <b>Preset value</b> parameter and the totaling process is restarted.
Hold	Totalizing is stopped.

Function scope of the "Reset all totalizers" parameter

Options	Description
Reset + totalize	Resets all totalizers to 0 and restarts the totaling process. This deletes all the flow values previously totalized.

Navigation

"Operation" menu → Totalizer handling

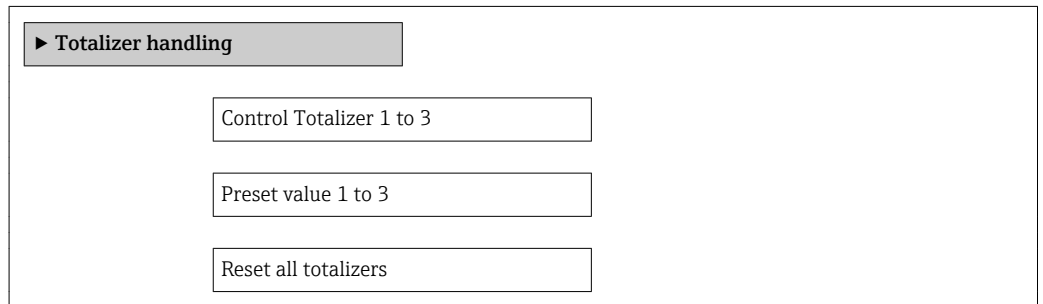

Parameter overview with brief description

Parameter	Prerequisite	Description	Selection / User entry	Factory setting
Control Totalizer 1 to 3	One of the following options is selected in the <b>Assign process variable</b> parameter of the <b>Totalizer 1 to 3</b> submenu: <ul style="list-style-type: none"> <li>▪ Volume flow</li> <li>▪ Mass flow</li> <li>▪ Corrected volume flow</li> <li>▪ Target mass flow *</li> <li>▪ Carrier mass flow *</li> </ul>	Control totalizer value.	<ul style="list-style-type: none"> <li>▪ Totalize</li> <li>▪ Reset + hold</li> <li>▪ Preset + hold</li> <li>▪ Reset + totalize</li> <li>▪ Preset + totalize</li> <li>▪ Hold</li> </ul>	Totalize
Preset value 1 to 3	One of the following options is selected in the <b>Assign process variable</b> parameter of the <b>Totalizer 1 to 3</b> submenu: <ul style="list-style-type: none"> <li>▪ Volume flow</li> <li>▪ Mass flow</li> <li>▪ Corrected volume flow</li> <li>▪ Target mass flow *</li> <li>▪ Carrier mass flow *</li> </ul>	Specify start value for totalizer. <i>Dependency</i>  The unit of the selected process variable is specified for the totalizer in the <b>Unit totalizer</b> parameter.	Signed floating-point number	Country-specific: <ul style="list-style-type: none"> <li>▪ 0 kg</li> <li>▪ 0 lb</li> </ul>
Reset all totalizers	–	Reset all totalizers to 0 and start.	<ul style="list-style-type: none"> <li>▪ Cancel</li> <li>▪ Reset + totalize</li> </ul>	Cancel

\* Visibility depends on order options or device settings

## 12 Diagnostics and troubleshooting

### 12.1 General troubleshooting

*For local display*

Problem	Possible causes	Remedy
Local display dark and no output signals	Supply voltage does not match the value indicated on the nameplate.	Apply the correct supply voltage → 31.
Local display dark and no output signals	The polarity of the supply voltage is wrong.	Correct the polarity.
Local display dark and no output signals	No contact between connecting cables and terminals.	Check the connection of the cables and correct if necessary.
Local display dark and no output signals	Terminals are not plugged into the I/O electronics module correctly.	Check terminals.
Local display dark and no output signals	I/O electronics module is defective.	Order spare part → 114.
Local display is dark, but signal output is within the valid range	Display is set too bright or too dark.	<ul style="list-style-type: none"> <li>▪ Set the display brighter by simultaneously pressing <math>\boxplus</math> + <math>\boxminus</math>.</li> <li>▪ Set the display darker by simultaneously pressing <math>\boxminus</math> + <math>\boxplus</math>.</li> </ul>
Local display is dark, but signal output is within the valid range	The cable of the display module is not plugged in correctly.	Insert the plug correctly into the main electronics module and display module.
Local display is dark, but signal output is within the valid range	Display module is defective.	Order spare part → 114.
Backlighting of local display is red	Diagnostic event with "Alarm" diagnostic behavior has occurred.	Take remedial measures → 86
Message on local display: "Communication Error" "Check Electronics"	Communication between the display module and the electronics is interrupted.	<ul style="list-style-type: none"> <li>▪ Check the cable and the connector between the main electronics module and display module.</li> <li>▪ Order spare part → 114.</li> </ul>

*For output signals*

Problem	Possible causes	Remedy
Green power LED on the main electronics module of the transmitter is dark	Supply voltage does not match the value indicated on the nameplate.	Apply the correct supply voltage → 31.
Device measures incorrectly.	Configuration error or device is operated outside the application.	<ol style="list-style-type: none"> <li>1. Check and correct parameter configuration.</li> <li>2. Observe limit values specified in the "Technical Data".</li> </ol>

*For access*

Problem	Possible causes	Remedy
No write access to parameters	Hardware write protection enabled	Set the write protection switch on the main electronics module to the OFF position .
No connection via PROFINET	PROFINET bus cable connected incorrectly	Check the terminal assignment .
No connection via PROFINET	Device plug connected incorrectly	Check the pin assignment of the device plug .

Problem	Possible causes	Remedy
Not connecting to Web server	Incorrect setting for the Ethernet interface of the computer	1. Check the properties of the Internet protocol (TCP/IP) → 39. 2. Check the network settings with the IT manager.
Not connecting to Web server	Web server disabled	Via the "FieldCare" operating tool check whether the Web server of the measuring device is enabled and enable it if necessary → 42.
No or incomplete display of contents in the Web browser	<ul style="list-style-type: none"> <li>▪ JavaScript not enabled</li> <li>▪ JavaScript cannot be enabled</li> </ul>	1. Enable JavaScript. 2. Enter http://XXX.XXX.X.XXX/basic.html as the IP address.
Web browser frozen and operation no longer possible	Data transfer active	Wait until data transfer or current action is finished.
Web browser frozen and operation no longer possible	Connection lost	1. Check cable connection and power supply. 2. Refresh the Web browser and restart if necessary.
Content of Web browser incomplete or difficult to read	Not using optimum version of Web server.	1. Use the correct Web browser version → 39. 2. Clear the Web browser cache and restart the Web browser.
Content of Web browser incomplete or difficult to read	Unsuitable view settings.	Change the font size/display ratio of the Web browser.

#### *For system integration*

Problem	Possible causes	Remedy
The device name is not displayed correctly and contains coding.	A device name containing one or more underscores has been specified via the automation system.	Specify a correct device name (without underscores) via the automation system.

## 12.2 Diagnostic information via light emitting diodes

### 12.2.1 Transmitter

Various light emitting diodes (LEDs) on the main electronics module of the transmitter provide information on device status.

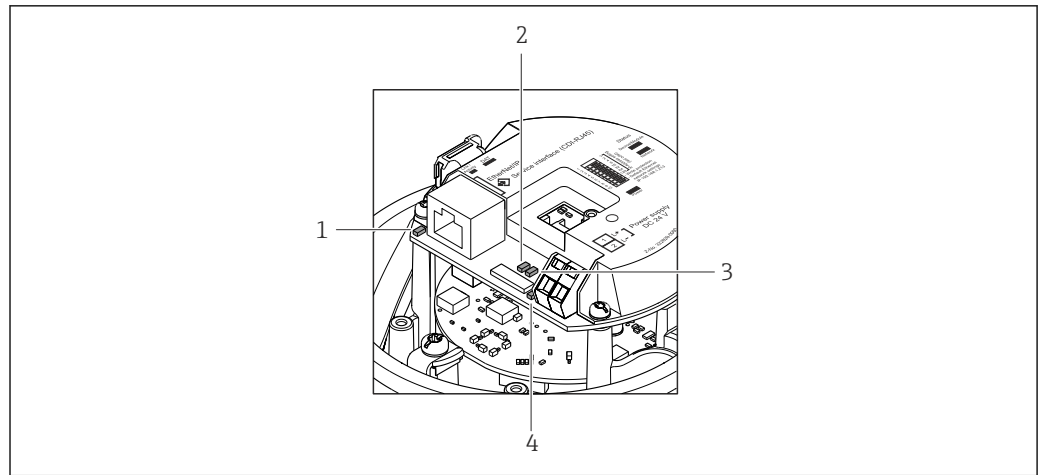

A0027678

- 1 Link/Activity
- 2 Network status
- 3 Device status
- 4 Supply voltage

LED	Color	Meaning
Supply voltage	Off	Supply voltage is off or too low
	Green	Supply voltage is ok
Device status	Green	Device status is ok
	Flashing red	A device error of diagnostic behavior "Warning" has occurred
	Red	A device error of diagnostic behavior "Alarm" has occurred
Network status	Green	Device performing cyclic data exchange
	Flashing green	Following request from automation system: Flash frequency: 1 Hz (flash functionality: 500 ms on, 500 ms off) The device does not have an IP address, no cyclic data exchange Flash frequency: 3 Hz
	Red	IP address is available but no connection to the automation system
	Flashing red	Cyclic connection was established but connection was dropped Flash frequency: 3 Hz
Link/Activity	Orange	Link available but no activity
	Flashing orange	Activity present

## 12.3 Diagnostic information in the Web browser

### 12.3.1 Diagnostic options

Any faults detected by the measuring device are displayed in the Web browser on the home page once the user has logged on.



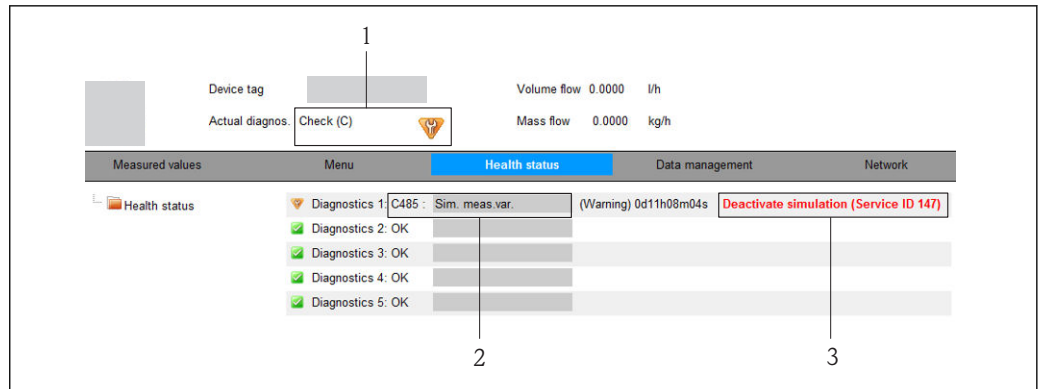

A0017759-EN

- 1 Status area with status signal
- 2 Diagnostic information → 81
- 3 Remedy information with Service ID

**i** Furthermore, diagnostic events that have occurred can be viewed in the **Diagnostics** menu:

- Via parameters → 107
- Via submenus → 107

### Status signals

The status signals provide information on the state and reliability of the device by categorizing the cause of the diagnostic information (diagnostic event).

Symbol	Meaning
 A0017271	<b>Failure</b> A device error has occurred. The measured value is no longer valid.
 A0017278	<b>Function check</b> The device is in service mode (e.g. during a simulation).
 A0017277	<b>Out of specification</b> The device is operated: Outside its technical specification limits (e.g. outside the process temperature range)
 A0017276	<b>Maintenance required</b> Maintenance is required. The measured value is still valid.

**i** The status signals are categorized in accordance with VDI/VDE 2650 and NAMUR Recommendation NE 107.

### Diagnostic information

The fault can be identified using the diagnostic information. The short text helps you by providing information about the fault.

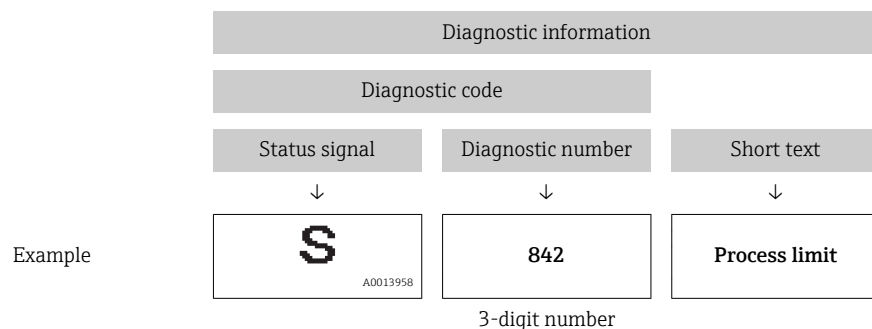

### 12.3.2 Calling up remedy information

Remedy information is provided for every diagnostic event to ensure that problems can be rectified quickly. These measures are displayed in red along with the diagnostic event and the related diagnostic information.

## 12.4 Diagnostic information in FieldCare

### 12.4.1 Diagnostic options

Any faults detected by the measuring device are displayed on the home page of the operating tool once the connection has been established.

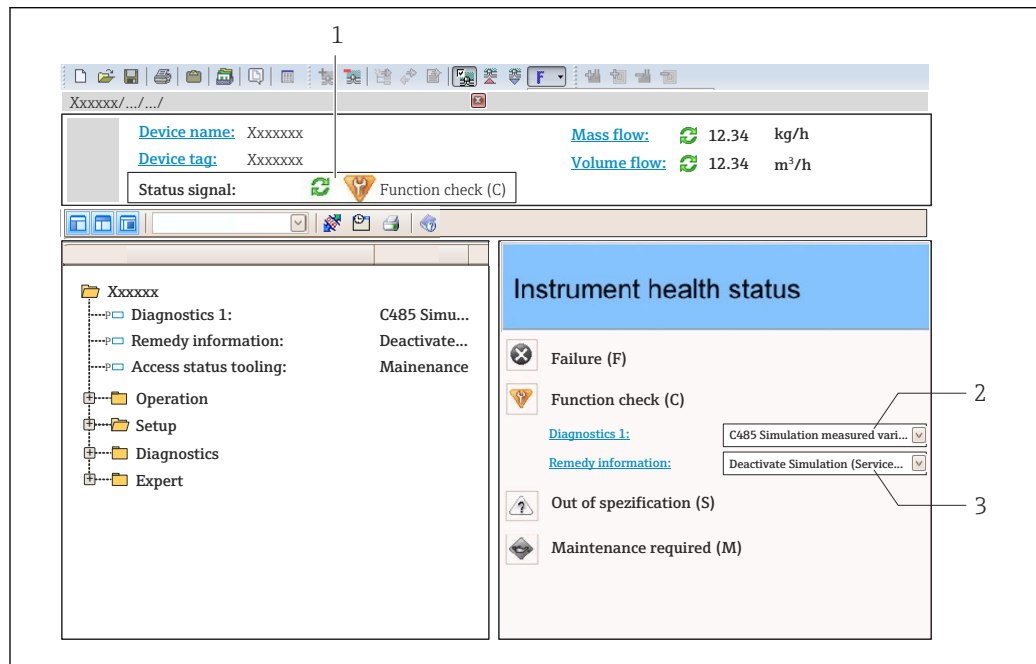

A0021799-EN



- 1 Status area with status signal
- 2 Diagnostic information → 81
- 3 Remedy information with Service ID



**i** Furthermore, diagnostic events that have occurred can be viewed in the **Diagnostics** menu:

- Via parameter → 107
- Via submenu → 107

### Status signals

The status signals provide information on the state and reliability of the device by categorizing the cause of the diagnostic information (diagnostic event).

Symbol	Meaning
 <small>A0017271</small>	<b>Failure</b> A device error has occurred. The measured value is no longer valid.
 <small>A0017278</small>	<b>Function check</b> The device is in service mode (e.g. during a simulation).

Symbol	Meaning
 <small>A0017277</small>	<b>Out of specification</b> The device is operated: Outside its technical specification limits (e.g. outside the process temperature range)
 <small>A0017276</small>	<b>Maintenance required</b> Maintenance is required. The measured value is still valid.

 The status signals are categorized in accordance with VDI/VDE 2650 and NAMUR Recommendation NE 107.

### Diagnostic information

The fault can be identified using the diagnostic information. The short text helps you by providing information about the fault.

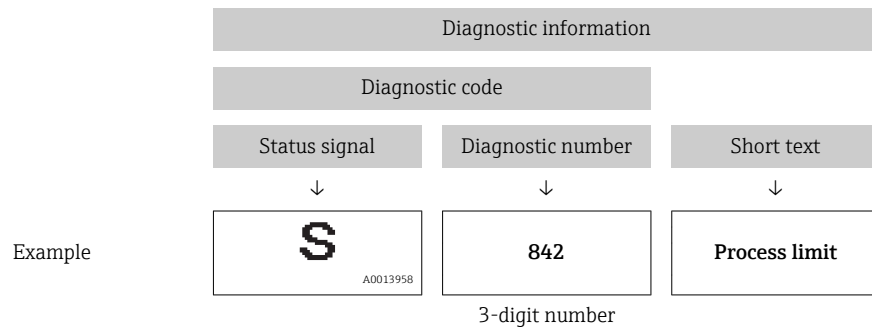

### 12.4.2 Calling up remedy information

Remedy information is provided for every diagnostic event to ensure that problems can be rectified quickly:

- On the home page  
Remedy information is displayed in a separate field below the diagnostics information.
- In the **Diagnostics** menu  
Remedy information can be called up in the working area of the user interface.

The user is in the **Diagnostics** menu.

1. Call up the desired parameter.
2. On the right in the working area, mouse over the parameter.
  - ↳ A tool tip with remedy information for the diagnostic event appears.

## 12.5 Adapting the diagnostic information

### 12.5.1 Adapting the diagnostic behavior

Each item of diagnostic information is assigned a specific diagnostic behavior at the factory. The user can change this assignment for certain diagnostic information in the **Diagnostic behavior** submenu.

 Diagnostic behavior in accordance with Specification PROFIBUS PA Profile 3.02, Condensed Status.

"Expert" menu → System → Diagnostic handling → Diagnostic behavior

**Available diagnostic behaviors**

The following diagnostic behaviors can be assigned:

Diagnostic behavior	Description
Alarm	Measurement is interrupted. The totalizers assume the defined alarm condition. A diagnostic message is generated.
Warning	Measurement is resumed. Measured value output via PROFIBUS and totalizers are not affected. A diagnostic message is generated.
Logbook entry only	The device continues to measure. The diagnostic message is entered in the Event logbook (events list) submenu only and is not displayed in alternation with the measured value display.
Off	The diagnostic event is ignored, and no diagnostic message is generated or entered.

**Displaying the measured value status**

If modules with input data (e.g. Analog Input module, Discrete Input module, Totalizer module, Heartbeat module) are configured for cyclic data transmission, the measured value status is coded as per PROFIBUS PA Profile 3.02 Specification and transmitted along with the measured value to the PROFINET Controller via the status byte. The status byte is split into three segments: Quality, Quality Substatus and Limits.

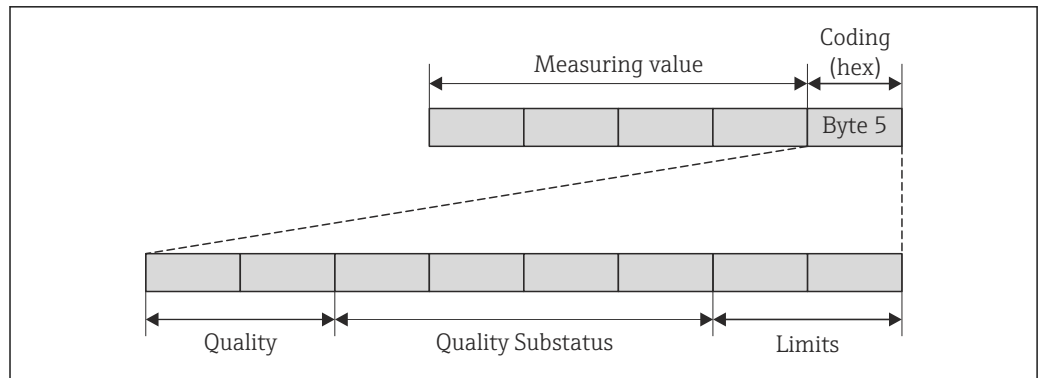

A0021271-EN

15 Structure of the status byte

The content of the status byte depends on the configured failsafe mode in the particular function block. Depending on which failsafe mode has been configured, status information in accordance with PROFIBUS PA Profile Specification 3.02 is transmitted to the the PROFINET controller via the status byte. The two bits for the limits always have the value 0.

*Supported status information*

Status	Coding (hex)
BAD - Maintenance alarm	0x24
BAD - Process related	0x28
BAD - Function check	0x3C
UNCERTAIN - Initial value	0x4F
UNCERTAIN - Maintenance demanded	0x68
UNCERTAIN - Process related	0x78
GOOD - OK	0x80
GOOD - Maintenance demanded	0xA8
GOOD - Function check	0xBC

**Determining the measured value status and device status via the diagnostic behavior**

When the diagnostic behavior is assigned, this also changes the measured value status and device status for the diagnostic information. The measured value status and device status depend on the choice of diagnostic behavior and the group in which the diagnostic information is located. The measured value status and device status are firmly assigned to the particular diagnostic behavior and cannot be changed individually.

The diagnostic information is grouped as follows:

- Diagnostic information pertaining to the sensor: diagnostic number 000 to 199  
→ 85
- Diagnostic information pertaining to the electronics: diagnostic number 200 to 399  
→ 85
- Diagnostic information pertaining to the configuration: diagnostic number 400 to 599  
→ 85
- Diagnostic information pertaining to the process: diagnostic number 800 to 999  
→ 86

Depending on the group in which diagnostic information is located, the following measured value status and device status are firmly assigned to the particular diagnostic behavior:

*Diagnostic information pertaining to the sensor (diagnostic no.: 000 to 199)*

Diagnostic behavior (configurable)	Measured value status (fixed assignment)				Device diagnostics (fixed assignment)
	Quality	Quality Substatus	Coding (hex)	Category (NE107)	
Alarm	BAD	Maintenance alarm	0x24	F (Failure)	Maintenance alarm
Warning	GOOD	Maintenance demanded	0xA8	M (Maintenance)	Maintenance demanded
Logbook entry only	GOOD	ok	0x80	-	-
Off					

*Diagnostic information pertaining to the electronics (diagnostic no.: 200 to 399)*

Diagnostic behavior (configurable)	Measured value status (fixed assignment)				Device diagnostics (fixed assignment)
	Quality	Quality Substatus	Coding (hex)	Category (NE107)	
Alarm	BAD	Maintenance alarm	0x24	F (Failure)	Maintenance alarm
Warning					
Logbook entry only	GOOD	ok	0x80	-	-
Off					

*Diagnostic information pertaining to the configuration (diagnostic no.: 400 to 599)*

Diagnostic behavior (configurable)	Measured value status (fixed assignment)				Device diagnostics (fixed assignment)
	Quality	Quality Substatus	Coding (hex)	Category (NE107)	
Alarm	BAD	Process related	0x28	F (Failure)	Invalid process condition
Warning	UNCERTAIN	Process related	0x78	S (Out of specification)	Invalid process condition



Diagnostic behavior (configurable)	Measured value status (fixed assignment)				Device diagnostics (fixed assignment)
	Quality	Quality Substatus	Coding (hex)	Category (NE107)	
Logbook entry only	GOOD	ok	0x80	-	-
Off					

Diagnostic information pertaining to the process (diagnostic no.: 800 to 999)

Diagnostic behavior (configurable)	Measured value status (fixed assignment)				Device diagnostics (fixed assignment)
	Quality	Quality Substatus	Coding (hex)	Category (NE107)	
Alarm	BAD	Process related	0x28	F (Failure)	Invalid process condition
Warning	UNCERTAIN	Process related	0x78	S (Out of specification)	Invalid process condition
Logbook entry only	GOOD	ok	0x80	-	-
Off					

## 12.6 Overview of diagnostic information

 The amount of diagnostic information and the number of measured variables affected increase if the measuring device has one or more application packages.

 In the case of some items of diagnostic information, the diagnostic behavior can be changed. Change the diagnostic information →  83

### 12.6.1 Diagnostic of sensor

No.	Diagnostic information		Remedy instructions	Influenced measured variables
	Short text			
022	Sensor temperature		1. Change main electronic module 2. Change sensor	<ul style="list-style-type: none"> <li>▪ Carrier mass flow</li> <li>▪ Concentration</li> <li>▪ Density</li> <li>▪ Dynamic viscosity</li> <li>▪ Kinematic viscosity</li> <li>▪ Mass flow</li> <li>▪ Sensor integrity</li> <li>▪ Reference density</li> <li>▪ Corrected volume flow</li> <li>▪ Target mass flow</li> <li>▪ Temp. compensated dynamic viscosity</li> <li>▪ Temp. compensated kinematic viscosity</li> <li>▪ Temperature</li> <li>▪ Status</li> <li>▪ Volume flow</li> </ul>
	<b>Measured variable status</b>			
	Quality	Bad		
	Quality substatus	Maintenance alarm		
	Coding (hex)	0x24 to 0x27		
	Status signal	F		
	Diagnostic behavior	Alarm		

Diagnostic information		Remedy instructions	Influenced measured variables	
No.	Short text			
046	Sensor limit exceeded	1. Inspect sensor 2. Check process condition	<ul style="list-style-type: none"> <li>■ Carrier mass flow</li> <li>■ Concentration</li> <li>■ Density</li> <li>■ Dynamic viscosity</li> <li>■ Kinematic viscosity</li> <li>■ Mass flow</li> <li>■ Sensor integrity</li> <li>■ Reference density</li> <li>■ Corrected volume flow</li> <li>■ Target mass flow</li> <li>■ Temp. compensated dynamic viscosity</li> <li>■ Temp. compensated kinematic viscosity</li> <li>■ Volume flow</li> </ul>	
	<b>Measured variable status [from the factory] <sup>1)</sup></b>			
	Quality			Good
	Quality substatus			Ok
	Coding (hex)			0x80 to 0x83
	Status signal			S
	Diagnostic behavior			Warning

1) Diagnostic behavior can be changed. This causes the overall status of the measured variable to change.

Diagnostic information		Remedy instructions	Influenced measured variables	
No.	Short text			
062	Sensor connection	1. Change main electronic module 2. Change sensor	<ul style="list-style-type: none"> <li>■ Carrier mass flow</li> <li>■ Concentration</li> <li>■ Density</li> <li>■ Dynamic viscosity</li> <li>■ Kinematic viscosity</li> <li>■ Mass flow</li> <li>■ Sensor integrity</li> <li>■ Reference density</li> <li>■ Corrected volume flow</li> <li>■ Target mass flow</li> <li>■ Temp. compensated dynamic viscosity</li> <li>■ Temp. compensated kinematic viscosity</li> <li>■ Temperature</li> <li>■ Status</li> <li>■ Volume flow</li> </ul>	
	<b>Measured variable status</b>			
	Quality			Bad
	Quality substatus			Maintenance alarm
	Coding (hex)			0x24 to 0x27
	Status signal			F
	Diagnostic behavior			Alarm

Diagnostic information		Remedy instructions	Influenced measured variables	
No.	Short text			
082	Data storage	1. Check module connections 2. Contact service	<ul style="list-style-type: none"> <li>■ Carrier mass flow</li> <li>■ Concentration</li> <li>■ Density</li> <li>■ Dynamic viscosity</li> <li>■ Kinematic viscosity</li> <li>■ Mass flow</li> <li>■ Sensor integrity</li> <li>■ Reference density</li> <li>■ Corrected volume flow</li> <li>■ Target mass flow</li> <li>■ Temp. compensated dynamic viscosity</li> <li>■ Temp. compensated kinematic viscosity</li> <li>■ Temperature</li> <li>■ Volume flow</li> </ul>	
	<b>Measured variable status</b>			
	Quality			Bad
	Quality substatus			Maintenance alarm
	Coding (hex)			0x24 to 0x27
	Status signal			F
	Diagnostic behavior			Alarm

Diagnostic information		Remedy instructions	Influenced measured variables	
No.	Short text			
083	Memory content	1. Restart device 2. Contact service	<ul style="list-style-type: none"> <li>▪ Carrier mass flow</li> <li>▪ Concentration</li> <li>▪ Density</li> <li>▪ Dynamic viscosity</li> <li>▪ Kinematic viscosity</li> <li>▪ Mass flow</li> <li>▪ Sensor integrity</li> <li>▪ Reference density</li> <li>▪ Corrected volume flow</li> <li>▪ Target mass flow</li> <li>▪ Temp. compensated dynamic viscosity</li> <li>▪ Temp. compensated kinematic viscosity</li> <li>▪ Temperature</li> <li>▪ Status</li> <li>▪ Volume flow</li> </ul>	
	<b>Measured variable status</b>			
	Quality			Bad
	Quality substatus			Maintenance alarm
	Coding (hex)			0x24 to 0x27
	Status signal			F
	Diagnostic behavior			Alarm

Diagnostic information		Remedy instructions	Influenced measured variables	
No.	Short text			
140	Sensor signal	1. Check or change main electronics 2. Change sensor	<ul style="list-style-type: none"> <li>▪ Carrier mass flow</li> <li>▪ Concentration</li> <li>▪ Density</li> <li>▪ Dynamic viscosity</li> <li>▪ Kinematic viscosity</li> <li>▪ Mass flow</li> <li>▪ Sensor integrity</li> <li>▪ Reference density</li> <li>▪ Corrected volume flow</li> <li>▪ Target mass flow</li> <li>▪ Temp. compensated dynamic viscosity</li> <li>▪ Temp. compensated kinematic viscosity</li> <li>▪ Temperature</li> </ul>	
	<b>Measured variable status [from the factory] <sup>1)</sup></b>			
	Quality			Good
	Quality substatus			Ok
	Coding (hex)			0x80 to 0x83
	Status signal			S
	Diagnostic behavior			Alarm

1) Diagnostic behavior can be changed. This causes the overall status of the measured variable to change.

Diagnostic information		Remedy instructions	Influenced measured variables	
No.	Short text			
144	Measuring error too high	1. Check or change sensor 2. Check process conditions	<ul style="list-style-type: none"> <li>▪ Carrier mass flow</li> <li>▪ Concentration</li> <li>▪ Density</li> <li>▪ Dynamic viscosity</li> <li>▪ Kinematic viscosity</li> <li>▪ Mass flow</li> <li>▪ Sensor integrity</li> <li>▪ Reference density</li> <li>▪ Corrected volume flow</li> <li>▪ Target mass flow</li> <li>▪ Temp. compensated dynamic viscosity</li> <li>▪ Temp. compensated kinematic viscosity</li> <li>▪ Temperature</li> </ul>	
	<b>Measured variable status [from the factory] <sup>1)</sup></b>			
	Quality			Good
	Quality substatus			Ok
	Coding (hex)			0x80 to 0x83
	Status signal			F
	Diagnostic behavior			Alarm

1) Diagnostic behavior can be changed. This causes the overall status of the measured variable to change.



Diagnostic information		Remedy instructions	Influenced measured variables	
No.	Short text			
190	Special event 1	Contact service	<ul style="list-style-type: none"> <li>■ Carrier mass flow</li> <li>■ Concentration</li> <li>■ Density</li> <li>■ Dynamic viscosity</li> <li>■ Kinematic viscosity</li> <li>■ Mass flow</li> <li>■ Sensor integrity</li> <li>■ Reference density</li> <li>■ Corrected volume flow</li> <li>■ Target mass flow</li> <li>■ Temp. compensated dynamic viscosity</li> <li>■ Temp. compensated kinematic viscosity</li> <li>■ Temperature</li> <li>■ Status</li> <li>■ Volume flow</li> </ul>	
	<b>Measured variable status</b>			
	Quality			Bad
	Quality substatus			Maintenance alarm
	Coding (hex)			0x24 to 0x27
	Status signal			F
	Diagnostic behavior			Alarm

Diagnostic information		Remedy instructions	Influenced measured variables	
No.	Short text			
191	Special event 5	Contact service	<ul style="list-style-type: none"> <li>■ Carrier mass flow</li> <li>■ Concentration</li> <li>■ Density</li> <li>■ Dynamic viscosity</li> <li>■ Kinematic viscosity</li> <li>■ Mass flow</li> <li>■ Sensor integrity</li> <li>■ Reference density</li> <li>■ Corrected volume flow</li> <li>■ Target mass flow</li> <li>■ Temp. compensated dynamic viscosity</li> <li>■ Temp. compensated kinematic viscosity</li> <li>■ Temperature</li> <li>■ Status</li> <li>■ Volume flow</li> </ul>	
	<b>Measured variable status</b>			
	Quality			Bad
	Quality substatus			Maintenance alarm
	Coding (hex)			0x24 to 0x27
	Status signal			F
	Diagnostic behavior			Alarm

Diagnostic information		Remedy instructions	Influenced measured variables	
No.	Short text			
192	Special event 9	Contact service	<ul style="list-style-type: none"> <li>■ Carrier mass flow</li> <li>■ Concentration</li> <li>■ Density</li> <li>■ Dynamic viscosity</li> <li>■ Kinematic viscosity</li> <li>■ Mass flow</li> <li>■ Sensor integrity</li> <li>■ Reference density</li> <li>■ Corrected volume flow</li> <li>■ Target mass flow</li> <li>■ Temp. compensated dynamic viscosity</li> <li>■ Temp. compensated kinematic viscosity</li> <li>■ Temperature</li> <li>■ Status</li> <li>■ Volume flow</li> </ul>	
	<b>Measured variable status [from the factory] <sup>1)</sup></b>			
	Quality			Good
	Quality substatus			Ok
	Coding (hex)			0x80 to 0x83
	Status signal			F
	Diagnostic behavior			Alarm

1) Diagnostic behavior can be changed. This causes the overall status of the measured variable to change.

## 12.6.2 Diagnostic of electronic

Diagnostic information		Remedy instructions	Influenced measured variables	
No.	Short text			
201	Device failure	1. Restart device 2. Contact service	<ul style="list-style-type: none"> <li>▪ Carrier mass flow</li> <li>▪ Concentration</li> <li>▪ Density</li> <li>▪ Dynamic viscosity</li> <li>▪ Kinematic viscosity</li> <li>▪ Mass flow</li> <li>▪ Sensor integrity</li> <li>▪ Reference density</li> <li>▪ Corrected volume flow</li> <li>▪ Target mass flow</li> <li>▪ Temp. compensated dynamic viscosity</li> <li>▪ Temp. compensated kinematic viscosity</li> <li>▪ Temperature</li> <li>▪ Status</li> <li>▪ Volume flow</li> </ul>	
	<b>Measured variable status</b>			
	Quality			Bad
	Quality substatus			Maintenance alarm
	Coding (hex)			0x24 to 0x27
	Status signal			F
	Diagnostic behavior			Alarm

Diagnostic information		Remedy instructions	Influenced measured variables	
No.	Short text			
242	Software incompatible	1. Check software 2. Flash or change main electronics module	<ul style="list-style-type: none"> <li>▪ Carrier mass flow</li> <li>▪ Concentration</li> <li>▪ Density</li> <li>▪ Dynamic viscosity</li> <li>▪ Kinematic viscosity</li> <li>▪ Mass flow</li> <li>▪ Sensor integrity</li> <li>▪ Reference density</li> <li>▪ Corrected volume flow</li> <li>▪ Target mass flow</li> <li>▪ Temp. compensated dynamic viscosity</li> <li>▪ Temp. compensated kinematic viscosity</li> <li>▪ Temperature</li> <li>▪ Status</li> <li>▪ Volume flow</li> </ul>	
	<b>Measured variable status</b>			
	Quality			Bad
	Quality substatus			Maintenance alarm
	Coding (hex)			0x24 to 0x27
	Status signal			F
	Diagnostic behavior			Alarm

Diagnostic information		Remedy instructions	Influenced measured variables	
No.	Short text			
252	Modules incompatible	1. Check electronic modules 2. Change electronic modules	<ul style="list-style-type: none"> <li>▪ Carrier mass flow</li> <li>▪ Concentration</li> <li>▪ Density</li> <li>▪ Dynamic viscosity</li> <li>▪ Kinematic viscosity</li> <li>▪ Mass flow</li> <li>▪ Reference density</li> <li>▪ Corrected volume flow</li> <li>▪ Target mass flow</li> <li>▪ Temp. compensated dynamic viscosity</li> <li>▪ Temp. compensated kinematic viscosity</li> <li>▪ Temperature</li> <li>▪ Status</li> <li>▪ Volume flow</li> </ul>	
	<b>Measured variable status [from the factory] <sup>1)</sup></b>			
	Quality			Good
	Quality substatus			Ok
	Coding (hex)			0x80 to 0x83
	Status signal			F
	Diagnostic behavior			Alarm

1) Diagnostic behavior can be changed. This causes the overall status of the measured variable to change.

Diagnostic information		Remedy instructions	Influenced measured variables	
No.	Short text			
262	Module connection	1. Check module connections 2. Change main electronics	<ul style="list-style-type: none"> <li>■ Carrier mass flow</li> <li>■ Concentration</li> <li>■ Density</li> <li>■ Dynamic viscosity</li> <li>■ Kinematic viscosity</li> <li>■ Mass flow</li> <li>■ Sensor integrity</li> <li>■ Reference density</li> <li>■ Corrected volume flow</li> <li>■ Target mass flow</li> <li>■ Temp. compensated dynamic viscosity</li> <li>■ Temp. compensated kinematic viscosity</li> <li>■ Temperature</li> <li>■ Status</li> <li>■ Volume flow</li> </ul>	
	<b>Measured variable status</b>			
	Quality			Bad
	Quality substatus			Maintenance alarm
	Coding (hex)			0x24 to 0x27
	Status signal			F
	Diagnostic behavior			Alarm

Diagnostic information		Remedy instructions	Influenced measured variables	
No.	Short text			
270	Main electronic failure	Change main electronic module	<ul style="list-style-type: none"> <li>■ Carrier mass flow</li> <li>■ Concentration</li> <li>■ Density</li> <li>■ Dynamic viscosity</li> <li>■ Kinematic viscosity</li> <li>■ Mass flow</li> <li>■ Sensor integrity</li> <li>■ Reference density</li> <li>■ Corrected volume flow</li> <li>■ Target mass flow</li> <li>■ Temp. compensated dynamic viscosity</li> <li>■ Temp. compensated kinematic viscosity</li> <li>■ Temperature</li> <li>■ Status</li> <li>■ Volume flow</li> </ul>	
	<b>Measured variable status</b>			
	Quality			Bad
	Quality substatus			Maintenance alarm
	Coding (hex)			0x24 to 0x27
	Status signal			F
	Diagnostic behavior			Alarm

Diagnostic information		Remedy instructions	Influenced measured variables	
No.	Short text			
271	Main electronic failure	1. Restart device 2. Change main electronic module	<ul style="list-style-type: none"> <li>■ Carrier mass flow</li> <li>■ Concentration</li> <li>■ Density</li> <li>■ Dynamic viscosity</li> <li>■ Kinematic viscosity</li> <li>■ Mass flow</li> <li>■ Sensor integrity</li> <li>■ Reference density</li> <li>■ Corrected volume flow</li> <li>■ Target mass flow</li> <li>■ Temp. compensated dynamic viscosity</li> <li>■ Temp. compensated kinematic viscosity</li> <li>■ Temperature</li> <li>■ Status</li> <li>■ Volume flow</li> </ul>	
	<b>Measured variable status</b>			
	Quality			Bad
	Quality substatus			Maintenance alarm
	Coding (hex)			0x24 to 0x27
	Status signal			F
	Diagnostic behavior			Alarm

Diagnostic information		Remedy instructions	Influenced measured variables	
No.	Short text			
272	Main electronic failure	1. Restart device 2. Contact service	<ul style="list-style-type: none"> <li>▪ Carrier mass flow</li> <li>▪ Concentration</li> <li>▪ Density</li> <li>▪ Dynamic viscosity</li> <li>▪ Kinematic viscosity</li> <li>▪ Mass flow</li> <li>▪ Sensor integrity</li> <li>▪ Reference density</li> <li>▪ Corrected volume flow</li> <li>▪ Target mass flow</li> <li>▪ Temp. compensated dynamic viscosity</li> <li>▪ Temp. compensated kinematic viscosity</li> <li>▪ Temperature</li> <li>▪ Status</li> <li>▪ Volume flow</li> </ul>	
	<b>Measured variable status</b>			
	Quality			Bad
	Quality substatus			Maintenance alarm
	Coding (hex)			0x24 to 0x27
	Status signal			F
	Diagnostic behavior			Alarm

Diagnostic information		Remedy instructions	Influenced measured variables	
No.	Short text			
273	Main electronic failure	Change electronic	<ul style="list-style-type: none"> <li>▪ Carrier mass flow</li> <li>▪ Concentration</li> <li>▪ Density</li> <li>▪ Dynamic viscosity</li> <li>▪ Kinematic viscosity</li> <li>▪ Mass flow</li> <li>▪ Sensor integrity</li> <li>▪ Reference density</li> <li>▪ Corrected volume flow</li> <li>▪ Target mass flow</li> <li>▪ Temp. compensated dynamic viscosity</li> <li>▪ Temp. compensated kinematic viscosity</li> <li>▪ Temperature</li> <li>▪ Status</li> <li>▪ Volume flow</li> </ul>	
	<b>Measured variable status</b>			
	Quality			Bad
	Quality substatus			Maintenance alarm
	Coding (hex)			0x24 to 0x27
	Status signal			F
	Diagnostic behavior			Alarm

Diagnostic information		Remedy instructions	Influenced measured variables	
No.	Short text			
274	Main electronic failure	Change electronic	<ul style="list-style-type: none"> <li>▪ Mass flow</li> <li>▪ Sensor integrity</li> <li>▪ Corrected volume flow</li> <li>▪ Volume flow</li> </ul>	
	<b>Measured variable status [from the factory] <sup>1)</sup></b>			
	Quality			Good
	Quality substatus			Ok
	Coding (hex)			0x80 to 0x83
	Status signal			S
	Diagnostic behavior			Warning

1) Diagnostic behavior can be changed. This causes the overall status of the measured variable to change.

Diagnostic information		Remedy instructions	Influenced measured variables	
No.	Short text			
283	Memory content	1. Reset device 2. Contact service	<ul style="list-style-type: none"> <li>■ Carrier mass flow</li> <li>■ Concentration</li> <li>■ Density</li> <li>■ Dynamic viscosity</li> <li>■ Kinematic viscosity</li> <li>■ Mass flow</li> <li>■ Reference density</li> <li>■ Corrected volume flow</li> <li>■ Target mass flow</li> <li>■ Temp. compensated dynamic viscosity</li> <li>■ Temp. compensated kinematic viscosity</li> <li>■ Temperature</li> <li>■ Status</li> <li>■ Volume flow</li> </ul>	
	<b>Measured variable status</b>			
	Quality			Bad
	Quality substatus			Maintenance alarm
	Coding (hex)			0x24 to 0x27
	Status signal			F
	Diagnostic behavior			Alarm

Diagnostic information		Remedy instructions	Influenced measured variables	
No.	Short text			
311	Electronic failure	1. Reset device 2. Contact service	<ul style="list-style-type: none"> <li>■ Carrier mass flow</li> <li>■ Concentration</li> <li>■ Density</li> <li>■ Dynamic viscosity</li> <li>■ Kinematic viscosity</li> <li>■ Mass flow</li> <li>■ Sensor integrity</li> <li>■ Reference density</li> <li>■ Corrected volume flow</li> <li>■ Target mass flow</li> <li>■ Temp. compensated dynamic viscosity</li> <li>■ Temp. compensated kinematic viscosity</li> <li>■ Temperature</li> <li>■ Status</li> <li>■ Volume flow</li> </ul>	
	<b>Measured variable status</b>			
	Quality			Bad
	Quality substatus			Maintenance alarm
	Coding (hex)			0x24 to 0x27
	Status signal			F
	Diagnostic behavior			Alarm

Diagnostic information		Remedy instructions	Influenced measured variables	
No.	Short text			
311	Electronic failure	1. Do not reset device 2. Contact service	<ul style="list-style-type: none"> <li>■ Carrier mass flow</li> <li>■ Concentration</li> <li>■ Density</li> <li>■ Dynamic viscosity</li> <li>■ Kinematic viscosity</li> <li>■ Mass flow</li> <li>■ Sensor integrity</li> <li>■ Reference density</li> <li>■ Corrected volume flow</li> <li>■ Target mass flow</li> <li>■ Temp. compensated dynamic viscosity</li> <li>■ Temp. compensated kinematic viscosity</li> <li>■ Temperature</li> <li>■ Volume flow</li> </ul>	
	<b>Measured variable status</b>			
	Quality			Bad
	Quality substatus			Maintenance alarm
	Coding (hex)			0x24 to 0x27
	Status signal			M
	Diagnostic behavior			Warning

Diagnostic information		Remedy instructions	Influenced measured variables	
No.	Short text			
382	Data storage	1. Insert DAT module 2. Change DAT module	<ul style="list-style-type: none"> <li>▪ Carrier mass flow</li> <li>▪ Concentration</li> <li>▪ Density</li> <li>▪ Dynamic viscosity</li> <li>▪ Kinematic viscosity</li> <li>▪ Mass flow</li> <li>▪ Reference density</li> <li>▪ Corrected volume flow</li> <li>▪ Target mass flow</li> <li>▪ Temp. compensated dynamic viscosity</li> <li>▪ Temp. compensated kinematic viscosity</li> <li>▪ Temperature</li> <li>▪ Status</li> <li>▪ Volume flow</li> </ul>	
	<b>Measured variable status</b>			
	Quality			Bad
	Quality substatus			Maintenance alarm
	Coding (hex)			0x24 to 0x27
	Status signal			F
	Diagnostic behavior			Alarm

Diagnostic information		Remedy instructions	Influenced measured variables	
No.	Short text			
383	Memory content	1. Restart device 2. Check or change DAT module 3. Contact service	<ul style="list-style-type: none"> <li>▪ Carrier mass flow</li> <li>▪ Concentration</li> <li>▪ Density</li> <li>▪ Dynamic viscosity</li> <li>▪ Kinematic viscosity</li> <li>▪ Mass flow</li> <li>▪ Reference density</li> <li>▪ Corrected volume flow</li> <li>▪ Target mass flow</li> <li>▪ Temp. compensated dynamic viscosity</li> <li>▪ Temp. compensated kinematic viscosity</li> <li>▪ Temperature</li> <li>▪ Status</li> <li>▪ Volume flow</li> </ul>	
	<b>Measured variable status</b>			
	Quality			Bad
	Quality substatus			Maintenance alarm
	Coding (hex)			0x24 to 0x27
	Status signal			F
	Diagnostic behavior			Alarm

Diagnostic information		Remedy instructions	Influenced measured variables	
No.	Short text			
390	Special event 2	Contact service	<ul style="list-style-type: none"> <li>▪ Carrier mass flow</li> <li>▪ Concentration</li> <li>▪ Density</li> <li>▪ Dynamic viscosity</li> <li>▪ Kinematic viscosity</li> <li>▪ Mass flow</li> <li>▪ Sensor integrity</li> <li>▪ Reference density</li> <li>▪ Corrected volume flow</li> <li>▪ Target mass flow</li> <li>▪ Temp. compensated dynamic viscosity</li> <li>▪ Temp. compensated kinematic viscosity</li> <li>▪ Temperature</li> <li>▪ Status</li> <li>▪ Volume flow</li> </ul>	
	<b>Measured variable status</b>			
	Quality			Bad
	Quality substatus			Maintenance alarm
	Coding (hex)			0x24 to 0x27
	Status signal			F
	Diagnostic behavior			Alarm

Diagnostic information		Remedy instructions	Influenced measured variables	
No.	Short text			
391	Special event 6	Contact service	<ul style="list-style-type: none"> <li>■ Carrier mass flow</li> <li>■ Concentration</li> <li>■ Density</li> <li>■ Dynamic viscosity</li> <li>■ Kinematic viscosity</li> <li>■ Mass flow</li> <li>■ Sensor integrity</li> <li>■ Reference density</li> <li>■ Corrected volume flow</li> <li>■ Target mass flow</li> <li>■ Temp. compensated dynamic viscosity</li> <li>■ Temp. compensated kinematic viscosity</li> <li>■ Temperature</li> <li>■ Status</li> <li>■ Volume flow</li> </ul>	
	<b>Measured variable status</b>			
	Quality			Bad
	Quality substatus			Maintenance alarm
	Coding (hex)			0x24 to 0x27
	Status signal			F
	Diagnostic behavior			Alarm

Diagnostic information		Remedy instructions	Influenced measured variables	
No.	Short text			
392	Special event 10	Contact service	<ul style="list-style-type: none"> <li>■ Carrier mass flow</li> <li>■ Concentration</li> <li>■ Density</li> <li>■ Dynamic viscosity</li> <li>■ Kinematic viscosity</li> <li>■ Mass flow</li> <li>■ Sensor integrity</li> <li>■ Reference density</li> <li>■ Corrected volume flow</li> <li>■ Target mass flow</li> <li>■ Temp. compensated dynamic viscosity</li> <li>■ Temp. compensated kinematic viscosity</li> <li>■ Temperature</li> <li>■ Status</li> <li>■ Volume flow</li> </ul>	
	<b>Measured variable status [from the factory] <sup>1)</sup></b>			
	Quality			Good
	Quality substatus			Ok
	Coding (hex)			0x80 to 0x83
	Status signal			F
	Diagnostic behavior			Alarm

1) Diagnostic behavior can be changed. This causes the overall status of the measured variable to change.

### 12.6.3 Diagnostic of configuration

Diagnostic information		Remedy instructions	Influenced measured variables	
No.	Short text			
410	Data transfer	1. Check connection 2. Retry data transfer	<ul style="list-style-type: none"> <li>■ Carrier mass flow</li> <li>■ Concentration</li> <li>■ Density</li> <li>■ Dynamic viscosity</li> <li>■ Kinematic viscosity</li> <li>■ Mass flow</li> <li>■ Sensor integrity</li> <li>■ Reference density</li> <li>■ Corrected volume flow</li> <li>■ Target mass flow</li> <li>■ Temp. compensated dynamic viscosity</li> <li>■ Temp. compensated kinematic viscosity</li> <li>■ Temperature</li> <li>■ Volume flow</li> </ul>	
	<b>Measured variable status</b>			
	Quality			Bad
	Quality substatus			Maintenance alarm
	Coding (hex)			0x24 to 0x27
	Status signal			F
	Diagnostic behavior			Alarm

Diagnostic information		Remedy instructions	Influenced measured variables	
No.	Short text			
412	Processing download	Download active, please wait	<ul style="list-style-type: none"> <li>▪ Carrier mass flow</li> <li>▪ Concentration</li> <li>▪ Density</li> <li>▪ Dynamic viscosity</li> <li>▪ Kinematic viscosity</li> <li>▪ Mass flow</li> <li>▪ Sensor integrity</li> <li>▪ Reference density</li> <li>▪ Corrected volume flow</li> <li>▪ Target mass flow</li> <li>▪ Temp. compensated dynamic viscosity</li> <li>▪ Temp. compensated kinematic viscosity</li> <li>▪ Temperature</li> <li>▪ Volume flow</li> </ul>	
	<b>Measured variable status</b>			
	Quality			Uncertain
	Quality substatus			Initial value
	Coding (hex)			0x4C to 0x4F
	Status signal			C
	Diagnostic behavior			Warning

Diagnostic information		Remedy instructions	Influenced measured variables	
No.	Short text			
437	Configuration incompatible	<ol style="list-style-type: none"> <li>1. Restart device</li> <li>2. Contact service</li> </ol>	<ul style="list-style-type: none"> <li>▪ Carrier mass flow</li> <li>▪ Concentration</li> <li>▪ Density</li> <li>▪ Dynamic viscosity</li> <li>▪ Kinematic viscosity</li> <li>▪ Mass flow</li> <li>▪ Reference density</li> <li>▪ Corrected volume flow</li> <li>▪ Target mass flow</li> <li>▪ Temp. compensated dynamic viscosity</li> <li>▪ Temp. compensated kinematic viscosity</li> <li>▪ Temperature</li> <li>▪ Status</li> <li>▪ Volume flow</li> </ul>	
	<b>Measured variable status</b>			
	Quality			Bad
	Quality substatus			Maintenance alarm
	Coding (hex)			0x24 to 0x27
	Status signal			F
	Diagnostic behavior			Alarm

Diagnostic information		Remedy instructions	Influenced measured variables	
No.	Short text			
438	Dataset	<ol style="list-style-type: none"> <li>1. Check data set file</li> <li>2. Check device configuration</li> <li>3. Up- and download new configuration</li> </ol>	<ul style="list-style-type: none"> <li>▪ Carrier mass flow</li> <li>▪ Concentration</li> <li>▪ Density</li> <li>▪ Dynamic viscosity</li> <li>▪ Kinematic viscosity</li> <li>▪ Mass flow</li> <li>▪ Sensor integrity</li> <li>▪ Reference density</li> <li>▪ Corrected volume flow</li> <li>▪ Target mass flow</li> <li>▪ Temp. compensated dynamic viscosity</li> <li>▪ Temp. compensated kinematic viscosity</li> <li>▪ Temperature</li> <li>▪ Volume flow</li> </ul>	
	<b>Measured variable status</b>			
	Quality			Uncertain
	Quality substatus			Maintenance demanded
	Coding (hex)			0x68 to 0x6B
	Status signal			M
	Diagnostic behavior			Warning



Diagnostic information		Remedy instructions	Influenced measured variables
No.	Short text		
453	Flow override		Deactivate flow override <ul style="list-style-type: none"> <li>■ Carrier mass flow</li> <li>■ Concentration</li> <li>■ Density</li> <li>■ Dynamic viscosity</li> <li>■ Kinematic viscosity</li> <li>■ Mass flow</li> <li>■ Sensor integrity</li> <li>■ Reference density</li> <li>■ Corrected volume flow</li> <li>■ Target mass flow</li> <li>■ Temp. compensated dynamic viscosity</li> <li>■ Temp. compensated kinematic viscosity</li> <li>■ Temperature</li> <li>■ Volume flow</li> </ul>
	<b>Measured variable status</b>		
	Quality	Good	
	Quality substatus	Function check	
	Coding (hex)	0xBC to 0xBF	
	Status signal	C	
	Diagnostic behavior	Warning	

Diagnostic information		Remedy instructions	Influenced measured variables
No.	Short text		
484	Simulation Failure Mode		Deactivate simulation <ul style="list-style-type: none"> <li>■ Carrier mass flow</li> <li>■ Concentration</li> <li>■ Density</li> <li>■ Dynamic viscosity</li> <li>■ Kinematic viscosity</li> <li>■ Mass flow</li> <li>■ Sensor integrity</li> <li>■ Reference density</li> <li>■ Corrected volume flow</li> <li>■ Target mass flow</li> <li>■ Temp. compensated dynamic viscosity</li> <li>■ Temp. compensated kinematic viscosity</li> <li>■ Temperature</li> <li>■ Status</li> <li>■ Volume flow</li> </ul>
	<b>Measured variable status</b>		
	Quality	Bad	
	Quality substatus	Function check	
	Coding (hex)	0x3C to 0x3F	
	Status signal	C	
	Diagnostic behavior	Alarm	

Diagnostic information		Remedy instructions	Influenced measured variables
No.	Short text		
485	Simulation measured variable		Deactivate simulation <ul style="list-style-type: none"> <li>■ Carrier mass flow</li> <li>■ Concentration</li> <li>■ Density</li> <li>■ Dynamic viscosity</li> <li>■ Kinematic viscosity</li> <li>■ Mass flow</li> <li>■ Sensor integrity</li> <li>■ Reference density</li> <li>■ Corrected volume flow</li> <li>■ Target mass flow</li> <li>■ Temp. compensated dynamic viscosity</li> <li>■ Temp. compensated kinematic viscosity</li> <li>■ Temperature</li> <li>■ Volume flow</li> </ul>
	<b>Measured variable status</b>		
	Quality	Good	
	Quality substatus	Function check	
	Coding (hex)	0xBC to 0xBF	
	Status signal	C	
	Diagnostic behavior	Warning	

Diagnostic information		Remedy instructions	Influenced measured variables	
No.	Short text			
495	Diagnostic event simulation	Deactivate simulation	-	
	<b>Measured variable status</b>			
	Quality			Good
	Quality substatus			Ok
	Coding (hex)			0x80 to 0x83
	Status signal			C
	Diagnostic behavior			Warning

Diagnostic information		Remedy instructions	Influenced measured variables	
No.	Short text			
537	Configuration	1. Check IP addresses in network 2. Change IP address	-	
	<b>Measured variable status</b>			
	Quality			Good
	Quality substatus			Ok
	Coding (hex)			0x80 to 0x83
	Status signal			F
	Diagnostic behavior			Warning

Diagnostic information		Remedy instructions	Influenced measured variables	
No.	Short text			
590	Special event 3	Contact service	<ul style="list-style-type: none"> <li>▪ Carrier mass flow</li> <li>▪ Concentration</li> <li>▪ Density</li> <li>▪ Dynamic viscosity</li> <li>▪ Kinematic viscosity</li> <li>▪ Mass flow</li> <li>▪ Sensor integrity</li> <li>▪ Reference density</li> <li>▪ Corrected volume flow</li> <li>▪ Target mass flow</li> <li>▪ Temp. compensated dynamic viscosity</li> <li>▪ Temp. compensated kinematic viscosity</li> <li>▪ Status</li> <li>▪ Volume flow</li> </ul>	
	<b>Measured variable status</b>			
	Quality			Bad
	Quality substatus			Maintenance alarm
	Coding (hex)			0x24 to 0x27
	Status signal			F
	Diagnostic behavior			Alarm

Diagnostic information		Remedy instructions	Influenced measured variables	
No.	Short text			
591	Special event 7	Contact service	<ul style="list-style-type: none"> <li>■ Carrier mass flow</li> <li>■ Concentration</li> <li>■ Density</li> <li>■ Dynamic viscosity</li> <li>■ Kinematic viscosity</li> <li>■ Mass flow</li> <li>■ Sensor integrity</li> <li>■ Reference density</li> <li>■ Corrected volume flow</li> <li>■ Target mass flow</li> <li>■ Temp. compensated dynamic viscosity</li> <li>■ Temp. compensated kinematic viscosity</li> <li>■ Temperature</li> <li>■ Status</li> <li>■ Volume flow</li> </ul>	
	<b>Measured variable status</b>			
	Quality			Bad
	Quality substatus			Maintenance alarm
	Coding (hex)			0x24 to 0x27
	Status signal			F
	Diagnostic behavior			Alarm

Diagnostic information		Remedy instructions	Influenced measured variables	
No.	Short text			
592	Special event 11	Contact service	<ul style="list-style-type: none"> <li>■ Carrier mass flow</li> <li>■ Concentration</li> <li>■ Density</li> <li>■ Dynamic viscosity</li> <li>■ Kinematic viscosity</li> <li>■ Mass flow</li> <li>■ Sensor integrity</li> <li>■ Reference density</li> <li>■ Corrected volume flow</li> <li>■ Target mass flow</li> <li>■ Temp. compensated dynamic viscosity</li> <li>■ Temp. compensated kinematic viscosity</li> <li>■ Temperature</li> <li>■ Status</li> <li>■ Volume flow</li> </ul>	
	<b>Measured variable status [from the factory] <sup>1)</sup></b>			
	Quality			Good
	Quality substatus			Ok
	Coding (hex)			0x80 to 0x83
	Status signal			F
	Diagnostic behavior			Alarm

1) Diagnostic behavior can be changed. This causes the overall status of the measured variable to change.

### 12.6.4 Diagnostic of process

Diagnostic information		Remedy instructions	Influenced measured variables	
No.	Short text			
825	Operating temperature	1. Check ambient temperature 2. Check process temperature	<ul style="list-style-type: none"> <li>■ Carrier mass flow</li> <li>■ Concentration</li> <li>■ Density</li> <li>■ Dynamic viscosity</li> <li>■ Kinematic viscosity</li> <li>■ Mass flow</li> <li>■ Sensor integrity</li> <li>■ Reference density</li> <li>■ Corrected volume flow</li> <li>■ Target mass flow</li> <li>■ Temp. compensated dynamic viscosity</li> <li>■ Temp. compensated kinematic viscosity</li> <li>■ Temperature</li> <li>■ Status</li> <li>■ Volume flow</li> </ul>	
	<b>Measured variable status</b>			
	Quality			Good
	Quality substatus			Ok
	Coding (hex)			0x80 to 0x83
	Status signal			S
	Diagnostic behavior			Warning

Diagnostic information		Remedy instructions	Influenced measured variables	
No.	Short text			
825	Operating temperature	1. Check ambient temperature 2. Check process temperature	<ul style="list-style-type: none"> <li>▪ Carrier mass flow</li> <li>▪ Concentration</li> <li>▪ Density</li> <li>▪ Dynamic viscosity</li> <li>▪ Kinematic viscosity</li> <li>▪ Mass flow</li> <li>▪ Sensor integrity</li> <li>▪ Reference density</li> <li>▪ Corrected volume flow</li> <li>▪ Target mass flow</li> <li>▪ Temp. compensated dynamic viscosity</li> <li>▪ Temp. compensated kinematic viscosity</li> <li>▪ Temperature</li> <li>▪ Status</li> <li>▪ Volume flow</li> </ul>	
	<b>Measured variable status</b>			
	Quality			Uncertain
	Quality substatus			Process related
	Coding (hex)			0x78 to 0x7B
	Status signal			S
	Diagnostic behavior			Warning

Diagnostic information		Remedy instructions	Influenced measured variables	
No.	Short text			
825	Operating temperature	1. Check ambient temperature 2. Check process temperature	<ul style="list-style-type: none"> <li>▪ Carrier mass flow</li> <li>▪ Concentration</li> <li>▪ Density</li> <li>▪ Dynamic viscosity</li> <li>▪ Kinematic viscosity</li> <li>▪ Mass flow</li> <li>▪ Reference density</li> <li>▪ Corrected volume flow</li> <li>▪ Target mass flow</li> <li>▪ Temp. compensated dynamic viscosity</li> <li>▪ Temp. compensated kinematic viscosity</li> <li>▪ Temperature</li> <li>▪ Status</li> <li>▪ Volume flow</li> </ul>	
	<b>Measured variable status</b>			
	Quality			Bad
	Quality substatus			Process related
	Coding (hex)			0x28 to 0x2B
	Status signal			F
	Diagnostic behavior			Alarm

Diagnostic information		Remedy instructions	Influenced measured variables	
No.	Short text			
830	Sensor temperature too high	Reduce ambient temp. around the sensor housing	<ul style="list-style-type: none"> <li>▪ Carrier mass flow</li> <li>▪ Concentration</li> <li>▪ Density</li> <li>▪ Dynamic viscosity</li> <li>▪ Kinematic viscosity</li> <li>▪ Mass flow</li> <li>▪ Sensor integrity</li> <li>▪ Reference density</li> <li>▪ Corrected volume flow</li> <li>▪ Target mass flow</li> <li>▪ Temp. compensated dynamic viscosity</li> <li>▪ Temp. compensated kinematic viscosity</li> <li>▪ Temperature</li> <li>▪ Volume flow</li> </ul>	
	<b>Measured variable status</b>			
	Quality			Uncertain
	Quality substatus			Process related
	Coding (hex)			0x78 to 0x7B
	Status signal			S
	Diagnostic behavior			Warning

Diagnostic information		Remedy instructions	Influenced measured variables
No.	Short text		
831	Sensor temperature too low		Increase ambient temp. around the sensor housing  <ul style="list-style-type: none"> <li>■ Carrier mass flow</li> <li>■ Concentration</li> <li>■ Density</li> <li>■ Dynamic viscosity</li> <li>■ Kinematic viscosity</li> <li>■ Mass flow</li> <li>■ Sensor integrity</li> <li>■ Reference density</li> <li>■ Corrected volume flow</li> <li>■ Target mass flow</li> <li>■ Temp. compensated dynamic viscosity</li> <li>■ Temp. compensated kinematic viscosity</li> <li>■ Temperature</li> <li>■ Volume flow</li> </ul>
	<b>Measured variable status</b>		
	Quality	Uncertain	
	Quality substatus	Process related	
	Coding (hex)	0x78 to 0x7B	
	Status signal	S	
	Diagnostic behavior	Warning	

Diagnostic information		Remedy instructions	Influenced measured variables
No.	Short text		
832	Electronic temperature too high		Reduce ambient temperature  <ul style="list-style-type: none"> <li>■ Carrier mass flow</li> <li>■ Concentration</li> <li>■ Density</li> <li>■ Mass flow</li> <li>■ Sensor integrity</li> <li>■ Reference density</li> <li>■ Corrected volume flow</li> <li>■ Target mass flow</li> <li>■ Temperature</li> <li>■ Volume flow</li> </ul>
	<b>Measured variable status [from the factory] <sup>1)</sup></b>		
	Quality	Good	
	Quality substatus	Ok	
	Coding (hex)	0x80 to 0x83	
	Status signal	S	
	Diagnostic behavior	Warning	

1) Diagnostic behavior can be changed. This causes the overall status of the measured variable to change.

Diagnostic information		Remedy instructions	Influenced measured variables
No.	Short text		
833	Electronic temperature too low		Increase ambient temperature  <ul style="list-style-type: none"> <li>■ Carrier mass flow</li> <li>■ Concentration</li> <li>■ Density</li> <li>■ Dynamic viscosity</li> <li>■ Kinematic viscosity</li> <li>■ Mass flow</li> <li>■ Sensor integrity</li> <li>■ Reference density</li> <li>■ Corrected volume flow</li> <li>■ Target mass flow</li> <li>■ Temp. compensated dynamic viscosity</li> <li>■ Temp. compensated kinematic viscosity</li> <li>■ Volume flow</li> </ul>
	<b>Measured variable status [from the factory] <sup>1)</sup></b>		
	Quality	Good	
	Quality substatus	Ok	
	Coding (hex)	0x80 to 0x83	
	Status signal	S	
	Diagnostic behavior	Warning	

1) Diagnostic behavior can be changed. This causes the overall status of the measured variable to change.

Diagnostic information		Remedy instructions	Influenced measured variables	
No.	Short text			
834	Process temperature too high	Reduce process temperature	<ul style="list-style-type: none"> <li>▪ Carrier mass flow</li> <li>▪ Concentration</li> <li>▪ Density</li> <li>▪ Dynamic viscosity</li> <li>▪ Kinematic viscosity</li> <li>▪ Mass flow</li> <li>▪ Sensor integrity</li> <li>▪ Reference density</li> <li>▪ Corrected volume flow</li> <li>▪ Target mass flow</li> <li>▪ Temp. compensated dynamic viscosity</li> <li>▪ Temp. compensated kinematic viscosity</li> <li>▪ Temperature</li> <li>▪ Volume flow</li> </ul>	
	<b>Measured variable status [from the factory] <sup>1)</sup></b>			
	Quality			Good
	Quality substatus			Ok
	Coding (hex)			0x80 to 0x83
	Status signal			S
	Diagnostic behavior			Warning

1) Diagnostic behavior can be changed. This causes the overall status of the measured variable to change.

Diagnostic information		Remedy instructions	Influenced measured variables	
No.	Short text			
835	Process temperature too low	Increase process temperature	<ul style="list-style-type: none"> <li>▪ Carrier mass flow</li> <li>▪ Concentration</li> <li>▪ Density</li> <li>▪ Dynamic viscosity</li> <li>▪ Kinematic viscosity</li> <li>▪ Mass flow</li> <li>▪ Sensor integrity</li> <li>▪ Reference density</li> <li>▪ Corrected volume flow</li> <li>▪ Target mass flow</li> <li>▪ Temp. compensated dynamic viscosity</li> <li>▪ Temp. compensated kinematic viscosity</li> <li>▪ Temperature</li> <li>▪ Volume flow</li> </ul>	
	<b>Measured variable status [from the factory] <sup>1)</sup></b>			
	Quality			Good
	Quality substatus			Ok
	Coding (hex)			0x80 to 0x83
	Status signal			S
	Diagnostic behavior			Warning

1) Diagnostic behavior can be changed. This causes the overall status of the measured variable to change.

Diagnostic information		Remedy instructions	Influenced measured variables	
No.	Short text			
842	Process limit	Low flow cut off active! 1. Check low flow cut off configuration	<ul style="list-style-type: none"> <li>▪ Carrier mass flow</li> <li>▪ Concentration</li> <li>▪ Density</li> <li>▪ Dynamic viscosity</li> <li>▪ Kinematic viscosity</li> <li>▪ Mass flow</li> <li>▪ Reference density</li> <li>▪ Corrected volume flow</li> <li>▪ Target mass flow</li> <li>▪ Temp. compensated dynamic viscosity</li> <li>▪ Temp. compensated kinematic viscosity</li> <li>▪ Temperature</li> <li>▪ Volume flow</li> </ul>	
	<b>Measured variable status</b>			
	Quality			Good
	Quality substatus			Ok
	Coding (hex)			0x80 to 0x83
	Status signal			S
	Diagnostic behavior			Warning

Diagnostic information		Remedy instructions	Influenced measured variables	
No.	Short text			
843	Process limit	Check process conditions	<ul style="list-style-type: none"> <li>▪ Carrier mass flow</li> <li>▪ Concentration</li> <li>▪ Density</li> <li>▪ Dynamic viscosity</li> <li>▪ Kinematic viscosity</li> <li>▪ Mass flow</li> <li>▪ Sensor integrity</li> <li>▪ Reference density</li> <li>▪ Corrected volume flow</li> <li>▪ Target mass flow</li> <li>▪ Temp. compensated dynamic viscosity</li> <li>▪ Temp. compensated kinematic viscosity</li> <li>▪ Temperature</li> <li>▪ Volume flow</li> </ul>	
	<b>Measured variable status</b>			
	Quality			Good
	Quality substatus			Ok
	Coding (hex)			0x80 to 0x83
	Status signal			S
	Diagnostic behavior			Warning

Diagnostic information		Remedy instructions	Influenced measured variables	
No.	Short text			
862	Partly filled pipe	<ol style="list-style-type: none"> <li>1. Check for gas in process</li> <li>2. Adjust detection limits</li> </ol>	<ul style="list-style-type: none"> <li>▪ Carrier mass flow</li> <li>▪ Concentration</li> <li>▪ Density</li> <li>▪ Dynamic viscosity</li> <li>▪ Kinematic viscosity</li> <li>▪ Mass flow</li> <li>▪ Sensor integrity</li> <li>▪ Reference density</li> <li>▪ Corrected volume flow</li> <li>▪ Target mass flow</li> <li>▪ Temp. compensated dynamic viscosity</li> <li>▪ Temp. compensated kinematic viscosity</li> <li>▪ Temperature</li> <li>▪ Volume flow</li> </ul>	
	<b>Measured variable status</b>			
	Quality			Uncertain
	Quality substatus			Process related
	Coding (hex)			0x78 to 0x7B
	Status signal			S
	Diagnostic behavior			Warning

Diagnostic information		Remedy instructions	Influenced measured variables	
No.	Short text			
882	Input signal	<ol style="list-style-type: none"> <li>1. Check input configuration</li> <li>2. Check external device or process conditions</li> </ol>	<ul style="list-style-type: none"> <li>▪ Density</li> <li>▪ Mass flow</li> <li>▪ Reference density</li> <li>▪ Corrected volume flow</li> <li>▪ Volume flow</li> </ul>	
	<b>Measured variable status</b>			
	Quality			Bad
	Quality substatus			Maintenance alarm
	Coding (hex)			0x24 to 0x27
	Status signal			F
	Diagnostic behavior			Alarm

Diagnostic information		Remedy instructions	Influenced measured variables	
No.	Short text			
910	Tubes not oscillating	1. Check electronic 2. Inspect sensor	<ul style="list-style-type: none"> <li>▪ Carrier mass flow</li> <li>▪ Concentration</li> <li>▪ Density</li> <li>▪ Mass flow</li> <li>▪ Sensor integrity</li> <li>▪ Reference density</li> <li>▪ Corrected volume flow</li> <li>▪ Target mass flow</li> <li>▪ Temperature</li> <li>▪ Volume flow</li> </ul>	
	<b>Measured variable status</b>			
	Quality			Bad
	Quality substatus			Maintenance alarm
	Coding (hex)			0x24 to 0x27
	Status signal			F
	Diagnostic behavior			Alarm

Diagnostic information		Remedy instructions	Influenced measured variables	
No.	Short text			
912	Medium inhomogeneous	1. Check process cond. 2. Increase system pressure	<ul style="list-style-type: none"> <li>▪ Carrier mass flow</li> <li>▪ Concentration</li> <li>▪ Density</li> <li>▪ Dynamic viscosity</li> <li>▪ Kinematic viscosity</li> <li>▪ Mass flow</li> <li>▪ Sensor integrity</li> <li>▪ Reference density</li> <li>▪ Corrected volume flow</li> <li>▪ Target mass flow</li> <li>▪ Temp. compensated dynamic viscosity</li> <li>▪ Temp. compensated kinematic viscosity</li> <li>▪ Temperature</li> <li>▪ Volume flow</li> </ul>	
	<b>Measured variable status [from the factory] <sup>1)</sup></b>			
	Quality			Good
	Quality substatus			Ok
	Coding (hex)			0x80 to 0x83
	Status signal			S
	Diagnostic behavior			Warning

1) Diagnostic behavior can be changed. This causes the overall status of the measured variable to change.

Diagnostic information		Remedy instructions	Influenced measured variables	
No.	Short text			
912	Inhomogeneous	1. Check process cond. 2. Increase system pressure <sup>1)</sup>	<ul style="list-style-type: none"> <li>▪ Carrier mass flow</li> <li>▪ Concentration</li> <li>▪ Density</li> <li>▪ Dynamic viscosity</li> <li>▪ Kinematic viscosity</li> <li>▪ Mass flow</li> <li>▪ Sensor integrity</li> <li>▪ Reference density</li> <li>▪ Corrected volume flow</li> <li>▪ Target mass flow</li> <li>▪ Temp. compensated dynamic viscosity</li> <li>▪ Temp. compensated kinematic viscosity</li> <li>▪ Temperature</li> <li>▪ Volume flow</li> </ul>	
	<b>Measured variable status [from the factory] <sup>1)</sup></b>			
	Quality			Good
	Quality substatus			Ok
	Coding (hex)			0x80 to 0x83
	Status signal			S
	Diagnostic behavior			Warning

1) Diagnostic behavior can be changed. This causes the overall status of the measured variable to change.



Diagnostic information		Remedy instructions	Influenced measured variables	
No.	Short text			
913	Medium unsuitable	1. Check process conditions 2. Check electronic modules or sensor	<ul style="list-style-type: none"> <li>■ Carrier mass flow</li> <li>■ Concentration</li> <li>■ Density</li> <li>■ Dynamic viscosity</li> <li>■ Kinematic viscosity</li> <li>■ Mass flow</li> <li>■ Sensor integrity</li> <li>■ Reference density</li> <li>■ Corrected volume flow</li> <li>■ Target mass flow</li> <li>■ Temp. compensated dynamic viscosity</li> <li>■ Temp. compensated kinematic viscosity</li> <li>■ Temperature</li> <li>■ Volume flow</li> </ul>	
	<b>Measured variable status [from the factory] <sup>1)</sup></b>			
	Quality			Good
	Quality substatus			Ok
	Coding (hex)			0x80 to 0x83
	Status signal			S
	Diagnostic behavior			Warning

1) Diagnostic behavior can be changed. This causes the overall status of the measured variable to change.

Diagnostic information		Remedy instructions	Influenced measured variables	
No.	Short text			
944	Monitoring failed	Check process conditions for Heartbeat Monitoring	<ul style="list-style-type: none"> <li>■ Carrier mass flow</li> <li>■ Concentration</li> <li>■ Density</li> <li>■ Mass flow</li> <li>■ Sensor integrity</li> <li>■ Reference density</li> <li>■ Corrected volume flow</li> <li>■ Target mass flow</li> <li>■ Temperature</li> </ul>	
	<b>Measured variable status [from the factory] <sup>1)</sup></b>			
	Quality			Good
	Quality substatus			Ok
	Coding (hex)			0x80 to 0x83
	Status signal			S
	Diagnostic behavior			Warning

1) Diagnostic behavior can be changed. This causes the overall status of the measured variable to change.

Diagnostic information		Remedy instructions	Influenced measured variables	
No.	Short text			
948	Tube damping too high	Check process conditions	<ul style="list-style-type: none"> <li>■ Carrier mass flow</li> <li>■ Concentration</li> <li>■ Density</li> <li>■ Dynamic viscosity</li> <li>■ Kinematic viscosity</li> <li>■ Mass flow</li> <li>■ Sensor integrity</li> <li>■ Reference density</li> <li>■ Corrected volume flow</li> <li>■ Target mass flow</li> <li>■ Temp. compensated dynamic viscosity</li> <li>■ Temp. compensated kinematic viscosity</li> <li>■ Temperature</li> <li>■ Status</li> <li>■ Volume flow</li> </ul>	
	<b>Measured variable status [from the factory] <sup>1)</sup></b>			
	Quality			Good
	Quality substatus			Ok
	Coding (hex)			0x80 to 0x83
	Status signal			S
	Diagnostic behavior			Warning

1) Diagnostic behavior can be changed. This causes the overall status of the measured variable to change.

Diagnostic information		Remedy instructions	Influenced measured variables	
No.	Short text			
990	Special event 4	Contact service	<ul style="list-style-type: none"> <li>▪ Carrier mass flow</li> <li>▪ Concentration</li> <li>▪ Density</li> <li>▪ Dynamic viscosity</li> <li>▪ Kinematic viscosity</li> <li>▪ Mass flow</li> <li>▪ Sensor integrity</li> <li>▪ Reference density</li> <li>▪ Corrected volume flow</li> <li>▪ Target mass flow</li> <li>▪ Temp. compensated dynamic viscosity</li> <li>▪ Temp. compensated kinematic viscosity</li> <li>▪ Temperature</li> <li>▪ Status</li> <li>▪ Volume flow</li> </ul>	
	<b>Measured variable status</b>			
	Quality			Bad
	Quality substatus			Maintenance alarm
	Coding (hex)			0x24 to 0x27
	Status signal			F
	Diagnostic behavior			Alarm



Diagnostic information		Remedy instructions	Influenced measured variables	
No.	Short text			
991	Special event 8	Contact service	<ul style="list-style-type: none"> <li>▪ Carrier mass flow</li> <li>▪ Concentration</li> <li>▪ Density</li> <li>▪ Dynamic viscosity</li> <li>▪ Kinematic viscosity</li> <li>▪ Mass flow</li> <li>▪ Sensor integrity</li> <li>▪ Reference density</li> <li>▪ Corrected volume flow</li> <li>▪ Target mass flow</li> <li>▪ Temp. compensated dynamic viscosity</li> <li>▪ Temp. compensated kinematic viscosity</li> <li>▪ Temperature</li> <li>▪ Status</li> <li>▪ Volume flow</li> </ul>	
	<b>Measured variable status</b>			
	Quality			Bad
	Quality substatus			Maintenance alarm
	Coding (hex)			0x24 to 0x27
	Status signal			F
	Diagnostic behavior			Alarm



Diagnostic information		Remedy instructions	Influenced measured variables	
No.	Short text			
992	Special event 12	Contact service	<ul style="list-style-type: none"> <li>▪ Carrier mass flow</li> <li>▪ Concentration</li> <li>▪ Density</li> <li>▪ Dynamic viscosity</li> <li>▪ Kinematic viscosity</li> <li>▪ Mass flow</li> <li>▪ Sensor integrity</li> <li>▪ Reference density</li> <li>▪ Corrected volume flow</li> <li>▪ Target mass flow</li> <li>▪ Temp. compensated dynamic viscosity</li> <li>▪ Temp. compensated kinematic viscosity</li> <li>▪ Temperature</li> <li>▪ Status</li> <li>▪ Volume flow</li> </ul>	
	<b>Measured variable status [from the factory] <sup>1)</sup></b>			
	Quality			Good
	Quality substatus			Ok
	Coding (hex)			0x80 to 0x83
	Status signal			F
	Diagnostic behavior			Alarm

1) Diagnostic behavior can be changed. This causes the overall status of the measured variable to change.

## 12.7 Pending diagnostic events

The **Diagnostics** menu allows the user to view the current diagnostic event and the previous diagnostic event separately.

-  To call up the measures to rectify a diagnostic event:
  - Via Web browser →  82
  - Via "FieldCare" operating tool →  83

-  Other pending diagnostic events can be displayed in the **Diagnostic list** submenu →  107

**Navigation**  
 "Diagnostics" menu

### Structure of the submenu

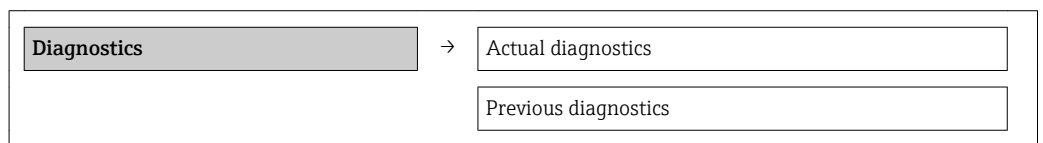



### Parameter overview with brief description

Parameter	Prerequisite	Description	User interface
Actual diagnostics	A diagnostic event has occurred.	Shows the current occurred diagnostic event along with its diagnostic information.  If two or more messages occur simultaneously, the message with the highest priority is shown on the display.	Symbol for diagnostic behavior, diagnostic code and short message.
Previous diagnostics	Two diagnostic events have already occurred.	Shows the diagnostic event that occurred prior to the current diagnostic event along with its diagnostic information.	Symbol for diagnostic behavior, diagnostic code and short message.

## 12.8 Diagnostic list

In the **Diagnostic list** submenu, up to 5 currently pending diagnostic events can be displayed along with the related diagnostic information. If more than 5 diagnostic events are pending, the events with the highest priority are shown on the display.

**Navigation path**  
**Diagnostics** menu → **Diagnostic list** submenu

-  To call up the measures to rectify a diagnostic event:
  - Via Web browser →  82
  - Via "FieldCare" operating tool →  83

## 12.9 Event logbook

### 12.9.1 Event history



A chronological overview of the event messages that have occurred is provided in the events list which contains a maximum of 20 message entries. This list can be displayed via FieldCare if necessary.

**Navigation path**



Edit toolbar: **F** → Additional functions → Events list

 For information on the Edit toolbar, see the FieldCare user interface

This event history includes entries for:

- Diagnostic events →  86
- Information events →  108

In addition to the operation time of its occurrence and possible troubleshooting measures, each event is also assigned a symbol that indicates whether the event has occurred or is ended:



- Diagnostic event
  - : Event has occurred
  - : Event has ended
- Information event
  - : Event has occurred

A chronological overview of the event messages that have occurred is provided in the **Events list** submenu.

**Navigation path**

"Diagnostics" menu → Event logbook → Events list

 To call up the measures to rectify a diagnostic event:

- Via Web browser →  82
- Via "FieldCare" operating tool →  83

 For filtering the displayed event messages →  108

**12.9.2 Filtering the event logbook**

Using the **Filter options** parameter, you can define which category of event messages is displayed in the **Events list** submenu.

**Navigation path**

"Diagnostics" menu → Event logbook → Filter options

**Filter categories**

- All
- Failure (F)
- Function check (C)
- Out of specification (S)
- Maintenance required (M)
- Information (I)

**12.9.3 Overview of information events**

Unlike a diagnostic event, an information event is displayed in the event logbook only and not in the diagnostic list.

Info number	Info name
I1000	----- (Device ok)
I1089	Power on
I1090	Configuration reset
I1091	Configuration changed
I1111	Density adjust failure
I1137	Electronic changed
I1151	History reset
I1155	Reset electronic temperature

Info number	Info name
I1157	Memory error event list
I1185	Display backup done
I1186	Restore via display done
I1187	Settings downloaded with display
I1188	Display data cleared
I1189	Backup compared
I1209	Density adjustment ok
I1221	Zero point adjust failure
I1222	Zero point adjustment ok
I1256	Display: access status changed
I1335	Firmware changed
I1361	Web server login failed
I1397	Fieldbus: access status changed
I1398	CDI: access status changed
I1444	Device verification passed
I1445	Device verification failed
I1446	Device verification active
I1447	Record application reference data
I1448	Application reference data recorded
I1449	Recording application ref. data failed
I1450	Monitoring off
I1451	Monitoring on
I1457	Measured error verification failed
I1459	I/O module verification failed
I1460	Sensor integrity verification failed
I1461	Sensor verification failed
I1462	Sensor electronic module verific. failed
I1512	Download started
I1513	Download finished
I1514	Upload started
I1515	Upload finished
I1627	Web server login successful
I1631	Web server access changed
I1649	Hardware write protection activated
I1650	Hardware write protection deactivated

## 12.10 Resetting the measuring device

Using the **Device reset** parameter it is possible to reset the entire device configuration or some of the configuration to a defined state.

**Navigation**

"Setup" menu → Advanced setup → Administration → Device reset

▶ Administration

Define access code

Device reset

**Parameter overview with brief description**

Parameter	Description	Selection	Factory setting
Device reset	Reset the device configuration - either entirely or in part - to a defined state.	<ul style="list-style-type: none"> <li>■ Cancel</li> <li>■ To delivery settings</li> <li>■ Restart device</li> <li>■ Delete factory data</li> </ul>	Cancel

**12.10.1 Function scope of the "Device reset" parameter**

Options	Description
Cancel	No action is executed and the user exits the parameter.
To delivery settings	Every parameter for which a customer-specific default setting was ordered is reset to this customer-specific value. All other parameters are reset to the factory setting.
Restart device	The restart resets every parameter whose data are in the volatile memory (RAM) to the factory setting (e.g. measured value data). The device configuration remains unchanged.
History reset	Every parameter is reset to the factory setting.

**12.11 Device information**

The **Device information** submenu contains all the parameters that display different information for identifying the device.

**Navigation**

"Diagnostics" menu → Device information

▶ Device information

Device tag

Serial number





Firmware version

Device name

Order code



Extended order code 1
Extended order code 2
Extended order code 3
ENP version

### Parameter overview with brief description

Parameter	Description	User interface	Factory setting
Device tag	Display the name for the measuring point.	Max. 32 characters such as letters, numbers or special characters (e.g. @, %, /)	Promass 100 PNIO
Serial number	Shows the serial number of the measuring device.	A maximum of 11-digit character string comprising letters and numbers.	–
Firmware version	Shows the device firmware version installed.	Character string in the format xx.yy	01.00
Device name	Shows the name of the transmitter.  The name can be found on the nameplate of the transmitter.	Promass 100	–
Order code	Shows the device order code.  The order code can be found on the nameplate of the sensor and transmitter in the "Order code" field.	Character string composed of letters, numbers and certain punctuation marks (e.g. /).	–
Extended order code 1	Shows the 1st part of the extended order code.  The extended order code can also be found on the nameplate of the sensor and transmitter in the "Ext. ord. cd." field.	Character string	–
Extended order code 2	Shows the 2nd part of the extended order code.  The extended order code can also be found on the nameplate of the sensor and transmitter in the "Ext. ord. cd." field.	Character string	–
Extended order code 3	Shows the 3rd part of the extended order code.  The extended order code can also be found on the nameplate of the sensor and transmitter in the "Ext. ord. cd." field.	Character string	–
ENP version	Shows the version of the electronic nameplate (ENP).	Character string	2.02.00

## 12.12 Firmware history

Release date	Firmware version	Order code for "Firmware version"	Firmware changes	Documentation type	Documentation
12.2015	01.00.zz	Option 68	Original firmware	Operating Instructions	BA01432D/06/EN/01.15

-  Flashing the firmware to the current version is possible via the service interface (CDI).
-  For the compatibility of the firmware version with the installed device description files and operating tools, observe the information about the device in the "Manufacturer's information" document.
-  The manufacturer's information is available:
  - In the Downloads area of the Endress+Hauser web site: [www.endress.com](http://www.endress.com) → Downloads
  - Specify the following details:
    - Product root: e.g. 8E1B
    - Text search: Manufacturer's information
    - Media type: Documentation – Technical Documentation



## 13 Maintenance

### 13.1 Maintenance tasks

No special maintenance work is required.

#### 13.1.1 Exterior cleaning

When cleaning the exterior of measuring devices, always use cleaning agents that do not attack the surface of the housing or the seals.

#### 13.1.2 Interior cleaning

Observe the following points for CIP and SIP cleaning:

- Use only cleaning agents to which the process-wetted materials are adequately resistant.
- Observe the maximum permitted medium temperature for the measuring device  
→  129.

Observe the following point for cleaning with pigs:

Observe the inside diameter of the measuring tube and process connection.

### 13.2 Measuring and test equipment

Endress+Hauser offers a wide variety of measuring and test equipment, such as W@M or device tests.

 Your Endress+Hauser Sales Center can provide detailed information on the services.

 For a list of some of the measuring and test equipment, refer to the "Accessories" chapter of the "Technical Information" document for the device.

### 13.3 Endress+Hauser services

Endress+Hauser offers a wide variety of services for maintenance such as recalibration, maintenance service or device tests.

 Your Endress+Hauser Sales Center can provide detailed information on the services.

## 14 Repair

### 14.1 General notes

#### Repair and conversion concept

The Endress+Hauser repair and conversion concept provides for the following:

- The measuring devices have a modular design.
- Spare parts are grouped into logical kits with the associated Installation Instructions.
- Repairs are carried out by Endress+Hauser Service or by correspondingly trained customers.
- Certified devices can be converted into other certified devices by Endress+Hauser Service or at the factory only.

#### Notes for repair and conversion

For repair and modification of a measuring device, observe the following notes:

- Use only original Endress+Hauser spare parts.
- Carry out the repair according to the Installation Instructions.
- Observe the applicable standards, federal/national regulations, Ex documentation (XA) and certificates.
- Document every repair and each conversion and enter them into the *W@M* life cycle management database.

### 14.2 Spare parts

*W@M Device Viewer* ([www.endress.com/deviceviewer](http://www.endress.com/deviceviewer)):

All the spare parts for the measuring device, along with the order code, are listed here and can be ordered. If available, users can also download the associated Installation Instructions.

-  Measuring device serial number:
  - Is located on the nameplate of the device.
  - Can be read out via the **Serial number** parameter in the **Device information** submenu .

### 14.3 Endress+Hauser services

Endress+Hauser offers a wide range of services.

-  Your Endress+Hauser Sales Center can provide detailed information on the services.

### 14.4 Return

The measuring device must be returned if it is need of repair or a factory calibration, or if the wrong measuring device has been delivered or ordered. Legal specifications require Endress+Hauser, as an ISO-certified company, to follow certain procedures when handling products that are in contact with the medium.

To ensure safe, swift and professional device returns, please refer to the procedure and conditions for returning devices provided on the Endress+Hauser website at <http://www.endress.com/support/return-material>

## 14.5 Disposal

### 14.5.1 Removing the measuring device

1. Switch off the device.

2. **⚠ WARNING**

**Danger to persons from process conditions.**

- ▶ Beware of hazardous process conditions such as pressure in the measuring device, high temperatures or aggressive fluids.

Carry out the mounting and connection steps from the chapters "Mounting the measuring device" and "Connecting the measuring device" in the logically reverse sequence. Observe the safety instructions.

### 14.5.2 Disposing of the measuring device

**⚠ WARNING**

**Danger to personnel and environment from fluids that are hazardous to health.**

- ▶ Ensure that the measuring device and all cavities are free of fluid residues that are hazardous to health or the environment, e.g. substances that have permeated into crevices or diffused through plastic.

Observe the following notes during disposal:

- Observe valid federal/national regulations.
- Ensure proper separation and reuse of the device components.

## 15 Accessories



Various accessories, which can be ordered with the device or subsequently from Endress+Hauser, are available for the device. Detailed information on the order code in question is available from your local Endress+Hauser sales center or on the product page of the Endress+Hauser website: [www.endress.com](http://www.endress.com).

### 15.1 Device-specific accessories



#### 15.1.1 For the sensor

Accessories	Description
Heating jacket	<p>Is used to stabilize the temperature of the fluids in the sensor. Water, water vapor and other non-corrosive liquids are permitted for use as fluids. If using oil as a heating medium, please consult with Endress+Hauser.</p> <p> For details, see Operating Instructions BA00099D</p>

### 15.2 Service-specific accessories

Accessories	Description
Applicator	<p>Software for selecting and sizing Endress+Hauser measuring devices:</p> <ul style="list-style-type: none"> <li>■ Calculation of all the necessary data for identifying the optimum flowmeter: e.g. nominal diameter, pressure loss, accuracy or process connections.</li> <li>■ Graphic illustration of the calculation results</li> </ul> <p>Administration, documentation and access to all project-related data and parameters throughout the entire life cycle of a project.</p> <p>Applicator is available:</p> <ul style="list-style-type: none"> <li>■ Via the Internet: <a href="https://wapps.endress.com/applicator">https://wapps.endress.com/applicator</a></li> <li>■ On CD-ROM for local PC installation.</li> </ul>
W@M	<p>Life cycle management for your plant</p> <p>W@M supports you with a wide range of software applications over the entire process: from planning and procurement, to the installation, commissioning and operation of the measuring devices. All the relevant device information, such as the device status, spare parts and device-specific documentation, is available for every device over the entire life cycle.</p> <p>The application already contains the data of your Endress+Hauser device. Endress+Hauser also takes care of maintaining and updating the data records.</p> <p>W@M is available:</p> <ul style="list-style-type: none"> <li>■ Via the Internet: <a href="http://www.endress.com/lifecyclemanagement">www.endress.com/lifecyclemanagement</a></li> <li>■ On CD-ROM for local PC installation.</li> </ul>
FieldCare	<p>FDT-based plant asset management tool from Endress+Hauser.</p> <p>It can configure all smart field units in your system and helps you manage them. By using the status information, it is also a simple but effective way of checking their status and condition.</p> <p> For details, see Operating Instructions BA00027S and BA00059S</p>
DeviceCare	<p>Tool for connecting and configuring Endress+Hauser field devices.</p> <p> For details, see Innovation brochure IN01047S</p>

## 15.3 System components

Accessories	Description
Memograph M graphic display recorder	<p>The Memograph M graphic display recorder provides information on all relevant measured variables. Measured values are recorded correctly, limit values are monitored and measuring points analyzed. The data are stored in the 256 MB internal memory and also on a SD card or USB stick.</p> <p> For details, see "Technical Information" TI00133R and Operating Instructions BA00247R</p>
iTEMP	<p>The temperature transmitters can be used in all applications and are suitable for the measurement of gases, steam and liquids. They can be used to read in the fluid temperature.</p> <p> For details, see "Fields of Activity", FA00006T</p>

## 16 Technical data

### 16.1 Application

The measuring device is suitable for flow measurement of liquids and gases only.

Depending on the version ordered, the measuring device can also measure potentially explosive, flammable, poisonous and oxidizing media.

To ensure that the device remains in proper operating condition for its service life, use the measuring device only for media against which the process-wetted materials are adequately resistant.

### 16.2 Function and system design

---

Measuring principle	Mass flow measurement based on the Coriolis measuring principle
---------------------	---

---

Measuring system	<p>The device consists of a transmitter and a sensor.</p> <p>The device is available as a compact version: The transmitter and sensor form a mechanical unit.</p> <p>For information on the structure of the device →  12</p>
------------------	--

## 16.3 Input

Measured variable

### Direct measured variables

- Mass flow
- Density
- Temperature

### Calculated measured variables

- Volume flow
- Corrected volume flow
- Reference density

Measuring range

### Measuring ranges for liquids

DN		Measuring range full scale values $\dot{m}_{\min(F)}$ to $\dot{m}_{\max(F)}$	
[mm]	[in]	[kg/h]	[lb/min]
8	$\frac{3}{8}$	0 to 2 000	0 to 73.50
15	$\frac{1}{2}$	0 to 6 500	0 to 238.9
25	1	0 to 18 000	0 to 661.5
40	$1\frac{1}{2}$	0 to 45 000	0 to 1 654
50	2	0 to 70 000	0 to 2 573

### Recommended measuring range

"Flow limit" section →  130

Operable flow range

Over 1000 : 1.



Flow rates above the preset full scale value are not overridden by the electronics unit, with the result that the totalizer values are registered correctly.

Input signal

### External measured values

To increase the accuracy of certain measured variables or to calculate the corrected volume flow for gases, the automation system can continuously write different measured values to the measuring device:

- Operating pressure to increase accuracy (Endress+Hauser recommends the use of a pressure measuring device for absolute pressure, e.g. Cerabar M or Cerabar S)
- Medium temperature to increase accuracy (e.g. iTEMP)
- Reference density for calculating the corrected volume flow for gases

 Various pressure transmitters and temperature measuring devices can be ordered from Endress+Hauser: see "Accessories" section →  117

It is recommended to read in external measured values to calculate the following measured variables:

- Mass flow
- Corrected volume flow

#### Digital communication

The measured values are written from the automation system to the measuring device via PROFINET.

## 16.4 Output

Output signal

**PROFINET**

<b>Standards</b>	In accordance with IEEE 802.3
------------------	-------------------------------

Signal on alarm

Depending on the interface, failure information is displayed as follows:

**PROFINET**

<b>Device diagnostics</b>	In accordance with "Application Layer protocol for decentral device periphery and distributed automation", version 2.3
---------------------------	--

**Local display**

<b>Plain text display</b>	With information on cause and remedial measures
<b>Backlight</b>	Red backlighting indicates a device error.

 Status signal as per NAMUR recommendation NE 107

**Operating tool**



- Via digital communication:  
PROFINET
- Via service interface
- Via Web server

<b>Plain text display</b>	With information on cause and remedial measures
---------------------------	---

**Web browser**

<b>Plain text display</b>	With information on cause and remedial measures
---------------------------	---

**Light emitting diodes (LED)**

<b>Status information</b>	<p>Status indicated by various light emitting diodes</p> <p>The following information is displayed depending on the device version:</p> <ul style="list-style-type: none"> <li>▪ Supply voltage active</li> <li>▪ Data transmission active</li> <li>▪ Device alarm/error has occurred</li> <li>▪ PROFINET network available</li> <li>▪ PROFINET connection established</li> <li>▪ PROFINET blinking feature</li> </ul> <p> Diagnostic information via light emitting diodes →  79</p>
---------------------------	---

Low flow cut off

The switch points for low flow cut off are user-selectable.

Galvanic isolation

The following connections are galvanically isolated from each other:



- Outputs
- Power supply



## Protocol-specific data

**PROFINET**

<b>Protocol</b>	"Application layer protocol for decentral device periphery and distributed automation", version 2.3
<b>Conformity class</b>	B
<b>Communication type</b>	100 MBit/s
<b>Device profile</b>	Application interface identifier 0xF600 Generic device
<b>Manufacturer ID</b>	0x11
<b>Device type ID</b>	0x844A
<b>Device description files (GSD, DTM)</b>	Information and files under: <ul style="list-style-type: none"> <li>▪ <a href="http://www.endress.com">www.endress.com</a> On the product page for the device: Documents/Software → Device drivers</li> <li>▪ <a href="http://www.profibus.org">www.profibus.org</a></li> </ul>
<b>Baud rates</b>	Automatic 100 Mbit/s with full-duplex detection
<b>Cycle times</b>	From 8 ms
<b>Polarity</b>	Auto-polarity for automatic correction of crossed TxD and RxD pairs
<b>Supported connections</b>	<ul style="list-style-type: none"> <li>▪ 1 x AR (Application Relation)</li> <li>▪ 1 x Input CR (Communication Relation)</li> <li>▪ 1 x Output CR (Communication Relation)</li> <li>▪ 1 x Alarm CR (Communication Relation)</li> </ul>
<b>Configuration options for measuring device</b>	<ul style="list-style-type: none"> <li>▪ DIP switches on the electronics module, for device name assignment (last part)</li> <li>▪ Manufacturer-specific software (FieldCare, DeviceCare)</li> <li>▪ Web browser</li> <li>▪ Device master file (GSD), can be read out via the integrated Web server of the measuring device</li> </ul>
<b>Configuration of the device name</b>	<ul style="list-style-type: none"> <li>▪ DIP switches on the electronics module, for device name assignment (last part)</li> <li>▪ DCP protocol</li> </ul>

<p><b>Output values</b> (from measuring device to automation system)</p>	<p><b>Analog Input module (slot 1 to 14)</b></p> <ul style="list-style-type: none"> <li>▪ Mass flow</li> <li>▪ Volume flow</li> <li>▪ Corrected volume flow</li> <li>▪ Target mass flow</li> <li>▪ Carrier mass flow</li> <li>▪ Density</li> <li>▪ Reference density</li> <li>▪ Concentration</li> <li>▪ Temperature</li> <li>▪ Carrier pipe temperature</li> <li>▪ Electronic temperature</li> <li>▪ Oscillation frequency</li> <li>▪ Oscillation amplitude</li> <li>▪ Frequency fluctuation</li> <li>▪ Oscillation damping</li> <li>▪ Tube damping fluctuation</li> <li>▪ Signal asymmetry</li> <li>▪ Exciter current</li> </ul> <p><b>Discrete Input module (slot 1 to 14)</b></p> <ul style="list-style-type: none"> <li>▪ Empty pipe detection</li> <li>▪ Low flow cut off</li> </ul> <p><b>Diagnostics Input module (slot 1 to 14)</b></p> <ul style="list-style-type: none"> <li>▪ Last diagnostics</li> <li>▪ Current diagnosis</li> </ul> <p><b>Totalizer 1 to 3 (slot 15 to 17)</b></p> <ul style="list-style-type: none"> <li>▪ Mass flow</li> <li>▪ Volume flow</li> <li>▪ Corrected volume flow</li> </ul> <p><b>Heartbeat Verification module (fixed assignment)</b> Verification status (slot 23)</p> <p> The range of options increases if the measuring device has one or more application packages.</p>
<p><b>Input values</b> (from automation system to measuring device)</p>	<p><b>Analog Output module (fixed assignment)</b></p> <ul style="list-style-type: none"> <li>▪ External pressure (slot 18)</li> <li>▪ External temperature (slot 19)</li> <li>▪ External reference density (slot 20)</li> </ul> <p><b>Discrete Output module (fixed assignment)</b></p> <ul style="list-style-type: none"> <li>▪ Activate/deactivate positive zero return (slot 21)</li> <li>▪ Perform zero point adjustment (slot 22)</li> </ul> <p><b>Totalizer 1 to 3 (slot 15 to 17)</b></p> <ul style="list-style-type: none"> <li>▪ Totalize</li> <li>▪ Reset and hold</li> <li>▪ Preset and hold</li> <li>▪ Stop</li> <li>▪ Operating mode configuration:             <ul style="list-style-type: none"> <li>– Net flow total</li> <li>– Forward flow total</li> <li>– Reverse flow total</li> </ul> </li> </ul> <p><b>Heartbeat Verification module (fixed assignment)</b> Start verification (slot 23)</p> <p> The range of options increases if the measuring device has one or more application packages.</p>
<p><b>Supported functions</b></p>	<ul style="list-style-type: none"> <li>▪ Identification &amp; Maintenance Simple device identification via:             <ul style="list-style-type: none"> <li>– Control system</li> <li>– Nameplate</li> </ul> </li> <li>▪ Measured value status The process variables are communicated with a measured value status</li> <li>▪ Blinking feature via the onsite display for simple device identification and assignment</li> </ul>

*Administration of software options*

Input/output value	Process variable	Category	Slot
Output value	Mass flow	Process variable	1...14
	Volume flow		
	Corrected volume flow		
	Density		
	Reference density		
	Temperature		
	Electronic temperature		
	Oscillation frequency		
	Frequency fluctuation		
	Oscillation damping		
	Oscillation frequency		
	Signal asymmetry		
	Exciter current		
	Empty pipe detection		
	Low flow cut off		
Current device diagnostics			
Previous device diagnostics			
Output value	Target mass flow	Concentration <sup>1)</sup>	1...14
	Carrier mass flow		
	Concentration		
Output value	Carrier pipe temperature	Heartbeat <sup>2)</sup>	1...14
	Oscillation damping 1		
	Oscillation frequency 1		
	Oscillation amplitude 0		
	Oscillation amplitude 1		
	Frequency fluctuation 1		
	Tube damping fluctuation 1		
	Exciter current 1		
Input value	External density	Process monitoring	18
	External temperature		19
	External reference density		20
	Flow override		21
	Zero point adjustment		22
	Verification status	Heartbeat Verification <sup>2)</sup>	23

1) Only available with the "Concentration" application package.

2) Only available with the "Heartbeat" application package.

*Startup configuration*

<p>Startup configuration (NSU)</p>	<p>If startup configuration is enabled, the configuration of the most important device parameters is taken from the automation system and used.</p> <p>The following configuration is taken from the automation system:</p> <ul style="list-style-type: none"> <li>▪ Management             <ul style="list-style-type: none"> <li>- Software revision</li> <li>- Write protection</li> </ul> </li> <li>▪ System units             <ul style="list-style-type: none"> <li>- Mass flow</li> <li>- Mass</li> <li>- Volume flow</li> <li>- Volume</li> <li>- Corrected volume flow</li> <li>- Corrected volume</li> <li>- Density</li> <li>- Reference density</li> <li>- Temperature</li> <li>- Pressure</li> </ul> </li> <li>▪ Concentration application package             <ul style="list-style-type: none"> <li>- Coefficients A0 to A4</li> <li>- Coefficients B1 to B3</li> </ul> </li> <li>▪ Sensor adjustment</li> <li>▪ Process param.             <ul style="list-style-type: none"> <li>- Damping (flow, density, temperature)</li> <li>- Flow override</li> </ul> </li> <li>▪ Low flow cut off             <ul style="list-style-type: none"> <li>- Assign process variable</li> <li>- Switch-on/switch-off point</li> <li>- Pressure shock suppression</li> </ul> </li> <li>▪ Empty pipe detection             <ul style="list-style-type: none"> <li>- Assign process variable</li> <li>- Limit values</li> <li>- Response time</li> <li>- Max. damping</li> </ul> </li> <li>▪ Corrected volume flow calculation             <ul style="list-style-type: none"> <li>- External reference density</li> <li>- Fixed reference density</li> <li>- Reference temperature</li> <li>- Linear expansion coefficient</li> <li>- Square expansion coefficient</li> </ul> </li> <li>▪ Measuring mode             <ul style="list-style-type: none"> <li>- Medium</li> <li>- Gas type</li> <li>- Reference sound velocity</li> <li>- Temperature coefficient sound velocity</li> </ul> </li> <li>▪ External compensation             <ul style="list-style-type: none"> <li>- Pressure compensation</li> <li>- Pressure value</li> <li>- External pressure</li> </ul> </li> <li>▪ Diagnostic settings</li> <li>▪ Diagnostic behavior for diverse diagnostic information</li> </ul>
------------------------------------	--

## 16.5 Power supply

Terminal assignment →  29

Supply voltage The power unit must be tested to ensure it meets safety requirements (e.g. PELV, SELV).

## Power consumption

**Transmitter**

Order code for "Output"	Maximum Power consumption
Option R: PROFINET	3.5 W

## Current consumption

**Transmitter**

Order code for "Output"	Maximum Current consumption	Maximum switch-on current
Option R: PROFINET	145 mA	18 A (< 0.125 ms)

## Power supply failure

- Totalizers stop at the last value measured.
- Configuration is retained in the plug-in memory (HistoROM DAT).
- Error messages (incl. total operated hours) are stored.

## Electrical connection

→  30

## Potential equalization

→  32

## Terminals

**Transmitter**Spring terminals for wire cross-sections 0.5 to 2.5 mm<sup>2</sup> (20 to 14 AWG)

## Cable entries

- Cable gland: M20 × 1.5 with cable  $\phi$ 6 to 12 mm (0.24 to 0.47 in)
- Thread for cable entry:
  - NPT ½"
  - G ½"
  - M20

## Cable specification

→  28

## 16.6 Performance characteristics

## Reference operating conditions

- Error limits based on ISO 11631
- Water with +15 to +45 °C (+59 to +113 °F) at 2 to 6 bar (29 to 87 psi)
- Specifications as per calibration protocol
- Accuracy based on accredited calibration rigs that are traced to ISO 17025.

To obtain measured errors, use the *Applicator* sizing tool →  116 →  138

## Maximum measured error

o.r. = of reading; 1 g/cm<sup>3</sup> = 1 kg/l; T = medium temperature**Base accuracy**Design fundamentals →  128*Mass flow and volume flow (liquids)*

±0.10 % o.r.

*Density (liquids)*

Under reference operating conditions		Standard density calibration <sup>1)</sup>		Wide-range density specification <sup>2) 3)</sup>	
[g/cm <sup>3</sup> ]	[lbs/in <sup>3</sup> ]	[g/cm <sup>3</sup> ]	[lbs/in <sup>3</sup> ]	[g/cm <sup>3</sup> ]	[lbs/in <sup>3</sup> ]
±0.0005	±0.00097	±0.01	±0.019	±0.002	±0.0039

- 1) Valid over the entire temperature and density range
- 2) Valid range for special density calibration: 0 to 2 g/cm<sup>3</sup>, +5 to +80 °C (+41 to +176 °F)
- 3) Order code for "Application package", option EF "Special density and concentration "

*Temperature*

$\pm 0.5 \text{ °C} \pm 0.005 \cdot T \text{ °C} (\pm 0.9 \text{ °F} \pm 0.003 \cdot (T - 32) \text{ °F})$

**Zero point stability**

DN		Zero point stability	
[mm]	[in]	[kg/h]	[lb/min]
8	<sup>3</sup> / <sub>8</sub>	0.20	0.007
15	<sup>1</sup> / <sub>2</sub>	0.65	0.024
25	1	1.80	0.066
40	1 <sup>1</sup> / <sub>2</sub>	4.50	0.165
50	2	7.0	0.257

**Flow values**

Flow values as turndown parameter depending on nominal diameter.

*SI units*

DN	1:1	1:10	1:20	1:50	1:100	1:500
[mm]	[kg/h]	[kg/h]	[kg/h]	[kg/h]	[kg/h]	[kg/h]
8	2 000	200	100	40	20	4
15	6 500	650	325	130	65	13
25	18 000	1 800	900	360	180	36
40	45 000	4 500	2 250	900	450	90
50	70 000	7 000	3 500	1 400	700	140

*US units*

DN	1:1	1:10	1:20	1:50	1:100	1:500
[inch]	[lb/min]	[lb/min]	[lb/min]	[lb/min]	[lb/min]	[lb/min]
<sup>3</sup> / <sub>8</sub>	73.50	7.350	3.675	1.470	0.735	0.147
<sup>1</sup> / <sub>2</sub>	238.9	23.89	11.95	4.778	2.389	0.478
1	661.5	66.15	33.08	13.23	6.615	1.323
1 <sup>1</sup> / <sub>2</sub>	1 654	165.4	82.70	33.08	16.54	3.308
2	2 573	257.3	128.7	51.46	25.73	5.146



Repeatability

o.r. = of reading; 1 g/cm<sup>3</sup> = 1 kg/l; T = medium temperature

**Base repeatability**

**Mass flow and volume flow (liquids)**

±0.05 % o.r.

 Design fundamentals →  128

**Density (liquids)**

±0.00025 g/cm<sup>3</sup>

**Temperature**

±0.25 °C ± 0.0025 · T °C (±0.45 °F ± 0.0015 · (T-32) °F)

Response time

The response time depends on the configuration (damping).

Influence of medium temperature

**Mass flow and volume flow**

When there is a difference between the temperature for zero point adjustment and the process temperature, the typical measured error of the sensor is ±0.0002 % of the full scale value/°C (±0.0001 % of the full scale value/°F).

**Density**

When there is a difference between the density calibration temperature and the process temperature, the typical measured error of the sensor is ±0.0001 g/cm<sup>3</sup> /°C (±0.00005 g/cm<sup>3</sup> /°F). Field density calibration is possible.

**Wide-range density specification (special density calibration)**

If the process temperature is outside the valid range (→  125) the measured error is ±0.0001 g/cm<sup>3</sup> /°C (±0.00005 g/cm<sup>3</sup> /°F)

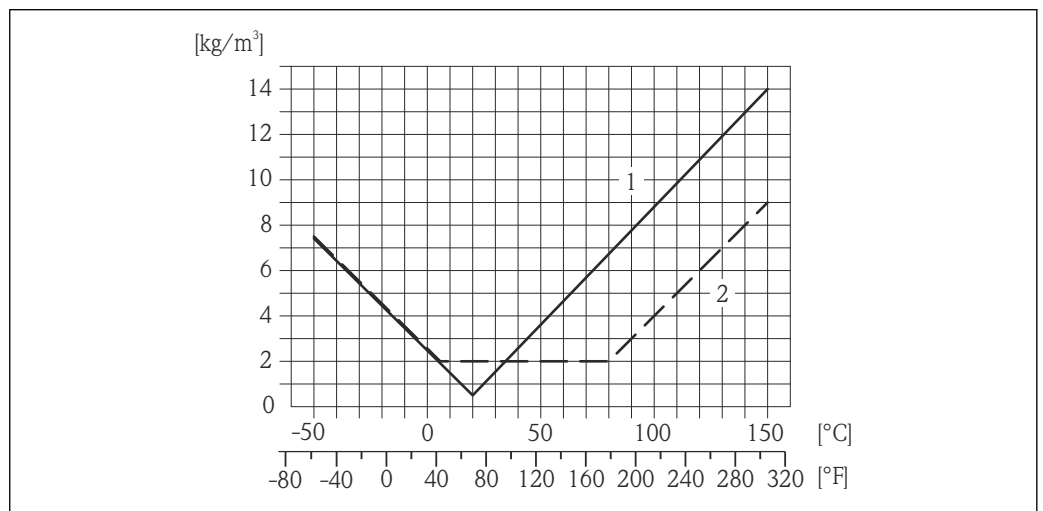

A0016611

- 1 Field density calibration, for example at +20 °C (+68 °F)
- 2 Special density calibration

**Temperature**

±0.005 · T °C (± 0.005 · (T - 32) °F)

Influence of medium pressure

The table below shows the effect on accuracy of mass flow due to a difference between calibration pressure and process pressure.

o.r. = of reading

DN		[% o.r./bar]	[% o.r./psi]
[mm]	[in]		
8	3/8	-0.002	-0.0001
15	1/2	-0.006	-0.0004
25	1	-0.005	-0.0003
40	1 1/2	-0.007	-0.0005
50	2	-0.006	-0.0004

Design fundamentals

o.r. = of reading, o.f.s. = of full scale value

BaseAccu = base accuracy in % o.r., BaseRepeat = base repeatability in % o.r.

MeasValue = measured value; ZeroPoint = zero point stability

Calculation of the maximum measured error as a function of the flow rate

Flow rate	Maximum measured error in % o.r.
$\geq \frac{\text{ZeroPoint}}{\text{BaseAccu}} \cdot 100$ <small>A0021332</small>	$\pm \text{BaseAccu}$ <small>A0021339</small>
$< \frac{\text{ZeroPoint}}{\text{BaseAccu}} \cdot 100$ <small>A0021333</small>	$\pm \frac{\text{ZeroPoint}}{\text{MeasValue}} \cdot 100$ <small>A0021334</small>

Calculation of the maximum repeatability as a function of the flow rate

Flow rate	Maximum repeatability in % o.r.
$\geq \frac{1/2 \cdot \text{ZeroPoint}}{\text{BaseRepeat}} \cdot 100$ <small>A0021335</small>	$\pm \text{BaseRepeat}$ <small>A0021340</small>
$< \frac{1/2 \cdot \text{ZeroPoint}}{\text{BaseRepeat}} \cdot 100$ <small>A0021336</small>	$\pm 1/2 \cdot \frac{\text{ZeroPoint}}{\text{MeasValue}} \cdot 100$ <small>A0021337</small>

Example for max. measured error

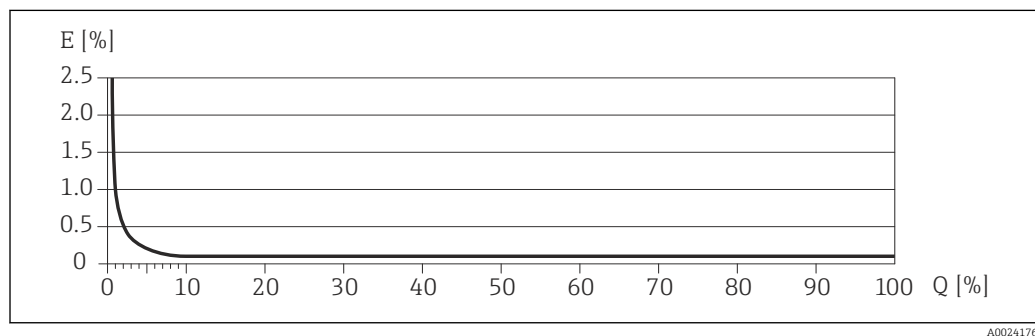

E Error: Maximum measured error as % o.r. (example)  
 Q Flow rate as %

## 16.7 Installation



"Mounting requirements" → 19



## 16.8 Environment

Ambient temperature range

### Temperature tables

-  Observe the interdependencies between the permitted ambient and fluid temperatures when operating the device in hazardous areas.
-  For detailed information on the temperature tables, see the separate document entitled "Safety Instructions" (XA) for the device.

Storage temperature

–40 to +80 °C (–40 to +176 °F), preferably at +20 °C (+68 °F) (standard version)  
–50 to +80 °C (–58 to +176 °F) (Order code for "Test, certificate", option JM)

Climate class

DIN EN 60068-2-38 (test Z/AD)

Degree of protection

### Transmitter and sensor

- As standard: IP66/67, type 4X enclosure
- With the order code for "Sensor options", option **CM**: IP69K can also be ordered
- When housing is open: IP20, type 1 enclosure
- Display module: IP20, type 1 enclosure

Vibration resistance

### Compact version

- Vibration, sinusoidal according to IEC 60068-2-6
  - 2 to 8.4 Hz, 3.5 mm peak
  - 8.4 to 2 000 Hz, 1 g peak
- Vibration broad-band random, according to IEC 60068-2-64
  - 10 to 200 Hz, 0.003 g<sup>2</sup>/Hz
  - 200 to 2 000 Hz, 0.001 g<sup>2</sup>/Hz
  - Total: 1.54 g rms

Shock resistance

### Compact version

Shock, half-sine according to IEC 60068-2-27  
6 ms 30 g

Shock resistance

### Compact version

Rough handling shocks according to IEC 60068-2-31

Electromagnetic compatibility (EMC)

- According to IEC/EN 61326
- Complies with emission limits for industry as per EN 55011 (Class A)

 For details, refer to the Declaration of Conformity.

## 16.9 Process

Medium temperature range

### Sensor

–50 to +150 °C (–58 to +302 °F)

### Seals

No internal seals

Density 0 to 5 000 kg/m<sup>3</sup> (0 to 312 lb/cf)

Pressure-temperature ratings  An overview of the pressure-temperature ratings for the process connections is provided in the "Technical Information" document

Secondary containment pressure rating The sensor housing is filled with dry nitrogen and protects the electronics and mechanics inside.  
The following secondary containment pressure rating is only valid for a fully welded sensor housing and/or a device equipped with closed purge connections (never opened/as delivered).

DN		Secondary containment pressure rating (designed with a safety factor ≥ 4)		Secondary containment burst pressure	
[mm]	[in]	[bar]	[psi]	[bar]	[psi]
8	3/8	25	362	190	2755
15	1/2	25	362	175	2535
25	1	25	362	165	2930
40	1 1/2	25	362	152	2204
50	2	25	362	103	1493

 If there is a risk of measuring tube failure due to process characteristics, e.g. with corrosive fluids, we recommend the use of sensors whose secondary containment is equipped with special pressure monitoring connections (order code for "Sensor option", option CH "Purge connection").

With the help of these connections, the fluid collected in the secondary containment can be bled off in the event of tube failure. This is especially important in high-pressure gas applications. These connections can also be used for gas purging (gas detection).

Do not open the purge connections unless the containment can be filled immediately with a dry, inert gas. Use only low gauge pressure to purge. Maximum pressure: 5 bar (72.5 psi).

If a device fitted with purge connections is connected to the purge system, the maximum nominal pressure is determined by the purge system itself or by the device, depending on which component has the lower nominal pressure.

 For the dimensions and installation lengths of the device, see the "Technical Information" document, "Mechanical construction" section

Flow limit Select the nominal diameter by optimizing between the required flow range and permissible pressure loss.

 For an overview of the full scale values for the measuring range, see the "Measuring range" section

- The minimum recommended full scale value is approx. 1/20 of the maximum full scale value
- For the most common applications, 20 to 50 % of the maximum full scale value can be considered ideal
- Select a low full scale value for abrasive media (e.g. liquids with entrained solids): Flow velocity < 1 m/s (< 3 ft/s).
- For gas measurement the following rules apply:
  - The flow velocity in the measuring tubes should not exceed half the sound velocity (0.5 Mach).
  - The maximum mass flow depends on the density of the gas: Formula

---

Pressure loss



To calculate the pressure loss, use the *Applicator* sizing tool → 138

---

System pressure

→ 21

## 16.10 Mechanical construction

Design, dimensions



For the dimensions and installation lengths of the device, see the "Technical Information" document, "Mechanical construction" section

Weight

**Compact version**

*Weight in SI units*

All values (weight) refer to devices with EN/DIN PN 40 flanges. Weight information in [kg].

DN [mm]	Weight [kg]
8	11
15	13
25	19
40	35
50	58

*Weight in US units*

All values (weight) refer to devices with EN/DIN PN 40 flanges. Weight information in [lbs].

DN [in]	Weight [lbs]
3/8	24
1/2	29
1	42
1 1/2	77
2	128

Materials

**Transmitter housing**

- Order code for "Housing", option **A** "Compact, aluminum coated":  
Aluminum, AlSi10Mg, coated
- Order code for "Housing", option **B** "Compact, hygienic, stainless":  
Hygienic version, stainless steel 1.4301 (304)
- Order code for "Housing", option **C** "Ultra-compact, hygienic, stainless":  
Hygienic version, stainless steel 1.4301 (304)
- Window material for optional local display (→  134):
  - For order code for "Housing", option **A**: glass
  - For order code for "Housing", option **B** and **C**: plastic

**Cable entries/cable glands**

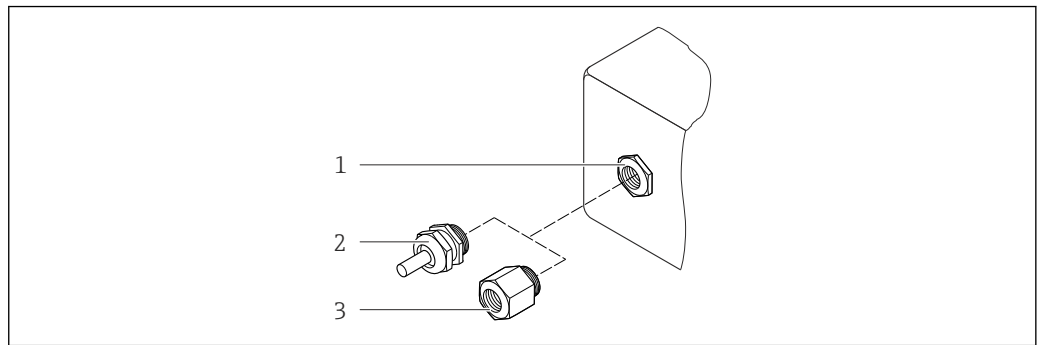

A0020640

16 Possible cable entries/cable glands

- 1 Cable entry in transmitter housing with internal thread M20 x 1.5
- 2 Cable gland M20 x 1.5
- 3 Adapter for cable entry with internal thread G 1/2" or NPT 1/2"

Order code for "Housing", option A "Compact, coated aluminum"

The various cable entries are suitable for hazardous and non-hazardous areas.

Cable entry/cable gland	Material
Cable gland M20 x 1.5	Nickel-plated brass
Adapter for cable entry with internal thread G 1/2"	
Adapter for cable entry with internal thread NPT 1/2"	

Order code for "Housing", option B "Compact, hygienic, stainless"

The various cable entries are suitable for hazardous and non-hazardous areas.

Cable entry/cable gland	Material
Cable gland M20 x 1.5	Stainless steel, 1.4404 (316L)
Adapter for cable entry with internal thread G 1/2"	
Adapter for cable entry with internal thread NPT 1/2"	

**Device plug**

Electrical connection	Material
Plug M12x1	<ul style="list-style-type: none"> <li>▪ Socket: Stainless steel, 1.4404 (316L)</li> <li>▪ Contact housing: Polyamide</li> <li>▪ Contacts: Gold-plated brass</li> </ul>

**Sensor housing**



- Acid and alkali-resistant outer surface
- Stainless steel 1.4301 (304)

**Measuring tubes**

Stainless steel, 1.4435 (316L)

**Process connections**

- Flanges according to EN 1092-1 (DIN 2501) / according to ASME B16.5 / according to JIS B2220:  
Stainless steel, 1.4404 (316/316L)
- All other process connections:  
Stainless steel, 1.4435 (316L)

 List of all available process connections →  134

**Seals**

Welded process connections without internal seals

**Safety Barrier Promass 100**

Housing: Polyamide

**Process connections**

- Fixed flange connections:
  - EN 1092-1 (DIN 2501) flange
  - EN 1092-1 (DIN 2512N) flange
  - ASME B16.5 flange
  - JIS B2220 flange
  - DIN 11864-2 Form A flange, DIN11866 series A, flat flange
- Clamp connections
  - Tri-Clamp (OD tubes), DIN 11866 series C
  - DIN 11864-3 Form A Clamp, DIN11866 series A, aseptic liner
  - DIN 32676 clamp, DIN11866 series A
  - ISO 2852 clamp, DIN11866 series B
- Threaded hygienic connection:
  - DIN 11851 threaded hygienic connection, DIN11866 series A
  - SMS 1145 threaded hygienic connection
  - ISO 2853 threaded hygienic connection, ISO2037
  - DIN 11864-1 Form A threaded hygienic connection, DIN11866 series A

 For information on the different materials used in the process connections →  132

**Surface roughness**

All data relate to parts in contact with fluid.

- $Ra_{max} = 0.8 \mu\text{m}$  (32  $\mu\text{in}$ ) mechanically polished
- $Ra_{max} = 0.4 \mu\text{m}$  (16  $\mu\text{in}$ ) mechanically polished

**16.11 Operability****Local display**

The local display is only available with the following device order code:  
Order code for "Display; Operation", option **B**: 4-line; lit, via communication

**Display element**

- 4-line liquid crystal display with 16 characters per line.
- White background lighting; switches to red in event of device errors.
- Format for displaying measured variables and status variables can be individually configured.
- Permitted ambient temperature for the display:  $-20$  to  $+60$  °C ( $-4$  to  $+140$  °F). The readability of the display may be impaired at temperatures outside the temperature range.

### Disconnecting the local display from the main electronics module

**i** In the case of the "Compact, aluminum coated" housing version, the local display must only be disconnected manually from the main electronics module. In the case of the "Compact, hygienic, stainless" and "Ultra-compact, hygienic, stainless" housing versions, the local display is integrated in the housing cover and is disconnected from the main electronics module when the housing cover is opened.

#### *"Compact, aluminum coated" housing version*

The local display is plugged onto the main electronics module. The electronic connection between the local display and main electronics module is established via a connecting cable.

For some work performed on the measuring device (e.g. electrical connection), it is advisable to disconnect the local display from the main electronics module:

1. Press in the side latches of the local display.
2. Remove the local display from the main electronics module. Pay attention to the length of the connecting cable when doing so.

Once the work is completed, plug the local display back on.

### Remote operation

#### Via PROFINET network

This communication interface is available in device versions with PROFINET.

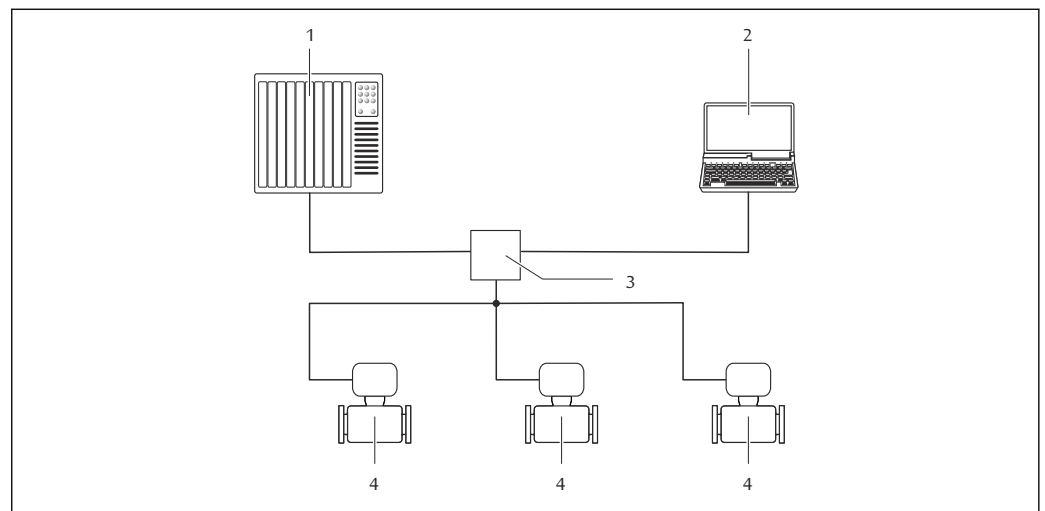

**17** Options for remote operation via PROFINET network

- 1 Automation system, e.g. Simatic S7 (Siemens)
- 2 Computer with Web browser (e.g. Internet Explorer) for accessing the integrated device Web server or with "FieldCare" operating tool with COM DTM "CDI Communication TCP/IP"
- 3 Switch, e.g. Scalance X204 (Siemens)
- 4 Measuring device

### Service interface

#### Via service interface (CDI-RJ45)

PROFINET

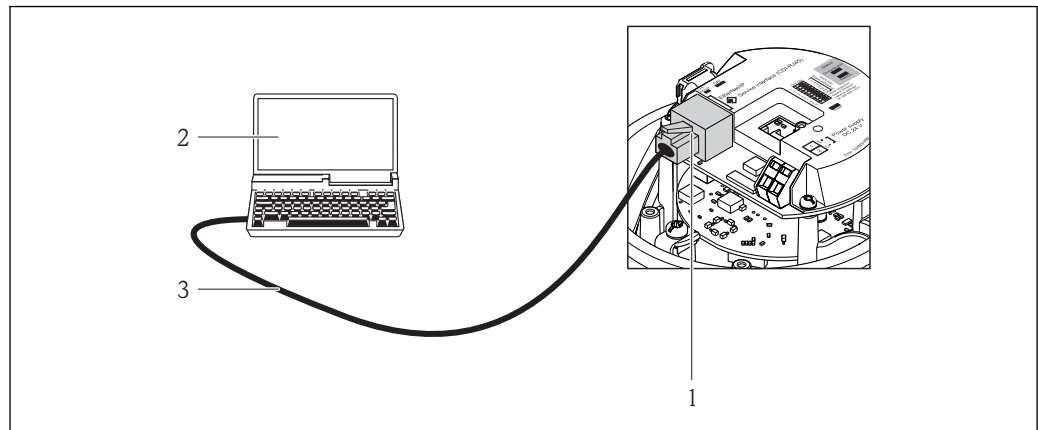

A0016940

18 Connection for order code for "Output", option R: PROFINET

- 1 Service interface (CDI -RJ45) and PROFINET interface of the measuring device with access to the integrated Web server
- 2 Computer with Web browser (e.g. Internet Explorer) for accessing the integrated device Web server or with "FieldCare" operating tool with COM DTM "CDI Communication TCP/IP"
- 3 Standard Ethernet connecting cable with RJ45 plug

Languages

Can be operated in the following languages:

Via "FieldCare" operating tool: English, German, French, Spanish, Italian, Chinese, Japanese

## 16.12 Certificates and approvals

CE mark

The measuring system is in conformity with the statutory requirements of the applicable EC Directives. These are listed in the corresponding EC Declaration of Conformity along with the standards applied.

Endress+Hauser confirms successful testing of the device by affixing to it the CE mark.

Ex approval

The devices are certified for use in hazardous areas and the relevant safety instructions are provided in the separate "Safety Instructions" (XA) document. Reference is made to this document on the nameplate.

Sanitary compatibility

- 3-A approval
- EHEDG-tested

Certification PROFINET

**PROFINET interface**

The measuring device is certified and registered by the PNO (PROFIBUS User Organization ). The measuring system meets all the requirements of the following specifications:

- Certified according to:
  - Test specification for PROFINET devices
  - PROFINET Security Level 1 – Net load test
- The device can also be operated with certified devices of other manufacturers (interoperability)



Pressure Equipment Directive	<ul style="list-style-type: none"> <li>■ With the PED/G1/x (x = category) marking on the sensor nameplate, Endress+Hauser confirms compliance with the "Essential Safety Requirements" specified in Annex I of the Pressure Equipment Directive 97/23/EC.</li> <li>■ Devices not bearing this marking (PED) are designed and manufactured according to good engineering practice. They meet the requirements of Art.3 Section 3 of the Pressure Equipment Directive 97/23/EC. The range of application is indicated in tables 6 to 9 in Annex II of the Pressure Equipment Directive.</li> </ul>
Other standards and guidelines	<ul style="list-style-type: none"> <li>■ EN 60529 Degrees of protection provided by enclosures (IP code)</li> <li>■ IEC/EN 60068-2-6 Environmental influences: Test procedure - Test Fc: vibrate (sinusoidal).</li> <li>■ IEC/EN 60068-2-31 Environmental influences: Test procedure - Test Ec: shocks due to rough handling, primarily for devices.</li> <li>■ EN 61010-1 Safety requirements for electrical equipment for measurement, control and laboratory use - general requirements</li> <li>■ IEC/EN 61326 Emission in accordance with Class A requirements. Electromagnetic compatibility (EMC requirements).</li> <li>■ NAMUR NE 21 Electromagnetic compatibility (EMC) of industrial process and laboratory control equipment</li> <li>■ NAMUR NE 32 Data retention in the event of a power failure in field and control instruments with microprocessors</li> <li>■ NAMUR NE 43 Standardization of the signal level for the breakdown information of digital transmitters with analog output signal.</li> <li>■ NAMUR NE 53 Software of field devices and signal-processing devices with digital electronics</li> <li>■ NAMUR NE 80 The application of the pressure equipment directive to process control devices</li> <li>■ NAMUR NE 105 Specifications for integrating fieldbus devices in engineering tools for field devices</li> <li>■ NAMUR NE 107 Self-monitoring and diagnosis of field devices</li> <li>■ NAMUR NE 131 Requirements for field devices for standard applications</li> <li>■ NAMUR NE 132 Coriolis mass meter</li> </ul>

## 16.13 Application packages

Many different application packages are available to enhance the functionality of the device. Such packages might be needed to address safety aspects or specific application requirements.

The application packages can be ordered with the device or subsequently from Endress+Hauser. Detailed information on the order code in question is available from your local Endress+Hauser sales center or on the product page of the Endress+Hauser website: [www.endress.com](http://www.endress.com).



Detailed information on the application packages:

- Special Documentation for the device
- Special Documentation for the device



Heartbeat Technology

Package	Description
Heartbeat Verification +Monitoring	<p><b>Heartbeat Monitoring</b> Continuously supplies data, which are characteristic of the measuring principle, to an external condition monitoring system for the purpose of preventive maintenance or process analysis. These data enable the operator to:</p> <ul style="list-style-type: none"> <li>▪ Draw conclusions - using these data and other information - about the impact process influences (such as corrosion, abrasion, buildup etc.) have on the measuring performance over time.</li> <li>▪ Schedule servicing in time.</li> <li>▪ Monitor the process or product quality, e.g. gas pockets.</li> </ul> <p><b>Heartbeat Verification</b> Meets the requirement for traceable verification to DIN ISO 9001:2008 Chapter 7.6 a) "Control of monitoring and measuring equipment".</p> <ul style="list-style-type: none"> <li>▪ Functional testing in the installed state without interrupting the process.</li> <li>▪ Traceable verification results on request, including a report.</li> <li>▪ Simple testing process via local operation or other operating interfaces.</li> <li>▪ Clear measuring point assessment (pass/fail) with high test coverage within the framework of manufacturer specifications.</li> <li>▪ Extension of calibration intervals according to operator's risk assessment.</li> </ul>

Concentration

Package	Description
Concentration measurement and special density	<p><b>Calculation and outputting of fluid concentrations</b> Many applications use density as a key measured value for monitoring quality or controlling processes. The device measures the density of the fluid as standard and makes this value available to the control system. The "Special Density" application package offers high-precision density measurement over a wide density and temperature range particularly for applications subject to varying process conditions. With the help of the "Concentration Measurement" application package, the measured density is used to calculate other process parameters:</p> <ul style="list-style-type: none"> <li>▪ Temperature-compensated density (reference density).</li> <li>▪ Percentage mass of the individual substances in a two-phase fluid. (Concentration in %).</li> <li>▪ Fluid concentration is output with special units (°Brix, °Baumé, °API, etc.) for standard applications.</li> </ul> <p>The measured values are output via the digital and analog outputs of the device.</p>

### 16.14 Accessories

 Overview of accessories available for order →  116

### 16.15 Supplementary documentation

 For an overview of the scope of the associated Technical Documentation, refer to the following:

- The *W@M Device Viewer* : Enter the serial number from the nameplate ([www.endress.com/deviceviewer](http://www.endress.com/deviceviewer))
- The *Endress+Hauser Operations App*: Enter the serial number from the nameplate or scan the 2-D matrix code (QR code) on the nameplate.

Standard documentation

#### Brief Operating Instructions

 Brief Operating Instructions containing the most important information for standard commissioning are supplied with the device.

**Technical Information**

Measuring device	Documentation code
Promass S 100	TI01037D

**Description of device parameters**

Measuring device	Documentation code
Promass 100	GP01037D



Supplementary device-  
dependent documentation**Safety Instructions**

Content	Documentation code
ATEX/IECEX Ex i	XA00159D
ATEX/IECEX Ex nA	XA01029D
cCSAus IS	XA00160D
INMETRO Ex i	XA01219D
INMETRO Ex nA	XA01220D
NEPSI Ex i	XA01249D
NEPSI Ex nA	XA01262D

**Special Documentation**

Content	Documentation code
Information on the Pressure Equipment Directive	SD00142D
Concentration Measurement	SD01152D
Heartbeat Technology	SD01153D

**Installation Instructions**

Contents	Documentation code
Installation Instructions for spare part sets	 Overview of accessories available for order →  116

# Index

## A

Accuracy . . . . .	125
Adapting the diagnostic behavior . . . . .	83
Application . . . . .	9, 118
Application packages . . . . .	137
Approvals . . . . .	136

## C

Cable entries	
Technical data . . . . .	125
Cable entry	
Degree of protection . . . . .	34
CE mark . . . . .	10, 136
Certificates . . . . .	136
Certification PROFIBUS . . . . .	136
Check	
Installation . . . . .	26
Checklist	
Post-connection check . . . . .	35
Post-installation check . . . . .	26
Cleaning	
Cleaning in place (CIP) . . . . .	113
Exterior cleaning . . . . .	113
Interior cleaning . . . . .	113
Sterilization in place (SIP) . . . . .	113
Climate class . . . . .	129
Commissioning . . . . .	55
Advanced settings . . . . .	63
Configuring the measuring device . . . . .	55
Connecting cable . . . . .	28
Connecting the measuring device . . . . .	30
Connection	
see Electrical connection	
Connection preparations . . . . .	30
Connection tools . . . . .	28
Current consumption . . . . .	125
Cyclic data transmission . . . . .	47

## D

Declaration of Conformity . . . . .	10
Define access code . . . . .	71
Degree of protection . . . . .	34, 129
Density . . . . .	130
Design	
Measuring device . . . . .	12
Design fundamentals	
Maximum measured error . . . . .	128
Repeatability . . . . .	128
Designated use . . . . .	9
Device components . . . . .	12
Device description files . . . . .	46
Device documentation	
Supplementary documentation . . . . .	8
Device locking, status . . . . .	73
Device master file	
GSD . . . . .	47

Device name	
Sensor . . . . .	15
Transmitter . . . . .	14
Device repair . . . . .	114
Device revision . . . . .	46
Device type ID . . . . .	46
DeviceCare . . . . .	45
Diagnostic information	
Design, description . . . . .	81, 83
FieldCare . . . . .	82
Light emitting diodes . . . . .	79
Overview . . . . .	86
Remedy information . . . . .	86
Web browser . . . . .	80
Diagnostic list . . . . .	107
DIP switches	
see Write protection switch	
Disabling write protection . . . . .	71
Display values	
For locking status . . . . .	73
Disposal . . . . .	115
Document	
Function . . . . .	6
Symbols used . . . . .	6
Document function . . . . .	6
Down pipe . . . . .	19

## E

Electrical connection	
Degree of protection . . . . .	34
Measuring device . . . . .	28
Operating tools	
Via PROFINET network . . . . .	43, 135
Via service interface (CDI-RJ45) . . . . .	43, 135
RSLogix 5000 . . . . .	43, 135
Web server . . . . .	43, 135
Electromagnetic compatibility . . . . .	129
Enabling write protection . . . . .	71
Endress+Hauser services	
Maintenance . . . . .	113
Repair . . . . .	114
Environment	
Shock resistance . . . . .	129
Storage temperature . . . . .	129
Vibration resistance . . . . .	129
Error messages	
see Diagnostic messages	
Event history . . . . .	107
Events list . . . . .	107
Ex approval . . . . .	136
Extended order code	
Sensor . . . . .	15
Transmitter . . . . .	14
Exterior cleaning . . . . .	113

- F**
- Field of application
    - Residual risks . . . . . 10
  - FieldCare . . . . . 44
    - Device description file . . . . . 46
    - Establishing a connection . . . . . 44
    - Function . . . . . 44
    - User interface . . . . . 45
  - Filtering the event logbook . . . . . 108
  - Firmware
    - Release date . . . . . 46
    - Version . . . . . 46
  - Firmware history . . . . . 112
  - Flash function . . . . . 55
  - Flow direction . . . . . 20, 25
  - Flow limit . . . . . 130
  - Function check . . . . . 55
  - Functions
    - see Parameters
- G**
- Galvanic isolation . . . . . 120
- H**
- Hardware write protection . . . . . 72
- I**
- I/O electronics module . . . . . 12, 31
  - Identifying the measuring device . . . . . 13
  - Incoming acceptance . . . . . 13
  - Influence
    - Medium pressure . . . . . 127
    - Medium temperature . . . . . 127
  - Information on the document . . . . . 6
  - Inlet runs . . . . . 21
  - Input . . . . . 119
  - Inspection
    - Received goods . . . . . 13
  - Inspection check
    - Connection . . . . . 35
  - Installation . . . . . 19
  - Installation conditions
    - Down pipe . . . . . 19
    - Mounting location . . . . . 19
    - Orientation . . . . . 20
    - System pressure . . . . . 21
    - Thermal insulation . . . . . 22
    - Vibrations . . . . . 24
  - Installation dimensions . . . . . 21
  - Interior cleaning . . . . . 113
- L**
- Languages, operation options . . . . . 136
  - Low flow cut off . . . . . 120
- M**
- Main electronics module . . . . . 12
  - Maintenance tasks . . . . . 113
  - Manufacturer ID . . . . . 46
  - Manufacturing date . . . . . 14, 15
  - Materials . . . . . 132
  - Maximum measured error . . . . . 125
  - Measured variables
    - see Process variables
  - Measuring and test equipment . . . . . 113
  - Measuring device
    - Configuration . . . . . 55
    - Conversion . . . . . 114
    - Design . . . . . 12
    - Disposal . . . . . 115
    - Mounting the sensor . . . . . 25
    - Preparing for electrical connection . . . . . 30
    - Preparing for mounting . . . . . 25
    - Removing . . . . . 115
    - Repair . . . . . 114
  - Measuring principle . . . . . 118
  - Measuring range
    - For liquids . . . . . 119
  - Measuring range, recommended . . . . . 130
  - Measuring system . . . . . 118
  - Media . . . . . 9
  - Medium pressure
    - Influence . . . . . 127
  - Medium temperature
    - Influence . . . . . 127
  - Menu
    - Diagnostics . . . . . 107
    - Operation . . . . . 73
    - Setup . . . . . 56
  - Menus
    - For measuring device configuration . . . . . 55
    - For specific settings . . . . . 63
  - Mounting dimensions
    - see Installation dimensions
  - Mounting location . . . . . 19
  - Mounting preparations . . . . . 25
  - Mounting requirements
    - Inlet and outlet runs . . . . . 21
    - Installation dimensions . . . . . 21
    - Sensor heating . . . . . 23
  - Mounting tools . . . . . 25
- N**
- Nameplate
    - Sensor . . . . . 15
    - Transmitter . . . . . 14
  - Nominal pressure
    - Secondary containment . . . . . 130
- O**
- Operable flow range . . . . . 119
  - Operating menu
    - Menus, submenus . . . . . 37
    - Structure . . . . . 37
    - Submenus and user roles . . . . . 38
  - Operating philosophy . . . . . 38
  - Operation . . . . . 73
  - Operation options . . . . . 36

- Operational safety . . . . . 10
- Order code . . . . . 14, 15
- Orientation (vertical, horizontal) . . . . . 20
- Outlet runs . . . . . 21
- Output . . . . . 120
- Output signal . . . . . 120
- P**
- Packaging disposal . . . . . 18
- Parameter settings
  - Administration (Submenu) . . . . . 109
  - Calculated values (Submenu) . . . . . 63
  - Communication (Submenu) . . . . . 58
  - Device information (Submenu) . . . . . 110
  - Diagnostics (Menu) . . . . . 107
  - Display (Submenu) . . . . . 67
  - Low flow cut off (Wizard) . . . . . 61
  - Medium selection (Submenu) . . . . . 59
  - Partially filled pipe detection (Wizard) . . . . . 62
  - Process variables (Submenu) . . . . . 73
  - Sensor adjustment (Submenu) . . . . . 64
  - Setup (Menu) . . . . . 56
  - Simulation (Submenu) . . . . . 70
  - System units (Submenu) . . . . . 56
  - Totalizer 1 to 3 (Submenu) . . . . . 65, 75
  - Totalizer handling (Submenu) . . . . . 76
  - Web server (Submenu) . . . . . 42
  - Zero point adjustment (Submenu) . . . . . 65
- Performance characteristics . . . . . 125
- Post-connection check (checklist) . . . . . 35
- Post-installation check . . . . . 55
- Post-installation check (checklist) . . . . . 26
- Potential equalization . . . . . 32
- Power consumption . . . . . 125
- Power supply failure . . . . . 125
- Pressure Equipment Directive . . . . . 137
- Pressure loss . . . . . 131
- Pressure-temperature ratings . . . . . 130
- Process connections . . . . . 134
- Process variables
  - Calculated . . . . . 119
  - Measured . . . . . 119
- Product safety . . . . . 10
- Protecting parameter settings . . . . . 71
- R**
- Reading measured values . . . . . 73
- Recalibration . . . . . 113
- Reference operating conditions . . . . . 125
- Registered trademarks . . . . . 8
- Remote operation . . . . . 135
- Repair . . . . . 114
  - Notes . . . . . 114
- Repair of a device . . . . . 114
- Repeatability . . . . . 126
- Replacement
  - Device components . . . . . 114
- Requirements for personnel . . . . . 9
- Response time . . . . . 127
- Return . . . . . 114
- S**
- Safety . . . . . 9
- Sanitary compatibility . . . . . 136
- Seals
  - Medium temperature range . . . . . 129
- Sensor
  - Medium temperature range . . . . . 129
  - Mounting . . . . . 25
- Sensor heating . . . . . 23
- Serial number . . . . . 14, 15
- Setting the operating language . . . . . 55
- Settings
  - Adapting the measuring device to the process conditions . . . . . 76
  - Advanced display configurations . . . . . 67
  - Communication interface . . . . . 58
  - Device reset . . . . . 109
  - Device tag . . . . . 56
  - Low flow cut off . . . . . 61
  - Medium . . . . . 59
  - Operating language . . . . . 55
  - Partial filled pipe detection . . . . . 62
  - Resetting the totalizer . . . . . 76
  - Sensor adjustment . . . . . 64
  - Simulation . . . . . 70
  - System units . . . . . 56
  - Totalizer . . . . . 65
  - Totalizer reset . . . . . 76
- Shock resistance . . . . . 129
- Signal on alarm . . . . . 120
- Software release . . . . . 46
- Software write protection . . . . . 72
- Spare part . . . . . 114
- Spare parts . . . . . 114
- Special connection instructions . . . . . 32
- Standards and guidelines . . . . . 137
- Startup parameterization (NSU) . . . . . 55
- Status signals . . . . . 81, 82
- Storage conditions . . . . . 17
- Storage temperature . . . . . 17
- Storage temperature range . . . . . 129
- Structure
  - Operating menu . . . . . 37
- Submenu
  - Administration . . . . . 109
  - Advanced setup . . . . . 63
  - Calculated values . . . . . 63
  - Communication . . . . . 58
  - Device information . . . . . 110
  - Display . . . . . 67
  - Events list . . . . . 107
  - Medium selection . . . . . 59
  - Overview . . . . . 38
  - Process variables . . . . . 63, 73
  - Sensor adjustment . . . . . 64
  - Simulation . . . . . 70
  - System units . . . . . 56

- Totalizer 1 to 3 . . . . . 65, 75
- Totalizer handling . . . . . 76
- Web server . . . . . 42
- Zero point adjustment . . . . . 65
- Supply voltage . . . . . 124
- Surface roughness . . . . . 134
- System design
  - Measuring system . . . . . 118
  - see Measuring device design
- System integration . . . . . 46
- System pressure . . . . . 21
- T**
- Technical data, overview . . . . . 118
- Temperature range
  - Medium temperature . . . . . 129
  - Storage temperature . . . . . 17
- Terminal assignment . . . . . 29, 31
- Terminals . . . . . 125
- Thermal insulation . . . . . 22
- Tools
  - Electrical connection . . . . . 28
  - Installation . . . . . 25
  - Transport . . . . . 17
- Transmitter
  - Connecting the signal cables . . . . . 31
  - Turning the display module . . . . . 25
- Transporting the measuring device . . . . . 17
- Troubleshooting
  - General . . . . . 78
- Turning the display module . . . . . 25
- U**
- Use of the measuring device
  - Borderline cases . . . . . 9
  - Incorrect use . . . . . 9
  - see Designated use
- User interface
  - Current diagnostic event . . . . . 107
  - Previous diagnostic event . . . . . 107
- User roles . . . . . 38
- V**
- Version data for the device . . . . . 46
- Vibration resistance . . . . . 129
- Vibrations . . . . . 24
- W**
- W@M . . . . . 113, 114
- W@M Device Viewer . . . . . 13, 114
- Weight
  - SI units . . . . . 132
  - Transport (notes) . . . . . 17
  - US units . . . . . 132
- Wizard
  - Define access code . . . . . 71
  - Low flow cut off . . . . . 61
  - Partially filled pipe detection . . . . . 62
- Workplace safety . . . . . 10
- Write protection
  - Via access code . . . . . 71
  - Via startup parameterization (NSU) . . . . . 72
  - Via write protection switch . . . . . 72
- Write protection switch . . . . . 72

[www.addresses.endress.com](http://www.addresses.endress.com)

---