

Rosemount™ Smart Pressure Gauge



NOTICE

The products described in this document are NOT designed for nuclear-qualified applications. Using non-nuclear qualified products in applications that require nuclear-qualified hardware or products may cause inaccurate readings. For information on Rosemount nuclear-qualified products, contact your local Emerson Sales Representative.

For information on Emerson nuclear-qualified products, contact your local Rosemount Sales Representative.

Changes or modifications to the equipment not expressly approved by Rosemount Inc. could void the user's authority to operate the equipment.

Using the Rosemount Smart Pressure Gauge in a manner other than what is specified by the manufacturer may impair the protection provided by the equipment.

Shipping considerations

The device is shipped with the battery installed.

Each device contains one "D" size primary lithium-thionyl chloride battery. Primary 5.0 gram lithium batteries are regulated in transportation by the U.S. Department of Transportation, and are also covered by IATA (International Air Transport Association), ICAO (International Civil Aviation Organization), and ARD (European Ground Transportation of Dangerous Goods). It is the responsibility of the shipper to ensure compliance with these or any other local requirements. Consult current regulations and requirements before shipping.

⚠ WARNING

Explosions could result in death or serious injury.

Installation of device in an explosive environment must be in accordance with appropriate local, national, and international standards, codes, and practices.

Ensure device is installed in accordance with intrinsically safe or non-incendive field practices.

Before connecting a Field Communicator in an explosive atmosphere, make sure the instruments are installed in accordance with intrinsically safe or non-incendive field wiring practices.

Verify that the operating environment of the device is consistent with the appropriate hazardous locations certifications.

Electrical shock could cause death or serious injury.

Care must be taken during transportation of device to prevent electrostatic charge build-up.

Process leaks may cause harm or result in death.

Handle the device carefully.

Failure to follow these installation guidelines could result in death or serious injury.

Ensure only qualified personnel perform the installation.

Apply wrench only to the flats, not on housing.

The battery is not replaceable in a hazardous location.

⚠ CAUTION

Keep the vent path free of any obstruction, including but not limited to paint, dust, and lubrication by mounting the device so the process can drain away.

Interfering or blocking the atmospheric reference port will cause the device to output erroneous pressure values.

Absolute pressure devices are calibrated at the factory. Trimming adjusts the position of the factory characterization curve. It is possible to degrade performance of the device if any trim is done improperly or with inaccurate equipment.

Individuals who handle products exposed to a hazardous substance can avoid injury if they are informed of and understand the hazard. The product being returned will require a copy of the required Safety Data Sheet (SDS) for each substance. The SDS must be included with the returned goods.

⚠ WARNING

Physical access

Unauthorized personnel may potentially cause significant damage to and/or misconfiguration of end users' equipment. This could be intentional or unintentional and needs to be protected against.

Physical security is an important part of any security program and fundamental to protecting your system. Restrict physical access by unauthorized personnel to protect end users' assets. This is true for all systems used within the facility.

Contents

Chapter 1	Introduction.....	7
	1.1 Using this manual.....	7
	1.2 Models covered.....	7
	1.3 Product recycling/disposal.....	7
Chapter 2	Hardware installation.....	9
	2.1 Overview.....	9
	2.2 Safety messages.....	9
	2.3 Considerations.....	9
	2.4 Installation procedure.....	12
	2.5 Impulse piping considerations.....	14
	2.6 Process connection.....	15
	2.7 Rosemount manifolds.....	16
Chapter 3	Configuration.....	21
	3.1 Overview.....	21
	3.2 Safety messages.....	21
	3.3 System readiness.....	21
	3.4 Configuration basics.....	22
	3.5 Basic gauge setup.....	23
	3.6 Configuration verification.....	24
	3.7 Advanced device parameter setup.....	26
	3.8 Notifications and service.....	27
	3.9 Advanced configuration.....	28
Chapter 4	Operation and maintenance.....	31
	4.1 Overview.....	31
	4.2 Safety messages.....	31
	4.3 Pressure signal trimming.....	31
	4.4 Replacing the battery.....	36
	4.5 Local device status and notifications.....	36
Chapter 5	Troubleshooting.....	39
	5.1 Service support.....	39
	5.2 Local troubleshooting.....	39
Appendix A	Reference data.....	41
	A.1 Product certifications.....	41
	A.2 Ordering information, specifications, and drawings.....	41
Appendix B	Field Communicator menu trees.....	43
	B.1 Overview.....	43

1 Introduction

1.1 Using this manual

The sections in this manual provide information on installing, operating, and maintaining the Rosemount™ Smart Pressure Gauge. The sections are organized as follows:

[Hardware installation](#) contains mechanical and electrical installation instructions and considerations.

[Configuration](#) provides instruction on commissioning and operating the gauge. Information on software functions, configuration parameters, and online variables are also included.

[Operation and maintenance](#) contains operation and maintenance techniques.

[Troubleshooting](#) provides troubleshooting techniques for the most common operating problems.

[Reference data](#) supplies procedure on how to get the specifications, ordering information, and product certification.

[Field Communicator menu trees](#) provides full menu trees and abbreviated fast key sequences for commissioning tasks.

1.2 Models covered

This manual covers the Rosemount Smart Pressure Gauge.

- Measures gage/absolute/compound/vacuum pressure up to 10,000 psi (689.5 bar)

1.3 Product recycling/disposal

Recycling of equipment and packaging should be taken into consideration and disposed of in accordance with local and national legislation/regulations.

2 Hardware installation

2.1 Overview

The information in this section covers installation considerations. A Quick Start Guide is shipped with every device to describe basic installation and startup procedures. Dimensional drawings for the Rosemount™ Smart Pressure Gauge can be found in the [Product Data Sheet](#).

2.2 Safety messages

Procedures and instructions in this section may require special precautions to ensure the safety of the personnel performing the operation. Information that raises potential safety issues is indicated with a warning symbol (⚠). Refer to the following safety messages before performing an operation preceded by this symbol.

⚠ WARNING

Explosions could result in death or serious injury.

Installation of device in an explosive environment must be in accordance with appropriate local, national, and international standards, codes, and practices.

Ensure device is installed in accordance with intrinsically safe or non-incendive field practices.

Electrical shock could cause death or serious injury.

Care must be taken during transportation of device to prevent electrostatic charge build-up.

Process leaks could result in death or serious injury.

Handle the device carefully.

Failure to follow safe installation guidelines could result in death or serious injury.

Only qualified personnel should install the equipment.

2.3 Considerations

2.3.1 Pre-installation

Optional: power/device check

The device is designed to be installation-ready. To check device battery prior to installation, perform the following:

Procedure

1. Perform [Turn on device](#).
2. Slide the ON/OFF switch to the **OFF** position until ready for use.

Field Communicator connections

The device needs to be turned on in order for the Field Communicator to interface with the Rosemount Smart Pressure Gauge. The Field Communicator connection is located to the right of the ON/OFF switch. To communicate with the device, connect the Field Communicator to connections labeled “COMM”. Field communication with this device requires a HART®-based tool using the correct Rosemount Smart Pressure Gauge device driver (DD). Refer to [Figure 2-1](#) for instructions on connecting the Field Communicator to the device.

Figure 2-1: Connect to Device

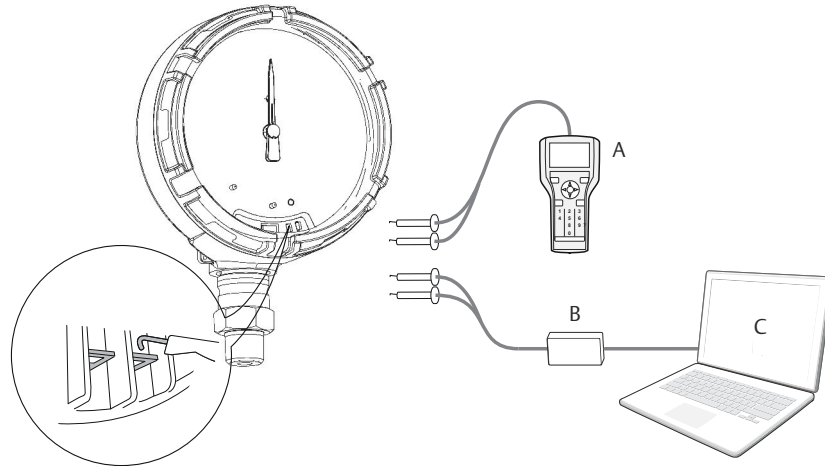

- A** Field Communicator
- B** HART modem
- C** AMS Device Manager

2.3.2 Installation

Measurement performance depends upon proper installation of the device and impulse piping. Mount the device close to the process and use minimal piping to achieve best performance. Also, consider the need for easy access, personnel safety, and a suitable device environment. Install the device to minimize vibration, shock, and temperature fluctuation.

2.3.3 Mechanical

Location

When choosing an installation location and position, take into account the direction of the device for future access to the COMM connections and readability of the analog display.

Electronics cover

The electronics cover is tightened so that polymer contacts polymer. When removing the electronics cover, ensure that there is no damage done to the O-ring. If damaged, replace before reattaching cover, ensuring polymer contacts polymer (i.e. no O-ring visible).

2.3.4 Electrical

Battery

The Rosemount Smart Pressure Gauge is self-powered. The battery contains approximately five grams of lithium. Under normal conditions, the battery materials are self-contained and are not reactive as the battery is maintained inside the enclosure of the device. Care should be taken to prevent thermal, electrical, or mechanical damage. Contacts should be protected to prevent premature discharge.

Use caution when handling the battery, it may be damaged if dropped.

The battery should be stored in a clean, dry area. For maximum battery life, storage temperature should not exceed 86 °F (30 °C).

2.3.5 Environmental

Verify the operating atmosphere of the device is consistent with the appropriate hazardous locations certifications.

Temperature effects

The device will operate within specifications for ambient temperatures as outlined in the specifications section of the [Product Data Sheet](#). Heat from the process is transferred to the device housing. If the process temperature is high, the ambient temperature will need to be lower to account for heat transferred to the device housing. See Temperature limits for process temperature derating.

2.4 Installation procedure

Figure 2-2: Installation Flowchart

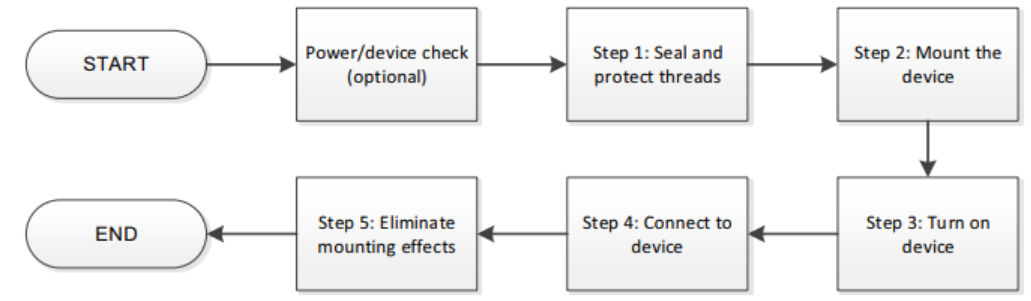

2.4.1 Seal and protect threads

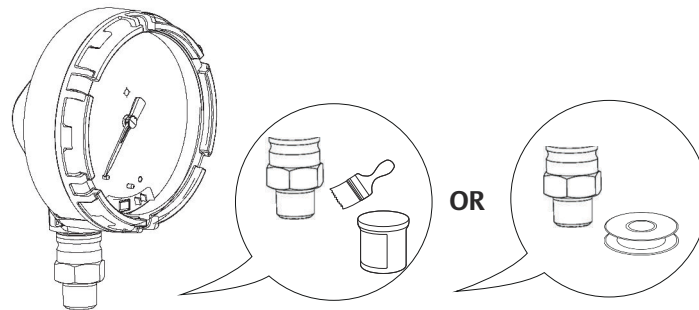

2.4.2 Mount device

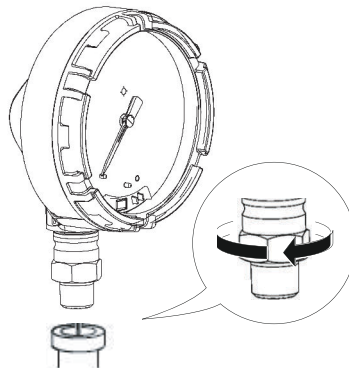

Note

Use wrench on flats, not on housing.

Mounting orientation

The low side pressure port (atmospheric reference) on the pressure gauge is located in the neck of the device behind the housing. The vent path is between the housing and sensor. See [Figure 2-3](#).

⚠ CAUTION

Keep the vent path free of any obstruction, including but not limited to paint, dust, and lubrication by mounting the device so the process can drain away.

Figure 2-3: Low Side Pressure Port

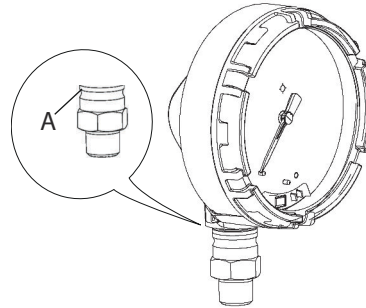

A Low side pressure port (atmospheric reference)

2.4.3 Turn on device

Check to ensure the device and battery are working properly.

Procedure

1. Twist the cover counterclockwise to remove it.
2. Slide the OFF/ON switch to the **ON** position to initiate the power sequence.

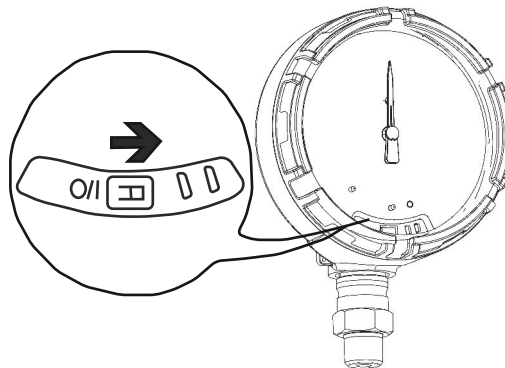

Note

During the power sequence, the dial tests full range of motion and LED flashes amber.

3. Once the power sequence ends, verify the LED flashes green.

Note

The LED may display several colors; see [Table 4-2](#) for device statuses.

2.5 Impulse piping considerations

2.5.1 Best practices

The piping between the process and the device must accurately transfer the pressure to obtain accurate measurements. There are five possible sources of error: leaks, friction loss (particularly if purging is used), trapped gas in a liquid line, liquid in a gas line, and density variations between the legs.

The best location for the device in relation to the process pipe depends on the process itself. Use the following guidelines to determine device location and placement of impulse piping:

- Keep impulse piping as short as possible.
- For liquid service, slope the impulse piping at least 1 in. per ft. (8 cm per m) upward from the device toward the process connection.
- For gas service, slope the impulse piping at least 1 in. per ft. (8 cm per m) downward from the device toward the process connection.
- Avoid high points in liquid lines and low points in gas lines.
- Make sure both impulse legs are the same temperature.
- Use impulse piping large enough to avoid friction effects and blockage.
- Vent all gas from liquid piping legs.
- When using a sealing fluid, fill both piping legs to the same level.
- When purging, make the purge connection close to the process taps and purge through equal lengths of the same size pipe. Avoid purging through the device.
- Keep corrosive or hot (above 250 °F [121 °C]) process material out of direct contact with the sensor module and flanges.
- Prevent sediment deposits in the impulse piping.
- Keep the liquid head balanced on both legs of the impulse piping.
- Avoid conditions that might allow process fluid to freeze within the process flange.

2.5.2 Mounting requirements

Liquid flow measurement

- Place taps to the side of the line to prevent sediment deposits on the process isolators.
- Mount the device beside or below the taps so gases vent into the process line.
- Mount drain/vent valve upward to allow gases to vent.

Gas flow measurement

- Place taps in the top or side of the line.
- Mount the device beside or above the taps so to drain liquid into the process line.

Steam flow measurement

- Place taps to the side of the line.
- Mount the device below the taps to ensure that impulse piping will remain filled with condensate.
- Fill impulse lines with water to prevent steam from contacting the device directly and to ensure accurate measurement start-up.

Note

For steam or other elevated temperature services, it is important that temperatures do not exceed 250 °F (121 °C) for devices with silicone fill. For vacuum service, these temperature limits are reduced to 220 °F (104 °C) for silicone fill.

2.6 Process connection

⚠ CAUTION

Interfering or blocking the atmospheric reference port will cause the device to output erroneous pressure values.

Keep the vent path free of any obstruction, including but not limited to paint, dust, and lubrication by mounting the device so the process can drain away.

The low side pressure port (atmospheric reference) on the pressure gauge is located in the neck of the device behind the housing. The vent path is between the housing and sensor. (See [Figure 2-3](#)).

Figure 2-4: Low Side Pressure Port

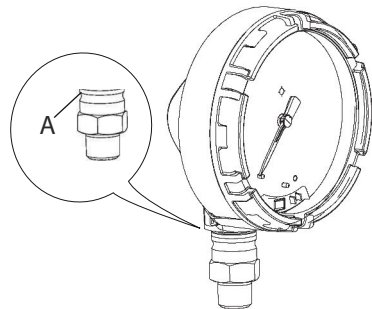

A low side pressure port (atmospheric reference).

⚠ WARNING

Do not apply torque directly to the sensor module. Rotation between the sensor module and the process connection can damage the electronics. To avoid damage, apply torque only to the hex-shaped process connection.

2.7 Rosemount manifolds

The Rosemount 306 Integral Manifold mounts directly to the device. The manifold is used with this device to provide block-and-bleed valve capabilities of up to 10,000 psi (689.5 bar).

2.7.1 Installation procedure

The Rosemount 306 Integral Manifold is for use only with a Rosemount Smart Pressure Gauge.

⚠ Assemble the Rosemount 306 Manifold to the device with a thread sealant.

Procedure

1. Place device into holding fixture.
2. Apply appropriate thread paste or tape to threaded instrument end of the manifold.
3. Count total threads on the manifold before starting assembly.
4. Start turning the manifold by hand into the process connection on the device.

Note

If using thread tape, be sure the thread tape does not strip when the manifold assembly is started.

5. Wrench tighten manifold into process connection (minimum torque value is 425 in-lbs).
6. Count how many threads are still showing (minimum engagement is three revolutions).
7. Subtract the number of threads showing (after tightening) from the total threads to calculate the revolutions engaged. Further tighten until a minimum of three rotations is achieved.
8. For block and bleed manifold, verify the bleed screw is installed and tightened. For 2-valve manifold, verify the vent plug is installed and tightened.
9. Leak-check assembly to maximum pressure range of device.

2.7.2 Manifold operation

2-valve and block and bleed style manifolds

Isolating the device

In normal operation the Isolate (block) valve between the process port and device will be open and the Test/Vent valve will be closed. On a block and bleed style manifold, a single block valve provides device isolation and a bleed screw provides drain/vent capabilities.

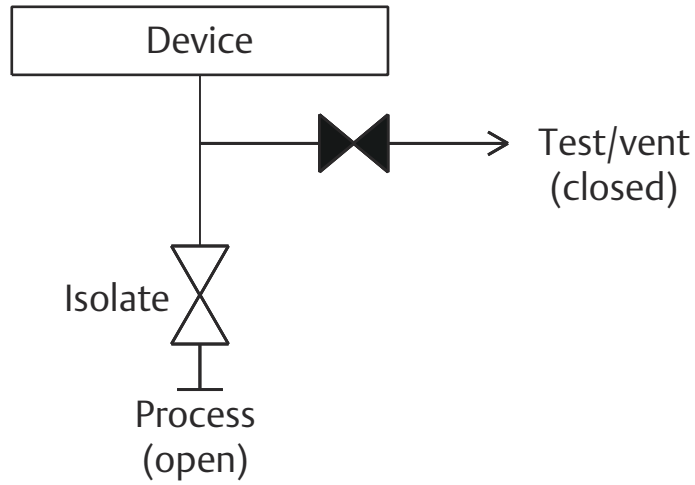

Procedure

1. To isolate the device, close the isolate valve.

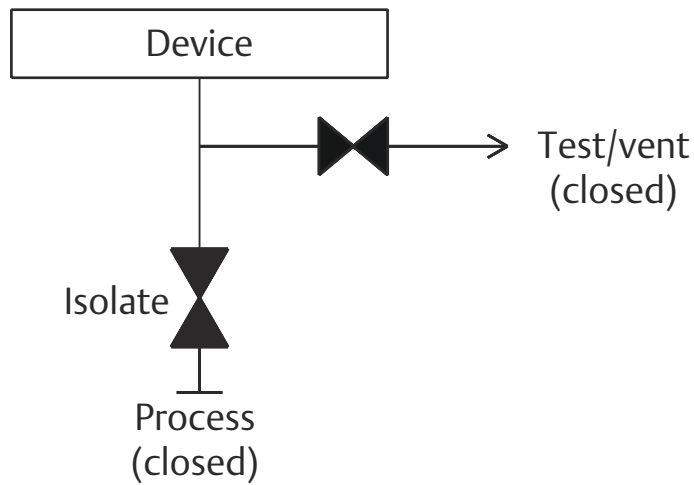

2. To bring the device to atmospheric pressure, open the vent valve or bleed screw.

Note

A ¼-in. male NPT pipe plug may be installed in the test/vent port and will need to be removed with a wrench in order to vent the manifold properly.

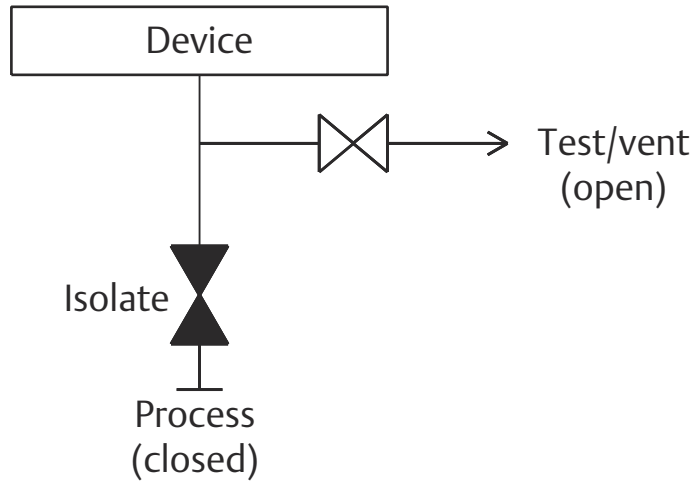

3. After venting to atmosphere, perform any required calibration and then close the test/vent valve or replace the bleed screw.

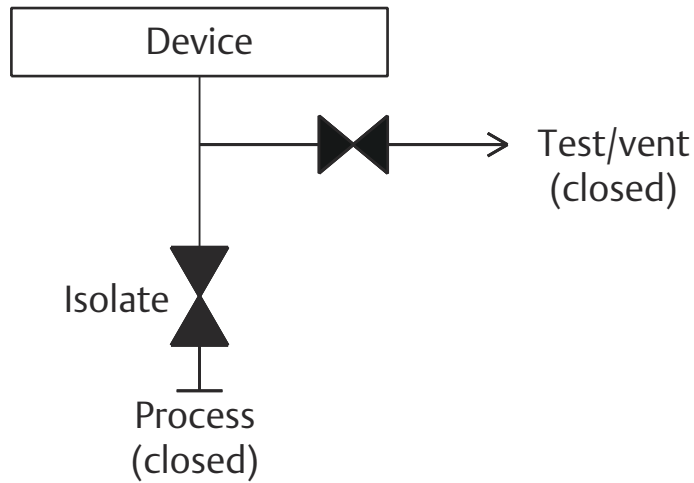

4. Open the Isolate (block) valve to return the device to service.

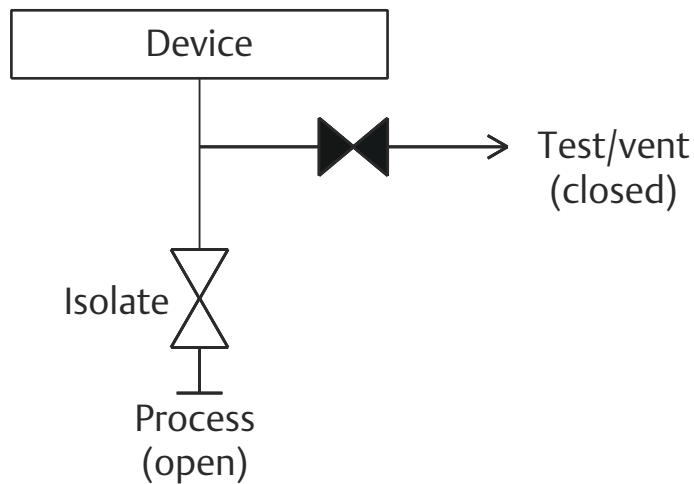

Adjusting valve packing

Over time, the packing material inside a Rosemount manifold may require adjustment in order to continue to provide proper pressure retention. Not all Rosemount manifolds have this adjustment capability. The Rosemount manifold model number will indicate what type of stem seal or packing material has been used.

The following steps are provided as a procedure to adjust valve packing.

Procedure

1. Remove all pressure from device.
2. Loosen manifold valve jam nut.
3. Tighten manifold valve packing adjuster nut $\frac{1}{4}$ turn.
4. Tighten manifold valve jam nut.
5. Re-apply pressure and check for leaks.
6. Above steps can be repeated, if necessary.

If the above procedure does not result in proper pressure retention, the complete manifold should be replaced.

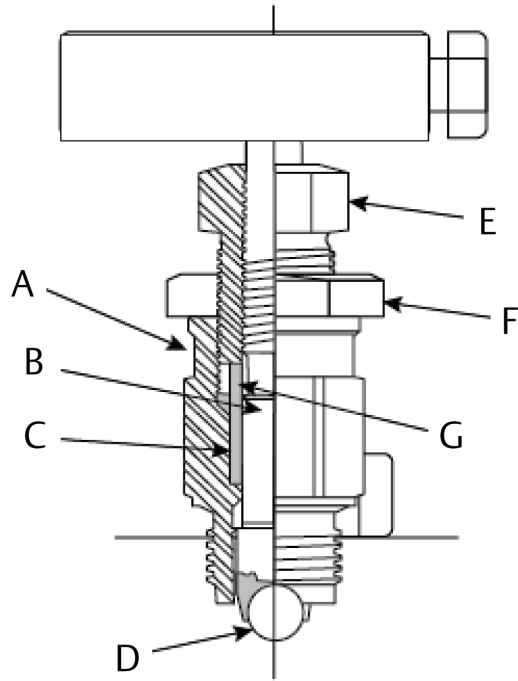

- A** Bonnet
- B** Stem
- C** Packing
- D** Ball seat
- E** Packing adjuster
- F** Jam nut
- G** Packing follower

3 Configuration

3.1 Overview

This section contains information on commissioning and tasks.

Field Communicator and AMS Device Manager Instructions are given to perform configuration functions.

Full Field Communicator menu trees are available in [Field Communicator menu trees](#).

3.2 Safety messages

Procedures and instructions in this section may require special precautions to ensure the safety of the personnel performing the operation. Information that raises potential safety issues is indicated with a warning symbol (⚠). Refer to the following safety messages before performing an operation preceded by this symbol.

⚠ WARNING

Explosions could result in death or serious injury.

Installation of this device in an explosive environment must be in accordance with the appropriate local, national, and international standards, codes, and practices. Review the approvals section of the Rosemount™ Smart Pressure Gauge Reference Manual for any restrictions associated with a safe installation.

Before connecting a Field Communicator in an explosive atmosphere, make sure the instruments are installed in accordance with intrinsically safe or non-incendive field wiring practices.

Verify that the operating environment of the device is consistent with the appropriate hazardous locations certifications.

3.3 System readiness

3.3.1 Confirm correct device driver

Verify the latest Device Description (DD/DTM™) is loaded on your systems to ensure proper communications.

Procedure

1. Visit the Emerson Device Install Kits [Library](#) or [Fieldcommgroup.org](#).
2. Select desired product.
 - a) Within [Table 3-1](#), use the HART Universal Revision and Device Revision numbers to find the correct Device Description.

Table 3-1: Rosemount Smart Pressure Gauge Device Revisions and Files

Software release date	Identify device			Find device driver		Review instructions	Review functionality
	NAMUR software revision ⁽¹⁾	NAMUR software revision	HART software revision ⁽²⁾	HART universal revision	Device revision ⁽³⁾	Manual document number	Changes to software
October 2017	1.0.0	1.0.0	2	7	1	00809-0100-4145	Initial release

- (1) NAMUR Software Revision is located on the hardware tag of the device.
- (2) HART Software Revision can be read using a HART capable configuration tool.
- (3) Device Driver file names use Device and DD Revision (e.g. 10_01). HART Protocol is designed to enable legacy device driver revisions to continue to communicate with new HART devices. To access new functionality, the new Device Driver must be downloaded. It is recommended to download new Device Driver files to ensure full functionality.

Figure 3-1: Data Flow

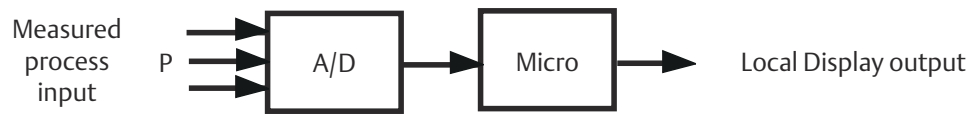

3.4 Configuration basics

3.4.1 Configuration tools

Configuration requires a Field Communicator or AMS Device Manager. Connect the Field Communicator leads to the terminals labeled “COMM” on the front of the device (see [Figure 2-1](#)).

When using a Field Communicator, any configuration changes made must be sent to the device by using the **Send** key (F2). AMS Device Manager configuration changes are implemented when the **Apply** button is selected.

3.4.2 Connection diagrams

[Figure 2-1](#) illustrates the wiring for a field hook-up with a Field Communicator or AMS Device Manager. The Field Communicator or AMS Device Manager may be connected at “COMM” on the device.

3.5 Basic gauge setup

3.5.1 Eliminate mounting effects

Devices are factory-calibrated. Once installed, it is recommended to perform this step to eliminate potential error caused by mounting position or static pressure. Instructions for using a Field Communicator are listed below:

Procedure

1. Vent the device.
2. Connect the Field Communicator.
3. From the *HOME* screen, enter the HART Fast Key sequence.

Fast Keys	2, 1, 1
-----------	---------

4. Follow the commands to perform the procedure.

3.5.2 Activate wireless

Do not activate wireless until Emerson Wireless Gateway is installed and functioning properly; toggling off and on reduces battery life.

Join device to network.

1. Obtain Network ID and Join Key for the wireless network (available in wireless gateway).
2. From the *HOME* screen, enter the HART Fast Key sequence.

Fast Keys	2, 1, 2
-----------	---------

3. Follow the commands to perform the procedure.
4. Select **Overview > Status**.
5. Verify communication status displays *Connected*.

Note

Joining the device to the network could take several minutes.

3.5.3 Considerations for devices with percent of range engineering unit

Set range points

The range values command sets the lower and upper range values used for the percent of range engineering unit.

Note

Devices are shipped from Emerson fully calibrated to the factory default of full scale (scale range = upper range limit).

From the *HOME* screen, enter the Fast Key sequence.

Fast Keys	2, 2, 1, 2
-----------	------------

Procedure

1. Select lower or upper range value as applicable.
2. Follow the commands to perform the procedure.

3.6 Configuration verification

The following is a list of factory default configurations that can be viewed by using the Field Communicator or AMS Device Manager. Follow the steps below to review the gauge configuration information.

Note

Information and procedures in this section that make use of Field Communicator Fast Key sequences and AMS Device Manager assume the gauge and communication equipment are connected, powered, and operating correctly.

3.6.1 Review pressure information

From the *HOME* screen, enter the Fast Key sequence.

Fast Keys	1, 2
-----------	------

Procedure

1. From the *Home* screen, select **1: Overview**.
2. Select **2: Pressure**.

3.6.2 Review device information

From the *HOME* screen, enter the Fast Key sequence.

Fast Keys	1, 9
-----------	------

Procedure

1. From the *Home* screen, select **1: Overview**.
2. Select **9: Device Information**.
3. Select from the corresponding number to view each field:
 - 1 Identification
 - 2 Revisions
 - 3 Materials of Construction

- 4 Security
- 5 Dial Faceplate
- 6 Capabilities

3.6.3 Review radio information

From the *HOME* screen, enter the Fast Key sequence.

Table 3-2:

Fast Keys	1, 9, 3
-----------	---------

1. From the *Home* screen, select **1: Overview**.
2. Select **9: Device Information**.
3. Select **3: Radio**.
4. Select from the corresponding number to view each field:
 - 1 MAC address
 - 2 Manufacturer
 - 3 Device type
 - 4 Devision revision
 - 5 Software revisions
 - 6 Hardware revision
 - 7 Xmit power level
 - 8 Min brdcst rate

3.6.4 Review operating parameters

The pressure output value in both engineering units and percent of range will reflect it even when it is outside of the configured range as long as it is between the upper and lower range limit of the device. For example, if a scale range 0 - 150 psi (LRL = 0 psi, URL = 150 psi) is ranged from 0 to 100 psi, an applied pressure of 150 psi will return a percent of range output of 150 percent.

From the *HOME* screen, enter the Fast Key sequence.

Fast Keys	3, 2, 1
-----------	---------

Procedure

1. From the *Home* screen, select **3: Service Tools**.
2. Select **2: Variables**.
3. Select **1: All Variables**.

The Operating Parameters menu displays the following information pertaining to the device:

All variables:

- Pressure
- Pressure Quality
- Custom Scale
- Cust Scale Quality
- Percent of Range
- Percent of Rng Quality
- Sensor Temp
- Sensor Temp Quality
- Sensor Temp Unit
- Supply Voltage
- Supply Voltage Quality

3.7 Advanced device parameter setup

3.7.1 Write protect

The device has a software write protect security feature.

From the *HOME* screen, enter the Fast Key sequence.

Table 3-3:

Fast Keys	2, 2, 4, 1
-----------	------------

1. Select **Write Protect** to enable.
2. Right click on device and select **2: Configure**.
3. Select **2: Advanced Setup**.
4. Select the tab labeled **4: Security**.
5. Select **Write Protect** to enable this feature.

3.7.2 Wireless update rate

From the *HOME* screen, enter the Fast Key sequence.

Fast Keys	2, 2, 3, 2
-----------	------------

1. From the *Home* screen, select **2: Configure**.
2. Select **2: Advanced Setup**.
3. Select **3: Wireless**.
4. Select **2: Update Rate**.

5. Follow the commands to perform the procedure.

3.7.3 Dial update rate

From the *HOME* screen, enter the Fast Key sequence.

Fast Keys	2, 2, 1, 1, 2
-----------	---------------

Procedure

1. From the *Home* screen, select **2: Configure**.
2. Select **2: Manual Setup**.
3. Select **1: Measurements**.
4. Select **1: Dial/Pressure**.
5. Select **2: Dial Update Rate**.
6. Follow the commands to perform the procedure.

3.8 Notifications and service

Notifications and service functions listed below are primarily for the user after field installation. The device simulation feature is designed to verify proper operating functionality, and can be performed either on the bench or in the field.

3.8.1 Simulating device variables

From the *HOME* screen, enter the Fast Key sequence.

Fast Keys	3, 4
-----------	------

Procedure

1. From the *Home* screen, select **3: Service Tools**.
2. Select **4: Simulate**.

Note

The following parameters pertaining to the device can be simulated: Pressure, sensor temperature, and supply voltage

3.8.2 Device reset

The master reset function will reset the device electronics. To perform a device reset:

From the *HOME* screen, enter the Fast Key sequence.

Fast Keys	3, 3, 1
-----------	---------

Procedure

1. From the *Home* screen, select **3: Service Tools**.

2. Select **3: Maintenance**
3. Select **1: Device Reset**

3.8.3 Join status

From the *HOME* screen, enter the Fast Key sequence.

Table 3-4:

Fast Keys	3, 3, 1
-----------	---------

1. From the *Home* screen, select **3: Service Tools**.
2. Select **3: Communications**.
3. Select **1: Join Status**.

Wireless devices join the secure network through a four-step process:

- Step 1. Network Found
- Step 2. Network Security Clearance Granted
- Step 3. Network Bandwidth Allocated
- Step 4. Network Join Complete

3.9 Advanced configuration

3.9.1 Overpressure notification

This notification can be used to know if a process pressure higher than 105 percentage of the devices maximum working pressure (MWP) has been measured. The overpressure notification must be configured to latched mode to activate the notification. If this event occurs when the device is configured to latch, the dial will be driven to the Red X and the LED will blink red. Additionally, it is required to acknowledge and reset the overpressure notification after an overpressure event before the dial can move back to an on-scale position.

[Table 3-5](#) contains further information on device specific MWP as it correlates to the device specific scale range.

Table 3-5: Maximum Working Pressure

Scale range	Maximum working pressure (MWP)	105% of MWP	Maximum overpressure limit
Vacuum to 30 psi	30 psi	31.5 psi	750 psi
31–150 psi	150 psi	157.5 psi	1,500 psi
151–800 psi	800 psi	840 psi	1,600 psi
801–4,000 psi	4,000 psi	4,200 psi	6,000 psi
4,001-10,000 psi	10,000 psi	10,500 psi	15,000 psi

Table 3-6 demonstrates the different dial locations based on configuration of the overpressure notification (Unlatched vs Latched).

Table 3-6: Dial Locations

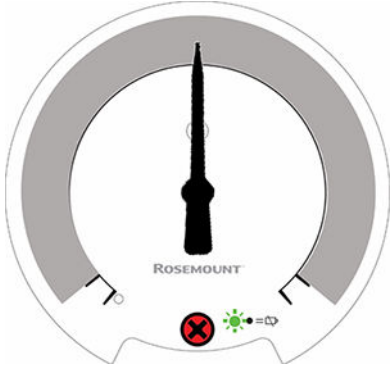
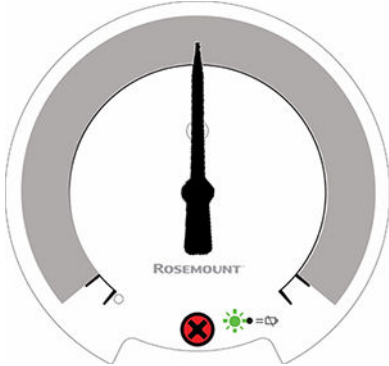
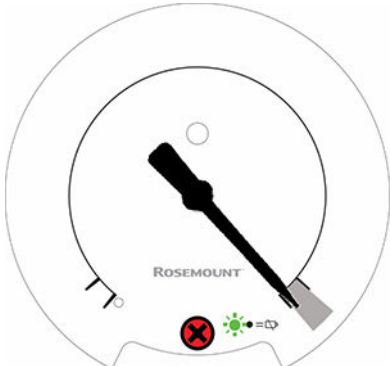
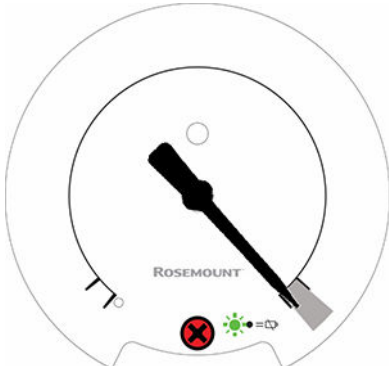
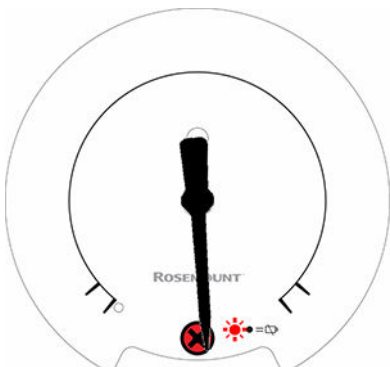
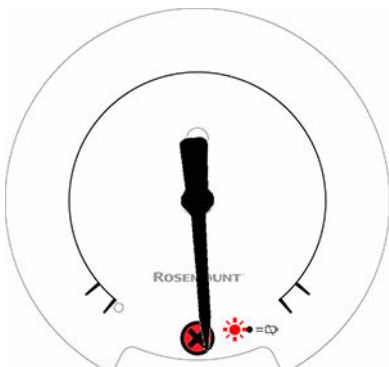
Measured process pressure	Parameter configuration	
	Unlatched (factory default)	Latched
Within scale range	 <p>LED color: Green Dial location: On-scale</p>	 <p>LED color: Green Dial location: On-scale</p>
Beyond scale range and <105% of MWP	 <p>LED color: Green Dial location: Off-scale</p>	 <p>LED color: Green Dial location: Off-scale</p>
>105% MWP	 <p>LED color: Green Dial location: Off-scale</p>	 <p>LED color: Red Dial location: Red X</p>

See [Local device status and notifications](#) for more information.

From the *HOME* screen, enter the Fast Key sequence

Fast Keys	2, 2, 1, 1, 3
-----------	---------------

Procedure

1. From the *Home* screen, select **2: Configure**
2. Select **2: Manual Setup**
3. Select **1: Measurements**
4. Select **1: Dial/Pressure**
5. Select **3: Over-Press Ind**
6. Follow the commands to perform the procedure.

Note

When the parameter has been set to activate, the notification must be acknowledged and cleared for the device to return to normal operation.

3.9.2 Acknowledge and reset overpressure notification

From the *HOME* screen, enter the Fast Key sequence

Fast Keys	3, 3, 3
-----------	---------

Procedure

1. From the *Home* screen, select **3: Service Tools**.
2. Select **3: Maintenance**.
3. Select **3: Acknowledge Over-Pressure**.
4. Follow the commands to perform the procedure.

4 Operation and maintenance

4.1 Overview

This section contains information on commissioning and operating Rosemount™ Wireless Pressure Gauges.

Field Communicator and AMS Device Manager instructions are provided for convenience.

4.2 Safety messages

Procedures and instructions in this section may require special precautions to ensure the safety of the personnel performing the operation. Information that raises potential safety issues is indicated with a warning symbol (⚠). Refer to the following safety messages before performing an operation preceded by this symbol.

4.3 Pressure signal trimming

Calibrating a Rosemount™ Smart Pressure Gauge may include the sensor trim procedure to adjust for mounting effects.

Sensor trimming requires an accurate pressure input and adds additional compensation that adjusts the position of the factory trim to optimize performance over a specific pressure range.

Note

Sensor trimming adjusts the position of the factory trim. It is possible to degrade the performance of the gauge if the trim is done improperly or with inaccurate equipment.

CAUTION

Absolute pressure devices are calibrated at the factory. Trimming adjusts the position of the factory characterization curve. It is possible to degrade performance of the device if any trim is done improperly or with inaccurate equipment.

Table 4-1: Recommended Calibration Tasks

Measurement type	Tasks
Gage Compound Vacuum	<ol style="list-style-type: none">1. Reconfigure parameters if necessary.2. Zero trim the device to compensate for mounting effects or static pressure effects.3. Optional: Perform a sensor trim. (Accurate pressure source required.)

Table 4-1: Recommended Calibration Tasks (continued)

Measurement type	Tasks
Absolute	<ol style="list-style-type: none"> 1. Reconfigure parameters if necessary. 2. Perform low trim value section of the sensor trim procedure to correct for mounting position effects. 3. Optional: Perform a sensor trim if equipment available (accurate absolute pressure source required), otherwise perform the low trim value section of the sensor trim procedure.

Note

For devices with absolute measurement type, an accurate absolute pressure source is required.

4.3.1 Determining necessary sensor trims

Bench calibrations allow for calibrating the instrument for its desired range of operation. Straightforward connections to pressure source allow for a full calibration at the planned operating points. Exercising the device over the desired pressure range allows for verification of the output value. [Sensor trim](#) discusses how the trim operations change the calibration. It is possible to degrade the performance of the device if a trim is done improperly or with inaccurate equipment. The device can be set back to factory settings using the [Recall Factory Trim](#) command in [Manifold operation](#).

For devices that are field installed, the manifolds discussed in [Manifold operation](#) allow the device to be zeroed using the zero trim function. This field calibration will eliminate any pressure offsets caused by mounting effects (head effect of the oil fill) and static pressure effects of the process.

Determine the necessary trims with the following steps.

Procedure

1. Apply pressure.
2. Check pressure. If the pressure does not match the applied pressure, perform a digital zero trim. See [Manifold operation](#).

4.3.2 Sensor trim overview

A sensor trim corrects the pressure offset and pressure range to match a pressure standard. The upper sensor trim corrects the pressure range and the lower sensor trim (zero trim) corrects the pressure offset. An accurate pressure standard is required for full calibration. A zero trim can be performed if the process is vented.

Zero trim is a single-point offset adjustment. It is useful for compensating for mounting position effects and is most effective when performed with the device installed in its final mounting position. Since this correction maintains the slope of the characterization curve, it should not be used in place of a sensor trim over the full sensor range.

When performing a zero trim, ensure the equalizing valve is open and all wet legs are filled to the correct levels. Line pressure should be applied to the device during a zero trim to eliminate line pressure errors. Refer to [Manifold operation](#).

Note

Do not perform a zero trim on the Rosemount Smart Pressure Gauge with absolute measurement type. Zero trim uses a zero reference against ambient air pressure for gage, vacuum, and compound pressure devices, while absolute pressure devices reference absolute zero. To correct mounting position effects on a Smart Pressure Gauge with absolute measurement type, perform a low trim within the sensor trim function. The low trim function provides an offset correction similar to the zero trim function, but it does not require zero-based input.

Sensor trim is a two-point sensor calibration where two end-point pressures are applied, and output is linearized. Always adjust the low trim value first to establish the correct offset. Adjustment of the high trim value provides a slope correction to the characterization curve based on the low trim value. The trim values allow you to optimize performance over your specified measuring range at the calibration temperature.

During a trim operation, the device is placed in high power refresh mode, which provides frequent pressure measurement updates. This behavior allows for more accurate calibration of the device. When the device is in high power refresh mode, the battery power supply will be depleted more rapidly.

Figure 4-1: Sensor Trim Example

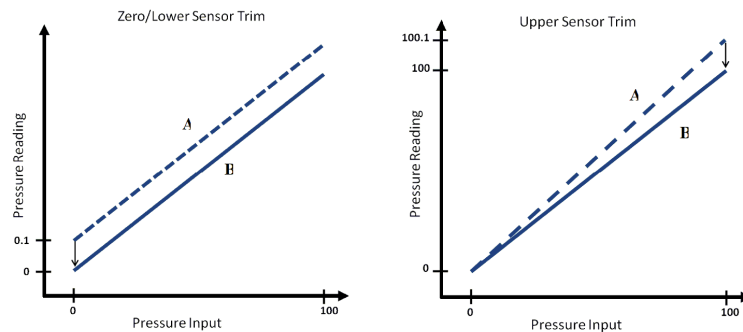

- A Before trim
- B After trim

4.3.3 Sensor trim

When performing a sensor trim, both the upper and lower limits can be trimmed. If both upper and lower trims are to be performed, the lower trim must be done before the upper trim.

Note

Use a pressure input source at least four times more accurate than the device, and allow the input pressure to stabilize for 60 seconds before entering any values.

From the *HOME* screen, enter the Fast Key sequence

Fast Keys	2, 2, 1, 1, 1
-----------	---------------

Procedure

1. Assemble and power the entire calibration system including the gauge, Field Communicator or AMS Device Manager, power supply, pressure input source, and readout device.
2. From the *Home* screen, select **2: Configure**.
3. Select **2: Manual Setup**.
4. Select **1: Measurements**.
5. Select **1: Dial/Pressure**.
6. Select **1: Verify/Calibrate**.

Note

Select pressure points so that lower and upper values are equal to or outside the expected process operation range.

Note

The applied pressure must be within five percent of the selected pressure points when performing sensor trim.

7. Follow the on-screen instructions to complete the adjustment of the lower value.
8. Repeat the procedure for the upper value.

Performing a digital zero trim

Devices are factory-calibrated. Once installed, it is recommended to perform this step to eliminate potential error caused by mounting position or static pressure. Instructions for using a Field Communicator are listed below.

Procedure

1. Vent the device.
2. Connect the Field Communicator.
3. From the HOME screen, enter the HART® Fast Key sequence.

Fast Keys	1, 8
-----------	------

4. Follow the commands to perform the procedure.

4.3.4 Dial adjustment

Dial adjustment can be used to adjust the dial above or below zero and allows for adjustments up to 13 percent of span. Dial adjustment only impacts needle position and does not impact sensor.

Note

Dial adjustment adjusts the position of the factory dial calibration. It is possible to degrade the performance of the gauge if the operation is done improperly or inaccurately.

From the *HOME* screen, enter the Fast Key sequence

Fast Keys	2, 2, 1, 1, 1, 1
-----------	------------------

Procedure

1. Select **2: Configure**.
2. Select **2: Manual Setup**.
3. Select **1: Measurements**.
4. Select **1: Dial/Pressure**.
5. Select **1: Verify/Calibrate**.
6. Select **1: Verify/Calibrate Dial+Digital Pressure**.
7. Adjust dial indicator until it points to lower endpoint.

The following adjustments are available and can be used to complete the dial adjustment.

- Fine counterclockwise (0.1 percent of Span)
 - Fine clockwise (0.1 percent of Span)
 - Coarse counterclockwise (0.3 percent of Span)
 - Coarse clockwise (0.3 percent of Span)
8. Select **5: Save Dial**.

4.3.5 Recall factory trim—sensor trim

The recall factory trim—sensor trim command allows the restoration of the as-shipped factory settings of the sensor trim. This command can be useful for recovering from an inadvertent zero trim of an absolute pressure unit or inaccurate pressure source.

From the *HOME* screen, enter the Fast Key sequence

Fast Keys	3, 3, 2
-----------	---------

Procedure

1. Select **3: Service Tools**.
2. Select **3: Maintenance**.
3. Select **2: Restore to Default Settings**.
4. Follow the screen prompts to recall sensor and dial trim.

4.4 Replacing the battery

⚠ WARNING

The Rosemount Pressure Gauge shall be used only with the battery (00G45-9000-0001) supplied by Rosemount. This battery has been officially tested with the device as required by the I.S. standards during the assessment of the Rosemount Pressure Gauge.

The battery is not replaceable in a hazardous location.

Dispose of battery in accordance with local and national jurisdictions.

Procedure to replace the battery:

Procedure

1. Remove enclosure cover.
2. Switch the device “OFF”.
3. Loosen the screw holding the electronics assembly to the enclosure.

Note

Use caution as the electronics assembly is connected to the pressure sensor via a cable. Take care not to over stretch this cable as this could damage the device.

4. Release battery connection from electronics board.
5. Loosen the two screws on the battery holder and slide the battery holder to the left.

Note

The screws holding down the electronics board do not need to be removed, just loosened. Take care not to let the battery fall out of the enclosure.

6. Remove battery from enclosure.
7. Installation of new battery is the reverse of the removal.

4.5 Local device status and notifications

The flashing LED indicates device status using the colors described in [Table 4-2](#). For start up considerations, refer to [Turn on device](#).

Table 4-2: Status Descriptions





LED color	Device status
 = 	Green Functioning properly
 = 	Amber Battery is low, battery replacement recommended

Table 4-2: Status Descriptions (continued)

LED color		Device status
	Red	Battery replacement required OR Device is malfunctioning
	No color	No power, verify ON/OFF switch is in “on” position

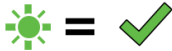
If the dial is pointing towards the red “X”, refer to [Troubleshooting](#) for more information.

5 Troubleshooting

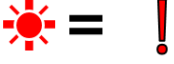
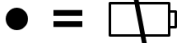
5.1 Service support

To expedite the return process outside of the United States, contact the nearest Emerson representative.

Contact information for a regional Rosemount™ office is provided on the last page of this document.

The center will ask for product model and serial numbers, and will provide a Return Material Authorization (RMA) number. The center will also ask for the process material to which the product was last exposed.

⚠ CAUTION

Individuals who handle products exposed to a hazardous substance can avoid injury if they are informed of and understand the hazard. The product being returned will require a copy of the required Safety Data Sheet (SDS) for each substance must be included with the returned goods.

Emerson representatives will explain the additional information and procedures necessary to return goods exposed to hazardous substances.

5.2 Local troubleshooting

Table 5-1: Interpreting Local Notifications











LED color	Dial location	Device status	Recommended action(s)
Green  = 		Functioning properly	No action required.
Amber  = 		Battery is low	Battery replacement recommended.
		Battery is low, device is malfunctioning	Investigate active notification via a HART® Communicator. Replace battery if device is determined to be functioning properly and notifications have been verified.
Red  = 		Battery replacement required OR Device is malfunctioning	Investigate active notification via a HART Communicator. Replace battery if device is determined to be functioning properly and notifications have been verified.

Table 5-1: Interpreting Local Notifications (continued)

LED color	Dial location	Device status	Recommended action(s)
Black, no color 	N/A	No power	Verify ON/OFF switch is in "ON" position.

A Reference data

A.1 Product certifications

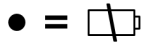
To view current Rosemount™ Smart Pressure Gauge product certifications, follow these steps:

Procedure

1. Go to [Emerson.com/Rosemount/Rosemount-Smart-Pressure-Gauge](https://emerson.com/Rosemount/Rosemount-Smart-Pressure-Gauge).
2. Scroll as needed to the green menu bar and click **Documents & Drawings**.
3. Click **Manuals & Guides**.
4. Select the appropriate Quick Start Guide.

A.2 Ordering information, specifications, and drawings

To view current Rosemount Smart Pressure Gauge ordering information, specifications, and drawings, follow these steps:

Procedure

1. Go to [Emerson.com/Rosemount/Rosemount-Smart-Pressure-Gauge](https://emerson.com/Rosemount/Rosemount-Smart-Pressure-Gauge).
2. Scroll as needed to the green menu bar and click **Documents & Drawings**.
3. For installation drawings, click **Drawings & Schematics** and select the appropriate document.
4. For ordering information, specifications, and dimensional drawings, click **Data Sheets & Bulletins**.
5. Select the appropriate Product Data Sheet.

B Field Communicator menu trees

B.1 Overview

Figure B-1: Overview

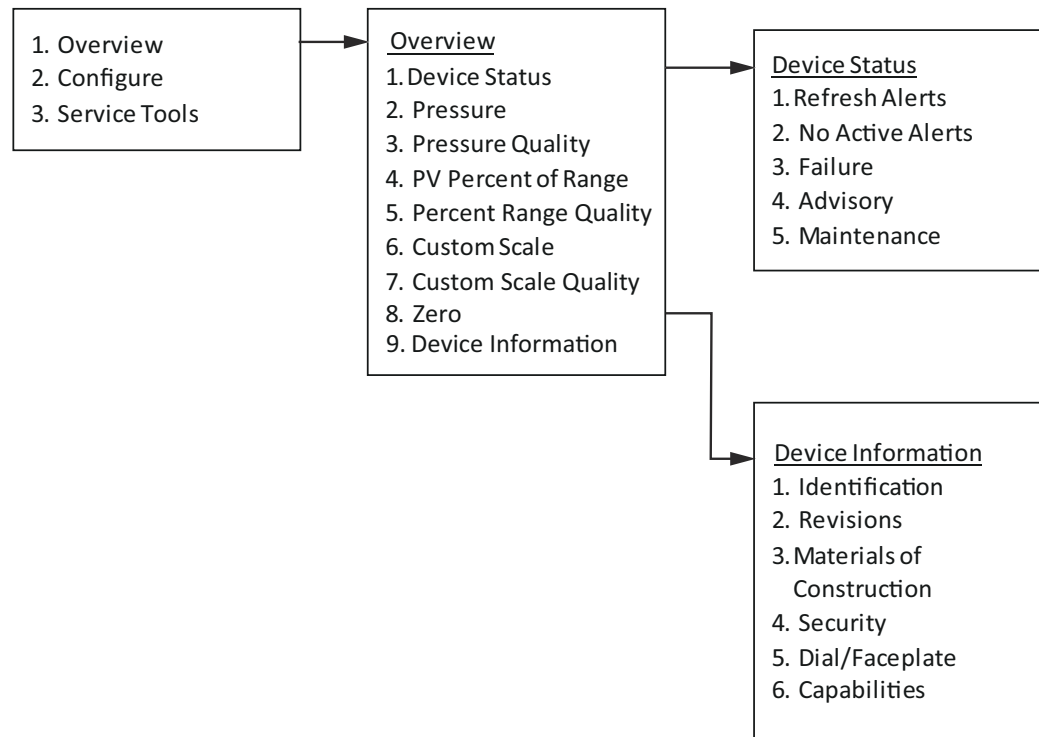

Figure B-2: Configure

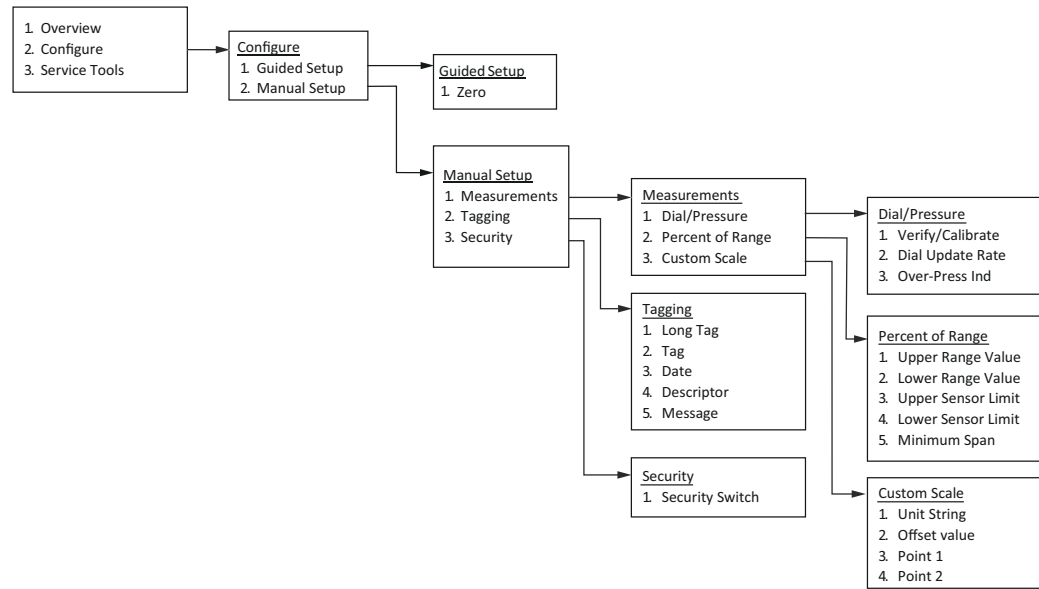

Figure B-3: Service Tools

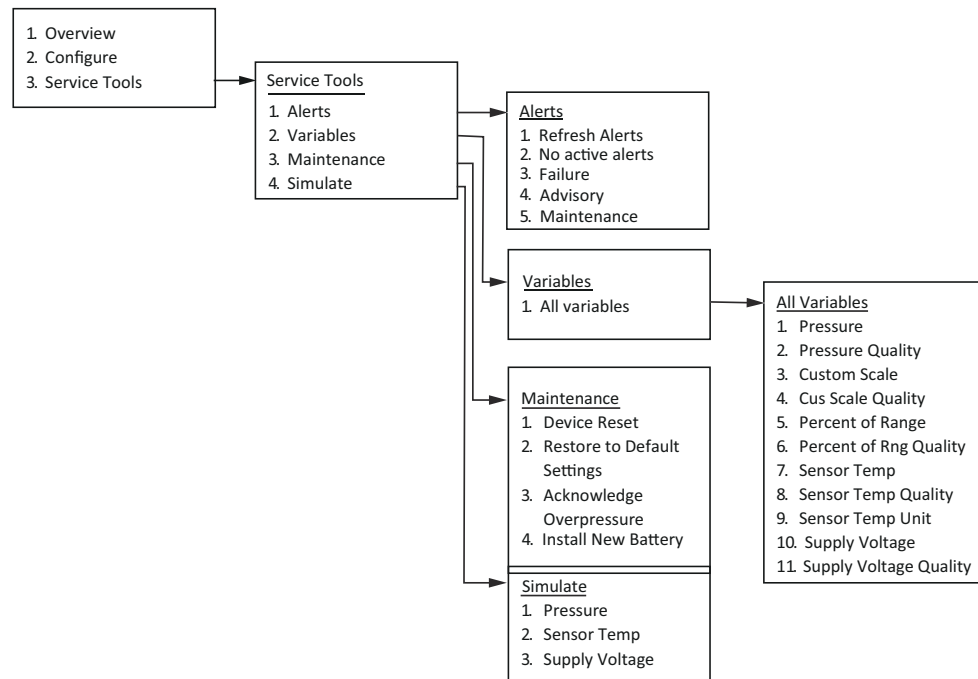

Figure B-4: Device Information

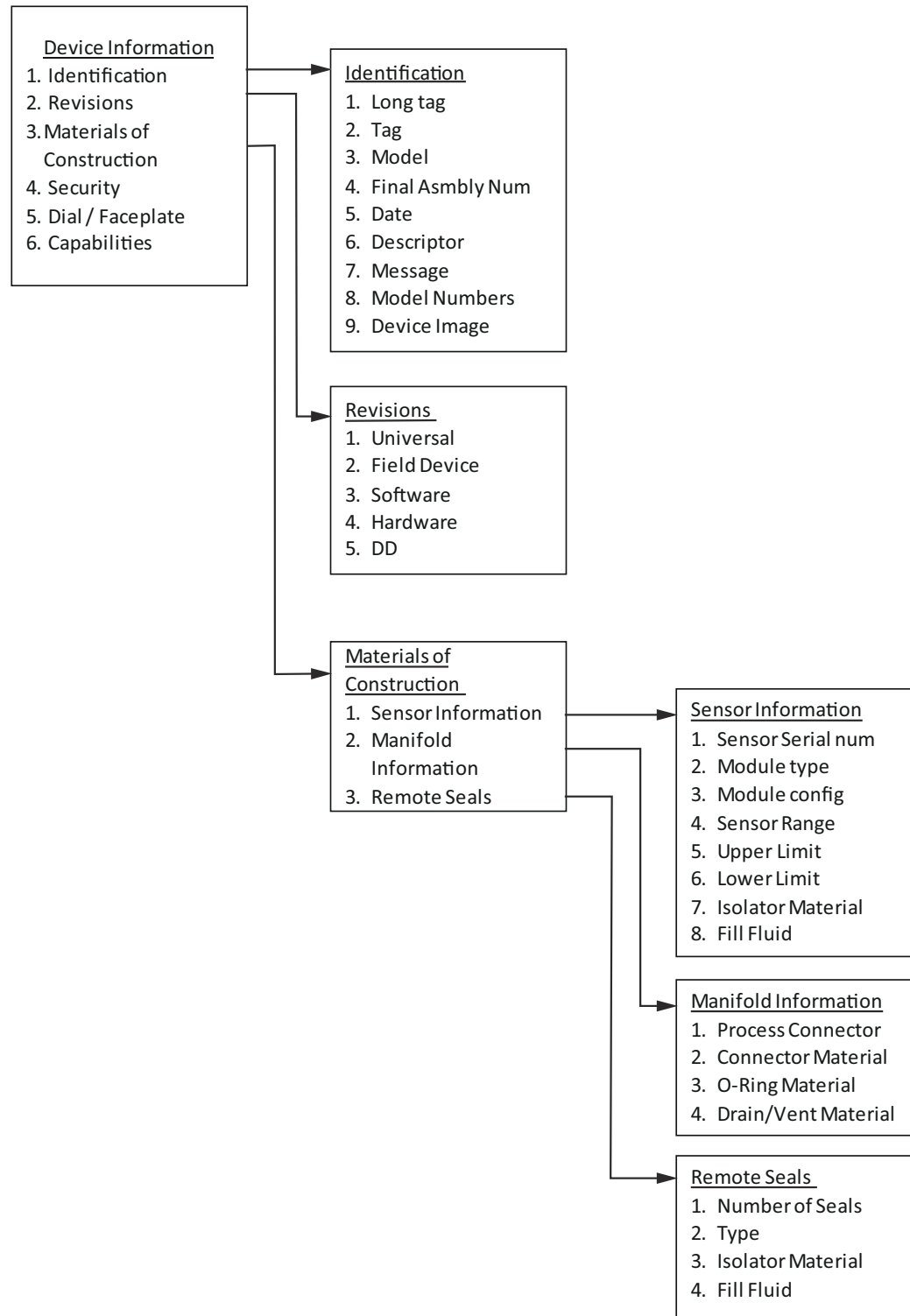
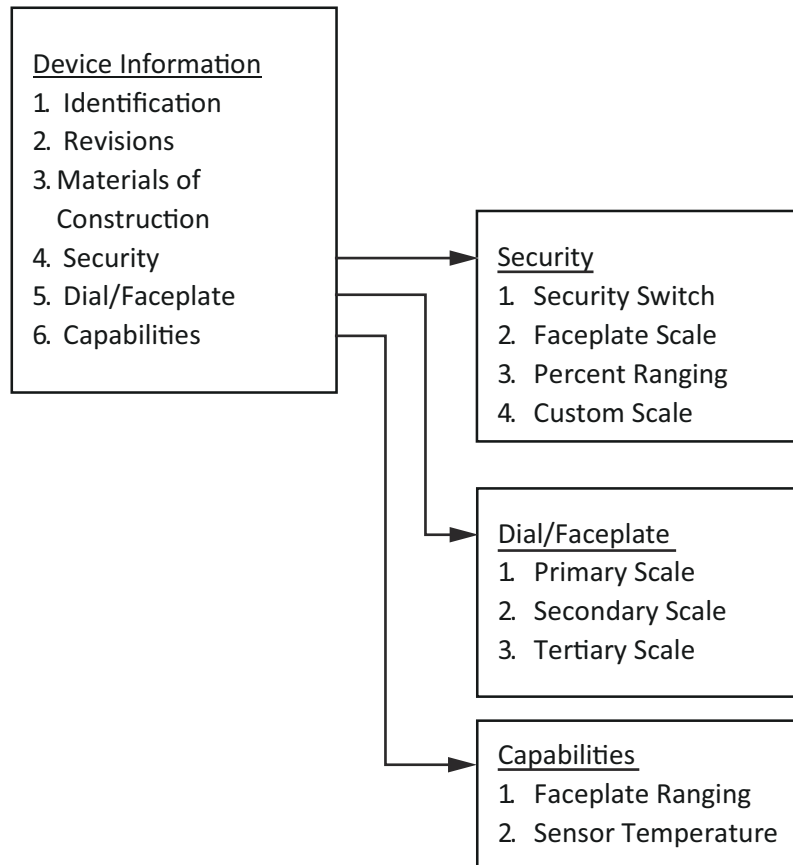

Figure B-5: Device Information (continued)



Global Headquarters

Emerson Automation Solutions
6021 Innovation Blvd.
Shakopee, MN 55379, USA

+1 800 999 9307 or +1 952 906 8888
+1 952 204 8889
RFQ.RMD-RCC@Emerson.com

North America Regional Office

Emerson Automation Solutions
8200 Market Blvd.
Chanhassen, MN 55317, USA

+1 800 999 9307 or +1 952 906 8888
+1 952 204 8889
RMT-NA.RCCRFQ@Emerson.com

Latin America Regional Office

Emerson Automation Solutions
1300 Concord Terrace, Suite 400
Sunrise, FL 33323, USA

+1 954 846 5030
+1 954 846 5121
RFQ.RMD-RCC@Emerson.com

Europe Regional Office

Emerson Automation Solutions Europe
GmbH
Neuhofstrasse 19a P.O. Box 1046
CH 6340 Baar
Switzerland

+41 (0) 41 768 6111
+41 (0) 41 768 6300
RFQ.RMD-RCC@Emerson.com

Asia Pacific Regional Office

Emerson Automation Solutions
1 Pandan Crescent
Singapore 128461

+65 6777 8211
+65 6777 0947
Enquiries@AP.Emerson.com

Middle East and Africa Regional Office

Emerson Automation Solutions
Emerson FZE P.O. Box 17033
Jebel Ali Free Zone - South 2
Dubai, United Arab Emirates

+971 4 8118100
+971 4 8865465
RFQ.RMTMEA@Emerson.com

 [Linkedin.com/company/Emerson-Automation-Solutions](https://www.linkedin.com/company/Emerson-Automation-Solutions)

 [Twitter.com/Rosemount_News](https://twitter.com/Rosemount_News)

 [Facebook.com/Rosemount](https://www.facebook.com/Rosemount)

 [Youtube.com/user/RosemountMeasurement](https://www.youtube.com/user/RosemountMeasurement)

©2019 Emerson. All rights reserved.

Emerson Terms and Conditions of Sale are available upon request. The Emerson logo is a trademark and service mark of Emerson Electric Co. Rosemount is a mark of one of the Emerson family of companies. All other marks are the property of their respective owners.