

Instruction Manual

LIQ-MAN-5081P/rev.J

January 2015

Model 5081-P

Two-Wire pH/ORP Transmitter



ESSENTIAL INSTRUCTIONS

READ THIS PAGE BEFORE PROCEEDING!

Rosemount Analytical designs, manufactures, and tests its products to meet many national and international standards. Because these instruments are sophisticated technical products, you must properly install, use, and maintain them to ensure they continue to operate within their normal specifications. The following instructions must be adhered to and integrated into your safety program when installing, using, and maintaining Rosemount Analytical products. Failure to follow the proper instructions may cause any one of the following situations to occur: Loss of life; personal injury; property damage; damage to this instrument; and warranty invalidation.

- Read all instructions prior to installing, operating, and servicing the product. If this Instruction Manual is not the correct manual, telephone 1-800-654-7768 and the requested manual will be provided. Save this Instruction Manual for future reference.
- If you do not understand any of the instructions, contact your Rosemount representative for clarification.
- Follow all warnings, cautions, and instructions marked on and supplied with the product.
- Inform and educate your personnel in the proper installation, operation, and maintenance of the product.
- Install your equipment as specified in the Installation Instructions of the appropriate Instruction Manual and per applicable local and national codes. Connect all products to the proper electrical and pressure sources.
- To ensure proper performance, use qualified personnel to install, operate, update, program, and maintain the product.
- When replacement parts are required, ensure that qualified people use replacement parts specified by Rosemount. Unauthorized parts and procedures can affect the product's performance and place the safe operation of your process at risk. Look alike substitutions may result in fire, electrical hazards, or improper operation.
- Ensure that all equipment doors are closed and protective covers are in place, except when maintenance is being performed by qualified persons, to prevent electrical shock and personal injury.

CAUTION

If a Model 375 Universal Hart® Communicator is used with these transmitters, the software within the Model 375 may require modification. If a software modification is required, please contact your local Emerson Process Management Service Group or National Response Center at 1-800-654-7768.

About This Document

This manual contains instructions for installation and operation of the Model 5081-P Two-Wire pH/ORP Transmitter. The following list provides notes concerning all revisions of this document.

<u>Rev. Level</u>	<u>Date</u>	<u>Notes</u>
A	10/04	This is the initial release of the product manual. The manual has been reformatted to reflect the Emerson documentation style and updated to reflect any changes in the product offering. This manual contains information on HART Smart and FOUNDATION Fieldbus versions of 5081-P.
B	3/05	Updated FM dwg & sensor compatibility chart.
C	4/05	Fixed drawings that changed in pdf conversion.
D	2/06	Added drawings, pages 52-60.
E	11/07	Added Mcerts to page 2.
F	06/09	Page 136 phone # change
G	1/11	Updated Enclosure specifications, updated ©
H	11/12	Added Fieldbus specifications, updated ITK revision and CE certifications
J	10/14	Changed agency water exposure testing description to "Type".

Emerson Process Management

2400 Barranca Parkway
Irvine, CA 92606 USA
Tel: (949) 757-8500
Fax: (949) 474-7250
<http://www.railhome.com>

MODEL 5081-P pH/ORP TWO-WIRE TRANSMITTER

TABLE OF CONTENTS

Section	Title	Page
1.0	DESCRIPTION AND SPECIFICATIONS	1
1.1	Features and Applications.....	1
1.2	Specifications.....	2
1.3	Hazardous Location Approval.....	3
1.4	Transmitter Display During Calibration and Programming.....	5
1.5	Infrared Remote Controller	5
1.6	FOUNDATION Fieldbus.....	5
1.7	General Specifications	5
1.8	HART Communications	6
1.9	Asset Management Solutions	7
2.0	INSTALLATION	9
2.1	Unpacking and Inspection.....	9
2.2	Pre-Installation Set Up	9
2.3	Orienting the Display Board	11
2.4	Mechanical Installation.....	11
2.5	Power Supply/Current Loop Wiring for Model 5081-P-HT	14
2.6	Power Supply Wiring for Model 5081-P-FF	15
3.0	WIRING	16
3.1	General Information	16
3.2	Wiring Diagrams	17
4.0	INTRINSICALLY SAFE AND EXPLOSION PROOF INSTALLATIONS	31
4.1	Intrinsically Safe and Explosion-Proof Installations for 5081-P-HT.....	32
4.2	Intrinsically Safe and Explosion-Proof Installations for 5081-P-FF	40
4.3	Intrinsically Safe and Explosion-Proof Installations for 5081-P-FI	48
5.0	OPERATION WITH REMOTE CONTROLLER	55
5.1	Overview	55
5.2	Displays	56
5.3	Infrared Remote Controller (IRC) — Key Functions	57
5.4	Menu Tree - pH.....	58
5.5	Diagnostic Messages - pH.....	58
5.6	Menu Tree -ORP	60
5.7	Diagnostic Messages - ORP	60
5.8	Security	62
6.0	OPERATION WITH MODEL 375	63
6.1	Note on Model 375 or 475 HART Communicator	63
6.2	Connecting the HART Communicator.....	63
6.3	Operation	64

Continued on the following page

TABLE OF CONTENTS CONT'D

7.0	CALIBRATION OF pH MEASUREMENTS	69
7.1	General	69
7.2	Entering and Leaving the Calibrate Menu.....	69
7.3	Using the Hold Function.....	69
7.4	Temperature Calibration.....	70
7.5	Auto Calibration	71
7.6	Manual Calibration	73
7.7	Making the Transmitter Reading Match a Second pH Meter (Standardization).....	75
8.0	PROGRAMMING FOR pH MEASUREMENTS	77
8.1	General	77
8.2	Entering and Leaving the Program Menu	77
8.3	Output Ranging.....	79
8.4	Diagnostic Parameters.....	80
8.5	Temperature Related Settings	84
8.6	Display Units	86
8.7	Buffer Calibration Parameters.....	87
8.8	Isopotential Parameters	89
8.9	Generating a Test Current.....	91
9.0	CALIBRATION OF ORP MEASUREMENTS	92
9.1	General	92
9.2	Entering and Leaving the Calibrate Menu.....	92
9.3	Using the Hold Function.....	92
9.4	Temperature Calibration.....	93
9.5	Standardization	94
10.0	PROGRAMMING FOR ORP MEASUREMENTS	95
10.1	General	95
10.2	Entering and Leaving the Program Menu	95
10.3	Output Ranging.....	97
10.4	Temperature Element.....	99
10.5	Display Units	100
10.6	Diagnostic Parameters.....	101
10.7	Generating a Test Current.....	104
11.0	MAINTENANCE	105
11.1	Overview	105
11.2	Transmitter Maintenance	105
11.3	pH Sensor Maintenance	106
11.4	ORP Sensor Maintenance	108
11.5	Calibration	108

Continued on the following page

TABLE OF CONTENTS CONT'D

12.0	TROUBLESHOOTING	109
12.1	Warning and Fault Messages	109
12.2	Calibration Errors	110
12.3	Troubleshooting - General	110
12.4	Troubleshooting When a Diagnostic Message is Showing	110
12.5	Troubleshooting When No Diagnostic Message is Showing.....	122
12.6	Displaying Diagnostic Variables.....	127
12.7	Testing the Transmitter by Simulating pH	127
12.8	Factory Assistance and Repairs	130
13.0	pH MEASUREMENTS.....	131
13.1	General	131
13.2	Measuring Electrode	132
13.3	Reference Electrode	132
13.4	Liquid Junction Potential	133
13.5	Converting Voltage to pH	133
13.6	Glass Electrode Slope	134
13.7	Buffers and Calibration	134
13.8	Isopotential pH.....	135
13.9	Junction Potential Mismatch	135
13.10	Sensor Diagnostics.....	136
13.11	Shields, Insulation, and Preamplifiers.....	136
14.0	ORP MEASUREMENTS.....	137
14.1	General	137
14.2	Measuring Electrode	138
14.3	Reference Electrode	138
14.4	Liquid Junction Potential	138
14.5	Relating Cell Voltage to ORP.....	139
14.6	ORP, Concentration, and pH.....	139
14.7	Interpreting ORP Measurements	140
14.8	Calibration	142
15.0	THEORY — REMOTE COMMUNICATIONS.....	143
15.1	Overview of HART Communications.....	143
15.2	HART Interface Devices.....	143
15.3	Asset Management Solutions	144
16.0	RETURN OF MATERIAL.....	145

LIST OF FIGURES

Number	Title	Page
1-1	Transmitter Display During Calibration and Programming	5
1-2	Infrared Remote Controller	5
1-3	Configuring Model 5081 Transmitter with FOUNDATION Fieldbus	6
1-4	HART Communicator	7
1-5	AMS Main Menu Tools	8
2-1	Mounting the Model 5081-P pH/ORP Transmitter on a Flat Surface.....	12
2-2	Using the Pipe Mounting Kit to Attach the Model 5081-P pH/ORP to a pipe.....	13
2-3	Load/Power Supply Wiring	14
2-4	Model 5081-P-HT Power Wiring Details.....	14
2-5	Typical Fieldbus Network Electrical Wiring Configuration	15
2-6	Model 5081-P-FF Power Wiring Details	15
3-1	Wiring and Preamplifier Configurations for pH and ORP Sensors	16
3-2	Wire Functions for Models 399-02, 399-09, 381pH-30-41, and 381pHE-31-41 before removing BNC and terminating cable	20
3-3	Wire Functions for Models 399-02, 399-09, 381pH-30-41, and 381pHE-31-41 after removing BNC and terminating cable. Wire Functions for Models 399-09-10-62, 381pH-30-42, and 381pHE-31-42 as received	20
3-4	Wiring Diagram for Models 399-02, 399-09, 381pH-30-41, and 381pHE-31-41 after removing BNC and terminating cable. Wiring Diagram for Models 399-09-10-62, 381pH-30-42, and 381pHE-31-42 as received. Wiring directly to the transmitter	20
3-5	Wiring Diagram for Models 399-02, 399-09, 381pH-30-41 after removing BNC and terminating cable. Wiring Diagram for Model 399-09-10-62, 381pH-30-42, and 381pH-31-42 as received. Wiring through a remote junction box to the transmitter	20
3-6	Wire Functions for Models 397-50, 397-54, 396-50, 396-54, 396R-50-60, 396R-54-60, 389-02-50, and 389-02-54 before removing BNC and terminating cable.....	21
3-7	Wire Functions for Models 397-50, 397-54, 369-50, 396-54, 396R-50-60, 396R-54-60, 389-02-50, and 389-02-54 after removing BNC and terminating cable. Wire Functions for Models 397-54-62, 396-02-62, and 389-02-54-62 as received	21
3-8	Wiring Diagram for Models 397-50, 397-54, 369-50, 396-54, 389-02-50, and..... 389-02-54 after removing BNC and terminating cable. Wiring Diagram for Models 397-54-62, 396-02-62, and 389-02-54-62 as received. Wiring Directly to the Transmitter	21
3-9	Wiring Diagram for Models 397-50, 397-54, 369-50, 396-54, 396R-50-60, 396R-54-60, 389-02-50, and 389-02-54 after removing BNC and terminating cable. Wiring Diagram for Models 397-54-62, 396-02-62, and 389-02-54-62 as received. Wiring Through a Remote Junction Box to the Transmitter	21
3-10	Wire Functions for Models 396R-50, 396R-54, 396R-50-61, 396P-02-50, 396P-02-54, 396P-05-55, 385+-04, and 385+-41-52.....	22
3-11	Wiring Diagram for Models 396R-50, 396R-54, 396R-50-61, 396P-02-50, 396P-02-54, 396P-05-55, 385+-04, and 385+-41-52. Wiring Directly to the Transmitter	22
3-12	Wiring Diagram for Models 396R-50, 396R-54, 396R-54-61, 396P-02-50, 396P-02-54, 396P-02-55, 385+-04, and 385+-41-52. Wiring Through a Sensor-Mounted Junction Box to the Transmitter	22
3-13	Wire Functions for Models 396P-01-55, 385+-03, 381+-40-55, and 381+-43-55	23
3-14	Wiring Diagram for Models 396P-01-55, 385+-03, 381+-40-55, and 381+-43-55....	23
3-15	Wire Functions for Model 328A-07	24
3-16	Wiring Diagram for Models 328A and 385+-02	24
3-17	Wiring Diagram for Model 385+-02	24

LIST OF FIGURES - CONT'D

Number	Title	Page
3-18	Wiring Diagram for Model 320HP-10-55	25
3-19	Wiring Diagram for Model 320HP-10-58	25
3-20	Procedure for Removing BNC Connector and Preparing Coaxial Cable for Connection to the Model 5081-P pH/ORP Transmitter.....	26
3-21	Preparation of Raw Connecting Cable	27
4-1	Model 5081-P-HT Infrared Remote Control — CSA, FM, & ATEX approvals	31
4-2	Model 5081-P-FF Infrared Remote Control — CSA, FM, & ATEX approvals.....	31
4-3	FM Explosion-Proof Installation for Model 5081-P-HT	32
4-4	FM Intrinsically Safe Label for Model 5081-P-HT.....	33
4-5	FM Intrinsically Safe Installation for Model 5081-P-HT	34
4-6	CSA Intrinsically Safe Label for Model 5081-P-HT.....	36
4-7	CSA Intrinsically Safe Installation for Model 5081-P-HT	37
4-8	ATEX Intrinsically Safe Label for Model 5081-P-HT.....	39
4-9	FM Explosion-Proof Installation for Model 5081-P-FF	40
4-10	FM Intrinsically Safe Label for Model 5081-P-FF	41
4-11	FM Intrinsically Safe Installation for Model 5081-P-FF.....	42
4-12	CSA Intrinsically Safe Label for Model 5081-P-FF	44
4-13	CSA Intrinsically Safe Installation for Model 5081-P-FF.....	45
4-14	ATEX Intrinsically Safe Label for Model 5081-P-FF	47
4-15	FM Intrinsically Safe Label for Model 5081-P-FI	48
4-16	FM Intrinsically Safe Installation for Model 5081-P-FI.....	49
4-17	CSA Intrinsically Safe Label for Model 5081-P-FI	51
4-18	CSA Intrinsically Safe Installation for Model 5081-P-FI.....	52
4-19	ATEX Intrinsically Safe Label for Model 5081-P-FI	54
5-1	Functional Block Diagram for the Model 5081-P pH/ORP Transmitter with FOUNDATION Fieldbus	55
5-2	Process Display Screen	56
5-3	Program Display Screen	56
5-4	Infrared Remote Controller	57
5-5	pH Menu Tree for Model 5081-P-HT	58
5-6	pH Menu Tree for Model 5081-P-FF	59
5-7	ORP Menu Tree for Model 5081-P-HT	60
5-8	ORP Menu Tree for Model 5081-P-FF	61
6-1	Connecting the HART Communicator	63
6-2	5081-P-HT HART / Model 375 Menu Tree	65
8-1	Suggested Glass Impedance Warning and Failure Limits	80
8-2	Suggested Warning and Failure Limits for Low Impedance Reference Electrodes .	81
8-3	Suggested Warning and Failure Limits for High Impedance Glass Reference Electrodes	81
10-1	Suggested Warning and Failure Limits for Low Impedance Reference Electrodes .	101
10-2	Suggested Glass Impedance Warning and Failure Limits for a Glass Reference Electrode	101
11-1	Checking the Potential of the Reference Electrode.....	107
12-1	Warning Annunciation.....	109
12-2	Fault Annunciation.....	109
12-3	Three-Wire RTD	116
12-4	Temperature Simulation into the Model 5081-P pH/ORP Transmitter	116
12-5	pH Simulation When the Preamplifier is Located in the Transmitter	128
12-6	pH Simulation When the Preamplifier is Located in a Remote Junction Box or in a Sensor-Mounted Junction Box	128

LIST OF FIGURES - CONT'D

12-7	Simulate pH Through Model 381+ Sensor Preamplifier	129
13-1	pH Measurement Cell.....	131
13-2	Measuring Electrode (pH)	132
13-3	Cross-Section Through the pH Glass.....	132
13-4	Reference Electrode.....	133
13-5	The Origin of Liquid Junction Potential.....	133
13-6	Glass Electrode Slope.....	134
13-7	Two-Point Buffer Calibration.....	136
13-8	Liquid Junction Potential Mismatch	136
14-1	ORP Measurement Cell	137
14-2	Measuring Electrode (ORP)	138
14-3	Reference Electrode.....	138
14-4	The Origin of Liquid Junction Potential.....	139
14-5	Electrode Potential	139
14-6	ORP Measurement Interpretation	140
15-1	HART Communications	143
15-2	AMS Main Menu Tools	144

LIST OF TABLES

Number	Title	Page
3-1	Wiring Diagrams for Model 399 Sensors.....	17
3-2	Wiring Diagrams for Model 397 Sensors.....	17
3-3	Wiring Diagrams for Model 396R Sensors	17
3-4	Wiring Diagrams for Model 396P Sensors	18
3-5	Wiring Diagrams for Model 396 Sensors.....	18
3-6	Wiring Diagrams for Model 389 Sensors.....	18
3-7	Wiring Diagrams for Model 385+ Sensors.....	19
3-8	Wiring Diagrams for Model 381+ Sensors.....	19
3-9	Wiring Diagrams for Model 381pHE and 381pH Sensors	19
3-10	Wiring Diagrams for Model 328A Sensors	19
3-11	Wiring Diagrams for Model 320HP Sensors.....	19
8-1	pH Settings List	78
8-2	pH Values of Standard Buffer Solutions and the Temperature Range over which pH Values are Defined	87
8-3	pH Values of Commercial (technical) Buffers and the Temperature Range over which pH Values are Defined	88
8-4	Standard and Technical Buffers Recognized by the Model 5081-P pH Transmitter	88
10-1	ORP Settings List	96
11-1	Replacement Parts for Model 5081-P pH Transmitter	106
12-1	RTD Resistance Values	116

SECTION 1.0

DESCRIPTION AND SPECIFICATIONS

- CHOICE OF COMMUNICATION PROTOCOL: HART® or FOUNDATION Fieldbus.
- LARGE, EASY-TO-READ two-line display shows the process measurement and temperature.
- SIMPLE MENU STRUCTURE.
- ROBUST TYPE 4X ENCLOSURE.
- INTRINSICALLY SAFE DESIGN allows the transmitter to be used in hazardous environments (with appropriate safety barriers).
- NON-VOLATILE MEMORY retains program settings and calibration data during power failures.
- CHANGING FROM pH TO ORP operation takes only seconds.
- AUTOMATIC TWO-POINT BUFFER CALIBRATION reduces errors.
- SOLUTION TEMPERATURE COMPENSATION converts measured pH to the pH at 25°C.
- CONTINUOUS DIAGNOSTICS monitor sensor performance and warn the user of failure (FAULT) or approaching failure (WARNING).

1.1 FEATURES AND APPLICATIONS

The Model 5081 family of transmitters can be used to measure pH or ORP in a variety of process liquids. The 5081 is compatible with most Rosemount Analytical sensors. See the Specifications section for details.

The transmitter has a rugged, weatherproof, corrosion-resistant enclosure (Type 4X and IP65) of epoxy-painted aluminum. The enclosure also meets explosion-proof standards.

The transmitter has a two-line seven-segment display. The main measurement appears in 0.8-inch (20 mm) high numerals. The secondary measurement, temperature (and pH if free chlorine is being measured), appears in 0.3-inch (7 mm) high digits.

Two digital communication protocols are available: HART (model option -HT) and Foundation Fieldbus (model option -FF). Digital communications allows access to AMS (Asset Management Solutions). Use AMS to set up and configure the transmitter, read process variables, and troubleshoot problems from a personal computer or host anywhere in the plant.

A handheld infrared remote controller or the HART Model 375 communicator can also be used for programming and calibrating the transmitter. The remote controller works from as far away as six feet.

The Model 5081-P Transmitter with the appropriate sensor can be configured for either pH or ORP (oxidation reduction potential) measurement of aqueous solutions. Housed in a Type 4X case, the Model 5081 can be located close to the sensor even in the harshest environments, including process, water or wastewater monitoring.

Advanced features include automatic 2-point buffer calibration routine, automatic recognition of Pt100 or Pt1000 RTD, and menu-selected internal preamplifier. Predictive sensor diagnostic capability is possible through the impedance measurement of the pH glass membrane and reference electrode, fully supported by AMS. Solution temperature calibration allows the instrument to calculate and display the pH at 25°C when the temperature coefficient of the measured liquid is provided.

1.2 SPECIFICATIONS

1.2.1 GENERAL SPECIFICATIONS

Housing: Cast aluminum with epoxy coating. Type 4X (IP65). Neoprene O-ring cover seals.

Dimensions: 160.5 mm x 175.3 mm x 161.3 mm (6.3 in. x 6.9 in. x 6.4 in.) See drawing.

Conduit Openings: 3/4-in. FNPT

Ambient Temperature: -4 to 149°F (-20 to 65°C)

Storage Temperature: -22 to 176°F (-30 to 80°C)

Relative Humidity: 0 to 95% (non-condensing)

Weight/Shipping Weight: 10 lb/10 lb (4.5/5.0 kg)

Display: Two-line LCD; first line shows process variable (pH, ORP, conductivity, % concentration, oxygen, ozone, or chlorine), second line shows process temperature and output current. For pH/chlorine combination, the second line can be toggled to show pH. Fault and warning messages, when triggered, alternate with temperature and output readings.

First line: 7 segment LCD, 0.8 in. (20 mm) high.

Second line: 7 segment LCD, 0.3 in. (7mm) high.

Display board can be rotated 90 degrees clockwise or counterclockwise.

During calibration and programming, messages and prompts appear in the second line.

Temperature resolution: 0.1°C

Hazardous Location Approval: For details, see specifications for the measurement of interest.

RFI/EMI: EN-61326 



Digital Communications:

HART —

Power & Load Requirements:

Supply voltage at the transmitter terminals should be at least 12 Vdc. Power supply voltage should cover the voltage drop on the cable plus the external load resistor required for HART communications (250 Ω minimum). Minimum power supply voltage is 12 Vdc. Maximum power supply voltage is 42.4 Vdc (30 Vdc for intrinsically safe operation). The graph shows the supply voltage required to maintain 12 Vdc (upper line) and 30 Vdc (lower line) at the transmitter terminals when the current is 22 mA.

Analog Output: Two-wire, 4-20 mA output with superimposed HART digital signal. Fully scalable over the operating range of the sensor.

Output accuracy: ±0.05 mA

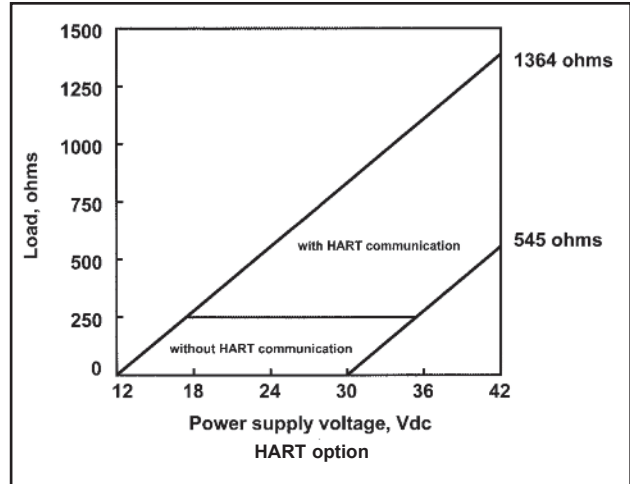

FOUNDATION FIELDBUS —

Power & Load Requirements: A power supply voltage of 9-32 Vdc at 22 mA is required.

1.2.2 FUNCTIONAL SPECIFICATIONS

pH Range: 0 to 14

ORP Range: -1400 to +1400mV

Calibrations/standardization: The automatic buffer recognition uses stored buffer values and their temperature curves for the most common buffer standards available worldwide. The transmitter also performs a stabilization check on the sensor in each buffer.

A manual two-point calibration is made by immersing the sensor in two different buffer solutions and entering the pH values. The microprocessor automatically calculates the slope which is used for self-diagnostics. An error message will be displayed if the pH sensor is faulty. This slope can be read on the display and/or manually adjusted if desired.

An on-line one-point process standardization is accomplished by entering the pH or ORP value of a grab sample as measured by a lab reference.

Preamplifier Location: A preamplifier must be used to convert the high impedance pH electrode signal to a low impedance signal for transmitter use. The integral preamplifier of the Model 5081-P may be used when the sensor to transmitter distance is less than 15 ft (4.5 m). Locate the preamplifier in the sensor or junction box for longer distances.

Automatic Temperature Compensation: External 3 or 4 wire Pt 100 RTD or Pt 1000 RTD located in the sensor, compensates the pH reading for temperature fluctuations. Compensation covers the range -15 to 130°C (5 to 270°F). Manual temperature compensation is also selectable.

Accuracy: ±1 mV @ 25°C ±0.01 pH

Repeatability: ±1 mV @ 25°C ±0.01 pH

Stability: 0.25% / year @ 25°C

Diagnostics: The internal diagnostics can detect:

Calibration Error	Low Temperature Error
High Temperature Error	Sensor Failure
Line Failure	CPU Failure
ROM Failure	Input Warning
Glass Failure	Glass Warning
Reference Failure	Reference Warning

Once one of the above is diagnosed, the LCD will display a message describing the failure/default detected.

Digital Communications as applicable by model:

HART (pH): PV assigned to pH. SV, TV, and 4V assignable to pH, temperature, mV, glass impedance, reference impedance, or RTD resistance.

HART (ORP): PV assigned to ORP. SV, TV, and 4V assignable to ORP, temperature, reference impedance, or RTD resistance.

Fieldbus (pH): Four AI blocks assigned to pH, temperature, reference impedance, and glass impedance.

Fieldbus (ORP): Three AI blocks assigned to ORP, temperature, and reference impedance.

1.3 HAZARDOUS LOCATION APPROVAL

Intrinsic Safety:



Class I, II, III, Div. 1
Groups A-G
T4 Tamb = 70°C



Exia Entity
Class I, Groups A-D
Class II, Groups E-G
Class III
T4 Tamb = 70°C



IECEX BAS 09.0159X
Ex ia IIC T4 Ga

ATEX



CE 0600 II 1 G
Baseefa02ATEX1284
EEx ia IIC T4
Tamb = -20°C to +65°C

ATEX and IECEx Special Conditions for Use: The model 5081 enclosure is made of aluminum alloy and is given a protective polyurethane paint finish. However, care should be taken to protect it from impact or abrasion if located in a zone 0 hazardous area.

Non-Incendive:



Class I, Div. 2, Groups A-D
Dust Ignition Proof
Class II & III, Div. 1, Groups E-G
Type 4X Enclosure



Class I, Div. 2, Groups A-D
Suitable for
Class II, Div. 2, Groups E-G
T4 Tamb = 70°C

Explosion-Proof:



Class I, Div. 1, Groups B-D
Class II, Div. 1, Groups E-G
Class III, Div. 1



Class I, Groups B-D
Class II, Groups E-G
Class III
Tamb = 65°C max

1.4 TRANSMITTER DISPLAY DURING CALIBRATION AND PROGRAMMING (FIGURE 1-1)

1. Continuous display of pH, ORP, conductivity, oxygen, chlorine, or ozone reading.
2. Units: pH, mV, $\mu\text{S}/\text{cm}$, mS/cm , ppm, ppb, % saturation, or %.
3. Current menu section appears here.
4. Submenus, prompts, and diagnostic readings appear here.
5. Commands available in each submenu or at each prompt appear here.
6. Hold appears when the transmitter is in hold.
7. Fault appears when the transmitter detects a sensor or instrument fault.
8. © flashes during HART digital communication.

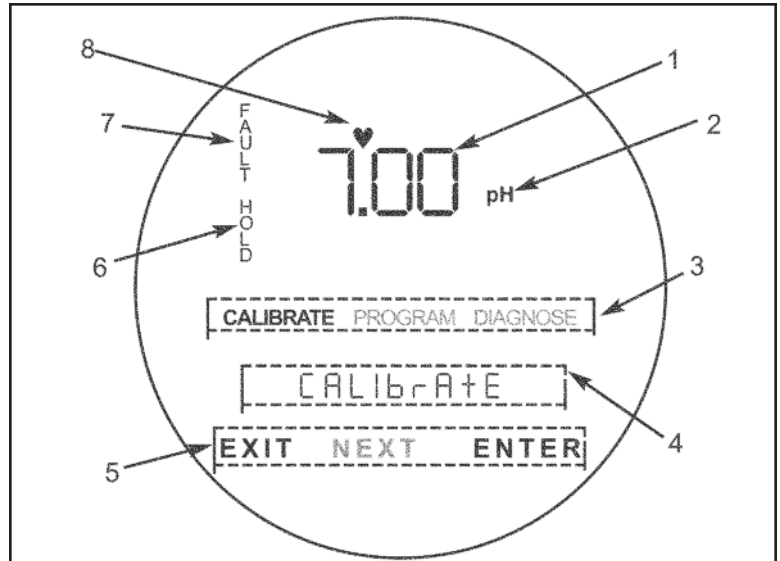

FIGURE 1-1. TRANSMITTER DISPLAY DURING CALIBRATION AND PROGRAMMING
The program display screen allows access to calibration and programming menus.

1.5 INFRARED REMOTE CONTROLLER (FIGURE 1-2)

1. Pressing a menu key allows the user access to calibrate, program, or diagnostic menus.
2. Press ENTER to store data and settings. Press NEXT to move from one submenu to the next. Press EXIT to leave without storing changes.
3. Use the editing arrow keys to scroll through lists of allowed settings or to change a numerical setting to the desired value.
4. Pressing HOLD puts the transmitter in hold and sends the output current to a pre-programmed value. Pressing RESET causes the transmitter to abandon the present menu operation and return to the main display.

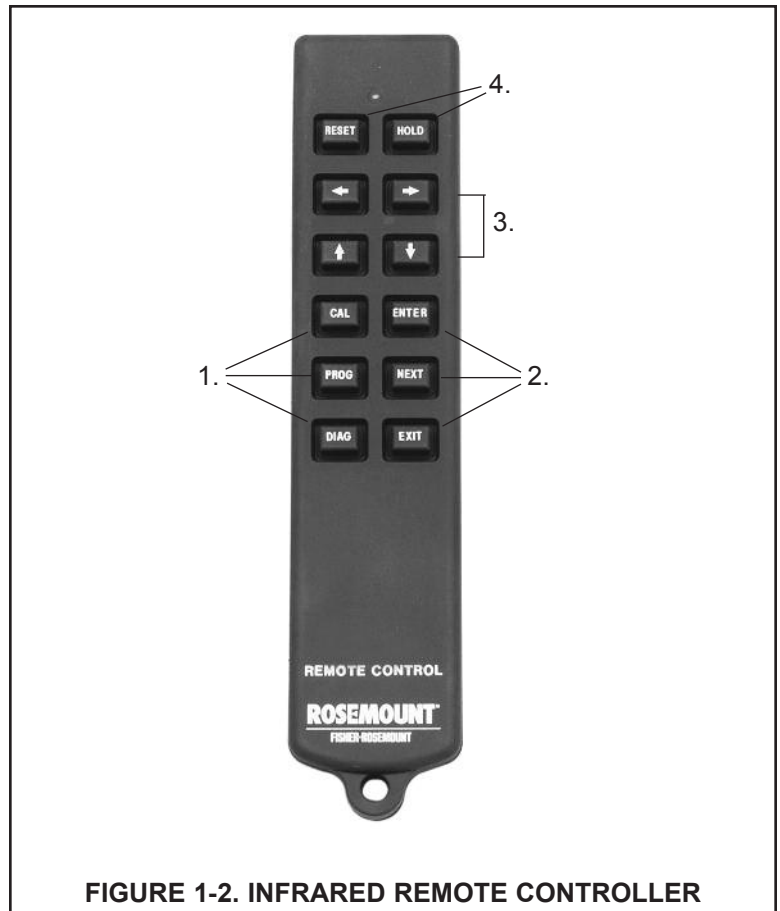

FIGURE 1-2. INFRARED REMOTE CONTROLLER

1.6 FOUNDATION FIELDBUS

Figure 1-3 shows a 5081-P-FF being used to measure and control pH and chlorine levels in drinking water. The figure also shows three ways in which Fieldbus communication can be used to read process variables and configure the transmitter.

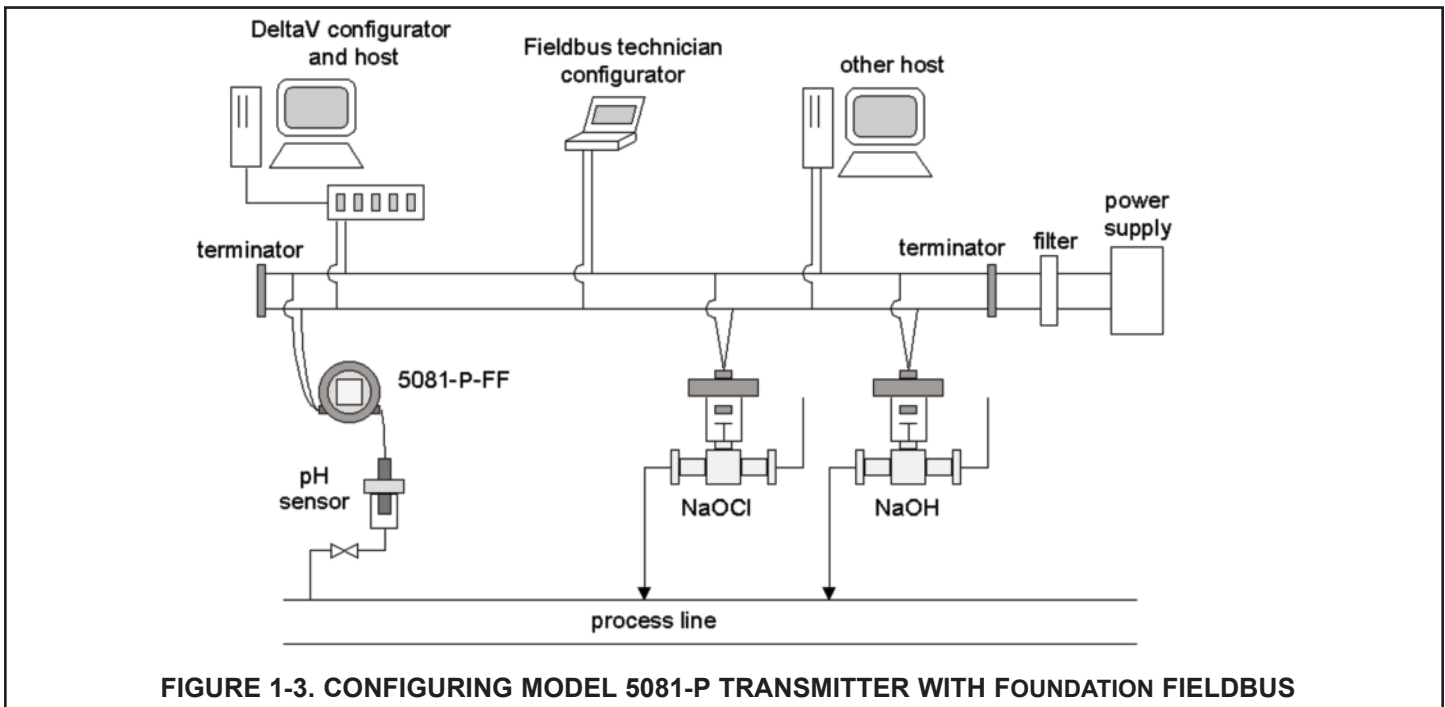

FIGURE 1-3. CONFIGURING MODEL 5081-P TRANSMITTER WITH FOUNDATION FIELDBUS

1.7 GENERAL SPECIFICATIONS

Model: 5081-P-FF pH Fieldbus Transmitter

Type: pH/ORP Transmitter

Device ITK Profile: 6 (Released for ITK 6.0.0 / 6.0.1)

Manufacturer Identification (MANUFAC_ID): 0x524149

Device Type (DEV_TYPE): 0x4085

Device Revision (DEV_REV): 0x03

Linkmaster: Yes

Number of Link Objects: 20

VCR's supported: 20

Mandatory Features:

- Resource Block
- Alarm and Events
- Function Block Linking
- Trending
- Multi-Bit Alert Reporting
- Field Diagnostics

Additional Features:

- Common Software Download
- Block Instantiation
- Supports DeltaV Auto Commissioning
- Supports DeltaV Auto Replacement
- Supports DeltaV Firmware Live Download
- PlantWeb Alerts with re-annunciation / multibit
- Supports Easy Configuration Assistant

Function Blocks (Execution Time):

- 4 – Analog Input Blocks (15 mseconds)
- AI Block Channels:
 - Channel 1: pH, ORP
 - Channel 2: Temperature
 - Channel 3: Reference Electrode Impedance
 - Channel 4: Glass Electrode Impedance (pH only)
- Proportional Integral Derivative (25 mseconds)

Power:

- Two Wire Device; Fieldbus Polarity Insensitive
- Current Draw: 21 mA
- Device Certifications: IS / FISCO
- Maximum certified input Voltage for IS: 30V
- Maximum certified input current for IS: 300mA
- Maximum certified input power for IS: 1.3W
- Internal Capacitance (Ci): 0 nF
- Internal Inductance (Li): 0 μ H

1.8 HART COMMUNICATIONS

1.8.1 OVERVIEW OF HART COMMUNICATION

HART (highway addressable remote transducer) is a digital communication system in which two frequencies are superimposed on the 4 to 20 mA output signal from the transmitter. A 1200 Hz sine wave represents the digit 1, and a 2400 Hz sine wave represents the digit 0. Because the average value of a sine wave is zero, the digital signal adds no dc component to the analog signal. HART permits digital communication while retaining the analog signal for process control.

The HART protocol, originally developed by Fisher-Rosemount, is now overseen by the independent HART Communication Foundation. The Foundation ensures that all HART devices can communicate with one another. For more information about HART communications, call the HART Communication Foundation at (512) 794-0369. The internet address is <http://www.hartcomm.org>.

1.8.2 HART INTERFACE DEVICES

HART communicators allow the user to view measurement data (pH, ORP and temperature), program the transmitter, and download information from the transmitter for transfer to a computer for analysis. Downloaded information can also be sent to another HART transmitter. Either a hand-held communicator, such as the Rosemount Model 375, or a computer can be used. HART interface devices operate from any wiring termination point in the 4 - 20 mA loop. A minimum load of 250 ohms must be present between the transmitter and the power supply. See Figure 1-4.

If your communicator does not recognize the Model 5081 pH/ORP transmitter, the device description library may need updating. Call the manufacturer of your HART communication device for updates.

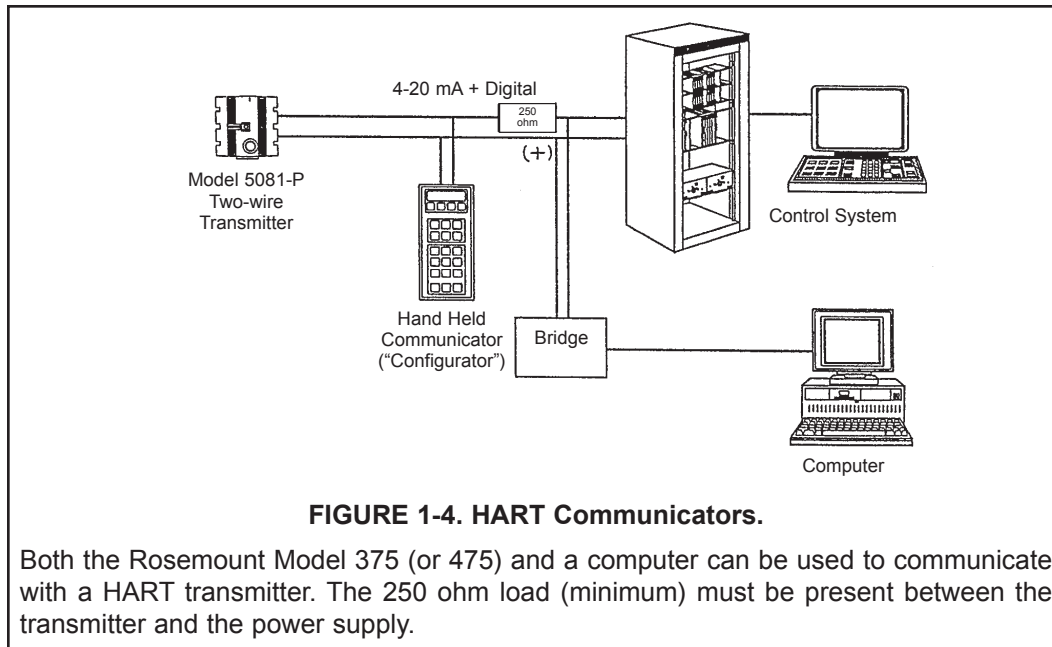

1.9 ASSET MANAGEMENT SOLUTIONS

Asset Management Solutions (AMS) is software that helps plant personnel better monitor the performance of analytical instruments, pressure and temperature transmitters, and control valves. Continuous monitoring means maintenance personnel can anticipate equipment failures and plan preventative measures before costly breakdown maintenance is required.

AMS uses remote monitoring. The operator, sitting at a computer, can view measurement data, change program settings, read diagnostic and warning messages, and retrieve historical data from any HART-compatible device, including the Model 5081-P transmitter. Although AMS allows access to the basic functions of any HART compatible device, Rosemount Analytical has developed additional software for that allows access to all features of the Model 5081-P transmitter.

AMS can play a central role in plant quality assurance and quality control. Using AMS Audit Trail, plant operators can track calibration frequency and results as well as warnings and diagnostic messages. The information is available to Audit Trail whether calibrations were done using the infrared remote controller, the Model 375 HART communicator, or AMS software.

AMS operates in Windows 95. See Figure 1-5 for a sample screen. AMS communicates through a HART-compatible modem with any HART transmitters, including those from other manufacturers. AMS is also compatible with FOUNDATION[®] Fieldbus, which allows future upgrades to Fieldbus instruments.

Rosemount Analytical AMS windows provide access to all transmitter measurement and configuration variables. The user can read raw data, final data, and program settings and can reconfigure the transmitter from anywhere in the plant. Figures 1-6 and 1-7 show two of the many configuration and measurement screens available using HART AMS. Figure 1-8 shows a configuration screen available through AMS Inside using FOUNDATION[®] Fieldbus.

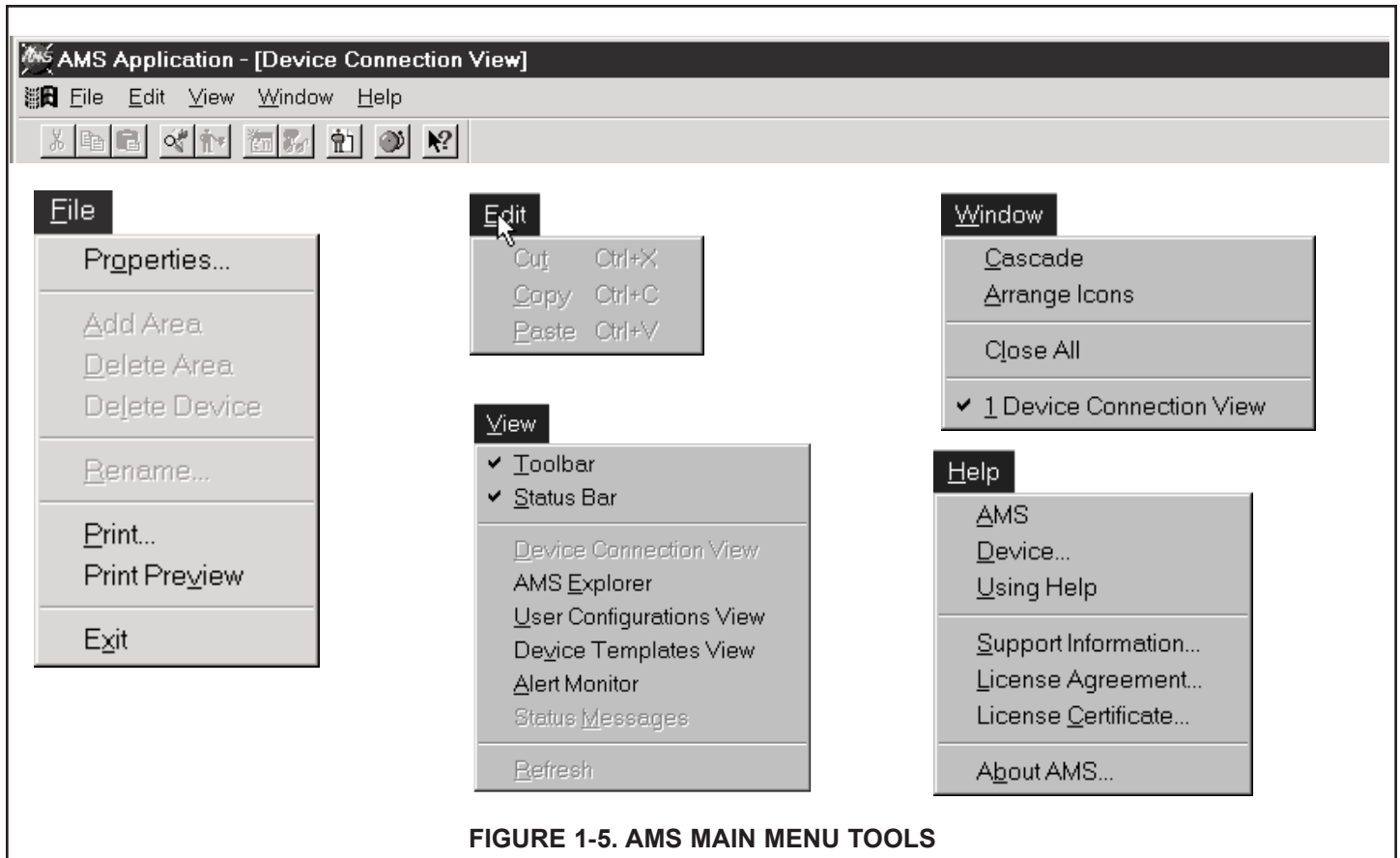

FIGURE 1-5. AMS MAIN MENU TOOLS

SECTION 2.0 INSTALLATION

- 2.1 Unpacking and Inspection**
- 2.2 Pre-Installation Set Up**
- 2.3 Orienting the Display Board**
- 2.4 Mechanical Installation**
- 2.5 Power Supply Wiring**

2.1 UNPACKING AND INSPECTION

Inspect the shipping container. If it is damaged, contact the shipper immediately for instructions. Save the box. If there is no apparent damage, remove the transmitter. Be sure all items shown on the packing list are present. If items are missing, immediately notify Rosemount Analytical.

Save the shipping container and packaging. They can be reused if it is later necessary to return the transmitter to the factory.

2.2 PRE-INSTALLATION SETUP

2.2.1 Temperature Element

The Model 5081-P pH/ORP transmitter is compatible with sensors having Pt 100 and Pt 1000. Sensors from other manufacturers may have a Pt 1000 RTD. For Rosemount Analytical sensors, the type of temperature element in the sensor is printed on the tag attached to the sensor cable. For the majority of sensors manufactured by Rosemount Analytical, the RTD IN lead is red and the RTD RTN lead is white. The Model 328A sensor has no RTD. The Model 320HP system has a readily identifiable separate temperature element. Resistance at room temperature for common RTDs is given in the table.

If the resistance is...	the temperature element is a
about 110 ohms	Pt 100 RTD
about 1100 ohms	Pt 1000 RTD

2.2.2 Reference Electrode Impedance

The standard silver-silver chloride reference electrode used in most industrial and laboratory pH electrodes is low impedance. EVERY pH and ORP sensor manufactured by Rosemount Analytical has a low impedance reference. Certain specialized applications require a high impedance reference electrode. The transmitter must be re-programmed to recognize the high impedance reference.

2.2.3 Preamplifier Location

pH sensors produce a high impedance voltage signal that must be preamplified before use. The signal can be preamplified before it reaches the transmitter or it can be preamplified in the transmitter. To work properly, the transmitter must know where preamplification occurs. Although ORP sensors produce a low impedance signal, the voltage from an ORP sensor is amplified the same way as a pH signal.

If the sensor is wired to the transmitter through a junction box, the preamplifier is ALWAYS in either the junction box or the sensor. Junction boxes can be attached to the sensor or installed some distance away. If the junction box is not attached to the sensor, it is called a remote junction box. In most junction boxes used with the Model 5081-P pH/ORP, a flat, black plastic box attached to the same circuit board as the terminal strips houses the preamplifier. The preamplifier housing in the 381+ sensor is crescent shaped.

If the sensor is wired directly to the transmitter, the preamplifier can be in the sensor or in the transmitter. If the sensor cable has a GREEN wire, the preamplifier is in the sensor. If there is no green wire, the sensor cable will contain a coaxial cable. A coaxial cable is an insulated wire surrounded by a braided metal shield. Depending on the sensor model, the coaxial cable terminates in either a BNC connector or in a separate ORANGE wire and CLEAR shield.

2.3 ORIENTING THE DISPLAY BOARD

The display board can be rotated 90 degrees, clockwise or counterclockwise, from the original position. To reposition the display:

1. Loosen the cover lock nut until the tab disengages from the circuit end cap. Unscrew the cap.
2. Remove the three bolts holding the circuit board stack.
3. Lift and rotate the display board 90 degrees, clockwise or counterclockwise, into the desired position.
4. Position the display board on the stand offs. Replace and tighten the bolts.
5. Replace the circuit end cap.

2.4 MECHANICAL INSTALLATION

2.4.1 General information

1. The transmitter tolerates harsh environments. For best results, install the transmitter in an area where temperature extremes, vibrations, and electromagnetic and radio frequency interference are minimized or absent.
2. To prevent unintentional exposure of the transmitter circuitry to the plant environment, keep the security lock in place over the circuit end cap. To remove the circuit end cap, loosen the lock nut until the tab disengages from the end cap, then unscrew the cover.
3. The transmitter has two 3/4-inch conduit openings, one on each side of the housing. Run sensor cable through the left side opening (as viewed from the wiring terminal end of the transmitter) and run power wiring through the right side opening.
4. Use weathertight cable glands to keep moisture out of the transmitter.
5. If conduit is used, plug and seal the connections at the transmitter housing to prevent moisture from getting inside the transmitter.

NOTE

Moisture accumulating in the transmitter housing can affect the performance of the transmitter and may void the warranty.

6. If the transmitter is installed some distance from the sensor, a remote junction box with preamplifier in the junction box or in the sensor may be necessary. Consult the sensor instruction manual for maximum cable lengths.

2.4.2 Mounting on a Flat Surface.

See Figure 2-1.

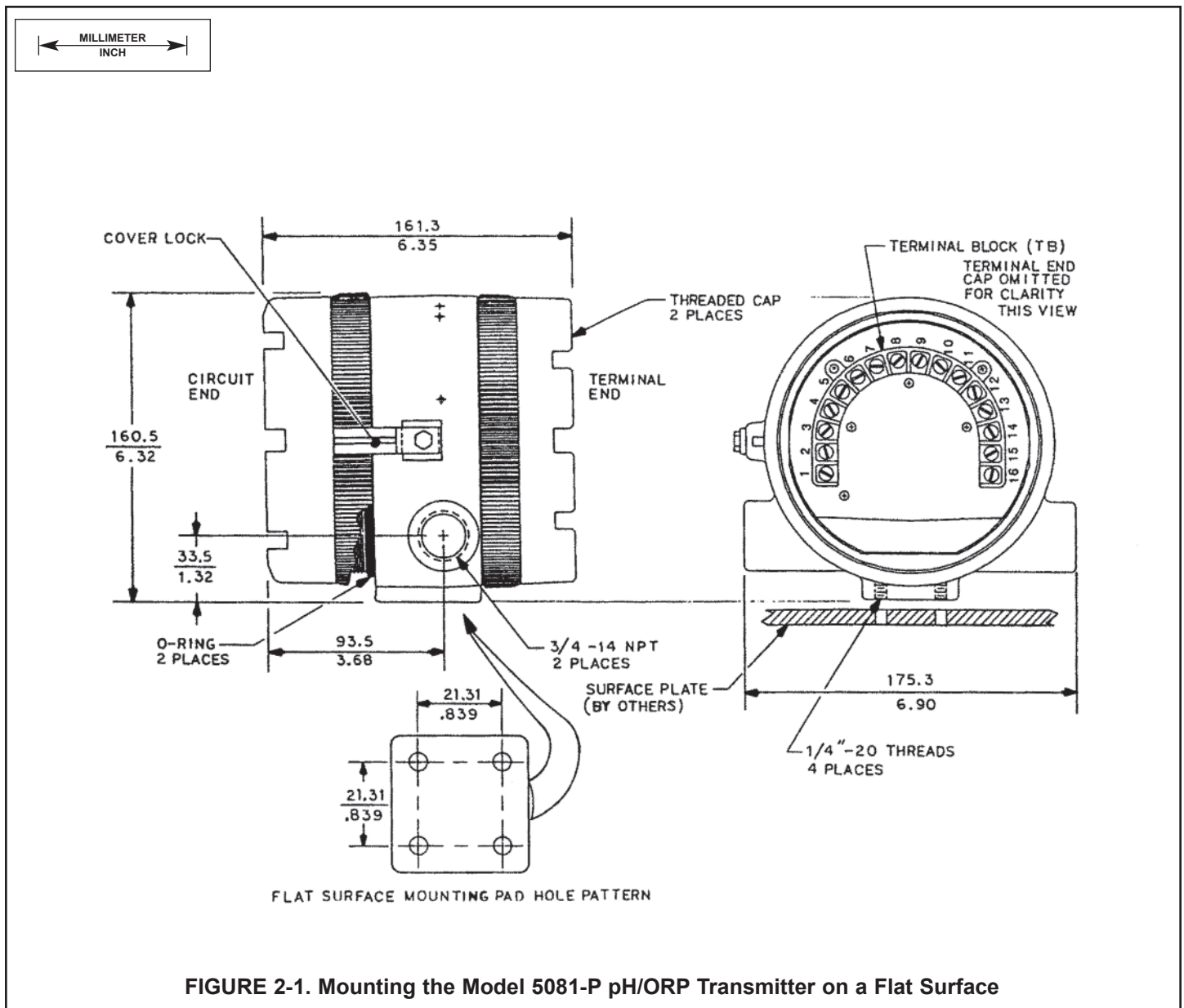

FIGURE 2-1. Mounting the Model 5081-P pH/ORP Transmitter on a Flat Surface

2.4.3 Pipe Mounting.

See Figure 2-2. The pipe mounting kit (PN 2002577) accommodates 1-1/2 to 2 in. pipe.

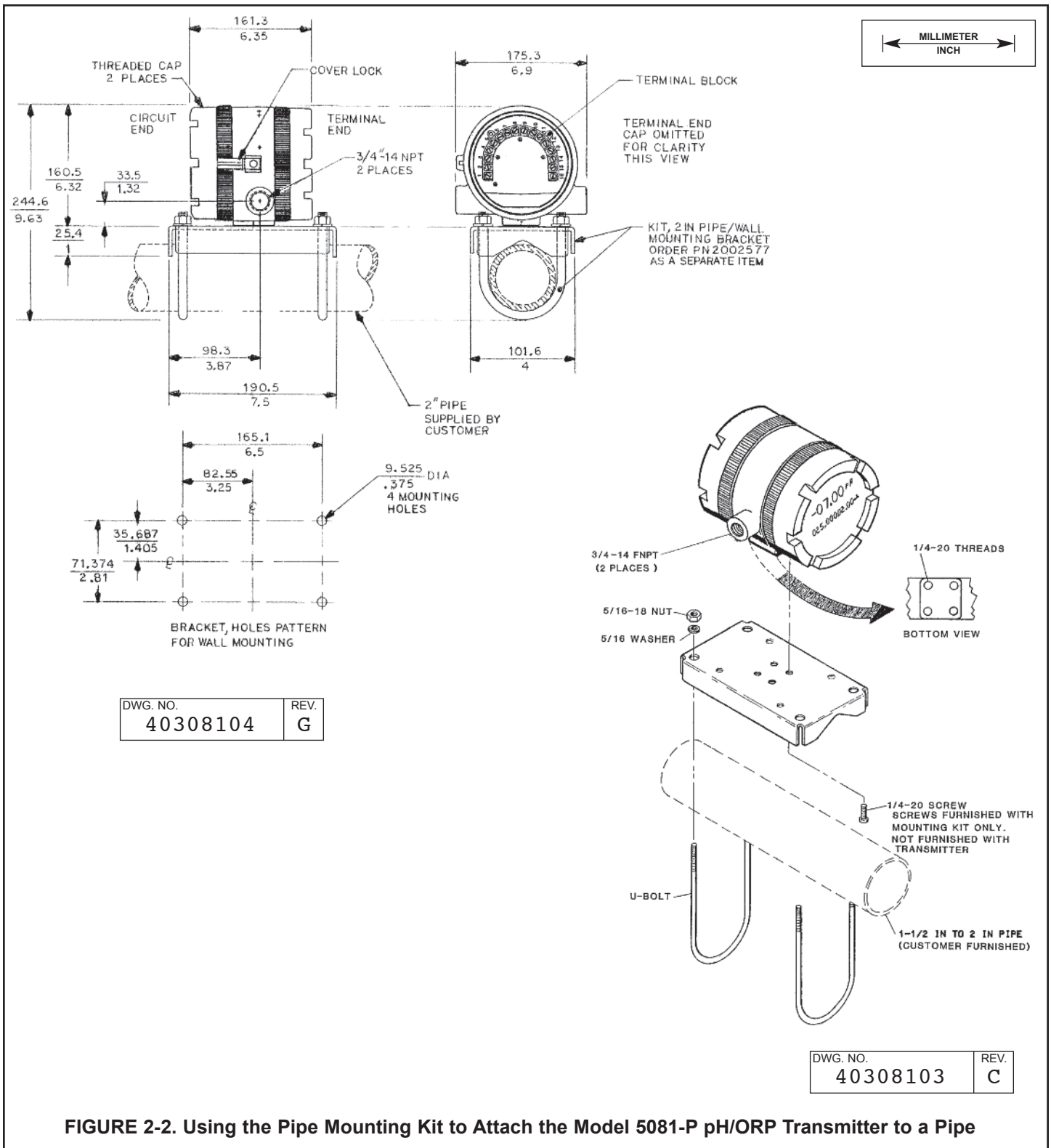

FIGURE 2-2. Using the Pipe Mounting Kit to Attach the Model 5081-P pH/ORP Transmitter to a Pipe

2.5 POWER SUPPLY/CURRENT LOOP — MODEL 5081-P-HT

2.5.1 Power Supply and Load Requirements. Refer to Figure 2-3.

The minimum power supply voltage is 12.5 Vdc and the maximum is 42.4 Vdc. The top line on the graph gives the voltage required to maintain at least 12.5 Vdc at the transmitter terminals when the output signal is 22 mA. The lower line is the supply voltage required to maintain a 30 Vdc terminal voltage when the output signal is 22 mA.

The power supply must provide a surge current during the first 80 milliseconds of start-up. For a 24 Vdc power supply and a 250 ohm load resistor the surge current is 40 mA. For all other supply voltage and resistance combinations the surge current is not expected to exceed 70 mA.

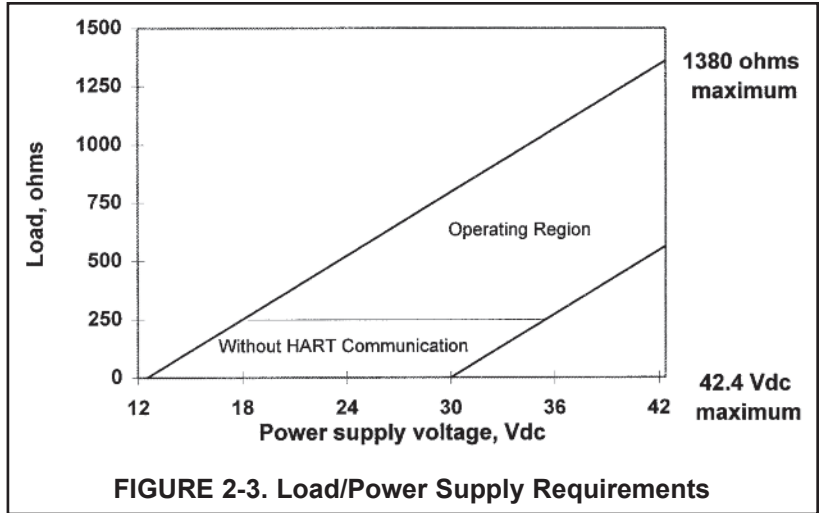

For digital (HART or AMS) communications, the load must be at least 250 ohms. To supply the 12.5 Vdc lift off voltage at the transmitter, the power supply voltage must be at least 18 Vdc.

For intrinsically safe operation the supply voltage should not exceed 30.0 Vdc.

2.5.2 Power Supply-Current Loop Wiring. Refer to Figure 2-4.

Run the power/signal wiring through the opening nearest terminals 15 and 16. Use shielded cable and ground the shield at the power supply. To ground the transmitter, attach the shield to the grounding screw on the inside of the transmitter case. A third wire can also be used to connect the transmitter case to earth ground.

NOTE

For optimum EMI/RFI immunity, the power supply/output cable should be shielded and enclosed in an earth-grounded metal conduit.

Do not run power supply/signal wiring in the same conduit or cable tray with AC power lines or with relay actuated signal cables. Keep power supply/ signal wiring at least 6 ft (2 m) away from heavy electrical equipment.

An additional 0-1 mA current loop is available between TB-14 and TB-15. A 1 mA current in this loop signifies a sensor fault. See Figure 4-3 for wiring instructions. See Section 8.4 or 10.6 and Section 12.0 for more information about sensor faults.

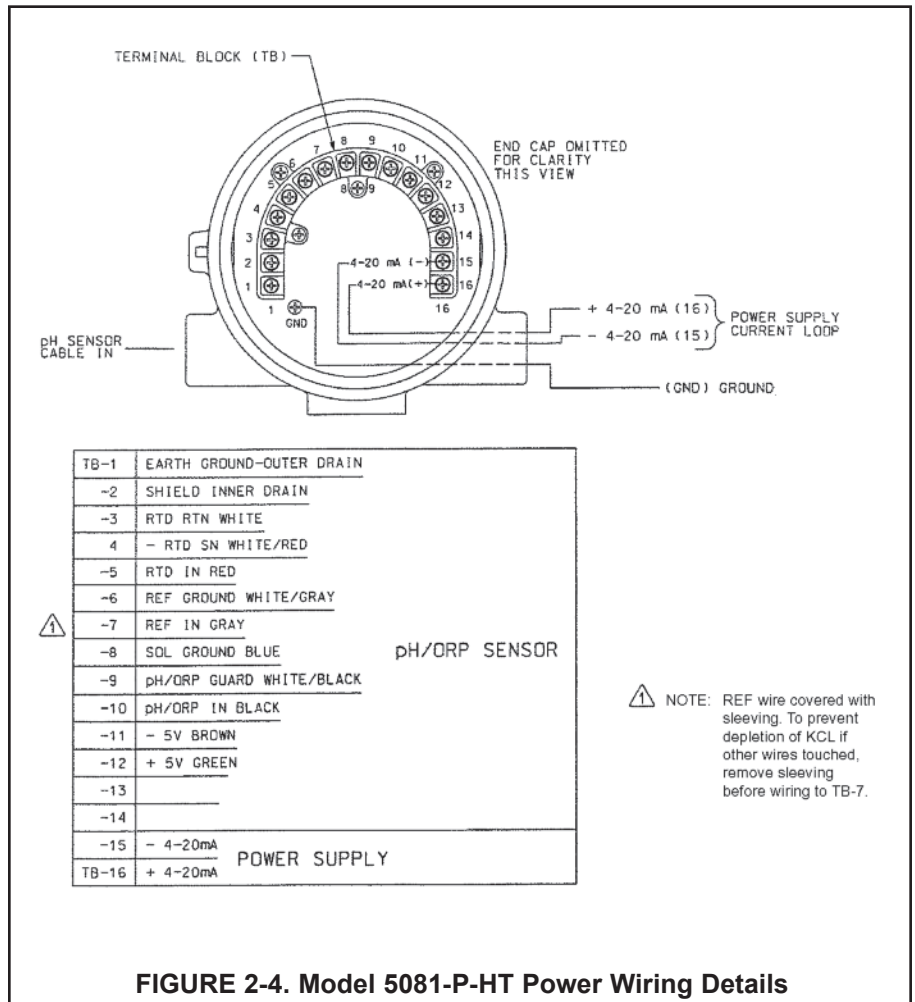

2.6 POWER SUPPLY WIRING FOR MODEL 5081-P-FF

2.6.1 Power Supply Wiring. Refer to Figure 2-5 and Figure 2-6.

Run the power/signal wiring through the opening nearest terminals 15 and 16. Use shielded cable and ground the shield at the power supply. To ground the transmitter, attach the shield to the grounding screw on the inside of the transmitter case. A third wire can also be used to connect the transmitter case to earth ground.

NOTE

For optimum EMI/RFI immunity, the power supply/output cable should be shielded and enclosed in an earth-grounded metal conduit.

Do not run power supply/signal wiring in the same conduit or cable tray with AC power lines or with relay actuated signal cables. Keep power supply/signal wiring at least 6 ft (2 m) away from heavy electrical equipment.

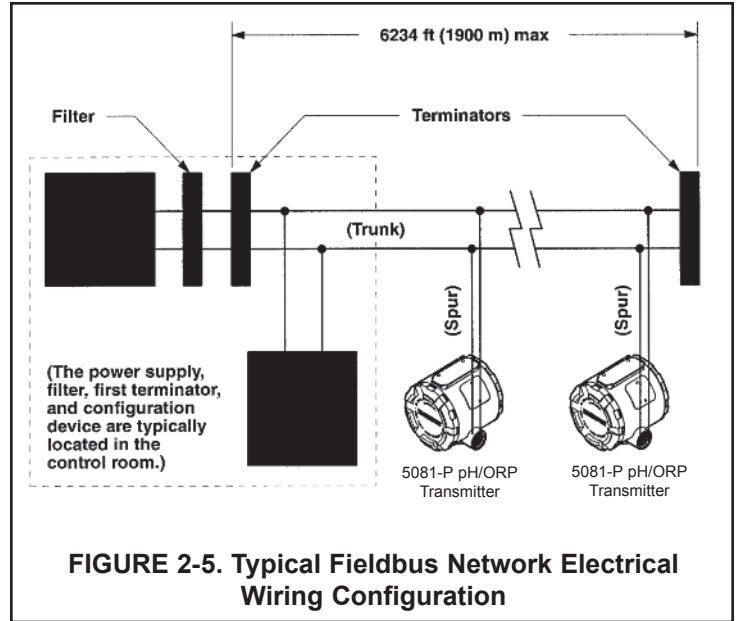

FIGURE 2-5. Typical Fieldbus Network Electrical Wiring Configuration

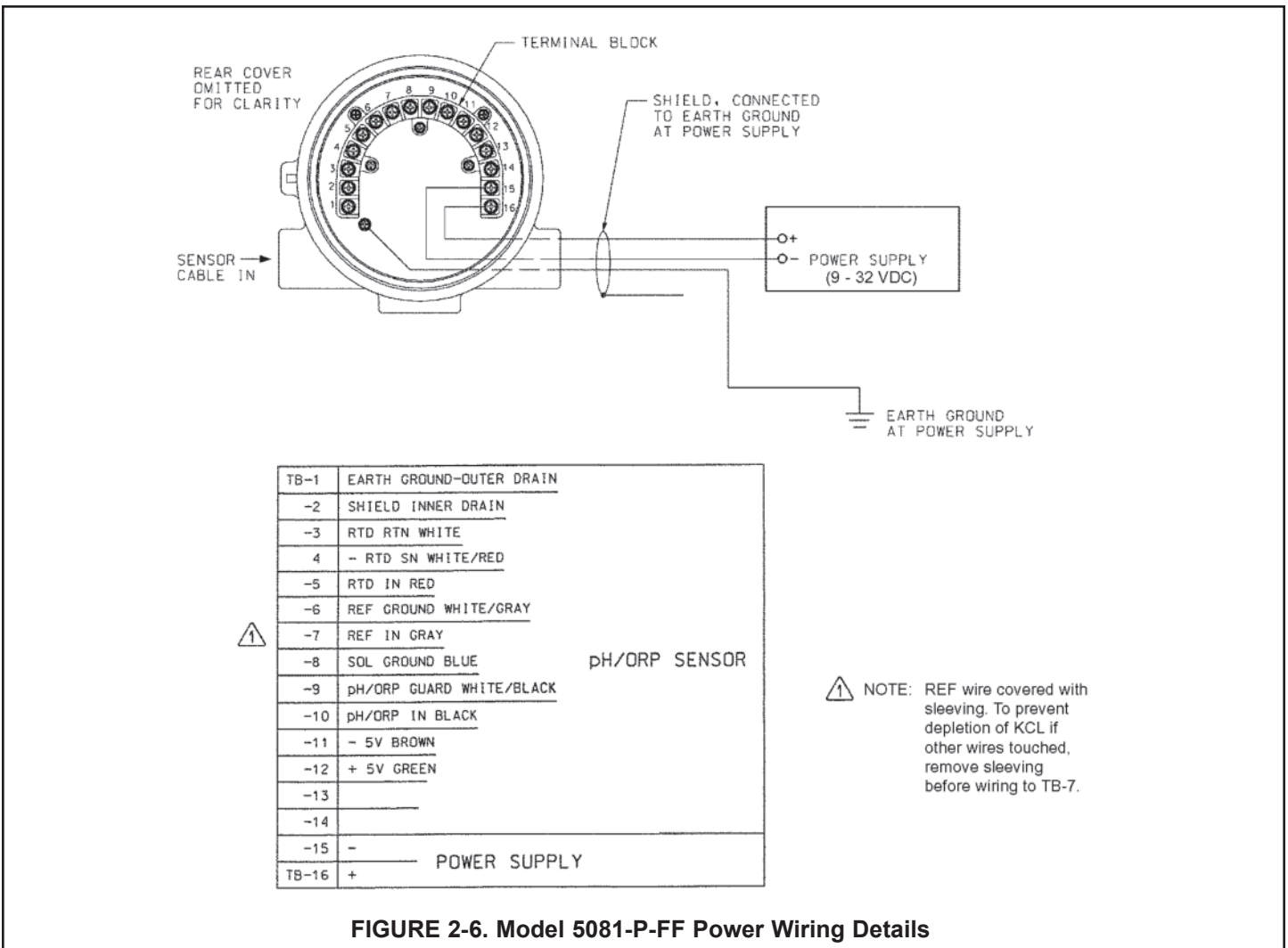

FIGURE 2-6. Model 5081-P-FF Power Wiring Details

SECTION 3.0 WIRING

3.1 General Information 3.2 Wiring Diagrams

3.1 GENERAL INFORMATION

pH and ORP sensors manufactured by Rosemount Analytical can be wired to the Model 5081-P pH/ORP transmitter in three ways:

1. directly to the transmitter,
2. to a sensor-mounted junction box and then to the transmitter,
3. to a remote junction box and then from the remote junction box to the transmitter.

The pH (or ORP) signal can also be preamplified in one of four places.

1. in the sensor (a, d),
2. in a junction box mounted on the sensor (c),
3. in a remote junction box (e).
4. at the transmitter (b).

Figure 3-1 illustrates the various arrangements.

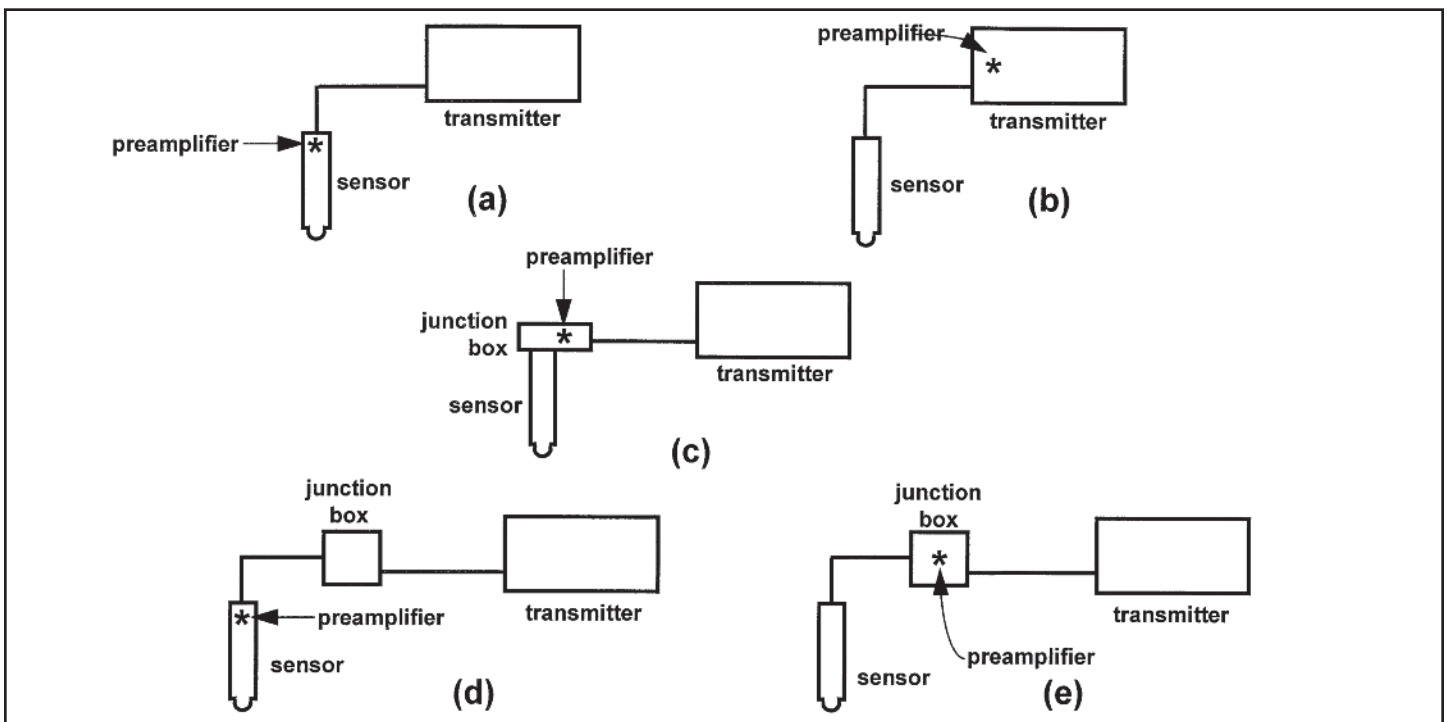

FIGURE 3-1. Wiring and Preamplifier Configurations for pH and ORP Sensors.

The asterisk identifies the location of the preamplifier. In (a) and (b) the sensor is wired directly to the transmitter. The signal is amplified at the sensor (a) or at the transmitter (b). In (c) the sensor is wired through a sensor-mounted junction box to the transmitter. The preamplifier is in the sensor-mounted junction box. In (d) and (e) the sensor is wired through a remote junction box to the transmitter. The preamplifier is located in the sensor (d) or the junction box (e).

3.2 WIRING DIAGRAMS

Refer to Tables 3-1 through 3-11 to locate the appropriate wire function and wiring diagram. There is a separate table for each model. The sensor models having the highest number appear first. If you do not know the model number of the sensor, refer to the flow charts on pages 32 through 34. **Only the model option numbers needed to select the correct wiring diagram are shown. Other numbers are not shown.** For all other sensors, see sensor manual.

Table 3-1. Wiring Diagrams for Model 399 sensors

Sensor	Junction Box	Preamplifier	RTD	Wire Function	Wiring Diagram
399-09*	none	in transmitter	Pt 100	Figure 3-2	Figure 3-4
399-09*	remote	in remote junction box	Pt 100	Figure 3-2	Figure 3-5
399-09-62	none	in transmitter	Pt 100	Figure 3-3	Figure 3-4
399-09-62	remote	in remote junction box	Pt 100	Figure 3-3	Figure 3-5
399-33 (ORP only)	none	in transmitter	Pt 100	Figure 3-19	Figure 3-20

Table 3-2 Wiring Diagrams for Model 397 Sensors

Sensor	Junction Box	Preamplifier	RTD	Wire Function	Wiring Diagram
397-54*	none	in transmitter	Pt 100	Figure 3-6	Figure 3-8
397-54*	remote	in remote junction box	Pt 100	Figure 3-6	Figure 3-9
397-54-62	none	in transmitter	Pt 100	Figure 3-7	Figure 3-8
397-54-62	remote	in remote junction box	Pt 100	Figure 3-7	Figure 3-9

Table 3-3 Wiring Diagrams for Model 396R Sensors

Sensor	Junction Box	Preamplifier	RTD	Wire Function	Wiring Diagram
396R-54	none	in transmitter	Pt 100	Figure 3-10	Figure 3-11
396R-54	remote	in remote junction box	Pt 100	Figure 3-10	Figure 3-12
396R-54-60	sensor-mounted	in sensor-mounted junction box	Pt 100	Figure 3-7	Figure 3-9
396R-54-61	sensor-mounted	in sensor-mounted junction box	Pt 100	Figure 3-10	Figure 3-12

* Sensors have a BNC connector that the Model 5081-P pH/ORP transmitter does not accept. Cut off the BNC and terminate the coaxial cable as shown in Figure 3-23. Alternatively, use a BNC adapter.

Table 3-4 Wiring Diagrams for Model 396P Sensors

Sensor	Junction Box	Preamplifier	RTD	Wire Function	Wiring Diagram
396P-01-55	none	in sensor	Pt 100	Figure 3-13	Figure 3-14
396P-01-55	remote	in sensor	Pt 100	Figure 3-13	Figure 3-14
396P-02-54	none	in transmitter	Pt 100	Figure 3-10	Figure 3-11
396P-02-54	remote	in remote junction box	Pt 100	Figure 3-10	Figure 3-12
396P-02-55	none	in transmitter	Pt 100	Figure 3-10	Figure 3-11
396P-02-55	remote	in remote junction box	Pt 100	Figure 3-10	Figure 3-12

Table 3-5 Wiring Diagrams for Model 396 Sensor

Sensor	Junction Box	Preamplifier	RTD	Wire Function	Wiring Diagram
396-54*	none	in transmitter	Pt 100	Figure 3-6	Figure 3-8
396-54*	remote	in remote junction box	Pt 100	Figure 3-6	Figure 3-9
396-54-62	none	in transmitter	Pt 100	Figure 3-7	Figure 3-8
396-54-62	remote	in remote junction box	Pt 100	Figure 3-7	Figure 3-9

Table 3-6 Wiring Diagrams for Model 389 Sensors

Sensor	Junction Box	Preamplifier	RTD	Wire Function	Wiring Diagram
389-02-54*	none	in transmitter	Pt 100	Figure 3-6	Figure 3-8
389-02-54*	remote	in remote junction box	Pt 100	Figure 3-6	Figure 3-9
389-02-54-62	none	in transmitter	Pt 100	Figure 3-7	Figure 3-8
389-02-54-62	remote	in remote junction box	Pt 100	Figure 3-7	Figure 3-9

* Sensors have a BNC connector that the Model 5081-P pH/ORP transmitter does not accept. Cut off the BNC and terminate the coaxial cable as shown in Figure 3-23. Alternatively, use a BNC adapter (PN 9120531).

Table 3-7 Wiring Diagrams for Model 385+ Sensors

Sensor	Junction Box	Preamplifier	RTD	Wire Functions	Wiring Diagram
385+ -02	sensor-mounted	in sensor-mounted junction box	Pt 100	Figure 3-15	Figure 3-17
385+ -03	none	in sensor	Pt 100	Figure 3-13	Figure 3-14
385+ -03	remote	in sensor	Pt 100	Figure 3-13	Figure 3-14
385+ -04	none	in transmitter	Pt 100	Figure 3-10	Figure 3-11
385+ -04	remote	in remote junction box	Pt 100	Figure 3-10	Figure 3-12

Table 3-8 Wiring Diagrams for Model 381+ Sensors

Sensor	Junction Box	Preamplifier	RTD	Wire Functions	Wiring Diagram
381+ -40-55	none	in sensor	Pt 100	Figure 3-13	Figure 3-14
381+ -43-55	none	in sensor	Pt 100	Figure 3-13	Figure 3-14
381+ -40-55	remote	in sensor	Pt 100	Figure 3-13	Figure 3-14
381+ -43-55	remote	in sensor	Pt 100	Figure 3-13	Figure 3-14

Table 3-9 Wiring Diagrams for Model 381pH Sensors

Sensor	Junction Box	Preamplifier	RTD	Wire Functions	Wiring Diagram
381pH-31-41-52*	none	in transmitter	Pt 100	Figure 3-2	Figure 3-4
381pH-31-41-52*	remote	in remote junction box	Pt 100	Figure 3-2	Figure 3-5
381pH-31-42-52	none	in transmitter	Pt 100	Figure 3-3	Figure 3-4
381pH-31-42-52	remote	in remote junction box	Pt 100	Figure 3-3	Figure 3-5

Table 3-10 Wiring Diagrams for Model 328A Sensor

Sensor	Junction Box	Preamplifier	RTD	Wire Functions	Wiring Diagram
328A	none	in transmitter	none	Figure 3-15	Figure 3-16

Table 3-11 Wiring Diagrams for Model 320HP Sensor

Sensor	Junction Box	Preamplifier	RTD	Wiring Diagram
320HP-10-55	on mounting plate	in transmitter	Pt 100	Figure 3-18
320HP-10-58	on mounting plate	in junction box attached to mounting plate	Pt 100	Figure 3-19

* Sensors have a BNC connector that the Model 5081-P pH/ORP transmitter does not accept. Cut off the BNC and terminate the coaxial cable as shown in Figure 3-23. Alternatively, use a BNC adapter (PN 9120531).

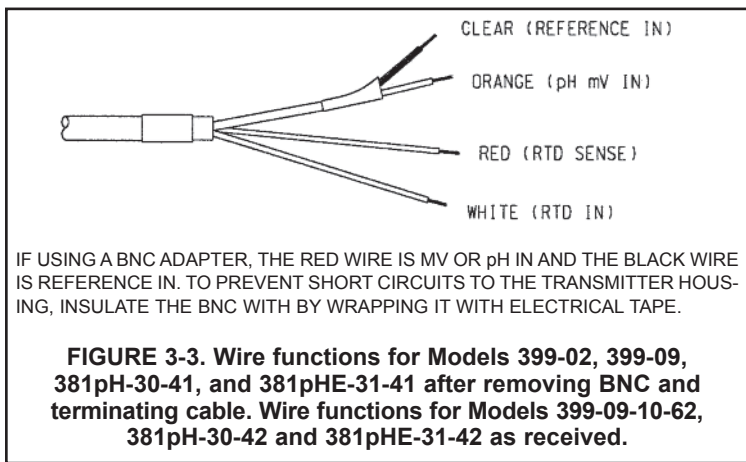
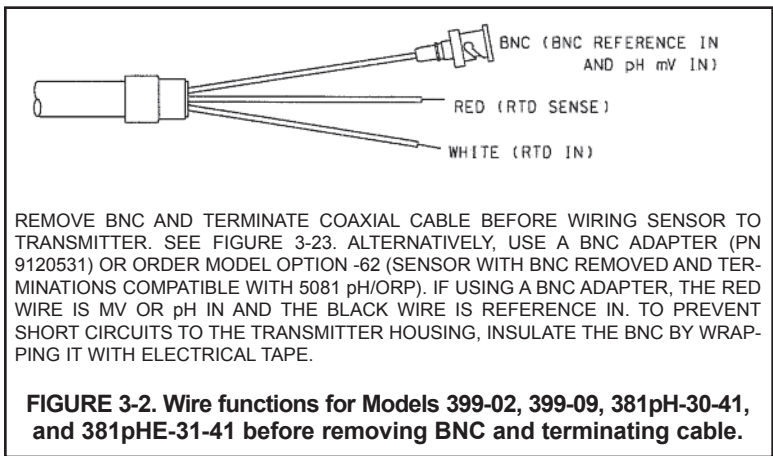

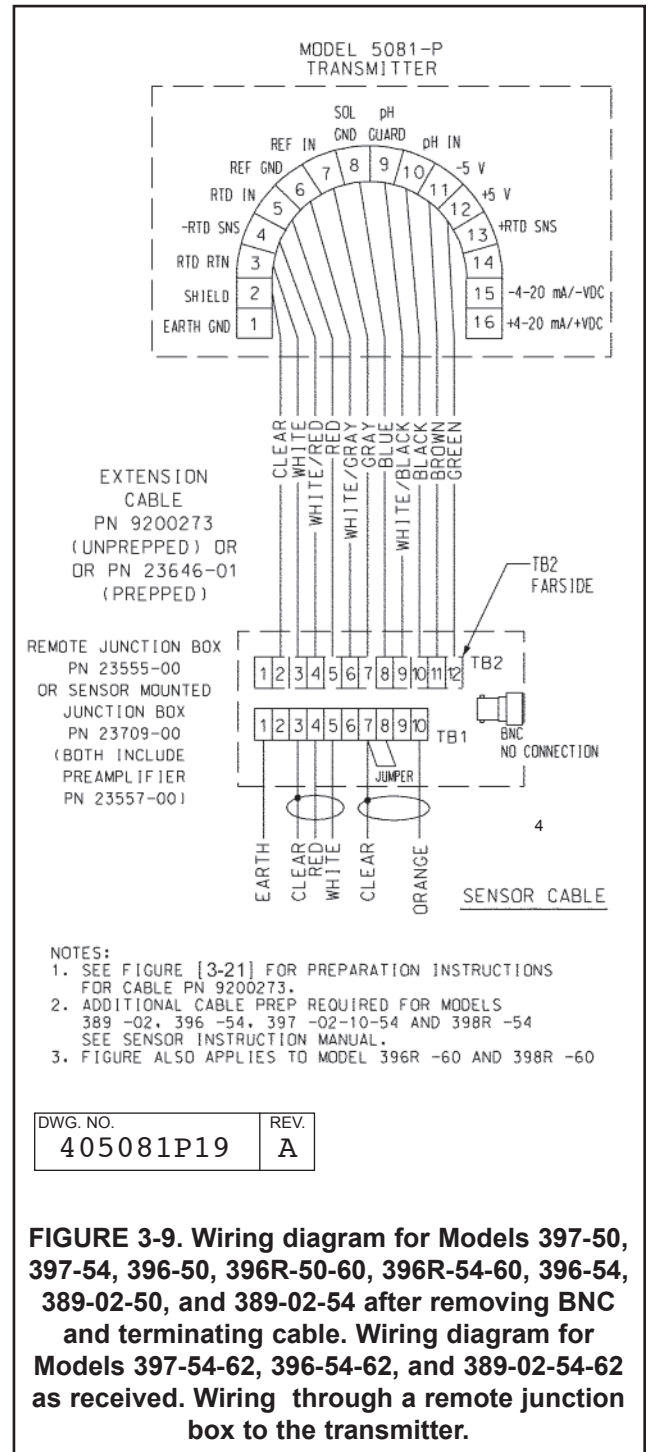
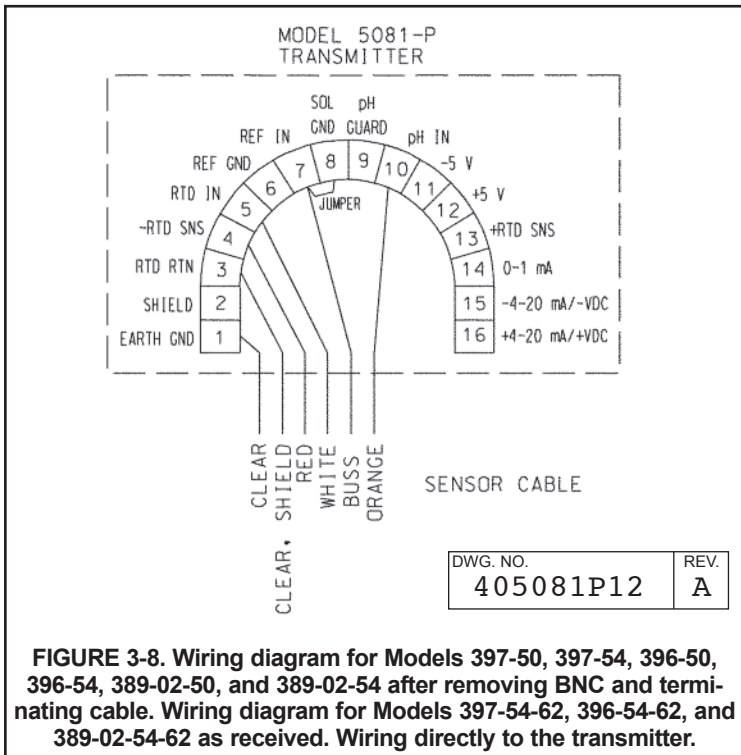
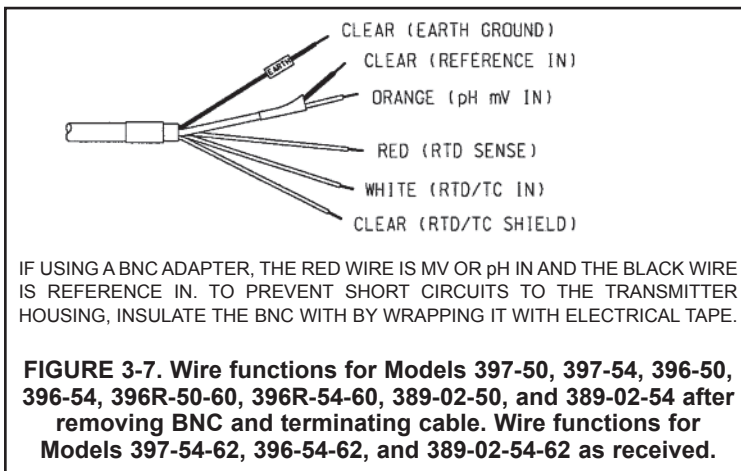
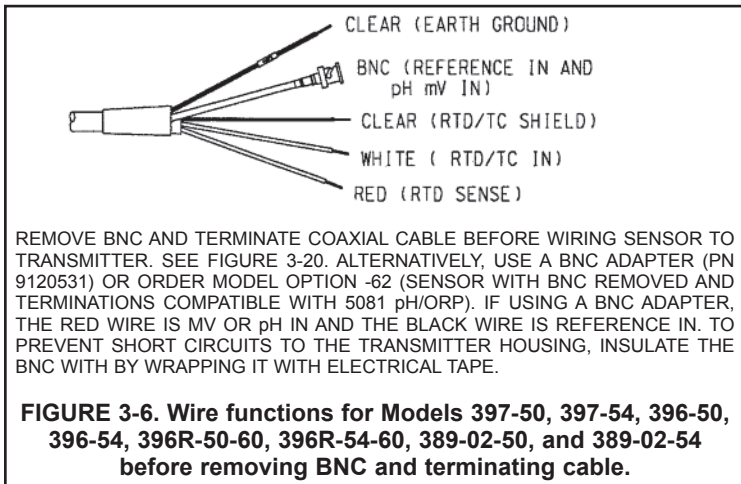

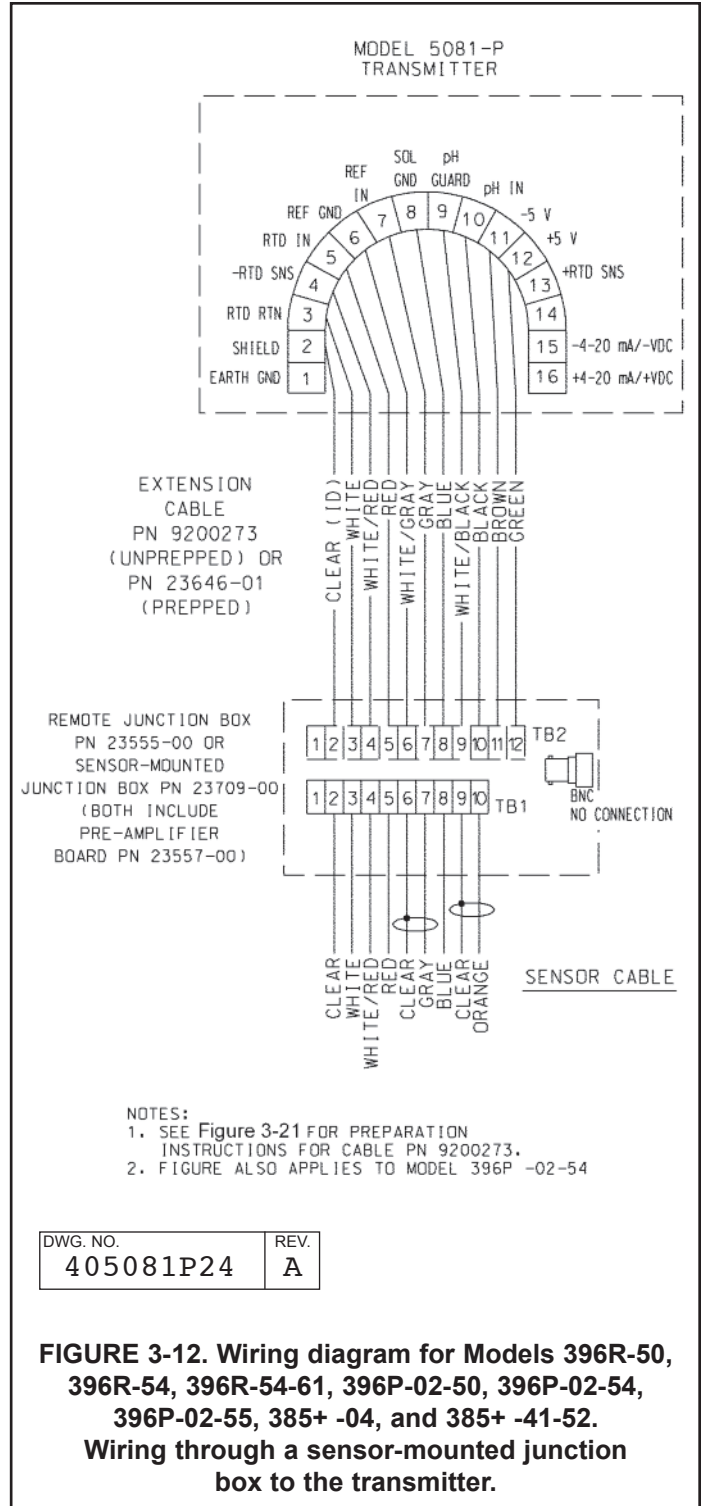
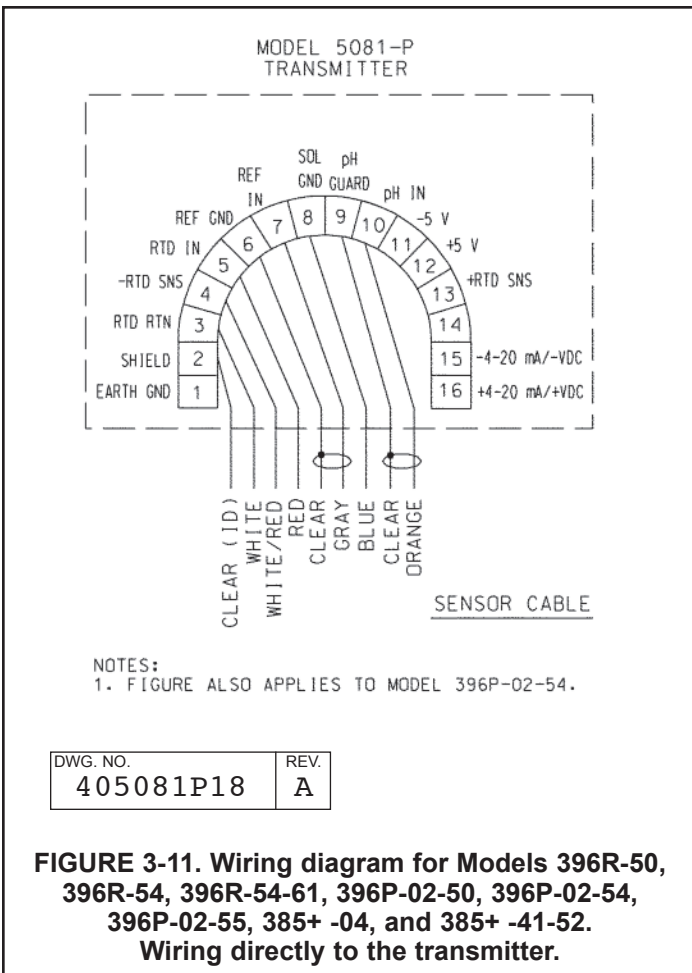
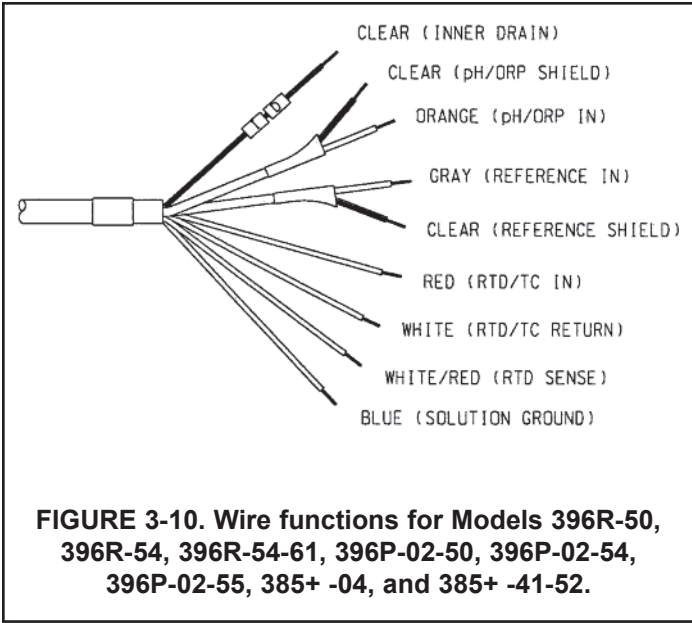

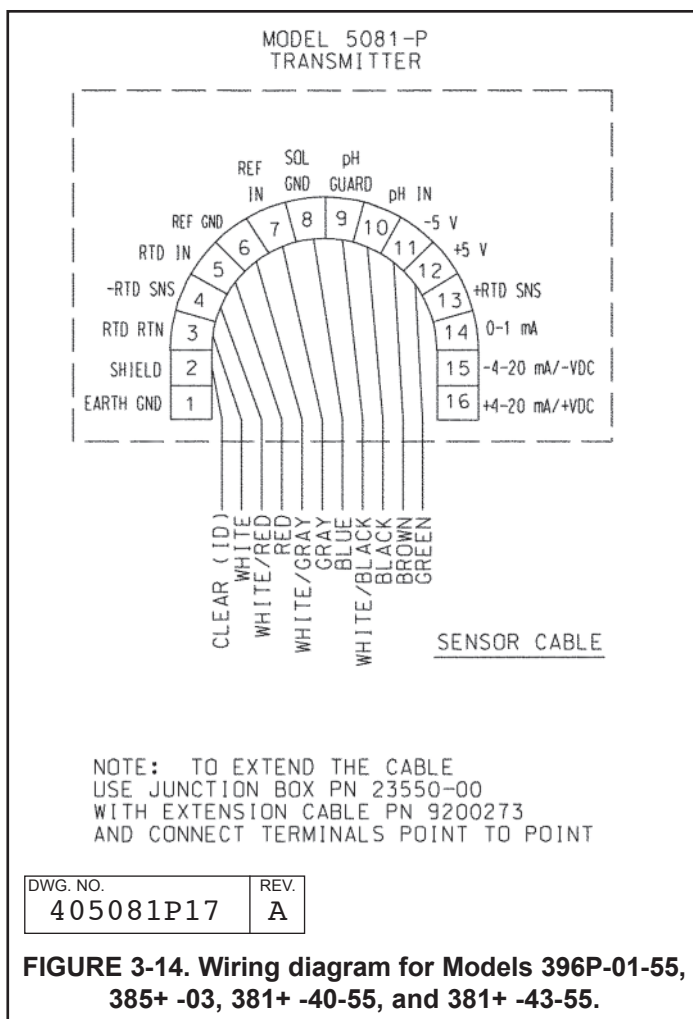
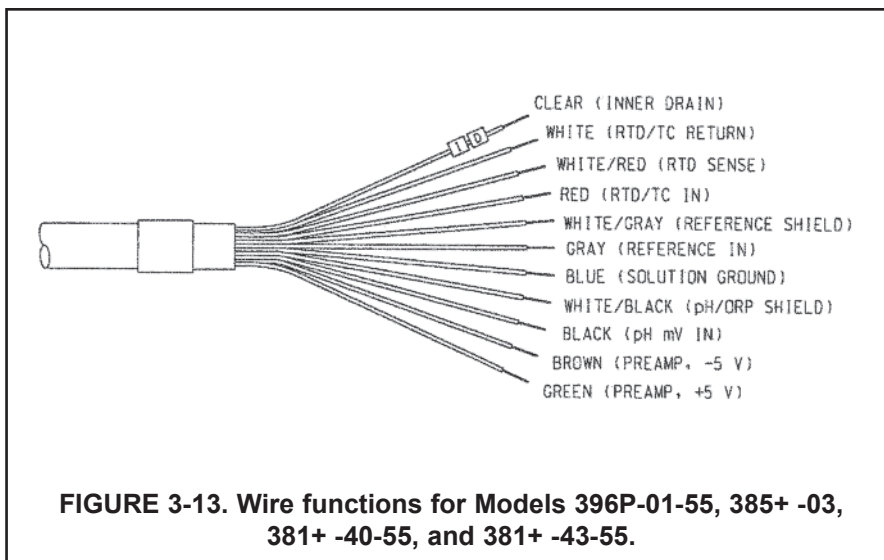

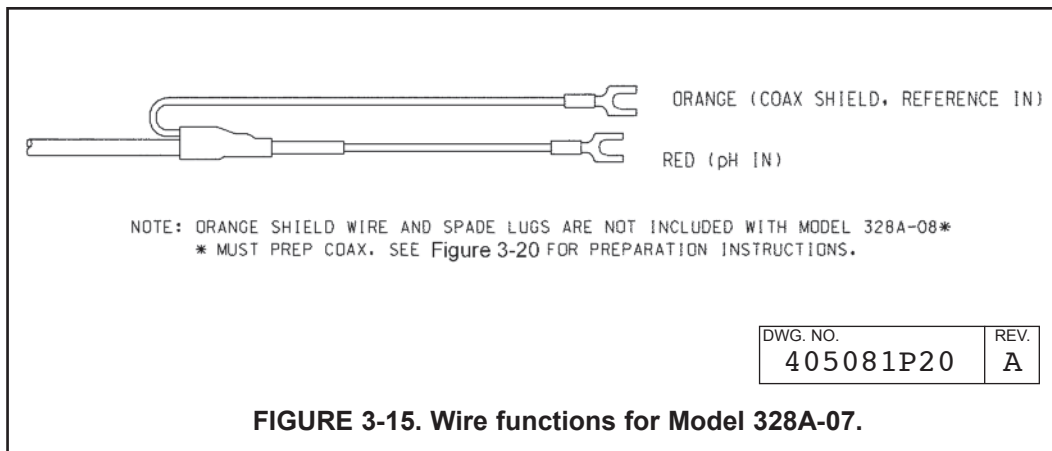

FIGURE 3-15. Wire functions for Model 328A-07.

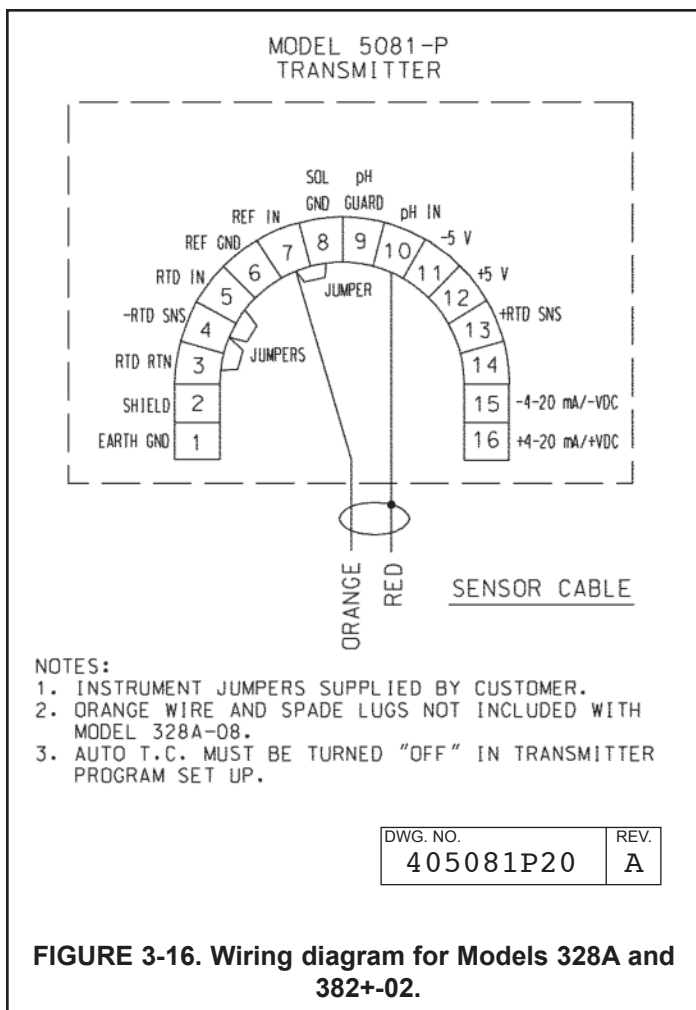

FIGURE 3-16. Wiring diagram for Models 328A and 382+-02.

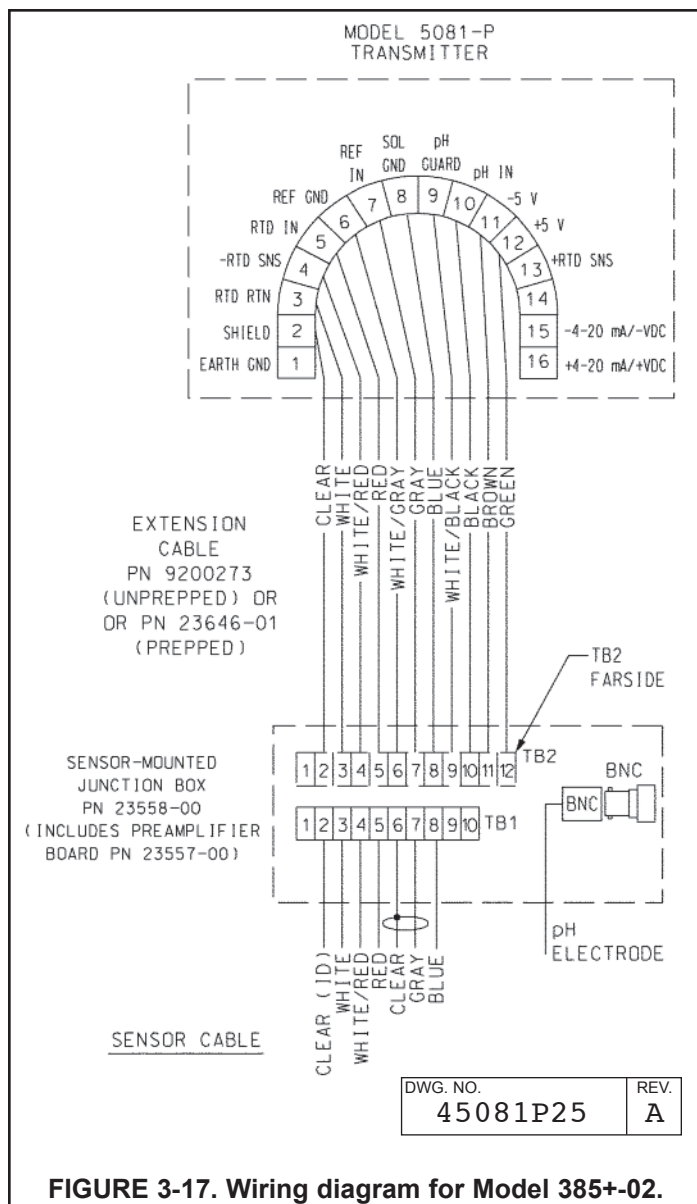

FIGURE 3-17. Wiring diagram for Model 385+-02.

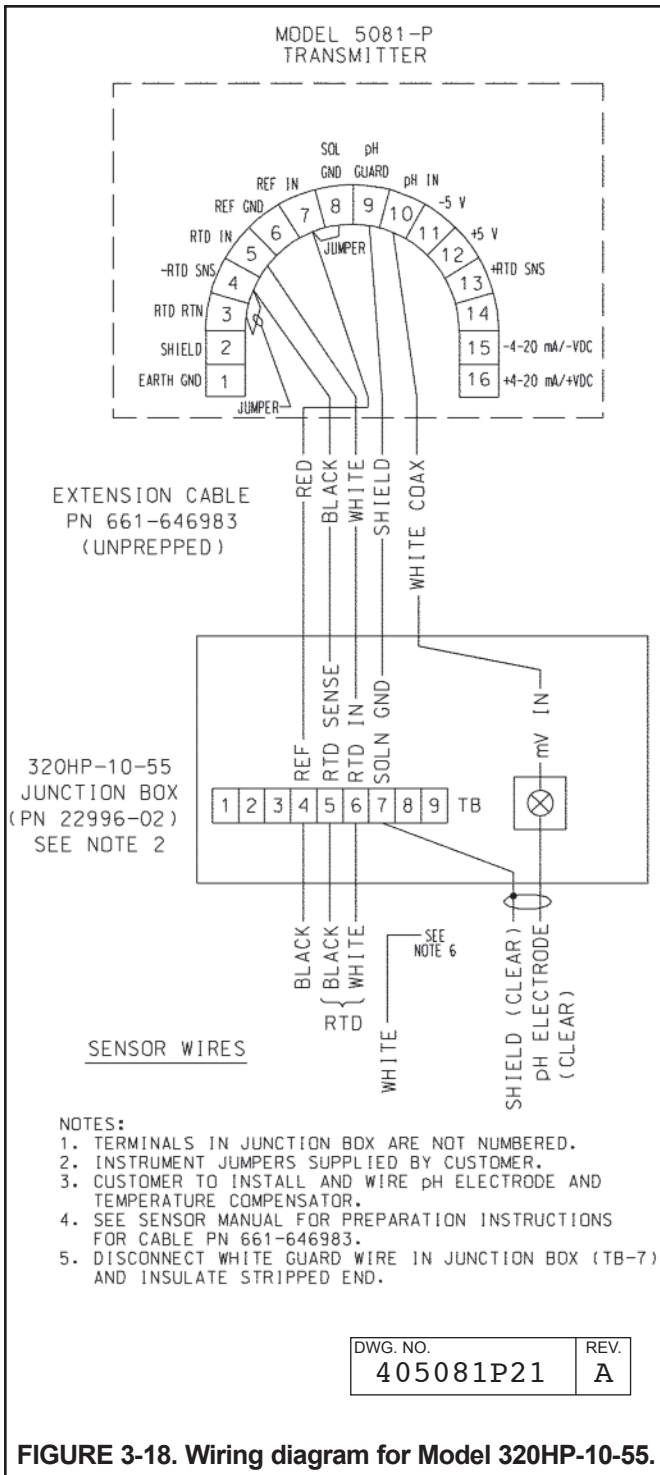

FIGURE 3-18. Wiring diagram for Model 320HP-10-55.

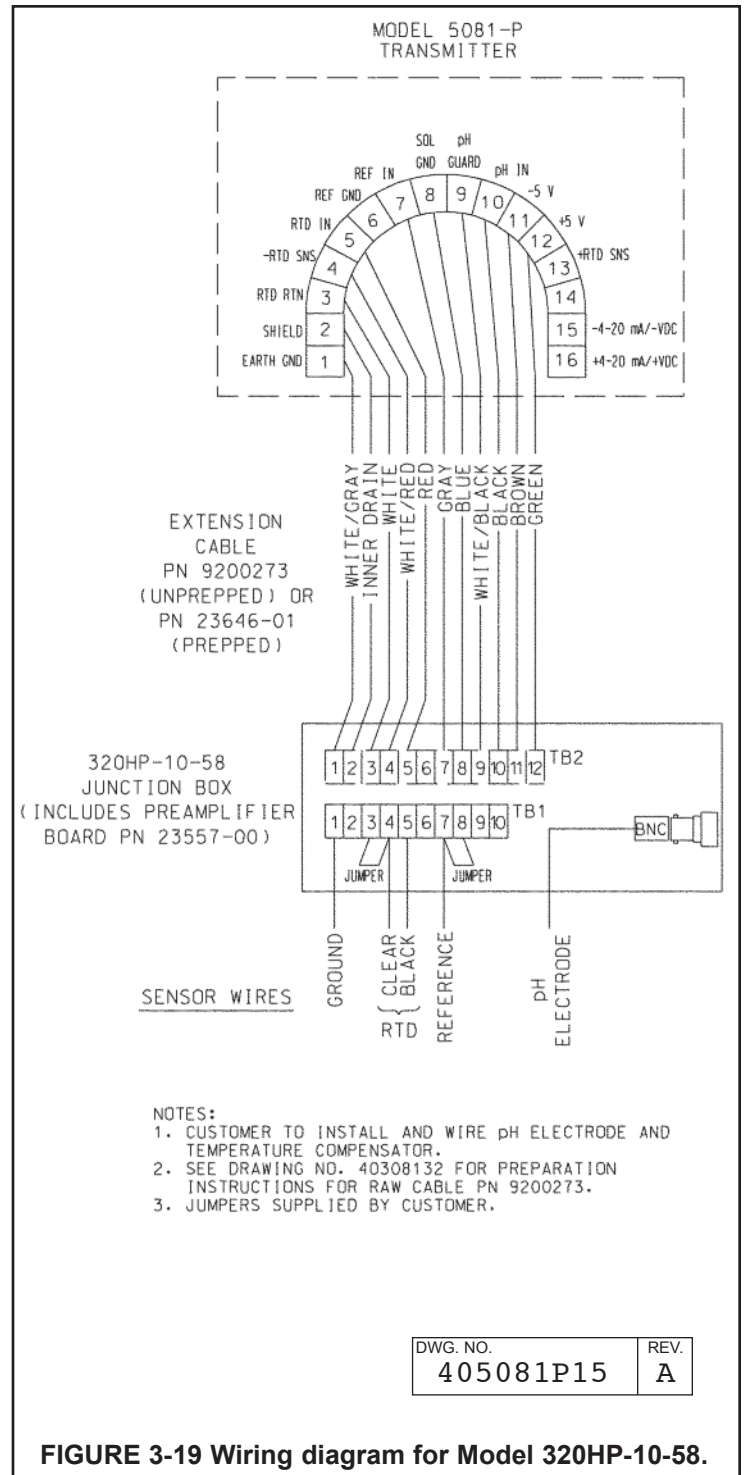

FIGURE 3-19 Wiring diagram for Model 320HP-10-58.

PREPARE THE COAX CABLE AS FOLLOWS:

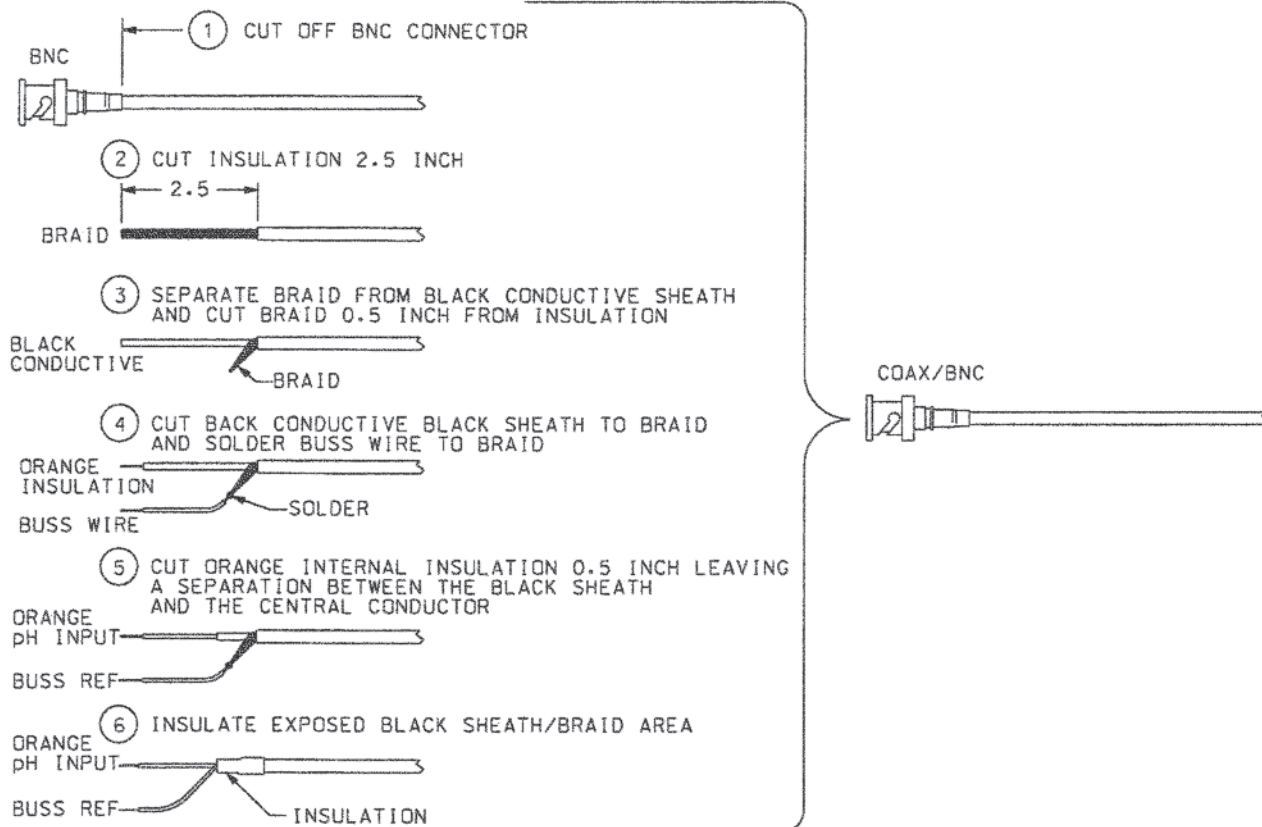
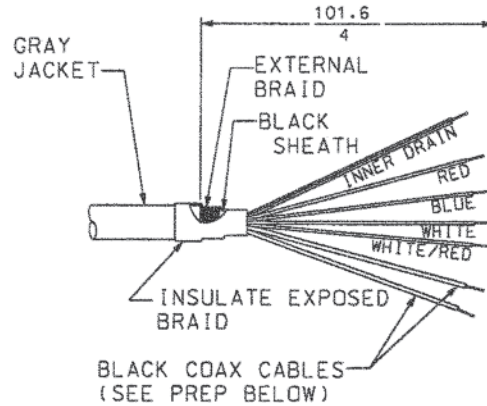

FIGURE 3-20. Procedure for Removing BNC Connector and Preparing Coaxial Cable

- 1 STRIP BACK OUTER BRAID AND FOIL ABOUT 4 IN FROM END OF CABLE
- 2 STRIP INDIVIDUAL SHEATHS BACK ABOUT 1/4 IN TO EXPOSE THE WIRES
- 3 LOCATE THE 2 COAXIAL CABLES AND PREPARE AS FOLLOWS (SEE BELOW)



PREPARE THE COAX CABLE AS FOLLOWS

- 3A STRIP INSULATING BLACK SHEATH BACK ABOUT 1 1/2 IN

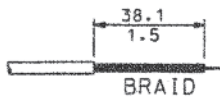

- 3B SEPARATE THE BRAID FROM THE INNER BLACK CONDUCTIVE SHEATH

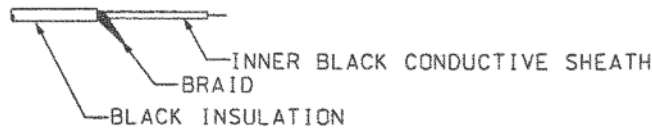

- 3C SOLDER INSULATED WIRE (USER SUPPLIED) TO BRAID IF NEEDED

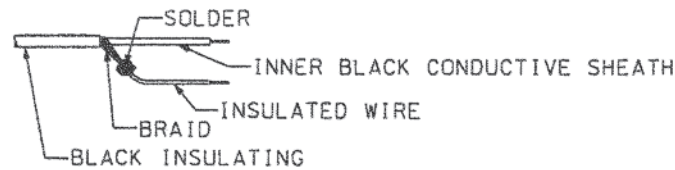

- 3D STRIP BLACK CONDUCTIVE SHEATH 1 IN TO EXPOSE (ORANGE OR GRAY) DEPENDING ON WHICH COAX YOU ARE PREPARING

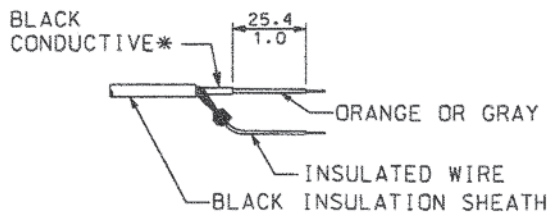

* WARNING: IF INNER BLACK CONDUCTIVE SHEATH IS IN CONTACT WITH THE EXPOSED LEADS, OR IS NOT PREPARED PROPERLY, IT MAY CAUSE AN ELECTRICAL SHORT.

- 3E INSULATE EXPOSED BLACK SHEATH/BRAID AREA



FIGURE 3-21. Preparation of Raw Connecting Cable (PN 9200273).

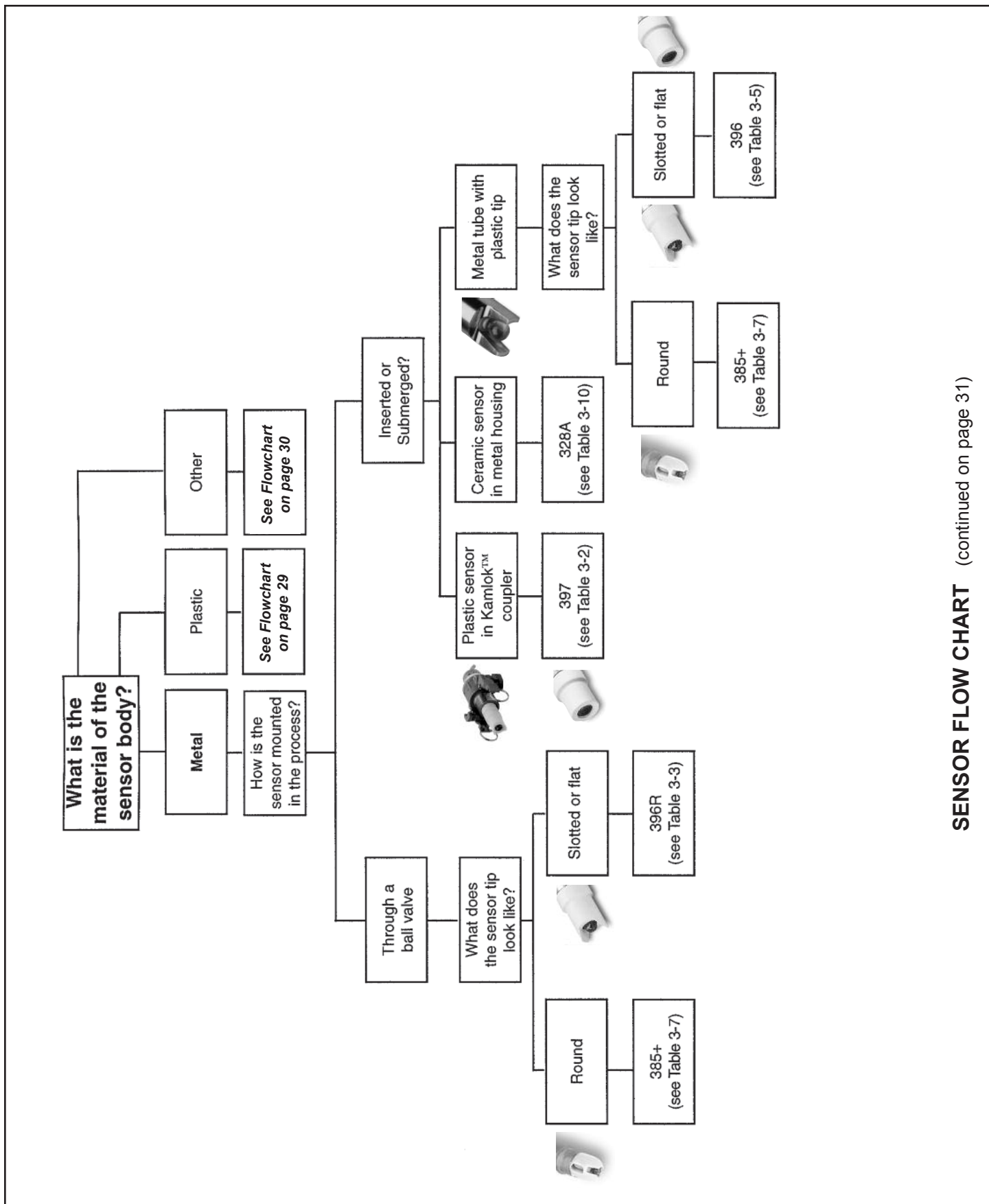

SENSOR FLOW CHART (continued on page 31)

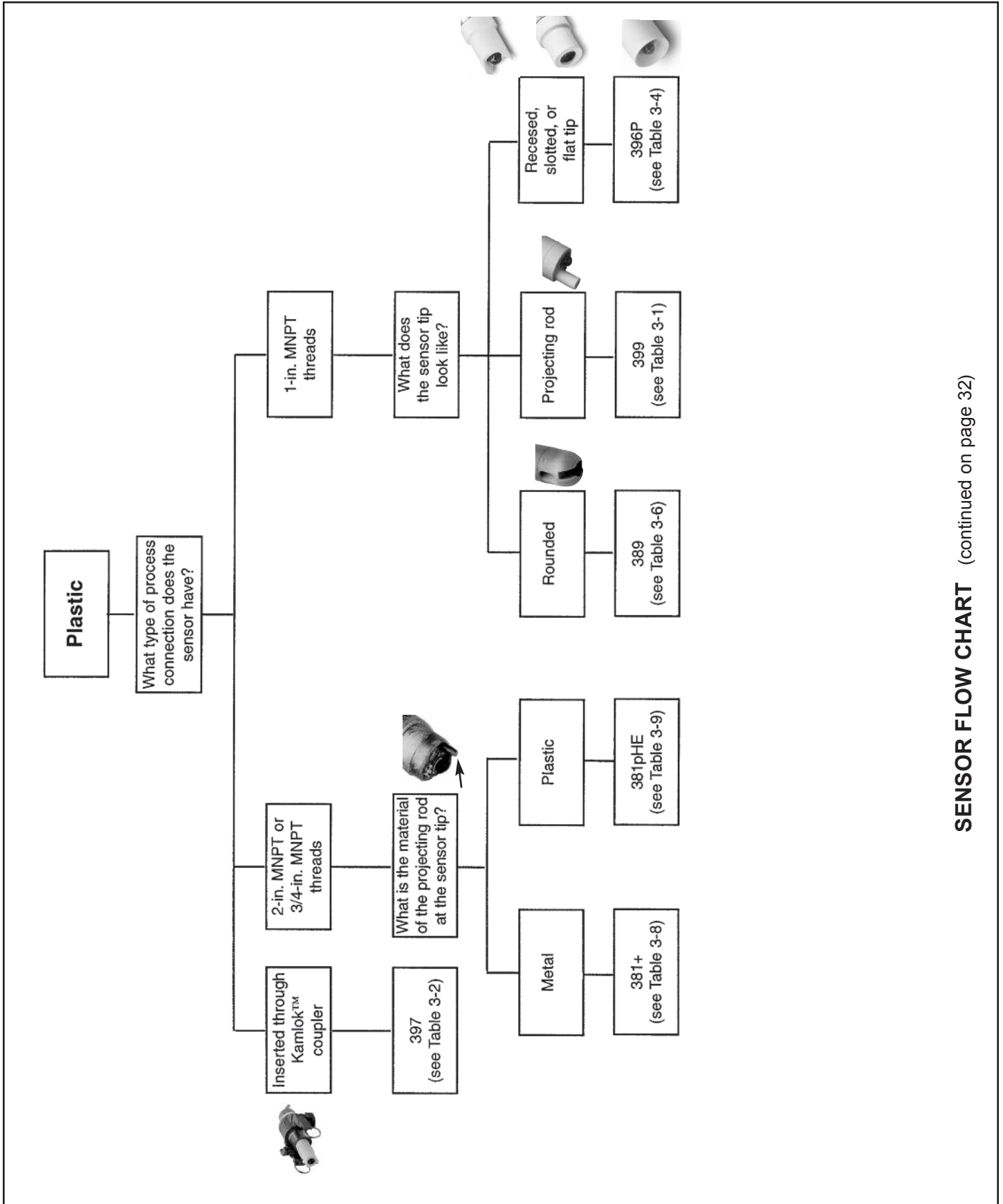

SENSOR FLOW CHART (continued on page 32)

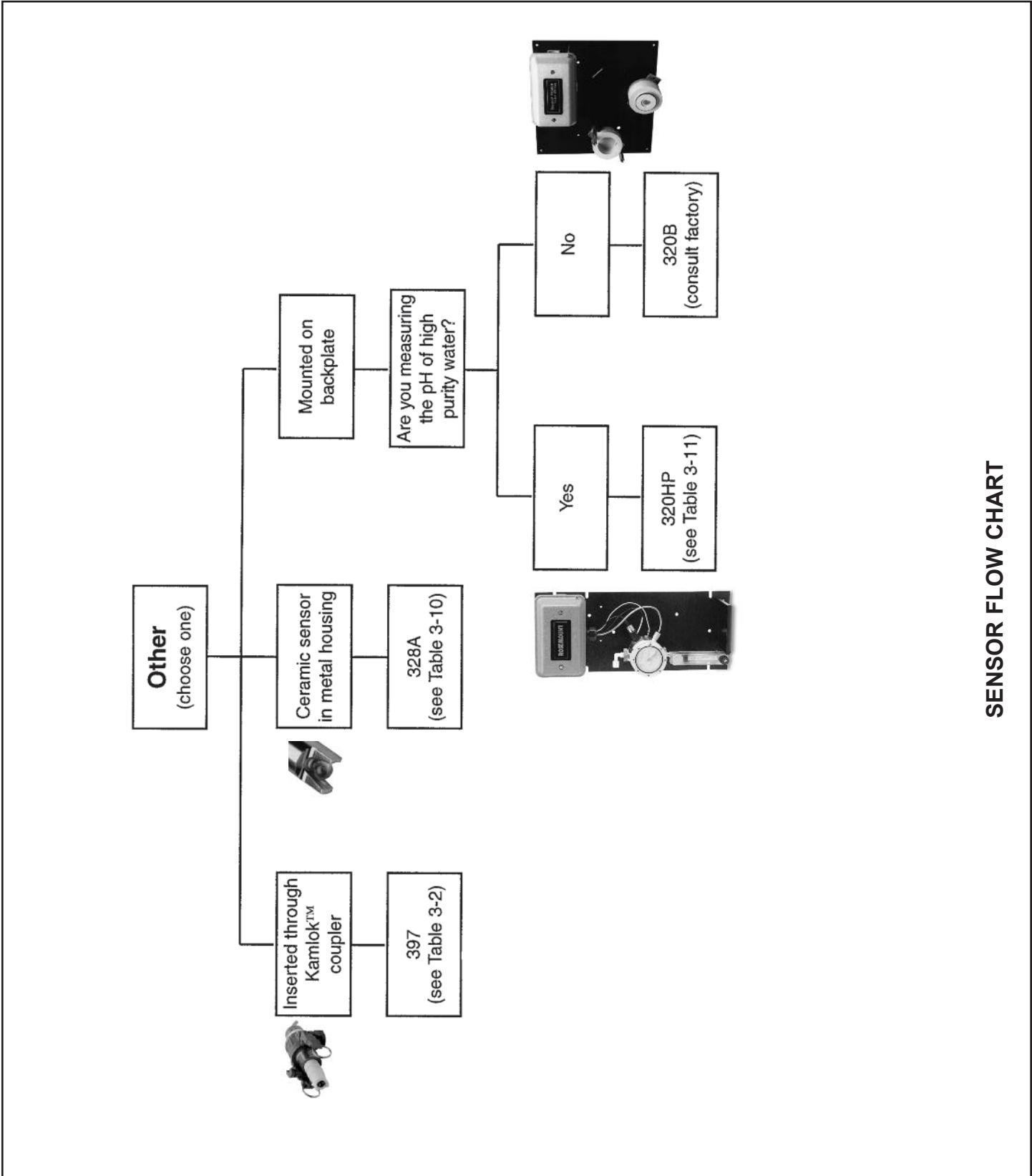

SENSOR FLOW CHART

SECTION 4.0 INTRINSICALLY SAFE & EXPLOSION PROOF

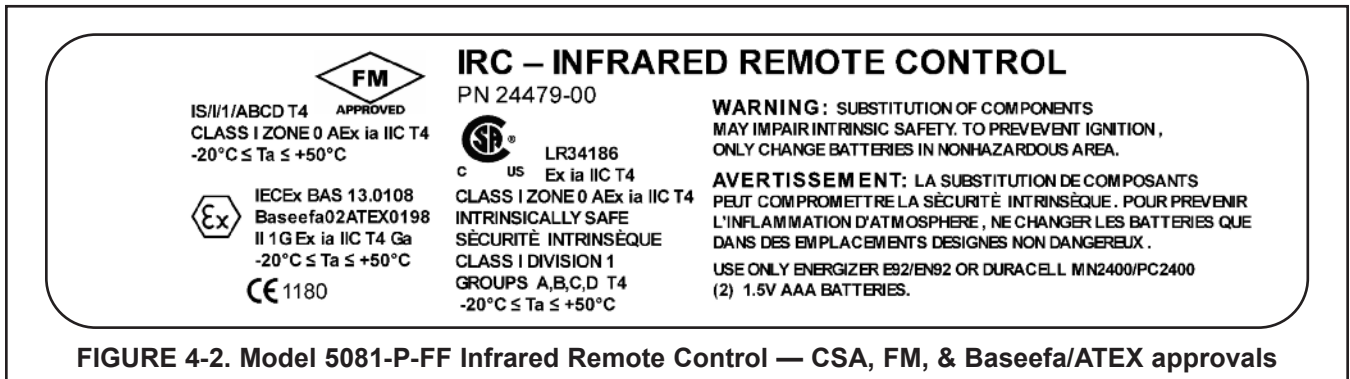
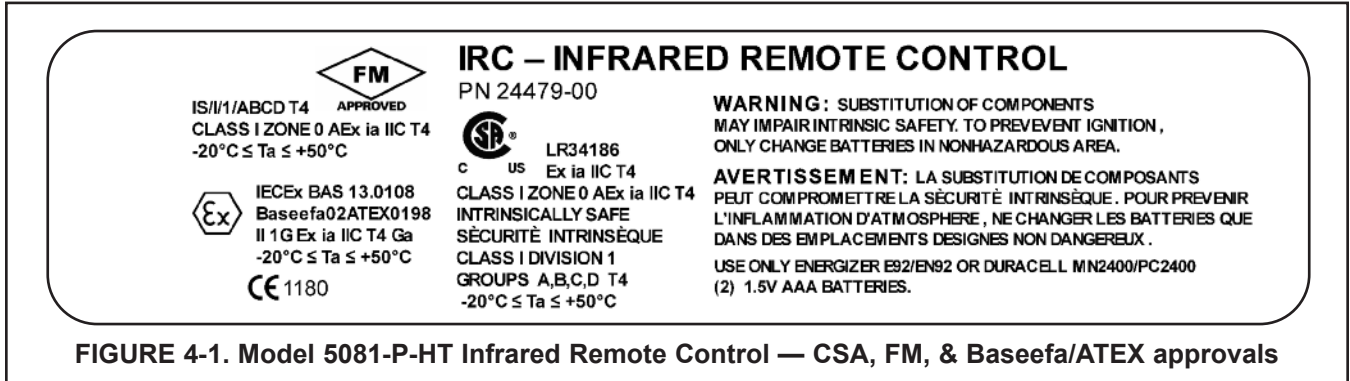

4.1 INTRINSICALLY SAFE AND EXPLOSION-PROOF INSTALLATIONS FOR MODEL 5081-P-HT

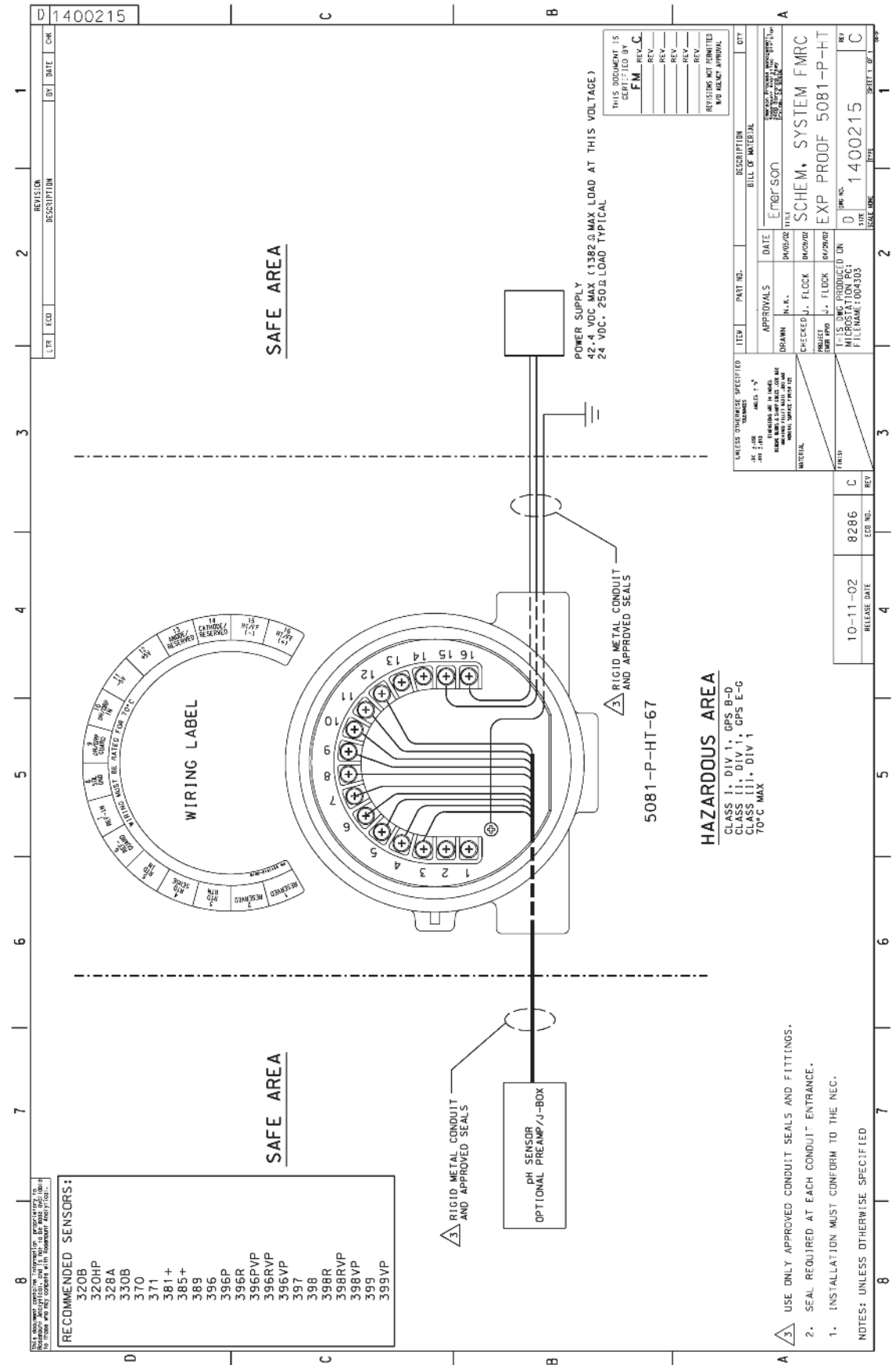

FIGURE 4-3. FM Explosion-Proof Installation for Model 5081-P-HT

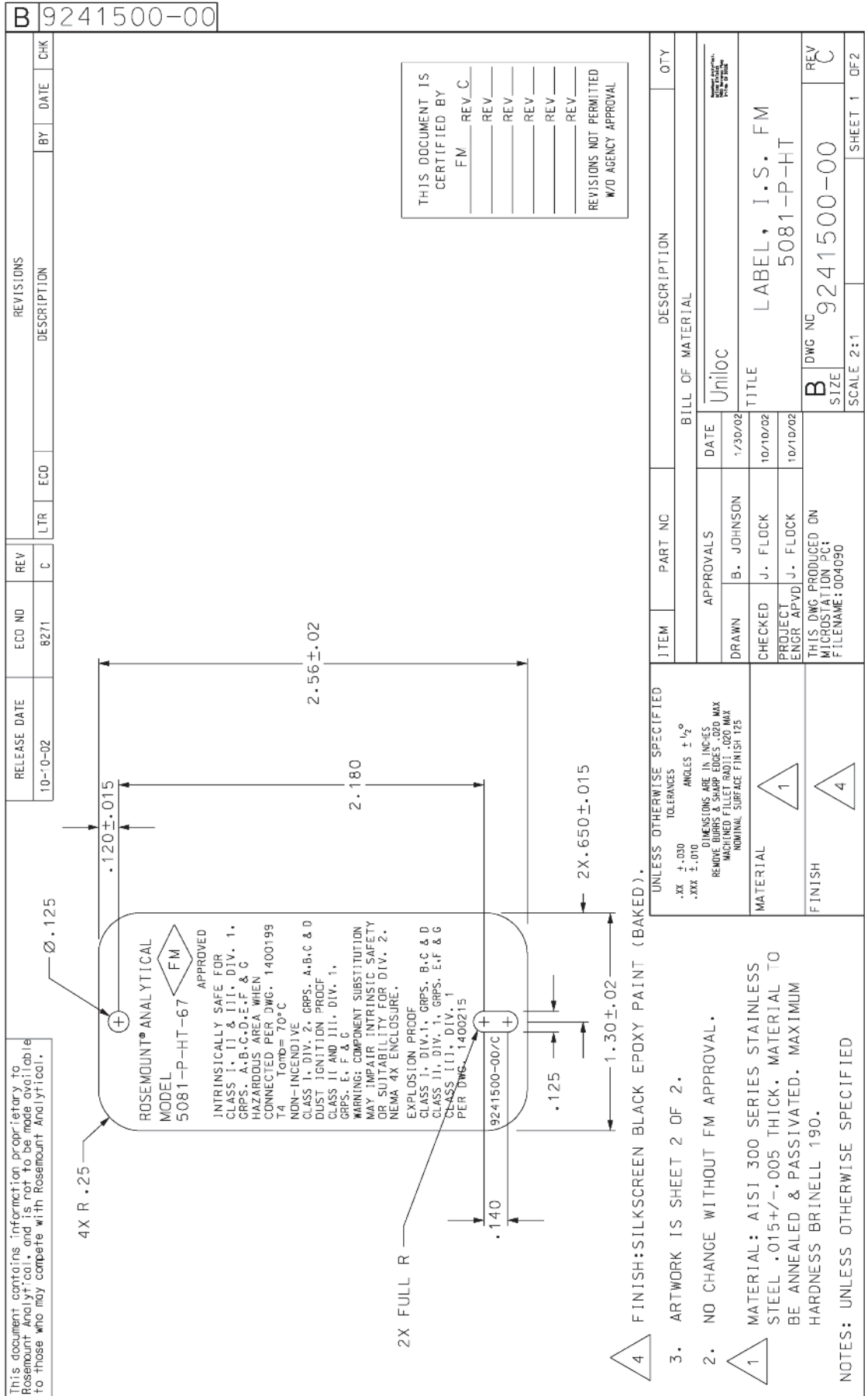

FIGURE 4-4. FM Intrinsically Safe Label for Model 5081-P-HT

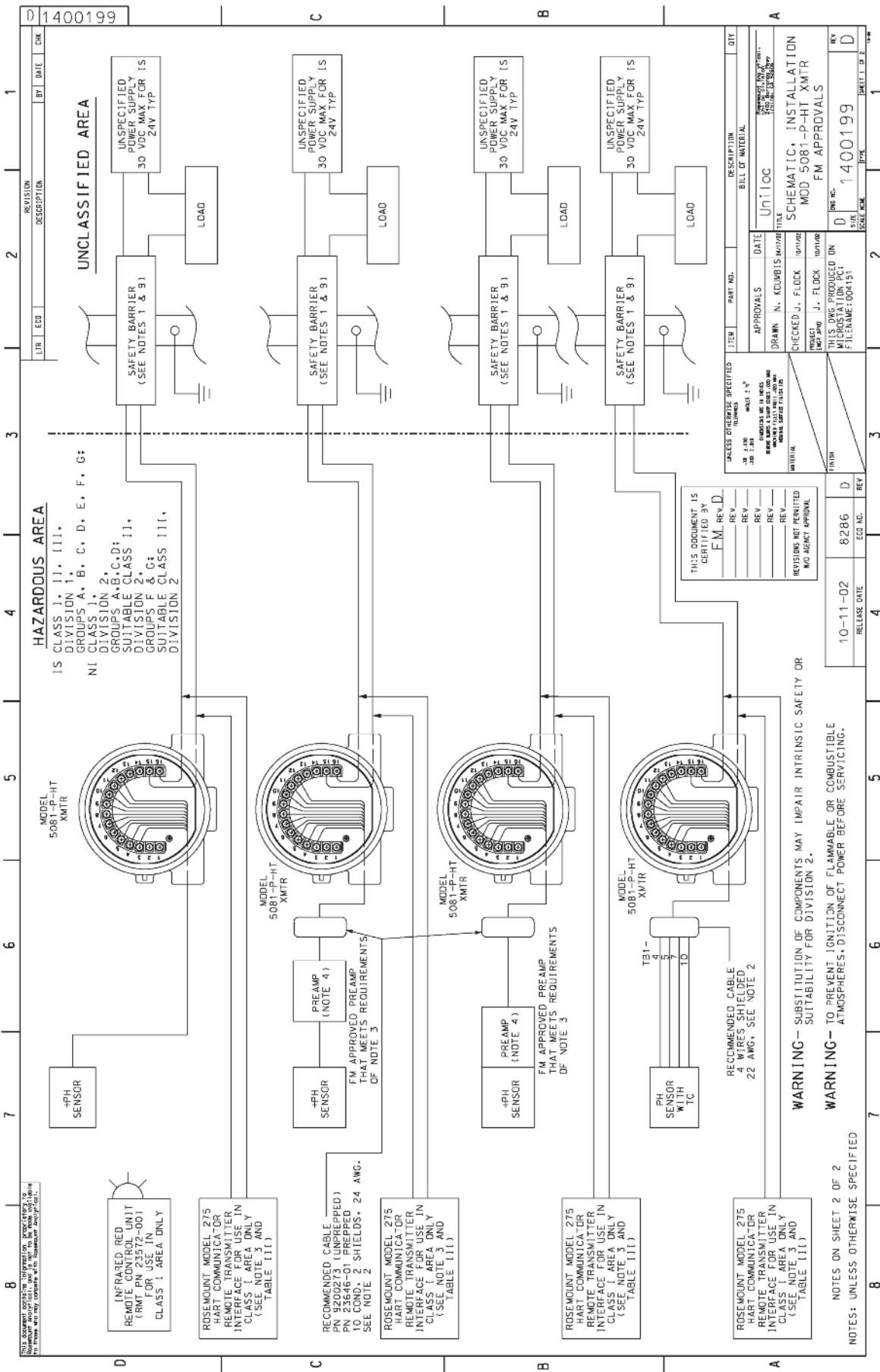
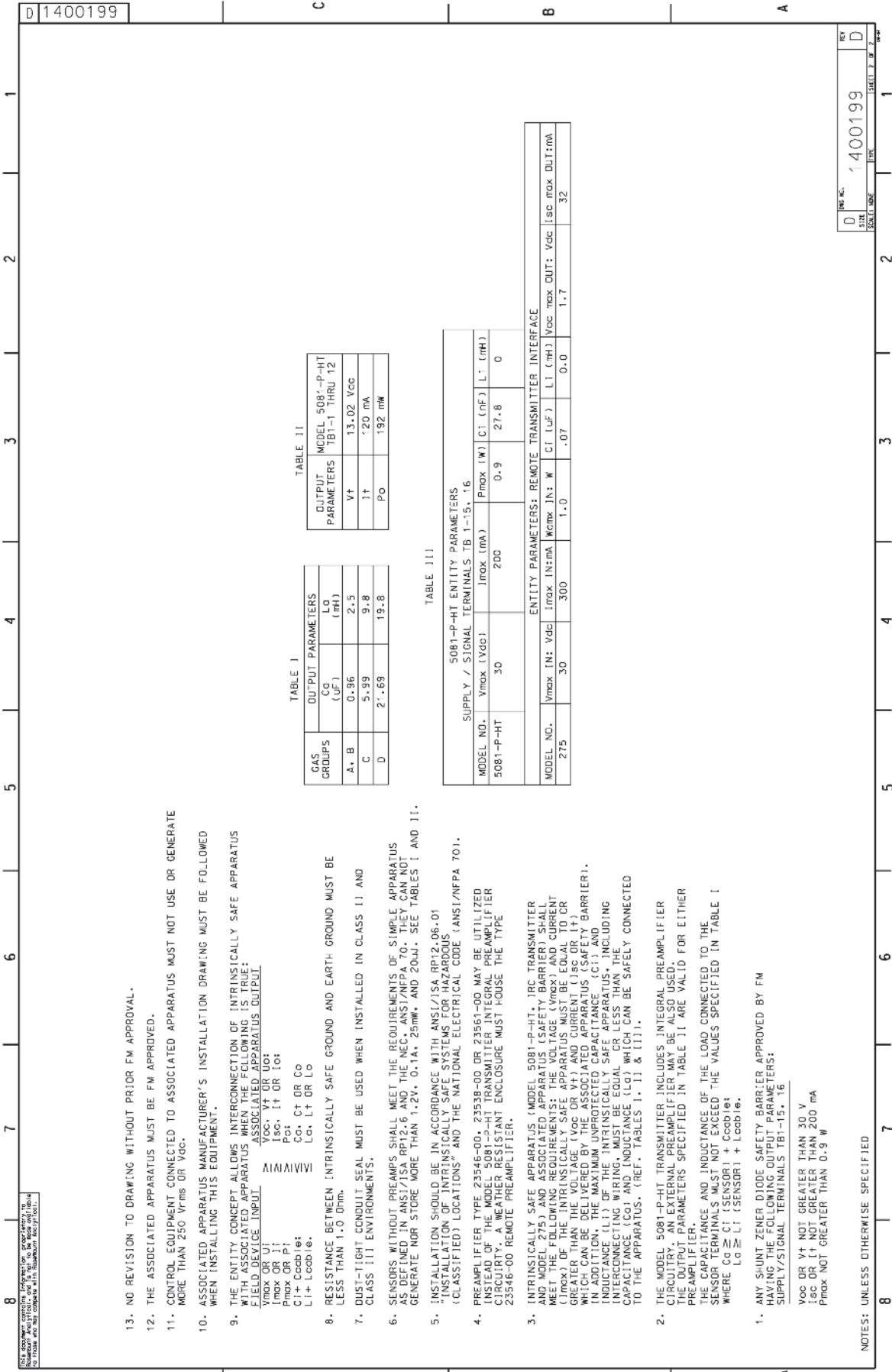

FIGURE 4-5. FM Intrinsically Safe Installation for Model 5081-P-HT (1 of 2)



1. NO REVISION TO DRAWING WITHOUT PRIOR FM APPROVAL.

2. THE ASSOCIATED APPARATUS MUST BE FM APPROVED.

3. CONTROL EQUIPMENT CONNECTED TO ASSOCIATED APPARATUS MUST NOT USE OR GENERATE MORE THAN 250 Vrms OR Vdc.

4. ASSOCIATED APPARATUS MANUFACTURER'S INSTALLATION DRAWING MUST BE FOLLOWED WHEN INSTALLING THIS EQUIPMENT.

5. THE ENTITY CONCEPT ALLOWS INTERCONNECTION OF INTRINSICALLY SAFE APPARATUS WITH ASSOCIATED APPARATUS WHEN THE FOLLOWING IS TRUE:

- 5.1. ISOLATED INPUT
- 5.2. ISOLATED OUTPUT
- 5.3. ISOLATED I/O
- 5.4. I/O OR I/O
- 5.5. I/O OR I/O
- 5.6. I/O OR I/O
- 5.7. I/O OR I/O
- 5.8. I/O OR I/O
- 5.9. I/O OR I/O
- 5.10. I/O OR I/O
- 5.11. I/O OR I/O
- 5.12. I/O OR I/O
- 5.13. I/O OR I/O
- 5.14. I/O OR I/O
- 5.15. I/O OR I/O
- 5.16. I/O OR I/O
- 5.17. I/O OR I/O
- 5.18. I/O OR I/O
- 5.19. I/O OR I/O
- 5.20. I/O OR I/O
- 5.21. I/O OR I/O
- 5.22. I/O OR I/O
- 5.23. I/O OR I/O
- 5.24. I/O OR I/O
- 5.25. I/O OR I/O
- 5.26. I/O OR I/O
- 5.27. I/O OR I/O
- 5.28. I/O OR I/O
- 5.29. I/O OR I/O
- 5.30. I/O OR I/O
- 5.31. I/O OR I/O
- 5.32. I/O OR I/O
- 5.33. I/O OR I/O
- 5.34. I/O OR I/O
- 5.35. I/O OR I/O
- 5.36. I/O OR I/O
- 5.37. I/O OR I/O
- 5.38. I/O OR I/O
- 5.39. I/O OR I/O
- 5.40. I/O OR I/O
- 5.41. I/O OR I/O
- 5.42. I/O OR I/O
- 5.43. I/O OR I/O
- 5.44. I/O OR I/O
- 5.45. I/O OR I/O
- 5.46. I/O OR I/O
- 5.47. I/O OR I/O
- 5.48. I/O OR I/O
- 5.49. I/O OR I/O
- 5.50. I/O OR I/O
- 5.51. I/O OR I/O
- 5.52. I/O OR I/O
- 5.53. I/O OR I/O
- 5.54. I/O OR I/O
- 5.55. I/O OR I/O
- 5.56. I/O OR I/O
- 5.57. I/O OR I/O
- 5.58. I/O OR I/O
- 5.59. I/O OR I/O
- 5.60. I/O OR I/O
- 5.61. I/O OR I/O
- 5.62. I/O OR I/O
- 5.63. I/O OR I/O
- 5.64. I/O OR I/O
- 5.65. I/O OR I/O
- 5.66. I/O OR I/O
- 5.67. I/O OR I/O
- 5.68. I/O OR I/O
- 5.69. I/O OR I/O
- 5.70. I/O OR I/O
- 5.71. I/O OR I/O
- 5.72. I/O OR I/O
- 5.73. I/O OR I/O
- 5.74. I/O OR I/O
- 5.75. I/O OR I/O
- 5.76. I/O OR I/O
- 5.77. I/O OR I/O
- 5.78. I/O OR I/O
- 5.79. I/O OR I/O
- 5.80. I/O OR I/O
- 5.81. I/O OR I/O
- 5.82. I/O OR I/O
- 5.83. I/O OR I/O
- 5.84. I/O OR I/O
- 5.85. I/O OR I/O
- 5.86. I/O OR I/O
- 5.87. I/O OR I/O
- 5.88. I/O OR I/O
- 5.89. I/O OR I/O
- 5.90. I/O OR I/O
- 5.91. I/O OR I/O
- 5.92. I/O OR I/O
- 5.93. I/O OR I/O
- 5.94. I/O OR I/O
- 5.95. I/O OR I/O
- 5.96. I/O OR I/O
- 5.97. I/O OR I/O
- 5.98. I/O OR I/O
- 5.99. I/O OR I/O
- 5.100. I/O OR I/O

6. RESISTANCE BETWEEN INTRINSICALLY SAFE GROUND AND EARTH GROUND MUST BE LESS THAN 1.0 Ohm.

7. DUST-TIGHT CONDUIT SEAL MUST BE USED WHEN INSTALLED IN CLASS I AND CLASS II ENVIRONMENTS.

8. SENSORS WITHOUT PREAMPS SHALL MEET THE REQUIREMENTS OF SIMPLE APPARATUS AS DEFINED IN ANSI/ISA RP12.6 AND THE NEC, ANSI/NFPA 70. THEY CAN NOT GENERATE NOR STORE MORE THAN 1.2V, 0.1A, 25mm, AND 200J. SEE TABLES I AND II.

9. INSTALLATION SHOULD BE IN ACCORDANCE WITH ANSI/ISA RP12.06.01 "INSTALLATION OF INTRINSICALLY SAFE SYSTEMS FOR HAZARDOUS (CLASSIFIED) LOCATIONS" AND THE NATIONAL ELECTRICAL CODE (ANSI/NFPA 70).

10. PREAMPLIFIER TYPE 23546-00, 23538-00 OR 23561-00 MAY BE UTILIZED INSTEAD OF THE INTRINSICALLY SAFE INTEGRATED PREAMPLIFIER. THE PREAMPLIFIER MUST BE INSTALLED IN A WEATHER RESISTANT ENCLOSURE MUST HOUSE THE TYPE 23546-00 REMOTE PREAMPLIFIER.

11. INTRINSICALLY SAFE APPARATUS (MODEL 5081-P-HT, IRC TRANSMITTER AND MODEL 275) AND ASSOCIATED APPARATUS (SAFETY BARRIER) SHALL MEET THE FOLLOWING REQUIREMENTS: THE VOLTAGE (Vmax) AND CURRENT (Imax) OF THE INTRINSICALLY SAFE APPARATUS MUST BE EQUAL TO OR GREATER THAN THE DELIVERED CURRENT (Isc) AND VOLTAGE (Voc) OF THE SAFETY BARRIER. IN ADDITION, THE MAXIMUM UNPROTECTED CAPACITANCE (C1) AND INDUCTANCE (L1) OF THE INTRINSICALLY SAFE APPARATUS, INCLUDING INTERCONNECTING WIRING, MUST BE EQUAL OR LESS THAN THE CAPACITANCE (C0) AND INDUCTANCE (L0) WHICH CAN BE SAFELY CONNECTED TO THE APPARATUS. (REF. TABLES I, II & III).

12. THE MODEL 5081-P-HT TRANSMITTER INCLUDES INTEGRAL PREAMPLIFIER CIRCUITRY. EXTERNAL PREAMPLIFIERS MAY BE USED. THE OUTPUT PARAMETERS SPECIFIED IN TABLE I ARE VALID FOR EITHER PREAMPLIFIER.

13. THE CAPACITANCE AND INDUCTANCE OF THE LOAD CONNECTED TO THE SENSOR TERMINALS MUST NOT EXCEED THE VALUES SPECIFIED IN TABLE I WHERE $C_0 \geq C_1$; $(SENSOR) + C_{cable}$; $L_0 \geq L_1$; $(SENSOR) + L_{cable}$.

14. ANY SHUNT ZENER DIODE SAFETY BARRIER APPROVED BY FM HAVING THE FOLLOWING OUTPUT PARAMETERS:

15. SUPPLY/SIGNAL TERMINALS TB1-15, 16

16. VOC DR Vt NOT GREATER THAN 30 V

17. Isc OR It NOT GREATER THAN 200 mA

18. Pmax NOT GREATER THAN 0.9 W

NOTES: UNLESS OTHERWISE SPECIFIED

TABLE I
OUTPUT PARAMETERS

GAS GROUPS	CO (UF)	LO (mH)
A, B	0.96	2.5
C	5.99	9.8
D	21.69	19.8

TABLE II
MODEL 5081-P-HT OUTPUT PARAMETERS

PARAMETER	VALUE
Vt	13.02 Vdc
It	20 mA
PO	192 mW

TABLE III
5081-P-HT ENTITY PARAMETERS

MODEL NO.	Vmax (Vdc)	Imax (mA)	Pmax (W)	C1 (nF)	L1 (mH)
5081-P-HT	30	300	1.0	0.07	0.0

ENTITY PARAMETERS: REMOTE TRANSMITTER INTERFACE

MODEL NO.	Vmax IN: Vdc	Imax IN: mA	Pmax IN: W	C1 (uF)	L1 (mH)	Voc max OUT: Vdc	Isc max OUT: mA
275	30	300	1.0	0.07	0.0	1.7	32

FIGURE 4-5. FM Intrinsically Safe Installation for Model 5081-P-HT (2 of 2)

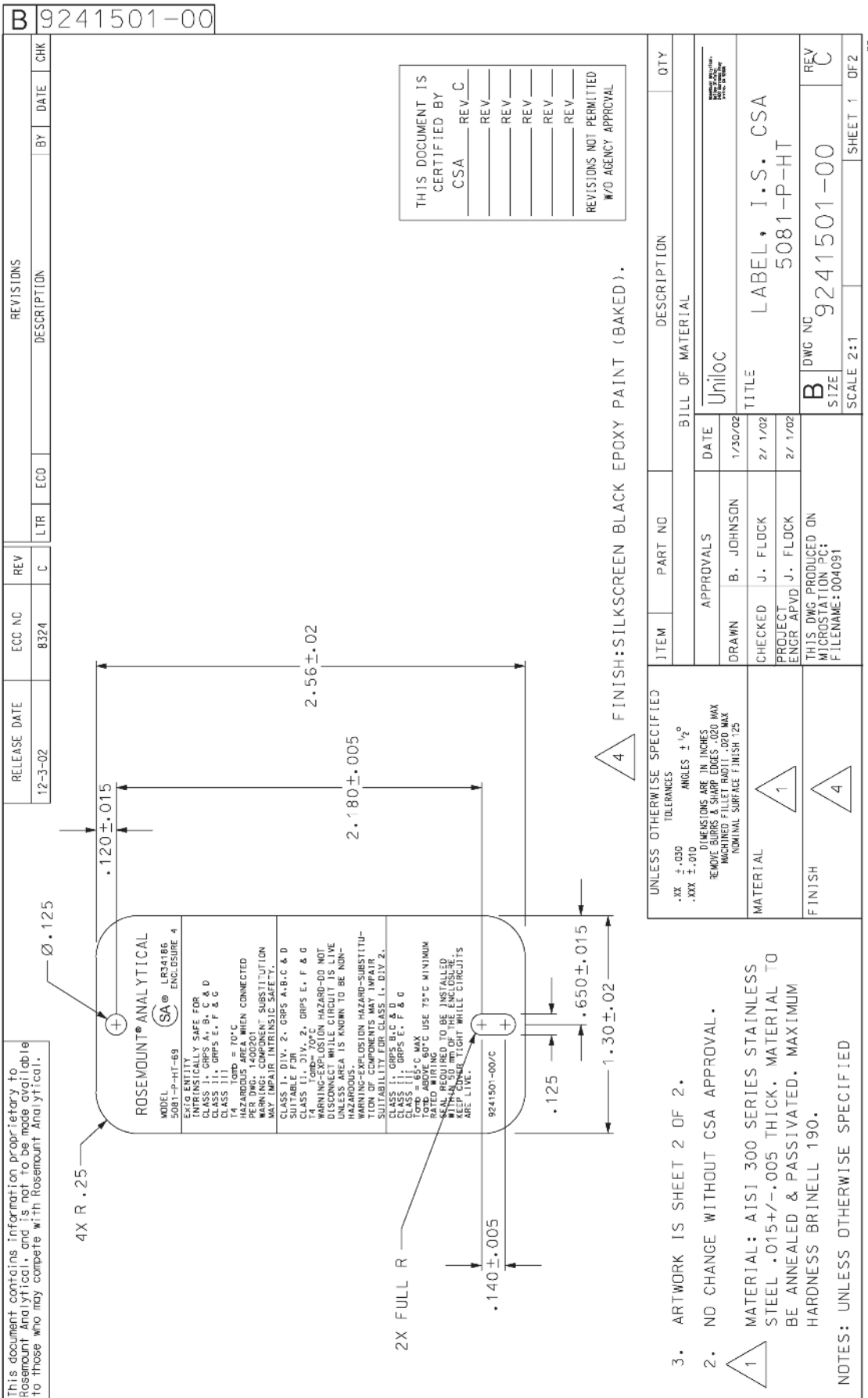

FIGURE 4-6. CSA Intrinsically Safe Label for Model 5081-P-HT

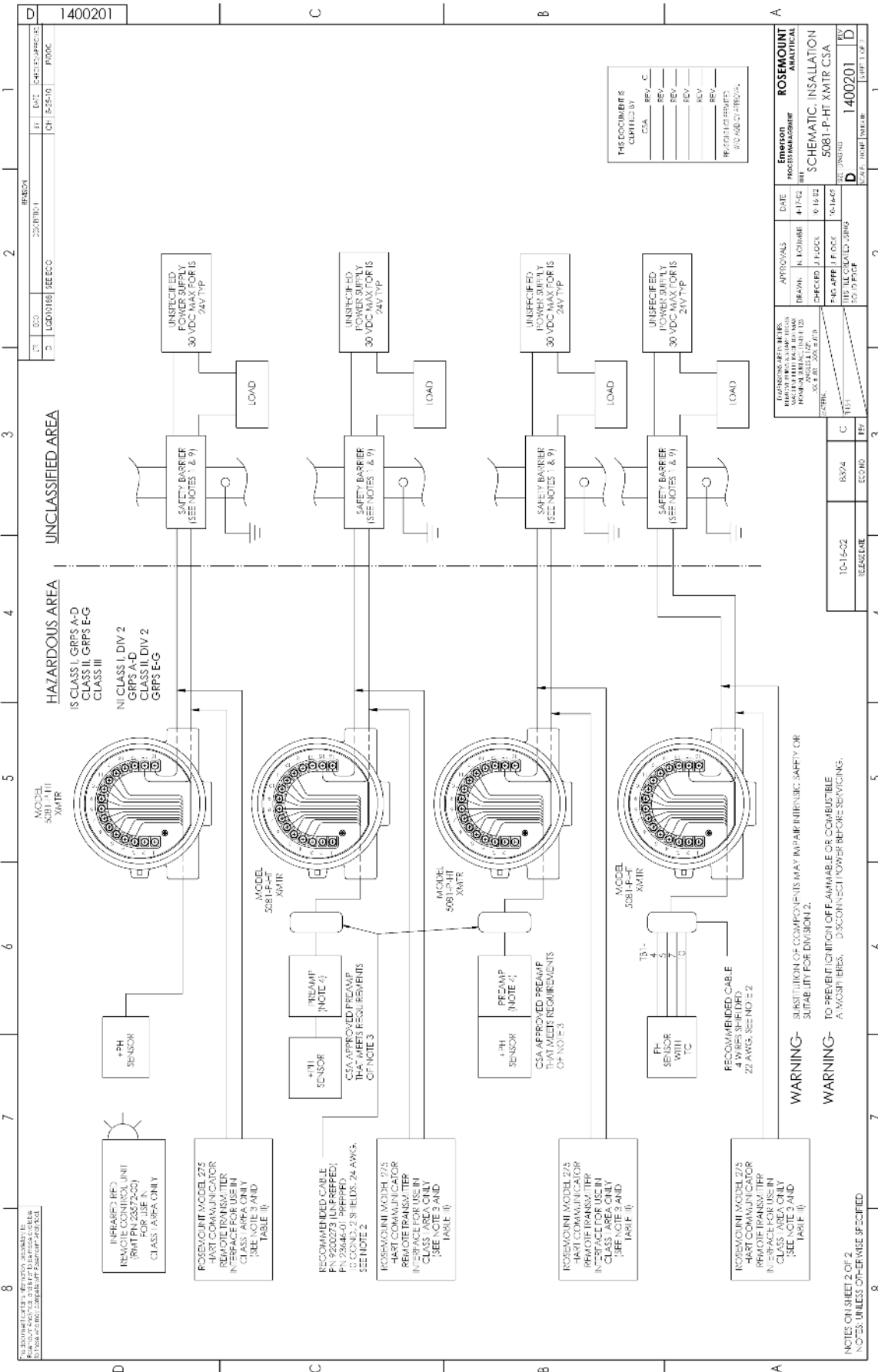
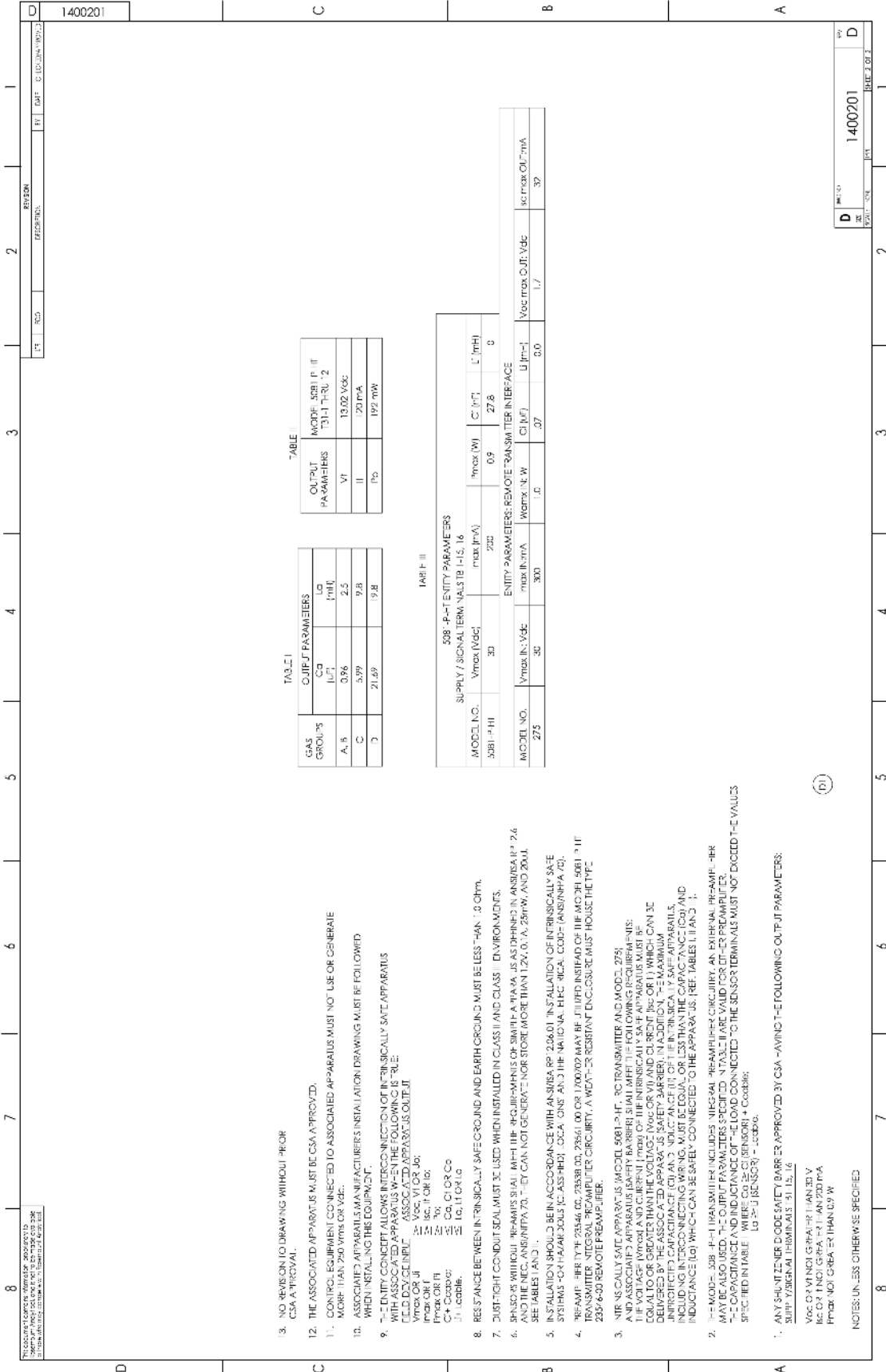

FIGURE 4-7. CSA Intrinsically Safe Installation for Model 5081-P-HT (1 of 2)



4.2 INTRINSICALLY SAFE AND EXPLOSION-PROOF INSTALLATIONS FOR MODEL 5081-P-FF

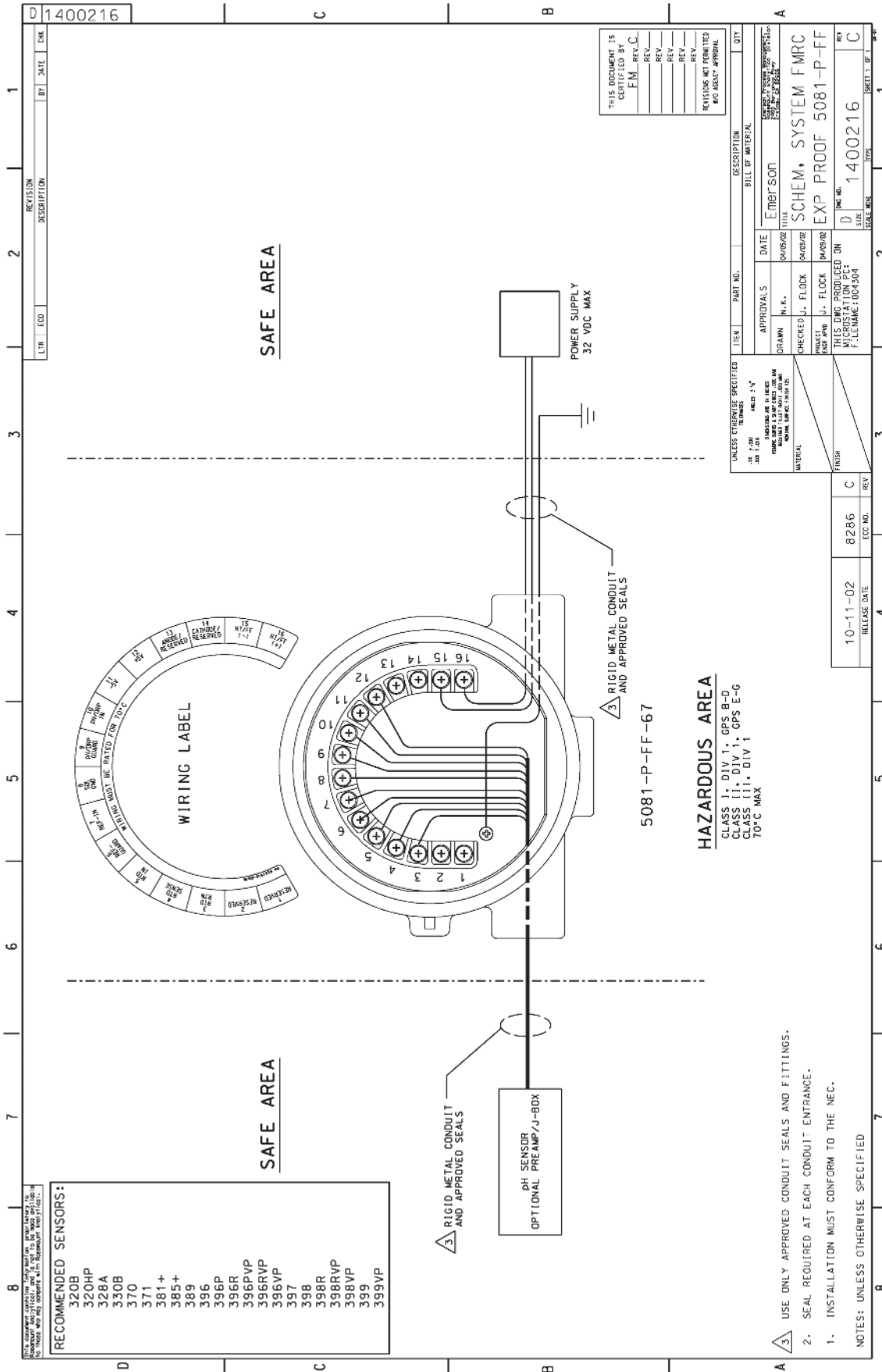

FIGURE 4-9. FM Explosion-Proof Installation for Model 5081-P-FF

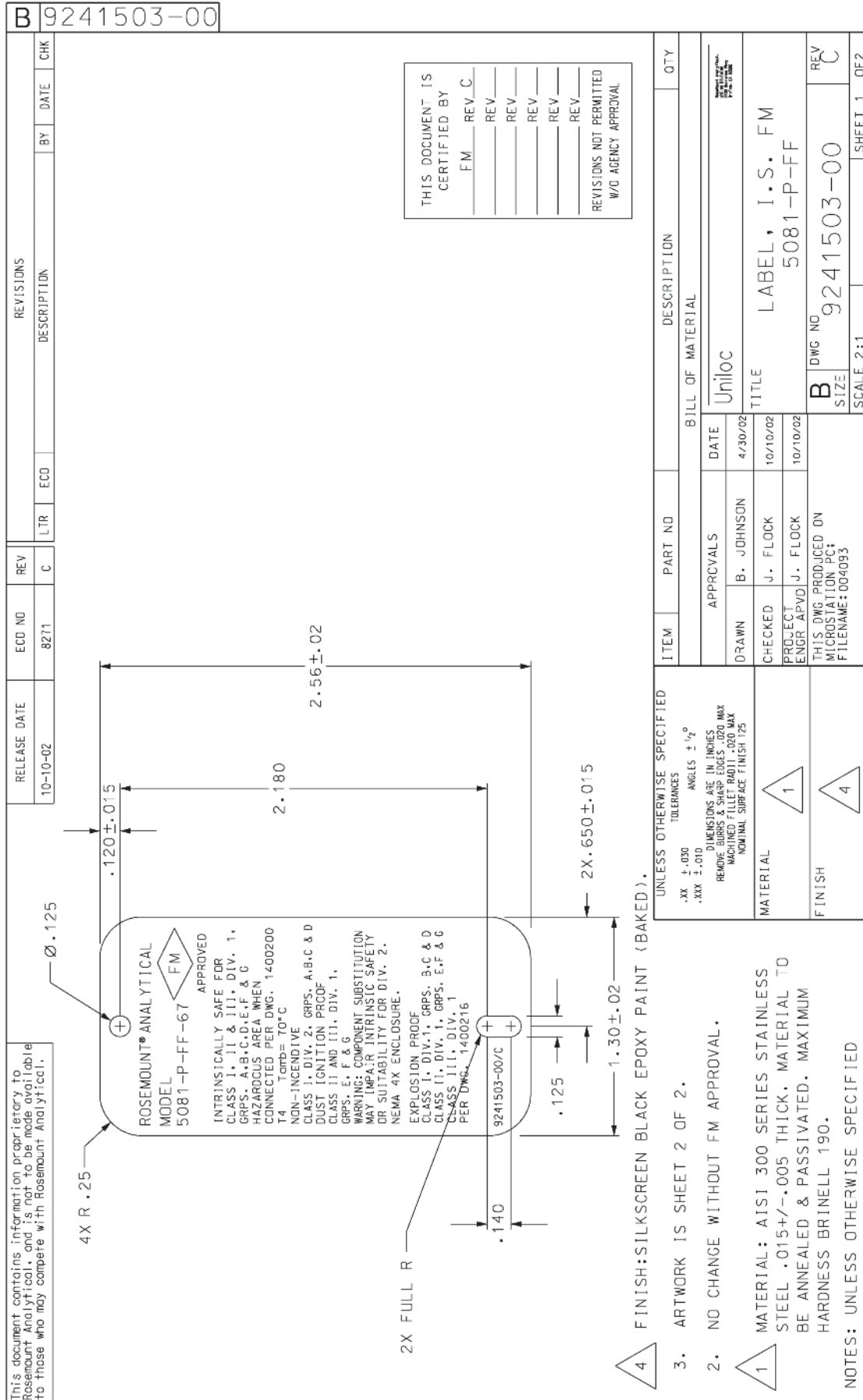

FIGURE 4-10. FM Intrinsically Safe Label for Model 5081-P-FF

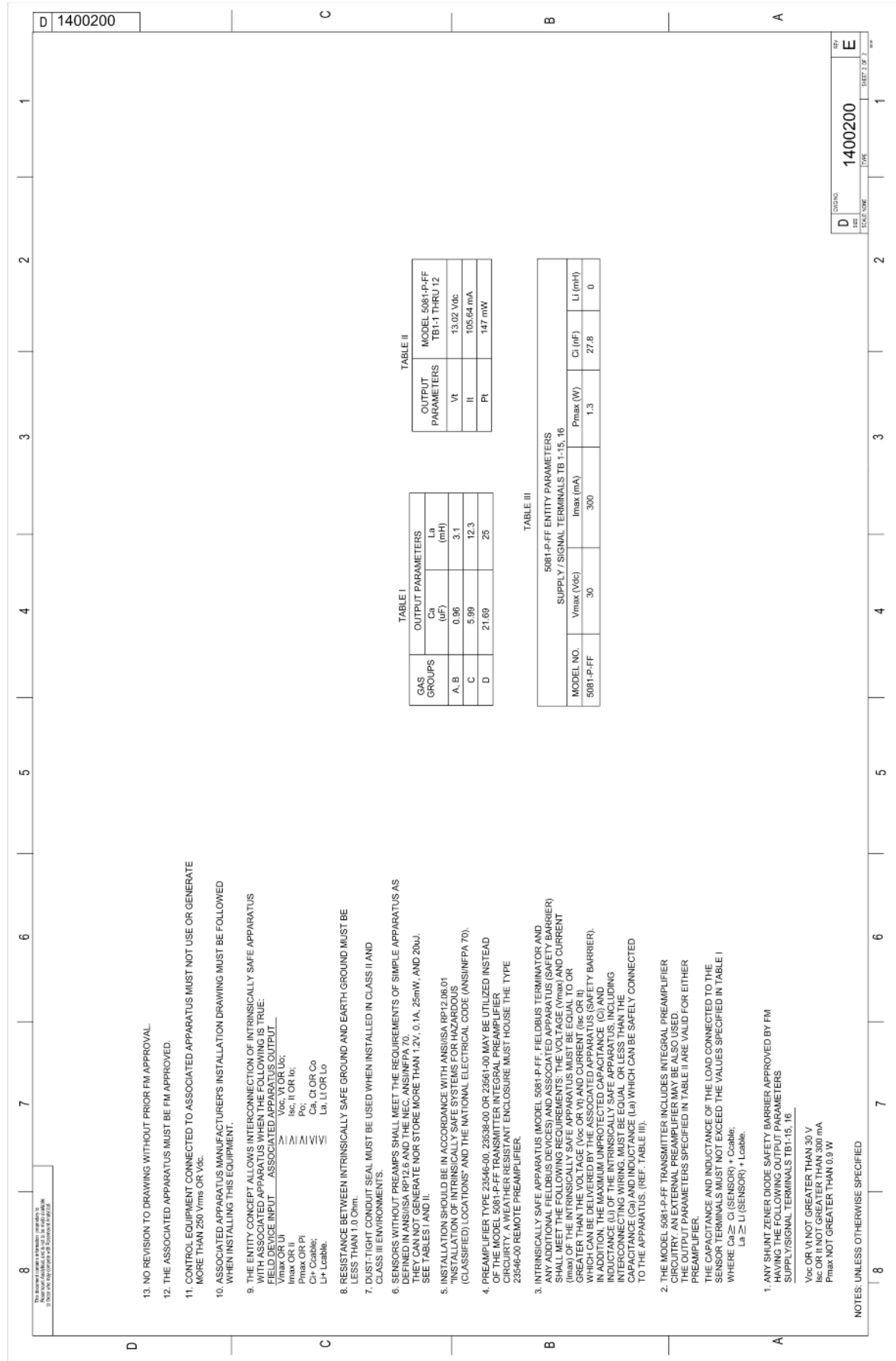

FIGURE 4FIGURE 4-11. FM Intrinsically Safe Installation for Model 5081-P-PF (2 of 2)

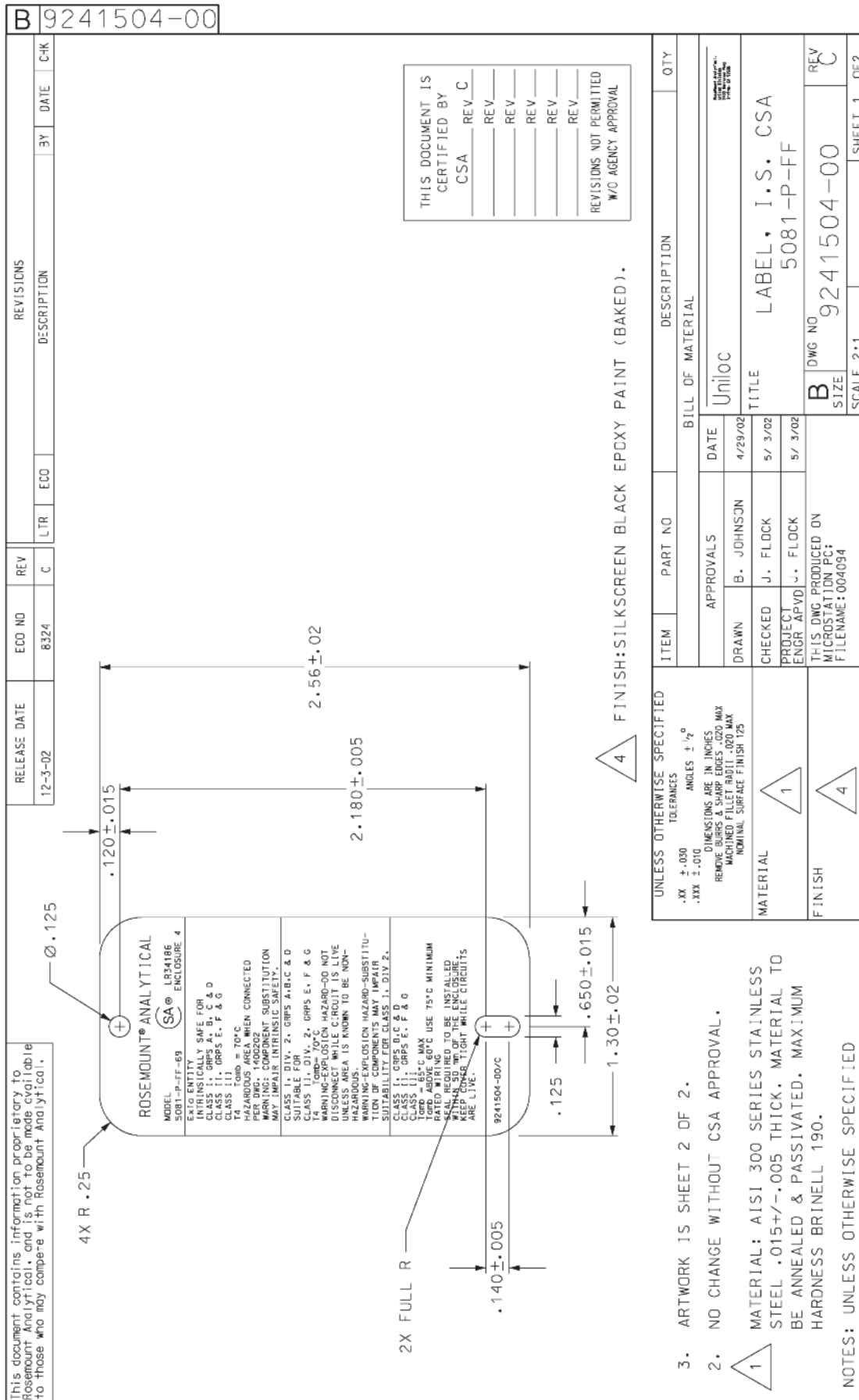
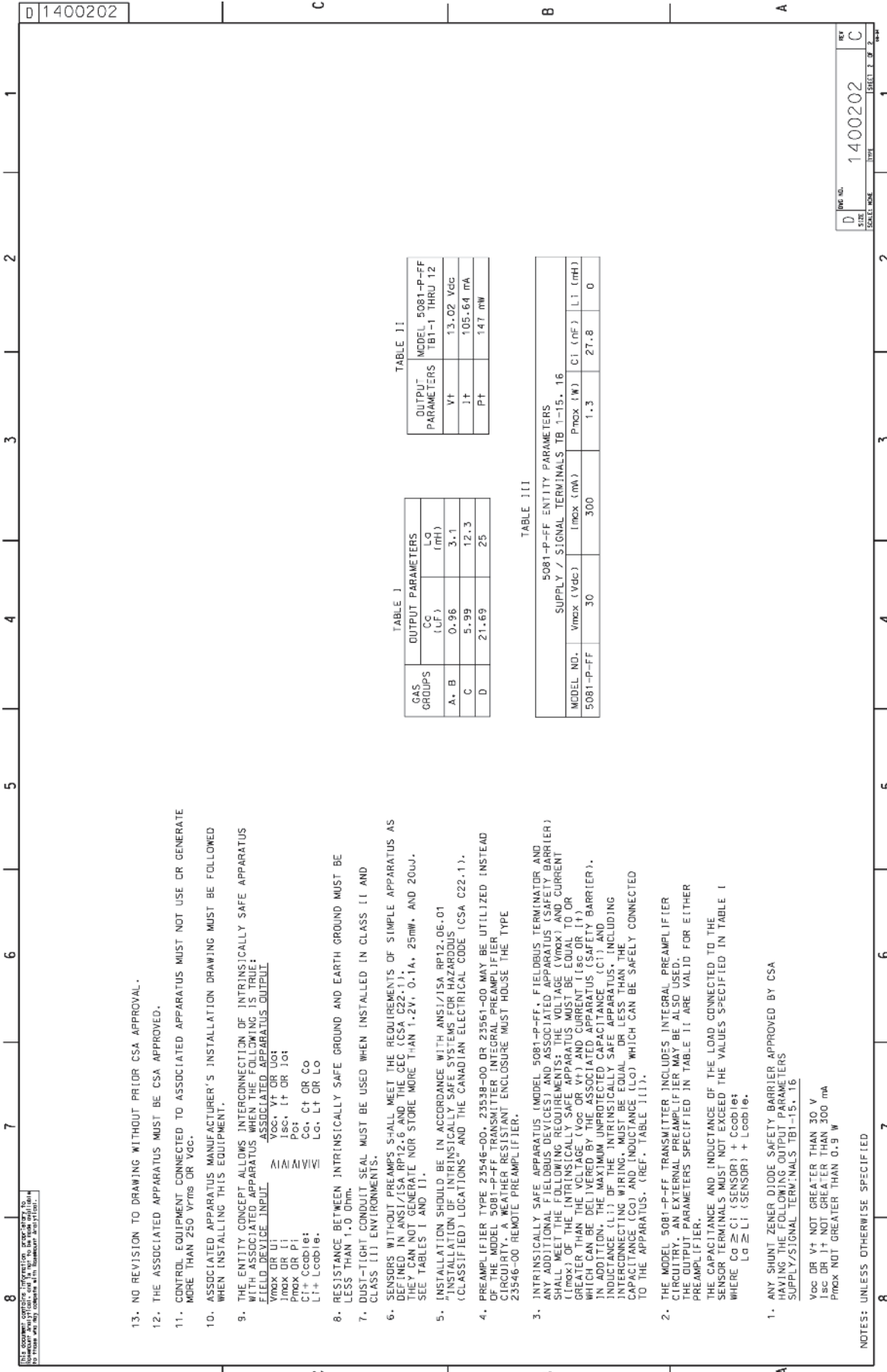

FIGURE 4-12. CSA Intrinsically Safe Label for Model 5081-P-PF



13. NO REVISION TO DRAWING WITHOUT PRIOR CSA APPROVAL.

12. THE ASSOCIATED APPARATUS MUST BE CSA APPROVED.

11. CONTROL EQUIPMENT CONNECTED TO ASSOCIATED APPARATUS MUST NOT USE OR GENERATE MORE THAN 250 Vrms OR Vcc.

10. ASSOCIATED APPARATUS MANUFACTURER'S INSTALLATION DRAWING MUST BE FOLLOWED WHEN INSTALLING THIS EQUIPMENT.

9. THE ENTITY CONCEPT ALLOWS INTERCONNECTION OF INTRINSICALLY SAFE APPARATUS WITH ASSOCIATED APPARATUS. THE FOLLOWING INSTALLATION IS SUBJECT TO THE FIELD DEVICE INPUT ASSOCIATED APPARATUS OUTPUT:
 Vmax OR Ii Vcc, Vt OR Iot
 Imax OR Ii Isc, It OR Iot
 Pmax OR Pi Po
 Cf + Ccoble; Cg, Ct OR Co
 Lt + Lcoble; Lg, Lt OR Lo

8. RESISTANCE BETWEEN INTRINSICALLY SAFE GROUND AND EARTH GROUND MUST BE LESS THAN 1.0 Ohm.

7. DUST-TIGHT CONDUIT SEAL MUST BE USED WHEN INSTALLED IN CLASS II AND CLASS III ENVIRONMENTS.

6. SENSORS WITHOUT PREAMPS SHALL MEET THE REQUIREMENTS OF SIMPLE APPARATUS AS DEFINED IN ANSI/ISA RP12.6 AND THE CEC (CSA C22.11). THE CAN NOT GENERATE NOR STORE MORE THAN 1.2V, 0.1A, 25mW, AND 20uJ. SEE TABLE I AND II.

5. INSTALLATION SHOULD BE IN ACCORDANCE WITH ANSI/ISA RP12.06-01 "INSTALLATION OF INTRINSICALLY SAFE SYSTEMS FOR HAZARDOUS (CLASSIFIED) LOCATIONS" AND THE CANADIAN ELECTRICAL CODE (CSA C22.1).

4. PREAMPLIFIER TYPE 23546-00, 23538-00 OR 23561-00 MAY BE UTILIZED INSTEAD OF THE MODEL 5081-P-FF TRANSMITTER INTEGRAL PREAMPLIFIER CIRCUITRY. A WEATHER RESISTANT ENCLOSURE MUST HOUSE THE TYPE 23546-00 REMOTE PREAMPLIFIER.

3. INTRINSICALLY SAFE APPARATUS (MODEL 5081-P-FF, FIELD BUS TERMINATOR AND ANY ADDITIONAL FIELD BUS DEVICES) AND ASSOCIATED APPARATUS (SAFETY BARRIER) SHALL MEET THE FOLLOWING REQUIREMENTS: THE VOLTAGE (Vmax) AND CURRENT (Imax) OF THE SUPPLY OR SIGNAL TERMINALS TB1-15, 16 WHICH CAN BE DELIVERED BY THE ASSOCIATED APPARATUS (SAFETY BARRIER). IN ADDITION, THE MAXIMUM UNPROTECTED CAPACITANCE (C1) AND INDUCTANCE (L1) OF THE INTRINSICALLY SAFE APPARATUS, INCLUDING INTERCONNECTING WIRING, MUST BE EQUAL OR LESS THAN THE CAPACITANCE (Co) AND INDUCTANCE (Lo) WHICH CAN BE SAFELY CONNECTED TO THE APPARATUS. (REF. TABLE III).

2. THE MODEL 5081-P-FF TRANSMITTER INCLUDES INTEGRAL PREAMPLIFIER CIRCUITRY. AN EXTERNAL PREAMPLIFIER MAY BE ALSO USED. THE OUTPUT PARAMETERS SPECIFIED IN TABLE II ARE VALID FOR EITHER PREAMPLIFIER.

1. ANY SHUNT ZENER DIODE SAFETY BARRIER APPROVED BY CSA HAVING THE FOLLOWING OUTPUT PARAMETERS:
 SUPPLY/SIGNAL TERMINALS TB1-15, 16
 Vcc OR Vt NOT GREATER THAN 30 V
 Icc OR It NOT GREATER THAN 300 mA
 Pmax NOT GREATER THAN 0.9 W
 La ≥ Lt (SENSOR) + Lcoble;
 Co ≥ Ct (SENSOR) + Ccoble;

NOTES: UNLESS OTHERWISE SPECIFIED

TABLE I I

GAS GROUPS	CC (uF)	Lg (mH)	OUTPUT PARAMETERS
A, B	0.96	3.1	Vt 13.02 Vcc It 105.64 mA
C	5.99	12.3	Pt 147 mW
D	21.69	25	

TABLE J

GAS GROUPS	CC (uF)	Lg (mH)
A, B	0.96	3.1
C	5.99	12.3
D	21.69	25

TABLE III

MODEL NO.	5081-P-FF ENTITY PARAMETERS		
	SUPPLY / SIGNAL TERMINALS TB 1-15, 16	Pmax (W)	CI (nF) LI (mH)
5081-P-FF	30	300	1.3 27.8 0

FIGURE 4-13. CSA Intrinsically Safe Installation for Model 5081-P-FF (2 of 2)

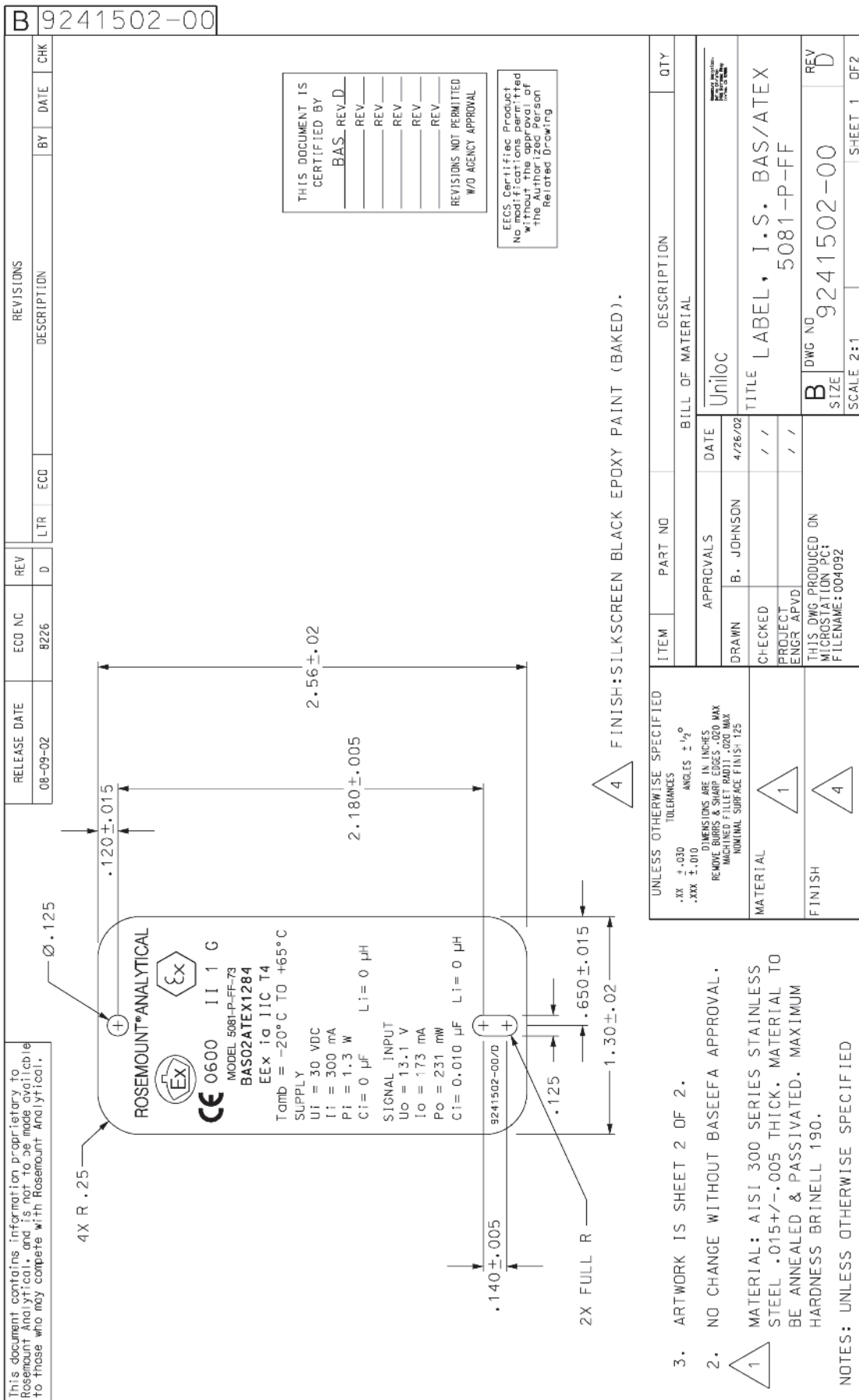

FIGURE 4-14. ATEX Intrinsicly Safe Label for Model 5081-P-FF

4.3 INTRINSICALLY SAFE AND EXPLOSION-PROOF INSTALLATIONS FOR MODEL 5081-P-FI

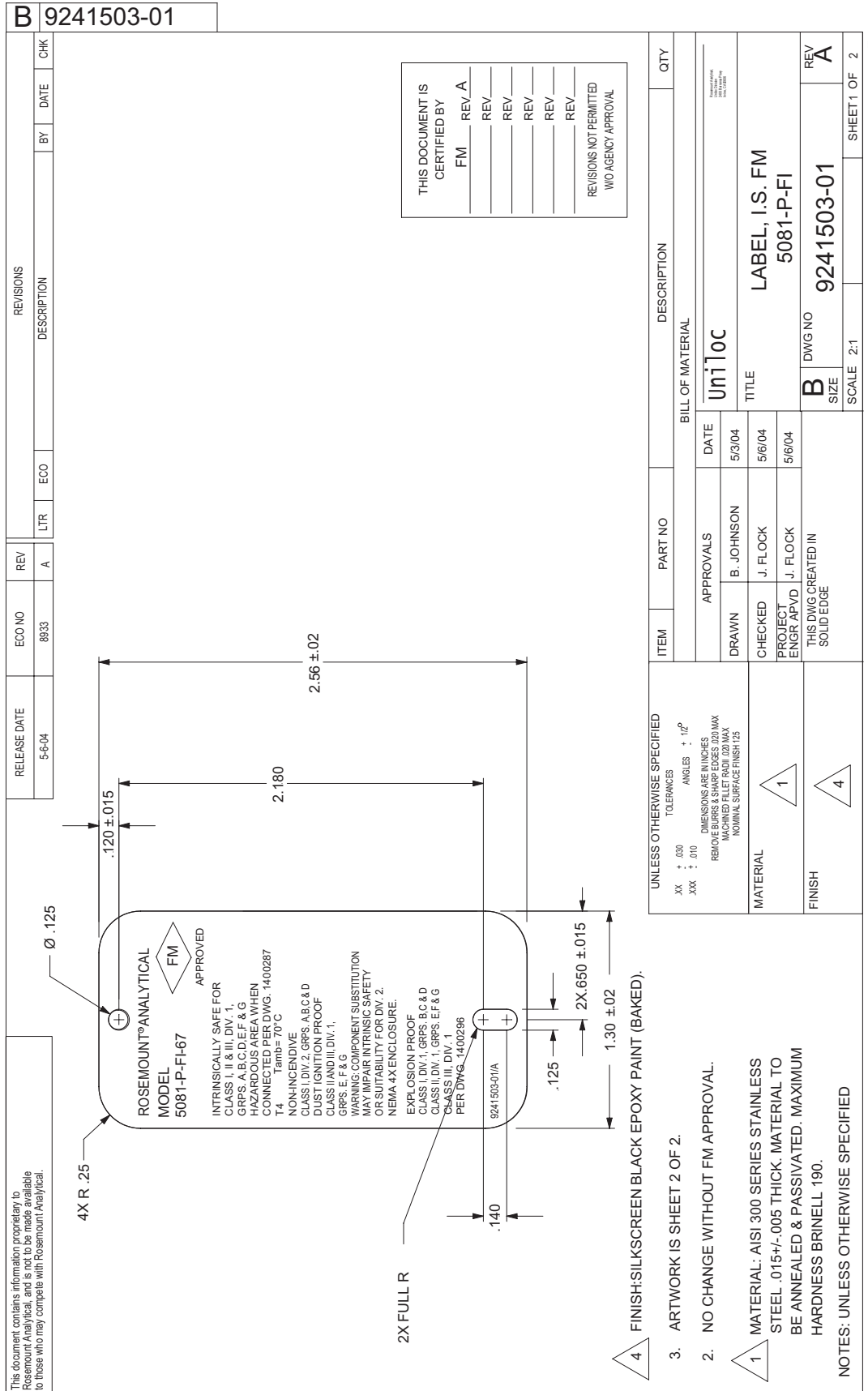

FIGURE 4-15. FM Intrinsically Safe Label for Model 5081-P-FI

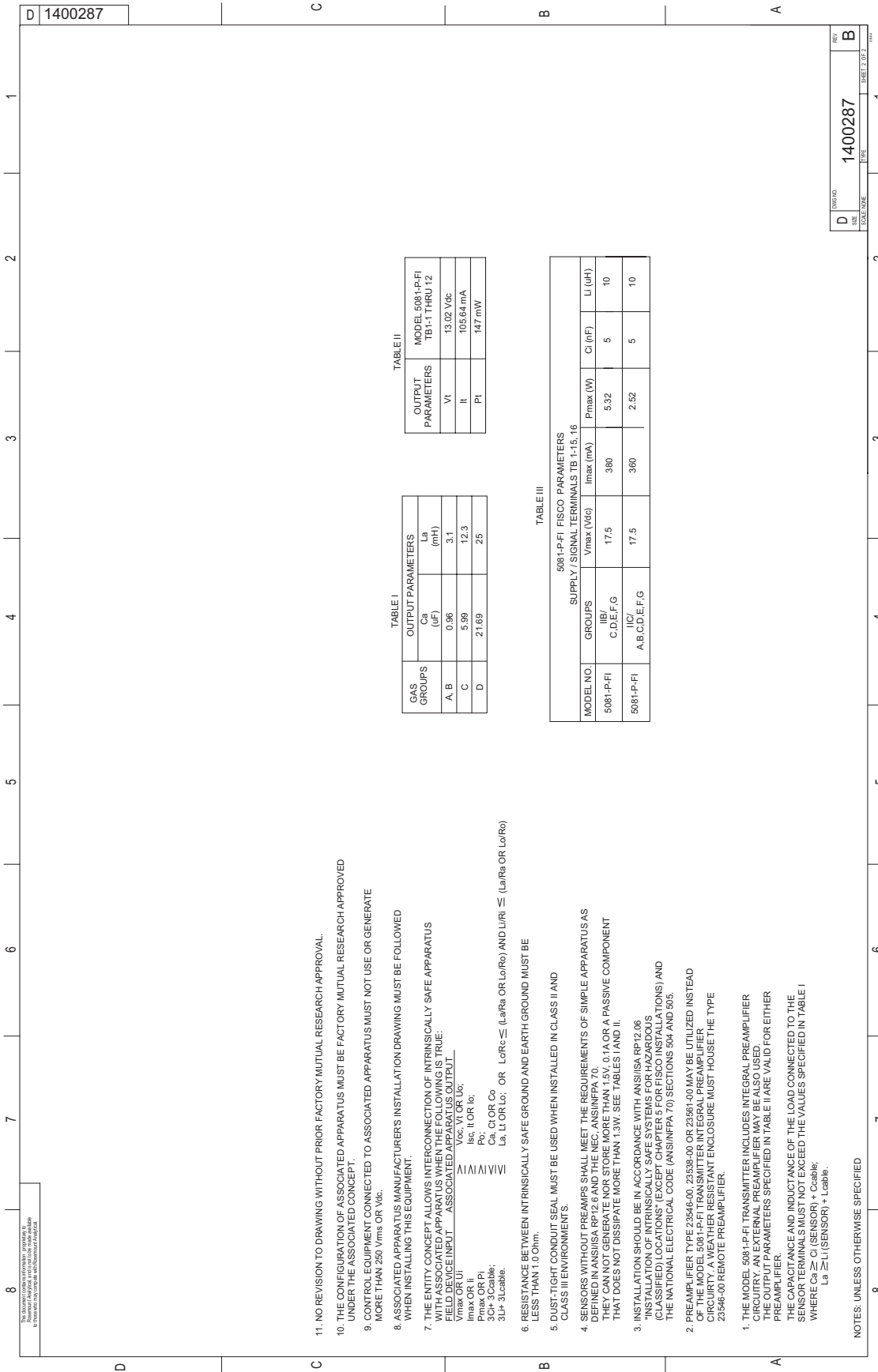
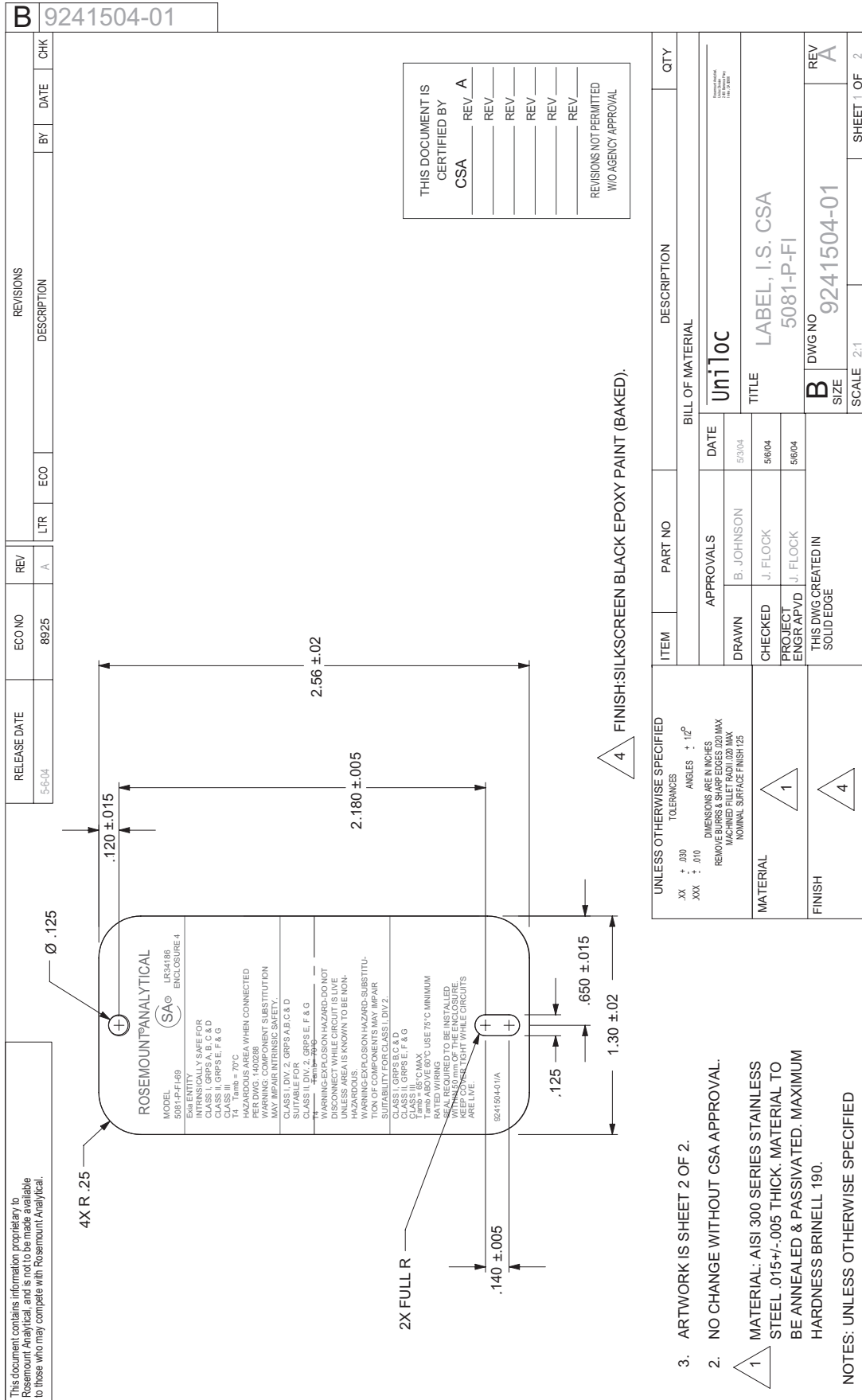

FIGURE 4-16. FM Intrinsically Safe Installation for Model 5081-P-FI (2 of 2)



UNLESS OTHERWISE SPECIFIED

TOLERANCES

ANGLES ± 1/2°

DIMENSIONS ARE IN INCHES

REMOVE BURRS & SHARP EDGES .020 MAX

MACHINED FILLET RADI .020 MAX

NOMINAL SURFACE FINISH 125

MATERIAL

FINISH

ITEM

PART NO

DESCRIPTION

QTY

BILL OF MATERIAL

UNiToc

DATE

5/3/04

APPROVALS

B. JOHNSON

5/6/04

J. FLOCK

5/6/04

J. FLOCK

5/6/04

TITLE

LABEL, I.S. CSA 5081-P-FI

DWG NO

9241504-01

REV

A

SCALE

2:1

SHEET 1 OF 2

3. ARTWORK IS SHEET 2 OF 2.
 2. NO CHANGE WITHOUT CSA APPROVAL.
- 1 MATERIAL: AISI 300 SERIES STAINLESS STEEL .015+/-0.005 THICK. MATERIAL TO BE ANNEALED & PASSIVATED. MAXIMUM HARDNESS BRINELL 190.
- NOTES: UNLESS OTHERWISE SPECIFIED

FIGURE 4-17. CSA Intrinsically Safe Label for Model 5081-P-FI

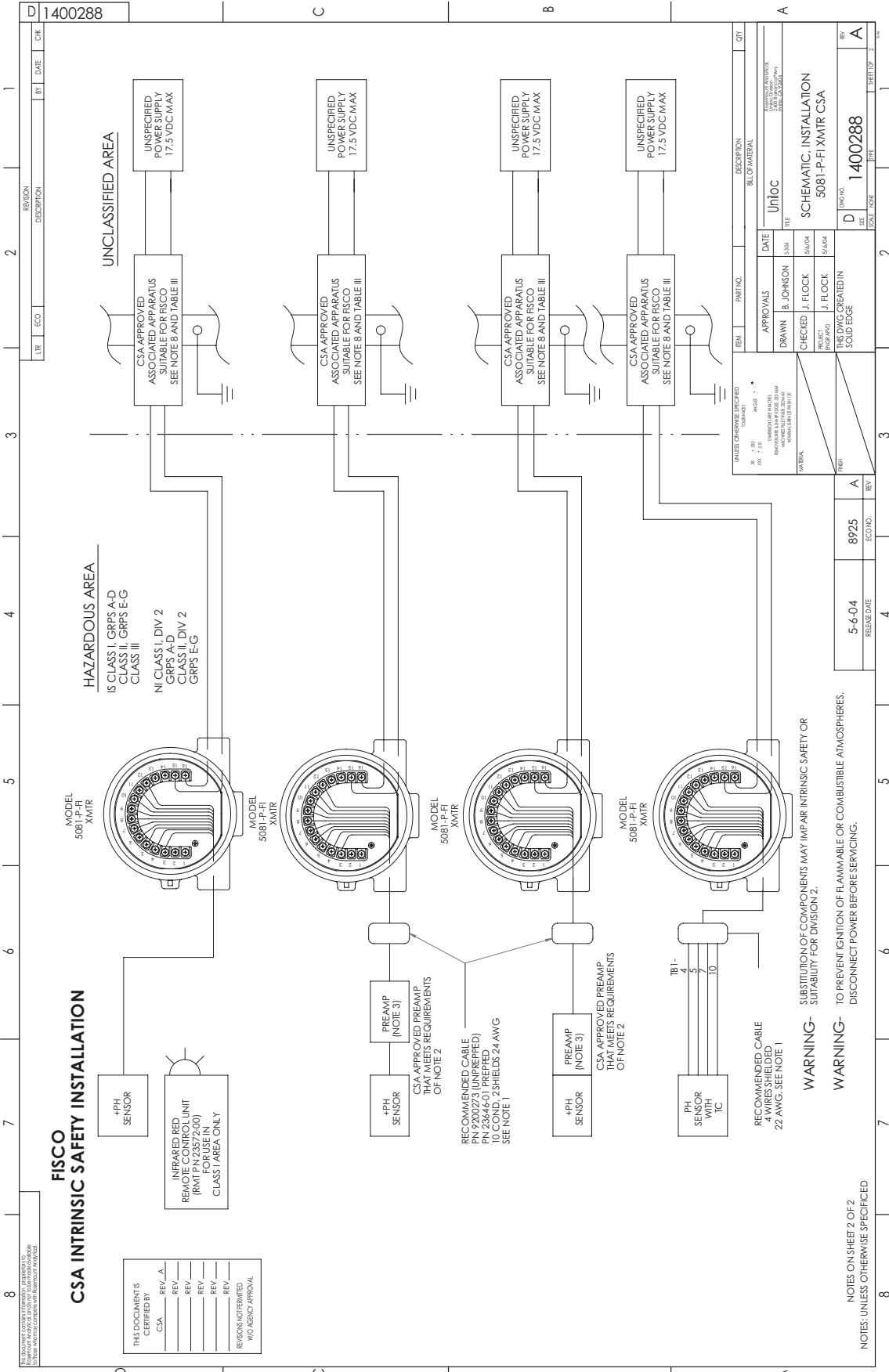
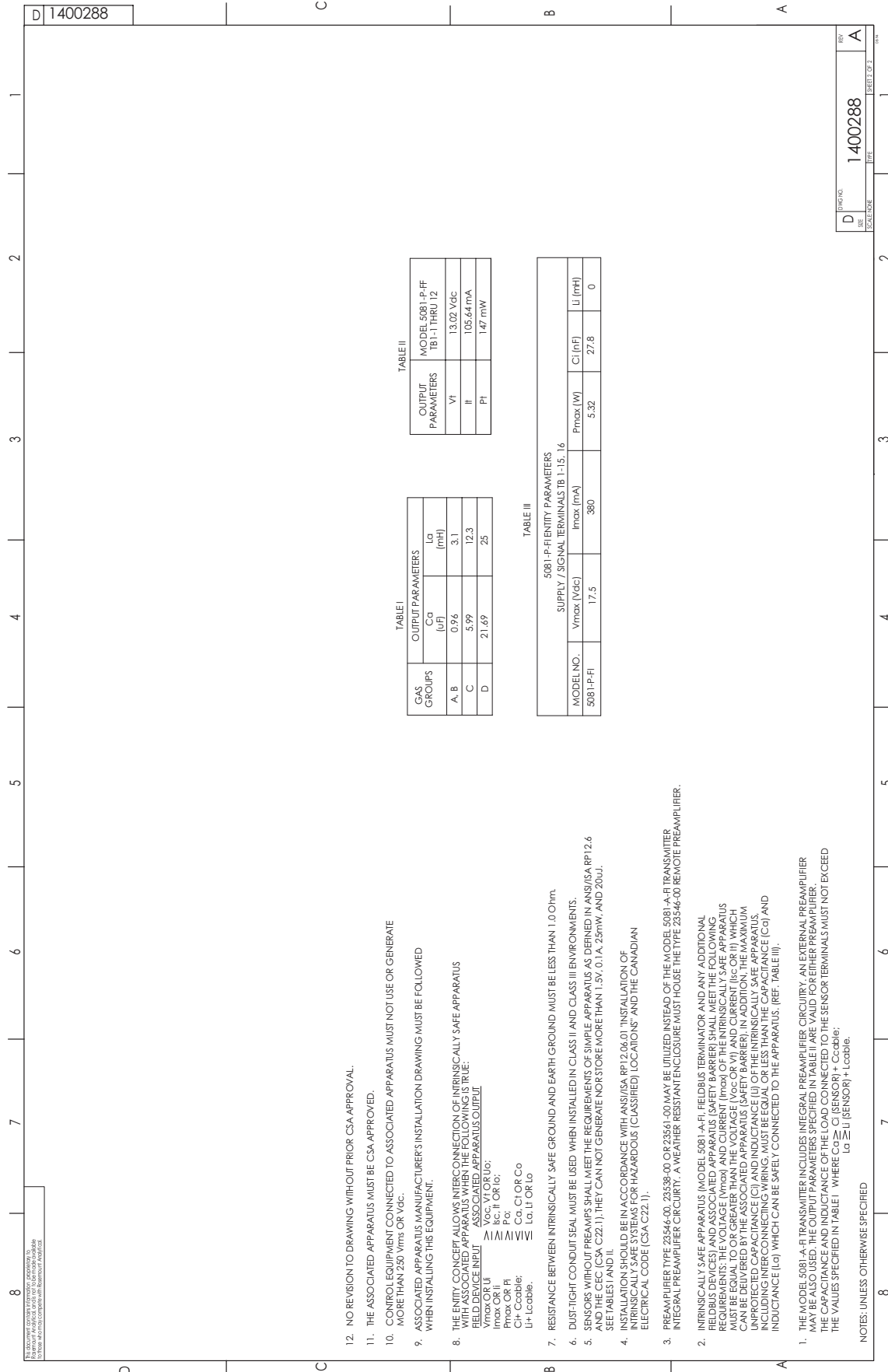

FIGURE 4-18. CSA Intrinsically Safe Installation for Model 5081-P-FI (1 of 2)



1. Do not connect the sensor to the transmitter until the transmitter has been properly calibrated. Refer to the transmitter manual for instructions on how to calibrate the transmitter. Do not connect the sensor to the transmitter until the transmitter has been properly calibrated.

12. NO REVISION TO DRAWING WITHOUT PRIOR CSA-APPROVAL.
11. THE ASSOCIATED APPARATUS MUST BE CSA APPROVED.
10. CONTROL EQUIPMENT CONNECTED TO ASSOCIATED APPARATUS MUST NOT USE OR GENERATE MORE THAN 250 Vrms OR Vdc.
9. ASSOCIATED APPARATUS MANUFACTURER'S INSTALLATION DRAWING MUST BE FOLLOWED WHEN INSTALLING THIS EQUIPMENT.
8. THE ENTITY CONCEPT ALLOWS INTERCONNECTION OF INTRINSICALLY SAFE APPARATUS WITH ASSOCIATED APPARATUS WHEN THE FOLLOWING IS TRUE:
 Vmax OR Li ≤ Vmax OR Li of the associated apparatus output;
 Vmax OR Li ≤ Vmax OR Li of the associated apparatus output;
 Imax OR Pi ≤ Imax OR Pi of the associated apparatus output;
 CH, Ccable, L, Lcable, Ca, Ci OR Co, Lg, Li OR Lo.
7. RESISTANCE BETWEEN INTRINSICALLY SAFE GROUND AND EARTH GROUND MUST BE LESS THAN 1.0 Ohm.
6. DUST/TIGHT CONDUIT SEAL MUST BE USED WHEN INSTALLED IN CLASS II AND CLASS III ENVIRONMENTS.
5. SENSORS WITHOUT PREAMPS SHALL MEET THE REQUIREMENTS OF SIMPLE APPARATUS AS DERIVED IN ANSI/ISA RP 12.6 AND THE CEC (CSA C22.1); THEY CAN NOT GENERATE NOR STORE MORE THAN 1.5V, 0.1A, 25mWh, AND 200J. SEE TABLE I AND II.
4. INSTALLATION SHOULD BE IN ACCORDANCE WITH ANSI/ISA RP 12.06.01 "INSTALLATION OF INTRINSICALLY SAFE SYSTEMS FOR HAZARDOUS (CLASSIFIED) LOCATIONS" AND THE CANADIAN ELECTRICAL CODE (CSA C22.1).
3. PREAMPLIFIER TYPE 23546-00, 23538-00 OR 23561-00 MAY BE UTILIZED INSTEAD OF THE MODEL 5081-A-FI TRANSMITTER INTEGRAL PREAMPLIFIER CIRCUITRY. A WEATHER RESISTANT ENCLOSURE MUST HOUSE THE TYPE 23546-00 REMOTE PREAMPLIFIER.
2. INTRINSICALLY SAFE APPARATUS (MODEL 5081-P-FI, FIELD BUS TERMINATOR AND ANY ADDITIONAL RELAYS, DEVICES AND ACCESSORIES) MUST BE INSTALLED IN ACCORDANCE WITH THE ADDITIONAL REQUIREMENTS THE VOLTAGE (Vmax) AND CURRENT (Imax) OF THE INTRINSICALLY SAFE APPARATUS MUST BE EQUAL TO OR GREATER THAN THE VOLTAGE (Voc OR Vi) AND CURRENT (Isc OR Ii) WHICH CAN BE DELIVERED BY THE ASSOCIATED APPARATUS (SAFETY BARRIER). IN ADDITION, THE MAXIMUM UNPROTECTED CAPACITANCE (Ci) AND INDUCTANCE (Li) OF THE INTRINSICALLY SAFE APPARATUS INCLUDING INTERCONNECTING WIRING, MUST BE EQUAL OR LESS THAN THE CAPACITANCE (Co) AND INDUCTANCE (Lo) WHICH CAN BE SAFELY CONNECTED TO THE APPARATUS. [REF: TABLE III].
1. THE MODEL 5081-A-FI TRANSMITTER INCLUDES INTEGRAL PREAMPLIFIER CIRCUITRY. AN EXTERNAL PREAMPLIFIER MAY BE ALSO USED. THE OUTPUT PARAMETERS SPECIFIED IN TABLE I ARE VALID FOR EITHER PREAMPLIFIER. THE VALUES SPECIFIED IN TABLE I WHERE Co, Ci, ISENSOR, I, Lcable, Lo ≤ Li (SENSOR) + Lcable.

TABLE I
OUTPUT PARAMETERS

GAS GROUPS	Co (uF)	Li (mH)
A, B	0.96	3.1
C	5.99	12.3
D	21.69	25

TABLE II
OUTPUT PARAMETERS

MODEL 5081-P-FI TB 1-1 THRU 12	Vt	Ii	Pt
	13.02 Vdc	105.64 mA	1.47 mW

TABLE III
5081-P-FI ENTITY PARAMETERS
SUPPLY / SIGNAL TERMINALS TB 1-15, 16

MODEL NO.	Vmax (Vdc)	Imax (mA)	Pmax (W)	Ci (nF)	Li (mH)
5081-P-FI	17.5	380	5.32	27.8	0

DWG NO: 1400288
REV: A
SCALE: AS SHOWN
SHEET 2 OF 2

FIGURE 4-18. CSA Intrinsically Safe Installation for Model 5081-P-FI (2 of 2)

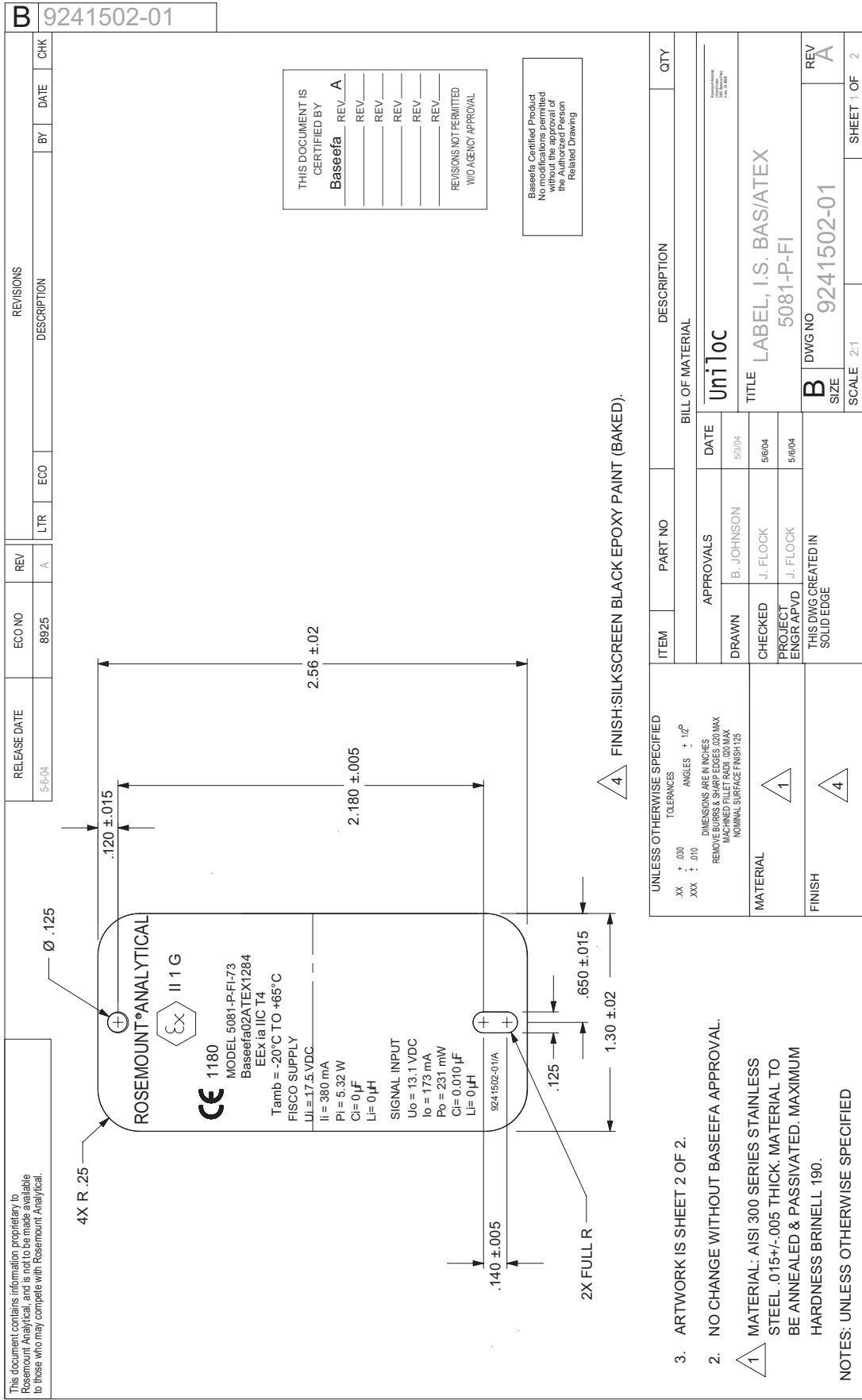

THIS DOCUMENT IS
CERTIFIED BY
Baseeefa REV. A

REVISIONS NOT PERMITTED
W/O AGENCY APPROVAL

Baseeefa Certified Product
No modifications permitted
without the approval of
the Baseeefa Engineering
Department
Related Drawing

ITEM	PART NO	DESCRIPTION	QTY
BILL OF MATERIAL			
Unit Toc			
APPROVALS		DATE	
DRAWN	B. JOHNSON	5/3/04	
CHECKED	J. FLOCK	5/8/04	
PROJECT ENGR	J. FLOCK	5/8/04	
THIS DWG CREATED IN SOLID EDGE		DWG NO	REV
		9241502-01	A
		SCALE	SHEET 1 OF 2
		2:1	2

UNLESS OTHERWISE SPECIFIED
TOLERANCES
XX +.000
XXX ±.010
ANGLES ±10°
DIMENSIONS ARE IN INCHES
REMOVE BURRS & FILE EDGES TO MAX
FINISH
NOMINAL SURFACE FINISH 125

MATERIAL	1
FINISH	4

3. ARTWORK IS SHEET 2 OF 2.
 2. NO CHANGE WITHOUT BASEEFA APPROVAL.
 - 1 MATERIAL: AISI 300 SERIES STAINLESS STEEL .015+/- .005 THICK. MATERIAL TO BE ANNEALED & PASSIVATED. MAXIMUM HARDNESS BRINELL 190.
- NOTES: UNLESS OTHERWISE SPECIFIED

FIGURE 4.19. ATEX Intrinsically Safe Label for Model 5081-P-FI

SECTION 5.0 OPERATION WITH INFRARED REMOTE CONTROLLER

- 5.1 Overview
- 5.2 Displays
- 5.3 Infrared Remote Controller (IRC) - Key Functions
- 5.4 Menu Tree - pH
- 5.5 Diagnostic Messages - pH
- 5.6 Menu Tree - ORP
- 5.7 Diagnostic Messages - ORP
- 5.8 Security

5.1 OVERVIEW

This section covers basic transmitter operation and software functionality. For detailed descriptions of the function blocks common to all Fieldbus devices, refer to Fisher-Rosemount Fieldbus FOUNDATION Function Blocks manual, publication number 00809-4783.

Figure 5-1 illustrates how the pH/ORP signal is channelled through the transmitter to the control room and the FOUNDATION Fieldbus configuration device.

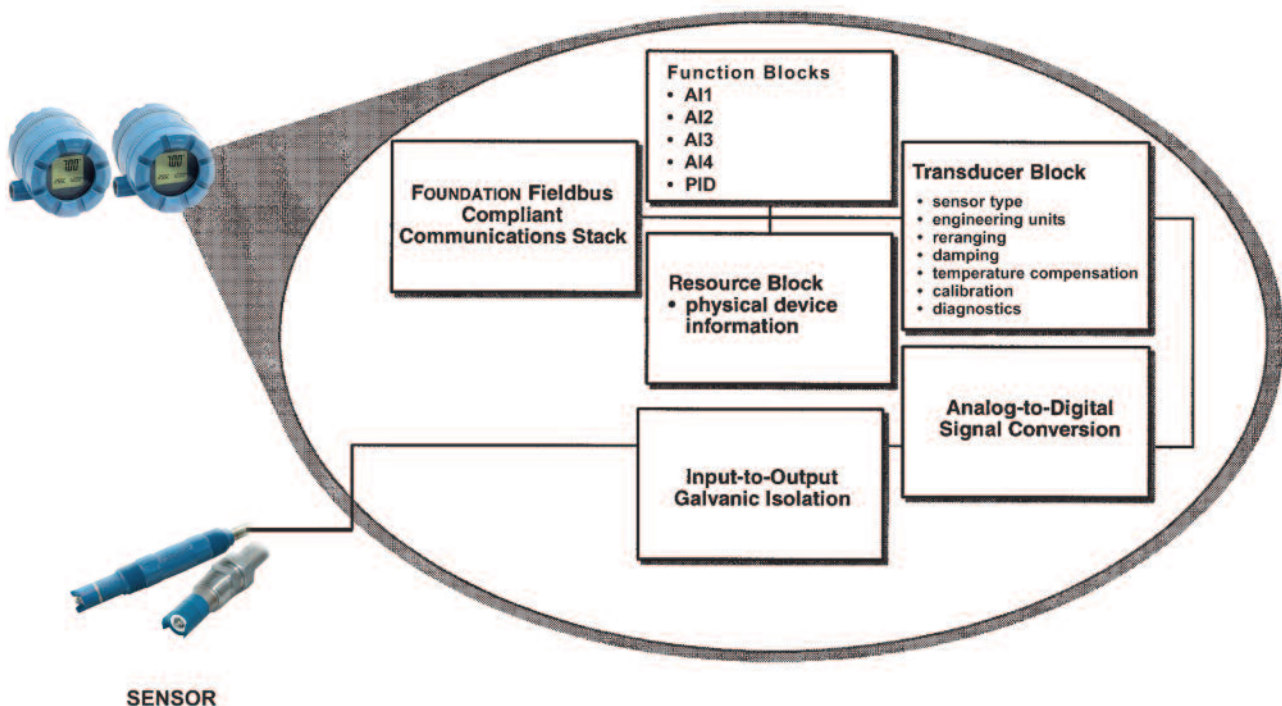

FIGURE 5-1. Functional Block Diagram for the Model 5081-P pH/ORP Transmitter with FOUNDATION Fieldbus.

5.1.1 Software Functionality. The Model 5081-P pH/ORP software is designed to permit remote testing and configuration of the transmitter using the Fisher-Rosemount DeltaV Fieldbus Configuration Tool, or other FOUNDATION fieldbus compliant host.

5.1.2 Transducer Block. The transducer block contains the actual measurement data. It includes information about sensor type, engineering units, reranging, damping, temperature compensation, calibration, and diagnostics.

5.1.3 Resource Block. The resource Block contains physical device information, including available memory, manufacturer identification, type of device, and features.

5.1.4 FOUNDATION fieldbus Function Blocks. The Model 5081-P pH/ORP includes three Analog Input (AI) function blocks and one Input Selector (ISEL) function block as part of its standard offering.

Analog Input. The Analog Input (AI) block processes the measurement and makes it available to other function blocks. It also allows filtering, alarming, and engineering unit change.

Characterizer (optional). The characterizer block changes the characteristic of the input signal. Common uses of the characterizer block include converting temperature to density or humidity, and converting millivolts to temperature for an IR sensor.

5.2 DISPLAYS

Figure 5-2 shows the process display screen, and Figure 5-3 shows the program display screen.

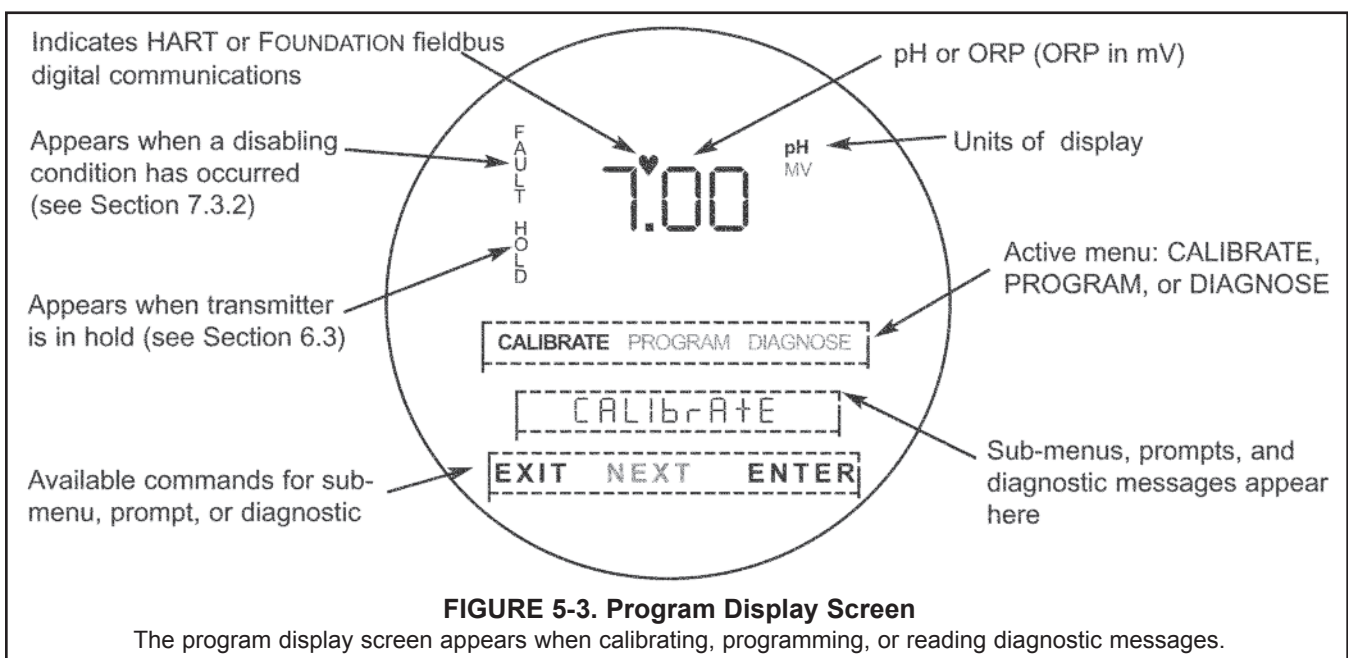
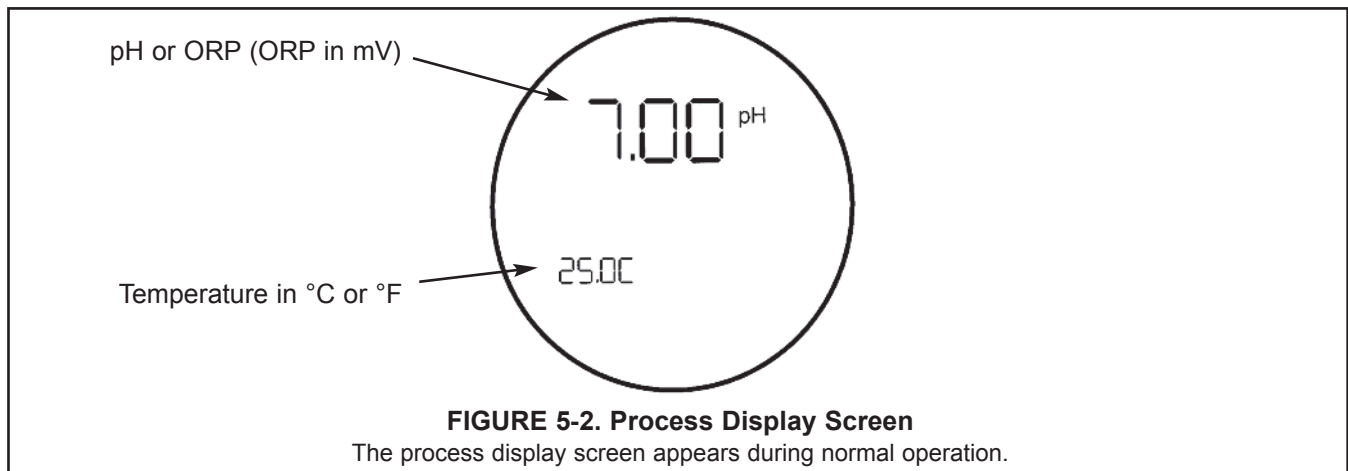

5.3 INFRARED REMOTE CONTROLLER (IRC) - KEY FUNCTIONS

The infrared remote controller is used to calibrate and program the transmitter and to read diagnostic messages. See Figure 5-4 for a description of the function of the keys.

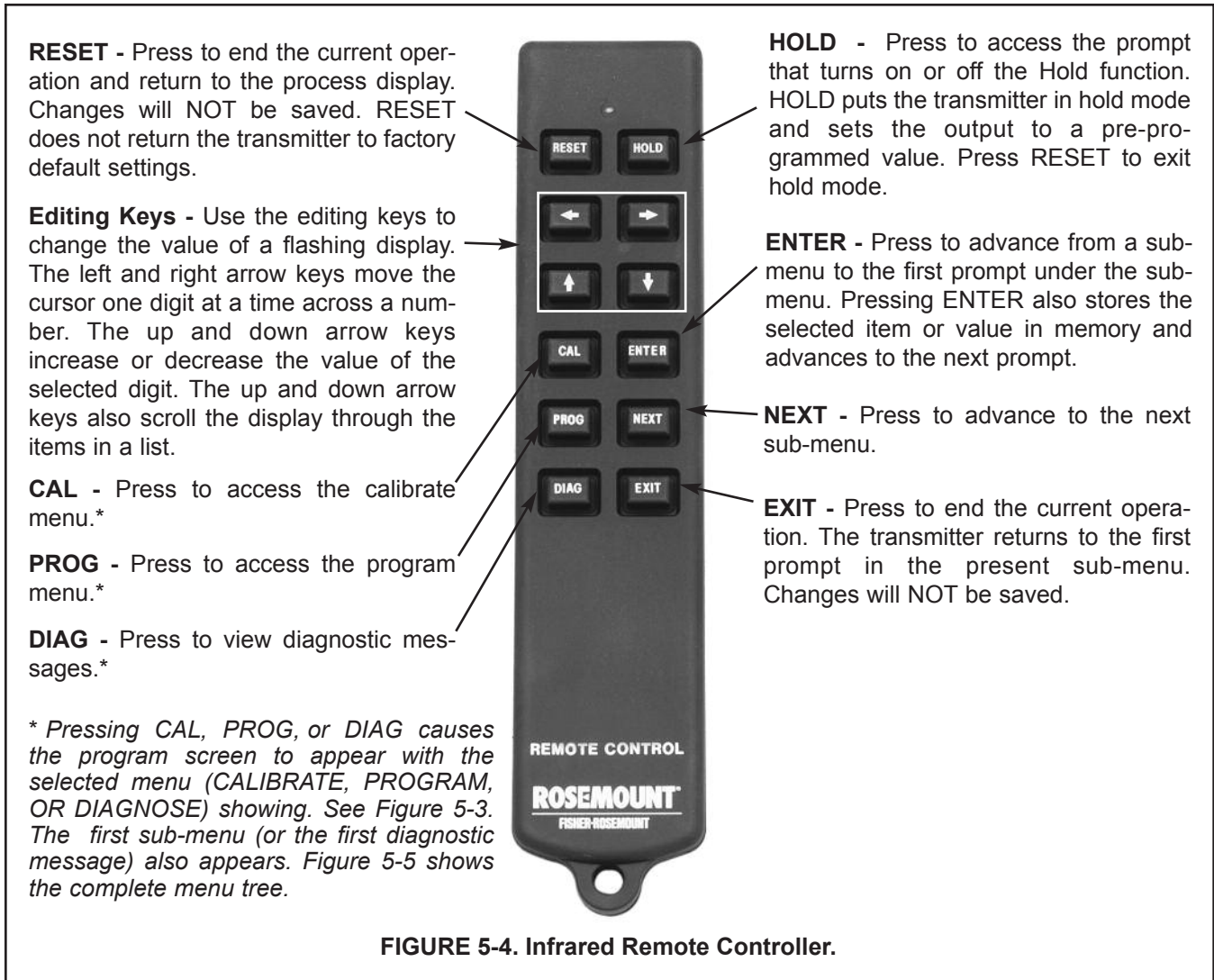

FIGURE 5-4. Infrared Remote Controller.

Hold the IRC within 6 feet of the transmitter, and not more than 15 degrees from horizontal to the display window.

5.4 MENU TREE - pH

The Model 5081-P pH transmitter has three menus: CALIBRATE, PROGRAM, and DIAGNOSE. Under the Calibrate and Program menus are several sub-menus. For example, under CALIBRATE, the sub-menus are **CALibrAtE**, **Std** (standard), and **tEMP AdJ** (temperature adjust). Under each sub-menu are prompts. For example, under **Std**, the prompts are **Std xx.xx** and **slope xx.xx**. The DIAGNOSE menu lets the user view diagnostic messages. Figure 5-5 shows the complete menu tree for Model 5081-P-HT. Figure 5-6 shows the complete menu tree for Model 5081-P-FF.

5.5 DIAGNOSTIC MESSAGES - pH

Whenever a warning or fault limit has been exceeded, the transmitter displays diagnostic messages to aid in troubleshooting. Diagnostic messages appear in the same area as the temperature/output readings in the process display screen (see Figure 5-2). The display alternates between the regular display and the diagnostic message. Figure 5-5 shows the diagnostic fault messages for pH. Figure 5-5 shows the diagnostic fault messages for pH for Model 5081-P-HT. Figure 5-6 shows the diagnostic fault messages for pH for Model 5081-P-FF. If more than one warning or fault message has been generated, the messages appear alternately.

See Section 11.0, Troubleshooting, for the meanings of the fault and warning messages.

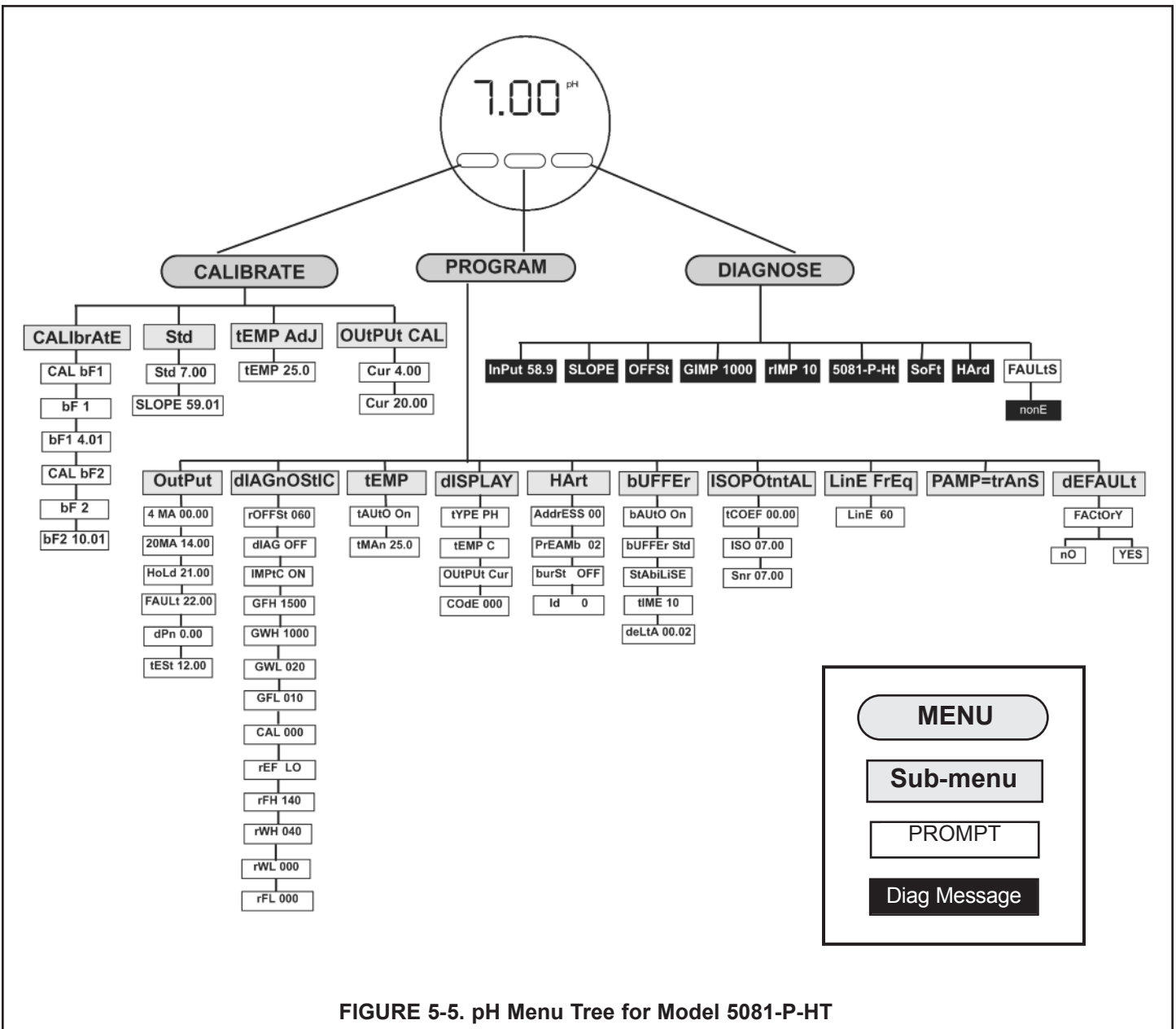

FIGURE 5-5. pH Menu Tree for Model 5081-P-HT

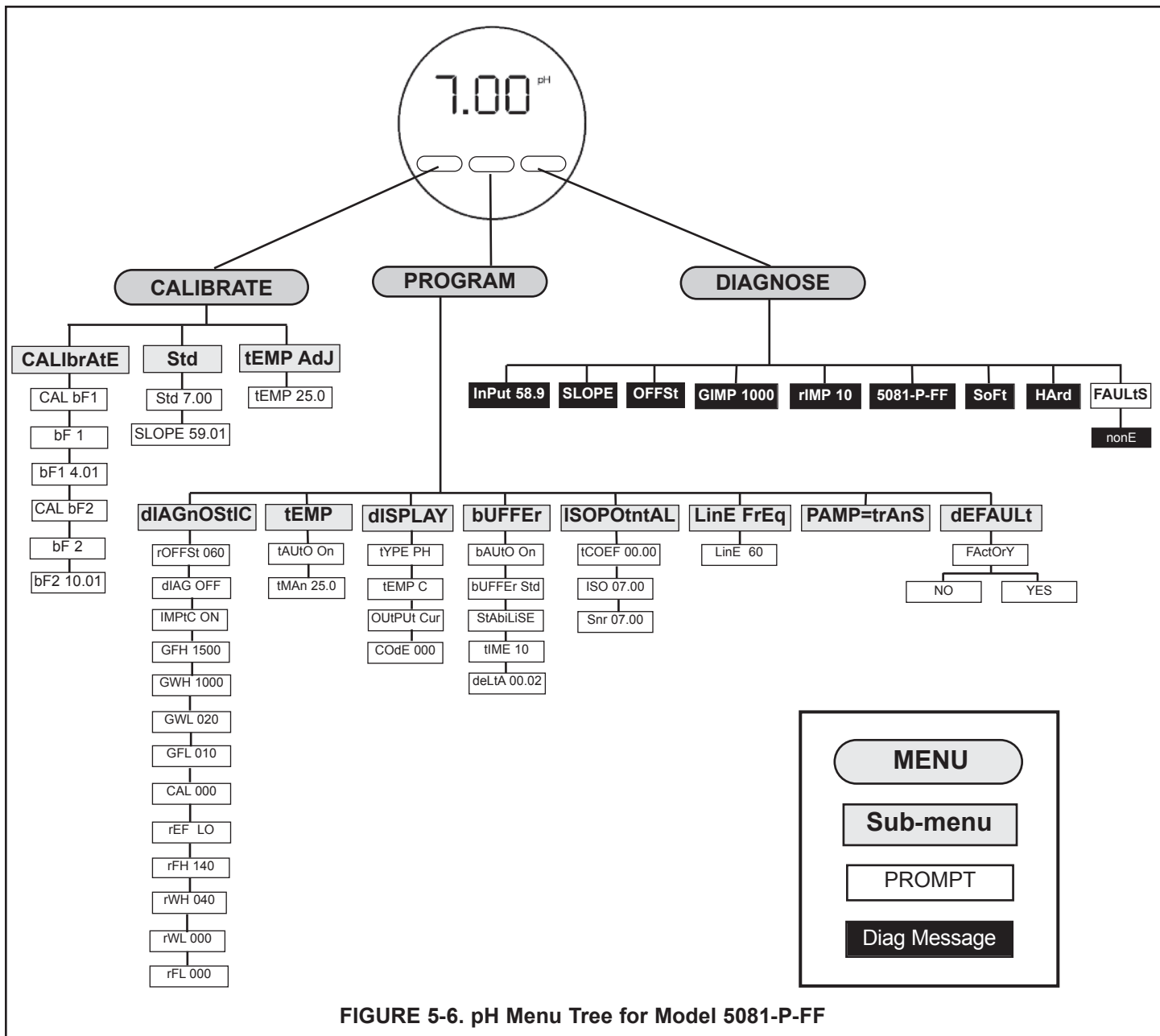

FIGURE 5-6. pH Menu Tree for Model 5081-P-FF

5.6 MENU TREE - ORP

The Model 5081-P ORP transmitter has three menus: CALIBRATE, PROGRAM, and DIAGNOSE. Under the Calibrate and Program menus are several sub-menus. For example, under CALIBRATE, the sub-menus are **Std** (standard) and **tEMP Adj** (temperature adjust). Under each sub-menu are prompts. For example, the **Std** sub-menu contains the single prompt **Std**. Other sub-menus may contain more than one prompt. Figure 5-7 shows the complete menu tree for Model 5081-P-HT. Figure 5-8 shows the complete menu tree for Model 5081-P-FF.

5.7 DIAGNOSTIC MESSAGES - ORP

Whenever a warning or fault limit has been exceeded, the transmitter displays diagnostic messages to aid in troubleshooting. Diagnostic messages appear in the same area as the temperature/output readings in the process display (Figure 5-2). The display alternates between the regular display and the diagnostic message. Figure 5-7 shows the diagnostic fault messages for ORP for Model 5081-P-HT. Figure 5-8 shows the diagnostic fault messages for ORP for Model 5081-P-FF. If more than one warning or fault message has been generated, the messages appear alternately.

See Section 11.0, Troubleshooting, for the meanings of the fault and warning messages.

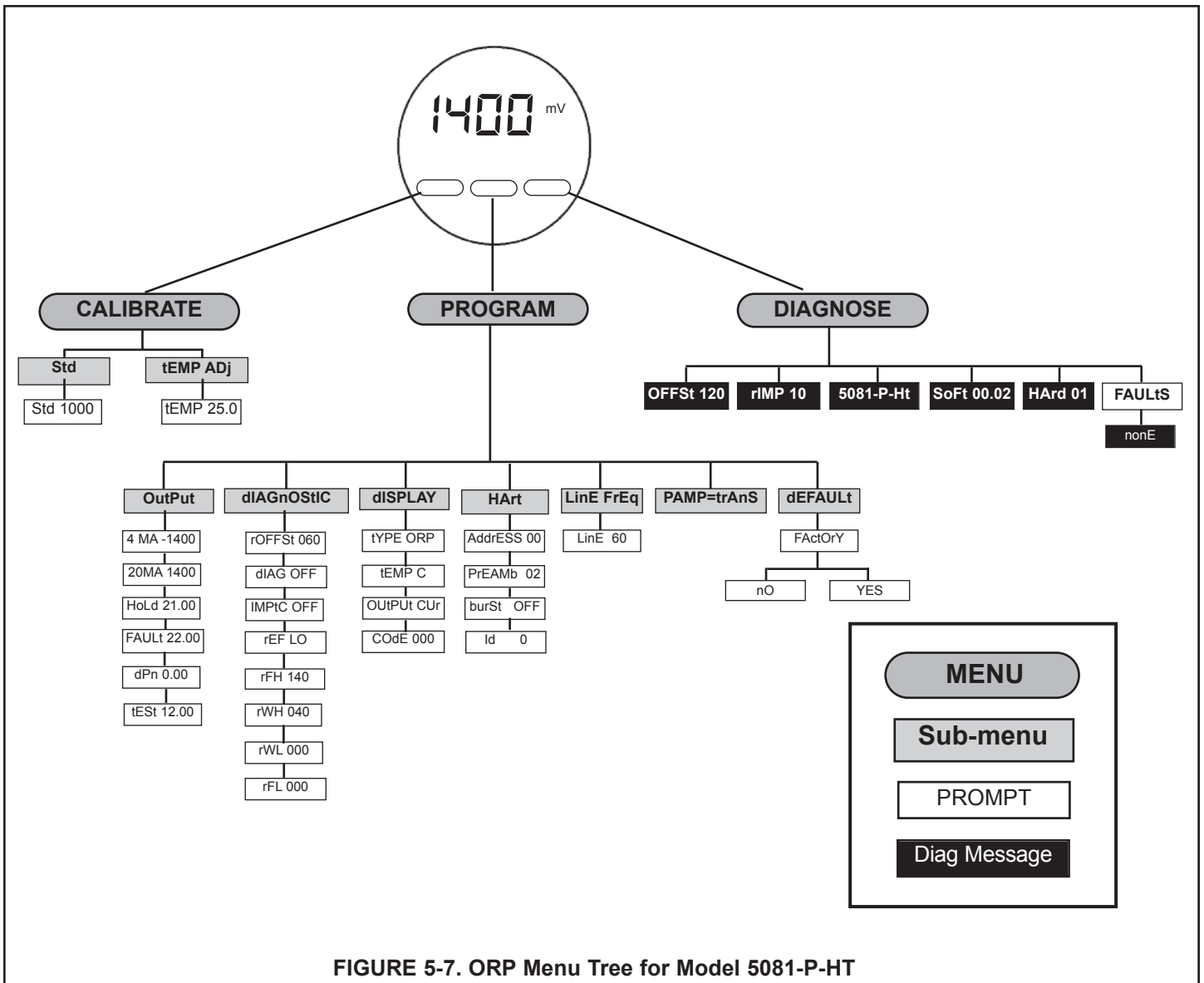
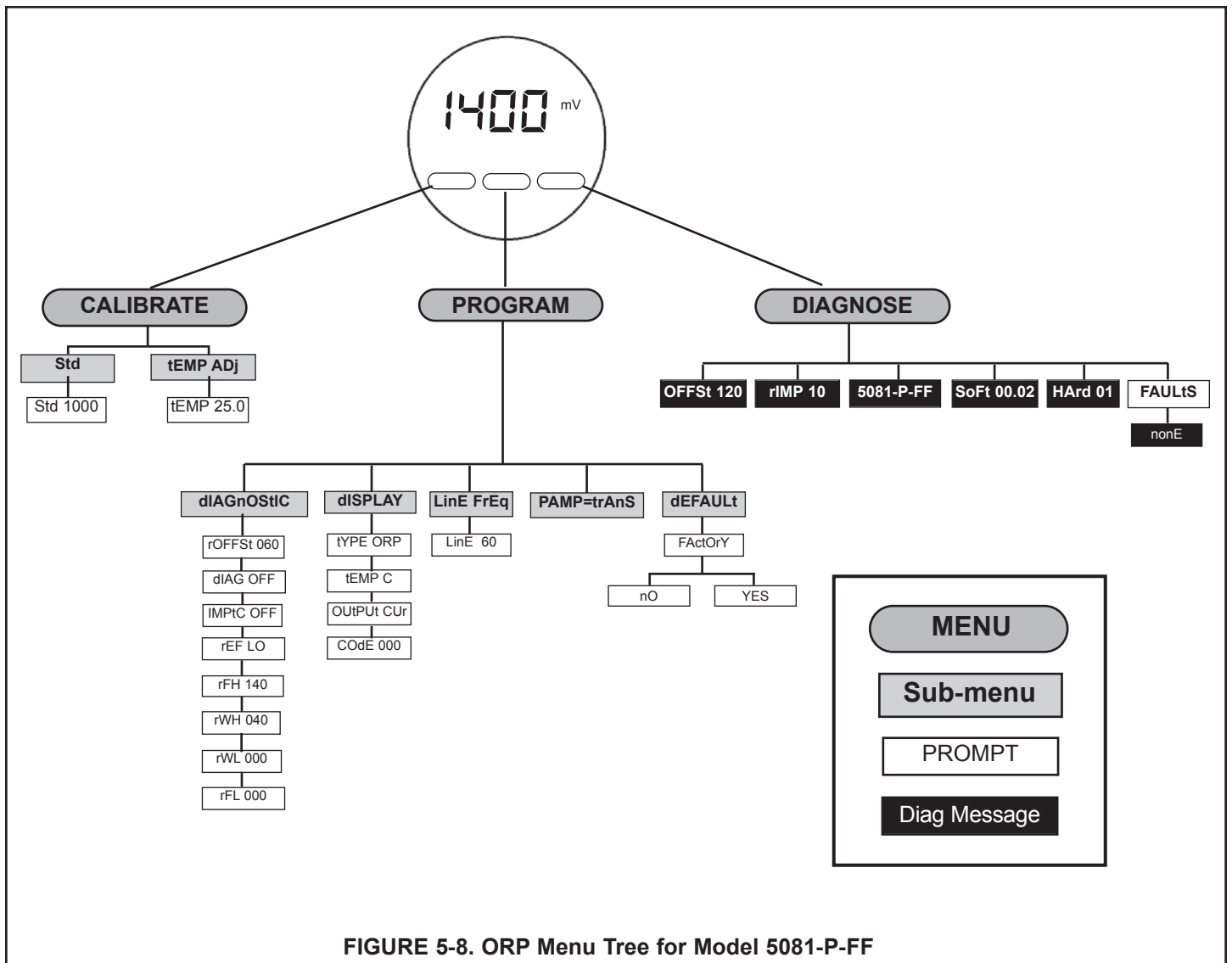
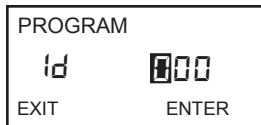

FIGURE 5-7. ORP Menu Tree for Model 5081-P-HT



5.8 SECURITY

5.8.1 General. Use the programmable security code to protect program and calibration settings from accidentally being changed. The transmitter is shipped with the security feature disabled. To program a security code, refer to Section 8.6, Display Units.



5.8.2 Entering the Security Code.

1. If calibration and program settings are protected with a security code, pressing PROG or CAL on the infrared remote controller causes the Id screen to appear.
2. Use the editing keys to enter the security code. Press ENTER .
3. If the security code is correct, the first sub-menu appears. If the security code is incorrect, the process display reappears.

5.8.3 Retrieving a Lost Security Code.

1. If the security code has been forgotten, enter 555 at the Id prompt and press ENTER . The transmitter will display the present code.
2. Press EXIT to return to the process display.
3. Press PROG or CAL . The Id screen appears.
4. Use the editing keys to enter the security code just shown; then press ENTER .
5. The first sub-menu under the selected menu will appear.

SECTION 6.0 OPERATION WITH MODEL 375

6.1 Note on Model 375 or 475 Communicator

The Model 375 or 475 Communicator is a product of Emerson Process Management, Rosemount Inc. This section contains selected information on using the Model 375 or 475 with the Rosemount Analytical Model 5081-P-HT Transmitter. For complete information on the Model 375 or 475 Communicator, see the Model 375 or 475 instruction manual. For technical support on the Model 375 or 475 Communicator, call Emerson Process Management at (800) 999-9307 within the United States. Support is available worldwide on the internet at <http://rosemount.com>.

6.2 Connecting the Communicator

Figure 6-1 shows how the Model 475 or 375 Communicator connects to the output lines from the Model 5081-P-HT Transmitter.

CAUTION

For intrinsically safe CSA and FM wiring connections, see the Model 375 instruction manual.

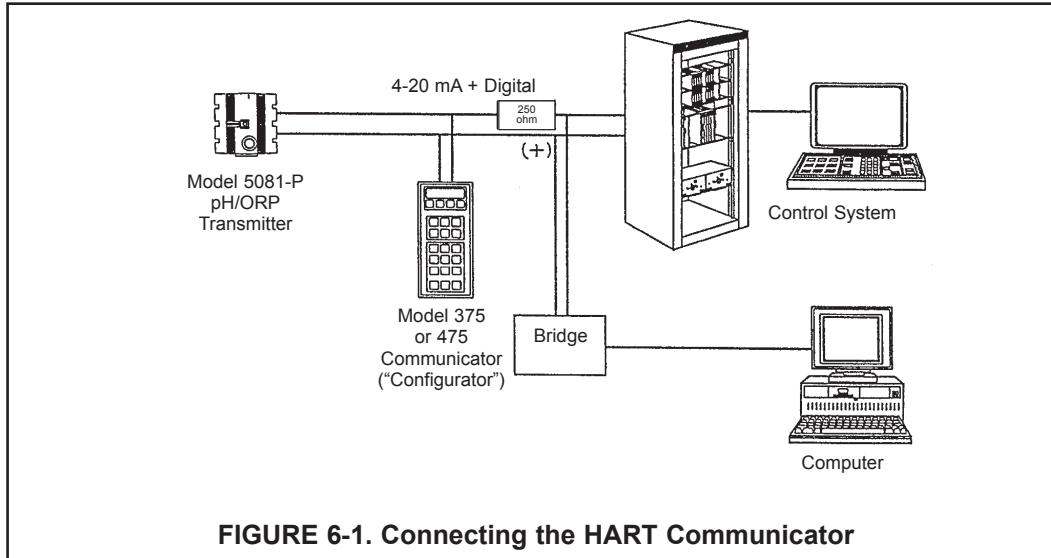

6.3 Operation

6.3.1 Off-line and On-line Operation

The Model 375 Communicator features off-line and on-line communications. On-line means the communicator is connected to the transmitter in the usual fashion. While the communicator is on line, the operator can view measurement data, change program settings, and read diagnostic messages. Off-line means the communicator is not connected to the transmitter. When the communicator is off line, the operator can still program settings into the communicator. Later, after the communicator has been connected to a transmitter, the operator can transfer the programmed settings to the transmitter. Off-line operation permits settings common to several transmitters to be easily stored in all of them.

6.3.2 Making HART related settings from the keypad

Calibrate	Hold
Program	Display

Output	Temp
Measurement	>>

Security	HART
	>>

DevID	PollAddr
Burst	Preamble

1. Press MENU. The main menu screen appears. Choose **Program**.
2. Choose >>.
3. Choose **HART**.
4. To display the device ID, choose **DevID**. To change the polling address, choose **PollAddr**. To make burst mode settings, choose **Burst**. To change the preamble count, choose **Preamble**.

6.3.3 Menu Tree

The menu tree for the Model 375 HART communicator is on the following page. The menu tree for the Model 375 FOUNDATION Fieldbus communicator is on page 69.

5081-P-HT 375 Menu Tree

Device setup

Process variables

View Fld Dev Vars

Oxygen *

Temp

Snsr Cur

pH #

pH mV #

GI #

Temp Res

View PV-Analog 1

PV is Oxygen *

PV

PV % rng

PV AO

View SV

SV is Temp **

SV

View TV

TV is Snsr Cur ***

TV

View 4V

4V is Temp Res ****

4V

View Status

Diag/Service

Test device

Loop test

View Status

Master Reset

Fault History

Hold Mode

Calibration

Zero Main Sensor

Air Calibration

In-process Cal

Dual Range Cal #####

Adjust Temperature

pH 2-Pt Cal #

pH Auto Cal #

Standardize pH #

D/A trim

FIGURE 6-2. 5081-P-HT HART/Model 375 Menu Tree

```

Diagnostic Vars
  Oxygen
  Snr Cur
  Sensitivity
  Zero Current
  pH Value #
  pH mV #
  pH Slope #
  pH Zero Offset #
  GI #
  Temp
  Temp Res
  Noise rejection
Basic setup
  Tag
  PV Range Values
  PV LRV
  PV URV
  PV
  PV % rnge
Device information
  Distributor
  Model
  Dev id
  Tag
  Date
  Write protect
  Snr text
  Descriptor
  Message
  Revision #'s
      Universal rev
      Fld dev rev
      Software rev
      Hardware rev
Detailed setup
  Sensors
  Oxygen *
    Oxygen Unit [ppm, ppb, %sat, mmHg, inHg, atm, kPa, mbar, bar] *, *****
    Oxygen Sensor [ADO, TRDO, SSDO1, SSDO2] ##
    Salinity ###
    Pressure Unit [mmHg, inHg, atm, kPa, mbar, bar] ##
    Use process pressure for %saturation? [No, Yes] ###
    Process pressure (Note: Valid only when process pressure is enabled)
    Air cal pressure ## (read only)
    Input filter
    Sensor SST
    Sensor SSS
    Dual Range Cal [Disable, Enable] #####

```

FIGURE 6-2. 5081-P-HT HART/Model 375 Menu Tree

pH #
pH Value
pH Comp [Auto, Manual]
Manual pH
Preamp loc [Sensor, Xmtr]
Autocal [Manual, Standard, DIN 19267, Ingold, Merck]
pH Slope
pH SST
pH SSS
pH Zero Offset Limit
pH Diagnostics
 Diagnostics [Off, On]
 GFH
 GFL
 Imped Comp [Off, On]
Temperature
 Temp Comp [Auto, Manual]
 Man. Temp
 Temp unit [°C, °F]
 Temp Snsr
Signal condition
 LRV
 URV
 AO Damp
 % rngc
 Xfer frctn
 AO lo end point
 AO hi end pt
Output condition
 Analog output
 AO
 AO Alrm typ
 Fixed
 Fault mode [Fixed, Live]
 Fault
 Loop test
 D/A trim
 HART output
 PV is Oxygen *
 SV is Temp **
 TV is Snsr Cur ***
 4V is pH ****
 Poll addr
 Burst option [PV, %range/current, Process vars/crnt]
 Burst mode [Off, On]
 Num req preams
 Num resp preams

FIGURE 6-2. 5081-P-HT HART/Model 375 Menu Tree

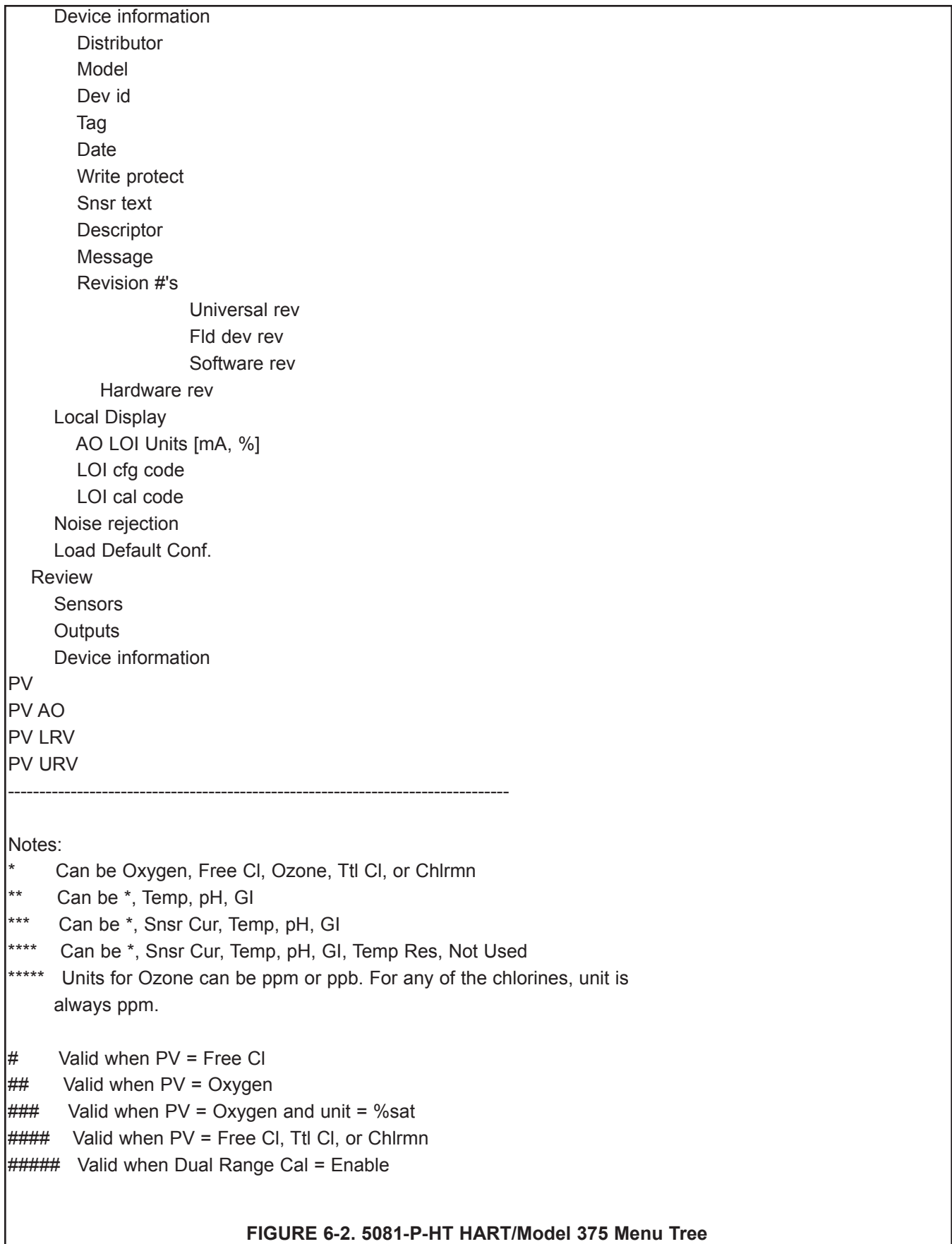

FIGURE 6-2. 5081-P-HT HART/Model 375 Menu Tree

SECTION 7.0

CALIBRATION OF pH MEASUREMENTS

- 7.1 General
- 7.2 Entering and Leaving the Calibrate Menu
- 7.3 Using the Hold Function
- 7.4 Temperature Calibration
- 7.5 Auto Calibration
- 7.6 Manual Calibration
- 7.7 Making the Transmitter Reading Match a Second pH Meter (Standardization)

7.1 GENERAL

The Calibrate menu allows the user to calibrate the pH and temperature response of the sensor.

The transmitter does a two-point pH calibration. Both manual and auto calibration are available. In auto calibration the transmitter automatically stores temperature-corrected calibration data once readings have met programmed stability limits. In manual calibration the user enters buffer values and judges when readings are stable. The transmitter reading can also be made to match the reading of a second pH meter.

Temperature calibration is a one-point standardization against a reference thermometer.

Prompts guide the user through the calibration procedures.

7.2. ENTERING AND LEAVING THE CALIBRATE MENU

Press **CAL** on the infrared remote controller (IRC) to enter the Calibrate menu. To store new settings in memory, press **ENTER**. To leave the Calibrate menu without storing new values, press **EXIT**. Pressing **EXIT** with a prompt showing returns the display to the first prompt in the sub-menu. Pressing **EXIT** a second time returns the transmitter to the process display.

If program settings are protected with a security code, pressing **PROG** or **CAL** will cause the **Id** screen to appear. Key in the security code and press **ENTER**. The first sub-menu will appear. For more information, see Section 5.8, Security.

A transmitter adjacent to the one being calibrated may pick up signals from the IRC. To avoid accidentally changing settings, use a different security code for each nearby transmitter. See Section 5.8, Security, and Section 8.5, Display Units, for details.

7.3 USING THE HOLD FUNCTION

During calibration, the sensor may be exposed to solutions having pH outside the normal range of the process. To prevent false alarms and possible undesired operation of chemical dosing pumps, place the transmitter in hold during calibration. Activating hold keeps the transmitter output at the last value or sends the output to a previously determined value.

After calibration, reinstall the sensor in the process stream. Wait until readings have stabilized before deactivating Hold.

To activate or deactivate Hold, do the following:

1. Press **HOLD** on the IRC.
2. The **HoLd** prompt appears in the display. Press **3** or **5** to toggle the Hold function between **On** and **OFF**.
3. Press **ENTER** to save.

7.4 TEMPERATURE CALIBRATION

7.4.1 Purpose

1. As discussed in Section 13.6, Glass Electrode Slope, measuring temperature is an important part of measuring pH. The accuracy of a new sensor and transmitter loop is about $\pm 1^{\circ}\text{C}$, which is adequate for most applications. A new sensor seldom requires temperature calibration.
2. Calibrate the sensor/transmitter loop if . . .
 - a. $\pm 1^{\circ}\text{C}$ accuracy is NOT acceptable, or
 - b. the temperature measurement is suspected of being in error.

NOTE

A transmitter adjacent to the one being calibrated may pick up signals from the IRC. To avoid accidentally changing settings, use a different security code for each nearby transmitter. See Section 5.8, Security.



7.4.2 Procedure

1. Place the pH sensor and a calibrated reference thermometer in an insulated container of water at ambient temperature. Be sure the temperature element in the sensor is completely submerged by keeping the sensor tip at least three inches below the water level. Do not let the weight of the sensor rest on the glass bulb. Stir continuously. Allow at least 20 minutes for the standard thermometer, sensor, and water to reach constant temperature.
2. Enter the CALIBRATE menu by pressing CAL on the IRC. The **CALibrAtE** sub-menu appears (pictured above left).
3. At the **CALibrAtE** sub-menu, press NEXT twice. The **tEMP AdJ** sub-menu appears.
4. Press ENTER to display the temperature editing prompt.
5. Compare the temperature displayed by the transmitter with the temperature measured with the reference thermometer. If the readings are different, use the editing keys to change the flashing display to the value determined with the reference thermometer. The reading cannot be changed by more than 15°C .
6. Press ENTER. The value will be saved, and the display will return to the **tEMP AdJ** sub-menu.
7. To leave the CALIBRATE menu, press EXIT.
8. Check linearity by measuring the temperature of water 10 to 15°C cooler and 10 to 15°C warmer than the water used for calibration. Because of the time required for the temperature element in the sensor to reach constant temperature, a well-insulated container or, better, a constant temperature bath is required for this step.

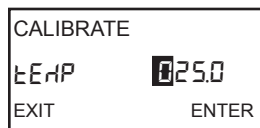
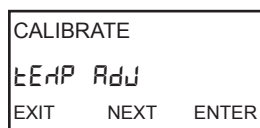

7.5 AUTO CALIBRATION

7.5.1 Purpose

1. New sensors must be calibrated before use. Regular recalibration is also necessary.
2. The use of auto calibration instead of manual calibration is strongly recommended. Auto calibration avoids common pitfalls and reduces errors.
3. For more information about calibration in pH measurements and the use of buffers, refer to Section 8.7, Buffers and Calibration.

7.5.2 What Happens During Auto Calibration?

1. The transmitter displays prompts that guide the user through a two-point buffer calibration.
2. The transmitter recognizes the buffers and uses the temperature-corrected pH value in the calibration. The transmitter also measures noise and drift and does not accept calibration data until readings are stable. Stability limits are user-programmable. See Section 8.7, Buffer Calibration Parameters.

7.5.3 Use of Calibration Standards (buffers)

1. A pH measurement is only as good as the calibration, and the calibration is only as good as the buffers used. A careful buffer calibration is the first step in making an accurate pH measurement.
2. Calibrate with buffers having pH values that bracket the pH of the process. For example, if the pH is between 8 and 9, calibrate with pH 7 and 10 buffers. Commercial buffers for intermediate range pH are readily available. Buffers outside the range pH 3.0 to pH 10.0 may not be readily available and must be prepared by the user. Tables 7-2 and 7-3 in Section 7.6, Buffer Calibration Parameters, list the buffers that the transmitter recognizes.
3. Allow time for the sensor and buffers to reach the same temperature. If the sensor was just removed from a process having a temperature more than 10°C different from the buffer, allow at least 20 minutes.
4. For best results, calibrate with buffers having the same temperature as the process. If the buffer and process temperature differ by more than about 15°C an error as great as 0.1pH may result.
5. Be careful using buffers at high temperatures. Protect the solution from evaporation. Evaporation changes the concentration of the buffer and its pH. Be sure the pH of the buffer is defined at high temperatures. Finally, no matter what the temperature is, allow the entire measurement cell, sensor and solution, to reach constant temperature before calibrating.
6. The pH of a buffer changes with temperature. Equations relating pH to temperature for common buffers have been programmed into the Model 5081-P pH transmitter. During auto calibration, the transmitter calculates the correct buffer value and uses it in the calibration.
7. Buffers have limited shelf lives. Do not use a buffer if the expiration date has passed. Store buffers at controlled room temperature.
8. Do not return used buffer to the stock bottle. Discard it.
9. Protect buffers from excessive exposure to air. Atmospheric carbon dioxide lowers the pH of alkaline buffers. Other trace gases commonly found in industrial environments, for example, ammonia and hydrogen chloride, also affect the pH of buffers. Molds, from airborne spores, grow readily in neutral and slightly acidic buffers. Mold growth can substantially alter the pH of a buffer.
10. Rinse the sensor with deionized water before placing it in a buffer. Remove excess water from the sensor by gently daubing it with a clean tissue. Do not wipe the sensor. Wiping may generate a static charge, leading to noisy readings. The static charge may take hours to dissipate. A few drops of deionized water carried with the sensor into the buffer will not appreciably alter the pH.

NOTE

A transmitter adjacent to the one being calibrated may pick up signals from the IRC. To avoid accidentally changing settings, use a different security code for each nearby transmitter. See Section 5.8, Security.

NOTE

During calibration, the sensor may be exposed to solutions having pH outside the normal range of the process. To prevent false alarms and possible undesired operation of chemical dosing pumps, place the analyzer in hold during calibration. See Section 7.3, Using the Hold Function, for details.

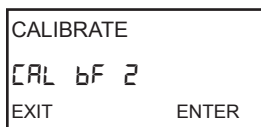
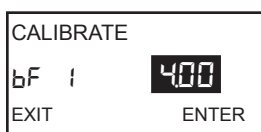
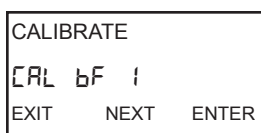
**7.5.4 Procedure**

1. Verify that auto calibration is activated. Identify the buffers being used and set the stability limits.
2. Enter the CALIBRATE menu by pressing CAL on the IRC. The **CALibrAtE** sub-menu appears (pictured above left).
3. At the **CALibrAtE** sub-menu, press ENTER. The **CAL bF1** prompt appears.
4. Rinse the sensor and place it in the first buffer. Be sure the glass bulb and the temperature element are completely submerged. Keep the sensor tip at least three inches below the liquid level. Do not let the weight of the sensor rest on the glass bulb. Swirl the sensor to dislodge trapped bubbles. The main display will show the measured pH based on the previous calibration.
5. Press ENTER. **bF1** flashes until the measured pH meets the programmed stability limits. If the pH reading is not stable after 20 minutes, the transmitter automatically leaves the CALIBRATE menu and returns to the process mode. If this happens, consult Section 12.5.4, Troubleshooting, for assistance. Once the reading is stable, the display changes to look like the figure at the left. The flashing number is the nominal pH, that is, the pH of the buffer at 25°C. If the flashing number does not match the nominal pH, press **▲** or **▼** until the correct pH appears. Press ENTER to save the first calibration point.
6. The **CAL bF2** prompt appears.
7. At the **CAL bF2** prompt, remove the sensor from the first buffer. Rinse the sensor and place it in the second buffer. Be sure the glass bulb and the temperature element are completely submerged. Keep the sensor tip at least three inches below the liquid level. Do not let the weight of the sensor rest on the glass bulb. Swirl the sensor to dislodge trapped bubbles. The main display will show the measured pH of the buffer based on the previous calibration.
8. Press ENTER. **bF2** flashes until the pH reading is stable. If the pH reading is not stable after 20 minutes, the transmitter automatically leaves the CALIBRATE menu and returns to process mode. If this happens, consult Section 12.5.4, Troubleshooting, for assistance. Once the reading is stable, the display changes to look like the figure at the left. The flashing number is the nominal pH, that is, the pH of the buffer at 25°C. If the flashing number does not match the nominal pH, press **▲** or **▼** until the correct pH appears. Press ENTER to save the second calibration point.
9. The calibration is complete, but the transmitter remains in the **CALibrAtE** sub-menu for two minutes after ENTER is pressed.
10. Remove the sensor from the buffer and return it to the process. If the transmitter was in hold during calibration, wait until readings have stabilized before taking the transmitter out of hold. See Section 6.3, Using the Hold Function.
11. The transmitter uses the calibration data to calculate a new slope. Refer to Section 12.7, Buffers and Calibration, for more details. If the slope is unacceptable, the calibration will not be updated, and the transmitter will display a **SLOPE Err HI** or **SLOPE Err LO** error message. Refer to Section 12.5.3, Troubleshooting, for assistance.
12. To leave the CALIBRATE menu, press EXIT.
13. For quality control and troubleshooting, it is helpful to know the electrode slope. To display the slope, press CAL on the IRC. The **CALibrAtE** sub-menu will appear. Press NEXT. The **Std** sub-menu appears. Press ENTER. The **Std** prompt appears. Press ENTER again and **SLOPE xx.xx** will appear in the display. The four digit number is the electrode slope. For a good sensor, the slope is between 50 and 60.

7.6 MANUAL CALIBRATION

7.6.1 Purpose

1. New sensors must be calibrated before use. Regular recalibration is also necessary.
2. Manual calibration is an alternative to auto calibration. Because auto calibration eliminates many common calibration errors, it is strongly recommended.
3. In auto calibration, the transmitter recognizes the buffer and uses the temperature-corrected pH value in the calibration. The transmitter also measures noise and drift and does not accept calibration data until readings meet programmed limits. In manual calibration, however, the user must judge when readings are stable, look up the buffer value at the calibration temperature, and key in the value.
4. Manual calibration is necessary if non-standard buffers are used for calibration. Manual calibration is also useful in troubleshooting.
5. Because temperature readings from the pH sensor are not available during calibration, a reliable thermometer is required to complete the procedure.

7.6.2 Use of calibration standards (buffers). See Tables 8-2 and 8-3.

1. A pH measurement is only as good as the calibration, and the calibration is only as good as the buffers. A careful buffer calibration is the first step in making an accurate pH measurement.
2. Calibrate with buffers having pH values that bracket the pH of the process. For example, if the pH is between 8 and 9, calibrate with pH 7 and 10 buffers. Commercial buffers having intermediate range pH are readily available. Buffers outside the range pH 3.0 to pH 10.0 may not be readily available and must be prepared by the user.
3. Allow time for the sensor and buffers to reach the same temperature. If the process temperature is more than 10°C different from the buffer, allow at least 20 minutes.
4. For best results, calibrate with buffers having the same temperature as the process. If the buffer and process temperature differ by more than about 15°C an error as great as 0.1pH may result.
5. Be careful using buffers at high temperatures. Protect the solution from evaporation. Evaporation changes the concentration of the buffer and its pH. Be sure the pH of the buffer is defined at high temperatures. The pH of many buffers is undefined above 60°C. Finally, no matter what the temperature is, allow the entire measurement cell, sensor and solution, to reach constant temperature before calibrating.
6. The pH of a buffer changes with temperature. Equations relating pH to temperature for common buffers have been programmed into the Model 5081-P pH transmitter. During auto calibration, the transmitter calculates the correct buffer value and uses it in the calibration. During manual calibration, the user must enter the correct pH value.
7. Buffers have limited shelf lives. Do not use a buffer if the expiration date has passed. Store buffers at controlled room temperature.
8. Do not return used buffer to the stock bottle. Discard it.
9. Protect buffers from excessive exposure to air. Atmospheric carbon dioxide lowers the pH of alkaline buffers. Other trace gases commonly found in industrial environments, for example, ammonia and hydrogen chloride, also affect the pH of buffers. Molds, from airborne spores, grow readily in neutral and slightly acidic buffers. Mold growth can substantially alter the pH of a buffer.
10. Rinse the sensor with deionized water before placing it in a buffer. Remove excess water from the sensor by gently daubing it with a clean tissue. Do not wipe the sensor. Wiping may generate a static charge, leading to noisy readings. The static charge may take hours to dissipate. A few drops of deionized water carried with the sensor into the buffer will not appreciably alter the pH.

NOTE

A transmitter adjacent to the one being calibrated may pick up signals from the IRC. To avoid accidentally changing settings, use a different security code for each nearby transmitter. See Section 5.8, Security.

NOTE

During calibration, the sensor may be exposed to solutions having pH outside the normal range of the process. To prevent false alarms and possible undesired operation of chemical dosing pumps, place the analyzer in hold during calibration. See Section 7.3, Using the Hold Function, for details.



7.6.3 Procedure

1. Before starting, refer to Section 8.7, to deactivate auto calibration.
2. Enter the CALIBRATE menu by pressing CAL on the IRC. The **CALibrAtE** sub-menu appears (pictured above left).
3. At the **CALibrAtE** sub-menu, press ENTER. The **CAL bF1** prompt appears.
4. Rinse the sensor with deionized water and place it in the first buffer along with a calibrated thermometer. Submerge the sensor tip at least three inches below the liquid level. Do not let the weight of the sensor rest on the glass bulb. Swirl the sensor to dislodge trapped bubbles. The main display will show the measured pH based on the previous calibration.
5. Once the pH reading and temperature are stable, press ENTER. The display changes to the screen shown at the left. Use the editing keys to change the flashing display to the pH value of the buffer at the measurement temperature. Press ENTER to save the value as buffer bF1. The transmitter expects a reading to be entered within 20 minutes after the **CAL bF1** prompt appears. If ENTER is not pressed, the transmitter leaves the CALIBRATE menu and returns to the process mode.
6. At the **CAL bF2** prompt, remove the sensor from the first buffer. Rinse the sensor and thermometer with deionized water and place them in the second buffer. Submerge the sensor tip at least three inches below the liquid level. Do not let the weight of the sensor rest on the glass bulb. Swirl the sensor to dislodge trapped bubbles. The main display will show the measured pH based on the previous calibration.
7. Once the pH reading and temperature are stable, press ENTER. The display changes to the screen shown at the left. Use the editing keys to change the flashing display to the pH value of the buffer at the measurement temperature. Press ENTER to save the value as buffer bF2. The transmitter expects a reading to be entered within 20 minutes after the **CAL bF2** prompt appears. If ENTER is not pressed, the transmitter leaves the CALIBRATE menu and returns to the process mode.
8. The calibration is complete, but the transmitter remains in the **CALibrAtE** sub-menu for two minutes after ENTER is pressed.
9. Remove the sensor from the buffer and return it to the process. If the transmitter was in hold during calibration, wait until readings have stabilized before taking the transmitter out of hold.
10. The transmitter uses the calibration data to calculate a new slope. Refer to Section 12.7, Buffers and Calibration, for more details. If the slope is unacceptable, the calibration will not be updated, and the transmitter will display a **SLOPE Err HI** or **SLOPE Err LO** error message. Refer to Sections 12.5.3 and 12.5.4, Troubleshooting, for assistance.
11. To leave the CALIBRATE menu, press EXIT.
12. For quality control and troubleshooting, it is helpful to know the electrode slope. To display the slope, press CAL on the IRC. The **CALibrAtE** sub-menu will appear. Press NEXT. The **Std** sub-menu appears. Press ENTER. The **Std** prompt appears. Press ENTER again and **SLOPE xx.xx** will appear in the display. The four digit number is the electrode slope. For a good sensor, the slope is between 50 and 60.

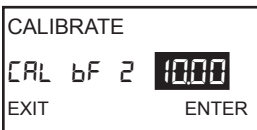
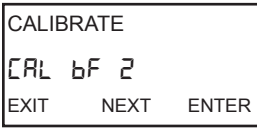
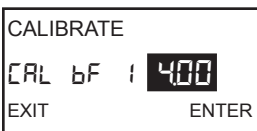
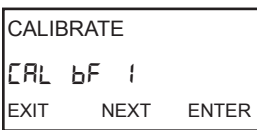

7.7 MAKING THE TRANSMITTER READING MATCH A SECOND pH METER (STANDARDIZATION).

7.7.1 Purpose

1. This section describes how to make the transmitter reading match the reading from a second pH meter. The measurement made with the second meter is called the standard pH (pH_{std}). The process of making the two readings agree is called standardization.
2. This section also describes how to enter an independently determined slope into the transmitter.

7.7.2 What Happens During Standardization?

1. The user enters the pH reading from a second meter into the transmitter. The transmitter changes the displayed pH to the new value.
2. The transmitter converts the difference between the pH readings, ΔpH , into a voltage difference. The voltage difference, ΔV , is calculated from the equation:

$$\Delta V = [0.1984 (t + 273.14)] \Delta pH$$

where t is the temperature in °C. The voltage difference, called the reference offset, is then added to subsequent pH cell voltage measurements before the voltage is converted to pH. See Section 13.0 for details on how the pH meter converts voltage into pH readings.

3. Before the transmitter accepts the offset, it compares the offset with the value (**rOFFSt**) programmed into the transmitter in Section 7.3, Diagnostic Parameters. If the difference exceeds **rOFFSt**, the transmitter will not accept the data and will not update the display to the corrected pH.



NOTE

A transmitter adjacent to the one being calibrated may pick up signals from the IRC. To avoid accidentally changing settings, use a different security code for each nearby transmitter. See Section 5.8, Security.

7.7.3 Procedure

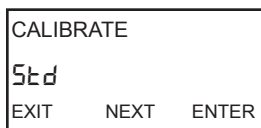

1. Enter the CALIBRATE menu by pressing CAL on the IRC. The **CALibrAtE** sub-menu appears (pictured above left).

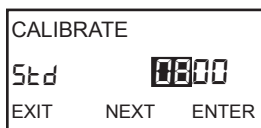

← 2. At the **CALibrAtE** sub-menu, press NEXT. The **Std** sub-menu appears.

← 3. With the **Std** sub-menu displayed, press ENTER. The **Std** prompt appears.

4. Be sure that the process pH and temperature are stable or, at worst, slowly drifting. Take a grab sample from the process stream or sample line at a point as close as possible to the pH sensor. Note the transmitter reading (pH_{trans}) at the time the sample was taken.

5. Measure the pH of the sample (pH_{std}) using the second pH meter. For best results make the measurement at the same temperature as the process.

6. Note the current process reading (pH_{curr}). Calculate the corrected reading from the equation:

$$pH_{corr} = pH_{curr} + (pH_{std} - pH_{trans})$$

where, pH_{corr} is the corrected pH value, pH_{curr} is the current process reading, pH_{std} is the pH measured using the standard instrument, and pH_{trans} is the pH measured by the transmitter when the sample was taken. Use the editing keys to change the flashing display to pH_{corr} calculated above. Press ENTER to save the corrected pH.

7. The transmitter converts the difference between pH_{corr} and pH_{curr} into mV and compares the result with the value programmed for **rOFFSt** in Section 8.4, Diagnostic Parameters. If the difference exceeds the value for **rOFFSt**, the transmitter will not accept the data and will not update the display to the corrected pH. The message **Std Err** will appear.

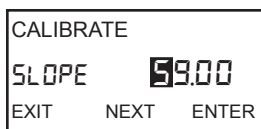

← 8. If the corrected pH value is acceptable, the display will change to look like the screen at the left. The slope displayed is the current electrode slope. If the slope is incorrect and the correct value is known, use the editing keys to change the slope to the desired value. Press ENTER to save the value. To leave the slope unchanged, press EXIT .

9. To leave the CALIBRATE menu, press EXIT .

SECTION 8.0

PROGRAMMING FOR pH MEASUREMENTS

- 8.1 General
- 8.2 Entering and Leaving the Program Menu
- 8.3 Output Ranging
- 8.4 Diagnostic Parameters
- 8.5 Temperature Related Settings
- 8.6 Display Units
- 8.7 Buffer Calibration Parameters
- 8.8 Isopotential Parameters
- 8.9 Generating a Test Current

8.1 GENERAL

This section describes how to do the following:

1. assign pH values to the 4 and 20 mA outputs (for Model 5081-P-HT only),
2. set the current generated by the transmitter during hold,
3. set the current generated by the transmitter when a fault is detected (for Model 5081-P-HT only),
4. change sensor diagnostic limits,
5. enable and disable automatic temperature compensation,
6. change the units of the displayed variables,
7. program a security code,
8. identify buffers for auto calibration,
9. change the transmitter isopotential point,
10. simulate output currents for testing (for Model 5081-P-HT only).

Factory default settings are given in Table 8-1. If default settings are acceptable, the transmitter is ready for calibration. See Section 7.0, Calibration of pH Measurements. Once a setting has been changed, there is no way to automatically reset the transmitter to factory defaults. Settings must be returned to default values one at a time. Figure 5-4 shows the menu tree.

8.2 ENTERING AND LEAVING THE PROGRAM MENU

Press **PROG** on the infrared remote controller (IRC) to enter the Program menu. To save new settings, press **ENTER**. To leave the Program menu without saving new values, press **EXIT**. Pressing **EXIT** with a prompt showing returns the display to the first prompt in the sub-menu. Pressing **EXIT** again returns the transmitter to the process display.

If program settings are protected with a security code, pressing **PROG** or **CAL** will cause the **Id** screen to appear. Key in the security code and press **ENTER**. The first sub-menu will appear. For more information, see Section 5.7, Security.

A transmitter adjacent to the one being programmed may pick up signals from the IRC. To avoid accidentally changing settings, use a different security code for each nearby transmitter. See Section 5.8, Security, and Section 8.6, Display Units, for details.

TABLE 8-1. pH Settings List

ITEM	MNEMONIC	DISPLAY LIMITS	FACTORY SETTINGS	USER SETTINGS
PROGRAM LEVEL (Sections 8.0 - 8.9).				
A. Output Range (Section 8.3) (for 5081-P-HT only)				
1. 4 mA Output	OutPut	0 - 14 pH	0.00 pH	_____
2. 20 mA Output:		0 - 14 pH	14.00 pH	_____
3. Hold	HOLd	3.80 to 22.00 mA	21.00mA	_____
4. Dampening	dPn	0 to 255 seconds	0 seconds	_____
5. Fault Current Output Setting	FAULT	3.80 to 22.00 mA	22.00mA	_____
B. Diagnostic (Section 8.4)				
1. Reference Cell Offset (Standardize error)	dIAgnOStIC rOFFSt	0 to 1000 mV	60 mV (pH on glass electrode)	_____
2. Diagnostics Function	dIAG	On/Off	Off	_____
3. Glass Impedance Temperature Correction	IMPtC	On/Off	On	_____
4. Glass Electrode High Impedance Fault	GFH	0 to 2000 megohms	1500 megohms	_____
5. Glass Electrode High Impedance Warning	GWH	0 to 2000 megohms	1000 megohms	_____
6. Glass Electrode Low Impedance Warning	GWL	0 to 900 megohms	20 megohms	_____
7. Glass Electrode Low Impedance Fault	GFL	0 to 900 megohms	10 megohms	_____
8. Glass Impedance Calibration Warning	CAL	0 to 500 %	0 % (not Active)	_____
9. Reference Cell Impedance Type	rEF	LO/HI	LO	_____
10. Reference Cell High Impedance Fault	rFH	0 to 2000 megohms (HI) 0 to 2000 kilohms (LO)	1500 megohms 140 kilohms	_____
11. Reference Cell High Impedance Warning	rWH	0 to 2000 megohms (HI) 0 to 2000 kilohms (LO)	1000 megohms 40 kilohms	_____
12. Reference Cell Low Impedance Warning	rWL	0 to 900 megohms (HI)	20 megohms	_____
13. Reference Cell Low Impedance Fault	rFL	Does not apply for low impedance reference cell 0 to 900 megohms (HI)	10 megohms	_____
C. Temperature (Section 8.5)				
1. Auto Temperature Compensation	tEMP tAUtO	On/Off	On	_____
2. Manual Temperature	tMAN	-15 to 130 °C 5 to 266 °F	25 °C	_____
3. Temperature Sensor Type	tC	100-3; 100-4; 1000-3; 1000-4: 3000	100-3	_____
D. Display (Section 8.6)				
1. Measurement type	dISPLAY tYPE	pH/ORP	pH	_____
2. Temperature Units	tEMP	°C/°F	°C	_____
3. Output Units (for 5081-P-HT only)	OUtPUt	mA/% of full scale	mA	_____
4. Code	COdE	0 to 999	000	_____
E. Buffer (Section 8.7)				
1. Auto Calibration Function	bUFFER b AUtO	ON/OFF	ON	_____
2. Buffers Selection List	bUFFER	See Tables 8-2 and 8-3	Standard	_____
3. Auto Buffer Stabilization Time	tIME	0 to 30 seconds	10 seconds	_____
4. Auto Stabilization pH Change	PH	.002 to .5pH	.02 pH	_____
F. Isopotential (Section 8.8)				
1. Temperature Coefficient	ISOPotnAL tCOEF	-0.044 to 0.028 pH/ °C	0.000 pH/ °C	_____
2. Solution Isopotential pH	ISO	-1.35 to 20.12 pH	7.00 pH	_____
3. Sensor Isopotential pH	Snr	0.00 to 14.00 pH	7.00 pH	_____
G. Output Simulation (Section 8.9) (for 5081-P-HT only)				
Test	SIMOUtPUt tEST	3.80 to 22 mA	12.00 mA	_____

8.3 OUTPUT RANGING

8.3.1 Purpose

This section describes how to do the following:

1. assign pH values to the 4 and 20 mA outputs,
2. set the output current generated by the transmitter during hold,
3. set the output current generated by the transmitter when a fault is detected,
4. control the amount of dampening on the output signal.

8.3.2 Definitions

1. **CURRENT OUTPUTS.** The transmitter provides a continuous 4 - 20 mA output directly proportional to the measured pH. Any pH value between 0 and 14 can be assigned to the low output (4 mA) and the high output (20 mA).
2. **HOLD.** During calibration and maintenance the transmitter output may be outside the normal operating range. Placing the transmitter on hold prevents false alarms or the unwanted operation of chemical dosing pumps. The transmitter output can be programmed to remain at the last value or to generate any current between 3.80 and 22.0 mA. During hold, the transmitter displays the present pH and temperature. The word HOLD appears in the display.
3. **FAULT.** A fault is a system disabling condition. When the transmitter detects a fault, the following happens:
 - a. The display flashes.
 - b. The words FAULT and HOLD appear in the main display.
 - c. A fault or diagnostic message appears in the temperature/current display area.
 - d. The output signal remains at the present value or goes to the programmed fault value. Permitted values are between 3.80 and 22.00 mA.
 - e. If the transmitter is in HOLD when the fault occurs, the output remains at the programmed hold value. To alert the user that a fault exists, the word FAULT appears in the main display, and the display flashes. A fault or diagnostic message also appears.
 - f. If the transmitter is simulating an output current when the fault occurs, the transmitter continues to generate the simulated current. To alert the user that a fault exists, the word FAULT appears in the display, and the display flashes.
4. **DAMPEN.** Output dampening smooths out noisy readings. But it also increases the response time of the output. To estimate the time (in minutes) required for the output to reach 95% of the final reading following a step change, divide the setting by 20. Thus, a setting of 140 means that, following a step change, the output takes about seven minutes to reach 95% of final reading. The output dampen setting does not affect the response time of the process display. The maximum setting is 255.

8.4 DIAGNOSTIC PARAMETERS

8.4.1 Purpose

This section describes how to do the following:

1. change the standardization or reference offset,
2. enable and disable sensor diagnostics,
3. enable and disable glass impedance temperature compensation,
4. set the high and low warning and failure limits for the glass electrode.
5. set the high and low warning and failure limits for the reference electrode.

8.4.2 Definitions

1. **STANDARDIZATION (REFERENCE) OFFSET.** The transmitter reading can be changed to match the reading of a second pH meter. If the difference (converted to millivolts) between the transmitter reading and the desired value exceeds the programmed limit, the transmitter will not accept the new reading. To estimate the millivolt difference, multiply the pH difference by 60. Refer to Section 7.6, Manual Calibration, for additional information. The standardization offset is also the absolute value of the actual cell voltage in pH 7 buffer. For certain types of non-glass pH electrodes, the offset in pH 7 buffer may be as great as 800 mV. To accommodate non-glass electrodes, the offset must be changed from the default value of 60 millivolts.
2. **GLASS IMPEDANCE TEMPERATURE COMPENSATION.** The impedance of the glass electrode changes with temperature. For changes in glass impedance to be a useful indicator of electrode condition, the measurement must be corrected to a reference temperature.
3. **WARNING AND FAILURE LIMITS FOR THE GLASS ELECTRODE.** Warning tells the user that the glass electrode impedance is approaching the failure limit. Low and high warning and failure limits are programmable. Low impedance means the glass electrode has cracked and is no longer functioning. High impedance often means the electrode is aging and may soon need replacement. High glass impedance may also mean the electrode is not immersed in the liquid stream. Figure 8-1 shows suggested settings for glass impedance warning and failure limits.

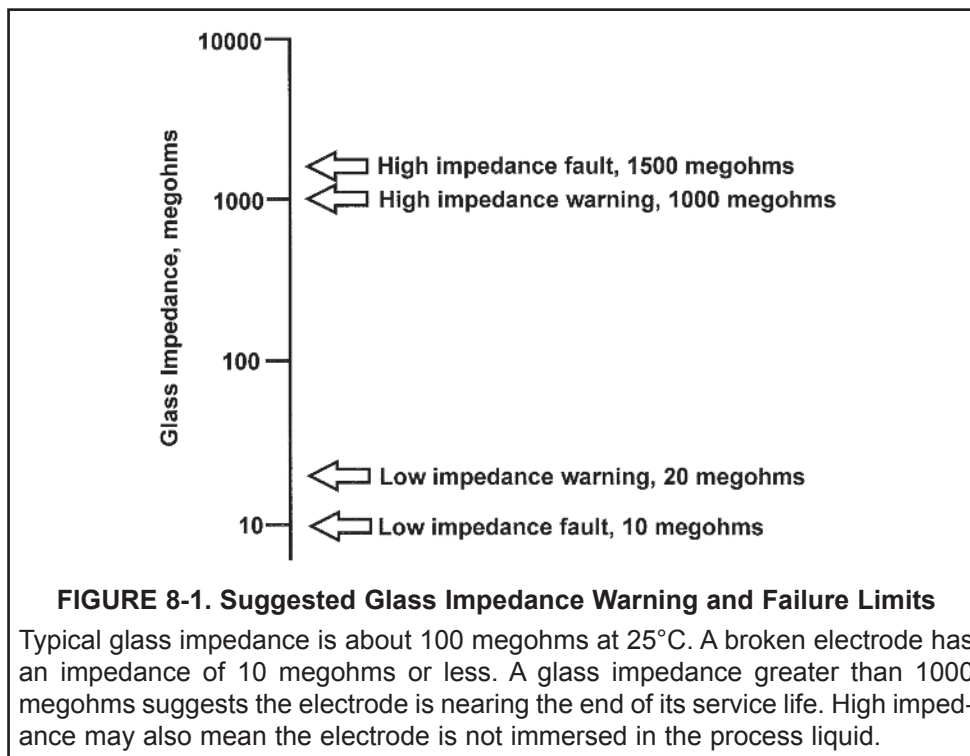

- 4. REFERENCE IMPEDANCE. The majority of reference electrodes used in industry are low impedance silver-silver chloride electrodes. Every pH and ORP sensor manufactured by Rosemount Analytical has a low impedance reference. However, there are applications that call for either a high impedance sodium or pH glass reference electrode. Both high impedance and low impedance reference electrodes can be used with the Model 5081-P pH/ORP transmitter.
- 5. WARNING AND FAILURE LIMITS FOR THE REFERENCE ELECTRODE. Warning tells the user that the reference electrode impedance is approaching the failure limit. Low and high warning and failure limits are programmable. For conventional low impedance silver-silver chloride reference electrodes only the high limits are useful. For high impedance reference electrodes, both low and high limits are used.

Figure 8-2 shows suggested limits for low impedance reference electrodes.

Figure 8-3 shows suggested limits for high impedance glass reference electrodes.

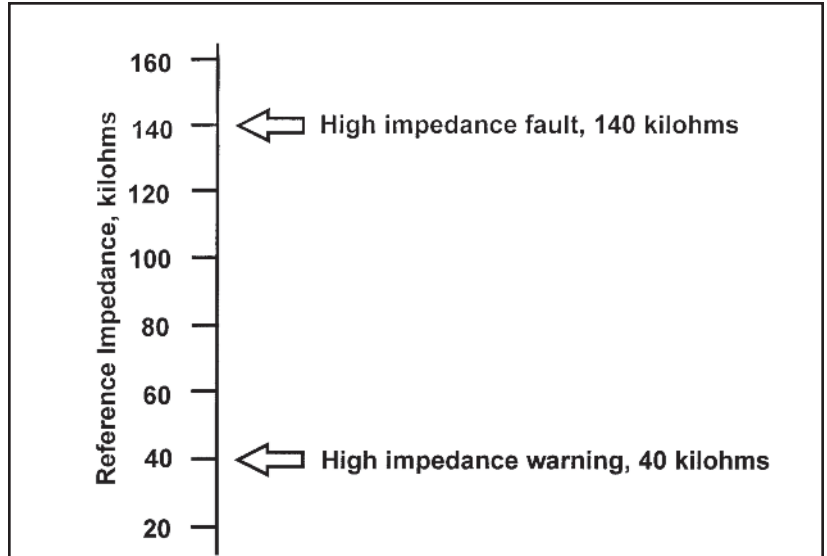

FIGURE 8-2. Suggested Warning and Failure Limits for Low Impedance Reference Electrodes

The impedance of a typical silver-silver chloride reference electrode is less than 40 kilohms. If the impedance is greater than about 140 kilohms the reference electrode has failed. Failure is usually caused by a plugged or coated reference junction or a depleted electrolyte fill solution (gel). The reference impedance will also be high if the sensor is out of the process liquid.

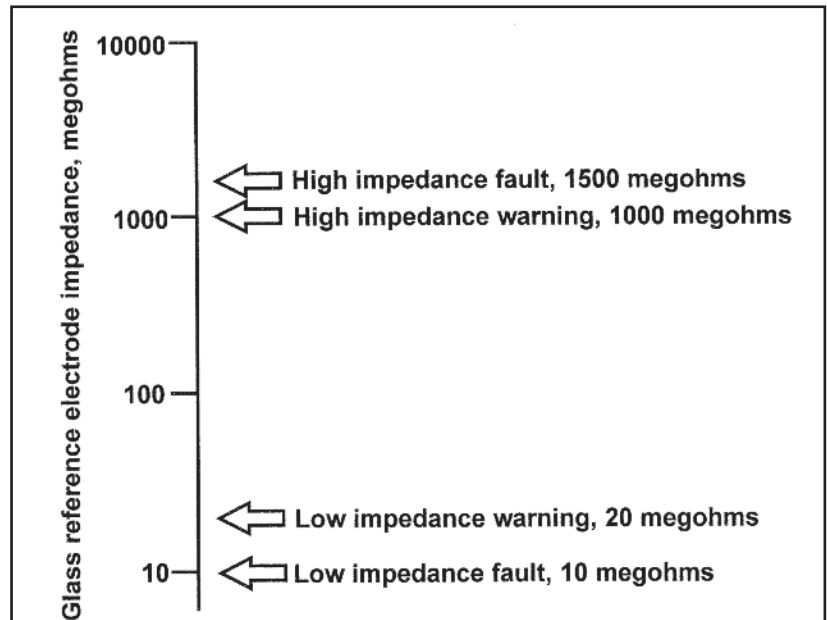
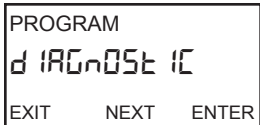

FIGURE 8-3. Suggested Warning and Failure Limits for High Impedance Glass Reference Electrodes.

The limits for a high impedance glass reference electrode are the same as the limits for a high impedance glass measuring electrode.

8.4.3 Procedure



1. Press PROG on the infrared remote controller (IRC).
2. Press NEXT until the **diAGnOSTIC** sub-menu appear. Press ENTER .



3. The screen displays the **rOFFSt** prompt. Use the editing keys to change the flashing display to the desired standardization (reference) offset (in millivolts). The range is 0 to 1000 mV. Press ENTER to save.

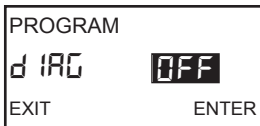

4. The **diAG** prompt appears. Use **Ⓢ** or **Ⓣ** to enable (**On**) or disable (**OFF**) the sensor diagnostics. Press ENTER to save.

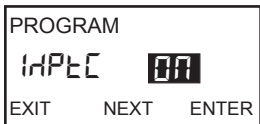

5. The **IMPtC** prompt appears. Use **Ⓢ** or **Ⓣ** to enable (**On**) or disable (**OFF**) glass impedance temperature compensation. Because glass impedance is a strong function of temperature, correcting glass impedance for temperature is recommended. A third setting (**SPC**) appears in addition to **On** and **OFF**. Do not select **SPC**; the setting is intended for factory use. Press ENTER to save.

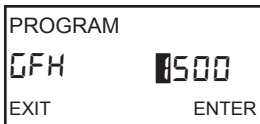

6. The **GFH** prompt appears. Use the editing keys to change the display to the desired glass electrode impedance high fault value. The allowed values are between 0 and 2000 megohms. Entering 0000 disables the feature. When the glass electrode impedance exceeds the fault value, the transmitter displays the diagnostic message **GLASS-FAIL** and sets a fault condition. Press ENTER to save.

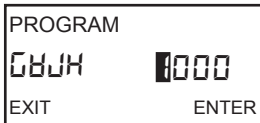

7. The **GWH** prompt appears. In the transmitter display, **W** is a **W**. Use the editing keys to change the display to the desired glass electrode impedance high warning value. The allowed values are between 0 and 2000 megohms. Entering 0000 disables the feature. When the glass electrode impedance exceeds the warning value, the transmitter displays the diagnostic message **GLASSWarn**. Press ENTER to save.

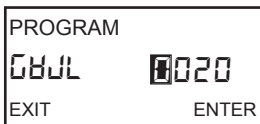

8. The **GWL** prompt appears. Use the editing keys to change the display to the desired glass electrode impedance low warning value. The allowed values are between 0 and 900 megohms. Entering 0000 disables the feature. When the glass electrode impedance drops below the warning value, the transmitter displays the diagnostic message **GLASSWarn**. Press ENTER to save.

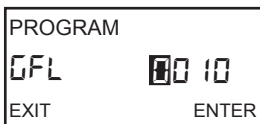

9. The **GFL** prompt appears. Use the editing keys to change the display to the desired glass electrode impedance low fault value. The allowed values are between 0 and 900 megohms. Entering 0000 disables the feature. When the glass electrode impedance drops below the fault value, the transmitter displays the diagnostic message **GLASS-FAIL** and sets a fault condition. Press ENTER to save.

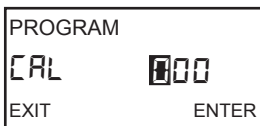

10. The **CAL** prompt appears. This diagnostic is intended for factory use. The default value 000 should appear. If 000 is not showing, use the editing keys to change the display to 000. Press ENTER to save.

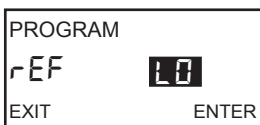

11. The **rEF** prompt appears. Press **Ⓢ** or **Ⓣ** until the desired setting appears. **LO** identifies a low impedance reference electrode, and **HI** identifies a high impedance reference electrode. Press ENTER to save. Selecting **LO** disables the low impedance warning and failure limits for the reference electrode.

NOTE

Be sure the jumpers on the analog board are set to match the reference electrode impedance. See Section 2.2, Pre-Installation Set Up.

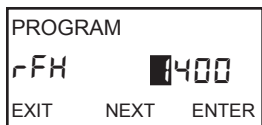

12. The **rFH** prompt appears. Use the editing keys to change the display to the desired reference electrode high impedance fault value. The allowed ranges are

Type of reference electrode	Allowed range
Low impedance (LO in step 11)	0 - 2000 kilohms
High impedance (HI in step 11)	0 - 2000 megohms

Entering 0000 disables the feature. When the reference electrode impedance goes above the fault value, the transmitter displays the diagnostic message **rEFFAIL** and sets a fault condition. Press **ENTER** to save.

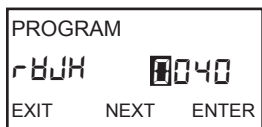

13. The **rWH** prompt appears. Use the editing keys to change the display to the desired reference electrode high impedance warning value. The allowed ranges are

Type of reference electrode	Allowed range
Low impedance (LO in step 11)	0 - 2000 kilohms
High impedance (HI in step 11)	0 - 2000 megohms

Entering 0000 disables the feature. When the reference electrode impedance goes above the fault value, the transmitter displays the diagnostic message **rEFWArn**. Press **ENTER** to save.

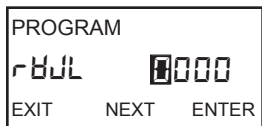

14. The **rWL** prompt appears. Use the editing keys to change the display to the desired reference electrode low impedance warning value. The allowed ranges are

Type of reference electrode	Allowed range
Low impedance (LO in step 11)	not applicable
High impedance (HI in step 11)	0 - 900 megohms

Entering 0000 disables the feature. When the reference electrode impedance goes below the warning value, the transmitter displays the diagnostic message **rEFWArn**. Press **ENTER** to save. The prompt appears but is disabled when **LO** is selected in step 11.

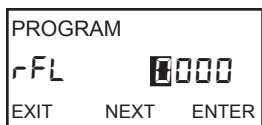

15. The **rFL** prompt appears. Use the editing keys to change the display to the desired reference electrode low impedance fault value. The allowed ranges are

Type of reference electrode	Allowed range
Low impedance (LO in step 11)	not applicable
High impedance (HI in step 11)	0 - 900 megohms

Entering 0000 disables the feature. When the reference electrode impedance goes below the fault value, the transmitter displays the diagnostic message **rEFFAIL** and sets a fault condition. Press **ENTER** to save. The prompt appears but is disabled when **LO** is selected in step 11.

16. Press **EXIT** to return to the process display.

8.5 TEMPERATURE RELATED SETTINGS

8.5.1 Purpose

This section describes how to do the following:

1. activate and deactivate automatic temperature compensation,
2. set a manual temperature compensation value,
3. match the transmitter to the type of temperature element in the pH sensor.

8.5.2 Definitions

1. **AUTOMATIC TEMPERATURE COMPENSATION.** The transmitter uses a temperature-dependent factor to convert measured cell voltage to pH. In automatic temperature compensation the transmitter measures the temperature of the process and automatically calculates the correct conversion factor. For maximum accuracy, use automatic temperature compensation. See Section 13.6, Glass Electrode Slope, for more information.
2. **MANUAL TEMPERATURE COMPENSATION.** In manual temperature compensation, the transmitter uses the programmed temperature to convert measured voltage to pH. It does not use the actual process temperature. Do NOT use manual temperature compensation unless the process temperature varies no more than $\pm 2^{\circ}\text{C}$ or the pH is between 6 and 8. See Section 13.6, Glass Electrode Slope, for more information about errors associated with improper temperature compensation. Manual temperature compensation is useful if the sensor temperature element has failed and a replacement sensor is not available.
3. **TEMPERATURE ELEMENT.** pH sensors use a variety of temperature elements. The Model 5081-P transmitter recognizes the following temperature elements and configurations:
 - a. three and four wire 100 ohm platinum RTDs
 - b. three and four wire 1000 ohm platinum RTDs

A 100 ohm platinum RTD has a resistance of 100 ohms at 0°C . A 1000 ohm platinum RTD has a resistance of 1000 ohms at 0°C . Although only two lead wires are necessary to connect the RTD to the transmitter, connecting a third (and sometimes fourth) wire allows the transmitter to correct for the resistance of the lead wires and for changes in wire resistance with temperature.

The Model 5081-P pH/ORP transmitter can also be used with a two-wire RTD. Select a three-wire configuration and jumper the RTD return and -RTD sense terminals (terminals 3 and 4, respectively).

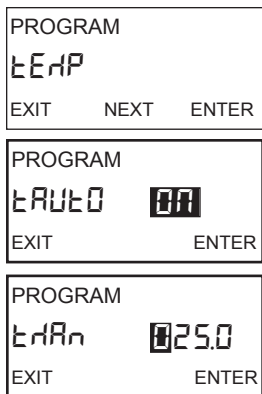

8.5.3 Procedure

1. Press PROG on the infrared remote controller (IRC).
2. Press NEXT until the **tEMP** sub-menu appears in the display. Press ENTER .
3. The screen displays the **tAUTO** prompt. Press **0** or **5** to enable (**On**) or disable (**OFF**) automatic temperature compensation. Press ENTER to save.
4. The **tMAN** prompt appears. Use the editing keys to change the temperature to the desired value. To enter a negative number, press **4** or **2** until no digit is flashing. Then press **0** or **5** to display the negative sign. Permitted values are between -5.0 and 130.0°C. If **tAUTO** was disabled in step 3, the temperature entered in this step will be used in all subsequent measurements, no matter what the process temperature is. Press ENTER to save.

8.6 DISPLAY UNITS

8.6.1 Purpose

This section describes how to do the following:

1. switch the process display units between pH and ORP (millivolts),
2. select °C or °F for the temperature display,
3. select percent of full scale or milliamps for the output display,
4. program a security code.

8.6.2 Definitions

1. **DISPLAY UNITS.** Select pH if the transmitter is being used to measure pH. Select ORP if the transmitter is being used to measure ORP. ORP is oxidation-reduction potential. ORP has units of millivolts and is usually measured with an inert metal electrode, such as a platinum electrode. The units selected are shown in the main display next to the measured value.
2. **OUTPUT CURRENT DISPLAY (5081-P-HT only).** The transmitter generates a 4 to 20 mA output signal directly proportional to the pH of the sample. The output signal appears on the same line with the temperature. The output signal can be displayed as current (in mA) or as percent of full scale.
3. **SECURITY CODE.** The security code unlocks the transmitter and allows complete access to all menus. The transmitter is shipped with the security code disabled.

8.6.3 Procedure

```
PROGRAM
d ISPLAY
EXIT  NEXT  ENTER
```

1. Press **PROG** on the infrared remote controller (IRC).
2. Press **NEXT** until the **dISPLAY** sub-menu appears. Press **ENTER**.

```
PROGRAM
tYPE  PH
EXIT  ENTER
```

3. The screen displays the **tYPE** prompt. Press **3** or **5** to toggle between **pH** and **OrP**. Press **ENTER** to save.

```
PROGRAM
tEMP  C
EXIT  ENTER
```

4. The screen displays the **tEMP** prompt. Press **3** or **5** to toggle between **C** and **F**. Press **ENTER** to save.

```
PROGRAM
OUtPUt  CUR
EXIT  ENTER
```

5. The screen displays the **OUtPUt** prompt. Press **3** or **5** to toggle between **%** and **CUR**. Press **ENTER** to save.

```
PROGRAM
COdE  000
EXIT  ENTER
```

6. The screen displays the **COdE** prompt. Use the editing keys to enter a security code between 001 and 999. Entering 000 disables the security feature. Press **ENTER** to save. The security code does not become effective until about two minutes after the last keystroke.

7. Press **EXIT** to return to the process display.

8.7 BUFFER CALIBRATION PARAMETERS

8.7.1 Purpose

This section describes how to do the following:

1. activate or deactivate auto calibration,
2. identify which buffers will be used during auto calibration,
3. set the stability criteria for auto calibration.

8.7.2 Definitions

1. **AUTO CALIBRATION.** In auto calibration, screen prompts direct the user through a two point buffer calibration. The transmitter recognizes the buffers and uses temperature-corrected values in the calibration. The transmitter does not accept data until programmed stability limits have been met. If auto calibration is deactivated, the user must perform a manual calibration. In manual calibration, the user judges when readings are stable and manually enters buffer values. The use of auto calibration is strongly recommended.
2. **BUFFERS.** Buffers are aqueous solutions to which exactly known pH values have been assigned. Assigning a pH value to a buffer involves certain fundamental assumptions. Slightly different assumptions lead to slightly different pH scales. Over the years, various national standards organizations have developed different scales. The Model 5081-P pH/ORP transmitter recognizes the common standard scales as well as common commercial buffers. Commercial buffers, which are sometimes called technical buffers, are traceable to standard buffers, but the accuracy of commercial buffers is generally less than standard buffers. Tables 8-2 and 8-3 list the buffers the Model 5081-P pH/ORP transmitter recognizes and the temperature range over which the buffer pH is defined.

TABLE 8-2. pH values of standard buffer solutions and the temperature range over which pH values are defined

NIST		DIN 19266		JIS 8802		BSI	
pH	temp (°C)	pH	temp (°C)	pH	temp (°C)	pH	temp (°C)
1.68	5 - 95	1.68	5 - 95	1.68	0 - 95	1.68	0 - 60
3.56	25 - 95					3.56	25 - 60
3.78	0 - 95						
4.01	0 - 95	4.01	0 - 95	4.01	0 - 95	4.01	0 - 60
6.86	0 - 95	6.86	0 - 95	6.86	0 - 95	6.86	0 - 60
7.00	see note						
7.41	0 - 50						
9.18	0 - 95	9.18	0 - 95	9.18	0 - 95	9.18	0 - 60
10.01	0 - 50			10.01	0 - 50	10.01	0 - 50
12.45	0 - 60	12.45	0 - 60				

NOTE: pH 7 buffer is not a standard buffer. Because it is a popular commercial buffer in the United States, it is included with the standard buffers. The pH of the buffer is defined between 0 and 95°C.

TABLE 8-3. pH values of commercial (technical) buffers and the temperature range over which pH values are defined

Merck		Ingold		DIN 19267		Fisher	
pH	temp (°C)	pH	temp (°C)	pH	temp (°C)	pH	temp (°C)
				1.09	0 - 90	1.0	0 - 60
2.00	0 - 95	2.00	0 - 95			2.0	0 - 60
				3.06	0 - 90	3.0	0 - 60
		4.01	0 - 95			4.0	0 - 60
				4.65	0 - 90	5.0	0 - 60
				6.79	0 - 90	6.0	0 - 60
7.00	0 - 95	7.00	0 - 95			7.0	0 - 60
						8.0	0 - 60
9.00	0 - 95	9.21	0 - 95	9.23	0 - 90	8.99	0 - 60
						10.0	0 - 60
						11.0	0 - 60
12.00	0 - 95			12.75	0 - 90		

3. STABILITY CRITERIA. For the Model 5081-P pH/ORP transmitter to accept calibration data, the pH must remain within a specified range for a specified period of time. The default values are 0.02 pH units and 10 seconds. In other words, at the default setting, calibration data will be accepted as soon as the pH reading is constant to within 0.02 units for 10 seconds. The minimum range is 0.01, and the maximum time is 30 seconds.

8.7.3 Procedure

1. Press PROG on the infrared remote controller (IRC).
2. Press NEXT until the **bUFFER** sub-menu appears. Press ENTER.
3. The screen displays the **bAUTO** prompt. Press **ON** or **OFF** to activate (On) or deactivate (OFF) auto calibration. Press ENTER to save.
4. The screen displays the **bUFFER** prompt. Press **Std** or **ErC** to select the desired buffer or buffers. The buffer values available under each designation are given in Table 8-4. Press ENTER to save.

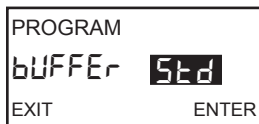
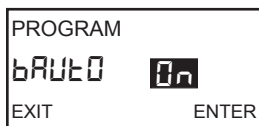
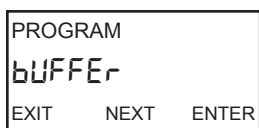
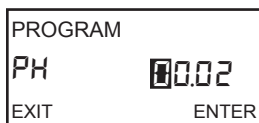
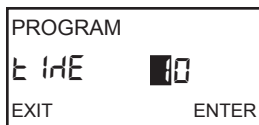

TABLE 8-4. Standard and Technical Buffers Recognized by the 5081pH Transmitter

Std	NIST, DIN 19266, JIS 8802, and BSM standard buffers
ErC	Merck Buffers (technical buffers)
InG	Ingold Buffers (technical buffers)
din	DIN 19267 (technical buffers)
FSH	Fisher Buffers (technical buffers)



5. The screen changes to display the **TIME** prompt. Use the editing keys to change the flashing number to the time in seconds the reading must remain stable for calibration data to be accepted. The maximum is 30 seconds. Press ENTER to save.
6. The screen changes to display the **pH** prompt. Use the editing keys to change the flashing display to the pH range the reading must remain in for calibration data to be accepted. The minimum range is 0.01. Press ENTER to save.
7. Press EXIT twice to return to the process display.

8.8 ISOPOTENTIAL PARAMETERS

8.8.1 Purpose

This section describes how to do the following:

1. convert the pH at the measurement temperature to the pH at a reference temperature by entering a solution temperature coefficient,
2. change the transmitter isopotential pH.

NOTE

Do NOT change the isopotential pH of the transmitter unless you are thoroughly familiar with the role of sensor and transmitter isopotential points in pH measurement, OR unless the sensor operating instructions specifically state that the isopotential pH is a value other than pH 7.

8.8.2 Definitions

1. **pH AT A REFERENCE TEMPERATURE.** Certain industries (for example, power generation) use pH to indirectly measure the concentration of dilute alkaline solutions, typically ammonia. The pH of dilute ammonia solutions is a strong function of temperature. Therefore, to make pH solely a measure of concentration, the pH must be converted to a value at a reference temperature. The correction factor is expressed as the pH change per unit temperature change (in °C). The correction is commonly called the solution temperature coefficient. The almost universal reference temperature is 25°C.

Example: The temperature coefficient of dilute aqueous ammonia solutions (0.1 to 5 ppm) is about -0.032 pH/°C (the minus sign means the pH decreases as temperature increases). If the pH at 31°C is 8.96, the pH at 25°C is $8.96 + (-0.032)(25 - 31) = 9.15$.

2. **ISOPOTENTIAL pH.** The isopotential pH is the pH at which the cell voltage is independent of temperature. The closer the agreement between the transmitter and sensor isopotential pH, the smaller the error when the calibration and measurement temperatures are different. The default isopotential value for the transmitter is pH 7. Most sensors have an isopotential point fairly close to pH 7, so the default value rarely needs changing. For more information, consult Section 13.8, Isopotential pH. Some sensors have an isopotential pH distinctly different from pH 7. For these sensors, the transmitter isopotential pH must be changed to match the sensor.

NOTE

Do NOT change the isopotential pH of the transmitter unless you are thoroughly familiar with the role of sensor and transmitter isopotential points in pH measurement, OR unless the sensor operating instructions specifically state that the isopotential pH is a value other than pH 7.

3. **OPERATING ISOPOTENTIAL pH.** The operating isopotential pH is a mathematical combination of the solution temperature coefficient and the meter isopotential pH. Changing the solution temperature coefficient ALWAYS changes the operating isopotential pH. When programming the transmitter to perform a solution temperature compensation, it is ALWAYS better to enter the solution temperature coefficient and allow the transmitter to calculate the operating isopotential pH.

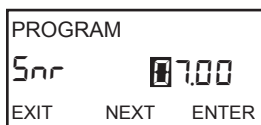
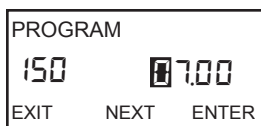
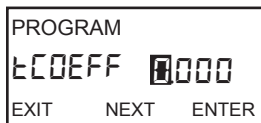
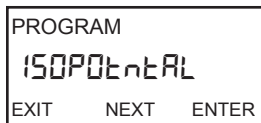

8.8.3 Procedure

1. Press PROG on the infrared remote controller (IRC).
2. Press NEXT until the **ISOPotntAL** sub-menu appears. Press ENTER .
3. The screen displays the **tCOEFF** prompt. Use the editing keys to change the display to the desired solution temperature coefficient. The allowed values are -0.044 to +0.028 pH/°C. To enter a negative coefficient, press **4** or **2** until no digit is flashing. Then press **3** or **5** to display the negative sign. Press ENTER to save.
4. The screen displays the **ISO** prompt. The number showing in the display is the operating isopotential pH. The transmitter calculates the operating isopotential pH from the transmitter isopotential pH and the solution temperature coefficient. If the solution temperature coefficient is 0.00, the operating isopotential pH is 7.00. If the solution temperature coefficient is different from 0.00, the operating isopotential pH will be different from 7.00. It is ALWAYS better to enter the solution temperature coefficient as described in step 3 and let the transmitter calculate the operating isopotential pH. To move to the next prompt without changing the value, press NEXT .
5. The screen displays the **Snr** prompt. The flashing display is the current transmitter isopotential point. Use the editing keys to change the transmitter isopotential pH to match the sensor isopotential pH. The limits are pH 0.00 to pH 14.00. The default is pH 7.00. Press ENTER to save.

NOTE

Do NOT change the isopotential pH of the transmitter unless you are thoroughly familiar with the role of sensor and transmitter isopotential points in pH measurement, OR unless the sensor operating instructions specifically state that the isopotential pH is a value other than pH 7.

6. Press EXIT to return to the process display.

8.9 GENERATING A TEST CURRENT (for 5081-P-HT only)

8.9.1 Purpose

This section describes how to generate output currents for testing recorders and data handling systems.

8.9.2 What happens while the transmitter is generating a test current?

1. The output current goes to the programmed test value and remains there until the TEST function is disabled.
2. The main display continues to show the pH of the process stream. The word HOLD appears in the display.
3. The test current value supersedes both the HOLD value and the FAULT value.
4. If a fault occurs while the transmitter is generating the test current, the word fault appears in the display and the display flashes.

8.9.3 Procedure

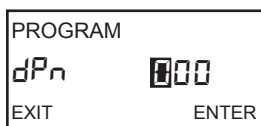

1. Press PROG on the infrared remote controller (IRC). **OUTPUT** will appear. Press ENTER
2. Press NEXT until the **dPn** sub-menu appears. Press ENTER .
3. The **tEst** prompt appears. Use the editing keys to change the number to the desired value. The allowed values are between 3.80 mA and 22.00 mA.
4. Press ENTER to start the test current. **HOLD** will appear on the left side of the screen.
5. To end the test current, press EXIT.
6. Press EXIT to return to the process display.

SECTION 9.0

CALIBRATION OF ORP MEASUREMENTS

- 9.1 General
- 9.2 Entering and Leaving the Calibrate Menu
- 9.3 Using the Hold Function
- 9.4 Temperature Calibration
- 9.5 Standardization

9.1 GENERAL

The Calibrate menu allows the user to calibrate the ORP and temperature response of the sensor.

The ORP calibration is a one-point standardization against an ORP standard. The temperature calibration is a one-point standardization against a reference thermometer. Prompts guide the user through the calibration procedures.

9.2. ENTERING AND LEAVING THE CALIBRATE MENU

Press **CAL** on the infrared remote controller (IRC) to enter the Calibrate menu. To store new settings in memory, press **ENTER**. To leave the Calibrate menu without storing new values, press **EXIT**. Pressing **EXIT** with a prompt showing returns the display to the first prompt in the sub-menu. Pressing **EXIT** a second time returns the transmitter to the process display.

If program settings are protected with a security code, pressing **PROG** or **CAL** will cause the **Id** screen to appear. Key in the security code and press **ENTER**. The first sub-menu will appear. For more information, see Section 5.8, Security.

A transmitter adjacent to the one being calibrated may pick up signals from the IRC. To avoid accidentally changing settings, use a different security code for each nearby transmitter.

9.3 USING THE HOLD FUNCTION

During calibration, the sensor may be exposed to solutions having an ORP outside the normal range of the process. To prevent false alarms and possible undesired operation of chemical dosing pumps, place the transmitter in hold during calibration. Activating **HOLD** keeps the transmitter output at the last value or sends the output to a previously determined value.

After calibration, reinstall the sensor in the process stream. Wait until readings have stabilized before deactivating **Hold**.

To activate or deactivate **Hold**, do the following:

1. Press **HOLD** on the IRC.
2. The **HoLd** prompt appears in the display. Press **3** or **5** to toggle the Hold function between **On** and **OFF**.
3. Press **ENTER** to save the setting.

9.4 TEMPERATURE CALIBRATION

9.4.1 Purpose

1. As discussed in Section 14.6 (ORP, Concentration, and pH), ORP is a function of temperature. The accuracy of a new sensor/transmitter loop is about $\pm 1^\circ\text{C}$, which is adequate for most applications. A new sensor seldom requires temperature calibration.
2. Calibrate the sensor/transmitter loop if . . .
 - a. $\pm 1^\circ\text{C}$ accuracy is NOT acceptable, or
 - b. the temperature measurement is suspected of being in error.

NOTE

A transmitter adjacent to the one being calibrated may pick up signals from the IRC. To avoid accidentally changing settings, use a different security code for each nearby transmitter. See Section 5.8, Security.

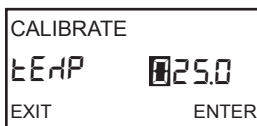
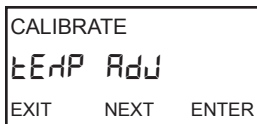

9.4.2 Procedure

1. Place the transmitter in ORP mode. See Section 10.5.3, steps 1 - 3. After selecting and saving **OrP**, press **EXIT** twice to return to the main display.
2. Place the ORP sensor and a calibrated reference thermometer in an insulated container of water at ambient temperature. Be sure the temperature element in the sensor is completely submerged by keeping the sensor tip at least three inches below the water level. Stir continuously. Allow at least 20 minutes for the standard thermometer, sensor, and water to reach constant temperature.
3. Enter the **CALIBRATE** menu by pressing **CAL** on the IRC. The **Std** sub-menu appears (pictured above left).
4. At the **Std** sub-menu, press **NEXT**. The **tEMP Adj** sub-menu appears.
5. Press **ENTER** to display the temperature editing prompt.
6. Compare the temperature displayed by the transmitter with the temperature measured with the reference thermometer. If the readings are different, use the editing keys to change the flashing display to the value determined with the reference thermometer. The reading cannot be changed by more than 15°C .
7. Press **ENTER**. The value will be saved, and the display will return to the **tEMP Adj** sub-menu.
8. To leave the **CALIBRATE** menu, press **EXIT**.
9. Check linearity by measuring the temperature of water 10 to 15°C cooler and 10 to 15°C warmer than the water used for calibration. Because of the time required for the temperature element in the sensor to reach constant temperature, a well-insulated container or, better, a constant temperature bath is required for this step.

9.5 Standardization

9.5.1 Purpose

This section describes how to prepare ORP standard solutions and how to make the transmitter reading match the ORP of the standard. Procedures for making ORP standards are taken from ASTM Method D1498-93.

9.5.2 Preparation of ORP Standard Solutions

ASTM D 1498-93 gives procedures for making iron (II) - iron (III) and quinhydrone ORP standards. The iron (II) - iron (III) standard is recommended. It is fairly easy to make and has a shelf life of about one year. In contrast, quinhydrone standards contain toxic quinhydrone and have only an 8-hour shelf life.

Iron (II) - iron (III) standard is available from Rosemount Analytical as PN R508-16OZ. The ORP of the standard solution measured against a silver-silver chloride reference electrode is 476±20 mV at 25°C.

NOTE

A transmitter adjacent to the one being calibrated may pick up signals from the IRC. To avoid accidentally changing settings, use a different security code for each nearby transmitter. See Section 5.8, Security.

NOTE

During calibration, the sensor may be exposed to solutions having ORP outside the normal range of the process. To prevent false alarms and possible undesired operation of chemical dosing pumps, place the analyzer in hold during calibration. See Section 9.3, Using the Hold Function, for details.



9.5.3 Procedure

1. Place the transmitter in ORP mode. See Section 10.5.1, steps 1 - 3. After selecting and saving **OrP**, press **EXIT** twice to return to the main display.
2. Enter the CALIBRATE menu by pressing **CAL** on the IRC. The **Std** sub-menu appears.
3. Rinse the sensor with deionized water and place it in the ORP standard along with a thermometer. Submerge the sensor tip at least three inches below the surface of the liquid. Swirl the sensor to dislodge trapped air bubbles. The main display will show the measured ORP based on the previous calibration.
4. Once the temperature and ORP readings are stable, press **ENTER**. The screen changes to look like the figure to the left.
5. Use the editing keys to change the flashing display to the desired ORP reading. Press **ENTER** to save.
6. Press **EXIT** to return to the main display.

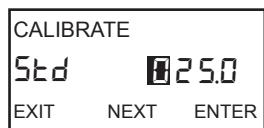
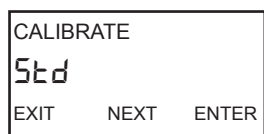

SECTION 10.0

PROGRAMMING FOR ORP MEASUREMENTS

- 10.1 General**
- 10.2 Entering and Leaving the Program Menu**
- 10.3 Output Ranging**
- 10.4 Temperature Element**
- 10.5 Display Units**
- 10.6 Diagnostic Parameters**
- 10.7 Generating a Test Current**

10.1 GENERAL

This section describes how to do the following:

1. assign ORP values to the 4 and 20 mA outputs (for Model 5081-P-HT only),
2. set the current generated by the transmitter during hold (for Model 5081-P-HT only),
3. set the current generated by the transmitter when a fault is detected (for Model 5081-P-HT only),
4. change sensor diagnostic limits,
5. change the units of the displayed variables,
6. program a security code,
7. simulate output currents for testing (for Model 5081-P-HT only).

Factory default settings are given in Table 10-1. If default settings are acceptable, the transmitter is ready for calibration. See Section 9.0, Calibration of ORP Measurements. There is no way to automatically reset the transmitter to factory defaults. Settings must be returned to default values one at a time. Figure 5-5 shows the menu tree.

10.2 ENTERING AND LEAVING THE PROGRAM MENU

Press **PROG** on the infrared remote controller (IRC) to enter the Program menu. To save new settings, press **ENTER**. To leave the Program menu without saving new values, press **EXIT**. Pressing **EXIT** with a prompt showing returns the display to the first prompt in the sub-menu. Pressing **EXIT** again returns the transmitter to the process display.

If program settings are protected with a security code, pressing **PROG** or **CAL** will cause the **Id** screen to appear. Key in the security code and press **ENTER**. The first sub-menu will appear. For more information, see Section 5.8, Security.

A transmitter adjacent to the one being programmed may pick up signals from the IRC. To avoid accidentally changing settings, use a different security code for each nearby transmitter. See Section 5.8, Security, and Section 10.5, Display Units, for details.

TABLE 10-1. ORP Settings List

ITEM	MNEMONIC	DISPLAY LIMITS	FACTORY SETTINGS	USER SETTINGS
PROGRAM LEVEL				
A. Output Range (Section 10.3) (for Model 5081-P-HT only)				
1. 4 mA Output	OutPut	-1400 to 1400 mV	-1400 mV	_____
2. 20 mA Output:		-1400 to 1400 mV	1400 mV	_____
3. Hold	HoLd	3.80 to 22.00 mA	21.00mA	_____
4. Dampening	dPn	0 to 255 seconds	0 seconds	_____
5. Fault Current Output Setting	FAULT	3.80 to 22.00 mA	22.00mA	_____
B. Diagnostic (Section 10.4)				
dIAGnOStIC				
1. Reference Cell Offset (Standardize error)	rOFFSt	0 to 1000 mV	60 mV	_____
2. Diagnostics Function	dIAG	On/Off	Off	_____
3. Glass Impedance Temperature Correction)	IMPtC	On/Off	Off	_____
4. Reference Cell Impedance Type	rEF	LO/HI	LO	_____
5. Reference Cell High Impedance Fault	rFH	0 to 2000 megohms (HI)	1500 megohms	_____
		0 to 2000 kilohms (LO)	140 kilohms	_____
6. Reference Cell High Impedance Warning	rWH	0 to 2000 megohms (HI)	1000 megohms	_____
		0 to 2000 kilohms (LO)	40 kilohms	_____
7. Reference Cell Low Impedance Warning	rWL	0 to 900 megohms (HI)	20 megohms	_____
		Does not apply for low impedance reference cell		_____
8. Reference Cell Low Impedance Fault	rFL	0 to 900 megohms (HI)	10 megohms	_____
		Does not apply for low impedance reference cell		_____
C. Display (Section 10.6)				
dISPLAY				
1. Measurement type	tYPE	pH/ORP	pH	_____
2. Temperature Units	tEMP	°C/°F	°C	_____
3. Output Units (for Model 5081-P-HT only)	OUtPUt	mA/% of full scale	mA	_____
4. Code	COdE	0 to 999	000	_____
D. Output Simulation (Section 10.7) (for Model 5081-P-HT only)				
SIMOUtPUt				
1. Test	tESt	3.80 to 22.00 mA	12.00 mA	_____

10.3 OUTPUT RANGING (For Model 5081-P-HT only)

10.3.1 Purpose

This section describes how to do the following:

1. assign ORP values to the 4 and 20 mA outputs,
2. set the output current generated by the transmitter during hold,
3. set the output current generated by the transmitter when a fault is detected,
4. control the amount of dampening on the output signal.

10.3.2 Definitions

1. **CURRENT OUTPUTS.** The transmitter provides a continuous 4 - 20 mA output directly proportional to the measured ORP. Any ORP value between -1400 and 1400 mV can be assigned to the low output (4 mA) and the high output (20 mA).
2. **HOLD.** During calibration and maintenance the transmitter output may be outside the normal operating range. Placing the transmitter on hold prevents false alarms or the unwanted operation of chemical dosing pumps. The transmitter output can be programmed to remain at the last value or to generate any current between 3.80 and 22.0 mA. During hold, the transmitter displays the present ORP and temperature. The word HOLD appears in the display.
3. **FAULT.** A fault is a system disabling condition. When the transmitter detects a fault, the following happens:
 - a. The display flashes.
 - b. The words FAULT and HOLD appear in the main display.
 - c. A fault or diagnostic message appears in the temperature/current display area.
 - d. The output signal remains at the present value or goes to the programmed fault value. Permitted values are between 3.80 and 22.00 mA.
 - e. If the transmitter is in HOLD when the fault occurs, the output remains at the programmed hold value. To alert the user that a fault exists, the word FAULT appears in the main display, and the display flashes. A fault or diagnostic message also appears.
 - f. If the transmitter is simulating an output current when the fault occurs, the transmitter continues to generate the simulated current. To alert the user that a fault exists, the word FAULT appears in the display, and the display flashes.
4. **DAMPEN.** Output dampening smooths out noisy readings. But it also increases the response time of the output. To estimate the time (in minutes) required for the output to read 95% of the final reading following a step change, divide the setting by 20. Thus, a setting of 140 means that, following a step change, the output takes about seven minutes to reach 95% of final reading. The output dampen setting does not affect the response time of the process display. The maximum setting is 255.

10.3.3 Procedure

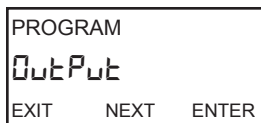

← 1. Enter the Program menu by pressing PROG on the IRC. The **OutPut** sub-menu appears.

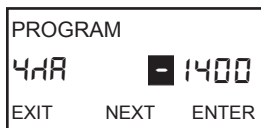

← 2. Press ENTER. The screen displays the **4 MA** prompt. Use the editing keys to change the displayed number to the desired ORP. The allowed range is -1400 to 1400. To change the display to a negative number, press 4 or 2 until no digit is flashing. Then press 3 or 5 until the minus sign appears. To change the display to a positive number, press 4 or 2 until the negative sign is flashing. Then press 3 or 5 until the minus sign disappears. Press ENTER to save.



← 3. The screen displays the **20 MA** prompt. Use the editing keys to change the displayed number to the desired ORP. The allowed range is -1400 to 1400. Press ENTER to save.

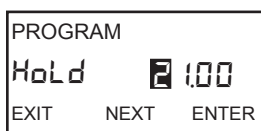

← 4. The screen displays the **Hold** prompt. Use the editing keys to change the display to the output desired when the transmitter is in hold. The range is 3.80 to 22.00 mA. Entering 00.00 causes the transmitter to hold the output at the value it was when placed in hold. The hold setting overrides the fault setting. Press ENTER to save.

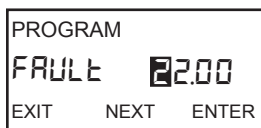

← 5. The screen displays the **FAULT** prompt. Use the editing keys to change the display to the output desired when the transmitter detects a fault. The range is 3.80 to 22.00 mA. Entering 00.00 causes the transmitter to hold the output at the value it was when the fault occurred. Press ENTER to save.

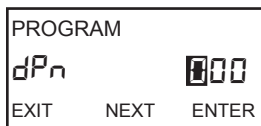

← 6. The screen displays the **dPn** prompt. Use the editing keys to change the display to the desired output dampening. The range is 0 to 255. Press ENTER to save.

7. Press EXIT to return to the process display.

10.4 TEMPERATURE ELEMENT

10.4.1 Purpose

This section describes how to match the transmitter to the type of temperature element in the ORP sensor.

10.4.2 Definition

TEMPERATURE ELEMENT: ORP sensors use a variety of temperature elements. The Model 5081-P ORP transmitter recognizes the following temperature elements and configurations:

- a. three and four wire 100 ohm platinum RTDs
- b. three and four wire 1000 ohm platinum RTDs

A 100 ohm platinum RTD has a resistance of 100 ohms at 0°C. A 1000 ohm platinum RTD has a resistance of 1000 ohms at 0°C. Although only two lead wires are necessary to connect the RTD to the transmitter, connecting a third wire allows the transmitter to correct for the resistance of the lead wires and for changes in wire resistance with temperature.

The Model 5081-P transmitter can also be used with a two-wire RTD. Select a three-wire configuration and jumper the RTD return and -RTD sense terminals (terminals 3 and 4, respectively).

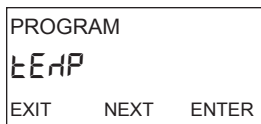

10.4.2 Procedure

1. Press PROG on the infrared remote controller (IRC).
2. Press NEXT until the **tEMP** sub-menu appears in the display. Press ENTER .
3. Press EXIT to return to the process display.

10.5 DISPLAY UNITS

10.5.1 Purpose

This section describes how to do the following:

1. switch the process display units between pH and ORP (millivolts),
2. select °C or °F for the temperature display,
3. select percent of full scale or milliamps for the output display,
4. program a security code.

10.5.2 Definitions

1. **DISPLAY UNITS.** Select pH if the transmitter is being used to measure pH. Select ORP if the transmitter is being used to measure ORP. The units selected are shown in the main display next to the measured value.
2. **OUTPUT CURRENT DISPLAY (Model 5081-P-HT only).** The transmitter generates a 4 to 20 mA output signal directly proportional to the ORP of the sample. The output signal also appears on the temperature-output display line. The output signal can be displayed as current (in mA) or as percent of full scale.
3. **SECURITY CODE.** The security code unlocks the transmitter and allows complete access to all menus. The transmitter is shipped with security code disabled.

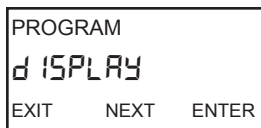

10.5.3 Procedure

1. Press PROG on the infrared remote controller (IRC).
2. Press NEXT until the **dISPLAY** sub-menu appears. Press ENTER.



3. The screen displays the **tYPE** prompt. Press **3** or **5** to toggle between **pH** and **OrP**. Press ENTER to save.



4. The screen displays the **tEMP** prompt. Press **3** or **5** to toggle between **C** and **F**. Press ENTER to save.



5. For Model 5081-P-HT only — The screen displays the **OUtPUt** prompt. Press **3** or **5** to toggle between **%** and **CUr**. Press ENTER to save.

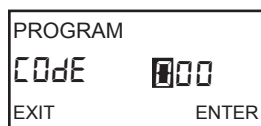

6. The screen displays the **COde** prompt. Use the editing keys to enter a security code between 001 and 999. Entering 000 disables the security feature. Press ENTER to save.

7. Press EXIT to return to the process display.

**This screen appears only with Model 5081-P-HT.*

10.6 DIAGNOSTIC PARAMETERS

10.6.1 Purpose

This section describes how to do the following:

1. change the standardization (reference) offset,
2. enable and disable sensor diagnostics,
3. enable and disable glass impedance temperature compensation for a glass reference electrode,
4. set the high and low warning and failure limits for a glass reference electrode.

10.6.2 Definitions

1. **STANDARDIZATION OFFSET (REFERENCE OFFSET).** During calibration, the transmitter reading is made to match the ORP of a standard solution. If the difference between the transmitter reading and the desired value exceeds the programmed limit, the transmitter will not accept the new reading. The default value is 60 mV.
2. **GLASS IMPEDANCE TEMPERATURE COMPENSATION.** In certain applications, the use of a glass (i.e., pH) electrode as a reference electrode may be required. The impedance of a glass electrode changes with temperature. For changes in glass impedance to be a useful indicator of electrode condition, the impedance measurement must be corrected to a reference temperature.
3. **REFERENCE IMPEDANCE.** The majority of reference electrodes used in industry are low impedance silver-silver chloride electrodes. However, there are applications that call for either a high impedance sodium or pH glass reference electrode. Both high impedance and low impedance reference electrodes can be used with the Model 5081-P pH/ORP transmitter.
4. **WARNING AND FAILURE LIMITS FOR THE REFERENCE ELECTRODE.** Warning tells the user that the reference electrode impedance is approaching the failure limit. Low and high warning and failure limits are programmable. For conventional silver-silver chloride reference electrodes only the high limits are useful. For high impedance reference electrodes, both low and high limits are used.

Figure 10-1 shows suggested limits for low impedance reference electrodes.

Figure 10-2 shows suggested limits for high impedance glass reference electrodes.

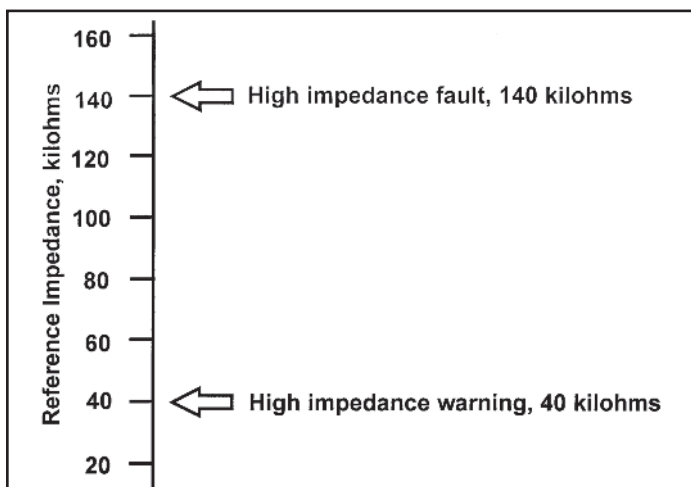

FIGURE 10-1. Suggested Warning and Failure Limits for Low Impedance Reference Electrodes

The impedance of a typical silver-silver chloride reference electrode is less than 40 kilohms. If the impedance is greater than about 140 kilohms the reference electrode has failed. Failure is usually caused by a plugged or coated reference junction or a depleted electrolyte fill solution (gel). The reference impedance will also be high if the sensor is out of the process liquid.

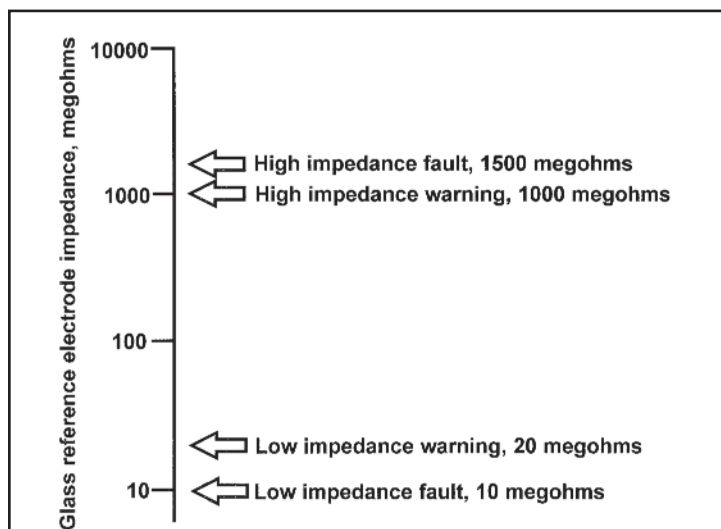
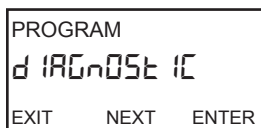

FIGURE 10-2. Suggested Glass Impedance Warning and Failure Limits for a Glass Reference Electrode

Typical glass impedance is about 100 megohms at 25°C. A broken or cracked electrode has an impedance of 10 megohms or less. A glass impedance greater than 1000 megohms suggests the electrode is nearing the end of its service life. High impedance may also mean the electrode is not immersed in the process liquid.

10.6.3 Procedure



1. Press PROG on the infrared remote controller (IRC).

2. Press NEXT until the **diAGnOStIC** sub-menu appears. Press ENTER.

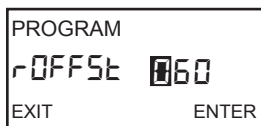

3. The screen displays the **rOFFSt** prompt. Use the editing keys to change the flashing display to the desired standardization (reference) offset (in millivolts). The range is 0 to 1000 mV. Press ENTER to save.

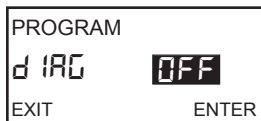

4. The **diAG** prompt appears. Use the **3** or **5** keys to enable (**On**) or disable (**OFF**) the sensor diagnostics. Press ENTER to save.

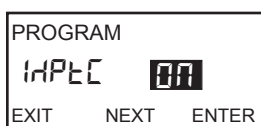

5. The **IMPtC** prompt appears. Use the **3** or **5** keys to enable (**On**) or disable (**OFF**) glass impedance temperature compensation. Because glass impedance is a strong function of temperature, correcting glass impedance for temperature is recommended. A third setting (**SPC**) appears in addition to **On** and **OFF**. Do not select **SPC**; the setting is intended for factory use. Press ENTER to save.

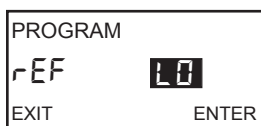

6. The **rEF** prompt appears. Press **3** or **5** until the desired setting appears. **LO** identifies a low impedance reference electrode, and **HI** identifies a high impedance reference electrode. Press ENTER to save. Selecting **LO** disables the low impedance warning and failure limits for the reference electrode.

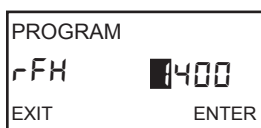

7. The **rFH** prompt appears. Use the editing keys to change the display to the desired reference electrode high impedance fault value. The allowed ranges are

Type of reference electrode	Allowed range
Low impedance (LO in step 6)	0 - 2000 kilohms
High impedance (HI in step 6)	0 - 2000 megohms

Entering 0000 disables the feature. When the reference electrode impedance goes above the fault value, the transmitter displays the diagnostic message **rEFFAIL** and sets a fault condition. Press ENTER to save.

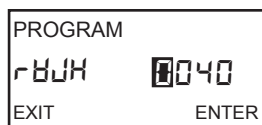

8. The **rWH** prompt appears. In the display, W appears as \bar{W} . Use the editing keys to change the display to the desired reference electrode high impedance warning value. The allowed ranges are

Type of reference electrode	Allowed range
Low impedance (LO in step 6)	0 - 2000 kilohms
High impedance (HI in step 6)	0 - 2000 megohms

Entering 0000 disables the feature. When the reference electrode impedance goes above the fault value, the transmitter displays the diagnostic message **rEFWArn**. Press **ENTER** to save.

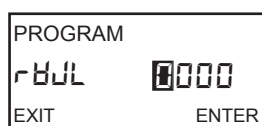

9. The **rWL** prompt appears. Use the editing keys to change the display to the desired reference electrode low impedance warning value. The allowed ranges are

Type of reference electrode	Allowed range
Low impedance (LO in step 6)	not applicable
High impedance (HI in step 6)	0 - 900 megohms

Entering 0000 disables the feature. When the reference electrode impedance goes below the warning value, the transmitter displays the diagnostic message **rEFWArn**. Press **ENTER** to save. The prompt appears but is disabled when **LO** is selected in step 6.

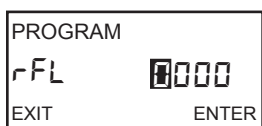

10. The **rFL** prompt appears. Use the editing keys to change the display to the desired reference electrode low impedance fault value. The allowed ranges are

Type of reference electrode	Allowed range
Low impedance (LO in step 6)	not applicable
High impedance (HI in step 6)	0 - 900 megohms

Entering 0000 disables the feature. When the reference electrode impedance goes below the fault value, the transmitter displays the diagnostic message **rEFFAIL** and sets a fault condition. Press **ENTER** to save. The prompt appears but is disabled when **LO** is selected in step 6.

11. Press **EXIT** to return to the process display.

10.7 GENERATING A TEST CURRENT (for Model 5081-P-HT only)

10.7.1 Purpose

This section describes how to generate output currents for testing recorders and data handling systems.

10.7.2 What happens while the transmitter is generating a test current?

1. The output current goes to the programmed test value and remains there until the TEST function is disabled.
2. The main display continues to show the pH of the process stream. The word HOLD appears in the display.
3. The test current value supersedes both the HOLD value and the FAULT value.
4. If a fault occurs while the transmitter is generating the test current, the word fault appears in the display and the display flashes.

10.7.3 Procedure

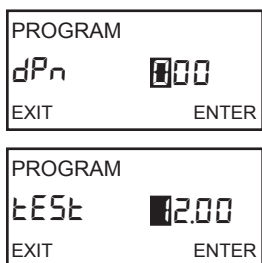

1. Press PROG on the infrared remote controller (IRC). **OUTPUT** will appear. Press ENTER
2. Press NEXT until the **dPn** sub-menu appears. Press ENTER .
3. The **tEst** prompt appears. Use the editing keys to change the number to the desired value. The allowed values are between 3.80 mA and 22.00 mA.
4. Press ENTER to start the test current. **HOLD** will appear on the left side of the screen.
5. To end the test current, press EXIT.
6. Press EXIT to return to the process display.

SECTION 11.0 MAINTENANCE

- 11.1 Overview**
- 11.2 Transmitter Maintenance**
- 11.3 pH Sensor Maintenance**
- 11.4 ORP Sensor Maintenance**
- 11.5 Calibration**

11.1 OVERVIEW

This section gives general procedures for routine maintenance of the 5081-P pH/ORP transmitter and pH and ORP sensors. The transmitter needs almost no routine maintenance. Sensors require periodic inspection and cleaning. The calibration of the transmitter-sensor combination should be checked regularly, and the loop recalibrated if necessary.

11.2 TRANSMITTER MAINTENANCE

Periodically clean the transmitter window with household ammonia or glass cleaner. The detector for the infrared remote controller is located behind the window at the top of the transmitter face. The window in front of the detector must be kept clean. The o-rings and sealing surfaces must be kept clean or moisture may enter the electronic enclosure.

Most components of the transmitter are replaceable. Refer to Table 11-1 for parts and part numbers.

TABLE 11-1. Replacement Parts for Model 5081-P pH/ORP Transmitter

PN	Description	Shipping Weight
23992-02	For Model 5081-P-HT — PCB stack consisting of the CPU, communication, and analog boards; display board is not included; CPU, communication, and analog boards are factory-calibrated as a unit and cannot be ordered separately	1 lb/0.5 kg
23992-03	For Model 5081-P-FF — PCB stack consisting of the CPU, communication, and analog boards; display board is not included; CPU, communication, and analog boards are factory-calibrated as a unit and cannot be ordered separately	1 lb/0.5 kg
23652-01	LCD display PCB	1 lb/0.5 kg
33337-02	Terminal block	1 lb/0.5 kg
23593-01	Enclosure cover, front with glass window	3 lb/1.5 kg
33360-00	Enclosure, center housing	4 lb/1.5 kg
33362-00	Enclosure cover, rear	3 lb/1.0 kg
9550187	O-ring (2-252), one, front and rear covers each require an O-ring	1 lb/0.5 kg
NOTE	Screw, 8-32 x 0.5 inch, for attaching terminal block to center housing	*
NOTE	Screw, 8-32 x 1.75 inch, for attaching circuit board stack to center housing	* housing
33342-00	Cover lock	1 lb/0.5 kg
33343-00	Locking bracket nut	1 lb/0.5 kg
NOTE	Screw, 10-24 x 0.38 inch, for attaching cover lock and locking bracket nut to center housing	*

NOTE: For information only. Screws cannot be purchased from Rosemount Analytical.

* Weights are rounded up to the nearest whole pound or 0.5 kg.

11.3 pH SENSOR MAINTENANCE

11.3.1 Frequency of Cleaning

The frequency at which a sensor should be inspected and cleaned can be determined only by experience. If the process liquid coats or fouls the sensor, frequent cleaning may be necessary. If the process does not contain a high level of suspended solids, the need for regular cleaning will be less. Often an increase in glass impedance indicates the electrode is becoming fouled and needs cleaning. Refer to Section 12.4 for a description of the glass impedance diagnostic.

11.3.2 Cleaning Procedures

PROBLEM	CLEANING SUGGESTIONS
Loose scale or debris	Use a stream of water from a wash bottle to rinse away solids from the tip of the sensor. If water does not work, gently wipe the glass bulb and liquid junction with a soft cloth, tissue, cotton-tipped swab, or a soft bristle brush.
Oil and grease	Wash the glass bulb with mild detergent solution and rinse thoroughly with water.
Hard scale (carbonate sulfate scales and corrosion products)	If wiping the sensor tip with a tissue or cotton swab does not remove the scale, soak the glass bulb ONLY in a solution of 5% hydrochloric acid. To prepare the acid solution, add 15 mL of concentrated hydrochloric acid to 85 mL of water. Keep the acid away from the liquid junction and from any stainless steel portions of the sensor. Rinse the sensor thoroughly with deionized water. Some scales (for example, calcium sulfate) cannot be removed easily with acid. Soaking the glass bulb in a 2% solution of disodium EDTA may be helpful.

When using acid or alkaline solvents, be careful to keep the solvent away from the liquid junction. If the cleaning solvent contacts the junction, hydrogen ions (acid solvent) or hydroxide ions (alkaline solvent) will diffuse into the junction. Because hydrogen and hydroxide ions have much greater mobility than other ions, they produce a large junction potential. When the electrode goes back in service, the hydrogen or hydroxide ions slowly diffuse out of the junction, causing the liquid junction potential and the pH reading to drift. It may take hours or days for the reading to stabilize. For a discussion of the influence of ion mobility on liquid junction potentials, see Section 12.4.

Consult the sensor instruction manual for additional information.

Always recalibrate the sensor after cleaning. If the sensor was cleaned with detergent or acid, soak the sensor in pH 4 or pH 7 buffer for at least an hour before calibrating.

11.3.3 Checking the Reference Electrode.

Some processes contain substances, for example, sulfides, that poison the reference electrode. Poisoning alters the electrode potential. For example, sulfide poisoning converts the reference electrode from a silver/silver chloride electrode into a silver/silver sulfide electrode, causing a shift in potential of several hundred millivolts.

A good way to check for poisoning is to compare the voltage of the reference electrode with a silver/silver chloride electrode that is known to be good. The reference electrode from a new sensor is the best choice. To check the suspect electrode, place both sensors in a beaker containing buffer or a solution of potassium chloride. Connect the reference leads to a voltmeter and measure the potential difference. If the suspect electrode is good, the difference should be no more than about 20 mV. Refer to Figure 11-1. A poisoned reference electrode usually requires replacement.

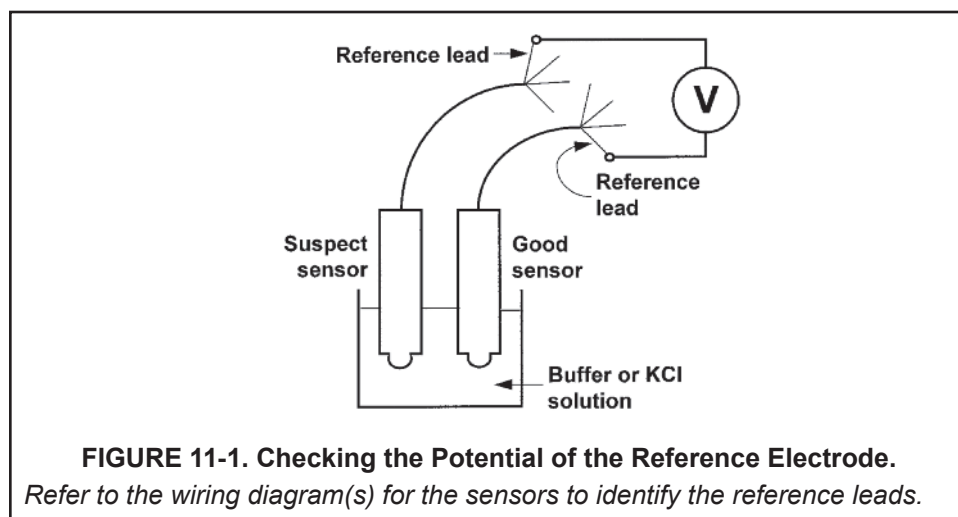

A laboratory silver/silver chloride reference electrode can be used in place of the second sensor. All Rosemount Analytical pH sensors have a silver/silver chloride reference, and most sensors use gelled saturated potassium chloride for the fill. The potentials of a good sensor reference electrode and a saturated silver/silver chloride laboratory electrode will agree within about 20 mV.

11.3.4 Rejuvenating Reference Electrodes

Occasionally, a poisoned or plugged reference electrode can be reconditioned. Although the electrode seldom recovers completely, the procedure might extend the life of the sensor by a few weeks.

- Clean the sensor as thoroughly as possible.
- Soak the sensor for several hours in a hot (**NOT BOILING**) 3% potassium chloride solution. Prepare the solution by dissolving 3 g of potassium chloride in 100 mL of water.
- Soak the sensor in pH 4 buffer at room temperature overnight.
- Calibrate the sensor in buffers and retest it in the process liquid.

11.4 ORP SENSOR MAINTENANCE

11.4.1 Frequency of Cleaning

The frequency at which an ORP sensor should be inspected and cleaned can be determined only by experience. If the process liquid coats or fouls the sensor, frequent cleaning may be necessary. If the process does not contain a high level of suspended solids, the need for regular cleaning will be less.

11.4.2 Cleaning Procedures

The platinum electrode is easily cleaned by using a tissue to rub the metal surface with a paste of baking soda (sodium bicarbonate). A clean platinum electrode is bright and shiny.

11.4.3 Checking the Reference Electrode

ORP electrodes manufactured by Rosemount Analytical have a silver/silver chloride reference. Section 11.3.3 describes how to check the performance of the reference electrode.

11.5 CALIBRATION

11.5.1 General

Many users regard calibration as a routine part of sensor/transmitter maintenance. Procedures for calibrating pH sensors, ORP sensors, and general information regarding the use of pH calibration buffers and ORP standards are given in Sections 7.0 Calibration of pH Measurements, 9.0 Calibration of ORP Measurements, 13.0 pH Measurements, and 13.0 ORP Measurements.

11.5.2 Calibration Frequency

The frequency at which sensors should be calibrated can be determined only by experience. Many factors influence calibration frequency. Sensors installed in dirty or corrosive process streams usually require more frequent calibration than sensors used in clean water. Sensors measuring extreme pH values, particularly high pH, also require more frequent calibration than sensors measuring mid-range pH. The width of the pH or ORP control range and the consequences of an out-of-limits condition has a major influence on calibration frequency. The narrower the control range and the greater the sensitivity of the process to control excursions, the more often the sensor should be checked. Finally, if monitoring data are reported to regulatory agencies, the agency itself may dictate the calibration frequency.

Use the following procedure to determine how often a pH sensor should be calibrated.

1. Calibrate the sensor. Record the date of calibration and the sensor response in buffers. That is, after calibrating, place the sensor back in the buffers and record the pH and temperature reading in each buffer. Also note the value of the reference offset and slope.
2. Install the sensor in the process stream.
3. After the appropriate period—two weeks for a clean process, several days for a dirty or aggressive process—remove the sensor and check its performance in buffers. Record the pH and temperature readings. The performance of the sensor in buffer after it has been in service is called the as-found condition. Keeping a good record of as-found data is an important step in determining the calibration frequency.
4. If the as-found data are acceptable, do not recalibrate the sensor. Return it to the process. Continue checking the calibration at the same interval.
5. If the as-found data are not acceptable, recalibrate the sensor. After calibration, check the sensor response in each buffer and record the results. Also note the reference offset and the slope. Return the sensor to service. Check the sensor again after a period shorter than the one originally selected. For example, if the first interval was two weeks, repeat the check after one week.
6. After a while it will become apparent how long the sensor holds calibration. The minimum calibration frequency can then be determined.
7. Check the calibration of the sensor at least several times during the regular calibration interval. Interim checks verify the sensor is still in calibration and validate the process measurements made since the last calibration or calibration check.

SECTION 12.0 TROUBLESHOOTING

- 12.1 WARNING AND FAULT MESSAGES
- 12.2 CALIBRATION ERRORS
- 12.3 TROUBLESHOOTING - GENERAL
- 12.4 TROUBLESHOOTING WHEN A DIAGNOSTIC MESSAGE IS SHOWING
- 12.5 TROUBLESHOOTING WHEN NO DIAGNOSTIC MESSAGE IS SHOWING
- 12.6 SYSTEMATIC TROUBLESHOOTING
- 12.7 DISPLAYING DIAGNOSTIC VARIABLES
- 12.8 TESTING THE TRANSMITTER BY SIMULATING pH
- 12.9 FACTORY ASSISTANCE AND REPAIRS

12.1 WARNING AND FAULT MESSAGES

The Model 5081-P pH/ORP transmitter continuously monitors the measurement loop (sensor and transmitter) for conditions that cause erroneous measurements. When a problem occurs, the transmitter displays either a warning or fault message. A warning alerts the user that a potentially system disabling condition exists. If the condition causing the problem is not corrected, there is a high probability that the system will soon fail. A fault alerts the user that a system disabling condition exists. If a fault message is showing, all measurements should be regarded as erroneous.

When a WARNING condition exists:

1. The main display remains stable; it does not flash.
2. A warning message appears alternately with the temperature display. See Figure 12-1. See Section 12.4 for an explanation of the different warnings and suggested ways of correcting the problem.

When a FAULT exists:

1. The main display flashes.
2. The words FAULT and HOLD appear in the main display.
3. A fault message appears alternately with the temperature/output display. See Figure 12-2. See Section 12.4 for an explanation of the different fault messages and suggested ways of correcting the problem.
4. The output current will remain at the present value or go to the programmed fault value. See Section 8.3 Output Ranging for pH Measurements, or Section 10.3 Output Ranging for ORP Measurements for details on how to program the current generated during a fault condition.
5. If the transmitter is in HOLD when the fault occurs, the output remains at the programmed hold value. To alert the user that a fault exists, the word FAULT appears in the main display, and the display flashes. A fault or diagnostic message also appears.
6. If the transmitter is simulating an output current when the fault occurs, the transmitter continues to generate the simulated current. To alert the user that a fault exists, the word FAULT appears in the display, and the display flashes.

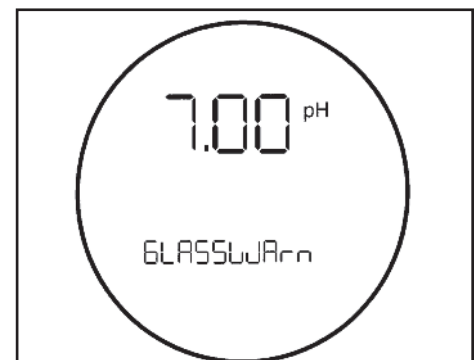

FIGURE 12-1. Warning Annunciation

When a non-disabling problem occurs, a warning message appears alternately with the temperature display.

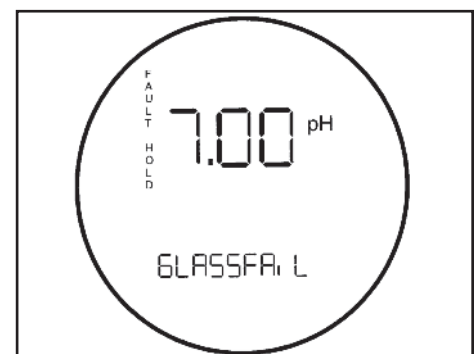

FIGURE 12-2. Fault Annunciation

When a disabling condition, a fault, occurs, the display appears as pictured above. To further alert the user that measurements are in error, the display flashes. Diagnostic messages appear in the temperature/output area on the screen.

12.2 CALIBRATION ERRORS

If an error occurs during calibration, an error message appears in the main display, and the transmitter does not update the calibration. The calibration errors are **Std Err**, **SLOPE Err LO**, and **SLOPE Err HI**. See Section 12.4 for an explanation of the error messages and suggested ways of correcting the problem.

12.3 TROUBLESHOOTING - GENERAL

Troubleshooting is easy as 1, 2, 3 . . .

Step 1 Look for a diagnostic message on the display to help identify the problem. Refer to Section 12.4 for an explanation of the message and a list of the possible problems that triggered it.

Step 2 Refer to Section 12.5 for common measurement problems and the recommended actions to resolve them.

Step 3 Follow the step by step troubleshooting approach, offered in Section 12.6, to diagnose and correct less common or more complex problems.

12.4 TROUBLESHOOTING WHEN A DIAGNOSTIC MESSAGE IS SHOWING

The Model 5081-P pH/ORP transmitter continuously monitors the measurement loop (sensor and transmitter) for problems. If a problem is detected, the transmitter displays a fault or error message. The message appears in the temperature/output area of the main display. The table lists each diagnostic message and the section to consult for help.

MESSAGE	SECTION
GLASSFAIL	12.4.1
GLASSWArn	12.4.2
rEF FAIL	12.4.3
rEF WArn	12.4.4
CALibrAtE	12.4.5
tEMP HI	12.4.6
tEMP LO	12.4.6
LInE FAIL	12.4.7
InPUt WArn	12.4.8
SLOPE Err LO	12.4.9
SLOPE Err HI	12.4.10
Std Err	12.4.11
rOM FAIL	12.4.12
CPU FAIL	12.4.12
AdC WArn	12.4.13
CyCLE PWr	12.4.13
WritE Err	12.4.14
FACT FAIL	12.4.15

12.4.1 GLASSFAIL

GLASSFAIL is an electrode fault message. It means the glass impedance is outside the programmed Glass Fault High (**GFH**) or Glass Fault Low (**GFL**) limit. Glass Fault High suggests the electrode is aging or the electrode is not immersed in the process liquid. Glass Fault Low implies the pH sensitive glass is cracked. **GLASSFAIL** also appears if inappropriate limits have been entered into the transmitter.

If the measurement system was previously commissioned and operating correctly, **GLASSFAIL** likely means a real problem exists. However if the system is being started up or if the advanced diagnostic feature is being used for the first time, **GLASSFAIL** could be caused by a miswired sensor or by programmed limits that are not correct for the sensor.

NOTE

GLASSFAIL is a sensor diagnostic message. Sensor diagnostic messages are optional. They can be turned off. To disable sensor diagnostic messages, refer to Section 7.3.

Troubleshooting Flowchart - GLASSFAIL

A. Be sure the sensor is completely immersed in the process liquid.

- If the diagnostic message disappears, the sensor is in good condition.
- If the diagnostic message remains, go to step B.

B. Measure the glass impedance. See Section 12.7 for the procedure. Note the reading.

- If the glass impedance is low (<40 megohms)...
 1. Check preamp location in program menu (PAMP = ____). See Section 5.0.
 - If location is incorrect, go to step 2.
 - If after selecting the correct location of Preamp in program menu, the glass impedance is still low, go to step 2.
 2. Calibrate the sensor. Use the autocalibration procedure in Section 6.5.
 - If the sensor calibrates properly...
 - a. The sensor is in good condition, but the Glass Fail Low (**GFL**) limit is set too high.
 - b. Lower the **GFL** limit to about 10 megohms below the glass impedance value (**GIMP**) measured in step B.
 - c. If the Glass Warning Low (**GWL**) message was also flashing, lower the limit from its former value by the same amount **GFL** was lowered from its former value.
 - If the sensor cannot be calibrated...

The pH sensitive glass membrane is likely cracked and the sensor must be replaced. The crack in the glass may not be visible or may be difficult to see.
- If the glass impedance is high (>800 megohms)...
 1. Check that the sensor is correctly wired to the transmitter. See the appropriate wiring diagram in Section 3.0. Pay particular attention to the following:
 - a. For Rosemount Analytical PLUS (+) and TUpH sensors with integral preamplifiers, the blue solution ground wire must be attached to TB-8 (SOL GND) and the gray reference in wire must be attached to TB-7 (REF IN). (NOTE: TB-8 means terminal 8 on the terminal board.)

- b. If the sensor was wired with the blue solution ground wire unattached and a jumper between terminals TB-8 and TB-7, remove the jumper and reattach the blue solution ground wire to TB-8. Keep the gray reference in wire attached to TB-7.
- c. For Rosemount Analytical PLUS (+) and TUpH sensors that do not have an integral preamplifier, attach the blue solution ground wire to TB-8 or, better, leave the blue wire unattached and jumper TB-7 to TB-8.
- d. If the sensor does not have a blue solution ground wire, jumper terminals TB-7 and TB-8.
 - If the wiring was correct and the glass impedance is still high, go on to step 2.
 - If correcting wiring errors causes the diagnostic message to disappear, the sensor is in good condition.
 - If after correcting wiring errors, the glass impedance is still high go on to step 2.

2. Inspect and clean the sensor. Refer to Section 10.3. After cleaning the sensor, calibrate it following the autocalibration procedure in Section 6.5. Be sure to note the sensor slope.

→ If cleaning the sensor lowers the impedance below 800 megohms...

- a. The sensor is in good condition.
- b. Return the calibrated sensor to service.

→ If cleaning does not lower the glass impedance and the sensor can be calibrated...

- a. The sensor is probably in good condition; however, it may be nearing the end of its life. The electrode slope is a good indicator of remaining life.

SLOPE	CONDITION OF SENSOR
54-60 mV/unit pH	Sensor is in good condition.
48-50 mV/unit pH	Sensor is nearing the end of its life. Once the slope drops below 48 mV/unit pH, the sensor can no longer be calibrated.

- b. The Glass Fail High (**GFH**) limit is probably set too low for the sensor. Set the **GFH** limit to about 150 megohms greater than the measured glass impedance.
- c. If the **GLASSWarn** message was also flashing, raise the **GWH** limit from its former value by the same amount **GFH** was raised from its former value.

→ If cleaning does not lower the glass impedance and the sensor cannot be calibrated...
The sensor has failed and should be replaced.

→ If the glass impedance is moderate (between 40 and 800 megohms)...

1. The sensor may be dirty, in which case cleaning it will lower the impedance reading. The sensor may also be in good condition. The warning and fail limits are simply set too low.

2. Inspect and clean the sensor. Refer to Section 11.3. After cleaning the sensor, calibrate it following the autocalibration procedure in Section 7.5. Be sure to note the sensor slope.

→ If cleaning the sensor reduces the impedance...

- a. The sensor is in good condition.
- b. Return the calibrated sensor to service.

→ If cleaning does not lower the glass impedance and the sensor can be calibrated...

- a. The sensor is probably in good condition; however it may be nearing the end of its life. The electrode slope is a good indicator of remaining life.

SLOPE	STATUS OF SENSOR
54-60 mV/unit pH	Sensor is in good condition.
48-50 mV/unit pH	Sensor is nearing the end of its life. Once the slope drops below 48 mV/unit pH, the sensor can no longer be calibrated.

- b. The Glass Fail High (**GFH**) limit is probably set too low for the sensor. Set the **GFH** limit to about 150 megohms greater than the measured glass impedance.
- c. If the **GLASSWArn** message was also flashing, raise the **GWH** limit from its former value by the same amount **GFH** was raised from its former value.

→ If cleaning does not lower the glass impedance and the sensor cannot be calibrated...

The sensor has failed and should be replaced.

12.4.2 GLASSWArn

GLASSWArn is an electrode fault message. It means the glass impedance is outside the programmed Glass Warning High (**GWH**) or Glass Warning Low (**GWL**) limit. Ideally, when the measurement system exceeds the glass warning limits, the user will have adequate time to diagnose and correct problems before a failure occurs. High impedance implies the electrode is aging or the sensor is not completely submerged in the process liquid. Low impedance suggests the pH sensitive glass is cracked. The message also appears if inappropriate limits have been entered into the transmitter.

If the measurement system was previously commissioned and operating correctly, **GLASSWArn** likely means a real problem exists. However, if the system is being started up or if the advanced diagnostic feature is being used for the first time, **GLASSWArn** could be caused by a miswired sensor or by programmed limits that are not correct for the sensor.

NOTE

GLASSWArn is a sensor diagnostic message. All sensor diagnostic messages are optional. They can be turned off. To disable sensor diagnostic messages, refer to Section 8.4.

Troubleshooting Flowchart - GLASSWArn

Troubleshooting **GLASSWArn** problems is exactly the same steps as troubleshooting **GLASSFAIL** problems. Refer to Section 12.4.1.

12.4.3 rEF FAIL

rEF FAIL is an electrode fault message. **rEF FAIL** means that the reference impedance exceeds the programmed Reference Fault High (**RFH**) limit. A plugged or dry reference junction is the usual cause of a high reference impedance. High reference impedance also occurs if the sensor is not submerged in the process liquid or if inappropriate limits have been entered into the transmitter.

If the measurement system was previously commissioned and operating correctly, **rEF FAIL** likely means a real problem exists. However, if the system is being started up or if the advanced diagnostic feature is being used for the first time, **rEFFAIL** could be caused by a miswired sensor or by programmed limits that are not correct for the sensor.

NOTE

rEF FAIL is a sensor diagnostic message. All sensor diagnostic messages are optional. They can be turned off. To disable sensor diagnostic messages, refer to Section 8.4.

Troubleshooting Flowchart - rEF FAIL

- A. Be sure the sensor is completely immersed in the process liquid.
- If the diagnostic message disappears, the sensor is in good condition.
 - If the diagnostic message remains, go to step B.
- B. Check that the sensor is properly wired to the transmitter. See the appropriate wiring diagram in Section 3.0. Be sure the reference in wire is attached to TB-7 and the solution ground wire is attached to TB-8. (NOTE: TB-8 means terminal 8 on the terminal board.)
- If correcting wiring problems makes the diagnostic message disappear, the sensor is in good condition.
 - If wiring is correct and the message still remains, go to step C.
- C. Measure and make a note of the reference impedance (**rIMP**). See Section 12.7.
- If the reference impedance is low (<70 kilohms)...
 - a. The reference electrode is in good condition. pH sensors manufactured by Rosemount Analytical use low impedance silver/silver chloride reference electrodes.
 - b. The reference failure high (**RFH**) limit is probably set too low. Change the limit to a value about 50 kilohms greater than the measured reference impedance. If **rEF WARN** was also displayed, change the reference warning high (**RWH**) limit to about 25 kilohms above the measured reference impedance.
 - If the reference impedance is high (>70 kilohms)...
 1. The sensor may be dirty, in which case cleaning it will lower the impedance. If the sensor is rebuildable, the reference electrolyte may be depleted. Finally, the sensor may be in good condition. The warning and failure limits are simply set too high.
 2. Inspect and clean the sensor. Refer to Section 11.3. If the sensor is rebuildable, replace the reference junction and replenish the electrolyte solution. Refer to the sensor instruction manual for details. Check the reference impedance again.
 - If cleaning the sensor reduces the impedance...
 - a. The sensor is in good condition. Calibrate the sensor and return it to the process.
 - b. Change the reference failure high (**RFH**) limit to a value about 50 kilohms greater than the measured reference impedance. If **rEF WARN** was also displayed, change the reference warning high (**RWH**) limit to about 25 kilohms above the measured reference impedance.
 - If cleaning does not reduce the impedance and the sensor is not rebuildable...
 - a. Try the reference junction rejuvenation procedure described in Section 11.3.4.
 - b. The rejuvenation procedure may not work. At best it will get a little more life out of a sensor with a plugged reference.
 - c. Whether or not the rejuvenation procedure worked, go on to step 3.
 3. Recalibrate the sensor using the autocalibration procedure in Section 6.5.
 - If the sensor can be calibrated...
 - a. The sensor is in good condition. Return it to the process.
 - b. Change the reference failure high (**RFH**) limit to a value about 50 kilohms greater than the measured reference impedance. If **rEF WARN** was also displayed, change the reference warning high (**RWH**) limit to about 25 kilohms greater than the measured reference impedance.
 - If the sensor cannot be calibrated...

The sensor has failed and must be replaced.

12.4.4 rEFWArn

rEF WArn is an electrode fault message. It means the reference electrode impedance exceeds the programmed Reference Warning High (**RWH**) limit. Ideally, when the measurement system exceeds the warning limits, the user will have adequate time to diagnose and correct problems before a failure occurs. A high reference impedance implies that the liquid junction is plugged or the reference electrolyte is depleted. The message also appears if an inappropriate limit has been entered into the transmitter.

If the measurement system was previously commissioned and operating correctly, **rEF WArn** likely means a real problem exists. However, if the system is being started up or if the advanced diagnostic feature is being used for the first time, **rEF WArn** could be caused by a miswired sensor or by programmed limits that are not correct for the sensor.

NOTE

rEF WArn is a sensor diagnostic message. Sensor diagnostic messages are optional. They can be turned off. To disable sensor diagnostic messages, refer to Section 8.4.

Troubleshooting Flowchart - rEF WArn

Troubleshooting **rEF WArn** problems is exactly the same as troubleshooting **rEF FAIL** problems. Refer to Section 12.4.3.

12.4.5 CALibrAtE

CALibrAtE is a diagnostic intended for future use. If the **CALibrAtE** message is showing go to Section 8.3 and disable **CALibrAtE**.

12.4.6 tEMP HI and tEMP LO

tEMP HI and **tEMP LO** mean the transmitter has detected a problem with the temperature measuring circuit. The problem may lie in the sensor, the cable, or the transmitter. The determination of temperature is an integral part of the pH measurement. Therefore, failure of the temperature measuring circuit is a system disabling condition. However, in an emergency, automatic temperature compensation can be disabled and the transmitter placed in manual temperature compensation. Refer to Section 8.5. For manual temperature compensation, choose a temperature equal to the average temperature of the process. The resulting pH reading will be in error. The more variable the temperature and the further the pH from 7, the greater the error.

Troubleshooting Flowchart- tEMP HI and tEMP LO

A. Check wiring, jumper settings, and software settings.

1. Check the wiring between the sensor and the transmitter. Refer to the appropriate wiring diagram in Section 3.0. Pay particular attention to TB-3 (RTD RTN), TB-4 (RTD SN), and TB-5 (RTD RTN). (NOTE: TB-3 means terminal 3 on the terminal board.)
2. Be sure the software settings in Section 8.5 match the type of RTD in the sensor.
 - If the diagnostic message disappears, the sensor is in good condition.
 - If the message persists, go to step B.

B. Check the sensor.

Refer to the wiring diagrams in Section 3.0 to identify the RTD leads. Disconnect the RTD leads and measure the resistances shown in Figure 12-3. The measured resistance should agree with the value in Table 12-1 to within about 1%. If the measured resistance is appreciably different (between 1 and 5%) from the value shown, the discrepancy can be calibrated out. See Section 8.4.

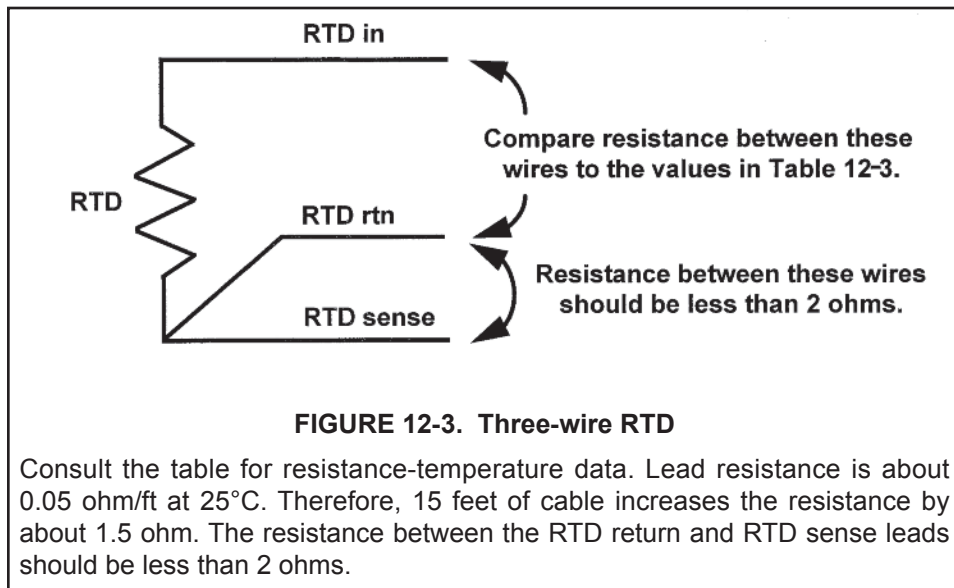

TABLE 12-1. RTD Resistance Values

Temperature	Pt-100 Resistance	Pt-1000 Resistance
0°C	100.0 ohms	1000 ohms
10°C	103.9 ohms	1039 ohms
20°C	107.8 ohms	1078 ohms
25°C	109.6 ohms	1096 ohms
30°C	111.7 ohms	1117 ohms
40°C	115.5 ohms	1155 ohms
50°C	119.4 ohms	1194 ohms
60°C	123.2 ohms	1232 ohms
70°C	127.1 ohms	1271 ohms
80°C	130.9 ohms	1309 ohms
90°C	134.7 ohms	1347 ohms
100°C	138.5 ohms	1385 ohms

- ➔ If a connection is open or shorted and it should not be, the sensor has failed. Replace the sensor.
- ➔ If the measured resistances are acceptable, go to step C.

C. Check the transmitter.

1. Disconnect the RTD sensor leads and wire the circuit shown in Figure 12-4. Set the resistance to the value for 25°C shown in Table 12-1. The measured temperature should equal 25°C to within $\pm 1^\circ\text{C}$.

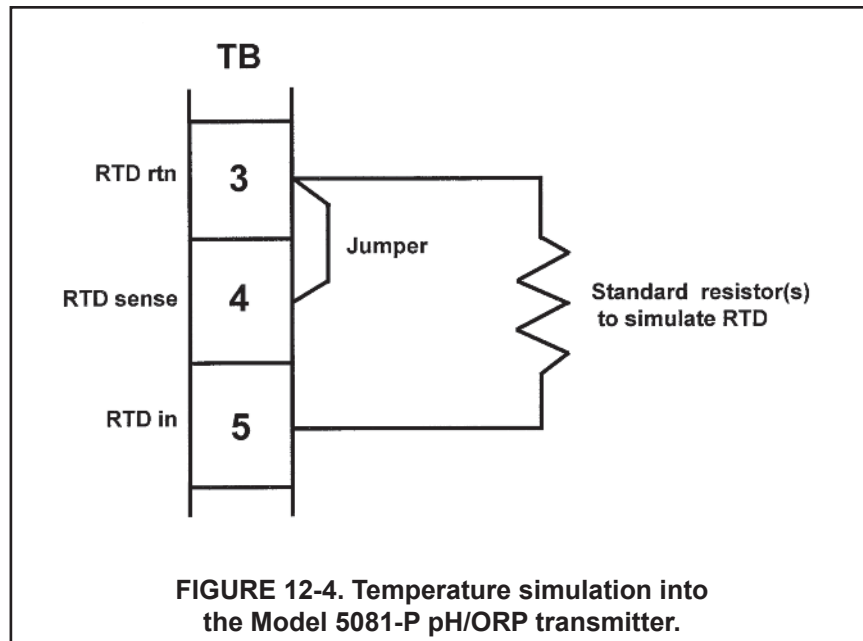

- If the measured temperature is correct, the transmitter is working properly.
- If the measured temperature is incorrect, calibrate the transmitter against the standard resistance equivalent to 25°C. See Section 8.4 for the procedure. Change the resistance and verify that the temperature reading changes to the correct value.
 - If the transmitter works properly after temperature calibration, the original calibration was in error. Re-attach the RTD wires and check the temperature performance of the sensor.
 - If the reading is still wrong, the transmitter electronics have failed. Replace the electronic board stack .

12.4.7 LInE FAIL

LInE FAIL almost always means that the transmitter is measuring an incorrect resistance between terminal TB-3 (RTD RTN) and TB-4 (RTD SNS). These terminals are critical connections for the three-wire RTD measurement. Figure 12-3 shows a three-wire RTD connection.

Troubleshooting Flowchart- LInE FAIL

A. Check for miswires and open connections at TB-3 and TB-4. Open connections can be caused by loose connections, poor spade crimps, or broken wires. Be sure to check junction boxes for proper pass through of all wires. See Section 3.0 for junction box wiring.

- If correcting a wiring problem makes the message disappear, the system is in good condition.
- If the message is still showing go to step B.

- B. The RTD sense or the RTD return wire inside the sensor cable may be broken. Keep the sensor wires attached and jumper TB-3 and TB-4.
- If the diagnostic message disappears, either the RTD return or RTD sense wire is broken. To verify a broken wire, disconnect the leads and measure the resistance between them. Installing the jumper completes the circuit, but bypasses the three-wire function. The transmitter no longer corrects for changes in lead wire resistance with temperature. Replace the sensor as soon as possible.
 - If the diagnostic message remains, go to step C.
- C. The cable connecting the sensor to the transmitter may be too long. Test using a sensor with a shorter cable.
- If shortening the cable eliminates the problem, move the transmitter closer to the sensor. It may also be possible to increase diameter of the RTD wires. Consult the factory for assistance.
 - If the diagnostic message remains go to step D.
- D. Check the performance of the transmitter. Simulate both temperature and pH. See Section 12.4.6 (steps B and C) for temperature simulation and Section 12.8 for pH simulation.
- If the transmitter fails either simulation, the electronic board stack should be replaced.
 - If the transmitter passes the simulations, the transmitter is in good condition and the sensor should be replaced.

12.4.8 InPUt WArn

InPUt WArn means that the input value or the calculated pH is outside the measurement range. The measured pH is less than -2 or greater than 16.

Troubleshooting Flowchart-InPUt WArn

- A. Check for miswires and open connections, particularly at TB-10. Open connections can be caused by loose connections, poor spade crimps, or broken wires. Be sure to check junction boxes for proper pass through of all wires. See Section 3.0 for junction box wiring.
- If correcting a wiring problem clears the message, the system is in good condition.
 - If the message is still showing go to step B.
- B. Check that the transmitter is working properly by simulating a pH input. See Section 12.8.
- If the transmitter does not respond to simulated inputs, replace the board stack.
 - If the transmitter performs satisfactorily and the preamplifier is located in a remote junction box or in a sensor - mounted junction box, go to step C.
 - If the transmitter performs properly and the preamplifier is located in the transmitter, the sensor has failed and should be replaced.
- C. The problem may lie with the remote preamplifier or with the cable connecting the preamplifier and junction box to the transmitter.
1. Be sure all wires between the junction box and the transmitter are connected.
 2. Use Rosemount Analytical cable. Generic cable may not work. Refer to Section 3.0 for part numbers.
 - If the diagnostic message clears, the interconnecting cable was the problem.
 - If the message remains, go to step D.
- D. Confirm that the problem is with the remote preamplifier. Wire the pH sensor directly to the transmitter. Change the menu from **PAMP=SnSr** to **trAnS** for the test and return it to **SnSr** afterwards. See Section 2.2.
- If the error message clears, the remote preamplifier is faulty. Replace the preamplifier.
 - If the error message remains, the sensor has failed. Replace the sensor.

12.4.9 SLOPE Err LO

SLOPE Err LO means that a two-point buffer calibration attempt has failed. The slope is too low (<40 mV/pH) for a good measurement.

Troubleshooting Flowchart-SLOPE Err LO

- A. Repeat the calibration.
1. Inaccurate buffers can cause a low slope. Repeat the calibration using fresh buffers. Alkaline buffers, pH 10 or greater, are particularly susceptible to changing value in air or with age. If a high pH buffer was used in the failed calibration, try a lower pH buffer when repeating the calibration. For example, use pH 4 and 7 buffer instead of pH 7 and 10 buffer.
 2. Allow adequate time for readings in buffer to become constant. If the sensor was in a process substantially colder or hotter than the buffer, allow at least 20 minutes for readings in the buffer to stabilize. Alternatively, place the sensor in a container of water at ambient temperature for 20 minutes before starting the calibration.
 3. Be sure the correct buffer values are being entered during calibration.
 - If the second calibration was successful, an error was made during the first attempt.
 - If the second calibration fails, go to step B.
- B. Refer to the wiring diagrams in Section 3.0 and check wiring. Connections to TB-10, TB-7, and TB-8 are particularly important. Recalibrate the sensor using the auto calibration procedure in Section 7.5.
 - If wiring was the only problem, the sensor should calibrate.
 - If the message persists, go to step C.
- C. Inspect and clean the sensor. See Section 11.3. Recalibrate the sensor using the autocalibration procedure in Section 7.5.
 - If the sensor was dirty, it should calibrate after cleaning.
 - If the message persists, go to step D.
- D. Check for a faulty sensor.
 - If a spare sensor is available, connect it to the transmitter. Use the auto calibration procedure in Section 6.5 to calibrate the sensor.
 - If the new sensor cannot be calibrated, the transmitter is faulty. Go to step E.
 - If the new sensor can be calibrated, the old sensor has failed.
 - If a spare sensor is not available measure the glass impedance (**GIMP**). See Section 12.7.
 - If the glass impedance is less than about 20 megohms, the glass has cracked and the electrode must be replaced.
 - If the glass impedance is greater than about 20 megohms, the sensor is probably in good condition. Go to step E.
- E. Check transmitter performance by simulating pH inputs. See Section 12.8.
 - If the transmitter performs satisfactorily, go to step F.
 - If the transmitter does not respond to simulated inputs, replace the board stack.
- F. If the transmitter responds to simulated inputs, the problem must lie with the sensor or the interconnecting wiring. Verify the interconnecting wiring point to point. Fix or replace bad cable. If cable is good, replace the pH sensor.

12.4.10 SLOPE Err HI

SLOPE Err HI means that a two-point buffer calibration attempt has failed. The slope is too high (>62 mV/pH) for a good measurement.

Troubleshooting Flowchart-SLOPE Err HI

- A. Repeat the calibration.
1. Inaccurate buffers can cause a low slope. Repeat the calibration using fresh buffers. Alkaline buffers, pH 10 or greater, are particularly susceptible to changing value in air or with age. If a high pH buffer was used in the failed calibration, try a lower pH buffer when repeating the calibration. For example, use pH 4 and 7 buffer instead of pH 7 and 10 buffer.
 2. Allow adequate time for readings in buffer to become constant. If the sensor was in a process substantially colder or hotter than the buffer, allow at least 20 minutes for readings in the buffer to stabilize. Alternatively, place the sensor in a container of water at ambient temperature for 20 minutes before starting the calibration.
 3. Be sure the correct buffer values are being entered during calibration. To minimize errors caused by entering the wrong buffer values, use autocalibration procedure described in Section 7.5.
 4. Verify that the temperature reading is accurate. Compare the sensor reading against a thermometer known to be accurate. Recalibrate if necessary. See the procedure in Section 7.4.
 - If the second calibration was successful, an error was made during the first attempt.
 - If the second calibration fails, go to step B.
- B. There is a remote possibility of a problem with the autocalibration program. Repeat the calibration using the manual calibration procedure in Section 7.6
- If manual calibration was successful when autocalibration failed, the problem might be with the sensor electronics. Call the factory for assistance.
 - If manual calibration is not possible, go to step C.
- C. Check transmitter performance by simulating pH inputs. See Section 12.8.
- If the transmitter performs satisfactorily, go to step D.
 - If the transmitter does not respond to simulated inputs, replace the board stack.
- D. If the transmitter responds to simulated inputs, the problem must lie with the sensor or the interconnecting wiring. Verify the interconnecting wiring point to point. Fix or replace bad cable. If cable is good, replace the pH sensor.

12.4.11 Std Err

Std Err means the reference electrode voltage has changed drastically. Typical causes are exposure to poisoning agents, sulfides or cyanides, or prolonged exposure to high temperature.

Troubleshooting Flowchart-Std Err

Troubleshooting depends on the type of sensor.

- If the sensor is rebuildable...
 - Replenish the electrolyte solution and replace the liquid junction. Calibrate the sensor.
 - If the sensor can be calibrated, the problem has been corrected.
 - If the sensor cannot be calibrated, replace the sensor. If the sensor has separate measuring and reference electrodes, replace only the reference electrode.

If the sensor is not rebuildable...

- ↳ Try the reference electrode rejuvenation procedure described in Section 11.0.
 - ↳ If the rejuvenated sensor can be calibrated, the problem has been corrected.
 - ↳ If the sensor cannot be calibrated, replace the sensor.

12.4.12 rOM FAIL or CPU FAIL

rOM FAIL or **CPU FAIL** means the transmitter electronics have failed. Replace the electronic board stack (PN 23992-02 [-HT] or PN 23992-03 [-FF]).

12.4.13 AdC WArn or CyCLE PWr

The **AdC WArn** or **CyCLE PWr** message appears momentarily when the transmitter has recognized an internal calculation problem. The transmitter repeats the calculation, and the message disappears once the calculation is successful. If the message is displayed constantly, the transmitter electronics may be faulty.

Troubleshooting-AdC WArn or CyCLE PWr

- A. Check transmitter performance by simulating pH inputs. See Section 12.8.
 - ↳ If the transmitter performs satisfactorily, go to step B.
 - ↳ If the transmitter does not respond to simulated inputs, replace the board stack.
- B. If the transmitter responds to simulated inputs, the problem must lie with the sensor or the interconnecting wiring. Verify the interconnecting wiring point to point. Fix or replace bad cable. If cable is good, replace the pH sensor.

12.4.14 WritE Err

WritE Err means that jumper JP1 on the CPU board is not in place. If the sensor is not in place, the transmitter cannot be programmed or calibrated.

Troubleshooting-WritE Err

Refer to Section 2.2. Check the position of jumper JP1 on the CPU board. If the jumper is hanging off one of the pins, place it across both pins. If the jumper is missing entirely, use jumper JP3 (50/60 Hz), which is not a critical jumper. THERE ARE SIMILAR NUMBERED JUMPERS ON THE ANALOG BOARD. THE JUMPER TO BE CHECKED IS ON THE CPU BOARD, WHICH IS THE CENTER BOARD IN THE STACK. Turn the power to the transmitter off and then back on.

- ↳ Toggling the power should cause the message to disappear.
- ↳ If the message does not disappear, replace the electronic board stack.

12.4.15 FACT FAIL

FACT FAIL appears if the transmitter factory calibration message has been triggered. A stray noise spike can cause this message to appear. If the pH reading seems acceptable, reset the calibration flag.

1. Enter the factory calibration menu by pressing **2** on the IRC ten times. The display will not change. Immediately press **3**. **FactorYCAL** appears in the display.
2. Press NEXT. **rEPAir** appears in the display.
3. Press NEXT. **ConFiG** appears in the display.
4. Press NEXT. **rESEt** appears in the display.
5. Press ENTER. **rESEtCFG** appears in the display.
6. Press ENTER. **rESEt** appears again.
7. Press NEXT. **FactorYCAL** reappears.
8. Press ENTER. **FactOn** appears in the display.
9. Press **3**. **FactOFF** appears. Press ENTER to store the settings.
10. Press EXIT repeatedly until the main display reappears.

If the message does not clear or problems persist, the electronics have failed. Replace the electronic board stack.

12.5 TROUBLESHOOTING WHEN NO DIAGNOSTIC MESSAGE IS SHOWING

If no diagnostic message is showing, locate the symptom(s) in the table below and refer to the appropriate section for assistance.

SYMPTOM	SECTION
Id 000 appears in display when trying to program or calibrate transmitter	12.5.1
Error message flashing in display	12.4
Transmitter does not respond to remote controller	12.5.2
Calibration Problems:	
SLOPE Err HI or SLOPE Err LO appears after calibration attempt	12.5.3
bF1 or bF2 continuously flashes during auto calibration	12.5.4
pH reading in buffer drifts during manual calibration	12.5.5
Measurement Problems:	
Sensor does not respond to known pH changes	12.5.6
Buffer calibration is acceptable; process pH is slightly different from expected value	12.5.7
Buffer calibration is acceptable; process pH is grossly wrong and/or readings are noisy	12.5.8
Temperature reading is inaccurate	12.5.9
Transmitter problems	
No display	12.5.10
Display segments missing or display incorrect	12.5.11
Transmitter locked up, all display segments lit	12.5.12
Transmitter periodically restarts itself	12.5.13

12.5.1 Id 000 in Display

A security code has been programmed into the transmitter. The correct code must be entered before the transmitter can be programmed or calibrated. To retrieve a lost security code see Section 5.8. To change the security code, see Section 5.8.

12.5.2 Transmitter Does Not Respond to Infrared Remote Controller (IRC)

- A. Be sure the transmitter is receiving the signal.
 - 1. Clean the window in front of the IR detector. The detector is a small rectangle just above the main display
 - 2. Hold the IRC at least six feet from the transmitter and not more than 15 degrees from the center.
 - 3. Hold the IRC closer (within two feet) in case the batteries are getting weak.
- B. If step A fails to help, check the IRC.
 - 1. If a second Model 5081-P transmitter is available, test the IRC on that transmitter. If a spare transmitter is not available, continue with step 2.
 - 2. The green LED, located just above and between the RESET and HOLD buttons, should light when a key is pressed. A piece of black rubber film may be covering the LED. Scrape the film away with your fingernail to expose the LED. The two clear LEDs on the front end of the IRC never light. They transmit the invisible IR signal.
 - 3. If the green LED does not light, the IRC is not working. Go to step C.
- C. Take the IRC to a non-hazardous area and replace the two 1.5 Vdc AAA batteries.
 - If the green LED lights, but the transmitter still does not respond, go to step D.
 - If neither the LED lights nor the transmitter responds, replace the IRC.
- D. Replace the transmitter display board.

12.5.3 SLOPE Err LO or SLOPE Err HI Appear After Calibration Attempt

Refer to Section 12.4.9 and Section 12.4.10 for assistance in solving calibration slope problems.

12.5.4 bF1 or bF2 Continuously Flashes During Auto Calibration

During autocalibration, bF1 or bF2 flashes until the pH reading of the sensor in buffer is stable.

- A. Check the stability limits set in Section 8.7. If the stabilization range (prompt **PH**) is set too narrow or the stabilization time (prompt **tIME**) is set too long, the transmitter will not accept buffer readings. A good choice for **PH** is 0.02, and a good choice for **tIME** is 10 - 20 seconds.
- B. Allow adequate time for the temperature of the sensor to reach the temperature of the buffer. If the sensor was in a process substantially hotter or colder than the buffer, allow at least 20 minutes for readings in the buffer to stabilize. Alternatively, place the sensor in a container of water at ambient temperature for 20 minutes before starting the calibration.
- C. Be sure to swirl sensor after placing it in each new buffer solution.
- D. Finally, check the sensor. Verify that wiring is correct. Also, the sensor may be dirty or aged, or the reference junction may be depleted.
 - 1. Check that the sensor is properly wired to the transmitter. See Section 3.0. Pay particular attention to terminals TB-10 (mV in), TB-7 (reference), and TB-8 (solution ground).
 - 2. See Section 11.3 for cleaning procedures.
 - 3. If the sensor is not rebuildable, see Section 11.3.4 for a method of rejuvenating the reference junction.
 - 4. If the sensor is rebuildable, replenish the reference electrolyte and replace the liquid junction.
 - 5. Replace the sensor. A clean pH sensor should not drift in buffer.

12.5.5 pH Reading in Buffer Drifts During Manual Calibration

- A. Allow adequate time for the temperature of the sensor to reach the temperature of the buffer. If the sensor was in a process substantially hotter or colder than the buffer, allow at least 20 minutes for readings in the buffer to stabilize. Alternatively, place the sensor in a container of water at ambient temperature for 20 minutes before starting the calibration.
- B. Be sure to swirl sensor after placing it in each new buffer solution.
- C. Finally, check the sensor. Verify that wiring is correct. Also, the sensor may be dirty or aged, or the reference junction may be depleted.
 1. Check that the sensor is properly wired to the transmitter. See Section 3.0. Pay particular attention to terminals TB-10 (mV in), TB-7 (reference), and TB-8 (solution ground).
 2. See Section 11.3 for cleaning procedures.
 3. If the sensor is not rebuildable, see Section 11.3.4 for a method of rejuvenating the reference junction.
 4. If the sensor is rebuildable, replenish the reference electrolyte and replace the liquid junction.
 5. Replace the sensor. A clean pH sensor should not drift in buffer.

12.5.6 Sensor Does Not Respond To Known pH Changes

- A. Verify that the change really happened. If pH response was being checked in buffers, recheck performance with fresh buffers. If a process pH reading was not what was expected, check the performance of the sensor in buffers. Also, use a second pH meter to verify that the expected change in the process pH really occurred.
- B. Check the sensor. Verify that wiring is correct. Also, the sensor may be dirty or aged, or the reference junction may be depleted.
 1. Check that the sensor is properly wired to the transmitter. See Section 3.0. Pay particular attention to terminals TB-10 (mV in), TB-7 (reference), and TB-8 (solution ground).
 2. See Section 11.3 for cleaning procedures.
- C. If a clean, properly wired sensor does not respond to pH changes, the glass bulb is probably broken or cracked.
 - If a spare sensor is available, check the spare.
 - If the spare sensor responds to pH changes, the old sensor has failed.
 - If the spare sensor does not respond to pH changes, go to step D.
 - If a spare sensor is not available, check the glass impedance (**GIMP**) of the existing sensor. See Section 11.7.
 - If the impedance is less than about 20 megohm, the pH glass is cracked. Replace the sensor.
 - If the impedance is greater than about 20 megohm, go to step D.
- D. Check transmitter performance by simulating pH inputs. See Section 12.8.
 - If the transmitter responds to simulated inputs, the problem must lie with the sensor or the interconnecting wiring. Verify the interconnecting wiring point to point. Fix or replace bad cable. If cable is good, replace the pH sensor.
 - If the transmitter does not respond to simulated inputs, replace the board stack.

12.5.7 Buffer Calibration Is Acceptable; Process pH is Slightly Different from Expected Value.

Differences between pH readings made with an on-line instrument and a laboratory or portable instrument are normal. The on-line instrument is subject to process variables, for example grounding potentials, stray voltages, and orientation effects, that do not affect the laboratory or portable instrument. To make the Model 5081-P pH/ORP transmitter match the reading from a second pH meter refer to Section 7.7.

12.5.8 Buffer Calibration Is Acceptable; Process pH is Grossly Different from Expected Value.

The symptoms suggest a ground loop (measurement system connected to earth ground at more than one point), a floating system (no earth ground), or noise being induced into the transmitter by sensor cabling. The problem arises from the process or installation. It is not a fault of the transmitter. The problem should disappear once the sensor is taken out of the system.

- A. To confirm a ground loop...
1. Verify that the system works properly in buffers. Be sure there is no direct electrical connection between the buffer containers and the process liquid or piping.
 2. Strip back the ends of a heavy gauge wire. Connect one end of the wire to the process piping or place it in the process liquid. Place the other end of the wire in the container of buffer with the sensor. The wire makes an electrical connection between the process and sensor.
 3. If similar symptoms develop after making the connection, a ground loop exists. If no symptoms develop, a ground loop may or may not exist.
- B. Check the grounding of the process.
1. The measurement system needs one path to ground: through the process liquid and piping. Plastic piping, fiber glass tanks, and ungrounded or poorly grounded vessels do not provide a path. A floating system can pick up stray voltages from other electrical equipment.
 2. Ground the piping or tank to a local earth ground. Metal tees, grounding rings, or grounding rods may be required.
 3. If problems persist, connect a wire from the the ground connection at the dc power supply to the transmitter case. Connect a second wire from the transmitter case to the process. These connections force the grounds to the same potential.
 4. If the problem persists, simple grounding is not the problem. Noise is probably being carried into the instrument through the sensor wiring. Go to step C.
- C. Simplify the sensor wiring.
1. Disconnect all sensor wires at the transmitter except: TB-4 (RTD SNS), TB-5 (RTD IN), TB-7 (REF IN), and TB-10 (pH/ORP IN). If a remote preamplifier is being used, disconnect the wires at the input side of the junction box.
 2. Tape back the ends of the disconnected wires, including all shield and drain wires, to keep them from making accidental connections with other wires, terminals, or the transmitter case.
 3. Connect a jumper wire between TB-3 (RTD RTN) and TB-4 (RTD-SNS). Connect a second jumper wire between TB-7 (REF IN) and TB-8 (SOL GND).
 4. Place the sensor back in the process liquid. If diagnostic messages such as GLASSFAIL or REF WArn appear, turn off the sensor diagnostics. See Section 8.4.
 - If the symptoms disappear, interference was coming into the transmitter along one of the sensor wires. The measurement system can be operated permanently with the simplified wiring.
 - If symptoms still persist, go to step D.
- D. Check for extra ground connections or induced noise.
1. The electrode system is connected to earth ground through the process. If other ground connections exist, there are multiple paths and ground loops are present. Noise enters the measurement either by a direct connection, usually between the cable and grounded metal, or by an indirect connection, usually EMI/RFI picked up by the cable.
 2. If the sensor cable is run inside conduit, there may be a short between the cable and the conduit. Re-run the cable outside the conduit. If symptoms disappear, then a short exists between the cable and the conduit. Likely a shield is exposed and is touching the conduit. Repair the cable and reinstall it in the conduit.
 3. To avoid induced noise in the sensor cable, run it as far away as possible from power cables, relays, and electric motors. Keep sensor wiring out of crowded panels and cable trays.
 4. Occasionally, noise can travel into the transmitter housing from the metal it is mounted on. The noise is then radiated into the transmitter electronics. If isolating the transmitter from its metal mounting eliminates the symptoms, move the transmitter to a different location or mount it with isolating materials.
 5. If ground loop problems persist, consult the factory. A visit from an experienced service technician may be required to solve plant-induced problems.

12.5.9 Temperature Reading Is Inaccurate

- A. To troubleshoot temperature problems refer, to Section 12.4.6.
- B. To calibrate the temperature response of the sensor, refer to Section 6.4.
- C. If necessary, automatic temperature compensation can be temporarily disabled and the transmitter placed in manual temperature compensation. Refer to Section 8.5. For manual temperature, choose a temperature equal to the average temperature of the process. The resulting pH reading will be in error. The more variable the temperature and the further from pH 7, the greater the error.

12.5.10 HART Communications Problems

- A. If the Model 375 or 475 Communicator software does not recognize the Model 5081pH/ORP transmitter, order an upgrade from Rosemount Measurement at (800) 999-9307.
- B. Be sure the HART load and voltage requirements are met.
 - 1. HART communications requires a minimum 250 ohm load in the current loop.
 - 2. Install a 250-500 ohm resistor in series with the current loop. Check the actual resistor value with an ohmmeter.
 - 3. For HART communications, the power supply voltage must be at least 18 Vdc. See Section 2.4.
- C. Be sure the HART Communicator is properly connected.
 - 1. The Communicator leads must be connected across the load.
 - 2. The Communicator can be connected across the power terminals (TB-15 and TB-16).
- D. Verify that the Model 375 or 475 is working correctly by testing it on another HART Smart device.
 - 1. If the Communicator is working, the transmitter electronics may have failed. Call Rosemount Analytical for assistance.
 - 2. If the Communicator seems to be malfunctioning, call Rosemount Measurement at (800) 999-9307 for assistance.

12.5.11 No Display

- A. Be sure power requirements are being met.
 - 1. The positive voltage lead must be connected to TB-16.
 - 2. Check dc voltage requirements and load restrictions. Refer to Section 2.5.
- B. Check for bad connections between the circuit boards. Refer to Section 2.2. Be sure the ribbon cable between the display and CPU boards is firmly seated in the socket on the CPU board. Be sure the socket connection between the CPU and analog boards is firm.

12.5.12 Display Segments Missing

Replace the display board.

12. 5.13 Transmitter Locks Up

- A. Turn the dc power off, then turn it back on.
- B. If the problem persists, replace the electronic board stack (PN 23992-02, HT; PN 23992-03, FF).

12. 5.14 Transmitter Periodically Restarts Itself

- A. The problem is usually related to improperly wired RTD input terminals.
 - 1. The RTD return wire must be connected to TB-3. The RTD sense wire must be connected to TB-4, and the RTD in wire must be connected to TB-5. See the wiring diagrams in Section 3.0. If the pH sensor does not have an RTD, connect a jumper wire across the terminals TB-3 and TB-4 and a second jumper across TB-4 and TB-5.
 - 2. If the RTD connections have been jumpered as described in step B, automatic temperature compensation must be turned off and the transmitter operated in manual temperature mode. See Section 7.4 for the procedure.
- B. If RTD wiring is correct and problems still persist.
 - 1. Monitor the dc power supply. Be sure the power is not intermittent and the correct voltage is present. See Section 2.5.
 - 2. Try connecting the transmitter to a different power supply.

12.6 DISPLAYING DIAGNOSTIC VARIABLES

12.6.1 Purpose

This section describes how to display the diagnostic variables listed below:

DIAGNOSTIC MEASUREMENTS
1. Sensor voltage in mV (InPut)
2. Glass impedance in megohms (GIMP)
3. Reference impedance in kilohms* (rIMP)
4. Temperature in °C (tEMP)

* For high impedance reference electrodes, the reference impedance is in megohms.

DIAGNOSTIC MESSAGES
1. Software version (Ver)
2. Display last three fault messages (ShoW FLt)

For an explanation of the meaning of diagnostic messages, refer to Section 8.3. **Displays are read only.**

12.6.2 Procedure

1. Enter the Diagnostic menu by pressing **DIAG** on the IRC. Sensor voltage in mV (**InPut**) appears.
2. Press **NEXT**. The temperature corrected glass impedance in megohms (**GIMP**) appears.
3. Press **NEXT**. The reference impedance (**rIMP**) appears. For conventional low impedance silver/silver chloride reference electrodes, the reference impedance has units of kilohms. For the rare occasions when a high impedance reference is used, the units are megohms. See Section 8.4.3 (for pH) for more information.
4. Press **NEXT**. The model number and software version (**Ver**) appears.
5. Press **NEXT**. The temperature (**tEMP**) measured by the sensor appears.
6. Press **NEXT**. The **ShoW FLt** sub-menu appears.
7. Press **ENTER**. The most recent fault message appears in the display. Press **NEXT** repeatedly to scroll through the stored messages. The transmitter only remembers the three most recent messages. **nonE** appears if there are no faults. Pressing **EXIT** clears all the stored messages and returns the transmitter to the **ShoW FLt** display. If the transmitter loses power, all stored warning and fault messages are lost.
8. Press **EXIT** to return to the process display.

12.7 TESTING THE TRANSMITTER BY SIMULATING THE pH.

12.7.1 General.

This section describes how to simulate a pH input into the 5081-P pH/ORP transmitter. pH is directly proportional to voltage. To simulate the pH measurement, connect a standard millivolt source to the transmitter. If the transmitter is working properly, it will accurately measure the input voltage and convert it to pH. Although the general procedure is the same, the wiring details depend on the location of the preamplifier. Consult the table to find the correct procedure.

Preamplifier located in	Section
Transmitter	12.8.2
Remote junction box	12.8.3
Sensor-mounted junction box	12.8.3
Sensor (Model 381+ only)	12.8.4
Sensor (all other models)	12.8.5

12.7.2 pH Simulation When the Preamplifier Is Located in the Transmitter.

1. Program PAMP to "transmitter". See Section 5.0.
2. Turn off sensor diagnostics. See Section 8.3.
3. Turn off automatic temperature compensation. Set manual temperature compensation to 25°C. See Section 8.4.
4. Disconnect the sensor and wire the transmitter as shown in Figure 12-5.
5. Attach a jumper between TB-7 (REF IN) and TB-10 (pH IN).
6. Measure the voltage. Press DIAG on the IRC. The InPut voltage in millivolts will appear in the temperature-output area. The main display will continue to show pH. The measured voltage should be 0 mV, and the pH should be approximately 7. Because the calibration data in the transmitter may be offsetting the input voltage, the displayed pH may not be exactly 7.0. If the actual readings are close to expected, the transmitter is probably operating properly.
7. If a standard millivolt source is available, remove the jumper between TB-7 and TB-10 and connect the voltage source.
8. Following the procedure in Section 7.5, calibrate the transmitter. Use 0.0 mV for pH 7 (**bF1**) and -177.4 mV for pH 10 (**bF2**). If the transmitter is working, it should accept the calibration.
9. To check linearity, leave autocalibration and return to the main display. Set the voltage source to the values in the table and verify that the pH reading matches the expected value.

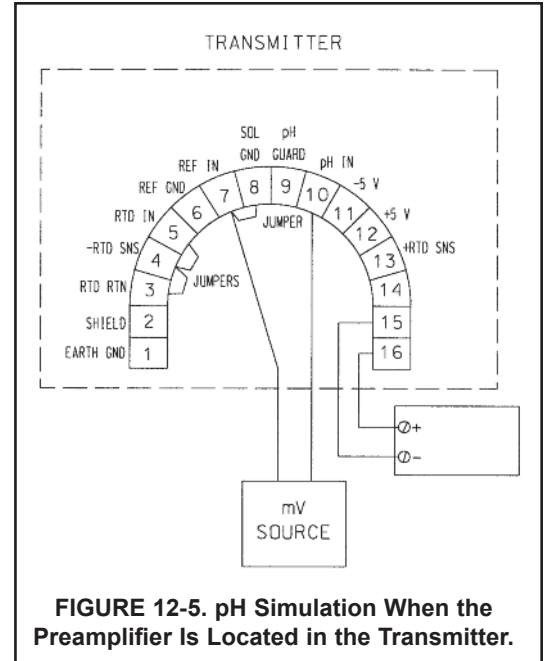

FIGURE 12-5. pH Simulation When the Preamplifier Is Located in the Transmitter.

Voltage (mV)	pH
295.8	2.00
118.3	5.00
-118.3	9.00
-295.8	12.00

12.7.3 pH Simulation When the Preamplifier Is Located in a Remote Junction Box or in a Sensor-Mounted Junction Box.

1. Program PAMP to "sensor". See Section 5.0.
2. Turn off sensor diagnostics. See Section 8.3.
3. Turn off automatic temperature compensation. Set manual temperature compensation to 25°C. See Section 8.4.
4. Disconnect the sensor and wire the sensor side of the junction box as shown in Figure 12-6. Leave the interconnecting cable between the junction box and transmitter in place.
5. Attach a jumper between TB1-7 (REF IN) and TB1-10 (pH IN).
6. From this point on, continue with steps 6 through 9 in Section 12.8.2. For testing using a standard millivolt source, be sure to remove the jumper between TB1-7 and TB1-10 before connecting the standard millivolt source.

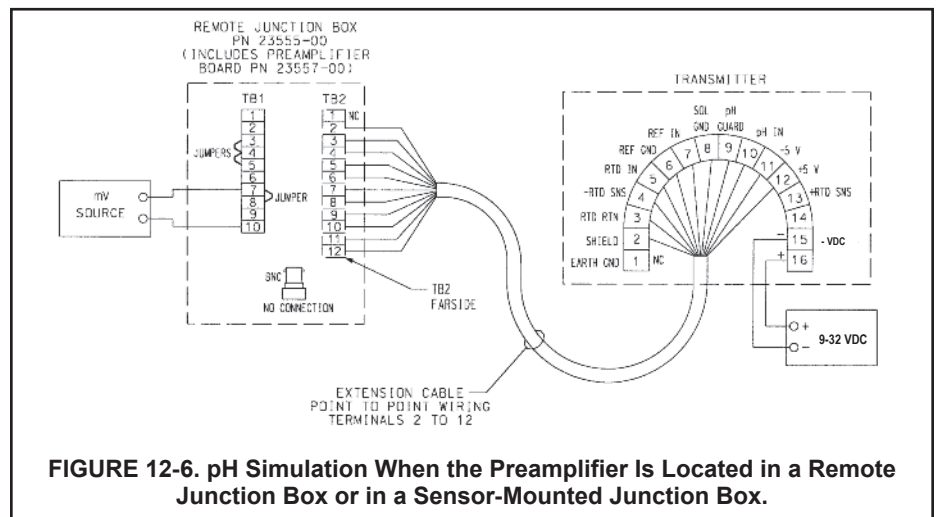
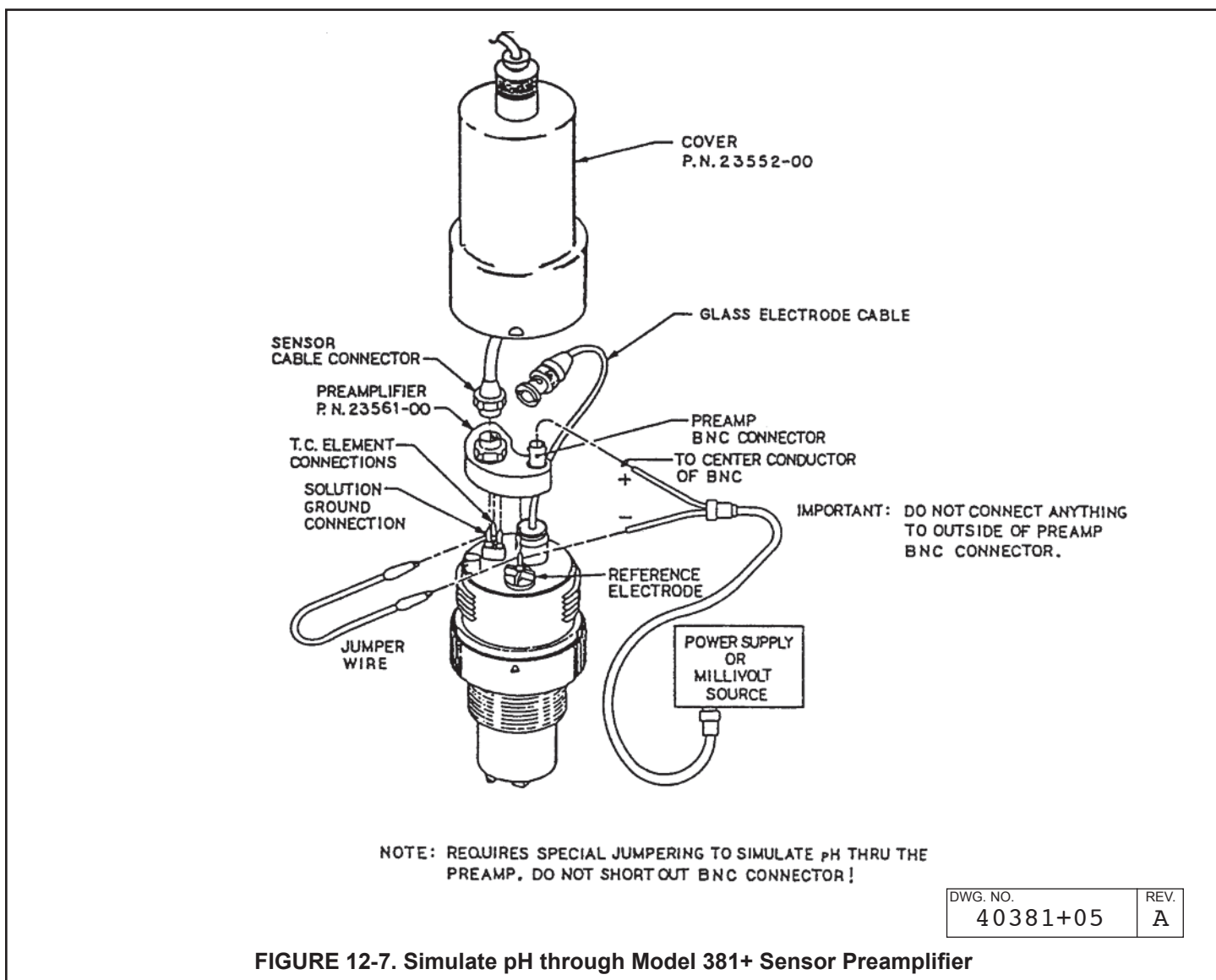

FIGURE 12-6. pH Simulation When the Preamplifier Is Located in a Remote Junction Box or in a Sensor-Mounted Junction Box.

12.7.4 pH Simulation with the Model 381+ Sensor

1. Verify that switch S-1 is set to "sensor or junction box". See Section 2.2.
2. Turn off sensor diagnostics. See Section 5.5.
3. Turn off automatic temperature compensation. Set manual temperature compensation to 25°C. See Section 8.5.
4. Refer to Figure 12-7 for connections to the sensor.
5. Remove the cover from the sensor. Leave the sensor cable connector attached.
6. Remove the glass electrode cable from the BNC connection at the preamplifier.
7. Connect one end of a jumper wire to the solution ground pin and connect the other end to the reference electrode pin. Both pins are underneath the preamplifier. Leave the preamplifier installed on the pins.
8. Connect one end of a second jumper wire to the reference electrode pin. Be sure the preamplifier remains connected to the pins.
9. Press DIAG on the IRC. The **InPut** voltage in millivolts will appear in the temperature-output area. The main display will show pH.

**FIGURE 12-7. Simulate pH through Model 381+ Sensor Preamplifier**

10. Touch the other end of the second jumper to the center pin of the BNC connector on the preamplifier. DO NOT LET THE WIRE TOUCH THE OUTSIDE OF THE BNC CONNECTOR.
11. Measure the voltage. The measured voltage should be 0 mV, and the pH should be approximately 7. Because the calibration data in the transmitter may be offsetting the input voltage, the displayed pH may not be exactly 7.0. If the actual readings are close to expected, the transmitter is probably working fine.
12. If a standard millivolt source is available, use it to perform a simulated calibration.
13. Remove the jumper used to connect the reference pin to the center pin of the BNC. Connect the negative terminal of the standard millivolt source to the reference pin and connect the positive terminal to the center pin of the BNC. DO NOT LET THE WIRE TOUCH THE OUTSIDE OF THE BNC CONNECTOR.
14. Following the autocalibration procedure in Section 7.5, calibrate the transmitter. Use 0.0 mV for pH 7 (**bF1**) and -177.4 mV for pH 10 (**bF2**). If the transmitter is working, it should accept the calibration.
15. To check linearity, leave autocalibration and return to the main display. Set the voltage source to the values in the table and verify that the pH reading matches the expected value.

Voltage (mV)	pH
295.8	2.00
118.3	5.00
-118.3	9.00
-295.8	12.00

12.7.5 pH Simulation When Preamplifier is in Sensor

The preamplifier in the sensor simply converts the high impedance signal into a low impedance signal without amplifying it. To simulate pH values, use the procedure in Section 12.8.

12.8 FACTORY ASSISTANCE AND REPAIRS

12.8.1 Troubleshooting Assistance.

For assistance in correcting transmitter, sensor, and measurement problems...

- in the United States call Emerson Process Management Liquid Division at (800) 854-8527.
- outside the United States call the nearest Emerson Process Management office. See the back page of the manual.

12.8.2 Return of Materials

If it is necessary to return the transmitter to the factory for repairs...

- in the United States call Emerson Process Management Liquid Division at (800) 854-8257.
- outside the United States call the nearest Emerson Process Management office. See the back page of the manual.

Always call before returning material. Do not send anything without obtaining a Return Material Authorization (RMA) number.

SECTION 13.0

pH MEASUREMENTS

- 13.1 General
- 13.2 Measuring Electrode
- 13.3 Reference Electrode
- 13.4 Liquid Junction Potential
- 13.5 Converting Voltage to pH
- 13.6 Glass Electrode Slope
- 13.7 Buffers and Calibration
- 13.8 Isopotential pH
- 13.9 Junction Potential Mismatch
- 13.10 Sensor Diagnostics
- 13.11 Shields, Insulation, and Preamplifiers

13.1 GENERAL

In nearly every industrial and scientific application, pH is determined by measuring the voltage of an electrochemical cell. Figure 13-1 shows a simplified diagram of a pH cell. The cell consists of a measuring electrode, a reference electrode, a temperature sensing element, and the liquid being measured. The voltage of the cell is directly proportional to the pH of the liquid. The pH meter measures the voltage and uses a temperature-dependent factor to convert the voltage to pH. Because the cell has high internal resistance, the pH meter must have a very high input impedance.

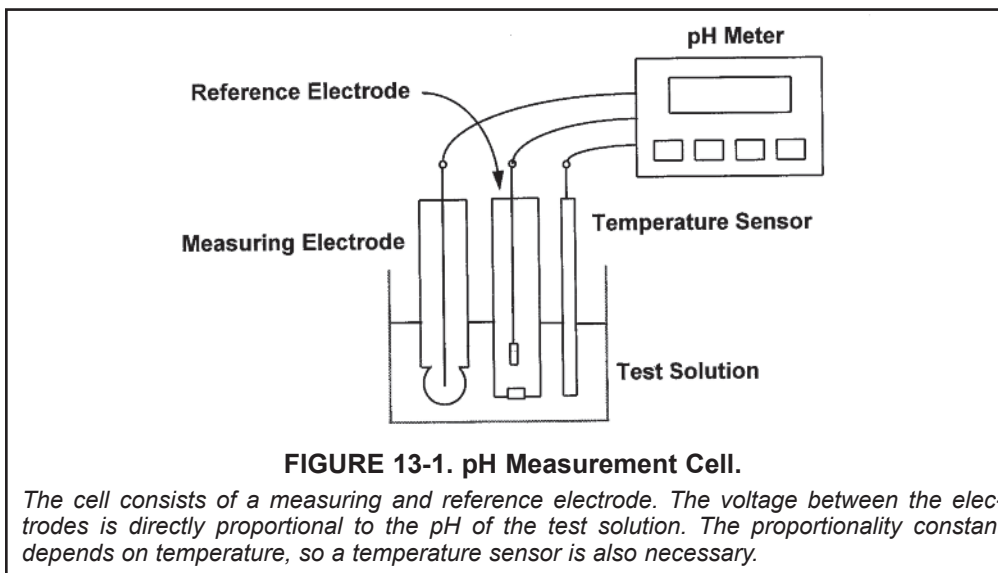

Figure 13-1 shows separate measuring and reference electrodes. In most process sensors, the electrodes and the temperature element are combined into a single body. Such sensors are often called combination electrodes.

The cell voltage is the algebraic sum of the potential of the measuring electrode, the potential of the reference electrode, and the liquid junction potential. The potential of the measuring electrode depends only on the pH of the solution. The potential of the reference electrode is unaffected by pH, so it provides a stable reference voltage. The liquid junction potential depends in a complex way on the identity and concentration of the ions in the sample. It is always present, but if the sensor is properly

designed, the liquid junction potential is usually small and relatively constant. All three potentials depend on temperature. As discussed in Sections 13.5 and 13.6, the factor relating the cell voltage to pH is also a function of temperature.

The construction of each electrode and the electrical potentials associated with it are discussed in Sections 13.2, 13.3, and 13.4.

13.2 MEASURING ELECTRODE

Figure 13-2 shows the internals of the measuring electrode. The heart of the electrode is a thin piece of pH-sensitive glass blown onto the end of a length of glass tubing. The pH-sensitive glass, usually called a glass membrane, gives the electrode its common name: glass electrode. Sealed inside the electrode is a solution of potassium chloride buffered at pH 7. A piece of silver wire plated with silver chloride contacts the solution.

The silver wire-silver chloride combination in contact with the filling solution constitutes an internal reference electrode. Its potential depends solely on the chloride concentration in the filling solution. Because the chloride concentration is fixed, the electrode potential is constant.

As Figure 13-2 shows, the outside surface of the glass membrane contacts the liquid being measured, and the inside surface contacts the filling solution. Through a complex mechanism, an electrical potential directly proportional to pH develops at each glass-liquid interface. Because the pH of the filling solution is fixed, the potential at the inside surface is constant. The potential at the outside surface, however, depends on the pH of the test solution.

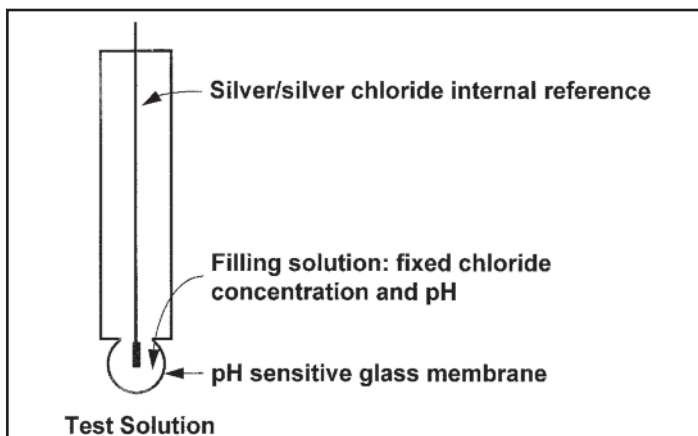

FIGURE 13-2. Measuring Electrode.

The essential element of the glass electrode is a pH-sensitive glass membrane. An electrical potential develops at glass-liquid interfaces. The potential at the outside surface depends on the pH of the test solution. The potential at the inside surface is fixed by the constant pH of the filling solution. Overall, the measuring electrode potential depends solely on the pH of the test solution.

The overall potential of the measuring electrode equals the potential of the internal reference electrode plus the potentials at the glass membrane surfaces. Because the potentials inside the electrode are constant, the overall electrode potential depends solely on the pH of the test solution. The potential of the measuring electrode also depends on temperature. If the pH of the sample remains constant but the temperature changes, the electrode potential will change. Compensating for changes in glass electrode potential with temperature is an important part of the pH measurement.

Figure 13-3 shows a cross-section through the pH glass. pH sensitive glasses absorb water. Although the glass does not penetrate more than about 50 nanometers (5×10^{-8} m) into the glass, the hydrated layer must be present for the glass to respond to pH changes. The layer of glass between the two hydrated layers remains dry. The dry layer makes the glass a poor conductor of electricity and causes the high internal resistance (several hundred megohms) typical of glass electrodes.

13.3 REFERENCE ELECTRODE

As Figure 13-4 shows, the reference electrode is a piece of silver wire plated with silver chloride in contact with a concentrated solution of potassium chloride held in a glass or plastic tube. In many reference electrodes the solution is an aqueous gel, not a liquid. Like the electrode inside the glass electrode, the potential of the external reference is controlled by the concentration of chloride in the filling solution. Because the chloride level is constant, the potential of the reference electrode is fixed. The potential does change if the temperature changes.

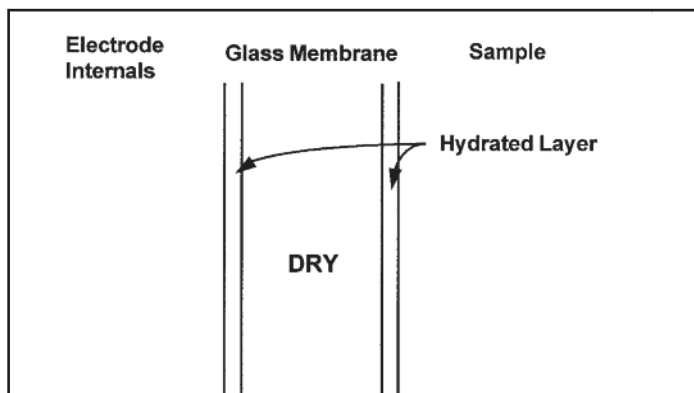

FIGURE 13-3. Cross-Section through the pH Glass.

For the glass electrode to work, the glass must be hydrated. An ion exchange mechanism involving alkali metals and hydrogen ions in the hydrated layer is responsible for the pH response of the glass.

13.4 LIQUID JUNCTION POTENTIAL

The salt bridge (see Figure 13-4) is an integral part of the reference electrode. It provides the electrical connection between the reference electrode and the liquid being measured. Salt bridges take a variety of forms, anything from a glass frit to a wooden plug. Salt bridges are highly porous, and the pores are filled with ions. The ions come from the filling solution and the sample. Some bridges permit only diffusion of ions through the junction. In other designs, a slow outflow of filling solution occurs. Migration of ions in the bridge generates a voltage, called the liquid junction potential. The liquid junction potential is in series with the measuring and reference electrode potentials and is part of the overall cell voltage.

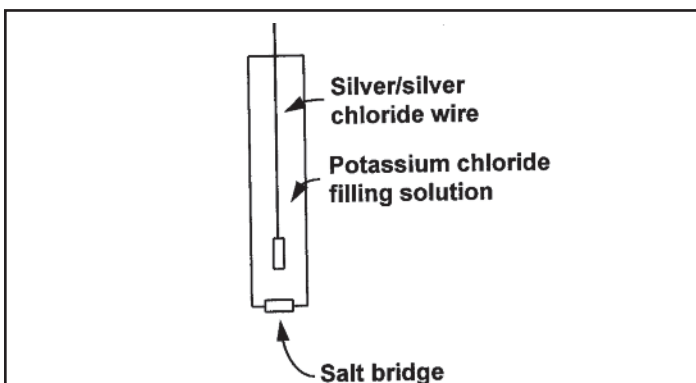

FIGURE 13-4. Reference Electrode.

The fixed concentration of chloride inside the electrode keeps the potential constant. A porous plug salt bridge at the bottom of the electrode permits electrical contact between the reference electrode and the test solution.

Figure 13-5 helps illustrate how liquid junction potentials originate. The figure shows a section through a pore in the salt bridge. For simplicity, assume the bridge connects a solution of potassium chloride and hydrochloric acid of equal molar concentration. Ions from the filling solution and ions

from the sample diffuse through the pores. Diffusion is driven by concentration differences. Each ion migrates from where its concentration is high to where its concentration is low. Because ions move at different rates, a charge separation develops. As the charge separation increases, electrostatic forces cause the faster moving ions to slow down and the slower moving ions to speed up. Eventually, the migration rates become equal, and the system reaches equilibrium. The amount of charge separation at equilibrium determines the liquid junction potential.

Liquid junction potentials exist whenever dissimilar electrolyte solutions come into contact. The magnitude of the potential depends on the difference between the mobility of the ions. Although liquid junction potentials cannot be eliminated, they can be made small and relatively constant. A small liquid junction potential exists when the ions present in greatest concentration have equal (or almost equal) mobilities. The customary way of reducing junction potentials is to fill the reference electrode with concentrated potassium chloride solution. The high concentration ensures that potassium chloride is the major contributor to the junction potential, and the nearly equal mobilities of potassium and chloride ions makes the potential small.

13.5 CONVERTING VOLTAGE TO pH

Equation 1 summarizes the relationship between measured cell voltage (in mV), pH, and temperature (in Kelvin):

$$E(T) = E^{\circ}(T) + 0.1984 T \text{ pH} \quad (1)$$

The cell voltage, $E(T)$ —the notation emphasizes the dependence of cell voltage on temperature—is the sum of five electrical potentials. Four are independent of the pH of the test solution and are combined in the first term, $E^{\circ}(T)$. These potentials are listed below:

1. the potential of the reference electrode inside the glass electrode
2. the potential at the inside surface of the glass membrane
3. the potential of the external reference electrode
4. the liquid junction potential.

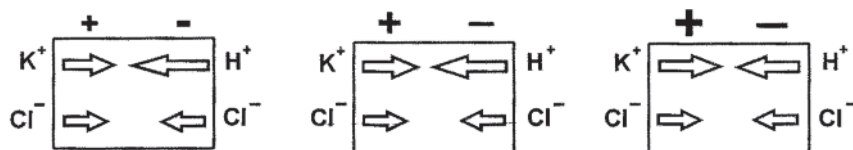

FIGURE 13-5. The Origin of Liquid Junction Potentials.

The figure shows a thin section through a pore in the junction plug. The junction separates a solution of potassium chloride on the left from a solution of hydrochloric acid on the right. The solutions have equal molar concentration. Driven by concentration differences, hydrogen ions and potassium ions diffuse in the directions shown. The length of each arrow indicates relative rates. Because hydrogen ions move faster than potassium ions, positive charge builds up on the left side of the section and negative charge builds up on the right side. The ever-increasing positive charge repels hydrogen and potassium ions. The ever-increasing negative charge attracts the ions. Therefore, the migration rate of hydrogen decreases, and the migration rate of potassium increases. Eventually the rates become equal. Because the chloride concentrations are the same, chloride does not influence the charge separation or the liquid junction potential.

The second term, $0.1984 T$ pH, is the potential (in mV) at the outside surface of the pH glass. This potential depends on temperature and on the pH of the sample. Assuming temperature remains constant, any change in cell voltage is caused solely by a change in the pH of the sample. Therefore, the cell voltage is a measure of the sample pH.

Note that a graph of equation 1, $E(T)$ plotted against pH, is a straight line having a y-intercept of $E^\circ(T)$ and a slope of $0.1984 T$.

13.6 GLASS ELECTRODE SLOPE

For reasons beyond the scope of this discussion, equation 1 is commonly rewritten to remove the temperature dependence in the intercept and to shift the origin of the axes to pH 7. The result is plotted in Figure 13-6. Two lines appear on the graph. One line shows how cell voltage changes with pH at 25°C , and the other line shows the relationship at 50°C . The lines, which are commonly called isotherms, intersect at the point (pH 7, 0 mV). An entire family of curves, each having a slope determined by the temperature and all passing through the point (pH 7, 0 mV) can be drawn on the graph.

Figure 13-6 shows why temperature is important in making pH measurements. When temperature changes, the slope of the isotherm changes. Therefore, a given cell voltage corresponds to a different pH value, depending on the temperature. For example, assume the cell voltage is -150 mV. At 25°C the pH is 9.54, and at 50°C the pH is 9.35. The process of selecting the correct isotherm for converting voltage to pH is called temperature compensation. All modern process pH meters, including the Model 5081-P pH/ORP transmitter, have automatic temperature compensation.

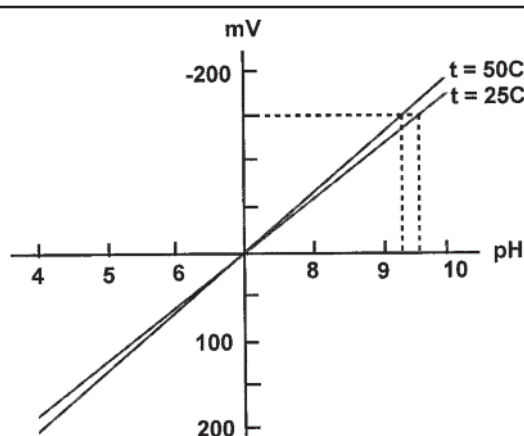

FIGURE 13-6. Glass Electrode Slope.

The voltage of a pH measurement cell depends on pH and temperature. A given pH produces different voltages depending on the temperature. The further from pH 7, the greater the influence of temperature on the relationship between pH and cell voltage.

The slope of the isotherm is often called the glass electrode or sensor slope. The slope can be calculated from the equation: slope = $0.1984 (t + 273.15)$, where t is temperature in $^\circ\text{C}$. The slope has units of mV per unit change in pH. The table lists slopes for different temperatures.

Temp ($^\circ\text{C}$)	Slope (mV/unit pH)
15	-57.2
20	-58.2
25	-59.2
30	-60.1
35	-61.1

As the graph in Figure 13-6 suggests, the closer the pH is to 7, the less important is temperature compensation. For example, if the pH is 8 and the temperature is 30°C , a 10°C error in temperature introduces a pH error of ± 0.03 . At pH 10, the error in the measured pH is ± 0.10 .

12.7 BUFFERS AND CALIBRATION

Figure 13-6 shows an ideal cell: one in which the voltage is zero when the pH is 7, and the slope is $0.1984 T$ over the entire pH range. In a real cell the voltage at pH 7 is rarely zero, but it is usually between -30 mV and $+30$ mV. The slope is also seldom $0.1984 T$ over the entire range of pH. However, over a range of two or three pH units, the slope is usually close to ideal.

Calibration compensates for non-ideal behavior. Calibration involves the use of solutions having exactly known pH, called calibration buffers or simply buffers. Assigning a pH value to a buffer is not a simple process. The laboratory work is demanding, and extensive theoretical work is needed to support certain assumptions that must be made. Normally, establishing pH scales is a task best left to national standards laboratories. pH scales developed by the United States National Institute of Standards and Technology (NIST), the British Standards Institute (BSI), the Japan Standards Institute (JSI), and the German Deutsche Institute für Normung (DIN) are in common use. Although there are some minor differences, for practical purposes the scales are identical. Commercial buffers are usually traceable to a recognized standard scale. Generally, commercial buffers are less accurate than standard buffers. Typical accuracy is ± 0.01 pH units. Commercial buffers, sometimes called technical buffers, do have greater buffer capacity. They are less susceptible to accidental contamination and dilution than standard buffers.

Figure 13-7 shows graphically what happens during calibration. The example assumes calibration is being done at pH 7.00 and pH 10.00. When the electrodes are placed in pH 7 buffer the cell voltage is V_7 , and when the electrodes

are placed in pH 10 buffer, the cell voltage is V_{10} . Note that V_7 is not 0 mV as would be expected in an ideal sensor, but is slightly different.

The microprocessor calculates the equation of the straight line connecting the points. The general form of the equation is:

$$E = A + B (t + 273.15) (\text{pH} - 7) \quad (2)$$

The slope of the line is $B (t + 273.15)$, where t is the temperature in $^{\circ}\text{C}$, and the y-intercept is A . If pH 7 buffer is used for calibration, V_7 equals A . If pH 7 buffer is not used, A is calculated from the calibration data.

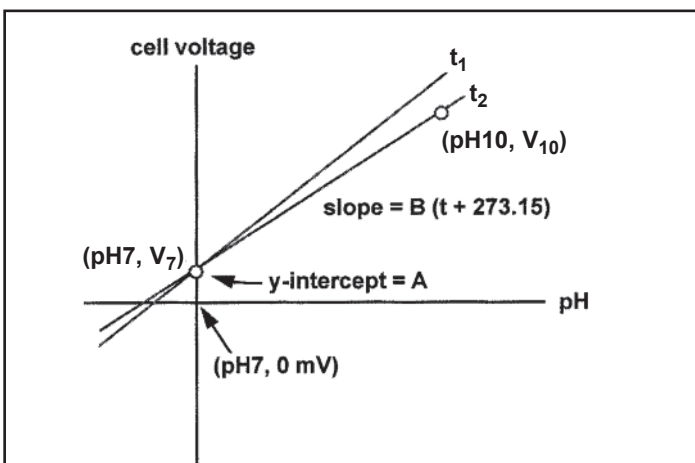

FIGURE 13-7. Two-Point Buffer Calibration.

The graph shows a calibration using pH 7 and pH 10 buffers. The calibration equation is the straight line connecting the two points. If temperature changes, the slope changes by the ratio $(t_2 + 273.15)/(t_1 + 273.15)$, where t_1 is the calibration temperature and t_2 is the process temperature in $^{\circ}\text{C}$. The calibration equations rotate about the point (pH 7, A).

The microprocessor then converts subsequent cell voltage measurements into pH using the calibration line.

13.8 ISOPOTENTIAL pH

Frequently, the calibration temperature and the process temperature are different. Therefore, the calibration slope is not appropriate for the sample. Figure 13-7 shows what the microprocessor does when buffer and sample temperatures are different. Assume the sensor was calibrated at temperature t_1 and the process temperature is t_2 . To measure the pH of the process, the microprocessor rotates the calibration line about the point (pH 7, A) until the slope equals $B (t_2 + 273.15)$. The microprocessor then uses the new isotherm to convert voltage to pH. The point (pH 7, A) is called the isopotential pH. As Figure 13-7 shows, the isopotential pH is the pH at which the cell voltage does not change when the temperature changes.

The microprocessor makes assumptions when the measurement and calibration temperatures are different. It assumes the actual measurement cell isotherms rotate about the point (pH 7, A). The assumption may not be correct, so the measurement will be in error. The size of the error depends on two things: the difference between the isopotential pH of the measurement cell and pH 7 and the difference between the calibration and measurement temperatures. For a 10°C temperature difference and a difference in isopotential pH of 2, the error is about ± 0.07 pH units. The factors that cause the isopotential pH of a real cell to differ from 7 are beyond the scope of this discussion and to a great extent are out of the control of the user as well.

Most pH cells do not have an isopotential pH point. Instead, the cell isopotential pH changes with temperature, and the cell isotherms rotate about a general area. Measuring the isopotential pH requires great care and patience.

One way to reduce the error caused by disagreement between the sensor and meter isopotential pH is to calibrate the sensor at the same temperature as the process. However, great care must be exercised when the buffer temperature is significantly greater than ambient temperature. First, the buffer solution must be protected from evaporation. Evaporation changes the concentration of the buffer and its pH. Above 50°C , a reflux condenser may be necessary. Second, the pH of buffers is defined over a limited temperature range. For example, if the buffer pH is defined only to 60°C , the buffer cannot be used for calibration at 70°C . Finally, no matter what the temperature, it is important that the entire measurement cell, sensor and solution, be at constant temperature. This requirement is critical because lack of temperature uniformity in the cell is one reason the cell isopotential point moves when the temperature changes.

13.9 JUNCTION POTENTIAL MISMATCH

Although glass electrodes are always calibrated with buffers, the use of buffers causes a fundamental error in the measurement.

When the glass and reference electrodes are placed in a buffer, a liquid junction potential, E_{ij} , develops at the interface between the buffer and the salt bridge. The liquid junction potential is part of the overall cell voltage and is included in A in equation 2. Equation 2 can be modified to

show E_{ij} as a separate term:

$$E = A' + E_{ij} + B (t + 273.15) (\text{pH} - 7) \quad (3)$$

or

$$E = E' (\text{pH}, t) + E_{ij} \quad (4)$$

where $E' (\text{pH}, t) = A' + B (t + 273.15) (\text{pH} - 7)$.

In Figure 13-8, calibration and measurement data are plotted in terms of equation 4. The cell voltage, E , is represented by the dashed vertical line. The contribution of each

term in equation 4 to the voltage is also shown. The liquid junction potentials in the buffers are assumed to be equal and are exaggerated for clarity.

If the liquid junction potential in the sample differs from the buffers, a measurement error results. Figure 13-8 illustrates how the error comes about. Assume the true pH of the sample is pH_s and the cell voltage is E_s . The point (pH_s, E_s) is shown on the graph. If the liquid junction potential in the sample were equal to the value in the buffers, the point would lie on the line. However, the liquid junction potential in the sample is greater, so the point E_s lies above the calibration line. Therefore, when the cell voltage is converted to pH, the result is greater than the true pH by the amount shown.

A typical mismatch between liquid junction potentials in buffer and sample is 2-3 mV, which is equivalent to an error of about ± 0.02 pH units. The mismatch produces a fundamental error in pH determinations using a cell with liquid junction.

13.10 SENSOR DIAGNOSTICS

Sensor diagnostics alert the user to problems with the sensor or to actual sensor failures. The two sensor diagnostics are reference impedance and glass impedance.

The major contributor to reference impedance is the resistance across the liquid junction plug. In a properly functioning electrode, the resistance of the liquid junction should be no more than several hundred kilohms. If the junction is plugged or if the filling solution or gel is depleted, the resistance increases. A high reference impedance may also mean the sensor is not immersed in the process stream.

Glass impedance refers to the impedance of the pH-sensitive glass membrane. The impedance of the glass membrane is a strong function of temperature. As temperature increases, the impedance decreases. For a change in glass impedance to have any meaning, the impedance measurement must be corrected to a reference temperature. The impedance of a typical glass electrode at 25°C is several hundred megohms. A sharp decrease in the temperature-corrected impedance implies that the glass is cracked. A cracked glass electrode produces erroneous pH readings. The electrode should be replaced immediately. A high temperature-corrected glass impedance implies the sensor is nearing the end of its life and should be replaced as soon as possible.

13.11 SHIELDS, INSULATION, AND PREAMPLIFIERS

pH measurement systems, cell and meter, have high impedance. The high impedance circuit imposes important restrictions on how pH measurement systems are designed.

The lead wire from the glass electrode connects two high resistances: about $100\ \text{M}\Omega$ at the electrode and about $1,000,000\ \text{M}\Omega$ at the meter. Therefore, electrostatic charges, which accumulate on the wire from environmental influences, cannot readily drain away. Buildup of charge results in degraded, noisy readings. Shielding the wire with metal braid connected to ground at the instrument is one way to improve the signal. It is also helpful to keep the sensor cable as far away as possible from AC power cables. The high input impedance of the pH meter requires that the lead insulation and the insulation between the meter inputs be of high quality. To provide further protection from environmental interference, the entire sensor cable can be enclosed in conduit.

To avoid the need for expensive cable and cable installations, a preamplifier built into the sensor or installed in a junction box near the sensor can be used. The preamplifier converts the high impedance signal into a low impedance signal that can be sent as far as 200 feet without special cable.

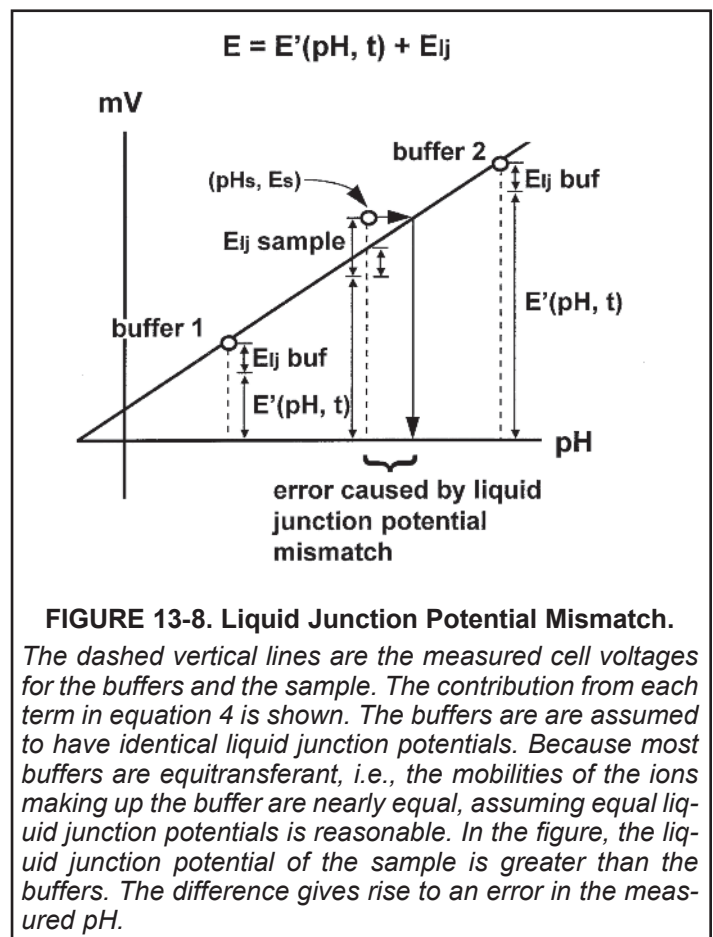

SECTION 14.0

ORP MEASUREMENTS

- 14.1 General
- 14.2 Measuring Electrode
- 14.3 Reference Electrode
- 14.4 Liquid Junction Potential
- 14.5 Relating Cell Voltage to ORP
- 14.6 ORP, Concentration, and pH
- 14.7 Interpreting ORP Measurements
- 14.8 Calibration

14.1 GENERAL

Figure 14-1 shows a simplified diagram of an electrochemical cell that can be used to determine the oxidation-reduction potential or ORP of a sample. The cell consists of a measuring electrode, a reference electrode, the liquid being measured, and a temperature-sensing element. The cell voltage is the ORP of the sample. In most industrial and scientific applications, a pH meter is used to measure the voltage. Because a pH meter is really a high impedance voltmeter, it makes an ideal ORP meter.

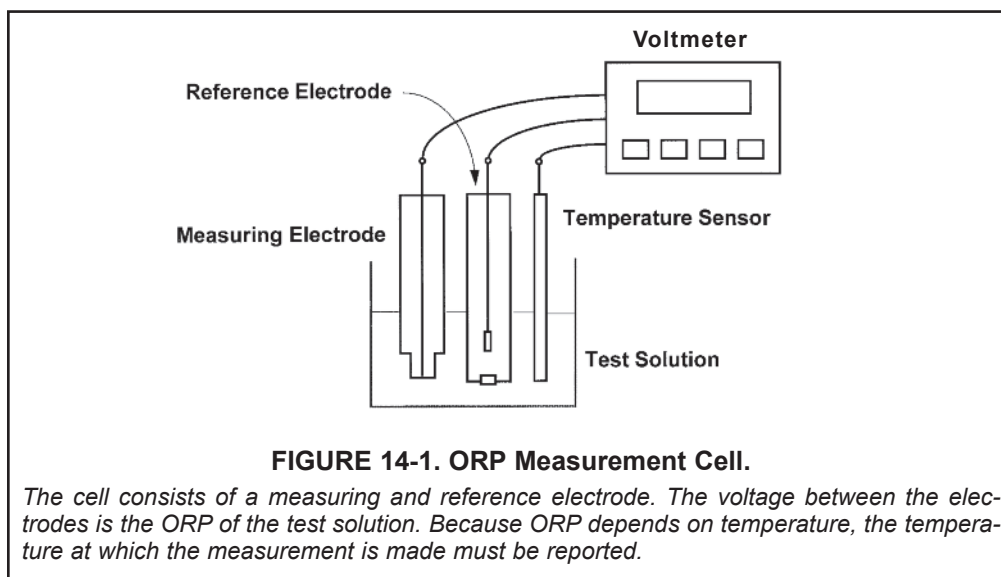

Figure 14-1 shows separate measuring and reference electrodes. In most process sensors the electrodes and the temperature element are combined into a single body. Such sensors are often called combination electrodes.

The cell voltage is the algebraic sum of the potential of the measuring electrode, the potential of the reference electrode, and the liquid junction potential. The potential of the measuring electrode depends on the ORP of the solution. The potential of the reference electrode is unaffected by ORP, so it provides a stable reference voltage. The liquid junction potential depends in a complex way on the identity and concentration of the ions in the sample. It is always present, but if the sensor is properly designed, the liquid junction potential is usually small and relatively constant. All three potentials depend on temperature.

The construction of each electrode and the electrical potential associated with the electrode are discussed in Sections 14.2, 14.3, and 14.4.

14.2 MEASURING ELECTRODE

Figure 14-2 shows a typical ORP measuring electrode. The electrode consists of a band or disc of platinum attached to the base of a sealed glass tube. A platinum wire welded to the band connects it to the lead wire.

For a noble metal electrode to develop a stable potential, a redox couple must be present. A redox couple is simply two compounds that can be converted into one another by the gain or loss of electrons. Iron (II) and iron (III) are a redox couple. The oxidized form, iron (III), can be converted into the reduced form, iron (II), by the gain of one electron. Similarly, iron (II) can be converted to iron (III) by the loss of an electron. For more details concerning the nature of redox potential, see Section 14.5.

14.3 REFERENCE ELECTRODE

As Figure 14-3 shows, the reference electrode is a piece of silver wire plated with silver chloride in contact with a concentrated solution of potassium chloride held in a glass or plastic tube. In many reference electrodes the solution is an aqueous gel, not a liquid. The potential of the reference electrode is controlled by the concentration of chloride in the filling solution. Because the chloride level is constant, the potential of the reference electrode is fixed. The potential does change if the temperature changes.

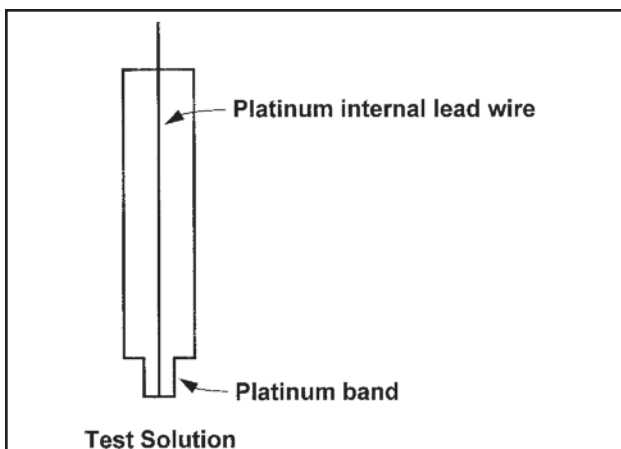

FIGURE 14-2. Measuring Electrode.

An ORP electrode is a piece of noble metal, usually platinum, but sometimes gold, attached to the end of a glass tube. The potential of the electrode is controlled by the ratio of oxidized to reduced substances in the sample. pH and other constituents in the sample may also affect ORP.

14.4 LIQUID JUNCTION POTENTIAL

A salt bridge (see Figure 14-3) is an integral part of the reference electrode. It provides the electrical connection between the reference electrode and the liquid being measured. Salt bridges take a variety of forms, anything from a glass frit to a wooden plug. Salt bridges are highly porous and the pores are filled with ions. The ions come from the filling solution and the sample. Some bridges permit only diffusion of ions through the junction. In other designs, a slow outflow of filling solution occurs. Migration of ions in the bridge generates a voltage, called the liquid junction potential. The liquid junction potential is in series with the measuring and reference electrode potentials and is part of the overall cell voltage.

Figure 14-4 helps illustrate how liquid junction potentials originate. The figure shows a section through a pore in the salt bridge. For simplicity, assume the bridge connects a solution of potassium chloride and hydrochloric acid of equal molar concentration. Ions from the filling solution and ions from the sample diffuse through the pores. Diffusion is driven by concentration differences. Each ion migrates from where its concentration is high to where its concentration is low. Because ions move at different rates, a charge separation develops. As the charge separation increases, electrostatic forces cause the faster moving ions to slow down and the slower moving ions to speed up. Eventually, the migration rates become equal, and the system reaches equilibrium. The amount of charge separation at equilibrium determines the liquid junction potential.

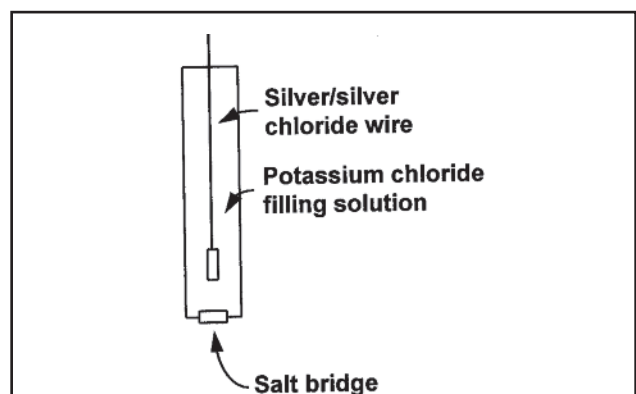

FIGURE 14-3. Reference Electrode.

The fixed concentration of chloride inside the electrode keeps the potential constant. A porous plug salt bridge at the bottom of the electrode permits electrical contact between the reference electrode and the test solution.

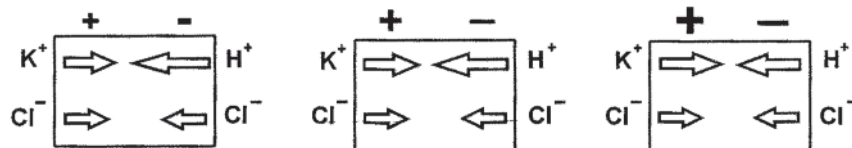

FIGURE 14-4. The Origin of Liquid Junction Potentials.

The figure shows a thin section through a pore in the junction plug. The junction separates a solution of potassium chloride on the left from a solution of hydrochloric acid on the right. The solutions have equal molar concentration. Driven by concentration differences, hydrogen ions and potassium ions diffuse in the directions shown. The length of each arrow indicates relative rates. Because hydrogen ions move faster than potassium ions, positive charge builds up on the left side of the section and negative charge builds up on the right side. The ever-increasing positive charge repels hydrogen and potassium ions. The ever-increasing negative charge attracts the ions. Therefore, the migration rate of hydrogen decreases, and the migration rate of potassium increases. Eventually the rates become equal. Because the chloride concentrations are the same, chloride does not influence the charge separation or the liquid junction potential.

Liquid junction potentials exist whenever dissimilar electrolyte solutions come into contact. The magnitude of the potential depends on the difference between the mobility of the ions. Although liquid junction potentials cannot be eliminated, they can be made small and relatively constant. A small liquid junction potential exists when the ions present in greatest concentration have equal (or almost equal) mobilities. The customary way of reducing junction potentials is to fill the reference electrode with concentrated potassium chloride solution. The high concentration ensures that potassium chloride is the major contributor to the junction potential, and the nearly equal mobilities of potassium and chloride ions makes the potential small.

14.5 RELATING CELL VOLTAGE TO ORP

The measured cell voltage, $E(T)$ —the notation emphasizes the temperature dependence—is the algebraic sum of the measuring (platinum) electrode potential, the reference electrode potential, and the liquid junction potential. Because the potential of the reference electrode is independent of ORP and the liquid junction potential is small, the measured cell voltage is controlled by the ORP of the sample. Stated another way, the cell voltage is the ORP of the sample relative to the reference electrode.

14.6 ORP, CONCENTRATION, AND pH

ORP depends on the relative concentration of oxidized and reduced substances in the sample and on the pH of the sample. An understanding of how concentration and pH influence ORP is necessary for the correct interpretation of ORP readings.

Figure 14-5 shows a platinum ORP electrode in contact with a solution of iron (II) and iron (III). As discussed earlier, iron (II) and iron (III) are a redox couple. They are related by the following half reaction:



If a redox couple is present, a stable electrical potential eventually develops at the interface between the platinum electrode and the sample. The magnitude of the potential

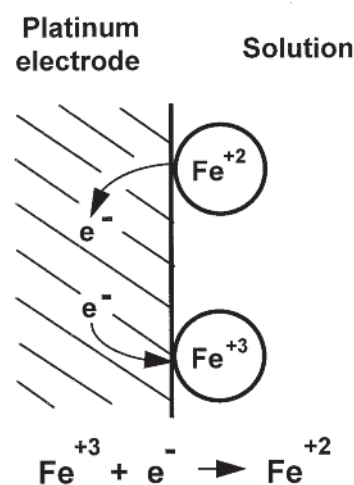

FIGURE 14-5. Electrode Potential.

The drawing shows an iron (II) and iron (III) ion at the surface of a platinum electrode. Iron (III) can take an electron from the platinum and be reduced, and iron (II) can place an electron on the metal and be oxidized. The electrode potential is the tendency of the half reaction shown in the figure to occur spontaneously. Because the voltmeter used to measure ORP draws almost no current, there is no change in the concentration of iron (II) and iron (III) at the electrode.

is described by the following equation, called the Nernst equation:

$$E = E^\circ - \frac{0.1987 (t + 273.15)}{n} \log \frac{[\text{Fe}^{+2}]}{[\text{Fe}^{+3}]} \quad (2)$$

In the Nernst equation, E is the electrode potential and E° is the standard electrode potential, both in millivolts, t is temperature in $^\circ\text{C}$, n is the number of electrons transferred ($n = 1$ in the present case), and $[\text{Fe}^{+2}]$ and $[\text{Fe}^{+3}]$ are the concentrations of iron (II) and iron (III) respectively. There are several ways of defining the standard electrode potential, E° . No matter which definition is used, the standard electrode potential is simply the electrode potential when the concentrations of iron (II) and iron (III) have defined standard values.

Equation 2 shows that the electrode potential is controlled by the logarithm of the ratio of the concentration of iron (II) to iron (III). Therefore, at 25°C if the ratio changes by a factor of ten, the electrode potential changes by

$$- \frac{0.1987 (25 + 273.15)}{1} \log 10 = - 59.2 \text{ mV}$$

As the expression above shows, the voltage change is also directly proportional to temperature and inversely proportional to the number of electrons transferred.

14.7 INTERPRETING ORP MEASUREMENTS

Interpreting ORP and changes in ORP requires great caution. There are several concepts to keep in mind concerning industrial ORP measurements.

- ORP is best used to track changes in concentration or to detect the presence or absence of certain chemicals. For example, in the treatment of wastes from metal finishing plants, chromium (VI) is converted to chromium (III) by treatment with sulfur dioxide. Because chromium (VI) and chromium (III) are a redox couple, ORP can be used to monitor the reaction. As sulfur dioxide converts chromium (VI) to chromium (III), the concentration ratio changes and the ORP drops. Once all the chromium (VI) has been converted to chromium (III) and a slight excess of sulfur dioxide is present, the chromium couple no longer determines ORP. Instead, ORP is controlled by the sulfur dioxide-sulfate couple. When sulfur dioxide reacts with chromium (VI), it is converted to sulfate. Figure 14-6 shows how ORP and the concentration of chromium (VI) change as sulfur dioxide is added. Because the change in ORP at the endpoint is large, monitoring ORP is an efficient way of tracking the process.

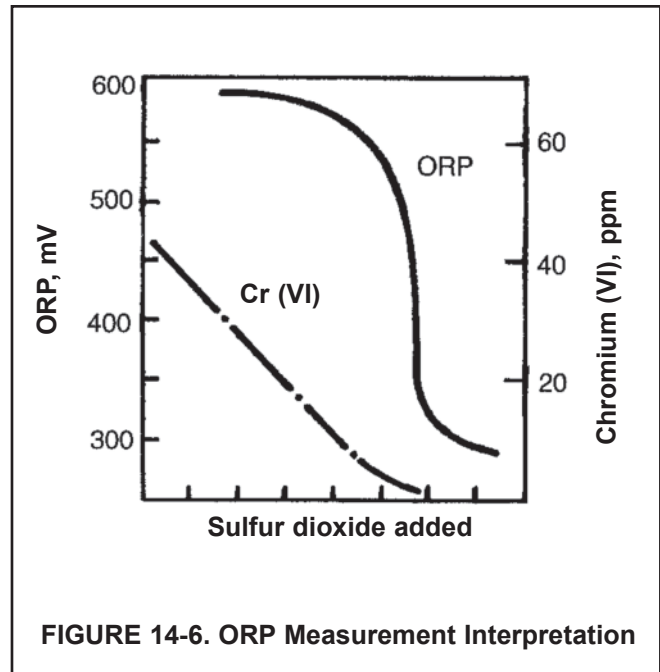
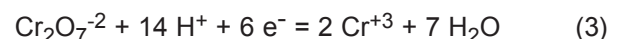

FIGURE 14-6. ORP Measurement Interpretation

- ORP measures activity, not concentration. Activity accounts for the way in which other ions in solution influence the behavior of the redox couple being measured. To be strictly correct, ORP is controlled by the the ratio of activities, not concentrations. The dependence of ORP on activity has an important consequence. Suppose a salt, like sodium sulfate, is added to a solution containing a redox couple, for example iron (II) and iron (III). The sodium sulfate does not change the concentration of either ion. But, the ORP of the solution does change because the salt alters the ratio of the activity of the ions.
- pH can have a profound influence on ORP. Referring to the earlier example where ORP was used to monitor the conversion of chromium (VI) to chromium (III). The reaction is generally carried out at about pH 2. Because the concentration ratio in the Nernst equation also includes hydrogen ions, the ORP of a mixture of chromium (VI) and chromium (III) is a function of pH.

To appreciate the extent to which pH influences ORP, consider the conversion of chromium (VI) to chromium (III). In acidic solution the half reaction is:



- Chromium (VI) exists as dichromate, $\text{Cr}_2\text{O}_7^{-2}$, in acidic solution.

The Nernst equation for reaction 3 is:

$$E = E^\circ - \frac{0.1987 (t + 273.15)}{6} \log \frac{[\text{Cr}^{+3}]^2}{[\text{Cr}_2\text{O}_7^{-2}] [\text{H}^+]^{14}} \quad (4)$$

Note that the hydrogen ion factor in the concentration ratio is raised to the fourteenth power. The table shows the expected effect of changing pH on the measured ORP at 25°C.

pH changes	ORP changes by
from 2.0 to 2.2	7 mV
from 2.0 to 2.4	35 mV
from 2.0 to 1.8	47 mV
from 2.0 to 1.6	75 mV

The Nernst equation can be written for any half reaction. However, not all half reactions behave exactly as predicted by the Nernst equation. Why real systems do not act as expected is beyond the scope of this discussion. The potential of chromium (VI) - chromium (III) couple used as an example above does not perfectly obey the Nernst equation. However, the statement that pH has a strong effect on the electrode potential of the couple is true.

- As mentioned earlier, ORP is best suited for measuring changes, not absolute concentrations. If ORP is used to determine concentration, great care should be exercised. An example is the determination of chlorine in water. When water is disinfected by treatment with chlorine gas or sodium hypochlorite, free chlorine forms. Free chlorine is a mixture of hypochlorous acid (HOCl) and hypochlorite ions (OCl⁻). The relative amount of hypochlorous acid and hypochlorite present depends on pH. For disinfection control, total free chlorine, the sum of hypochlorous acid and hypochlorite ion, is important. Equation 5 shows the half reaction for hypochlorous acid:

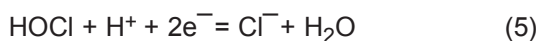

The Nernst equation is

$$E = E^\circ - \frac{0.1987 (t + 273.15)}{2} \log \frac{[\text{Cl}^-]}{[\text{HOCl}] [\text{H}^+]^2} \quad (6)$$

Only the concentration of hypochlorous acid appears in the Nernst equation. To use ORP to determine total free chlorine, equation 7 must be rewritten in terms of free

chlorine. Although the details are beyond the scope of this discussion, the result is shown in equation 7:

$$E = E^\circ - \frac{0.1987 (t + 273.15)}{2} \log \frac{[\text{Cl}^-] \{[\text{H}^+] + K\}}{C_a [\text{H}^+]^2} \quad (7)$$

where K is the acid dissociation constant for hypochlorous acid (2.3×10^{-8}) and C_a is the total free chlorine concentration. As equation 7 shows the measured ORP depends on the hydrogen ion concentration (i.e., pH), the chloride concentration, the free chlorine concentration, and temperature. Therefore, for ORP to be a reliable measurement of free chlorine, pH, chloride, and temperature must be reasonably constant.

Assume the free chlorine level is 1.00 ppm and the chloride concentration is 100 ppm. The table shows how slight changes in pH influence the ORP.

pH changes	ORP changes by
from 8.0 to 7.8	3.9 mV
from 8.0 to 7.6	7.1 mV
from 8.0 to 8.2	4.4 mV
from 8.0 to 8.4	9.2 mV

Around pH 8 and 1.00 ppm chlorine, a change in ORP of 1.4 mV corresponds to a change in chlorine level of about 0.1 ppm. Therefore, if pH changed only 0.2 units and the true chlorine level remained constant at 1.00 ppm, the apparent chlorine level (determined by ORP) would change about 0.3 ppm.

14.8 CALIBRATION

Although there is no internationally recognized ORP calibration standard, the iron (II) - iron (III) couple enjoys some popularity. The standard is a solution of 0.1 M iron (II) ammonium sulfate and 0.1 M iron (III) ammonium sulfate in 1 M sulfuric acid. The solution has good resistance to air oxidation. If stored in a tightly closed container, the shelf life is one year. Because the standard contains equal amounts of iron (II) and iron (III), the ORP does not change appreciably if the solution becomes slightly diluted. In addition, minor variability in actual concentration does not affect the standard ORP.

The ORP of the iron (II) - iron (III) standard when measured with a platinum electrode against a saturated silver-silver chloride reference is 476 ± 20 mV at 25°C. The range of values is caused primarily by the high and variable liquid junction potential generated in solutions containing high acid concentrations.

Quinhydrone - hydroquinone ORP standards are also used. They are prepared by dissolving excess quinhydrone in either pH 4.00 or pH 6.86 buffer. The ORP of the standards at a platinum electrode against a silver - silver chloride reference has been measured at 20°C, 25°C, and 30°C.

Temperature	ORP in pH 4.00 buffer	ORP in pH 6.86 buffer
20°C	268 mV	92 mV
25°C	263 mV	86 mV
30°C	258 mV	79 mV

There are two disadvantages to using quinhydrone standards. First, the shelf life is only about eight hours, so fresh standard must be prepared daily. Second, hydroquinone is highly toxic, so preparing, handling, and disposing of the standards requires care.

Unlike pH calibrations, which are generally done using two calibration buffers, ORP calibrations are almost always single point calibrations.

SECTION 15.0

THEORY - REMOTE COMMUNICATIONS

- 15.1 Overview of HART Communications
- 15.2 HART Interface Devices
- 15.3 AMS Communication

15.1 OVERVIEW OF HART COMMUNICATION

HART (highway addressable remote transducer) is a digital communication system in which two frequencies are superimposed on the 4 to 20 mA output signal from the transmitter. A 1200 Hz sine wave represents the digit 1, and a 2400 Hz sine wave represents the digit 0. Because the average value of a sine wave is zero, the digital signal adds no dc component to the analog signal. HART permits digital communication while retaining the analog signal for process control.

The HART protocol, originally developed by Fisher-Rosemount, is now overseen by the independent HART Communication Foundation. The Foundation ensures that all HART devices can communicate with one another. For more information about HART communications, call the HART Communication Foundation at (512) 794-0369. The internet address is <http://www.hartcomm.org>.

15.2 HART INTERFACE DEVICES

HART communicators allow the user to view measurement data (pH, ORP and temperature), program the transmitter, and download information from the transmitter for transfer to a computer for analysis. Downloaded information can also be sent to another HART transmitter. Either a hand-held communicator, such as the Rosemount Model 475, or a computer can be used. HART interface devices operate from any wiring termination point in the 4 - 20 mA loop. A minimum load of 250 ohms must be present between the transmitter and the power supply. See Figure 15-1.

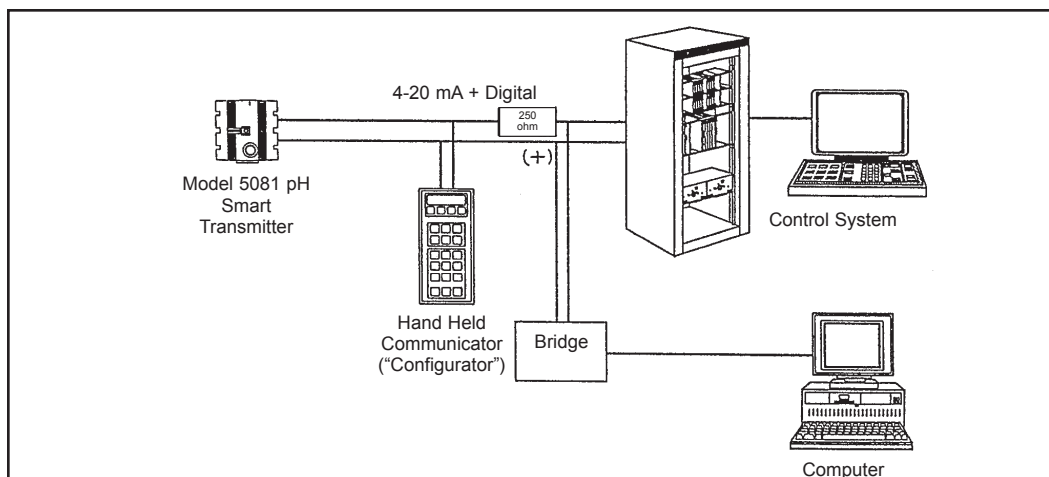

FIGURE 15-1. HART Communicators.

Both the Rosemount Model 375 or 475 and a computer can be used to communicate with a HART transmitter. The 250 ohm load (minimum) must be present between the transmitter and the power supply.

If your communicator does not recognize the Model 5081-P pH/ORP transmitter, the device description library may need updating. Call the manufacturer of your HART communication device for updates.

15.3 ASSET MANAGEMENT SOLUTIONS

Asset Management Solutions (AMS) is software that helps plant personnel better monitor the performance of analytical instruments, pressure and temperature transmitters, and control valves. Continuous monitoring means maintenance personnel can anticipate equipment failures and plan preventative measures before costly breakdown maintenance is required.

AMS uses remote monitoring. The operator, sitting at a computer, can view measurement data, change program settings, read diagnostic and warning messages, and retrieve historical data from any HART-compatible device, including the Model 5081-P pH/ORP transmitter. Although AMS allows access to the basic functions of any HART compatible device, Rosemount Analytical has developed additional software for that allows access to all features of the Model 5081-P pH/ORP transmitter.

AMS can play a central role in plant quality assurance and quality control. Using AMS Audit Trail, plant operators can track calibration frequency and results as well as warnings and diagnostic messages. The information is available to Audit Trail whether calibrations were done using the infrared remote controller, the Model 375 or 475 HART communicator, or AMS software.

AMS operates in Windows 95. See Figure 15-2 for a sample screen. AMS communicates through a HART-compatible modem with any HART transmitters, including those from other manufacturers. AMS is also compatible with FOUNDATION| Fieldbus, which allows future upgrades to Fieldbus instruments.

For more information about AMS, including upgrades, renewals, and training, call Fisher-Rosemount Systems, Inc. at (612) 895-2000.

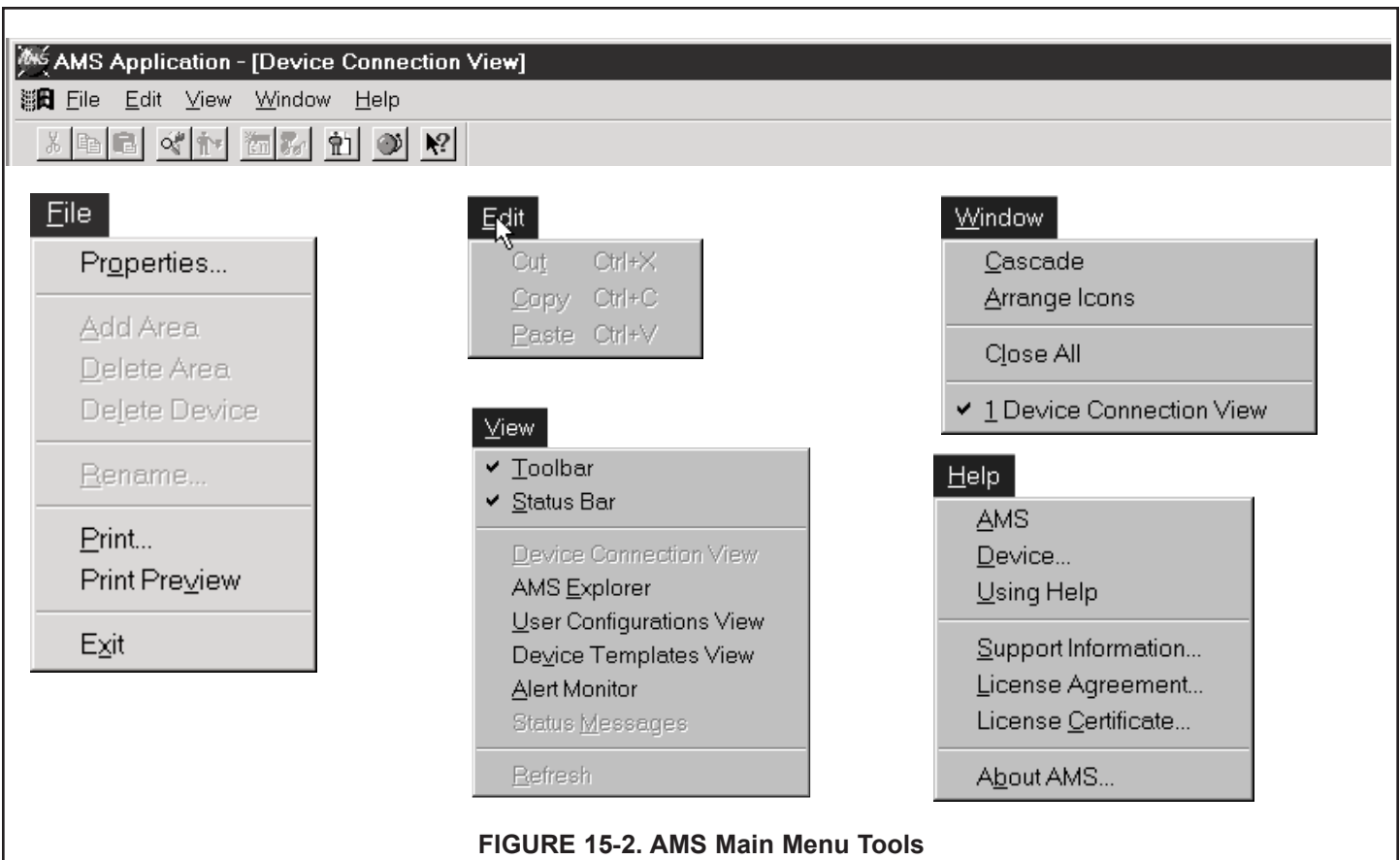

FIGURE 15-2. AMS Main Menu Tools

SECTION 16.0 RETURN OF MATERIAL

16.1 GENERAL.

To expedite the repair and return of instruments, proper communication between the customer and the factory is important. Call 1-949-757-8500 for a Return Materials Authorization (RMA) number.

16.2 WARRANTY REPAIR.

The following is the procedure for returning instruments still under warranty:

1. Call Rosemount Analytical for authorization.
2. To verify warranty, supply the factory sales order number or the original purchase order number. In the case of individual parts or sub-assemblies, the serial number on the unit must be supplied.
3. Carefully package the materials and enclose your "Letter of Transmittal" (see Warranty). If possible, pack the materials in the same manner as they were received.
4. Send the package prepaid to:

Emerson Process Management
Rosemount Analytical
2400 Barranca Parkway
Irvine, CA 92606

Attn: Factory Repair

RMA No. _____

Mark the package: Returned for Repair

Model No. _____

16.3 NON-WARRANTY REPAIR.

The following is the procedure for returning for repair instruments that are no longer under warranty:

1. Call Rosemount Analytical for authorization.
2. Supply the purchase order number, and make sure to provide the name and telephone number of the individual to be contacted should additional information be needed.
3. Do Steps 3 and 4 of Section 16.2.

NOTE

Consult the factory for additional information regarding service or repair.

EC Declaration of Conformity



We, Emerson Process Management, Blegistrasse 21, Barr, Switzerland CH 6341 declare under our sole responsibility that the product,

5081-A-HT
5081-P-HT
5081-A-FF-73
5081-P-FF-73
5081-A-FI-73
5081-P-FI-73
Amperometric Transmitter, HART;
pH Transmitter, HART;
Amperometric Transmitter, Fieldbus;
pH Transmitter, Fieldbus;
Amperometric Transmitter, FISCO;
pH Transmitter, FISCO

manufactured by, Emerson Process Management, Rosemount Analytical 2400 Barranca Parkway, Irvine, California 92606 USA to which this declaration relates, is in conformity with the provisions of the European Community directives, including the latest amendments, as listed below.

Assumption of conformity is based on the application of the harmonized standards and, when applicable or required, a European Community notified body certification, as shown below.

Andy Kernish
(name printed)

Vice President Analytical Europe
(function name printed)

October 2, 2012
(date of issue)

EMC Directive (2004/108/EC)

5081-A-HT, 5081-P-HT (HART)
5081-A-FF-73, 5081-P-FF-73 (Fieldbus)
5081-A-FI-73, 5081-P-FI-73 (FISCO Fieldbus)

Harmonized standard used: EN 61326-1:2006

ATEX Directive (94/9/EC)

Provisions of the directive fulfilled by the equipment:

Equipment Group II, Category 1 G Ex ia IIC T4 Ga (-20°C ≤ Ta ≤ +65°C)
5081-A-HT, 5081-P-HT (HART)
5081-A-FF-73, 5081-P-FF-73 (Fieldbus)
5081-A-FI-73, 5081-P-FI-73 (FISCO Fieldbus)

BAS02ATEX1284X -- Intrinsically Safe Certificate

Harmonized standards used: EN 60079-0:2009 EN 60079-11:2007

Special condition for safe use:

The apparatus enclosure may contain light metals. The apparatus must be installed in such a manner as to minimize the risk of impact or friction with other metal surfaces.

ATEX Notified Body for EC Type Examination Certificate & Quality Assurance:

Baseefa [Notified Body Number 1180], Rockhead Business Park, Staden Lane
Buxton, Derbyshire SK17 9RZ, United Kingdom

EC Declaration of Conformity



We, Emerson Process Management, Blegistrasse 21, Barr, Switzerland CH 6341 declare under our sole responsibility that the product,

5081-A-HT-60
5081-P-HT-60
5081-A-FF-60
5081-P-FF-60
5081-A-FI-60
5081-P-FI-60
Amperometric Transmitter, HART;
pH Transmitter, HART;
Amperometric Transmitter, Fieldbus;
pH Transmitter, Fieldbus;
Amperometric Transmitter, FISCO;
pH Transmitter, FISCO

manufactured by, Emerson Process Management, Rosemount Analytical 2400 Barranca Parkway, Irvine, California 92606 USA to which this declaration relates, is in conformity with the provisions of the European Community directive, including the latest amendments, as listed below.

Assumption of conformity is based on the application of the harmonized standards,

Andy Kernish
(name printed)

Vice President Analytical Europe
(function name printed)

October 1, 2012
(date of issue)

EMC Directive (2004/108/EC)

5081-A-HT-60, 5081-P-HT-60 (HART)
5081-A-FF-60, 5081-P-FF-60 (Fieldbus)
5081-A-FI-60, 5081-P-FI-60 (FISCO Fieldbus)

Harmonized standard used: EN 61326-1:2006

WARRANTY

Goods and part(s) (excluding consumables) manufactured by Seller are warranted to be free from defects in workmanship and material under normal use and service for a period of twelve (12) months from the date of shipment by Seller. Consumables, pH electrodes, membranes, liquid junctions, electrolyte, O-rings, etc. are warranted to be free from defects in workmanship and material under normal use and service for a period of ninety (90) days from date of shipment by Seller. Goods, part(s) and consumables proven by Seller to be defective in workmanship and / or material shall be replaced or repaired, free of charge, F.O.B. Seller's factory provided that the goods, parts(s), or consumables are returned to Seller's designated factory, transportation charges prepaid, within the twelve (12) month period of warranty in the case of goods and part(s), and in the case of consumables, within the ninety (90) day period of warranty. This warranty shall be in effect for replacement or repaired goods, part(s) and consumables for the remaining portion of the period of the twelve (12) month warranty in the case of goods and part(s) and the remaining portion of the ninety (90) day warranty in the case of consumables. A defect in goods, part(s) and consumables of the commercial unit shall not operate to condemn such commercial unit when such goods, parts(s) or consumables are capable of being renewed, repaired or replaced.

The Seller shall not be liable to the Buyer, or to any other person, for the loss or damage, directly or indirectly, arising from the use of the equipment or goods, from breach of any warranty or from any other cause. All other warranties, expressed or implied are hereby excluded.

IN CONSIDERATION OF THE STATED PURCHASE PRICE OF THE GOODS, SELLER GRANTS ONLY THE ABOVE STATED EXPRESS WARRANTY. NO OTHER WARRANTIES ARE GRANTED INCLUDING, BUT NOT LIMITED TO, EXPRESS AND IMPLIED WARRANTIES OF MERCHANTABILITY AND FITNESS FOR A PARTICULAR PURPOSE.

RETURN OF MATERIAL

Material returned for repair, whether in or out of warranty, should be shipped prepaid to:

**Emerson Process Management
Rosemount Analytical
2400 Barranca Parkway
Irvine, CA 92606**

The shipping container should be marked:

Return for Repair

Model _____

The returned material should be accompanied by a letter of transmittal which should include the following information (make a copy of the "Return of Materials Request" found on the last page of the Manual and provide the following thereon):

1. Location type of service, and length of time of service of the device.
2. Description of the faulty operation of the device and the circumstances of the failure.
3. Name and telephone number of the person to contact if there are questions about the returned material.
4. Statement as to whether warranty or non-warranty service is requested.
5. Complete shipping instructions for return of the material.

Adherence to these procedures will expedite handling of the returned material and will prevent unnecessary additional charges for inspection and testing to determine the problem with the device.

If the material is returned for out-of-warranty repairs, a purchase order for repairs should be enclosed.

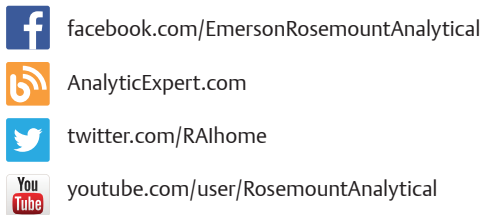

Credit Cards for U.S. Purchases Only.



Emerson Process Management

2400 Barranca Parkway
Irvine, CA 92606 USA
Tel: (949) 757-8500
Fax: (949) 474-7250
rosemountanalytical.com

© Rosemount Analytical Inc. 2015

©2015 Rosemount Analytical, Inc. All rights reserved.

The Emerson logo is a trademark and service mark of Emerson Electric Co. Brand name is a mark of one of the Emerson Process Management family of companies. All other marks are the property of their respective owners.

The contents of this publication are presented for information purposes only, and while effort has been made to ensure their accuracy, they are not to be construed as warranties or guarantees, express or implied, regarding the products or services described herein or their use or applicability. All sales are governed by our terms and conditions, which are available on request. We reserve the right to modify or improve the designs or specifications of our products at any time without notice.

