

# Rosemount 3051S Wireless Series

Pressure, Level, and Flow Solutions with IEC 62951  
(WirelessHART™) Protocol



**WirelessHART**

**ROSEMOUNT**



**EMERSON**  
Process Management



# Rosemount 3051S Wireless Series Scalable Pressure, Flow, and Level Solutions

## **▲ WARNING**

Read this manual before working with the product. For personal and system safety, and for optimum product performance, make sure you thoroughly understand the contents before installing, using, or maintaining this product.

For technical assistance, contacts are listed below:

Customer Central

Technical support, quoting, and order-related questions.

United States - 1 800 999 9307 (7:00 am to 7:00 pm CST)

Asia Pacific- 65 777 8211

Europe/ Middle East/ Africa - 49 (8153) 9390

North American Response Center

Equipment service needs.

1 800 654 7768 (24 hours—includes Canada)

Outside of these areas, contact your local Emerson Process Management representative.

---

## **▲ CAUTION**

The products described in this document are NOT designed for nuclear-qualified applications. Using non-nuclear qualified products in applications that require nuclear-qualified hardware or products may cause inaccurate readings.

For information on Rosemount nuclear-qualified products, contact your local Emerson Process Management Sales Representative.

---

## ▲ WARNING

### **Failure to follow these installation guidelines could result in death or serious injury:**

- Make sure only qualified personnel perform the installation.

### **Explosions could result in death or serious injury:**

Installation of this transmitter in an explosive environment must be in accordance with the appropriate local, national, and international standards, codes, and practices. Please review the approvals section of this manual for any restrictions associated with a safe installation.

- Before connecting a 375 Field Communicator in an explosive atmosphere, ensure the instruments are installed in accordance with intrinsically safe or non-incendive field wiring practices.
- Verify that the operating atmosphere of the transmitter is consistent with the appropriate hazardous locations certifications.

### **Process leaks could result in death or serious injury.**

- Install and tighten process connectors before applying pressure.
- Do not attempt to loosen or remove process connectors while the transmitter is in service.

### **Electrical shock can result in death or serious injury.**

- Avoid contact with the leads and terminals. High voltage that may be present on leads can cause electrical shock.

---

## ▲ CAUTION

The Rosemount 3051S and all other wireless devices should be installed only after the Smart Wireless Gateway has been installed and is functioning properly. Wireless devices should also be powered up in order of proximity from the Smart Wireless Gateway, beginning with the closest. This will result in a simpler and faster network installation.

---

## ▲ CAUTION

Shipping considerations for wireless products (Lithium Batteries):

The unit was shipped to you without the Power Module installed. Please remove the Power Module from the unit prior to shipping.

Primary lithium batteries are regulated in transportation by the U. S. Department of Transportation, and are also covered by IATA (International Air Transport Association), ICAO (International Civil Aviation Organization), and ARD (European Ground Transportation of Dangerous Goods). It is the responsibility of the shipper to ensure compliance with these or any other local requirements. Please consult current regulations and requirements before shipping.

The power module may be replaced in a hazardous area. The power module has surface resistivity greater than one gigaohm and must be properly installed in the wireless device enclosure. Care must be taken during transportation to and from the point of installation to prevent electrostatic charge build-up.

---

---

# Table of contents

## Section 1: Introduction

1.1 Using This Manual .....	1
1.2 Models Covered .....	2
1.3 Service support.....	3
1.4 Product Recycling/Disposal .....	4

## Section 2: Configuration

2.1 Overview .....	5
2.2 Safety Messages .....	5
2.2.1 Warnings ().....	6
2.3 System readiness .....	6
2.3.1 Confirm correct Device Driver .....	6
2.4 Required bench top configuration .....	7
2.4.1 Connection diagrams.....	7
2.5 Device network configuration .....	8
2.5.1 Join device to network .....	8
2.5.2 Configure update rate .....	9
2.5.3 Remove power module .....	9
2.6 Review configuration data .....	10
2.6.1 Review Pressure Information .....	10
2.6.2 Review Device and Sensor Information .....	11
2.6.3 Review radio information .....	12
2.7 Check output .....	12
2.7.1 Operating parameters .....	12
2.8 Basic setup.....	13
2.8.1 Set process variable unit .....	13
2.8.2 Set transfer function.....	14
2.8.3 Damping.....	15
2.8.4 Write protect.....	15
2.9 LCD display .....	16
2.9.1 LCD display configuration.....	16
2.10 Detailed setup .....	17
2.10.1 Configure process alarms .....	17
2.10.2 Sensor temperature unit .....	18

---

2.10.3 Scaled Variable Configuration .....	18
2.10.4 Re-Mapping device variables .....	22
2.11 Diagnostics and service .....	23
2.11.1 Master reset.....	23
2.11.2 Join status.....	24
2.11.3 Number of available neighbors .....	24
2.12 Advanced functions for HART Protocol .....	25
2.12.1 Saving, recalling, and cloning configuration data .....	25

## Section 3: Installation

3.1 Overview .....	27
3.2 Safety messages.....	27
3.2.1 Warnings ().....	28
3.3 Considerations .....	29
3.3.1 General .....	29
3.3.2 Wireless .....	29
3.3.3 Mechanical .....	30
3.3.4 Environmental .....	30
3.4 Installation procedures .....	32
3.4.1 Mount the transmitter.....	32
3.4.2 Process connections.....	38
3.4.3 Consider housing rotation.....	39
3.4.4 Grounding .....	39
3.4.5 High gain, remote antenna (optional) .....	39
3.4.6 Power module installation .....	40
3.4.7 Installing the LCD display .....	40
3.5 Rosemount 304, 305 and 306 Integral Manifolds .....	41
3.5.1 Rosemount 305 Integral Manifold installation procedure .....	42
3.5.2 Rosemount 306 Integral Manifold installation procedure .....	42
3.5.3 Rosemount 304 Conventional Manifold installation procedure .....	43
3.5.4 Manifold operation.....	43

## Section 4: Commissioning

4.1 Safety messages.....	47
4.1.1 Warnings ().....	47
4.2 Network status .....	48
4.3 Verify operation .....	48

## Section 5: Operation and Maintenance

5.1 Overview .....	51
5.2 Calibration .....	51
5.2.1 Sensor trim overview .....	52
5.2.2 Zero trim .....	53
5.2.3 Sensor trim .....	53
5.2.4 Line pressure effect (Range 2 and Range 3) .....	54
5.2.5 Compensating for line pressure (Range 4 and Range 5) .....	54
5.3 LCD screen messages .....	57
5.3.1 Startup screen sequence .....	57
5.3.2 Diagnostic Button Screen Sequence .....	59
5.3.3 Network diagnostic status screens .....	60
5.3.4 Device diagnostic screens .....	63

## Section 6: Troubleshooting

6.1 Overview .....	67
6.2 Safety messages .....	67
6.2.1 Warnings (.) .....	68
6.3 Disassembly procedures .....	72
6.3.1 Remove from service .....	72
6.3.2 Remove terminal block .....	72
6.3.3 Removing the feature assembly and the SuperModule from the housing .....	73
6.4 Reassembly procedures .....	74
6.4.1 Attach the SuperModule to the wireless housing .....	74
6.4.2 Install the Terminal Block .....	74
6.4.3 Reassemble the process flange .....	75

## Appendix A: Specifications and Reference Data

A.1 Specifications .....	77
A.1.1 Performance specifications .....	77
A.1.2 Functional specifications .....	82
A.1.3 Physical specifications .....	87
A.2 Dimensional drawings .....	92
A.3 Ordering Information .....	94

## Appendix B: Product Certifications

B.1 Wireless certifications .....	139
-----------------------------------	-----

---

B.1.1	Approved manufacturing locations.....	139
B.1.2	Telecommunication compliance .....	139
B.1.3	FCC and IC approvals .....	139
B.1.4	Ordinary location certification for FM.....	139
B.1.5	Hazardous locations certifications.....	141

## **Appendix C: High Gain Remote Antenna Option**

C.1	Safety messages.....	143
C.1.1	Warnings .....	143
C.2	Functional specifications .....	144
C.3	Installation considerations.....	145
C.4	Transient / lightning considerations.....	145
C.5	Dimensional drawings.....	146
C.6	Installation steps .....	147

## **Appendix D: Field Communicator Menu Trees and Fast Keys**

D.1	Field Communicator menu trees.....	151
-----	------------------------------------	-----



---

# Section 1 Introduction

---

---

Using This Manual .....	page 1
Models Covered .....	page 2
Service support .....	page 3
Product Recycling/Disposal .....	page 4

---

## 1.1 Using This Manual

The sections in this manual provide information on installing, operating, and maintaining the Rosemount 3051S Wireless pressure transmitter with IEC 62591 (WirelessHART™) protocol. The sections are organized as follows:

- [Section 2: Configuration](#) provides instruction on commissioning and operating 3051S Wireless transmitters. Information on software functions, configuration parameters, and online variables is also included.
- [Section 3: Installation](#) contains mechanical and electrical installation instructions.
- [Section 4: Commissioning](#) contains techniques for properly commissioning the device.
- [Section 5: Operation and Maintenance](#) contains operation and maintenance techniques.
- [Section 6: Troubleshooting](#) provides troubleshooting techniques for the most common operating problems.
- [Section A: Specifications and Reference Data](#) supplies reference and specification data, as well as ordering information.
- [Section B: Product Certifications](#) contains approval information.

## 1.2 Models Covered

The following Rosemount 3051S Wireless pressure transmitters are covered in this manual.

### Rosemount 3051S Wireless Coplanar™ Pressure Transmitter

Performance Class	Measurement Type		
	Differential	Gage	Absolute
Classic	X	X	X
Ultra	X	X	X
Ultra for Flow	X	–	–

### Rosemount 3051S Wireless In-Line Pressure Transmitter

Performance Class	Measurement Type		
	Differential	Gage	Absolute
Classic	–	X	X
Ultra	–	X	X

### Rosemount 3051S Wireless Liquid Level Pressure Transmitter

Performance Class	Measurement Type		
	Differential	Gage	Absolute
Classic	X	X	X
Ultra	X	X	X

## 1.3 Service support

To expedite the return process outside of the United States, contact the nearest Emerson Process Management representative.

Within the United States, call the Emerson Process Management Instrument and Valves Response Center using the 1-800-654-RSMT (7768) toll-free number. This center, available 24 hours a day, will assist you with any needed information or materials.

The center will ask for product model and serial numbers, and will provide a Return Material Authorization (RMA) number. The center will also ask for the process material to which the product was last exposed.

### **▲ CAUTION**

Individuals who handle products exposed to a hazardous substance can avoid injury if they are informed of and understand the hazard. If the product being returned was exposed to a hazardous substance as defined by OSHA, a copy of the required Material Safety Data Sheet (MSDS) for each hazardous substance identified must be included with the returned goods.

### **NOTICE**

Shipping considerations for wireless products (Lithium Batteries):

The unit was shipped to you without the Power Module installed. Please remove the Power Module from the unit prior to shipping.

Primary lithium batteries (charged or discharged) are regulated in transportation by the U. S. Department of Transportation, and are also covered by IATA (International Air Transport Association), ICAO (International Civil Aviation Organization), and ARD (European Ground Transportation of Dangerous Goods). It is the responsibility of the shipper to ensure compliance with these or any other local requirements. Please consult current regulations and requirements before shipping.

The Power Module contains two “C” size primary lithium/thionyl chloride batteries. Each Power Module contains approximately 2.5 grams of lithium, for a total of 5 grams in each module. Under normal conditions, the Power Module materials are self-contained and are not reactive as long as the batteries and the module integrity are maintained. Care should be taken to prevent thermal, electrical or mechanical damage. Contacts should be protected to prevent premature discharge. Power Module hazards remain when cells are discharged.

Power Module should be stored in a clean and dry area. For maximum battery life, storage temperature should not exceed 86 °F (30° C).

Emerson Process Management Instrument and Valves Response Center representatives will explain the additional information and procedures necessary to return goods exposed to hazardous substances.

## **1.4 Product Recycling/Disposal**

Recycling of equipment and packaging should be taken into consideration and disposed of in accordance with local and national legislation/regulations.

---

# Section 2 Configuration

---

---

Overview .....	page 5
Safety Messages .....	page 5
Required bench top configuration .....	page 7
Device network configuration .....	page 8
Review configuration data .....	page 10
Check output .....	page 12
Check output .....	page 12
Basic setup .....	page 13
LCD display .....	page 16
Detailed setup .....	page 17
Diagnostics and service .....	page 23
Advanced functions for HART Protocol .....	page 25

---

## 2.1 Overview

This section contains information on configuration and verification that should be performed prior to installation.

Field Communicator and AMS instructions are given to perform configuration functions. For convenience, Field Communicator fast key sequences are labeled “Fast Keys” for each software function below the appropriate headings.

### Example Software Function

Fast Keys	1, 2, 3, etc.
-----------	---------------

## 2.2 Safety Messages

Procedures and instructions in this section may require special precautions to ensure the safety of the personnel performing the operations. Information that raises potential safety issues is indicated by a warning symbol (⚠). Refer to the following safety messages before performing an operation preceded by this symbol.

## 2.2.1 Warnings (⚠)

### ⚠ WARNING

Explosions can result in death or serious injury.

- Before connecting a 375 Field Communicator in an explosive atmosphere, make sure the instruments are installed in accordance with intrinsically safe or nonincendive field wiring practices.

Electrical shock can result in death or serious injury.

- Avoid contact with the leads and terminals. High voltage that may be present on leads can cause electrical shock.

This device complies with Part 15 of the FCC Rules. Operation is subject to the following conditions: This device may not cause harmful interference this device must accept any interference received, including interference that may cause undesired operation.

This device must be installed to ensure a minimum antenna separation distance of 20cm from all persons.

## 2.3 System readiness

- If using HART based control or asset management systems, confirm the HART capability of such systems prior to commissioning and installation. Not all systems are capable of communicating with HART revision 7 devices.

### 2.3.1 Confirm correct Device Driver

- Verify the latest Device Driver (DD/DTM) is loaded on your systems to ensure proper communications.
  1. Download the latest DD at [www.emersonprocess.com](http://www.emersonprocess.com).
  2. In the Browse by Member dropdown menu, select Rosemount business unit of Emerson Process Management.
  3. Select desired Product
    - a. Within [Table 2-1 on page 7](#), use the HART Universal Revision and Device Revision numbers to find the correct Device Driver

**Table 2-1. Rosemount 3051S Wireless Device Revisions and files**

Software Release Date	Identify Device		Find Device Driver		Review Instructions	Review Functionality
	NAMUR Software Revision <sup>(1)</sup>	HART Software Revision <sup>(2)</sup>	HART Universal Revision	Device Revision <sup>(3)</sup>	Manual Document Number	Changes to Software
April 2013	3.1.0	3	7	3	00809-0200-4802 Rev BA	Added Scaled Variable
June 2010	2.0.0	2	7	2	00809-0200-4802 Rev AA	N/A

(1) NAMUR Software Revision is located on the hardware tag of the device.

(2) HART Software Revision can be read using a HART capable configuration tool.

(3) Device Driver file names use Device and DD Revision, e.g. 10\_01. HART Protocol is designed to enable legacy device driver revisions to continue to communicate with new HART devices. To access new functionality, the new Device Driver must be downloaded. It is recommended to download new Device Driver files to ensure full functionality.

## 2.4 Required bench top configuration

Bench top configuration requires a 375 Field Communicator, AMS, or any IEC 62591 (WirelessHART) Communicator. Connect the Field Communicator leads to the terminals labeled “COMM” on the terminal block. See [Figure 2-1 on page 8](#).

Bench top configuration consists of testing the transmitter and verifying transmitter configuration data. 3051S Wireless transmitters must be configured before installation. Configuring the transmitter on the bench before installation using a 375 Field Communicator, AMS, or any IEC 62591 (WirelessHART) Communicator ensures that all network settings are working correctly.

When using a Field Communicator, any configuration changes made must be sent to the transmitter by using the “Send” key (F2). AMS configuration changes are implemented when the “Apply” button is clicked.

### AMS Wireless Configurator

AMS is capable of connecting to devices either directly, using a HART modem, or wirelessly via the Smart Wireless Gateway. When configuring the device, double click the device icon or right click and select Configure.

### 2.4.1 Connection diagrams

#### Bench hook-up

Connect the bench equipment as shown in [Figure 2-1 on page 8](#), and turn on the Field Communicator by pressing the ON/OFF key or log into AMS. The Field Communicator or AMS will search for a HART-compatible device and indicate when the connection is made. If the Field Communicator or AMS fail to connect, it indicates that no device was found. If this occurs, refer to [Section 6: Troubleshooting](#).

## Field Hook-up

Figure 2-1 illustrates the wiring for a field hook-up with a Field Communicator or AMS. The Field Communicator or AMS may be connected at “COMM” on the transmitter terminal block.

Figure 2-1. Field Communicator Connection

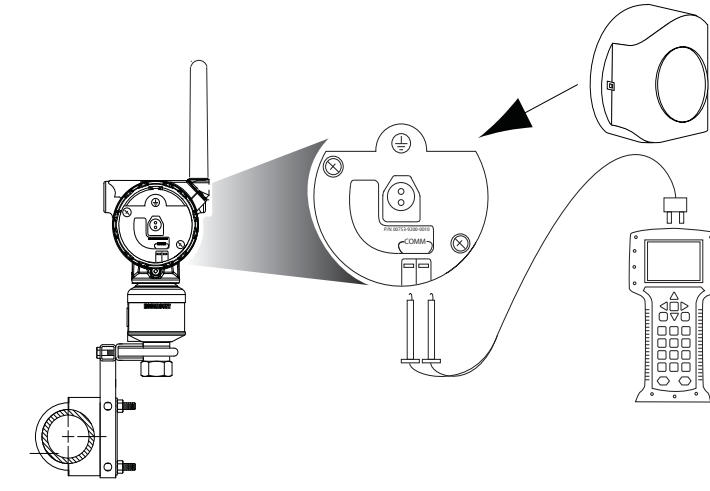

For HART communication, a 3051S WirelessHART DD is required.

## 2.5 Device network configuration

### 2.5.1 Join device to network

Fast Keys	2, 1, 3
-----------	---------

In order to communicate with the Smart Wireless Gateway, and ultimately the Host System, the transmitter must be configured to communicate over the wireless network. This step is the wireless equivalent of connecting wires from a transmitter to the host system.

1. From the *Home* screen, choose **2: Configure**.
2. Choose **1: Guided Setup**.
3. Choose **3: Join Device to Network**.

Using a Field Communicator or AMS, enter the Network ID and Join Key so that they match the Network ID and Join Key of the Smart Wireless Gateway and other devices in the network. If the Network ID and Join Key are not identical to those set in the Gateway, the transmitter will not communicate with the network. The Network ID and Join Key may be obtained from the Smart Wireless Gateway on the *Setup>Network>Settings* page on the web server.



## 2.5.2 Configure update rate

Fast Keys	2, 1, 4
-----------	---------

The Update Rate is the frequency at which a new measurement is taken and transmitted over the wireless network. This by default is 1 minute. This may be changed at commissioning, or at any time via AMS Wireless Configurator. The Update Rate is user selectable from 1 seconds to 60 minutes.

1. From the *Home* screen, choose **2: Configure**.
2. Choose **1: Guided Setup**.
3. Choose **4: Configure Update Rate**.

When device configuration is completed, remove the Power Module and replace the housing cover. Tighten the cover so that metal contacts metal.

## 2.5.3 Remove power module

After the sensor and network have been configured, remove the Power Module and replace the housing cover. The Power Module should be inserted only when the device is ready to be commissioned.

Use caution when handling the power module. It may be damaged if dropped onto a hard surface. Battery hazards remain when cells are discharged.

This transmitter uses the Black Power Module. Please order model number 701PBKKF or spare part number 00753-9200-0001.

## 2.6 Review configuration data

The following is a list of factory default configurations that can be viewed by using the Field Communicator or AMS. Follow the steps below to review the transmitter configuration information.

---

### Note

Information and procedures in this section that make use of Field Communicator fast key sequences and AMS assume that the transmitter and communication equipment are connected, powered, and operating correctly.

---

### 2.6.1 Review Pressure Information

Fast Keys	2, 2, 2
-----------	---------

To view pressure information:

1. From the *Home* screen, choose **2: Configure**.
2. Choose **2: Manual Setup**.
3. Choose **2: Pressure**.
4. Choose from the corresponding number to view each field:
  - 1 Pressure
  - 2 Pressure Status
  - 3 Units
  - 4 Damping
  - 5 Sensor Limits

## 2.6.2 Review Device and Sensor Information

Fast Keys	2, 2, 9
-----------	---------

To view device information:

1. From the *Home* screen, choose **2: Configure**.
2. Choose **2: Manual Setup**.
3. Choose **9: Device Information**.
4. Choose from the corresponding number to view each field:
  - 1 Identification
  - 2 Revisions
  - 3 Radio
  - 4 Sensor information
  - 5 Flange information
  - 6 Remote seal information

## 2.6.3 Review radio information

Fast Keys	2, 2, 9, 3
-----------	------------

To view radio information:

1. From the *Home* screen, choose **2: Configure**.
2. Choose **2: Manual Setup**.
3. Choose **9: Device Information**.
4. Choose **3: Radio**.
5. Select from the corresponding number to view each field:
  - 1 Manufacturer
  - 2 Device Type
  - 3 Device Revision
  - 4 Software Revision
  - 5 Hardware Revision

## 2.7 Check output

Before performing other transmitter operations, ensure that the transmitter is operating properly by checking the operating parameters.

### 2.7.1 Operating parameters

Fast Keys	3, 2
-----------	------

The pressure output value in both engineering units and percent of range will reflect the applied pressure even when the applied pressure is outside of the configured range as long as the applied pressure is between the upper and lower range limit of the transmitter. For example, if a Range 2 3051S\_T (LRL = 0 psi, URL = 150 psi) is ranged from 0 to 100 psi, an applied pressure of 150 psi will return a % of range output of 150% and an engineering output of 150 psi.

To view the *Operating Parameters* menu:

1. From the *Home* screen, select 3: Service Tools.
2. Choose **2: Variables**.

The Operating Parameters menu displays the following information pertaining to the device:

- Percent of Range
- Pressure
- Pressure Status
- Sensor Temperature
- Sensor Temperature Status
- Electronics Temperature
- Electronics Temperature Status
- Supply Voltage
- Supply Voltage Status
- Last Update Time

## 2.8 Basic setup

### 2.8.1 Set process variable unit

Fast Keys	2, 2, 2, 3
-----------	------------

The PV Unit command sets the process variable units to allow you to monitor your process using the appropriate units of measure.

To select a unit of measure for the PV:

1. From the *Home* screen, choose **2: Configure**.
2. Choose **2: Manual Setup**.
3. Choose **2: Pressure**.
4. Choose **3: Unit** to select from the following engineering units:
 

■ inH <sub>2</sub> O at 4 °C	■ mmH <sub>2</sub> O at 68 °F	■ mmHg	■ Mpa
■ inH <sub>2</sub> O at 60 °F	■ cmH <sub>2</sub> O at 4 °C	■ Psi	■ Bar
■ inH <sub>2</sub> O at 68 °F	■ mH <sub>2</sub> O at 4 °C	■ Atm	■ Mbar
■ ftH <sub>2</sub> O at 4 °C	■ inHg at 0 °C	■ Torr	■ g/cm <sup>2</sup>
■ ftH <sub>2</sub> O at 60 °F	■ mmHg at 0 °C	■ Pascals	■ kg/cm <sup>2</sup>
■ ftH <sub>2</sub> O at 68 °F	■ cmHg at 0 °C	■ hectoPascals	■ kg/m <sup>2</sup>
■ mmH <sub>2</sub> O at 4 °C	■ mHg at 0 °C	■ Kilopascals	

## 2.8.2 Set transfer function

Fast Keys	2, 2, 4, 2
-----------	------------

The Rosemount 3051S Wireless has two output settings: Linear and Square Root. Activate the square root output option to make output proportional to flow. As input approaches zero, the 3051S Wireless automatically switches to linear output in order to ensure a more smooth, stable output near zero (see Figure 2-2).

From 0 to 0.6 percent of the ranged pressure input, the slope of the curve is unity ( $y = x$ ). This allows accurate calibration near zero. Greater slopes would cause large changes in output (for small changes at input). From 0.6 percent to 0.8 percent, curve slope equals 42 ( $y = 42x$ ) to achieve continuous transition from linear to square root at the transition point.

To select the output transfer function:

1. From the *Home* screen, choose **2: Configure**.
2. Choose **2: Manual Setup**.
3. Choose **4: Percent of Range**
4. Choose **2: Transfer Function** and choose either Linear or Square Root.

Figure 2-2. Square Root Output Transition Point

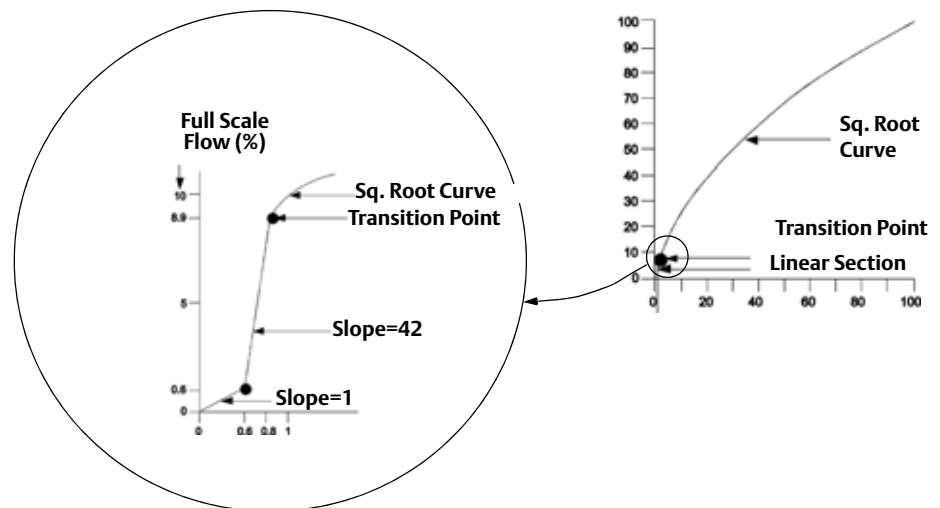

## 2.8.3 Damping

Fast Keys	2, 2, 2, 4
-----------	------------

The Damping command introduces a delay in processing which increases the response time of the transmitter; smoothing variations in output readings caused by rapid input changes. In the 3051S Wireless pressure transmitter, damping only takes effect when the device is placed in high power refresh mode and during calibration. In normal power mode, the effective damping is 0. Note that when the device is in high power refresh mode, battery power will be depleted rapidly. Determine the appropriate damp setting based on the necessary response time, signal stability, and other requirements of the loop dynamics of your system. The damping value of your device is user selectable from 0 to 60 seconds.

To determine the current damping value:

1. From the Home screen, choose **2: Configure**.
2. Choose **2: Manual Setup**.
3. Choose **2: Pressure**.
4. Choose **4: Damping**.

## 2.8.4 Write protect

Fast Keys	2, 2, 7, 1
-----------	------------

The 3051S Wireless has a software write protect security feature.

The view write protect security settings:

1. From the *Home* screen, choose **2: Configure**.
2. Choose **2: Manual Setup**.
3. Choose **7: Device Information**.
4. Choose **1: Write Protect**.

---

## 2.9 LCD display

### 2.9.1 LCD display configuration

Fast Keys	2, 1, 5
-----------	---------

The LCD display indicates output and abbreviated diagnostic messages.

---

#### Note

Use Rosemount Wireless LCD Part Number: 00753-9004-0002.

---

The LCD display features a four-line display and a bar graph. The first line of five characters displays the output description, the second line of seven digits displays the actual value, the third line of six characters displays engineering units and the fourth line displays “Error” when the transmitter is in alarm. The LCD display can also display diagnostic messages. The bar graph represents the network connectivity status.

See “LCD Screen Messages” on page 6 for more information on LCD messages.

To configure LCD display options:

1. From the *Home* screen, choose **2: Configure**.
2. Choose **1: Guided Setup**.
3. Choose **5: Configure Device Display**.



## 2.10 Detailed setup

### 2.10.1 Configure process alarms

Fast Keys	2, 1, 6
-----------	---------

Alerts allow the user to configure the transmitter to output a HART message when the configured data point is exceeded. A process alert will be transmitted continuously if the set points are exceeded and the alert mode is ON. An alert will be displayed on a Field Communicator, AMS status screen or in the error section of the LCD display. The alert will reset once the value returns within range.

#### Note

HI alert value must be higher than the LO alert value. Both alert values must be within the pressure or temperature sensor limits.

Example 1: Rising Alert

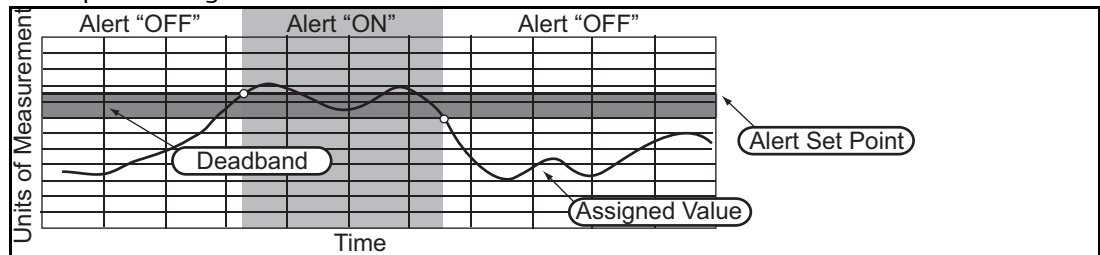

Example 2: Falling Alert

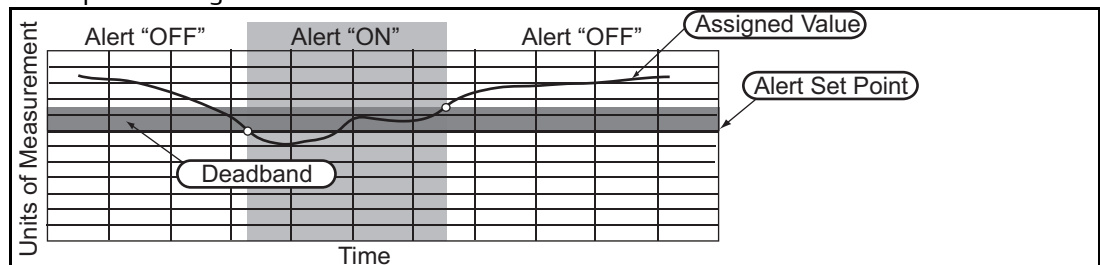

To configure the process alerts, perform the following procedure:

1. From the *Home* screen, choose **2: Configure**.
2. Choose **1: Guided Setup**.
3. Choose **6: Configure Process Alarms** and follow the on-screen instructions to complete configure of process alarms.

## 2.10.2 Sensor temperature unit

Fast Keys	2, 2, 8, 3
-----------	------------

The Sensor Temperature Unit command selects between Celsius and Fahrenheit units for the sensor temperature. The sensor temperature output is accessible via HART only.

To select the sensor temperature unit:

1. From the *Home* screen, choose **2: Configure**.
2. Choose **2: Manual Setup**.
3. Choose **8: Device Temperatures**.
4. Choose **3: Sensor Temperature**.

## 2.10.3 Scaled Variable Configuration

Fast Keys	2, 2, 3
-----------	---------

The scaled variable configuration allows the user to create a relationship/conversion between the pressure units and user-defined/custom units. There are two use cases for scaled variable. The first use case is to allow custom units to be displayed on the transmitter's LCD display. The second use case is to allow custom units to drive the transmitter's 4-20 mA output.

If the user desires custom units to drive the 4-20 mA output, scaled variable must be re-mapped as the primary variable. Refer to [“Re-Mapping device variables” on page 22](#).

The scaled variable configuration defines the following items:

- Scaled variable units - Custom units to be displayed.
- Scaled data options - Defines the transfer function for the application
  - a. Linear
  - b. Square root
- Pressure value position 1 - Lower known value point (possible 4 mA point) with consideration of linear offset.
- Scaled variable value position 1 - Custom unit equivalent to the lower known value point (The lower known value point may or may not be the 4 mA point.)
- Pressure value position 2 - Upper known value point (possible 20 mA point)
- Scaled variable value position 2 - Custom unit equivalent to the upper known value point (possible 20 mA point)
- Linear offset - The value required to zero out pressures effecting the desired pressure reading.
- Low flow cutoff - Point at which output is driven to zero to prevent problems caused by process noise. It is highly recommended to use the low flow cutoff function in order to have a stable output and avoid problems due to process noise at a low flow or no flow condition. A low flow cutoff value that is practical for the flow element in the application should be entered.

---

**Note**

If Scaled Variable is mapped as the primary variable and square root mode is selected, ensure transfer function is set to linear. Refer to “Set transfer function” on page 14.

---

## Field Communicator v3.3

To configure the scaled variable with a Field Communicator, perform the following procedure:

1. From the *HOME* screen follow the fast key sequence “Scaled Variable Configuration.”
2. Choose **OK** after the control loop is set to manual.
3. Enter the scaled variable units.
  - a. Units can be up to five characters long and include A—Z, 0—9, -, /, %, and \*.  
Default unit is DEFLT.
  - b. The first character is always an asterisk (\*), which identifies the units displayed are scaled variable units.
4. Select scaled data options
  - a. Select linear if the relationship between PV and scaled variable units are linear.  
Linear prompts for two data points.
  - b. Select square root if the relationship between PV and scaled variable is square root (flow applications). Square root will prompt for one data point.
5. Enter pressure value position 1. Pressure values must be within the range of the transmitter.
  - a. (If performing a *Linear Function*) Enter the lower known value point considering any linear offset.
  - b. (If performing a *Square Root Function*) Choose **OK** to acknowledge pressure value is set to zero.
6. Enter scaled variable position 1.
  - a. (If performing a *Linear Function*) Enter the lower known value point; this value must be no longer than seven digits.
  - b. (If performing a *Square Root Function*) Choose **OK** to acknowledge scaled variable value is set to zero.
7. Enter pressure value position 2. Pressure values must be within the range of the transmitter.
  - a. Enter the upper known value point.
8. Enter scaled variable position 2.
  - a. (If performing a *Linear Function*) Enter custom unit equivalent to the upper known value point; this value must be no longer than seven digits.
  - b. (If performing a *Square Root Function*) Enter custom unit equivalent to the value in step 7; this value must be no longer than seven digits. Skip to step 10.

9. Enter linear offset value in scaled variable (custom) units (If performing a *Linear Function*). Skip to step 11.
10. Enter Low Flow cutoff mode (If performing a *Square Root Function*)
  - a. Choose **OFF** if a low flow cutoff value is not desired.
  - b. Choose **ON** if a low flow cutoff value is desired and enter this value in scaled variable (custom) units on the next screen.
11. Choose **OK** to acknowledge that the loop can be returned to automatic control.

## AMS v7.0

Right click on the device and choose **Device Configuration** then choose **SV Config** from the menu.

1. Choose **Next** after setting the control loop to manual.
2. Enter desired scaled variable units in *Enter SV units* box and choose **Next**.
3. Choose scaled data options: *Linear* or *Square Root* and choose **Next**. If square root is selected skip to Step 9.
4. Enter pressure value position 1 and choose **Next**.
5. Enter scaled variable position 1 and choose **Next**.
6. Enter pressure value position 2 and choose **Next**.
7. Enter scaled variable position 2 and choose **Next**.
8. Enter linear offset and choose **Next**. Skip to Step 15.
9. Choose **Next** to acknowledge that *Pressure value for position 1* is set to zero.
10. Choose **Next** to acknowledged that *Square root value for position 1* is set to zero.
11. Enter pressure value for position 2 and choose **Next**.
12. Enter square root value for position 2 and choose **Next**.
13. Enter low flow cutoff mode: **Off** or **On**. If off is selected, skip to Step 15.
14. Enter low flow cutoff value in scaled variable (custom) units and choose **Next**.
15. Choose **Next** to acknowledge that the loop can be returned to automatic control.
16. Choose **Finish** to acknowledge the method is complete.

## DP Level example

Figure 2-3. Example tank

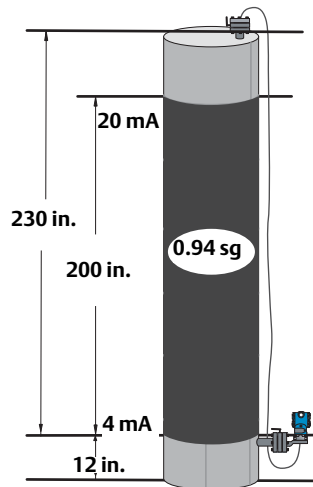

A differential transmitter is used in a level application where the span is 188 inH<sub>2</sub>O (200 in. \* 0.94 sg). Once installed on an empty tank and taps vented, the process variable reading is -209.4 inH<sub>2</sub>O. The process variable reading is the head pressure created by fill fluid in the capillary. Based on Figure 2-3, the Scaled Variable configuration would be as follows:

Scaled Variable units:	inches
Scaled data options:	linear
Pressure value position 1:	0 inH <sub>2</sub> O (0 mbar)
Scaled Variable position 1:	12 in. (305 mm)
Pressure value position 2:	188 inH <sub>2</sub> O (0.47 bar)
Scaled Variable position 2:	212 in.(5385 mm)
Linear offset:	-209.4 inH <sub>2</sub> O (-0.52 bar)

## DP Flow Example

A differential transmitter is used in conjunction with an orifice plate in a flow application where the differential pressure at full scale flow is 125 inH<sub>2</sub>O. In this particular application, the flow rate at full scale flow is 20,000 gallons of water per hour. It is highly recommended to use the low flow cutoff function in order to have a stable output and avoid problems due to process noise at a low flow or no flow condition. A low flow cutoff value that is practical for the flow element in the application should be entered. In this particular example, the low flow cutoff

value is 1000 gallons of water per hour. Based on this information, the Scaled Variable configuration would be as follows:

Scaled Variable units:	gal/h
Scaled data options:	square root
Pressure value position 2:	125 inH2O (311 mbar)
Scaled Variable position 2:	20,000 gal/h (75,708 lt/hr)
Low Flow Cutoff:	1000 gal/h (ON)

**Note**

Pressure value position 1 and Scaled Variable position 1 are always set to zero for a flow application. No configuration of these values is required.

## 2.10.4 Re-Mapping device variables

 The re-mapping function allows the transmitter primary, secondary, tertiary, and quaternary variables (PV, SV, TV, and QV) to be configured in one of two configurations. The user may select either the option of Classic mapping or Scaled Variable Mapping, see [Table 2-2](#) for what is mapped to each variable. All variables can be remapped with a Field Communicator or AMS Device Manager.

**Table 2-2. Variable Mapping**

	Classic Mapping	Scaled Variable Mapping
PV	Pressure	Scaled Variable
SV	Sensor Temperature	Pressure
TV	Electronics Temperature	Sensor Temperature
QV	Supply Voltage	Supply Voltage

**Note**

The variable assigned to the primary variable drives the output. This value can be selected as Pressure or Scaled Variable.

## Re-mapping using a Field Communicator

From the *HOME* screen, enter the fast key sequence

<b>Fast Keys: guided set up</b>	2, 1, 7
<b>Fast Keys: manual set up</b>	2, 2, 3, 5

## Re-mapping using AMS Device Manager

Right click on the device and select **Configure**.

1. Select **Manual Setup** and click on the **HART** tab.
2. Assign Primary, secondary, tertiary and quaternary variables under *Variable Mapping*.
3. Click **Send**.
4. Carefully read the warning and click **Yes** if it is safe to apply the changes.

## 2.11 Diagnostics and service

Diagnostics and service functions listed below are primarily for use after field installation. The Transmitter Test feature is designed to verify that the transmitter is operating properly, and can be performed either on the bench or in the field.

### 2.11.1 Master reset

<b>Fast Keys</b>	3, 5, 4
------------------	---------

The master reset function will reset the device electronics. To perform a master reset:

1. From the *Home* screen, choose **3: Service Tools**.
2. Choose **5: Routine Maintenance**.
3. Choose **4: Other**.

## 2.11.2 Join status

Fast Keys	3, 4, 1
-----------	---------

To view the join status of the device, perform the following procedure:

1. From the *Home* screen, choose **3: Service Tools**.
2. Choose **4: Communications**.
3. Choose **1: Join Status**.

Wireless devices join the secure network through a four step process:

- Step 1. Network Found
- Step 2. Network Security Clearance Granted
- Step 3. Network Bandwidth Allocated
- Step 4. Network Join Complete

## 2.11.3 Number of available neighbors

Fast Keys	3, 4, 3
-----------	---------

In a self-organizing network, the more neighbors a device has, the more robust the network will be. To view the number of available neighbors for the wireless device, perform the following procedure:

1. From the *Home* screen, choose **3: Service Tools**.
2. Choose **4: Routine Maintenance**.
3. Choose **3: Number of Available Neighbors**.



## 2.12 Advanced functions for HART Protocol

### 2.12.1 Saving, recalling, and cloning configuration data

<b>Fast Keys</b>	left arrow, 1, 2
------------------	------------------

Use the cloning feature of the Field Communicator or the AMS “User Configuration” feature to configure several 3051S Wireless transmitters similarly. Cloning involves configuring a transmitter, saving the configuration data, then sending a copy of the data to a separate transmitter. Several possible procedures exist when saving, recalling, and cloning configuration data. For complete instructions refer to the Field Communicator manual (publication no. 00809-0100-4276) or AMS Books Online. One common method is as follows:

#### Field communicator

1. Completely configure the first transmitter.
2. Save the configuration data:
  - a. Choose **F2 SAVE** from the Field Communicator *HOME/ONLINE* screen.
  - b. Ensure that the location to which the data will be saved is set to *MODULE*. If it is not, choose **1: Location** to set the save location to *MODULE*.
  - c. Choose **2: Name**, to name the configuration data. The default is the transmitter tag number.
  - d. Ensure that the data type is set to *STANDARD*. If the data type is NOT STANDARD, choose **3: Data Type** to set the data type to *STANDARD*.
  - e. Choose **F2 SAVE**.
3. Connect and power the receiving transmitter and Field Communicator.
4. Select the back arrow from the *HOME/ONLINE* screen. The Field Communicator menu appears.
5. Choose **1: Offline, 2: Saved Configuration, 1: Module Contents** to reach the *MODULE CONTENTS* menu.
6. Use the *DOWN ARROW* to scroll through the list of configurations in the memory module, and use the *RIGHT ARROW* to select and retrieve the required configuration.
7. Choose **1: Edit**.
8. Choose **1: Mark All**.
9. Choose **F2 SAVE**.
10. Use the *DOWN ARROW* to scroll through the list of configurations in the memory module, and use the *RIGHT ARROW* to select the configuration again.
11. Choose **3: Send** to download the configuration to the transmitter.
12. Choose **OK** after the control loop is set to manual.
13. After the configuration has been sent, choose **OK**.

---

When finished, the Field Communicator informs you of the status. Repeat Steps 3 through 13 to configure another transmitter.

---

**Note**

The transmitter receiving cloned data must have the same software version (or later) as the original transmitter.

---

## AMS creating a reusable copy

To create a reusable copy of a configuration perform the following procedure:

1. Completely configure the first transmitter.
2. Choose **View** then **User Configuration View** from the menu bar (or click the toolbar button).
3. In the *User Configuration* window, right click and choose **New** from the context menu.
4. In the *New* window, choose a device from the list of templates shown, and click **OK**.
5. The template is copied into the *User Configurations* window, with the tag name highlighted; rename it as appropriate and choose **Enter**.

---

**Note**

A device icon can also be copied by dragging and dropping a device template or any other device icon from AMS Explorer or Device Connection View into the User Configurations window.

---

The *Compare Configurations* window appears, showing the Current values of the copied device on one side and mostly blank fields on the other (User Configuration) side.

6. Transfer values from the current configuration to the user configuration as appropriate or enter values by typing them into the available fields.
7. Choose **Apply** to apply the values, or **OK** to apply the values and close the window.

## AMS applying a user configuration

Any amount of user configurations can be created for the application. They can also be saved, and applied to connected devices or to devices in the Device List or Plant Database.

To apply a user configuration perform the following procedure:

1. Choose the desired user configuration in the *User Configurations* window.
2. Drag the icon onto a like device in *AMS Explorer* or *Device Connection View*. The *Compare Configurations* window opens, showing the parameters of the target device on one side and the parameters of the user configuration on the other.
3. Transfer parameters from the user configuration to the target device as desired. Choose **OK** to apply the configuration and close the window.

---

# Section 3 Installation

---

---

Overview .....	page 27
Safety messages .....	page 27
Considerations .....	page 29
Installation procedures .....	page 32
Installing the LCD display .....	page 40
Rosemount 304, 305 and 306 Integral Manifolds .....	page 41

---

## 3.1 Overview

The information in this section covers installation considerations. A Quick Installation Guide (document number 00825-0200-4802) is shipped with every transmitter to describe basic installation and startup procedures. Dimensional drawings for each Rosemount 3051S Wireless variation and mounting configuration are included in Appendix A: Specifications and Reference Data.

Field Communicator and AMS instructions are given to perform configuration functions. For convenience, Field Communicator fast key sequences are labeled “Fast Keys” for each software function below the appropriate headings.

## 3.2 Safety messages

Procedures and instructions in this section may require special precautions to ensure the safety of the personnel performing the operation. Information that raises potential safety issues is indicated with a warning symbol ( ⚠ ). Refer to the following safety messages before performing an operation preceded by this symbol.

### 3.2.1 Warnings (⚠)

#### ⚠ WARNING

Failure to follow these installation guidelines could result in death or serious injury.

- Make sure only qualified personnel perform the installation.

Explosions can result in death or serious injury.

Installation of this transmitter in an explosive environment must be in accordance with the appropriate local, national, and international standards, codes, and practices. Please review the approvals section of the 3051S Wireless reference manual for any restrictions associated with a safe installation.

- Before connecting a 375 Field Communicator in an explosive atmosphere, make sure the instruments are installed in accordance with intrinsically safe or non-incendive field wiring practices.
- Verify that the operating atmosphere of the transmitter is consistent with the appropriate hazardous locations certifications.

Electrical shock can result in death or serious injury.

- Avoid contact with the leads and terminals. High voltage may be present on leads can cause electrical shock.

#### ⚠ WARNING

Process leaks could result in death or serious injury.

- Install and tighten process connectors before applying pressure.
- Do not attempt to loosen or remove process connectors while the transmitter is in service.

Replacement equipment or spare parts not approved by Rosemount Inc. for use as spare parts could reduce the pressure retaining capabilities of the transmitter and may render the instrument dangerous.

- Use only bolts supplied or sold by Rosemount Inc. as spare parts.

Improper assembly of manifolds to traditional flange can damage SuperModule™.

- For safe assembly of manifold to traditional flange, bolts must break back plane of flange web (i.e., bolt hold) but must not contact module housing.

The Power Module with the wireless unit contains two “C” size primary lithium/thionyl chloride batteries. Each Power Module contains approximately 2.5 grams of lithium, for a total of 5 grams in each pack. Under normal conditions, the Power Module materials are self-contained and are not reactive as long as the batteries and the pack integrity are maintained. Care should be taken to prevent thermal, electrical or mechanical damage. Contacts should be protected to prevent premature discharge.

## 3.3 Considerations

### 3.3.1 General

Measurement performance depends upon proper installation of the transmitter and impulse piping. Mount the transmitter close to the process and use a minimum of piping to achieve best performance. Also, consider the need for easy access, personnel safety, practical field calibration, and a suitable transmitter environment. Install the transmitter to minimize vibration, shock, and temperature fluctuation.

### 3.3.2 Wireless

#### Power up sequence

The Power Module should not be installed on any wireless device until the Smart Wireless Gateway is installed and functioning properly. This transmitter uses the Black Power Module. Please order model number 701PBKKF or spare part number 00753-9200-0001. Wireless devices should also be powered up in order of proximity from the Smart Wireless Gateway beginning with the closest. This will result in a simpler and faster network installation. Enable High Speed Operation on the Gateway to ensure that new devices join the network faster. For more information see the Smart Wireless Gateway Manual (Doc. No. 00809-0200-4420).

#### Antenna position

Position the antenna vertically, either straight up or straight down. The antenna should be approximately 3 ft (1 m) from any large structure, building, or to allow clear communication to other devices.

Figure 3-1. Antenna Position

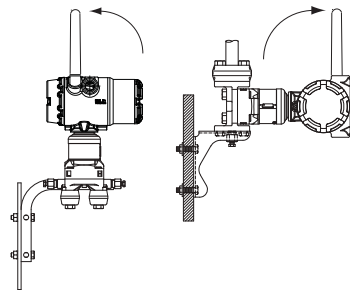

#### Note

Replace temporary orange plugs with included conduit plugs using approved thread sealant.

Figure 3-2. Conduit Plug Location

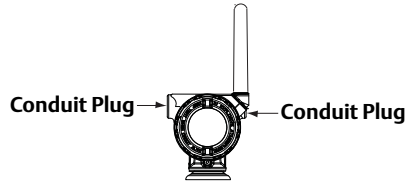

## Field Communicator connections

In order for the Field Communicator to interface with the Rosemount 3051S, the Power Module must be connected.

Figure 3-3. 375 Field Communicator Connections

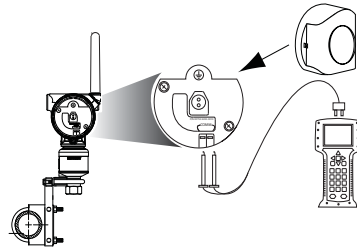

### 3.3.3 Mechanical

#### Note

For steam service or for applications with process temperatures greater than the limits of the transmitter, do not blow down impulse piping through the transmitter. Flush lines with the blocking valves closed and refill lines with water before resuming measurement.

#### Note

When the transmitter is mounted on its side, position the Coplanar flange to ensure proper venting or draining. Mount the flange as shown in [Figure 3-5 on page 37](#), keeping drain/vent connections on the bottom for gas service and on the top for liquid service.

### 3.3.4 Environmental

Access requirements and cover installation on [page 32](#) can help optimize transmitter performance. Mount the transmitter to minimize ambient temperature changes, vibration, mechanical shock, and to avoid external contact with corrosive materials. Appendix A: Specifications and Reference Data lists temperature operating limits.

Figure 3-4. Installation Flowchart

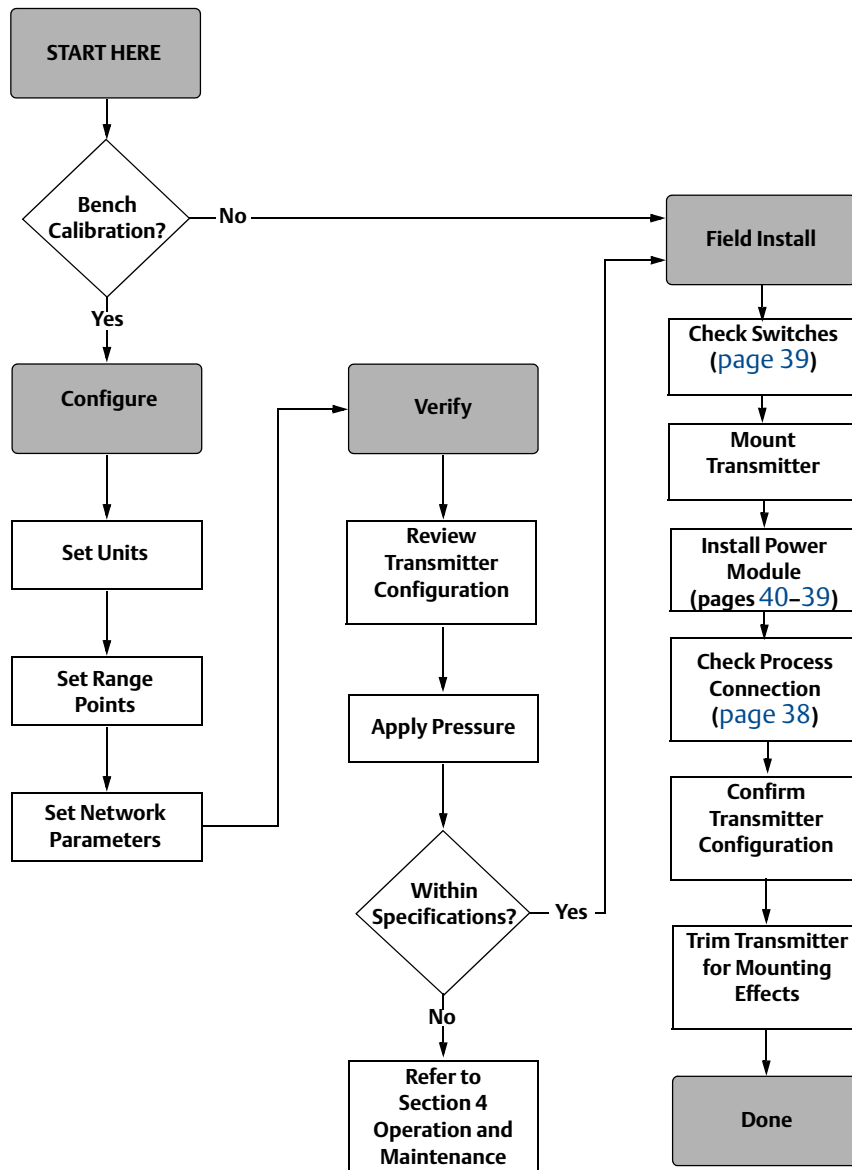

## 3.4 Installation procedures

For dimensional drawing information refer to “Dimensional Drawings” on page 13.

### Process flange orientation

Mount the process flanges with sufficient clearance for process connections. For safety reasons, place the drain/vent valves so the process fluid is directed away from possible human contact when the vents are used. In addition, consider the need for a testing or calibration input.

### Housing rotation

See “Consider housing rotation” on page 39.

### Power Module side of electronics housing

Mount the transmitter so the Power Module side is accessible. Clearance of 2.75-in. (70 mm) is required for cover removal.

### Circuit side of electronics housing

Provide 0.75 in. (19 mm) of clearance for units with out an LCD display. Three inches of clearance is required for cover removal if a meter is installed.

### Cover installation

Always ensure a proper seal by installing the electronics housing cover(s) so that metal contacts metal. Use Rosemount O-rings.

### Conduit plugs

Replace temporary orange plugs with included conduit plugs (found in the box) using approved thread sealant. For material compatibility considerations, see document number 00816-0100-3045 on [www.rosemount.com](http://www.rosemount.com).

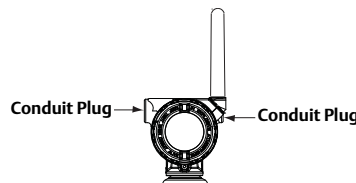

### 3.4.1 Mount the transmitter

#### Mounting brackets

Facilitate mounting transmitter to a 2-in. pipe, or to a panel. The B4 Bracket (SST) option is standard for use with the Coplanar and In-Line flanges. “Coplanar Flange Mounting Configurations” on page 13 shows bracket dimensions and mounting configurations for the B4 option.

Options B1–B3 and B7–B9 are sturdy, epoxy/polyester-painted brackets designed for use with the traditional flange. The B1–B3 brackets have carbon steel bolts, while the B7–B9 brackets



have stainless steel bolts. The BA and BC brackets and bolts are stainless steel. The B1/B7/BA and B3/B9/BC style brackets support 2-inch pipe-mount installations, and the B2/B8 style brackets support panel mounting.

**Note**

Most transmitters are calibrated in the horizontal position. Mounting the transmitter in any other position will shift the zero point to the equivalent amount of liquid head caused by the varied mounting position. To reset zero point, refer to “Sensor Trim” on page 3.

Position the antenna such that it is vertical, typically straight up (antenna may be pointed down as well.)

### Flange bolts

The 3051S can be shipped with a Coplanar flange or a Traditional flange installed with four 1.75-inch flange bolts. Mounting bolts and bolting configurations for the Coplanar and Traditional flanges can be found on page 33. Stainless steel bolts supplied by Emerson Process Management are coated with a lubricant to ease installation. Carbon steel bolts do not require lubrication. No additional lubricant should be applied when installing either type of bolt. Bolts supplied by Emerson Process Management are identified by their head markings:

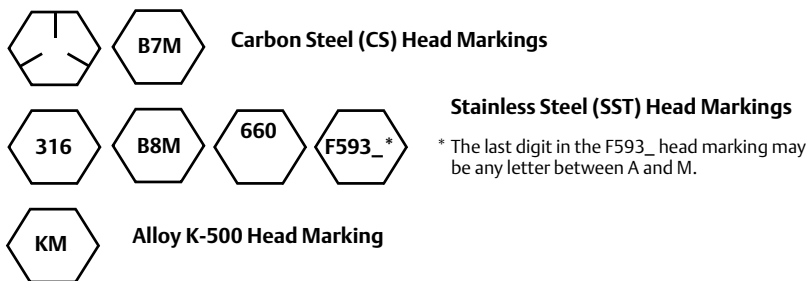

### Bolt Installation

⚠ Only use bolts supplied with the Rosemount 3051S or sold by Emerson Process Management as spare parts. When installing the transmitter to one of the optional mounting brackets, torque the bolts to 125 in.-lb. (0,9 N-m). Use the following bolt installation procedure:

1. Finger-tighten the bolts.
2. Torque the bolts to the initial torque value using a crossing pattern.
3. Torque the bolts to the final torque value using the same crossing pattern.

Torque values for the flange and manifold adapter bolts are as follows:

**Table 3-1. Bolt Installation Torque Values**

Bolt Material	Initial Torque Value	Final Torque Value
CS-ASTM-A445 Standard	300 in.-lb (34 N-m)	650 in.-lb (73 N-m)
316 SST—Option L4	150 in.-lb (17 N-m)	300 in.-lb (34 N-m)
ASTM-A-193-B7M—Option L5	300 in.-lb (34 N-m)	650 in.-lb (73 N-m)
Alloy K-500—Option L6	300 in.-lb (34 N-m)	650 in.-lb (73 N-m)
ASTM-A-453-660—Option L7	150 in.-lb (17 N-m)	300 in.-lb (34 N-m)
ASTM-A-193-B8M—Option L8	150 in.-lb (17 N-m)	300 in.-lb (34 N-m)

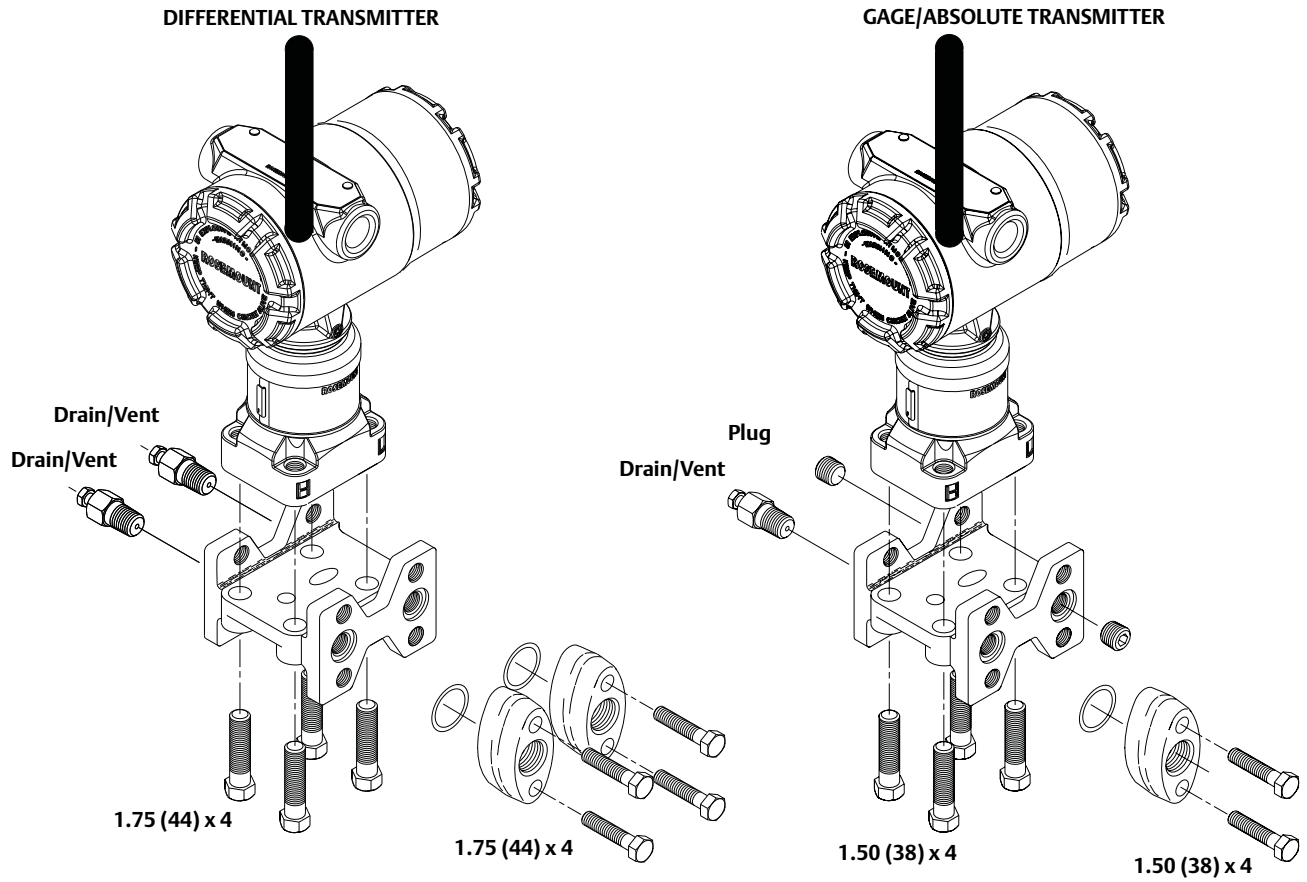

**Note**  
Dimensions are in inches (millimeters).

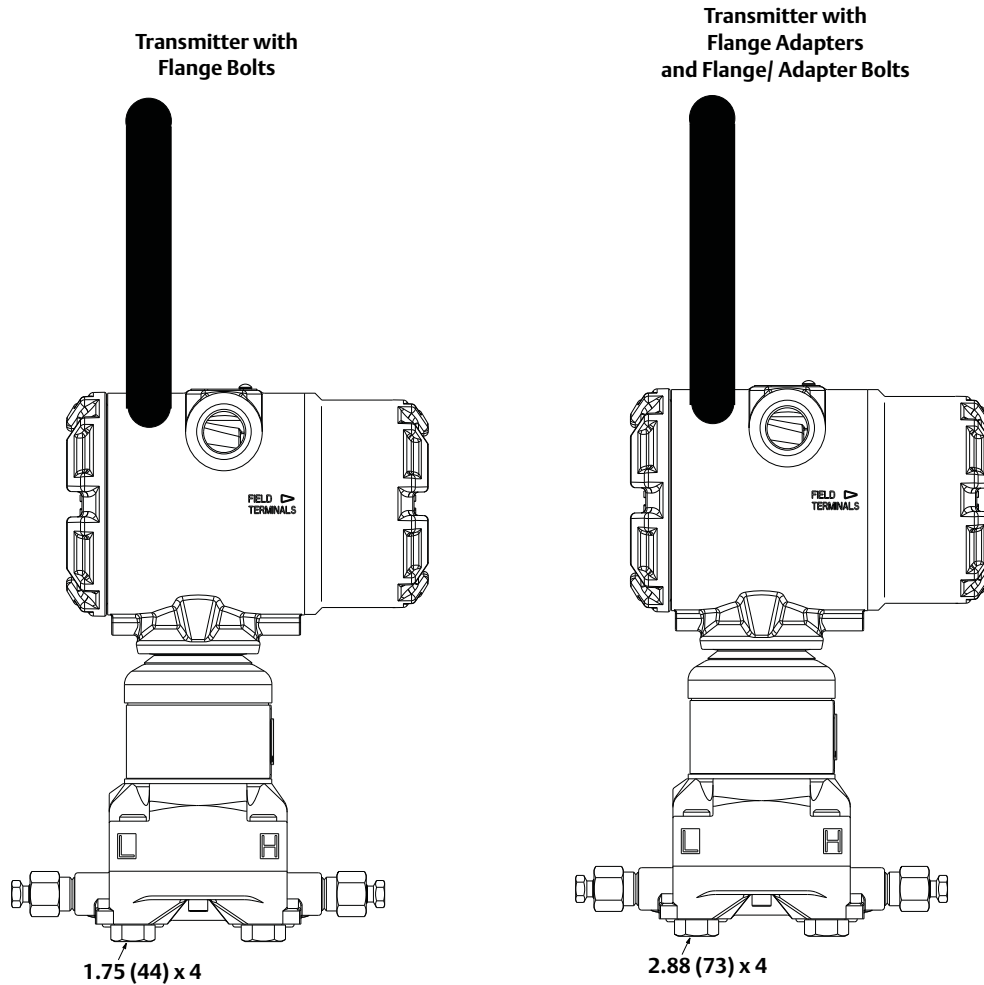

Description	Qty	Size in in. (mm)
Differential Pressure		
Flange Bolts	4	1.75 (44)
Adapter Bolts	4	1.50 (38) <sup>(1)</sup>
Flange/ Adapter Bolts	4	2.88 (73)
Gage/Absolute Pressure <sup>(2)</sup>		
Flange Bolts	4	1.75 (44)
Adapter Bolts	2	1.50 (38) <sup>(1)</sup>
Flange/ Adapter Bolts	2	2.88(73)

(1) DIN-compliant traditional flange requires 1.75 in. (44 mm) length adapter bolts.  
 (2) Rosemount 3051S In-line transmitters are direct mount and do not require bolts for process connection.

## Impulse piping

The piping between the process and the transmitter must accurately transfer the pressure to obtain accurate measurements. There are five possible sources of error: leaks, friction loss (particularly if purging is used), trapped gas in a liquid line, liquid in a gas line, and density variations between the legs.

The best location for the transmitter in relation to the process pipe depends on the process itself. Use the following guidelines to determine transmitter location and placement of impulse piping:

- Keep impulse piping as short as possible.
- For liquid service, slope the impulse piping at least 1 inch per foot (8 cm per m) upward from the transmitter toward the process connection.
- For gas service, slope the impulse piping at least 1 inch per foot (8 cm per m) downward from the transmitter toward the process connection.
- Avoid high points in liquid lines and low points in gas lines.
- Make sure both impulse legs are the same temperature.
- Use impulse piping large enough to avoid friction effects and blockage.
- Vent all gas from liquid piping legs.
- When using a sealing fluid, fill both piping legs to the same level.
- When purging, make the purge connection close to the process taps and purge through equal lengths of the same size pipe. Avoid purging through the transmitter.
- Keep corrosive or hot (above 250 °F [121 °C]) process material out of direct contact with the SuperModule and flanges.
- Prevent sediment deposits in the impulse piping.
- Keep the liquid head balanced on both legs of the impulse piping.
- Avoid conditions that might allow process fluid to freeze within the process flange.

## Mounting requirements

Refer to [Figure 3-5](#) for examples of the following mounting configurations:

### Liquid flow measurement

- Place taps to the side of the line to prevent sediment deposits on the process isolators.
- Mount the transmitter beside or below the taps so gases vent into the process line.
- Mount drain/vent valve upward to allow gases to vent.
- Position the antenna such that it is vertical.

### Gas flow measurement

- Place taps in the top or side of the line.
- Mount the transmitter beside or above the taps so to drain liquid into the process line.
- Position the antenna such that it is vertical.

### Steam flow measurement

- Place taps to the side of the line.
- Mount the transmitter below the taps to ensure that impulse piping will remain filled with condensate.
- Fill impulse lines with water to prevent steam from contacting the transmitter directly and to ensure accurate measurement start-up.
- Position the antenna such that it is vertical.

#### Note

For steam or other elevated temperature services, it is important that temperatures at the Coplanar process flanges must not exceed 250 °F (121 °C) for transmitters with silicone fill, or 185 °F (85 °C) for inert fill. For vacuum service, these temperature limits are reduced to 220 °F (104 °C) for silicone fill and 160 °F (71 °C) for inert fill.

Figure 3-5. Installation Examples

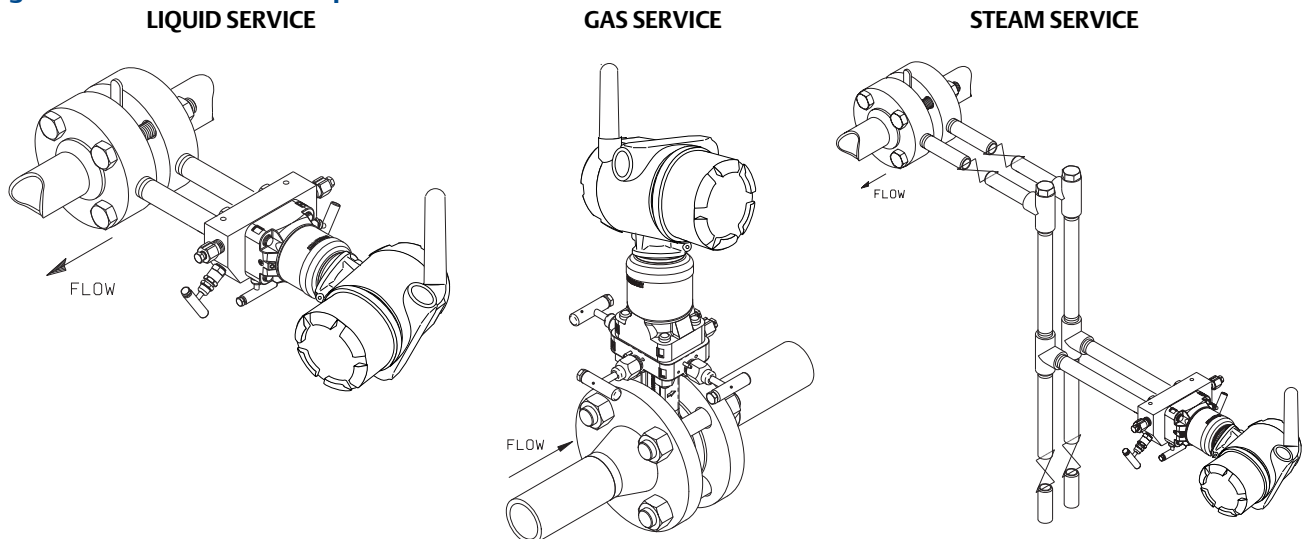

## 3.4.2 Process connections

Rosemount 3051S Wireless transmitter flange process connection size is  $\frac{1}{4}$ –18 NPT. Flange adapters with  $\frac{1}{2}$ –14 NPT connections are available as the D2 option. Use your plant-approved lubricant or sealant when making the process connections. The process connections on the transmitter flange are on  $2\frac{1}{8}$ -inch (54 mm) centers to allow direct mounting to a three-valve or five-valve manifold. Rotate one or both of the flange adapters to attain connection centers of 2 inches (51 mm),  $2\frac{1}{8}$  inches (54 mm), or  $2\frac{1}{4}$  inches (57 mm).

- ⚠ Install and tighten all four flange bolts before applying pressure to avoid leakage. When properly installed, the flange bolts will protrude through the top of the SuperModule housing. Do not attempt to loosen or remove the flange bolts while the transmitter is in service.

To install adapters to a Coplanar flange, perform the following procedure:

1. Remove the flange bolts.
2. Leaving the flange in place, move the adapters into position with the O-ring installed.
3. Clamp the adapters and the Coplanar flange to the transmitter module using the longer of the bolts supplied.
4. Tighten the bolts. Refer to “Flange bolts” on page 33 for torque specifications.

### ⚠ WARNING

Failure to install proper flange adapter o-rings may cause process leaks, which can result in death or serious injury. The two flange adapters are distinguished by unique o-ring grooves. Only use the o-ring that is designed for its specific flange adapter, as shown below.  
ROSEMOUNT 3051S / 3051 / 2051 / 3001 / 3095 / 2024

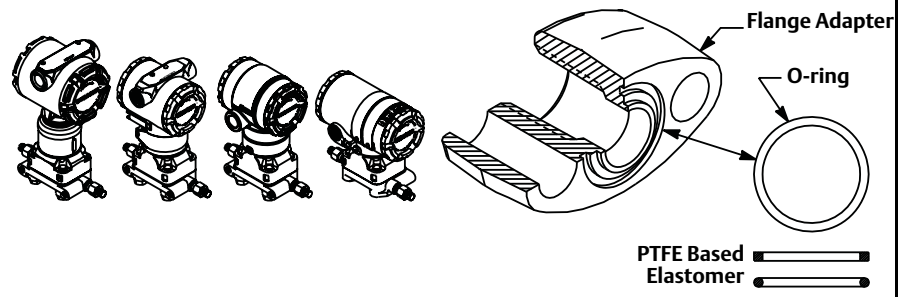

### Note

PTFE O-rings should be replaced if the flange adapter is removed.

Whenever you remove flanges or adapters, visually inspect the Teflon® O-rings. Replace them if there are any signs of damage, such as nicks or cuts. If you replace the O-rings, re-torque the flange bolts after installation to compensate for cold flow. Refer to the process sensor body reassembly procedure in [Section 6: Troubleshooting](#) on page 74.

### 3.4.3 Consider housing rotation

The housing can be rotated to improve field access to wiring or to better view the optional LCD display. Perform the following procedure:

**Figure 3-6. Housings**

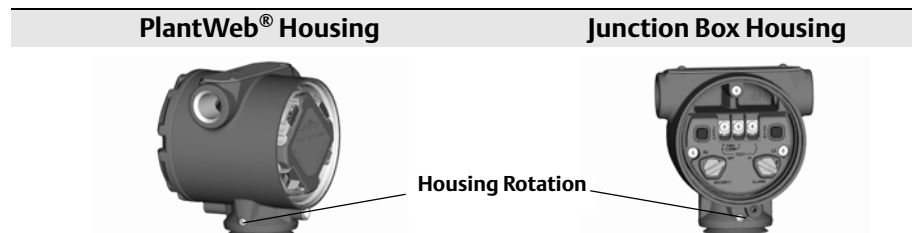

1. Loosen the housing rotation set screw.
2. Turn the housing up to 180 degrees to the left or right of its original (as shipped) position.

**Note**

Do not rotate the housing more than 180 degrees without first performing a disassembly procedure (see “[Remove Feature Assembly](#)” on page 5). Over-rotation may sever the electrical connection between the sensor module and the feature board.

3. Retighten the housing rotation set screw.

In addition to housing rotation, the optional LCD display can be rotated in 90-degree increments by squeezing the two tabs, pulling out, rotating and snapping back into place.

**Note**

If LCD pins are inadvertently removed from the interface board, carefully re-insert the pins before snapping the LCD display back into place.

### 3.4.4 Grounding

#### Transmitter case

Always ground the transmitter case in accordance with national and local electrical codes. The most effective transmitter case grounding method is a direct connection to earth ground with minimal impedance. Methods for grounding the transmitter case include:

- External Ground Assembly: The External Ground Assembly can also be ordered with the transmitter (Option Code D4), or as a spare part (03151-9060-0001).

### 3.4.5 High gain, remote antenna (optional)

For detailed installation and product information on the high gain, remote antenna (WN) option, please refer to Appendix C: High Gain Remote Antenna Option.

## 3.4.6 Power module installation

**Figure 3-7. Power Module Installation**

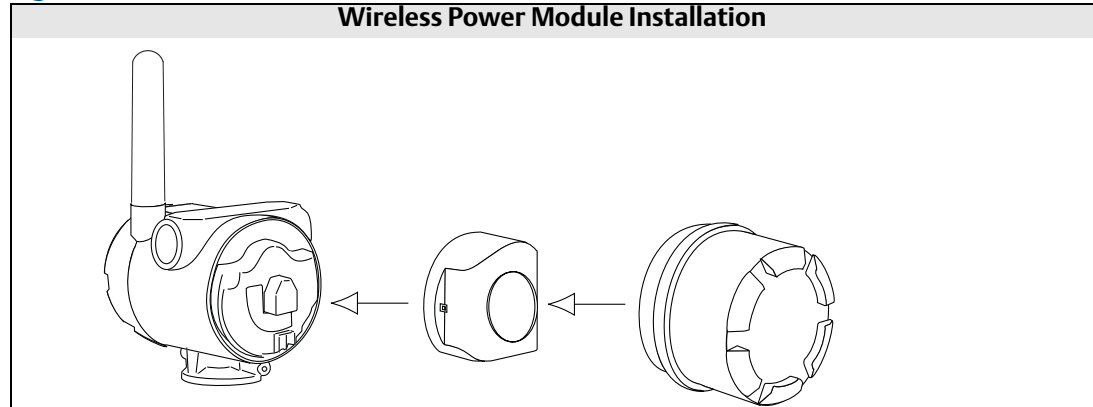

To make connections, perform the following procedure:

**Note**

This transmitter uses the Black Power Module. Please order model number 701PBKKF or spare part number 00753-9200-0001.

1. ⚠ Remove the housing cover on the Power Module compartment side. The Power Module supplies all power to the transmitter. Plug and seal both conduit connections on the transmitter housing to avoid moisture accumulation in the terminal side.
2. Connect the Power Module.
3. Replace the Power Module cover and tighten to safety specification (metal to metal).

## 3.4.7 Installing the LCD display

Transmitters ordered with the LCD display will be shipped with the display installed.

**Note**

Only use Rosemount Wireless LCD Part Number: 00753-9004-0002

**Note**

An LCD from a wired device will not function in a wireless device.

In addition to housing rotation, the optional LCD display can be rotated in 90-degree increments by squeezing the two tabs, pulling out, rotating and snapping back into place.

If LCD pins are inadvertently removed from the interface board, carefully re-insert the pins before snapping the LCD display back into place.



Use the following procedure and [Figure 3-8](#) to install the LCD display:

1. Remove the back cover and Power Module.
2.  Remove the transmitter cover opposite the field terminal side. Do not remove the instrument covers in explosive environments when the circuit is live.
3. Engage the four-pin connector into the LCD display and snap into place.

Note the following LCD temperature limits:

Operating: -40 to 175 °F (-40 to 80 °C)

Storage: -40 to 185 °F (-40 to 85 °C)

**Figure 3-8. Optional LCD Display**

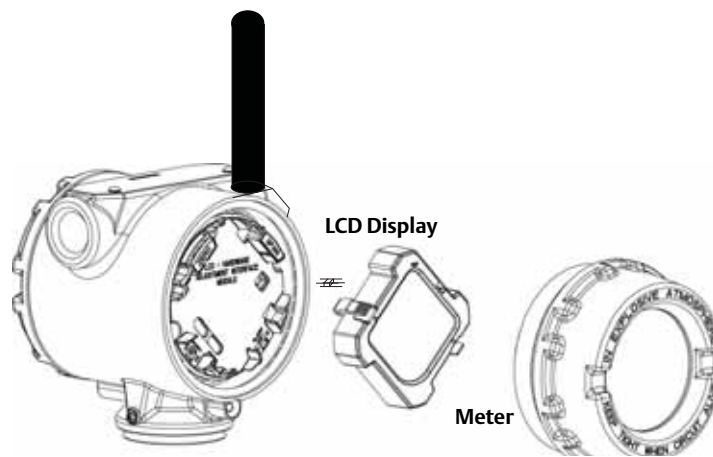

## 3.5 Rosemount 304, 305 and 306 Integral Manifolds

The Rosemount 305 is available in two designs: Traditional and Coplanar. The traditional 305 Integral Manifold can be mounted to most primary elements with mounting adapters in the market today. The Rosemount 306 Integral Manifold is used with In-line transmitters to provide block-and-bleed valve capabilities of up to 10000 psi (690 bar). The Rosemount 304 comes in two basic styles: traditional (flange x flange and flange x pipe) and wafer. The 304 traditional manifold comes in 2, 3, and 5-valve configurations. The 304 wafer manifold comes in 3 and 5 valve configurations.

Figure 3-9. Integral Manifold Designs

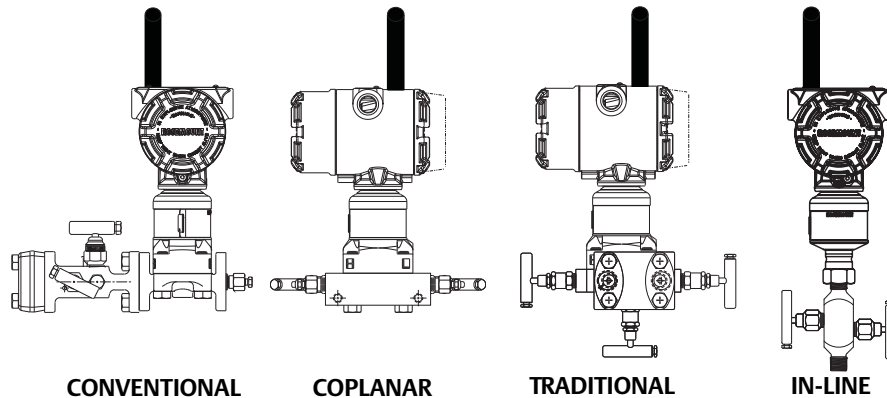

### 3.5.1 Rosemount 305 Integral Manifold installation procedure

To install a 305 Integral Manifold to a Rosemount 3051S Wireless transmitter:

1.  Inspect the Teflon SuperModule O-rings. If the O-rings are undamaged, reusing them is recommended. If the O-rings are damaged (if they have nicks or cuts, for example), replace them with new O-rings.

#### Important

If replacing the O-rings, take care not to scratch or deface the O-ring grooves or the surface of the isolating diaphragm while you remove the damaged O-rings.

2. Install the Integral Manifold on the SuperModule. Use the four 2.25-in. manifold bolts for alignment. Finger tighten the bolts, then tighten the bolts incrementally in a cross pattern to final torque value. See “Flange bolts” on page 33 for complete bolt installation information and torque values. When fully tightened, the bolts should extend through the top of the module housing.
3. If the Teflon SuperModule O-rings have been replaced, the flange bolts should be re-tightened after installation to compensate for cold flow of the O-rings.
4. If applicable, install flange adapters on the process end of the manifold using the 1.75-in. flange bolts supplied with the transmitter.

#### Note

Always perform a zero trim on the transmitter/manifold assembly after installation to eliminate mounting effects. See Section 5: Operation and Maintenance, “Zero Trim” on page 3.

### 3.5.2 Rosemount 306 Integral Manifold installation procedure

The 306 Manifold is for use only with a 3051S Wireless In-line transmitter.

1.  Assemble the 306 Manifold to the 3051S Wireless In-line transmitter with a thread sealant.

1. Place transmitter into holding fixture.
2. Apply appropriate thread paste or tape to threaded instrument end of the manifold.
3. Count total threads on the manifold before starting assembly.
4. Start turning the manifold by hand into the process connection on the transmitter.

---

**Note**

If using thread tape, be sure the thread tape does not strip when the manifold assembly is started.

---

5. Wrench tighten manifold into process connection. (Note: Minimum torque value is 425 in-lbs)
6. Count how many threads are still showing. (Note: Minimum engagement is 3 revolutions)
7. Subtract the number of threads showing (after tightening) from the total threads to calculate the revolutions engaged. Further tighten until a minimum of 3 rotations is achieved.
8. For block and bleed manifold, verify the bleed screw is installed and tightened. For two-valve manifold, verify the vent plug is installed and tightened.
9. Leak-check assembly to maximum pressure range of transmitter.

### 3.5.3 Rosemount 304 Conventional Manifold installation procedure

To install a Rosemount 304 Conventional Manifold to a Rosemount 3051S Wireless transmitter:

1. Align the Conventional Manifold with the transmitter flange. Use the four manifold bolts for alignment.
2. Finger tighten the bolts, then tighten the bolts incrementally in a cross pattern to final torque value. See “[Flange bolts](#)” on page 33 for complete bolt installation information and torque values. When fully tightened, the bolts should extend through the top of the module housing.
3. If applicable, install flange adapters on the process end of the manifold using the 1.75-in. flange bolts supplied with the transmitter.

### 3.5.4 Manifold operation

 Improper installation or operation of manifolds may result in process leaks, which may cause death or serious injury.

Always perform a zero trim on the transmitter/manifold assembly after installation to eliminate any shift due to mounting effects. See [Section 5: Operation and Maintenance](#), “[Sensor trim overview](#)” on page 52.

Three and five-valve configurations shown:

In normal operation the two block valves between the process and instrument ports will be open and the equalizing valve will be closed.

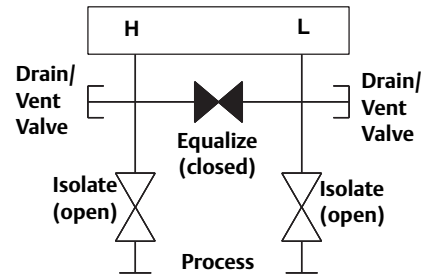

1. To zero the 3051S, close the block valve to the low pressure (downstream) side of the transmitter first.

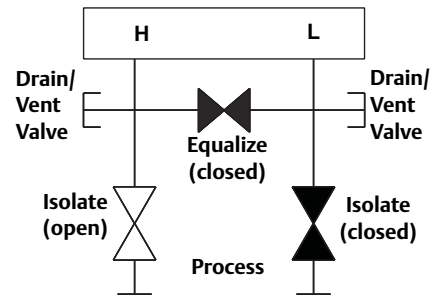

2. Open the center (equalize) valve to equalize the pressure on both sides of the transmitter. The manifold valves are now in the proper configuration for zeroing the transmitter.

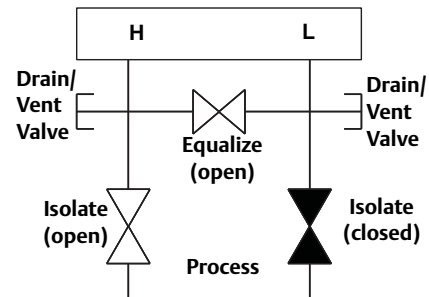

3. After zeroing the transmitter, close the equalizing valve.

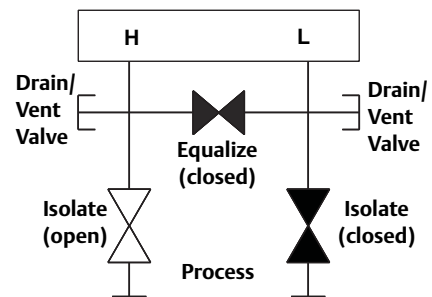

4. Open the block valve on the low pressure side of the transmitter to return the transmitter to service.

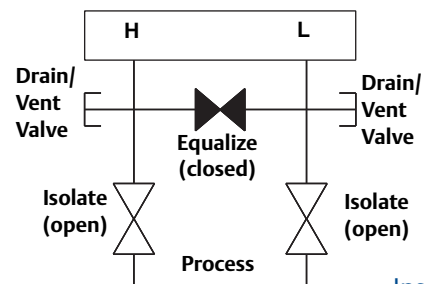

Five-valve Natural Gas configurations shown:

In normal operation, the two block valves between the process and instrument ports will be open, and the equalizing valves will be closed.

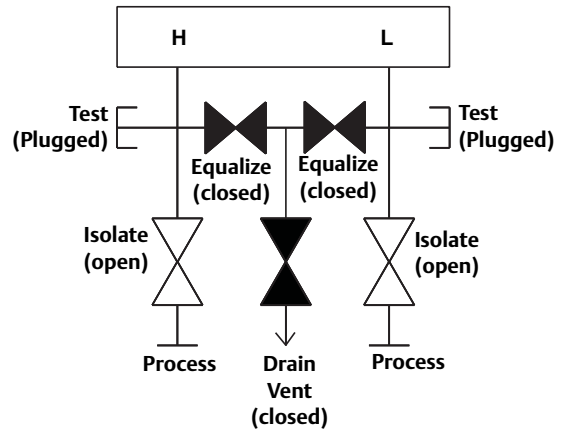

1. To zero the 3051S, first close the block valve on the low pressure (downstream) side of the transmitter.

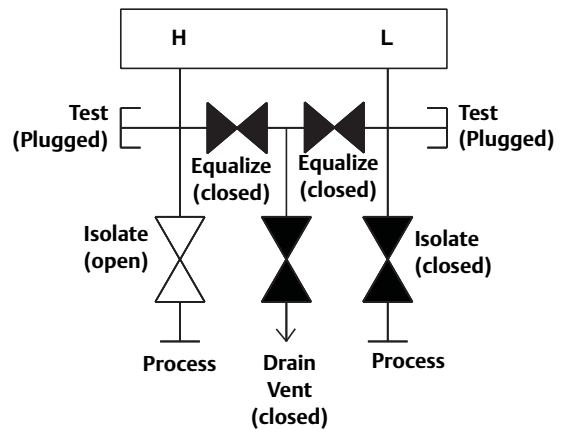

**Note**

Do not open the low side equalize valve before the high side equalize valve. Doing so will overpressure the transmitter.

2. Open the equalize valve on the high pressure (upstream) side of the transmitter.

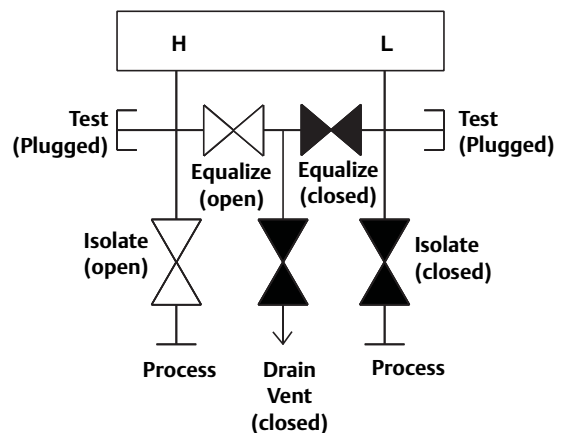

- Open the equalize valve on the low pressure (downstream) side of the transmitter. The manifold is now in the proper configuration for zeroing the transmitter.

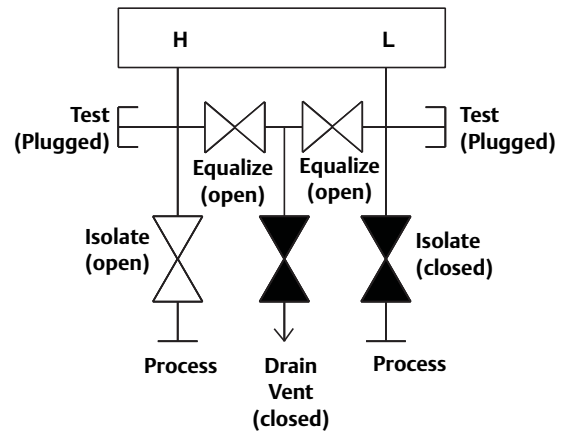

- After zeroing the transmitter, close the equalize valve on the low pressure (downstream) side of the transmitter.

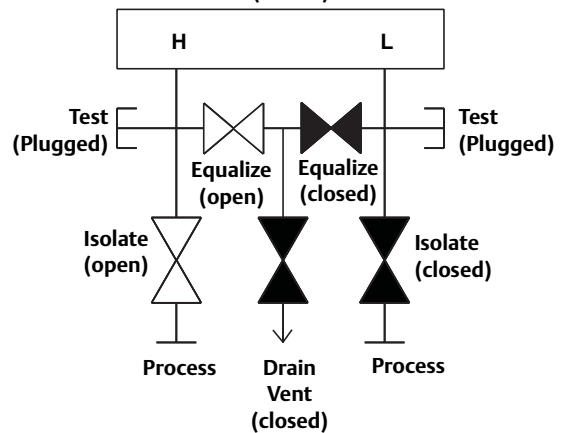

- Close the equalize valve on the high pressure (upstream) side.

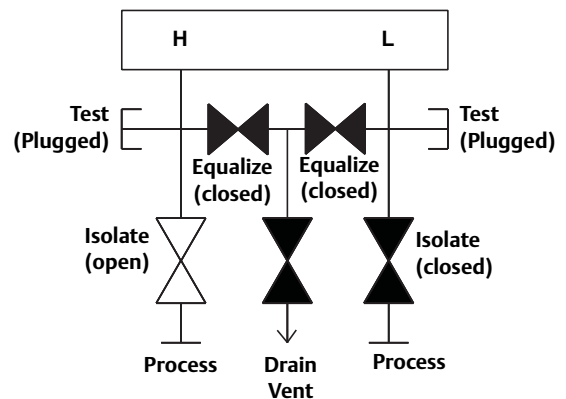

- Finally, to return the transmitter to service, open the low side isolation valve.

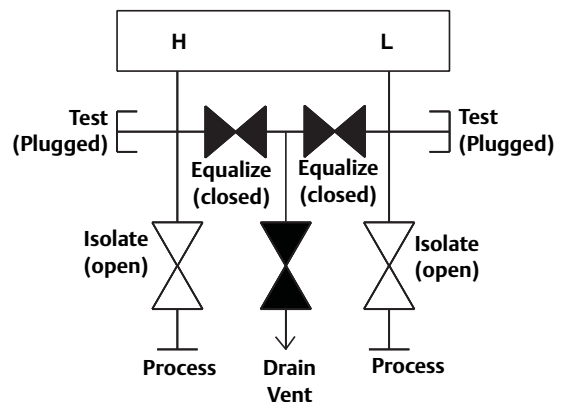

# Section 4 Commissioning

---

Safety messages .....	page 47
Network status .....	page 48
Verify operation .....	page 48

---

## 4.1 Safety messages

Instructions and procedures in this section may require special precautions to ensure the safety of the personnel performing the operations. Information that potentially raises safety issues is indicated by a warning symbol (⚠). Please refer to the following safety messages before performing an operation preceded by this symbol.

### 4.1.1 Warnings (⚠)

#### **⚠ WARNING**

Failure to follow these installation guidelines could result in death or serious injury.

- Make sure only qualified personnel perform the installation.

Explosions could result in death or serious injury.

- Before connecting a 375 Field Communicator in an explosive atmosphere, make sure the instruments are installed in accordance with intrinsically safe or non-incendive field wiring practices.
- Verify that the operating atmosphere of the transmitter is consistent with the appropriate hazardous locations certifications.

Process leaks could result in death or serious injury.

- Install and tighten process connectors before applying pressure.
- Do not attempt to loosen or remove process connectors while the transmitter is in service.

Electrical shock could cause death or serious injury.

- Avoid contact with the leads and terminals. High voltage that may be present on leads can cause electrical shock.

---

#### **Note**

The Rosemount 3051S Wireless and all other wireless devices should be installed only after the Smart Wireless Gateway has been installed and is functioning properly. Wireless devices should also be powered up in order of proximity from the Smart Wireless Gateway, beginning with the closest device to the Smart Wireless GatewaySmart. This will result in a simpler and faster network installation.

---

## 4.2 Network status

If the Rosemount 3051S Wireless was configured with the Network ID and Join Key and sufficient time for network polling has passed, the transmitter should be connected to the network. To verify connectivity, open the Smart Wireless Gateway's integral web interface and navigate to the Explorer page.

The screenshot shows the 'Smart Wireless Gateway' Explorer page. It features a table with columns for 'SMART Tag', 'HART status', 'Last update', 'PV', 'SV', 'TV', 'QV', and 'Status'. The table lists various process variables with their current values and status indicators (green for good, red for error).

SMART Tag	HART status	Last update	PV	SV	TV	QV	Status
3051A1001	●	04/05/11 18:09:53	0.000	3.094 A03 mV	23.000 DegC	7.000 v	●
3051B Pressure	●	04/05/11 18:09:55	0.007 Dm000 bar	22.700 DegC	22.700 DegC	7.110 v	●
3051C Conductivity	●	04/05/11 18:09:42	0.790 µM	23.900 DegC		7.000 v	●
3051D pH	●	04/05/11 18:09:50	0.000 µM	23.000 DegC	-100.000 µV	7.000 v	●
3051E Temperature	●	04/05/11 18:09:55	22.600 DegC	Null DegC	22.000 DegC	7.110 v	●
3051F Pressure	●	04/05/11 18:09:57	0.000 %	0.000	0.000	23.000 DegC	●
3051G Humidity	●	04/05/11 18:09:53	0.000	0.000	23.000 DegC	7.000 v	●
3051H Temperature	●	04/05/11 18:09:55	22.000 DegC	22.000 DegC	22.000 DegC	24.000 DegC	●
3051I Conductivity	●	04/05/11 17:25:00	0.000 µM	0.000 g/L	2.000 v	7.140 v	●
3051J Temperature	●	04/05/11 18:09:59	22.000 DegC	Null DegC	22.000 DegC	7.110 v	●
3051K Acoustic	●	04/05/11 18:09:54	0.070 Counts	24.000 DegC	22.000 DegC	0.000 v	●

This page will display the transmitter's HART tag, PV, SV, TV, QV, and Update Rate. A green status indicator means that the device is working properly. A red indicator means that there is a problem with either the device or its communication path. For more detail on a specific device, click on the tag name.

## 4.3 Verify operation

Operation can be verified in three locations, at the device via the Local Display, using the 375 Field Communicator, or at the Smart Wireless Gateway's integrated web interface.

### Local display

The LCD will display the output values based on the configured wireless update rate. Press the Diagnostic button to display the TAG, Device ID, Network ID, Network Join Status and Device Status screens.

For Device Status screens, see "LCD screen messages" on page 57.



**Figure 4-1. Diagnostic Screen Sequence**

Tag	Device ID	Network ID	Network Join Status	Device Status

**Figure 4-2. Network Join Status Screens**

Searching for Network	Joining Network	Connected with Limited Bandwidth	Connected

## Field communicator

To verify device operation using a HART Field Communicator, a 3051S Wireless DD is required. For connecting with a 375 Field Communicator, refer to [Figure 2-1 on page 8](#).

**Table 4-1.**

Function	Key Sequence	Menu Items
Communications	3, 3	Join Status, Wireless Mode, Join Mode, Number of Available Neighbors, Number of Advertisements Heard, Number of Join Attempts.

## Smart Wireless Gateway

To verify device operation using the Smart Wireless Gateway's integrated web interface, navigate to the Explorer page. This page will show whether the device has joined the network and if it is communicating properly.

The screenshot shows the 'Smart Wireless Gateway' Explorer interface. It features a table with columns for 'SMART Tag', 'SMART Status', 'Last update', 'PV', 'TV', 'YV', 'QV', and 'Smart rate'. The table lists various devices with their respective status indicators (green for good, red for error) and numerical values.

SMART Tag	SMART Status	Last update	PV	TV	YV	QV	Smart rate
2101.Land	●	04/05/11 23:09:53	0.000	3.094 403 Hz	23.000 DegC	7.200 V	8
2012.Potential	●	04/05/11 23:09:53	-0.027 24000 bar	22.700 DegC	22.700 DegC	7.110 V	8
2021.Landwidth	●	04/05/11 23:09:42	8.790 psi	23.300 DegC		7.200 V	18
2022.pH	●	04/05/11 23:09:39	0.000 pH	22.800 DegC	-180.000 psi	7.000 V	18
2041.Temperature	●	04/05/11 23:09:53	22.800 DegC	Null DegC	22.800 DegC	7.110 V	8
2023.Potential	●	04/05/11 23:09:37	0.000 %	0.000	0.000	23.000 DegC	8
2001.Disturbance	●	04/05/11 23:09:33	0.000	0.000	23.200 DegC	7.000 V	8
2042.Temperature	●	04/05/11 23:09:35	22.800 DegC	22.800 DegC	22.800 DegC	24.800 DegC	35
2043.Lithium	●	04/05/11 17:21:22	0.000 psi	0.000 psi	2.000 V	0.240 V	41:00:00
2002.Temperature	●	04/05/11 23:09:53	22.800 DegC	Null DegC	22.800 DegC	7.110 V	18
2003.Aromatic	●	04/05/11 23:09:54	0.070 Counts	24.600 DegC	22.800 DegC	0.200 V	18

A green status indicator means that the device is working properly. A red indicator means that there is a problem with either the device or its communication path. For more detail on a specific device, click on the tag name.

## Troubleshooting

The most common cause of incorrect operation is incorrect configuration of the Network ID and Join Key. The Network ID and Join Key in the device must match that of the Smart Wireless Gateway. The Network ID and Join Key may be obtained from the Smart Wireless Gateway on the Setup>Network>Settings page of the web interface.

The screenshot shows the 'Network Settings' page in the Smart Wireless Gateway web interface. It includes fields for 'Network name', 'Network ID', 'Security mode', 'Join key', 'Share join key', and 'Generate random join key'. There are also radio buttons for 'Build into network key?' and 'Keep network key secret?'.

---

# Section 5      Operation and Maintenance

---

---

Overview .....	page 51
Calibration .....	page 51
LCD screen messages .....	page 57

---

## 5.1      Overview

This section contains information on commissioning and operating 3051S Wireless Pressure Transmitters.

Field Communicator and AMS instructions are given to perform configuration functions. For convenience, Field Communicator fast key sequences are labeled “Fast Keys” for each software function below the appropriate headings.

## 5.2      Calibration

Calibrating a Rosemount 3051S Wireless transmitter may include the following procedures:

- **Sensor Trim:** Adjusts the position of the factory sensor characterization curve to optimize performance over a specified pressure range, or to adjust for mounting effects.

The 3051S SuperModule uses a microprocessor that contains information about the sensor’s specific characteristics in response to pressure and temperature inputs. A smart transmitter compensates for these sensor variations. The process of generating the sensor performance profile is called factory sensor characterization.

Sensor trimming requires an accurate pressure input and adds additional compensation that adjusts the position of the factory sensor characterization curve to optimize performance over a specific pressure range.

---

### Note

Sensor trimming adjusts the position of the factory sensor characterization curve. It is possible to degrade performance of the transmitter if the trim is done improperly or with inaccurate equipment.

---

**Table 5-1. Recommended Calibration Tasks**

Transmitter	Bench Calibration Tasks	Field Calibration Tasks
3051S 2CD 3051S 2CG 3051S 2L	<ol style="list-style-type: none"> <li>1. Set output configuration parameters:               <ol style="list-style-type: none"> <li>a. Set the % range points.</li> <li>b. Set the output units.</li> <li>c. Set the output type.</li> </ol> </li> <li>2. <i>Optional:</i> Perform a sensor trim. (Accurate pressure source required)</li> </ol>	<ol style="list-style-type: none"> <li>1. Reconfigure parameters if necessary.</li> <li>2. Zero trim the transmitter to compensate for mounting effects or static pressure effects.</li> </ol>
3051S 2CA 3051S 2TA 3051S 2TG	<ol style="list-style-type: none"> <li>1. Set output configuration parameters:               <ol style="list-style-type: none"> <li>a. Set the range points.</li> <li>b. Set the output units.</li> <li>c. Set the output type.</li> </ol> </li> <li>2. <i>Optional:</i> Perform a sensor trim if equipment available (accurate absolute pressure source required), otherwise perform the low trim value section of the sensor trim procedure.</li> </ol>	<ol style="list-style-type: none"> <li>1. Reconfigure parameters if necessary.</li> <li>2. Perform low trim value section of the sensor trim procedure to correct for mounting position effects.</li> </ol>

**Note:**

A 375 Field Communicator or AMS is required for all sensor and output trim procedures.

Rosemount 3051S2TG Range 5 transmitters use an absolute sensor that requires an accurate absolute pressure source to perform the optional sensor trim.

## 5.2.1 Sensor trim overview

Trim the sensor using either sensor or zero trim functions. Trim functions vary in complexity and are application-dependent. Both trim functions alter the transmitter's interpretation of the input signal.

Zero trim is a single-point offset adjustment. It is useful for compensating for mounting position effects and is most effective when performed with the transmitter installed in its final mounting position. Since this correction maintains the slope of the characterization curve, it should not be used in place of a sensor trim over the full sensor range.

When performing a zero trim, ensure that the equalizing valve is open and all wet legs are filled to the correct levels.

**Note**

Do not perform a zero trim on 3051S Wireless absolute pressure transmitters. Zero trim is zero based, and absolute pressure transmitters reference absolute zero. To correct mounting position effects on a 3051S Wireless absolute pressure transmitter, perform a low trim within the sensor trim function. The low trim function provides an offset correction similar to the zero trim function, but it does not require zero-based input.

Sensor trim is a two-point sensor calibration where two end-point pressures are applied, and all output is linearized between them. Always adjust the low trim value first to establish the correct offset. Adjustment of the high trim value provides a slope correction to the characterization curve based on the low trim value. The trim values allow you to optimize performance over your specified measuring range at the calibration temperature.

During a trim operation, the 3051S Wireless is placed in high power refresh mode, which provides frequent pressure measurement updates and allows the configured damping to take effect. This behavior allows for more accurate calibration of the device. When the device is in high power refresh mode, the battery power supply will be depleted more rapidly.

## 5.2.2 Zero trim

Fast Keys	2, 1, 2
-----------	---------

### Note

The transmitter must be within three percent of true zero (zero-based) in order to calibrate with zero trim function.

After properly venting the transmitter, calibrate the transmitter with the zero trim function:

1. From the *Home* screen, choose **2: Configure**.
2. Choose **1: Guided Setup**.
3. Choose **2: Zero Trim** and follow the on-screen instruction to complete the zero trim adjustment.

## 5.2.3 Sensor trim

Fast Keys	3, 5, 1
-----------	---------

### Note

Use a pressure input source that is at least three times more accurate than the transmitter, and allow the input pressure to stabilize for ten seconds before entering any values.

To calibrate the transmitter using the sensor trim function:

1. Assemble and power the entire calibration system including the Rosemount 3051S, Field Communicator/AMS, power supply, pressure input source, and readout device.
2. From the *Home* screen, choose **3: Service Tools**.
3. Choose **5: Routine Maintenance**.
4. Choose **1: Sensor Calibration**.
5. Choose **Lower Sensor Trim**. The lower sensor trim value should be the sensor trim point that is closest to zero.
6. Follow the on-screen instructions to complete the adjustment of the lower value.
7. Repeat the procedure for the upper value. Choose **5: Upper Sensor Trim** and follow the on-screen instructions to complete the adjustment of the upper value.

---

**Note**

Select pressure input values so that lower and upper values are equal to or outside the Lower and Upper Operating points. Do not attempt to obtain reverse output by reversing the high and low points. The transmitter allows approximately five percent deviation.

---

## 5.2.4 Line pressure effect (Range 2 and Range 3)

The following specifications show the static pressure effect for the Rosemount 3051S Range 2 and Range 3 pressure transmitters used in differential pressure applications where line pressure exceeds 2000 psi (138 bar).

### Zero effect

Ultra and Ultra for Flow:  $\pm 0.05\%$  of the upper range limit plus an additional  $\pm 0.1\%$  of upper range limit error for each 1000 psi (69 bar) of line pressure above 2000 psi (138 bar).

Classic:  $\pm 0.1\%$  of the upper range limit plus an additional  $\pm 0.1\%$  of upper range limit error for each 1000 psi (69 bar) of line pressure above 2000 psi (138 bar).

Example: Line pressure is 3000 psi (207 bar) for Ultra performance transmitter. Zero effect error calculation:

$$\pm \{0.05 + 0.1 \times [3 \text{ kpsi} - 2 \text{ kpsi}]\} = \pm 0.15\% \text{ of the upper range limit}$$

### Span Effect

Refer to “Line pressure effect(1)” on page 81.

## 5.2.5 Compensating for line pressure (Range 4 and Range 5)

The Rosemount 3051S Wireless Range 4 and 5 pressure transmitters require a special calibration procedure when used in differential pressure applications. The purpose of this procedure is to optimize transmitter performance by reducing the effect of static line pressure in these applications. The Rosemount 3051S Wireless differential pressure transmitters (Ranges 0, 1, 2, and 3) do not require this procedure because optimization occurs in the sensor.

Applying high static pressure to the 3051S Wireless Range 4 and Range 5 pressure transmitters causes a systematic shift in the output. This shift is linear with static pressure; correct it by performing the “Sensor trim” procedure on page 53.

The following specifications show the static pressure effect for the 3051S Wireless Range 4 and Range 5 transmitters used in differential pressure applications:

### Zero effect:

$\pm 0.1\%$  of the upper range limit per 1000 psi (69 bar) for line pressures from 0 to 2000 psi (0 to 138 bar)

For line pressures above 2000 psi (138 bar), the zero effect error is  $\pm 0.2\%$  of the upper range limit plus an additional  $\pm 0.2\%$  of upper range limit error for each 1000 psi (69 bar) of line pressure above 2000 psi (138 bar).

Example: Line pressure is 3000 psi (3 kpsi). Zero effect error calculation:

$$\pm \{0.2 + 0.2 \times [3 \text{ kpsi} - 2 \text{ kpsi}]\} = \pm 0.4\% \text{ of the upper range limit}$$

### Span effect:

Correctable to  $\pm 0.2\%$  of reading per 1000 psi (69 bar) for line pressures from 0 to 3626 psi (0 to 250 bar)

The systematic span shift caused by the application of static line pressure is  $-1.00\%$  of reading per 1000 psi (69 bar) for Range 4 transmitters, and  $-1.25\%$  of reading per 1000 psi (69 bar) for Range 5 transmitters.

Use the following example to compute corrected input values.

### Example

A transmitter with model number 3051S\_CD4 will be used in a differential pressure application where the static line pressure is 1200 psi (83 bar). The transmitter output is ranged with 4 mA at 500 inH<sub>2</sub>O (1,2 bar) and 20 mA at 1500 inH<sub>2</sub>O (3,7 bar).

To correct for systematic error caused by high static line pressure, first use the following formulas to determine corrected values for the low trim and high trim.

$$LT = LRV + S \times (LRV) \times P$$

Where:	LT =	Corrected Low Trim Value
	LRV =	Lower Range Value
	S =	-(Span shift per specification)
	P =	Static Line Pressure

$$HT = URV + S \times (URV) \times P$$

Where:	HT =	Corrected High Trim Value
	URV =	Upper Range Value
	S =	-(Span shift per specification)
	P =	Static Line Pressure

In this example:

URV =	1500 inH <sub>2</sub> O (3.74 bar)
LRV =	500 inH <sub>2</sub> O (1.25 bar)
P =	1200 psi (82.74 bar)
S =	$\pm 0.01/1000$

To calculate the low trim (LT) value:

$$LT = 500 + (0.01/1000)(500)(1200)$$

$$LT = 506 \text{ inH}_2\text{O} (1.26 \text{ bar})$$

To calculate the high trim (HT) value:

$$HT = 1500 + (0.01/1000)(1500)(1200)$$

$$HT = 1518 \text{ inH}_2\text{O} (3.78 \text{ bar})$$

Complete a Rosemount 3051S Wireless sensor trim and enter the corrected values for low trim (LT) and high trim (HT), refer to [“Sensor trim” on page 53](#).

Enter the corrected input values for low trim and high trim through the Field Communicator keypad after you apply the nominal value of pressure as the transmitter input.

---

**Note**

After sensor trimming Rosemount 3051S Wireless Range 4 and 5 transmitters for high differential pressure applications, verify that the Lower and Upper Operating points are at nominal values using the Field Communicator.

---



## 5.3 LCD screen messages

### 5.3.1 Startup screen sequence

The following screens will display when the Power Module is first connected to the Rosemount 3051S Wireless.

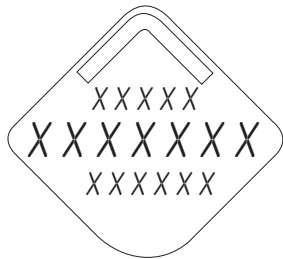

**All Segments On:** used to visually determine if there are any bad segments on the LCD

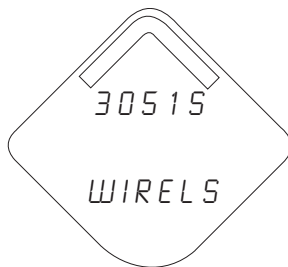

**Device Identification:** used to determine Device Type.

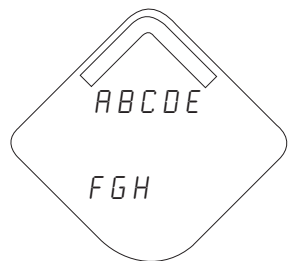

**Device Information - Tag:** user entered tag which is eight characters long - will not display if all characters are blank



**PV Screen - process pressure**



**SV Screen** - sensor temperature value



**TV Screen** - device temperature value

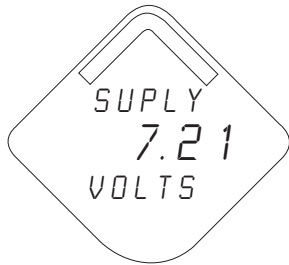

**QV Screen** - voltage reading at the power supply terminals

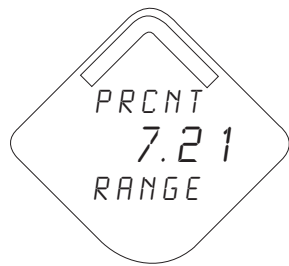

**Percent Range Screen** - percent range reading

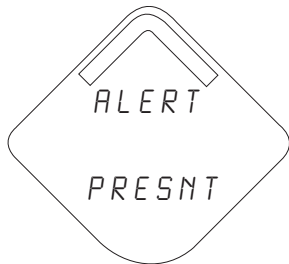

**Alert Screen** - at least one alert is present - this screen will not display if no alerts are present

## 5.3.2 Diagnostic Button Screen Sequence

The following five screens will display when the device is operating properly and the Diagnostic Button has been pressed.

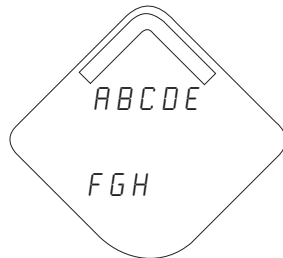

**Device Information - Tag:** user entered tag which is eight characters long - will not display if all characters are blank

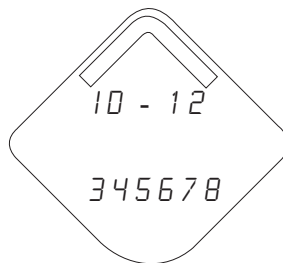

**Device Identification:** used to determine Device ID

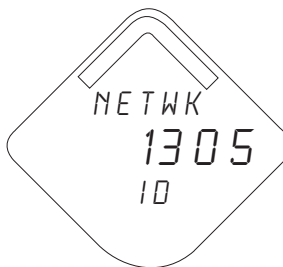

**Diagnostic Button Screen 3:** assuming the device has the correct join key, this ID tells the user what network the device can connect with



**Diagnostic Button Screen 4:** the device has joined a network and has been fully configured and has multiple parents

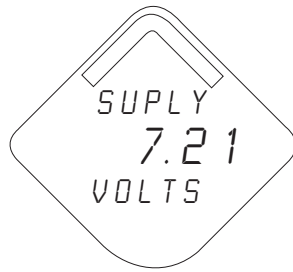

**Diagnostic Button Screen 5:** voltage reading at the power supply terminals

### 5.3.3 Network diagnostic status screens

These screens display the network status of the device. Only one will be shown during the startup sequence or diagnostic sequence.

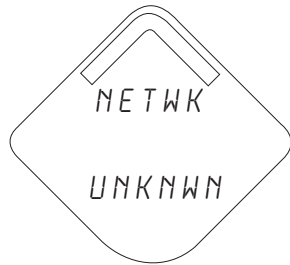

**Diagnostic Button Screen 4.1:** the device is attempting to start the radio

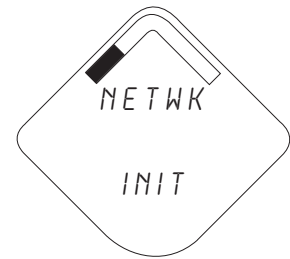

**Diagnostic Button Screen 4.2:** the device has just restarted

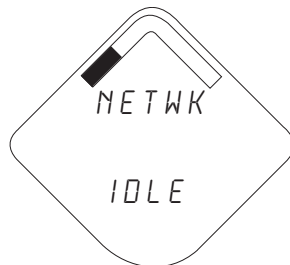

**Diagnostic Button Screen 4.3:** the device is starting to join the process

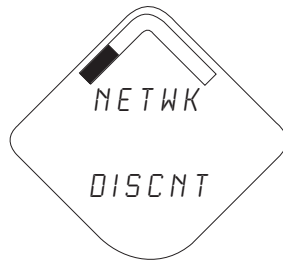

**Diagnostic Button Screen 4.4:** the device is in a disconnected state and requires a “Force Join” command to join the network

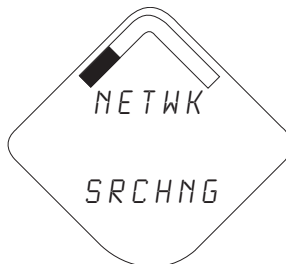

**Diagnostic Button Screen 4.5:** the device is searching for the Network

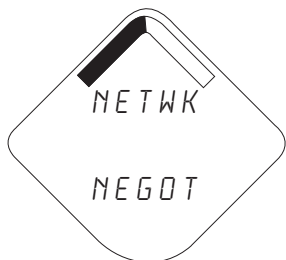

**Diagnostic Button Screen 4.6:** the device is attempting to join a network

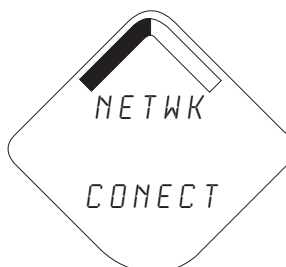

**Diagnostic Button Screen 4.7:** the device is connected to the Network, but is in a “Quarantined” state

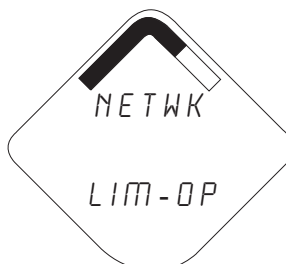

**Diagnostic Button Screen 4.8:** the device is joined and operational, but is running with limited bandwidth for sending periodic data



**Diagnostic Button Screen 4.9:** the device has joined a network and has been fully configured and has multiple parents

### 5.3.4 Device diagnostic screens

The following screens will show the device diagnostics depending on the state of the device.

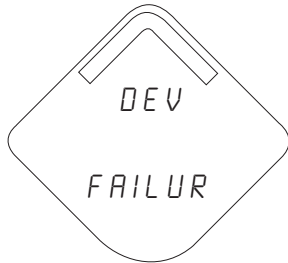

**Device Information - Status:** there is a critical error which may prevent the device from operating correctly. Check additional status screens for more information.



**PV Screen** - process pressure value



**SV Screen** - sensor temperature value



**TV Screen** - device temperature value

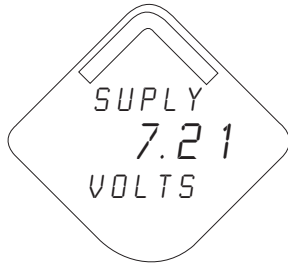

**QV Screen** - voltage reading at the power supply terminals

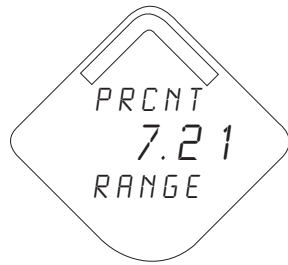

**Percent Range Screen** - percent range reading

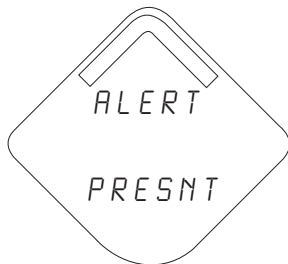

**Alert Screen** - at least one alert is present - this screen will not display if no alerts are present

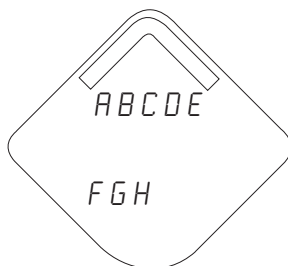

**Diagnostic Button Screen 1 - Tag:** user entered tag which is eight characters long - will not display if all characters are blank

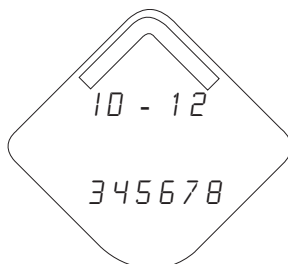

**Diagnostic Button Screen 2:** the device's identifier that is used to make up the HART long address - the Smart Wireless Gateway may use this to help identify devices if no unique user tag is available



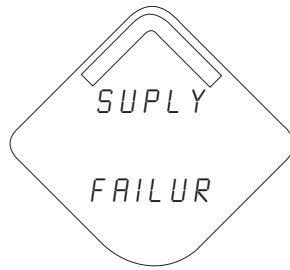

**Diagnostic Button Screen 7.1:** the terminal voltage has dropped below level of operating limit. Replace the Power Module (Part Number: 00753-9220-0001)

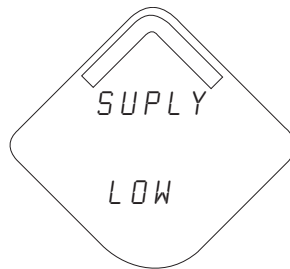

**Diagnostic Button Screen 7.2:** the terminal voltage is below the recommended operating range - if this is a battery operated device, the Power Module should be replaced - for line powered devices, the supply voltage should be increased



**Diagnostic Button Screen 8:** the device may not be able to communicate with the radio or the radio has an internal error. In this state the device may still be operational and publishing HART data



**Diagnostic Button Screen 9.1:** configuration of the transmitter is invalid such that critical operation of the device may be affected - check the extended configuration status to identify which configuration item(s) need to be corrected

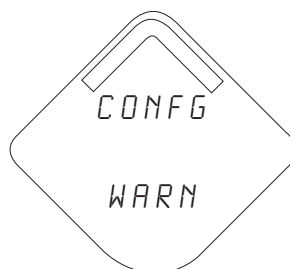

**Diagnostic Button Screen 9.2:** configuration of the transmitter is invalid such that non-critical operation of the device may be affected - check the extended configuration status to identify which configuration item(s) need to be corrected

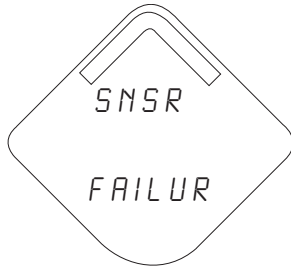

**Diagnostic Button Screen 10.1:** a sensor attached to the transmitter has failed, and valid readings from that sensor are no longer possible - check the sensor and sensor wiring connections - check additional status for more detailed information of the failure source

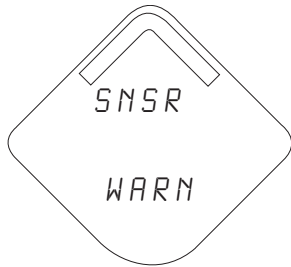

**Diagnostic Button Screen 10.2:** a sensor attached to the transmitter is degraded, readings from that sensor may not be within accuracy specifications - check the process, and sensor wiring connections - check additional status for more detailed information of the warning source

---

**Note**

Use the Rosemount Wireless LCD Part Number: 00753-9004-0002.

---

---

# Section 6 Troubleshooting

---

---

Overview .....	page 67
Safety messages .....	page 67
Disassembly procedures .....	page 72
Reassembly procedures .....	page 74

---

## 6.1 Overview

Table 6-2 provides summarized maintenance and troubleshooting suggestions for the most common operating problems.

If you suspect malfunction despite the absence of any diagnostic messages on the Field Communicator display, follow the procedures described here to verify that transmitter hardware and process connections are in good working order. Always deal with the most likely checkpoints first.

## 6.2 Safety messages

Procedures and instructions in this section may require special precautions to ensure the safety of the personnel performing the operations. Information that raises potential safety issues is indicated by a warning symbol () . Refer to the following safety messages before performing an operation preceded by this symbol.

## 6.2.1 Warnings (⚠)

### ⚠ WARNING

Explosions can result in death or serious injury.

- Before connecting a 375 Field Communicator in an explosive atmosphere, make sure that the instruments are installed according to intrinsically safe or nonincendive field wiring practices.

Improper installation or repair of the SuperModule with high pressure option (P0) could result in death or serious injury.

- For safe assembly, the high pressure SuperModule must be installed with ASTM A193 Class 2 Grade B8M Bolts and either a 305 manifold or a DIN-compliant traditional flange.

Static electricity can damage sensitive components.

- Observe safe handling precautions for static-sensitive components.

Electrical shock can result in death or serious injury.

- Avoid contact with the leads and terminals. High voltage that may be present on leads can cause electrical shock.

Process leaks could result in death or serious injury.

- Install and tighten process connectors before applying pressure.
- Do not attempt to loosen or remove process connectors while the transmitter is in service.

**Table 6-1. Rosemount 3051S Wireless Device Status Information**

Device Status	Description	Recommended Action
Electronics Failure	An electronics error that could impact the device measurement reading has occurred.	<ol style="list-style-type: none"> <li>1. Reset the device</li> <li>2. Reconfirm all configuration items in the device</li> <li>3. If the condition persists, replace the electronics</li> </ol>
Radio Failure	The wireless radio has detected a failure or stopped communicating.	<ol style="list-style-type: none"> <li>1. Reset the device</li> <li>2. If the condition persists, replace the electronics</li> </ol>
Supply Voltage Failure	The supply voltage is too low for the device to function properly.	<ol style="list-style-type: none"> <li>1. Replace the Power Module</li> </ol>
Electronics Warning	The device has detected an electronics error that does not currently impact the device measurement reading.	<ol style="list-style-type: none"> <li>1. Reset the device</li> <li>2. Reconfirm all configuration items in the device</li> <li>3. If the condition persists, replace the electronics</li> </ol>

Device Status	Description	Recommended Action
Pressure has Exceeded Limits	The sensor has exceeded the maximum measurement range.	<ol style="list-style-type: none"> <li>1. Check process for possible saturation condition</li> <li>2. Verify that the appropriate sensor was chosen for the application</li> <li>3. Reconfirm sensor configuration</li> <li>4. Reset the device</li> <li>5. Replace the sensor</li> </ol>
Electronics Temperature has Exceeded Limits	The electronics temperature has exceeded the transmitter's maximum range.	<ol style="list-style-type: none"> <li>1. Verify environmental temperature is within the transmitter's range</li> <li>2. Remote mount the transmitter away from process and environmental conditions</li> <li>3. Reset the device</li> <li>4. If the condition persists, replace the electronics</li> </ol>
Supply Voltage Low	The supply voltage is low and may soon affect broadcast updates.	<ol style="list-style-type: none"> <li>1. Replace the Power Module</li> </ol>
Database Memory Warning	The device has failed to write to the database memory. Any data written during this time may have been lost.	<ol style="list-style-type: none"> <li>1. Reset the device</li> <li>2. Reconfirm all configuration items in the device</li> <li>3. If logging dynamic data not needed, this advisory can be safely ignored</li> <li>4. If the condition persists, replace the electronics</li> </ol>
Configuration Error	The device has detected a configuration error based on a change to the device.	<ol style="list-style-type: none"> <li>1. Click on details for more information</li> <li>2. Correct the parameter that has a configuration error</li> <li>3. Reset the device</li> <li>4. If the condition persists, replace the electronics</li> </ol>
HI HI Alarm	The primary variable has surpassed the user defined limit.	<ol style="list-style-type: none"> <li>1. Verify that the process variable is within user specified limits</li> <li>2. Reconfirm the user defined alarm limit</li> <li>3. If not needed, disable this alert</li> </ol>
HI Alarm	The primary variable has surpassed the user defined limit.	<ol style="list-style-type: none"> <li>1. Verify that the process variable is within user specified limits</li> <li>2. Reconfirm the user defined alarm limit</li> <li>3. If not needed, disable this alert</li> </ol>

Device Status	Description	Recommended Action
LO Alarm	The primary variable has surpassed the user defined limit.	<ol style="list-style-type: none"> <li>1. Verify that the process variable is within user specified limits</li> <li>2. Reconfirm the user defined alarm limit</li> <li>3. If not needed, disable this alert</li> </ol>
LO LO Alarm	The primary variable has surpassed the user defined limit.	<ol style="list-style-type: none"> <li>1. Verify that the process variable is within user specified limits</li> <li>2. Reconfirm the user defined alarm limit</li> <li>3. If not needed, disable this alert</li> </ol>
Button Stuck	A buttons on the Electronics Board is detected as stuck in the active position.	<ol style="list-style-type: none"> <li>1. Check the buttons for obstructions</li> <li>2. Reset the device</li> <li>3. If the condition persists, replace the electronics</li> </ol>
Simulation Active	The device is in simulation mode and may not be reporting actual information.	<ol style="list-style-type: none"> <li>1. Verify that simulation is no longer required</li> <li>2. Disable Simulation mode in Service Tools</li> <li>3. Reset the device</li> </ol>

**Table 6-2. Rosemount 3051S Wireless Troubleshooting**

Symptom	Recommended Actions
Transmitter will not respond to changes in applied pressure	Check test equipment
	Check impulse piping or manifold for blockage
	Verify applied pressure is within sensor limits
Digital Pressure Variable reading is low or high	Check test equipment (verify accuracy)
	Check impulse piping for blockage or low fill in wet leg
	Verify transmitter is calibrated properly
	Verify pressure calculations for application
Digital Pressure Variable reading is erratic	Check application for faulty equipment in pressure line
	Verify transmitter is not reacting directly to equipment turning on/off
LCD display is not functioning	Reseat the LCD according to <a href="#">“Installing the LCD Display” on page 14</a>
	Verify that the LCD display is a wireless LCD Meter. An LCD from a wired device will not function in a wireless device. Rosemount part number: 00753-9004-0002 Verify that the LCD display mode is not disabled.

**Table 6-3. Wireless Network Troubleshooting**

Symptom	Recommended Actions
Device not joining the network	Verify network ID and join key
	Wait longer (30 min.)
	Enable High Speed Operation on Smart Wireless Gateway
	Check Power Module
	Verify device is within range of at least one other device
	Verify network is in active network advertise
	Power Cycle device to try again
	Verify device is configured to join. Send the “Force Join” command to the device See troubleshooting section of Smart Wireless Gateway for more information
Short battery life	Check that “Power Always On” mode is off
	Verify device is not installed in extreme temperatures
	Verify that device is not a network pinch point
	Check for excessive network rejoins due to poor connectivity
Limited Bandwidth Error	Reduce the Update Rate on transmitter
	Increase communication paths by adding more wireless points
	Check that device has been online for at least an hour
	Check that device is not routing through a “limited” routing node
	Create a new network with an additional Smart Wireless Gateway

## 6.3 Disassembly procedures

### 6.3.1 Remove from service

Be aware of the following:

- Follow all plant safety rules and procedures.
- Isolate and vent the process from the transmitter before removing the transmitter from service.
- Detach the process flange by removing the four flange bolts and two alignment screws that secure it.
- Do not scratch, puncture, or depress the isolating diaphragms.
- Clean isolating diaphragms with a soft rag and a mild cleaning solution, and rinse with clear water.
- Whenever you remove the process flange or flange adapters, visually inspect the Teflon o-rings. Replace the o-rings if they show any signs of damage, such as nicks or cuts. If they are not damaged, reuse them.

The Rosemount 3051S Wireless transmitter is attached to the process connection by four bolts and two cap screws. Remove the bolts and separate the transmitter from the process connection. Leave the process connection in place and ready for re-installation.

The Rosemount 3051S Wireless In-line transmitter is attached to the process by a single hex nut process connection. Loosen the hex nut to separate the transmitter from the process.

### 6.3.2 Remove terminal block

#### Wireless PlantWeb housing

Remove the Power Module. Loosen the two small screws and pull the entire terminal block out.

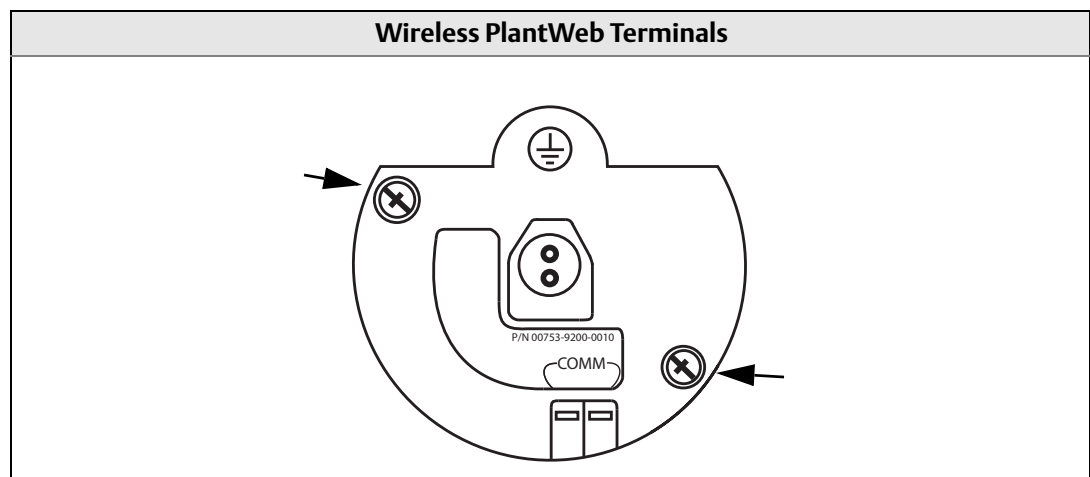



### 6.3.3 Removing the feature assembly and the SuperModule from the housing

The Wireless Feature Board is located in the electronics compartment. To remove the assembly, perform the following procedure.

1. Remove the housing cover opposite the field terminal side.
2. Remove the LCD Display, if applicable. To do this, hold in the two clips and pull outward.
3. Loosen the two small screws located on the assembly.
4. Replace the LCD Display. This will help in removing the assembly.
5. Pull out the assembly to expose and locate the SuperModule connector and antenna connector.
6. Grasp antenna connector by the base and pull upwards to disconnect.
7. Grasp the SuperModule connector, squeeze the clips and pull upwards (avoid pulling wires).

**Figure 6-1. SuperModule connector view**

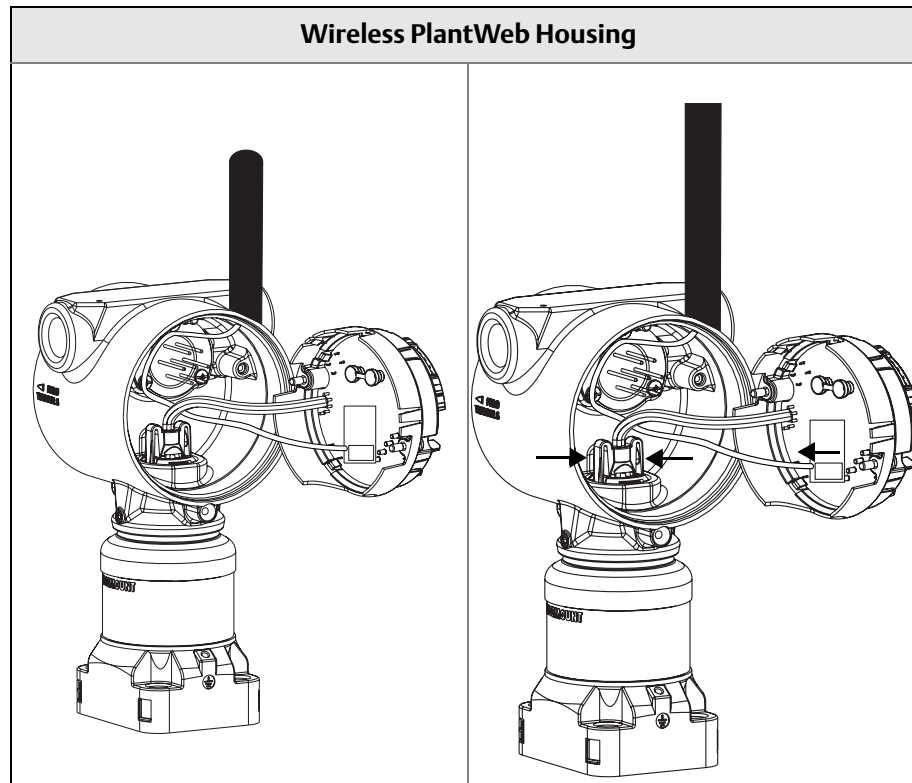

---

**Important**

To prevent damage to the SuperModule cable, disconnect it from the PlantWeb assembly before you remove the SuperModule from the housing.

---

8. Loosen the housing rotation set screw with a  $3/32$ -inch hex wrench, then rotate back one full turn.
9. Unscrew the housing from the SuperModule.

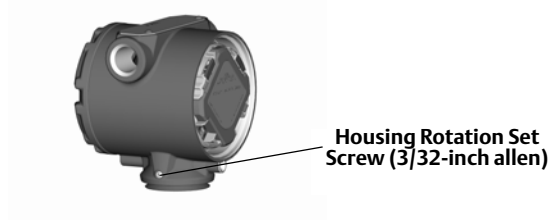

## 6.4 Reassembly procedures

---

**important**

The V-Seal must be installed at the bottom of the housing.

---

### 6.4.1 Attach the SuperModule to the wireless housing

1. Apply a light coat of low temperature silicon grease to the SuperModule connector.
2. Insert the SuperModule connector into the top of the SuperModule.
3. Reconnect the antenna wiring.
4. Gently slide the assembly into the housing, making sure the pins from the PlantWeb housing properly engage the receptacles on the assembly.
5. Tighten the captive mounting screws.
- ⚠ 6. Attach the PlantWeb housing cover and tighten so that metal contacts metal.

### 6.4.2 Install the Terminal Block

1. Gently slide the terminal block into the housing, making sure the pins from the PlantWeb housing properly engage the receptacles on the terminal block.
2. Tighten the captive screws on the terminal block.
- ⚠ 3. Attach the Wireless PlantWeb housing cover and tighten so that metal contacts metal.

### 6.4.3 Reassemble the process flange

1. Inspect the Teflon SuperModule o-rings. If the o-rings are not damaged, reuse them. Replace o-rings that show any signs of damage, such as nicks, cuts, or general wear.

---

**Note**

If you are replacing the o-rings, be careful not to scratch the o-ring grooves or the surface of the isolating diaphragm when removing the damaged o-rings.

---

2. Install the process flange on the SuperModule. To hold the process flange in place, install the two alignment screws to finger tight (screws are not pressure retaining). Do not overtighten; this will affect module-to-flange alignment.
3. Install the appropriate flange bolts.
  - a. If the installation requires a  $\frac{1}{4}$ -18 NPT mounting, use four 1.75-in. flange bolts. Go to Step f.
  - b. If the installation requires a  $\frac{1}{2}$ -14 NPT mounting, use four 2.88-in. process flange/adaptor bolts. For gage pressure configurations, use two 2.88-in. bolts and two 1.75-in. bolts. Go to Step d.
  - c. If the installation uses a manifold (differential pressure applications only), use appropriate bolts. Go to Step e.
  - d. Hold the flange adapters and adapter o-rings in place while finger-tightening the bolts. Go to Step g.
  - e. Align the process flange with the manifold.
  - f. Finger tighten the bolts.
  - g. Tighten the bolts to the initial torque value using a crossed pattern. See [Table 6-4](#) for appropriate torque values.
  - h. Tighten the bolts to the final torque value using a crossed pattern. See [Table 6-4](#) for appropriate torque values. When fully tightened, the bolts should extend through the top of the module housing.
  - i. If the installation uses a manifold, then install flange adapters on the process end of the manifold using the 1.75-in. flange bolts supplied with the transmitter.

**Table 6-4. Bolt Installation  
Torque Values**

Bolt Material	Initial Torque Value	Final Torque Value
CS-ASTM-A445 Standard	300 in-lb. (34 N-m)	650 in-lb. (73 N-m)
316 SST—Option L4	150 in-lb. (17 N-m)	300 in-lb. (34 N-m)
ASTM-A-193-B7M—Option L5	300 in-lb. (34 N-m)	650 in-lb. (73 N-m)
Alloy K-500—Option L6	300 in-lb. (34 N-m)	650 in-lb. (73 N-m)
ASTM-A-453-660—Option L7	150 in-lb. (17 N-m)	300 in-lb. (34 N-m)
ASTM-A-193-B8M—Option L8	150 in-lb. (17 N-m)	300 in-lb. (34 N-m)

4. If you replaced the Teflon SuperModule o-rings, re-torque the flange bolts after installation to compensate for cold flow.
5. Install the drain/vent valve.
  - a. Apply sealing tape to the threads on the seat. Starting at the base of the valve with the threaded end pointing toward the installer, apply two clockwise turns of sealing tape.
  - b. Take care to place the opening on the valve so that process fluid will drain toward the ground and away from human contact when the valve is opened.
  - c. Tighten the drain/vent valve to 250 in-lb. (28.25 N-m).

**Note**

After replacing o-rings on Range 1 transmitters and re-installing the process flange, expose the transmitter to a temperature of 185 °F (85 °C) for two hours. Then re-tighten the flange bolts in a cross pattern, and again expose the transmitter to a temperature of 185 °F (85 °C) for two hours before calibration.

---

# Appendix A Specifications and Reference Data

---

---

Performance specifications .....	page 77
Functional specifications .....	page 82
Physical specifications .....	page 87
Dimensional drawings .....	page 92
Ordering Information .....	page 94

---

## A.1 Specifications

### A.1.1 Performance specifications

For zero-based spans, reference conditions, silicone oil fill, glass-filled PTFE o-rings, SST materials, *Coplanar* flange (3051S\_C) or 1/2 in.- 14 NPT (3051S\_T) process connections, digital trim values set to equal range points.

#### **Conformance to specification ( $\pm 3\sigma$ (Sigma))**

Technology leadership, advanced manufacturing techniques and statistical process control ensure specification conformance to  $\pm 3\sigma$  or better.

#### **Digital output**

For wireless devices, use calibrated range in place of span.

## Reference accuracy

Models	Ultra <sup>(1)</sup>	Classic <sup>(1)</sup>	Ultra for Flow <sup>(1)(2)</sup>
3051S_CD, CG			
Ranges 2 - 4	±0.025% of span. For spans less than 10:1, $\pm\left[0.005 + 0.0035\left(\frac{\text{URL}}{\text{span}}\right)\right]\%$ of span	±0.055% of span. For spans less than 10:1, $\pm\left[0.015 + 0.005\left(\frac{\text{URL}}{\text{span}}\right)\right]\%$ of span	±0.04% of reading up to 8:1 DP turndown from URL; $\pm\left[0.04 + 0.0023\left(\frac{\text{URL}}{\text{RDG}}\right)\right]\%$ reading to 200:1 DP turndown from URL
Range 5	±0.05% of span. For spans less than 10:1, $\pm\left[0.005 + 0.0045\left(\frac{\text{URL}}{\text{span}}\right)\right]\%$ of span	±0.065% of span. For spans less than 10:1, $\pm\left[0.015 + 0.005\left(\frac{\text{URL}}{\text{span}}\right)\right]\%$ of span	N/A
Range 1	±0.09% of span. For spans less than 15:1, $\pm\left[0.015 + 0.005\left(\frac{\text{URL}}{\text{span}}\right)\right]\%$ of span	±0.10% of span. For spans less than 15:1, $\pm\left[0.025 + 0.005\left(\frac{\text{URL}}{\text{span}}\right)\right]\%$ of span	N/A
Range 0	±0.09% of span. For spans less than 2:1, ±0.045% of URL	±0.10% of span. For spans less than 2:1, ±0.05% of URL	N/A
3051S_T			
Ranges 1 - 4	±0.025% of span. For spans less than 10:1, $\pm\left[0.004\left(\frac{\text{URL}}{\text{span}}\right)\right]\%$ of span	±0.055% of span. For spans less than 10:1, $\pm\left[0.0065\left(\frac{\text{URL}}{\text{span}}\right)\right]\%$ of span	N/A
Range 5	±0.04% of span. For spans less than 10:1, $\pm\left[0.004\left(\frac{\text{URL}}{\text{span}}\right)\right]\%$ of span	±0.065% of span. For spans less than 10:1, $\pm\left[0.0065\left(\frac{\text{URL}}{\text{span}}\right)\right]\%$ of span	N/A
3051S_CA			
Ranges 1 - 4	±0.025% of span. For spans less than 10:1, $\pm\left[0.004\left(\frac{\text{URL}}{\text{span}}\right)\right]\%$ of span	±0.055% of span. For spans less than 10:1, $\pm\left[0.0065\left(\frac{\text{URL}}{\text{span}}\right)\right]\%$ of span	N/A
Range 0	±0.075% of span. For spans less than 5:1, $\pm\left[0.025 + 0.01\left(\frac{\text{URL}}{\text{span}}\right)\right]\%$ of span	±0.075% of span. For spans less than 5:1, $\pm\left[0.025 + 0.01\left(\frac{\text{URL}}{\text{span}}\right)\right]\%$ of span	N/A
3051S_L	±0.065% of span. For spans less than 10:1,  $\pm\left[0.015 + 0.005\left(\frac{\text{URL}}{\text{span}}\right)\right]\%$ of span	±0.065% of span. For spans less than 10:1, $\pm\left[0.015 + 0.005\left(\frac{\text{URL}}{\text{span}}\right)\right]\%$ of span	N/A

(1) Stated reference accuracy equations include terminal based linearity, hysteresis, and repeatability.

(2) Ultra for Flow available on 3051S\_CD Ranges 2-3 only. For calibrated spans from 1:1 to 2:1 of URL, add ±0.005% of span analog output error.

(3) RDG refers to transmitter reading.

## Total performance<sup>(1)</sup>

Models		Ultra <sup>(1)</sup>	Classic	Ultra for Flow <sup>(2)</sup>
3051S_CD 3051S_CG 3051S_CA 3051S_T	Ranges 2-3 Ranges 2-5 Ranges 2-4 Ranges 2-4	±0.1% of span; for ±50°F (28°C) temperature changes; 0-100% relative humidity, up to 740 psi (51 bar) line pressure (DP only), from 1:1 to 5:1 rangedown	±0.15% of span; for ±50°F (28°C) temperature changes; 0-100% relative humidity, up to 740 psi (51 bar) line pressure (DP only), from 1:1 to 5:1 rangedown	±0.1% of reading; for ±50°F (28°C) temperature changes; 0-100% relative humidity, up to 740 psi (51 bar) line pressure, over 8:1 DP turndown from URL

(1) Total performance is based on combined errors of reference accuracy, ambient temperature effect, and line pressure effect. For 3051SMV, specification applies to differential pressure measurement.

(2) Ultra for Flow is only available for 3051S\_CD Ranges 2-3 and 3051SMV DP Ranges 2-3.

## Long term stability

Models		Ultra and Ultra for Flow <sup>(1)</sup>	Classic
3051S_CD 3051S_CG 3051S_CA 3051S_T	Ranges 2-5 Ranges 2-5 Ranges 1-4 Ranges 1-5	±0.20% of URL for 10 years; for ±50°F (28°C) temperature changes, up to 1000 psi (68,9 bar) line pressure	±0.125% of URL for 5 years; for ±50°F (28°C) temperature changes, up to 1000 psi (68,9 bar) line pressure

(1) Ultra for Flow is only available for 3051S\_CD Ranges 2-3.

## Warranty<sup>(1)</sup>

Models <sup>(1)</sup>	Ultra and Ultra for Flow	Classic
3051S Scalable Products	12-year limited warranty <sup>(2)</sup>	1-year limited warranty <sup>(3)</sup>

(1) Warranty details can be found in Emerson Process Management Terms & Conditions of Sale, Document 63445, Rev G (10/06).

(2) Rosemount Ultra and Ultra for Flow transmitters have a limited warranty of twelve (12) years from date of shipment. All other provisions of Emerson Process Management standard limited warranty remain the same.

(3) Goods are warranted for twelve (12) months from the date of initial installation or eighteen (18) months from the date of shipment by Seller, whichever period expires first.

## Ambient temperature effect

Models	Ultra	Classic	Ultra for Flow <sup>(1)</sup>
3051S_CD, CG	per 50 °F (28 °C)	per 50 °F (28 °C)	per 50 °F (28 °C)
Range 2 - 5 <sup>(2)</sup>	± (0.009% URL + 0.025% span) from 1:1 to 10:1 ± (0.018% URL + 0.08% span) from >10:1 to 200:1	± (0.0125% URL + 0.0625% span) from 1:1 to 5:1 ± (0.025% URL + 0.125% span) from >5:1 to 100:1	From -40 to 185 °F (-40 to 85 °C): ±0.13% reading up to 8:1 DP turndown from URL; ±[0.13 + 0.0187 (URL/RDG <sup>(3)</sup> )]% reading to 100:1 DP turndown from URL
Range 0	± (0.25% URL + 0.05% span) from 1:1 to 30:1	± (0.25% URL + 0.05% span) from 1:1 to 30:1	N/A
Range 1	± (0.1% URL + 0.25% span) from 1:1 to 50:1	± (0.1% URL + 0.25% span) from 1:1 to 50:1	N/A
3051S_T Ranges 2 - 4	± (0.009% URL + 0.025% span) from 1:1 to 10:1 ± (0.018% URL + 0.08% span) from >10:1 to 100:1	± (0.0125% URL + 0.0625% span) from 1:1 to 5:1 ± (0.025% URL + 0.125% span) from >5:1 to 100:1	N/A
Range 5	± (0.05% URL + 0.075% span) from 1:1 to 10:1	± (0.05% URL + 0.075% span) from 1:1 to 5:1	N/A
Range 1	± (0.0125% URL + 0.0625% span) from 1:1 to 5:1 ± (0.025% URL + 0.125% span) from >5:1 to 100:1	± (0.0125% URL + 0.0625% span) from 1:1 to 5:1 ± (0.025% URL + 0.125% span) from >5:1 to 100:1	N/A
3051S_CA Ranges 2 - 4	± (0.0125% URL + 0.0625% span) from 1:1 to 5:1 ± (0.025% URL + 0.125% span) from >5:1 to 200:1	± (0.0125% URL + 0.0625% span) from 1:1 to 5:1 ± (0.025% URL + 0.125% span) from >5:1 to 100:1	N/A
Range 0	± (0.1% URL + 0.25% span) from 1:1 to 30:1	± (0.1% URL + 0.25% span) from 1:1 to 30:1	N/A
Range 1	± (0.0125% URL + 0.0625% span) from 1:1 to 5:1 ± (0.025% URL + 0.125% span) from >5:1 to 100:1	± (0.0125% URL + 0.0625% span) from 1:1 to 5:1 ± (0.025% URL + 0.125% span) from >5:1 to 100:1	N/A
3051S_L	See <i>Instrument Toolkit</i> .	See <i>Instrument Toolkit</i> .	

(1) Ultra for Flow available on 3051S\_CD Ranges 2-3 only.

(2) Use Classic specification for 3051S\_CD Range 5 Ultra.

(3) RDG refers to transmitter reading.



## Line pressure effect<sup>(1)</sup>

Models <sup>(1)</sup>	Ultra and Ultra for Flow	Classic
3051S_CD Range 2 - 3 Range 0 Range 1	Zero Error <sup>(2)</sup> ± 0.025% URL per 1000 psi (69 bar) ± 0.125% URL per 100 psi (6,89 bar) ± 0.25% URL per 1000 psi (69 bar)	Zero Error <sup>(2)</sup> ± 0.05% URL per 1000 psi (69 bar) ± 0.125% URL per 100 psi (6,89 bar) ± 0.25% URL per 1000 psi (69 bar)
Range 2 - 3 Range 0 Range 1	Span Error <sup>(3)</sup> ± 0.1% of reading per 1000 psi (69 bar) ± 0.15% of reading per 100 psi (6,89 bar) ± 0.4% of reading per 1000 psi (69 bar)	Span Error <sup>(3)</sup> ± 0.1% of reading per 1000 psi (69 bar) ± 0.15% of reading per 100 psi (6,89 bar) ± 0.4% of reading per 1000 psi (69 bar)

(1) For line pressures above 2000 psi (137,9 bar) and 3051S\_CD Ranges 4-5, see the 3051S Reference Manual (document number 00809-0100-4801).

(2) Zero error can be calibrated out.

(3) Specifications for option code P0 are 2 times those shown above.

## Mounting position effects

Models	Ultra, Ultra for Flow, and Classic
3051S_C	Zero shifts up to ±1.25 inH <sub>2</sub> O (3,11 mbar), which can be calibrated out; no span effect
3051S_L	With liquid level diaphragm in vertical plane, zero shift of up to 1 inH <sub>2</sub> O (25,4 mmH <sub>2</sub> O); with diaphragm in horizontal plane, zero shift of up to 5 inH <sub>2</sub> O (127 mmH <sub>2</sub> O) plus extension length on extended units; all zero shifts can be calibrated out; no span effect
3051S_T and 3051S_CA	Zero shifts to 2.5 inH <sub>2</sub> O (63,5 mmH <sub>2</sub> O), which can be calibrated out; no span effect

## Vibration effect

Less than ±0.1% of URL when tested per the requirements of IEC60770-1 field or pipeline with high vibration level (10-60 Hz 0.21mm displacement peak amplitude / 60-2000 Hz 3g).

For Housing Style codes 1J, 1K, 1L, 2J, and 2M:

Less than ±0.1% of URL when tested per the requirements of IEC60770-1 field with general application or pipeline with low vibration level (10-60 Hz 0.15mm displacement peak amplitude / 60-500 Hz 2g).

## A.1.2 Functional specifications

### Range and sensor limits

Range	3051S_ Minimum Span		3051S_ Range and Sensor Limits			
	Ultra and Ultra for Flow <sup>(1)</sup>	Classic	Upper (URL)	Lower (LRL)		
				3051S_CD <sup>(2)</sup>	3051S_CG, LG <sup>(3)(4)</sup>	3051S_LD <sup>(4)</sup>
0	0.1 inH <sub>2</sub> O (0,25 mbar)	0.1 inH <sub>2</sub> O (0,25 mbar)	3.0 inH <sub>2</sub> O (7,5 mbar)	-3.0 inH <sub>2</sub> O (-7,5 mbar)	NA	NA
1	0.5 inH <sub>2</sub> O (1,24 mbar)	0.5 inH <sub>2</sub> O (1,24 mbar)	25.0 inH <sub>2</sub> O (62,3 mbar)	-25.0 inH <sub>2</sub> O (-62,3 mbar)	-25.0 inH <sub>2</sub> O (-62,3 mbar)	-25.0 inH <sub>2</sub> O (-62,3 mbar)
2	1.3 inH <sub>2</sub> O (3,11 mbar)	2.5 inH <sub>2</sub> O (6,23 mbar)	250.0 inH <sub>2</sub> O (0,62 bar)	-250.0 inH <sub>2</sub> O (-0,62 bar)	-250.0 inH <sub>2</sub> O (-0,62 bar)	-250.0 inH <sub>2</sub> O (-0,62 bar)
3	5.0 inH <sub>2</sub> O (12,4 mbar)	10.0 inH <sub>2</sub> O (24,9 mbar)	1000.0 inH <sub>2</sub> O (2,49 bar)	-1000.0 inH <sub>2</sub> O (-2,49 bar)	-393.0 inH <sub>2</sub> O (-979 mbar)	-1000.0 inH <sub>2</sub> O (-2,49 bar)
4	1.5 psi (103,4 mbar)	3.0 psi (206,8 mbar)	300.0 psi (20,7 bar)	-300.0 psi (-20,7 bar)	-14.2 psig (-979 mbar)	-300.0 psi (-20,7 bar)
5	10.0 psi (689,5 mbar)	20.0 psi (1,38 bar)	2000.0 psi (137,9 bar)	-2000.0 psi (-137,9 bar)	-14.2 psig (-979 mbar)	-2000.0 psi (-137,9 bar)

(1) Ultra for Flow available on 3051S\_CD Ranges 2-3 only.

(2) Lower (LRL) is 0 inH<sub>2</sub>O (0 mbar) for Ultra for Flow.

(3) Assumes atmospheric pressure of 14.7 psig.

(4) When specifying a 3051S\_L Ultra, use Classic minimum span.

Range	3051S_T Range and Sensor Limits				
	Minimum Span		Upper (URL)	Lower (LRL) (Abs.)	Lower <sup>(1)</sup> (LRL) (Gage)
	Ultra	Classic			
1	0.3 psi (20,7 mbar)	0.3 psi (20,7 mbar)	30 psi (2,07 bar)	0 psia (0 bar)	-14.7 psig (-1,01 bar)
2	0.75 psi (51,7 mbar)	1.5 psi (0,103 bar)	150 psi (10,34 bar)	0 psia (0 bar)	-14.7 psig (-1,01 bar)
3	4 psi (275,8 mbar)	8 psi (0,55 bar)	800 psi (55,16 bar)	0 psia (0 bar)	-14.7 psig (-1,01 bar)
4	20 psi (1,38 bar)	40 psi (2,76 bar)	4000 psi (275,8 bar)	0 psia (0 bar)	-14.7 psig (-1,01 bar)
5	1000 psi (68,9 bar)	2000 psi (137,9 bar)	10000 psi (689,5 bar)	0 psia (0 bar)	-14.7 psig (-1,01 bar)

(1) Assumes atmospheric pressure of 14.7 psig.

3051S_CA, LA <sup>(1)</sup> Range and Sensor Limits				
Range	Minimum Span		Upper (URL)	Lower (LRL)
	Ultra	Classic		
0 <sup>(2)</sup>	0.167 psia (11,5 mbar)	0.167 psia (11,5 mbar)	5 psia (0,34 bar)	0 psia (0 bar)
1	0.3 psia (20,7 mbar)	0.3 psia (20,7 mbar)	30 psia (2,07 bar)	0 psia (0 bar)
2	0.75 psia (51,7 mbar)	1.5 psia (0,103 bar)	150 psia (10,34 bar)	0 psia (0 bar)
3	4 psia (275,8 mbar)	8 psia (0,55 bar)	800 psia (55,16 bar)	0 psia (0 bar)
4	20 psia (1,38 bar)	40 psia (2,76 bar)	4000 psia (275,8 bar)	0 psia (0 bar)

(1) When specifying a 3051S\_L Ultra, use Classic minimum span.

(2) Range 0 is not available for 3051S\_LA.

## Wireless Self-Organizing Networks

### Output

IEC 62591 (WirelessHART), 2.4 GHz DSSS.

### Local display

The optional five-digit LCD can display user-selectable information such as primary variable in engineering units, percent of range, sensor module temperature, and electronics temperature. The display updates based on the wireless update rate.

### Radio frequency power output from antenna

External Antenna (WK option): Maximum of 10 mW (10 dBm) EIRP

Extended Range, External Antenna (WM option): Maximum of 18 mW (12.5 dBm) EIRP

High-Gain, Remote Antenna (WN option): Maximum of 40 mW (16 dBm) EIRP

### Update Rate

User selectable, 1 sec. to 60 min.

### Wireless power module

Field replaceable, keyed connection eliminates the risk of incorrect installation, Intrinsically Safe Lithium-thionyl chloride Power Module with polybutadine terephthalate (PBT) enclosure. Ten-year life at one minute update rate.<sup>(1)</sup>

(1) Reference conditions are 70 °F (21 °C), and routing data for three additional network devices.  
NOTE: Continuous exposure to ambient temperature limits of -40 °F or 185 °F (-40 °C or 85 °C) may reduce specified life by less than 20 percent.

## Overpressure Limits

Transmitters withstand the following limits without damage:

### Rosemount 3051S\_CD, CG

Range 0: 750 psi (51,7 bar)  
Range 1: 2000 psig (137,9 bar)  
Ranges 2–5: 3626 psig (250,0 bar)  
4500 psig (310,3 bar) for option code P9  
6092 psig (420 bar) for option code P0 (3051S2CD only)

### Rosemount 3051S\_CA

Range 0: 60 psia (4,13 bar)  
Range 1: 750 psia (51,7 bar)  
Range 2: 1500 psia (103,4 bar)  
Range 3: 1600 psia (110,3 bar)  
Range 4: 6000 psia (413,7 bar)

## Rosemount 3051S\_T

Range 1: 750 psi (51,7 bar)  
Range 2: 1500 psi (103,4 bar)  
Range 3: 1600 psi (110,3 bar)  
Range 4: 6000 psi (413,7 bar)  
Range 5: 15000 psi (1034,2 bar)

## Rosemount 3051S\_L

Limit is flange rating or sensor rating, whichever is lower (see the table below).

Standard	Type	CS Rating	SST Rating
ANSI/ASME	Class 150	285 psig	275 psig
ANSI/ASME	Class 300	740 psig	720 psig
ANSI/ASME	Class 600	1480 psig	1440 psig
<i>At 100 °F (38 °C), the rating decreases with increasing temperature, per ANSI/ASME B16.5.</i>			
DIN	PN 10–40	40 bar	40 bar
DIN	PN 10/16	16 bar	16 bar
DIN	PN 25/40	40 bar	40 bar
<i>At 248 °F (120 °C), the rating decreases with increasing temperature, per DIN 2401.</i>			

## Static pressure limit

### Rosemount 3051S\_CD Only

Operates within specifications between static line pressures of 0.5 psia and 3626 psig;  
4500 psig (310,3 bar) for option code P9  
6092 psig (420 bar) for option code P0 (3051S2CD only)  
Range 0: 0.5 psia to 750 psig (0,03 to 51,71 bar)  
Range 1: 0.5 psia to 2000 psig (0,03 to 137,90 bar)

## Burst pressure limits

Coplanar or traditional process flange

- 10000 psig (689,5 bar).

Rosemount 3051S\_T:

- Ranges 1–4: 11000 psi (758,4 bar)
- Range 5: 26000 psig (1792,64 bar)

## Temperature limits

### Ambient

-40 to 185 °F (-40 to 85 °C)

With LCD display<sup>(1)</sup>: -40 to 175 °F (-40 to 80 °C)

With option code P0: -20 to 185 °F (-29 to 85 °C)

<sup>(1)</sup> LCD display may not be readable and LCD updates will be slower at temperatures below -4 °F (-20 °C).

### Storage

-40 to 185 °F (-40 to 85 °C)

With LCD display: -40 to 185 °F (-40 to 85 °C)

### Process temperature limits

At atmospheric pressures and above.

Rosemount 3051S_C Coplanar	
Silicone Fill Sensor <sup>(1)</sup>	
with Coplanar Flange	-40 to 250 °F (-40 to 121 °C) <sup>(2)</sup>
with Traditional Flange	-40 to 300 °F (-40 to 149 °C) <sup>(2)(3)</sup>
with Level Flange	-40 to 300 °F (-40 to 149 °C) <sup>(2)</sup>
with 305 Integral Manifold	-40 to 300 °F (-40 to 149 °C) <sup>(2)(3)</sup>
Inert Fill Sensor <sup>(1)</sup>	-40 to 185 °F (-40 to 85 °C) <sup>(4)(5)</sup>
Rosemount 3051S_T In-Line (Process Fill Fluid)	
Silicone Fill Sensor <sup>(1)</sup>	-40 to 250 °F (-40 to 121 °C) <sup>(2)</sup>
Inert Fill Sensor <sup>(1)</sup>	-22 to 250 °F (-30 to 121 °C) <sup>(2)</sup>
Rosemount 3051S_L Low-Side Temperature Limits	
Silicone Fill Sensor <sup>(1)</sup>	-40 to 250 °F (-40 to 121 °C) <sup>(2)</sup>
Inert Fill Sensor <sup>(1)</sup>	0 to 185 °F (-18 to 85 °C) <sup>(2)</sup>
Rosemount 3051S_L High-Side Temperature Limits (Process Fill Fluid)	
Syltherm <sup>®</sup> XLT	-102 to 302 °F (-75 to 150 °C)
D. C. <sup>®</sup> Silicone 704 <sup>(6)</sup>	32 to 400 °F (0 to 205 °C)
D. C. Silicone 200	-49 to 400 °F (-45 to 205 °C)
Inert (Halocarbon)	-49 to 320 °F (-45 to 160 °C)
Glycerin and Water	5 to 203 °F (-15 to 95 °C)
Neobee M-20 <sup>®</sup>	5 to 400 °F (-15 to 205 °C)
Propylene Glycol and Water	5 to 203 °F (-15 to 95 °C)

<sup>(1)</sup> Process temperatures above 185 °F (85 °C) require derating the ambient limits by a 1.5:1 ratio.

<sup>(2)</sup> 220 °F (104 °C) limit in vacuum service; 130 °F (54 °C) for pressures below 0.5 psia.

<sup>(3)</sup> -20 °F (-29 °C) is the lower process temperature limit with option code P0.

<sup>(4)</sup> 160 °F (71 °C) limit in vacuum service.

<sup>(5)</sup> Not available for 3051S\_CA.

<sup>(6)</sup> Upper limit of 600 °F (315 °C) is available with 1199 seal assemblies mounted away from the transmitter with the use of capillaries and up to 500 °F (260 °C) with direct mount extension.

### **Humidity limits**

0–100% relative humidity

### **Volumetric displacement**

Less than 0.005 in<sup>3</sup> (0,08 cm<sup>3</sup>)

### **Damping**

The Damping command introduces a delay in processing which increases the response time of the transmitter; smoothing variations in output readings caused by rapid input changes. In the 3051S Wireless pressure transmitter, damping only takes effect when the device is placed in high power refresh mode and during calibration. In normal power mode, the effective damping is 0. Note that when the device is in high power refresh mode, battery power will be depleted rapidly.

## A.1.3 Physical specifications

### Electrical connections

1/2-14 NPT, G1/2, and M20 x 1.5 (CM20) conduit. HART interface connections fixed to terminal block.

### Process connections

#### Rosemount 3051S\_C

1/4-18 NPT on 2 1/8-in. centers

1/2-14 NPT and RC 1/2 on 2-in. (50.8 mm), 2 1/8-in. (54.0 mm), or 2 1/4-in. (57.2 mm) centers (process adapters)

#### Rosemount 3051S\_T

1/2-14 NPT female,  
Non-Threaded instrument flange (available in SST for Range 1-4 transmitters only),  
G1/2 A DIN 16288 Male (available in SST for Range 1-4 transmitters only), or  
Autoclave type F-250-C (Pressure relieved 9/16-18 gland thread; 1/4 OD high pressure tube 60° cone; available in SST for Range 5 transmitters only).

#### Rosemount 3051S\_L

High pressure side: 2-in.(50.8mm), 3-in. (72 mm), or 4-in. (102mm), ASME B 16.5 (ANSI) Class 150, 300 or 600 flange; 50, 80 or 100 mm, DIN 2501 PN 40 or 10/16 flange

Low pressure side: 1/4-18 NPT on flange, 1/2-14 NPT on process adapter

### Process-wetted parts

#### Process isolating diaphragms

Isolating Diaphragm Material	3051S_			
	CD, CG	T	CA	L
316L SST	•	•	•	See Below
Alloy C-276	•	•	•	
Alloy 400	•		•	
Tantalum	•			
Gold-plated Alloy 400	•		•	
Gold-plated 316L SST	•		•	

#### Drain/Vent valves

316 SST, Alloy C-276, or Alloy 400/K-500 material (Alloy 400/K-500 is not available with 3051S\_L).

#### Process flanges and adapters

Plated carbon steel  
SST: CF-8M (Cast 316 SST) per ASTM A743  
Cast C-276: CW-12MW per ASTM A494  
Cast Alloy 400: M-30C per ASTM A494

## Wetted O-rings

Glass-filled PTFE  
(Graphite-filled PTFE with Isolating Diaphragm code 6)

## Rosemount 3051S\_L process wetted parts

Flanged Process Connection (Transmitter High Side)

## Process diaphragms, including process gasket surface

316L SST, Alloy C-276, or Tantalum

## Extension

CF-3M (Cast 316L SST, material per ASTM A743), or CW-12MW (Cast C-276, material ASTM A494); fits schedule 40 and 80 pipe

## Mounting flange

Zinc-cobalt plated CS or 316 SST

## Reference process connection (transmitter low side)

## Isolating diaphragms

316L SST or Alloy C-276

## Reference flange and adapter

CF-8M (Cast version of 316 SST, material per ASTM-A743)

## Non-wetted parts

## Electronics housing

Low-copper aluminum alloy or SST: CF-3M (Cast 316L SST) or CF-8M (Cast 316 SST)  
NEMA 4X, IP 66

## Coplanar sensor module housing

CF-3M (Cast version of 316L SST)

## Bolts

Plated carbon steel per ASTM A449, Type 1  
Austenitic 316 SST per ASTM F593  
ASTM A453, Class D, Grade 660 SST  
ASTM A193, Grade B7M alloy steel  
ASTM A193, Class 2, Grade B8M SST  
Alloy K-500



### Sensor module fill fluid

Silicone or inert halocarbon (Inert is not available with 3051S\_CA). In-Line series uses Fluorinert<sup>®</sup> FC-43.

### Process fill fluid (liquid level only)

3051S\_L: *Syltherm* XLT, D.C. Silicone 704, D.C. Silicone 200, inert, glycerin and water, *Neobee M-20*, propylene glycol and water.

### Paint

Polyurethane

### Cover O-rings

Buna-N

### Wireless antenna

External Antenna (WK / WM): PBT/ PC integrated omnidirectional antenna

Remote Antenna (WN): Fiberglass omnidirectional antenna

### Power module

Field replaceable, keyed connection eliminates the risk of incorrect installation, Intrinsically Safe Lithium-thionyl chloride Power Module with PBT enclosure

## Shipping weights for Rosemount 3051S Wireless Pressure Transmitter

**Table A-1. SuperModule Platform weights**

SuperModule Platform	Weight in lb. (kg)
Coplanar <sup>(1)</sup>	3.1 (1,4)
In-Line	1.4 (0,6)

(1) Flange and bolts not included.

**Table A-2. Transmitter weights without options**

Complete Transmitter <sup>(1)</sup>	Add Weight In lb (kg)
3051S_C with wireless PlantWeb housing	7.3 (3,3)
3051S_T with wireless PlantWeb housing	4.2 (1,9)

(1) Fully functional transmitter with terminal block, covers, and SST flange.

**Table A-3. 3051S\_L weights without options**

Flange	Flush lb. (kg)	2-in. Ext. lb (kg)	4-in. Ext. lb (kg)	6-in. Ext. lb (kg)
2-in., 150	9.5 (4,3)	—	—	—
3-in., 150	15.7 (7,1)	16.4 (7,4)	17.6 (8,0)	18.9 (8,6)
4-in., 150	21.2 (9,6)	20.9 (9,5)	22.1 (10,0)	23.4 (10,6)
2-in., 300	11.3 (5,1)	—	—	—
3-in., 300	19.6 (8,9)	20.3 (9,2)	21.5 (9,8)	22.8 (10,3)
4-in., 300	30.4 (13,8)	30.3 (13,7)	31.5 (14,3)	32.8 (14,9)
2-in., 600	12.8 (5,8)	—	—	—
3-in., 600	22.1 (10,0)	22.8 (10,3)	24.0 (10,9)	25.3 (11,5)
DN 50 / PN 40	11.3 (5,1)	—	—	—
DN 80 / PN 40	16.0 (7,3)	16.7 (7,6)	17.9 (8,1)	19.2 (8,7)
DN 100 / PN 10/16	11.2 (5,1)	11.9 (5,4)	13.1 (5,9)	14.4 (6,5)
DN 100 / PN 40	12.6 (5,7)	13.3 (6,0)	14.5 (6,6)	15.8 (7,1)

**Table A-4. Transmitter option weights**

Option Code	Option	Add lb (kg)
M5	LCD Display for Aluminum PlantWeb Housing <sup>(1)</sup> , LCD Display for SST PlantWeb Housing <sup>(1)</sup>	0.8 (0,4) 1.6 (0,7)
B4	SST Mounting Bracket for Coplanar Flange	1.2 (0,5)
B1, B2, B3	Mounting Bracket for Traditional Flange	1.7 (0,8)
B7, B8, B9	Mounting Bracket for Traditional Flange with SST Bolts	1.7 (0,8)
BA, BC	SST Bracket for Traditional Flange	1.6 (0,7)
B4	SST Mounting Bracket for In-Line	1.3 (0,6)
F12, F22	SST Traditional Flange with SST Drain Vents <sup>(2)</sup>	3.2 (1,5)
F13, F23	Cast C-276 Traditional Flange with Alloy C-276 Drain Vents <sup>(2)</sup>	3.6 (1,6)
E12, E22	SST Coplanar Flange with SST Drain Vents <sup>(2)</sup>	1.9 (0,9)
F14, F24	Cast Alloy 400 Traditional Flange with Alloy 400/K-500 Drain Vents <sup>(2)</sup>	3.6 (1,6)
F15, F25	SST Traditional Flange with Alloy C-276 Drain Vents <sup>(2)</sup>	3.2 (1,5)
G21	Level Flange—3 in., 150	12.6 (5,7)
G22	Level Flange—3 in., 300	15.9 (7,2)
G11	Level Flange—2 in., 150	6.8 (3,1)

Option Code	Option	Add lb (kg)
G12	Level Flange—2 in., 300	8.2 (3,7)
G31	DIN Level Flange, SST, DN 50, PN 40	7.8 (3,5)
G41	DIN Level Flange, SST, DN 80, PN 40	13.0 (5,9)

(1) Includes LCD display and display cover.

(2) Includes mounting bolts.

Item	Weight in lb. (kg)
Aluminum Standard Cover	0.4 (0,2)
SST Standard Cover	1.3 (0,6)
Aluminum Display Cover	0.7 (0,3)
SST Display Cover	1.5 (0,7)
Wireless Extended Cover	0.7 (0,3)
LCD Display <sup>(1)</sup>	0.1 (0,04)
Junction Box Terminal Block	0.2 (0,1)
PlantWeb Terminal Block	0.2 (0,1)
Power Module	0.5 (0,2)

(1) Display only.

## A.2 Dimensional drawings

Dimensions are in inches (millimeters).  
 Process adapters (option D2) and Rosemount 305 integral manifolds must be ordered with the transmitter.

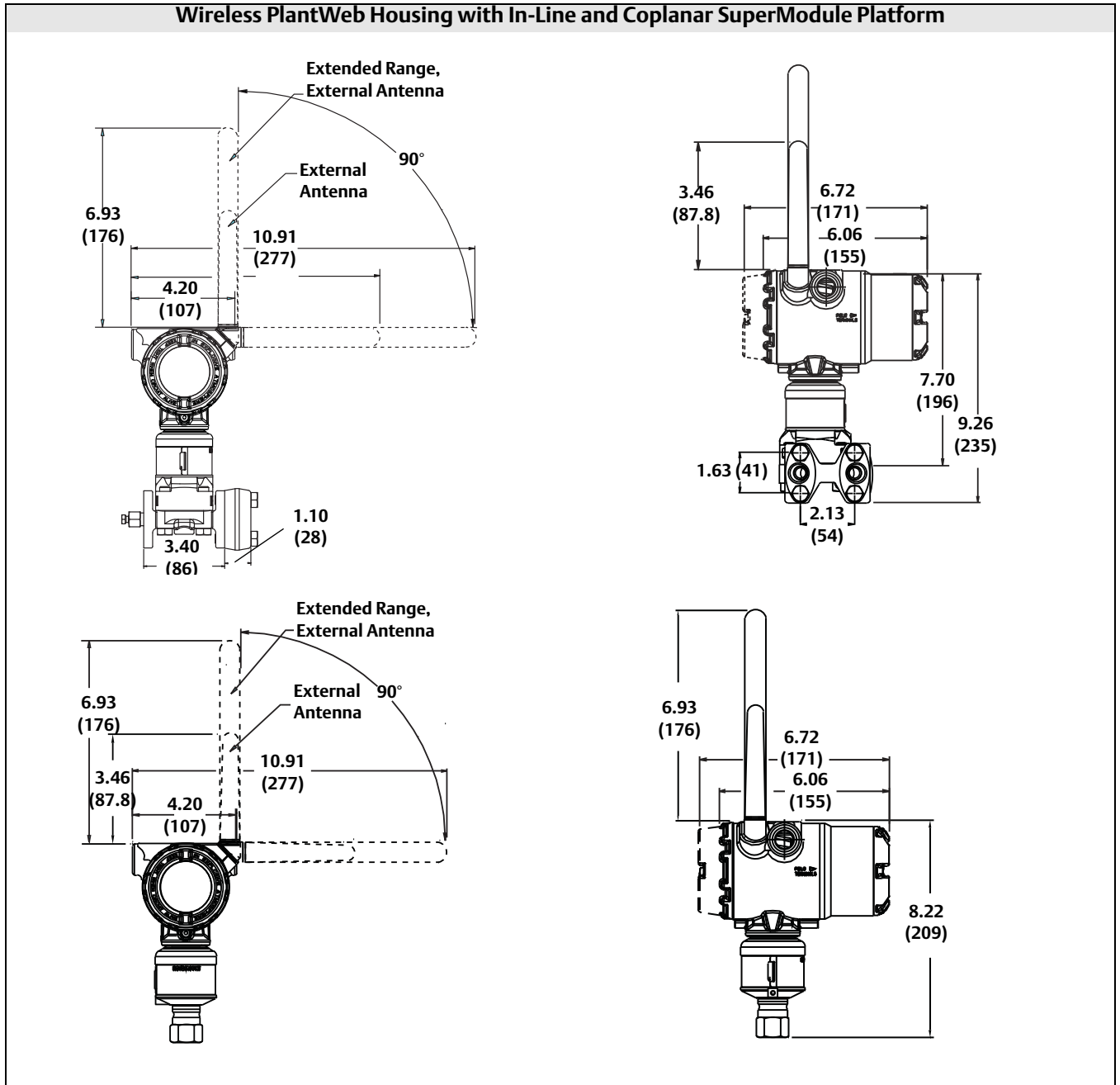

**Table A-5. 3051S\_L Dimensional Specifications**

Except where indicated, dimensions are in inches (millimeters).

Class	Pipe Size	Flange Thickness A	Bolt Circle Diameter B	Outside Diameter C	No. of Bolts	Bolt Hole Diameter	Extension Diameter <sup>(1)</sup> D	O.D. Gasket Surface E
ASME B16.5 (ANSI) 150	2 (51)	0.69 (18)	4.75 (121)	6.0 (152)	4	0.75 (19)	NA	3.6 (92)
	3 (76)	0.88 (22)	6.0 (152)	7.5 (191)	4	0.75 (19)	2.58 (66)	5.0 (127)
	4 (102)	0.88 (22)	7.5 (191)	9.0 (229)	8	0.75 (19)	3.5 (89)	6.2 (158)
ASME B16.5 (ANSI) 300	2 (51)	0.82 (21)	5.0 (127)	6.5 (165)	8	0.75 (19)	NA	3.6 (92)
	3 (76)	1.06 (27)	6.62 (168)	8.25 (210)	8	0.88 (22)	2.58 (66)	5.0 (127)
	4 (102)	1.19 (30)	7.88 (200)	10.0 (254)	8	0.88 (22)	3.5 (89)	6.2 (158)
ASME B16.5 (ANSI) 600	2 (51)	1.00 (25)	5.0 (127)	6.5 (165)	8	0.75 (19)	NA	3.6 (92)
	3 (76)	1.25 (32)	6.62 (168)	8.25 (210)	8	0.88 (22)	2.58 (66)	5.0 (127)
DIN 2501 PN 10-40	DN 50	20 mm	125 mm	165 mm	4	18 mm	NA	4.0 (102)
DIN 2501 PN 25/40	DN 80	24 mm	160 mm	200 mm	8	18 mm	65 mm	5.4 (138)
	DN 100	24 mm	190 mm	235 mm	8	22 mm	89 mm	6.2 (158)
DIN 2501 PN 10/16	DN 100	20 mm	180 mm	220 mm	8	18 mm	89 mm	6.2 (158)

Class	Pipe Size	Process Side F	Lower Housing G		H
			1/4 NPT	1/2 NPT	
ASME B16.5 (ANSI) 150	2 (51)	2.12 (54)	0.97 (25)	1.31 (33)	6.66 (169)
	3 (76)	3.6 (91)	0.97 (25)	1.31 (33)	6.66 (169)
	4 (102)	3.6 (91)	0.97 (25)	1.31 (33)	6.66 (169)
ASME B16.5 (ANSI) 300	2 (51)	2.12 (54)	0.97 (25)	1.31 (33)	6.66 (169)
	3 (76)	3.6 (91)	0.97 (25)	1.31 (33)	6.66 (169)
	4 (102)	3.6 (91)	0.97 (25)	1.31 (33)	6.66 (169)
ASME B16.5 (ANSI) 600	2 (51)	2.12 (54)	0.97 (25)	1.31 (33)	8.66 (219)
	3 (76)	3.6 (91)	0.97 (25)	1.31 (33)	8.66 (219)
DIN 2501 PN 10-40	DN 50	2.4 (61)	0.97 (25)	1.31 (33)	6.66 (169)
DIN 2501 PN 25/40	DN 80	3.6 (91)	0.97 (25)	1.31 (33)	6.66 (169)
	DN 100	3.6 (91)	0.97 (25)	1.31 (33)	6.66 (169)
DIN 2501 PN 10/16	DN 100	3.6 (91)	0.97 (25)	1.31 (33)	6.66 (169)

(1) Tolerances are 0.040 (1.02), -0.020 (0.51).

## A.3 Ordering Information

**Table A-6. Rosemount 3051S Coplanar Differential, Gage, or Absolute Transmitter**

★ The Standard offering represents the most common models and options. These options should be selected for best delivery.  
The Expanded offering is subject to additional delivery lead time.

Model	Transmitter Type			
3051S	Scalable Pressure Transmitter			
<b>Performance Class</b>				
<b>Standard</b>				<b>Standard</b>
1	Ultra: 0.025 percent span accuracy, 200:1 rangedown, 10-yr stability, 12-yr limited warranty			★
3 <sup>(1)</sup>	Ultra for Flow: 0.04 percent reading accuracy, 200:1 turndown, 10-yr stability, 12-yr ltd warranty			
2	Classic: 0.055 percent span accuracy, 100:1 rangedown, 5-yr stability			★
<b>Connection Type</b>				
<b>Standard</b>				<b>Standard</b>
C	Coplanar			★
<b>Measurement Type<sup>(2)</sup></b>				
<b>Standard</b>				<b>Standard</b>
D	Differential			★
G	Gage			★
<b>Expanded</b>				
A	Absolute			
<b>Pressure Range</b>				
	<b>Differential</b>	<b>Gage</b>	<b>Absolute</b>	
<b>Standard</b>				<b>Standard</b>
1A	-25 to 25 inH <sub>2</sub> O (-62,2 to 62,2 mbar)	-25 to 25 inH <sub>2</sub> O (-62,2 to 62,2 mbar)	0 to 30 psia (0 to 2,06 bar)	★
2A	-250 to 250 inH <sub>2</sub> O (-623 to 623 mbar)	-250 to 250 inH <sub>2</sub> O (-623 to 623 mbar)	0 to 150 psia (0 to 10,34 bar)	★
3A	-1000 to 1000 inH <sub>2</sub> O (-2,5 to 2,5 bar)	-393 to 1000 inH <sub>2</sub> O (-0,98 to 2,5 bar)	0 to 800 psia (0 to 55,2 bar)	★
4A	-300 to 300 psi (-20,7 to 20,7 bar)	-14.2 to 300 psig (-0,98 to 21 bar)	0 to 4000 psia (0 to 275,8 bar)	★
5A	-2000 to 2000 psi (-137,9 to 137,9 bar)	-14.2 to 2000 psig (-0,98 to 137,9 bar)	N/A	★
<b>Expanded</b>				
0A <sup>(3)</sup>	-3 to 3 inH <sub>2</sub> O (-7,47 to 7,47 mbar)	N/A	0 to 5 psia (0 to 0,34 bar)	
<b>Isolating Diaphragm</b>				
<b>Standard</b>				<b>Standard</b>
2 <sup>(4)</sup>	316L SST			★
3 <sup>(4)</sup>	Alloy C-276			★

Expanded						
4	Alloy 400					
5 <sup>(5)</sup>	Tantalum					
6	Gold-Plated Alloy 400 (includes Graphite-Filled PTFE o-ring)					
7	Gold-plated 316L SST					
Process Connection			Size	Material Type <sup>(6)</sup>		
				Flange Material	Drain Vent	
Standard						Standard
000	None					★
A11 <sup>(7)</sup>	Assemble to Rosemount 305 Integral Manifold					★
A12 <sup>(7)</sup>	Assemble to Rosemount 304 or AMF Manifold and SST traditional flange					★
B11 <sup>(7)(8)(9)</sup>	Assemble to one Rosemount 1199 Diaphragm Seal					★
B12 <sup>(7)(8)(9)</sup>	Assemble to two Rosemount 1199 Diaphragm Seals					★
C11 <sup>(7)</sup>	Assemble to Rosemount 405 Primary Element					★
D11 <sup>(7)</sup>	Assemble to Rosemount 1195 integral orifice and Rosemount 305 Integral Manifold					★
EA2 <sup>(7)</sup>	Assemble to Rosemount Annubar <sup>®</sup> Primary Element with Coplanar flange			SST	316 SST	★
EA3 <sup>(7)</sup>	Assemble to Rosemount Annubar Primary Element with Coplanar flange			Cast C-276	Alloy C-276	★
EA5 <sup>(7)</sup>	Assemble to Rosemount Annubar Primary Element with Coplanar flange			SST	Alloy C-276	★
E11	Coplanar flange	1/4-18 NPT		CS	316 SST	★
E12	Coplanar flange	1/4-18 NPT		SST	316 SST	★
E13 <sup>(4)</sup>	Coplanar flange	1/4-18 NPT		Cast C-276	Alloy C-276	★
E14	Coplanar flange	1/4-18 NPT		Cast Alloy 400	Alloy 400/K-500	★
E15 <sup>(4)</sup>	Coplanar flange	1/4-18 NPT		SST	Alloy C-276	★
E16 <sup>(4)</sup>	Coplanar flange	1/4-18 NPT		CS	Alloy C-276	★
E21	Coplanar flange	RC 1/4		CS	316 SST	★
E22	Coplanar flange	RC 1/4		SST	316 SST	★
E23 <sup>(4)</sup>	Coplanar flange	RC 1/4		Cast C-276	Alloy C-276	★
E24	Coplanar flange	RC 1/4		Cast Alloy 400	Alloy 400/K-500	★
E25 <sup>(4)</sup>	Coplanar flange	RC 1/4		SST	Alloy C-276	★
E26 <sup>(4)</sup>	Coplanar flange	RC 1/4		CS	Alloy C-276	★
F12	Traditional flange	1/4-18 NPT		SST	316 SST	★
F13 <sup>(4)</sup>	Traditional flange	1/4-18 NPT		Cast C-276	Alloy C-276	★
F14	Traditional flange	1/4-18 NPT		Cast Alloy 400	Alloy 400/K-500	★
F15 <sup>(4)</sup>	Traditional flange	1/4-18 NPT		SST	Alloy C-276	★

F22	Traditional flange	RC 1/4	SST	316 SST		★
F23 <sup>(4)</sup>	Traditional flange	RC 1/4	Cast C-276	Alloy C-276		★
F24	Traditional flange	RC 1/4	Cast Alloy 400	Alloy 400/K-500		★
F25 <sup>(4)</sup>	Traditional flange	RC 1/4	SST	Alloy C-276		★
F52	DIN-compliant traditional flange	1/4-18 NPT	SST	316 SST	7/16-in. bolting	★
G11	Vertical mount level flange	2-in. ANSI class 150	SST	316 SST		★
G12	Vertical mount level flange	2-in. ANSI class 300	SST	316 SST		★
G21	Vertical mount level flange	3-in. ANSI class 150	SST	316 SST		★
G22	Vertical mount level flange	3-in. ANSI class 300	SST	316 SST		★
G31	Vertical mount level flange	DIN- DN 50 PN 40	SST	316 SST		★
G41	Vertical mount level flange	DIN- DN 80 PN 40	SST	316 SST		★
<b>Expanded</b>						
F32	Bottom vent traditional flange	1/4-18 NPT	SST	316 SST		
F42	Bottom vent traditional flange	RC 1/4	SST	316 SST		
F62	DIN-compliant traditional flange	1/4-18 NPT	SST	316 SST	M10 bolting	
F72	DIN-compliant traditional flange	1/4-18 NPT	SST	316 SST	M12 bolting	
<b>Transmitter Output</b>						
<b>Standard</b>						<b>Standard</b>
A	4-20 mA with digital signal based on HART protocol					★
F <sup>(10)</sup>	FOUNDATION fieldbus protocol					★
X <sup>(11)</sup>	Wireless (Requires wireless options and wireless PlantWeb housing)					★
<b>Housing Style</b>				<b>Material<sup>(6)</sup></b>	<b>Conduit Entry Size</b>	
<b>Standard</b>						<b>Standard</b>
00	None (SuperModule Platform only, no housing included)					★
1A	PlantWeb housing			Aluminum	1/2-14 NPT	★
1B	PlantWeb housing			Aluminum	M20 x 1.5	★
1J	PlantWeb housing			SST	1/2-14 NPT	★
1K	PlantWeb housing			SST	M20 x 1.5	★
5A	Wireless PlantWeb housing			Aluminum	1/2-14 NPT	★
5J	Wireless PlantWeb housing			SST	1/2-14 NPT	★
2A	Junction Box housing			Aluminum	1/2-14 NPT	★
2B	Junction Box housing			Aluminum	M20 x 1.5	★



2J	Junction Box housing	SST	1/2-14 NPT	★
2E	Junction Box Housing with output for remote display and interface	Aluminum	1/2-14 NPT	★
2F	Junction Box Housing with output for remote display and interface	Aluminum	M20 x 1.5	★
2M	Junction Box Housing with output for remote display and interface	SST	1/2-14 NPT	★
7J <sup>(12)</sup>	Quick Connect (A size Mini, 4-pin male termination)	SST		★
<b>Expanded</b>				
1C	PlantWeb housing	Aluminum	G1/2	
1L	PlantWeb housing	SST	G1/2	
2C	Junction Box housing	Aluminum	G1/2	
2G	Junction Box Housing with output for remote display and interface	Aluminum	G1/2	

### Wireless Options (Requires option code X and wireless PlantWeb housing)

<b>Update Rate</b>				
<b>Standard</b>				<b>Standard</b>
WA	User Configurable Update Rate			★
<b>Operating Frequency and Protocol</b>				
<b>Standard</b>				<b>Standard</b>
3	2.4 GHz DSSS, IEC 62591 (WirelessHART)			★
<b>Omnidirectional Wireless Antenna</b>				
<b>Standard</b>				<b>Standard</b>
WK <sup>(13)</sup>	External Antenna			★
WM <sup>(13)</sup>	Extended Range, External Antenna			
<b>Expanded</b>				<b>Expanded</b>
WN <sup>(13)</sup>	High-Gain, Remote Antenna			
<b>SmartPower™</b>				
<b>Standard</b>				<b>Standard</b>
1	Adapter for Black Power Module (I.S Power Module sold separately)			★

### Other Options (Include with selected model number)

<b>PlantWeb Control Functionality</b>				
<b>Standard</b>				<b>Standard</b>
A01	FOUNDATION fieldbus Advanced Control Function Block Suite			★
<b>PlantWeb Diagnostic Functionality</b>				
<b>Standard</b>				<b>Standard</b>
D01	FOUNDATION fieldbus Diagnostics Suite			★
DA2 <sup>(14)</sup>	Advanced HART Diagnostics Suite (SPM, Power Advisory, Variable & Status Log, Service & Process Alerts)			★

<b>PlantWeb Enhanced Measurement Functionality</b>		
<b>Standard</b>		<b>Standard</b>
H01 <sup>(15)</sup>	FOUNDATION fieldbus Fully Compensated Mass Flow Block	★
<b>Mounting Bracket<sup>(16)</sup></b>		
<b>Standard</b>		<b>Standard</b>
B4	Coplanar flange bracket, all SST, 2-in. pipe and panel	★
B1	Traditional flange bracket, CS, 2-in. pipe	★
B2	Traditional flange bracket, CS, panel	★
B3	Traditional flange flat bracket, CS, 2-in. pipe	★
B7	Traditional flange bracket, B1 with SST bolts	★
B8	Traditional flange bracket, B2 with SST bolts	★
B9	Traditional flange bracket, B3 with SST bolts	★
BA	Traditional flange bracket, B1, all SST	★
BC	Traditional flange bracket, B3, all SST	★
<b>Software Configuration</b>		
<b>Standard</b>		<b>Standard</b>
C1 <sup>(17)</sup>	Custom software configuration (Requires Configuration Data Sheet)	★
C2	Custom flow configuration (Requires H01 and Configuration Data Sheet)	★
<b>Gage Pressure Calibration</b>		
<b>Standard</b>		<b>Standard</b>
C3	Gage pressure calibration on Rosemount 3051S_CA4 only	★
<b>Alarm Limit</b>		
<b>Standard</b>		<b>Standard</b>
C4 <sup>(17)</sup>	NAMUR alarm and saturation levels, high alarm	★
C5 <sup>(17)</sup>	NAMUR alarm and saturation levels, low alarm	★
C6 <sup>(17)</sup>	Custom alarm and saturation signal levels, high alarm (Requires C1 and Configuration Data Sheet)	★
C7 <sup>(17)</sup>	Custom alarm and saturation signal levels, low alarm (Requires C1 and Configuration Data Sheet)	★
C8 <sup>(17)</sup>	Low alarm (standard Rosemount alarm and saturation levels)	★
<b>Hardware Adjustments</b>		
<b>Standard</b>		<b>Standard</b>
D1 <sup>(17)(18)</sup>	Hardware adjustments (zero, span, alarm, security)	★
<b>Process Adapters</b>		
<b>Standard</b>		<b>Standard</b>
D2 <sup>(16)</sup>	1/2-14 NPT process adapters	★
Expanded		
D9 <sup>(16)</sup>	RC <sup>1</sup> /2 SST process adapters	

<b>Custody Transfer</b>		
<b>Standard</b>		<b>Standard</b>
D3 <sup>(19)</sup>	Measurement Canada Accuracy Approval	★
<b>External Ground Screw Assembly</b>		
<b>Standard</b>		<b>Standard</b>
D4	External ground screw assembly	★
<b>Drain/Vent Valve</b>		
<b>Standard</b>		<b>Standard</b>
D5 <sup>(16)</sup>	Delete transmitter drain/vent valves (install plugs)	★
<b>Expanded</b>		
D7 <sup>(16)</sup>	Coplanar flange without drain/vent ports	
<b>Conduit Plug</b>		
<b>Standard</b>		<b>Standard</b>
DO <sup>(20)</sup>	316 SST Conduit Plug	★
<b>Product Certifications<sup>(21)</sup></b>		
<b>Standard</b>		<b>Standard</b>
E1	ATEX Flameproof	★
I1	ATEX Intrinsic Safety	★
IA	ATEX FISCO Intrinsic Safety (FOUNDATION fieldbus protocol only)	★
N1	ATEX Type n	★
K1	ATEX Flameproof, Intrinsic Safety, Type n, Dust	★
ND	ATEX Dust	★
E4	TIIS Flameproof	★
I4	TIIS Intrinsic Safety	★
E5	FM Explosion-proof, Dust Ignition-proof	★
I5	FM Intrinsically Safe, Division 2	★
IE	FM FISCO Intrinsically Safe (FOUNDATION fieldbus protocol only)	★
K5	FM Explosion-proof, Dust Ignition-proof, Intrinsically Safe,	★
E6 <sup>(22)</sup>	CSA Explosion-proof, Dust Ignition-proof, Division 2	★
I6	CSA Intrinsically Safe	★
IF	CSA FISCO Intrinsically Safe (FOUNDATION fieldbus protocol only)	★
K6 <sup>(22)</sup>	CSA Explosion-proof, Dust Ignition-proof, Intrinsically Safe, Division 2	★
E7	IECEx Flameproof, Dust Ignition-proof	★
I7	IECEx Intrinsic Safety	★
IG	IECEx FISCO Intrinsic Safety (FOUNDATION fieldbus protocol only)	★
N7	IECEx Type n	★
K7	IECEx Flameproof, Dust Ignition-proof, Intrinsic Safety, Type n	★
E2	INMETRO Flameproof	★

I2	INMETRO Intrinsic Safety	★
K2	INMETRO Flameproof, Intrinsic Safety	★
E3	China Flameproof	★
I3	China Intrinsic Safety	★
KA <sup>(22)</sup>	ATEX and CSA Flameproof, Intrinsically Safe, Division 2	★
KB <sup>(22)</sup>	FM and CSA Explosion-proof, Dust Ignition-proof, Intrinsically Safe, Division 2	★
KC	FM and ATEX Explosion-proof, Intrinsically Safe, Division 2	★
KD <sup>(22)</sup>	FM, CSA, and ATEX Explosion-proof, Intrinsically Safe	★
<b>Sensor Fill Fluid</b>		
<b>Standard</b>		<b>Standard</b>
L1 <sup>(23)(24)</sup>	Inert sensor fill fluid	★
<b>O-Ring</b>		
<b>Standard</b>		<b>Standard</b>
L2	Graphite-filled PTFE o-ring	★
<b>Bolting Material</b>		
<b>Standard</b>		<b>Standard</b>
L4 <sup>(16)</sup>	Austenitic 316 SST bolts	★
L5 <sup>(4)(16)</sup>	ASTM A 193, Grade B7M bolts	★
L6 <sup>(16)</sup>	Alloy K-500 bolts	★
L7 <sup>(4)(16)</sup>	ASTM A453, Class D, Grade 660 bolts	★
L8 <sup>(16)</sup>	ASTM A193, Class 2, Grade B8M bolts	★
<b>Display Type<sup>(25)</sup></b>		
<b>Standard</b>		<b>Standard</b>
M5	PlantWeb LCD Display	★
M7 <sup>(26)(27)</sup>	Remote mount LCD display and interface, PlantWeb housing, no cable, SST bracket	★
M8 <sup>(26)</sup>	Remote mount LCD display and interface, PlantWeb housing, 50 ft. (15 m) cable, SST bracket	★
M9 <sup>(26)</sup>	Remote mount LCD display and interface, PlantWeb housing, 100 ft. (31 m) cable, SST bracket	★
<b>Hydrostatic Testing</b>		
<b>Expanded</b>		
P1 <sup>(28)</sup>	Hydrostatic testing with certificate	
<b>Special Cleaning</b>		
<b>Expanded</b>		
P2 <sup>(16)</sup>	Cleaning for special services	
P3 <sup>(16)</sup>	Cleaning for less than 1PPM chlorine/fluorine	
<b>Bolting Material</b>		
<b>Standard</b>		<b>Standard</b>
P9	4500 psig (310 bar) static pressure limit (Rosemount 3051S_CD only)	★
P0 <sup>(29)</sup>	6092 psig (420 bar) static pressure limit (Rosemount 3051S2CD only)	★

Calibration Data Certification		
<b>Standard</b>		<b>Standard</b>
Q4	Calibration certificate	★
QP	Calibration certificate and tamper evident seal	★
<b>Material Traceability Certification</b>		
<b>Standard</b>		<b>Standard</b>
Q8	Material traceability certification per EN 10204 3.1.B	★
<b>Quality Certification for Safety</b>		
<b>Standard</b>		<b>Standard</b>
QS <sup>(17)</sup>	Prior-use certificate of FMEDA Data	★
QT <sup>(30)</sup>	Safety-certified to IEC 61508 with certificate of FMEDA data	★
<b>Terminal Blocks</b>		
<b>Standard</b>		<b>Standard</b>
T1 <sup>(31)</sup>	Transient terminal block	★
<b>Drinking Water Approval</b>		
<b>Standard</b>		<b>Standard</b>
DW <sup>(32)</sup>	NSF Drinking Water Approval	★
<b>Surface Finish Certification</b>		
<b>Standard</b>		<b>Standard</b>
Q16	Surface finish certification for sanitary remote seals	★
<b>Toolkit Total System Performance Reports</b>		
<b>Standard</b>		<b>Standard</b>
QZ	Remote Seal System Performance Calculation Report	★
<b>Conduit Electrical Connector</b>		
<b>Standard</b>		<b>Standard</b>
GE <sup>(33)</sup>	M12, 4-pin, Male Connector ( <i>euromast</i> <sup>®</sup> )	★
GM <sup>(33)</sup>	A size Mini, 4-pin, Male Connector ( <i>minifast</i> <sup>®</sup> )	★
<b>Typical Model Number: 3051S1CD 2A 2 E12 A 1A DA1 B4 M5</b>		

- (1) This option is only available with range codes 2A and 3A, 316L SST or Alloy C-276 isolating diaphragm and silicone fill fluid.
- (2) Performance Class code 3 is available with Measurement Type code D only.
- (3) 3051S\_CDO is only available with traditional flange, 316L SST diaphragm material, and Bolting option L4.
- (4) Materials of Construction comply with metallurgical requirements highlighted within NACE MR0175/ISO 15156 for sour oil field production environments. Environmental limits apply to certain materials. Consult latest standard for details. Selected materials also conform to NACE MR0103 for sour refining environments.
- (5) Tantalum diaphragm material is only available for ranges 2A - 5A, differential and gage.
- (6) Material specified is cast as follows: CF-8M is the cast version of 316 SST, CF-3M is the cast version of 316L SST, CW-12MW is the cast version of Alloy C-276, M-30C is the cast version of Alloy 400. For housing, material is aluminum with polyurethane paint.
- (7) "Assemble to" items are specified separately and require a completed model number. Process connection option codes B12, C11, D11, EA2, EA3, and EA5 are only available on differential Measurement Type, code D.
- (8) Consult an Emerson Process Management representative for performance specifications.
- (9) Not available with performance class code 3.
- (10) Requires PlantWeb housing.
- (11) Available approvals are FM Intrinsically Safe, Division 2 (option code I5), CSA Intrinsically Safe (option code I6), ATEX Intrinsic Safety (option code I1; only available with 2.4 GHz), and IECEx Intrinsic Safety (option code I7; only available with 2.4 GHz).
- (12) Available with output code A only. Available approvals are FM Intrinsically Safe, Division 2 (option code I5), ATEX Intrinsic Safety (option code I1), or IECEx Intrinsic Safety (option code I7). Contact an Emerson Process Management representative for additional information.
- (13) Long-Life Power Module must be shipped separately, order Part #00753-9220-0001 or order 701PBKKF.
- (14) Requires PlantWeb housing and output code A. Includes Hardware Adjustments as standard.
- (15) Requires Rosemount Engineering Assistant to configure.
- (16) Not available with process connection option code A11.
- (17) Not available with output code F.
- (18) Not available with housing style codes 00, 2E, 2F, 2G, 2M, 5A, or 7J.

- (19) Requires PlantWeb housing and Hardware Adjustments option code D1. Limited availability depending on transmitter type and range. Contact an Emerson Process Management representative for additional information.
- (20) Transmitter is shipped with 316 SST conduit plug (uninstalled) in place of standard carbon steel conduit plug.
- (21) Valid when SuperModule Platform and housing have equivalent approvals.
- (22) Not available with M20 or G 1/2 conduit entry size.
- (23) Only available on differential and gage measurement types.
- (24) Silicone fill fluid is standard.
- (25) Not available with Housing code 7J.
- (26) Not available with output code F, output code X, option code DA1, or option code QT.
- (27) See the 3051S Reference Manual (document number 00809-0100-4801) for cable requirements. Contact an Emerson Process Management representative for additional information.
- (28) P1 is not available with 3051S\_CA0.
- (29) Requires 316L SST, Alloy C-276, or Gold-plated 316L SST diaphragm material, assemble to Rosemount 305 integral manifold or DIN-compliant traditional flange process connection, and bolting option L8. Limited to Pressure Range (Differential), ranges 2A – 5A.
- (30) Not available with output code F. Not available with housing code 7J.
- (31) Not available with Housing code 00, 5A, or 7J.
- (32) Requires 316L SST diaphragm material, glass-filled PTFE O-ring (standard), and Process Connection code E12 or F12.
- (33) Not available with Housing code 00, 5A, or 7J. Available with Intrinsically Safe approvals only. For FM Intrinsically Safe, Division 2 (option code I5) or FM FISCO Intrinsically Safe (option code IE), install in accordance with Rosemount drawing 03151-1009 to maintain outdoor rating (NEMA 4X and IP66).

**Table A-7. Rosemount 3051S In-Line Gage or Absolute Transmitter**

★ The Standard offering represents the most common models and options. These options should be selected for best delivery.  
The Expanded offering is subject to additional delivery lead time.

Model	Transmitter Type		
3051S	Scalable Pressure Transmitter		
<b>Performance Class</b>			
<b>Standard</b>			<b>Standard</b>
1	Ultra: 0.025 percent span accuracy, 200:1 rangedown, 10-yr stability, 12-yr limited warranty		★
2	Classic: 0.055 percent span accuracy, 100:1 rangedown, 5-yr stability		★
<b>Connection Type</b>			
<b>Standard</b>			<b>Standard</b>
T	In-Line		★
<b>Measurement Type<sup>(1)</sup></b>			
<b>Standard</b>			<b>Standard</b>
G	Gage		★
A	Absolute		★
<b>Pressure Range</b>			
	<b>Gage</b>	<b>Absolute</b>	
<b>Standard</b>			<b>Standard</b>
1A	-14.7 to 30 psi (-1,0 to 2,1 bar)	0 to 30 psia (2,1 bar)	★
2A	-14.7 to 150 psi (-1,0 to 10,3 bar)	0 to 150 psia (10,3 bar)	★
3A	-14.7 to 800 psi (-1,0 to 55 bar)	0 to 800 psia (55 bar)	★
4A	-14.7 to 4000 psi (-1,0 to 276 bar)	0 to 4000 psia (276 bar)	★
5A	-14.7 to 10000 psi (-1,0 to 689 bar)	0 to 10000 psia (689 bar)	★
<b>Isolating Diaphragm</b>			
<b>Standard</b>			<b>Standard</b>
2 <sup>(2)</sup>	316L SST		★
3 <sup>(4)</sup>	Alloy C-276		★

Process Connection		Size	Material Type <sup>(3)</sup>			
			Flange Material	Drain Vent	Bolting	
<b>Standard</b>						<b>Standard</b>
A11 <sup>(4)</sup>	Assemble to Rosemount 306 Integral Manifold					★
B11 <sup>(7)(5)(6)</sup>	Assemble to one Rosemount 1199 Diaphragm Seal					★
E11	1/2-14 NPT female	1/4-18 NPT	CS	316 SST		★
G11	G1/2 A DIN 16288 male (Range 1-4 only)	2-in. ANSI class 150	SST	316 SST		★
Expanded						
F11	Traditional flange, 1/4-18 NPT, CS, 316 SST / Non-threaded instrument flange (I-flange) (Range 1-4 only)					
<b>Transmitter Output</b>						
<b>Standard</b>						<b>Standard</b>
A	4-20 mA with digital signal based on HART protocol					★
F <sup>(7)</sup>	FOUNDATION fieldbus protocol					★
X <sup>(8)</sup>	Wireless (Requires wireless options and wireless PlantWeb housing)					★
Housing Style			Material <sup>(6)</sup>	Conduit Entry Size		
<b>Standard</b>						<b>Standard</b>
00	None (SuperModule Platform only, no housing included)					★
1A	PlantWeb housing		Aluminum	1/2-14 NPT		★
1B	PlantWeb housing		Aluminum	M20 x 1.5		★
1J	PlantWeb housing		SST	1/2-14 NPT		★
1K	PlantWeb housing		SST	M20 x 1.5		★
5A	Wireless PlantWeb housing		Aluminum	1/2-14 NPT		★
5J	Wireless PlantWeb housing		SST	1/2-14 NPT		★
2A	Junction Box housing		Aluminum	1/2-14 NPT		★
2B	Junction Box housing		Aluminum	M20 x 1.5		★
2J	Junction Box housing		SST	1/2-14 NPT		★
2E	Junction Box Housing with output for remote display and interface		Aluminum	1/2-14 NPT		★
2F	Junction Box Housing with output for remote display and interface		Aluminum	M20 x 1.5		★
2M	Junction Box Housing with output for remote display and interface		SST	1/2-14 NPT		★
7J <sup>(9)</sup>	Quick Connect (A size Mini, 4-pin male termination)		SST			★

Expanded			
1C	PlantWeb housing	Aluminum	G <sup>1/2</sup>
1L	PlantWeb housing	SST	G <sup>1/2</sup>
2C	Junction Box housing	Aluminum	G <sup>1/2</sup>
2G	Junction Box Housing with output for remote display and interface	Aluminum	G <sup>1/2</sup>

### Wireless Options (Requires option code X and wireless PlantWeb housing)

Update Rate		
<b>Standard</b>		<b>Standard</b>
WA	User Configurable Update Rate	★
Operating Frequency and Protocol		
<b>Standard</b>		<b>Standard</b>
3	2.4 GHz DSSS, IEC 62591 (WirelessHART)	★
Omnidirectional Wireless Antenna		
<b>Standard</b>		<b>Standard</b>
WK <sup>(10)</sup>	External Antenna	★
WM <sup>(10)</sup>	Extended Range, External Antenna	
<b>Expanded</b>		<b>Expanded</b>
WN <sup>(13)</sup>	High-Gain, Remote Antenna	
SmartPower™		
<b>Standard</b>		<b>Standard</b>
1	Adapter for Black Power Module (I.S Power Module sold separately)	★

### Other Options (Include with selected model number)

PlantWeb Control Functionality		
<b>Standard</b>		<b>Standard</b>
A01	FOUNDATION fieldbus Advanced Control Function Block Suite	★
PlantWeb Diagnostic Functionality		
<b>Standard</b>		<b>Standard</b>
D01	FOUNDATION fieldbus Diagnostics Suite	★
DA2 <sup>(11)</sup>	Advanced HART Diagnostics Suite (SPM, Power Advisory, Variable & Status Log, Service & Process Alerts)	★
Mounting Bracket <sup>(12)</sup>		
<b>Standard</b>		<b>Standard</b>
B4	Bracket, all SST, 2-in. pipe and panel	★
Software Configuration		
<b>Standard</b>		<b>Standard</b>
C1	Custom software configuration (Requires Configuration Data Sheet)	★



<b>Alarm Limit</b>		
<b>Standard</b>		<b>Standard</b>
C4 <sup>(17)</sup>	NAMUR alarm and saturation levels, high alarm	★
C5 <sup>(17)</sup>	NAMUR alarm and saturation levels, low alarm	★
C6 <sup>(17)</sup>	Custom alarm and saturation signal levels, high alarm (Requires C1 and Configuration Data Sheet)	★
C7 <sup>(17)</sup>	Custom alarm and saturation signal levels, low alarm (Requires C1 and Configuration Data Sheet)	★
C8 <sup>(17)</sup>	Low alarm (standard Rosemount alarm and saturation levels)	★
<b>Hardware Adjustments</b>		
<b>Standard</b>		<b>Standard</b>
D1 <sup>(17)(13)</sup>	Hardware adjustments (zero, span, alarm, security)	★
<b>Custody Transfer</b>		
<b>Standard</b>		<b>Standard</b>
D3 <sup>(14)</sup>	Measurement Canada Accuracy Approval	★
<b>External Ground Screw Assembly</b>		
<b>Standard</b>		<b>Standard</b>
D4	External ground screw assembly	★
<b>Conduit Plug</b>		
<b>Standard</b>		<b>Standard</b>
DO <sup>(15)</sup>	316 SST Conduit Plug	★
<b>Product Certifications<sup>(16)</sup></b>		
<b>Standard</b>		<b>Standard</b>
E1	ATEX Flameproof	★
I1	ATEX Intrinsic Safety	★
IA	ATEX FISCO Intrinsic Safety (FOUNDATION fieldbus protocol only)	★
N1	ATEX Type n	★
K1	ATEX Flameproof, Intrinsic Safety, Type n, Dust	★
ND	ATEX Dust	★
E4	TIIS Flameproof	★
I4	TIIS Intrinsic Safety	★
E5	FM Explosion-proof, Dust Ignition-proof	★
I5	FM Intrinsically Safe, Division 2	★
IE	FM FISCO Intrinsically Safe (FOUNDATION fieldbus protocol only)	★
K5	FM Explosion-proof, Dust Ignition-proof, Intrinsically Safe, Division 2	★
E6 <sup>(17)</sup>	CSA Explosion-proof, Dust Ignition-proof, Division 2	★
I6	CSA Intrinsically Safe	★
IF	CSA FISCO Intrinsically Safe (FOUNDATION fieldbus protocol only)	★
K6 <sup>(17)</sup>	CSA Explosion-proof, Dust Ignition-proof, Intrinsically Safe, Division 2	★

E7	IECEX Flameproof, Dust Ignition-proof	★
I7	IECEX Intrinsic Safety	★
IG	IECEX FISCO Intrinsic Safety (FOUNDATION fieldbus protocol only)	★
N7	IECEX Type n	★
K7	IECEX Flameproof, Dust Ignition-proof, Intrinsic Safety, Type n	★
E2	INMETRO Flameproof	★
I2	INMETRO Intrinsic Safety	★
K2	INMETRO Flameproof, Intrinsic Safety	★
E3	China Flameproof	★
I3	China Intrinsic Safety	★
KA <sup>(17)</sup>	ATEX and CSA Flameproof, Intrinsically Safe, Division 2	★
KB <sup>(17)</sup>	FM and CSA Explosion-proof, Dust Ignition-proof, Intrinsically Safe, Division 2	★
KC	FM and ATEX Explosion-proof, Intrinsically Safe, Division 2	★
KD <sup>(17)</sup>	FM, CSA, and ATEX Explosion-proof, Intrinsically Safe	★
<b>Sensor Fill Fluid</b>		
<b>Standard</b>		<b>Standard</b>
L1 <sup>(18)</sup>	Inert sensor fill fluid	★
<b>Display Type<sup>(19)</sup></b>		
<b>Standard</b>		<b>Standard</b>
M5	PlantWeb LCD Display	★
M7 <sup>(20)(21)</sup>	Remote mount LCD display and interface, PlantWeb housing, no cable, SST bracket	★
M8 <sup>(26)</sup>	Remote mount LCD display and interface, PlantWeb housing, 50 ft. (15 m) cable, SST bracket	★
M9 <sup>(26)</sup>	Remote mount LCD display and interface, PlantWeb housing, 100 ft. (31 m) cable, SST bracket	★
<b>Hydrostatic Testing</b>		
<b>Expanded</b>		
P1 <sup>(22)</sup>	Hydrostatic testing with certificate	
<b>Special Cleaning</b>		
<b>Expanded</b>		
P2 <sup>(16)</sup>	Cleaning for special services	
P3 <sup>(16)</sup>	Cleaning for less than 1PPM chlorine/fluorine	
<b>Calibration Data Certification</b>		
<b>Standard</b>		<b>Standard</b>
Q4	Calibration certificate	★
QP	Calibration certificate and tamper evident seal	★
<b>Material Traceability Certification</b>		
<b>Standard</b>		<b>Standard</b>
Q8	Material traceability certification per EN 10204 3.1	★

Quality Certification for Safety		
<b>Standard</b>		<b>Standard</b>
QS <sup>(17)</sup>	Prior-use certificate of FMEDA Data	★
QT <sup>(23)</sup>	Safety-certified to IEC 61508 with certificate of FMEDA data	★
<b>Terminal Blocks</b>		
<b>Standard</b>		<b>Standard</b>
T1 <sup>(24)</sup>	Transient terminal block	★
<b>Drinking Water Approval</b>		
<b>Standard</b>		<b>Standard</b>
DW <sup>(25)</sup>	NSF Drinking Water Approval	★
<b>Surface Finish Certification</b>		
<b>Standard</b>		<b>Standard</b>
Q16	Surface finish certification for sanitary remote seals	★
<b>Toolkit Total System Performance Reports</b>		
<b>Standard</b>		<b>Standard</b>
QZ	Remote Seal System Performance Calculation Report	★
<b>Conduit Electrical Connector</b>		
<b>Standard</b>		<b>Standard</b>
GE <sup>(26)</sup>	M12, 4-pin, Male Connector ( <i>euromast</i> <sup>®</sup> )	★
GM <sup>(33)</sup>	A size Mini, 4-pin, Male Connector ( <i>minifast</i> <sup>®</sup> )	★
<b>Typical Model Number: 3051S1TG 2A 2 E11 A 1A DA1 B4 M5</b>		

- (1) Performance Class code 3 is available with Measurement Type code D only.
- (2) Materials of Construction comply with metallurgical requirements highlighted within NACE MR0175/ISO 15156 for sour oil field production environments. Environmental limits apply to certain materials. Consult latest standard for details. Selected materials also conform to NACE MR0103 for sour refining environments.
- (3) Material specified is cast as follows: CF-8M is the cast version of 316 SST, CF-3M is the cast version of 316L SST, CW-12MW is the cast version of Alloy C-276, M-30C is the cast version of Alloy 400. For housing, material is aluminum with polyurethane paint.
- (4) "Assemble to" items are specified separately and require a completed model number. Process connection option codes B12, C11, D11, EA2, EA3, and EA5 are only available on differential Measurement Type, code D.
- (5) Consult an Emerson Process Management representative for performance specifications.
- (6) Not available with performance class code 3.
- (7) Requires PlantWeb housing.
- (8) Available approvals are FM Intrinsically Safe, Division 2 (option code I5), CSA Intrinsically Safe (option code I6), ATEX Intrinsic Safety (option code I1; only available with 2.4 GHz), and IECEx Intrinsic Safety (option code I7; only available with 2.4 GHz).
- (9) Available with output code A only. Available approvals are FM Intrinsically Safe, Division 2 (option code I5), ATEX Intrinsic Safety (option code I1), or IECEx Intrinsic Safety (option code I7). Contact an Emerson Process Management representative for additional information.
- (10) Long-Life Power Module must be shipped separately, order Part #00753-9220-0001.
- (11) Requires PlantWeb housing and output code A. Includes Hardware Adjustments as standard.
- (12) Not available with process connection option code A11.
- (13) Not available with housing style codes 00, 01, 2E, 2F, 2G, 2M, 5A, or 7J.
- (14) Requires PlantWeb housing and Hardware Adjustments option code D1. Limited availability depending on transmitter type and range. Contact an Emerson Process Management representative for additional information.
- (15) Transmitter is shipped with 316 SST conduit plug (uninstalled) in place of standard carbon steel conduit plug.
- (16) Valid when SuperModule Platform and housing have equivalent approvals.
- (17) Not available with M20 or G 1/2 conduit entry size.
- (18) Silicone fill fluid is standard.
- (19) Not available with Housing code 01 or 7J.
- (20) Not available with output code F, Housing code 01, option code DA1, or option code QT.
- (21) See the 3051S Reference Manual (document number 00809-0100-4801) for cable requirements. Contact an Emerson Process Management representative for additional information.
- (22) P1 is not available with 3051S\_CA0.
- (23) Not available with output code F. Not available with housing code 01 or 7J.
- (24) Not available with Housing code 00, 01, 5A, or 7J.
- (25) Requires 316L SST diaphragm material, glass-filled PTFE O-ring (standard), and Process Connection code E12 or F12.
- (26) Not available with Housing code 00, 01, 5A, or 7J. Available with Intrinsically Safe approvals only. For FM Intrinsically Safe, Division 2 (option code I5) or FM FISCO Intrinsically Safe (option code IE), install in accordance with Rosemount drawing 03151-1009 to maintain outdoor rating (NEMA 4X and IP66).

**Table A-8. Rosemount 3051SFA Annubar Flowmeter Ordering Information**

★ The Standard offering represents the most common models and options. These options should be selected for best delivery.  
The Expanded offering is subject to additional delivery lead time.

Model	Product Description	
3051SFA	Annubar Flowmeter	
<b>Measurement Type</b>		
<b>Standard</b>		<b>Standard</b>
1	MultiVariable (Fully Compensated Flow) – Differential and Static Pressures with Temperature	★
2	MultiVariable (Compensated Flow) – Differential and Static Pressures	★
3	MultiVariable (Compensated Flow) – Differential Pressure and Temperature	★
4	MultiVariable (Compensated Flow) – Differential Pressure	★
5	MultiVariable (Direct Measurement) – Differential and Static Pressures with Temperature	★
6	MultiVariable (Direct Measurement) – Differential and Static Pressures	★
7	MultiVariable (Direct Measurement) – Differential Pressure and Temperature	★
D	Differential Pressure	★
<b>Fluid Type</b>		
<b>Standard</b>		<b>Standard</b>
L	Liquid	★
G	Gas	★
S	Steam	★
<b>Line Size</b>		
<b>Standard</b>		<b>Standard</b>
020	2-in. (50 mm)	★
025	2½-in. (63.5 mm)	★
030	3-in. (80 mm)	★
035	3½-in. (89 mm)	★
040	4-in. (100 mm)	★
050	5-in. (125 mm)	★
060	6-in. (150 mm)	★
070	7-in. (175 mm)	★
080	8-in. (200 mm)	★
100	10-in. (250 mm)	★
120	12-in. (300 mm)	★
<b>Expanded</b>		
140	14-in. (350 mm)	
160	16-in. (400 mm)	
180	18-in. (450 mm)	
200	20-in. (500 mm)	
240	24-in. (600 mm)	
300	30-in. (750 mm)	
360	36-in. (900 mm)	
420	42-in. (1066 mm)	
480	48-in. (1210 mm)	
600	60-in. (1520 mm)	
720	72-in. (1820 mm)	
780	78-in. (1950 mm)	
840	84-in. (2100 mm)	
900	90-in. (2250 mm)	
960	96-in. (2400 mm)	

**Table A-8. Rosemount 3051SFA Annubar Flowmeter Ordering Information**

★ The Standard offering represents the most common models and options. These options should be selected for best delivery.  
The Expanded offering is subject to additional delivery lead time.

<b>Pipe I.D. Range</b>		
<b>Standard</b>		<b>Standard</b>
C	Range C from the Pipe I.D. table	★
D	Range D from the Pipe I.D. table	★
<b>Expanded</b>		
A	Range A from the Pipe I.D. table	
B	Range B from the Pipe I.D. table	
E	Range E from the Pipe I.D. table	
Z	Non-standard Pipe I.D. Range or Line Sizes greater than 12 inches	
<b>Pipe Material / Mounting Assembly Material</b>		
<b>Standard</b>		<b>Standard</b>
C <sup>(1)</sup>	Carbon steel	★
S	316 Stainless Steel	★
<b>Expanded</b>		
G	Chrome-Moly Grade F-11	
N	Chrome-Moly Grade F-22	
J	Chrome-Moly Grade F-91	
Q <sup>(2)</sup>	No Mounting (Customer Supplied)	
<b>Piping Orientation</b>		
<b>Standard</b>		<b>Standard</b>
H	Horizontal Piping	★
D	Vertical Piping with Downwards Flow	★
U	Vertical Piping with Upwards Flow	★
<b>Annubar Type</b>		
<b>Standard</b>		<b>Standard</b>
P	Pak-Lok	★
F	Flanged with opposite side support	★
<b>Expanded</b>		
L	Flange-Lok	
G	Gear-Drive Flo-Tap	
M	Manual Flo-Tap	
<b>Sensor Material</b>		
<b>Standard</b>		<b>Standard</b>
S	316 Stainless Steel	★
<b>Expanded</b>		
H	Alloy C-276	
<b>Sensor Size</b>		
<b>Standard</b>		<b>Standard</b>
1	Sensor size 1 — Line sizes 2-in. (50 mm) to 8-in. (200 mm)	★
2	Sensor size 2 — Line sizes 6-in. (150 mm) to 96-in. (2400 mm)	★
3	Sensor size 3 — Line sizes greater than 12-in. (300 mm)	★

**Table A-8. Rosemount 3051SFA Annubar Flowmeter Ordering Information**

★ The Standard offering represents the most common models and options. These options should be selected for best delivery.  
The Expanded offering is subject to additional delivery lead time.

<b>Mounting Type</b>				
<b>Standard</b>				<b>Standard</b>
T1	Compression or Threaded Connection			★
A1	150# RF ANSI			★
A3	300# RF ANSI			★
A6	600# RF ANSI			★
D1	DN PN16 Flange			★
D3	DN PN40 Flange			★
D6	DN PN100 Flange			★
<b>Expanded</b>				
A9 <sup>(3)</sup>	900# RF ANSI			
AF <sup>(3)</sup>	1500# RF ANSI			
AT <sup>(3)</sup>	2500 # RF ANSI			
R1	150# RTJ Flange			
R3	300# RTJ Flange			
R6	600# RTJ Flange			
R9 <sup>(3)</sup>	900# RTJ Flange			
RF <sup>(3)</sup>	1500# RTJ Flange			
RT <sup>(3)</sup>	2500# RTJ Flange			
<b>Opposite Side Support and Packing Gland</b>				
<b>Standard</b>				<b>Standard</b>
0	No opposite side support or packing gland (Required for Pak-Lok and Flange-Lok models)			★
<b>Opposite Side Support – Required for Flanged Models</b>				
<b>Standard</b>				<b>Standard</b>
C	NPT Threaded Opposite Support Assembly – Extended Tip			★
D	Welded Opposite Support Assembly – Extended Tip			★
<b>Packing Gland – Required for Flo-Tap Models</b>				
	<b>Packing Gland Material</b>	<b>Rod Material</b>	<b>Packing Material</b>	
<b>Standard</b>				<b>Standard</b>
J	Stainless Steel Packing Gland / Cage Nipple	Carbon Steel	PTFE	★
K	Stainless Steel Packing Gland / Cage Nipple	Stainless Steel	PTFE	★
L	Stainless Steel Packing Gland / Cage Nipple	Carbon Steel	Graphite	★
N	Stainless Steel Packing Gland / Cage Nipple	Stainless Steel	Graphite	★
R	Alloy C-276 Packing Gland / Cage Nipple	Stainless Steel	Graphite	★
<b>Isolation Valve for Flo-Tap Models</b>				
<b>Standard</b>				<b>Standard</b>
1	Gate Valve, Carbon Steel			★
2	Gate Valve, Stainless Steel			★
5	Ball Valve, Carbon Steel			★
6	Ball Valve, Stainless Steel			★
0 <sup>(2)</sup>	Not Applicable or Customer Supplied			★
<b>Temperature Measurement</b>				
<b>Standard</b>				<b>Standard</b>
T <sup>(4)</sup>	Integral RTD – not available with Flanged model greater than class 600			★
0 <sup>(5)</sup>	No Temperature Sensor			★
<b>Expanded</b>				
R <sup>(4)</sup>	Remote Thermowell and RTD			

**Table A-8. Rosemount 3051SFA Annubar Flowmeter Ordering Information**

★ The Standard offering represents the most common models and options. These options should be selected for best delivery.  
The Expanded offering is subject to additional delivery lead time.

<b>Transmitter Connection Platform</b>					
<b>Standard</b>				<b>Standard</b>	
3	Direct-mount, Integral 3-valve Manifold– not available with Flanged model greater than class 600			★	
5	Direct -mount, 5-valve Manifold – not available with Flanged model greater than class 600			★	
7	Remote-mount NPT Connections (1/2-in. FNPT)			★	
<b>Expanded</b>					
6	Direct-mount, high temperature 5-valve Manifold – not available with Flanged model greater than class 600				
8	Remote-mount SW Connections (1/2-in.)				
<b>Differential Pressure Ranges</b>					
<b>Standard</b>				<b>Standard</b>	
1	0 to 25 in H <sub>2</sub> O (0 to 62,2 mbar)			★	
2	0 to 250 in H <sub>2</sub> O (0 to 623 mbar)			★	
3	0 to 1000 in H <sub>2</sub> O (0 to 2,5 bar)			★	
<b>Static Pressure Ranges</b>					
<b>Standard</b>				<b>Standard</b>	
A <sup>(6)</sup>	None			★	
D	Absolute 0.5 to 800 psia (0,033 to 55,2 bar)			★	
E <sup>(7)</sup>	Absolute 0.5 to 3626 psia (0,033 to 250 bar)			★	
J	Gage -14.2 to 800 psig (-0,979 to 55,2 bar)			★	
K <sup>(7)</sup>	Gage -14.2 to 3626 psig (-0,979 to 250 bar)			★	
<b>Output Protocol</b>					
<b>Standard</b>				<b>Standard</b>	
A	4–20 mA with digital signal based on HART protocol			★	
F <sup>(8)(9)</sup>	FOUNDATION fieldbus protocol: AI block, Link Master, Input Selector Block (requires PlantWeb housing)			★	
X <sup>(9)(10)</sup>	Wireless (Requires wireless options and wireless housing 5A)			★	
<b>Transmitter Housing Style</b>		<b>Material<sup>(11)</sup></b>	<b>Conduit Entry Size</b>		
<b>Standard</b>				<b>Standard</b>	
00	None (Customer-supplied electrical connection)			★	
1A	PlantWeb Housing		Aluminum	1/2-14 NPT	★
1B	PlantWeb Housing		Aluminum	M20 x 1.5	★
1C	PlantWeb Housing		Aluminum	G1/2	★
1J	PlantWeb Housing		SST	1/2-14 NPT	★
1K	PlantWeb Housing		SST	M20 x 1.5	★
1L	PlantWeb Housing		SST	G1/2	★
2A <sup>(9)</sup>	Junction Box Housing		Aluminum	1/2-14 NPT	★
2B <sup>(9)</sup>	Junction Box Housing		Aluminum	M20 x 1.5	★
2C <sup>(9)</sup>	Junction Box Housing		Aluminum	G1/2	★
2E <sup>(9)</sup>	Junction Box housing with output for remote display and interface		Aluminum	1/2-14 NPT	★
2F <sup>(9)</sup>	Junction Box housing with output for remote display and interface		Aluminum	M20 x 1.5	★
2G <sup>(9)</sup>	Junction Box housing with output for remote display and interface		Aluminum	G1/2	★
2J <sup>(9)</sup>	Junction Box Housing		SST	1/2-14 NPT	★
2M <sup>(9)</sup>	Junction Box housing with output for remote display and interface		SST	1/2-14 NPT	★
5A <sup>(9)</sup>	Wireless PlantWeb housing		Aluminum	M20 x 1.5	★
5J	Wireless PlantWeb housing		SST	1/2 NPT	★
7J <sup>(9)(12)</sup>	Quick Connect (A size Mini, 4-pin male termination)				★

**Table A-8. Rosemount 3051SFA Annubar Flowmeter Ordering Information**

★ The Standard offering represents the most common models and options. These options should be selected for best delivery.  
The Expanded offering is subject to additional delivery lead time.

<b>Expanded</b>		
01 <sup>(9)(13)</sup>	Assemble to Rosemount 753R Web-based Monitoring Indicator	
<b>Transmitter Performance Class</b>		
<b>Standard</b>		<b>Standard</b>
3051S MultiVariable SuperModule, Measurement Types 1, 2, 5, and 6		
3	Ultra for Flow: 0.8% flow rate accuracy, 14:1 flow turndown, 10-year stability. limited 12-year warranty	★
5	Classic MV: 0.85% flow rate accuracy, 8:1 flow turndown, 5-yr. stability	★
3051S Single Variable SuperModule, Measurement Types 3, 4, 7, and D		
1 <sup>(14)</sup>	Ultra: up to 0.9% flow rate accuracy, 8:1 flow turndown, 10-year stability, limited 12-year warranty	★
2	Classic: up to 1.1% flow rate accuracy, 8:1 flow turndown, 5-year stability	★
3 <sup>(15)</sup>	Ultra for Flow: 0.8% flow rate accuracy, 14:1 flow turndown, 10-year stability. limited 12-year warranty	★

**Wireless Options** (Requires option code X and Housing Style 5A)

<b>Wireless Transmitter Rate</b>		
<b>Standard</b>		<b>Standard</b>
WA	User Configurable Transmit Rate	★
<b>Operating Frequency and Protocol</b>		
<b>Standard</b>		<b>Standard</b>
3	2.4 GHz DSSS, IEC 62591 (WirelessHART)	★
<b>Omnidirectional Wireless Antenna</b>		
<b>Standard</b>		<b>Standard</b>
WK	External Antenna	★
WM	Extended Range, External Antenna	
<b>Expanded</b>		<b>Expanded</b>
WN <sup>(13)</sup>	High-Gain, Remote Antenna	
<b>SmartPower™</b>		
<b>Standard</b>		<b>Standard</b>
1	Adapter for Black Power Module (I.S Power Module sold separately)	★

**Other Options** (Include with selected model number)

<b>Pressure Testing</b>		
<b>Standard</b>		<b>Standard</b>
P1 <sup>(16)</sup>	Hydrostatic Testing with Certificate	★
<b>Expanded</b>		
PX <sup>(16)</sup>	Extended Hydrostatic Testing	
<b>Special Cleaning</b>		
<b>Expanded</b>		
P2	Cleaning for Special Processes	
PA	Cleaning per ASTM G93 level D (section 11.4)	
<b>Material Testing</b>		
<b>Expanded</b>		
V1	Dye Penetrant Exam	
<b>Material Examination</b>		
<b>Expanded</b>		
V2	Radiographic Examination	



**Table A-8. Rosemount 3051SFA Annubar Flowmeter Ordering Information**

★ The Standard offering represents the most common models and options. These options should be selected for best delivery.  
The Expanded offering is subject to additional delivery lead time.

<b>Flow Calibration</b>		
<b>Expanded</b>		
W1	Flow Calibration (Average K)	
WZ	Special Calibration	
<b>Special Inspection</b>		
<b>Standard</b>		<b>Standard</b>
QC1	Visual and Dimensional Inspection with Certificate	★
QC7	Inspection and Performance Certificate	★
<b>Surface Finish</b>		
<b>Standard</b>		<b>Standard</b>
RL	Surface finish for Low Pipe Reynolds Number in Gas and Steam	★
RH	Surface finish for High Pipe Reynolds Number in Liquid	★
<b>Material Traceability Certification</b>		
<b>Standard</b>		<b>Standard</b>
Q8 <sup>(17)</sup>	Material Traceability Certificate per EN 10204:2004 3.1	★
<b>Code Conformance</b>		
<b>Expanded</b>		
J2 <sup>(18)</sup>	ANSI B31.1	
J3 <sup>(18)</sup>	ANSI B31.3	
J4 <sup>(18)</sup>	ANSI B31.8	
<b>Material Conformance</b>		
<b>Expanded</b>		
J5 <sup>(19)</sup>	NACE MR-0175 / ISO 15156	
<b>Country Certification</b>		
<b>Standard</b>		<b>Standard</b>
J1	Canadian Registration	★
J6	European Pressure Directive (PED)	★
<b>Installed in Flanged Pipe Spool Section</b>		
<b>Expanded</b>		
H3	150# Flanged Connection with Rosemount Standard Length and Schedule	
H4	300# Flanged Connection with Rosemount Standard Length and Schedule	
H5	600# Flanged Connection with Rosemount Standard Length and Schedule	
<b>Instrument Connections for Remote Mount Option</b>		
<b>Standard</b>		<b>Standard</b>
G2	Needle Valves, Stainless Steel	★
<b>Expanded</b>		
G1	Needle Valves, Carbon Steel	
G3	Needle Valves, Alloy C-276	
G5	OS&Y Gate Valve, Carbon Steel	
G6	OS&Y Gate Valve, Stainless Steel	
G7	OS&Y Gate Valve, Alloy C-276	
<b>Special Shipment</b>		
<b>Standard</b>		<b>Standard</b>
Y1	Mounting Hardware Shipped Separately	★

**Table A-8. Rosemount 3051SFA Annubar Flowmeter Ordering Information**

★ The Standard offering represents the most common models and options. These options should be selected for best delivery.  
The Expanded offering is subject to additional delivery lead time.

<b>Special Dimensions</b>		
<b>Expanded</b>		
VM	Variable Mounting	
VT	Variable Tip	
VS	Variable length Spool Section	
V9	Special Dimension	
<b>Transmitter Calibration Certification</b>		
<b>Standard</b>		<b>Standard</b>
Q4	Calibration Data Certificate for Transmitter	★
<b>Safety Certification</b>		
<b>Standard</b>		<b>Standard</b>
QS <sup>(9)(20)</sup>	Certificate of FMEDA data	★
QT <sup>(9)(21)</sup>	Safety certified to IEC 61508 with certificate of FMEDA data	★
<b>Product Certifications</b>		
<b>Standard</b>		<b>Standard</b>
E1	ATEX Flameproof	★
I1	ATEX Intrinsic Safety	★
IA <sup>(9)</sup>	ATEX FISCO Intrinsic Safety; for FOUNDATION fieldbus protocol only	★
N1	ATEX Type n	★
ND	ATEX Dust	★
K1	ATEX Flameproof, Intrinsic Safety, Type n, Dust (combination of E1, I1, N1, and ND)	★
E4	TIIS Flameproof	★
I4 <sup>(22)</sup>	TIIS Intrinsic Safety	★
K4 <sup>(22)</sup>	TIIS Flameproof, Intrinsic Safety (combination of E4 and I4)	★
E5	FM Explosion-proof, Dust Ignition-proof	★
I5	FM Intrinsically Safe, Division 2	★
K5	FM Explosion-proof, Dust Ignition-proof, Intrinsically Safe, Division 2 (combination of E5 and I5)	★
E6 <sup>(23)</sup>	CSA Explosion-proof, Dust Ignition-proof, Division 2	★
I6	CSA Intrinsically Safe	★
K6 <sup>(23)</sup>	CSA Explosion-proof, Dust Ignition-proof, Intrinsically Safe, Division 2 (combination of E6 and I6)	★
E7	IECEx Flameproof, Dust Ignition-proof	★
I7	IECEx Intrinsic Safety	★
K7	IECEx Flameproof, Dust Ignition-proof, Intrinsic Safety, Type n (combination of E7, I7, and N7)	★
E3 <sup>(24)</sup>	China Flameproof	★
I3 <sup>(24)</sup>	China Intrinsic Safety	★
KA <sup>(23)</sup>	ATEX and CSA Explosion-proof, Intrinsically Safe, Division 2 (combination of E1, I1, E6, and I6) <i>Note: Only available on Housing Style codes 00, 1A, 1J, 2A, 2J, 2E, or 2M.</i>	★
KB <sup>(23)</sup>	FM and CSA Explosion-proof, Dust Ignition-proof, Intrinsically Safe, Division 2 (combination of E5, E6, I5, and I6) <i>Note: Only available on Housing Style codes 00, 1A, 1J, 2A, 2J, 2E, or 2M.</i>	★
KC	FM and ATEX Explosion-proof, Intrinsically Safe, Division 2 (combination of E5, E1, I5, and I1) <i>Note: Only available on Housing Style codes 00, 1A, 1J, 2A, 2J, 2E, or 2M.</i>	★
KD <sup>(23)</sup>	FM, CSA, and ATEX Explosion-proof, Intrinsically Safe (combination of E5, I5, E6, I6, E1, and I1) <i>Note: Only available on Housing Style codes 00, 1A, 1J, 2A, 2J, 2E, or 2M.</i>	★
<b>Alternate Transmitter Material of Construction</b>		
<b>Standard</b>		<b>Standard</b>
L1	Inert Sensor Fill Fluid <i>Note: Silicone fill fluid is standard.</i>	★
L2	Graphite-Filled (PTFE) o-ring	★
LA	Inert Sensor Fill Fluid and Graphite-Filled (PTFE) o-ring	★

**Table A-8. Rosemount 3051SFA Annubar Flowmeter Ordering Information**

★ The Standard offering represents the most common models and options. These options should be selected for best delivery.  
The Expanded offering is subject to additional delivery lead time.

<b>Digital Display<sup>(25)</sup></b>		
<b>Standard</b>		<b>Standard</b>
M5	PlantWeb LCD display (Requires PlantWeb housing)	★
M7 <sup>(26)(26)</sup>	Remote mount LCD display and interface, no cable; PlantWeb housing, SST bracket	★
M8 <sup>(26)(27)(28)</sup>	Remote mount LCD display and interface, 50 ft. (15 m) cable; PlantWeb housing, SST bracket	★
M9 <sup>(26)(26)</sup>	Remote mount LCD display and interface, 100 ft. (31 m) cable; PlantWeb housing, SST bracket	★
<b>Terminal Blocks</b>		
<b>Standard</b>		<b>Standard</b>
T1 <sup>(29)</sup>	Transient terminal block	★
<b>Expanded</b>		
T2 <sup>(9)(30)</sup>	Terminal block with WAGO® spring clamp terminals	
T3 <sup>(9)(30)</sup>	Transient terminal block with WAGO spring clamp terminals	
<b>Manifold for Remote Mount Option</b>		
<b>Standard</b>		<b>Standard</b>
F2	3-Valve Manifold, Stainless Steel	★
F6	5-Valve Manifold, Stainless Steel	★
<b>Expanded</b>		
F1	3-Valve Manifold, Carbon Steel	
F3	3-Valve Manifold, Alloy C-276	
F5	5-Valve Manifold, Carbon Steel	
F7	5-Valve Manifold, Alloy C-276	
<b>PlantWeb Control Functionality</b>		
<b>Standard</b>		<b>Standard</b>
A01 <sup>(9)(31)</sup>	FOUNDATION fieldbus Advanced Control Function Block Suite	★
<b>PlantWeb Diagnostic Functionality</b>		
<b>Standard</b>		<b>Standard</b>
D01 <sup>(9)(31)</sup>	FOUNDATION fieldbus Diagnostics Suite	★
DA2 <sup>(9)(32)</sup>	Advanced HART Diagnostics Suite (SPM, Power Advisory, Variable & Status Log, Service & Process Alerts)	★
<b>PlantWeb Enhanced Measurement Functionality</b>		
<b>Standard</b>		<b>Standard</b>
H01 <sup>(9)(33)</sup>	FOUNDATION fieldbus Fully Compensated Mass Flow Block	★
<b>Special Configuration (Software)</b>		
<b>Standard</b>		<b>Standard</b>
C4 <sup>(20)</sup>	NAMUR Alarm and Saturation Signal Levels, High Alarm	★
C5 <sup>(20)</sup>	NAMUR Alarm and Saturation Signal Levels, Low Alarm	★
C6 <sup>(20)</sup>	Custom Alarm and Saturation Signal Levels, High Alarm <i>Note: A Configuration Data Sheet (00806-0100-4809) must be completed.</i>	★
C7 <sup>(20)</sup>	Custom Alarm and Saturation Signal Levels, Low Alarm <i>Note: A Configuration Data Sheet (00806-0100-4809) must be completed.</i>	★
C8 <sup>(20)</sup>	Low Alarm (Standard Rosemount Alarm and Saturation Signal Levels)	★
<b>Special Configuration (Hardware)</b>		
<b>Standard</b>		<b>Standard</b>
D1 <sup>(20)(26)</sup>	Hardware Adjustment (zero, span, security)	★
D4	External Ground Screw	★
DA <sup>(20)(26)</sup>	Hardware Adjustment (zero, span, security) and External Ground Screw	★
<b>Conduit Electrical Connector</b>		
<b>Expanded</b>		
GE <sup>(34)</sup>	M12, 4-pin, Male Connector ( <i>eurofast</i> ®)	
GM <sup>(33)</sup>	A size Mini, 4-pin, Male Connector ( <i>minifast</i> ®)	

**Table A-8. Rosemount 3051SFA Annubar Flowmeter Ordering Information**

★ The Standard offering represents the most common models and options. These options should be selected for best delivery.  
The Expanded offering is subject to additional delivery lead time.

<b>Cold Temperature</b>		
<b>Standard</b>		<b>Standard</b>
BRR <sup>(22)</sup>	-60 °F (-51 °C) Cold Temperature Start-up	★
<b>Typical Model</b>		
<b>Number: 3051SFA D L 060 D C H P S 2 T1 0 0 0 3 2A A 1A 3</b>		

- (1) Material specified is A105 carbon steel.
- (2) Provide the "A" dimension for Flanged, Flange-Lok, and Threaded Flo-Tap models. Provide the "B" dimension for Flange Flo-Tap models.
- (3) Available in remote mount applications only.
- (4) Option code T or R is required for Measurement Type codes 1, 3, 5, and 7.
- (5) Required for Measurement Type codes 2, 4, 6, and D.
- (6) Required for Measurement Type codes 3, 4, 7, and D.
- (7) For Measurement Type 1, 2, 5, and 6 with DP range 1, absolute limits are 0.5 to 2000 psi (0,03 to 137,9 bar) and gage limits are -14.2 to 2000 psig (-0,98 to 137,9 bar).
- (8) Requires PlantWeb housing.
- (9) Only available with Measurement Type D.
- (10) Available approvals are FM Intrinsically Safe, Division 2 (option code I5), CSA Intrinsically Safe (option code I6), ATEX Intrinsic Safety (option code I1; only available with 2.4 GHz), and IECEx Intrinsic Safety (option code I7; only available with 2.4 GHz).
- (11) Material specified is cast as follows: CF-8M is the cast version of 316 SST, CF-3M is the cast version of 316L SST. For housing, material is aluminum with polyurethane paint.
- (12) Available with output code A only. Available approvals are FM Intrinsically Safe, Division 2 (option code I5), ATEX Intrinsic Safety (option code I1), or IECEx Intrinsic Safety (option code I7). Contact an Emerson Process Management representative for additional information.
- (13) Available with output code A only. Not available with approvals. See Rosemount 753R Product Data Sheet, 00813-0100-4379, to specify Web-Based Monitoring Indicator. Does not integrate into plant host systems.
- (14) Not available with Wireless Operating Frequency and Protocol option codes 1 or 2.
- (15) Not available with Wireless Operating Frequency and Protocol option codes 1 or 2 or Housing code 01. This option is only available with differential pressure ranges 2 and 3, and silicone fill fluid.
- (16) Applies to assembled flowmeter only, mounting not tested.
- (17) Isolation and Instrument valves not included in Traceability Certification.
- (18) Not available with Transmitter Connection Platform 6.
- (19) Materials of Construction comply with metallurgical requirements within NACE MR0175/ISO 15156 for sour oil field production environments. Environmental limits apply to certain materials. Consult latest standard for details. Selected materials also conform to NACE MR0103 for sour refining environments.
- (20) Not available with Output Protocol code F or Housing code 01.
- (21) Not available with output code F. Not available with housing code 01 or 7J.
- (22) Only available with Measurement Types 1-7.
- (23) Not available with M20 or G ½ conduit entry size.
- (24) Consult an Emerson Process Management representative for availability.
- (25) Not available with Housing code 01 or 7J.
- (26) Only available with Measurement Type D.
- (27) Not available with output code F, Housing code 01, option code DA1, or option code QT.
- (28) Cable supplied is Belden 3084A, rated for ambient temperatures up to 167°F (75°C).
- (29) Not available with Housing code 00, 01, 5A, or 7J.
- (30) Available with Output Protocol code A and Plantweb housing only.
- (31) Requires PlantWeb housing and output code F.
- (32) Requires PlantWeb housing and output code A. Includes Hardware Adjustments as standard.
- (33) Requires Rosemount Engineering Assistant version 5.5.1 to configure.
- (34) Not available with Housing code 00, 01, 5A, or 7J. Available with Intrinsically Safe approvals only. For FM Intrinsically Safe, Division 2 (option code I5) or FM FISCO Intrinsically Safe (option code IE), install in accordance with Rosemount drawing 03151-1009 to maintain outdoor rating (NEMA 4X and IP66).

**Table A-9. Rosemount 3051SFC Compact Orifice Flowmeter Ordering Information**

★ The Standard offering represents the most common models and options. These options should be selected for best delivery.  
The Expanded offering is subject to additional delivery lead time.

Model	Product Description	
3051SFC	Compact Orifice Flowmeter	
<b>Transmitter Feature Board Measurement Type</b>		
<b>Standard</b>		<b>Standard</b>
1	MultiVariable (Fully Compensated Mass and Energy Flow) – Differential and Static Pressures with Temperature	★
2	MultiVariable (Compensated Flow) – Differential and Static Pressures	★
3	MultiVariable (Compensated Flow) – Differential Pressure and Temperature	★
4	MultiVariable (Compensated Flow) – Differential Pressure	★
5	MultiVariable (Direct Measurement) – Differential and Static Pressures with Temperature	★
6	MultiVariable (Direct Measurement) – Differential and Static Pressures	★
7	MultiVariable (Direct Measurement) – Differential Pressure and Temperature	★
D	Differential Pressure	★
<b>Primary Element Type</b>		
<b>Standard</b>		<b>Standard</b>
C	Conditioning Orifice Plate	★
P	Orifice Plate	★
<b>Material Type</b>		
<b>Standard</b>		<b>Standard</b>
S	316 SST	★
<b>Line Size</b>		
<b>Standard</b>		<b>Standard</b>
005 <sup>(1)</sup>	1/2-in. (15 mm)	★
010 <sup>(1)</sup>	1-in. (25 mm)	★
015 <sup>(1)</sup>	1 1/2-in. (40 mm)	★
020	2-in. (50 mm)	★
030	3-in. (80 mm)	★
040	4-in. (100 mm)	★
060	6-in. (150 mm)	★
080	8-in. (200 mm)	★
<b>Primary Element Style</b>		
<b>Standard</b>		<b>Standard</b>
N	Square Edged	★
<b>Beta Ratio</b>		
<b>Standard</b>		<b>Standard</b>
040	0.40 Beta Ratio ( $\beta$ )	★
065 <sup>(2)</sup>	0.65 Beta Ratio ( $\beta$ )	★
<b>Temperature Measurement</b>		
<b>Standard</b>		<b>Standard</b>
R <sup>(3)</sup>	Remote Thermowell and RTD	★
0 <sup>(4)</sup>	No Temperature Sensor	★
<b>Transmitter Connection Platform</b>		
<b>Standard</b>		<b>Standard</b>
3	Direct-mount, 3-valve Integral Manifold, SST	★
7	Remote-mount, 1/4-in. NPT Connections	★

**Table A-9. Rosemount 3051SFC Compact Orifice Flowmeter Ordering Information**

★ The Standard offering represents the most common models and options. These options should be selected for best delivery.  
The Expanded offering is subject to additional delivery lead time.

<b>Differential Pressure Range</b>				
<b>Standard</b>				<b>Standard</b>
1	0 to 25 inH <sub>2</sub> O (0 to 62,2 mbar)			★
2	0 to 250 inH <sub>2</sub> O (0 to 623 mbar)			★
3	0 to 1000 inH <sub>2</sub> O (0 to 2,5 bar)			★
<b>Static Pressure Range</b>				
<b>Standard</b>				<b>Standard</b>
A <sup>(5)</sup>	None			★
D	Absolute 0.5 to 800 psia (0,033 to 55,2 bar)			★
E <sup>(6)</sup>	Absolute 0.5 to 3626 psia (0,033 to 250 bar)			★
J	Gage -14.2 to 800 psig (-0,979 to 55,2 bar)			★
K <sup>(6)</sup>	Gage -14.2 to 3626 psig (-0,979 to 250 bar)			★
<b>Output Protocol</b>				
<b>Standard</b>				<b>Standard</b>
A	4–20 mA with digital signal based on HART protocol			★
F <sup>(7)(8)</sup>	FOUNDATION fieldbus protocol: AI block, Link Master, Input Selector Block (Requires PlantWeb housing)			★
X <sup>(8)(9)</sup>	Wireless (Requires wireless options and wireless housing 5A)			★
<b>Transmitter Housing Style</b>		<b>Material<sup>(10)</sup></b>	<b>Conduit Entry Size</b>	
<b>Standard</b>				<b>Standard</b>
00	None (Customer-supplied electrical connection)			★
1A	PlantWeb Housing	Aluminum	1/2-14 NPT	★
1B	PlantWeb Housing	Aluminum	M20 x 1.5	★
1C	PlantWeb Housing	Aluminum	G1/2	★
1J	PlantWeb Housing	SST	1/2-14 NPT	★
1K	PlantWeb Housing	SST	M20 x 1.5	★
1L	PlantWeb Housing	SST	G1/2	★
2A <sup>(9)</sup>	Junction Box Housing	Aluminum	1/2-14 NPT	★
2B <sup>(9)</sup>	Junction Box Housing	Aluminum	M20 x 1.5	★
2C <sup>(9)</sup>	Junction Box Housing	Aluminum	G1/2	★
2E <sup>(9)</sup>	Junction Box housing with output for remote display and interface	Aluminum	1/2-14 NPT	★
2F <sup>(9)</sup>	Junction Box housing with output for remote display and interface	Aluminum	M20 x 1.5	★
2G <sup>(9)</sup>	Junction Box housing with output for remote display and interface	Aluminum	G1/2	★
2J <sup>(9)</sup>	Junction Box Housing	SST	1/2-14 NPT	★
2M <sup>(9)</sup>	Junction Box housing with output for remote display and interface	SST	1/2-14 NPT	★
5A <sup>(9)</sup>	Wireless PlantWeb housing	Aluminum	M20 x 1.5	★
7J <sup>(9)(11)</sup>	Quick Connect (A size Mini, 4-pin male termination)			★
<b>Expanded</b>				
01 <sup>(9)(12)</sup>	Assemble to Rosemount 753R Web-based Monitoring Indicator			
<b>Transmitter Performance Class</b>				
<b>3051S MultiVariable SuperModule, Measurement Types 1, 2, 5, and 6</b>				
<b>Standard</b>				<b>Standard</b>
3	Ultra for Flow: 0.55% flow rate accuracy, 14:1 flow turndown, 10-yr stability. limited 12-yr warranty			★
5	Classic MV: 0.6% flow rate accuracy, 8:1 flow turndown, 5-yr stability			★

**Table A-9. Rosemount 3051SFC Compact Orifice Flowmeter Ordering Information**

★ The Standard offering represents the most common models and options. These options should be selected for best delivery.  
The Expanded offering is subject to additional delivery lead time.

<b>Transmitter Performance Class</b>		
<b>3051S Single Variable SuperModule, Measurement Types 3, 4, 7, and D</b>		
<b>Standard</b>		<b>Standard</b>
1 <sup>(13)</sup>	Ultra: 0.85% flow rate accuracy, 8:1 flow turndown, 10-yr stability, limited 12-yr warranty	★
2	Classic: 1.05% flow rate accuracy, 8:1 flow turndown, 5-yr stability	★
3 <sup>(14)</sup>	Ultra for Flow: 0.55% flow rate accuracy, 14:1 flow turndown, 10-yr stability, limited 12-yr warranty	★

**Wireless Options** (Requires option code X and Housing Style 5A)

<b>Wireless Transmitter Rate</b>		
<b>Standard</b>		<b>Standard</b>
WA	User Configurable Burst Rate	★
<b>Operating Frequency and Protocol</b>		
<b>Standard</b>		<b>Standard</b>
3	2.4 GHz DSSS, IEC 62591 (WirelessHART)	★
<b>Omnidirectional Wireless Antenna</b>		
<b>Standard</b>		<b>Standard</b>
WK	External Antenna	★
WM	Extended Range, External Antenna	
<b>Expanded</b>		<b>Expanded</b>
WN <sup>(13)</sup>	High-Gain, Remote Antenna	
<b>SmartPower™</b>		
<b>Standard</b>		<b>Standard</b>
1	Adapter for Black Power Module (I.S Power Module sold separately)	★

**Other Options** (Include with selected model number)

<b>Installation Accessories</b>		
<b>Standard</b>		<b>Standard</b>
G	DIN alignment ring (PN 16)	★
H	DIN alignment ring (PN 40, PN 100)	★
<b>Expanded</b>		
B	JIS Alignment Ring (10K)	
R	JIS Alignment Ring (20K)	
S	JIS Alignment Ring (40K)	
<b>Remote Adapters</b>		
<b>Standard</b>		<b>Standard</b>
E	Flange adapters 316 SST (1/2-in. NPT)	★
<b>High Temperature Applications</b>		
<b>Expanded</b>		
T	Graphite Valve Packing (T <sub>max</sub> = 850 °F)	
<b>Flow Calibration</b>		
<b>Standard</b>		<b>Standard</b>
WC <sup>(15)</sup>	Discharge Coefficient Verification (3 point)	★
<b>Expanded</b>		
WD <sup>(15)</sup>	Discharge Coefficient Verification (10 point)	
<b>Pressure Testing</b>		
<b>Standard</b>		<b>Standard</b>
P1	Hydrostatic Testing	★

**Table A-9. Rosemount 3051SFC Compact Orifice Flowmeter Ordering Information**

★ The Standard offering represents the most common models and options. These options should be selected for best delivery.  
The Expanded offering is subject to additional delivery lead time.

<b>Special Cleaning</b>		
<b>Expanded</b>		
P2	Cleaning for special processes	
PA	Cleaning per ASTM G93 Level D (section 11.4)	
<b>Special Inspection</b>		
<b>Standard</b>		<b>Standard</b>
QC1	Visual and Dimensional Inspection with Certificate	★
QC7	Inspection and Performance Certificate	★
<b>Transmitter Calibration Certification</b>		
<b>Standard</b>		<b>Standard</b>
Q4	Calibration Data Certificate for Transmitter	★
QP	Calibration Data Certificate and Tamper Evident Seal	★
<b>Safety Certification</b>		
<b>Standard</b>		<b>Standard</b>
QS <sup>(16)(17)</sup>	Certificate of FMEDA data	★
QT <sup>(9)(18)</sup>	Safety Certified to IEC 61508 with certificate of FMEDA data	★
<b>Material Traceability Certifications</b>		
<b>Standard</b>		<b>Standard</b>
Q8 <sup>(19)</sup>	Material Traceability Certification per EN 10204:2004 3.1	★
<b>Code Conformance</b>		
<b>Expanded</b>		
J2	ANSI B31.1	
J3	ANSI B31.3	
J4	ANSI B31.8	
<b>Material Conformance</b>		
<b>Standard</b>		<b>Standard</b>
J5 <sup>(20)</sup>	NACE MR-0175-91 / ISO 15156	★
<b>Country Certification</b>		
<b>Standard</b>		<b>Standard</b>
J1	Canadian Registration	★
<b>Product Certifications</b>		
<b>Standard</b>		<b>Standard</b>
E1	ATEX Flameproof	★
I1	ATEX Intrinsic Safety	★
IA <sup>(9)</sup>	ATEX FISCO Intrinsic Safety; for FOUNDATION fieldbus protocol only	★
N1	ATEX Type n	★
ND	ATEX Dust	★
K1	ATEX Flameproof, Intrinsic Safety, Type n, Dust (combination of E1, I1, N1, and ND)	★
E4	TIIS Flameproof	★
I4 <sup>(21)</sup>	TIIS Intrinsic Safety	★
K4 <sup>(22)</sup>	TIIS Flameproof, Intrinsic Safety (combination of E4 and I4)	★
E5	FM Explosion-proof, Dust Ignition-proof	★
I5	FM Intrinsically Safe, Division 2	★
K5	FM Explosion-proof, Dust Ignition-proof, Intrinsically Safe, Division 2 (combination of E5 and I5)	★
E6 <sup>(22)</sup>	CSA Explosion-proof, Dust Ignition-proof, Division 2	★
I6	CSA Intrinsically Safe	★
K6 <sup>(21)</sup>	CSA Explosion-proof, Dust Ignition-proof, Intrinsically Safe, Division 2 (combination of E6 and I6)	★



**Table A-9. Rosemount 3051SFC Compact Orifice Flowmeter Ordering Information**

★ The Standard offering represents the most common models and options. These options should be selected for best delivery.  
The Expanded offering is subject to additional delivery lead time.

E7	IECEX Flameproof, Dust Ignition-proof	★
I7	IECEX Intrinsic Safety	★
N7	IECEX Type n	★
K7	IECEX Flameproof, Dust Ignition-proof, Intrinsic Safety, Type n (combination of E7, I7, and N7)	★
E3 <sup>(1)</sup>	China Flameproof	★
I3 <sup>(1)</sup>	China Intrinsic Safety	★
KA <sup>(21)</sup>	ATEX and CSA Flameproof, Intrinsically Safe, Division 2 (combination of E1, I1, E6, and I6) <i>Note: Only available on Housing Style codes 1A, 1J, 2A, 2J, 2E, or 2M.</i>	★
KB <sup>(21)</sup>	FM and CSA Explosion-proof, Dust Ignition-proof, Intrinsically Safe, Division 2 (combination of E5, E6, I5, and I6) <i>Note: Only available on Housing Style codes 1A, 1J, 2A, 2J, 2E, or 2M.</i>	★
KC	FM and ATEX Explosion-proof, Intrinsically Safe, Division 2 (combination of E5, E1, I5, and I1) <i>Note: Only available on Housing Style codes 1A, 1J, 2A, 2J, 2E, or 2M.</i>	★
KD <sup>(21)</sup>	FM, CSA, and ATEX Explosion-proof, Intrinsically Safe (combination of E5, I5, E6, I6, E1, and I1) <i>Note: Only available on Housing Style codes 1A, 1J, 2A, 2J, 2E, or 2M.</i>	★
<b>Alternative Transmitter Material of Construction</b>		
<b>Standard</b>		<b>Standard</b>
L1	Inert Sensor Fill Fluid (not available with Differential Pressure range code 1A)	★
L2	Graphite-filled (PTFE) o-ring	★
LA	Inert sensor fill fluid and graphite-filled (PTFE) o-ring	★
<b>Digital Display<sup>(23)</sup></b>		
<b>Standard</b>		<b>Standard</b>
M5	PlantWeb LCD display	★
M7 <sup>(26)(24)</sup>	Remote mount LCD display and interface, PlantWeb housing, no cable, SST bracket	★
M8 <sup>(26)(24)</sup> (25)	Remote mount LCD display and interface, PlantWeb housing, 50 foot cable, SST bracket	★
M9 <sup>(24)(26)</sup>	Remote mount LCD display and interface, PlantWeb housing, 100 foot cable, SST bracket	★
<b>Terminal Blocks</b>		
<b>Standard</b>		<b>Standard</b>
T1 <sup>(26)</sup>	Transient terminal block	★
T2 <sup>(9)(27)</sup>	Terminal block with WAGO® spring clamp terminals	★
T3 <sup>(9)(27)</sup>	Transient terminal block with WAGO spring clamp terminals	★
<b>Manifold for Remote Mount</b>		
<b>Standard</b>		<b>Standard</b>
F2	3-Valve Manifold, SST	★
F6	5-Valve Manifold, SST	★
<b>PlantWeb Control Functionality</b>		
<b>Standard</b>		<b>Standard</b>
A01 <sup>(9)(28)</sup>	FOUNDATION fieldbus Advanced Control Function Block Suite	★
<b>PlantWeb Diagnostic Functionality</b>		
<b>Standard</b>		<b>Standard</b>
D01 <sup>(9)(31)</sup>	FOUNDATION fieldbus Diagnostics Suite	★
DA2 <sup>(9)(29)</sup>	Advanced HART Diagnostics Suite (SPM, Power Advisory, Variable & Status Log, Service & Process Alerts)	★
<b>PlantWeb Enhanced Measurement Functionality</b>		
<b>Standard</b>		<b>Standard</b>
H01 <sup>(9)(30)(31)</sup>	FOUNDATION fieldbus Fully Compensated Mass Flow Block	★
<b>Cold Temperature</b>		
<b>Standard</b>		<b>Standard</b>
BRR <sup>(22)</sup>	-60 °F (-51 °C) Cold Temperature Start-up	★

**Table A-9. Rosemount 3051SFC Compact Orifice Flowmeter Ordering Information**

★ The Standard offering represents the most common models and options. These options should be selected for best delivery.  
The Expanded offering is subject to additional delivery lead time.

Special Configuration (Software)		
Standard		Standard
C4 <sup>(20)</sup>	NAMUR alarm and saturation signal levels, high alarm	★
C5 <sup>(20)(20)</sup>	NAMUR alarm and saturation signal levels, low alarm	★
C6 <sup>(20)(20)</sup>	Custom alarm and saturation signal levels, high alarm <i>Note: Requires option code C1, custom software configuration. A Configuration Data Sheet must be completed, see document number 00806-0100-4810.</i>	★
C7 <sup>(20)(20)</sup>	Custom alarm and saturation signal levels, low alarm <i>Note: Requires option code C1, custom software configuration. A Configuration Data Sheet must be completed, see document number 00806-0100-4810.</i>	★
C8 <sup>(20)(20)</sup>	Low alarm (standard Rosemount alarm and saturation signal levels)	★
Special Configuration (Hardware)		
Standard		Standard
D1 <sup>(20)(26)</sup>	Hardware Adjustment (zero, span, security).	★
D4	External ground screw	★
DA <sup>(20)(26)</sup>	Hardware adjustment (zero, span, security) and external ground screw	★
Conduit Electrical Connector		
Expanded		
ZE <sup>(31)</sup>	M12, 4-pin, Male Connector (eurofast)	
ZM <sup>(31)</sup>	A size Mini, 4-pin, Male Connector (minifast)	

- (1) Not available for Primary Element Type code C.
- (2) For 2-in. (50.8 mm) line sizes the Beta Ratio is 0.6 for Primary Element Type code C.
- (3) Option code R is required for Measurement Type codes 1, 3, 5, and 7.
- (4) Required for Measurement Type codes 2, 4, 6, and D.
- (5) Required for Measurement Type codes 3, 4, 7, and D.
- (6) For Measurement Type 1, 2, 5, and 6 with DP range 1, absolute limits are 0.5 to 2000 psi (0.03 to 137.9 bar) and gage limits are -14.2 to 2000 psig (-0.98 to 137.9 bar).
- (7) Requires PlantWeb housing.
- (8) Only available with Measurement Type D.
- (9) Available approvals are FM Intrinsic Safe, Division 2 (option code I5), CSA Intrinsically Safe (option code I6), ATEX Intrinsic Safety (option code I1; only available with 2.4 GHz), and IECEx Intrinsic Safety (option code I7; only available with 2.4 GHz).
- (10) Material specified is cast as follows: CF-8M is the cast version of 316 SST, CF-3M is the cast version of 316L SST. For housing, material is aluminum with polyurethane paint.
- (11) Available with output code A only. Available approvals are FM Intrinsic Safe, Division 2 (option code I5), ATEX Intrinsic Safety (option code I1), or IECEx Intrinsic Safety (option code I7). Contact an Emerson Process Management representative for additional information.
- (12) Available with output code A only. Not available with approvals. See Rosemount 753R Product Data Sheet, 00813-0100-4379, to specify Web-Based Monitoring Indicator. Does not integrate into plant host systems.
- (13) Not available with Wireless Operating Frequency and Protocol option codes 1 or 2.
- (14) Not available with Wireless Operating Frequency and Protocol option codes 1 or 2 or Housing code 01. This option is only available with differential pressure ranges 2 and 3, and silicone fill fluid.
- (15) Not available with Primary Element Type code P.
- (16) Not available with Output Protocol code F or Housing code 01.
- (17) Only available with Measurement Type D.
- (18) Not available with output code F. Not available with housing code 01 or 7J.
- (19) Instrument valves not included in Traceability Certification.
- (20) Materials of Construction comply with metallurgical requirements within NACE MR0175/ISO for sour oil field production environments. Environmental limits apply to certain materials. Consult latest standard for details. Selected materials also conform to NACE MR0103 for sour refining environments.
- (21) Only available with Measurement Types 1-7.
- (22) Not available with M20 or G ½ conduit entry size.
- (23) Not available with Housing code 01 or 7J.
- (24) Not available with output code F, Housing code 01, option code DA1, or option code QT.
- (25) Cable supplied is Belden 3084A, rated for ambient temperatures up to 167°F (75°C).
- (26) Not available with Housing code 00, 01, 5A, or 7J.
- (27) Available with Output Protocol code A and Plantweb housing only.
- (28) Requires PlantWeb housing and output code F.
- (29) Requires PlantWeb housing and output code A. Includes Hardware Adjustments as standard.
- (30) Requires Rosemount Engineering Assistant version 5.5.1 to configure.
- (31) Not available with Housing code 00, 01, 5A, or 7J. Available with Intrinsically Safe approvals only. For FM Intrinsically Safe, Division 2 (option code I5) or FM FISCO Intrinsically Safe (option code IE), install in accordance with Rosemount drawing 03151-1009 to maintain outdoor rating (NEMA 4X and IP66).

**Table A-10. Rosemount 3051SFP Integral Orifice Flowmeter Ordering Information**

★ The Standard offering represents the most common models and options. These options should be selected for best delivery.  
The Expanded offering is subject to additional delivery lead time.

Model	Product Description	
3051SFP	Integral Orifice Flowmeter	
<b>Measurement Type</b>		
<b>Standard</b>		<b>Standard</b>
1	MultiVariable (Fully Compensated Mass Flow) – Differential and Static Pressures with Temperature	★
2	MultiVariable (Compensated Flow) – Differential and Static Pressures	★
3	MultiVariable (Compensated Flow) – Differential Pressure and Temperature	★
4	MultiVariable (Compensated Flow) – Differential Pressure	★
5	MultiVariable (Direct Measurement) – Differential and Static Pressures with Temperature	★
6	MultiVariable (Direct Measurement) – Differential and Static Pressures	★
7	MultiVariable (Direct Measurement) – Differential Pressure and Temperature	★
D	Differential Pressure	★
<b>Body Material</b>		
<b>Standard</b>		<b>Standard</b>
S	316 SST	★
<b>Line Size</b>		
<b>Standard</b>		<b>Standard</b>
005	1/2-in. (15 mm)	★
010	1-in. (25 mm)	★
015	1 1/2-in. (40 mm)	★
<b>Process Connection</b>		
<b>Standard</b>		<b>Standard</b>
T1	NPT Female Body (Not Available with Remote Thermowell and RTD)	★
S1 <sup>(1)</sup>	Socket Weld Body (Not Available with Remote Thermowell and RTD)	★
P1	Pipe Ends: NPT threaded	★
P2	Pipe Ends: Beveled	★
D1	Pipe Ends: Flanged, DIN PN16, slip-on	★
D2	Pipe Ends: Flanged, DIN PN40, slip-on	★
D3	Pipe Ends: Flanged, DIN PN100, slip-on	★
W1	Pipe Ends: Flanged, ANSI Class 150, weld-neck	★
W3	Pipe Ends: Flanged, ANSI Class 300, weld-neck	★
W6	Pipe Ends: Flanged, ANSI Class 600, weld-neck	★
<b>Expanded</b>		
A1	Pipe Ends: Flanged, RF, ANSI Class 150, slip-on	
A3	Pipe Ends: Flanged, RF, ANSI Class 300, slip-on	
A6	Pipe Ends: Flanged, RF, ANSI Class 600, slip-on	
R1	Pipe Ends: Flanged, RTJ, ANSI Class 150, slip-on	
R3	Pipe Ends: Flanged, RTJ, ANSI Class 300, slip-on	
R6	Pipe Ends: Flanged, RTJ, ANSI Class 600, slip-on	
P9	Special Process Connection	
<b>Orifice Plate Material</b>		
<b>Standard</b>		<b>Standard</b>
S	316 SST	★
<b>Expanded</b>		
H	Alloy C-276	
M	Alloy 400	

**Table A-10. Rosemount 3051SFP Integral Orifice Flowmeter Ordering Information**

★ The Standard offering represents the most common models and options. These options should be selected for best delivery.  
The Expanded offering is subject to additional delivery lead time.

<b>Bore Size Option</b>		
<b>Standard</b>		<b>Standard</b>
0066	0.066-in. (1,68 mm) for 1/2-in. pipe	★
0109	0.109-in. (2,77 mm) for 1/2-in. pipe	★
0160 <sup>(2)</sup>	0.160-in. (4,06 mm) for 1/2-in. pipe	★
0196 <sup>(2)</sup>	0.196-in. (4,98 mm) for 1/2-in. pipe	★
0260 <sup>(2)</sup>	0.260-in. (6,60 mm) for 1/2-in. pipe	★
0340 <sup>(2)</sup>	0.340-in. (8,64 mm) for 1/2-in. pipe	★
0150	0.150-in. (3,81 mm) for 1-in. pipe	★
0250 <sup>(2)</sup>	0.250-in. (6,35 mm) for 1-in. pipe	★
0345 <sup>(2)</sup>	0.345-in. (8,76 mm) for 1-in. pipe	★
0500 <sup>(2)</sup>	0.500-in. (12,70 mm) for 1-in. pipe	★
0630 <sup>(2)</sup>	0.630-in. (16,00 mm) for 1-in. pipe	★
0800	0.800-in. (20,32 mm) for 1-in. pipe	★
0295	0.295-in. (7,49 mm) for 1 1/2-in. pipe	★
0376 <sup>(2)</sup>	0.376-in. (9,55 mm) for 1 1/2-in. pipe	★
0512 <sup>(2)</sup>	0.512-in. (13,00 mm) for 1 1/2-in. pipe	★
0748 <sup>(2)</sup>	0.748-in. (19,00 mm) for 1 1/2-in. pipe	★
1022	1.022-in. (25,96 mm) for 1 1/2-in. pipe	★
1184	1.184-in. (30,07 mm) for 1 1/2-in. pipe	★
<b>Expanded</b>		
0010	0.010-in. (0,25 mm) for 1/2-in. pipe	
0014	0.014-in. (0,36 mm) for 1/2-in. pipe	
0020	0.020-in. (0,51 mm) for 1/2-in. pipe	
0034	0.034-in. (0,86 mm) for 1/2-in. pipe	
<b>Transmitter Connection Platform</b>		
<b>Standard</b>		<b>Standard</b>
D3	Direct-mount, 3-valve Manifold, SST	★
D5	Direct-mount, 5-valve Manifold, SST	★
R3	Remote-mount, 3-valve Manifold, SST	★
R5	Remote-mount, 5-valve Manifold, SST	★
<b>Expanded</b>		
D4	Direct-mount, 3-valve Manifold, Alloy C-276	
D6	Direct-mount, 5-valve Manifold, Alloy C-276	
D7	Direct-mount, High Temperature, 5-valve Manifold, SST	
R4	Remote-mount, 3-valve Manifold, Alloy C-276	
R6	Remote-mount, 5-valve Manifold, Alloy C-276	
<b>Differential Pressure Range</b>		
<b>Standard</b>		<b>Standard</b>
1	0 to 25 in H <sub>2</sub> O (0 to 62,2 mbar)	★
2	0 to 250 in H <sub>2</sub> O (0 to 623 mbar)	★
3	0 to 1000 in H <sub>2</sub> O (0 to 2,5 bar)	★
<b>Static Pressure Range</b>		
<b>Standard</b>		<b>Standard</b>
A <sup>(3)</sup>	None	★
D	Absolute 0.5 to 800 psia (0,033 to 55,2 bar)	★
E <sup>(4)</sup>	Absolute 0.5 to 3626 psia (0,033 to 250 bar)	★
J	Gage -14.2 to 800 psig (-0,979 to 55,2 bar)	★
K <sup>(7)</sup>	Gage -14.2 to 3626 psig (-0,979 to 250 bar)	★

**Table A-10. Rosemount 3051SFP Integral Orifice Flowmeter Ordering Information**

★ The Standard offering represents the most common models and options. These options should be selected for best delivery.  
The Expanded offering is subject to additional delivery lead time.

Output Protocol				
<b>Standard</b>				<b>Standard</b>
A	4–20 mA with digital signal based on HART protocol			★
F <sup>(5)(6)</sup>	FOUNDATION fieldbus: AI block, Link Master, Input Selector Block (Requires PlantWeb housing)			★
X <sup>(6)(7)</sup>	Wireless (Requires wireless options and wireless housing 5A)			★
Transmitter Housing Style		Material <sup>(8)</sup>	Conduit Entry Size	
<b>Standard</b>				<b>Standard</b>
00	None (Customer-supplied electrical connection)			★
01 <sup>(6)(9)</sup>	Assemble to Rosemount 753R Web-based Monitoring Indicator			★
1A	PlantWeb Housing	Aluminum	1/2-14 NPT	★
1B	PlantWeb Housing	Aluminum	M20 x 1.5	★
1C	PlantWeb Housing	Aluminum	G1/2	★
1J	PlantWeb Housing	SST	1/2-14 NPT	★
1K	PlantWeb Housing	SST	M20 x 1.5	★
1L	PlantWeb Housing	SST	G1/2	★
2A <sup>(6)</sup>	Junction Box Housing	Aluminum	1/2-14 NPT	★
2B <sup>(6)</sup>	Junction Box Housing	Aluminum	M20 x 1.5	★
2C <sup>(6)</sup>	Junction Box Housing	Aluminum	G1/2	★
2E <sup>(6)</sup>	Junction Box Housing with output for remote display and interface	Aluminum	1/2-14 NPT	★
2F <sup>(6)</sup>	Junction Box Housing with output for remote display and interface	Aluminum	M20 x 1.5	★
2G <sup>(6)</sup>	Junction Box Housing with output for remote display and interface	Aluminum	G1/2	★
2J <sup>(6)</sup>	Junction Box Housing	SST	1/2-14 NPT	★
2M <sup>(6)</sup>	Junction Box Housing with output for remote display and interface	SST	1/2-14 NPT	★
5A <sup>(6)</sup>	Wireless PlantWeb Housing	Aluminum	1/2–14 NPT	★
7J <sup>(6)(10)</sup>	Quick Connect (A size Mini, 4-pin male termination)			★
Transmitter Performance Class				
3051S MultiVariable SuperModule, Measurement Types 1, 2, 5, and 6				
<b>Standard</b>				<b>Standard</b>
3	Ultra for Flow: 0.80% flow rate accuracy, 14:1 flow turndown, 10-year stability. limited 12-year warranty			★
5	Classic 2: 0.85% flow rate accuracy, 8:1 flow turndown, 5-year stability			★
Transmitter Performance Class				
3051S Single Variable SuperModule, Measurement Types 3, 4, 7, and D				
<b>Standard</b>				<b>Standard</b>
1 <sup>(11)</sup>	Ultra: 1.05% flow rate accuracy, 8:1 flow turndown, 10-year stability, limited 12-year warranty			★
2	Classic: 1.20% flow rate accuracy, 8:1 flow turndown, 5-year stability			★
3 <sup>(12)</sup>	Ultra for Flow: 0.95% flow rate accuracy, 14:1 flow turndown, 10-year stability. limited 12-year warranty			★

**Wireless Options (Requires option code X and Housing Style 5A)**

Wireless Burst Rate				
<b>Standard</b>				<b>Standard</b>
WA	User Configurable Burst Rate			★
Operating Frequency and Protocol				
<b>Standard</b>				<b>Standard</b>
3	2.4 GHz DSSS, IEC 62591 (WirelessHART)			★

**Table A-10. Rosemount 3051SFP Integral Orifice Flowmeter Ordering Information**

★ The Standard offering represents the most common models and options. These options should be selected for best delivery.  
The Expanded offering is subject to additional delivery lead time.

<b>Omnidirectional Wireless Antenna</b>		
<b>Standard</b>		<b>Standard</b>
WK	External Antenna	★
WM	Extended Range, External Antenna	
<b>Expanded</b>		<b>Expanded</b>
WN <sup>(13)</sup>	High-Gain, Remote Antenna	
<b>SmartPower™</b>		
<b>Standard</b>		<b>Standard</b>
1	Adapter for Black Power Module (I.S Power Module sold separately)	★

**Other Options** (Include with selected model number)

<b>Transmitter / Body Bolt Material</b>		
<b>Standard</b>		<b>Standard</b>
G	High temperature Option (850 °F (454 °C))	★
<b>Temperature Sensor</b>		
<b>Expanded</b>		
T <sup>(13)</sup>	Thermowell and RTD	
<b>Optional Connection</b>		
<b>Standard</b>		<b>Standard</b>
G1	DIN 19231 Transmitter Connection	★
<b>Pressure Testing</b>		
<b>Standard</b>		<b>Standard</b>
P1 <sup>(14)</sup>	Hydrostatic Testing with Certificate	★
<b>Special Cleaning</b>		
<b>Expanded</b>		
P2	Cleaning for Special Processes	
PA	Cleaning per ASTM G93 Level D (Section 11.4)	
<b>Material Testing</b>		
<b>Expanded</b>		
V1	Dye Penetrant Exam	
<b>Material Examination</b>		
<b>Expanded</b>		
V2	Radiographic Examination (available only with Process Connection code W1, W3, and W6)	
<b>Flow Calibration</b>		
<b>Expanded</b>		
WD <sup>(15)</sup>	Discharge Coefficient Verification	
WZ <sup>(15)</sup>	Special Calibration	
<b>Special Inspection</b>		
<b>Standard</b>		<b>Standard</b>
QC1	Visual and Dimensional Inspection with Certificate	★
QC7	Inspection and Performance Certificate	★
<b>Material Traceability Certification</b>		
<b>Expanded</b>		
Q8 <sup>(16)</sup>	Material certification per EN 10204:2004 3.1	
<b>Code Conformance</b>		
<b>Expanded</b>		
J2 <sup>(17)</sup>	ANSI / ASME B31.1	
J3 <sup>(17)</sup>	ANSI / ASME B31.3	

**Table A-10. Rosemount 3051SFP Integral Orifice Flowmeter Ordering Information**

★ The Standard offering represents the most common models and options. These options should be selected for best delivery.  
The Expanded offering is subject to additional delivery lead time.

<b>Materials Conformance</b>		
<b>Standard</b>		<b>Standard</b>
J5 <sup>(18)</sup>	NACE MR-0175 / ISO 15156	★
<b>Country Certification</b>		
<b>Standard</b>		<b>Standard</b>
J1	Canadian Registration	★
J6	European Pressure Directive (PED)	★
<b>Transmitter Calibration Certification</b>		
<b>Standard</b>		<b>Standard</b>
Q4	Calibration Data Certificate for Transmitter	★
<b>Special Certification</b>		
<b>Standard</b>		<b>Standard</b>
QS <sup>(19)(20)</sup>	Certificate of FMEDA data	★
QT <sup>(6)(21)</sup>	Safety-certified to IEC 61508 with Certificate of FMEDA data	★
<b>Product Certifications</b>		
<b>Standard</b>		<b>Standard</b>
E1	ATEX Flameproof	★
I1	ATEX Intrinsic Safety	★
IA <sup>(6)</sup>	ATEX FISCO Intrinsic Safety; for FOUNDATION fieldbus protocol only	★
N1	ATEX Type n	★
ND	ATEX Dust	★
K1	ATEX Flameproof, Intrinsic Safety, Type n, Dust (combination of E1, I1, N1, and ND)	★
E4	TIIS Flameproof	★
I4 <sup>(22)</sup>	TIIS Intrinsic Safety	★
K4 <sup>(22)</sup>	TIIS Flameproof, Intrinsic Safety (combination of E4 and I4)	★
E5	FM Explosion-proof, Dust Ignition-proof	★
I5	FM Intrinsically Safe, Division 2	★
K5	FM Explosion-proof, Dust Ignition-proof, Intrinsically Safe, Division 2 (combination of E5 and I5)	★
E6 <sup>(23)</sup>	CSA Explosion-proof, Dust Ignition-proof, Division 2	★
I6	CSA Intrinsically Safe	★
K6 <sup>(23)</sup>	CSA Explosion-proof, Dust Ignition-proof, Intrinsically Safe, Division 2 (combination of E6 and I6)	★
E7	IECEX Flameproof	★
I7	IECEX Intrinsic Safety	★
K7	IECEX Flameproof, Intrinsic Safety, Type n (combination of E7, I7, and N7)	★
E3 <sup>(24)</sup>	China Flameproof	★
I3 <sup>(24)</sup>	China Intrinsic Safety	★
KA <sup>(23)</sup>	ATEX and CSA Flameproof, Intrinsically Safe, Division 2 (combination of E1, I1, E6, and I6) <i>Note: Only available on Housing Style codes 1A, 1J, 2A, 2J, 2E, or 2M.</i>	★
KB <sup>(23)</sup>	FM and CSA Explosion-proof, Dust Ignition-proof, Intrinsically Safe, Division 2 (combination of E5, E6, I5, and I6) <i>Note: Only available on Housing Style codes 1A, 1J, 2A, 2J, 2E, or 2M.</i>	★
KC	FM and ATEX Explosion-proof, Intrinsically Safe, Division 2 (combination of E5, E1, I5, and I1) <i>Note: Only available on Housing Style codes 1A, 1J, 2A, 2J, 2E, or 2M.</i>	★
KD	FM, CSA, and ATEX Explosion-proof, Intrinsically Safe (combination of E5, I5, E6, I6, E1, and I1) <i>Note: Only available on Housing Style codes 1A, 1J, 2A, 2J, 2E, or 2M.</i>	★
<b>Alternative Transmitter Material of Construction</b>		
<b>Standard</b>		<b>Standard</b>
L1	Inert Sensor Fill Fluid	★
L2	Graphite-filled (PTFE) o-ring	★
LA	Inert sensor fill fluid and graphite-filled (PTFE) o-ring	★

**Table A-10. Rosemount 3051SFP Integral Orifice Flowmeter Ordering Information**

★ The Standard offering represents the most common models and options. These options should be selected for best delivery.  
The Expanded offering is subject to additional delivery lead time.

<b>Digital Display<sup>(25)</sup></b>		
<b>Standard</b>		<b>Standard</b>
M5	PlantWeb LCD display (Requires PlantWeb housing)	★
M8 <sup>(26)(27)</sup>	Remote mount LCD display and interface, PlantWeb housing, 50 foot cable, SST bracket	★
M9 <sup>(26)(26)</sup>	Remote mount LCD display and interface, PlantWeb housing, 100 foot cable, SST bracket	★
<b>Terminal Blocks</b>		
<b>Standard</b>		<b>Standard</b>
T1 <sup>(28)</sup>	Transient terminal block	★
<b>Expanded</b>		
T2 <sup>(6)(29)</sup>	Terminal block with WAGO® spring clamp terminals	
T3 <sup>(6)(29)</sup>	Transient terminal block with WAGO spring clamp terminals	
<b>PlantWeb Control Functionality</b>		
<b>Standard</b>		<b>Standard</b>
A01 <sup>(6)(30)</sup>	FOUNDATION fieldbus Advanced Control Function Block Suite	★
<b>PlantWeb Diagnostic Functionality</b>		
<b>Standard</b>		<b>Standard</b>
D01 <sup>(6)(31)</sup>	FOUNDATION fieldbus Diagnostics Suite	★
DA2 <sup>(6)(31)</sup>	Advanced HART Diagnostics Suite (SPM, Power Advisory, Variable & Status Log, Service & Process Alerts)	★
<b>PlantWeb Enhanced Measurement Functionality</b>		
<b>Standard</b>		<b>Standard</b>
H01 <sup>(6)(31)(32)</sup>	FOUNDATION fieldbus Fully Compensated Mass Flow Block	★
<b>Cold Temperature</b>		
<b>Standard</b>		<b>Standard</b>
BRR <sup>(22)</sup>	-60 °F (-51 °C) Cold Temperature Start-up	★
<b>Special Configuration (Software)</b>		
<b>Standard</b>		<b>Standard</b>
C4 <sup>(20)</sup>	NAMUR Alarm & Saturation Signal Levels, High Alarm	★
C5 <sup>(20)(20)</sup>	NAMUR Alarm & Saturation Signal Levels, Low Alarm	★
C6 <sup>(20)(20)</sup>	Custom Alarm & Saturation Signal Levels, High Alarm <i>Note: A Configuration Data Sheet must be completed, see document number 00806-0100-4686.</i>	★
C7 <sup>(20)(20)</sup>	Custom Alarm & Saturation Signal Levels, Low Alarm <i>Note: A Configuration Data Sheet must be completed, see document number 00806-0100-4686.</i>	★
C8 <sup>(20)(20)</sup>	Low Alarm (Standard Rosemount Alarm & Saturation Signal Levels)	★
<b>Special Configuration (Hardware)</b>		
<b>Standard</b>		<b>Standard</b>
D1 <sup>(26)(20)</sup>	Hardware Adjustment (zero, span, security)	★
D4	External Ground Screw	★
DA <sup>(26)(20)</sup>	Hardware adjustment (zero, span, security) and External Ground Screw	★
<b>Conduit Electrical Connector</b>		
<b>Expanded</b>		
GE <sup>(33)</sup>	M12, 4-pin, Male Connector ( <i>euromast</i> ®)	
GM <sup>(33)</sup>	A size Mini, 4-pin, Male Connector ( <i>minifast</i> ®)	
<b>Typical Model Number: 3051SFP D S 010 A3 S 0150 D3 1A A 1A 3</b>		

(1) To improve pipe perpendicularity for gasket sealing, socket diameter is smaller than standard pipe O.D.

(2) Best flow coefficient uncertainty is between  $(0.2 < \beta < 0.6)$ .

(3) Required for Measurement Type codes 3, 4, 7, and D.

(4) For Measurement Type 1, 2, 5, and 6 with DP range 1, absolute limits are 0.5 to 2000 psi (0.03 to 137.9 bar) and gage limits are -14.2 to 2000 psig (-0.98 to 137.9 bar).

(5) Requires PlantWeb housing.

(6) Only available with Measurement Type D.

(7) Available approvals are FM Intrinsically Safe, Division 2 (option code I5), CSA Intrinsically Safe (option code I6), ATEX Intrinsic Safety (option code I1; only available with 2.4 GHz), and IECEx Intrinsic Safety (option code I7; only available with 2.4 GHz).



- (8) Material specified is cast as follows: CF-8M is the cast version of 316 SST, CF-3M is the cast version of 316L SST. For housing, material is aluminum with polyurethane paint.
- (9) Available with output code A only. Not available with approvals. See Rosemount 753R Product Data Sheet, 00813-0100-4379, to specify Web-Based Monitoring Indicator. Does not integrate into plant host systems.
- (10) Available with output code A only. Available approvals are FM Intrinsically Safe, Division 2 (option code I5), ATEX Intrinsic Safety (option code I1), or IECEx Intrinsic Safety (option code I7). Contact an Emerson Process Management representative for additional information.
- (11) Not available with Wireless Operating Frequency and Protocol option codes 1 or 2.
- (12) Not available with Wireless Operating Frequency and Protocol option codes 1 or 2 or Housing code 01. This option is only available with differential pressure ranges 2 and 3, and silicone fill fluid.
- (13) Thermowell material is the same as the body material.
- (14) Applies to assembled flowmeter only, mounting not tested.
- (15) Not available for bore sizes 0010, 0014, 0020, or 0034.
- (16) Isolation and Instrument valves not included in Traceability Certification.
- (17) Not available with DIN Process Connection codes D1, D2, or D3.
- (18) Materials of Construction comply with metallurgical requirements within NACE MR0175/ISO for sour oil field production environments. Environmental limits apply to certain materials. Consult latest standard for details. Selected materials also conform to NACE MR0103 for sour refining environments.
- (19) Only available with Measurement Type D.
- (20) Not available with Output Protocol code F or Housing code 01.
- (21) Not available with output code F. Not available with housing code 01 or 7J.
- (22) Only available with Measurement Types 1-7.
- (23) Not available with M20 or G ½ conduit entry size.
- (24) Consult an Emerson Process Management representative for availability.
- (25) Not available with Housing code 01 or 7J.
- (26) Not available with output code F, Housing code 01, option code DA1, or option code QT.
- (27) Cable supplied is Belden 3084A, rated for ambient temperatures up to 167°F (75°C).
- (28) Not available with Housing code 00, 01, 5A or 7J.
- (29) Available with Output Protocol code A and PlantWeb housing only.
- (30) Requires PlantWeb housing and output code F.
- (31) Requires PlantWeb housing and output code A. Includes Hardware Adjustments as standard.
- (32) Requires Rosemount Engineering Assistant version 5.5.1 to configure.
- (33) Not available with Housing code 00, 01, 5A, or 7J. Available with Intrinsically Safe approvals only. For FM Intrinsically Safe, Division 2 (option code I5) or FM FISCO Intrinsically Safe (option code IE), install in accordance with Rosemount drawing 03151-1009 to maintain outdoor rating (NEMA 4X and IP66).

**Table A-11. Rosemount 3051S Liquid Level Transmitter**

★ The Standard offering represents the most common models and options. These options should be selected for best delivery.  
The Expanded offering is subject to additional delivery lead time.

Model	Transmitter Type			
3051S	Liquid Level Transmitter			
<b>Performance Class</b>				
<b>Standard</b>				<b>Standard</b>
1	Ultra: 0.065% span accuracy, 100:1 rangedown, 12-year limited warranty			★
2	Classic: 0.065% span accuracy, 100:1 rangedown			★
<b>Connection Type</b>				
<b>Standard</b>				<b>Standard</b>
L	Level			★
<b>Measurement Type</b>				
<b>Standard</b>				<b>Standard</b>
D	Differential			★
G	Gage			★
A	Absolute			★
<b>Pressure Range</b>				
	<b>Differential (LD)</b>	<b>Gage (LG)</b>	<b>Absolute (LA)</b>	
<b>Standard</b>				<b>Standard</b>
2A	-250 to 250 inH <sub>2</sub> O (-623 to 623 mbar)	-250 to 250 inH <sub>2</sub> O (-623 to 623 mbar)	0 to 150 psia (10 bar)	★
3A	-1000 to 1000 inH <sub>2</sub> O (-2,5 to 2,5 bar)	-393 to 1000 inH <sub>2</sub> O (-0,98 to 2,5 bar)	0 to 800 psia (55 bar)	★
4A	-300 to 300 psi (-20,7 to 20,7 bar)	-14.2 to 300 psig (-0,98 to 21 bar)	0 to 4000 psia (276 bar)	★
5A	-2000 to 2000 psi (-137,9 to 137,9 bar)	-14.2 to 2000 psig (-0,98 to 137,9 bar)	N/A	★
<b>Transmitter Output</b>				
<b>Standard</b>				<b>Standard</b>
A	4-20 mA with digital signal based on HART protocol			★
F <sup>(1)</sup>	FOUNDATION fieldbus protocol			★
X <sup>(2)</sup>	Wireless (Requires wireless options and wireless PlantWeb housing)			★
<b>Housing Style</b>		<b>Material</b>	<b>Conduit Entry Size</b>	
<b>Standard</b>				<b>Standard</b>
00	None (SuperModule spare part, order output code A)			★
1A	PlantWeb housing	Aluminum	1/2-14 NPT	★
1B	PlantWeb housing	Aluminum	M20 x 1.5	★
1J	PlantWeb housing	SST	1/2-14 NPT	★
1K	PlantWeb housing	SST	M20 x 1.5	★

2A	Junction Box housing	Aluminum	1/2-14 NPT	★
2B	Junction Box housing	Aluminum	M20 x 1.5	★
2E	Junction Box housing with output for remote interface	Aluminum	1/2-14 NPT	★
2F	Junction Box housing with output for remote interface	Aluminum	M20 x 1.5	★
2J	Junction Box housing	SST	1/2-14 NPT	★
2M	Junction Box housing with output for remote interface	SST	1/2-14 NPT	★
5A	Wireless PlantWeb housing	Aluminum	1/2-14 NPT	★
5J	Wireless PlantWeb housing	SST	1/2-14 NPT	★
7J <sup>(3)</sup>	Quick Connect (A size Mini, 4-pin male termination)	SST		★
<b>Expanded</b>				
1C	PlantWeb housing	Aluminum	G <sup>1</sup> / <sub>2</sub>	
1L	PlantWeb housing	SST	G <sup>1</sup> / <sub>2</sub>	
2C	Junction Box housing	Aluminum	G <sup>1</sup> / <sub>2</sub>	
2G	Junction Box housing with output for remote interface	Aluminum	G <sup>1</sup> / <sub>2</sub>	
<b>Seal System Type</b>				
<b>Standard</b>				<b>Standard</b>
1	Direct-mount seal system			★
<b>High Pressure Side Extension (Between Transmitter Flange and Seal)</b>				
<b>Standard</b>				<b>Standard</b>
0	Direct-Mount (No Extension)			★
<b>Sensor Module Configuration (Low Side)</b>				
<b>Standard</b>				<b>Standard</b>
1 <sup>(4)</sup>	Tuned-System Assembly, One Capillary Remote Seal (Requires 1199 model number, see Table 6 of Rosemount DP Level PDS for seal information)			★
2	316L SST isolator / SST transmitter flange			★
3	Alloy C-276 isolator / SST transmitter flange			★
<b>Capillary Length</b>				
<b>Standard</b>				<b>Standard</b>
0	None			★

Seal Fill Fluid (High Side)		Temperature Limits (Ambient Temperature of 70° F (21° C))		
<b>Standard</b>				<b>Standard</b>
A	Syltherm XLT	-102 to 293 °F (-75 to 145 °C)		★
C	Silicone 704	32 to 401 °F (0 to 205 °C)		★
D	Silicone 200	-49 to 401 °F (-45 to 205 °C)		★
H	Inert (Halocarbon)	-49 to 320 °F (-45 to 160 °C)		★
G	Glycerine and Water	5 to 203 °F (-15 to 95 °C)		★
N	Neobee M-20	5 to 401 °F (-15 to 205 °C)		★
P	Propylene Glycol and Water	5 to 203 F (-15 to 95 °C)		★
<b>Process Connection Style</b>				
<b>Standard</b>				<b>Standard</b>
FF	Flush Flanged Seal			★
EF	Extended Flanged Seal			★
<b>Process Connection Size (High Side)</b>				
	<b>Flush Flanged Seal</b>	<b>Extended Flanged Seal</b>		
<b>Standard</b>				<b>Standard</b>
G	2-in./DN 50	—		★
7	3-in.	3-in./DN 80, 2.58-in. diaphragm		★
J	DN 80	—		★
9	4-in./DN 100	4-in./DN 100, 3.5-in. diaphragm		★
<b>Flange Rating (High Side)</b>				
<b>Standard</b>				<b>Standard</b>
1	ANSI/ASME B16.5 Class 150			★
2	ANSI/ASME B16.5 Class 300			★
4	ANSI/ASME B16.5 Class 600			★
G	PN 40 per EN 1092-1			★
E	PN 10/16 per EN 1092-1, Available with DN 100 only			★
<b>Isolator, Flange Material (High Side)</b>				
	<b>Flush Flanged Seal Isolator</b>	<b>Extended Flanged Seal Isolator and Wetted Parts</b>	<b>Flange Material</b>	
<b>Standard</b>				<b>Standard</b>
CA	316L SST	316L SST	CS	★
DA	316L SST	316L SST	SST	★
CB	Alloy C-276	Alloy C-276	CS	★
DB	Alloy C-276	Alloy C-276	SST	★
CC	Tantalum - seam welded <sup>(5)</sup>	—	CS	★
DC	Tantalum - seam welded <sup>(5)</sup>	—	SST	★

Lower Housing Material for FF, Extension Length for EF (High Side) <sup>(6)</sup>			
	Flush Flanged Seal	Extended Flanged Seal	
<b>Standard</b>			<b>Standard</b>
0	None	—	★
2	—	2-in. (50 mm)	★
4	—	4-in. (100 mm)	★
6	—	6-in. (150 mm)	★
A	316 SST	—	★
B	Alloy C-276	—	★
D	Carbon Steel	—	★
Flushing Connection Quantity and Size (Lower Housing, High Side)			
	Flush Flanged Seal	Extended Flanged Seal	
<b>Standard</b>			<b>Standard</b>
0	None	None	★
1	1 (1/4 - 18 NPT)	—	★
3	2 (1/4 - 18 NPT)	—	★
7	1 (1/2 - 14 NPT)	—	★
9	2 (1/2 - 14 NPT)	—	★

### Wireless Options (Requires option code X and wireless PlantWeb housing)

Update Rate			
<b>Standard</b>			<b>Standard</b>
WA	User Configurable Update Rate		★
Operating Frequency and Protocol			
<b>Standard</b>			<b>Standard</b>
3	2.4 GHz DSSS, IEC 62591 (WirelessHART)		★
Omnidirectional Wireless Antenna			
<b>Standard</b>			<b>Standard</b>
WK	External Antenna		★
WM	Extended Range, External Antenna		★
<b>Expanded</b>			
WN <sup>(13)</sup>	High-Gain, Remote Antenna		
SmartPower™			
<b>Standard</b>			<b>Standard</b>
1 <sup>(7)</sup>	Adapter for Black Power Module (I.S Power Module sold separately)		★

**Other Options** (Include with selected model number)

<b>Diaphragm Thickness</b>		
<b>Expanded</b>		
SC	0.006-in. (150 μm) available with 316L SST and Alloy C-276	
<b>Flushing Plug, Vent/Drain Valve</b>		
<b>Standard</b>		<b>Standard</b>
SD	Alloy C-276 plug(s) for flushing connection(s)	★
SG	316 SST plug(s) for flushing connection(s)	★
SH	316 SST vent/drain for flushing connection(s)	★
<b>Gasket Material</b>		
<b>Standard</b>		<b>Standard</b>
SJ	PTFE gasket (for use with flushing connection ring)	★
<b>Expanded</b>		
SN	Grafoil® gasket (for use with flushing connection ring)	
<b>Code Conformance</b>		
<b>Standard</b>		<b>Standard</b>
ST <sup>(8)</sup>	Wetted Materials Compliance to NACE MRO175/ISO 15156, MRO103	★
<b>PlantWeb Control Functionality</b>		
<b>Standard</b>		<b>Standard</b>
A01	FOUNDATION fieldbus Advanced Control Function Block Suite	★
<b>PlantWeb Diagnostic Functionality</b>		
<b>Standard</b>		<b>Standard</b>
D01	FOUNDATION fieldbus Diagnostics Suite	★
DA1 <sup>(9)</sup>	HART Diagnostics Suite	★
DA2 <sup>(9)(10)</sup>	Advanced HART Diagnostics Suite	★
<b>Software Configuration</b>		
<b>Standard</b>		<b>Standard</b>
C1 <sup>(11)</sup>	Custom software configuration (Requires Configuration Data Sheet)	★
<b>Gage Pressure Calibration</b>		
<b>Standard</b>		<b>Standard</b>
C3	Gage Pressure Calibration (3051SxLA4 only)	★
<b>Alarm Limit</b>		
<b>Standard</b>		<b>Standard</b>
C4 <sup>(11)</sup>	NAMUR alarm and saturation levels, high alarm	★
C5 <sup>(11)</sup>	NAMUR alarm and saturation levels, low alarm	★
C6 <sup>(11)</sup>	Custom alarm and saturation signal levels, high alarm (Requires C1 and Configuration Data Sheet)	★
C7 <sup>(11)</sup>	Custom alarm and saturation signal levels, low alarm (Requires C1 and Configuration Data Sheet)	★
C8 <sup>(11)</sup>	Low alarm (standard Rosemount alarm and saturation levels)	★

<b>Hardware Adjustments</b>		
<b>Standard</b>		<b>Standard</b>
D1 <sup>(11)(12)</sup>	Hardware adjustments (zero, span, alarm, security)	★
<b>Flange Adapter</b>		
<b>Standard</b>		<b>Standard</b>
D2	1/2-14 NPT flange adapter	★
<b>Expanded</b>		
D9	RC 1/2 SST flange adapter	
<b>Custody Transfer</b>		
<b>Standard</b>		<b>Standard</b>
D3 <sup>(13)</sup>	Measurement Canada Accuracy Approval	★
<b>Ground Screw</b>		
<b>Standard</b>		<b>Standard</b>
D4	External ground screw assembly	★
<b>Drain/Vent Valve</b>		
<b>Standard</b>		<b>Standard</b>
D5	Delete transmitter drain/vent valves (install plugs)	★
<b>Conduit Plug</b>		
<b>Standard</b>		<b>Standard</b>
DO <sup>(14)</sup>	316 SST Conduit Plug	★
<b>Product Certifications<sup>(15)</sup></b>		
<b>Standard</b>		<b>Standard</b>
E1	ATEX Flameproof	★
E2	INMETRO Flameproof	★
E3	China Flameproof	★
E4	TIIS Flameproof	★
E5	FM Explosion-proof, Dust Ignition-proof	★
E6 <sup>(16)</sup>	CSA Explosion-proof, Dust Ignition-proof, Division 2	★
E7	IECEX Flameproof, Dust Ignition-proof	★
I1	ATEX Intrinsic Safety	★
I2	INMETRO Intrinsic Safety	★
I3	China Intrinsic Safety	★
I4	TIIS Intrinsic Safety	★
I5	FM Intrinsically Safe, Division 2	★
I6	CSA Intrinsically Safe	★
I7	IECEX Intrinsic Safety	★
IA	ATEX FISCO Intrinsic Safety (FOUNDATION fieldbus protocol only)	★
IE	FM FISCO Intrinsically Safe (FOUNDATION fieldbus protocol only)	★

IF	CSA FISCO Intrinsically Safe (FOUNDATION fieldbus protocol only)	★
IG	IECEX FISCO Intrinsic Safety (FOUNDATION fieldbus protocol only)	★
K1	ATEX Flameproof, Intrinsic Safety, Type n, Dust	★
K2	INMETRO Flameproof, Intrinsic Safety	★
K5	FM Explosion-proof, Dust Ignition-proof, Intrinsically Safe, Division 2	★
K6 <sup>(16)</sup>	CSA Explosion-proof, Dust Ignition-proof, Intrinsically Safe, Division 2	★
K7	IECEX Flameproof, Dust Ignition-proof, Intrinsic Safety, Type n	★
KA <sup>(16)</sup>	ATEX and CSA Flameproof, Intrinsically Safe, Division 2	★
KB <sup>(16)</sup>	FM and CSA Explosion-proof, Dust Ignition-proof, Intrinsically Safe, Division 2	★
KC	FM and ATEX Explosion-proof, Intrinsically Safe, Division 2	★
KD <sup>(16)</sup>	FM, CSA, and ATEX Explosion-proof, Intrinsically Safe	★
N1	ATEX Type n	★
N3	China Type n	★
N7	IECEX Type n	★
ND	ATEX Dust	★
<b>Sensor Fill Fluid</b>		
<b>Standard</b>		<b>Standard</b>
L1 <sup>(17)</sup>	Inert sensor fill fluid	★
<b>O-ring</b>		
<b>Standard</b>		<b>Standard</b>
L2	Graphite-filled PTFE o-ring	★
<b>Bolting Material</b>		
<b>Standard</b>		<b>Standard</b>
L4	Austenitic 316 SST bolts	★
L5 <sup>(8)</sup>	ASTM A193, Grade B7M bolts	★
L6	Alloy K-500 bolts	★
L7 <sup>(8)</sup>	ASTM A453, Class D, Grade 660 bolts	★
L8	ASTM A193, Class 2, Grade B8M bolts	★
<b>Display Type<sup>(18)</sup></b>		
<b>Standard</b>		<b>Standard</b>
M5	PlantWeb LCD Display	★
M7 <sup>(19)(20)</sup>	Remote mount LCD display and interface, PlantWeb housing, no cable, SST bracket	★
M8 <sup>(19)</sup>	Remote mount LCD display and interface, PlantWeb housing, 50 ft. (15 m) cable, SST bracket	★
M9 <sup>(19)</sup>	Remote mount LCD display and interface, PlantWeb housing, 100 ft. (31 m) cable, SST bracket	★
<b>Pressure Testing</b>		
<b>Expanded</b>		
P1	Hydrostatic testing with certificate	



<b>Special Cleaning</b>		
<b>Expanded</b>		
P2	Cleaning for special services	
P3	Cleaning for less than 1PPM chlorine/fluorine	
<b>Calibration Certification</b>		
<b>Standard</b>		<b>Standard</b>
Q4	Calibration certificate	★
QP	Calibration certificate and tamper evident seal	★
<b>Material Traceability Certification</b>		
<b>Standard</b>		<b>Standard</b>
Q8	Material traceability certification per EN 10204 3.1	★
<b>Quality Certification for Safety</b>		
<b>Standard</b>		<b>Standard</b>
QS <sup>(11)</sup>	Prior-use certificate of FMEDA data	★
QT <sup>(21)</sup>	Safety certified to IEC 61508 with certificate of FMEDA data	★
<b>Transient Protection</b>		
<b>Standard</b>		<b>Standard</b>
T1 <sup>(22)(23)</sup>	Transient terminal block	★
<b>Toolkit Total System Performance Reports</b>		
<b>Standard</b>		<b>Standard</b>
QZ	Remote Seal System Performance Calculation Report	★
<b>Conduit Electrical Connector</b>		
<b>Standard</b>		<b>Standard</b>
GE <sup>(24)</sup>	M12, 4-pin, Male Connector (eurofast <sup>®</sup> )	★
GM <sup>(24)</sup>	A size Mini, 4-pin, Male Connector (minifast <sup>®</sup> )	★
<b>Typical Model Number for EF seal:</b>		
<b>3051S2LD 2A A 1A 1 0 2 0 D EF 7 1 DA 2 0</b>		

- (1) Requires PlantWeb housing.
- (2) Available approvals are FM Intrinsically Safe, Division 2 (option code I5), CSA Intrinsically Safe (option code I6), ATEX Intrinsic Safety (option code I1), and IECEx Intrinsic Safety (option code I7).
- (3) Available with output code A only. Available approvals are FM Intrinsically Safe, Division 2 (option code I5), ATEX Intrinsic Safety (option code I1), or IECEx Intrinsic Safety (option code I7). Contact an Emerson Process Management representative for additional information.
- (4) With option code 1, user must select Seal Location option code M in Table 6 of Rosemount DP Level PDS.
- (5) Not recommended for use with spiral wound metallic gaskets (see 1199 product data sheet, document 00813-0100-4016 for additional options).
- (6) Standard gasket for lower housing consists of non-asbestos fiber.
- (7) Long-life Power Module must be shipped separately, order Part No. 00753-9220-0001.
- (8) Materials of Construction comply with metallurgical requirements highlighted within NACE MR0175/ISO 15156 for sour oil field production environments. Environmental limits apply to certain materials. Consult latest standard for details. Selected materials also conform to NACE MR0103 for sour refining environments.
- (9) Requires PlantWeb housing and output code A. Includes Hardware Adjustments as standard.
- (10) Consult an Emerson Process Management representative for availability.
- (11) Not available with output code F.
- (12) Not available with housing style codes 00, 2E, 2F, 2G, 2M, 5A, 5J, or 7J.
- (13) Requires PlantWeb housing and Hardware Adjustments option code D1. Limited availability depending on transmitter type and range. Contact an Emerson Process Management representative for additional information.
- (14) Transmitter is shipped with 316 SST conduit plug (uninstalled) in place of standard carbon steel conduit plug.
- (15) Valid when SuperModule Platform and housing have equivalent approvals.
- (16) Not available with M20 or G ½ conduit entry size.
- (17) Only available on differential and gage measurement types. Silicone fill fluid is standard.
- (18) Not available with Housing 7J.
- (19) Not available with output code F, option code DA1, option code DA2, or option code QT.
- (20) See the 3051S Reference Manual (document number 00809-0100-4801) for cable requirements. Contact an Emerson Process Management representative for additional information.

*(21) Not available with output code F or X. Not available with housing code 7J. Not available with option code DA1.*

*(22) Not available with Housing code 00, 5A, 5J, or 7J.*

*(23) The T1 option is not needed with FISCO Product Certifications; transient protection is included in the FISCO product certification codes IA, IE, IF, and IG.*

*(24) Not available with Housing code 00, 5A, 5J, or 7J. Available with Intrinsically Safe approvals only. For FM Intrinsically Safe, Division 2 (option code I5) or FM FISCO Intrinsically Safe (option code IE), install in accordance with Rosemount drawing 03151-1009 to maintain outdoor rating (NEMA 4X and IP66).*

---

# Appendix B Product Certifications

---

---

Approved manufacturing locations .....	page 139
Telecommunication compliance .....	page 139
FCC and IC approvals .....	page 139
Ordinary location certification for FM .....	page 139
Hazardous locations certifications .....	page 141

---

## B.1 Wireless certifications

### B.1.1 Approved manufacturing locations

Rosemount Inc. — Chanhassen, Minnesota USA  
Emerson Process Management GmbH & Co. — Wessling, Germany  
Emerson Process Management Asia Pacific Private Limited — Singapore  
Beijing Rosemount Far East Instrument Co., LTD — Beijing, China  
Emerson Process Management LTDA — Sorocaba, Brazil  
Emerson Process Management (India) Pvt. Ltd. — Daman, India

### B.1.2 Telecommunication compliance

All wireless devices require certification to ensure that they adhere to regulations regarding the use of the RF spectrum. Nearly every country requires this type of product certification. Emerson is working with governmental agencies around the world to supply fully compliant products and remove the risk of violating country directives or laws governing wireless device usage.

### B.1.3 FCC and IC approvals

This device complies with Part 15 of the FCC Rules. Operation is subject to the following conditions: This device may not cause harmful interference this device and must accept any interference received, including interference that may cause undesired operation.

This device must be installed to ensure a minimum antenna separation distance of 20cm from all persons.

### B.1.4 Ordinary location certification for FM

As standard, the transmitter has been examined and tested to determine that the design meets basic electrical, mechanical, and fire protection requirements by FM, a nationally recognized testing laboratory (NRTL) as accredited by the Federal Occupational Safety and Health Administration (OSHA).

## European directive information

The EC declaration of conformity for all applicable European directives for this product can be found at [www.rosemount.com](http://www.rosemount.com). A hard copy may be obtained by contacting an Emerson Process Management representative.

### ATEX directive (94/9/EC)

Emerson Process Management complies with the ATEX Directive.

### European Pressure Equipment Directive (PED) (97/23/EC)

Models 3051S\_CA4; 3051S\_CD2, 3, 4, 5; (*also with P9 option*) Pressure Transmitters — QS  
Certificate of Assessment -  
EC No. PED-H-100, Module H Conformity Assessment

All other Model 3051S Pressure Transmitters  
— Sound Engineering Practice

Transmitter Attachments: Diaphragm Seal - Process Flange -  
Manifold — Sound Engineering Practice

Primary Elements, Flowmeter  
— See appropriate Primary Element QIG

### Electro Magnetic Compatibility (EMC) (2004/108/EC)

EN 61326-1:2006  
EN 61326-2-3:2006

### Radio and telecommunications terminal equipment directive (R&TTE)(1999/5/EC)

Emerson Process Management complies with the R&TTE Directive.

## B.1.5 Hazardous locations certifications

### North American Certifications

#### Factory Mutual (FM) Approvals

- I5** FM Intrinsically Safe, Non-Incendive, and Dust Ignition-proof.  
Intrinsically Safe for Class I/II/III, Division 1,  
Groups A, B, C, D, E, F, and G.  
Zone Marking: Class I, Zone 0, AEx ia IIC  
Temperature Codes T4 ( $T_{amb} = -50$  to  $70^{\circ}\text{C}$ )  
Non-Incendive for Class I, Division 2, Groups A, B, C, and D.  
Dust Ignition-proof for Class II/III, Division 1,  
Groups E, F, and G.  
Ambient temperature limits:  $-50$  to  $85^{\circ}\text{C}$   
For use with Rosemount SmartPower options  
00753-9220-0001 only.  
Enclosure Type 4X / IP66

### CSA - Canadian Standards Association

#### Process sealing

All CSA hazardous approved transmitters are certified per ANSI/ISA 12.27.01-2003.

- I6** CSA Intrinsically Safe  
Intrinsically Safe for Class I, Division 1, Groups A, B, C, and D.  
Temp Code T3C  
Enclosure Type 4X / IP66  
For use with Rosemount SmartPower options  
00753-9220-0001 only.

### European Certifications

- I1** ATEX Intrinsic Safety  
Certificate No.: BAS01ATEX1303X  II 1G  
Ex ia IIC T4 ( $T_a = -60^{\circ}\text{C}$  to  $70^{\circ}\text{C}$ )  
IP66  
For use with Rosemount SmartPower options  
00753-9220-0001 only.

### Special conditions for safe use (x)

The surface resistivity of the antenna is greater than one gigaohm. To avoid electrostatic charge build-up, it must not be rubbed or cleaned with solvents or a dry cloth.

© 1180

## **IECEX certifications**

- I7** IECEX Intrinsic Safety  
Certificate No.: IECEX BAS 04.0017X  
Ex ia IIC T4 (Ta = -60 °C to 70 °C)  
For use with Rosemount SmartPower options  
00753-9220-0001 only.  
IP66

## **Special conditions for safe use (x)**

The surface resistivity of the antenna is greater than one gigaohm. To avoid electrostatic charge build-up, it must not be rubbed or cleaned with solvents or a dry cloth.

---

# Appendix C High Gain Remote Antenna Option

---

---

Safety messages .....	page 143
Functional specifications .....	page 144
Installation considerations .....	page 145
Transient / lightning considerations .....	page 145
Dimensional drawings .....	page 146
Installation steps .....	page 147

---

## C.1 Safety messages

Procedures and instructions in this section may require special precautions to ensure the safety of the personnel performing the operations. Information that raises potential safety issues is indicated by a warning symbol (⚠). Refer to the following safety messages before performing an operation preceded by this symbol.

### C.1.1 Warnings

#### WARNING

When installing remote mount antennas for the wireless field device, always use established safety procedures to avoid falling or contact with high-power electrical lines.

Install remote antenna components for the wireless field device in compliance with local and national electrical codes and use best practices for lightning protection.

Before installing consult with the local area electrical inspector, electrical officer, and work area supervisor.

The wireless field device remote antenna option is specifically engineered to provide installation flexibility while optimizing wireless performance and local spectrum approvals. To maintain wireless performance and avoid non-compliance with spectrum regulations, do not change the length of cable or the antenna type.

If the supplied remote mount antenna kit is not installed per these instructions, Emerson Process Management is not responsible for wireless performance or non-compliance with spectrum regulations.

Be aware of overhead electrical power lines.

---

## C.2 Functional specifications

### Output

WirelessHART 2.4 GHz DSSS (Direct Sequence Spread Spectrum).

Radio Frequency Power Output from Antenna:

- High Gain Remote (WN option) antenna: Maximum of 40 mW (16 dBm) EIRP (Equivalent Isotropically Radiated Power)

### Communications range

2/3 mile (3,300 feet) (1.0 km) with L.O.S.

### Coaxial length

25 feet (7.6 meters) with Type N Connections

### Coaxial material

- Heavy duty, low loss LMR400 cable
- Minimum coaxial bend diameter: 1.0 ft (0.3 meter)

### Antenna

- Remote mount Omni directional Antenna
- Fiberglass & Aluminum construction
- 8 Db Gain
- Meets MIL-STD-810G (Method 510.5, Procedure I and II)

### Physical specifications

Weight : 1.0 lb (0.4 kg)

### RF lightning arrestor

### In-line lightning arrestor

Electrical Connection: Lightning arrestor MUST be grounded per local electrical codes and regulations.

### Mounting Bracket

- Horizontal or vertical mast accommodation
- Supported mast diameter: 1.0-2.5 inch (2.5-6.4 cm)
- Aluminum bracket
- Nickel/Zinc plated mounting U-bolts

### Ratings

NEMA 4X, and IP66/67



## Vibration

3g Max vibration

## C.3 Installation considerations

### Antenna mounting

Mount antenna vertically ( $\pm 5^\circ$ )

### Antenna height

Mount antenna 14 feet (4.3 meters) above infrastructure with clear line of sight.

Coaxial Cable

Ensure that coaxial cable is securely affixed to the mast to avoid excessive cable movement.

### Coaxial drip loop

Ensure a drip loop is installed not closer than 1 foot (0.3 meters) from the transmitter. It may also be convenient to affix the drip loop to the lower portion of the mast ensuring that condensation or rainwater will flow away from the coaxial connections.

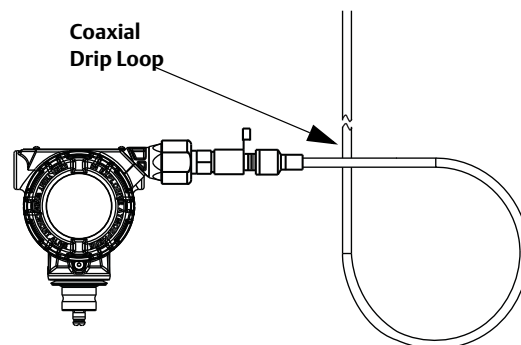

### Moisture protection

Utilize the coaxial sealant that is included in the high gain remote mounting kit package. Follow included instructions for application on the coaxial connection.

## C.4 Transient / lightning considerations

### Gateway transient protection

When installing, consider including transient / lightning protection (not provided) on interface connections (Ethernet, Modbus, and Coaxial connections) to other equipment.

### RF lightning arrestor ground connection

Ensure grounding connection is made on the RF lightning arrestor ground connection point.

## C.5 Dimensional drawings

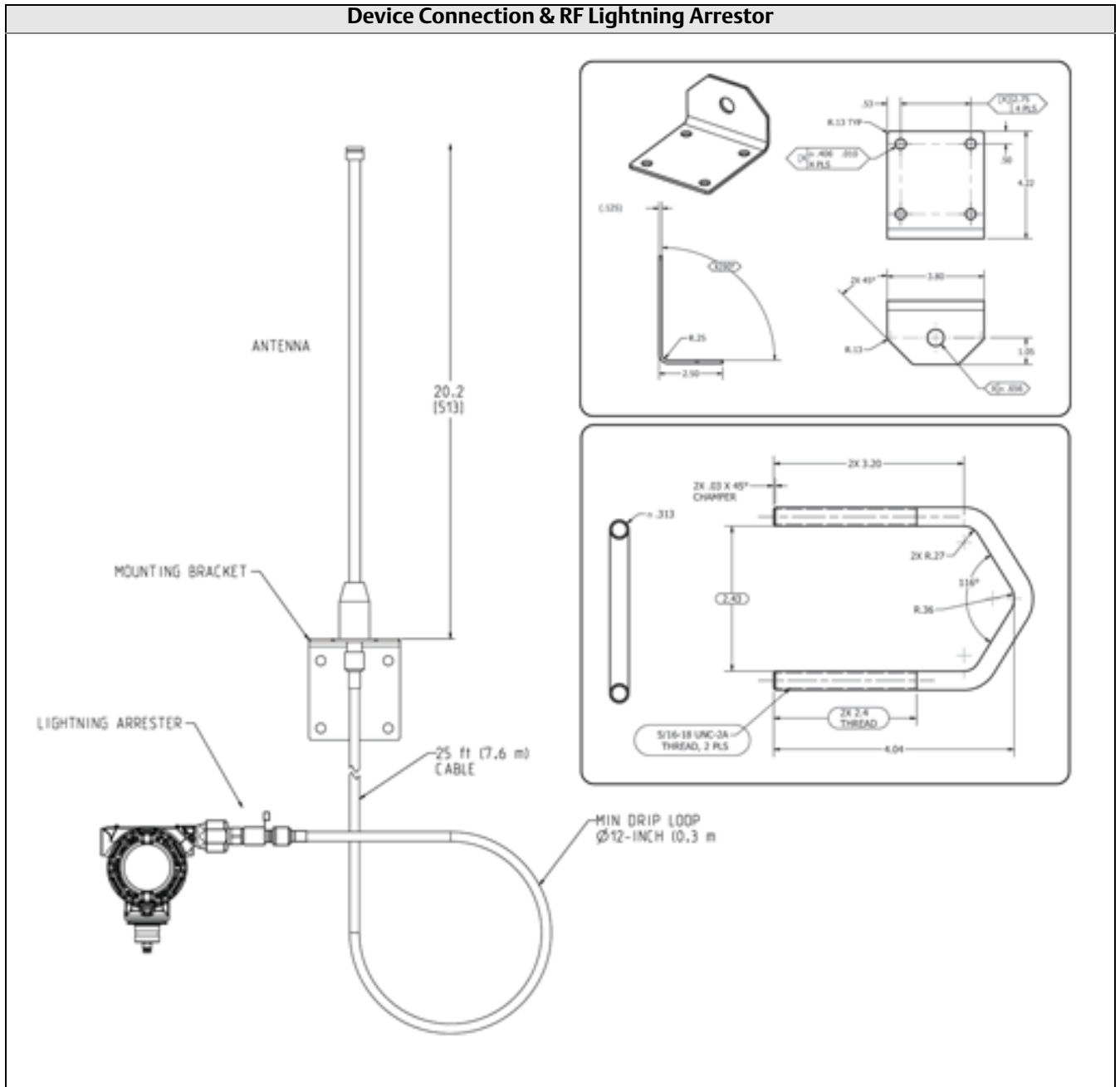

## C.6 Installation steps

1. Mount the transmitter following best practice mounting procedures as outlined in the Quick Installation Guide and Product Manual.
2. Connect the RF Lightning protector to the device and tighten.

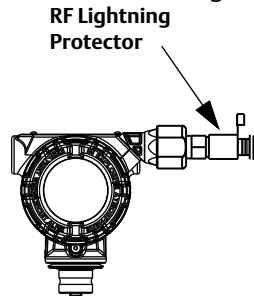

3. Connect antenna to mounting bracket and tighten nut carefully.

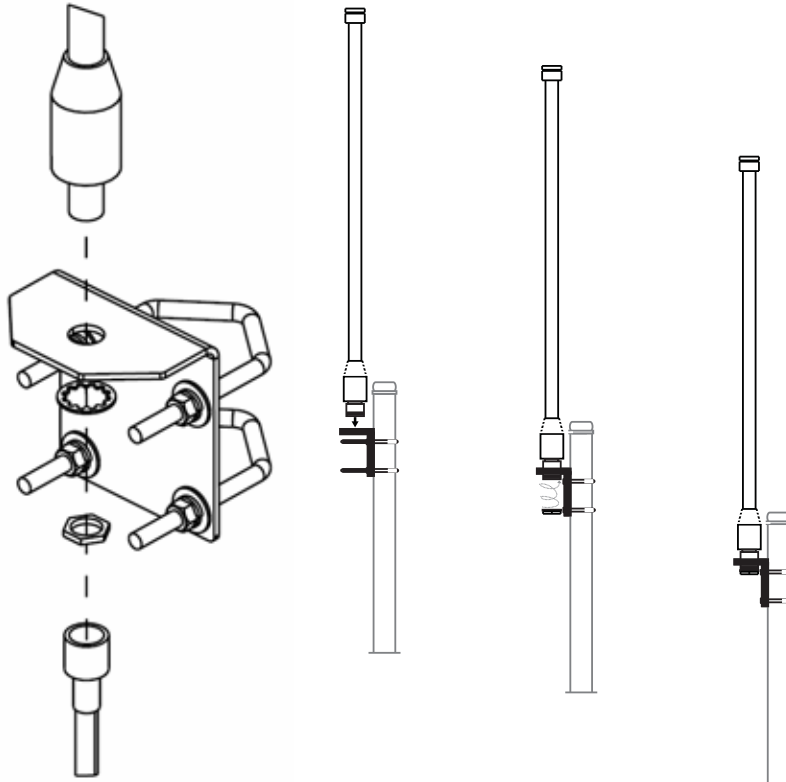

4. Unwind coaxial cable and connect the cable to both the antenna and the lightning protector connected to the transmitter. Leaving one loop minimum for a drip loop. Ensure the drip loop is lower than the device allowing water to flow away from the device.

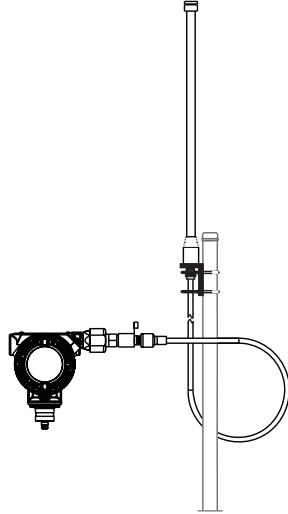

5. Apply the coaxial sealant around each of the coaxial connections and at the lightning arrester making sure the RF connections are completely sealed.

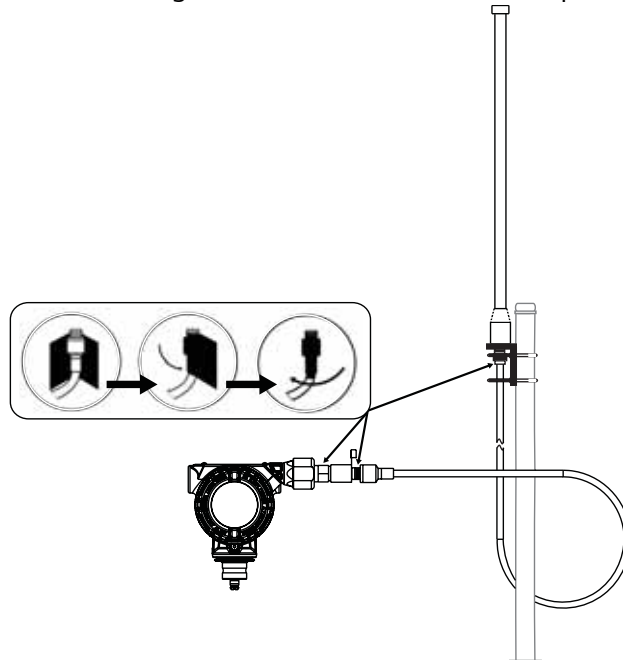

6. Attach u-bolts to mounting bracket in correct orientation ensuring that antenna will be positioned in a vertical position.

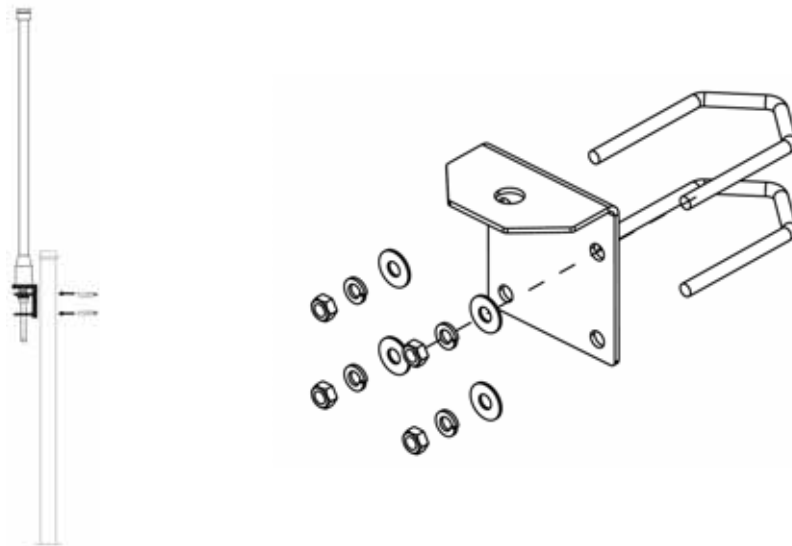

7. Tighten u-bolts to mast and ensure that antenna is pointed in a vertical direction.

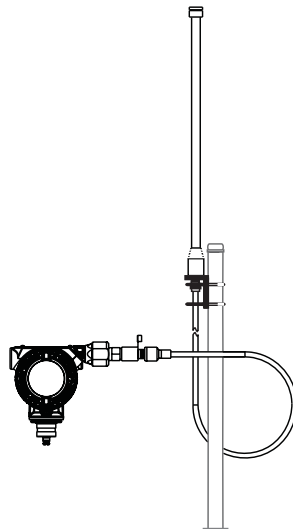



# Appendix D Field Communicator Menu Trees and Fast Keys

Field Communicator menu trees ..... page 151

## D.1 Field Communicator menu trees

Figure D-1. Rosemount 3051S Wireless Field Communicator menu tree: Overview

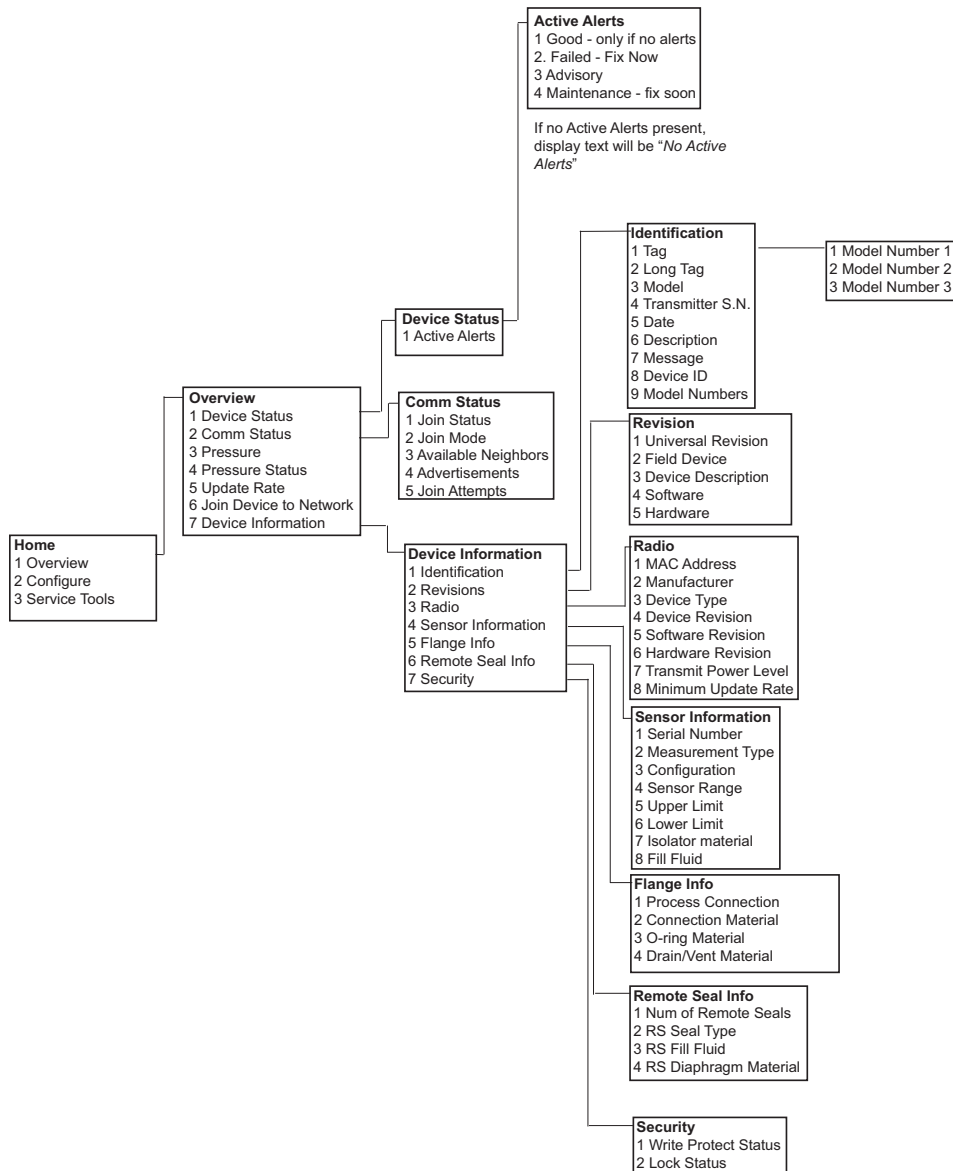

Figure D-2. Rosemount 3051S Wireless Field Communicator menu tree: Configure

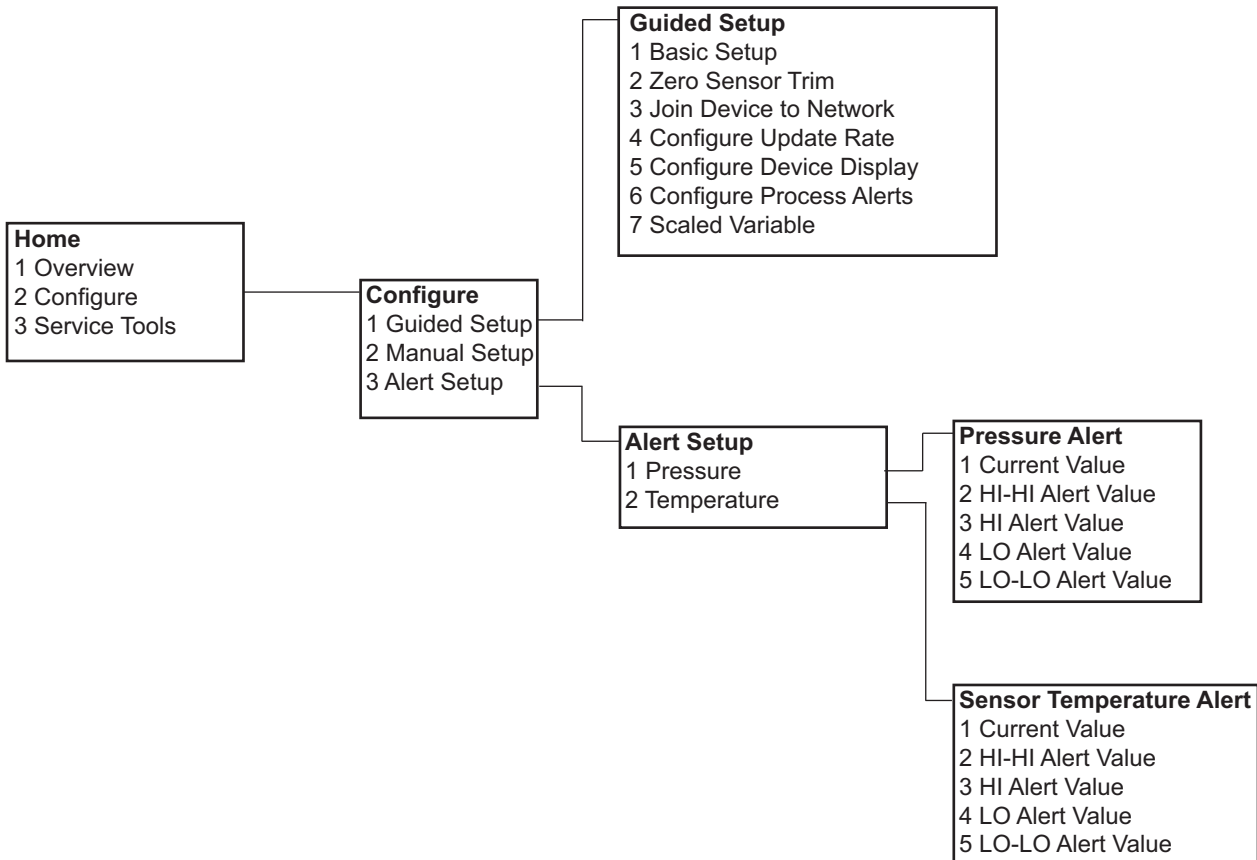



Figure D-3. Rosemount 3051S Wireless Field Communicator menu tree: Manual Setup

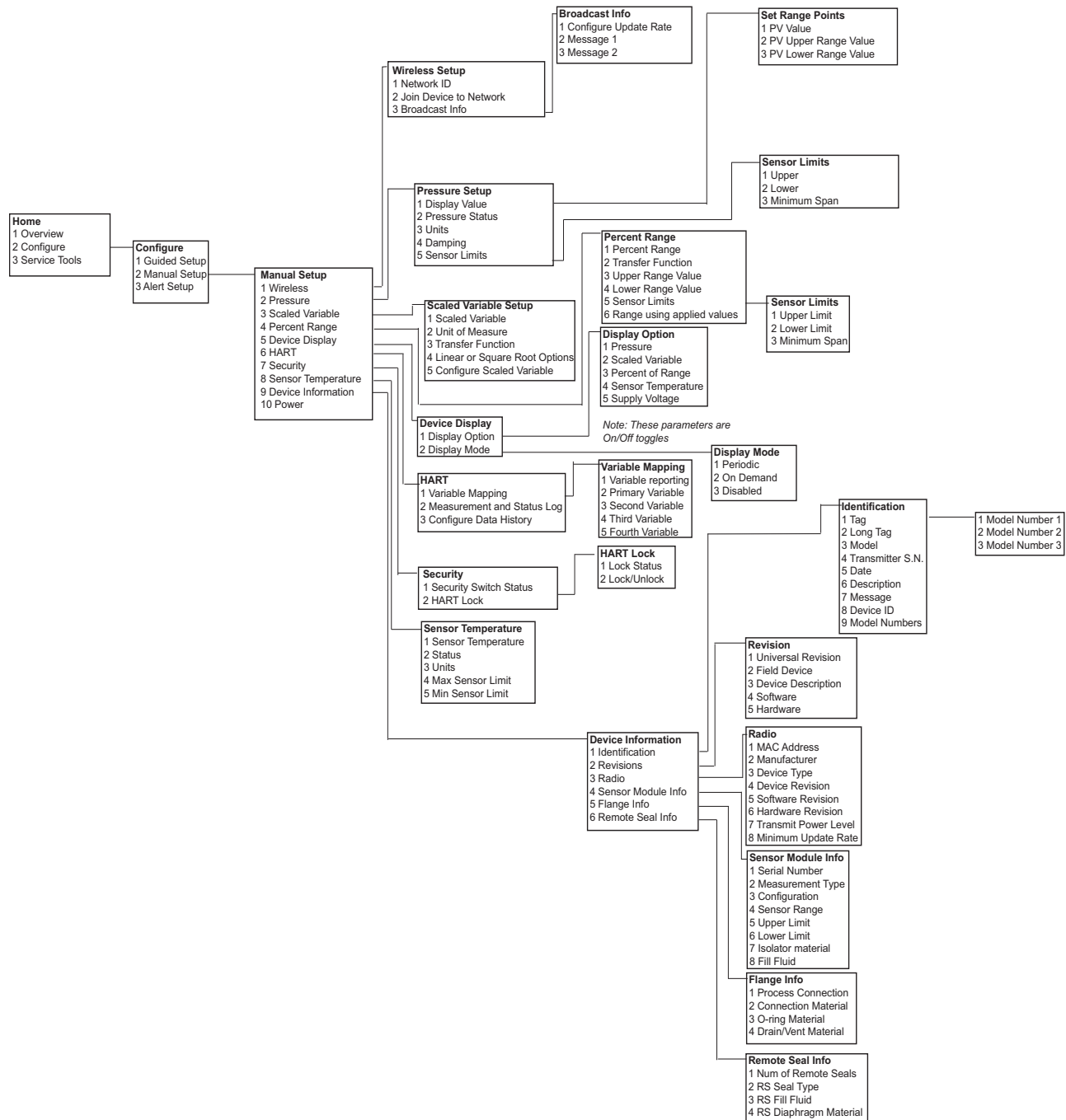
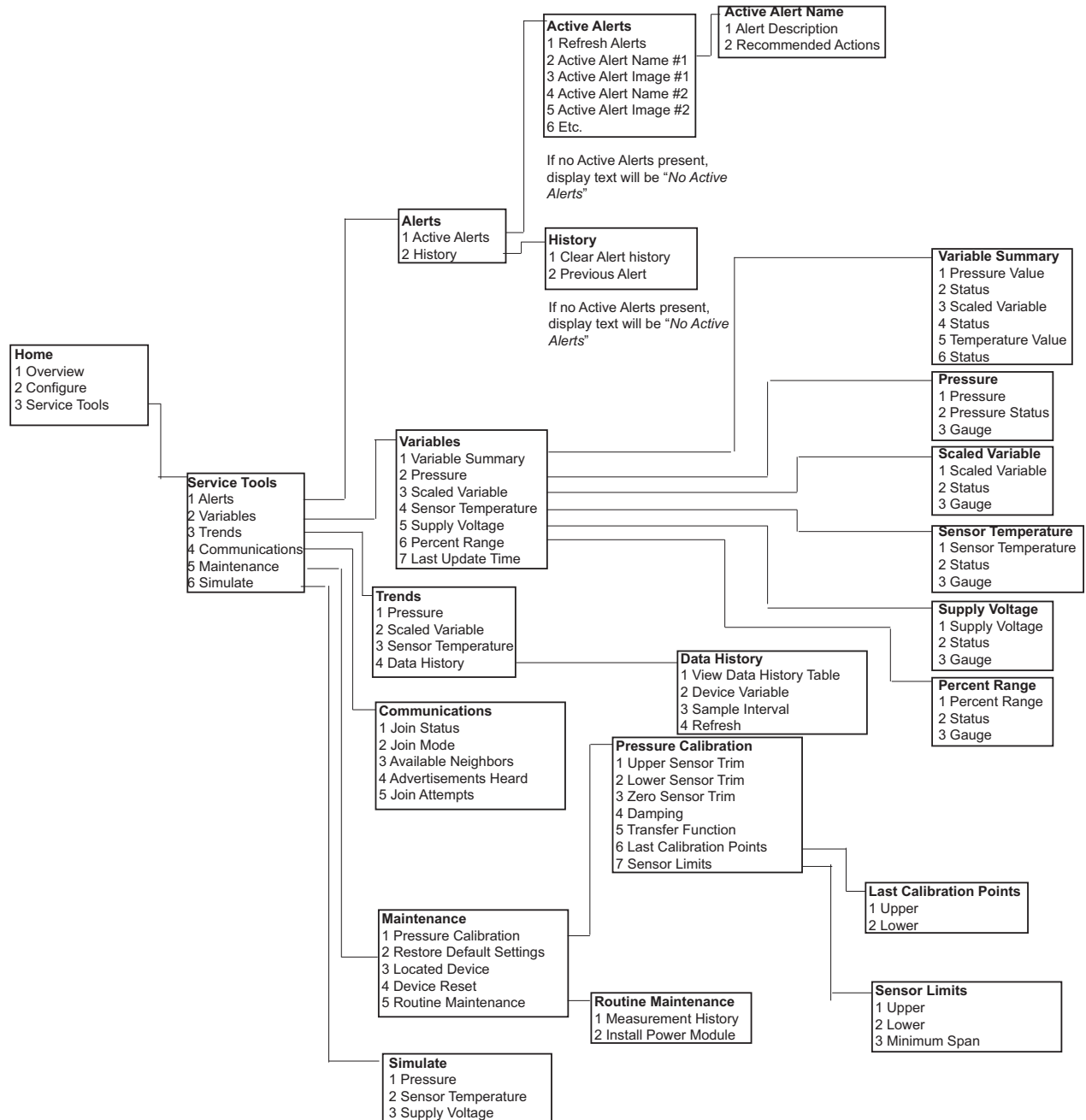

Figure D-4. Rosemount 3051S Wireless Field Communicator menu tree: Manual Setup



# Index

## A

Analog output trim ..... 54  
Approvals ..... 139, 143

## B

Basic setup ..... 13  
Bolts  
    Installation ..... 33  
    Material ..... 33  
Brackets  
    Mounting ..... 32

## C

Calibration ..... 51  
    Full trim ..... 53  
    Sensor trim ..... 52  
    Tasks ..... 52  
    Zero trim ..... 53  
Cloning ..... 25  
Commissioning  
    HART protocol  
        AMS7  
        HART Communicator7  
Compensating line pressure ..... 54  
Configuration  
    Applying a user configuration ..... 26  
    Cloning ..... 8, 25  
    Data review ..... 10  
    LCD meter ..... 16  
    Recalling ..... 8, 25  
    Reusable copy ..... 26  
    Saving ..... 8, 25  
Considerations  
    Compatibility ..... 32  
    Environmental ..... 30  
    General ..... 29  
    Mechanical ..... 30

## D

Detailed setup ..... 17  
Diagnostics and service ..... 23  
    Transmitter test ..... 23, 24  
Diagrams  
    HART terminal block ..... 40  
    Installation ..... 37  
Disassembly  
    Before disassembling ..... 72  
    Remove from service ..... 72  
    Remove housing ..... 73  
    Removing sensor module ..... 73  
Disassembly procedures ..... 72

## Operation and Maintenance

## E

Environmental considerations ..... 30

## F

Full trim ..... 53

## G

Gas mounting requirements ..... 37  
Grounding ..... 39  
    External assembly ..... 39

## H

Housing Rotation  
    Junction Box ..... 39  
    PlantWeb ..... 39

## I

Impulse piping ..... 36  
Installation ..... 32  
    Bolts ..... 33  
    Cover ..... 32  
    Housing rotation ..... 39  
    LCD meter ..... 40  
    Model 305 manifold ..... 42  
    Model 306 manifold ..... 42  
    Mounting ..... 32  
        Brackets32  
        Torque values33  
    Process Flange Orientation ..... 32  
Introduction ..... 1

## L

LCD meter ..... 16  
    Configuration ..... 16  
    Installing ..... 40  
    Options ..... 16  
Line pressure  
    Compensating ..... 54  
Liquid mounting requirements ..... 37  
Low flow cutoff ..... 18

## M

Maintenance ..... 51  
Manifold installations ..... 42  
Manual  
    Use of ..... 1  
Mechanical considerations ..... 29

Mounting	
Bolt installation	
Torque values	33
Installation	32
Mounting requirements	37
Gas	37
Liquid	37
Steam	37

## O

Operation	51
Options	
LCD meter	16
Output	
Process variables	12
Sensor temperature	12
Transfer function	14

## P

Piping, impulse	36
Process connections	38
Process variables	12
Units	13

## R

Reassembly	74
Install terminal block	74
Process sensor body	75
Reassembly procedures	74
Recalling	25
Re-mapping	21
Returning products and materials	76
Reusable copy	26

## S

Saving a configuration	25
Sensor module	
Removing	73
Sensor Temperature	13, 15
Sensor temperature	12
Unit	18
Sensor trim	52
Service and Diagnostics	23
Service Support	3
Setup	
Basic	13
Detailed	17
Steam mounting requirements	37

## T

Tagging	29
Terminal block	
Installing	74

Terminal block diagrams	
HART protocol	40
Test	23, 24
Torque values	33
Transfer function	14
Transmitter functions	51
Transmitter test	23, 24
Trim	
Analog output	54
Full	53
Sensor	52
Zero	53
Troubleshooting	67
Reference table	71

## U

Units, Process variable	13
-------------------------	----

## Z

Zero trim	53
-----------	----



*Standard Terms and Conditions of Sale can be found at [www.rosemount.com/terms\\_of\\_sale](http://www.rosemount.com/terms_of_sale)  
The Emerson logo is a trademark and service mark of Emerson Electric Co.  
Rosemount, the Rosemount logotype, and SMART FAMILY are registered trademarks of Rosemount Inc.  
Coplanar is a trademark of Rosemount Inc.  
Halocarbon is a trademark of the Halocarbon Products Corporation.  
Fluorinert is a registered trademark of Minnesota Mining and Manufacturing Company Corporation  
Syltherm 800 and D.C. 200 are registered trademarks of Dow Corning Corporation.  
Neobee M-20 is a registered trademark of PVO International, Inc.  
HART is a registered trademark of the HART Communication Foundation.  
Foundation fieldbus is a registered trademark of the Fieldbus Foundation.  
All other marks are the property of their respective owners.*

© May 2013 Rosemount, Inc. All rights reserved.

**Emerson Process Management  
Rosemount Measurement**

8200 Market Boulevard  
Chanhassen MN 55317 USA  
Tel (USA) 1 800 999 9307  
Tel (International) +1 952 906 8888  
Fax +1 952 906 8889

**Emerson Process Management  
Latin America**

1300 Concord Terrace, Suite 400  
Sunrise Florida 33323 USA  
Tel + 1 954 846 5030

**Emerson Process Management  
GmbH & Co.**

Argelsrieder Feld 3  
82234 Wessling  
Germany  
Tel 49 (8153) 9390  
Fax 49 (8153) 939172

**Emerson Process Management Asia  
Pacific Private Limited**

1 Pandan Crescent  
Singapore 128461  
T (65) 6777 8211  
F (65) 6777 0947  
Enquiries@AP.EmersonProcess.com

**Beijing Rosemount Far East  
Instrument Co., Limited**

No. 6 North Street,  
Hepingli, Dong Cheng District  
Beijing 100013, China  
T (86) (10) 6428 2233  
F (86) (10) 6422 8586

**ROSEMOUNT®**



**EMERSON™**  
Process Management