

Thermalert® GP Series

Operator's Manual

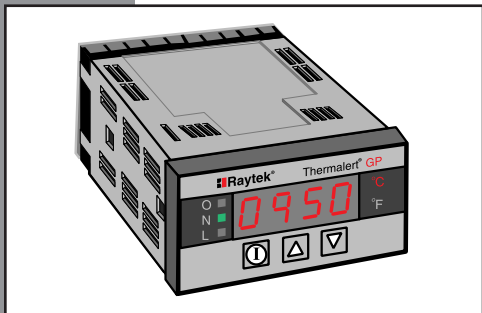

Raytek®
Infrared Temperature Measurement

58823-9
Rev C 11/2002

Worldwide Headquarters

Raytek Corporation

Box 1820, Santa Cruz, CA

95061-1820

Phone: (831) 458-1110

(800) 227-8074

FAX: (831) 458-1239

Raytek Mexico

Phone: 55-22 30-4380

FAX: 55-22 30-4438

Raytek do Brasil

Phone: 55-15-233-6338

FAX: 55-15-233-6826

Raytek China Company

Phone: 86-10/6437-0284

FAX: 86-10/6437-0285

Raytek Japan, Inc.

Phone: 81-6-4390-5015

FAX: 81-6-4390-5016

European Headquarters

Raytek GmbH

Berlin, Germany

Phone: 49 030/47 80 08-0

FAX: 49 030/47 10 25-1

Raytek UK Ltd.

Phone: 441-908/630800

FAX: 441-908/630900

Raytek France

Phone: +33 1 64 53 15 40

FAX: +33 1 64 53 15 44

Internet Address: <http://www.raytek.com>

Raytek and Thermalert are registered trademarks of Raytek Corp. All other brands or products are trademarks of their respective owners.

© 2001 Raytek Corporation

WARRANTY

Raytek warrants this instrument to be free from defects in material and workmanship under normal use and service for the period of two years from date of purchase. This warranty extends only to the original purchaser. This warranty shall not apply to fuses, batteries, or any product which has been subject to misuse, neglect, accident, or abnormal conditions of operation.

In the event of failure of a product covered by this warranty, Raytek will repair the instrument when it is returned to an authorized Service Facility within two years of the original purchase, provided the warrantor's examination discloses to its satisfaction that the product was defective. The warrantor may, at its option, replace the product in lieu of repair. With regard to any instrument returned within two years of the original purchase, said repairs or replacement will be made without charge. If the failure has been caused by misuse, neglect, accident, or abnormal conditions of operation, repairs will be billed at nominal cost. In such cases, an estimate will be submitted before work is started, if requested.

THE FOREGOING WARRANTY IS IN LIEU OF ALL OTHER WARRANTIES, EXPRESSED OR IMPLIED, INCLUDING BUT NOT LIMITED TO ANY IMPLIED WARRANTY OF MERCHANTABILITY, FITNESS, OR ADEQUACY FOR ANY PARTICULAR PURPOSE OR USE. RAYTEK SHALL NOT BE LIABLE FOR ANY SPECIAL, INCIDENTAL OR CONSEQUENTIAL DAMAGES, WHETHER IN CONTRACT, TORT, OR OTHERWISE.

TABLE OF CONTENTS

QUICK REFERENCE	SEE APPENDIX A
SECTION	PAGE
1.0 DESCRIPTION	1
2.0 THERMALERT GP MONITOR	2
2.1 SPECIFICATIONS	2
2.1.1 Operational	2
2.1.2 Electrical	3
2.1.3 Physical	3
2.2 MOUNTING INSTRUCTIONS	4
2.3 ELECTRICAL INSTALLATION	5
2.3.1 Terminal Block Layout	5
2.3.2 Connecting Input Devices	6
2.3.3 Power Connections	7
2.3.4 Output Connections	8
2.3.5 Relay Accessory	8
2.4 OPERATION	9
2.4.1 Display/Key Pad	10
2.4.2 Device Selection	11
2.4.3 Emissivity	14
2.4.4 Setpoints 1 and 2	15
2.4.5 4-20mA Analog Output	19
2.4.6 Degrees C and F	20
2.4.7 Peak Hold, Valley Hold, and Average	21
2.4.8 Ambient Temperature Compensation (T-ambient)	23
2.4.9 Display and Analog Output Offsets	24
2.4.10 Thermocouple Output	25
2.4.11 Lockout Mode	26
2.4.11 Factory Defaults	26

SECTION	PAGE
3.0 MAINTENANCE	27
3.1 TROUBLESHOOTING MINOR PROBLEMS	27
3.2 FAIL-SAFE OPERATION	28
APPENDIX A QUICK REFERENCE	29
APPENDIX B RAYTEK INFRARED SENSING HEADS	33
B.1 THERMALERT GP SENSOR MODELS	33
B.2 CONNECTING SENSOR HEADS AND INPUT DEVICES	34
B.3 POWER CONNECTIONS	35
B.4 OUTPUT CONNECTIONS	35
B.5 THE GPR AND GPS SENSING HEADS	36
B.5.1 GPR Head	36
B.5.2 GPS Laser Sighting Head	37
B.5.3 Adjustable Mounting Bracket Accessory	39
B.5.4 GPR & GPS Head with Air/Water-cooled Housing	40
B.5.5 GPR/GPS Air Purge Collar	41
B.5.6 GPR/GPS Right Angle Mirror	42
B.5.7 GPR Sighting Viewer Tool	43
B.5.8 GPR and GPS Head Specifications	44
B.5.8.1 Optical	44
B.5.8.2 Thermal	46
B.5.8.3 Physical	47
B.5.9 GPR and GPS Accessories	48
B.5.10 Options	48

SECTION	PAGE	
B.6	GP MINIATURE HEAD INFORMATION	49
B.6.1	GPM Head	49
B.6.2	Adjustable Mounting Bracket	50
B.6.3	GPM Head with Air Cooling System	50
B.6.4	GPM Air Purge Jacket	52
B.6.5	GPM Right Angle Mirror	53
B.6.6	GPM Head Specifications	54
B.6.6.1	Optical	54
B.6.6.2	Thermal	55
B.6.6.3	Physical	55
B.6.6.4	Environmental	55
B.6.7	GP Miniature Head Accessories	56
B.6.8	Options	56
B.7	INSTALLATION OF SENSING HEADS	57
B.7.1	Preparation	57
B.7.1.1	Ambient Temperature	57
B.7.1.2	Distance and Spot Size	58
B.7.1.3	Atmospheric Quality	59
B.7.1.4	Electrical Interference	59
B.7.2	GPR/GPS Mechanical Installation	60
B.7.3	GPR/GPS Electrical Installation	60
B.7.4	GPM Mechanical Installation	61
B.7.5	GPM Electrical Installation	61
B.7.6	Aiming the Sensing Head	62
B.7.7	Cleaning the Sensing Head Lens	63

SECTION	PAGE
APPENDIX C EMISSIVITY	65
C.1 HOW TO DETERMINE EMISSIVITY	65
C.2 TYPICAL EMISSIVITY VALUES FOR METALS	66
C.3 TYPICAL EMISSIVITY VALUES FOR NON-METALS	68
APPENDIX D MOUNTING BRACKET ACCESSORY	69
APPENDIX E CUTOUT TEMPLATE AND COSMETIC FRAME	71
APPENDIX F TRACEABILITY OF INSTRUMENT CALIBRATION	73
APPENDIX G CE CONFORMITY FOR EUROPEAN COMMUNITY	75

1.0 DESCRIPTION

The Thermalert® GP Series of instruments consist of components that can be purchased separately or as a complete infrared temperature measurement system.

The GP monitor consists of printed circuit boards, A/D converters, micro-processor, control switches, and power conditioners, all mounted in a 1/8 DIN panel-mount NEMA-12 (IP 54) enclosure. The GP monitor accepts inputs from any 0-5V and 4-20mA devices, which allows it to be used as a panel meter for many applications. Other settings allow the GP to act as a temperature monitor for Raytek fixed infrared sensors (refer to Appendix B) and for other temperature gathering devices. The GP Monitor also accepts various types of thermocouple inputs. It provides two setpoint alarm signals and one of two types of analog output: 4-20 mA output or thermocouple output. (Factory default is 4-20 mA output.)

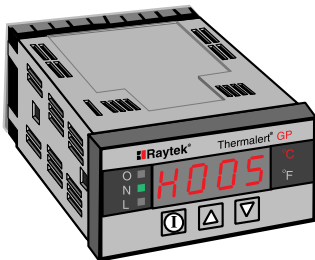

Figure 1: Thermalert GP Monitor

QUICK REFERENCE CHARTS FOR SETTING UP THE THERMALERT GP MONITOR FOR USE WITH ANY 0-5 VOLT OR 4-20 mA INPUT OR THERMOCOUPLE INPUT/OUTPUT, AS WELL AS RAYTEK SENSING HEADS, ARE IN APPENDIX A.

2.0 THERMALERT GP MONITOR

2.1 SPECIFICATIONS

The following sections cover thermal, operational, electrical, and physical specifications for each model.

2.1.1 Operational

Input Accuracy:	0-5V input resolution 1mV, accuracy $\pm 2\text{mV}$ 4-20mA input resolution 0.01mA, accuracy $\pm 0.02\text{mA}$ J, K, E, N, T thermocouple input, $\pm 0.5\%$ or $\pm 2^\circ\text{C}$, whichever is greater R, S thermocouple input, $\pm 0.5\%$ or $\pm 3^\circ\text{C}$, whichever is greater
Output Accuracy:	4-20mA output resolution 0.014mA, accuracy $\pm 0.02\text{mA}$ J, K, E, N, T thermocouple output, $\pm 0.5\%$ or $\pm 2^\circ\text{C}$, whichever is greater R, S thermocouple output, $\pm 0.5\%$ or $\pm 4^\circ\text{C}$, whichever is greater
Response Time:	GPR/GPS (system): 300ms GPM (system): 400ms All other inputs: 200ms
Display:	4 digit LED
Emissivity:	0.10 to 1.09 (adjustable in 0.01 increments-H001 and H002 only)
Warmup time:	5 seconds
Peak Hold Range:	0 to 998 seconds (999=infinite hold)
Valley Hold Range:	0 to 998 seconds (999=infinite hold)
Averaging Range:	0 to 60 seconds
Fail-safe:	Full or low scale, depending upon system failure (refer to Section 3.2)
Setpoint Ranges:	Head Types H001, H002: -18 to 538°C (0 to 1000°F) Head Type H003: 0 to 500°C (32 to 932°F) Head Type H004: 0V input setting = low scale, 5V input setting = high scale Head Type H005: 4mA input setting = low scale, 20mA input setting = high scale Head Type H006: scale = input thermocouple range

Thermocouple Measurement Range	J-type:	-40 to 750°C (-40 to 1382°F)
	K-type:	-40 to 1250°C (-40 to 2282°F)
	E-type:	-40 to 700°C (-40 to 1292°F)
	N-type:	-40 to 1300°C (-40 to 2372°F)
	R-type:	0 to 1750°C (32 to 3182°F)
	S-type:	0 to 1750°C (32 to 3182°F)
	T-type:	-100 to 350°C (-148 to 662°F)

2.1.2 Electrical

Power:	110 - 220VAC ±20%, 50-60Hz, 100mA
Analog Output:	4 to 20mA
Thermocouple Output	J-type: -40 to 750°C (-40 to 1382°F)
	K-type: -40 to 1250°C (-40 to 2282°F)
	E-type: -40 to 700°C (-40 to 1292°F)
	N-type: -40 to 1300°C (-40 to 2372°F)
	R-type: 0 to 1750°C (32 to 3182°F)
	S-type: 0 to 1750°C (32 to 3182°F)
	T-type: -100 to 350°C (-148 to 662°F)
Max loop impedance:	350 Ω
2 setpoints output:	CMOS Level Hi/Lo (~5V/0V) (SP1, SP2-15mA@ 5V)
Mechanical Relays (Optional)	AC Contact: 250VAC, 3A DC Contact: 30VDC, 3A

2.1.3 Physical

Dimensions:	1/8 DIN, 118mm length (1.75 in x 3.63 in x 4.75 in)
Weight:	320 grams (0.7 lbs)
Environmental Rating:	NEMA-12 (IEC 529, IP 54) front panel only
Ambient Operating Temperature Range:	0 to 50°C (32 to 122°F)
Relative Humidity:	10-95%, non-condensing (with Gpm head at <30°C (86°F))
Storage Temperature:	-30 to 65°C (-22 to 150°F)

2.2 MOUNTING INSTRUCTIONS

The GP monitor meets NEMA-12 (IEC529, IP54) requirements (front panel only) for protection of the electronics when mounted properly. It should be surface mounted using the flanges and holes provided and mounted in such a manner to allow the free flow of air around the unit. Ambient temperatures should be kept within the range of 0 to 50°C (32 to 120°F).

Note: Mount the monitor as far away as possible from potential sources of electromagnetic interference.

Complete the following steps to mount the GP monitor to a panel:

1. Cut a hole 45 mm high by 92 mm wide (1.8 in by 3.63 in) in the panel.
2. Slip the gasket over the rear of the monitor (see Figure 2), and then back the monitor into the hole from the front side of the panel. (Mounting bracket and cosmetic frame are available as accessories.)
3. Attach the fixing clamps as shown in Figure 2 to both sides of the monitor. Make sure the tab is secure in the hole on both sides.

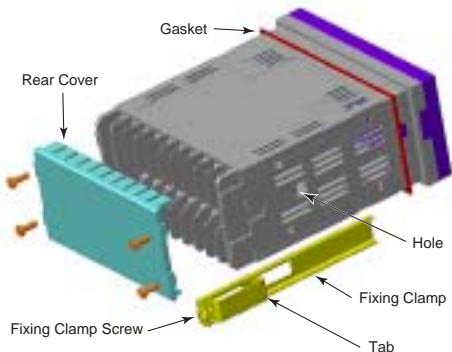

Figure 2: Mounting the Monitor

4. Secure the monitor to the panel by tightening both fixing clamp screws until the flanges are snug against the back surface of the panel.
5. Connect the terminal cable as described in the following section.
6. After you complete the electrical installation, secure the rear cover to the back of the monitor. **(Do not operate with rear cover removed because of electrical shock hazard.)**

2.3 ELECTRICAL INSTALLATION

2.3.1 Terminal Block Layout

The terminal block layout is shown in Figure 3. (Terminal definitions are on the following page.)

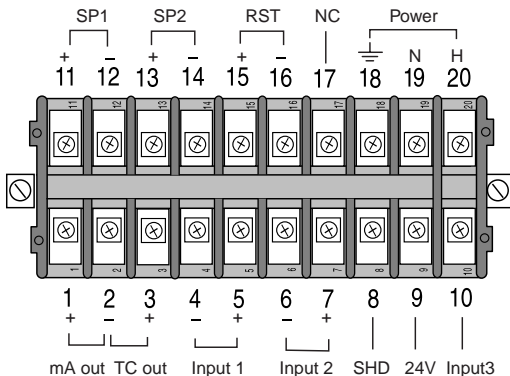

Note: Either soldered spade lugs or bare wires are acceptable for connections.

Figure 3: Terminal Block Layout

Terminal block definitions:

- | | | | |
|----|-----------------------------------|----|-------------------------------|
| 1 | 4-20mA output + | 11 | Setpoint 1 + |
| 2 | 4-20mA/TC output - | 12 | Setpoint 1 - (Ground) |
| 3 | TC (thermocouple) output + | 13 | Setpoint 2 + |
| 4 | Input 1 - (GPM or TCs) | 14 | Setpoint 2 - (Ground) |
| 5 | Input 1 + (GPM or TCs) | 15 | Reset + |
| 6 | Input 2 - (Ground) | 16 | Reset - (Ground) |
| 7 | Input 2 + 0-5V or ambient signal) | 17 | No Connection |
| 8 | Shield | 18 | \perp Ground (power) |
| 9 | 24 VDC output power (50mA max) | 19 | N Neutral (power) |
| 10 | Input 3 (4-20 mA or GPR/GPS) | 20 | H Hot (power) |

2.3.2 Connecting Input Devices

Table 1 shows wiring for sensing heads or input devices with 0-5V and 4-20 mA outputs or thermocouples to the monitor. (Refer to Appendix B for Raytek sensing heads.)

Table 1: Wiring Sensing Heads or Input Devices

<p>0-5V</p> <table border="1"> <thead> <tr> <th>TERMINAL NUMBER</th> <th>FUNCTION</th> </tr> </thead> <tbody> <tr> <td>6</td> <td>Signal (-)</td> </tr> <tr> <td>7</td> <td>Signal (+)</td> </tr> <tr> <td>8</td> <td>Shield</td> </tr> </tbody> </table>	TERMINAL NUMBER	FUNCTION	6	Signal (-)	7	Signal (+)	8	Shield	<p>4-20 mA</p> <table border="1"> <thead> <tr> <th>TERMINAL NUMBER</th> <th>FUNCTION</th> </tr> </thead> <tbody> <tr> <td>6</td> <td>GND</td> </tr> <tr> <td>8</td> <td>Shield</td> </tr> <tr> <td>10</td> <td>4-20mA Input</td> </tr> </tbody> </table>	TERMINAL NUMBER	FUNCTION	6	GND	8	Shield	10	4-20mA Input	<p>External Reset Input</p> <table border="1"> <thead> <tr> <th>TERMINAL NUMBER</th> <th>FUNCTION</th> </tr> </thead> <tbody> <tr> <td>15</td> <td>Reset</td> </tr> <tr> <td>16</td> <td>Ground</td> </tr> </tbody> </table> <p>Thermocouple Input</p> <table border="1"> <thead> <tr> <th>TERMINAL NUMBER</th> <th>FUNCTION</th> </tr> </thead> <tbody> <tr> <td>4</td> <td>Signal (-)</td> </tr> <tr> <td>5</td> <td>Signal (+)</td> </tr> </tbody> </table>	TERMINAL NUMBER	FUNCTION	15	Reset	16	Ground	TERMINAL NUMBER	FUNCTION	4	Signal (-)	5	Signal (+)
TERMINAL NUMBER	FUNCTION																													
6	Signal (-)																													
7	Signal (+)																													
8	Shield																													
TERMINAL NUMBER	FUNCTION																													
6	GND																													
8	Shield																													
10	4-20mA Input																													
TERMINAL NUMBER	FUNCTION																													
15	Reset																													
16	Ground																													
TERMINAL NUMBER	FUNCTION																													
4	Signal (-)																													
5	Signal (+)																													

The External Reset Input is used to restart the “clock” for the PeakHold/ ValleyHold/ Averaging functions but not to reset the values to 0. The reset can be activated by installing a switch between terminals 15 and 16.

Use Table 2 when connecting either 0-5V or 4-20mA input devices that can use the 24VDC/50mA power available from the monitor.

Table 2: Wiring Devices that Use Power from Monitor

0-5V		4-20 mA		2-Wire 4-20 mA	
TERMINAL NUMBER	FUNCTION	TERMINAL NUMBER	FUNCTION	TERMINAL NUMBER	FUNCTION
6	Power (-)	6	Power (-)	8	Shield
6	Signal (-)	6	4-20mA (-)	9	Power (+)
7	Signal (+)	8	Shield	10	4-20mA (-)
8	Shield	9	Power (+)		
9	Power (+)	10	4-20mA (+)		

WARNING

1. Incorrect wiring can damage the monitor and void the warranty.

Make sure to unplug the unit before wiring devices or power.

2. The unit be used in a closed cabinet to prevent electrical shock!

Refer to Section 2.4.2 for information on setting up parameters on the GP Monitor for 0-5 volt, 4-20 mA devices and thermocouples.

2.3.3 Power Connections

You can connect 110-220VAC, 50-60Hz, to the monitor. It can automatically sense whether you connect 110 or 220 VAC. Use Table 3 as a guide.

Table 3: Power Connections

TERMINAL NUMBER	FUNCTION
18	Ground
19	Neutral
20	Hot

2.3.4 Output Connections

The monitor has the following outputs (connections shown in Table 4):

- 4 – 20mA
- Thermocouple outputs (J, K, E, N, T, R, and S)
- Setpoints 1 and 2

Table 4: Output Connections

4-20 mA		Setpoints 1 & 2		Optional Dual Relays	
TERMINAL NUMBER	FUNCTION	TERMINAL NUMBER	FUNCTION	TERMINAL NUMBER	FUNCTION
1	4-20mA output	11	Digital ground	11	
2	Analog ground	12	Setpoint 1	12	
8	Shield	13	Digital ground	13	
		14	Setpoint 2	14	

Thermocouple	
TERMINAL NUMBER	FUNCTION
2	Thermocouple -
3	Thermocouple +

2.3.5 Relay Accessory

A solid state relay accessory is available as a switching output for Setpoint use as a control for an alarm or triggering mechanism. The Thermalert GP Setpoint output can supply 15mA @ 5V for SSR control. A wiring diagram for the relay accessory is shown in Figure 4.

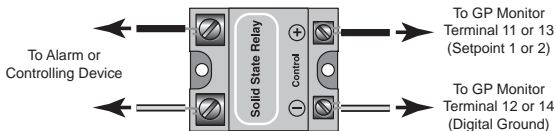

Two relays are necessary to take advantage of both setpoints.

Figure 4: Relay Accessory Wiring

2.4 OPERATION

The Thermalert GP Monitor consists of a control panel with 4 LEDs, 3 buttons, and 5 indicating lights. Besides displaying the current temperature or user-defined value, the LEDs also display parameter settings. By using the “I” key and the up and down arrow keys you can control the different functions, and the indicator LEDs show the function being addressed. Figure 5 shows the startup screen when power is first turned on (no information stored on EEPROM), or when factory defaults are restored (see Section 2.4.12).

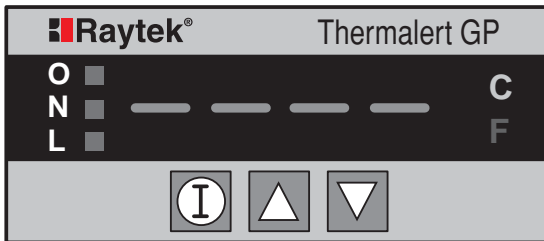

Figure 5: The Control Panel Startup Screen

The “N” indicator, on the left side of the panel, when lit, shows that the unit is working normally. The “O” and “L” indicators are controlled by Setpoints 1 and 2 (SP1, SP2). The “O” indicator, when lit, shows that the measured temperature or value exceeds the current SP1 or SP2 setting. The “L” indicator, when lit, indicates that the measured temperature or value is lower than the current SP1 or SP2 setting.

On the right side of the panel are two indicators that show which temperature value the unit is set to if temperature sensors are attached to the monitor. The “C” indicates if the temperature measurement is in degrees C (Celsius). The “F” indicates if the temperature measurement is in degrees F (Fahrenheit). For 0-5 volt and 4-20 mA devices that do not measure temperatures, C and F can both be turned off.

2.4.1 Display/Key Pad

Before turning on the power, make sure all wiring connections are secure. Table 5 shows the factory-set default values.



Note that all controls can be adjusted while the power is on without damaging sensor or electronics.

Table 5: Factory-set Default Values

PARAMETERS	DEFAULT VALUES	SETTING RANGE	REMARKS
Emissivity	0.95	0.10 - 1.09 in 0.01 increments	For 0 - 5V and 4 - 20 mA & thermocouple input, ϵ is not functional
Sensing Head/Device Number	H001	H001 - H006	See Section 2.4.2
Display Resolution	0	0 - 4	
Setpoints (SP1, SP2)	off	According to sensing head/device type	See Sections 2.4.2 and 2.4.4
Peak Hold	0	0 - 998 seconds 999 = infinite hold	Infinite reset by hardware
Valley Hold	0	0 - 998 seconds 999 = infinite hold	Infinite reset by hardware
Averaging	0	0 - 60 seconds	
Ambient Temperature Compensation (t-amb)	0	-18 to 1200°C (0 to 2200°F)	
Offset	0	-50 to 50°C (-99 to 99°F)	

2.4.2 Device Selection

Six device types can be connected to the electronics enclosure. Complete the following procedure to set the electronics to the appropriate device.

1. From the temperature / value display, press and hold , press , then release them both. A display similar to Figure 6 appears. (The “H” will be followed by numbers designating the device type. See Step 2.)

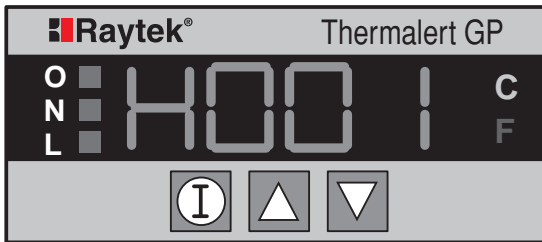



Figure 6: Device Selection Display



2. Press the  and  buttons to change the number on the display to the appropriate head type.

Head types are as follows:

- H001 = Raytek GPR/GPS Heads
- H002 = Raytek GPM Head
- H003 = Raytek CI3 Head
- H004 = 0 - 5V inputs
- H005 = 4 - 20mA inputs
- H006 = Thermocouple inputs

Note that all head types except H003 have additional display settings (as shown on the next page).

H001/H002

If H001 or H002 are displayed, press the  button once to be able to turn the decimal Off (“0”) or On (“1”). A “d” is displayed on the monitor. When the decimal is On, it will be positioned at a tenth of a degree (for example, 888.8). For H001, press the  button again to return to the temperature display.

For H002, press the  button to be able to adjust the sensor’s detector calibration value (“D” value) by using the up and down arrows.

Press  once more to adjust the ambient calibration value (“R” value).

H003



The sensor attached as H003 has a fixed emissivity and no additional monitor adjustments are necessary.

H004/H005



If H004 or H005 are displayed, press the  button once to turn the decimal Off or to set the location of the decimal on the display. Use the following as a guide:

- d = 0 Decimal turned Off
- d = 1 Decimal located at ones position (for example, 8888.)
- d = 2 Decimal located at tens position (for example, 888.8)
- d = 3 Decimal located at hundreds position (for example, 88.88)
- d = 4 Decimal located at thousands position (for example, 8.888)



Both H004 and H005 have additional settings as follows:

For H004, press the  button again to be able to adjust the 0 volt equivalent value (using the up and down arrows). Press  once more to adjust the 5 volt equivalent value.

H005

For H005, press the  button again to be able to adjust the 4mA equivalent value (using the up and down arrows). Press  once more to adjust the 20mA equivalent value.

H006

For H006, press the  button once to be able to turn the decimal Off (“0”) or On (“1”). A “d” is displayed on the monitor. When the decimal is On, it will be positioned at a tenth of a degree (e.g., 888.8). Press the  button again to be able to select the thermocouple input type. Use the following as a guide:

- TC1 = J-type thermocouple input
 - TC2 = K-type thermocouple input
 - TC3 = E-type thermocouple input
 - TC4 = N-type thermocouple input
 - TC5 = R-type thermocouple input
 - TC6 = S-type thermocouple input
 - TC7 = T-type thermocouple input
3. Press the  button until the temperature or user-defined value displays.

2.4.3 Emissivity

Emissivity is a function of infrared sensors and how they measure temperatures of different materials and surfaces.

Emissivities for H001 and H002 can be adjusted from 0.10 to 1.09 (adjustable in 0.01 increments). Note that you cannot change emissivity for device type H003 (fixed at 0.95) or for H004, H005 and H006, because emissivity adjustments are not available through the GP monitor for these device types and thermocouples. For H001 and H002, complete the following procedure to set emissivity.

1. In temperature mode display, press the  button until a display similar to Figure 7 appears. (The “E” will be followed by numbers designating

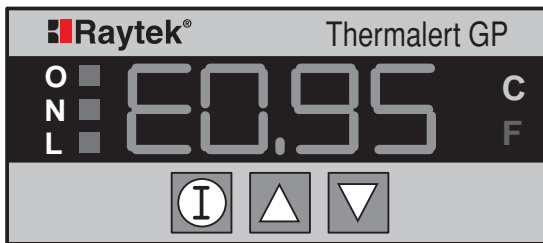



Figure 7: Emissivity Display

the emissivity.)

2. Press the  and  buttons to change the number on the display to the appropriate emissivity.

Note: Appendix C lists common emissivities for metals and non-metals.

3. Press the  button until the temperature displays.

2.4.4 Setpoints 1 and 2

Setpoints are preset at the factory for the highest measurement value but are deactivated by default. To adjust setpoints, complete the following:

1. In temperature/value display, press the  button until a display similar to Figure 8 appears. (Setpoint 1 shows as “S1” followed by a number 0, showing that Setpoint 1 is Inactive, or a number 1, designating active.)

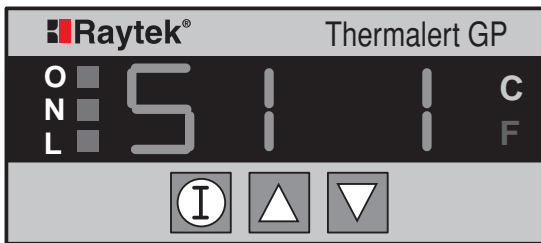





Figure 8: Setpoint Display (Showing Setpoint 1 Active)

2. When either S1 or S2 is displayed, press the  or  buttons to activate or deactivate the setpoint (a number “1” displays when the setpoint is active, a number “0” displays when it’s inactive).
3. Press the  button, and the display shows the current alarm temperature or value (Setpoint value). Use the up and down arrows to adjust the alarm value.
4. Press the  button again and a display similar to Figure 9 appears. If you see a number “1,” it means the Normally Low setpoint will change state when the target temperature or value exceeds the alarm value. If a number “0” displays, the Normally Low setpoint will change state when the target temperature or value is lower than the setpoint alarm value.

If you see a number “3,” it means the Normally High setpoint will change state when the target temperature or value exceeds the alarm value. If a number “2” displays, the Normally High setpoint will change state when the target temperature or value is lower than the setpoint alarm value.

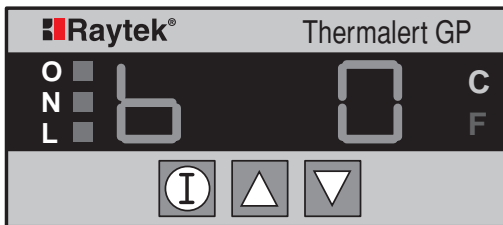

Figure 9: Setpoint Alarm (Trigger) Display

Note that the “O” and “L” indicators on the monitor are controlled by SP1 and SP2. The “L” lights when the input signal has fallen below either the SP1 or SP2 value and when the trigger level (“b”) is set to either “0” or “2”. The “O” indicator lights when the input signal has risen above either the SP1 or SP2 value and when the trigger level (“b”) is set to either “1” or “3”. Figure 10 (below and continued on next page) shows examples of how the setpoints change state when triggered.

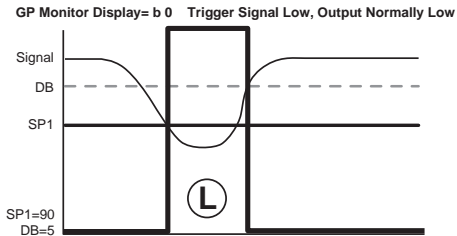
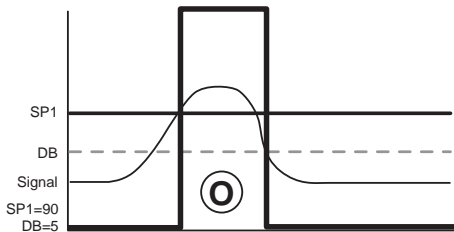
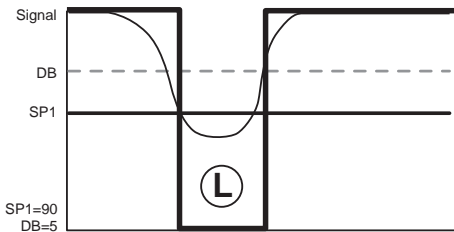

Figure 10: Output Examples

GP Monitor Display= b 1 Trigger Signal High, Output Normally Low





GP Monitor Display= b 2 Trigger Signal Low, Output Normally High

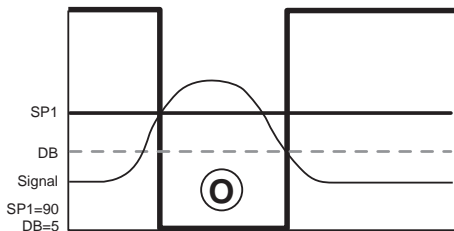

GP Monitor Display= b 3 Trigger Signal High, Output Normally High



5. Press the  button once more and a display similar to Figure 11 appears. Use the  or  buttons to adjust the deadband.

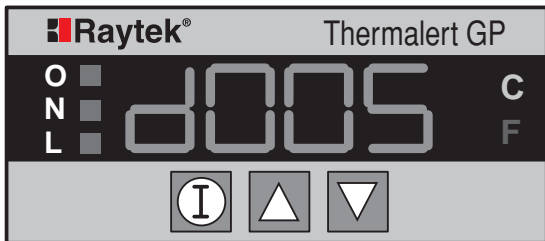



Figure 11: Deadband Display

6. If you have completed adjusting Setpoint 1 parameters, pressing the  button will take you to Setpoint 2. When finished with Setpoint 2, if used, pressing  again takes you to the 4-20mA output setup indicator display.

To return to the temperature/value display, press the  button until the temperature/value display appears.

Note: The deadband is the temperature/value band (\pm) about a setpoint, wherein an alarm output or relay cannot change state.

2.4.5 4-20mA Analog Output

Complete the following for setting a temperature to correspond to the 4-20mA analog output:

Note: The 4-20mA analog output is disabled when the thermocouple output is active. (Refer to Section 2.4.10.)

1. Press the  button until the 4 mA output display (Figure 12) displays.

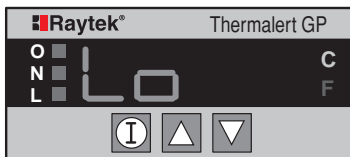





Figure 12: 4mA Analog Output Display

2. Press the  button again, and the current 4mA temperature displays.
3. Press the  and  buttons to adjust the temperature value.
4. Pressing the  button again brings up the 20mA display (Figure 13).

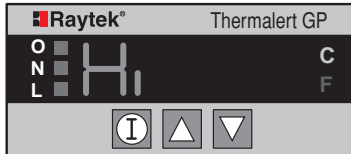





Figure 13: 20mA Analog Output Display

5. Press the  and  buttons to adjust the temperature value.
6. Press the  button until the temperature mode is displayed.

2.4.6 Degrees C and F

You can change the temperature display unit from °C to °F, from °F to °C, or to both off by completing the following steps:

1. Press the  button until a “C” shows in the display (Figure 14).

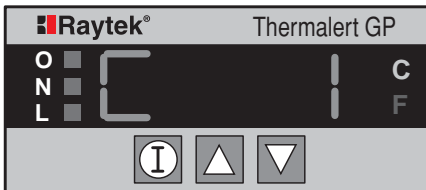

Figure 14: Degrees C Activation Display





2. Pressing the  and  buttons activates or deactivates °C as a temperature measurement unit. If you select number “1,” °C is active; if you select number “0,” it is inactive. See Table 6 for setting configurations.
3. Press the  button again brings up the degrees F activation display. To activate or deactivate degrees F, press the up and down arrows.
4. Press the  button until the temperature mode is displayed.

Table 6: The °C and °F Configurations

°C	°F	FUNCTION
1	0	°C lit on monitor
0	1	°F lit on monitor
0	0	To disable C/F indicators (only for H004 & H005)
1	1	Not available



Note: Thermocouple output is available for H004 and H005 only if either °C or °F is activated.

2.4.7 Peak Hold, Valley Hold, and Average

The Peak Hold, Valley Hold, and Average times are factory set at 0 seconds and are not activated. If you don't need to use these signal processing functions, no adjustments are necessary.

Note: Only one signal processing setting can be active at a time.

To set and activate, complete the following steps:

1. Press and hold the  button and press the  button and release them both. The Peak Hold display appears (Figure 15).

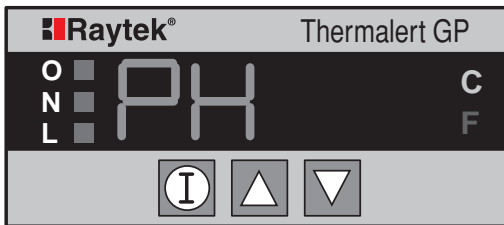





Figure 15: Peak Hold Display

2. Press the  button again and the display shows the current Peak Hold value in seconds.
3. Set the display by using the  and  buttons. Note that “000” turns off Peak Hold.
4. Press the  button again and the Valley Hold display (Figure 16) appears.

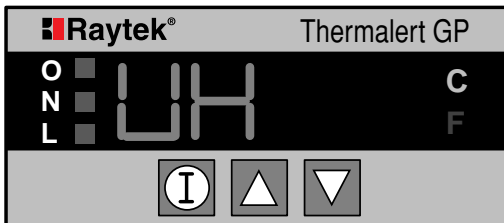





Figure 16: Valley Hold Display

5. Press the  button once more and the display shows the current Valley Hold value in seconds.
6. Set the display by using the  and  buttons. Note that “000” turns off Valley Hold.
7. Press the  button again and the Averaging display (Figure 17) appears.

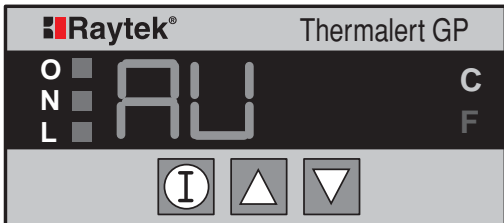



Figure 17: Averaging Display

8. Press the  button once more and the display shows the current Averaging value in seconds.

- Set the display by using the ▲ and ▼ buttons. Note that “000” turns off Averaging.
- Press the ⓘ button until the temperature mode is displayed.

2.4.8 Ambient Temperature Compensation (T-Ambient)

Head types H001 and H002 only - The ambient temperature compensation is factory preset as inactive. This value is normal for most applications. However, in some applications the surrounding ambient temperature is much higher than the target. If the target has an emissivity less than 1.0, it will reflect a certain portion of the surrounding energy and cause an erroneous temperature reading. To avoid this error, set in the average surrounding temperature and the microprocessor will automatically compensate for it.

To set T-Ambient, complete the following:

- Press and hold the ▼ button, and press the ⓘ button, then release them both. The Peak Hold display appears (as shown in Figure 15).
- Press the ⓘ button several times until the Ambient Compensation indicator displays (Figure 18). The display shows either a “0” or “1” (default= “0” - Off).
- You can activate or deactivate Ambient Temperature Compensation by using the up and down buttons. A number “1” means it is active; a number “0” means it is inactive.

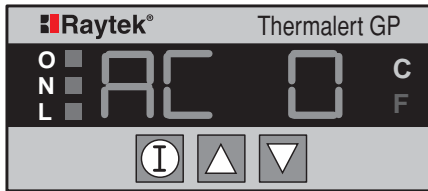









Figure 18: Ambient Temperature Compensation Display

- To adjust the ambient temperature compensation, press the  button once more.
- Set the value by using the  and  buttons.
- Press the  button until the temperature / value mode displays.

2.4.9 Display and Analog Output Offset

To adjust and set the Display and Analog Output Offset (applies to displayed temperature and all analog outputs), complete the following steps:

- Press the  button and the  button simultaneously then release. The Peak Hold display appears (as shown in Figure 15).
- Press the  button several times until the Offset indicator displays (Figure 19).

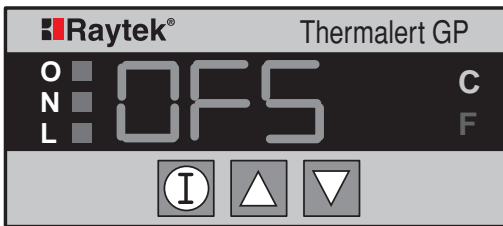









Figure 19: Offset Indicator Display

- To adjust the display and output offset, press the  button once more.
- Set the display by using the  and  buttons.
- Press the  button until the temperature mode displays.

2.4.10 Thermocouple Output

Thermocouple output is factory preset as inactive. To adjust and set the type of thermocouple output, complete the following steps:

1. Press and hold the  button, and press the  button, then release them both. The Peak Hold display appears (as shown in Figure 15).
2. Press the  button several times until the thermocouple output indicator displays as shown in Figure 20.

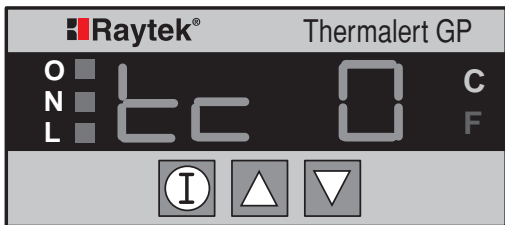





Figure 20: Thermocouple Output

3. Press the  and  buttons to change the number on the display to the appropriate thermocouple output type. Use the following as a guide:
 - TC1 = J-type thermocouple output
 - TC2 = K-type thermocouple output
 - TC3 = E-type thermocouple output
 - TC4 = N-type thermocouple output
 - TC5 = R-type thermocouple output
 - TC6 = S-type thermocouple output
 - TC7 = T-type thermocouple output
4. Press the  button until the temperature/value mode displays.



Notes: Thermocouple output is available for H004 and H005 inputs only if either °C or °F is activated.

The 4-20mA analog output is disabled when the thermocouple output is active.





2.4.11 Lockout Mode

The Lockout Mode protects you from accidental value changes or from tampering. When you activate lockout, no mode values can be changed.



To activate Lockout, complete the following step:

Press and hold the  button, press the  button 3 times, then release. The letter “L” appears on the display for approximately 3 seconds showing that Lockout has been activated.

To deactivate Lockout, complete the following steps:

1. Press the  button once to get the emissivity adjustment display.
2. Press the  button, the  button 3 times, then release. The letter “E” displays for approximately 3 seconds showing that Lockout has been deactivated.
3. Press the  button until the temperature mode displays.

2.4.12 Factory Defaults

If you need to reset the Thermalert GP monitor to its factory default settings, you can do so by pressing and holding the  button and then pressing the  button 3 times.

3.0 MAINTENANCE

Our customer service representatives are always at your disposal for questions regarding application assistance, calibration, repair, and solutions to specific problems. Our Service Department should be contacted before returning any equipment to us. In many cases, problems can be solved over the telephone.

3.1 TROUBLESHOOTING MINOR PROBLEMS

Table 7 lists common symptoms, their causes, and possible solutions. If you are experiencing a problem that is not listed below, please call our Service Department. Phone numbers are listed on the Warranty/Copyright page at the beginning of this manual.

Table 7: Troubleshooting

SYMPTOM	PROBABLE CAUSE	SOLUTION
No output	No power to monitor	Check power supply
Erroneous output	Wrong output range	Correct Lo/Hi output setting
Erroneous Temperature	Faulty sensor cable	Verify cable integrity
Erroneous Temperature	Field of view obstructed	Remove obstruction
Erroneous Temperature	Lens dirty	Clean lens (see Section 5.3)
Erroneous Temperature	Wrong emissivity	Correct emissivity setting
Erroneous Temperature	Wrong signal	Correct peak/valley setting
Relays "chatter"	Deadband too narrow	Correct deadband setting

3.2 FAIL-SAFE OPERATION

The Fail-Safe system is designed to alert the operator and provide a safe output in case of any system failure. Basically, it is designed to shutdown the process in the event of a set-up error or a failure in the sensor head or control electronics.

When an error or failure does occur, the display indicates the possible failure area, and the output circuits automatically adjust to their lowest or highest preset level (as shown in the Table 8).

Table 8: Fail-safe Error Codes

DISPLAY CODE (flashing)	CONDITION	MA OUTPUT	T.C. OUTPUT
E111	Over instrument input range	20mA	High value of input range
E000	Under instrument input range	4mA	Low value of input range
E444	Head disconnect	4mA	Low value of input range
E555	Head ambient temperature GPM: >85°C (185°F) GPR/GPS: >65°C (150°F)	4mA	Low value of input range
E666	Monitor ambient temperature >50°C (120°F) or <0°C(°F)	4mA	Low value of input range

Note: With either input type H003 or H004 the under instrument input range will display low scale for the input device, and the output will be 4mA.

APPENDIX A QUICK REFERENCE

On the following pages are Quick Reference charts for setting up the Thermalert GP Monitor with sensing head and input devices and for adjusting the monitor's normal and advanced functions.

WARNING

Make sure the device attached to the monitor is wired correctly or damage to the monitor and attached units could occur. Refer to the appropriate Sensing Head and Input Device wiring chart in Section 2.3.2, and the appropriate Power Connections wiring chart in Section 2.3.3 before continuing.

Figure A-1 shows you how to set up the Thermalert GP monitor for your particular sensing head or for your 0–5 volt, 4–20mA, or thermocouple input device.

Figure A-2 explains how to cycle through the monitor's normal sensor adjustments when the appropriate sensing head is attached to it.

Figure A-3 shows how to cycle through the monitor's advanced sensor adjustments when the appropriate sensing head is attached to it.

For a detailed explanation of each function, refer to the appropriate section in the manual.

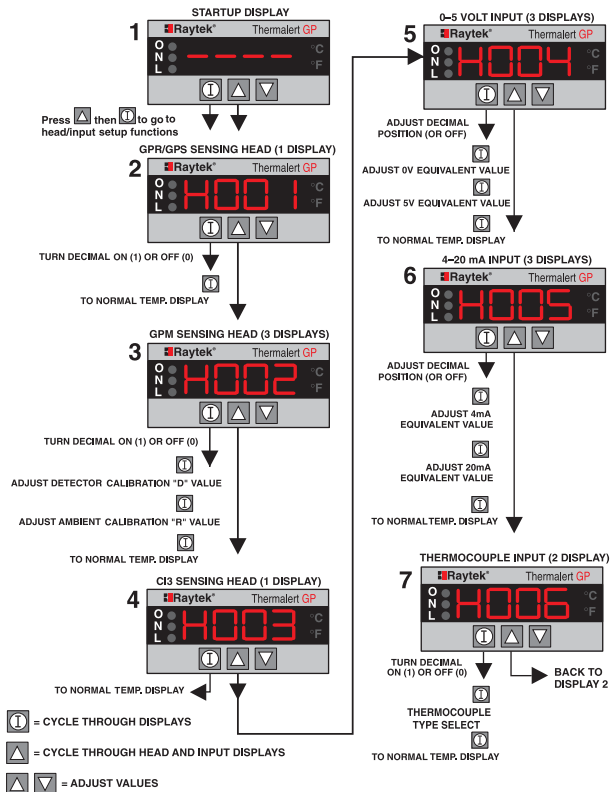

Figure A-1: Head and Input Setup

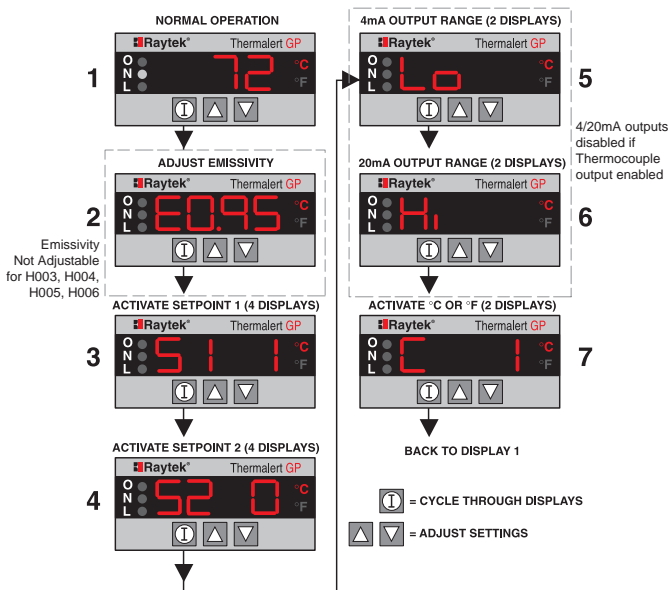

Figure A-2: Normal Functions

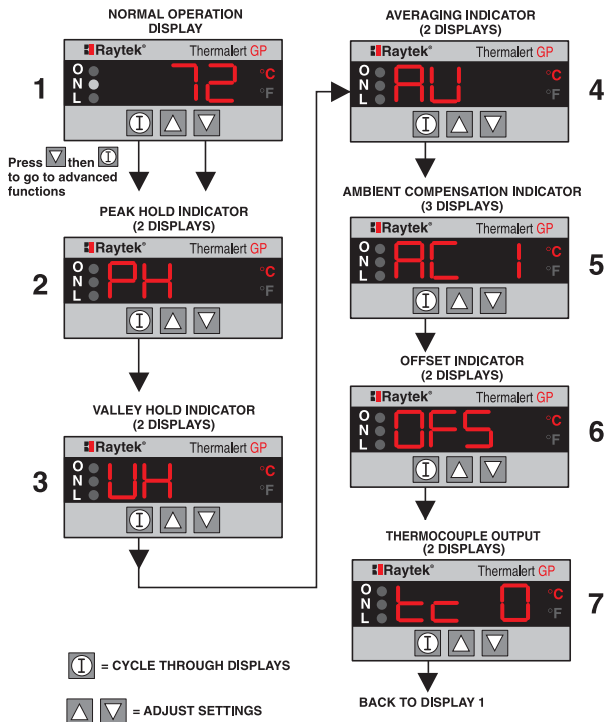

Figure A-3: Advanced Functions

APPENDIX B RAYTEK INFRARED SENSING HEADS

This section describes how to connect Raytek infrared sensing heads to the Thermalert GP monitor. Raytek sensing heads include the Thermalert GPR and GPS (laser) sensor (Head Type H001), the Thermalert GPM (Head Type H002), the Thermalert CI3 (Head Type H003), and the Thermalert TX, which uses the 4-20 mA connection (Head Type H005).

B.1 THERMALERT GP SENSOR MODELS

Table B-1 lists available Thermalert GP sensor models. If you need to connect other Thermalert heads, such as the Thermalert CI3 and TX, use the wiring layout in Table B-4. For information on selecting head / device types, refer to Section 2.4.2. For information on CI3 or TX specifications and use, refer to the manual that came with the sensing head.

Table B-1: Models

MODEL	TEMPERATURE RANGE	OPTICAL RESOLUTION (TYPICAL)
GPR (SF)*	-18 to 538°C (0 to 1000°F)	35:1
GPR (CF)*	-18 to 538°C (0 to 1000°F)	30:1
GPS (SF)*	-18 to 538°C (0 to 1000°F)	50:1
GPS (CF)*	-18 to 538°C (0 to 1000°F)	45:1
GPM2	-18 to 538°C (0 to 1000°F)	2:1
GPM10	-18 to 538°C (0 to 1000°F)	10:1

* SF = Standard Focus CF = Close Focus

B.2 CONNECTING SENSOR HEADS AND INPUT DEVICES

Table B-2 shows wiring connections for the GPR/GPS and GPM sensing heads to the monitor.

Table B-2: Wiring GPR/GPS and GPM Sensing Heads

Thermalert GPR/GPS		Thermalert GPM	
TERMINAL NUMBER	WIRE COLOR	TERMINAL NUMBER	WIRE COLOR
6	Black	4	Green
7	Green	5	Yellow
8	Bare	6	White
9	Red	7	Brown
10	White	8	Bare

For wiring connections for sensing heads or other input devices with 0 to 5 volt and 4 to 20 mA outputs to the monitor, refer to Section 2.3.2.

WARNING

Incorrect wiring can damage the monitor, sensor, and/or input device and void the warranty.

If you need to connect other Thermalert sensors, such as the CI3 and TX, use the wiring layout in Table B-3.

Table B-3: CI3 and TX Wiring Table

CI3		TX	
TERMINAL NUMBER	FUNCTION	TERMINAL NUMBER	FUNCTION
6	Power Supply -	8	Shield
6	Signal Ground	9	TX (+)
7	Signal +	10	TX (-)
8	Shield		
9	Power Supply +		

IMPORTANT

The GP monitor is supplying power to the CI3 and TX when connected as described in Table B-3, and external power connections are unnecessary. (Maximum power = 24VDC @ 50mA.) Please note that sensing heads other than those listed above may need external power if their power consumption needs exceed what is available from the monitor.

B.3 POWER CONNECTIONS

Please refer to Section 2.3.3 for power connection information.

B.4 OUTPUT CONNECTIONS

Please refer to Section 2.3.4 for output connection information and Section 2.3.5 for information on solid state relay wiring.

B.5 THE GPR AND GPS SENSING HEADS

The following sections cover the specifications and measurements of GPR and GPS sensing heads. Included at the end of this section are lists of available accessories and options. For installation instructions, refer to Section B.7

B.5.1 GPR Head

The GPR is available in Standard Focus and Close Focus models. Use the following measurements when determining space requirements for installation. The sensor is supplied with a fixed bracket and mounting nut. It can also be mounted using a customer-supplied bracket or pipe adapter or other accessories. (Accessories and options are listed at the end of this section.)

Note: All sensors and accessories are supplied with 3.8 cm (1.5") 20 UN machine threads and must not be used with standard pipe fittings. A pipe adapter is available for this purpose, if required. Make sure the inner diameter of any pipe or tube extension is not so small that it interferes with the optical field of view of the sensing head model being used.

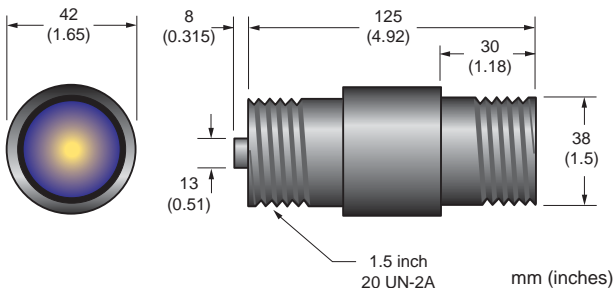

Figure B-1: GP Regular Head

B.5.2 GPS Laser Sighting Head

The laser sighting head (Figure B-2) allows fast and precise aiming at small and quick moving targets. The laser is specially aligned with the lens to provide accurate, non-parallax pinpointing of targets. Press the on/off switch at the laser switching box (see Figure B-3), and a small, bright red laser beam shows you the target center. **The laser dot indicates the center of the target, not the size of the spot being measured.** (To determine spot size, refer to the optical charts in Section B.5.10.) Figure B-4 is a wiring diagram for the laser switching box.

The laser is Class 2 with an output power less than 1 mW and an output wavelength of 630-670 nm. The laser has an operating range up to 30 m (100 ft), depending on ambient light level. The laser complies with FDA Radiation Performance Standards, 21 CFR, subchapter J, and meets IEC 825, Class 2 specifications.

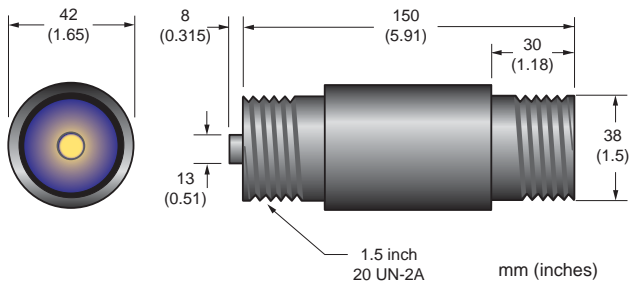

Figure B-2: GPS Laser Sighting Head

Note: The laser automatically turns off after approximately 10 minutes of use.

The fixed bracket (Figure B-5) is supplied with the sensing head.

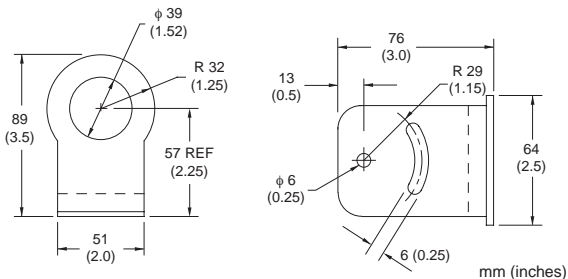

Figure B-5: Fixed Mounting Bracket

B.5.3 Adjustable Mounting Bracket Accessory

An adjustable mounting bracket is available if you require a sensor that can be aimed at different targets from the same mounted position.

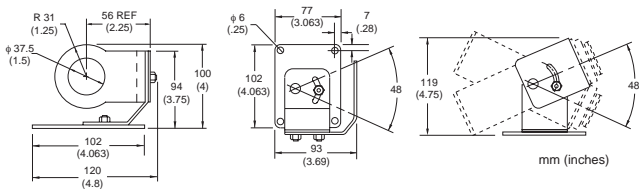

Figure B-6: Adjustable Mounting Bracket

B.5.4 GPR & GPS Head with Air/Water-cooled Housing

The air/water-cooled housing option allows the sensor to be used in ambient temperatures up to 120°C (250°F) for air-cooled and 177°C (350°F) for water-cooled. It is supplied with two 1/8" NPT brass fittings. Air flow should be 25°C (77°F) at 2.8 liters/sec (6 cfm) with a pressure drop across the housing of 0.63 Kg/cm² (9 PSID). Water flow should be approximately 2 liters (0.5 gallons) per minute. Water temperature should be 10-27°C (50-80°F) for efficient cooling. Using chilled water below 10°C (50°F) is not recommended. To avoid condensation, it is recommended to use the Air Purge Collar with the Water Cooled Housing.

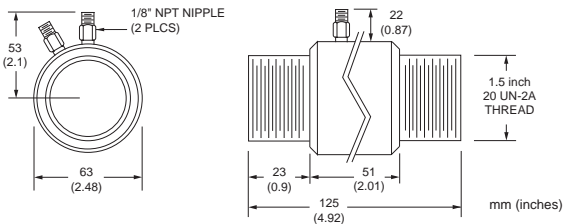

Figure B-7: GPR Head with Air/Water-cooled Housing

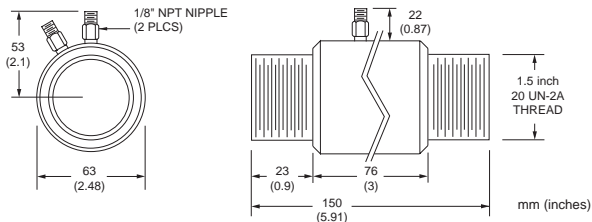

Figure B-8: GPS Head with Air/Water-cooled Housing

B.5.5 GPR/GPS Air Purge Collar

The Air Purge Collar accessory is used to keep dust, moisture, airborne particles, and vapors away from the lens. It can be installed before or after the mounting bracket. It must be screwed in fully. Air flows into the 1/8" NPT brass fitting and out the front aperture. Air flow should be a maximum of 0.5-1.5 l/s (1-3 cfm). Clean or "instrument" air is recommended to avoid contaminants from settling on the lens.

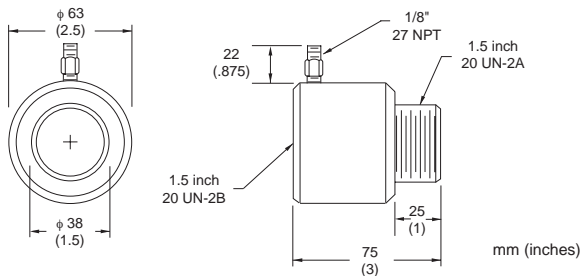

Figure B-9: GPR/GPS Air Purge Collar Accessory

B.5.6 GPR/GPS Right Angle Mirror

The Right Angle Mirror accessory is used to obtain a perpendicular view of the object. It is often used when space is limited or when you need to avoid excessive radiation to the sensor. It must be installed after the bracket or after the Air Purge Collar (if used) and screwed in fully. In dusty or contaminated environments, air purging is required to keep the first surface mirror clean. If used in conjunction with the Air Purge Collar, both the Right Angle Mirror and the Air Purge Collar must be air purged.

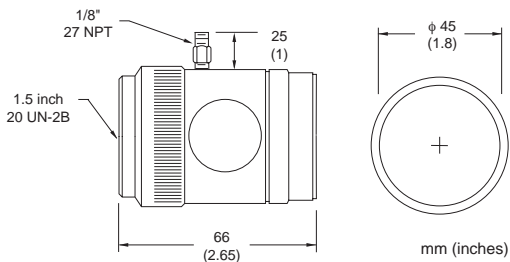

Figure B-10: GPR/GPS Right Angle Mirror Accessory

IMPORTANT

When using the Right Angle Mirror, adjust the emissivity settings downward by 5%. For example, for an object with an emissivity of 0.95 use 0.9; for an object with 0.8 use 0.76; for 0.65 use 0.62. This correction accounts for energy losses in the mirror.

B.5.7 GPR Sighting Viewer Tool

The Sighting Viewer Tool accessory is used to aid in the alignment of the sensor. It can be used when an object is small and far from the sensor. It can also be used when direct in-line sighting is difficult. It can be used both with and without the Air Purge Collar, but not with the Right Angle Mirror. For best results, first secure the sensor to the bracket using the mounting nut or Air Purge Collar and then screw on the Sighting Viewer Tool. Next, position and secure the bracket. Be sure to remove the Sighting Viewer Tool when alignment is complete.

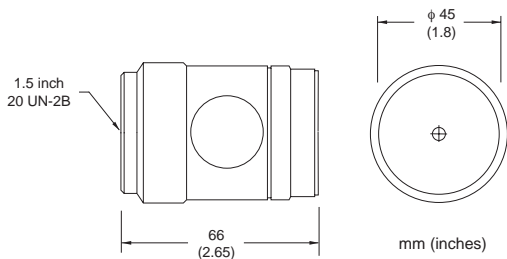

Figure B-11: GPR Sighting Viewer Tool

B.5.8 GPR and GPS Head Specifications

The following sections contain optical, thermal, and physical specifications for the GPR and GPS.

B.5.8.1 Optical

The optical charts indicate the nominal target spot diameter at any given distance from the sensing head. Information in the top half of each diagram is in inches or feet, the bottom half is in metric units. All optical diagrams within this manual assume 90% energy. Figure B-12 is for the GPR Standard Focus model, Figure B-13 is for the GPR Close Focus model, Figure B-14 is for the GPS Standard Focus model, and Figure B-15 is for the GPS Close Focus model.

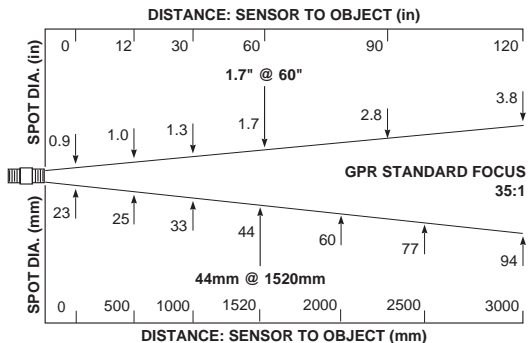

Figure B-12: GPR Standard Focus Optical Chart

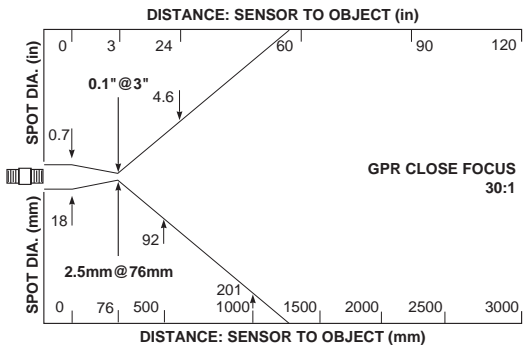

Figure B-13: GPR Close Focus Optical Chart

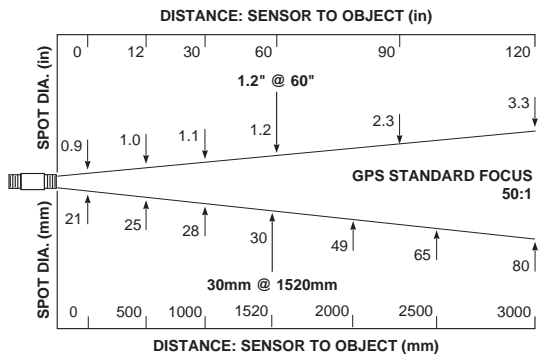

Figure B-14: GPS Standard Focus Optical Chart

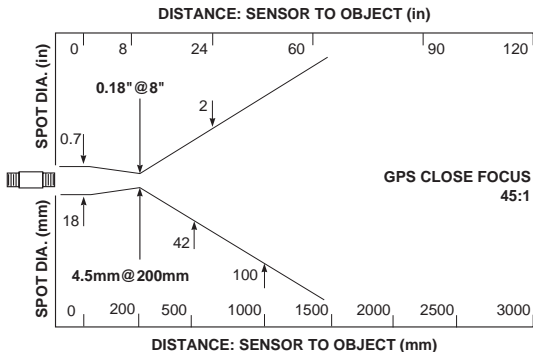

Figure B-15: GPS Close Focus Optical Chart

B.5.8.2 Thermal

Temperature range:	-18 to 538°C (0 to 1000°F)
Spectral Response:	8 to 14 microns
Accuracy: (with GP monitor)	± 1% of reading or ± 1°C (2°F), whichever is greater, @ 23°C ± 5°C (73 ± 9°F) ambient
Repeatability:	±0.5% of reading or ± 1°C (2°F), whichever is greater, @ 23°C ± 5°C (73 ± 9°F) ambient
Response Time:	300 ms (95% response, 4/20mA output)
Temperature Coefficient:	0.15°C per °C (0.15°F per °F)

B.5.8.3 Physical

Dimensions: (Refer to Figures B-1 and B-2)

Weight: GPR 275 grams (0.6 lbs), GPS 290 grams (0.65 lbs)

Environmental Rating: NEMA-4 (IEC 529, IP 65) rated with conduit adapter and compression fitting (which prevents liquid from entering through the connector)

Ambient Operating Temperature Range: GPR head: 0 to 65°C (32 to 150°F)
GPS head: 0 to 65°C (32 to 150°F)
with air cooling: 0 to 120°C (32 to 250°F)
with water cooling: 0 to 177°C (32 to 350°F)

Note: GPS head laser functions only up to 50°C (120°F) and automatically shuts down when that temperature is exceeded.

Storage Temperature: -30 to 65°C (-22 to 150°F)

Relative Humidity: 10-95%, non-condensing

Vibration: MIL-STD-810D (IEC 68-2-6): 3G's, 11 to 200Hz, any axis

Mechanical Shock: MIL-STD-810D (IEC 68-2-27): 50G's, 11msec duration, any axis

B.5.9 GPR and GPS Accessories

A full range of accessories for various applications and industrial environments are available. Accessories include items that may be ordered at any time and added on-site. These include the following:

- Right angle mirror
- Sighting viewer (GPR only)
- Air purge collar
- Conduit adapter
- Pipe adapter
- Adjustable bracket
- Fixed bracket (supplied with the unit)
- Mounting nut (supplied with the unit)
- Cable: 4m (13ft)
- 8m (26ft) high temperature cable
- 15m (49ft) high temperature cable
- DC activated/isolated Solid State Relay for DC voltages with minimum 0-100V/10A rating
- DC activated/isolated SSR for AC voltages with minimum 24-240VAC/8A rating

B.5.10 Options

A full range of options for various applications and industrial environments are available. Options are those items that are factory installed and must be ordered with base model units. These include the following:

- NIST certification
- Air/water-cooled housing

B.6 GP MINIATURE HEAD INFORMATION

The GPM has models available with 2:1 and 10:1 optical resolution. Use the following measurements when determining space requirements for installation.

B.6.1 GPM Head

The sensor can be mounted using the fixed or adjustable mounting bracket accessory or with a customer-supplied bracket or pipe adapter. (Other accessories and options are listed at the end of this section.)

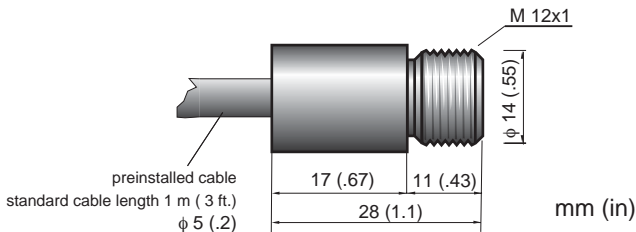

Figure B-16: The GPM Sensing Head

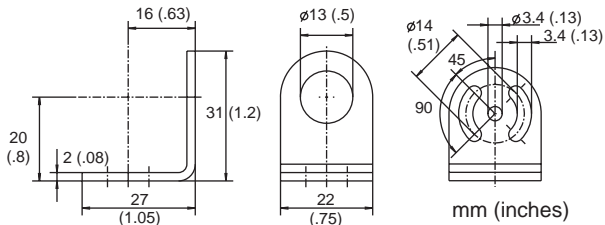

Figure B-17: Fixed Mounting Bracket

B.6.2 Adjustable Mounting Bracket

If you need more more than one measuring position for the sensing head, use the adjustable mounting bracket accessory.

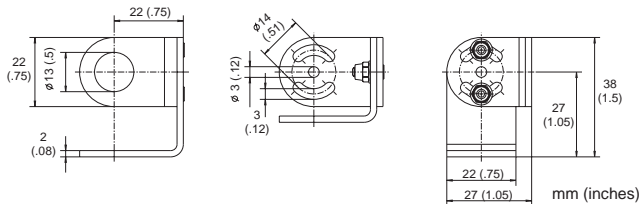

Figure B-18: Adjustable Mounting Bracket Accessory

B.6.3 GPM Head with Air Cooling System

The air cooling option allows the sensor to be used in ambient temperatures up to 200°C (392°F). The T-fitting allows the air cooling hose to be installed without interrupting the connections to the electronics. The air-cooling jacket may be combined with the air purging jacket (Section B.6.4) or with the right angle mirror (Section B.6.5).

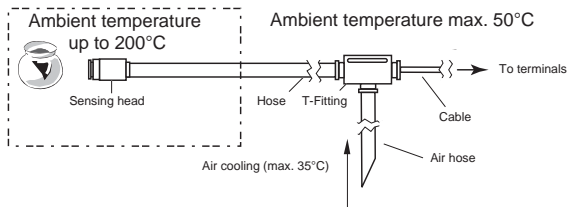

Figure B-19: Air Cooling System

The length of the air supply hose and the temperature of the cooling air can be estimated from the chart in Figure B-20.

Note: The “Hose Length” is the length of hose exposed to high ambient temperature and not the overall length of the hose.

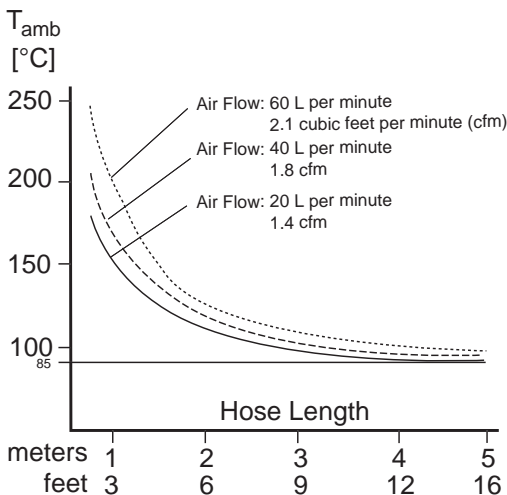

Figure B-20: Maximum Ambient Temperature Depending on Air Flow and Hose Length

B.6.4 GPM Air Purge Jacket

The Air Purge Jacket accessory is used to keep dust, moisture, airborne particles, and vapors away from the lens. It can be installed before or after the mounting bracket. It must be screwed in fully. Air flow should be a maximum of (0.5 - 1.5 liters/sec (1 - 3 cfm)). Clean or “instrument” air is recommended to avoid contaminants from settling on the lens.

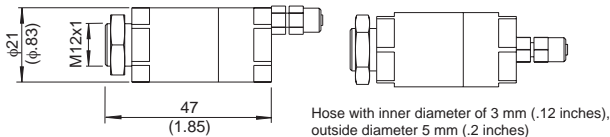

Figure B-21: GPM Air Purge Jacket

To install the air purge jacket (refer to Figure B-22), remove the sensor (1) and cable by disconnecting the cable from the electronics box. Then open the Air Purge Jacket (3, 4) and screw the white plastic fitting (2) onto the sensor up to the end of the threads. (Do not overtighten.) Slip the cable (6) through the backside (4) of the jacket. Close the Air Purge Jacket (3, 4) and reconnect the wires to the electronics box.

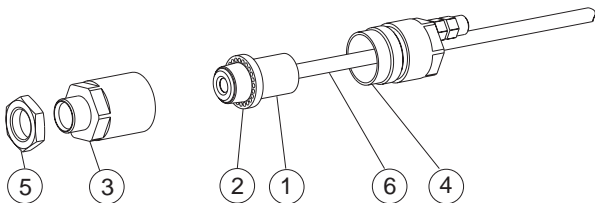

Figure B-22: Air Purge Jacket Installation

B.6.5 GPM Right Angle Mirror

The Right Angle Mirror accessory is used to obtain a perpendicular view of the object. It is often used when space is limited or when you need to avoid excessive radiation to the sensor. It must be installed after the bracket or after the Air Purge Collar (if used) and screwed in fully. In dusty or contaminated environments, air purging is required to keep the first surface mirror clean.

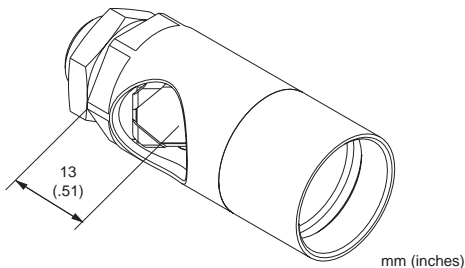

Figure B-23: GPM Right Angle Mirror

IMPORTANT

When using the Right Angle Mirror, adjust the emissivity settings downward by 5%. For example, for an object with an emissivity of 0.95 use 0.9; for an object with 0.8 use 0.76; for 0.65 use 0.62. This correction accounts for energy losses in the mirror.

B.6.6 GPM Head Specifications

The following sections contain optical, thermal, and physical specifications for the GPM.

B.6.6.1 Optical

The optical charts indicate the nominal target spot diameter at any given distance from the sensing head. Information in the top half of each diagram is in inches or feet, the bottom half is in metric units. All optical diagrams within this manual assume 90% energy. Figure B-24 is an optical chart for the 2:1 and 10:1 optical resolution models.

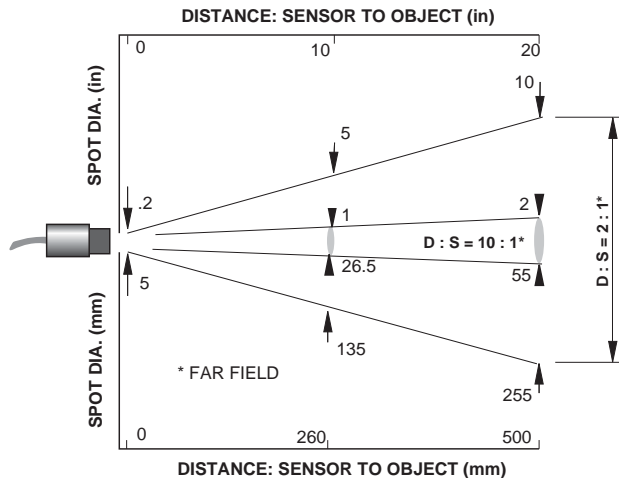

Figure B-24: GPM Sensor Heads Optical Chart

B.6.6.2 Thermal

Temperature range:	0 to 500°C (32 to 932°F)
Spectral Response Range:	7.6 to 18 microns
Accuracy:	± 1% of reading ± 1°C (2°F) @ 23°C ± 5°C (73 ± 9°F) ambient
Repeatability:	± 0.5% of reading or ± 1°C (2°F)
Temperature Resolution:	± 0.1°C (± 0.2°F)
Emissivity/Gain:	0.1 – 1.09 (adjustable)
Temperature Coefficient:	0.15°C per °C (0.15°F per °F)
Response Time:	400ms to 4/20mA output
Thermal Shock:	± 3.5°C at $\Delta T = 25^\circ\text{C}$ (20 minutes)

B.6.6.3 Physical

Dimensions:	(Refer to Figure B-13)
Weight:	50 g (2 oz. with 3 ft cable length)
Material:	Stainless Steel

B.6.6.4 Environmental

Environmental Rating:	NEMA-4 (IEC 529, IP 65)
EMI	IEC 801-3, Level 1
Ambient Operating Temperature Range:	GPM head: 0 to 85°C (32 to 185°F) with air cooling: -18 to 200°C (0 to 392°F)
Storage Temperature:	-18 to 85°C (0 to 185°F)
Relative Humidity:	10-95%, non-condensing

B.6.7 GP Miniature Head Accessories

A full range of accessories for various applications and industrial environments are available. Accessories include items that may be ordered at any time and added on-site. These include the following:

- Fixed Bracket
- Adjustable Bracket
- Air Purge Jacket
- Right Angle Mirror
- T-fitting, Hose, and Air Cooling Jacket

B.6.8 Options

A full range of options for various applications and industrial environments are available. Options are those items that are factory installed and must be ordered with base model units. These include the following:

- Longer cables—3 m (10 ft), 8 m (26 ft), and 15 m (50 ft)
- NIST Certification

B.7 INSTALLATION OF SENSING HEADS

The installation process for the GP Regular Head (GPR), GP Laser Sighting Head (GPS) and GP Miniature Head (GPM) consists of the following:

- Preparation
- Mechanical Installation
- Electrical Installation

The most important part in the installation process is preparation. Please read Section B.7.1, Preparation, thoroughly before proceeding with the mechanical and electrical installation sections. Note that the Mechanical and Electrical Installation sections for the GPR and GPM are divided as follows:

- Section B.7.2 covers the GPR/GPS Mechanical Installation
- Section B.7.3 covers the GPR/GPS Electrical Installation
- Section B.7.4 covers the GPM Mechanical Installation
- Section B.7.5 covers the GPM Electrical Installation

Aiming the sensing head is covered in Section B.7.6.

B.7.1 Preparation

Sensor location and configuration depends on the application. Before deciding on a location, be aware of the ambient temperature of the location, the atmospheric quality of the location, and the possible electromagnetic interference in that location. If you plan to use air purging, you need to have an air connection available. Also, wiring and conduit runs must be considered. The following subsections cover topics to consider before you install the sensor.

B.7.1.1 Ambient Temperature

The GPR/GPS optical heads operate in ambient temperatures of 0 to 65°C (32 to 150°F). (Laser operates from 0 to 50°C (32 to 122°F).) In ambient conditions above 65°C (150°F), an optional air/water-cooled housing is available, which extends the ambient operating range to 120°C (250°F) with air cooling or 177°C (350°F) with water cooling.

The GPM optical head is designed to operate in ambient temperatures of 0 to 85°C (32 to 185°F). With the air cooling accessory, it can operate in ambient temperatures up to 200°C (392°F).

The electronics enclosure is designed to operate in ambient temperatures of 0 to 50°C (32 to 120°F). Operation of these units outside of specified ambient temperatures is not recommended, and accuracy cannot be guaranteed.

B.7.1.2 Distance and Spot Size

The desired spot size to be measured on the target will determine the minimum and maximum working distance and the appropriate focus model. The target must contain the entire sensor field of view. The sensor must be positioned so the field of view is the same as or smaller than the desired target size. Figure B-25 illustrates proper sensor placement (applies to all models).

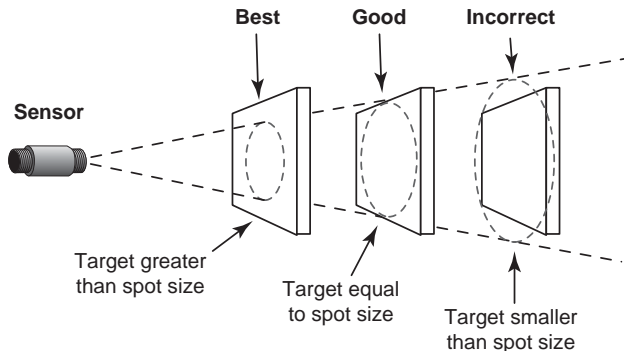

Figure B-25: Proper Sensor Placement

B.7.1.3 Atmospheric Quality

It is important to keep the lens clean at all times. A clean lens can prevent erroneous readings and possible lens damage. An Air Purge Collar is available, and recommended, for all models to protect the lens from smoke, fumes, dust, and other contaminants.

B.7.1.4 Electrical Interference

To minimize electrical or electromagnetic interference or “noise,” be aware of the following:

- Mount the sensor as far away as possible from potential sources of electrical interference such as motorized equipment producing large step load changes.
- With a regular sensing head, use solid or flexible conduit between the head and electronics box. Check continuity to ensure a good connection of the conduit between the sensor head and electronics box. For a good connection, the ends of the conduit should make metal to metal contact with the sensor head and the electronics box.
- Use shielded wire for all input and output connections. Connect the shield as described in the sensing head tables in Section B.2.
- Make sure the shield wire in the sensor cable is earth grounded.
- For additional protection, use conduit for the AC power lines and any external connections. Solid conduit is better than flexible conduit in high noise environments.
- Do not run AC power for other equipment in the same conduit.

B.7.2 GPR/GPS Mechanical Installation

For proper operation, make sure all wiring is installed correctly and the connections are tight. If strain relief is required, use standard conduit fittings.

After you complete preparations, fasten the supplied mounting bracket, or other mounting device, to the area you have chosen. You can fasten the sensor with the supplied nut either in the front, by the lens, or in the back by the cable connector. Make sure the nut is tight, but do not overtighten.

For the GPR, the standard 4 m (13ft) cable is an accessory and comes with a 5-pin DIN connector on one end and bare wires on the other. Plug the DIN connector into the sensing head, and run the wire to the monitor's connectors. The GPS head uses a 7-pin DIN connector. Be sure to allow space for mounting the GPS laser switch box.

If you are using a conduit adapter and conduit for the wiring, install the conduit adapter on the sensor end of the conduit, then run the wire through it. You might need to position and tighten the mounting bracket in place after attaching the DIN connector to the sensing head and screwing the sensing head into the conduit adapter. Note that a mounting bracket may not be necessary if using rigid conduit.

B.7.3 GPR/GPS Electrical Installation

For proper operation, this cable must be free of splices and connected to the monitor's terminals exactly as indicated in Section B.2 and B.5.2. The cable can be lengthened if good connectors are used.

WARNING

Incorrect wiring can damage the monitor and/or sensor and void the warranty.

B.7.4 GPM Mechanical Installation

For proper operation, make sure all wiring is installed correctly and the connections are tight.

After you complete preparations, fasten the supplied mounting bracket, or other mounting device, to the area you have chosen. Fasten the sensor to the bracket with the supplied nut. Make sure the nut is tight, but do not over-tighten.

The sensor comes with a 1 m (3ft) cable attached to it and bare wires on the other end. Once you have the sensor mounted, run the cable to the monitor's terminals.

B.7.5 GPM Electrical Installation

For proper operation, this cable must be free of splices and connected exactly as indicated in Section B.2. For mounting sensor cable in a conduit, use the T-fitter and hose accessory with the sensor head.

For proper operation, this cable must be free of splices and connected to the monitor's terminals exactly as indicated in Section B.2. **This cable cannot be lengthened, but it can be shortened.**

WARNING

Incorrect wiring can damage the monitor and/or sensor and void the warranty.

B.7.6 Aiming the Sensing Head

All sensing heads that can be attached to the GP monitor are aimed using the same technique, which is to peak the sensor to its maximum signal. (The GPS has laser aiming.) To do this, all connections must be secure and power applied to the monitor. If a temperature does not display, press the  button until it does. (Refer to Section 2.4 for operating instruction.)

To aim the sensor, complete the following:

1. Slightly loosen the mounting bracket's nuts.
2. Point the sensor toward the target.
3. Move it around until the target's temperature displays on the monitor.
4. Secure the mounting bracket.

B.7.7 Cleaning the Sensing Head Lens

Keep the lens clean at all times. Any foreign matter on the lens will affect measurement accuracy. However, care should be taken when cleaning the lens. To clean the lens, do the following:

1. Lightly blow off loose particles.
2. Gently brush off remaining particles with a soft camel hair brush.
3. Clean remaining "dirt" using a cotton swab dampened in distilled water. Do not scratch the surface.

For finger prints or other grease, use any of the following:

- Denatured alcohol
- Ethanol
- Kodak® lens cleaner

Apply one of the above to the lens. Wipe gently with a soft, clean cloth until you see colors on the surface, then allow to air dry. Do not wipe the surface dry, this may scratch the surface.

If silicones (used in hand creams) get on the lens, gently wipe the surface with Hexane. Allow to air dry.

WARNING

Do not use ammonia or cleaners with ammonia on the lens, this may result in permanent damage to the lens' surface.

APPENDIX C EMISSIVITY

The emissivity of a measured object is determined by the material it consists of. Emissivity is a measure of an object's ability to absorb, transmit, and emit infrared energy. It can have a value from 0 (shiny mirror) to 1.0 (blackbody).

C.1 HOW TO DETERMINE EMISSIVITY

Section C.2 lists common emissivity values for metals, and Section C.3 lists common emissivity values for non-metals. If your object is not similar to any the materials given, or extra precision is desired, you can use one of the following methods for determining a specific emissivity value.

1. If an accurate target temperature can be established using a contact temperature probe, you may adjust the emissivity/gain setting until the IR temperature reading agrees with the contact device reading.
2. Cover a portion of the target's surface with masking tape or flat black paint. The emissivity of both is 0.95. Allow time for the masking tape's temperature to equalize with the temperature of the surface underneath. Measure the masked area, using an emissivity/gain setting of 0.95, and then immediately measure the unmasked area. If the two temperatures are much different, emissivity may affect your readings. Compensate by adjusting emissivity while reading the unmasked area until it agrees with the 0.95 reading of the masked area. This value should then be used whenever that object or material is to be measured in the future.

C.2 TYPICAL EMISSIVITY VALUES FOR METALS

Material	Emissivity
Aluminum	
Unoxidized	0.02-0.1
Oxidized	0.2-0.4
Alloy A3003, Oxidized	0.3
Roughened	0.1-0.3
Brass	
Burnished	0.3
Oxidized	0.5
Copper	
Polished	0.03
Roughened	0.05-0.1
Oxidized	0.4-0.8
Haynes	
Alloy	0.3-0.8
Inconel	
Oxidized	0.7-0.95
Sandblasted	0.3-0.6
Iron	
Oxidized	0.5-0.9
Unoxidized	0.05-0.2
Rusted	0.5-0.7
Iron, Cast	
Oxidized	0.6-0.95
Unoxidized	0.2
Iron, Wrought	
Dull	0.9
Lead	
Rough	0.4
Molybdenum	
Oxidized	0.2-0.6

Material	Emissivity
Nickel	
Oxidized	0.2-0.5
Electrolytic	0.05-0.15
Platinum	
Black	0.9
Steel	
Cold-Rolled	0.7-0.9
Ground Sheet	0.4-0.6
Polished Sheet	0.1
Oxidized	0.7-0.9
Stainless	0.1-0.8
Titanium	
Oxidized	0.5-0.6

C.3 TYPICAL EMISSIVITY VALUES FOR NON-METALS

Material	Emissivity
Asbestos	0.95
Asphalt	0.95
Basalt	0.7
Carbon	
Unoxidized	0.8-0.9
Graphite	0.7-0.8
Carborundum	0.9
Ceramic	0.95
Clay	0.95
Concrete	0.95
Cloth	0.95
Glass	
Plate	0.85
Gravel	0.95
Gypsum	0.8-0.95
Ice	0.98
Limestone	0.98
Paint (non-al.)	0.9-0.95
Paper (any color)	0.95
Plastic (opaque, over 20 mils)	0.95
Rubber	0.95
Sand	0.9
Snow	0.9
Soil	0.9-0.98
Water	0.93
Wood, Natural	0.9-0.95

APPENDIX D MOUNTING BRACKET ACCESSORY

A mounting bracket is available as an accessory. To mount a GP Monitor to a wall, post, column, or other flat surface, complete the following steps:

1. Insert the rear of the monitor through the bracket's opening so the bottom of the monitor rests on the bracket surface. Make sure the gasket is in place. (See Figure D-1.)

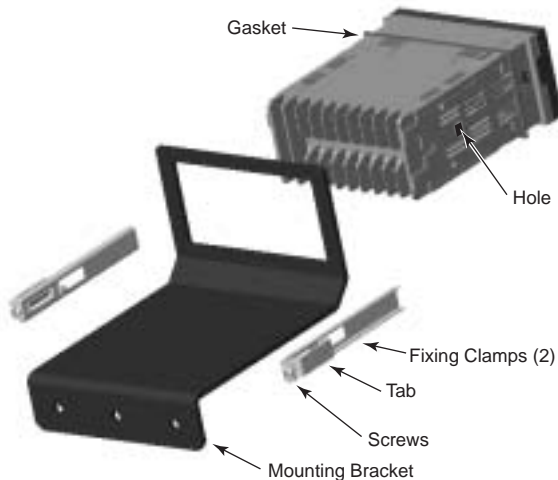

Figure D-1: Mounting Bracket Accessory Installation

2. Insert the Tab on the side of each fixing clamp (one per side) into the hole on the side of the monitor housing and hold them. (You might need to loosen the fixing clamp screws first.)

3. Tighten the fixing clamp screws on each fixing clamp. Make sure the tabs are snug against the bracket frame (Figure D-2). Do not overtighten.

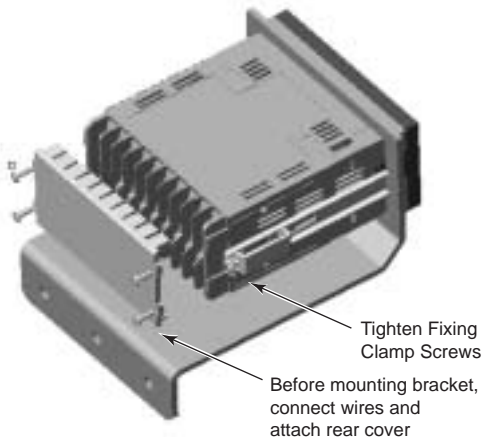

Figure D-2: Completing the Installation

4. You will need to attach wires to the monitor's terminals and attach the rear cover before mounting the bracket onto a surface. (Refer to the manual for wiring instructions for your particular device.)
5. Use 3 appropriately sized screws or bolts to fasten the bracket onto your work surface.

This completes the monitor bracket accessory installation.

APPENDIX E CUTOUT TEMPLATE AND COSMETIC FRAME

If you are mounting your monitor into a panel, this plastic frame can be used as a template for determining the proper dimensions for your panel cutout. To use, hold or tape the template against the panel at the location where you want to mount the monitor, and mark around the inside edges. (Refer to Figure E-1.)

Once you cut the panel, you can use this template as a frame to hide scratches or small voids on the panel that might have been created during the cutting process.

To install, simply insert the frame between the monitor bezel and mounting gasket prior to inserting the monitor into the panel. (For monitor installation and mounting instructions, refer to the manual.)

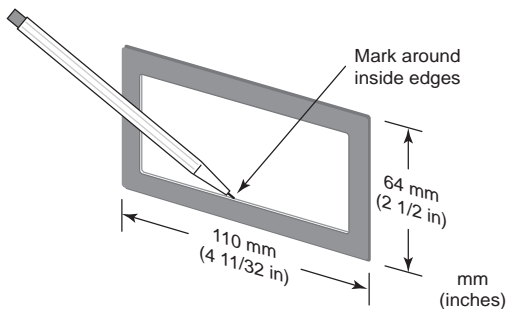

Figure E-1: 1/8 DIN Cutout Template and Cosmetic Frame

APPENDIX F TRACEABILITY OF INSTRUMENT CALIBRATION

The temperature sources (blackbodies) used to calibrate this instrument are traceable to the U.S. National Institute of Standards and Technology (NIST). (Refer to Figure F-1.)

The NIST certificate describes the equipment used for calibration and any corresponding NIST report numbers. In addition, the certificate lists test accuracy data and the next calibration date.

NIST certificates are available as an option (must be ordered with the instrument). Contact the manufacturer (not NIST) to order this option.

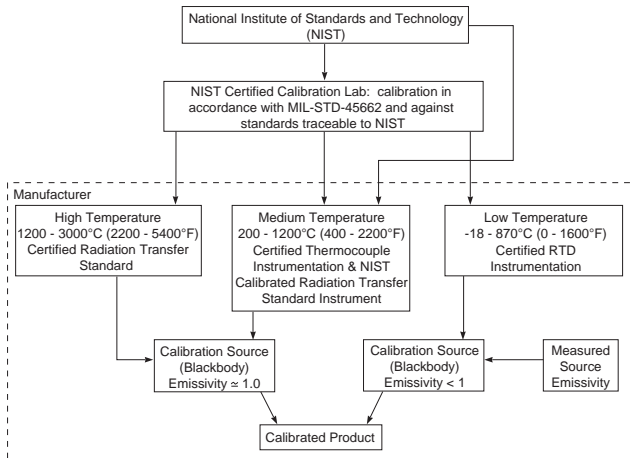

Figure F-1: NIST Traceability

**APPENDIX G CE CONFORMITY FOR THE
EUROPEAN COMMUNITY**



This instrument conforms to the following standards:

- EN50081-1 Emission Standard
- EN50082-1 Immunity Standard

