

# ToxiRAE 3

## User's Guide





# ToxiRAE 3 User's Guide

## Contents

Read Before Operating .....	3
1. General Information.....	7
2. Specifications.....	8
3. Overview.....	9
3.1.1. Display And Countdown Configurations.....	9
4. User Interface.....	10
5. Turning The ToxiRAE 3 On.....	11
6. Turning The ToxiRAE 3 Off .....	11
7. Testing The Alarms (Anytime).....	11
8. Low Battery Warnings.....	12
9. Dead Battery Warning & Shutoff .....	12
10. Operating The ToxiRAE 3 In Display Configuration.....	13
10.1. Mode Overview .....	13
10.2. Normal Mode.....	14
10.2.1. Enter Normal Mode / Turn On The ToxiRAE 3.....	14
10.2.2. Exit Normal Mode / Turn Off The ToxiRAE 3 .....	14
10.2.3. Stepping Through Normal Mode (Display).....	15
10.2.4. Clearing STEL, TWA, And Peak Values .....	16
10.2.5. Programming Mode .....	17
10.2.6. Enter Programming Mode.....	17
10.2.7. Navigating Programming Mode .....	19
11. Bump Testing & Calibrating The ToxiRAE 3.....	20
11.1. Bump Testing & Calibrating With An AutoRAE Lite .....	20
11.2. Calibration Adapter.....	21
11.2.1. Connecting The Calibration Adapter .....	21
11.2.2. Disconnecting The Calibration Adapter .....	22
11.2.3. Calibrations And Settings In Programming Mode.....	22
11.2.4. Zero (Fresh Air) Calibration .....	22
11.2.5. Span Calibration.....	23
11.2.6. Set Span Gas Value.....	24
11.2.7. Set High Alarm Value.....	24
11.2.8. Set Low Alarm Value .....	25
11.2.9. Set STEL Alarm Value .....	25
11.2.10. Set TWA Alarm Value.....	26
11.2.11. Set Bump Due Day .....	26
11.2.12. Set Calibration Due Day .....	27
11.2.13. End Programming (Exit To Normal Mode).....	27
11.3. Bump Testing.....	27
12. Diagnostic Mode.....	28
12.1. Enter Diagnostic Mode .....	28
12.2. Navigating Diagnostic Mode .....	28
12.3. Exit Diagnostic Mode .....	28
13. Changing The ToxiRAE 3 From Display To Countdown Configuration.....	29
13.1. Using AutoRAE Lite Utility To Change The Configuration.....	29
14. Changing The ToxiRAE 3 From Countdown To Display Configuration.....	32

## ToxiRAE 3 User's Guide

15. Operating The ToxiRAE 3 In Countdown Configuration .....	33
15.1. Turning On The ToxiRAE 3 .....	33
15.2. Main Display: Countdown .....	33
15.2.1. Stepping Through Displays .....	34
15.2.2. Clearing STEL, TWA, And Peak Values .....	35
16. Bump Testing & Calibrating The ToxiRAE 3 In Countdown Configuration .....	36
16.1. Bump Testing & Calibrating With An AutoRAE Lite .....	36
16.2. Calibration Adapter .....	36
16.2.1. Connecting The Calibration Adapter .....	37
16.2.2. Disconnecting The Calibration Adapter .....	37
16.2.3. Calibration .....	38
16.2.4. Zero (Fresh Air) Calibration .....	38
16.2.5. Span Calibration .....	38
16.2.6. Bump Due Day .....	39
16.2.7. Calibration Due Day .....	39
16.3. Bump Testing .....	40
17. Alarm Signal Summary .....	41
18. Maintenance .....	43
18.1. Replacing the ToxiRAE 3 Li-Ion Battery .....	43
18.2. External Filter .....	44
18.2.1. Cleaning .....	44
18.2.2. Ordering Replacement Parts .....	45
19. Troubleshooting .....	46
20. Technical Support .....	47
21. RAE Systems Contacts .....	47
22. Appendix A: Regulatory Information .....	49

# ToxiRAE 3 User's Guide

## **WARNINGS**

### **Read Before Operating**

This manual must be carefully read by all individuals who have or will have the responsibility of using, maintaining, or servicing this product. The product will perform as designed only if it is used, maintained, and serviced in accordance with the manufacturer's instructions.

### **CAUTION!**

Never operate the monitor when the cover is removed. Remove the monitor cover and battery only in an area known to be non-hazardous.
--

### **Warranty Registration**

Register your warranty online by visiting:

<http://www.raesystems.com/Support/ProductRegistration>

This ensures that your ToxiRAE 3 is registered and ensures that we can let you know of important updates.

## ToxiRAE 3 User's Guide



Use only RAE Systems lithium battery part number 500-0076-100 (3.6V, 1650mAh, size 2/3AA). This instrument has not been tested in an explosive gas/air atmosphere having an oxygen concentration greater than 21%. Substitution of components may impair suitability for intrinsic safety. Replace batteries only in non-hazardous locations.

**STATIC HAZARD:** Clean only with a damp cloth.

For safety reasons this equipment must be operated and serviced by qualified personnel only. Read and understand instruction manual completely before operating or servicing.

All newly purchased RAE Systems instruments should be bump tested by exposing the sensor(s) to known concentrations of calibration gas.



The monitor should be calibrated if it does not pass a bump test, but no less than every 6 months, depending on use and exposure to gas and contamination, and its operational mode.

Bump test is defined as an exposure to gas that triggers the lowest alarm.

- Calibration intervals and bump test procedures may vary due to national legislation.
- RAE Systems recommends using RAE calibration gas cylinders with 10 ppm H<sub>2</sub>S (25 ppm H<sub>2</sub>S can be used as well), 50 ppm CO (100 ppm CO can be used as well), or a 4-gas mix containing 10 ppm H<sub>2</sub>S, 50 ppm CO, 50% LEL Methane, and 18.5% Oxygen.

ToxiRAE 3 is certified for use in hazardous locations listed below.

### Intrinsic Safety:

US & Canada:  Class I, Division 1, Groups A, B, C, D, T4  
CE 0575  II 1G Ex ia IIC T4 Ga; DNV 2007 OSL-ATEX-9012X  
Ex ia IIC T4 Ga IECEx DNV 07. 0004X  
-20° C ≤ T<sub>amb</sub> ≤ +60° C

# ToxiRAE 3 User's Guide

## Intended operation area and conditions

### **Hazardous Area classified by Zones**

ToxiRAE 3 is intended to be used in hazardous areas classified zone 0, 1 or 2 in the temperature range of  $-20^{\circ}\text{C}$  to  $+60^{\circ}\text{C}$ , where gases of explosion groups IIA, IIB or IIC, T4 may be present.

### **Hazardous Area classified by Divisions**

ToxiRAE 3 is intended to be used in hazardous areas, classified Class I, Division 1 or 2, in the temperature range of  $-20^{\circ}\text{C}$  to  $+60^{\circ}\text{C}$ , where gases of groups A, B, C or D may be present.

## ToxiRAE 3 User's Guide



Utiliser seulement la batterie Lithium RAE Systems référence 500-0076-100 (3.6V, 1650mAh, format 2/3AA). Cet instrument n'a pas été testé dans une atmosphère de gaz/air explosive ayant une concentration d'oxygène plus élevée que 21%. La substitution de composants peut compromettre la sécurité intrinsèque. Ne changer les batteries que dans un emplacement désigné non dangereux.

**RISQUE D'ORIGINE ELECTROSTATIQUE:** Nettoyer uniquement avec un chiffon humide.

Pour des raisons de sécurité, cet équipement doit être utilisé et entretenu uniquement par un personnel qualifié. Étudier le manuel d'instructions en entier avant d'utiliser, ou d'entretenir l'équipement.

Tout appareil neuf de RAE Systems doit préalablement passer le test de vérification d'étalonnage qui consiste à exposer le ou les capteurs à une concentration connue de gaz étalon.

Le détecteur doit être impérativement étalonné s'il ne passe pas le test de vérification d'étalonnage, ou bien au moins tous les 6 mois, selon l'utilisation et l'exposition à des gaz poisons ou des contaminants, et selon le mode opératoire.

Une vérification d'étalonnage est définie par une exposition du détecteur au gaz d'étalonnage qui doit déclencher le seuil d'alarmes bas.



# ToxiRAE 3 User's Guide

## 1. General Information

**ToxiRAE 3** is a programmable single-gas monitor designed to provide exposure monitoring for workers in hazardous environments. It can be programmed to operate in either of two configurations: Display and Countdown. In Display Configuration, it is programmable and can be turned on and off. In Countdown Configuration, it operates continuously from the time it is turned on and cannot be turned off until the sensor is depleted.

### Key Features

#### **Lightweight and Compact**

3.5 oz (99 g), handheld size.

#### **Dependable and Accurate**

#### **User Friendly**

Menu-driven, intuitive end-use operation.

#### **Programmable Alarm Thresholds**

Audio buzzer and flashing display alarm.

- Standard sensor of CO (low), CO (high), or H<sub>2</sub>S
- Replaceable Li-ion battery
- Large, easy-to-read display
- Event logging
- Visual alarm with bright red flashing LEDs
- Loud audible alarm (95dB at 30 cm)
- Vibration alarm
- Rugged weather-resistant case

# ToxiRAE 3 User's Guide

## 2. Specifications

### ToxiRAE 3 Specifications

<b>Configuration</b>	Diffusion single-gas with event logging for up to 10 events												
<b>Dimensions</b>	3.4" L x 2.2" W x 0.8" H (8.6 cm x 5.5 cm x 2.0 cm)												
<b>Weight</b>	3.5 oz (99 g) with battery												
<b>Battery</b>	User-replaceable 2/3 AA high-capacity lithium												
<b>Alarms</b>	<ul style="list-style-type: none"><li>• 95 dB (at 30 cm) buzzer and flashing red LED to indicate exceeded preset limits</li><li>• High: Displays "High" and emits 3 beeps and flashes per second</li><li>• Low: Displays "Low" and emits 2 beeps and flashes per second</li><li>• STEL: Displays "STEL" and emits 1 beep and flash per second</li><li>• TWA: Displays "TWA" and emits 1 beep and flash per second</li><li>• Vibration alarm</li><li>• 6-LED visible alarm</li></ul>												
<b>Operating Time</b>	2 years, without IR communication usage												
<b>Display</b>	LCD												
<b>Keypad</b>	2 programming/operation keys												
<b>Direct Readout</b>	Measured gas value with sensor name, battery charge, high and low value, elapsed time, and event logging on/off state												
<b>Sampling Method</b>	Diffusion												
<b>Range &amp; Resolution</b>	<table><thead><tr><th>Sensor</th><th>Range (ppm)</th><th>Resolution (ppm)</th></tr></thead><tbody><tr><td>H<sub>2</sub>S</td><td>0 to 100</td><td>0.1</td></tr><tr><td>CO</td><td>0 to 500</td><td>1</td></tr><tr><td>CO</td><td>0 to 1999</td><td>1</td></tr></tbody></table>	Sensor	Range (ppm)	Resolution (ppm)	H <sub>2</sub> S	0 to 100	0.1	CO	0 to 500	1	CO	0 to 1999	1
Sensor	Range (ppm)	Resolution (ppm)											
H <sub>2</sub> S	0 to 100	0.1											
CO	0 to 500	1											
CO	0 to 1999	1											
<b>Datalogging</b>	10 events												
<b>Response Time</b>	T90 < 12 seconds												
<b>Calibration</b>	Two-point calibration for zero and span												
<b>IP Rating</b>	IP-67												
<b>Protection:</b>	Password protected calibration settings, alarm limits, and data												
<b>Certification:</b>	US and Canada: C1D1, Groups A, B, C, D, T4 Europe: ATEX II 1G EEx ia IIC T4 IECEX: Ex ia IIC T4												
<b>Operating Temperature</b>	Continuous: -20° C to +60° C												
<b>Humidity</b>	0 to 95% relative humidity (non-condensing)												
<b>Warranty</b>	2 years, including sensor and battery if used within specs												

# ToxiRAE 3 User's Guide

## 3. Overview

The ToxiRAE 3 single-gas monitor features fast response, small size, and long battery and sensor life. Its vibration, audible, and visible (LED) alarms and large display warn the user of dangerous gas concentrations.

### 3.1.1. Display And Countdown Configurations

The ToxiRAE 3 can be configured to operate in two ways: Display (showing all readings and allowing programming from the monitor) and Countdown (showing only the days remaining of the sensor's life and only changing when it goes into alarm). The factory default for the ToxiRAE 3 is to provide a ppm (parts per million) display. However, using the AutoRAE Lite Utility program, it is possible to set the ToxiRAE 3 to Countdown configuration, which only displays readings when in alarm. Refer to the procedure starting on page 29 that details how to change from Display to Countdown configuration.

**Display Configuration.** This display tells you the current reading, in parts per million.



However, the display may alert you if a bump test or calibration is necessary:

- If the bump due day has passed, OK is not shown on the display. Instead “BUMP” flashes.
- If the calibration due day has passed, OK is not shown, and instead “CAL” flashes.

If there are still days left until both bump testing and calibration are necessary, “OK” is displayed.

Unless a bump test or calibration is necessary, the ToxiRAE 3 is ready to use. You can proceed to perform a bump test, test the alarms, or view the STEL screen:

- To perform a bump test, press [MODE] repeatedly until you see “Bump” flashing in the display.
- To test the buzzer, LED, and vibration alarms, momentarily press [Y/+].
- To advance to the STEL screen, press [MODE].

**Countdown Configuration.** This display tells you how many days until the ToxiRAE 3 expires. The screen alternates between the word “dAy” and the number of days:

# ToxiRAE 3 User's Guide

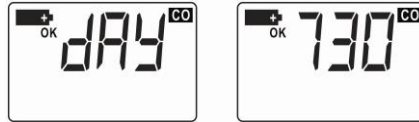

If the bump due day has passed, OK is not shown on the display. Instead “BUMP” flashes once for a half-second.

If the calibration due day has passed, OK is not shown, and instead “CAL” flashes once for a half-second.

If there are still days left until both bump testing and calibration are necessary, “OK” is displayed.

- To perform a bump test, press [MODE] repeatedly until you see “BUMP” flashing. Follow the instructions for bump testing on page 27.
- To test the buzzer, LED, and vibration alarms, momentarily press [Y/+].
- To advance to the STEL screen, press [MODE].

## 4. User Interface

The ToxiRAE 3’s user interface consists of the display, LEDs, an alarm buzzer, and two keys, [MODE] and [Y/+]. The LCD display provides visual feedback that includes calibration or bump request, sensor mode and battery condition.



# ToxiRAE 3 User's Guide

## 5. Turning The ToxiRAE 3 On

To turn the ToxiRAE 3 on, press and hold [MODE] for 3 seconds.

**Caution:** The alarm buzzer is very loud. During startup, you can mute most of the sound by holding a finger over the alarm buzzer port.

**Note:** Do not put tape over the alarm buzzer port to permanently mute it.

1. The ToxiRAE 3 turns on and the display shows “On” and a battery icon that indicates the battery’s condition. The buzzer and LEDs are tested.
2. The firmware version is shown in the display (for example, “F1.0” indicates firmware version 1.0).
3. The sensor is tested. If the sensor is okay, it warms up, and there is a countdown. (The countdown time depends on the sensor.)

**Note:** If the sensor is depleted or does not check out satisfactorily, an error message of “E01” flashes on the display. The ToxiRAE 3 should not be used until the sensor is replaced. (Shut off the ToxiRAE 3 by pressing and holding [MODE] until you see the countdown and the display shows “oFF.”)

4. Once the countdown is complete, the type of sensor is displayed (for example, “CO”), “OK” is displayed below the battery icon, and the reading is also shown (for example 0 ppm). The ToxiRAE 3 is now in Normal Mode and is ready for use.

## 6. Turning The ToxiRAE 3 Off

Press and hold [MODE]. In 2 seconds, a 5-second countdown to shutoff begins. You must hold your finger on the key for the entire shutoff process. If you remove your finger from the key during the countdown, the shutoff operation is canceled and the ToxiRAE 3 continues normal operation.

When you see “oFF,” release your finger from the [MODE] key. The ToxiRAE 3 is now off.

**Caution:** The alarm is very loud. During shutdown, you can mute most of the sound by holding a finger over the alarm port.

## 7. Testing The Alarms (Anytime)

Under normal non-alarm conditions, the buzzer, vibration alarm, and LEDs can be tested at any time by pressing [Y/+] once.

# ToxiRAE 3 User's Guide

## 8. Low Battery Warnings

When the battery's charge is low, the battery symbol flashes once per second and "bAt" flashes once per minute:

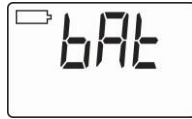

When the battery reaches a critically low charge, the battery symbol flashes once per second and "bAt" flashes once per minute, plus the buzzer sounds once per minute.

## 9. Dead Battery Warning & Shutoff

When the battery is dead, the buzzer sounds once per second for the last minute and then shuts off. The display shows "oFF":



**Important!** Do not operate the ToxiRAE 3 again until its battery has been replaced.

### WARNING!

**To reduce the risk of ignition of hazardous atmospheres, replace battery only in areas known to be non-hazardous.**

# ToxiRAE 3 User's Guide

## 10. Operating The ToxiRAE 3 In Display Configuration

### 10.1. Mode Overview

The ToxiRAE 3 has three operational modes:

- **Normal** — see page 14 for detailed instructions.
- **Programming** — see page 17 for detailed instructions.
- **Diagnostic** — see page 28 for detailed instructions.

**The following is an overview of the three modes:**

**Normal Mode** is the default mode. It is accessed when you turn on the ToxiRAE 3. There are no access restrictions (you do not need a password), and it provides the indications and data you need most for typical monitoring applications. There are two sub-modes of operation, Display and Disposable. Display includes:

- Readings of carbon monoxide (CO) or hydrogen sulfide (H<sub>2</sub>S), depending on the sensor.
- STEL (short-term exposure limit).
- TWA (time-weighted average).
- Battery level.
- Recent alarms.

Disposable only shows the number of days left until a bump test is required and information when an alarm is triggered.

Both sub-modes of Normal Mode also allow you to turn on IR (infrared) communication to communicate with an AutoRAE Lite.

**Programming Mode** is password-protected and includes adjustable settings to accomplish the following:

- Calibrate the monitor (this includes zero and span, and changing the span gas value).
- Change alarm limits.
- Change the monitor bump and calibration interval.
- Change the sensor configuration.

**Diagnostic Mode** is primarily intended for technicians to use during troubleshooting, although it also offers access to a few changeable parameters that you may rarely (if ever) change. You can enter Diagnostic Mode without restriction. In Diagnostic Mode, ToxiRAE 3 displays readings in raw counts instead of units such as parts per million (ppm).

# ToxiRAE 3 User's Guide

Parameters marked with an asterisk (\*) can be adjusted by entering Programming Mode from Diagnostic Mode. See Page 28 for details.

## 10.2. Normal Mode

Normal Mode is the default mode of the ToxiRAE 3 when it is turned on. By using the [MODE] key, you can step through the screens that provide you with information from the sensors, as well as the ToxiRAE 3's current settings. The selected sub-mode (Display or Disposable) determines the number of screens that are accessible.

### 10.2.1. Enter Normal Mode / Turn On The ToxiRAE 3

1. With the ToxiRAE 3 turned off, press and hold [MODE].
2. When the display turns on, release the key. The buzzer and LEDs are tested and the display shows "On" followed by the firmware version (for example, F 1.0). It then starts a countdown (the time is based on the sensor's warmup requirements).



**Note:** If the ToxiRAE 3 detects a bad sensor, it aborts the countdown and gives this message:



If you see this error message, shut off the ToxiRAE 3 and contact your distributor or RAE Systems technical support.

If the countdown proceeds and reaches 0, then the ToxiRAE 3 goes to one of two sub-mode types: Display and Disposable.

### 10.2.2. Exit Normal Mode / Turn Off The ToxiRAE 3

Whenever you turn off the ToxiRAE 3, it will start up in Normal Mode the next time it is turned on, unless you intentionally place it in Diagnostic Mode. Follow the detailed instructions on entering Programming Mode and Diagnostic Mode for information on entering the other two modes.

Press and hold [MODE] while the ToxiRAE 3 goes through a countdown to 0. When it says "oFF," release your finger, and the ToxiRAE 3 is off. After it is shut off, the ToxiRAE 3 will automatically be in Normal Mode the next time you start it.



## ToxiRAE 3 User's Guide

### 10.2.3. Stepping Through Normal Mode (Display)

**STEL** Press [MODE] to advance to STEL. This provides Short Term Exposure Limit (STEL) data. These are based on 15-minute STEL values of H<sub>2</sub>S and CO in ppm. A STEL value is only displayed after the ToxiRAE 3 has been on for 15 minutes.

**Note:** If you do not press a key within 1 minute, the display reverts to the normal reading.

**TWA** Press [MODE] to advance to TWA. The TWA (time-weighted average) reading is the average reading of the gas concentration times the fraction of 8 hours that the monitor has been on.

**Note:** If you do not press a key within 1 minute, the display reverts to the normal reading.

**Peak** Press [MODE] to advance to Peak (indicated by the letter “P” alternating with a reading). This tells you the highest reading for each sensor since the ToxiRAE 3 was turned on. Press [Y/+] twice to clear the Peak and Min or [MODE] once to advance to Min.

**Note:** If you do not press a key within 1 minute, the display reverts to the normal reading.

**Alarms** If there have been any alarms, you can step through them by pressing [MODE], and reading up to 10 events, labeled A01 through A10, including STEL, High, and Low alarms, and the readings stored with them. (If more than 10 events are recorded, new ones overwrite the oldest ones. Events cannot be cleared or selectively removed.)

**Note:** If you do not press a key within 1 minute, the display reverts to the normal reading.

**IR** When the ToxiRAE 3 is placed in an AutoRAE Lite that is connected to a computer running ProRAE Studio software, the ToxiRAE 3 can upload event data and download revised firmware. It also allows automatic calibration and bump testing in an AutoRAE Lite. See page 20 for details.

## ToxiRAE 3 User's Guide

### 10.2.4. Clearing STEL, TWA, And Peak Values

From the STEL screen, you can clear the STEL value, view and clear the TWA value, and view and clear the Peak value.

**STEL.** When viewing the STEL screen, you can clear the value or advance to the next screen, TWA.

**Clearing the STEL value:** Press [Y/+], and you then see “CLr” accompanied by a flashing “?”

- Press [Y/+] to clear the STEL value.
- Press [MODE] to leave the STEL value unchanged and advance to the TWA screen.

**Clearing the TWA value:** Press [Y/+], and you then see “CLr” accompanied by a flashing “?”

- Press [Y/+] to clear the TWA value.
- Press [MODE] to leave the TWA value unchanged and advance to the Peak screen.

**Clearing the Peak value:** The Peak value screen alternates between showing “P” and its value. Press [Y/+], and you then see “CLr” accompanied by a flashing “?” alternating with “P” accompanied by a flashing “?”

- Press [Y/+] to clear the Peak value.
- Press [MODE] to leave the Peak value unchanged and advance to the Event Logs screen (or, if there are no event logs, to the Enter Infrared Communications Mode screen).

# ToxiRAE 3 User's Guide

## 10.2.5. Programming Mode

Programming Mode can be entered from Normal Mode or Diagnostic Mode. This mode contains most adjustable settings for the ToxiRAE 3. It is organized into nine submenus:

- Zero calibration
- Span calibration
- Set span gas value
- Set high alarm value
- Set low alarm value
- Set STEL alarm value
- Set TWA alarm value
- Set Bump Due day
- Set Calibration Due day
- End (exit)

## 10.2.6. Enter Programming Mode

The following diagram shows how to enter Programming Mode from Normal Mode and from Diagnostic Mode:

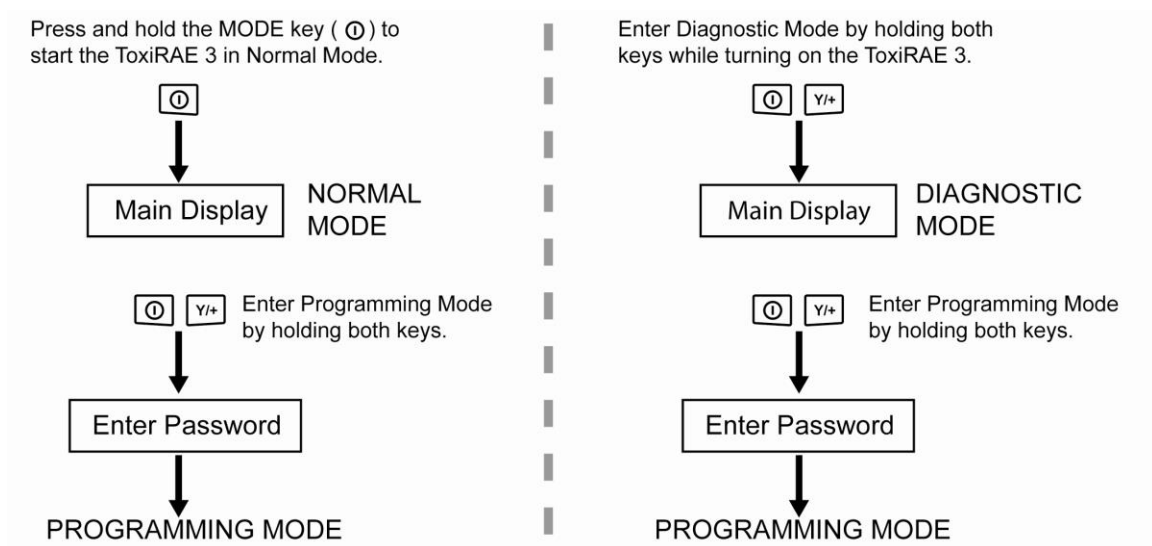

To enter Programming Mode, press and hold [MODE] and [Y/+] simultaneously for three seconds. To exit this mode, press and hold [MODE] until the ToxiRAE 3 shuts down. When you restart, it is in Normal Mode.

## ToxiRAE 3 User's Guide

When you enter Programming mode, the display shows three zeroes:

**000**

The first digit blinks to indicate that it is the active digit to modify.

Increase a number by pressing the [Y/+] key (1, 2, 3 ... etc.).

**Note:** The numbers advance until the number 9 and then “wrap around” to 0 again.

Advance to the next digit by pressing [MODE] (000, 000, 000, etc.). It blinks to indicate that it is the active digit to modify. **Note:** The display has a “wrap-around,” so once you reach the last digit, pressing [MODE] advances to the first digit again.

**Note:** The default password is 111.

Once you are satisfied with the password, press and hold [MODE].  
If you want to cancel, press [Y/+].

**Note:** If you do not enter the correct numbers and press [Y/+], the display shows this error message:



The ToxiRAE 3 then automatically exits and returns to Normal Mode's main screen.

**Note:** If you enter an incorrect number while trying to enter Programming Mode from Diagnostic Mode, the ToxiRAE 3 exits to Diagnostic Mode's main screen instead of Normal Mode's main screen.

**Note:** The password can only be changed by using AutoRAE Lite software on a PC.  
If you change the password, write it down and save it in a safe location.



## ToxiRAE 3 User's Guide

### 11. Bump Testing & Calibrating The ToxiRAE 3

RAE Systems recommends that a bump test be performed periodically on the ToxiRAE 3. The monitor should be calibrated if it does not pass a bump test, but no less than every 6 months, depending on use and exposure to gas and contamination, and its operational mode.

A bump test is defined as a brief exposure of the monitor to the calibration gas and the sensors to show response and trigger the lowest alarm set point for each sensor.

- Calibration intervals and bump test procedures may vary due to national legislation.

**Note:** Bump testing and calibration can also be performed by using the RAE Systems AutoRAE Lite™ docking station. Instructions are provided with it.

**Note:** After a bump test is performed and the ToxiRAE 3 passes, the ToxiRAE 3 resets its countdown until the next bump test is required to the maximum number programmed in its memory.

#### 11.1. Bump Testing & Calibrating With An AutoRAE Lite

Bump testing and calibrating a ToxiRAE 3 with an AutoRAE Lite docking station requires that the ToxiRAE 3 be placed in IR (infrared mode) before it is placed in the AutoRAE Lite's cradle.

1. Make sure the ToxiRAE 3 is on and in monitoring mode.
2. Press and hold [Y/+] for 3 seconds. When "Ir" appears, release the key.
3. Place the ToxiRAE 3 in the AutoRAE Lite's cradle and begin a bump test or calibration.

**Note:** Follow all instructions in the AutoRAE Lite User's Guide for successful calibration.

# ToxiRAE 3 User's Guide

## 11.2. Calibration Adapter

The ToxiRAE 3 is a diffusion monitor and must be calibrated using a fixed-flow regulator with a flow rate between 0.5 and 1.0 liters per minute. The ToxiRAE 3 is supplied with a special calibration adapter that covers the gas diffusion port. If the local air has impurities that might interfere with zero (fresh air) calibration, the calibration adapter and a cylinder of clean zero air should be used.

### 11.2.1. Connecting The Calibration Adapter

1. Attach the Calibration Adapter over the inlet port on the front of the ToxiRAE 3 by pressing it into place.

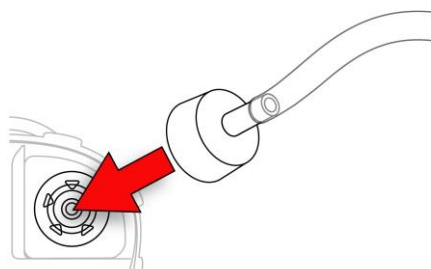

2. Attach the hose from the regulator/calibration gas cylinder to the Calibration Adapter's inlet.

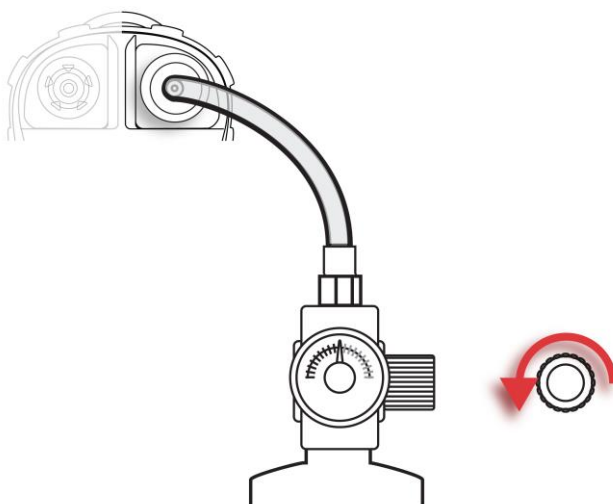

**Caution!** After calibration is complete, remove the Calibration Adapter. When monitoring, never operate the ToxiRAE 3 with the Calibration Adapter attached. The ToxiRAE 3's sensor operates by diffusion. If the Calibration Adapter is attached during normal operation, inconsistent and lower-than-normal readings will occur because of decreased concentration of the gas being monitored.

# ToxiRAE 3 User's Guide

## 11.2.2. Disconnecting The Calibration Adapter

After calibrating the ToxiRAE 3, you must remove the Calibration Adapter. Lift the Calibration Adapter from the ToxiRAE 3 and store it.

## 11.2.3. Calibrations And Settings In Programming Mode

Turn on the ToxiRAE 3. Once it has been through its startup, enter Programming Mode:

1. Press and hold both [MODE] and [Y/+] until you see the password screen, "000."
2. Enter the password (the default is 111) by pressing [Y/+] to increase the number, followed by pressing [MODE] to advance to the second digit. Follow this procedure until there are three "1"s.
3. Press and hold [MODE] until you see the "Zero Cal?" screen.



The ToxiRAE 3 is now ready for zero calibration.

**Note:** If the ToxiRAE 3 is in Programming Mode and you do not press a key within 60 seconds, it exits Programming Mode and re-enters Normal Mode.

## 11.2.4. Zero (Fresh Air) Calibration

This sets the zero point of the sensor calibration curve for clean air. Expose the ToxiRAE 3 to a clean air source with 20.9% oxygen and without any organic, toxic or combustible gas impurities. This "Zero Air" can be from a cylinder, clean ambient air, or ambient air purified through a charcoal filter.

**Note:** If you use a zero air cylinder, you must use the ToxiRAE 3 Calibration Adapter.

With the ToxiRAE 3 on and in Programming Mode, follow this procedure:

1. Press [Y/+]. A countdown starts and "CAL" blinks. This indicates that zero calibration is taking place.
2. When the countdown reaches "0," the display alternates between "0" and "dn" (for "done").

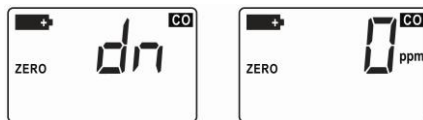

Upon completing a zero calibration, the ToxiRAE 3 automatically advances to the span calibration menu.



# ToxiRAE 3 User's Guide

**Note:** You can interrupt zero calibration during its countdown by pressing either key. When you do so, the display shows “no,” which indicates that no calibration was performed.

**Important!** If you used the Calibration Adapter and a zero air cylinder, you must remove the Calibration Adapter from the ToxiRAE 3. If the Calibration Adapter is attached during normal operation, inconsistent and lower-than-normal readings will occur because of decreased concentration of the gas being monitored.

## 11.2.5. Span Calibration

This procedure determines the second point of the sensor calibration curve for the sensor. Performing a Span Calibration requires using the Calibration Adapter, a flow regulator, and a tank of span gas.



Before starting a span calibration, connect the gas cylinder, flow regulator, and Calibration Adapter to the ToxiRAE 3 and start the gas flow.

With the ToxiRAE 3 on and Programming Mode, and with the Span Cal menu screen showing, follow this procedure:

1. Press [Y/+]. A countdown starts and “CAL” blinks. This indicates that span calibration is taking place.
2. When the countdown reaches “0,” the display alternates between the concentration in ppm and “dn” (for “done”).

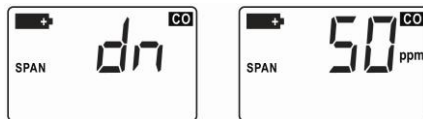

**Note:** You can interrupt span calibration during its countdown by pressing either key. When you do so, the display shows “no,” which indicates that no calibration was performed.

The ToxiRAE 3 automatically advances to the next menu, Set Span Gas Value.

**Important!** After calibration is complete, you must remove the Calibration Adapter from the ToxiRAE 3. If the Calibration Adapter is attached during normal operation, inconsistent and lower-than-normal readings will occur because of decreased concentration of the gas being monitored.

## ToxiRAE 3 User's Guide

### 11.2.6. Set Span Gas Value

This function allows selection of the gas concentration. The default value is 25 ppm for H<sub>2</sub>S and 50 ppm for CO.



1. Press [MODE] to step through the digits.
2. Press [Y/+] to increase the number from 0 through 9. Once the number 9 is reached, pressing [Y/+] causes the numbers to “wrap around” to 0 and count up again.
3. Press and hold [MODE] for 3 seconds to register your change.

The ToxiRAE 3 automatically advances to the next menu, Set High Alarm Value.

### IMPORTANT!

**Turning Off Alarms:** If you set the High Alarm, Low Alarm, STEL Alarm, or TWA Alarm value to 0 (zero), then that alarm is turned off. Make sure that you set an alarm value greater than zero if you want to be alerted to any of these alarms.

### 11.2.7. Set High Alarm Value

This function allows you to selectively set the high alarm limit in the ToxiRAE 3. The default value for the CO model is 200 ppm, and for the H<sub>2</sub>S model, it is 15 ppm.



1. Press [MODE] to step through the digits.
2. Press [Y/+] to increase the number from 0 through 9. Once the number 9 is reached, pressing [Y/+] causes the numbers to “wrap around” to 0 and count up again.
3. Press and hold [MODE] for 3 seconds to register your change.

After you have modified the settings:

The ToxiRAE 3 automatically advances to the next menu, Set Low Alarm.

## ToxiRAE 3 User's Guide

### 11.2.8. Set Low Alarm Value

This function allows you to selectively set the low limit of the sensor in the ToxiRAE 3. The default value for the CO model is 35 ppm, and for the H<sub>2</sub>S model it is 10 ppm.



1. Press [MODE] to step through the digits.
2. Press [Y/+] to increase the number from 0 through 9. Once the number 9 is reached, pressing [Y/+] causes the numbers to “wrap around” to 0 and count up again.
3. Press and hold [MODE] for 3 seconds to register your change.

The ToxiRAE 3 automatically advances to the next menu, Set STEL Alarm Value.

### 11.2.9. Set STEL Alarm Value

This function allows you to selectively set the STEL (short term exposure limit) of the ToxiRAE 3. If the concentration exceeds the limit you set, the loud buzzer, red flashing LED, and vibration alarm are activated immediately to warn of the alarm condition. The default value for the CO model is 100 ppm, and for the H<sub>2</sub>S model it is 15 ppm.



1. Press [MODE] to step through the digits.
2. Press [Y/+] to increase the number from 0 through 9. Once the number 9 is reached, pressing [Y/+] causes the numbers to “wrap around” to 0 and count up again.
3. Press and hold [MODE] for 3 seconds to register your change.

The ToxiRAE 3 automatically advances to the next menu, Set High Alarm Value.

## ToxiRAE 3 User's Guide

### 11.2.10. Set TWA Alarm Value

The TWA (time-weighted average) reading is the average reading of the gas concentration times the fraction of 8 hours that the monitor has been on. If the concentration exceeds the limit you set, the loud buzzer, red flashing LED, and vibration alarm are activated immediately to warn of the alarm condition. The default value is 10 ppm for H<sub>2</sub>S.



1. Press [MODE] to step through the digits.
2. Press [Y/+] to increase the number from 0 through 9. Once the number 9 is reached, pressing [Y/+] causes the numbers to “wrap around” to 0 and count up again.
3. Press and hold [MODE] for 3 seconds to register your change.

The ToxiRAE 3 automatically advances to the next menu, Set Bump Due Day.

### 11.2.11. Set Bump Due Day

You can set a number of days until the next bump test must be performed. The ToxiRAE 3 keeps track of the number of days, and on the expiration day, it notifies the user by flashing “BUMP” on the screen continuously until a bump test is performed.

**Note:** The default value is 0 (zero) days. This means that the Due Day reminder is turned off. Make sure that you set a value greater than zero if you want to be alerted to perform a bump test on a specific day.



1. Press [MODE] to step through the digits.
2. Press [Y/+] to increase the number from 0 through 9. Once the number 9 is reached, pressing [Y/+] causes the numbers to “wrap around” to 0 and count up again.
3. Press and hold [MODE] for 3 seconds to register your change.

**Note:** If the number you enter for the bump due day exceeds 255, the display shows “Err,” indicating that you must set a different number. It then reverts to your previous number, where you can set an allowed number, following the three steps above.

The ToxiRAE 3 automatically advances to the next menu, Set Calibration Due Day.

## ToxiRAE 3 User's Guide

### 11.2.12. Set Calibration Due Day

You can set a number of days until the next calibration must be performed. The ToxiRAE 3 keeps track of the number of days, and on the expiration day, it notifies the user by flashing “CAL” on the screen continuously until a calibration is performed. The default value is 180 days.



1. Press [MODE] to step through the digits.
2. Press [Y/+] to increase the number from 0 through 9. Once the number 9 is reached, pressing [Y/+] causes the numbers to “wrap around” to 0 and count up again.
3. Press and hold [MODE] for 3 seconds to register your change.

**Note:** If the number you enter for the calibration due day exceeds 255, the display shows “Err,” indicating that you must set a different number. It then reverts to your previous number, where you can set an allowed number, following the three steps above.

The ToxiRAE 3 automatically advances to a menu that says “End?”

### 11.2.13. End Programming (Exit To Normal Mode)

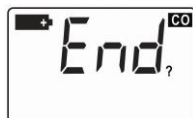

- Press [Y/+] to exit to Normal Mode.
- Press [MODE] to return to the first menu item, Zero Calibration.

## 11.3. Bump Testing

RAE Systems recommends that a bump test be performed periodically on the ToxiRAE 3. The monitor should be calibrated if it does not pass a bump test, but no less than every 6 months, depending on use and exposure to gas and contamination, and its operational mode.

1. Turn on the ToxiRAE 3 in Normal Mode.
2. Connect the calibration gas cylinder, flow regulator, and Calibration Adapter to the ToxiRAE 3 and start the gas flow.
3. Press [MODE] repeatedly until you see “BUMP” flashing.
4. Check that the bump gas concentration is the same as the gas cylinder’s concentration.
5. Press [Y/+] to start the bump test.
6. If the bump test is successful, the screen returns to Normal Mode and resets the bump due day icon on the screen.

# ToxiRAE 3 User's Guide

## 12. Diagnostic Mode

The ToxiRAE 3's Diagnostic Mode can only be accessed at startup time. In Diagnostic Mode, ToxiRAE 3 displays readings in raw counts instead of units such as parts per million (ppm).

### 12.1. Enter Diagnostic Mode

1. With the ToxiRAE 3 turned off, press and hold both [MODE] and [Y/+].
2. When the display turns on, release the keys.

### 12.2. Navigating Diagnostic Mode

In Diagnostic Mode, the ToxiRAE 3 provides raw counts for overall reading, STEL, TWA, and Low Alarm. Step through the four screens by pressing [MODE].

### 12.3. Exit Diagnostic Mode

1. Turn off the ToxiRAE 3 by pressing and holding [MODE]. There will be a standard shutoff countdown.
2. When it shuts off, you will be alerted. Release your finger.

**Note:** The next time you start ToxiRAE 3, hold only [MODE], and it will automatically be in Normal Mode.

## ToxiRAE 3 User's Guide

### 13. Changing The ToxiRAE 3 From Display To Countdown Configuration

When the ToxiRAE 3 is in Countdown Mode, it provides constant exposure monitoring over a two-year period, but it cannot be programmed or shut off. The main display shows the number of days until the sensor is expected to stop working and only changes to a reading when an alarm goes off. A ToxiRAE 3 with firmware version 1.80 and above can be reconfigured to operate in either mode by using an AutoRAE Lite For ToxiRAE 3 and a PC running AutoRAE Lite Utility software.

#### 13.1. Using AutoRAE Lite Utility To Change The Configuration

In order to change the ToxiRAE 3's configuration, you must use an AutoRAE Lite for ToxiRAE 3 and AutoRAE Lite Utility software running on a PC.

Follow the instructions that accompany the AutoRAE Lite to connect it to your PC and start the software. Make sure the port is configured correctly.

1. Start the AutoRAE Lite Utility Program.
2. Turn on the ToxiRAE 3.
3. Press and hold the ToxiRAE 3's [Y/+] key until the display shows "Ir."
4. Place the ToxiRAE 3 into the AutoRAE Lite's dock.
5. At the menu bar, pull down "Operation" and select "Get Configurations." You should see the AutoRAE Lite, ToxiRAE 3, and its sensor represented in the left pane, like this:

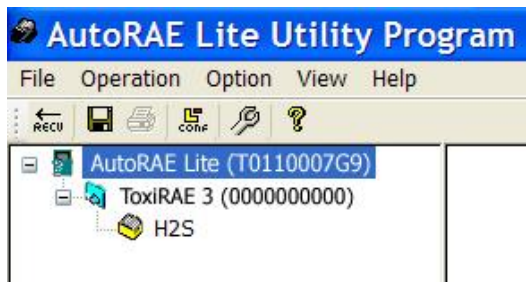

6. Enter a password to place the program in Administrator Mode. (The AutoRAE Lite Utility must be in Administrator Mode to change the ToxiRAE 3's settings.)

## ToxiRAE 3 User's Guide

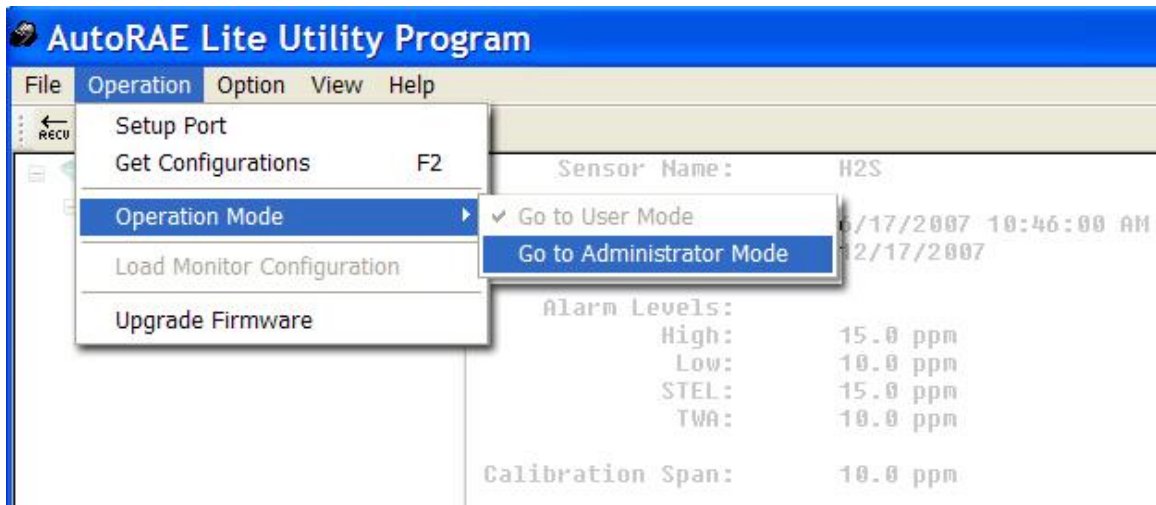

When the pop-up window appears, you must type in a password:



**Note:** The default password is **rae**.

Click "OK" to register your password and enter Administrator Mode.

Click "Get Configurations." As the connection is being made and the AutoRAE Lite configuration data is transferred, a succession of three animated progress pop-up windows is shown:

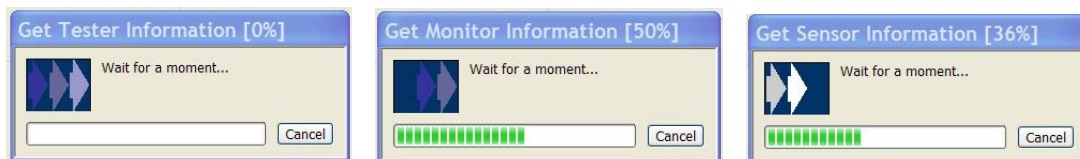

The main screen is populated with data and now includes icons of the AutoRAE Lite, the ToxiRAE 3, and its sensor in the left pane, along with the AutoRAE Lite's and ToxiRAE 3's serial numbers.



## ToxiRAE 3 User's Guide

Click the representation of the ToxiRAE 3 monitor:

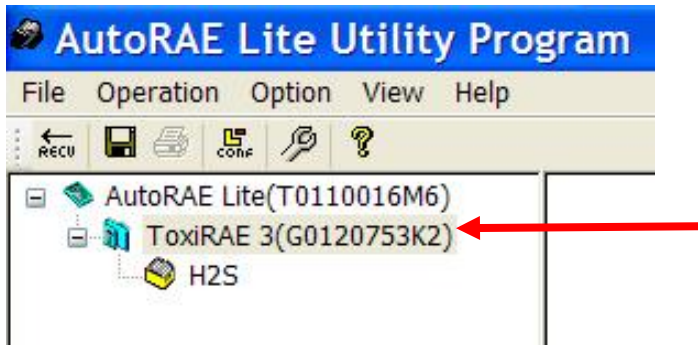

A section of the lower right pane labeled “Setting” shows you options for the ToxiRAE 3. If the ToxiRAE 3 is in Display configuration, the “Show Sensor Reading” option labeled “Always” is selected. To change the ToxiRAE 3’s configuration to Countdown, click “On Alarm”:



Click “Set.” While the new configuration data is sent to the ToxiRAE 3, this progress screen appears on the computer’s screen:

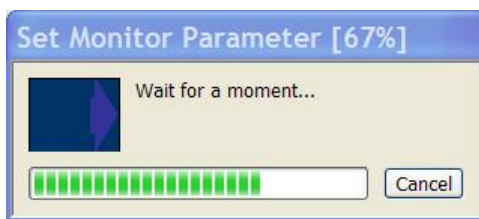

If the transfer is successful, you see this message:

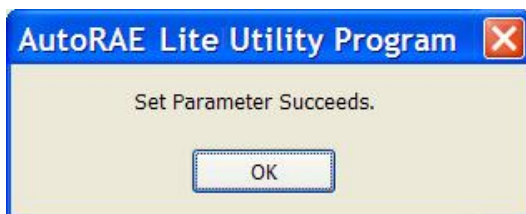

## ToxiRAE 3 User's Guide

Click “OK” and you are done.

Remove the ToxiRAE 3 from the AutoRAE Lite's cradle. It is now in Countdown configuration and alternately shows “dAy” and a number of days in the display.

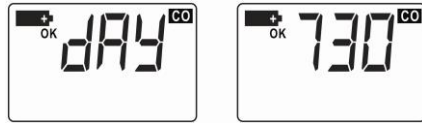

### 14. Changing The ToxiRAE 3 From Countdown To Display Configuration

Follow the procedure in the previous section, but instead of clicking “On Alarm” in the “Show Sensor Reading” options, click “Always.”



When configuration is complete, the settings have been placed in the ToxiRAE 3, and the ToxiRAE 3 removed from the AutoRAE Lite, the display in the ToxiRAE 3 should show standard reading instead of the countdown day:



## 15. Operating The ToxiRAE 3 In Countdown Configuration

### 15.1. Turning On The ToxiRAE 3

1. With the ToxiRAE 3 turned off, press and hold [MODE].
2. When the display turns on, release the key. The buzzer and LEDs are tested and the display shows “On” followed by the firmware version (for example, F 1.0). It then starts a countdown (the time is based on the sensor's warmup requirements).



**Note:** If the ToxiRAE 3 detects a bad sensor, it aborts the countdown and gives this message:



If you see this error message, shut off the ToxiRAE 3 and contact your distributor or RAE Systems technical support.

If the countdown proceeds and reaches 0, then the ToxiRAE 3 progresses to its main display.

**Note:** Once a ToxiRAE 3 in Countdown configuration has been turned on, it cannot be turned off, unless it is placed in an AutoRAE Lite and the configuration is changed to Display using AutoRAE Lite Utility software.

### 15.2. Main Display: Countdown

This is the main display, which tells you how many days until the ToxiRAE 3 sensor expires. The screen alternates between the word “dAy” and the number of days:

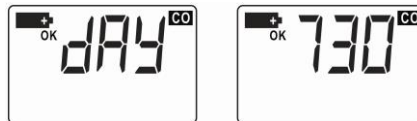

If the bump due day has passed, OK is not shown on the display. Instead “BUMP” flashes once for a half-second.

If the calibration due day has passed, OK is not shown, and instead “CAL” flashes once for a half-second.

# ToxiRAE 3 User's Guide

If there are still days left until both bump testing and calibration are necessary, “OK” is displayed.

- To perform a bump test, press [MODE] repeatedly until you see “BUMP” flashing. Follow the instructions for bump testing on page 27.
- To test the buzzer, LED, and vibration alarms, momentarily press [Y/+].
- To advance to the STEL screen, press [MODE].

## 15.2.1. Stepping Through Displays

Pressing [MODE] steps through the ToxiRAE 3 Countdown's displays. The following diagram shows the progression:

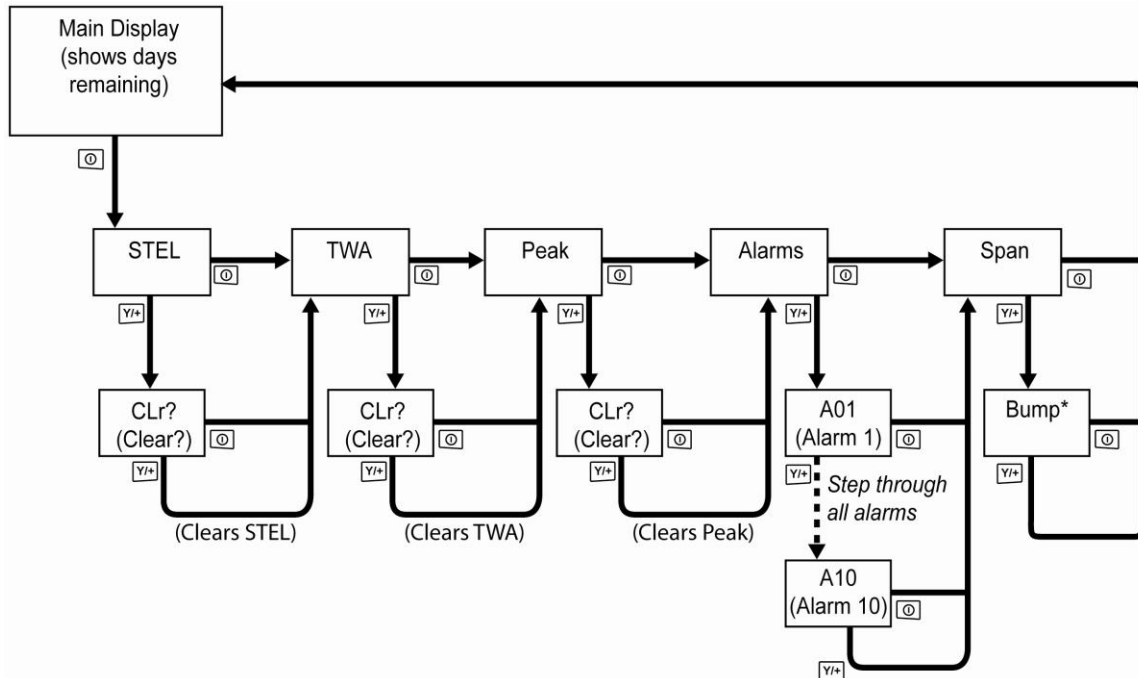

**Note:** STEL, TWA, and Peak values can be cleared (see next section.)

**STEL** Press [MODE] to advance to STEL. This provides Short Term Exposure Limit (STEL) data. These are based on 15-minute STEL values of H<sub>2</sub>S and CO in ppm. A STEL value is only displayed after the ToxiRAE 3 Countdown has been on for 15 minutes.

**Note:** If you do not press a key within 1 minute, the display reverts to the normal reading.

**TWA** Press [MODE] to advance to TWA. The TWA (time-weighted average) reading is the average reading of the gas concentration times the fraction of 8 hours that the monitor has been on.

## ToxiRAE 3 User's Guide

**Note:** If you do not press a key within 1 minute, the display reverts to the normal reading.

**Peak** Press [MODE] to advance to Peak (indicated by the letter “P” alternating with a reading). This tells you the highest reading for each sensor since the ToxiRAE 3 Countdown was turned on. Press [Y/+] twice to clear the Peak and Min or [MODE] once to advance to Min.

**Note:** If you do not press a key within 1 minute, the display reverts to the normal reading.

**Alarms** If there have been any alarms, you can step through them by pressing [MODE], and reading up to 10 events, labeled A01 through A10, including STEL, High, and Low alarms, and the readings stored with them. (If more than 10 events are recorded, new ones overwrite the oldest ones. Events cannot be cleared or selectively removed.)

**Note:** If you do not press a key within 1 minute, the display reverts to the normal reading.

### 15.2.2. Clearing STEL, TWA, And Peak Values

From the STEL screen, you can clear the STEL value, view and clear the TWA value, and view and clear the Peak value.

**STEL.** When viewing the STEL screen, you can clear the value or advance to the next screen, TWA.

**Clearing the STEL value:** Press [Y/+] , and you then see “CLr” accompanied by a flashing “?”

- Press [Y/+] to clear the STEL value.
- Press [MODE] to leave the STEL value unchanged and advance to the TWA screen.

**Clearing the TWA value:** Press [Y/+] , and you then see “CLr” accompanied by a flashing “?”

- Press [Y/+] to clear the TWA value.
- Press [MODE] to leave the TWA value unchanged and advance to the Peak screen.

**Clearing the Peak value:** The Peak value screen alternates between showing “P” and its value. Press [Y/+] , and you then see “CLr” accompanied by a flashing “?” alternating with “P” accompanied by a flashing “?”

## ToxiRAE 3 User's Guide

- Press [Y/+] to clear the Peak value.
- Press [MODE] to leave the Peak value unchanged and advance to the Event Logs screen (or, if there are no event logs, to the Enter Infrared Communications Mode screen).

### 16. Bump Testing & Calibrating The ToxiRAE 3 In Countdown Configuration

RAE Systems recommends that a bump test be performed periodically on the ToxiRAE 3 Countdown. The monitor should be calibrated if it does not pass a bump test, but no less than every 6 months, depending on use and exposure to gas and contamination, and its operational mode.

A bump test is defined as a brief exposure of the monitor to the calibration gas and the sensors to show response and trigger the lowest alarm set point for each sensor.

- Calibration intervals and bump test procedures may vary due to national legislation.

**Note:** Bump testing and calibration can also be performed by using the RAE Systems AutoRAE Lite™ docking station. Instructions are provided with it.

**Note:** After a bump test is performed and the ToxiRAE 3 Countdown passes, the ToxiRAE 3 Countdown resets its countdown until the next bump test is required to the maximum number programmed in its memory.

#### 16.1. Bump Testing & Calibrating With An AutoRAE Lite

Bump testing and calibrating a ToxiRAE 3 Countdown with an AutoRAE Lite docking station requires that the ToxiRAE 3 Countdown be placed in IR (infrared mode) before it is placed in the AutoRAE Lite's cradle.

1. Press and hold [Y/+] for 3 seconds. When "Ir" appears, release the key.
2. Place the ToxiRAE 3 Countdown in the AutoRAE Lite's cradle and begin a bump test or calibration.

**Note:** Follow all instructions in the AutoRAE Lite User's Guide for successful calibration.

#### 16.2. Calibration Adapter

The ToxiRAE 3 Countdown is a diffusion monitor and must be calibrated using a fixed-flow regulator with a flow rate between 0.5 and 1.0 liters per minute. The ToxiRAE 3

## ToxiRAE 3 User's Guide

Countdown is supplied with a special calibration adapter that covers the gas diffusion port. If the local air has impurities that might interfere with zero (fresh air) calibration, the calibration adapter and a cylinder of clean zero air should be used.

### 16.2.1. Connecting The Calibration Adapter

1. Attach the Calibration Adapter over the inlet port on the front of the ToxiRAE 3 Countdown by pressing it into place.

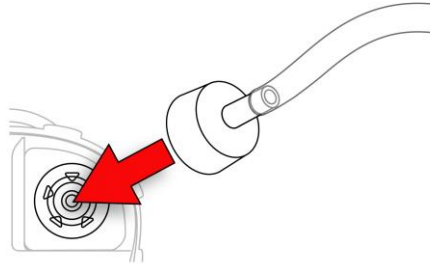

2. Attach the hose from the regulator/calibration gas cylinder to the Calibration Adapter's inlet.

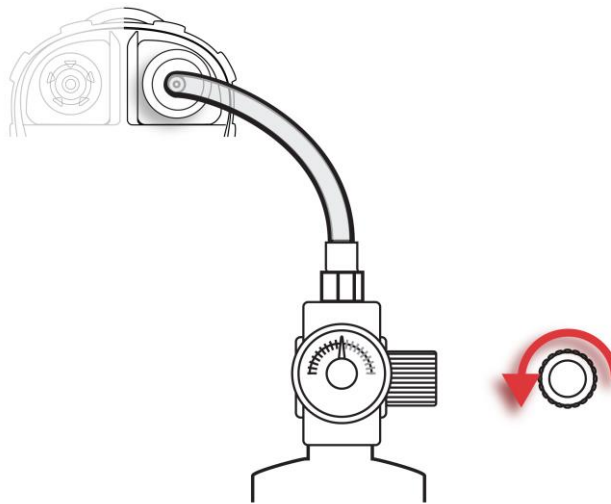

**Caution!** After calibration is complete, remove the Calibration Adapter. When monitoring, never operate the ToxiRAE 3 Countdown with the Calibration Adapter attached. The ToxiRAE 3 Countdown's sensor operates by diffusion. If the Calibration Adapter is attached during normal operation, inconsistent and lower-than-normal readings will occur because of decreased concentration of the gas being monitored.

### 16.2.2. Disconnecting The Calibration Adapter

After calibrating the ToxiRAE 3 Countdown, you must remove the Calibration Adapter. Lift the Calibration Adapter from the ToxiRAE 3 Countdown and store it.

# ToxiRAE 3 User's Guide

## 16.2.3. Calibration

When the ToxiRAE 3 Countdown requires calibration, the display blinks “SPAN” to alert you. You should perform a zero calibration and a span calibration with the correct gas type and concentration.

## 16.2.4. Zero (Fresh Air) Calibration

This sets the zero point of the sensor calibration curve for clean air. Expose the ToxiRAE 3 Countdown to a clean air source with 20.9% oxygen and without any organic, toxic or combustible gas impurities. This “Zero Air” can be from a cylinder, clean ambient air, or ambient air purified through a charcoal filter.

**Note:** If you use a zero air cylinder, you must use the ToxiRAE 3 Countdown Calibration Adapter.

With the ToxiRAE 3 Countdown on and in Programming Mode, follow this procedure:

1. Press [Y/+]. A countdown starts and “CAL” blinks. This indicates that zero calibration is taking place.
2. When the countdown reaches “0,” the display alternates between “0” and “dn” (for “done”).

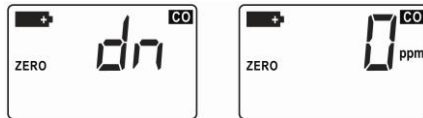

Upon completing a zero calibration, the ToxiRAE 3 Countdown automatically advances to the span calibration menu.

**Note:** You can interrupt zero calibration during its countdown by pressing either key. When you do so, the display shows “no,” which indicates that no calibration was performed.

**Important!** If you used the Calibration Adapter and a zero air cylinder, you must remove the Calibration Adapter from the ToxiRAE 3 Countdown. If the Calibration Adapter is attached during normal operation, inconsistent and lower-than-normal readings will occur because of decreased concentration of the gas being monitored.

## 16.2.5. Span Calibration

This procedure determines the second point of the sensor calibration curve for the sensor. Performing a Span Calibration requires using the Calibration Adapter, a flow regulator, and a tank of span gas.





## ToxiRAE 3 User's Guide

Before starting a span calibration, connect the gas cylinder, flow regulator, and Calibration Adapter to the ToxiRAE 3 Countdown and start the gas flow.

With the ToxiRAE 3 Countdown on and Programming Mode, and with the Span Cal menu screen showing, follow this procedure:

1. Press [Y/+]. A countdown starts and “CAL” blinks. This indicates that span calibration is taking place.
2. When the countdown reaches “0,” the display alternates between the concentration in ppm and “dn” (for “done”).

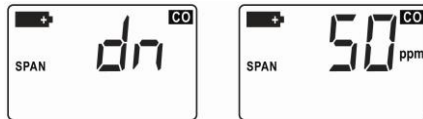

**Note:** You can interrupt span calibration during its countdown by pressing either key. When you do so, the display shows “no,” which indicates that no calibration was performed.

The ToxiRAE 3 Countdown automatically advances to the next menu, Set Span Gas Value.

**Important!** After calibration is complete, you must remove the Calibration Adapter from the ToxiRAE 3 Countdown. If the Calibration Adapter is attached during normal operation, inconsistent and lower-than-normal readings will occur because of decreased concentration of the gas being monitored.

### 16.2.6. Bump Due Day

The ToxiRAE 3 Countdown automatically keeps track of the number of days until the next bump test must be performed. On the expiration day, it notifies you by flashing “BUMP” on the screen continuously until a bump test is performed.

### 16.2.7. Calibration Due Day

The ToxiRAE 3 in Countdown configuration automatically keeps track of the number of days until the next calibration must be performed. On the expiration day, it notifies you by flashing “CAL” on the screen continuously until a calibration is performed. The default value is 180 days.



## ToxiRAE 3 User's Guide











### 16.3. Bump Testing

RAE Systems recommends that a bump test be performed periodically on the ToxiRAE 3 Countdown. The monitor should be calibrated if it does not pass a bump test, but no less than every 6 months, depending on use and exposure to gas and contamination, and its operational mode.

1. Connect the calibration gas cylinder, flow regulator, and Calibration Adapter to the ToxiRAE 3 Countdown and start the gas flow.
2. Press [MODE] repeatedly until you see "BUMP" flashing.
3. Check that the bump gas concentration is the same as the gas cylinder's concentration.
4. Press [Y/+] to start the bump test.
5. If the bump test is successful, the screen returns to Normal Mode and resets the bump due day icon on the screen.

## ToxiRAE 3 User's Guide



### 17. Alarm Signal Summary

Screen	Explanation
	<b>Sensor Fail Alarm</b> “E01” flashes once per second. ToxiRAE 3 shuts down if you hold down the [MODE] key.
	<b>Over Range Alarm</b> Buzzer sounds 3 times per second. Vibrates once every other second. “ovr” flashes once per second.
	<b>High Alarm</b> Buzzer sounds 3 times per second. Vibrates once every other second. “High” and “ALARM” flash once per second.
	<b>Low Alarm</b> Buzzer sounds 2 times per second. Vibrates once every other second. “Low” and “ALARM” flash once per second.
	<b>STEL Alarm</b> Buzzer sounds once per second. Vibrates once every other second. “STEL” and “ALARM” flash once per second.
	<b>TWA Alarm</b> Buzzer sounds once per second. Vibrates once every other second. “TWA” and “ALARM” flash once per second.
	<b>Negative Alarm</b> Buzzer sounds once per second. Vibrates once every other second. “-0” flashes once per second.
	<b>Battery Low Alarm</b> Battery symbol flashes once per second. “bAt” flashes once per minute.
	<b>Battery Critical Alarm</b> Buzzer sounds once per minute. Battery symbol flashes once per second. “bAt” flashes once per minute.
	<b>Battery Dead Alarm</b> Buzzer sounds once per second for the last minute and then ToxiRAE 3 powers off.

*Continued on next page*

## ToxiRAE 3 User's Guide

### *Alarm Signal Summary, continued*

Screen	Explanation
	<p><b>Calibration Failure Alarm</b>                      Buzzer sounds once per second.                      Vibrates once every other second.                      “CAL” and “ALARM” flash once per minute.</p>
	<p><b>Calibration Due</b>                      Buzzer sounds once per minute.                      “CAL” flashes once per second.</p>
	<p><b>Bump Test Due</b>                      Buzzer sounds once per minute.                      “BUMP” flashes once per second.</p>

# ToxiRAE 3 User's Guide

## 18. Maintenance



Maintenance should be performed only by a qualified person who has proper training and fully understands the contents of this manual.

The following guidelines should be followed when changing the battery:

1. Turn off the unit before changing the battery.
2. When replacing the battery, take note of its orientation. The battery's polarity (+/- orientation) is indicated on the printed circuit board.

### WARNING

To reduce the risk of ignition of hazardous atmospheres, replace the battery only in areas known to be non-hazardous.

### 18.1. Replacing the ToxiRAE 3 Li-Ion Battery

**Caution:** Turn off the ToxiRAE 3 before removing or replacing the 2/3 AA Li-Ion battery.

1. Place the ToxiRAE 3 face-down on a soft surface.
2. Use a Philips screwdriver to loosen each of the five screws by turning them counterclockwise.

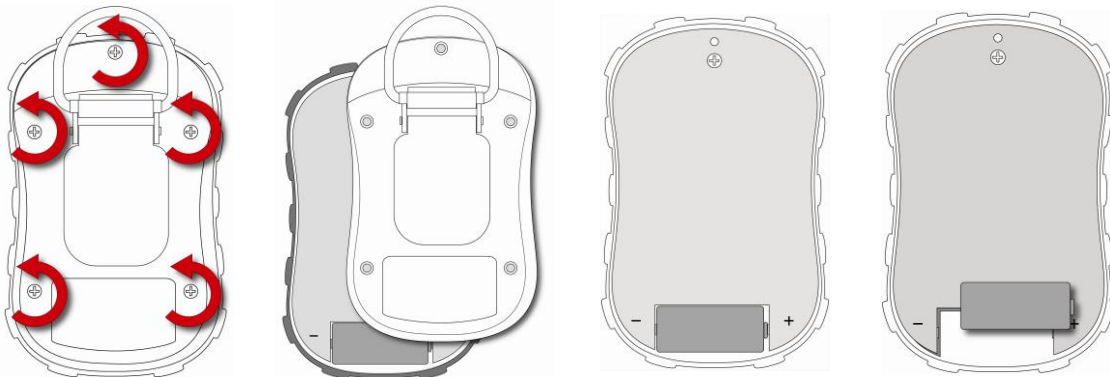

3. Hold the ToxiRAE 3 down and lift the compartment cover by pulling on the belt clip.

## ToxiRAE 3 User's Guide

- Slide the battery out of its compartment.
- Place the new battery into the compartment with its “+” end oriented toward the “+” on the printed circuit board.

**Note:** Before installing the new battery, visually inspect the contacts to make sure they are clean. If they are not, wipe them with a soft cloth. Do not use solvents or cleaners.

- Place the cover over the compartment.
- Place an O-ring on each of the five screws.
- Tighten all five screws by turning them clockwise with a Philips screwdriver.

### 18.2. External Filter

A “peel-and-stick” filter should be used on the ToxiRAE 3 in order to keep debris from fouling the sensor. Sheets of 100 filters (part number G01-2013-100) are available. Peel a filter from the sheet and center it over the sensor. Gently press down. When the filter appears dirty, replace it with a new one and dispose of the dirty filter.

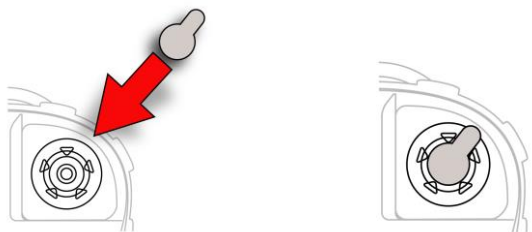

#### **WARNING**

**Using an external filter affects sensor response time. When a filter is used, the T<sub>90</sub> response time for the ToxiRAE 3 is typically increased from 30 seconds to around 60 seconds.**

#### 18.2.1. Cleaning

Occasional cleaning with a soft cloth is recommended. Do not use detergents or chemicals. If necessary, you can use a damp cloth (water only). It is a good idea to install the Calibration Adapter before cleaning the ToxiRAE 3's housing, to keep dirt, dust, or moisture away from the sensor openings and to keep the filter clean.

Visually inspect the contacts at the base of the ToxiRAE 3, on the battery, and on the Charging cradle to make sure they are clean. If they are not, wipe them with a soft, dry cloth. Never use solvents or cleaners.

## **ToxiRAE 3 User's Guide**

### **18.2.2. Ordering Replacement Parts**

If you need replacement parts, contact your local RAE Systems distributor. A list is available online:

<http://www.raesystems.com>

In the U.S., you can order sensors, replacement batteries, and other accessories online at:

<http://istore.raesystems.com/>

## ToxiRAE 3 User's Guide

### 19. Troubleshooting

<b>Problem</b>	<b>Possible Reasons &amp; Solutions</b>
Cannot turn on power	<b>Reasons:</b> Depleted battery. Defective battery.  <b>Solutions:</b> Replace battery.
Lost password	<b>Solutions:</b> Call Technical Support at +1 408-752-0723 or toll-free at +1 888-723-4800
Reading abnormally Low	<b>Reasons:</b> Calibration Adapter is attached. Incorrect calibration.  <b>Solutions:</b> Remove Calibration Adapter. Calibrate the ToxiRAE 3.
Buzzer, LEDs, or vibration alarm Inoperative	<b>Reasons:</b> Bad buzzer, LEDs, or vibration alarm. Blocked alarm port.  <b>Solutions:</b> Call authorized service center. Unblock alarm port.



# ToxiRAE 3 User's Guide

## 20. Technical Support

To contact RAE Systems Technical Support Team:

Monday through Friday, 7:00AM to 5:00PM Pacific (US) Time

Phone (toll-free): +1 888-723-4800

Phone: +1 408-952-8461

Email: [tech@raesystems.com](mailto:tech@raesystems.com)

## 21. RAE Systems Contacts

### **RAE Systems by Honeywell**

#### **World Headquarters**

3775 N. First St.

San Jose, CA 95134-1708 USA

Phone: +1 408.952.8200

Fax: +1 408.952.8480

**E-mail:** [customerserv@raesystems.com](mailto:customerserv@raesystems.com)

**Web Site:** [www.raesystems.com](http://www.raesystems.com)

### **RAE Systems Technical Support**

Monday through Friday, 7:00AM to 5:00PM Pacific Time

**Phone:** +1.408.952.8461

**Email:** [tech@raesystems.com](mailto:tech@raesystems.com)

### **EMEAI Headquarters**

Life Safety Distribution AG

Javastrasse 2

8604 Hegnau, Switzerland

**Phone:** +41 (0)44 943 4300

**Fax:** +41 (0)44 943 4398

**Email:** [haexpert@honeywell.com](mailto:haexpert@honeywell.com)

### **RAE Systems France**

ZI des Ayats

679390 MILLERY

France

**Phone:** +33 4 78 46 16 65

**Fax:** +33 4 78 46 25 98

**Email:** [info-france@raeeurope.com](mailto:info-france@raeeurope.com)

**Web:** [www.raesystems.fr](http://www.raesystems.fr)

## ToxiRAE 3 User's Guide

### **RAE BeNeLux BV**

Hoofdweg 34C  
2908 LC Capelle a/d IJssel  
The Netherlands

**Phone:** +31 10 4426149

**Fax:** +31 10 4426148

**Email:** info@rae.nl

**Web:** www.rae.nl

### **RAE Systems Spain, s.l.**

Av. Remolar, 31  
08820 El Prat de Llobregat  
Spain

**Phone:** +34 933 788 352

**Fax:** +34 933 788 353

**Mobile:** +34 687 491 106

**Email:** mdelgado@raespain.com

**Web:** www.raespain.com

### **RAE Systems (Hong Kong) Ltd.**

Room 8, 6/F, Hong Leong Plaza  
33 Lok Yip Road

Fanling, N.T, Hong Kong

**Phone:** +852.2669.0828

**Fax:** +852.2669.0803

**Email:** hksales@raesystems.com

### **RAE Systems Japan**

Marunouchi Nakadori Bldg 6F-617-B,  
2-3, Marunouchi 2-Chome, Chiyoda-ku,  
Tokyo, 100-0005 Japan

**Phone:** +81-3-6269-9646

**Fax:** +81-3-6269-9647

**Email:** jpsales@raesystems.com

### **RAE Systems Korea**

#1010, DaeMyungAnsVill First,  
Sang-Dong 412-2, Wonmi-Gu, Bucheon,  
Kyungki-Do, Korea

**Phone:** 82-32-328-7123

**Fax:** 82-32-328-7127

**Email:** krsales@raesystems.com

## 22. Appendix A: Regulatory Information

### **WARNINGS AND DIRECTIVE INFORMATION - READ BEFORE OPERATING -**

This manual must be carefully read by all individuals who have or will have the responsibility of using, maintaining, or servicing this product. The product will perform as designed only if it is used, maintained, and serviced in accordance with the manufacturer's instructions.

#### **CAUTION!**



 To reduce the risk of electric shock, turn off power before removing the monitor cover. Disconnect the battery before removing sensor modules for service. Never operate this monitor while the cover is removed. Remove monitor cover and sensor modules only in an area known to be non-hazardous.

 Sensors are not interchangeable; use only RAE Systems sensors, and use only the sensor type specified for your monitor. Use only RAE Systems batteries. Use of non-RAE Systems components will void the warranty and can compromise the safe performance of this product.

ToxiRAE 3 is certified for use in hazardous locations listed below.

ToxiRAE 3 is certified for use in hazardous locations listed below

US & Canadian Intrinsic Safety:  
Class I, Groups A, B, C, D, T4

 0575  II 1G Ex ia IIC T4 Ga, DNV-2007-OSL- ATEX 1912X  
Ex ia IICT4 Ga, IECEX DNV 07. 0004X  
-20°C ≤ T<sub>amb</sub> ≤ +60°C

### **Intended operation area and conditions**

#### **Hazardous Area classified by Zones**

ToxiRAE 3 is intended to be used in hazardous areas classified zone 0, 1 or 2 in the temperature range of -20°C to +60°C, where gases of explosion groups IIA, IIB or IIC, T4 may be present.

#### **Hazardous Area classified by Divisions**

ToxiRAE 3 is intended to be used in hazardous areas classified Class I, Division 1 or 2, in the temperature range of -20°C to +60°C, where gases of groups A, B, C or D may be present.

# ToxiRAE 3 User's Guide

## Year of manufacturing

To identify the year of manufacturing, please refer to the serial number of the instrument.

The second to last digit in the serial number indicates the year of manufacturing. “H” indicates the manufacturing year is 2007.

First digit	Year
H	2007
J	2008
K	2009
M	2010
N	2011
P	2012
Q	2013
R	2014
S	2015
T	2016
U	2017
V	2018
W	2019

## 22.1. Maintenance

### Calibration

The monitor should be calibrated if it does not pass a bump test, but no less than every 6 months, depending on use and exposure to gas and contamination.

- **Bump test and calibration interval may vary due to national legislation.**
- **Bump test is defined as an exposure to gas which triggers the lowest alarm.**

RAE Systems recommends the use of AutoRAE II LT and RAE Systems calibration gas.

# ToxiRAE 3 User's Guide

## 22.1.1. Replacing the Lithium Battery

The TOXIRAE 3 is shipped with the lithium battery installed. Change the battery when the low battery symbol appears. The alarm will beep and flash once per minute until a fresh battery is installed.

Just before the battery dies, "oFF" will appear instead of the reading. The alarm will continue to beep, flash and vibrate for a minute until the battery is dead. If the battery is not completely dead, the user can manually turn the monitor off by pressing the button.



1. To replace the battery, remove the four screws from the back of the monitor.
2. Remove the back cover.
3. Remove the dead battery.
4. Install a Lithium battery (Voltage: 3.6V, Capacity: 1650mAH, Size: 2/3AA, P/N: 500-0076-100).
5. Reattach the back cover and tighten the screws.

 Sensors are not interchangeable; use only RAE Systems sensors, and use only the sensor type specified for your TOXIRAE 3 monitor. Use only RAE Systems batteries. Use of non-RAE Systems components will void the warranty and can compromise the safe performance of this product.



**RAE Systems**  
**World Headquarters**  
3775 N. First St.  
San Jose, CA 95134-1708 USA  
Phone: 408.952.8200  
Fax: 408.952.8480

**E-mail:** [customerserv@raesystems.com](mailto:customerserv@raesystems.com)  
**Web Site:** [www.raesystems.com](http://www.raesystems.com)