

PACSystems™ RX3i and RSTi-EP CPU Reference Manual



Warnings and Caution Notes as Used in this Publication

WARNING

Warning notices are used in this publication to emphasize that hazardous voltages, currents, temperatures, or other conditions that could cause personal injury exist in this equipment or may be associated with its use.

In situations where inattention could cause either personal injury or damage to equipment, a Warning notice is used.

CAUTION

Caution notices are used where equipment might be damaged if care is not taken.

Note: *Notes merely call attention to information that is especially significant to understanding and operating the equipment.*

These instructions do not purport to cover all details or variations in equipment, nor to provide for every possible contingency to be met during installation, operation, and maintenance. The information is supplied for informational purposes only, and Emerson makes no warranty as to the accuracy of the information included herein. Changes, modifications, and/or improvements to equipment and specifications are made periodically and these changes may or may not be reflected herein. It is understood that Emerson may make changes, modifications, or improvements to the equipment referenced herein or to the document itself at any time. This document is intended for trained personnel familiar with the Emerson products referenced herein.

Emerson may have patents or pending patent applications covering subject matter in this document. The furnishing of this document does not provide any license whatsoever to any of these patents.

Emerson provides the following document and the information included therein as-is and without warranty of any kind, expressed or implied, including but not limited to any implied statutory warranty of merchantability or fitness for particular purpose.

Contents

Contents.....	ii
Table of Figures.....	vii
Section 1: Introduction.....	1
1.1 Revisions in this Manual	2
1.2 PACSystems Control System Overview.....	2
1.2.1 Programming and Configuration.....	5
1.2.2 Process Systems.....	5
1.2.3 PACSystems CPU Models.....	6
1.3 RX3i Overview	7
1.4 RSTi-EP Overview.....	10
1.5 Migrating Series 90 Applications to PACSystems.....	11
1.6 Documentation.....	11
1.6.1 PACSystems Manuals	11
1.6.2 RX3i Manuals	11
1.6.3 Field Agent Manuals	12
1.6.4 RSTi-EP Manuals	12
1.6.5 Series 90 Manuals.....	12
1.6.6 Distributed I/O Systems Manuals.....	12
Section 2: CPU Features & Specifications	13
Common CPU Features.....	13
2.1.1 Features Shared by Certain PACSystems CPU Models	14
2.1.2 Firmware Storage in Flash Memory.....	14
2.1.3 Operation, Protection, and Module Status.....	15
2.1.4 Ethernet Global Data.....	15
2.1.5 Embedded PROFINET Controller.....	15
2.1.6 OPC UA	17
2.1.7 Removable Data Storage Devices (RDSDs)	17
2.1.8 Uploading a Project from the CPU to the RDSD.....	19
2.1.9 Downloading a Project from the RDSD to the CPU.....	20
2.1.10 CPU Over-Temperature Monitoring and Behavior.....	22

2.2	RX3i CPU Features and Specifications.....	23
2.2.1	CPL410.....	29
2.2.2	CPE400	43
2.2.3	CPE330	68
2.2.4	CPE302, CPE305 and CPE310	77
2.2.5	CPU315 and CPU320/CRU320.....	86
2.2.6	CPU310.....	88
2.3	RSTi-EP CPU Features and Specifications	90
2.3.1	CPE100/CPE115	92
Section 3:	CPU Configuration.....	100
3.1	Configuring the CPU	100
3.2	Configuration Parameters	101
3.2.1	Settings Parameters	101
3.2.2	Modbus TCP Address Map	105
3.2.3	SNTP	105
3.2.4	Time	106
3.2.5	Scan Parameters	108
3.2.6	Memory Parameters.....	111
3.2.7	Fault Parameters	114
3.2.8	Redundancy Parameters (Redundancy CPUs Only)	116
3.2.9	Transfer List.....	116
3.2.10	COM1 and COM2 Parameters.....	116
3.2.11	Scan Sets Parameters	120
3.2.12	Power Consumption Parameters	121
3.2.13	Access Control	121
3.2.14	OPC UA Parameters.....	124
3.3	Storing (Downloading) Hardware Configuration	124
3.4	Configuring the Embedded Ethernet Interface	124
3.4.1	Establishing Initial Ethernet Communications.....	125
3.4.2	Setting a Temporary IP Address	127
Section 4:	CPU Operation	129
4.1	CPU Sweep.....	129
4.1.1	Parts of the CPU Sweep	130
4.1.2	CPU Sweep Modes.....	135

4.2	Program Scheduling Modes.....	138
4.3	Window Modes	138
4.4	Data Coherency in Communications Windows	139
4.5	Run/Stop Operations	139
4.5.1	CPU STOP Modes.....	140
4.5.2	STOP-to-RUN Mode Transition	144
4.6	Flash Memory Operation.....	144
4.6.1	RUN/STOP Switch Operation	145
4.7	Logic/Configuration Source and CPU Operating Mode at Power-Up	145
4.7.1	146
4.7.2	CPU Mode when Memory Not Preserved/Power-up Source is Flash	148
4.7.3	CPU Mode when Memory Preserved	149
4.8	Clocks and Timers.....	150
4.8.1	Elapsed Time Clock	150
4.8.2	Time-of-Day Clock.....	150
4.8.3	Watchdog Timer	151
4.9	System Security.....	153
4.9.1	Passwords and Privilege Levels - Legacy Mode	153
4.9.2	OEM Protection – Legacy Mode	159
4.9.3	Enhanced Security for Passwords and OEM Protection	159
4.9.4	Legacy/Enhanced Security Comparison	161
4.10	PACSystems I/O System	162
4.10.1	I/O Configuration	163
4.10.2	I/O System Diagnostic Data Collection	165
4.10.3	Power-Up and Power-Down Sequences	166
Section 5:	Communications	172
5.1	Ethernet Communications	172
5.1.1	Embedded Ethernet Interfaces	172
5.1.2	Ethernet Interface Modules	177
5.2	Serial Communications	177
5.2.1	Serial Port Communications Capabilities	178
5.2.2	Configurable STOP Mode Protocols	179
5.2.3	Serial Port Pin Assignments	179
5.2.4	Serial Port Electrical Isolation.....	185

5.2.5	Serial Cable Lengths and Shielding	186
5.2.6	Serial Port Baud Rates.....	186
5.2.7	Communications Coprocessor Module (CMM)	186
5.2.8	Programmable Coprocessor Module (PCM)	187
Section 6:	Serial I/O, SNP & RTU Protocols.....	189
6.1	Configuring Serial Ports Using COMMREQ Function 65520	189
6.1.1	COMMREQ Function Example.....	189
6.1.2	Timing	190
6.1.3	Sending Another COMMREQ to the Same Port	190
6.1.4	Invalid Port Configuration Combinations	190
6.1.5	COMMREQ Command Block Parameter Values.....	190
6.1.6	Example COMMREQ Command Blocks for Serial Port Setup function	192
6.1.7	Example COMMREQ Command Block for Configuring SNP Protocol	192
6.1.8	Example COMMREQ Data Block for Configuring RTU Protocol	192
6.1.9	Example COMMREQ Data Block for Configuring Serial I/O Protocol.....	194
6.2	Serial I/O Protocol.....	194
6.2.1	Calling Serial I/O COMMREQs from the CPU Sweep	195
6.2.2	Compatibility	195
6.2.3	Status Word for Serial I/O COMMREQs.....	196
6.2.4	Serial I/O COMMREQ Commands	198
6.2.5	Overlapping COMMREQs.....	198
6.2.6	Initialize Port Function (4300)	199
6.2.7	Set Up Input Buffer Function (4301)	200
6.2.8	Flush Input Buffer Function (4302)	200
6.2.9	Read Port Status Function (4303)	201
6.2.10	Write Port Control Function (4304)	204
6.2.11	Cancel COMMREQ Function (4399)	205
6.2.12	Autodial Function (4400).....	207
6.2.13	Write Bytes Function (4401).....	208
6.2.14	Read Bytes Function (4402).....	210
6.2.15	Read String Function (4403).....	211
6.3	RTU Slave Protocol.....	213
6.3.1	Message Format.....	214
6.3.2	Cyclic Redundancy Check (CRC)	219
6.3.3	RTU Message Descriptions	224
6.3.4	RTU Scratch Pad	241
6.3.5	Communication Errors	241
6.3.6	RTU Slave/SNP Slave Operation with Programmer Attached	244

6.4	SNP Slave Protocol	245
6.4.1	Permanent Datagrams	245
6.4.2	Communication Requests (COMMREQs) for SNP	246
Appendix.A:	Performance Data	247
A-1.1	Boolean Execution Measurements (ms per 1000 Boolean executions)	247
A-1.2	Instruction Timing	248
A-1.3	Overview.....	248
A-1.4	RX3i & RSTi-EP Instruction Times	249
A-1.5	Overhead Sweep Impact Times	250
A-1.6	Base Sweep Times	250
A-1.7	Base Sweep vs. Full Sweep Phases.....	252
A-1.8	What the Sweep Impact Tables Contain	253
A-1.9	Programmer Sweep Impact Times.....	253
A-1.10	I/O Scan and I/O Fault Sweep Impact.....	254
A-1.11	Ethernet Global Data Sweep Impact.....	259
A-1.12	EGD Sweep Impact for RX3i CPE330 and CPE400/CPL410	263
A-1.13	EGD Sweep Impact for RX3i CPE302/CPE305/CPE310 and RSTi-EP CPE100/CPE115 Embedded Ethernet Interface	263
A-1.14	Example Calculation for EGD Utilization on RX3i CPE302/CPE305/CPE310 and RSTi-EP CPE100/CPE115 Ethernet Interface	264
A-1.15	Normal Sweep – EGD on RX3i CPE302/CPE305/CPE310 and RSTi-EP CPE100/CPE115 Embedded Ethernet Interface	264
A-1.16	Constant Sweep - EGD on RX3i CPE302/CPE305/CPE310 and RSTi-EP CPE100/CPE115 Embedded Ethernet Interface	266
A-1.17	Sweep Impact of Intelligent Option Modules	266
A-1.18	I/O Interrupt Performance and Sweep Impact	269
A-1.19	Timed Interrupt Performance	271
A-1.20	User Memory Allocation.....	272
A-1.21	Items that Count Against User Memory.....	272
A-1.22	User Program Memory Usage	273
A-1.23	%L and %P Program Memory	273
A-1.24	Program Logic and Overhead	274
	General Contact Information	275
	Technical Support	275

Table of Figures

Figure 1: Configuring an Embedded PROFINET Controller	16
Figure 2: CPL410 Front View and Features	29
Figure 3: CPL410 Hardware/Software Separation	30
Figure 4: Underside Ports & Connectors	38
Figure 5: Login from Remote System	39
Figure 6: CPE400 Front View and Features	43
Figure 7: CPE400 Underside Ports & Connectors	47
Figure 8: CPE400 Micro-SD & USB Pinouts	49
Figure 9: Typical Field Agent Application	53
Figure 10: Login to Predix	54
Figure 11: Predix Change Password	55
Figure 12: Log Service Page	56
Figure 13: Technical Console, Network Configuration Page	56
Figure 14: Enter Proxy Server Address	57
Figure 15: Test Connection	57
Figure 16: Technician Console, Time Sync Configuration	58
Figure 17: LAN3 Interconnects for Hot Standby Redundancy	60
Figure 18: Display Port Connector	63
Figure 19: Location of RTC Battery on CPE400	64
Figure 20: Din Rail Mount Bracket Assembly CPE400	67
Figure 21: Panel-Mount Bracket Assembly CPE400	67
Figure 22: Front Display Port	68
Figure 23: CPE330 RUN/STOP Switch and RDSB Switches	70
Figure 24: Location and Orientation of Real-Time Clock Battery in CPE330	73
Figure 25: IC695CPE302/CPE305 Front View	77
Figure 26: IC695CPE310 Front View	77
Figure 27: External Features of CPE302/CPE305	79
Figure 28: External Features of CPE310	79
Figure 29: Accessing Real-Time Clock Battery (CPE302, CPE305, and CPE310)	82
Figure 30: Sample Tool for Battery Removal	83
Figure 31: IC695CPU320 Front View	86
Figure 32: CPU310 Front View	88
Figure 33: CPE100, Front, Top, and Bottom Views and Features	93
Figure 34: CPE100/CPE115 Membrane Pushbutton and Module Status LEDs	95
Figure 35: State Diagram for CPE100/CPE115 Run/Stop Operation	95
Figure 36: Typical Multi-Tier LAN Application (Star/Bus Topology)	98
Figure 37: Typical Multi-Tier LAN Application (Ring Topology)	98
Figure 38: Embedded Ethernet Interface Configuration	125
Figure 39: Set Temporary IP Address	128
Figure 40: Major Phases of a Typical CPU Sweep	130
Figure 41: Typical Sweeps in Normal Sweep Mode	135
Figure 42: Typical Sweeps in Constant Sweep Mode	136
Figure 43: Typical Sweeps in Constant Window Mode	137

Figure 44: CPU Sweep in Stop-I/O Disabled and Stop-I/O Enabled Modes	141
Figure 45: CPE330 Overlapping Local IP Subnet Example	173
Figure 46: Expected Response Path	174
Figure 47: Actual Response Path	174
Figure 48: COM1 Port CPE400/CPL410	181
Figure 49: COMMREQ Example	189
Figure 50: RTU Message Transactions	214
Figure 51: RTU Read Output Table Example	217
Figure 52: CRC Register Operation	219
Figure 53: RTU Read Output Table Message Format	224
Figure 54: RTU Read Input Table Message Format	225
Figure 55: RTU Read Registers Message Format	226
Figure 56: RTU Read Analog Inputs Message Format	227
Figure 57: RTU Force Single Output Message Format	228
Figure 58: RTU Preset Single Register Message Format	229
Figure 59: RTU Read Exception Status Message Format	229
Figure 60: RTU Loopback/Maintenance Message Format	231
Figure 61: RTU Force Multiple Outputs Message Format	233
Figure 62: RTU Preset Multiple Registers Message Format	234
Figure 63: RTU Report Device Type Message Format	235
Figure 64: RTU Read Scratch Pad Memory Message Format	240
Figure 65: RTU Error Response Format	242
Figure 66: Interrupt Execution Considerations	270

Section 1: Introduction

This manual contains general information about PACSystems CPU operation and product features.

Section 1 provides a **general introduction** to the PACSystems family of products, including new features, product overviews, and a list of related documentation.

CPU Features & Specifications are provided in Section 2:.

Installation procedures for the different platforms are described in their respective manuals as given below:

1. *PACSystems RX7i Installation Manual*, GFK-2223.
2. *PACSystems RX3i System Manual*, GFK-2314.
3. *RSTi-EP User Manual*, GFK-2958.

CPU Programming is covered in *PACSystems RX3i and RSTi-EP CPU Programmer's Reference Manual*, GFK-2950. It provides an overview of program structure and describes the various languages which may be used, their syntax and operation, and provides examples.

CPU Configuration is described in Section 3:.. Configuration using the proprietary PAC Machine Edition™ (PME) programming and configuration software package determines characteristics of CPU, System and module operation. It also establishes the program references used by each module in the system. For details on configuration of RX3i Ethernet Interface modules, refer to *PACSystems RX3i and RSTi-EP TCP/IP Ethernet Communications User Manual*, GFK-2224.

CPU Operation is described in Section 4:.

Ethernet Communications and Serial Communications are described in Section 5:.

Serial I/O, SNP & RTU Protocols are described in Section 6:.

Performance Data, including Instruction Timing, is provided in Appendix.A:.

User Memory Allocation is described in A-1.20.

1.1 Revisions in this Manual

Note: A given feature may not be implemented on all PACSystems CPUs. To determine whether a feature is available on a given CPU model and firmware version, please refer to the *Important Product Information (IPI)* document provided for the CPU version that you are using.

Rev	Date	Description
AM	May-2020	<ul style="list-style-type: none"> ▪ Updated CPE/CPL Features and Specifications in Section 2.2 ▪ Updated Tables 4-3 and 4-4 in Section <i>Privilege Level Request from PAC Machine Edition</i>
AL	Feb-2020	<ul style="list-style-type: none"> ▪ Addition of DNP3 to CPE400
AK	Oct-2019	<ul style="list-style-type: none"> ▪ Updated to reflect updated capabilities of FW 9.90 ▪ Following Emerson's acquisition of this product, changes have been made to apply appropriate branding and registration of the product with required certification agencies.
Aj	Jun-2019	<ul style="list-style-type: none"> ▪ Updated the Appendix A on Boolean Execution for clarity.
AH	Apr-2019	<ul style="list-style-type: none"> ▪ CPE400/CPL410 added ability to recover from STOP-Halt mode. ▪ CPE330 supports HSB CPU redundancy with Single RMX. This support includes CRU320 compatibly mode. Dual RMX configuration is no longer a requirement.¹
AG	Nov-2018	<ul style="list-style-type: none"> ▪ CPE330/CPE400/CPL410 increased block count from 512 to 768 including _Main
AF	Aug-2018	<ul style="list-style-type: none"> ▪ SoE and other minor changes for CPE330 ▪ European DST correction
AE	Jul-2018	<ul style="list-style-type: none"> ▪ Addition of IC695CPL410, CPU with Linux. ▪ Addition of IC695PNS101.
AD	Apr-2018	<ul style="list-style-type: none"> ▪ Added CPE115 module
AC	Feb-2018	<ul style="list-style-type: none"> ▪ Updated throughout for addition of CPE302 (initial firmware version 9.40). ▪ CPE400 Serial IO feature added ▪ New Authorized Firmware Update feature noted (part of RX3i firmware version 9.40).

¹ Requires PME 9.50 SIM 14 or later and CPE330 firmware 9.75 or later.
Introduction

Rev	Date	Description
AM	May-2020	<ul style="list-style-type: none"> ▪ Updated CPE/CPL Features and Specifications in Section 2.2 ▪ Updated Tables 4-3 and 4-4 in Section <i>Privilege Level Request from PAC Machine Edition</i>
AB	Oct-2017	<ul style="list-style-type: none"> ▪ Added Redundancy features for CPE400 ▪ Updated Field Agent information for CPE400. ▪ Updated Section 2.2 for new features of CPE400. ▪ Added Section 2.1.10 on CPU Over-Temperature behavior.
AA	Sep-2017	<ul style="list-style-type: none"> ▪ Addition of support for Media Redundancy Protocol (MRP) on CPE100.
Z	May-2017	<ul style="list-style-type: none"> ▪ Addition of RSTi-EP EPSCPE100 (new product) and updated other relevant sections. ▪ Addition of Simple Network Time Protocol (SNTP), Coordinated Universal Time (UTC), and Daylight Savings Time (DST) features for CPE305, CPE310, CPE330, and CPE400.
Y	Dec-2016	<ul style="list-style-type: none"> ▪ Added section on CPE400 and incorporated into CPU comparison table (section 2.2). This section also introduces Field Agent and documents how to set up Embedded Field Agent for the CPE400 (section ▪ Added section 2.1.5, Embedded PROFINET Controller. ▪ Update of Energy Pack Section 4.10.3.3 to include ACC403 and compatibility matrix. ▪ Added compatibility mode information for CPE330 with CPU320 & CRU320
X	Feb-2016	<ul style="list-style-type: none"> ▪ Corrected Ethernet Indicators CPE305 & CPE310 table.
W	Aug-2015	<ul style="list-style-type: none"> ▪ Addition of support for Ethernet Global Data (Class 1) on CPE330
V	Jun-2015	<ul style="list-style-type: none"> ▪ Addition of RX3i CPE330 (new product) and related Ethernet considerations. ▪ Update of Energy Pack Section 4.10.3.3 to include ACC402 and compatibility matrix. ▪ Addition of HART® Pass Through feature (see page 9). ▪ Addition of CPU Comparison Charts ▪ Update of Communications Section (Section 5:). Removed original Sections 5-11 (Sections dealing with CPU programming) and Section 14 (Diagnostics). These are now in PACSystems RX3i CPU Programmer's Reference Manual, GFK-2950 (Sections 2-8 and Section 9 respectively).

Rev	Date	Description
AM	May-2020	<ul style="list-style-type: none"> ▪ Updated CPE/CPL Features and Specifications in Section 2.2 ▪ Updated Tables 4-3 and 4-4 in Section <i>Privilege Level Request from PAC Machine Edition</i>
U	Nov-2014	<ul style="list-style-type: none"> ▪ New Section, 0 for EGD Sweep Impact for RX3i CPE302/CPE305/CPE310 and RSTi-EP CPE100/CPE115 Embedded Ethernet Interface.
T	Oct-2014	<ul style="list-style-type: none"> ▪ Support for OPC UA using embedded Ethernet port in CPE305/CPE310 with CPU firmware 8.20. ▪ Support for Ethernet Global Data (EGD Class 1) using embedded Ethernet port in CPE305/CPE310 with CPU firmware 8.30 Sweep impact of EGD on Embedded Ethernet interface. Direct replacement for S90-30 IC693CPU374. ▪ New communications capabilities provided by: <ul style="list-style-type: none"> ○ IC695PNS001 – PROFINET Scanner Module ○ IC695GCG001 – Genius Communications Gateway via PROFINET ○ IC695EDS001 – Ethernet based DNP3 Outstation
S	July-2013	<ul style="list-style-type: none"> ▪ Support for Modbus/TCP Server, SRTP channels and Modbus/TCP client channels on RX3i CPE305/CPE310 embedded Ethernet interface – Section 2: & Section 5: ▪ Support for Access Control List – Section 3: ▪ Modbus TCP/IP mapping for CPE305/CPE310 – Section 3:0 ▪ Enhanced Security Passwords and OEM Protection – Section 4: ▪ Serial I/O protocol enhancements (Data Set Ready, Ring Indicator, and Data Carrier Detect) – Section 6: ▪ Diagnostics for PROFINET alarms and PROFINET network faults, including #PNIO_ALARM, SA0030 – refer to PACSystems RX7i and RX3i CPU Programmer’s Reference Manual, GFK-2950 Section 3 & Section 9. ▪ Instruction executions times measured for RX3i CPU320/CRU320 – Appendix.A: ▪ Sweep impact times for new modules: IC694MDL758, IC694APU300-CA and later, IC695PNS001, IC694ALG442, IC694ALG220, IC694MDL645 and IC694MDL740–Appendix.A:
earlier		<ul style="list-style-type: none"> ▪ Added instructions for replacing the RX3i CPE305/CPE310 real-time clock battery: Section 2:. ▪ Corrected definitions of reverse acting and direct acting modes for PID functions: refer to PACSystems RX7i and RX3i CPU Programmer’s Reference Manual, GFK-2950 Section 7. ▪ Expanded data for Boolean execution measurements – Appendix.A: ▪ Re-instated instruction times for RX7i CPE030/CRE030/CPE040 release 6.0 as published in version Q of the manual (unintentionally omitted from version R) – Appendix.A: ▪ Compatibility information for volatile memory backup batteries has been consolidated in the PACSystems Battery and Energy Pack Manual, GFK-2741 – throughout

1.2 PACSystems Control System Overview

The PACSystems controller environment combines performance, productivity, openness and flexibility. The PACSystems control system integrates advanced technology with existing systems. The result is seamless migration that protects your investment in I/O and application development.

1.2.1 Programming and Configuration

PAC Machine Edition programming software provides a universal engineering development environment for all programming, configuration and diagnostics of PACSystems. A PACSystems CPU is programmed and configured using the programming software to perform process and discrete automation for various applications. The CPU communicates with I/O and smart option modules through a rack-mounted backplane. It communicates with the programmer and/or HMI devices via the Ethernet ports or via the serial ports COM1 and COM2 using Serial I/O, or Modbus RTU slave protocols.

1.2.2 Process Systems

PACSystems CPUs with firmware version 5.0 and later support PAC Process Systems (PPS). PPS is a complete, tightly integrated, seamless process control system using PACSystems, HMI/SCADA, and PAC Production Management Software to provide control, optimization, and performance management to manage and monitor batch or continuous manufacturing. It delivers the tools required to design, implement, document, and maintain an automated process. For information about purchasing PPS software, refer to the Support website.

1.2.3 PACSystems CPU Models

Family	Catalog #	Description
RSTi-EP Standalone CPUs	EPSCPE100	1 MB user memory
	EPSCPE115	1.5 MB user memory
RX3i Standalone CPUs with embedded Ethernet/PROFINET Interface	IC695CPE400	64 MB user memory with Field Agent
	IC695CPL410	64 MB user memory with Linux
RX3i CPUs with embedded Ethernet/PROFINET Interface	IC695CPE330	64 MB user memory
RX3i CPUs with embedded Ethernet Interface ²	IC695CPE302	2 MB user memory
	IC695CPE305	5 MB user memory
	IC695CPE310	10 MB user memory
RX3i CPUs	IC695CPU310	10 MB user memory
	IC695CPU315	20 MB user memory
	IC695CPU320	64 MB user memory
	IC695NIU001+ versions –AAAA & later	For information, refer to the <i>PACSystems RX3i Ethernet Network Interface Unit User's Manual</i> , GFK-2439
	IC695NIU001	For information, refer to the <i>PACSystems RX3i Ethernet Network Interface Unit User's Manual</i> , GFK-2439
RX3i Redundancy CPU	IC695CRU320	64 MB user memory

² The RX3i CPE302/CPE305/CPE310 embedded Ethernet interface provides a maximum of two programmer connections. It does not support the full set of Ethernet interface features described in this manual. For a summary of RX3i embedded Ethernet interface features, refer to *PACSystems RX3i TCP/IP Ethernet Communications User Manual*, GFK-2224K or later.

1.3 RX3i Overview

The RX3i control system hardware consists of an RX3i universal backplane and up to seven Series 90-30 expansion or remote racks. The CPU can be in any slot in the universal backplane except the last slot, which is reserved for the serial bus transmitter, IC695LRE001.

The RX3i supports user defined Function Blocks (LD logic only) and Structured Text programming.

The RX3i universal backplane uses a dual bus that provides both:

- High-speed PCI for fast throughput of new advanced I/O.
- Serial backplane for easy migration of existing Series 90-30 I/O

The RX3i universal backplane and Series 90-30 expansion/remote racks support the Series 90-30 Genius Bus Controller and Motion Control modules, and most Series 90-30/RX3i discrete and analog I/O with catalog prefixes IC693 and IC694. RX3i modules with catalog prefixes IC695, including the Ethernet and other communications modules can only be installed in the universal backplane. See the *PACSystems RX3i System Manual*, GFK-2314 for a list of supported modules.

RX3i supports hot standby (HSB) CPU redundancy, which allows a critical application or process to continue operating if a failure occurs in any single component. A CPU redundancy system consists of an active unit that actively controls the process and a backup unit that is synchronized with the active unit and can take over the process if it becomes necessary. Each unit must have a redundancy CPU (See section 2.2 for CPUs that support redundancy). For the backplane-based CPU redundancy, the redundancy communication path is provided by IC695RMX128 Redundancy Memory Xchange (RMX) modules set up as redundancy links. For the Ethernet-based CPU redundancy, the redundancy communication path is provided by Ethernet connections between the redundant CPUs. For details on the operation of PACSystems redundancy systems, refer to the *PACSystems Hot Standby CPU Redundancy User Manual*, GFK-2308.

RX3i communications features include:

- Open communications support includes Ethernet, PROFIBUS, PROFINET, Modbus TCP, Ethernet Global Data (EGD), DNP3 and serial protocols.
- On the CPL410, the Ethernet Port and Serial Port located on the underside and one of the USB ports are controlled by the Linux Operating System; all front-panel ports are controlled by the RX3i PLC, except for the one USB port mentioned above.
- On the CPE400, one of its embedded Ethernet ports is set up as a dedicated Field Agent port.
- The CPE302, CPE305¹¹, CPE310, and CPE330, CPE400 and CPL410 CPUs provide an embedded Ethernet interface which is used to connect to the programmer (PAC Machine Edition).
- Effective with RX3i CPE310/CPE305 firmware version 7.30, or CPE330 firmware version 8.50, the embedded Ethernet port on the CPU provides support for Service Request Transfer Protocol (SRTP) channels and for Modbus TCP. This feature is available on all firmware versions of CPE400 and CPL410.
- Effective with CPE310/CPE305 firmware version 8.20, or CPE330 firmware version 8.45, the CPE embedded Ethernet port supports OPC UA Server. This feature is available on all firmware versions of CPE400 and CPL410. Refer to *PACSystems RX3i TCP/IP Ethernet Communications User Manual*, GFK-2224 version M or higher (Section 10).

- Effective with RX3i firmware version 8.30³, the CPE310/CPE305 CPUs also support Ethernet Global Data (EGD). Prior to that firmware version, EGD was only available in the RX3i via the RX3i Ethernet Interface Module (IC695ETM001). With this upgrade, these CPUs are positioned as a direct replacement for S90-30 IC693CPU374.
- Effective with RX3i firmware version 8.60⁴, the CPE330 supports Ethernet Global Data (EGD) Class 1. This feature is available on all firmware versions of CPE400⁵, CPL410⁶, CPE100, CPE115 and CPE302¹¹.
- The rack-based IC695ETM001 Ethernet Interface has dual RJ45 ports connected through an auto-sensing switch. This eliminates the need for rack-to-rack switches or hubs. The ETM001 supports upload, download and online monitoring, and provides 32 SRTP channels with a maximum of 48 simultaneous SRTP server connections. It also supports Modbus TCP. For details on Ethernet Interface capabilities, refer to *PACSystems RX3i TCP/IP Ethernet Communications User Manual*, GFK-2224.
- PROFIBUS communications via the PROFIBUS Master module, IC695PBM300. For details, refer to the *PACSystems RX3i PROFIBUS Modules User's Manual*, GFK-2301.
- PROFINET communications via any supported PROFINET Controller and any supported PROFINET Scanner.
- Supported PROFINET Controllers include the embedded PROFINET Controller function offered by IC695CPE400 and IC695CPE330, and the rack-mounted PROFINET Controller module IC695PNC001.
- Supported PROFINET Scanners include the RX3i PROFINET Scanner modules IC695PNS001⁷, IC695PNS101, the RX3i IC695CEP001, and the VersaMax PROFINET Scanner modules IC200PNS001 and IC200PNS002.
- For details, refer to the PACSystems RX3i PROFINET IO-Controller Manual, GFK-2571F or later and PACSystems RX3i PROFINET Scanner Manual, GFK-2737F or later.
- Effective with the release of IC695CEP001 and IC694CEE001, the RX3i may be configured to control a remote drop consisting of one or two I/O modules. The RX3i interface to the remote drop is managed by the PROFINET Controller, IC695PNC001.
- Effective with the release of IC695GCG001, the RX3i may be equipped to control a Genius Bus. The RX3i interface to the Genius Gateway is managed by the PROFINET Controller, IC695PNC001. Refer to *PACSystems RX3i Genius Communications Gateway User Manual*, GFK-2892.
- Effective with the release of IC695EDS001, the RX3i may be configured as a DNP3 Outstation. Refer to *PACSystems RX3i DNP3 Outstation Module IC695EDS001 User's Manual*, GFK-2911.

³ PAC Machine Edition Release 8.50 SIM 7 is required for EGD Class 1 on Embedded Ethernet interface of CPE305/CPE310.

⁴ PAC Machine Edition Release 8.60 SIM 5 is required for EGD Class 1 on both LAN1 and LAN2 of CPE330. This PME version also supports Advanced Configuration Parameters for EGD on CPE330. Alternately, PME Release 8.60 (not SIM 5) supports EGD on CPE330 LAN1 only, and does not support Advanced Configuration Parameters for EGD.

⁵ PAC Machine Edition Release 9.00 SIM 8 or later is required for native configuration support of the CPE400.

⁶ PAC Machine Edition Release 9.50 SIM 10 or later is required for native configuration support of the CPL410.

⁷ IC695PNS001 firmware version 2.40 added support for a number of I/O modules not previously supported, as documented in *PACSystems RX3i PROFINET Scanner Important Product Information*, GFK-2738L.

- Effective with the release of IC695EIS001, the RX3i may be configured to act as an IEC 104 Server. Refer to *PACSystems RX3i IEC 104 Server Module IC695EIS001 User's Manual*, GFK-2949.
- PROFINET Scanner User Manual, GFK-2883.
- HART Pass Through allows an RX3i CPU to communicate HART asset management data between HART-capable I/O modules and PC-based asset management tools. This entails usage of PC-based applications, RX3i Analog modules with HART functionality and (optionally) supporting PROFINET products. HART Pass Through operation is described in the *PACSystems HART Pass Through User Manual*, GFK-2929.
- The following RX3i CPUs support HART Pass Through: IC695CPE305, IC695CPE310, IC695CPU315, IC695CPU320, IC695CRU320, IC695CPE330^{8,9} (firmware version 8.50 or later). All versions of IC695CPE302¹¹ support this feature.

The following RX3i analog modules support HART:

IC695ALG626
IC695ALG628
IC695ALG728

If used for HART Pass Through, the supporting RX3i PROFINET Controller and PROFINET Scanner must also contain HART-compatible firmware:

IC695PNC001-AK firmware version 2.20
IC695PNS001-ABAH firmware version 2.30¹⁰
IC695PNS101-AAAA firmware version 3.10
IC695CEP001-AAAD firmware version 2.30.

- IC695CMM002 and IC695CMM004 expand the serial communications capability of the RX3i system. Refer to *PACSystems RX3i Serial Communications Modules User's Manual*, GFK-2460.
- CPE310, CPU310, CPU315, CPU/CRU320 and NIU001 provide two serial ports, one RS-232 and one RS-485.
- CPE400 (firmware version 9.40), CPL410, CPE302 and CPE305 each provides one RS-232 serial port.
- CPE330 provides no serial ports.
- Effective with CPE302 firmware version 9.40¹¹, CPE305/CPE310/CPE400¹² firmware version 9.20, or CPE330 firmware version 9.21, the CPE embedded Ethernet interface supports Simple Network Time Protocol (SNTP) Client, Coordinated Universal Time (UTC), and Daylight Savings Time (DST). Refer to *PACSystems RX3i and RSTi-EP TCP/IP Ethernet Communications User Manual*, GFK-2224 version Q or higher. CPL410 supports this feature in all firmware versions.

⁸ When used to support HART Pass Through, CPE330 must do so via a PNC001 and cannot employ its embedded PROFINET feature for this purpose.

⁹ IC695CPE330 firmware version 8.95 added support for the Remote Get HART Device Information COMMREQ.

¹⁰ IC695PNS001 firmware version 2.41 added support for the Remote Get HART Device Information COMMREQ not previously supported, as documented in *PACSystems RX3i PROFINET Scanner Important Product Information*, GFK-2738L. The syntax and usage for this COMMREQ are described in the *PACSystems RX3i System Manual*, GFK-2314M or later.

¹¹ PAC Machine Edition Release 9.50 SIM 7 or later is required for CPE302 configuration.

¹² PAC Machine Edition Release 9.00 SIM 10, or 9.50 SIM 2, or later is required for SNTP Client, UTC, and DST support.

- Effective with RX3i firmware version 9.40, the Authorized Firmware Update functionality is available. Users may now authorize access to firmware updates using a custom password. Details are included in the revised firmware update instructions.
- Effective with CPE330 firmware version 9.60, Sequence of Events functionality is available. Refer to *PACSystems RX3i Sequence of Events User Manual*, GFK-3050.
- Effective with CPE330 firmware version 9.75, Hot Standby CPU redundancy is supported with a single RMX per rack. Refer to the *PACSystems Hot Standby CPE Redundancy User Manual*, GFK-2308.
- CPE400 and CPL410 firmware version 9.75 provide a mechanism to recover from STOP-Halt mode using the OLED Display and without removing the Energy Pack.

1.4 RSTi-EP Overview

RSTi-EP CPUs make it possible to incorporate the entire PACSystems programming suite in stand-alone applications or as auxiliary control in larger process applications that use RX3i. They allow the User to leverage the power and flexibility of PACSystems in smaller applications.

At a high level, CPE100/CPE115 supports real-time application status, remote diagnostics and:

- Dual LAN interfaces with four Ethernet ports
- Built-in RS-232, RS-485 serial port
- Support for a range of communications protocols, including PROFINET
- Up to 1 MB of non-volatile user memory.
- All in just 1.5" (38.1mm) of DIN rail space.

CPE100/CPE115 supports two independent 10/100 Ethernet LANs. LAN1 has only one port and is dedicated to highspeed Ethernet and whereas LAN2 is comprised of three switched ports (labelled as 2, 3 & 4) configurable as either a second embedded Ethernet controller or an embedded PROFINET controller. All four ports are located on the front panel of the CPU.

The Ethernet controller Interface of CPE100/CPE115 provides Transmission Control Protocol and Internet Protocol (TCP/IP) communications with other control systems, host computers running the Host Communications Toolkit or programmer software, and computers running the TCP/IP version of the programming software. These communications use the Service Request Transport Protocol (SRTP), Modbus TCP, and Ethernet Global Data (EGD) protocols over a four-layer TCP/IP (Internet) stack.

The RSTi-EP CPE100/CPE115 also embeds an industry standard PROFINET controller that allows it to connect to any type of PROFINET I/O solutions either from Emerson or any third party. It offers enhanced productivity, flexibility and performance advantages for virtually any type of control application in a range of industries. PROFINET supports a variety of I/O without compromising system performance and can operate in high-noise environments.

The RSTi-EP CPE100/CPE115 is secure by design, incorporating technologies such as Trusted Platform Modules (currently disabled) and verified boot. Centralized configuration allows encrypted firmware updates to be executed from a secure central location.

1.5 Migrating Series 90 Applications to PACSystems

The PACSystems control system provides cost-effective expansion of existing systems. Support for existing Series 90 modules, expansion racks and remote racks protects your hardware investment. You can upgrade on your timetable without disturbing panel wiring.

- The RX3i supports most Series 90-30 modules, expansion racks, and remote racks. For a list of supported I/O, Communications, Motion, and Intelligent modules, see the *PACSystems RX3i System Manual*, GFK-2314.
- The supports most existing Series 90-70 modules, expansion racks and Genius networks. For a list of supported I/O, Communications, and Intelligent modules, see the *PACSystems Installation Manual*, GFK-2223.
- Conversion of Series 90-70 and Series 90-30 programs preserves existing development effort.
- Conversion of VersaPro and Logicmaster applications to Machine Edition allows smooth transition to PACSystems.

1.6 Documentation

1.6.1 PACSystems Manuals

PACSystems RX3i and RSTi-EP CPU Reference Manual	GFK-2222
PACSystems RX3i and RSTi-EP CPU Programmer's Reference Manual	GFK-2950
PACSystems RX3i and RSTi-EP TCP/IP Ethernet Communications User Manual	GFK-2224
PACSystems TCP/IP Ethernet Communications Station Manager User Manual	GFK-2225
C Programmer's Toolkit for PACSystems	GFK-2259
PACSystems Memory Xchange Modules User's Manual	GFK-2300
PACSystems Hot Standby CPU Redundancy User Manual	GFK-2308
PACSystems Battery and Energy Pack Manual	GFK-2741
PAC Machine Edition Logic Developer Getting Started	GFK-1918
PAC Process Systems Getting Started Guide	GFK-2487
PACSystems RXi, RX3i Controller Secure Deployment Guide	GFK-2830

1.6.2 RX3i Manuals

PACSystems RX3i System Manual	GFK-2314
PACSystems RX3i IC695CPL410 1.2GHz 64MB Rackless CPU w/Linux QSG	GFK-3053
PACSystems RX3i IC695CPE400 1.2GHz 64MB Rackless CPU w/Field Agent QSG	GFK-3002
PACSystems RX3i IC695ACC403 Rackless Energy Pack Quick Start Guide	GFK-3000
PACSystems RX3i IC695CPE330 1GHz 64MB CPU w/Ethernet Quick Start Guide	GFK-2941
PACSystems RX3i Sequence of Events User Manual	GFK-3050
PACSystems RX3i IC695ACC402 Energy Pack Quick Start Guide	GFK-2939
PACSystems RX3i IC695ACC400 Energy Pack Data Sheet	GFK-2724
DSM324i Motion Controller for PACSystems RX3i and Series 90-30 User's Manual	GFK-2347
PACSystems RX3i PROFIBUS Modules User's Manual	GFK-2301
PACSystems RX3i Max-On Hot Standby Redundancy User's Manual	GFK-2409

PACSystems RX3i Ethernet Network Interface Unit User's Manual	GFK-2439
PACMotion Multi-Axis Motion Controller User's Manual	GFK-2448
PACSystems RX3i & RSTi-EP PROFINET IO-Controller Manual	GFK-2571
PACSystems RX3i PROFINET Scanner Manual	GFK-2737
PACSystems RX3i CEP PROFINET Scanner User Manual	GFK-2883
PACSystems RX3i Serial Communications Modules User's Manual	GFK-2460
PACSystems RX3i Genius Communications Gateway User Manual	GFK-2892
PACSystems RX3i DNP3 Outstation Module IC695EDS001 User's Manual	GFK-2911
PACSystems RX3i IEC 104 Server Module IC695EIS001 User's Manual	GFK-2949
PACSystems HART Pass Through User Manual	GFK-2929

1.6.3 Field Agent Manuals

Field Agent User's Guide	GFK-2993
--------------------------	----------

1.6.4 RSTi-EP Manuals

RSTi-EP User's Manual	GFK-2958
PACSystems DNP3 Outstation User Manual	GFK-3103

1.6.5 Series 90 Manuals

Series 90 Programmable Coprocessor Module and Support Software	GFK-0255
Series 90 PLC Serial Communications User's Manual	GFK-0582
Series 90-70 DLAN/DLAN+ Interface Module User's Manual	GFK-0729
Series 90-30 Genius Bus Controller User's Manual	GFK-1034

1.6.6 Distributed I/O Systems Manuals

Genius I/O System User's Manual	GEK-90486-1
Genius I/O Analog and Discrete Blocks User's Manual	GEK-90486-2

In addition to these manuals, datasheets and product update documents describe individual modules and product revisions. The most recent PACSystems documentation is available on Emerson's support website. (See link located at the end of this document.)

Section 2: CPU Features & Specifications

This Section provides details on the hardware features of the PACSystems CPUs and their specifications.

- Common CPU Features
- RX3i CPU Features and Specifications
- RSTi-EP CPU Features and Specifications

Common CPU Features

- Features are shared by all PACSystems CPU models
- Programming in Ladder Diagram, Function Block Diagram, Structured Text and C
- Floating point (real) data functions
- Configurable data and program memory
- Non-volatile built-in flash memory for user data (program, configuration, register data, and symbolic variable) storage. Use of this flash memory is optional.
- Configurable RUN/STOP Mode switch
- Embedded serial and/or Ethernet communications (refer to comparison charts in RX3i CPU Features and Specifications and RSTi-EP CPU Features and Specifications)
- Up to 512 program blocks (Refer to Features Shared by Certain PACSystems CPU Models
- Regarding increased block count to 768 for certain CPU models). Maximum size for a block is 128KB.
- Auto Located Symbolic Variables, which allows you to create a variable without specifying a reference address.
- Bulk memory area accessed via reference table %W. The upper limit of this memory area can be configured to the maximum available user RAM.
- Larger reference table sizes, compared to Series 90* CPUs: 32Kbits for discrete %I and %Q and up to 32K words each for analog %AI and %AQ.
- Online Editing mode that allows you to easily test modifications to a running program. (For details on using this feature, refer to the programming software online help and *PACLogic Developer Getting Started*, GFK-1918.)
- Bit in word referencing that allows you to specify individual bits in a WORD reference in retentive memory as inputs and outputs of Boolean expressions, function blocks, and calls that accept bit parameters.
- In-system upgradeable firmware for CPU
- Indirect mechanism for upgrading firmware in backplane modules via the CPU.

2.1.1 Features Shared by Certain PACSystems CPU Models

- RX3i CPE302, CPE305, CPE310, CPE330, CPE400 and CPL410 offer battery-less retention of user memory when each is connected to its compatible Energy Pack.
- RSTi-EP CPE100/CPE115 offers battery-less retention of user memory with the support of internal super capacitors.
- All prior RX3i models have battery-backed RAM for user data (program, configuration, register data, and symbolic variable) storage and clocks.
- RX3i CPE302, CPE305, CPE310, CPE330, CPE400, CPL410 and RSTi-EP CPE100/CPE115 models have coin battery backup for their real-time clocks (elapsed time clock)
- RX3i CPE302, CPE305, CPE310 and CPE330 models have the ability to upload and download data from a Removable Data Storage Device (RDS). This feature is not yet available on RX3i CPE400, CPL410 and RSTi-EP CPE100/CPE115.
- RX3i CPE302, CPE305, CPE310, CPE330, CPE400, CPL410 and RSTi-EP CPE100/CPE115 models support OPC UA.
- RX3i CPE302, CPE305, CPE310, CPE330, CPE400, CPL410 and RSTi-EP CPE100/CPE115 models support Ethernet Global Data Class 1.
- RX3i CPE302, CPE305, CPE310, CPE330, CPE400 and CPL410, CPE115 from firmware version 9.97 models support Simple Network Time Protocol (SNTP) Client, Coordinated Universal Time (UTC), and Daylight Savings Time (DST).
- RX3i CPE330, CPE400, CPL410 and RSTi-EP CPE100/CPE115 permit LAN2 to be configured as an Embedded PROFINET Controller. Refer to Section 2.1.5, *Embedded PROFINET Controller*.
- RX3i CPE330, CPE400, CPL410 support up to 768 blocks including the _MAIN block with firmware release 9.70 or later. Note that PME 9.50 SIM 13 or later is also required for supporting a block count of up to 768.
- RX3i CPE302, CPE305, CPE310, CPE330, CPE400 and CPL410 models monitor the internal temperature of the CPU hardware. CPU behavior under these conditions is documented in Section 2.1.10.

For a comparative review of CPU features, refer to RX3i CPU Features and Specifications and RSTi-EP CPU Features and Specifications. Note that each specific feature may require a corresponding firmware version of the CPU firmware.

2.1.2 Firmware Storage in Flash Memory

The CPU uses non-volatile flash memory for storing the operating system firmware. This allows firmware to be updated without disassembling the module or replacing EPROMs. The operating system firmware is updated by connecting to the CPU with a PC compatible computer and running the software included with the firmware upgrade kit.

Each upgrade kit contains specific instructions for performing the upgrade. Depending on the CPU Model and firmware version, the method employed is one of the following:

- a) Use a serial port and the WinLoader utility (applies to CPU310, CPU315 & CPU320 models and to CPE305/CPE310 models containing firmware versions prior to v7.30)

- b) Use a USB port and memory stick for CPE302 (with firmware version 9.40 and later) or for CPE305/CPE310 models (with firmware version 7.30 and later)
- c) Use an Ethernet port and a Web-based mechanism for RXi CPUs, RX3i CPE330, CPE400, CPL410 and RSTi-EP CPE100/CPE115.

2.1.3 Operation, Protection, and Module Status

Operation of the CPU can be controlled by the three-position RUN/STOP Switch or remotely by an attached programmer and programming software. Program and configuration data can be locked through software passwords. The status of the CPU is indicated by the CPU LEDs on the front of the module. For details, see *Indicators* for each PACSystems family.

Note: The RESET pushbutton is provided to support future features and has no effect on CPU operation in the current version

2.1.4 Ethernet Global Data

Note: Effective with RX3i firmware version 8.30³, the CPE310/CPE305 CPUs also support EGD Class 1. Prior to that firmware version, EGD was only available in the RX3i via the RX3i Ethernet Interface Module (ETM001).

Effective with RX3i firmware version 8.60⁴, CPE330 also supports EGD Class 1. This feature is available on all firmware versions of RX3i CPE400, CPL410, CPE302 and RSTi-EP CPE100/CPE115.

Each PACSystems CPU supports up to 255 simultaneous EGD pages across all Ethernet interfaces in the Controller. EGD pages must be configured in the programming software and stored into the CPU. The EGD configuration can also be loaded from the CPU into the programming software. Both produced and consumed pages can be configured. PACSystems CPUs support the use of only part of a consumed EGD page, and EGD page production and consumption to the broadcast IP address of the local subnet.

The PACSystems CPU supports 2ms EGD page production and timeout resolution. EGD pages can be configured for a production period of 0, indicating the page is to be produced every output scan. The minimum period for these “*as fast as possible*” pages is 2 ms. Refer to the Section, 0 for *EGD Sweep Impact for RX3i CPE302/CPE305/CPE310 and RSTi-EP CPE100/CPE115 Embedded Ethernet Interface*.

During EGD configuration, PACSystems Ethernet interfaces are identified by their Rack/Slot location.

2.1.5 Embedded PROFINET Controller

The following CPUs support a feature that permits an Ethernet LAN to be configured for use as a PROFINET Controller:

- RX3i CPL410
- RX3i CPE400¹³
- RX3i CPE330¹⁴
- RSTi-EP CPE100/CPE115¹⁵

If the Embedded PROFINET Controller feature is to be configured, it must be configured on LAN2 for the CPUs listed above. In the case of RX3i CPE400, CPL410 and RSTi-EP CPE100/CPE115, which are Rackless CPU's, this will be its only

¹³ CPE400 firmware version 9.00 or later is required for the embedded PROFINET Controller feature.

¹⁴ CPE330 firmware version 8.90 or later is required for the embedded PROFINET Controller feature.

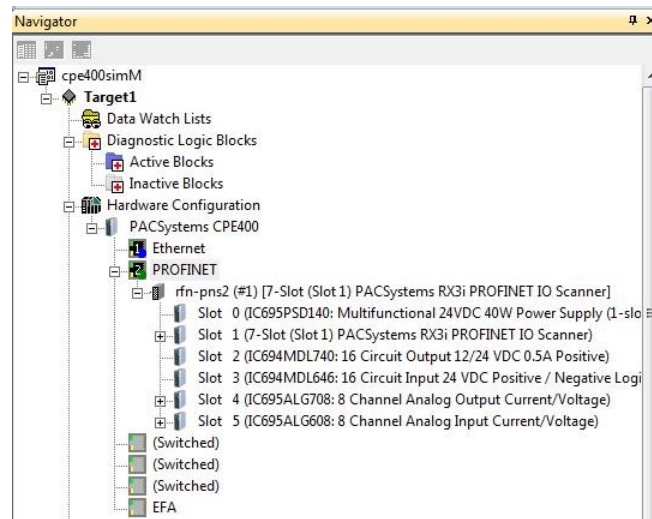
¹⁵ PAC Machine Edition™ (PME) 9.50 SIM 4 or later is required in order to configure the MRP parameters for CPE100/CPE115.

PROFINET Controller. In the case of CPE330, the Embedded PROFINET Controller can co-exist with any rack-mounted PROFINET Controllers (IC695PNC001) present in its CPU rack.

To enable the Embedded PROFINET Controller in a project in PAC Machine Edition¹⁶, select the RX3i CPE400, CPL410, or CPE330, or RSTi-EP CPE100/CPE115 target in the *PME Navigator* (Figure 1) and open the Hardware Configuration. On the *Settings* tab, change the designated *LAN Mode* of the selected port to *PROFINET*. The *PROFINET Controller* node description then displays that a PROFINET node exists on the selected LAN.

For further details, refer to the PACSystems RX3i & RSTi-EP PROFINET IO-Controller User Manual, GFK-2571G or later.

Figure 1: Configuring an Embedded PROFINET Controller



A PROFINET configuration may be transferred between a PROFINET Controller module (IC695PNC001) and the target Embedded PROFINET IO-Controller using the *cut / copy / paste* or equivalent drag and drop functions in PAC Machine Edition.

Note: If the PME Project has PROFINET redundant devices, you must record any unique Secondary Target information and disable Redundancy before *cut / copy / paste* functions on PROFINET Controller modules will work. Then, re-enable Redundancy, mirror, and restore your unique Secondary Target information.

The Embedded PROFINET Controller may be configured as a Simplex PROFINET IO-Controller with support for up to 32 I/O devices. For update rates, loading and other considerations, refer to the *PACSystems RX3i PROFINET IO Controller User Manual*, GFK-2571F or later.

The Embedded PROFINET Controller supports Media Redundancy Protocol (MRP) and may be used as either a Media Redundancy Manager (MRM) or Media Redundancy Client (MRC) on a redundant media ring. For details concerning the Media Redundancy Protocol, refer to the *PACSystems RX3i PROFINET IO Controller User Manual*, GFK-2571F or later.

The following CPUs support Hot Standby Redundancy with PROFINET IO, using the embedded PROFINET Controller (LAN2):

- CPE330 with firmware version 9.40 or later. The PROFINET Controller may be the embedded PROFINET Controller or a rack-mounted IC695PNC001.

¹⁶ PAC Machine Edition Logic Developer PLC 8.60 SIM 13 or 9.00 SIM 4 or later is required for configuration of the Embedded PROFINET Controller function.
CPU Features & Specifications

- CPE400 with firmware version 9.30 or later. The PROFINET Controller is always the embedded PROFINET Controller.
- CPL410: The PROFINET Controller is always the embedded PROFINET Controller.

For embedded PROFINET Controllers, this feature permits control of up to 32 devices, 20 of which may be redundant. For rack-mounted IC695PNC001, this feature permits control of up to 128 devices, all of which may be redundant.

Note that the host PLC CPU can support up to 255 redundant devices, which may be allocated across 2, 3, or 4 PROFINET Controllers (any combination of embedded PROFINET Controller and/or PNC001 modules).

2.1.6 OPC UA

Each PACSystems CPE302/CPE305/CPE310/CPE330/CPE400/CPL410/CPE100/CPE115 supports Open Productivity and Connectivity Unified Architecture (OPC UA) Servercommunications on the embedded Ethernet port only.

Effective with CPE310/CPE305 firmware version 8.20, or CPE302 firmware version 9.40, the CPE embedded Ethernet port supports OPC UA Server.

Effective with CPE310/CPE305 firmware version 9.20, or CPE330 firmware version 9.21, or CPE302 firmware version 9.40, OPC UA Server is configurable through PAC Machine Edition¹⁷.

For more information on OPC UA support refer to *PACSystems RX3i and RSTi-EP TCP/IP Ethernet Communications User Manual*, GFK-2224 version M or higher.

2.1.7 Removable Data Storage Devices (RDSDs)

The RX3i CPE302/CPE305/CPE310/CPE330¹⁸ provide the ability to transfer applications to and from Removable Data Storage Devices (RDSD). Typically, these are USB-compatible devices, such as a memory stick, smart phone, digital camera or an MP3 device. Once the data is copied to the RDSD, it can be written to other RX3i CPUs of the same type. In order to copy using RDSD, no PME programming software is needed. The RDSD interface requires a user-supplied flash memory device that complies with the USB 2.0 Specification.

The USB port must be enabled in the RX3i configuration in order to transfer data between the CPU and the RDSD. The compatible CPUs are shipped with the RDSD (USB) port enabled.

The RDSD load and store operations can include the following data:

- An entire application, including logic and configuration, reference table data, and cam files for Motion applications. (Motion files and local logic for DSM motion applications are supported.) Configuration can include Ethernet Global Data and Advanced User Parameters for the rack-based Ethernet interface. (Although a complete, unmodified application must be placed on the RDSD, you can use an *options.txt* file to download selected components of the application to the target CPU.)
- Passwords and OEM key, if any, are encrypted and written to the RDSD when the project is loaded from the CPU. When the project is stored to a CPU that has no passwords or OEM key, those are copied to the CPU.

¹⁷ PAC Machine Edition Logic Developer PLC 9.00 SIM 10, or 9.50 SIM 2, or later is required for OPC UA Server configuration.

¹⁸ Not yet available on RX3i CPE400 and RSTi-EP CPE100/CPE115

With Legacy security, when the project is stored to a CPU that has passwords and/or OEM key, the passwords must match or the store will fail.

- Fault tables are written to the RDSB before and after a load to or store from the RDSB.
- If a hardware configuration that disables the USB port is successfully stored to the CPU, the fault tables will not be written to the RDSB at completion of the store operation.

Notes:

- With Enhanced Security enabled, the RDSB update will fail if the RDSB source controller has Level 4 password protection and the destination controller is password protected, regardless of whether the passwords match.
- The USB port is for transfer of application data only. It is not intended for permanent connection. Do not leave RDSB devices connected during normal operation.
- When using RDSB, all programming software connections must be in the *Offline* state for the RDSB to function properly.
- CPE330 does not support Cfast memory cards as RDSB devices.
- CPE400/CPL410 does not support any RDSB devices.

2.1.8 Uploading a Project from the CPU to the RDSB

Flash devices write in whole memory blocks and memory block sizes vary among devices. The amount of space used by a project may vary between RDSBs due to the differences in minimum block sizes and therefore the number of blocks used by a project. The minimum amount of memory required will be the size of the entire project plus an additional block for the *options.txt* file, if used.

1. Place the CPU that contains the project to be transferred in RUN Mode or STOP Mode.
2. If PME is online with the RX3i, either go Offline or select Monitor mode.
3. Insert the RDSB into the USB connector on the CPU. (After 1 – 2 seconds, the RDSB LED turns solid green.)
4. For CPE302/CPE305/CPE310, push the RDSB direction switch to the left (UPLOAD), then momentarily depress the START pushbutton. For CPE330, depress the RDSB UPLD pushbutton.
5. **Do not** remove the RDSB from the CPU during the transfer.
 - The RDSB LED blinks green during the transfer. This can take from 10 – 150 seconds, depending upon the size of the project data.
 - The RDSB LED should turn solid green, indicating that the transfer completed successfully.
 - If the RDSB LED turns solid red, the transfer has failed. There will be a copy of the fault tables as they existed at the end of the attempted transfer on the RDSB. Insert the RDSB into a PC which has the PACS Analyzer software and select the *plcfaultafter.dat* file on the RDSB for fault table analysis by the Analyzer. The PACS Analyzer software can be downloaded from the support website.
 - If the RDSB LED turns solid red, indicating an error, another RDSB operation cannot be initiated until the device is disconnected then reconnected.

CAUTION

If the RDSB is removed during data transfer from the CPU, the integrity of the RDSB and the files on it cannot be guaranteed. The RDSB status LED may indicate an RDSB fault, and the CPU will abort the data transfer and remain in its current operating mode.

The project files, consisting of the entire contents of the *PACS_Folder* directory and all of its subdirectories, loaded on the RDSB must *not* be modified. If they are modified, the files transferred to the CPU will be invalid.

6. When the RDSB LED turns solid green, indicating the transfer has been successfully completed, remove the RDSB from the CPU. The RDSB can now be used to transfer the application to other RX3i controllers of the same model type.

You can copy the entire *applications* directory to another USB device and use that device as the source for downloads to CPE302/CPE305/CPE310/CPE330 CPUs, provided none of the files in that directory are changed in any way during the transfer.

Notes: Only one application project can be stored to the RDSB at a time. Before the RX3i writes the project to the RDSB, any previous application is removed; if a directory named *PACS_Folder* exists on the RDSB at the start of the upload, it is deleted with all of its contents.

2.1.9 Downloading a Project from the RDS D to the CPU

To download a project to the RX3i, the RDS D must contain a valid project, consisting of the hardware configuration, application logic, and reference memory in a compiled format (originating from another RX3i controller). The project files, consisting of the entire contents of the *PACS_Folder* directory and all of its subdirectories, loaded on the RDS D must **not** be modified. If they are modified, the files transferred to the CPU will be invalid.

By default, all project components are stored to the CPU and are written to flash. You can change this operation by placing an *options.txt* file on the RDS D as described below.

1. Ensure that the RX3i is in STOP Mode
2. If PAC Machine Edition is online with the RX3i, either go Offline or select Monitor mode.
3. Connect the RDS D to the USB connector on the CPU that will be receiving the files. The RDS D LED turns solid green.
4. For CPE302/CPE305/CPE310, move the RDS D direction switch to the right (DOWNLOAD), then momentarily depress the START pushbutton. For CPE330, depress the RDS D DNLD pushbutton.
5. **Do not** remove the RDS D from the CPU during the transfer.
 - If the target name in the RDS D is different from the target name in the RX3i, the RDS D LED will blink red. If this is expected or acceptable, momentarily depress the START pushbutton again.
 - The RDS D LED blinks green during the transfer. This can take from 10 – 150 seconds, depending upon the size of the project data.
 - The RDS D LED should turn solid green, indicating that the transfer completed successfully. Unless the RUN/STOP Switch has been disabled in the hardware configuration just stored, it can be used to place the RX3i into RUN Mode after the transfer.
 - If the RDS D LED turns solid red, the transfer has failed:
 - The target memory area(s) in the CPU are cleared. For example, if only the Logic is being download from the RDS D and the store fails (e.g. stick pulled, problem with transfer or data), Logic memory is cleared following the failed RDS D download. If other memory areas were also queued up for transfer, those memory areas are also cleared as a result of the failure.
 - There will be a copy of the fault tables as they existed at the end of the attempted transfer on the RDS D. Insert the RDS D into a PC which has the PACS Analyzer software and select the *plcfaultafter.dat* file on the RDS D for fault table analysis by the Analyzer.
 - If the RDS D LED turns solid red, indicating an error, another RDS D operation cannot be initiated until the device is disconnected then reconnected.

CAUTION

If the RDS D is removed during data transfer to the CPU, the RX3i controller will generate a fatal fault (sequence store fault) and SYS FLT LED will turn red. You will need to clear the fault tables through a programmer connection or by power cycling the CPU with the Energy Pack disconnected before attempting to download again. Each type of data being downloaded (logic, config, and/or data) is cleared within the target CPU.

6. When the RDS D LED turns solid green, indicating the transfer has been successfully completed, remove the RDS D from the CPU.

The RUN/STOP Switch can be used to place the RX3i into RUN Mode after the transfer, unless it has been disabled in the hardware configuration just stored. If the RUN/STOP Switch is disabled, you will first need to connect with the programmer to place the RX3i in RUN Mode.

2.1.9.1 Using an Options.txt File to Modify Download Operation

An *options.txt* file can be used to modify the operation of the RDS D during a store to the RX3i. This is a plain-text file which can contain some or all of the following statements, in any order. The format of each option line is the option keyword, followed by a space, followed by either a capital Y or a capital N. The option keyword must be spelled exactly as indicated below. If an option statement is omitted from the file, the default value will be used.

If you want to use all of the default operations, *the options.txt* file is not necessary.

2.1.9.1.1 Options.txt File Format

Option Keyword	Default value	Description
Download_LogicAndCfg	Y (yes)	Logic and configuration are copied to the CPE302/CPE305/CPE310/CPE330 (including symbolic variables)
Download_Data	Y (yes)	Reference memory is copied to the CPE302/CPE305/CPE310/CPE330 (excluding symbolic variables)
Download_CamFiles	Y (yes)	CAM files are copied to the CPE302/CPE305/CPE310/CPE330
Write_Flash	Y (yes)	The downloaded CPE302/CPE305/CPE310/CPE330 contents (as specified by the above keywords) by default will be written to flash upon completion of the store

2.1.9.1.2 Sample options.txt File

If the following *options.txt* file is present on the RDS D, logic, configuration and reference data are copied to the CPU, and files are written to flash. Cam files are not copied.

```
Download_LogicAndCfg Y
Download_Data Y
Download_CamFiles N
Write_Flash Y
```

2.1.9.2 Security

When the application is written to the RDS D from a controller that has passwords and/or an OEM key defined, the passwords and OEM key are encrypted and stored on the RDS D. When the project is written from the RDS D to a CPE302/CPE305/CPE310/CPE330¹⁹, the passwords and OEM key are copied to it.

¹⁹ Not implemented on CPE400 at time of publication.
CPU Features & Specifications

If an OEM key is defined on the RDS, when transfer is complete, the OEM protection will be enabled (locked). When an application is being stored to a CPE302/CPE305 that already has passwords and/or an OEM key defined, the passwords/key on the RDS must match the passwords/key in the target CPE302/CPE305/CPE310/CPE330, or the transfer will fail.

2.1.9.3 RDS Error Reporting

Errors are indicated when the RDS LED becomes solid red (not blinking). All errors are reported in the Controller fault tables. If the Controller has faults in its fault tables before it receives a store, the fault tables are written to *plcfaultbefore.dat* and *iofaultbefore.dat* on the RDS. If the Controller has faults in its fault tables after it receives a store, the fault tables are written to *plcfaultafter.dat* and *iofaultafter.dat* on the RDS. Previous versions of these files are deleted before the transfer. If either fault table is empty, the corresponding file is not written and will not be present.

To read any of the *.dat* files mentioned above, open PACS Analyzer. In *settings*, enable *file analyze*. Then click the *file analyze* button on the main screen. Select as *Input File* the *.dat* file to be analyzed. Select as *Output File* the filename and folder into which you wish to deposit the resulting text. The text will be in English.

If a hardware configuration that disables the USB port is stored to the CPU, the fault tables will not be written to the RDS at completion of the store operation because the USB port will be disabled at the end of the store process.

2.1.10 CPU Over-Temperature Monitoring and Behavior

RX3i CPE302, CPE305, CPE310, CPE330, CPE400 and CPL410 models monitor the internal temperature of the CPU.

- If the temperature rises to a near-critical level, these CPUs set the *CPU Over Temperature Fault* (refer to section 3.2.7). The actual temperature varies from CPU to CPU, as each has a different temperature specification.
- If the temperature continues to rise and reaches the specification limit, the CPU goes into a firmware-controlled reset.
- Uniquely, the CPE400 and CPL410 turn on its TEMP LED, using amber.
- Following reset, the CPU continues to monitor the internal temperature.
- If the temperature falls sufficiently (i.e. by 10°C or 18°F), the CPU will automatically attempt to restart.
- If the CPU is manually restarted before the temperature drops to the automatic restart level, the CPU will attempt to restart, and will monitor its internal temperature as before.
- Upon successfully restarting, the Overtemp Fault will be recovered, providing the CPU has been connected to an Energy Pack. If there is no Energy Pack connected, or if the Energy Pack has discharged, the Overtemp Fault will be lost.
- The CPE400 and CPL410 always turns off its TEMP LED at power-up.

2.2 RX3i CPU Features and Specifications

	CPU310	CPU315	CPU320/ CRU320 ²⁰	CPE302 ²¹ / CPE305	CPE310	CPE330	CPE400/ CPL410
Lifecycle Phase	Discontinued - use CPE310	Discontinued - use CPE310 or CPE330	Discontinued - use CPE330	Active	Active	Active	Active
Operating System	VxWorks	VxWorks	VxWorks	VxWorks	VxWorks	VxWorks	VxWorks
#RX3i Slots Occupied	2	2	2	1	2	2	N/A
Backplane	<-----Supports High-Speed PCI IC695* and Serial IC694* Modules ----->						Field Agent (CPE400) / Linux (CPL410)
Temperature Range							
RX3i	0°C to 60°C	0°C to 60°C	0°C to 60°C	0°C to 60°C ²²	0°C to 60°C ¹⁵	0°C to 60°C	-40°C to 70°C ²³
Power Requirements							
RX3i +3.3Vdc	1.25 A	1.0 A	1.0 A	1.0 A	1.0 A	0 A	N/A
RX3i +5 Vdc	1.0 A	1.2 A	1.2 A	1.0 A (up to 1.5 A if USB draws 0.5A)	1.0 A (up to 1.5 A if USB draws 0.5A)	0 A	N/A
RX3i +24Vdc Relay with Energy Pack				0.5 A at start-up; 0.1 A otherwise	0.5 A at start-up; 0.1 A otherwise	0.750 A	N/A
RX3i +24Vdc Relay w/o Energy Pack						0.625 A	N/A
Input Power (Max)							20 W
Input Voltage (Min)							18 Vdc
Input Voltage (Max)							30 Vdc
Memory Backup Mechanism ²⁴	Battery see GFK-2741	Battery see GFK-2741	Battery see GFK-2741	Energy Pack: IC695ACC400	Energy Pack: IC695ACC400	Energy Pack: IC695ACC402	Energy Pack: IC695ACC403
Display							
	LEDs	LEDs	LEDs	LEDs	LEDs	LEDs	LEDs & OLED

²⁰ For CRU-type CPUs, see Redundancy section at bottom of this table.

²¹ Where different, CPE302 value is shown in parentheses (). Also note that first Firmware Version of CPE302 was FW 9.40.

²² LT versions of the hardware are rated from -40°C to 60°C.

²³ The maximum operating temperature varies according to installation altitude: 70 °C at 0m to 2000m, 65 °C at 2000m to 3000m, and 60 °C at 3000m to 4000m.

²⁴ See Battery Compatibility and Memory Retention (Time in Days at 20°C) in GFK-2741

	CPU310	CPU315	CPU320/ CRU320 ²⁰	CPE302 ²¹ / CPE305	CPE310	CPE330	CPE400/ CPL410
Firmware Upgrade²⁵							
CPU Firmware Upgrade Mechanism	<-----WinLoader/Serial Port----->			v7.30 & later: USB earlier: WinLoader/ Serial Port	v7.30 & later: USB earlier: WinLoader/ Serial Port	Web Interface Ethernet Port	Web Interface Ethernet Port
Indirect Backplane Module Upgrade	<-----WinLoader/Serial Port----->					Web Interface Ethernet Port	N/A
Program Portability							
Direct Import (with limitations) ²⁶					CPU310, CPU315	CPU315, CPU320	N/A
RX3i PACSystems Applications using Family Type Conversion							Y
Program Security							
Secure Boot						N	Y
Trusted Platform Module (TPM)						Y	Y
Program Storage							
Battery-backed RAM	10 Mbytes ²⁷	20 Mbytes ²⁷	64 Mbytes ²⁷	(2)/5 Mbytes ²⁸	10 Mbytes ²⁸	64 Mbytes ²⁸	64 Mbytes ²⁸
Non-Volatile Flash	10 Mbytes	20 Mbytes	64 Mbytes	(2)/5 Mbytes	10 Mbytes	64 Mbytes	64 Mbytes
Battery Life Expectancy, RAM Backup ²⁴	see GFK-2741	see GFK-2741	see GFK-2741				N/A
Life Expectancy, Energy Pack Capacitors				5 years	5 years	5 years	5 years
Auxiliary Storage							
CFast						Inactive	N/A
Remote Data Storage Device (RDSD)				Y - USB	Y - USB	Y - USB	N
Micro SD							N/A

²⁵ Effective with RX3i firmware version 9.40, the Authorized Firmware Update feature was added: with it, user can set/change his own password.

²⁶ See corresponding IPI for target CPU.

²⁷ Battery-backed RAM.

²⁸ RAM backup with compatible Energy Pack attached.

	CPU310	CPU315	CPU320/ CRU320 ²⁰	CPE302 ²¹ / CPE305	CPE310	CPE330	CPE400/ CPL410
Programming Capabilities							
Max Number of Program Blocks ²⁹	512	512	512	512	512	768	768
Program Block Max Size	128 KB	128 KB	128 KB	128 KB	128 KB	128 KB	128 KB
Discrete Reference Memory (%I, %Q) ³⁰	32 Kbits	32 Kbits	32 Kbits	(16)/32 Kbits	32 Kbits	32 Kbits	32 Kbits
Analog Reference Memory (%AI, %AQ) ²¹	32 Kwords	32 Kwords	32 Kwords	32 Kwords	32 Kwords	32 Kwords	32 Kwords
Bulk Reference Memory (%W) ²¹	up to max user RAM	up to max user RAM	up to max user RAM	up to max user RAM	up to max user RAM	up to max user RAM	up to max user RAM
Managed Memory (Symbolic + I/O Variables) ^{21,31}	up to 10 Mbytes	up to 20 Mbytes	up to 64 Mbytes	up to (2)/5 Mbytes	up to 10 Mbytes	up to 64 Mbytes	up to 64 Mbytes
Floating Point	y	y	y	y	y	y	y
Ladder Diagram (LD)	y	y	y	y	y	y	y
Function Block Diagram (FBD)	y	y	y	y	y	y	y
Structured Text (ST)	y	y	y	y	y	y	y
PID Built-In Function Block	y	y	y	y	y	y	y
"C" Language External Blocks	y	y	y	y	y	y	y

²⁹ Support for up to 768 blocks requires firmware release 9.70 or later and PME 9.50 SIM 13 or later.

³⁰ Note: Whenever the size of any reference memory is changed, the content of the corresponding reference memory is automatically cleared.

³¹ For discussion of memory types and how they are managed, refer to PACSystems RX3i CPU Programmer's Reference Manual, GFK-2950 Section 3.

	CPU310	CPU315	CPU320/ CRU320 ²⁰	CPE302 ²¹ / CPE305	CPE310	CPE330	CPE400/ CPL410
Communications							
Ethernet Non-Switched RJ45 (dedicated NIC)						10/100/1000 x1	10/100/1000 x1
Embedded Field Agent Ethernet RJ45 (dedicated NIC)							10/100/1000 x1
Ethernet Switched RJ45 (shared NIC)						10/100/1000 x2	10/100/1000 x4 (2 pairs)
10BaseT/100BaseT RJ45				10/100 x1	10/100 x1		N
Ethernet Communications Platform	ETM001 only	ETM001 only	ETM001 only	Built-in and /or ETM001	Built-in and /or ETM001	Built-in and /or ETM001	Built-in
Advanced User Parameters (AUP file)	N/A	N/A	N/A	Y ³²	Y ²³	N ³³	N ²⁴
RS-232	9-pin D x1	9-pin D x1	9-pin D x1	RJ-25 x1	9-pin D x1	N/A	RJ-45 x1
RS-485	15-pin D x1	15-pin D x1	15-pin D x1		15-pin D x1	N/A	N/A
USB				USB-A 2.0 x1	USB-A 2.0 x1	USB-A 2.0 or USB-A 1.1 x1	USB 3.0 x 2 (inactive)
Time-of-Day Clock							
Time-of-Day Clock Accuracy (@60°C)	±2 secs/day	±2 secs/day	±2 secs/day	±2 secs/day	±2 secs/day	±2 secs/day	±2 secs/day
Elapsed Time Clock (internal timing) accuracy	±0.01% max	±0.01% max	±0.01% max	±0.01% max	±0.01% max	±0.01% max	±0.01% max
Simple Network Time Protocol (SNTP) accuracy to timestamp ³⁴	±2 ms using ETM001	±2 ms using ETM001	±2 ms using ETM001	±2 ms using ETM001	±2 ms using ETM001	±2 ms using ETM001 or embedded	±2 ms embedded only
RTC Battery Backup				Y	Y	Y	Y
RTC Battery Life expectancy				5 years	5 years	5 years	5 years

³² Refer to PACSystems RX3i TCP/IP Ethernet Communications User Manual, GFK-2224M or later for supported AUPs.

³³ The Advanced User Parameters (AUP) feature has been incorporated into PME Hardware Configuration (HWC) effective with PME release 8.60 SIM5.

³⁴ Effective with CPE302/CPE305/CPE310/CPE400 firmware version 9.20, or CPE330 firmware version 9.21, SNTP is supported by the embedded CPU Ethernet interfaces. PAC Machine Edition Release 9.00 SIM 10, or 9.50 SIM 2, or later is required for SNTP Client, UTC, and DST support.

	CPU310	CPU315	CPU320/ CRU320 ²⁰	CPE302 ²¹ / CPE305	CPE310	CPE330	CPE400/ CPL410
Protocols							
Modbus RTU Slave	Y	Y	Y	Y	Y	N/A	N/A
SNP Slave	Y	Y	Y	Y	Y	N/A	N/A
Serial I/O	Y	Y	Y	Y	Y	N/A	Y ³⁵
SRTP (# simultaneous server conns)				up to 32	up to 32	up to 48	up to 48
Modbus TCP (# simultaneous server connections)				up to 16 ³⁶	up to 16 ³⁶	up to 16 ³⁶	up to 16 ³⁶
SRTP Channel or Modbus TCP Client (# simultaneous)				up to 16 ³⁶	up to 16 ³⁶	up to 32 ³⁶	up to 32 ³⁶
Ethernet Global Data (EGD)				FW 8.30 ^{21,37}	FW 8.30 ³⁷	FW 8.60 ³⁷	Y
Number of EGD Exchanges (max) ³⁸				255	255	255	255
Selective Consumption of EGD				Y	Y	Y	Y
PROFINET ³⁹				N	N	FW 8.90	Y
OPC UA Server ⁴⁰				FW 8.20 ^{21,41}	FW 8.20 ⁴¹	Y ⁴¹	Y ⁴¹
Remote Station Manager over UDP				Y	Y	Y - limited	Y - limited
Station Manager over Serial Comm Port	via ETM001	via ETM001	via ETM001	via ETM001	via ETM001	via ETM001	N/A
DNP3 Outstation master/client support (# simultaneous)							Up to 8

³⁵ CPE400 Serial IO requires firmware version 9.40 or later.

³⁶ Sixteen clients are permitted: each may be SRTP or Modbus/TCP.

³⁷ EGD Class 1 only: supports up to 255 simultaneous Class 1 EGD exchanges.

³⁸ Limit is per target, so all producers and consumers in the CPU system are counted towards this limit.

³⁹ CPE400 and CPE330 (firmware version 8.90 or later) provide PROFINET support via an embedded PROFINET Controller: no external hardware is required. All other CPUs that support PROFINET require a rack-mounted PROFINET Controller (IC695PNC001). CPE330 may also host IC695PNC001 modules in the CPU rack. Refer to the PACSystems RX3i PROFINET IO-Controller Manual, GFK-2571F or later.

⁴⁰ For a discussion of OPC UA, refer to PACSystems RX3i TCP/IP Ethernet Communications User Manual, GFK-2224M Section 10.

⁴¹ Supports up to 5 concurrent sessions with up to 10 concurrent variable subscriptions and up to 12,500 Variables.

	CPU310	CPU315	CPU320/ CRU320 ²⁰	CPE302 ²¹ / CPE305	CPE310	CPE330	CPE400/ CPL410
Redundancy Features			Model CRU320 only			Configurable in CPE330	Configurable in CPE400/ CPL410
Memory Error Checking and Correction (ECC)			Single bit correcting & Multiple bit checking			Single bit correcting & Multiple bit checking	Single bit correcting & Multiple bit checking
Switchover Time (max) ⁴²			1 logic scan			1 logic scan	1 logic scan
Switchover Time (min) ³¹			3.133 ms			3.133ms	10ms
Max data in redundancy transfer list ⁴³			2 Mbytes			2 Mbytes	2 Mbytes
Redundant Synchronized Links Supported			RMX128 x2 max RMX228 x2 max			RMX128 x2 max RMX228 x2 max	LAN3

⁴² Switchover time is defined as the time from failure detection until backup CPU is active in a redundancy system.

⁴³ Symbolic variable and Reference data can be exchanged between redundancy controllers, up to the stipulated limit.

2.2.1 CPL410

2.2.1.1 Introduction

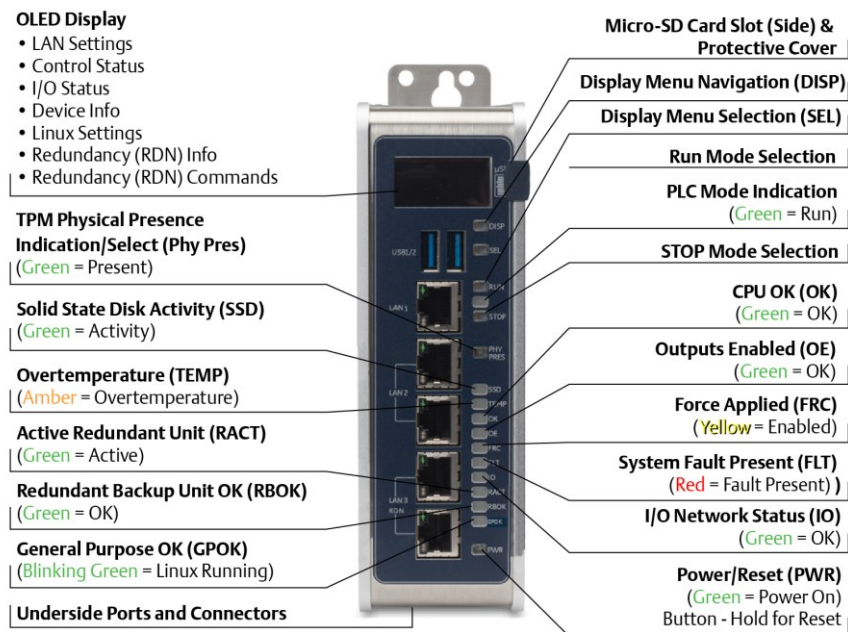
The IC695CPL410 is a Rackless RX3i CPU, similar to CPE400. All prior RX3i CPUs slotted into an RX3i backplane. The CPL410 does not.

There are two mounting options:

1. As shipped, it mounts onto a DIN rail using a DIN-rail adaptor plate, YAVD-I2C2-01-A.
2. Alternately, it mounts directly in a cabinet, using a panel-mount adaptor plate, YA-I2-C2.04-A.

The mounting instructions and power requirements are documented in the *RX3i IC695CPL410 1.2GHz 64MB Rackless CPU w/Linux Quick Start Guide*, GFK-3053, and are not replicated here.

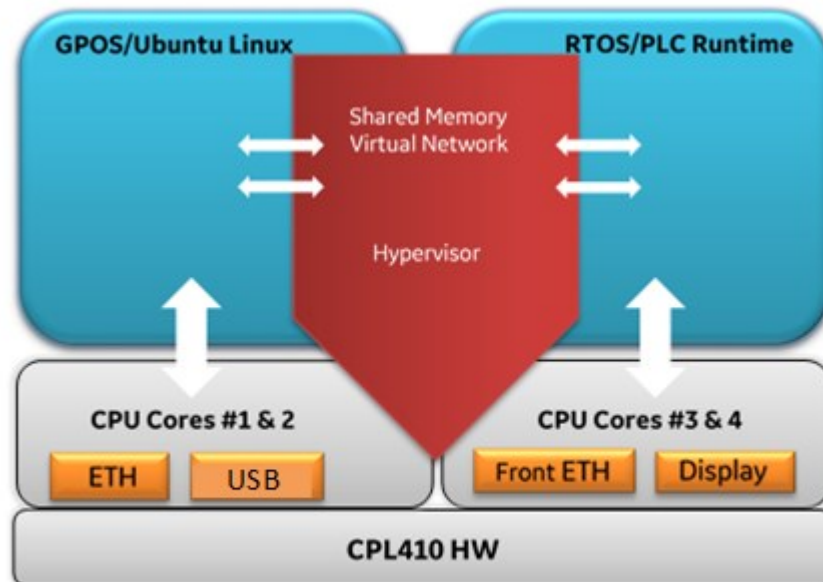
Figure 2: CPL410 Front View and Features



The PACSystems RX3i CPL410 is a controller with integrated Linux. It augments real-time deterministic control with an Ubuntu 16.04 Server Linux, open to modifications and enhancements. With this product, customers can implement custom data processing like Edge- or Cloud-based analytics, Cloud storage, WEB visualization and many more. Full Linux root access is granted, allowing the user to enhance CPL410 in a virtually limitless manner, thereby achieving outcomes that today's businesses require. Use cloud services which best fit your application; install freely-available data visualization tools and analytics programs, or use professional software to turn GE's CPL410 into your custom controller. CPL410 can be programmed to dynamically influence business outcomes, generate new forms of revenue, and improve profitability.

Figure 3 illustrates the principle of hardware and software separation on CPL410 (only major HW components shown).

Figure 3: CPL410 Hardware/Software Separation



2.2.1.2 Features

- The stand-alone CPL410 uses a 1.2GHz quad-core microprocessor and real-time hypervisor technology to run real time deterministic control applications concurrently with an Ubuntu Server Linux 16.04 LTS. Hypervisor technology ensures the separation of the real-time and Linux world security; performance-wise, each is independent of the other. OPC-UA industry standard protocol allows data exchange between the controls and the Linux application.
- A built-in RX3i PLC:
 - User may program in Ladder Diagram, Structured Text, Function Block Diagram, or C.
 - Contains 64Mbytes of configurable data and program memory.
 - Supports auto-located Symbolic Variables that can use any amount of user memory.
 - Reference table sizes include 32k bits for discrete %I and %Q and up to 32k words each for analog %AI and %AQ. Bulk memory (%W) also supported for data exchanges.
 - Supports up to 768 program blocks⁴⁴. Maximum size for a block is 128KB.

⁴⁴ Support for up to 768 blocks requires firmware release 9.70 or later and PME 9.50 SIM 13 or later.

- A built in Ubuntu 16.04 Server LTS:
 - Ubuntu is a free, open source operating system. It is very well known and in widespread use. For CPL410 the Ubuntu Server variant has been selected as it includes multiple network utilities and protocols and has a smaller footprint than the Desktop version. In contrast to the latter, the Server version offers a purely text based user interface, unlike the graphical desktop. LTS (Long Term Support) indicates availability of updates till 2021. Running Ubuntu Server concurrently with the real-time control applications allows the CPL410 to rapidly leverage external data. External monitoring may be used to analyze and optimize entire business operations. The analysis can then be used to dynamically adjust real-time industrial controls to align with changing business objectives in today's Industrial Internet age.
 - Supports four independent 10/100/1000 Ethernet LANs. The three Ethernet ports located on the front panel, as shown in Figure 2, are exclusively assigned to the RX3i PLC: LAN1 attaches via the upper, dedicated RJ 45 connector. LAN2 and LAN3 each attach via a pair of internally-switched RJ 45 connectors. The fourth LAN, labeled ETH, is located on the underside and is exclusively used for Linux connectivity.
 - The embedded communications interface has dedicated processing capability, which permits the CPU to independently support LAN1 and LAN2 with:
 - up to 48 simultaneous SRTP Server connections;
 - up to 16 simultaneous Modbus/TCP Server connections;
 - 32 Clients are permitted; each may be SRTP or Modbus/TCP.
 - OPC UA Server with support for up to 5 concurrent sessions with up to 10 concurrent variable subscriptions and up to 12,500 variables;
 - up to 255 simultaneous Class 1 Ethernet Global Data (EGD) exchanges.
 - The embedded PLC may use one or both Ethernet LAN2 ports to support the embedded PROFINET I/O Controller. PROFINET supports up to 32 I/O devices with update rates of 1 – 512ms. I/O device update rates of 8ms and faster are possible with 16 or fewer devices. Update rates of 16ms and higher result whenever more than 16 devices are configured.
 - Media Redundancy Protocol (MRP) allows the CPL410 RX3i PLC to participate in a PROFINET I/O network with MRP ring technology. This eliminates the I/O network as a single point of failure. The RX3i PLC may be used as either a Media Redundancy Manager or Media Redundancy Client.
 - The CPL410 RX3i PLC supports Hot Standby Redundancy with PROFINET IO. In this configuration, LAN3 is used as a high-speed data synchronization link between the two redundant CPUs. Only the Primary and Secondary CPUs may be attached to LAN3. Two OLED menu items support Redundancy operation: RDN Info and RDN Command. The RACT and RBOK LEDs reflect the status of the Redundant CPUs.
 - The CPL410 RX3i PLC supports two independent Redundant IP addresses, one for LAN1 and one for LAN2. LAN2 Redundant IP is supported when configured for Ethernet mode only. Redundant IP is supported by the SRTP Server, Modbus TCP Server, and EGD protocols. It is not possible to use Redundant IP with the OPC UA Server or with the Ethernet firmware update web page.
 - The real-time part of CPL410 is secure by design, incorporating technologies such as Trusted Platform Modules, secure boot, and encrypted firmware updates. It is neither accessible or modifiable by customers nor intruders, thus guaranteeing the integrity of the controller. As the Linux part of the CPL410 is open for modifications, this security can't be provided for

Linux. Customer must take care about sealing Linux to the degree necessary for the actual use case. Emerson provides a Secure Deployment Guide to support customers in this task.

- Optional Energy Pack, IC695ACC403, allows the RX3i PLC of CPL410 to instantly save user memory to non-volatile storage in the event of loss of power.
- OPC UA Sweep Mode & Sweep Time: The RX3i PLC's sweep mode and sweep time are available through the OPC UA server. The Sweep Mode variable reports the controller's current mode: Stop Disabled, Run Enabled, Stop Enabled, Run Disabled, Stop Faulted, and Stop Halted. The Sweep Time variable reports the sweep time in seconds. These variables are located under Emerson Device Information -> PACSystems RX3i -> Controller.
- An OLED display that provides access to basic CPL410 status and control information including each LAN's configured IP Address.
- Operating temperature range -40°C to 70°C (-40°F to 158°F).
- Alternate panel-mount adaptor plate included.

2.2.1.3 Switches

All user-accessible switches are provided as pushbuttons on the front panel as described below.

Pushbutton	Function
DISP	Permits user to navigate menus in the OLED display.
SEL	Permits user to select the menu item on the OLED display.
RUN	Activates OLED Menu to select RUN/Enabled or RUN/Disabled Mode for the embedded PLC.
STOP	Activates OLED Menu to select STOP/Enabled or STOP/Disabled Mode for the embedded PLC.
PHY PRES	Not functional.
PWR	Hold down for brief period to induce CPU Reset. Note that this does not turn unit power off, but only holds unit in Reset

2.2.1.4 Displays and Indicators (LEDs)










2.2.1.4.1 OLED Display

The monochrome organic light-emitting diode (OLED) display is used to display CPL410 system menus. It interacts with the DISP pushbutton, which jogs the cursor from one menu item to the next, and with the SEL pushbutton, which activates the currently indicated menu item for further action.























The OLED display permits the user to:

- Display Ethernet LAN Settings: IPv4 address.
- Display the PLC firmware revision.
- Set/view PLC mode and view sweep time.
- Set the PLC mode to RUN/STOP with I/O Enabled/Disabled via the display.
Note: the RUN and STOP pushbuttons activate the PLC Mode menu items per Section 2.2.1.3.
- View whether all, some, or none of the PROFINET I/O devices are connected.
- Display Linux Settings: IPv4 address, subnet mask, gateway, MAC address, IPv6 address.
- Issue Linux Commands: Perform factory reset, Reset Linux.
- View Linux Status: Off, Starting, Connecting, Connected, Connected-ACT.
- View HSB Redundancy Mode and State.
- Command an HSB Redundancy Role Switch.






2.2.1.4.2 Status Indicators (LEDs)

LED	LED State	Operating State
PLC MODE ⁴⁵	 On Green	PLC is in RUN mode.
	 Off	PLC is in STOP mode.
RUN OE	 Blinking in unison	CPU is updating an internal programmable hardware device.
PHY PRES	 On Green	TPM Physical Presence (not functional).
	 Off	
SSD	 On Green	Activity detected on Solid State Disk.
	 Off	No activity detected on Solid State Disk.
TEMP	 On Red	CPU Overtemperature condition detected.
	 Off	Overtemperature condition not detected.







⁴⁵ This LED is located between the RUN and STOP pushbuttons. It indicates the PLC Mode.

LED	LED State	Operating State
OK	 On Green	CPU has passed its power-up diagnostics and is functioning properly. (Following initialization sequence.)
	 Off	Power is not applied or CPU has a problem.
	 Blinking; All other LEDs off	PLC in STOP/Halt state; possible watchdog timer fault. If the programmer cannot connect, cycle power with charged Energy Pack attached and refer to fault tables.
OK OE		CPU encountered a Secure Boot Error.
OE	 On Green	Output scan is enabled.
	 Off	Output scan is disabled.
FRC	 On Yellow	One or more Overrides active in I/O Reference Table(s).
	 Off	No Overrides active in any I/O Reference Table.
FLT	 On Red	PLC is in STOP/Faulted mode: a fatal fault has occurred.
	 Off	No fatal faults detected.
IO	 On Green	PROFINET Connection Status = OK.
	 Off	PROFINET Connection Status not OK.
RACT	 On Green	Local Redundant CPU is Ready & Active.
	 Off	Local Redundant CPU is not Ready.
RBOK	 On Green	Remote Redundant CPU is Ready.
	 Off	Remote Redundant CPU is not Ready.
GPOK	 Blinking Green	Blink at 1 Hz: Linux Running.
	 Off	Linux not running.
PWR	 On Green	CPU running.
	 Blinking Green	Booting up – diagnostics in progress.
	 On Red	Off
	 Off	Reset / Power not detected.

2.2.1.4.3 Front Ethernet Indicators (LAN1, LAN2, LAN3 RJ45 Built-in LEDs)

LED	LED State	Operating State
Link Status (upper)	 On Green	The corresponding link has been established.
	 Blinking Green	Traffic is detected at the corresponding port.
	 Off	No connection established at corresponding port.
Link Speed (lower)	 On Green	Corresponding data speed is 1 Gbps or 100 Mbps.
	 Off	Corresponding network data speed is 10 Mbps

2.2.1.4.4 Bottom Ethernet Indicators (ETH RJ45 Built-in LED)

LED	LED State	Operating State
Link Status (upper)	 On Green	The corresponding link has been established.
	 Blinking Green	Traffic is detected at the corresponding port.
	 Off	No connection established at corresponding port.
Link Speed (lower)	 On Green	Corresponding network data speed is 1 Gbps.
	 On Yellow	GPOS port only: network data speed is 100 Mbps
	 Off	Corresponding network data speed is 10 Mbps

2.2.1.5 USB Ports

On the front panel CPL410 features two USB 3.0 ports, labeled USB1 and USB2.

- USB1 is assigned to Linux and can be used for keyboards, memory sticks or other memory devices. For other USB devices an appropriate Linux driver will need to be installed.
- USB2 is reserved for the Controller run time PACS.
- For USB port pinouts, refer to Section 2.2.2.5.

Note: In the first release, both USB ports are accessible by Linux. Do not implement Linux use cases relying on the availability of both USB ports, since USB2 will be assigned to the PLC/PACS in the future.

2.2.1.6 Front-Panel Ethernet Ports

All front panel Ethernet ports are exclusively assigned to the PLC component of the CPL410 and cannot be used by Linux.

LAN1 connects to the uppermost RJ45 connector. It is not switched.

LAN2 connects to the middle two RJ45 connectors. These two ports are switched internally.

LAN3 connects to the two lower RJ45 connectors. These two ports are switched internally. LAN3 may only be used to supply a high-speed synchronization link between the Primary and Secondary CPUs in Hot Standby Redundancy. Both ports are typically used, as described in the *PACSystems Hot Standby CPU Redundancy User Manual*, GFK-2308 (revision L or later).

Each of the embedded Ethernet interfaces automatically senses the data rate (10 Mbps or 100 Mbps or 1 Gbps), communications mode (half-duplex or full-duplex), and cabling arrangement (straight-through or crossover) of the attached link. LEDs embedded in each RJ45 connector provide indications per the table above.

LAN1 or LAN2 may be used to communicate with the PME programming software using the Service Request Transport Protocol (SRTP).

To establish Ethernet communications between the PME programming and configuration software and the CPU, you *first* need to know the target IP address. Use the OLED menu function to check the IP Address. The factory-shipped default settings are:

	CPL410 LAN1	CPL410 LAN2	CPL410 LAN3
IP Address:	192.168.0.100	10.10.0.100	N/A
Subnet Mask:	255.255.255.0	255.255.255.0	N/A
Gateway:	0.0.0.0	0.0.0.0	N/A

2.2.1.7 Serial COM Port

The RJ45 port, marked Serial COM, is located on the underside of the CPL410, as shown in Figure 4. The serial port is exclusively assigned to the PLC and is not accessible by Linux. This port supports Serial IO protocol.

2.2.1.8 Video Display Port

The Display Port is located on the underside of the CPL410, as shown in Figure 4. It provides signals for connecting either a suitable monitor or video adapter to the unit. **This port is not currently supported.**

2.2.1.9 Linux Port

The RJ45 port, marked ETH, is located on the underside of the CPL410, as shown in Figure 4. This Ethernet port is exclusively assigned to Linux. By default, this port is configured to use the DHCP protocol to receive a valid IP Address. Therefore, a DHCP server is needed to make first use of this port and to access Linux.

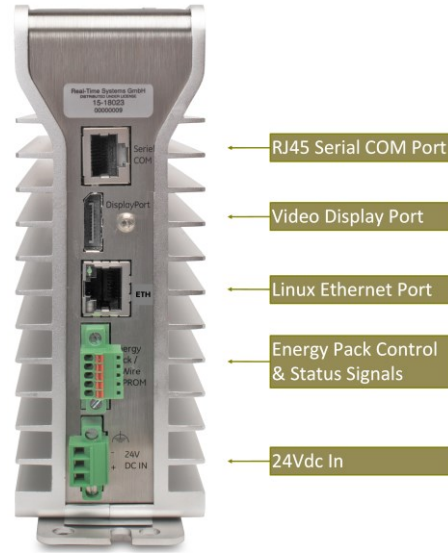


Figure 4: Underside Ports & Connectors

The GPOK LED, located on the front panel, indicates the status (refer to Section 0) of the Linux interface. Green blinking indicates Linux running and ready for login.

2.2.1.10 Energy Pack Connector

The CPL410 compatible Energy Pack, IC695ACC403, is supplied with a purpose-built cable, IC695CBL003, which installs in the 24Vdc In and Energy Pack Control & Status connectors. Use of the Energy Pack is optional. When used, it allows the RX3i PLC to save its current state upon loss of power. Refer to the *PACSystems RX3i Rackless Energy Pack IC695ACC403 Quick Start Guide*, GFK-3000, for complete wiring and grounding instructions.

Currently there is no event to inform the Linux part of the CPL410 about a power loss. Therefore, Linux currently cannot take advantage of the Energy Pack.

2.2.1.11 Input Power Connector

Refer the RX3i IC695CPL410 1.2GHz 64MB Rackless CPU w/Linux Quick Start Guide, GFK-3053, Section 2.4.

2.2.1.12 Linux

Ubuntu 16.04 Server LTS Linux is preinstalled on CPL410. Please note that the Server variant of Ubuntu does not offer a graphical desktop like GNOME or KDE, but only alphanumeric user interfaces (terminals). Additionally, the usage of graphic drivers is prevented by Kernel parameter to avoid unpredictable side effects (like CPU slow down due to overheating).

Refer to PACSystems RX3i IC695CPL410 1.2GHz 64MB Rackless CPU w/Linux QSG (GFK-3053) for detailed information.

2.2.1.12.1 Start Linux

After providing the CPL410 with power, Linux will begin to boot. The GPOK LED will start blinking to indicate when Linux has booted and is ready for user logins. (This may take about two minutes.)

2.2.1.12.2 Remote Login

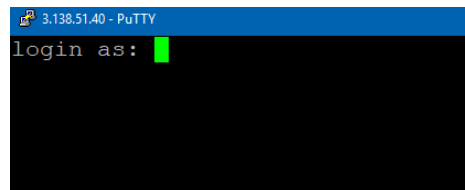
CPL410 is running a SSH service (daemon) which allows secure login from remote systems via the Ethernet network.

2.2.1.12.3 Log in via SSH over Ethernet Network

1. Connect the ETH port of the CPL410 (underside Ethernet port) to a network that has a DHCP server (see next section).
2. After CPL410 receives its IP Address from the DHCP server, the user can determine the active network parameters (incl. IP Address) via the display menu:
GP Settings ->Network Config
3. On the remote system (e.g. a desktop PC or Laptop) the user will need a SSH client like Putty (<https://putty.org/>) or Kitty (<http://www.9bis.net/kitty/>).

4. After the connection has been established, the CPL410 login prompt appears:

Figure 5: Login from Remote System



Default user on CPL410 is *admin* with password *admin*. When logging in for the first time, you will be asked to provide a new password. Be sure to remember your new password, as there is no other way to access Linux without it.

- Default User Name: ***admin***
- Default Password: ***admin***

2.2.1.12.4 Network Configuration

2.2.1.12.5 DHCP

CPL410 Linux is configured by default to receive its IP Address via DHCP over the ETH Ethernet port (underside Ethernet connector - Figure 4**Error! Reference source not found.**). After receiving the network parameters, the active IP Address, together with other network information, can be determined via the OLED display menu *GP Settings -> Network config*, or by issuing the command *ifconfig* when logged in.

Note: A DHCP server is essential for the first remote login over SSH. Once logged in, the user can change the configuration to disable use of DHCP (see next section).

2.2.1.12.6 Configure a Network Proxy

If a network HTTP/HTTPS proxy server is used to route traffic from the intranet to the Internet, the environment variables *http_proxy*, *https_proxy*, *ftp_proxy* need to be set accordingly. To create these variables permanently and for all users edit the file */etc/environment* file.

2.2.1.12.7 Proxy Settings for APT Package Management

The APT package management (*apt*, *apt-get* commands) uses a different configuration file for proxy settings: */etc/apt/apt.conf*.

2.2.1.12.8 Install or Update Packages

CPL410 Linux is open to software individually installed by customers. Standard Debian (Ubuntu is Debian based) package tools may be used to add, delete or update software packages.

Note: Please keep in mind, that preinstalled Ubuntu is a server variant, not offering a graphical desktop like KDE or GNOME. Therefore, installing graphical programs like Web browsers only makes sense if additionally installing a X11 windowing system (or similar) and forwarding the output to a remote device (the CPL410 Display Port can't be used for graphical output).

On the command line *apt* (Advanced Packaging Tool) or *apt-get* command is used to install, update or delete a software packages. Both commands are privileged commands, therefore, *sudo* needs to be prepended if not logged in as root.

For more details see Ubuntu help page about Package Management:
<https://help.ubuntu.com/16.04/serverguide/package-management.html.en>

2.2.1.12.9 CPL410 File Exchange

The ssh service, mentioned earlier regarding remote login, can also be used to copy files from a remote computer to the CPL410 Linux and vice versa. There are several Windows tools freely available to make use of this service from a Windows PC, like WinSCP (<https://winscp.net>) or FileZilla (<https://filezilla-project.org/>). Please configure either the SCP or the SFTP protocol when connecting with this tools to the SSH service of CPL410.

In Linux, the command line program *scp* can be used to copy a file from one CPL410 to another or to another SSH server.

Please pay attention to the CPL410 Secure Deployment Guide (GFK3055) regarding SSH key exchange and key generation.

2.2.1.12.10 Factory Reset

It might happen that a user locks him/herself out from Linux, or Linux fails to start following a misconfiguration. In such cases, Linux can be restored to its original manufacturer settings:

- Factory Reset can be triggered via the OLED-Display Menu:
GP Settings->Commands->Factory Reset.
- This reset reboots the CPL410 system (including runtime), subsequently formats the Linux root (/dev/sda8) and boot (/dev/sda9) partitions and installs the original factory software.

Note: All data, all user modifications, all updates etc. on these partitions are deleted and are unrecoverable following factory reset. Therefore, consider making frequent backups of all changes applied to Linux.

- The original factory software load is extracted from archives.
- The home partition (folder /home and below), where the customer data is expected to be stored, is not impacted.

2.2.1.12.11 SQLite Demonstration Database

Only used for demonstration purposes. Not to be used in production environment.

2.2.1.13 Removable Data Storage Device

The CPL410 is equipped with a micro-SD card slot and two USB ports Figure 2. The micro-SD card slot is not supported. The left USB port is assigned to Linux. The right USB port is reserved for future use.

2.2.1.14 PROFINET Controller

An Embedded PROFINET Controller may be configured on LAN2. For additional details, refer to Section 2.1.6, Embedded PROFINET Controller.

2.2.1.15 Hot Standby Redundancy

Same as for CPE400. Refer to Section 2.2.2.9.11.

2.2.1.16 Redundant IP Addresses

Same as for CPE400. Refer to Section 0.

2.2.1.17 Error Checking and Correction

Same as for CPE400. Refer to Section 2.2.2.9.13.

2.2.1.18 Backwards Compatibility of CPL410

Similar to CPE400. Refer to Section 2.2.2.9.18.

2.2.1.19 Replacement of Real-Time Clock Battery on CPL410

Same as for CPE400. Refer to Section 0.

2.2.1.19.1 Setting the Real-Time Clock on CPL410

The Real-Time Clock (RTC) may be set by both the PACSystems Runtime and Linux:

- The RTC may be set from PACSystems using utilities in Proficy Machine Edition.
- The RTC may be set from Linux.
- Regardless of whether the RTC is set from the PACSystems Runtime or from Linux, the CPL410 must be rebooted after the clock is set so that the time change is applied across both applications.

2.2.1.20 Replacement of CPL410 Mounting Bracket

Refer to Section 2.2.2.9.21.

2.2.2 CPE400

Introduction

The IC695CPE400 is the first RX3i Standalone (Rackless) CPU. All prior RX3i CPUs slotted into an RX3i backplane. The CPE400 does not.

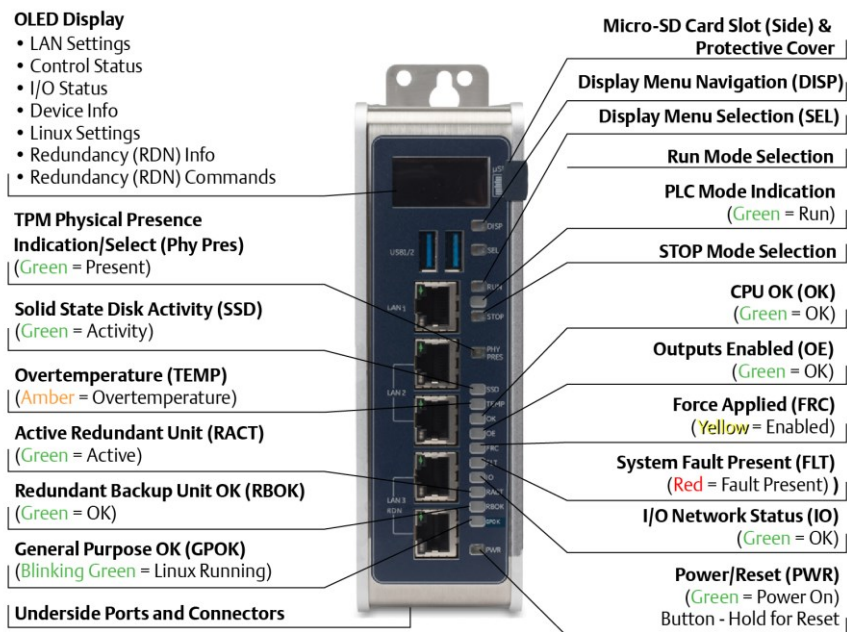
There are two mounting options:

1. As shipped, it mounts onto a DIN rail using a DIN-rail adaptor plate, YAVD-I2C2-01-A.
2. Alternately, it mounts directly in a cabinet, using a panel-mount adaptor plate, YA-I2-C2.04-A.

The mounting instructions and power requirements are documented in the *RX3i IC695CPE400 1.2GHz 64MB Rackless CPU w/Field Agent Quick Start Guide*, GFK-3002, and are not replicated here.

The physical features of the CPE400 are shown in Figure 6 and Figure 7

Figure 6: CPE400 Front View and Features



The PACSystems RX3i CPE400 is the industry’s first outcome optimizing controller. It augments real-time deterministic control with Field Agent technology, delivering near real time advice through market analysis, fleet and enterprise data, or asset/process knowledge to optimize the outcomes that today’s businesses require. The Predix™ enabled CPE400 provides reliable, secure communication and analytics using either cloud-based or edge-based outcome optimizing apps. Controls can now be programmed to dynamically influence business outcomes, generate new forms of revenue, and improve profitability.

- The stand-alone CPE400 uses a 1.2GHz quad-core microprocessor and real-time hypervisor technology to run real time deterministic control applications concurrently with Field Agent technology without any adverse impact of one over the other.
- A built-in RX3i PLC:
 - User may program in Ladder Diagram, Structured Text, Function Block Diagram, or C.
 - Contains 64Mbytes of configurable data and program memory.

- Supports auto-located Symbolic Variables that can use any amount of user memory.
- Reference table sizes include 32k bits for discrete %I and %Q and up to 32k words each for analog %AI and %AQ. Bulk memory (%W) also supported for data exchanges.
- Supports up to 768 program blocks⁴⁶. Maximum size for a block is 128KB.
- Field Agent technology is a platform for securely applying Predix applications and secure connectivity to the Predix Cloud as well as running edge apps. Running the Field Agent concurrently with the real-time control applications allows the CPE400 to rapidly leverage external data. External monitoring may be used to analyze and optimize entire business operations. The analysis can then be used to dynamically adjust real-time industrial controls to align with changing business objectives in today's Industrial Internet age.
- Supports four independent 10/100/1000 Ethernet LANs. Three are located on the front panel, as shown in Figure 1. LAN1 attaches via the upper, dedicated RJ 45 connector. LAN2 and LAN3 each attach via a pair of internally-switched RJ 45 connectors. The fourth LAN, labeled EFA (Embedded Field Agent), is located on the underside Figure 7, and is specifically used for Field Agent connectivity (see Field Agent bullet just above).
- The embedded communications interface has dedicated processing capability, which permits the CPU to independently support LAN1 and LAN2 with:
 - up to 48 simultaneous SRTP Server connections;
 - up to 16 simultaneous Modbus/TCP Server connections;
 - 32 Clients are permitted; each may be SRTP or Modbus/TCP;
 - OPC UA Server with support for up to 5 concurrent sessions with up to 10 concurrent variable subscriptions and up to 12,500 variables;
 - up to 255 simultaneous Class 1 Ethernet Global Data (EGD) exchanges.
- The embedded PLC may use one or both of the Ethernet LAN2 ports to support the embedded Simplex PROFINET I/O Controller. PROFINET supports up to 32 I/O devices with update rates of 1 – 512ms. I/O device update rates of 8ms and faster are possible with 16 or fewer devices. Update rates of 16ms and higher result whenever more than 16 devices are configured.
- Media Redundancy Protocol (MRP) allows the CPE400 to participate in a PROFINET I/O network with MRP ring technology. This eliminates the I/O network as a single point of failure. The CPE400 may be used as either a Media Redundancy Manager or Media Redundancy Client.
- Effective with firmware version 9.30, the CPE400 supports Hot Standby Redundancy with PROFINET IO. In this configuration, LAN3 is used as a high-speed data synchronization link between the two redundant CPUs. Only the Primary and Secondary CPUs may be attached to LAN3. Two OLED menu items support Redundancy operation: RDN Info and RDN Command. The RACT and RBOK LEDs reflect the status of the Redundant CPUs. Refer to the *PACSystems Hot Standby CPU Redundancy User Manual*, GFK-2308 for details and restrictions.
- Effective with firmware version 9.30, the CPE400 supports two independent Redundant IP addresses, one for LAN1 and one for LAN2. LAN2 Redundant IP is supported when configured for Ethernet mode only. Redundant IP is supported by the SRTP Server, Modbus TCP Server, and EGD protocols. It is not possible to use Redundant IP with the OPC UA Server or with the Ethernet firmware update web page.

⁴⁶ Support for up to 768 blocks requires firmware release 9.70 or later and PME 9.50 SIM 13 or later.

- Effective with firmware version 9.40, the CPE400 Serial Port (COM1) is supported. Refer to Section 0.
- The CPE400 is secure by design, incorporating technologies such as Trusted Platform Modules, secure boot, and encrypted firmware updates.
- Optional Energy Pack, IC695ACC403, allows CPE400 to instantly save user memory to non-volatile storage in the event of loss of power. Upon restoration of power, with the ACC403 connected, the CPE400 PLC function is able to resume operations from the state saved at power-down.
- OPC UA Sweep Mode & Sweep Time: The CPE400's sweep mode and sweep time are available through the OPC UA server. The Sweep Mode variable reports the controller's current mode: Stop Disabled, Run Enabled, Stop Enabled, Run Disabled, Stop Faulted, and Stop Halted. The Sweep Time variable reports the sweep time in seconds. These variables are located under Emerson Device Information -> PACSystems RX3i -> Controller.
- An OLED display that provides access to basic CPE400 status and control information including each LAN's configured IP Address.
- Alternate panel-mount adaptor plate included.
- Achilles Level 2 Communications Certification⁴⁷
- Ability to display serial number and date code in PME Device Information Details.
- Coordinated Universal Time (UTC) and Daylight Savings Time (DST) support.
- Operating temperature range -40°C to 70°C. (-40°F to 158°F) The maximum operating temperature varies according to installation altitude: 70°C at 0m to 2000m, 65°C at 2000m to 3000m, and 60°C at 3000m to 4000m.

⁴⁷ The CPE400's PACSystems Runtime is Achilles Level 2 certified in Release 9.20. Embedded Field Agent (EFA) certification is planned for a future release.
Communications

2.2.2.1 Switches CPE400

All user-accessible switches are provided as pushbuttons on the front panel, as described in the following table.

Pushbutton	Function
DISP	Permits user to navigate menus in the OLED display.
SEL	Permits user to select the menu item on the OLED display.
RUN	Activates OLED Menu to select RUN/Enabled or RUN/Disabled Mode for the embedded PLC.
STOP	Activates OLED Menu to select STOP/Enabled or STOP/Disabled Mode for the embedded PLC.
PHY PRES	Not functional.
PWR	Hold down for brief period to induce CPU Reset.

2.2.2.2 OLED Display

The monochrome organic light-emitting diode (OLED) display (Figure 2) is used to display operating system menus. It measures 34.5 x 23 cm and displays 128 dots horizontally and 64 dots vertically. It interacts with the DISP pushbutton, which jogs the cursor from one menu item to the next, and with the SEL pushbutton, which activates the currently indicated menu item for further action.

The OLED display permits the user to:

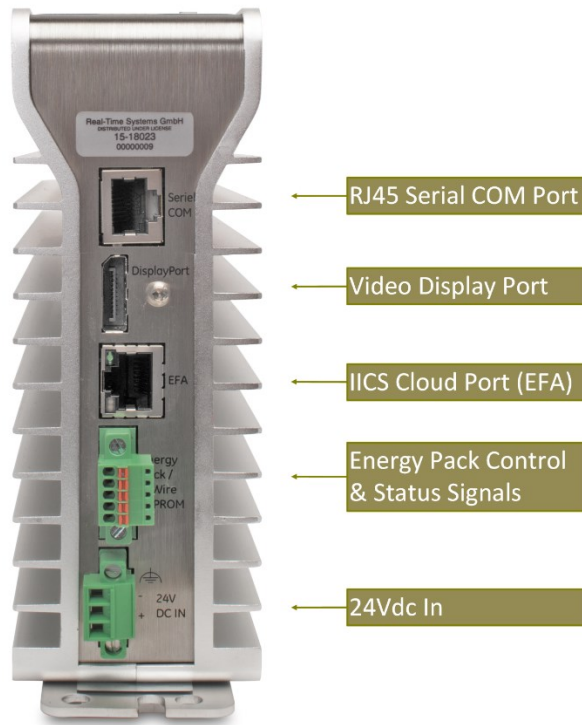
- Display Ethernet LAN Settings: IPv4 address.
- Display the PLC firmware revision.
- Set/view PLC mode and view sweep time.
- Set the PLC mode to RUN/STOP with I/O Enabled/Disabled via the display.

Note: the RUN and STOP pushbuttons activate the PLC Mode menu items per Section 0 above.

- View whether all, some, or none of the PROFINET I/O devices are connected.
- Display EFA Settings: IPv4 address, subnet mask, gateway, MAC address, IPv6 address.
- Issue Field Agent Commands:
 - Enter/Exit Configuration mode,
 - Clear Configuration,
 - Perform factory reset.
- View Field Agent Status:
 - Off,
 - Starting,
 - Connecting,
 - Connected,

- Connected-ACT.
- Display Redundancy Status (RND Info)
- Permits operator to perform a Hot Standby Redundancy Role Switch (RDN Command).
























Figure 7: CPE400 Underside Ports & Connectors



2.2.2.3 Status Indicator LEDs

LED	LED State	Operating State
RUN ⁴⁸	● On Green	PLC is in RUN mode.
	○ Off	PLC is in STOP mode.
RUN OE	⚙️ Blinking in unison ⚙️	CPU is updating an internal programmable hardware device.
PHY PRES	● On Green	TPM Physical Presence (not functional).
	○ Off	
SSD	● On Green	Activity detected on Solid State Disk.
	○ Off	No activity detected on Solid State Disk.
TEMP	● On Amber	Controlled shutdown due to CPU Overtemperature condition.
	○ Off	Overtemperature condition not detected.

⁴⁸ This LED is located between the RUN and STOP pushbuttons. It indicates the PLC Mode.
Communications

LED	LED State	Operating State
OK	 On Green	CPU has passed its power-up diagnostics and is functioning properly. <i>(Following initialization sequence.)</i>
	 Off	Power is not applied or CPU has a problem.
	 Blinking; All other LEDs off	PLC in STOP/Halt state; possible watchdog timer fault. If the programmer cannot connect, cycle power with charged Energy Pack attached and refer to fault tables.
OK	 Blinking alternately	CPU encountered a Secure Boot Error.
OE	 Blinking	
OE	 On Green	Output scan is enabled.
	 Off	Output scan is disabled.
FRC	 On Yellow	One or more Overrides active in I/O Reference Tables.
	 Off	No Overrides active in any I/O Reference Table.
FLT	 On Red	PLC is in STOP/Faulted mode: a fatal fault has occurred.
	 Off	No fatal faults detected.
IO	 On Green	PROFINET Connection Status = OK.
	 Off	PROFINET Connection Status not OK.
RACT	 On Green	Local Redundant CPU is Ready & Active.
	 Off	Local Redundant CPU is not Ready.
RBOK	 On Green	Remote Redundant CPU is Ready.
	 Off	Remote Redundant CPU is not Ready.
FAOK	 On Green	Field Agent Running and Connected to Cloud.
	 Blinking Green	Blink at 0.5 Hz: Field Agent Starting. Blink at 1 Hz: Field Agent Running.
	 Off	Field Agent Off.
PWR	 On Green	CPU running.
	 Blinking Green	Booting up – diagnostics in progress.
	 On Red	Off
	 Off	Reset / Power not detected.

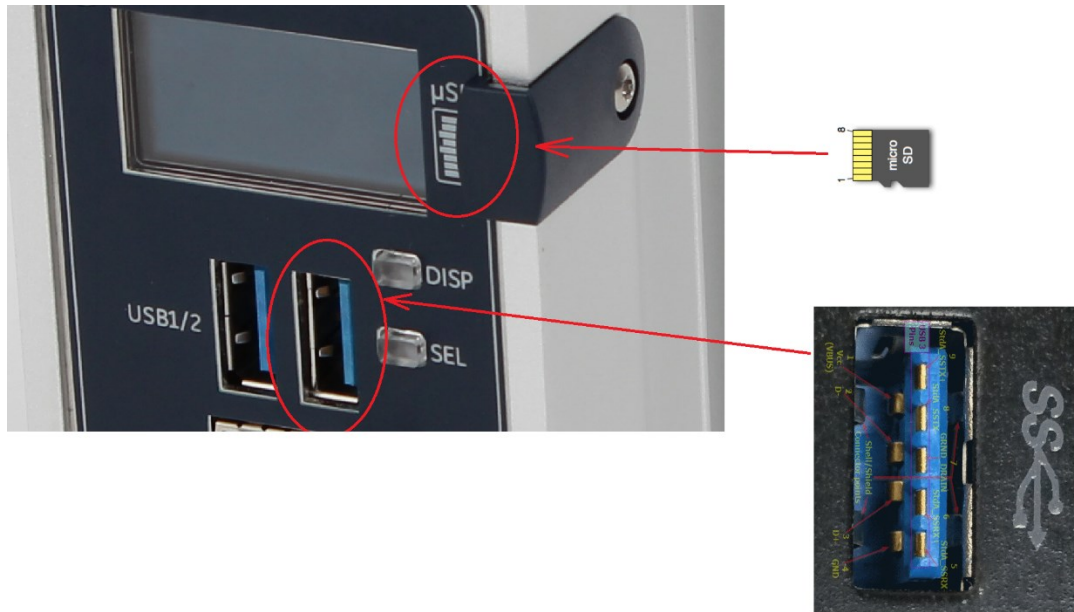
2.2.2.4 Micro-SD Card Interface

The Micro SD Card slot is located on the right-hand side of the equipment (Figure 6), level with the OLED display. This port is not functional at time of publication. Once functional, it will support the Removable Data Storage Device features discussed in Section 2.1.7.

The interface supports SD, SDHC and SDXC μ SD-Cards up to Version 3.0.

Insert the card into to slot, oriented as described below. Apply pressure it until you feel some resistance. The card will latch into place and can then be read by the equipment. Apply pressure again to remove the card from the slot.

Figure 8: CPE400 Micro-SD & USB Pinouts



- Note that the μ SD-Card needs to be inserted in the slot with the correct orientation. The pins of the card need to face towards the front of the equipment (Figure 8).
- A cover and screw are provided. To minimize CPE400 susceptibility to electrical noise interference, keep the cover in place during normal operation.

2.2.2.5 USB 3.0 Interface

The USB ports are not functional at time of publication. Once functional, they will support the Removable Data Storage Device features discussed in Section 2.1.7.

Two USB ports, using standard USB Type A connectors (Figure 6), are located on the faceplate below the OLED display.

This pair of ports is protected with a 1.5A fuse. For normal operation, do not exceed 0.9 A per connector. The USB overcurrent detection does not identify which port created the situation: it could be either one. Remove the root cause of the overcurrent in order to permit normal operation.

Pinouts for the USB ports (Figure 8) are:

Pin#	Signal Name
1	USB_VCC ⁴⁹
2	USB-
3	USB+
4	GND
5	SSRX-
6	SSRX+
7	GND
8	SSTX-
9	SSTX+

The maximum cable length for USB 3.0 cables is 3m (=118”) for Port 1 and 15cm (=6”) for Port 2.

2.2.2.6 Ethernet Ports CPE400

CPE400 supports a total of four independent 10/100/1000 Ethernet Local Area Networks (LANs).

- LAN1 connects to the uppermost faceplate RJ45 connector (Figure 6). It is not switched.
- LAN2 connects to the next two lower faceplate RJ45 connectors (Figure 6). These two connectors are switched internally. If desired, one or both of these ports may be configured as the Embedded PROFINET port.
- LAN3 connects to the two lowest faceplate RJ45 connectors (Figure 6). These two connectors are also switched internally. LAN3 may only be used in Redundancy applications. See Section 2.2.2.9.11, *Hot Standby Redundancy*.
- The fourth LAN is marked *EFA* (Embedded Field Agent) and is located on the underside of the equipment (Figure 6). It supports the Field Agent function and may not be used as a standard Ethernet port. Refer to Section 0,

⁴⁹ USB_VCC is limited to 1500mA by an electronic fuse shared by the two USB ports. For normal operation, do not exceed 900mA at this pin for either port.

- *Field Agent*, below.

Each of the embedded Ethernet interfaces automatically senses the data rate (10 Mbps or 100 Mbps or 1 Gbps), communications mode (half-duplex or full-duplex), and cabling arrangement (straight-through or crossover) of the attached link.

For improved performance, the LAN1, LAN2 and LAN3 are serviced by a dedicated microprocessor core. In this way, the servicing of the Ethernet ports is independent of the controller logic, I/O scanning and Field Agent activities. The EFA port is independently serviced by two of the four microprocessor cores. This superior level of servicing is required at the higher communications rates.

LAN1 and LAN2 may be used to communicate with the PME programming software using the Service Request Transport Protocol (SRTP). The EFA port cannot be used for this purpose.

LAN2 may be configured as an embedded PROFINET Controller, as discussed in Section 2.1.5. While configured as a PROFINET Controller, LAN2 may concurrently be used for Ethernet protocols. This topic is discussed in the *PACSystems RX3i PROFINET IO Controller User Manual*, GFK-2571F or later.

LAN2 and LAN3 each support a pair of RJ45 connectors. In this way, network devices on the same LAN, but operating at different data rates may be connected to a suitably configured port.






To establish Ethernet communications between the PME programming and configuration software and the CPU, you *first* need to know the target IP address. Use the OLED menu function to check the IP Address. For default IP Address and other details, refer to *Establishing Initial Ethernet Communications*, Section 3.4.1.

CAT 5 cables (or superior) are required for proper operation with 100/1000BaseT LANs. The pin arrangements are:

Pin	Name 10/100BASE-T	Name 1000BASE-T
1	TxD+	LP_DA+
2	TxD-	LP_DA-
3	RxD+	LP_DB+
4	NC	LP_DC+
5	NC	LP_DC-
6	RxD-	LP_DB-
7	NC	LP_DD+
8	NC	LP_DD-

Two LEDs are integrated into each RJ45 connector. These LEDs indicate the link status and link speed, as follows:

Ethernet Indicators (LAN1, LAN2, LAN3 RJ45 Built-in LEDs)

LED	LED State	Operating State
Link Status (upper)	 On Green	The corresponding link has been established.
	 Blinking Green	Traffic is detected at the corresponding port.
	 Off	No connection established at corresponding port.
Link Speed (lower)	 On Green	Corresponding data speed is 1 Gbps or 100 Mbps.
	 Off	Corresponding network data speed is 10 Mbps

2.2.2.7 PROFINET Controller

An Embedded PROFINET Controller may be configured on LAN2. For additional details, refer to Section 2.1.5, *Embedded PROFINET Controller*.

2.2.2.8 Field Agent

The Embedded Field Agent (EFA) port on the underside of CPE400 (Figure 7) is an Ethernet port dedicated to the Field Agent functionality.

Figure 9: Typical Field Agent Application

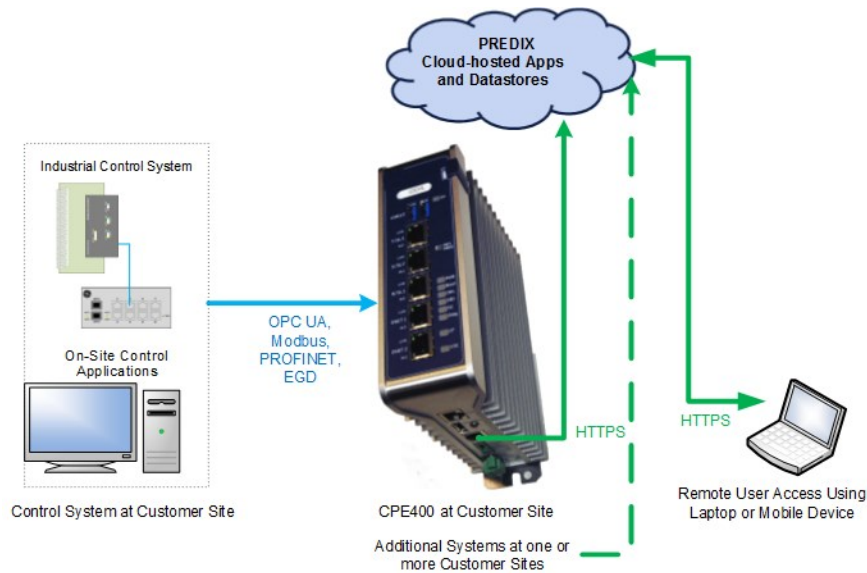


Figure 9 shows a typical Field Agent application, in which the role of the CPE400 Embedded Field Agent (EFA) is to gather data locally, then securely transfer selected data to the Predix Cloud via the EFA port. The PACSystems RX3i maintains control over the remaining Ethernet ports on the CPE400, as well as its serial port. Data from the local environment, obtained via any of these ports, can be manipulated by the RX3i PLC and tagged for use in the Field Control application.

The remote user with an acceptable security profile can then access data in the cloud from multiple installations, aggregate selected data and make decisions based on the bigger picture. For instance, the CPE400 could be installed in a control system monitoring a single wind turbine. The remote user might be monitoring several hundred such turbines. With a suitable dashboard-style application on his computer, the remote user could identify turbines that need to come offline for maintenance, or turbines whose power generation output could be enhanced or retarded to fit demand.

2.2.2.9 Field Agent Configuration

2.2.2.9.1 Start the Embedded Field Agent (EFA)

After providing the CPE400 with power, the Embedded Field Agent (EFA) application will begin to boot. The FAOK LED will start blinking to indicate when the EFA has booted and is ready for user logins. (This may take about two minutes.)

2.2.2.9.2 Log into the Web Console

To log into the Web Console:

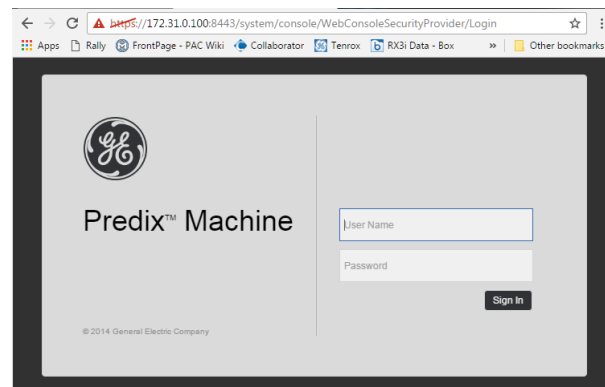
1. Connect a computer to the EFA's IICS Cloud Port or EFA Port.
2. Configure the computer's network adapter to be an address on the Field Agent network.

- The EFA's default IICS Cloud Port or EFA Port is assigned 172.31.0.100 with subnet mask 255.255.0.0. Set your computer's network adapter to any other IP address on the 172.31.x.x network. For example, 172.31.0.101 with subnet mask 255.255.0.0.
- 3. Use the OLED Menu to enable Configuration Mode as follows:
 - From the Main Menu, select the "FA Settings" menu item.
 - From the FA Settings Menus, select the "Commands" menu item.
 - From the Commands Menus, select the "Config Mode" menu item.
 - Confirm entering Config Mode.
 - Configuration Mode will remain active for one hour or until the above steps are repeated to disable Configuration Mode.

Note: Browsing to the Web Console too soon may result in seeing an Authentication Required or similar drop-down/pop-up dialog. Entering a user name and password into this dialog will not permit a log-in to the Web Console. Wait for the Field Agent to fully boot as indicated by the FAOK LED and re-attempt to browse to the Web Console. Closing the current browser tab or window may also be required.

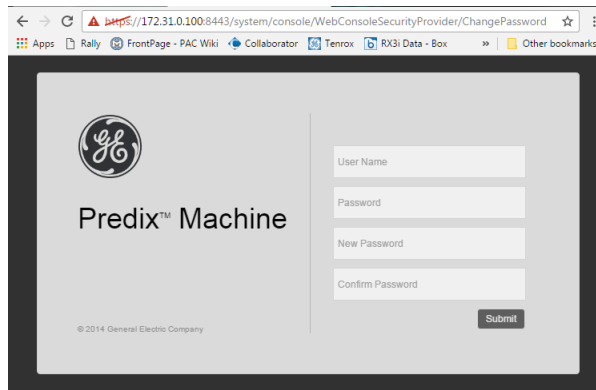
4. Using Google Chrome (recommended), browse to the Field Agent's Web Console at <https://172.31.0.100:8443/system/console>.
5. Since the Web Console uses a self-signed certificate, the browser will warn that the connection is not private. When prompted, accept the connection.
6. Login using the default credentials.

Figure 10: Login to Predix



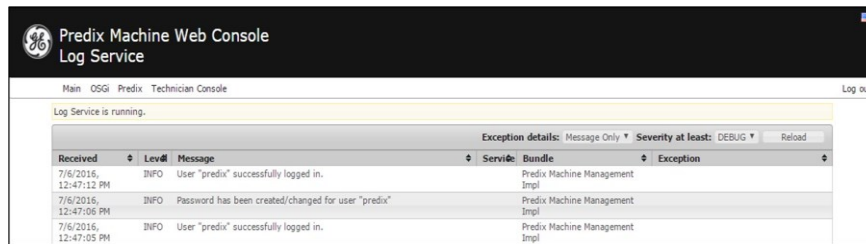
- Default User Name: **predix**
 - Default Password: **predix2machine**
7. A prompt to change the default password displays. Complete the form to change the default password.

Figure 11: Predix Change Password



8. The password complexity requirements display if the chosen password is not sufficiently complex. After changing the password, log in using the new password.
9. Verify that the *Log Service* page displays, which indicates a successful login.

Figure 12: Log Service Page



Note: After some idle time, the Web Console will time out. If this occurs, the user will need to return to the main page to log back into the console. Session timeout does not automatically redirect the console back to the login page.

2.2.2.9.3 Configure the Network

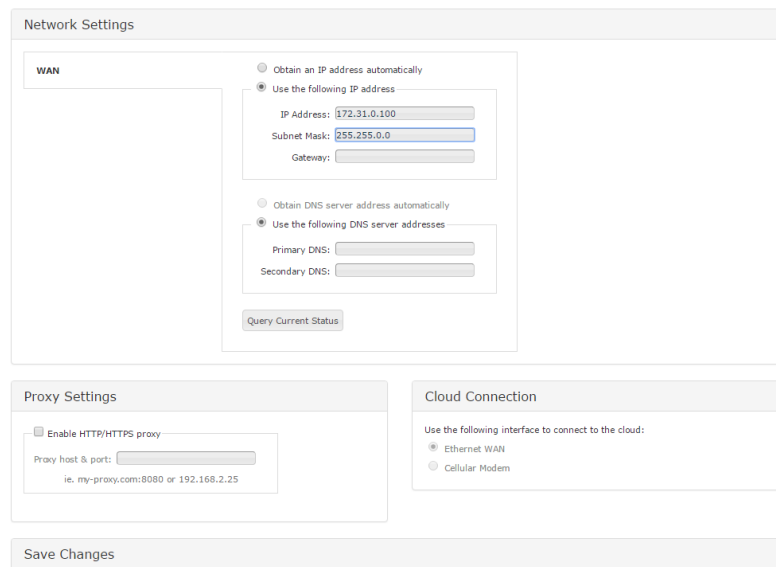
2.2.2.9.4 EFA IP Addresses

By default, the Embedded Field Agent’s WAN interface is set to a static address of 172.31.0.100 with a subnet mask of 255.255.0.0.

To change the WAN IP address

1. Verify that the WAN Ethernet cable is connected to the IICS Cloud port / EFA Port. If a network proxy is needed to connect the field agent to the WAN, refer to the section *Configure a Network Proxy*.
2. From the Web Console, navigate to the *Technician Console, Network Configuration* page.

Figure 13: Technical Console, Network Configuration Page



1. Set the WAN interface settings appropriately for the Field Agent’s network. DHCP can be used for networks where a DHCP server is available, and a static IP address for networks where each device is manually assigned an address. Click the Save button to accept the changes.

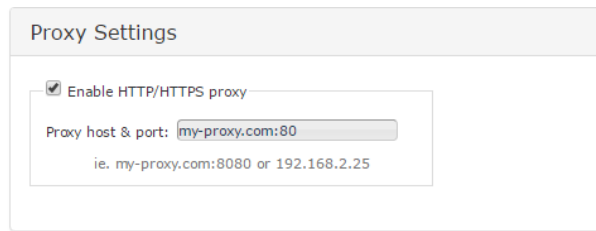
Note: The DNS servers can also be configured to be obtained automatically or specified statically. When using a static IP address, DNS servers must also be specified statically.

2.2.2.9.5 Configure a Network Proxy

A Network Proxy is only required when your network architecture is configured to restrict access directly to the Internet. Contact your network administrator for the Network Proxy information.

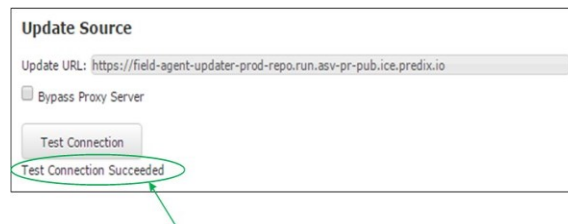
If a network HTTP/HTTPS proxy server is used to route traffic from the intranet to the Internet, the network proxy must be configured in the Web Console under *Technician Console, Network Configuration*. To add or update a network proxy server, check the “Enable HTTP/HTTPS Proxy” check box, enter the proxy server’s address and port in the form “proxy:port” into the Proxy Settings text box, and press the Save button.

Figure 14: Enter Proxy Server Address



To verify the Field Agent can successfully use the newly configured network proxy to reach the Internet, use the Test Connection feature of the Field Agent Updater page in the Web Console under *Technician Console, Field Agent Updater*. Internet reachability can be tested by using either the default Update URL or any other desired URL and pressing the Test Connection button.

Figure 15: Test Connection

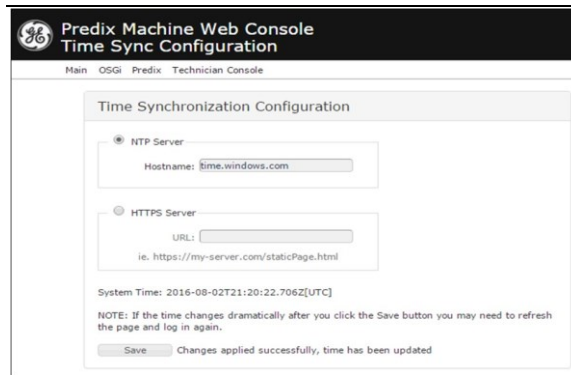


If the URL is reachable, a *Test Connection Succeeded* message is displayed below the *Test Connection* button after the button is pressed. Otherwise, a message will appear indicating that the Test Connection attempt failed.

2.2.2.9.6 Configure Time Synchronization

In order for industrial data time-stamping and Field Agent diagnostic information to operate reliably, it is important for the Field Agent to have an accurate time source. The Field Agent has two methods of synchronizing time – either by using a Network Time Protocol (NTP) server or by pulling time from a web page hosted by an HTTPS web server with its own reliable time source. Either method can be configured in the Web Console under *Technician Console, Time Sync Configuration*.

Figure 16: Technician Console, Time Sync Configuration



2.2.2.9.7 Using NTP Time Synchronization

By default, time synchronization is configured to use the time.windows.com NTP Server. If a valid network path to the Internet exists, time will be synchronized when the Field Agent boots and continuously while running. The current date and time on the Field Agent is displayed above the Save button on the Time Sync Configuration page when the page loads, and can be updated by pressing the Save button or reloading the page.

To change the NTP server to use for time synchronization enter the new NTP server URL in the NTP Server textbox and press the Save button. If the new server was successfully configured, a success statement will be displayed and the updated time will be displayed. If the time and date was more than 20 minutes out of date prior to time synchronization occurring after pressing the Save button, the Web Console session may end and an error message may be presented indicating that the session's timeout had been reached. Log back into the Web Console to verify the time was updated as expected.

2.2.2.9.8 Using HTTPS Time Synchronization

Time synchronization can also be configured to use an HTTPS web server's time by pulling it from the header of the web page it serves. To configure HTTPS time synchronization, select the HTTPS Server radio button on the Time Sync Configuration page, enter a valid HTTPS URL, and press the Save button. If a network proxy is in use, this time synchronization method will only work with HTTPS URLs that do not require a network proxy in order to reach them.

If the new HTTPS URL was successfully configured after pressing the Save button, a success statement will be displayed and the updated time will be displayed. If the time and date was more than 20 minutes out of date prior to time synchronization occurring after pressing the Save button, the Web Console session may end and an error message may be presented indicating that the session's timeout had been reached. Log back into the Web Console to verify the time was updated as expected.

2.2.2.9.9 Wrap-up

1. For security, toggle Configuration Mode to disable access to the Predix Machine Web Console.
2. Disconnect the local computer once enrollment has been completed.
3. Configure and Manage the activities on the EFA using Predix EdgeManager. This involves selecting tags in the CPE400's OPC-UA server and configuring these as read, write or read/write. In this way, the system is set up to allow data to pass securely from the CPE400 to

the Predix Cloud, where that data may be used by external cloud applications. Detailed steps are as follows:

Using a computer, download the default EFA configuration from:

https://emerson-mas.force.com/communities/en_US/Download/IC695CPE400-Embedded-Field-Agent-EFA-Application-Templates

- a. Configure the OPC UA Data Source to `opc.tcp://localControllerHost:4840`
- b. Configure the OPC UA tags and subscriptions in the OPCUA Machine Adaptor xml file.
- c. Configure the data destination in the WebSocket River configuration.
- d. Leave the Store and Forward service enabled.
- e. Zip up the configuration and upload it to the Edge Manager repository.
- f. Deploy the configuration to the Field Agent using Edge Manager.







Note that data will now be transferring from the Field Agent to the Predix Time Series Database.

Note that communications between the CPE400 and the Predix Cloud is secured using authentication and encryption.

Note that the Field Agent firmware within the CPE400 may need to be updated from time to time. Emerson recommends that all such firmware be kept up-to-date. The Technician has the ability to configure the Field Agent for scheduled automatic updates or manual updates. Refer to the chapter on *Updating the Field Agent* in the *Field Agent User's Guide*, GFK-2993.

2.2.2.9.10 Ethernet Indicators (EFA RJ45 Built-in LEDs)

Two LEDs are integrated into the EFA RJ45 connector. These LEDs indicate the link status and link speed, as follows:

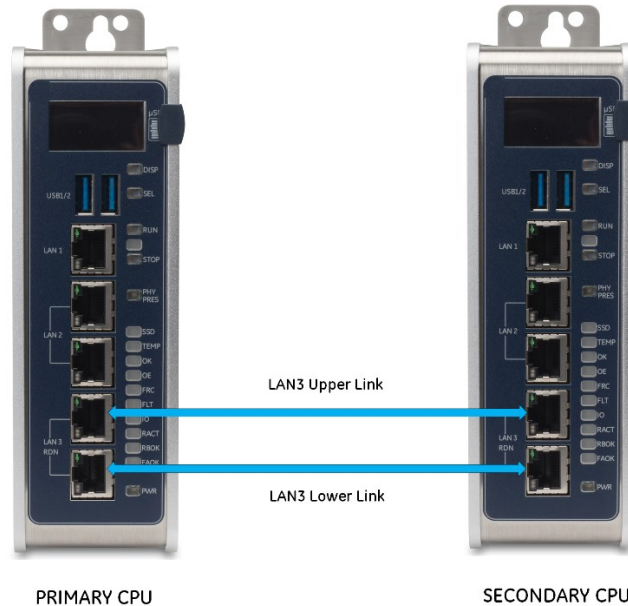
LED	LED State	Operating State
Link Status (upper)	 On Green	The corresponding link has been established.
	 Blinking Green	Traffic is detected at the corresponding port.
	 Off	No connection established at corresponding port.
Link Speed (lower)	 On Green	Corresponding network data speed is 1 Gbps.
	 On Yellow	EFA port only: Corresponding network data speed is 100 Mbps
	 Off	Corresponding network data speed is 10 Mbps

2.2.2.9.11 Hot Standby Redundancy

With firmware version 9.30 or later, it is possible to configure the CPE400 as a Hot Standby Redundancy CPU with PROFINET IO. The two ports on LAN3 are used exclusively for this purpose: they provide a high-speed data synchronization link between the two CPUs. Connect the upper LAN3 port

of the Primary CPU to the upper LAN3 port of the Secondary CPU and connect the lower LAN3 port of the Primary to the lower LAN3 port of the Secondary, as shown in Figure 17. Note that no additional hardware, other than the two redundant CPUs, may be connected to LAN3.

Figure 17: LAN3 Interconnects for Hot Standby Redundancy



To enable redundancy in a CPE400 project, select the CPE400 target in the *PME Navigator* and use the *Property Inspector* to change the *Enable Redundancy* target property to *True*.

Important: Set the *Background Window Timer* to a minimum of 5ms in both the Primary and Backup CPE400 hardware configurations. The *Background Window Timer* setting may be found on the *Scan* Tab in the CPE400's hardware configuration.

Once configured for HSB Redundancy, the RACT and RBOK LEDs (Figure 6) become functional.

- RACT indicates the Local CPU is Ready & Active;
- RBOK indicates the Remote CPU is Ready.

These two LEDs are also reflected in the Status Data of the CPU and are presented as OPC UA Variables.

The OLED display includes two menu items used in conjunction with Redundancy:

RDN Info provides status information via the OLED display.

RDN Command permits the operator to perform a Role Switch.

To support Hot Standby operations, LAN2 is configured as a PROFINET IO Controller. For additional details, refer to Section 2.1.5, *Embedded PROFINET Controller*.

For further details, refer to the *PACSystems Hot Standby CPU Redundancy User Manual*, GFK-2308 (rev L or later).

2.2.2.9.12 Redundant IP Addresses

Effective with firmware version 9.30, the CPE400 supports two independent Redundant IP addresses, one for LAN1 and one for LAN2. LAN2 Redundant IP is supported when configured for Ethernet mode only.

Redundant IP is supported by the SRTP Server, Modbus TCP Server, and EGD protocols. It is not possible to use Redundant IP with the OPC UA Server or with the Ethernet firmware update web page.

For further details, refer to the *PACSystems Hot Standby CPU Redundancy User Manual*, GFK-2308 (rev L or later).

2.2.2.9.13 Error Checking and Correction

RX3i Redundancy CPUs provide error checking and correction (ECC), which results in slightly slower system performance, primarily during power-up, because it uses an extra 8 bits that must be initialized.

For details on ECC, refer to the *PACSystems Hot Standby CPU Redundancy User Manual*, GFK-2308.

Note: Multiple Recoverable Memory Error faults may be generated when a single-bit ECC error is detected. When a single-bit ECC error is detected, the value presented to the microprocessor is corrected. However, the value stored in RAM is not corrected until the next time the microprocessor writes to that RAM location.

2.2.2.9.14 Serial Port CPE400

Effective with firmware version 9.40, the CPE400 Serial Port (COM1) is supported. Note that it only supports the Serial IO protocol at this time.

CPE400 is equipped with an RJ45 serial port. It is marked *COM* and is located on the underside of the equipment (Figure 7). Its default settings are RS-232C, 115kBaude, 8 data bits, no parity and 1 stop bit. For pinout, refer to Section 5.2.3.5. For more general information on serial port usage, refer to Section 5:.

Note that CPE400 does not support PME connection via the serial port; use an Ethernet port,

2.2.2.9.15 Display Port

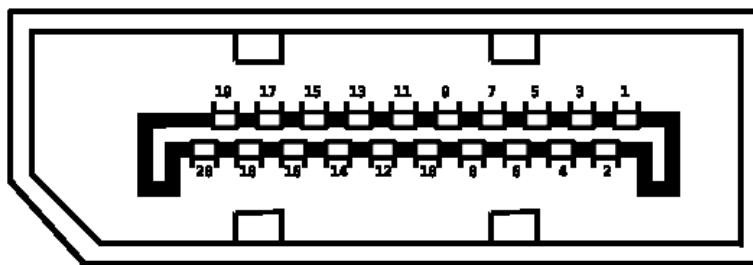
The Display port is not functional at time of publication.

The Display Port is a DP++ video port located on the underside of the CPE440 (Figure 7**Error! Reference source not found.**). It provides signals for connecting a suitable monitor or video adapter. Pinouts for the Display Port (Figure 18) are:

Pins	Signal Name
1/3	TxD0+/-
4/6	TxD1+/-
7/9	TxD2+/-
10/12	TxD3+/-
13	AUXSEL
15	CLK/AUX+
17	DAT/AUX-
18	HTPLG
14	NC
20	DP_VCC ⁵⁰
2, 5, 8, 11, 16, 19	GND

⁵⁰ DP_VCC is limited to 720mA by an electronic fuse. However, for normal operation do not exceed 500mA at this pin.

Figure 18: Disaply Port Connector



2.2.2.9.16 Energy Pack Connector

The CPE400 compatible Energy Pack, IC695ACC403, is supplied with a purpose-built cable which installs in the connector shown in Figure 7.

Use of the Energy Pack is optional. Once charged up, the ACC403 allows the CPE400 to instantly save user memory to non-volatile storage in the event of loss of power. Upon restoration of power, with the ACC403 connected, the CPE400 PLC function is able to resume operations from the state saved at power-down.

Refer to the *PACSystems RX3i Rackless Energy Pack IC695ACC403 Quick Start Guide*, GFK-3000, for complete wiring and grounding instructions.

Note that the connector shown in Figure 7 is not supplied with the CPE400.

2.2.2.9.17 Input Power Connector

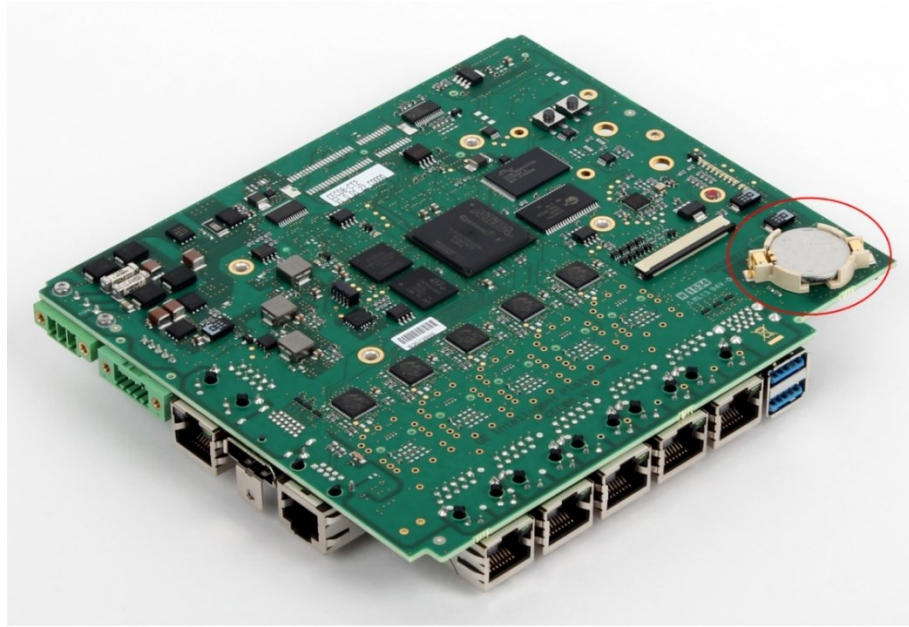
If no Energy Pack is to be connected, refer to Section 2.4 of the *RX3i IC695CPE400 1.2GHz 64MB Rackless CPU w/Field Agent Quick Start Guide*, GFK-3002. Otherwise, refer to the *PACSystems RX3i Rackless Energy Pack IC695ACC403 Quick Start Guide*, GFK-3000,

2.2.2.9.18 Backwards Compatibility of CPE400

In Proficy Machine Edition, the CPE400 is identified as a PLC within the *PACSystems RX3i Rackless* family. To convert an existing project which uses any other PLC, use the *Family Conversion* feature in PME. Be aware of the constraints involved. For instance, the first PROFINET Controller in an RX3i CPU320 application will be assigned to the Embedded PROFINET Controller feature (refer to Section 2.1.5) of the CPE400.

2.2.2.9.19 Replacement of Real-Time Clock Battery on CPE400

Figure 19: Location of RTC Battery on CPE400



The CPE400 is shipped with a real-time clock (RTC) battery installed on an internal circuit board (Figure 19). This battery will need to be replaced periodically by a qualified service technician. Typically, no action is required during initial installation.

Should the RTC battery fail, the CPU date and time will be reset to 12:00 AM, 01-10-2000 at start-up. The CPU operates normally with a failed or missing RTC battery; however, the initial CPU time-of-day (TOD) clock information will be incorrect.

There are no diagnostics or indicators to monitor RTC battery status. The RTC battery has an estimated life of 5 years and must be replaced every 5 years on a preventative maintenance schedule.

To replace a depleted battery:

1. Power down the CPE400.
2. Disconnect the external cables attached to the CPE400, labelling each for later reconnection.
3. Remove the CPE400 from its installed location.
4. Take the CPE400 to a clean environment.
5. Remove the DIN-rail or panel-mount adaptor plate, as applicable.
6. Place the CPE400 on a workbench so that the heat-sink adjacent to the Emerson logo on the front panel is facing up.
7. With ESD protection in place, remove the four screws holding the upper side heat sink in place.
8. Remove the heat sink. This exposes the circuit board, connectors and coin battery shown in Figure 19.
9. Take care to collect any thermal pads that may have been dislodged. These will be needed during reassembly.

10. While removing, or replacing the battery, take care not to damage the nearby ribbon cable (not shown).
11. Using a non-conductive pliers, grip the battery and simultaneously hold back the retaining clip so it is clear of the battery.
12. Remove the depleted battery and dispose of it by an approved method.
13. Install the replacement battery so that the inscribed positive face is up.
14. Check that the retaining clip has engaged the edge of the newly installed battery.
15. Apply any dislodged thermal pads to the surface of the corresponding components on the circuit board.
16. Replace the heat sink.
17. Tighten all four retaining screws to 0.6 Nm.
18. Reattach the adaptor plate removed in step 5.
19. Restore the CPE400 module to its original location and secure it in place.
20. Reconnect all cables to their original connectors.
21. Turn power back on.
22. If needed, set the current date and time via Proficy Machine Edition.

The replacement battery must be IC690ACC001 from Emerson, or an equivalent, such as Rayovac™ Lithium BR2032 Coin Cell 3V 190mAh -40°C to +85°C.

WARNING

Use of a different type of battery than that specified here may present a risk of fire or explosion. Battery may explode if mistreated. Do not recharge, disassemble, heat above 100°C (212°F), or incinerate.

CAUTION

- To avoid damage from electrostatic discharge, use proper precautions when performing these procedures:
 - Wear a properly functioning antistatic strap and be sure that you are fully grounded. Never touch the printed circuit board, or components on the board, unless you are wearing an antistatic strap.
 - Any surface upon which you place the unprotected circuit board should be static-safe, facilitated by antistatic mats if possible.
 - Extra caution should be taken in cold, dry weather, when static charges can easily build up.
-

2.2.2.9.20 Setting the Real-Time Clock on CPE400

The Real-Time Clock (RTRC) on the CPE400 may be set by both the PACSystems Runtime and the Field Agent:

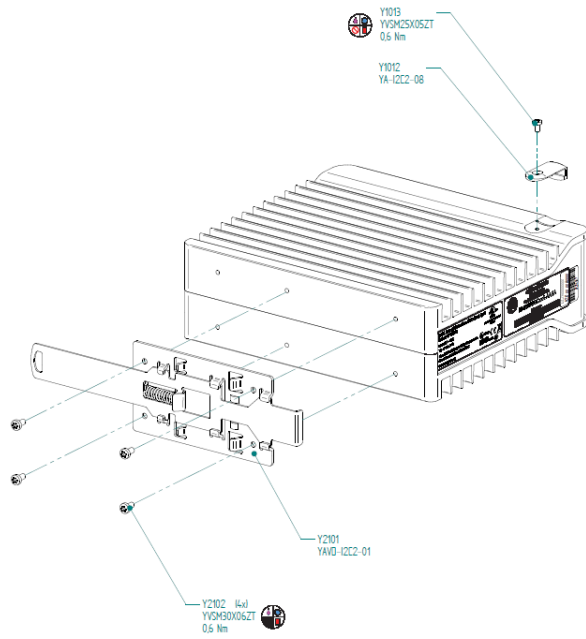
- The clock may be set from PACSystems using utilities in Proficy Machine Edition.
- The clock may be set from the Field Agent using the Technician Console or a network time server.
- Regardless of whether the clock is set from the PACSystems Runtime or the Field Agent, the CPE400 must be rebooted after the clock is set so that the time change is applied across both applications.
- The CPE400's clock must be set to UTC time when using the Field Agent to publish data to the Predix Cloud.

2.2.2.9.21 Replacement of CPE400 Mounting Bracket

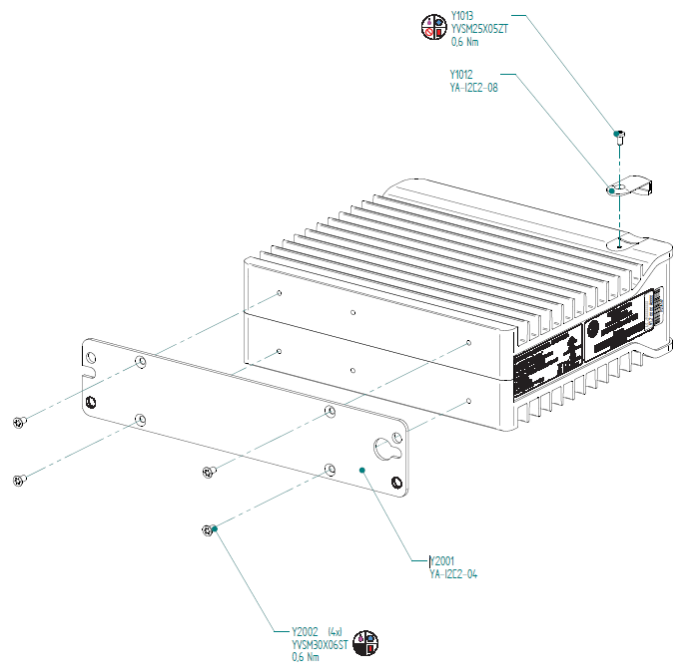
When shipped, the CPE400 is attached to the DIN-rail mounting bracket. The panel-mount bracket is supplied in the shipping carton, unattached. If the application requires panel-mounting rather than DIN-Rail mounting, exchange the mounting brackets, as follows.

1. Using a T10 TORX screwdriver, remove the four machine screws (Figure 20) that secure the DIN-Rail Mounting Bracket to the CPE400 chassis.
2. Keep the DIN-Rail Mounting Bracket and its four screws together in case of future need; otherwise discard.
3. Install the panel-mount bracket as shown in Figure 21, using the four machine screws supplied with that bracket. Note that the closed eyelet is towards the top of the chassis.
4. Using a T10 TORX screwdriver, torque these four machine screws to 0.6Nm (0.44 ft-lbs) in order to securely attach the bracket to the CPE400 chassis.
5. If reversing the bracket switch, note that each bracket requires its own set of machine screws. Torque requirements are the same.

**Figure 20: Din Rail Mount Bracket
Assembly CPE400**

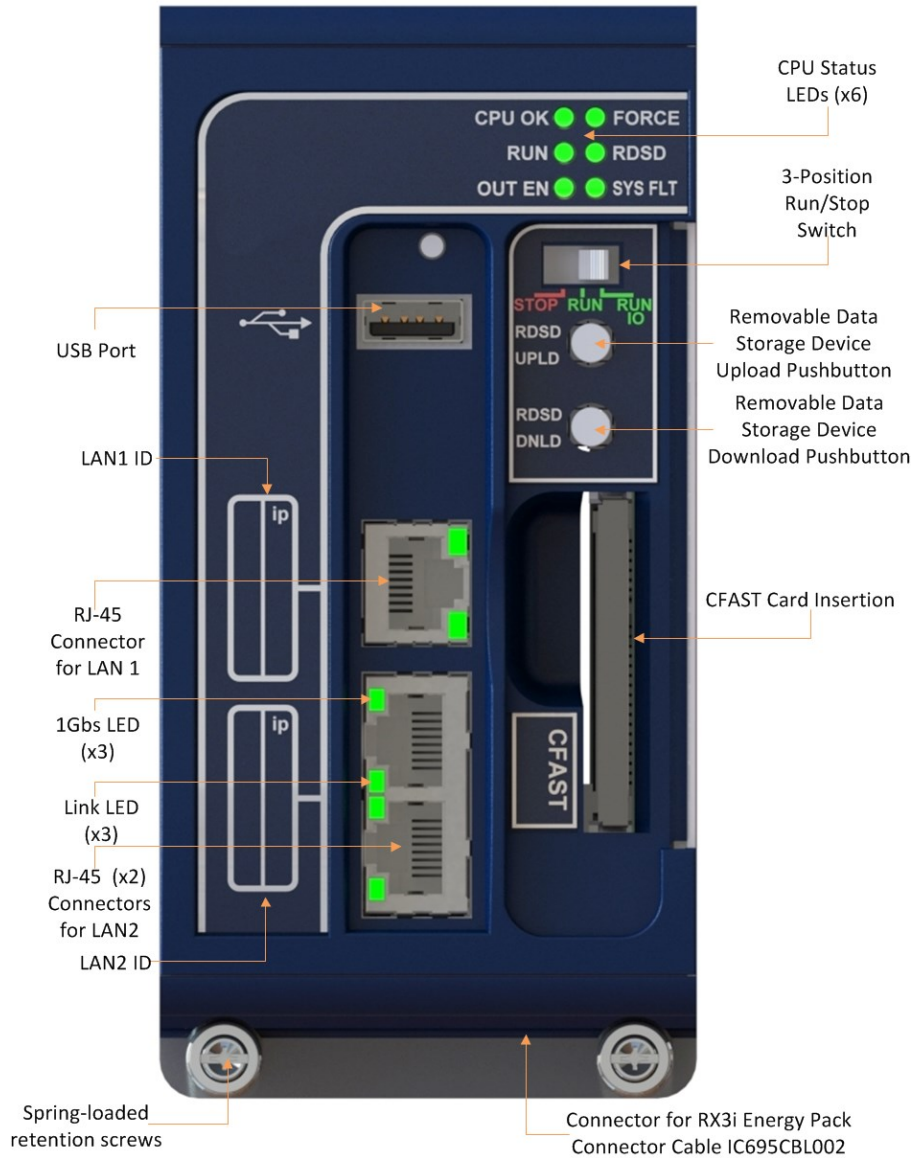


**Figure 21: Panel-Mount Bracket
Assembly CPE400**



2.2.3 CPE330

Figure 22: Front Display Port



2.2.3.1 Serial Ports CPE330

CPE330 is not equipped with a serial port. Use the embedded Ethernet ports for all communications with the CPU; use IC695CMM002 or IC695CMM004 modules for serial communications.

2.2.3.2 Ethernet Ports CPE330

CPE330 supports two independent 10/100/1000 Ethernet Local Area Networks (LANs).

- LAN1 connects to the uppermost RJ45 connector (Figure 22). It is not switched.
- LAN2 connects to the two lower RJ45 connectors. They are switched internally.

Space is provided beside each connector (Figure 22) to record the IP address used on each LAN.

Each of the embedded Ethernet interfaces automatically senses the data rate (10 Mbps or 100 Mbps or 1 Gbps), communications mode (half-duplex or full-duplex), and cabling arrangement (straight-through or crossover) of the attached link.

Any of the embedded Ethernet ports may be used to communicate with the Proficiency Machine Edition (PME) programming and configuration software using the Service Request Transport Protocol (SRTP).

For default IP Address and other details, refer to Establishing Initial Ethernet Communications, Section 3.4.1.

2.2.3.3 Ethernet Network Configuration CPE330

The user must be careful when assigning IP Addresses and Subnet Masks for CPE330:

- Each LAN supports a unique IP Address
- LAN1 and LAN2 interfaces should not be configured for the same network.

By default, PME prohibits configuring both LAN interfaces on an overlapping IP subnet.

Care must also be taken when assigning IP Addresses and subnet masks to each LAN so that each network does not overlap any remote subnets in the network infrastructure:

- Subnets overlap with one another when the subnet portions of the IP Addresses are not completely unique
- Overlapping subnets may result in intermittent Ethernet communications, or none at all. This would be due to packets being routed to the wrong LAN.
- Duplicate IP Addresses may also result in intermittent Ethernet communications, or none at all. This is due to collisions on the LAN induced by two devices with the same IP Addresses communicating at the same time.

2.2.3.4 Ethernet Gateway Operation CPE330

The CPE330 allows configuration of an Ethernet gateway on both LAN1 and LAN2. Since the CPE330 contains two LAN interfaces, each one supporting a unique IP Address, only one gateway is active at a time.

- Whenever a gateway is configured on only one of the two LAN interfaces and the other is not configured (0.0.0.0), the single gateway is shared by both interfaces;
- Whenever a gateway is configured on both LAN interfaces, the LAN1 gateway is given priority over the LAN2 gateway as long as LAN1 is functional. For example, in the event the LAN1 cable is disconnected, the CPE330 will use the LAN2 gateway as a backup.

2.2.3.5 PROFINET Controller

An Embedded PROFINET Controller may be configured on LAN2. For additional details, refer to Section 2.1.5, *Embedded PROFINET Controller*.

2.2.3.6 Sequence of Events

The CPE330 in combination with the IC695PNS101, IC694MDL660, and IC695HSC304/308 support a dedicated Sequence of Events monitoring system. Refer to PACSystems RX3i SoE User Manual, GFK-3050 for additional information.

2.2.3.7 Switches CPE330

**Figure 23: CPE330
RUN/STOP Switch and
RDSD Switches**



The RDSD and RUN/STOP Switches are located behind the protective door, as shown in Figure 23.

Refer to *RUN/STOP Switch Operation* in Section 4:.

The Reset pushbutton, located just above these switches, is currently not used.

2.2.3.7.1 RDSD Switch Operation CPE330

RDSD Pushbuttons	Function
RDSU UPLD	Loads user program or data from CPU to RDSD.
RDSU DNLD	Stores user program or data from RDSD to CPU.

Refer to Removable Data Storage Devices (RDSDs) for full description of RDSD functionality.

2.2.3.8 Indicators CPE330

2.2.3.8.1 CPU Status Indicators ● On ✚ Blinking ○ Off

CPE330 LED	LED State	Operating State
CPU OK	● On Green	CPU has passed its power-up diagnostics and is functioning properly. <i>(After initialization sequence is complete.)</i>
	○ Off	Power is not applied or CPU has a problem, which may be indicated by blink pattern.
	✚ Blinking Other LEDs off	CPU in STOP-Halt state; possible watchdog timer fault. If PME cannot connect, cycle power with charged Energy Pack attached and refer to fault tables.
	● On Amber	Whenever CPU OK and FORCE are both amber, CPU is indicating CPU320/CRU320 compatibility status. ⁵¹
RUN OUT EN	✚ Blinking in unison	CPU is updating an internal programmable hardware device.
RUN	● On Green	CPU is in RUN Mode.
	○ Off	CPU is in STOP Mode.
OUT EN	● On Green	Output scan is enabled.
	○ Off	Output scan is disabled.
FORCE	● On Amber	Override is active on a bit reference. Note: CPU OK is not simultaneously amber. ⁵¹
	○ Off	No Overrides active in I/O Reference Tables.
RDSD	● On Green	USB or Cfast Device detected (No Activity)
	✚ Blinking Green	Port activity detected on USB or Cfast Interface
	○ Off	No port activity detected on USB or Cfast Interface
	● On Red	RDSD Failure
	✚ Blinking Red	Target name mismatch: Press same RDSD pushbutton again to dismiss.

⁵¹ Refer to Backwards Compatibility of CPE330 with CPU320, CRU320, or CPU315.
Communications

CPE330 LED	LED State	Operating State
SYS FLT	● On Red	CPU is in Stop/Faulted mode: a fatal fault has occurred.
	○ Off	No fatal faults detected.

2.2.3.8.2 Ethernet Indicators CPE330 (embedded in RJ45 connectors) ● On 🟡 Blinking ○ Off

LED	LED State	Operating State
LINK (upper)	● On Green	The corresponding link is physically connected.
	🟡 Blinking Green	Traffic is detected at the corresponding port.
	○ Off	No connection detected at the corresponding port.
1Gbps (lower)	● On Amber (LAN1) or ● On Green (LAN2)	Corresponding network data speed is 1 Gbps.
	○ Off	Corresponding network data speed is 100 Mbps or 10 Mbps.

2.2.3.9 Error Checking and Correction

RX3i Redundancy CPUs provide error checking and correction (ECC), which results in slightly slower system performance, primarily during power-up, because it uses an extra 8 bits that must be initialized.

For details on ECC, refer to the PACSystems Hot Standby CPU Redundancy User Manual, GFK-2308.

Note: Multiple Recoverable Memory Error faults may be generated when a single-bit ECC error is detected. When a single-bit ECC error is detected, the value presented to the microprocessor is corrected. However, the value stored in RAM is not corrected until the next time the microprocessor writes to that RAM location.

2.2.3.10 Replacement of Real-Time Clock Battery on CPE330

The CPE330 is shipped with a real-time clock (RTC) battery installed (see Figure 24). There is no isolation barrier between the battery and the circuit. This battery will need to be replaced periodically. Typically, no action is required during initial installation.

Should the RTC battery fail, the CPU date and time will be reset to 12:00 AM, 01-10-2000 at start-up. The CPU operates normally with a failed or missing RTC battery; however, the initial CPU time-of-day (TOD) clock information will be incorrect.

There are no diagnostics or indicators to monitor RTC battery status. The RTC battery has an estimated life of 5 years and must be replaced every 5 years on a preventative maintenance schedule.

To replace a depleted battery,

1. Power down the RX3i rack.
2. Disconnect cables attached to the CPE330 module, labeling each for later reconnection.
3. Remove the CPE330 module.
4. Take the CPE330 module to a clean environment.
5. Place the module on a workbench with the heat-sink side down.
6. With ESD protection in place, remove the four screws holding the upper side sheet metal in place.
7. Remove the sheet metal. This exposes the circuit board, connectors and coin battery shown in Figure 24.
8. Using a non-conductive pliers, grip the battery and simultaneously hold back the retaining clip so it is clear of the battery.
9. Remove the depleted battery and dispose of it by an approved method.
10. Install the replacement battery so that the inscribed positive face is towards the green connector (i.e. downwards as shown in Figure 24).
11. Check that the retaining clip has engaged the edge of the newly installed battery.
12. Replace the sheet metal cover.
13. Tighten all four retaining screws to 0.9Nm (8 in-lbs).
14. Restore the CPE330 module to its original location and secure it in place.
15. Reconnect all cables to their original connectors.
16. Turn power on to the RX3i rack.
17. If needed, set the current date and time via PME or using SVC_REQ 7 (refer to *PACSystems RX7i and RX3i CPU Programmer's Reference Manual*, GFK-2950 Chapter 6).

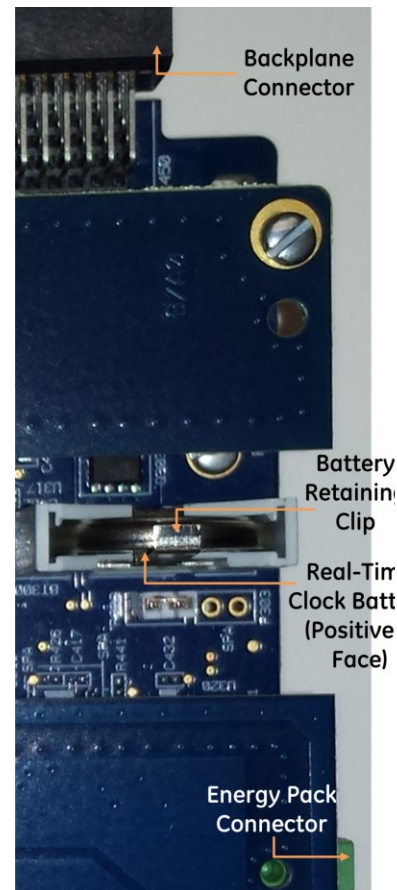


Figure 24: Location and Orientation of Real-Time Clock Battery in CPE330

Note: Battery replacement on CPE302/CPE305 & CPE310 is different: see Figure 29.

2.2.3.10.1 Replacement Real-Time Clock Battery

The replacement battery must be IC690ACC001 from Emerson, or an equivalent, such as Rayovac™ Lithium BR2032 Coin Cell 3V 190mAh -40°C to +85°C.

⚠ WARNING

Use of a different type of battery than that specified here may present a risk of fire or explosion. Battery may explode if mistreated. Do not recharge, disassemble, heat above 100°C (212°F), or incinerate.

⚠ CAUTION

- To avoid damage from electrostatic discharge, use proper precautions when performing these procedures:
- Wear a properly functioning antistatic strap and be sure that you are fully grounded. Never touch the printed circuit board, or components on the board, unless you are wearing an antistatic strap.
- Any surface upon which you place the unprotected circuit board should be static-safe, facilitated by antistatic mats if possible.
- Extra caution should be taken in cold, dry weather, when static charges can easily build up.

2.2.3.11 Backwards Compatibility of CPE330 with CPU320, CRU320, or CPU315

The CPE330 may be interchanged with a corresponding CPU320/CRU320 with no upgrade to Proficy Machine Edition (PME) software. Logic and configuration equality in PME are maintained when storing the same project to either a CPU320/CRU320 or a CPE330.

An *Extra Option Module* fault is logged in the Controller Fault Table on the CPE330's slot location after downloading a CPU320/CRU320 configuration to a CPE330. This indicates that the Embedded Ethernet interface did not receive a configuration. This fault is expected and does not interfere with normal controller operation.

Migration of CPU315 applications to the CPE330 is possible with no upgrade to PME by converting them to a CPU320 application and storing the project to the CPE330.

Versions of PME with native CPE330 support allow either a CPU320/CRU320 or a CPE330 configuration to be stored to the CPE330. When a CPE330 is configured as a CPU320/CRU320, Ethernet properties cannot be configured. However, the embedded Ethernet ports may be used with their previously configured IP Addresses or their default IP Addresses if the default IP Addresses were never changed.

Since CPE330 has no serial ports, any serial port activity associated with the previous CPU320/CRU320 application needs to be migrated to a suitable rack-based module (IC695CMM002 or IC695CMM004).

To download projects intended for the CPU320/CRU320 to a CPE330 with versions of PME that do not support the CPE330, you must change the CPE330's compatibility setting. To change the compatibility setting, perform the following operations:

1. Remove any USB stick that might be attached to the USB connector on the CPE330.
2. Place the RUN/STOP switch on the CPE330 in the STOP position.
3. Hold down the RDS D UPLD button and turn power on to the CPE330. Continue to depress the RDS D UPLD button until the CPE330 powers up and displays one of the following patterns on the LEDs.

2.2.3.11.1

CPU Status Indicators

● On ✚ Blinking ○ Off

CPE330 LED	LED State	Operating State
CPU OK	● On Amber	CPU320 Compatibility mode.
FORCE	● On Amber	
RUN	○ Off	
RDS D	● On Red	
OUT EN	○ Off	
SYS FLT	● On Red	
CPU OK	● On Amber	CRU320 Compatibility mode.
FORCE	● On Amber	
RUN	● On Red	
RDS D	○ Off	
OUT EN	○ Off	
SYS FLT	● On Red	

1. To toggle the compatibility setting, press the RDS D DNLD button. The compatibility indication will toggle between the CPU320 compatibility and CRU320 compatibility patterns each time the RDS D DNLD button is pressed.
2. When the desired compatibility setting is displayed, press the RDS D UPLD button to save the setting and allow the CPE330 to continue its normal startup procedures with the new setting. The setting is maintained over a power cycle and firmware upgrade.

Note that with versions of PME that do not have native CPE330 support, only CPU320 projects can be stored to a CPE330 that is in CPU320 compatibility mode. Similarly, only CRU320 projects can be stored to a CPE330 that is in CRU320 compatibility mode.

Users of a CPE330 with PME versions 8.60 SIM8 or later do not need to change this compatibility setting. PME versions 8.60 SIM8 or later allow for storing a CPU320 or CRU320 project without the need to change this setting. By factory default, the CPE330 identifies as a CPU320.

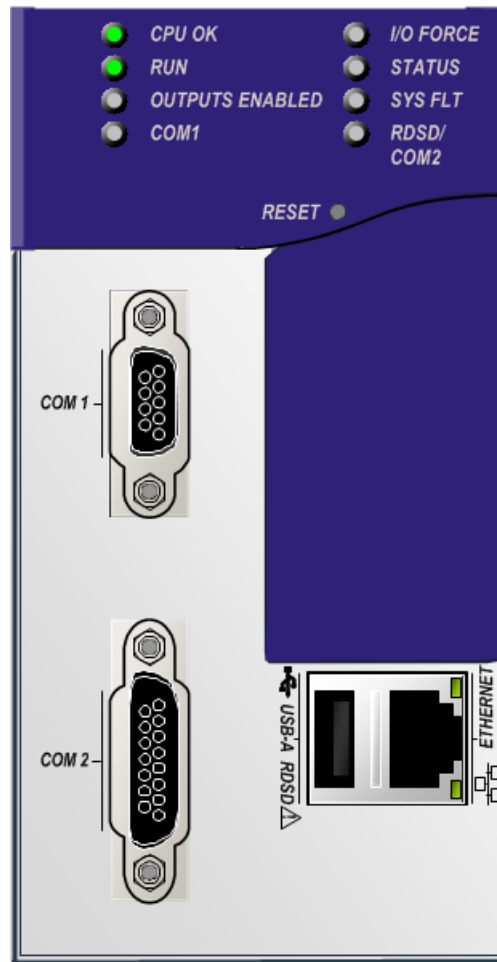
Note that CPE330s with firmware versions 8.45 through 8.60 support compatibility with the CPU320 and CPU315 only. The compatibility setting using the RDSB buttons (described above) is not supported for these firmware versions. Beginning with firmware version 8.70, CPE330s support compatibility with the CPU320, CPU315, and CRU320 using the RDSB buttons to set the compatibility setting.

2.2.4 CPE302, CPE305 and CPE310

Figure 25: IC695CPE302/CPE305 Front View



Figure 26: IC695CPE310 Front View



2.2.4.1 Serial Ports

These ports provide serial interfaces to external devices and can be used for firmware upgrades.

For serial port pin assignments, electrical isolation, and details on serial communications, refer to Section 5:

CPE302/CPE305: one RS-232 port (using RJ-25 connector).

CPE310: one RS-232 port (COM1) and one RS-485 port (COM2).

The RS-232 port does not supply the 5Vdc power offered by other RX3i and Series 90-30 CPUs.

Use cable IC693CBL316 to connect to the serial RJ-25 port on the CPE302/CPE305. This 3m shielded cable provides a 9-pin D-connector on the other end.

2.2.4.2 Ethernet Port

The embedded Ethernet interface connects via one RJ45 Ethernet port that automatically senses the data rate (10 Mbps or 100 Mbps), communication mode (half-duplex or full-duplex), and cabling arrangement (straight-through or crossover) of the attached link.

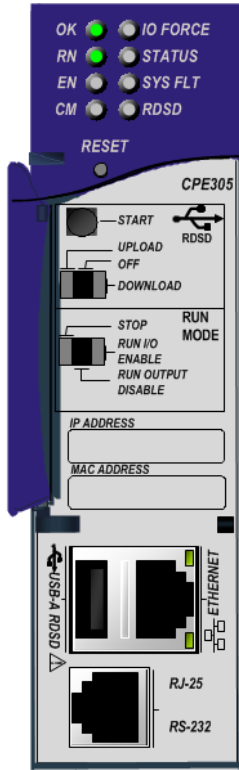
The embedded Ethernet interface supports communications with the Proficy Machine Edition (PME) programming and configuration software using the proprietary SRTP protocol. The CPE302/CPE305 /CPE310 CPUs provide two SRTP-server connections.

Refer to Establishing Initial Ethernet Communications, Section 3.4.1.

2.2.4.3 Switches CPE302/CPE305 & CPE310

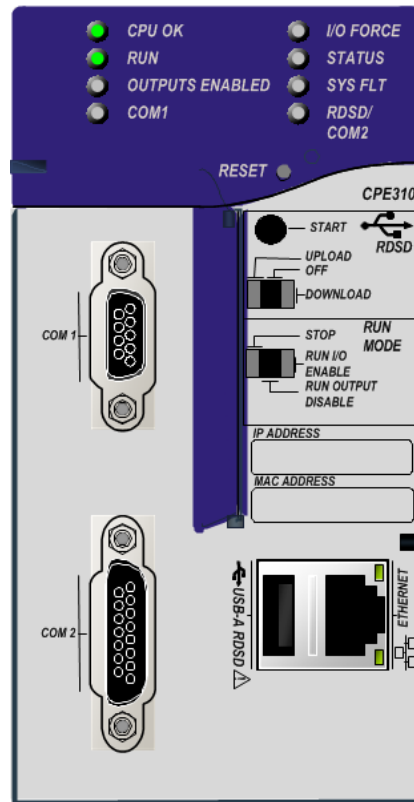
The RDSD and RUN/STOP Switches are located behind the protective door, as shown in Figure 27 and Figure 28. Refer to *RUN/STOP Switch Operation* in Section 4:. The Reset pushbutton is not used.

Figure 27: External Features of CPE302/CPE305



Energy Pack Connector
(Underneath)

Figure 28: External Features of CPE310





















Energy Pack Connector
(Underneath)



2.2.4.3.1 RDSD Switch Operation CPE302/CPE305 & CPE310

RDSD Switches	Function
Start pushbutton	Pressing this switch initiates RDSD data transfer. (The three-position switch must have previously been set to Upload or Download.) See <i>Removable Data Storage Devices (RDSDs)</i> for full description of RDSD functionality.
Three-position switch	Enables/disables RDSD data transfer and selects the direction of data transfer.
Upload	Loads application from CPU to RDSD.
Off	Disables RDSD data transfer.
Download	Stores application from RDSD to CPU.


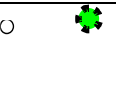





2.2.4.4 Indicators CPE302/CPE305 & CPE310

2.2.4.4.1 CPU Indicators On Blinking Off






CPE302/ CPE305 LED	CPE310 LED	LED State	CPU Operating State
OK	CPU OK	 On Green	CPU has passed its power-up diagnostics and is functioning properly. <i>(After initialization sequence is complete.)</i>
		 Off	CPU problem. RUN and OUTPUTS ENABLED LEDs may be blinking in an error code pattern, which can be used by technical support for troubleshooting. This condition and any error codes should be reported to your technical support representative.
		 Blinking Other LEDs off	CPU in STOP-Halt state; possible watchdog timer fault. Refer to the fault tables. If PME cannot connect, cycle power with a charged Energy Pack attached and refer to fault tables.
OK EN	CPU OK OUTPUTS ENABLED	 Blinking in unison 	CPU is in boot mode and is waiting for a firmware update through a serial port.
RN	RUN	 On Green	CPU is in RUN Mode.
		 Off	CPU is in STOP Mode.
EN	OUTPUTS ENABLED	 On Green	Output scan is enabled.
		 Off	Output scan is disabled.
I/O FORCE	I/O FORCE	 On Yellow	Override is active on a bit reference.
STATUS	STATUS	 Blinking Green	Energy Pack charging; not yet charged above the minimum operating voltage.
		 On Red	Energy Pack circuit fault.
		 Blinking Red	Energy Pack near its end-of-life and should be replaced soon.
		 On Green	Energy Pack is charged above its minimum operating voltage.
		 Off	Energy Pack not connected.
SYS FLT (System Fault)	SYS FLT	 On Red	CPU is in Stop/Faulted mode because a fatal fault has occurred.
CM	COM1	 Blinking Green	Signals activity on serial port COM1.
		 Off	No activity on serial port COM1.

CPE302/ CPE305 LED	CPE310 LED	LED State	CPU Operating State
N/A	RDSD / COM2	 Blinking Green	Signals activity on serial port COM2.
		 Off	No activity on serial port COM2. (RDSD <i>not</i> attached)

2.2.4.4.2 RDSD Indicators CPE302/CPE305 & CPE310  On  Blinking  Off

CPE302/ CPE305 LED	CPE310 LED	LED State	RDSD Operating State
	SYS FLT	 On Red	The RDSD has been removed during a store. The CPU must be power cycled to resume RDSD operations.
	RDSD / COM2	 Off or Blinking Green	
RDSD ⁵²	RDSD ⁵² /COM2	 On Green	Valid RDSD connected or data transfer complete.
		 Blinking Green	Data transfer in progress.
		 On Red	RDSD fault. Check for and correct the following conditions: <ul style="list-style-type: none"> • CPU type mismatch with project on RDSD. • Data transfer error. • Corrupted or invalid USB file system. • Insufficient space on RDSD.
		 Blinking Red	RDSD-Controller project name mismatch.
		 Off	RDSD not attached or USB port is disabled.

2.2.4.4.3 Ethernet Indicators CPE302/CPE305 & CPE310  On  Blinking  Off

LED	LED State	CPU Operating State
100	 On Green	Network data speed is 100 Mbps.
	 Off	Network data speed is 10 Mbps.
LINK	 On Amber	The link is physically connected.
	 Blinking Amber	Traffic is detected at the corresponding port.
	 Off	No connection detected.

⁵² RDSD active: RDSD attached to USB-A RDSD port.
Communications

2.2.4.5 Error Checking and Correction

CPE302, CPE305 and CPE310 do not support error checking and correction (ECC).

2.2.4.6 Real-Time Clock Battery CPE302/CPE305 & CPE310

The CPE302, CPE305 and CPE310 are shipped with a real-time clock (RTC) battery (IC690ACC001) installed (Figure 29), and with an isolation barrier on the battery. Remove the isolation barrier via its pull-tab before installing the CPE302, CPE305 or CPE310 module; otherwise the battery will not function.

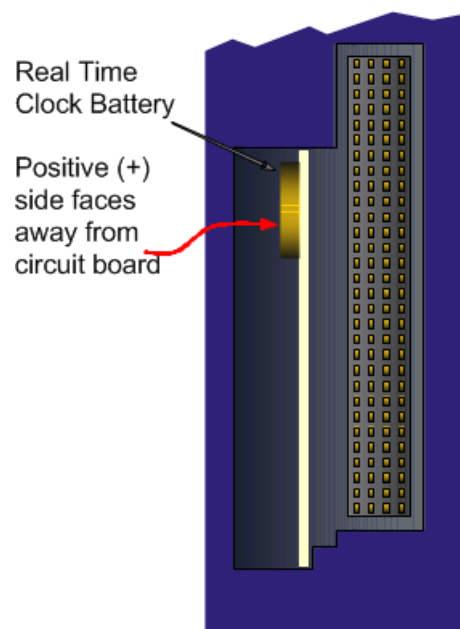
There are no diagnostics or indicators to monitor RTC battery status.

The RTC battery has an estimated life of 5 years and must be replaced every 5 years on a preventative maintenance schedule.

If the RTC battery fails, the CPU date and time is reset to 12:00 AM, 01-10-2000 at startup. The CPU operates normally with a failed or missing RTC battery; only the initial CPU TOD clock information will be incorrect.

Note: Battery replacement on CPE330 is different. Refer to Figure 24.

Figure 29: Accessing Real-Time Clock Battery (CPE302, CPE305, and CPE310)



2.2.4.6.1 Replacing the Real-Time Clock Battery in CPE302/CPE305/CPE310

⚠ WARNING

The replacement battery must be IC690ACC001 from Emerson, or an equivalent, such as Use of a different type of battery than that specified here may present a risk of fire or explosion.

Battery may explode if mistreated. Do not recharge, disassemble, heat above 100°C (212°F), or incinerate.

⚠ CAUTION

- To avoid damage from electrostatic discharge, use proper precautions when performing these procedures:
- Wear a properly functioning antistatic strap and be sure that you are fully grounded. Never touch the printed circuit board, or components on the board, unless you are wearing an antistatic strap.
- Any surface upon which you place the unprotected circuit board should be static-safe, facilitated by antistatic mats if possible.
- Extra caution should be taken in cold, dry weather, when static charges can easily build up.

2.2.4.6.2 Battery Removal Method 1

1. Power down the rack and remove the CPU from the backplane.
2. Using a curved probe with a non-conducting surface, for example a non-metallic dental pick, reach in from the back of the module and pull the battery out of its retaining clip. (You can use needle-nose pliers to grasp the battery and pull it the rest of the way out.)

2.2.4.6.3 Sample Tool for Battery Removal

Figure 30: Sample Tool for Battery Removal



2.2.4.6.4 Battery Removal Method 2

1. Power down the rack and remove the CPU from the backplane.
2. Squeeze both sides of the module and remove the front section of the plastic housing.
 1. Lift the two clips on the side of the plastic housing to release the circuit board and pull the board out of the housing.
 2. Pull the battery out of its retaining clip.

2.2.4.6.5 Installing a New RTC Battery

Install the battery with the positive (+) side up. That is, with the + side away from the board and toward the housing plastic.

2.2.4.6.6 Backwards Compatibility of CPE310 with CPU310

The CPE310 may be swapped with a CPU310 with no upgrade to the Proficy Machine Edition Logic Developer-PLC programming software. Logic and configuration equality in the programming software is maintained when storing the same project to either a CPU310 or a CPE310. Proficy Machine Edition versions that recognize the CPE310 (7.0 SIM3 and newer), allow either a CPU310 configuration or a CPE310 configuration to be stored to the CPE310. For all programming software versions (both current and legacy) a CPU310 device can accept only a CPU310 configuration.

2.2.4.6.7 Legacy CPU310 Projects

The CPE310 supports CPU310 projects. Proficy Machine Edition versions earlier than 7.10 SIM 3 interpret the CPE310 as a CPU310. The CPE310 can be configured as a CPU310 using Proficy Machine Edition versions as old as 5.5, Service Pack 1.

2.2.4.6.8 RDS Port

If a CPU310 configuration is stored to a CPE310, the RDS port is enabled to allow you to transfer CPU310 projects to CPE310 models without using Proficy Machine Edition.

2.2.4.6.9 Fault Behavior

Faults related to the embedded CPE310 Ethernet interface may be generated on power-up, as detailed in the following section.

2.2.4.6.10 Replacing a CPU310 with a CPE310

- A CPE310 that is configured as a CPU310 logs the following faults in the Controller fault table:
 - A *LAN Transceiver Fault* is generated because the RX3i system detects that the embedded Ethernet module does not have a network connection.
 - An *Extra Option Module* fault is generated because the embedded Ethernet module is detected as an unconfigured module.
 - If the Energy Pack capacitor pack is disconnected or fails, the legacy faults for a missing or failed battery are logged.
- When a CPE310 is configured as a CPU310, Ethernet properties cannot be configured and there should be no cable connected to the Ethernet port.
- When a CPE310 is configured as a CPU310, the Show Status dialog box in Proficy Machine Edition displays *CPU310A*.

2.2.4.7 CPE310 versus CPU310 Performance Differences

The following differences should be considered when converting legacy applications or developing new applications.

- Some exceptionally lengthy CPE backplane operations, such as MC_CamTableSelect, Data Log and Read Event Queue functions, will take longer to complete compared to other RX3i CPU models, and may delay backplane operations to IC695 modules.
- For example, when an MC_CamTableSelect function block is executed on the PMM335 module, the CPU's acknowledgement of the PMM355 module interrupt may be delayed. In this situation, you may see the following fault in the I/O Fault Table, even when the interrupt has not been dropped: *Error initiating an interrupt to the CPU.*
- Performance specifications for many features, such as power-up time, function block execution times and I/O module sweep times have changed. For details, refer to Appendix.A:.
- The RS-232 port on the CPE310 does not provide 5Vdc power on pin 5.

2.2.4.8 CPU305 Performance Differences vs. CPE310 and Legacy RX3i CPUs

The CPE302/CPE305 exhibits the same performance differences as listed above for the CPE310.

The CPE305 supports legacy CPU310 projects that fit within 5 Mbytes of user memory. The CPE302 supports legacy CPU310 projects that fit within 2 Mbytes of user memory. ***The project configuration must be changed to support any such conversion.***

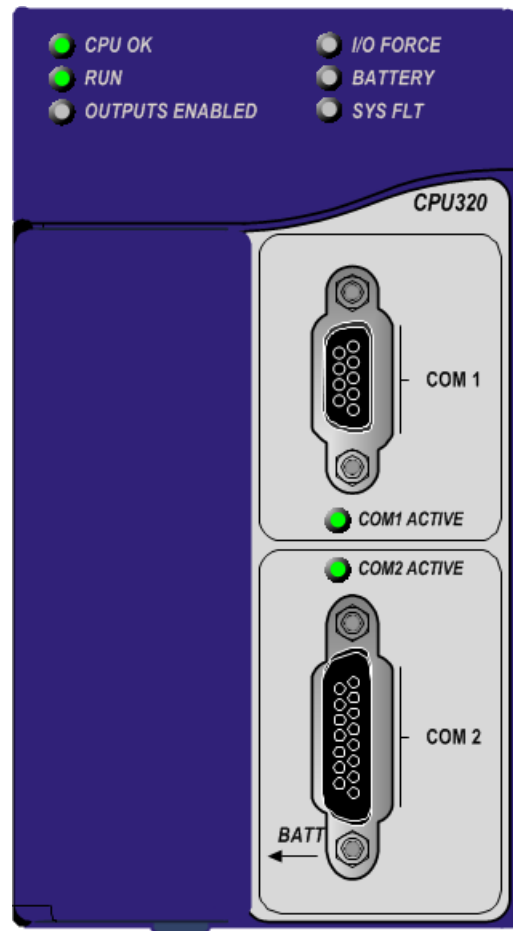
Because the CPE302/CPE305 has less user memory than the other RX3i CPUs, operations that involve transferring large files could fail.

For example, depending on the number and sizes of Data Log files already stored, the Get_DL (Get Data Log) command could fail with a C10 hex (file transfer failure occurred while sending the data log file to the CPU) error. To correct this error

1. Upload the data logs to Machine Edition and delete the logs from the CPU.
2. Take steps to reduce the size of the log file, such as reducing the number of samples, the sample rate, or the number of parameters logged.

2.2.5 CPU315 and CPU320/CRU320

Figure 31: IC695CPU320 Front View



2.2.5.1 Serial Ports CPU315, CPU320 & CRU320

Each CPU has two independent, on-board serial ports, accessed by connectors on the front of the module. COM1 and COM2 provide serial interfaces to external devices. Either port can be used for firmware upgrades. For serial port pin assignments, electrical isolation, and details on serial communications, refer to Section 5:

2.2.5.2 Indicators CPU315, CPU320 & CRU320

Eight CPU LEDs indicate the operating status of various CPU functions.
Two Comm LEDs indicate activity on COM1 and COM2.

LED State ● On 🟩 Blinking ○ Off		CPU Operating State
CPU OK	● On Green	CPU has passed its power-up diagnostics and is functioning properly. ⁵³
	○ Off	CPU problem. RUN and OUTPUTS ENABLED LEDs may be blinking in an error code pattern, which can be used by technical support for troubleshooting. This condition and any error codes should be reported to your technical support representative.
	🟩 Blinking Green Other LEDs off	CPU in Stop/Halt state; possible watchdog timer fault. Refer to the fault tables. If PME cannot connect, cycle power with battery attached and refer to fault tables.
CPU OK RUN OUTPUTS ENABLED	🟩 Blinking in unison 🟩 🟩	CPU is in boot mode and is waiting for a firmware update through a serial port.
RUN	● On Green	CPU is in RUN Mode.
	○ Off	CPU is in STOP Mode.
OUTPUTS ENABLED	● On Green	Output scan is enabled.
	○ Off	Output scan is disabled.
I/O FORCE	● On Yellow	Override is active on a bit reference.
BATTERY	○ Off	Normal battery ⁵⁴
	🔴 Blinking Red	Battery low ⁵⁴
	● On Red	Battery has failed or is not attached ³
SYSTEM FAULT	● On Red	CPU is in Stop/Faulted mode because a fatal fault has occurred.
COM1	🟩 Blinking Green	Signals activity on corresponding serial port.

⁵³ After initialization sequence is complete.

⁵⁴ Low battery detection requires hardware revision –Fx or later and a smart battery. For details, refer to the PACSystems Battery and Energy Pack Manual, GFK-2741.

LED State		CPU Operating State
● On ✚ Blinking ○ Off		
COM2	✚	

2.2.5.3 Error Checking and Correction, IC695CRU320

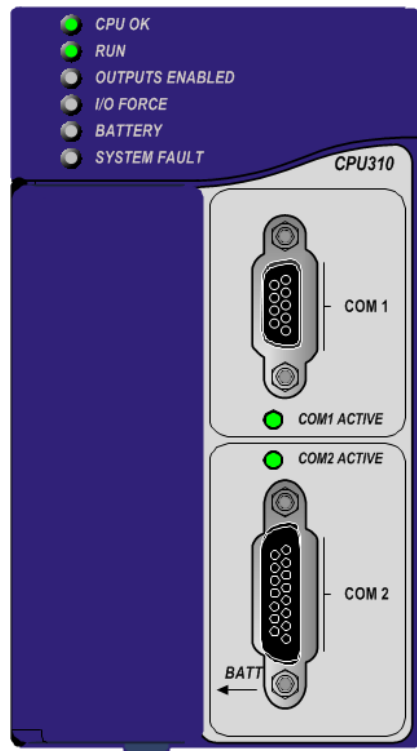
RX3i Redundancy CPUs provide error checking and correction (ECC), which results in slightly slower system performance, primarily during power-up, because it uses an extra 8 bits that must be initialized.

For details on ECC, refer to the PACSystems Hot Standby CPU Redundancy User Manual, GFK-2308.

Note: Multiple Recoverable Memory Error faults may be generated when a single-bit ECC error is detected. When a single-bit ECC error is detected, the value presented to the microprocessor is corrected. However, the value stored in RAM is not corrected until the next time the microprocessor writes to that RAM location.

2.2.5.4 CPU310

Figure 32: CPU310 Front View



2.2.5.5 Serial Ports CPU310

The CPU has two independent, on-board serial ports, accessed by connectors on the front of the module. COM1 and COM2 provide serial interfaces to external devices. Either port can be used for

firmware upgrades. For serial port pin assignments and other details on serial communications, refer to Section 5:

The eight CPU LEDs indicate the operating status of various CPU functions.
The two Comm LEDs indicate activity on COM1 and COM2.

LED State	● On	✚ Blinking	○ Off	CPU Operating State
CPU OK	●		On Green	CPU has passed its power-up diagnostics and is functioning properly. ⁵⁵
			Off	CPU problem. RUN and OUTPUTS ENABLED LEDs may be blinking in an error code pattern, which can be used by technical support for troubleshooting. This condition and any error codes should be reported to your technical support representative.
		✚	Blinking Green Other LEDs off	CPU in Stop/Halt state; possible watchdog timer fault. Refer to the fault tables. If PME cannot connect, cycle power with battery attached and refer to fault tables.
CPU OK RUN OUTPUTS ENABLED		✚ ✚ ✚	Blinking in unison	CPU is in boot mode and is waiting for a firmware update through a serial port.
RUN	●		On Green	CPU is in RUN Mode.
			Off	CPU is in STOP Mode.
OUTPUTS ENABLED	●		On Green	Output scan is enabled.
			Off	Output scan is disabled.
I/O FORCE		●	On Yellow	Override is active on a bit reference.
BATTERY			Off	Normal battery ⁵⁶
		✚	Blinking Red	Battery low ⁵⁶
		●	On Red	Battery has failed or is not attached ⁵⁶
SYSTEM FAULT		●	On Red	CPU is in Stop/Faulted mode because a fatal fault has occurred.
COM1 COM2		✚ ✚	Blinking Green	Signals activity on corresponding serial port.

⁵⁵ After initialization sequence is complete.

⁵⁶ Low battery detection requires a smart battery. For details, refer to PACSystems Battery and Energy Pack Manual, GFK-2741.

2.3 RSTi-EP CPU Features and Specifications

	CPE100/CPE115
Lifecycle Phase	Active
Operating System	VxWorks
#RX3i Slots Occupied	N/A
Backplane	Standalone
Temperature Range	
RSTi-EP	-40°C to 70°C
Power Requirements	
RSTi-EP +3.3Vdc	N/A
RSTi-EP +5 Vdc	N/A
RSTi-EP +24Vdc Relay with Energy Pack	N/A
RSTi-EP +24Vdc Relay w/o Energy Pack	N/A
Input Power (Max)	6 W (250mA@ 24Vdc)
Input Voltage (Min)	9Vdc
Input Voltage (Max)	30Vdc
Memory Backup Mechanism ⁵⁷	Internal super capacitor
Display	
	LEDs
Firmware Upgrade	
CPU Firmware Upgrade Mechanism	Web Interface Ethernet Port
Indirect Backplane Module Upgrade	N/A
Program Portability	
Direct Import (with limitations) ⁵⁸	N/A
RX3i PACSystems Applications using Family Type Conversion	Y
Program Security	
Secure Boot	Y
Trusted Platform Module (TPM)	Y (Disabled)
Program Storage	
Battery-backed RAM	1 Mbytes ⁵⁹
Non-Volatile Flash	512 Mbytes
Battery Life Expectancy, RAM Backup ⁵⁷	N/A
Life Expectancy, Energy Pack Capacitors	15 Years if ambient temp is 40°C

⁵⁷ See Battery Compatibility and Memory Retention (Time in Days at 20°C) in GFK-2741

⁵⁸ See corresponding IPI for target CPU.

⁵⁹ Battery-backed RAM.

	CPE100/CPE115
Auxiliary Storage	
CFast	N/A
Remote Data Storage Device (RDSD)	N/A
Micro SD	x 1 (Disabled)
Programming Capabilities	
Max Number of Program Blocks	512
Program Block Max Size	128 KB
Discrete Reference Memory (%I, %Q) ⁶⁰	2K Bits
Analog Reference Memory (%AI, %AQ) ⁶⁰	32K Words
Bulk Reference Memory (%W) ⁶⁰	up to max user RAM
Managed Memory (Symbolic + I/O Variables) ^{60,61}	up to 1 Mbytes
Floating Point	Y
Ladder Diagram (LD)	Y
Function Block Diagram (FBD)	Y
Structured Text (ST)	Y
PID Built-In Function Block	Y
"C" Language External Blocks	Y
Communications	
Ethernet Non-Switched RJ45 (dedicated NIC)	10/100 x1
Ethernet Switched RJ45 (shared NIC)	10/100 x3
10BaseT/100BaseT RJ45	Y
Ethernet Communications Platform	Built-in
Advanced User Parameters (AUP file)	N ⁶²
RS-232	x 1
RS-485	x 1
USB	USB 2.0 x 1 (Disabled)
Time-of-Day Clock	
Time-of-Day Clock Accuracy (@60°C)	±2 secs/day
Elapsed Time Clock (internal timing) accuracy	±0.01% max
Simple Network Time Protocol (SNTP) accuracy to timestamp	Y(CPE115 Only)
RTC Battery Backup	Y
RTC Battery Life expectancy	5 years

⁶⁰ Note: Whenever the size of any reference memory is changed, the content of the corresponding reference memory is automatically cleared.

⁶¹ For discussion of memory types and how they are managed, refer to PACSystems RX3i and RSTi-EP CPU Programmer's Reference Manual, GFK-2950 Section 3.

⁶² The Advanced User Parameters (AUP) feature has been incorporated into PME Hardware Configuration (HWC) effective with PME release 8.60 SIM5. Communications

	CPE100/CPE115
Protocols	
Modbus RTU Slave	Y
SNP Slave	N/A
Serial I/O	Y
SRTP (# simultaneous server conns)	up to 16
Modbus TCP (# simultaneous server connections)	up to 8
SRTP Channel or Modbus TCP Client (# simultaneous)	up to 8
Ethernet Global Data (EGD)	Y
Number of EGD Exchanges (max) ⁶³	8
Selective Consumption of EGD	N/A
PROFINET ⁶⁴	Y
OPC UA Server	Y
Remote Station Manager over UDP	Y (limited)
Station Manager over Serial Comm Port	N/A
DNP3 Outstation master/client support ⁵⁰ (# simultaneous)	Up to 8(CPE115 only)
Redundancy Features	N/A
Memory Error Checking and Correction (ECC)	N/A
Switchover Time (max) ⁶⁵	N/A
Switchover Time (min) ⁶⁵	N/A
Max data in redundancy transfer list ⁶⁶	N/A
Redundant Synchronized Links Supported	N/A

2.3.1 CPE100/CPE115

2.3.1.1 Introduction

The EPSCPE100 and EPSCPE115 are the first standalone CPUs in the RSTi-EP family. Each is supported by two mounting options:

1. As shipped, it mounts onto a DIN rail using a DIN-rail adaptor plate.
2. Alternately, it mounts directly in a cabinet, using a panel-mount adaptor plate ICMFAACC001-AA.

The mounting instructions and power requirements are documented in the *Quick Start Guide*, GFK-3012, and are not replicated here.

The physical features of the CPE100/CPE115 are shown in Figure 33.

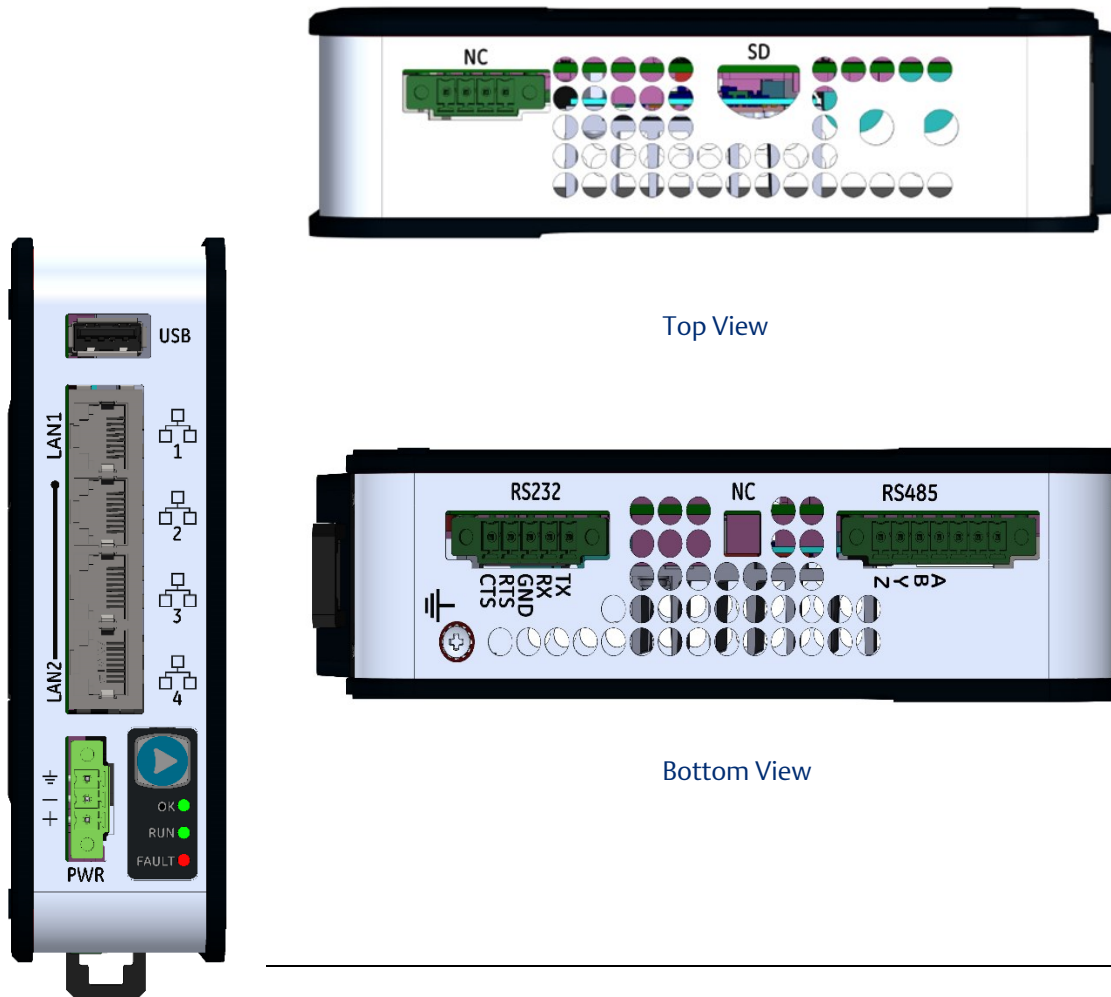
⁶³ Limit is per target, so all producers and consumers are counted towards this limit.

⁶⁴ CPE100/CPE115 (firmware version 9.30 or later) provide PROFINET support with MRP via an embedded PROFINET Controller: no external hardware is required.

⁶⁵ Switchover time is defined as the time from failure detection until backup CPU is active in a redundancy system.

⁶⁶ Symbolic variable and Reference data can be exchanged between redundancy controllers, up to the stipulated limit.

Figure 33: CPE100, Front, Top, and Bottom Views and Features



The PACSystems RSTi-EP EPSCPE100/CPE115 are enhanced performance standalone programmable controllers equipped with 1MB of user memory and four Ethernet ports to run real time deterministic control applications. LAN1 is dedicated to high speed Ethernet and LAN2 is comprised of three switched ports configurable as either a second embedded Ethernet controller or an embedded PROFINET controller, which provides the PROFINET functionality and supports only simplex mode of operation. It is a standalone PLC that supports distributed I/O.

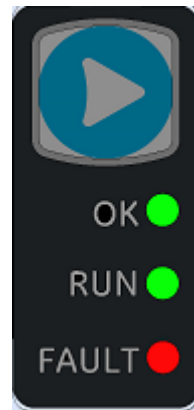
The CPE100/CPE115 are programmed and configured over Ethernet via Emerson’s PAC Machine Edition (PME) software. Each is a standalone CPU with the following features:

- A built-in PACSystems RSTi-EP PLC CPU
 - User may program in Ladder Diagram, Structured Text, Function Block Diagram.
 - Contains 1 Mb for CPE100 and 1.5Mbytes for CPE115 of configurable data and program memory. This entire memory will be preserved between power cycles.
 - Supports auto-located Symbolic Variables that can use any amount of user memory.
 - Reference table sizes include 2k bits for discrete %I and %Q and up to 32k words each for analog %AI and %AQ. Bulk memory (%W) also supported for data exchanges.
 - Supports up to 512 program blocks. Maximum block size is 128KB.

- Supports two independent 10/100 Ethernet LANs. LAN1 has only one port and is dedicated to high speed Ethernet; whereas, LAN2 is comprised of three switched ports (labelled as 2, 3 & 4) which are configurable as either a second embedded Ethernet controller or an embedded PROFINET controller. All four ports are located on the front panel.
- The embedded communications interface has dedicated processing capability, which permits the CPU to independently support LAN1 and LAN2 with:
 - up to 16 combined SRTP Server and Modbus TCP Server connections out of which:
 - a) Modbus TCP cannot exceed more than 8 simultaneous connections.
 - b) SRTP server cannot exceed more than 16 simultaneous connections.
 - Up to 8 Clients are permitted. Each may be SRTP or Modbus TCP or a Combination of both.
 - Up to 8 simultaneous Class 1 Ethernet Global Data (EGD) exchanges.
- Ability to display serial number and date code in PME Device Information Details.
- Media Redundancy Protocol (MRP) allows the CPE100/CPE115 to participate in a PROFINET I/O network with MRP ring technology. This eliminates the I/O network as a single point of failure. The CPE100/CPE115 may be used as either a Media Redundancy Manager or Media Redundancy Client.
- OPC UA Server supports up to two concurrent sessions with up to 4 concurrent variable subscriptions and up to 1000 variables.
- Modbus RTU Slave support on two serial ports i.e. RS-232 and RS-485 with both 2-wire and 4-wire interface. These ports are located on the underside of the controller and do not provide any type of isolation.
- CPE115 supports DNP3 outstation up to 8 concurrent master connections.
- Operating temperature range -40 °C to 70 °C (-40 °F to 158 °F).
- Supports 32-bit C blocks compiled with the C Toolkit Version 8.10 or later. All pre-existing C blocks must be recompiled before downloading.
- Supports Authorized Firmware Update feature. Users may now authorize access to firmware updates using a custom password. Details are included in the revised firmware update instructions.
- The PLC may use one, two or three of the Ethernet ports of LAN2 to support the embedded Simplex PROFINET I/O Controller. PROFINET supports up to 8 I/O devices with update rates of 16 – 512 ms. It is not recommended to use update rates below 16 ms.
- The CPE100/CPE115 is secure by design, incorporating technologies such as secure boot, trusted platform module (disabled), and encrypted firmware updates.
- Module LEDs on the face plate provides basic status and control information of CPE100/CPE115.
- When shipped, °°°°the CPE100/CPE115 is configured only for DIN-rail mounting. An alternate panel-mount adaptor plate (ICMFAACC001-AA) is optional, but not included in the ship-set.

2.3.1.2 Membrane Run/Stop Pushbutton

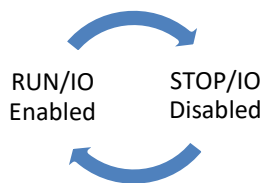
Figure 34: CPE100/CPE115 Membrane Pushbutton and Module Status LEDs



If the blue membrane pushbutton (Figure 34) is pressed while the CPE100/CPE115 is powering up, it restores the default IP address (192.168.0.100). It also erases the stored hardware configuration, logic, and contents of the backup RAM.

During normal operation, briefly pressing the membrane pushbutton changes the state of the CPU from its current Run/Stop state to its alternate state, as shown in the following state diagram:

Figure 35: State Diagram for CPE100/CPE115 Run/Stop Operation



The **Run/Stop** switch is enabled by default; it can be disabled in PME Hardware Configuration (HWC) settings.










2.3.1.3 LED Indicators (LEDs)

2.3.1.3.1 Ethernet Status Indicators

There are two LEDs (Yellow/Green) for each Ethernet ports of LAN1 and LAN2, which are embedded in the RJ45 connectors. The green LED indicates an Ethernet connection has been established. The yellow LED indicates packet traffic.

2.3.1.3.2 Module Status Indicators

There are three LEDs and one membrane pushbutton on the front panel, as shown in Figure 34. The table below describes the behavior of each LED:

LED	LED State	Operating State (after Power-Up)
RUN	 Blinking; All other LEDs off	This LED indicates the status of PLC during powering up. It starts blinking 6 seconds after applying power to the PLC and remains in this state for up to 15 seconds. After this all LEDs turn off and will remain in this state until PLC is ready.
OK	 On Green	PLC has passed its power-up diagnostics and is functioning properly
	 Off	Power is not applied or PLC has a problem.
	 Blinking; All other LEDs off	PLC in STOP/Halt state; possible watchdog timer fault. If the programmer cannot connect, cycle power and refer to the fault tables.
RUN	 On Green	PLC is in RUN mode.
	 Off	PLC is in STOP mode.
	 Blinking; All other LEDs off	Indicates that PLC has encountered a fatal error and is blinking the error code.
Fault	 On Red	PLC is in STOP/Faulted mode: a fatal fault has occurred.
	 Off	No fatal faults detected.

2.3.1.4 Ethernet Ports

CPE100/CPE115 provides two independent Fast Ethernet LANs. LAN1 has only one port and is dedicated to embedded Ethernet controller and whereas LAN2 is comprised of 3 switched ports configurable either as a second embedded Ethernet controller or as an embedded PROFINET controller.

All the Ethernet ports of both the LAN1 and LAN2 are capable of automatically sensing the link data rate (10 Mbps or 100 Mbps), communications mode (half-duplex or full-duplex), and cabling arrangement (straight-through or crossover).

To establish Ethernet communications between the PME programming software and the CPE100/CPE115, you *first* need to set a valid IP address.

EPSCPE100/CPE115	LAN1	LAN2
Default IP Address	192.168.0.100	0.0.0.0
Subnet Mask	255.255.255.0	0.0.0.0
Gateway	0.0.0.0	0.0.0.0

Note:

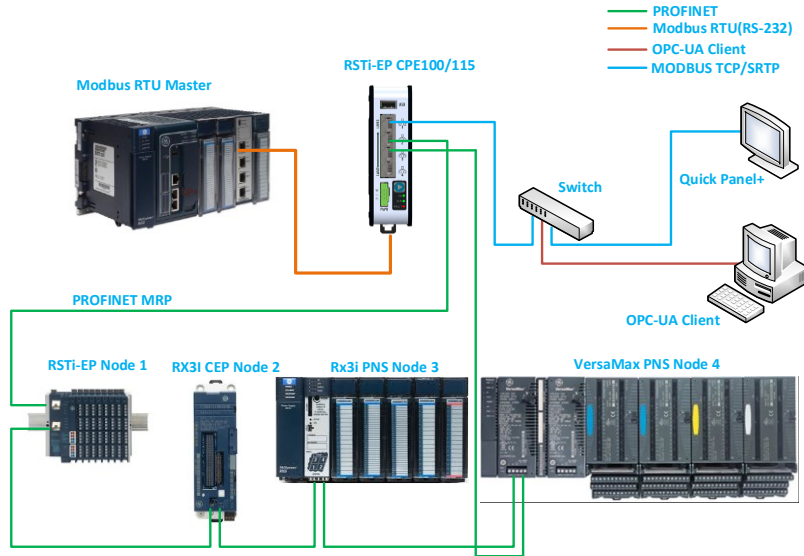
- LAN2 will not be operational unless it is configured from the programmer with a valid IP address.
- Care must be taken when assigning IP Addresses and subnet masks to each LAN so that an overlapping IP subnet is not created. Intermittent or no Ethernet communication may result if an overlapping IP subnet is created and the two interfaces are NOT connected (cabled) to the same physical network.
- By default, PME prohibits configuring both LAN interfaces on an overlapping IP subnet. (This may be changed by going to Controller General Options and changing the Multiple Embedded LANs on Same Subnet to Show as Warning.)

The programming software 'PAC Machine Edition' uses SRTP (Service Request Transport Protocol), a proprietary protocol used primarily for communication with the controllers. The Ethernet port of LAN1 can be used to communicate with the PME software and is also a recommended option. Alternatively, any port of LAN2 can also be used but first it should be configured with a valid IP address. Ethernet ports of LAN2 can also be configured to be used as either a second embedded Ethernet controller or as an embedded Simplex PROFINET I/O Controller.

2.3.1.5 Ethernet Topology

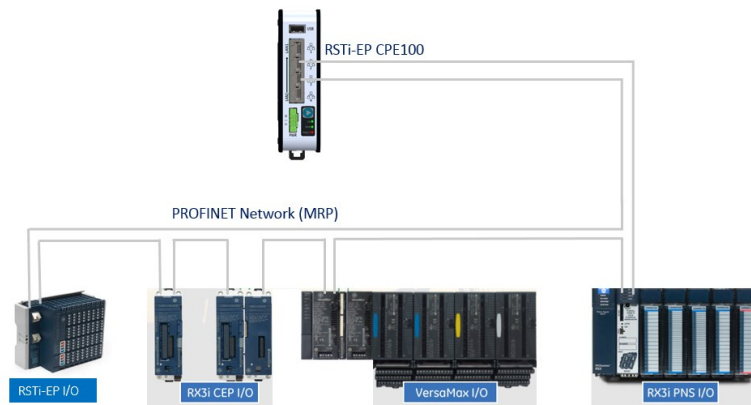
A typical application will take advantage of the two independent LANs. The dedicated LAN1 port will be used for communications with plant-level or supervisory layers. The switched LAN2 will be used to communicate with devices over PROFINET within the manufacturing cell or process.

Figure 36: Typical Multi-Tier LAN Application (Star/Bus Topology)



Whenever CPE100/CPE115 is configured for MRP only Ethernet Port2 & Port3 of LAN2 can be used to form a ring. Ethernet Port4 of LAN2 can still be used either to connect programmer, simplex PROFINET device or any other supported Ethernet protocols.

Figure 37: Typical Multi-Tier LAN Application (Ring Topology)



2.3.1.6 Super Capacitor

In the event of loss of system power, the internal super capacitor maintains power long enough for the CPE100/CPE115 to write its user memory contents to non-volatile storage (flash) memory.

2.3.1.6.1 Operation

When the CPE100/CPE115 is powered up for the first time, or is in a system that has been powered down long enough to completely discharge the internal super capacitor, it may additionally require 70 to 75 seconds for it to charge to its operating level. The CPE100/CPE115 does not provide any status information about the state of internal super capacitor during power-up.

2.3.1.6.2 Life Expectancy

The super capacitor's life is computed based on unit's ambient temperature and is given by the below estimates.

Surrounding Air Temperature near Capacitor	Typical Life Expectancy (in Years)
10°C	15
20°C	15
30°C	15
40°C	15
50°C	15
60°C	8.1
70°C	2.8

2.3.1.7 Product Limitations

This section lists the known limitations and features that are currently not supported by CPE100/CPE115:

1. SNTP is not supported by CPE100. CPE115 Supports SNTP.
2. RDSD is not supported.
3. Timed interrupt blocks are not supported.

Note: The above features may be supported in a subsequent firmware version. Refer to the data sheet for more information.

Section 3: CPU Configuration

The PACSystems CPU and I/O system is configured using PAC Machine Edition (PME) Logic Developer-PLC programming software.

The CPU verifies the physical module and rack configuration at power-up and periodically during operation. The physical configuration must be the same as the programmed configuration. Differences are reported to the CPU alarm processor for configured fault response. Refer to the *Machine Edition Logic Developer-PLC Getting Started Manual*, GFK-1918 and the online help for a description of configuration functions.

Note: A CPE020, CPE030 or CPE040 can be converted to the corresponding redundancy CPU (CRE020, CRE030 or CRE040) by installing different firmware and moving a jumper. Detailed instructions are included in the firmware upgrade kit for the redundancy CPU.

This Section covers:

- Configuring the CPU
- Configuration Parameters
- Storing (Downloading) Hardware Configuration
- Configuring the Embedded Ethernet Interface

3.1 Configuring the CPU

To configure the CPU using the Logic Developer-PLC programming software, do the following:

In the Project tab of the Navigator, expand your PACSystems Target, the hardware configuration, and the main rack (Rack 0).

1. Right click the CPU slot and choose Configure. The Parameter Editor window displays the CPU parameters.

Note: A double-wide RX3i CPU occupies two slots and can be installed in any pair of slots in Rack 0 except the two highest numbered lots in the rack. The single-wide CPE302/CPE305 RX3i CPU requires one slot and can be installed in any slot in RX3i Rack 0, **except** the highest numbered slot or slot 0.

2. To edit a parameter value, click the desired tab, then click in the appropriate Values field. For information on these fields, refer to Configuration Parameters.
3. Store the configuration to the Controller so these settings can take effect. For details, see *Storing (Downloading) Hardware Configuration*.

Note: If available, the embedded Ethernet Interface is displayed in a sub-slot of the CPU. For configuration details, refer to *Configuring the Embedded Ethernet Interface*.

3.2 Configuration Parameters

3.2.1 Settings Parameters

These parameters specify basic operating characteristics of the CPU. For details on how these parameters affect CPU operation, refer to *PACSystems RX3i and RSTi-EP CPU Programmer's Reference Manual*, GFK-2950 Section 2.

Settings Parameters	
Passwords	<p>Specifies whether passwords are Enabled or Disabled. Default: Enabled.</p> <p>Note: If Enhanced Security⁶⁷ is enabled in the target properties, the Passwords setting will be Enabled and read-only, and the <i>Access Control</i> tab appears.</p> <p>When passwords are disabled, they cannot be re-enabled without clearing PLC memory.</p>
Stop-Mode I/O Scanning	<p>Specifies whether the I/O is scanned while the PLC is in STOP Mode. Default: Disabled. (Always Disabled for Redundancy CPU.)</p> <p>Note: This parameter corresponds to the I/O ScanStop parameter on a Series 90-70 PLC.</p>
Watchdog Timer (ms)	<p>(Denominated in ms, set in 10ms increments.) Requires a value that is greater than the program sweep time.</p> <p>The software watchdog timer is designed to detect <i>failure to complete sweep</i> conditions. The CPU restarts the watchdog timer at the beginning of each sweep. The watchdog timer accumulates time during the sweep. The software watchdog timer is useful in detecting abnormal operation of the application program, which could prevent the PLC sweep from completing within the watchdog time period.</p> <p>Valid range: 10 ms through 2550 ms, in increments of 10 ms.</p> <p>Default: 200.</p> <p>For details on setting the watchdog timer in a CPU redundancy system, refer to the <i>PACSystems Hot Standby CPU Redundancy User Manual</i>, GFK-2308.</p>
Logic/ Configuration Power-up Source	<p>Specifies the location/source of the logic and configuration data that is to be used (or loaded/copied into RAM) after each power up.</p> <p>Choices: Always RAM, Always Flash, Conditional Flash.</p> <p>Default: Always RAM.</p>

⁶⁷ For availability, refer to the Important Product Information document for the CPU firmware version that you are using.
CPU Operation

Settings Parameters	
Data Power-up Source	<p>Specifies the location/source of the reference data that is to be used (or loaded/copied into RAM) after each power up.</p> <p>Choices: Always RAM, Always Flash, Conditional Flash.</p> <p>Default: Always RAM.</p>
RUN/STOP Switch	<p>Enables or disables the physical operation of the RUN/STOP Switch.</p> <p>Choices:</p> <p>Enabled: Enables you to use the physical switch on the PLC to switch the PLC into STOP Mode or from STOP Mode into RUN Mode and clear non-fatal faults.</p> <p>Disabled: Disables the physical RUN/STOP Switch on the PLC.</p> <p>Default: Enabled.</p> <p>Note: If COM1 and COM2 are configured for any protocol other than RTU Slave or SNP Slave, the RUN/STOP Switch should not be disabled without first must making sure that there is a way to stop the CPU, or take control of the CPU through another device such as an Ethernet interface. If the CPU can be set to STOP Mode, it will switch the protocol from Serial I/O to the STOP Mode protocol (default is RTU Slave). For details on STOP Mode settings, refer to <i>COM1 and COM2 Parameters</i>.</p> <p>This applies to COM1 on the CPE302/CPE305, which has only one serial port.</p> <p>This note does not apply to CPUs which have no serial ports.</p>
Memory Protection Switch	<p>Enables or disables the Memory Protect feature associated with the RUN/STOP Switch.</p> <p>Choices:</p> <p>Enabled: Memory Protect is enabled, which prevents writing to program memory and configuration and forcing or overriding discrete data.</p> <p>Disabled: Memory Protect is disabled.</p> <p>Default: Disabled.</p>
Power-up Mode	<p>Selects the CPU mode to be in effect immediately after power-up.</p> <p>Choices: Last, Stop, Run.</p> <p>Default: Last (the mode it was in when it last powered down).</p> <p>Note: If the battery or Energy Pack is missing or has failed and if Logic/Configuration Power-up Source is set to <i>Always RAM</i>, the CPU powers up in STOP Mode regardless of the setting of the Power-up Mode parameter.</p>

Settings Parameters	
Modbus Address Space Mapping Type	<p>Specifies the type of memory mapping to be used for data transfer between Modbus TCP/IP clients and the PACSystems controller.</p> <p>Choices:</p> <p>Disabled: The <i>Disabled</i> setting is intended for use in systems containing Ethernet firmware that does not support Modbus TCP.</p> <p>Standard Modbus Addressing: Causes the Ethernet firmware to use the standard map, which is displayed on the Modbus TCP Address Map tab.</p> <p>Default: Disabled</p> <p>For details on the PACSystems implementation of Modbus/TCP server, refer to <i>PACSystems & RX3i TCP/IP Ethernet Communications User Manual</i>, GFK-2224.</p>
Universal Serial Bus	<p>RX3i CPE302/CPE305/CPE310/CPE330 CPUs only. Enables or disables the USB port for use with RDS (Removable Data Storage Devices). The USB port is enabled by default in the CPE302/CPE305/CPE310/CPE330 and in the hardware configuration.</p> <p>If a CPU310 configuration is stored to a CPE310, the USB port will be enabled.</p>
LAN1 Mode	<p>RX3i CPE330/CPE400/CPL410 and RSTi-EP CPE100/CPE115 CPUs only. CPU LAN1 port mode.</p> <p>Choices:</p> <p>Ethernet: LAN port 1 is used for Ethernet communications.</p> <p>Default: Ethernet.</p>
LAN2 Mode	<p>RX3i CPE330/CPE400/CPL410 and RSTi-EP CPE100/CPE115 CPUs only. CPU LAN2 port mode.</p> <p>Choices:</p> <p>Ethernet: LAN port 2 is used for Ethernet communications. This setting disables embedded PROFINET controller.</p> <p>PROFINET: LAN port 2 is used by the embedded PROFINET controller for PROFINET communications. This setting enables the embedded PROFINET controller.</p> <p>Disabled: CPE400/CPL410 only. LAN port 2 is disabled. It will not require any configuration and cannot be used for any communications.</p> <p>Default: Ethernet for RX3i CPE330. PROFINET for RX3i CPE400, CPL410 and RSTi-EP CPE100/CPE115.</p>

Settings Parameters	
<p>LAN3 Mode</p>	<p><i>RX3i CPE400/CPL410 CPUs only.</i> CPU LAN3 port mode.</p> <p>Choices:</p> <p>Redundancy: Whenever redundancy is enabled in the hardware configuration, both LAN3 ports are used for Redundancy and Mode indicates Redundancy. The configuration is grayed out and is not editable. These ports may only be used as the high-speed data synchronization link between the Primary and Secondary CPUs in a Hot Standby Redundancy deployment. No additional hardware is permitted on LAN3.</p> <p>Disabled: Whenever redundancy is disabled in the hardware configuration, both LAN3 ports are disabled and Mode indicates Disabled. The configuration is grayed out and is not editable. The LAN3 ports cannot be used for any communications.</p> <p>Default: Disabled.</p>
<p>Network Time Sync</p>	<p><i>RX3i CPE302/CPE305/CPE310/CPE330/CPE400/CPL410/CPE115 CPUs only.</i></p> <p>Activates Simple Network Time Protocol (SNTP) clock synchronization for the controller.</p> <p>Choices:</p> <p>None: SNTP is not active.</p> <p>SNTP: SNTP is active and configurable.</p> <p>Default: None.</p>
<p>Enable UTC Offset</p>	<p><i>RX3i CPE302/CPE305/CPE310/CPE330/CPE400/CPL410/CPE115 CPUs only.</i></p> <p>Activates Coordinated Universal Time (UTC) settings for the controller. Allows you to select an appropriate local time zone with respect to UTC.</p> <p>Choices:</p> <p>Disabled: UTC settings are not active.</p> <p>Enabled: UTC settings are active and configurable.</p> <p>Default: Disabled.</p>

Settings Parameters	
Day Light Savings Time (DST)	<p><i>RX3i CPE302/CPE305/CPE310/CPE330/CPE400/CPL410/CPE115 CPUs only.</i></p> <p>Activates Day Light Savings Time (DST) settings for the controller. Allows you to select appropriate local start and end times for Day Light Savings Time.</p> <p>Choices:</p> <p>Disabled: Day Light Savings Time settings are not active.</p> <p>Enabled: Day Light Savings Time settings are active and configurable.</p> <p>Default: Disabled.</p>

3.2.2 Modbus TCP Address Map

This read-only tab displays the standard mapping assignments between Modbus address space and the CPU address space. Ethernet modules and daughterboards in the PACSystems controller use Modbus-to-PLC address mapping based on this map.

Modbus Register	<p>The Modbus protocol uses five reference table designations:</p> <p>0xxxx Coil Table. Mapped to the %Q table in the CPU.</p> <p>1xxxx Input Discrete Table. Mapped to the %I table in the CPU.</p> <p>3xxxx Input Register Table. Mapped to the %AI register table in the CPU.</p> <p>4xxxx Holding Register Table. Mapped to the %R table in the CPU.</p> <p>6xxxx File Access Table. Mapped to the %W table in the CPU.</p>
Start Address	Lists the beginning address of the mapped region.
End Address	Lists the ending address of the mapped region. For word memory types (%AI, %R and %W) the highest address available is configured on the Memory tab.
PLC Memory	Lists the memory type of the mapped region.
Length	Displays the length of the mapped region.

3.2.3 SNTP

This tab displays the Simple Network Time Protocol configuration settings when SNTP is active.

SNTP Mode	SNTP Mode of operation. Specify the use of Multicast/Broadcast or Unicast settings to communicate to the time server. Choices: Multicast/Broadcast or Unicast. Default: Multicast/Broadcast.
Poll Interval	Interval, in seconds, at which new time requests are sent to the server. Only available when SNTP Mode is set to Unicast. Valid Range: 16 to 1024, even values only. Default: 32.
Primary IP Address	IP address of the primary time server in dotted decimal format. Valid Range: Any valid unicast IPv4 address. Default: 0.0.0.0.
Secondary IP Address	Optional IP address of the secondary time server in dotted decimal format. Valid Range: Any valid unicast IPv4 address or 0.0.0.0 if unused. Default: 0.0.0.0.
Poll Count	Number of retransmissions that will be sent when no timely response is received from the server. Valid Range: 1 to 100. Default: 3.
Poll Timeout	The time, in seconds, to wait for a response from the server. Valid Range: 1 to 100. Default: 2.

3.2.4 Time

This tab displays the Coordinated Universal Time (UTC) and Day Light Savings Time (DST) configuration settings when UTC or DST are active.

UTC Offset	Local time zone offset with respect to UTC time. Valid Range: Select the closest appropriate time zone for your location. Default: [UTC-5] Eastern Standard Time.
-------------------	---

DST Offset	<p>The offset between DST and standard time in hours and minutes. Minutes are limited to values of 0, 15, 30, and 45.</p> <p>Valid Range: 0:00 to 1:00.</p> <p>Default: 0:00.</p>
DST Start Month	<p>The month when DST starts.</p> <p>Valid Range: January to December.</p> <p>Default: January.</p>
DST Start Day	<p>The day when DST starts.</p> <p>Valid Range: Sunday to Saturday.</p> <p>Default: Sunday.</p>
DST Start Week	<p>The week of the month when DST starts.</p> <p>Valid Range: 1 to 5. *</p> <p>Default: 0.</p>
DST Start Time	<p>The time of day in hours and minutes when DST starts.</p> <p>Valid Range: 0:00 to 23:59.</p> <p>Default: 0:00.</p>
DST Ref Zone	<p>Indicates the time zone of reference for the DST Start and End times. Start and End times may be relative to either UTC or Local time.</p> <p>Choices: UTC, Local Time.</p> <p>Default: UTC.</p>
DST End Month	<p>The month when DST ends.</p> <p>Valid Range: January to December.</p> <p>Default: January.</p>
DST End Day	<p>The day when DST ends.</p> <p>Valid Range: Sunday to Saturday.</p> <p>Default: Sunday.</p>
DST End Week	<p>The week of the month when DST ends.</p>

	Valid Range: 1 to 5. * Default: 0.
DST End Time	The time of day in hours and minutes when DST ends. Valid Range: 0:00 to 23:59. Default: 0:00.

* For European DST, enter 5 for start and end week to use last Sunday of the month.

3.2.5 Scan Parameters

These parameters determine the characteristics of CPU sweep execution.

Scan Parameters	
Sweep Mode	<p>The sweep mode determines the priority of tasks the CPU performs during the sweep and defines how much time is allotted to each task. The parameters that can be modified vary depending on the selection for sweep mode.</p> <p>The Controller Communications Window, Backplane Communications Window, and Background Window phases of the PLC sweep can be run in various modes, based on the PLC sweep mode.</p> <p>Choices:</p> <ul style="list-style-type: none"> ▪ Normal mode: The PLC sweep executes as quickly as possible. The overall PLC sweep time depends on the logic program and the requests being processed in the windows and is equal to the time required to execute the logic in the program plus the respective window timer values. The window terminates when it has no more tasks to complete. This is the default value. ▪ Constant Window mode: Each window operates in a Run-to-Completion mode. The PLC alternates among three windows for a time equal to the value set for the window timer parameter. The overall PLC sweep time is equal to the time required to execute the logic program plus the value of the window timer. This time may vary due to sweep-to-sweep differences in the execution of the program logic. ▪ Constant Sweep mode: The overall PLC sweep time is fixed. Some or all of the windows at the end of the sweep might not be executed. The windows terminate when the overall PLC sweep time has reached the value specified for the Sweep Timer parameter.
Logic Checksum Words	<p>The number of user logic words to use as input to the checksum algorithm each sweep.</p> <p>Valid range: 0 through 32760, in increments of 8.</p> <p>Default: 16.</p>

Scan Parameters	
<p>Controller Communication Window Mode</p>	<p>(Available only when Sweep Mode is set to <i>Normal</i>.) Execution settings for the Controller Communications Window.</p> <p>Choices:</p> <ul style="list-style-type: none"> ▪ Complete: The window runs to completion. There is no time limit. ▪ Limited: Time sliced. The maximum execution time for the Controller Communications Window per scan is specified in the Controller Communications Window Timer parameter. <p>Default: Limited.</p> <p>Note: This parameter corresponds to the Programmer Window Mode parameter on a Series 90-70 PLC.</p>
<p>Controller Communications Window Timer (ms)</p>	<p>(Available only when Sweep Mode is set to <i>Normal</i>. Read-only if the Controller Communications Window Mode is set to Complete.) The maximum execution time for the Controller Communications Window per scan. This value cannot be greater than the value for the watchdog timer.</p> <p>The valid range and default value depend on the Controller Communications Window Mode:</p> <ul style="list-style-type: none"> ▪ Complete: There is no time limit. ▪ Limited: Valid range: 0 through 255ms. Default: 10. <p>Note: This parameter corresponds to the Programmer Window Timer parameter on a Series 90-70 PLC.</p>
<p>Backplane Communication Window Mode</p>	<p>(Available only when Sweep Mode is set to <i>Normal</i>.) Execution settings for the Backplane Communications Window.</p> <p>Choices:</p> <p>Complete: The window runs to completion. There is no time limit.</p> <p>Limited: Time sliced. The maximum execution time for the Backplane Communications Window per scan is specified in the Backplane Communications Window Timer parameter.</p> <p>Default: Complete.</p>

Scan Parameters	
Backplane Communications Window Timer (ms)	<p>(Available only when Sweep Mode is set to <i>Normal</i>. Read-only if the Backplane Communications Window Mode is set to <i>Complete</i>.) The maximum execution time for the Backplane Communications Window per scan. This value can be greater than the value for the watchdog timer.</p> <p>The valid range and the default depend on the Backplane Communications Window Mode:</p> <ul style="list-style-type: none"> ▪ Complete: There is no time limit. The Backplane Communications Window Timer parameter is read-only. ▪ Limited: Valid range: 0 through 255ms. Default: 255. (10ms for Redundancy CPUs.)
Background Window Timer (ms)	<p>(Available only when Sweep Mode is set to <i>Normal</i>.) The maximum execution time for the Background Communications Window per scan. This value cannot be greater than the value for the watchdog timer.</p> <p>Valid range: 0 through 255</p> <p>Default: 0 (5ms for Redundancy CPUs)</p>
Sweep Timer (ms)	<p>(Available only when Sweep Mode is set to <i>Constant Sweep</i>.) The maximum overall PLC scan time. This value cannot be greater than the value for the watchdog timer.</p> <p>Some or all of the windows at the end of the sweep might not be executed. The windows terminate when the overall PLC sweep time has reached the value specified for the Sweep Timer parameter.</p> <p>Valid range: 5 through 2550 ms, in increments of 5 ms. If the value entered is not a multiple of 5ms, it is rounded to the next highest multiple of 5ms.</p> <p>Default: 100.</p>
Window Timer (ms)	<p>(Available only when Sweep Mode is set to <i>Constant Window</i>.) The maximum combined execution time per scan for the Controller Communications Window, Backplane Communications Window, and Background Communications Window. This value cannot be greater than the value for the watchdog timer.</p> <p>Valid range: 3 through 255, in increments of 1.</p> <p>Default: 10.</p>

Scan Parameters	
Number of Last Scans	<p>(Available only for CPUs with firmware version 1.5 and greater.) The number of scans to execute after the PACSystems CPU receives an indication that a transition from RUN Mode to STOP Mode should occur. (Used for STOP and STOP-Fault, but not STOP-Halt.)</p> <p>Choices: 0, 1, 2, 3, 4, 5.</p> <p>Default:</p> <ul style="list-style-type: none"> 0 when creating a new PACSystems target. 0 when converting a Series 90-70 target to a PACSystems target. 1 when converting a Series 90-30 target to a PACSystems target.

3.2.6 Memory Parameters

The PACSystems user memory contains the application program, hardware configuration (HWC), registers (%R), bulk memory (%W), analog inputs (%AI), analog outputs (%AQ), and managed memory.

Managed memory consists of allocations for symbolic variables and I/O variables. The symbolic variables feature allows you to create variables without having to manually locate them in memory. An I/O variable is a symbolic variable that is mapped to the inputs and outputs of a module in the hardware configuration. For details on using symbolic variables and I/O variables, refer to *PACSystems RX3i and RSTi-EP CPU Programmer's Reference Manual*, GFK-2950 Section 4.

The amount of memory allocated to the application program and hardware configuration is automatically determined by the actual program (including logic C data, and %L and %P), hardware configuration (including EGD and AUP), and symbolic variables created in the programming software. The rest of the user memory can be configured to suit the application. For example, an application may have a relatively large program that uses only a small amount of register and analog memory. Similarly, there might be a small logic program but a larger amount of memory needed for registers and analog inputs and outputs. Note that the content of reference memory is cleared any time the size of reference memory is changed.

A-1.20 provides a summary of items that count against user memory.

3.2.6.1 Calculation of Memory Required for Managed Memory

The total number of bytes required for symbolic and I/O variables is calculated as follows:

$$\begin{aligned}
 & [((\text{number of symbolic discrete bits}) \times 3) / (8 \text{ bits/byte})] \\
 + & [((\text{number of I/O discrete bits}) \times M_d) / (8 \text{ bits/byte})] \\
 + & [(\text{number of symbolic words}) \times (2 \text{ bytes/word})] \\
 + & [(\text{number of I/O words}) \times (M_w \text{ bytes/word})]
 \end{aligned}$$

$M_d = 3$ or 4 . The number of bits is multiplied by 3 to keep track of the force, transition, and value of each bit. If point faults are enabled, the number of I/O discrete bits is multiplied by 4.

$M_w = 2$ or 3 . There are two 8-bit bytes per 16-bit word. If point faults are enabled, the number of bytes is multiplied by 3 because each I/O word requires an extra byte.

3.2.6.2 Calculation of Total User Memory Configured

The total amount of configurable user memory (in bytes) configured in the CPU is calculated as follows:

Total managed memory (bytes)

$$\begin{aligned} &+ \text{total reference words} \times (2 \text{ bytes/word}) \\ &+ \text{[if Point Faults are enabled]} (\text{total words of \%AI memory} + \text{total words of \%AQ memory}) \times (1 \text{ byte / word}) \\ &+ \text{[if Point Faults are enabled]} (\text{total bits of \%I memory} + \text{total bits of \%Q memory}) / 8 \text{ bits/byte} \end{aligned}$$

Note: The total number of reference points is considered system memory and is not counted against user memory.

3.2.6.3 Memory Allocation Configuration

Memory Parameters	
Reference Points	
%I Discrete Input, %Q Discrete Output, %M Internal Discrete, %S System, %SA System, %SB System, %SC System, %T Temporary Status, %G Genius Global	The upper limit for the range of each of these memory types. Read only.
Total Reference Points	Read only. Calculated by the programming software.
Reference Words	
%AI Analog Input	Valid range: 0 through 32,640 words. Default: 64
%AQ Analog Output	Valid range: 0 through 32,640 words. Default: 64
%R Register Memory	Valid range: 0 through 32,640 words. Default: 1024.
%W Bulk Memory	Valid range: 0 through maximum available user RAM. Increments of 2048 words. Default: 0.
Total Reference Words	Read only. Calculated by the programming software.
Managed Memory	
Symbolic Discrete (Bits)	The configured number of bits reserved for symbolic discrete variables. Valid range: 0 through 83,886,080 in increments of 32768 bits. Default: 32,768.
Symbolic Non-Discrete (Words)	The configured number of 16-bit register memory locations reserved for symbolic non-discrete variables. Valid range: 0 through 5,242,880 in increments of 2048 words. Default: 65,536.
I/O Discrete (Bits)	The configured number of bits reserved for discrete IO variables. Valid range: 0 through 83,886,080 in increments of 32768 bits. Default: 0 For RSTi-EP CPE100/CPE115: Valid range: 0 through 4096 in increments of 2048 bits. Default: 0
I/O Non-Discrete (Words)	The configured number of 16-bit register memory locations reserved for non-discrete IO variables. Valid range: 0 through 5,242,880 in increments of 2048 words. Default: 0
Total Managed Memory Required (Bytes)	Read only. See <i>Calculation of Memory Required for Managed Memory</i> .
Total User Memory Required (Bytes)	Read only. See <i>Calculation of Total User Memory Configured</i> .

Memory Parameters	
Point Fault References	<p>The Point Fault References parameter must be enabled if you want to use fault contacts in your logic. Assigning point fault references causes the CPU to reserve additional memory.</p> <p>When you download both the HWC and the logic to the PLC, the download routine checks if there are fault contacts in the logic and if there are, it checks if the HWC to download has the Point Fault References parameter set to Enabled. If the parameter is Disabled, an error is displayed in the Feedback Zone.</p> <p>When you download only logic to the PLC, the download routine checks if there are fault contacts in the logic and if there are, it checks if the HWC on the PLC has the Point Fault References parameter set to Enabled. If the parameter is Disabled, an error is displayed in the Feedback Zone.</p>

3.2.7 Fault Parameters

You can configure each fault action to be either diagnostic or fatal.

A **diagnostic fault** does not stop the PLC from executing logic. It sets a diagnostic variable and is logged in a fault table.

A **fatal fault** transitions the PLC to the Stop Faulted mode. It also sets a diagnostic variable and is logged in a fault table.

Fault Parameters	
Loss of or Missing Rack	<p>(Fault group 1.) When BRM failure or loss of power loses a rack or when a configured rack is missing, system variable #LOS_RCK (%SA12) turns ON. (To turn it OFF, fix the hardware problem and cycle power on the rack.) Default: Diagnostic.</p>
Loss of or Missing I/O Controller	<p>(Fault group 2.) When a Bus Controller stops communicating with the PLC or when a configured Bus Controller is missing, system variable #LOS_IOC (%SA13) turns ON. (To turn it OFF, replace the module and cycle power on the rack containing the module.) Default: Diagnostic.</p>
Loss of or Missing I/O Module	<p>(Fault group 3.) When an I/O module stops communicating with the PLC CPU or a configured module is missing, system variable #LOS_IOM (%SA14) turns ON. (To turn it OFF, replace the module and cycle power on the rack containing the module.) Default: Diagnostic.</p>
Loss of or Missing Option Module	<p>(Fault group 4.) When an option module stops communicating with the PLC CPU or a configured option module is missing, system variable #LOS_SIO (%SA15) turns ON. (To turn it OFF, replace the module and cycle power on the rack containing the module.) Default: Diagnostic.</p>
System Bus Error	<p>(Fault group 12.) When a bus error occurs on the backplane, system variable #SBUS_ER (%SA32) turns ON. (To turn it OFF, cycle power on the main rack.) Default: Fatal.</p>

Fault Parameters	
I/O Controller or I/O Bus Fault	(Fault group 9.) When a Bus Controller reports a bus fault, a global memory fault, or an IOC hardware fault, system variable #IOC_FLT (%SA22) turns ON. (To turn it OFF, cycle power on the rack containing the module when the configuration matches the hardware after a download.) Default: Diagnostic.
System Configuration Mismatch	(Fault group 11.) When a configuration mismatch is detected during system power-up or during a download of the configuration, system variable #CFG_MM (%SA9) turns ON. (To turn it OFF, power up the PLC when no mismatches are present or download a configuration that matches the hardware.) This parameter determines the fault action when the CPU is not running . If a system configuration mismatch occurs when the CPU is in RUN Mode, the fault action will be Diagnostic. This prevents the running CPU from going to STOP/FAULT mode. To override this behavior, see <i>Configuring the CPU to Stop Upon the Loss of a Critical Module</i> . Default: Fatal.
Fan Kit Failure	(Fault group 0x17.) When a fault is detected in the Smart Fan kit, system variable #FAN_FLT (%SA7) turns ON. (To turn a fan kit fault OFF, clear the Controller fault table or reset the PLC.) Default: Diagnostic.
Recoverable Local Memory Error	Redundancy CPUs only. (Fault group 38) Determines whether a single-bit ECC error causes the CPU to stop or allows it to continue running. Choices: Diagnostic, Fatal. Default: Diagnostic. Note: When a multiple-bit ECC error occurs, a Fatal Local Memory Error fault (error code 169) is logged in the CPU Hardware Fault Group (group number 13).
CPU Over Temperature	(Fault group 24, error code 1.) When the operating temperature of the CPU exceeds the normal operating temperature, system variable #OVR_TMP (%SA8) turns ON. (To turn it OFF, clear the Controller Fault Table or reset the PLC.) Default: Diagnostic.
Controller Fault Table Size	(Read-only.) The maximum number of entries in the Controller Fault Table. Value set to 64.
I/O Fault Table Size	(Read-only.) The maximum number of entries in the I/O Fault Table. Value set to 64.

3.2.7.1 Configuring the CPU to Stop Upon the Loss of a Critical Module

In some cases, you may want to override the RUN Mode behavior of the System Configuration Mismatch fault. A given module may be critical to the PLC's ability to properly control a process. In this case, if the module fails then it may be better to have the CPU go to STOP Mode, especially if the CPU is acting as a backup unit in a redundant system.

One way to cause the CPU to stop is to set the configured action for a Loss-of-Module fault to *Fatal* so that the CPU stops if a module failure causes a loss-of-module fault. The correct loss-of-module fault must be chosen for the critical module of interest: I/O controller, I/O module, and Option module. The Ethernet communications module is an example of an Option module.

This approach has a couple of disadvantages. First, it applies to all modules of that category, which may include modules that are not critical to the process. Second, it relies on the content of the fault table. If the table is cleared via program logic or user action, the CPU will not stop.

In systems that use Ethernet Network Interface Units (ENIUs) for remote I/O, a critical module of interest may be the Ethernet module that provides the network connection to the ENIU. Other techniques can be used to provide a more selective response to an Ethernet module failure than the Loss-of-Option module fault. One technique is to use application logic to monitor the Ethernet Interface Status bits, which are described in *Monitoring the Ethernet Interface Status Bits* in the *PACSystems RX3i and RSTi-EP TCP/IP Ethernet Communications User Manual*, GFK-2224. If the logic determined that a critical Ethernet module was malfunctioning, it could execute SVC_REQ #13 to stop the CPU.

Since the ENIU uses Ethernet Global Data to communicate with the PACSystems CPU, another selective technique is to monitor the Exchange Status Words to determine the health of individual EGD exchanges. For details on this status word, refer to *Exchange Status Word Error Codes* in *PACSystems RX3i and RSTi-EP TCP/IP Ethernet Communications User Manual*, GFK-2224. Because the types of errors indicated by the exchange status word may be temporary in nature, stopping the CPU may not be an appropriate response for these errors. Nevertheless, the status could be used to tailor the response of the application to changing conditions in the EGD network.

In some cases, the critical module may reside in an expansion rack. In that case, in addition to the loss-of-module fault, it is recommended to set the Loss-of-Rack fault to Fatal. Then if the rack fails or loses power, the CPU will go to STOP Mode.

3.2.8 Redundancy Parameters (Redundancy CPUs Only)

These parameters apply only to redundancy CPUs or to those CPUs where the optional redundancy features have been activated. For details on configuring CPU for redundancy, refer to the *PACSystems Hot Standby CPU Redundancy User Manual*, GFK-2308.

3.2.9 Transfer List

These parameters apply only to redundancy CPUs. For details on configuring CPU for redundancy, refer to the *PACSystems Hot Standby CPU Redundancy User Manual*, GFK-2308.

3.2.10 COM1 and COM2 Parameters

These parameters configure the operating characteristics of the CPU serial ports. COM1 and COM2 have the same set of configuration parameters. The protocol (Port Mode) determines the parameters that can be set for each port.

Port Parameters	
Port Mode	<p>The protocol to execute on the serial port. Determines the list of parameters displayed on the Port tab. Only the parameters required by the selected protocol are displayed.</p> <p>Choices:</p> <ul style="list-style-type: none"> ▪ RTU Slave mode: Reserved for the use of the Modbus RTU Slave protocol. This mode also permits connection to the port by an SNP master, such as the WinLoader utility or the programming software. ▪ Message mode: The port is open for user logic access. This mode enables C language blocks to perform serial port I/O operations via the C Runtime Library functions.(CPE100/CPE115 does not support this feature) ▪ Available: The port is not to be used by the PLC firmware. (The CPE302/CPE305 does not support this selection.) ▪ SNP Slave: Reserved for the exclusive use of the SNP slave. This mode permits connection to the port by an SNP master, such as the WinLoader utility or the programming software.(CPE100/CPE115 does not support this feature) ▪ Serial I/O: Enables you to perform general-purpose serial communications by using COMMREQ functions. <p>Default: RTU Slave.</p> <p>Note: If both serial ports are configured for any protocol other than RTU Slave or SNP Slave, the RUN/STOP Switch should not be disabled without first making sure that there is a way to stop the CPU, or take control of the CPU through another device such as the Ethernet module. The Serial I/O protocol is only active when the CPU is in RUN Mode. If the CPU can be set to STOP Mode, it will switch the protocol from Serial I/O to the STOP Mode protocol (default is RTU Slave). If an SNP Master, such as the programming software in Serial mode, begins communicating on a port, the RTU protocol automatically switches to SNP Slave. As long as the CPU can be stopped, the protocol of the port can be auto-switched to one that enables serial programmer connection. Refer to <i>STOP Mode</i> protocols.</p> <p>If an Ethernet port is available, you can communicate with the CPU by connecting PME software via the Ethernet port.</p>
Station Address	<p>(RTU Slave only) ID for the RTU Slave. Valid range: 1 through 247. Default: 1.</p> <p>Note: You should avoid using station address 1 for any other Modbus slave in a PACSystems control system because the default station address for the CPU is 1. The CPU uses the default address in two situations:</p> <ol style="list-style-type: none"> 1. If you power up without a configuration, the default station address of 1 is used. 2. When the Port Mode parameter is set to Message Mode, and Modbus becomes the protocol in STOP Mode, the station address defaults to 1. <p>In either of these situations, if you have a slave configured with a station address of 1, confusion may result when the CPU responds to requests intended for that slave.</p> <p>Note: The least significant bit of the first byte must be 0. For example, in a station address of 090019010001, 9 is the first byte.</p>

Port Parameters	
Data Rate	(All Port Modes, except <i>Available</i> .) Data rate (bits per second) for the port. Choices: 1200 Baud, 2400 Baud, 4800 Baud, 9600 Baud, 19.2k Baud, 38.4k Baud, 57.6k Baud, 115.2k Baud. Default: 19.2k Baud.
Data Bits	(Available only when Port Mode is set to Message mode or Serial I/O.) The number of bits in a word for serial communication. SNP uses 8-bit words. Choices: 7, 8. Default: 8.
Flow Control	(RTU slave, Message Mode, or Serial I/O.) Type of flow control to be used on the port. Choices: <ul style="list-style-type: none"> ▪ For Serial I/O Port Mode: None, Hardware, Software (XON/XOFF). ▪ For all other Port Modes: None, Hardware. Default: None. Note: The Hardware flow-control is RTS/CTS crossed.
Parity	(All Port Modes, except <i>Available</i> .) The parity used in serial communication. Can be changed if required for communication over modems or with a different SNP master device. Choices: None, Odd, Even. Default: Odd.
Stop bits	(Available only when Port Mode is set to Message Mode, SNP Slave or Serial I/O.) The number of stop bits for serial communication. SNP uses 1 stop bit. Choices: 1, 2. Default: 1.
Physical Interface	(All port modes except <i>Available</i> .) The type of physical interface that this protocol is communicating over. Choices: <ul style="list-style-type: none"> ▪ 2-wire: There is only a single path for receive and transmit communications. The receiver is disabled while transmitting. ▪ 4-wire: There is a separate path for receive and transmit communications and the transmit line is driven only while transmitting. ▪ 4-wire Transmitter on: There is a separate path for receive and transmit communications and the transmit line is driven continuously. Note that this choice is not appropriate for SNP multi-drop communications, since only one device on the multi-drop line can be transmitting at a given time. Default: 4-wire Transmitter On.
Turn Around Delay Time (ms)	(Available only when Port Mode is set to SNP Slave.) The Turn Around Delay Time is the minimum time interval required between the reception of a message and the next transmission. In 2-wire mode, this interval is required for switching the direction of data transmission on the communication line. Valid range: 0 through 2550ms, in increments of 10 ms. Default: 0.

Port Parameters													
Timeout(s)	(Available only when Port Mode is set to SNP Slave.) The maximum time that the slave will wait to receive a message from the master. If a message is not received within this timeout interval, the slave will assume that communications have been disrupted, and then it will wait for a new attach message from the master. Valid range: 0 through 60 seconds. Default: 10.												
SNP ID	(Available only when Port Mode is set to SNP Slave.) The port ID to be used for SNP communications. In SNP multi-drop communications, this ID is used to identify the intended receiver of a message. This parameter can be left blank if communication is point to point. To change the SNP ID, click the values field and enter the new ID. The SNP ID is up to seven characters long and can contain the alphanumeric characters (A through Z, 0 through 9) or the underline (_).												
Specify STOP Mode	(All port modes except <i>Available</i> .) Determines whether you accept the default STOP Mode or set it yourself. Choices: No: The default STOP Mode is used. Yes: The STOP Mode parameters appear and you can select the STOP Mode. If you set the STOP Mode to the same protocol as the RUN Mode, then the other STOP Mode parameters are read-only and are set to the same values as for the RUN Mode. Default: No.												
STOP Mode	(Available only when <i>Specify STOP Mode</i> is set to Yes.) The STOP Mode protocol to execute on the serial port. If you set the STOP Mode to the same protocol as for the RUN Mode, then the other STOP Mode parameters are read-only and are set to the same values as for the RUN Mode. Choices and defaults are determined by the Port Mode setting. <ul style="list-style-type: none"> ■ SNP Slave: Reserved for the exclusive use of the SNP slave. ■ RTU Slave: Reserved for the exclusive use of the Modbus RTU Slave protocol. <p>If the STOP Mode protocol is different from the Port mode protocol, you can set parameters for the STOP Mode protocol.</p> <p>If you do not select a STOP Mode protocol, the default protocol with default parameter settings is used.</p> <table border="1" style="margin-left: auto; margin-right: auto;"> <thead> <tr> <th>Port (RUN) Mode</th> <th>STOP Mode</th> </tr> </thead> <tbody> <tr> <td>RTU Slave</td> <td>Choices: SNP Slave, RTU Slave Default: RTU Slave.</td> </tr> <tr> <td>Message Mode</td> <td>Choices: SNP Slave, RTU Slave Default: RTU Slave.</td> </tr> <tr> <td>Available</td> <td>Available (Not supported on CPE302/CPE305)</td> </tr> <tr> <td>SNP Slave</td> <td>SNP Slave</td> </tr> <tr> <td>Serial I/O</td> <td>Choices: SNP Slave, RTU Slave Default: RTU Slave.</td> </tr> </tbody> </table> <p>Note: Setting the Port Mode to RTU Slave and the STOP Mode to SNP Slave may cause loss of programmer connection and delayed reconnection when the controller transitions from STOP to RUN Mode. To avoid this behavior, select SNP Slave for the Port Mode and do not specify a STOP Mode. For additional details, see <i>RTU Slave/SNP Slave Operation with Programmer Attached</i>.</p>	Port (RUN) Mode	STOP Mode	RTU Slave	Choices: SNP Slave, RTU Slave Default: RTU Slave.	Message Mode	Choices: SNP Slave, RTU Slave Default: RTU Slave.	Available	Available (Not supported on CPE302/CPE305)	SNP Slave	SNP Slave	Serial I/O	Choices: SNP Slave, RTU Slave Default: RTU Slave.
Port (RUN) Mode	STOP Mode												
RTU Slave	Choices: SNP Slave, RTU Slave Default: RTU Slave.												
Message Mode	Choices: SNP Slave, RTU Slave Default: RTU Slave.												
Available	Available (Not supported on CPE302/CPE305)												
SNP Slave	SNP Slave												
Serial I/O	Choices: SNP Slave, RTU Slave Default: RTU Slave.												

Port Parameters	
Turn Around Delay Time (ms)	(Available only when STOP Mode is set to SNP Slave.) The Turn Around Delay Time is the minimum time interval required between the reception of a message and the next transmission. In 2-wire mode, this interval is required for switching the direction of data transmission on the communication line. Valid range: 0 through 2550ms, in increments of 10 ms. Default: <ul style="list-style-type: none"> ▪ When the STOP Mode is different from the Port Mode: 0ms. ▪ When the STOP Mode is the same as the Port Mode: the value is read-only and is set to the same value as the Turn-Around Delay Time for the Port Mode.
Timeout(s)	(Available only when STOP Mode is set to SNP Slave.) The maximum time that the slave will wait to receive a message from the master. If a message is not received within this timeout interval, the slave will assume that communications have been disrupted, and then it will wait for a new attach message from the master. Valid range: 0 through 60 seconds. Default: <ul style="list-style-type: none"> ▪ When the STOP Mode is different from the Port Mode: 10 seconds. ▪ When the STOP Mode is the same as the Port Mode: the value is read-only and is set to the same value as the Timeout for the Port Mode.
SNP ID	(Available only when STOP Mode is set to SNP Slave.) The port ID to be used for SNP communications. In SNP multi-drop communications, this ID is used to identify the intended receiver of a message. This parameter can be left blank if communication is point to point. To change the SNP ID, click the values field and enter the new ID. The SNP ID is up to seven characters long and can contain the alphanumeric characters (A through Z, 0 through 9) or the underline (_). Default: <ul style="list-style-type: none"> ▪ When the STOP Mode is different from the Port Mode: the default is blank. ▪ When the STOP Mode is the same as the Port Mode: the value is read-only and is set to the same value as the SNP ID for the Port Mode.
Station Address	(Available only when STOP Mode is set to RTU slave.) ID for the RTU Slave. Valid range: 1 through 247. Default: <ul style="list-style-type: none"> ▪ When the STOP Mode is different from the Port Mode: 1. ▪ When the STOP Mode is the same as the Port Mode: the value is read-only and is set to the same value as the Station Address for the Port Mode.

3.2.11 Scan Sets Parameters

You can create multiple sets of asynchronous I/O scans, with a unique scan rate assigned to each scan set. You can assign up to 31 scan sets for a total of 32. Scan set 1 is the standard scan set where I/O is scanned once per sweep. Each module is assigned to a scan set during the configuration of that module. Scan Set 1 is the default scan set.

Scan Set Parameters

Number	A sequential number from 1 to 32 is automatically assigned to each scan set. Scan set 1 is reserved for the standard scan set.
Scan Type	Determines whether the scan set is enabled (as a fixed scan) or is disabled. Choices: Disabled, Fixed Scan. Default: Disabled.
Number of Sweeps	(Editable only when the Scan Type is set to Fixed Scan.) The scan rate of the scan set. Double-click the field, then select a value. A value of 0 prevents the I/O from being scanned. Valid range: 0 through 64. Default: 1.
Output Delay	(Editable only when the Number of Sweeps is non-zero.) The number of sweeps that the output scan is delayed after the input scan has occurred. Double-click on field, then select a value. Valid range: 0 to (number of Sweeps - 1) Default: 0.
Description	(Editable only when the Scan Type is set to Fixed Scan.) Brief description of the scan set (32 characters maximum).

3.2.12 Power Consumption Parameters

The programming software displays the power consumed by the CPU (in Amps) for each voltage provided by the power supply.

3.2.13 Access Control

The Access Control List allows you to specify the reference address ranges that can be accessed by non-local devices such as HMIs and other controllers. To use this feature, Enhanced Security must be enabled in the properties of the target.

When Enhanced Security mode is enabled, any reference address range not defined **cannot** be accessed by other devices. External reads and writes that do not exist in the table are rejected by the firmware.

If overlapping memory ranges are defined, they must have the same Access level.

For symbolic variables, access control is specified by the *Publish* property of the variable, which includes a Read Only and Read/Write setting.

Note: When requesting data from an external device, some drivers packetize data to optimize communication. If a request attempts to read a value that is not published, the entire packet will fail. A fault has been added to the fault table to help you understand a failed read/write. After addressing the fault, you must clear the fault in order to try again.

3.2.13.1 Access Control List Settings

Memory Area	<p>The memory area in which the reference address range is defined.</p> <p>Default: Select an Area</p> <p>Choices: %AI Analog Input, %AQ Analog Output, %I Discrete Input, %G Genius Global, %M Internal Discrete, %Q Discrete Output, %R Register Memory, %S System, %SA System, %SB System, %SC System, %T Temporary Status, %W Bulk Memory.</p>
Start	<p>The starting offset of the reference address range.</p> <p>Default: 0 (not valid)</p> <p>Valid range:</p> <p>For %S, %SA, %SB and %SC, must be 1.</p> <p>All other memory types: 1 through the upper limit of the reference address range. Must be less than the End value.</p>
End	<p>The ending offset of the reference address range.</p> <p>Default: 0 (not valid)</p> <p>Valid range:</p> <p>For %S, %SA, %SB and %SC, must be 128.</p> <p>All other memory types: Any value greater than Start, through the upper limit of the reference address range.</p> <p>For word memory types (%AI, %R and %W) the highest address available is configured on the Memory tab.</p>
Access	<p>Selects the type of external access allowed for the defined address range.</p> <p>Choices: Read-Only, Read/Write</p> <p>Default: Read-Only</p>

3.2.14 OPC UA Parameters

These parameters enable or disable the OPC UA Server.

OPC UA Parameters	
Server Enabled	Specify whether the CPU's OPC UA Server is enabled or not. Valid Range: True or False. Default: True.
UTC Offset	Local time zone offset with respect to UTC time. (Read-Only: Controlled by the UTC Offset on the Time tab.)

3.3 Storing (Downloading) Hardware Configuration

A PACSystems control system is configured by creating a configuration file using the PME programming and configuration software, then transferring (downloading) the file from the programmer to the CPU via serial port COM1, serial port COM2, or via an Ethernet port. If you use a serial port, it must be configured as RTU Slave (default) or SNP Slave.

The CPU stores the configuration file in its non-volatile RAM memory. After the configuration is stored, I/O scanning is enabled or disabled per the newly stored configuration parameters.

Before you can use an Ethernet Interface to store the hardware configuration to the PACSystems, you must first set the IP Address in the Ethernet Interface either by using the Set Temporary IP Address utility (refer to *Setting a Temporary IP Address*) or by downloading a hardware configuration through a serial connection.

- 1) In the programmer software, go to the Project tab of the Navigator, right click the Target, and choose Go Online.
- 2) Right click the Target and choose Online Commands, Set Programmer Mode. Make sure the CPU is in STOP Mode.
- 3) Right click the Target node, and choose Download to Controller.
- 4) In the Download to Controller dialog box, select the items to download and click OK.

Note If you download to a PACSystems target that already has a project on it, the existing project is overwritten.

If I/O variables are configured, hardware configuration and logic cannot be stored independently. They must be stored at the same time.

If passwords have been set, when you go online, you will be taken to the highest unprotected level. If no passwords have been set, you will go online with Privilege Level 4.

3.4 Configuring the Embedded Ethernet Interface

Before you can use the embedded Ethernet Interface, you must configure it using the programming software. To configure the embedded Ethernet interface:

- 1) In the Project tab of the Navigator, expand your PACSystems Target, the hardware configuration, and the main rack (Rack 0).
- 2) Expand the CPU slot (Slot 1). The Ethernet Interface daughterboard is displayed as *Ethernet*.
- 3) Right click the daughterboard slot and choose Configure. The Parameter Editor window displays the Ethernet Interface parameters.

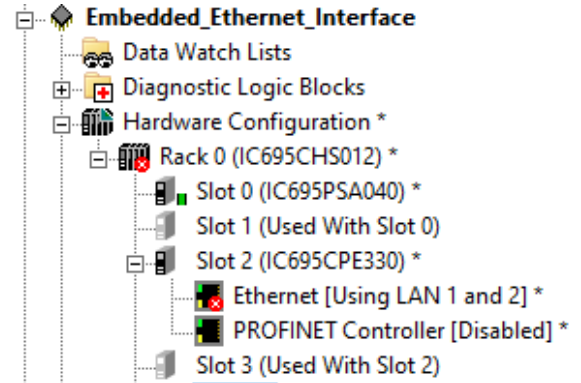


Figure 38: Embedded Ethernet Interface Configuration

Ethernet interface configuration includes the following additional procedures. For details on completing these steps, refer to the *PACSystems RX3i and RSTi-EP TCP/IP Ethernet Communications User Manual*, GFK-2224.

- Assigning an IP Address for initial network operation, such as connecting the programmer to download the hardware configuration, using the Set Temporary IP Address utility (refer to *Setting a Temporary IP Address*) or by downloading a hardware configuration through a serial connection.
- Configuring the characteristics of the Ethernet interface.
- Configuring Ethernet Global Data, if used.
- (Optional, not required for most systems). Setting up the RS-232 port for Local Station Manager Operation. This is part of the basic Ethernet Interface configuration.
- (Optional, not required for most systems). Configuring advanced user parameters. This requires creating a separate ASCII parameter file that is stored to the Controller with the hardware configuration. The Ethernet Interface has a set of default Advanced User Parameter values that should be changed only in exceptional circumstances by experienced users.
- (Optional) Setting up the Controller for Modbus/TCP Server operation.

Note: Whenever a CPE310 is configured as a CPU310, Ethernet properties cannot be configured.

- The embedded Ethernet interface is *not* supported when CPE310 is configured as a CPU310 and the Ethernet port should *not* be connected to any network because it may have adverse effects on the network and/or operation of the CPU.

Note: Whenever a CPE330 is configured as a CPU320, Ethernet properties cannot be configured. However, the embedded Ethernet ports may be used with their default IP Addresses.

3.4.1 Establishing Initial Ethernet Communications

To establish Ethernet communications between the PME programming and configuration software and the CPU, you *first* need to set an IP address. Use one of the following methods:

<p>Default IP Addresses for RX3i CPE302/CPE305/CPE310/CPE330/CPE400/CPL410⁶⁸ & RSTi-EP CPE100/CPE115 Embedded Ethernet</p>	<p>Initial Ethernet communication with the CPU may be established using the default IP addresses programmed at the factory:</p> <table border="1" data-bbox="688 363 1515 678"> <thead> <tr> <th></th> <th>RX3i CPE302/CPE305/ CPE310/CPE330/ CPE400/CPL410 and RSTi-EP CPE100/CPE115 LAN1</th> <th>CPE330/ CPE400/CPL410 LAN2</th> <th>RSTi-EP CPE100/C PE115 LAN2</th> </tr> </thead> <tbody> <tr> <td>IP Address:</td> <td>192.168.0.100</td> <td>10.10.0.100</td> <td>0.0.0.0</td> </tr> <tr> <td>Subnet Mask:</td> <td>255.255.255.0</td> <td>255.255.255.0</td> <td>0.0.0.0</td> </tr> <tr> <td>Gateway:</td> <td>0.0.0.0</td> <td>0.0.0.0</td> <td>0.0.0.0</td> </tr> </tbody> </table>		RX3i CPE302/CPE305/ CPE310/CPE330/ CPE400/CPL410 and RSTi-EP CPE100/CPE115 LAN1	CPE330/ CPE400/CPL410 LAN2	RSTi-EP CPE100/C PE115 LAN2	IP Address:	192.168.0.100	10.10.0.100	0.0.0.0	Subnet Mask:	255.255.255.0	255.255.255.0	0.0.0.0	Gateway:	0.0.0.0	0.0.0.0	0.0.0.0
	RX3i CPE302/CPE305/ CPE310/CPE330/ CPE400/CPL410 and RSTi-EP CPE100/CPE115 LAN1	CPE330/ CPE400/CPL410 LAN2	RSTi-EP CPE100/C PE115 LAN2														
IP Address:	192.168.0.100	10.10.0.100	0.0.0.0														
Subnet Mask:	255.255.255.0	255.255.255.0	0.0.0.0														
Gateway:	0.0.0.0	0.0.0.0	0.0.0.0														
<p>Connecting to CPE302/CPE305/CPE310 Embedded Ethernet when IP Addresses are not known</p>	<p>If the IP Address of the CPE302/CPE305/CPE310 embedded Ethernet interface is not known, communication may be established using one of these methods to set a permanent IP addresses:</p> <ul style="list-style-type: none"> • Connect to the CPE302/CPE305/CPE310 via its serial port and assign an IP Address to the embedded Ethernet interface by downloading a hardware configuration. • Connect to the CPE302/CPE305/CPE310 with PME using an IC695ETM001 module with a known IP address and located in the same rack. Download a new hardware configuration with the desired IP address for the embedded Ethernet interface. 																
<p>Connecting to CPE330 Embedded Ethernet when IP Addresses are not known</p>	<p>If the IP Addresses of the CPE330 embedded LAN1 and LAN2 Ethernet interfaces are not known, communication may be established using one of these methods to set new IP addresses:</p> <ul style="list-style-type: none"> • <i>Setting a Temporary IP Address</i> using the <i>Set Temporary IP Address</i> tool in PAC Machine Edition (PME). After setting the temporary address, connect to the selected CPE330 LAN using PME and download a new hardware configuration with the desired permanent IP addresses. • Connect to the CPE330 with PME using an IC695ETM001 module with a known IP address and located in the same rack. Download a new hardware configuration with the desired permanent IP addresses for the CPE330 embedded Ethernet interfaces. 																
<p>Connecting to CPE400/CPL410 Embedded Ethernet when IP Addresses are not known</p>	<p>Use the OLED display to read the IP Address of any LAN. Note: <i>Setting a Temporary IP Address</i> tool is not available for CPE400 or CPL410.</p>																

⁶⁸ CPE LAN3 IP Address is not configurable.
CPU Operation

<p>Connecting to RSTi-EP CPE100/CPE115 Embedded Ethernet when IP Addresses are not known</p>	<p>The default IP address (192.168.0.100) of CPE100/CPE115 can be restored by powering up the module with the pushbutton pressed and waiting until the OK LED flashes twice.</p> <p>Note: <i>Setting a Temporary IP Address</i> tool is not available for CPE100/CPE115.</p> <p>CAUTION</p> <p>This procedure also erases the stored hardware configuration, logic and contents of the backup RAM.</p> <hr/>
--	--

3.4.2 Setting a Temporary IP Address

If supported by the host CPU⁶⁹, use the Set Temporary IP Address utility to specify an IP address in place of one that has been lost or forgotten.

The following restrictions apply when using the Set Temporary IP Address utility:

- To use the Set Temporary IP Address utility, the PLC CPU must not be in RUN Mode. IP address assignment over the network will not be processed until the CPU is stopped and is not scanning outputs.

The Set Temporary IP Address utility does not function if communications with the networked PACSystems target travel through a router. The Set Temporary IP Address utility can be used if communications with the networked PACSystems target travel across network switches and hubs.

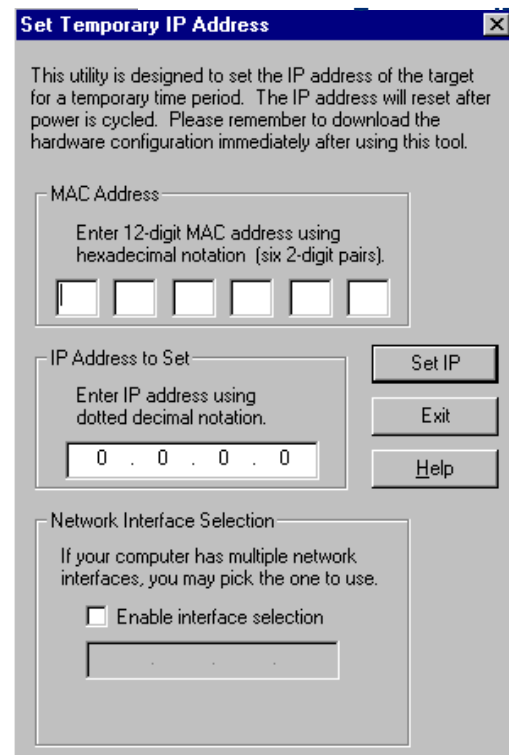
- The current user logged on the computer running the Set Temporary IP Address utility must have full administrator privileges.
- The target PACSystems must be located on the same local sub-network as the computer running the Set Temporary IP Address utility. The sub-network is specified by the computer's subnet mask and the IP addresses of the computer and the PACSystems Ethernet Interface.

⁶⁹ Not supported by RX3i CPE400 and RSTi-EP CPE100/CPE115.
CPU Operation

Note: To set the IP address, you will need the MAC address of the Ethernet Interface to which PME will be connected.

1. Connect the PACSystems CPU LAN to the Ethernet network on which PME is communicating.
2. In the Project tab of the Navigator, right click the PACSystems target, choose Offline Commands, and then choose Set Temporary IP Address. The Set Temporary IP Address dialog box (Figure 39) appears.
3. In the Set Temporary IP Address dialog box, do the following:
 - Key in the 12-digit hexadecimal MAC address (two digits per field).
 - In the *IP Address to Set* box, specify the temporary IP address you want to set for the PACSystems LAN.
 - If necessary, select the Enable Network Interface Selections check box and specify the IP address of the network interface on which the PACSystems is located.
4. When the fields are properly configured, click the Set IP button.
5. The IP Address of the specified PACSystems LAN will be set to the specified temporary address. This may take up to a minute.

Figure 39: Set



After the programmer connects over Ethernet, the permanent IP address for the Ethernet interface, which is set in the hardware configuration, will have been downloaded to the CPU.

The temporary IP address remains in effect until the Ethernet interface is restarted, power-cycled or until the hardware configuration is downloaded or cleared.

CAUTION

The temporary IP Address set by the Set Temporary IP Address utility is not retained through a power cycle. To set a permanent IP Address, you must set the IP Address property of the target and download (store) HWC to the PACSystems.

The Set Temporary IP Address utility can assign a temporary IP Address even if the target Ethernet Interface has previously been configured to a non-default IP Address. (This includes overriding an IP Address previously configured by the programmer.)

Use this IP Address assignment mechanism with care.

Section 4: CPU Operation

This Section describes the operating modes of a PACSystems CPU and describes the tasks the CPU carries out during these modes. The following topics are discussed:

- CPU Sweep
- Program Scheduling Modes
- Window Modes
- Data Coherency in Communications Windows
- Run/Stop Operations
- Flash Memory Operation
- RUN/STOP Switch Operation
- The RUN/STOP Switch is a 3-position switch which operates as follows:

Switch Position	CPU and Sweep Mode	Memory Protection
RUN I/O or RUN I/O Enable	The CPU runs with I/O sweep enabled.	User program memory is read only.
RUN or RUN Output Disable	The CPU runs with outputs disabled.	User program memory is read only.
STOP	The CPU is not allowed to go into RUN Mode.	User program memory can be written.

The RUN/STOP Switch can be disabled in the programming software HWC. The memory protection function of the switch can be disabled separately in HWC. The RUN/STOP Switch is enabled by default. The memory protection functionality is disabled by default.

The Read Switch Position (Switch_Pos) function allows the logic to read the current position of the RUN/STOP Switch, as well as the mode for which the switch is configured. For details, refer to *PACSystems RX3i and RSTi-EP CPU Programmer's Reference Manual*, GFK-2950.

- Logic/Configuration Source and CPU Operating Mode at Power-Up
- System Security
- PACSystems I/O System
- Power-Up and Power-Down Sequences

4.1 CPU Sweep

The application program in the CPU executes repeatedly until stopped by a command from the programmer, from another device, from the RUN/STOP Switch on the CPU module, or a fatal fault occurs. In addition to executing the application program, the CPU obtains data from input devices,

sends data to output devices, performs internal housekeeping, performs communications tasks, and performs self-tests. This sequence of operations is called the **sweep**.

The CPU sweep runs in one of three sweep modes:

Normal Sweep In this mode, each sweep can consume a variable amount of time. The Logic Window is executed in its entirety each sweep. The Communications and Background Windows can be set to execute in Limited or Run-to-Completion mode.

Constant Sweep In this mode, each sweep begins at a user-specified Constant Sweep time after the previous sweep began. The Logic Window is executed in its entirety each sweep. If there is sufficient time at the end of the sweep, the CPU alternates among the Communications and Background Windows, allowing them to execute until it is time for the next sweep to begin.

Constant Window In this mode, each sweep can consume a variable amount of time. The Logic Window is executed in its entirety each sweep. The CPU alternates among the Communications and Background Windows, allowing them to execute for a time equal to the user-specified Constant Window timer.

Note: The information presented above summarizes the different sweep modes. For additional information, refer to *CPU Sweep Modes*.

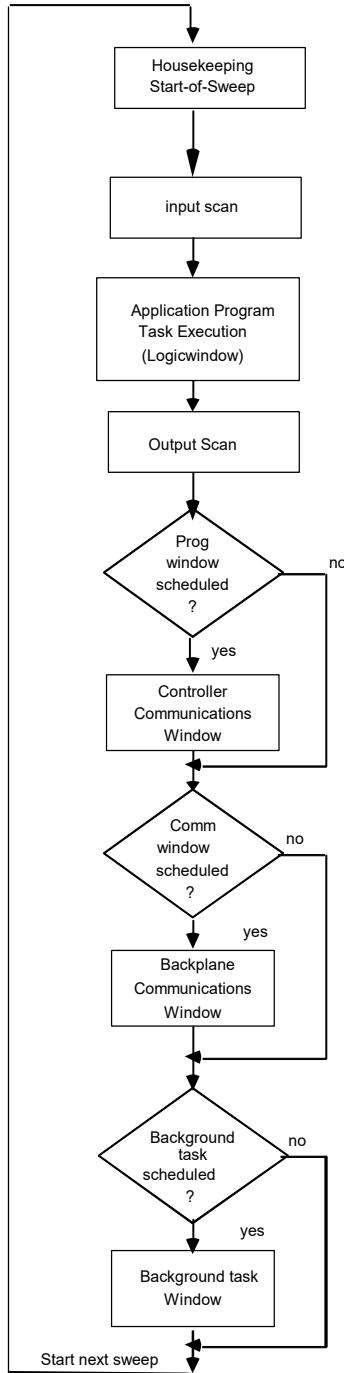
The CPU also operates in one of four RUN/STOP Modes (for details, refer to *Run/Stop Operations*):

- Run/Outputs Enabled
- Run/Outputs Disabled
- Stop/IO Scan
- Stop/No IO

4.1.1 Parts of the CPU Sweep

There are seven major phases in a typical CPU sweep as shown in the following figure.

Figure 40: Major Phases of a Typical CPU Sweep



4.1.1.1 Major Phases in a Typical CPU Sweep

Phase	Activity
Housekeeping	<p>The housekeeping portion of the sweep performs the tasks necessary to prepare for the start of the sweep. This includes updating %S bits, determining timer update values, determining the mode of the sweep (Stop or Run), and polling of expansion racks.</p> <p>Expansion racks are polled to determine if power has just been applied to an expansion rack. Once an expansion rack is recognized, then configuration of that rack and all of its modules are processed in the Controller Communications Window.</p>
Input Scan	<p>During the input scan, the CPU reads input data from the Genius Bus Controllers and input modules. If data has been received on an EGD page, the CPU copies the data for that page from the Ethernet interface to the appropriate reference memory. For details, see <i>PACSystems and RX3i TCP/IP Ethernet Communications User Manual</i>, GFK-2224.</p> <p>Note: The input scan is not performed if a program has an active Suspend I/O function on the previous sweep.</p>
Application Program Task Execution (Logic Window)	<p>The CPU solves the application program logic. It always starts with the first instruction in the program. It ends when the last instruction is executed. Solving the logic creates a new set of output data.</p> <p>For details on controlling the execution of programs, refer to <i>PACSystems RX3i and RSTi-EP CPU Programmer's Reference Manual</i>, GFK-2950 .</p> <p>Interrupt driven logic can execute during any phase of the sweep. For details, refer to <i>PACSystems RX3i and RSTi-EP CPU Programmer's Reference Manual</i>, GFK-2950 Section 2.</p> <p>A list of execution times for instructions can be found in Appendix.A:.</p>
Output Scan	<p>The CPU writes output data to bus controllers and output modules. The user program checksum is computed.</p> <p>During the output scan, the CPU sends output data to the Genius Bus Controllers and output modules. If the producer period of an EGD page has expired, the CPU copies the data for that page from the appropriate reference memory to the Ethernet interface. The output scan is completed when all output data has been sent.</p> <p>If the CPU is in RUN Mode and it is configured to perform a background checksum calculation, the background checksum is performed at the end of the output scan. The default setting for number of words to checksum each sweep is 16. If the words to checksum each sweep is set to zero, this processing is skipped. The background checksum helps ensure the integrity of the user logic while the CPU is in RUN Mode.</p> <p>The output scan is not performed if a program has an active Suspend I/O function on the current sweep.</p>

Phase	Activity
Controller Communications Window	<p>Serves the onboard Ethernet and serial ports. In addition, reconfiguration of expansion racks and individual modules occurs during this portion of the sweep.</p> <p>The CPU always executes this window. The following items are serviced in this window:</p> <ul style="list-style-type: none"> ▪ Reconfiguration of expansion racks and individual modules. During the Controller Communications Window, highest priority is given to reconfiguration. Modules are reconfigured as needed, up to the total time allocated to this window. Several sweeps are required to complete reconfiguration of a module. ▪ Communications activity involving the embedded Ethernet port and the two serial ports of the CPU. <p>Time and execution of the Controller Communications Window can be configured using the programming software. It can also be dynamically controlled from the user program using Service Request function #3. The window time can be set to a value from 0 to 255 ms (default is 10 ms).</p> <p>Note that if the Controller Communications Window is set to 0, there are two alternate ways to open the window: perform a power-cycle without the battery (or Energy Pack) attached, or go to STOP Mode.</p>
Backplane Communications Window	<p>Communications with intelligent devices occur during this window. The rack-based Ethernet Interface module communicates in the Backplane Communications window. During this part of the sweep the CPU communicates with intelligent modules such as the Genius Bus Controller and TCP/IP Ethernet modules.</p> <p>In this window, the CPU completes any previously unfinished request before executing any pending requests in the queue. When the time allocated for the window expires, processing stops.</p> <p>The Backplane Communications Window defaults to Complete (Run to Completion) mode. This means that all currently pending requests on all intelligent option modules are processed every sweep. This window can also run in Limited mode, in which the maximum time allocated for the window per scan is specified.</p> <p>The mode and time limit can be configured and stored to the CPU, or it can be dynamically controlled from the user program using Service Request function #4. The Backplane Communications Window time can be set to a value from 0 to 255ms (default is 255ms). This allows communications functions to be skipped during certain time-critical sweeps.</p>

Phase	Activity
Background Window	<p>CPU self-tests occur in this window.</p> <p>A CPU self-test is performed in this window. Included in this self-test is a verification of the checksum for the CPU operating system software.</p> <p>The Background Window time defaults to 0 ms. A different value can be configured and stored to the CPU, or it can be changed online using the programming software.</p> <p>Time and execution of the Background Window can also be dynamically controlled from the user program using Service Request function #5. This allows background functions to be skipped during certain time-critical sweeps.</p>

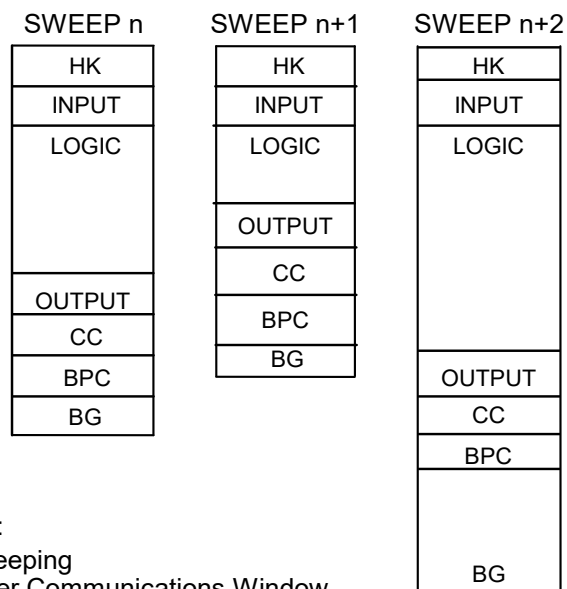
4.1.2 CPU Sweep Modes

4.1.2.1 Normal Sweep Mode

In Normal Sweep mode, each sweep can consume a variable amount of time. The Logic window is executed in its entirety each sweep. The Communications windows can be set to execute in a Limited or Run-to-Completion mode. Normal Sweep is the most common sweep mode used for control system applications.

The following figure illustrates three successive CPU sweeps in Normal Sweep mode. Note that the total sweep times may vary due to sweep-to-sweep variations in the Logic window, Communications windows, and Background window.

Figure 41: Typical Sweeps in Normal Sweep Mode



Abbreviations:
 HK = Housekeeping
 CC = Controller Communications Window
 BPC = Backplane Communications Window
 BG = Background Window

4.1.2.2 Constant Sweep Mode

In Constant Sweep mode, each sweep begins at a specified Constant Sweep time after the previous sweep began. The Logic Window is executed in its entirety each sweep. If there is sufficient time at the end of the sweep, the CPU alternates among the Controller Communications, Backplane Communications, and Background Windows, allowing them to execute until it is time for the next sweep to begin. Some or all of the Communications and Background Windows may not be executed. The Communications and Background Windows terminate when the overall CPU sweep time has reached the value specified as the Constant Sweep time.

One reason for using Constant Sweep mode is to ensure that I/O data are updated at constant intervals.

The value of the Constant Sweep timer can be configured to be any value from 5 to 2550 ms. The Constant Sweep timer value may also be set and Constant Sweep mode may be enabled or disabled by the programming software or by the user program using Service Request function #1. The Constant Sweep timer has no default value; a timer value must be set prior to or at the same time Constant Sweep mode is enabled.

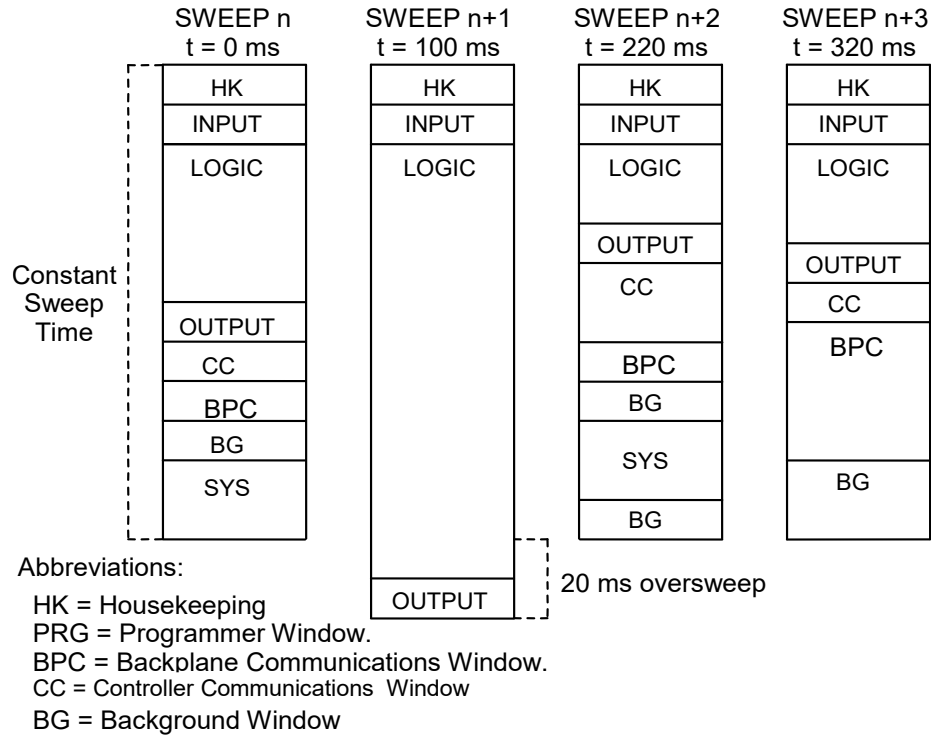
The Ethernet Global Data⁷⁰ page, configured for either consumption or production, can add up to 1 ms to the sweep time. This sweep impact should be considered when configuring the CPU constant sweep mode and setting the CPU watchdog timeout.

If the sweep exceeds the Constant Sweep time in a given sweep, the CPU places an oversweep alarm in the CPU fault table and sets the OV_SWP (%SA0002) status reference at the beginning of the next sweep. Additional sweep time due to an oversweep condition in a given sweep does not affect the time given to the next sweep.

The following figure illustrates four successive sweeps in Constant Sweep mode with a Constant Sweep time of 100 ms. Note that the total sweep time is constant, but an oversweep may occur due to the Logic Window taking longer than normal.

Figure 42: Typical Sweeps in Constant Sweep Mode

⁷⁰ For EGD configured on Embedded Ethernet interface of CPE302/CPE305/CPE310, refer to A.3.6 for Constant sweep impact.
CPU Operation



4.1.2.3 Constant Window Mode

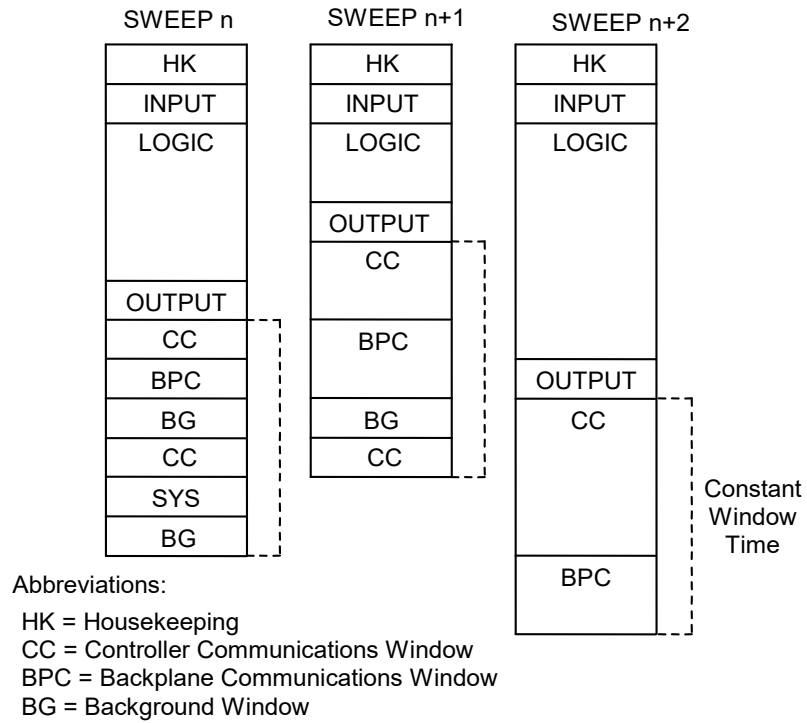
In Constant Window mode, each sweep can consume a variable amount of time. The Logic Window is executed in its entirety each sweep. The CPU alternates among the three windows, allowing them to execute for a time equal to the value set for the Constant Window timer. The overall CPU sweep time is equal to the time required to execute the Housekeeping, Input Scan, Logic Window, and Output Scan phases of the sweep plus the value of the Constant Window timer. This time may vary due to sweep-to-sweep variances in the execution time of the Logic Window.

An application that requires a certain amount of time between the Output Scan and the Input Scan, permitting inputs to settle after receiving output data from the program, would be ideal for Constant Window mode.

The value of the Constant Window timer can be configured to be any value from 3 to 255 ms. The Constant Window timer value may also be set by the programming software or by the user program using Service Request functions #3, #4, and #5.

The following figure illustrates three successive sweeps in Constant Window mode. Note that the total sweep times may vary due to sweep-to-sweep variations in the Logic Window, but the time given to the Communications and Background Windows is constant. Some of the Communications or Background Windows may be skipped, suspended, or run multiple times based on the Constant Window time.

Figure 43: Typical Sweeps in Constant Window Mode



4.2 Program Scheduling Modes

The CPU supports one program scheduling mode: the Ordered mode. An ordered program is executed in its entirety once per sweep in the Logic Window.

4.3 Window Modes

The previous section describes the phases of a typical CPU sweep. The Controller Communications, Backplane Communications, and Background windows can be run in various modes, based on the CPU sweep mode. The following three window modes are available:

Mode Type	Description
Run-to-Completion	In Run-to-Completion mode, all requests made when the window has started are serviced. When all pending requests in the given window have completed, the CPU transitions to the next phase of the sweep. (This does not apply to the Background window because it does not process requests.)
Constant	In Constant Window mode, the total amount of time that the Controller Communications window, Backplane Communications window, and Background window run is fixed. If the time expires while in the middle of servicing a request, these windows are closed, and communications will be resumed the next sweep. If no requests are pending in this window, the CPU cycles through these windows the specified amount of time polling for further requests. If any window is put in constant window mode, all are in constant window mode.
Limited	In Limited mode, the maximum time is fixed for the execution of the window. If time expires while in the middle of servicing a request, the window is closed, and communications will be resumed the next time that the given window is run. If no requests are pending in this window, the CPU proceeds to the next phase of the sweep.

4.4 Data Coherency in Communications Windows

When running in Constant or Limited Window mode, the Controller and Backplane Communications Windows may be terminated early in all CPU sweep modes. If an external device, such as CIMPLICITY HMI, is transferring a block of data, the coherency of the data block may be disrupted if the communications window is terminated prior to completing the request. The request will complete during the next sweep; however, part of the data will have resulted from one sweep and the remainder will be from the following sweep. When the CPU is in Normal Sweep mode and the Communications Window is in Run-to-Completion mode, the data coherency problem described above does not exist.

Note: External devices that communicate to the CPU while it is stopped will read information as it was left in its last state. This may be misleading to operators viewing an HMI system that does not indicate CPU Run/Stop state. Process graphics will often indicate everything is still operating normally.

Also, note that non-retentive outputs do not clear until the CPU is transitioned from Stop to Run.

4.5 Run/Stop Operations

The PACSystems CPUs support four RUN/STOP Modes of operation. You can change these modes in the following ways: the RUN/STOP Switch, configuration from the programming software, LD function blocks, and system calls from C applications. Switching to and from various modes can be restricted based on privilege levels, position of the RUN/STOP Switch, passwords, etc.

Mode	Operation
Run/Outputs Enabled	The CPU runs user programs and continually scans inputs and updates physical outputs, including Genius and Ethernet outputs. The Controller and Backplane Communications Windows are run in Limited, Run-to-Completion, or Constant mode.
Run/Outputs Disabled	The CPU runs user programs and continually scans inputs, but updates to physical outputs, including Genius and Field Control, are not performed. Physical outputs are held in their configured default state in this mode. The Controller and Backplane Communications Windows are run in Limited, Run-to-Completion, or Constant mode.
Stop/I/O Scan Enabled	The CPU does not run user programs, but the inputs and outputs are scanned. The Controller and Backplane Communications Windows are run in Run-to-Completion mode. The Background Window is limited to 10ms.
Stop/I/O Scan Disabled	The CPU does not run user programs, and the inputs and outputs are not scanned. The Controller and Backplane Communications Windows are run in a Run-to-Completion mode. The Background Window is limited to 10ms. Note: STOP Mode I/O scanning is always disabled for redundancy CPUs.

Note: You cannot add to the size of %P and %L reference tables in RUN Mode unless the %P and %L references are the first of their type in the block being stored or the block being stored is a totally new block.

4.5.1 CPU STOP Modes

The CPU has four modes of operation while it is in STOP Mode. The two most common are:

4.5.1.1 STOP-I/O Enabled Mode

I/O Scan Enabled - the Input and Output scans are performed each sweep.

4.5.1.2 STOP-I/O Disabled Mode

I/O Scan Disabled - the Input and Output scans are skipped.

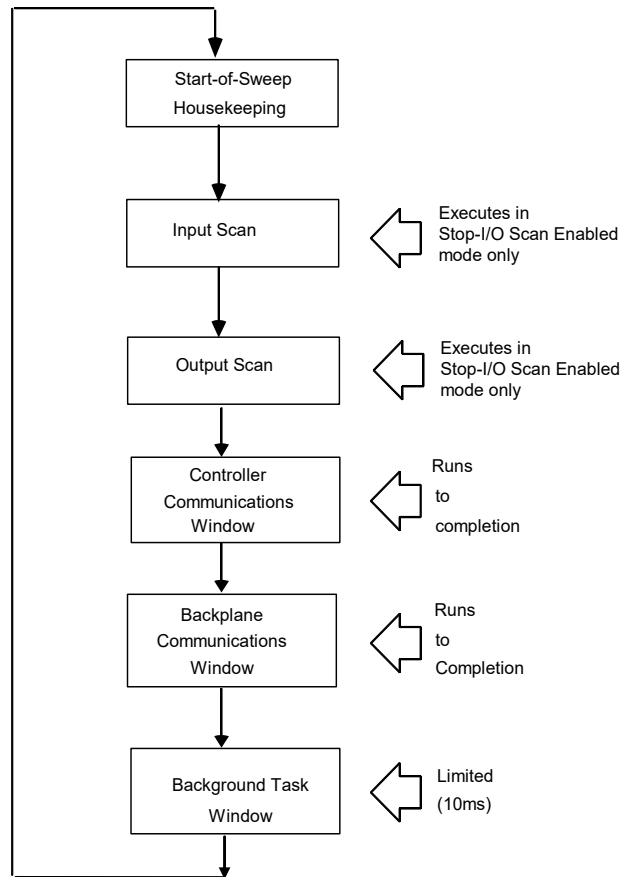
When the CPU is in STOP Mode, it does not execute the application program. You can configure whether the I/O is scanned during STOP Mode. Communications with the programmer and intelligent option modules continue in STOP Mode. Also, bus receiver module polling and rack reconfiguration continue in STOP Mode.

In both STOP Modes, the Controller Communications and Backplane Communications windows run in Run-to-Completion mode and the Background window runs in Limited mode with a 10 ms limit.

The number of last scans can be configured in the hardware configuration. Last scans are completed after the CPU has received an indication that a transition from Run to Stop or Stop Faulted mode should occur. The default is 0.

SVCREQ13 can be used in the application program to stop the CPU after a specified number of scans. All I/O will go to their configured default states, and a diagnostic message will be placed in the CPU Fault Table.

Figure 44: CPU Sweep in Stop-I/O Disabled and Stop-I/O Enabled Modes



4.5.1.3 STOP-Halt Mode

The CPU will automatically go into STOP-Halt mode and suspend logic execution and I/O scanning for the following conditions:

- Software Watchdog timeout
- ECC Memory Check fault
- Illegal memory access from a C-Block
- Hardware Watchdog timeout. This condition resets the CPU and suspends backplane communications.

To recover from STOP-Halt mode, the CPU/CPE must be disconnected from its backup power source (battery or Energy Pack), powered off, then powered back on, after which the backup power source should be reconnected. The CPE400/CPL410 provides an alternative way to recover from STOP-Halt mode by means of the OLED display and without the need of removing the Energy Pack. The section below described this alternative.

To enable backplane communications where they have been disabled in STOP-Halt mode, cycle power with its backup power source attached (battery or Energy Pack).

While the CPU is in STOP-Halt mode, the PACS Analyzer tool may be employed to examine the CPU's fault tables. The PACS Analyzer software is a tool that is embedded in PME. It can also be downloaded from Emerson's support website. (See link located at the end of this document.)

If backplane communications have been suspended, the PACS Analyzer must be directly connected to a serial or Ethernet port on the CPU. If backplane communications are operational, the PACS Analyzer may be connected via a communications or Ethernet module in the backplane, or to a CPU-embedded port.

RX3i CPE302/CPE305/CPE310/CPE330/CPE400/CPL410 and RSTi-EP CPE100/CPE115 CPU models only: The programmer can connect to these CPUs in STOP-Halt mode through the embedded Ethernet port without a reset or power cycle.

4.5.1.3.1 Recovering from STOP-Halt mode (CPE400/CPL410 Only)

The CPE400/CPL410 provides the ability to recover from STOP-Halt mode using the OLED display and without the need of removing the Energy Pack. This recovery mechanism is particularly effective when the PLC is configured to power up in RUN mode from Flash and the user logic contains code that causes the CPU to go into STOP-Halt mode (e.g., exceeding Software Watchdog, or accessing an illegal memory location from a C-Block). Once the user applies the STOP-Halt recovery mechanism the CPU will automatically reset and will come up in STOP mode, preventing executing of the offending user code. At this point the user can connect to the CPU and perform the necessary changes.

The following are the steps to apply the STOP-Halt recovery:

1. Collect a PACSAnalyzer trace prior to performing the rest of the steps. Once the recovery is applied, the CPU clears its Energy Pack memory. The User Flash memory is not automatically cleared.
2. Navigate to the "Controller Status" page in the OLED Display.
3. Select the "Recovery PLC" option.
4. Select the "Clear StopHalt" option.

5. Confirm the command by selecting “OK”.
 - The message “Please wait. Resetting in about 30 secs” appears in the display.
 - After about 30 seconds, the PLC restarts.
 - After the restart, the PLC will be in STOP mode. The STOP-Halt mode is gone.
 - The following faults are present in the Controller Fault table:
 - “User memory not preserved.” Error Code: 7. Group: 130
 - “User Initiated Recovery Action: Controller commanded to power up in Stop Mode.” Error Code: 670. Group: 140
6. Connect to the PLC and perform the necessary corrections. If the PLC is placed in RUN mode without fixing the offending code, the PLC will enter STOP-Halt and the procedure will have to be performed again.

4.5.1.3.2 Recovering from STOP-Halt mode RSTi-EP Controllers (CPE100/CPE115)

To recover the controller from a Stop/Halt state, complete the following:

1. Connect a live Ethernet cable to LAN1.
2. Press and hold the membrane Run/Stop pushbutton and power down the controller.
3. Continue holding the Run/Stop push button until power has drained completely (30 seconds) and then release the pushbutton. The LEDs for the LAN1 port will turn off completely. Note: Ethernet LEDs may blink slowly during shutdown.
4. Reconnect power and power on the controller. Note: If the configuration and logic was downloaded into flash and the Power-up Mode parameter is also set as flash then, the only way to recover from Stop/Halt state is to perform a factory reset.

4.5.1.4 STOP-Fault Mode

In STOP-Fault Mode, logic execution and I/O Scanning cease after the number of last scans (configured by the user) has been exhausted. Client communications also cease at that time. Server communications are available, but with PLC data which has become static.

Within PME, the user can configure each fault action to be either *diagnostic* or *fatal*.

- A diagnostic fault does not stop the Controller from executing logic. It sets a diagnostic variable and is logged in a fault table.
- A fatal fault transitions the Controller to the STOP-Fault Mode. It also sets a diagnostic variable and is logged in a fault table.

Within PME, the user can also configure the number of last scans to be executed in the event of a fault (see PME Scans tab, *Number of Last Scans* parameter).

To recover from STOP-Fault Mode, resolve the underlying cause and clear the Controller Fault Table. This allows the CPU to transition to STOP-I/O Disabled Mode.

4.5.2 STOP-to-RUN Mode Transition

The CPU performs the following operations on Stop-to-Run transition:

- Validation of sweep mode and program scheduling mode selections
- Validation of references used by programs with the actual configured sizes
- Re-initialization of data areas for external blocks and standalone C programs
- Clearing of non-retentive memory

4.6 Flash Memory Operation

The CPU stores the current configuration and application in user memory (either battery-backed RAM or non-volatile user memory, depending on the CPU model). You can also store the Logic, Hardware Configuration, and Reference Data into non-volatile flash memory. The PACSystems CPU provides enough flash memory to hold all of user space, all reference tables that aren't counted against user space, and any overhead required. For details on which items count against user memory space, refer to A-1.20.

By default, the CPU reads program logic and configuration, and reference table data from user memory at power-up. However, logic/configuration and reference tables can each be configured to always read from flash or conditionally read from flash. To configure these parameters in the programming software, select the CPU's Settings tab in Hardware Configuration.

If logic/configuration and/or reference tables are configured for conditional power-up from flash, these items are restored from flash to user memory when the user memory is corrupted or was not preserved (for example, the memory backup battery or Energy Pack is not installed or not operational). If logic/configuration and/or reference memory are configured for conditional power-up from flash and user memory has been preserved, no flash operation will occur.

If logic/configuration and/or reference tables are configured to always power up from flash, these items are restored from flash to user memory regardless of the state of the user memory.

- **Note:** If *any* component (logic/configuration or reference tables) is read from flash, OEM-mode and passwords are also read from flash.

In addition to configuring where the CPU obtains logic, configuration, and data during power-up, the programming software provides the following flash operations:

- Write a copy of the current configuration, application program, and reference tables (excluding overrides) to flash memory. Note that a write-to-flash operation causes all components to be stored to flash.
- Read a previously stored configuration and application program, and/or reference table values from flash into user memory.
- Verify that flash and user memory contain identical data.
- Clear flash contents.

Flash read and write operations copy the contents of flash memory or user memory as individual files. The programming software displays the progress of the copy operation and allows you to cancel a flash read or write operation during the copy process instead of waiting for the entire transfer process to complete. The entire user memory image must be successfully transferred for the flash copy to be

considered successful. If an entire write-to-flash transfer is not completed due to canceling, power cycle, or some other intervention, the CPU will clear flash memory. Similarly, if a read-from-flash transfer is interrupted, user memory will be cleared.

4.6.1 RUN/STOP Switch Operation

The RUN/STOP Switch is a 3-position switch which operates as follows:

Switch Position	CPU and Sweep Mode	Memory Protection
RUN I/O or RUN I/O Enable	The CPU runs with I/O sweep enabled.	User program memory is read only.
RUN or RUN Output Disable	The CPU runs with outputs disabled.	User program memory is read only.
STOP	The CPU is not allowed to go into RUN Mode.	User program memory can be written.

The RUN/STOP Switch can be disabled in the programming software HWC. The memory protection function of the switch can be disabled separately in HWC. The RUN/STOP Switch is enabled by default. The memory protection functionality is disabled by default.

The Read Switch Position (Switch_Pos) function allows the logic to read the current position of the RUN/STOP Switch, as well as the mode for which the switch is configured. For details, refer to *PACSystems RX3i and RSTi-EP CPU Programmer's Reference Manual*, GFK-2950.

4.7 Logic/Configuration Source and CPU Operating Mode at Power-Up

Flash and user memory can contain different values for the Logic/Configuration Power-up Source parameter. The following tables summarize how these settings determine the logic/configuration source after a power cycle. CPU mode is affected by the Power-up Mode, the RUN/STOP Switch and Stop-Mode I/O Scanning parameters, the physical RUN/STOP Mode Switch position, and the Power Down Mode as shown in sections 4.7.1 and 4.7.3.

Before Power Cycle		After Power Cycle	
Logic/Configuration Power-up Source in Flash	Logic/Configuration Power-up Source in RAM	Origin of Logic/Configuration	CPU Mode
Always Flash	Memory not preserved (i.e. no battery/Energy Pack, or memory corrupted)	Flash	See <i>CPU Mode when Memory Not Preserved/Power-up Source is Flash.</i>
Always Flash	No configuration in RAM, memory preserved	Flash	See <i>CPU Mode when Memory Preserved.</i>
Always Flash	Always Flash	Flash	
Always Flash	Conditional Flash	Flash	
Always Flash	Always RAM	Flash	
Conditional Flash	Memory not preserved (i.e. no battery/Energy Pack or memory corrupted)	Flash	See <i>CPU Mode when Memory Not Preserved/Power-up Source is Flash.</i>
Conditional Flash	No configuration in RAM, memory preserved	Uses default logic/configuration	Stop Disabled
Conditional Flash	Always Flash	RAM	See <i>CPU Mode when Memory Preserved.</i>
Conditional Flash	Conditional Flash	RAM	
Conditional Flash	Always RAM	RAM	
Always RAM	Memory not preserved (i.e. no battery/Energy Pack, or memory corrupted)	Uses default logic/configuration	Stop Disabled
Always RAM	No configuration in RAM, memory preserved	Uses default logic/configuration	Stop Disabled
Always RAM	Always Flash	Flash	See <i>CPU Mode when Memory Preserved.</i>
Always RAM	Conditional Flash	RAM	
Always RAM	Always RAM	RAM	
No Configuration in Flash	Memory not preserved (i.e. no battery/Energy Pack, or memory corrupted)	Uses default logic/configuration	Stop Disabled
No Configuration in Flash	No configuration in RAM, memory preserved	Uses default logic/configuration	Stop Disabled
No Configuration in Flash	Always Flash	RAM	See <i>CPU Mode when Memory Preserved.</i>
No Configuration in Flash	Conditional Flash	RAM	
No Configuration in Flash	Always RAM	RAM	

4.7.1

4.7.2 CPU Mode when Memory Not Preserved/Power-up Source is Flash

Configuration Parameters		RUN/STOP Switch Position	CPU Mode
Power-up Mode	RUN/STOP Switch		
Run	Enabled	Stop	Stop Disabled
Run	Enabled	Run Disabled	Run Disabled
Run	Enabled	Run Enabled	Run Enabled
Run	Disabled	N/A	Run Disabled
Stop	N/A	N/A	Stop Disabled
Last	Enabled	Stop	Stop Disabled
Last	Enabled	Run Disabled	Run Disabled
Last	Enabled	Run Enabled	Run Disabled
Last	Disabled	N/A	Run Disabled

4.7.3 CPU Mode when Memory Preserved

Configuration Parameters			RUN/STOP Switch Position	Power Down Mode	CPU Mode
Power-up Mode	RUN/STOP Switch	Stop-Mode I/O Scanning			
Run	Enabled	Enabled	Stop	N/A	Stop Enabled
Run	Enabled	Disabled	Stop	N/A	Stop Disabled
Run	Enabled	N/A	Run Disabled	N/A	Run Disabled
Run	Enabled	N/A	Run Enabled	N/A	Run Enabled
Run	Disabled	N/A	N/A	N/A	Run Enabled
Stop	N/A	Enabled	N/A	N/A	Stop Enabled
Stop	N/A	Disabled	N/A	N/A	Stop Disabled
Last	Enabled	Enabled	Stop	Stop Disabled	Stop Disabled
Last	Enabled	Enabled	Stop	Stop Enabled	Stop Enabled
Last	Enabled	Enabled	Stop	Run Disabled	Stop Enabled
Last	Enabled	Enabled	Stop	Run Enabled	Stop Enabled
Last	Enabled	Disabled	Stop	N/A	Stop Disabled
Last	Enabled	N/A	Run Disabled	Stop Disabled	Stop Disabled
Last	Enabled	Enabled	Run Disabled	Stop Enabled	Stop Enabled
Last	Enabled	Disabled	Run Disabled	Stop Enabled	Stop Disabled
Last	Enabled	N/A	Run Disabled	Run Disabled	Run Disabled
Last	Enabled	N/A	Run Disabled	Run Enabled	Run Disabled
Last	Enabled	N/A	Run Enabled	Stop Disabled	Stop Disabled
Last	Enabled	Enabled	Run Enabled	Stop Enabled	Stop Enabled
Last	Enabled	Disabled	Run Enabled	Stop Enabled	Stop Disabled
Last	Enabled	N/A	Run Enabled	Run Disabled	Run Disabled
Last	Enabled	N/A	Run Enabled	Run Enabled	Run Enabled
Last	Disabled	N/A	N/A	Stop Disabled	Stop Disabled
Last	Disabled	Enabled	N/A	Stop Enabled	Stop Enabled
Last	Disabled	Disabled	N/A	Stop Enabled	Stop Disabled
Last	Disabled	N/A	N/A	Run Disabled	Run Disabled
Last	Disabled	N/A	N/A	Run Enabled	Run Enabled

4.8 Clocks and Timers

Clocks and timers provided by the CPU include an elapsed time clock, a time-of-day clock, and software and hardware watchdog timers.

For information on timer functions and timed contacts provided by the CPU instruction set, refer to *Timers* in *PACSystems RX3i and RSTi-EP CPU Programmer's Reference Manual*, GFK-2950.

4.8.1 Elapsed Time Clock

The elapsed time clock tracks the time elapsed since the CPU powered on. The clock is not retentive across a power failure; it restarts on each power-up. This seconds count rolls over (seconds count returns to zero) approximately 100 years after the clock begins timing.

Because the elapsed time clock provides the base for system software operations and timer function blocks, it may not be reset from the user program or the programmer. However, the application program can read the current value of the elapsed time clock by using Service Request #16 or Service Request #50, which provides higher resolution.

4.8.2 Time-of-Day Clock

A hardware time-of-day clock maintains the time-of-day (TOD) in the CPU. The time-of-day clock maintains the following time functions:

- Year (two digits)
- Month
- Day of month
- Hour
- Minute
- Second
- Day of week

The TOD clock is battery-backed and maintains its present state across a power failure. The time-of-day clock handles month-to-month and year-to-year transitions and automatically compensates for leap years through year 2036.

You can read and set the hardware TOD time and date through the application program using Service Request function #7. For details, refer to *PACSystems RX3i and RSTi-EP CPU Programmer's Reference Manual*, GFK-2950 Section 6.

4.8.2.1 High-Resolution Time of Day Software Clock

A high-resolution software TOD clock is implemented in firmware to provide nanoseconds resolution. When the high-resolution software TOD clock is set, the hardware TOD clock is set with the YYYY: Mon: Day: Hr: Min: Sec fields in the POSIX⁷¹ time, the RTC is read, and the delta between the POSIXtime and the value read from the RTC is computed and saved. Thus, if 1-second resolution is

⁷¹ RSTi-EP CPE100/CPE115 does not allow the Time-of-Day clock to be set older than 1st Jan, 2001 when POSIX format is used along with SVC_REQ 7.
CPU Operation

desired the hardware TOD clock is read. Otherwise, the high-resolution software TOD clock is read to provide greater resolution. When the latter occurs, the hardware RTC is read and the saved delta added to the value read.

When the SNTP Time Transfer feature is implemented, all SNTP time updates received at the CPU will cause the high-resolution software TOD clock to be updated.

4.8.2.2 Synchronizing the High-resolution Time of Day Clock to an SNTP Network Time Server

In an SNTP system, a computer on the network (called an SNTP server) sends out a periodic timing message to all SNTP-capable Ethernet Interfaces on the network, which synchronize their internal clocks with this SNTP timing message. If SNTP is used to perform network time synchronization, the time-stamp information typically has ± 10 ms accuracy between controllers on the same network.

Synchronizing the CPU TOD clock to an SNTP server allows you to set a consistent time across multiple systems. Once the CPU TOD clock has been synchronized with the SNTP time, all produced EGD exchanges will use the CPU TOD current value for the time-stamp.

The CPU TOD clock is set with accuracy within ± 2 ms of the SNTP time-stamp.

TOD clock synchronization is enabled on an Ethernet module by the advanced user parameter (AUP), *ncpu_sync*. The CPU must also use a COMMREQ in user logic to select an Ethernet module as the time master. For additional information, refer to *Time-stamping of Ethernet Global Data Exchanges in PACSystems RX3i and RSTi-EP TCP/IP Ethernet Communications User Manual*, GFK-2224 Section 4.

4.8.3 Watchdog Timer

4.8.3.1 Software Watchdog Timer

A software watchdog timer in the CPU is designed to detect *failure to complete sweep* conditions. The timer value for the software watchdog timer is set by using the programming software. The allowable range for this timer is 10 ms to 2550 ms; the default value is 200 ms. The software watchdog timer always starts from zero at the beginning of each sweep.

The software watchdog timer is useful in detecting abnormal operation of the application program that prevents the CPU sweep from completing within the user-specified time. Examples of such abnormal application program conditions are as follows:

- Excessive recursive calling of a block
- Excessive looping (large loop count or large amounts of execution time for each iteration)
- Infinite execution loop

When selecting a software watchdog value, always set the value higher than the longest expected sweep time to prevent accidental expiration. For Constant Sweep mode, allowance for over sweep conditions should be considered when selecting the software watchdog timer value.

Refer to Section, 0 for *EGD Sweep Impact for RX3i CPE302/CPE305/CPE310 and RSTi-EP CPE100/CPE115 Embedded Ethernet Interface*.

The watchdog timer continues during interrupt execution. Queuing of interrupts within a single sweep may cause watchdog timer expiration.

If the software watchdog timeout value is exceeded, the OK LED blinks, and the CPU goes to STOP-Halt mode⁷². Certain functions, however, are still possible. A fault is placed in the CPU fault table, and outputs go to their default state. The CPU will only communicate with the programmer; no other communications or operations are possible. To recover, power must be cycled on the rack or backplane containing the CPU.

To extend the current sweep beyond the software watchdog timer value, the application program may restart the software watchdog timer using Service Request function #8. However, the software watchdog timer value may only be changed from the configuration software.

Note that Service Request Function #8 does not reset the output scan timer implemented on the Genius Bus Controller.

4.8.3.2 Hardware Watchdog Timer

A backup circuit provides additional protection for the CPU. If this backup circuit activates, the CPU is immediately Reset. Outputs go to their default states, no communications of any kind are possible, and the CPU halts. The recovery procedure is documented below.

There are two basic forms of hardware watchdog:

- 1) for RX3i CPE302, CPE305, CPE310, CPE330, CPE400, CPL410 and RSTi-EP CPE100/CPE115, a watchdog reset results in an automatic restart into STOP-Halt mode;
- 2) for RX3i CPU310, CPU315, CPU320 and all CPUs, the watchdog reset holds the CPU in reset until the next power cycle. There is no automatic restart. If a charged battery is connected, the power cycle will result in a restart into STOP-Halt mode.

For both watchdog reset types, the CPU is power cycled after the energy pack (for the CPE models), or battery (for the other models listed) has been removed. This procedure gets the CPU out of STOP-Halt. The backup power source should then be reconnected.

4.8.3.2.1 RX3i CPU Response to a Hardware Watchdog Timeout:

The following responses to a hardware watchdog timeout are common to all RX3i CPU and CPE models:

- While the CPU/CPE is in STOP-Halt mode, you can connect the programmer software or PACs Analyzer to view the fault tables, including any faults logged before the timeout. (See below for distinctions between CPU and CPE behavior.) The PACS Analyzer software is a tool that is embedded in PME. It can also be downloaded from Emerson's support website.
- During startup following hardware watchdog reset, the CPU/CPE logs an *informational fault* with Error Code 446, which indicates a watchdog auto-reset occurred.

The following responses to a hardware watchdog timeout are different between RX3i CPU and RX3i CPE models:

- RX3i CPU310, CPU315, and CPU320 retain Controller and I/O Fault tables after a hardware watchdog timeout.
- RX3i CPE302, CPE305, CPE310, CPE330, CPE400, CPL410 and RSTi-EP CPE100/CPE115 do not retain Controller and I/O Fault tables following a hardware watchdog timeout.

Note: PACSystems does not support Fatal Fault Retries.

⁷² RSTi-EP CPE100/CPE115 may remain in STOP-HALT mode even after power cycle. To recover it from STOP-HALT mode, power down the module after pressing and holding the membrane switch.

4.9 System Security

PACSystems CPUs support two types of system security:

- Passwords/privilege levels
- OEM protection

CPU versions 7.80 and later support Enhanced Security (including merged password tables). This provides a more secure mechanism for setting and authenticating passwords and OEM keys versus the Legacy Security Mode. Refer to the *Important Product Information* document for the CPU model and firmware version that you are using for any additional information.

For Enhanced Security operation, see Section 4.9.3, *Enhanced Security for Passwords and OEM Protection*. A summary of operational differences between Enhanced and Legacy Security modes is provided in Section Legacy/Enhanced Security Comparison.

4.9.1 Passwords and Privilege Levels - Legacy Mode

PACSystems CPUs are equipped with password management. Passwords are disabled by default, but can be enabled, disabled, or configured with PAC Machine Edition (PME). When in Online mode, PLCs can be password protected at varying privilege levels (1-4). (Passwords are not enabled when the PLC is in Offline mode.) Passwords are unique to the PLC (and subsequently each access level), but will be shared between users. Unique passwords cannot be assigned to individual users.

NOTE:

- Duplicate passwords may be used on different privilege levels. For example, Level 1 and Level 2 may share the same password.
- Passwords must be between one and seven ASCII characters in length.

After passwords have been configured, access to the CPU data will be restricted to the user's privilege level. Higher privilege levels will provide access to lower privilege levels. For example, users with a Level 4 Privilege Level will be able to access privileges at *all* privilege levels.

Note: The RUN/STOP Switch on the CPU overrides password protection. Even though the programmer may not be able to switch between RUN and STOP Mode, the switch on the CPU can do so.

4.9.1.1 Privilege Levels

There are four different privilege levels. Level 1 provides the least access and Level 4 provides the most access. The current privilege level is identified by the padlock icon on bottom row of PME screen. (For example, the icon will display that the PLC is in privilege Level 2). Please see

Table 4-1 for a description of CPU Privilege Levels.

Table 4-1: CPU Privilege Levels

Level	Password	Access Description
4	Yes	Write to configuration or logic. Configuration may only be written in STOP Mode; logic may be written in STOP Mode or RUN Mode. Set or delete passwords for any level. Note: This is the default privilege for a connection to the CPU if no passwords are defined.
3	Yes	Write to configuration or logic when the CPU is in STOP Mode, including word-for-word changes, addition/deletion of program logic, and the overriding of discrete I/O.
2	Yes	Write to any data memory. This does not include overriding discrete I/O by applying a force. The CPU can be started or stopped. CPU and I/O Fault Tables can be cleared.
1	Yes	Read any CPU data except for passwords. This includes reading fault tables, performing datagrams, verifying logic/configuration, loading program and configuration, etc. from the CPU. None of this data may be changed. At this level, RUN/STOP Mode transitions from the programmer are not allowed.

Please refer the table below for more information on the PLC operation restrictions in each privilege level (Yes – Allowed; No – Restricted).

Table 4-2: PLC Operation Categorized by PLC Privilege Level

PLC Operations	PLC mode	PLC Privilege Level			
		Level 1	Level 2	Level 3	Level 4
Write to Data Memory	RUN	No	Yes	Yes	Yes
	STOP	No	Yes	Yes	Yes
Read from Data Memory	RUN	Yes	Yes	Yes	Yes
	STOP	Yes	Yes	Yes	Yes
Discrete I/O override	RUN	No	No	Yes	Yes
	STOP	No	No	Yes	Yes
RUN/STOP transitions	RUN	No	Yes	Yes	Yes
	STOP	No	Yes	Yes	Yes
Verify Logic	RUN	Yes	Yes	Yes	Yes
	STOP	Yes	Yes	Yes	Yes
Verify Configuration	RUN	Yes	Yes	Yes	Yes
	STOP	Yes	Yes	Yes	Yes
Read Fault tables	RUN	Yes	Yes	Yes	Yes
	STOP	Yes	Yes	Yes	Yes
Clear fault tables	RUN	No	Yes	Yes	Yes
	STOP	No	Yes	Yes	Yes
Addition of program logic	RUN	No	No	No	Yes
	STOP	No	No	Yes	Yes
Deletion of program logic	RUN	No	No	No	Yes
	STOP	No	No	Yes	Yes
Download Logic	RUN	No	No	No	Yes
	STOP	No	No	Yes	Yes
Download Configuration	RUN	No	No	No	Yes
	STOP	No	No	Yes	Yes
Upload Logic	RUN	Yes	Yes	Yes	Yes
	STOP	Yes	Yes	Yes	Yes
Upload Configuration	RUN	Yes	Yes	Yes	Yes

	STOP	Yes	Yes	Yes	Yes
Set Passwords for any Level	RUN	No	No	No	Yes
	STOP	No	No	No	Yes
Delete Passwords for any Level	RUN	No	No	No	Yes
	STOP	No	No	No	Yes
Modbus Writes	RUN	No	No	Yes	Yes
	STOP	No	No	Yes	Yes
Modbus Reads	RUN	Yes	Yes	Yes	Yes
	STOP	Yes	Yes	Yes	Yes
SRTP Writes	RUN	No	Yes	Yes	Yes
	STOP	No	Yes	Yes	Yes
SRTP Reads	RUN	Yes	Yes	Yes	Yes
	STOP	Yes	Yes	Yes	Yes

4.9.1.2 Privilege Level Request from PAC Machine Edition

The CPU Privilege Level is configured by PME. In Legacy mode, upon connection to the CPU, PME will request the CPU to move to the highest non-protected level. The user can request a higher (or lower) privilege level by supplying the password for the desired privilege level in PME.

If the password sent by PME does not match the password stored in the CPU's password access table for the requested level, the privilege level change is denied, the current privilege level is maintained, and a fault is logged in the CPU fault table.

Note:

- A request to change to a privilege level that is not password protected is made by supplying the new level and a null password.

If no passwords are defined, the default privilege level for a connection to the CPU is Privilege Level 4.

If a password is defined for any privilege level, then the default access level for a connection to the CPU is set to one level below. (For example, if password is defined for Level 4 then on the next connect, the PLC access level is set to Level 3, if a password is defined for Level 3 & Level 4, then on the next connection, the PLC Privilege Level is Level 2). Please refer the table Table 4-3 for details.

Table 4-3: Privilege Level After Password Config

The following table applies when passwords are defined with the following protocol conditions:

- Modbus TCP Protocol

Passwords Defined				Privilege Level on Connection
Level 1	Level 2	Level 3	Level 4	
No	Yes	Yes	Yes	Level 1
No	No	Yes	Yes	Level 2
No	No	No	Yes	Level 3
No	No	Yes	No	Level 2
No	Yes	No	No	Level 1

Table 4-4: Privilege Level After Password Config

The following table applies when passwords are defined with the following protocol conditions:

- PME Connection with SRTP Protocol

PME SRTP will connect and obtain the highest access level that has no password set.

Note: SRTP password levels are obtained on a per session basis. For example, obtaining Level 4 access on a PME connection does *NOT* automatically permit Level 4 access on any other SRTP session. Each SRTP Connection session must obtain its own access level.

Passwords Defined				Privilege Level on Connection
Level 1	Level 2	Level 3	Level 4	
No	Yes	Yes	Yes	Level 1
No	No	Yes	Yes	Level 2
No	No	No	Yes	Level 3
No	No	Yes	No	Level 4
No	Yes	No	No	Level 4

4.9.1.3 Maintaining Passwords through a Power Cycle

Initial passwords are blank for a new controller or a controller that has its passwords cleared. For passwords to be maintained through power cycles, the controller must either:

- Store to RAM and use an Energy Pack or battery to maintain memory.
- Store to User Flash with configuration set up to load from Flash at power up.

4.9.1.4 Disabling Passwords

The use of password protection is optional. Passwords can be disabled using the programming software.

Note: To enable passwords after they have been disabled, the CPU must be power cycled with the battery or Energy Pack removed.

4.9.2 OEM Protection – Legacy Mode

Original Equipment Manufacturer (OEM) protection provides a higher level of security than password levels 1 through 4. This feature allows a third-party OEM to create control programs for the CPU and then set the OEM-locked mode, which prevents the end user from reading or modifying the program.

The OEM protection feature is enabled/disabled using a 1- to 7-character password, known as the *OEM key*. When OEM protection is enabled, all read and write access to the CPU program and configuration is prohibited: any store, load, verify, or clear user program operation will fail.

4.9.2.1 OEM Protection in Systems that Load from Flash Memory

For OEM protection, it is recommended to store the program to User Flash and set configuration to always load from Flash. When setting up OEM protection it is important to download the user program to RAM and User Flash before enabling the OEM protection. For example, the following steps can be used to set up OEM protection.

1. Set OEM Key password (Must be at Access Level 4 to set OEM Key)
2. Download program to both RAM and User Flash.
3. Set OEM Protection to the Locked state (see firmware note below).

If you are storing a non-blank OEM key to flash memory, you should be careful to record the OEM key for future reference. If disabling OEM protection, be sure to clear the OEM key that is stored in flash memory.

Note: In CPU firmware versions 7.80 or later which support Enhanced Security (with merged password tables), OEM Protection Lock must be explicitly set.

In earlier versions, the OEM Protection could be enabled in User Flash without explicitly setting the OEM Protection to Locked. With the earlier firmware, a non-blank OEM Key that is loaded from User Flash at power-up would result in an automatic OEM Lock. In CPU firmware versions 7.80 or later (i.e., with merged passwords), this is no longer supported.

In firmware versions earlier than 6.01, the OEM protection was not preserved unless a battery was attached.

4.9.3 Enhanced Security for Passwords and OEM Protection

Enhanced Security passwords are supported by CPU firmware versions 7.80 or later. This feature provides a cryptographically secure password protocol between an SRTP client (for example, PAC Machine Edition) and a PACSystems controller. Enhanced Security passwords operate in a very similar fashion to the Legacy Security password operation that is supported by previous firmware versions.

Enhanced Security passwords are enabled in PME⁷³. PME requires a password in order to enable/disable the Enhanced Security mode of a target. This PME password restricts changes to the

⁷³ To determine the required PME version, refer to the Important Product Information (IPI) document provided with the CPU firmware version you are using.
CPU Operation

security mode used by a specific PME target and is independent of any passwords later configured on the controller.

Enabling Enhanced Security on a target does not force the controller to use only Enhanced Security. The controller supports both Legacy and Enhanced Security requests concurrently. For example, one PME target could be used to set initial passwords with Legacy security and a different PME target with Enhanced Security could connect and authenticate with the same controller.

Passwords set with one password mechanism (Legacy or Enhanced Security) can be authenticated and changed using the other mechanism, as long as the password is 7 ASCII characters or fewer. Setting passwords with Enhanced Security that are more than 7 characters prevents access using the Legacy mechanism. For example, you could use Enhanced Security to set a 10-character ASCII password for Level 4 and Level 3 privileges, but set a 7-character ASCII password for Level 2. In this case, a Legacy target could be used to obtain Level 2 privileges, but the Legacy target could never access Level 4 or Level 3 privileges because of 7-character ASCII limit of the Legacy scheme.

4.9.3.1 Password and OEM Protection in Systems that Load from Flash Memory

CAUTION

Be careful when setting and loading passwords from User Flash on every power-up. In this situation, it is not possible to clear passwords back to a default state if the Level 4 password and OEM key are forgotten.

For a recommended procedure, see *OEM Protection in Systems that Load from Flash Memory*.

4.9.4 Legacy/Enhanced Security Comparison

Table 4-5: Legacy/Enhanced Security Comparison

Feature	Legacy (less secure)	Enhanced (more secure)
Level 2, 3 and 4 protection	Levels 2, 3 and 4 must be set or modified simultaneously. (If you only want to change one, you must enter all three.)	Passwords can be set individually or in a group. When changing passwords, the old password for that level is required in order to change it.
Maximum password length	7 characters	31 characters
Clearing passwords	Passwords can be cleared back to initial blank password values.	Once a password is set, the Enhanced Security mode in PME will not allow it to be cleared back to a blank password. To revert to a blank password, the CPU memory must be cleared and power cycled.
Passwords ≤7 characters, set with either mode	Password verification and password changes allowed.	Password verification and password changes allowed.
Passwords >7 characters, set with Enhanced Security mode	Password verification and password changes <i>not</i> allowed.	Password verification and password changes allowed.
Maximum OEM key length	7 characters.	31 characters.
OEM keys ≤7 characters, set with Enhanced Security	Can change OEM Protection Lock state <i>Cannot</i> change the OEM key.	Can change OEM Protection Lock state and the OEM key.
OEM keys >7 characters, set with Enhanced Security	<i>Cannot</i> change OEM Protection Lock state or the OEM key.	Can change OEM Protection Lock state and the OEM key.

4.10 PACSystems I/O System

The PACSystems I/O system provides the interface between the CPU and other devices. The PACSystems I/O system supports:

- I/O and Intelligent option modules.
- Ethernet Interface
- Motion modules (RX3i)

PROFINET:

- RX3i CPE330, CPE400, CPL410 and RSTi-EP CPE100/CPE115 all permit one of their LANs to be configured as an embedded PROFINET Controller (see Section 2.1.5, *Embedded PROFINET Controller*). Alternately, the RX3i PROFINET Controller IC695PNC001 installs in the RX3i Main I/O Rack⁷⁴. The embedded PROFINET Controller and the IC695PNC001 are used to control remote I/O drops. Refer to *PACSystems RX3i & RSTi-EP PROFINET IO-Controller Manual*, GFK-2571G or later. Some examples of remote drops are:
 - Standard rack-mounted I/O modules in RX3i racks scanned by the PROFINET scanner IC695PNS001 and IC695PNS101. Refer to *PACSystems RX3i PROFINET Scanner Manual*, GFK-2737.
 - A mini-drop consisting of one or two I/O modules and supervised by the IC695CEP001. Refer to *PACSystems RX3i CEP PROFINET Scanner User Manual*, GFK-2883.
 - A Genius Bus supervised by a Genius Communications Gateway (IC695GCG001). Refer to *PACSystems RX3i Genius Communications Gateway User Manual*, GFK-2892.

The Genius I/O System

- A Genius I/O Bus Controller (GBC) module provides the interface between the CPU and a Genius I/O bus. Refer to *Series 90-70 Genius Bus Controller User's Manual*, GFK-2017.
- RX3i: A Genius Communications Gateway (IC695GCG001) provides the interface between devices on the Genius I/O bus and a PROFINET Controller (IC695PNC001) which is installed in the RX3i Main I/O rack. Refer to *PACSystems RX3i Genius Communications Gateway User Manual*, GFK-2892.
- For information on Genius I/O, refer to *Genius I/O System User's Manual*, GEK-90486-1 and *Genius I/O Analog and Discrete Blocks User's Manual*, GEK-90486-2.

⁷⁴ Note that RX3i CPE400 and RSTi-EP CPE100/CPE115 does not support IC695PNC001, since they are Standalone CPUs. Both may co-exist on a PROFINET LAN.
CPU Operation

4.10.1 I/O Configuration

4.10.1.1 Module Identification

In addition to the catalog number, the programming software stores a Module ID for each configured module in the hardware configuration that it delivers to the CPU. The CPU uses the Module ID to determine how to communicate with a given module.

When the hardware configuration is downloaded to the CPU (and during subsequent power-ups), the CPU compares the Module IDs stored by the programmer with the IDs of the modules physically present in the system. If the Module IDs do not match, a System Configuration Mismatch fault will be generated.

Because I/O modules of similar type may share the same Module ID, it is possible to download a configuration containing a module catalog number that does not match the module that is physically present in the slot without generating a System Configuration Mismatch.

Certain discrete modules with both reference memory inputs and reference memory outputs will experience invalid I/O transfer if incorrect configuration is stored from a similar mixed I/O module. No fault or error condition will be detected during configuration store and the module will be operational, although not in the manner described by configuration.

For example, a configuration swap between the IC693MDL754 output module and IC693MDL660 input module will not be detected as a configuration mismatch, but I/O data transfer between the module and the CPU reference memory will be invalid. If the input module (MDL660) is sent the configuration of the output module (MDL754) with the following parameters:

Reference Address: %Q601
Module Status Reference: %I33
Hold Last State Enable

It will receive inputs at the module status reference %I33 and the status of the module will be received at %Q601.

If the output module is sent the configuration of the input module with the following parameters:

Reference Address: %I601
Input Filter: Enable
Digital Filter Settings Reference: %I65

It will output values at the digital filter settings reference %I65 and the status of the module will be received at %I601.

4.10.1.2 Default Conditions for I/O Modules

4.10.1.2.1 Interrupts

Some input modules can be configured to send an interrupt to the application program. By default, this interrupt is disabled and the input filter is set to slow. If changed by the programming software, the new settings are applied when the configuration is stored and during subsequent power-cycles.

4.10.1.2.2 Outputs

Some output modules have a configurable output default mode that can be specified as either Off or Hold Last State. If a module does not have a configurable output default mode, its output default mode is Off. The selected action applies when the CPU transitions from RUN/Enabled to RUN/Disabled or STOP Mode, or experiences a fatal fault.

At power-up, Series 90-30 discrete output modules default to all outputs off. They will retain this default condition until the first output scan from the PACSystems controller. Analog output modules can be configured with a jumper located on the removable terminal block of the module. The jumper may be set to cause outputs to either *default to zero* or *retain last state*.

4.10.1.2.3 Inputs

Input modules that have a configurable input default mode can be configured to Hold Last State or to set inputs to 0. If a module does not have a configurable input default mode, its input default mode is Off. The selected action applies when the CPU transitions from RUN/Enabled to RUN/Disabled or STOP Mode, or experiences a fatal fault.

For details on the power-up and STOP Mode behavior of other modules, refer to the documentation for that module.

4.10.1.3 Multiple I/O Scan Sets

Up to 32 I/O scan sets can be defined for a PACSystems CPU. A scan set is a group of I/O modules that can be assigned a unique scan rate. A given I/O module can belong to one scan set. By default, all I/O modules are assigned to scan set 1, which is scanned every sweep.

For some applications, the CPU logic does not need to have the I/O information every sweep. The I/O scan set feature allows the scanning of I/O points to be more closely scheduled with their use in user logic programs. If you have a large number of I/O modules, you may be able to significantly reduce scan time by staggering the scanning of those modules.

A disadvantage of placing all modules into different scan sets appears when the CPU is transitioning from Stop to Run. In that case, scan sets with a programmed delay are not scanned on the first sweep. These modules' outputs are not enabled until the new data has been scanned to them, perhaps many scans later. Therefore, there is a period of time during which the user logic is executing and some modules' outputs are disabled. During that time, outputs of those modules are in the module's stop-mode state. Stop-mode behavior is module-dependent. Some modules zero their outputs, some hold their last scanned state (if any), and some force their outputs to a configured default value. When the module's outputs are enabled, the module uses the last scanned value, which will either be zero or the contents of the register the module uses to hold the corresponding output values from the reference tables.

4.10.2 I/O System Diagnostic Data Collection

Diagnostic data in a PACSystems I/O system is obtained in either of the following two ways:

- If an I/O module has an associated bus controller, the bus controller provides the diagnostic data from that module to the CPU. For details on GBC faults, see *PACSystems Handling of GBC Faults*.
- For I/O modules not interfaced through a bus controller, the CPU's I/O Scanner subsystem generates the diagnostic bits based on data provided by the module.

The diagnostic bits are derived from the diagnostic data sent from the I/O modules to their I/O controllers (CPU or bus controller). Diagnostic bits indicate the current fault status of the associated module. Bits are set when faults occur and are cleared when faults are cleared.

Diagnostic data is not maintained for modules from other manufacturers. The application program must use the BUS Read function blocks to access diagnostic information provided by those boards.

Note: At least two sweeps must occur to clear the diagnostic bits: one scan to send the %Q data to the module and one scan to return the %I data to the CPU. Because module processing is asynchronous to the controller sweep, more than two sweeps may be needed to clear the bits, depending on the sweep rate and the point at which the data is made available to the module.

4.10.2.1 Discrete I/O Diagnostic Information

The CPU maintains diagnostic information for each discrete I/O point. Two memory blocks are allocated in application RAM for discrete diagnostic data, one for %I memory and one for %Q memory. One bit of diagnostic memory is associated with each I/O point. This bit indicates the validity of the associated I/O data. Each discrete point has a fault reference that can be interrogated using two special contacts: a fault contact (-[F]-) and a no-fault contact (-[NF]-). The CPU collects this fault data if enabled to do so by the programming software. The following table shows the state of the fault and no-fault contacts.

Condition	[FAULT]	[NOFLT]
Fault Present	ON	OFF
Fault Absent	OFF	ON

4.10.2.2 Analog I/O Diagnostic Data

Diagnostic information is made available by the CPU for each analog channel associated with analog modules and Genius analog blocks. One byte of diagnostic memory is allocated to each analog I/O channel. Since each analog I/O channel uses two bytes of %AI and %AQ memory, the diagnostic memory is half the size of the data memory.

The analog diagnostic data contains both diagnostics and process data with the process data being the High Alarm and Low Alarm bits. The diagnostic data is referenced with the -[F]- and -[NF]- contacts. The process bits are referenced with the high alarm (-[HA]-) and low alarm (-[LA]-) contacts. The memory allocation for analog diagnostic data is one byte per word of analog input and analog output allocated by programming software. When an analog fault contact is referenced in the

application program, the CPU does an Inclusive OR on all bits in the diagnostic byte, except the process bits. The alarm contact is closed if any diagnostic bit is ON and OFF only if all bits are OFF.

4.10.2.3 PACSystems Handling of GBC Faults

4.10.2.3.1 Defaulting of input data associated with failed/lost GBCs

When a GBC is missing, mismatched, or otherwise failed, the CPU applies the Input Default setting for each device on that Genius bus when defaulting the input data. If the device is configured for HOLD LAST STATE, the data is left alone. If the device is configured for OFF, the input data is set to 0. If a redundant GBC is operational, the input data is not affected.

4.10.2.3.2 Application of default input and diagnostic data for lost redundant blocks

When a GBC reports that a redundant block is lost, the CPU updates the input data tables and input diagnostic tables with the default data during the very next input scan. The output diagnostic data tables are updated during the very next output scan.

4.10.3 Power-Up and Power-Down Sequences

4.10.3.1 Power-Up Sequence

System power-up consists of the following parts:

- Power-up self-test
- CPU memory validation
- System configuration
- Intelligent option module self-test completion
- Intelligent option module dual port interface tests
- I/O system initialization

4.10.3.1.1 Power-Up Self-Test

On system power-up, many modules in the system perform a power-up diagnostic self-test. The CPU module executes hardware checks and software validity checks. Intelligent option modules perform setup and verification of on-board microprocessors, software checksum verification, local hardware verification, and notification to the CPU of self-check completion. Any failed tests are queued for reporting to the CPU during the system configuration portion of the cycle.

If a low or failed battery (or Energy Pack fault) indication is present, a fault is logged in the CPU fault table.

4.10.3.1.2 CPU Memory Validation

The next phase of system power-up is the validation of the CPU memory. First, if the system verifies that user memory areas are still valid. A known area of user memory is checked to determine if data was preserved. Next, if a ladder diagram program exists, a checksum is calculated across the _MAIN ladder block. If no ladder diagram program exists, a checksum is calculated across the smallest standalone C program.

When the system is sure that the user memory is preserved, a known area of the bit cache area is checked to determine if the bit cache data was preserved. If this test passes, the Bit Cache memory is

left containing its power-up values. (Non-retentive outputs are cleared on a transition from STOP Mode to RUN Mode.) If the checksum is not valid or the retentive test on the user memory fails, the bit cache memory is assumed to be in error and all areas are cleared. The CPU is now in a cleared state, the same as if a new CPU module were installed. All logic and configuration files must be stored from the programmer to the CPU.

4.10.3.1.3 System Configuration

After completing its self-test, the CPU performs the system configuration. It first clears all system diagnostic bits in the bit cache memory. This prevents faults that were present before power-down but are no longer present from accidentally remaining as faulted. Then it polls each module in the system for completion of the corresponding self-test.

The CPU reads information from each module, comparing it with the stored (downloaded) rack/slot configuration information. Any differences between actual configuration and the stored configuration are logged in the fault tables.

4.10.3.1.4 Intelligent Option Module Self-Test Completion

Intelligent option modules may take a longer time to complete their self-tests than the CPU due to the time required to test communications media or other interface devices. As an intelligent option module completes its initial self-tests, it tells the CPU the time required to complete the remainder of these self-tests. During this time, the CPU provides whatever additional information the module needs to complete its self-configuration, and the module continues self-tests and configuration. If the module does not report back in the time it specified, the CPU marks the module as faulted and makes an entry in one of the fault tables. When all self-tests are complete, the CPU obtains reports from the module as generated during that particular module's power-up self-test and places fault information (if any) in the fault tables.

4.10.3.1.5 Intelligent Option Module Dual Port Interface Tests

After completion of the intelligent option module self-test and results reporting, integrity tests are jointly performed on the dual-port interface used by the CPU and intelligent option module for communications. These tests validate that the two modules are able to pass information back and forth, as well as verify the interrupt and semaphore capabilities needed by the communications protocol. After dual port interface tests are complete, the communications messaging system is initialized.

4.10.3.1.6 I/O System Initialization

If the module is an input module, no further configuration is required. If the module is an output module, the module is commanded to go to its default state. The output modules default to all outputs off at power-up and in failure mode, unless configured otherwise.

A bus transmitter module is interrogated about what expansion racks are present in the system. Based on the bus transmitter module's response, the CPU adds those racks and their associated slots into the list of slots to be configured.

Finally, the I/O Scanner performs its initialization. The I/O Scanner initializes all the I/O controllers in the system by establishing the I/O connections to each I/O bus on the I/O controller and obtaining all I/O configuration data from that I/O controller. This configuration data is compared with the stored I/O configuration and any differences reported in the I/O Fault Table. The I/O Scanner then sends each I/O controller a list of the I/O modules to be configured on the I/O bus. After the I/O controllers have been initialized, the I/O Scanner replaces the factory default settings in all I/O modules with any application-specified settings.

4.10.3.2 Power-Down Sequence

System power-down occurs when the power supply detects that incoming power has dropped for more than 15ms.

4.10.3.3 Power Cycle Operation with an Energy Pack

Energy Packs offer distinct advantages over batteries:

- a) significantly longer life cycles
- b) they are more reliable
- c) flammability during shipment is not an issue
- d) in their end-of-life phase, their decline is a lot more gradual.

The system design includes the ability of the CPU and the Energy Pack to monitor each other in real time. This permits the user to monitor alarms and thereby determine when to replace a capacitor pack. The capacitor pack is normally replaced while the CPU is powered on, giving it time to charge up before any subsequent loss of power. Users should target periods which are expected to be free from electrical events, such as thunderstorms, to carry out such work. Capacitor packs may also be replaced while power is off.

When power is lost, the Energy Pack supplies current and maintains voltage levels for a period of time sufficient to permit the connected CPU to save all dynamic memory to non-volatile memory.

When power is restored, the CPU will not start running its application until the Energy Pack signals that it is fully charged. The CPU will then resume operation using the contents of memory retained at the previous loss of power event. The Energy Pack charges continuously during normal operation.

The RX3i product lines encompass several different Energy Packs, so it is important to use compatible products:

CPU	IC695CPE400 IC695CPL410	IC695CPE330	IC695CPE302 IC695CPE305 IC695CPE310	ICRXICTL000
Energy Pack	IC695ACC403	IC695ACC402	IC695ACC400	ICRXIACCEPK01
Capacitor Pack	IC695ACC413	IC695ACC412	IC695ACC400	ICRXIACCCPK01
Connecting Cable	IC695CBL003	IC695CBL002	IC695CBL001	ICRXIACCCBL01
Documentation	GFK-3000	GFK-2939	GFK-2724	GFK-2741

User memory is preserved only if the compatible Energy Pack is connected (and charged) at power-down.

If the Energy Pack is connected at power-up, the CPU waits for it to charge up before beginning normal operations. For CPE330/CPE400/CPL410, this typically takes up to 90 seconds.

In the event the Energy Pack fails to charge up in a reasonable amount of time, or is absent, the CPU will time out the wait period and will then commence operations without the Energy Pack. When this occurs, the CPU is vulnerable to loss of memory, should another power failure occur. It is critical to monitor the status bits shown in *Energy Pack Status Bit Operation* so that human intervention can be summoned.

Removing or reconnecting the Energy Pack while the connected CPU is powered off has no effect on the preservation of user memory.

Note: Because the Time of Day (TOD) clock is powered by a separate Real Time Clock battery in CPE302/CPE305/CPE310/CPE330/CPE400/CPL410, the Energy Pack has no effect on the CPU TOD value.

4.10.3.3.1 Energy Pack Status Bit Operation

As shown in the table below, the CPU application program can monitor the status of the attached Energy Pack via %S0014 (PLC_BAT) and %SA0011 (LOW_BAT). For more details, refer to the Section on Diagnostics in *PACSystems and RX3i CPU Programmer's Reference Manual*, GFK-2950.

PLC_BAT (%S0014)	LOW_BAT (%SA0011)	Energy Pack Status
0	0	Energy Pack connected and operational (may be charging)
1	1	Energy Pack not connected or has failed
0	1	Energy Pack is nearing its end-of-life and should be replaced.

The LEDs on the Energy Pack also indicate its status. Refer to the documentation for each product for corresponding LED status.

4.10.3.3.2 Energy Pack Replacement

If an Energy Pack fails, you can replace it while the CPU is in operation. Use a compatible new unit or a compatible replacement Cap Pack. Whenever an Energy Pack is replaced, the newly installed Cap Pack must build up its charge.

In the case of ACC402 attached to CPE330, the Energy Pack, when hot-swapped, draws minimal current in order to recharge: it may therefore take up to 10 minutes for ACC402 to charge completely. This is normal operation. Similarly for ACC403/CPE400 and ACC403/CPL410.

If a loss of power occurs while the Energy Pack is disconnected, or before the capacitors are fully charged, memory loss may occur.

4.10.3.3.3 CPE330/ACC402 Status Detection & Fault Reporting

Both the CPE330 and ACC402 contain intelligence, allowing each to determine the status of the other. This permits the CPU to report various conditions to the user via the status bits discussed in *Energy Pack Status Bit Operation*.

Whenever the CPE330 detects any kind of issue with the ACC402 Energy Pack, it resumes normal operation and issues warnings or faults to the user. The table below details the various permutations possible at power-up. If the Cap Pack is removed during normal operation, this fault will be reported as a failed battery fault.

Energy Pack Base	Cap Pack	CPE330 power-up response
Not present (removed or failed)	Not present (removed or failed)	Detects missing ACC402 and boots up immediately but does not use any stored memory when resuming operations. Issues fail battery fault.
Not present (bad base)	Present (good cap pack)	Detects missing ACC402 and boots up immediately but does not use any stored memory when resuming operations. Issues fail battery fault.

Present (good base)	Not present (removed or failed)	When the CPU does not see a fully charged status within 90 seconds, it does not use any stored memory when resuming operations. Issues fail battery fault.
Present (good base)	Present (good cap pack)	The CPU will wait for fully charged status within timeout period and then resume operation using the contents of memory retained at the previous loss of power event
Present (suspicious)	Present (suspicious)	If the CPU does not see a fully charged status within 90 seconds, it does not use any stored memory when resuming operations. Issues fail battery fault.

4.10.3.3.4 CPE400/CPL410/ACC403 Status Detection & Fault Reporting

Both the CPU (CPE400 or CPL410) and ACC403 contain intelligence, allowing each to determine the status of the other. This permits the CPU to report various conditions to the user via the status bits discussed in *Energy Pack Status Bit Operation*.

Whenever the CPE400 or CPL410 detects any kind of issue with the ACC403 Energy Pack, it resumes normal operation and issues warnings or faults to the user. The table below details the various permutations possible at power-up. If the Cap Pack is removed during normal operation, this fault will be reported as a failed battery fault.

<i>Energy Pack Base</i>	<i>Cap Pack</i>	<i>CPE400/CPL410 power-up response</i>
Not present (removed or failed)	Not present (removed or failed)	Detects missing ACC403 and boots up immediately but does not use any stored memory when resuming operations. Issues fail battery fault.
Not present (bad base)	Present (good cap pack)	Detects missing ACC403 and boots up immediately but does not use any stored memory when resuming operations. Issues fail battery fault.
Present (good base)	Not present (removed or failed)	When the CPU does not see a fully charged status within 45 seconds, it does not use any stored memory when resuming operations. Issues fail battery fault.
Present (good base)	Present (good cap pack)	The CPU will wait for fully charged status within timeout period and then resume operation using the contents of memory retained at the previous loss of power event
Present (suspicious)	Present (suspicious)	If the CPU does not see a fully charged status within 45 seconds, it does not use any stored memory when resuming operations. Issues fail battery fault.

4.10.3.4 Retention of Data Memory Across Power Failure

The following types of data are preserved across a power cycle with an operational battery (or for RX3i CPE302, CPE305, CPE310, CPE330, CPE400 or CPL410 models with an operational and attached Energy Pack and RSTi-EP CPE100/CPE115):

- Application program
- Fault tables and other diagnostic data
- Checksums on programs and blocks
- Override data
- Data in register (%R), local register (%L), and program register (%P) memory
- Data in analog memory (%AI and %AQ)
- State of discrete inputs (%I)
- State of retentive discrete outputs (%Q)
- State of retentive discrete internals (%M)

The following types of data are not preserved across a power cycle:

- State of discrete temporary memory (%T)
- %M and %Q memories used on non-retentive -()- coils
- State of discrete system internals (system bits, fault bits, reserved bits).
- CPL410 Linux data

Section 5: Communications

This Section describes the Ethernet and Serial communications features of the PACSystems CPU.

Ethernet communications may be handled by the embedded CPU Ethernet port(s) or by an IC695ETM001 module installed in an RX3i rack. Refer to *PACSystems RX3i TCP/IP Ethernet Communications User Manual*, GFK-2224.

Serial communications may be handled by the embedded CPU Serial port(s) or by an IC695CMM002 or IC695CMM004 module installed in an RX3i rack. Refer to *PACSystems RX3i Serial Communications Modules User's Manual*, GFK-2460.

This Section contains the following information with respect to the embedded CPU ports:

- Ethernet Communications
- Serial Communications

5.1 Ethernet Communications

For details on Ethernet communications for PACSystems, please refer to the following manuals:

PACSystems RX3i and RSTi-EP TCP/IP Ethernet Communications User Manual, GFK-2224
PACSystems TCP/IP Ethernet Communications Station Manager User Manual, GFK-2225.

5.1.1 Embedded Ethernet Interfaces

5.1.1.1 RX3i

RX3i CPE302, CPE305, CPE310, CPE330, CPE400 and CPL410 CPUs provide one or more embedded Ethernet interfaces. If used, each interface connects to a Local Area Network (LAN).

The corresponding RJ45 Ethernet port(s) automatically sense the data rate on the attached LAN (1 Gbps, 100 Mbps or 10 Mbps), as well as the corresponding communication mode (half-duplex or full-duplex), and the corresponding cabling arrangement (straight through or crossover). Automatic detection greatly simplifies installation procedures.

See RX3i CPU Features and Specifications to determine the complete list of Internet protocols supported by each CPU.

Some important protocols supported by all RX3i CPUs are:

- TCP/IP, which provides basic Internet capabilities;
- SRTP, which is proprietary and which provides the interface with the PME programming and configuration software and supports communications with certain control systems and supervisory computer layers in the factory;
- Modbus/TCP, which supports the Modbus messaging structure over the Internet.

On the CPE302/CPE305/CPE310 models, the same shared processor performs both Ethernet port processing and Controller logic processing.

On the CPE330, the dual core CPU enables communication to be handled by one core while CPU logic and I/O scanning is handled by the second core. Furthermore, each LAN interface is controlled by a dedicated Network Interface Controller (NIC). In the CPE400 and CPL410, one of the four microprocessor cores is dedicated to handling the communications function (LAN1, LAN2 and LAN3).

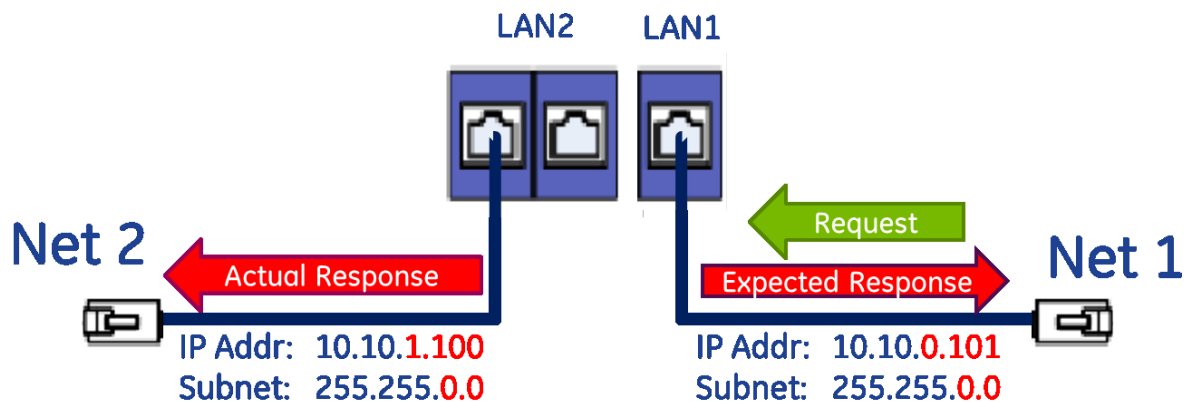
As a result of the hardware advances in the CPE330, CPE400 and CPL410, a higher level of processing power is provided in support of each LAN. This is especially important at higher data rates. It also offloads the handling of Ethernet-level activity from the processor core tasked with performing CPU logic and I/O scanning, permitting that core to run more efficiently.

Each interface on a LAN must have a unique IP Address *and* a non-overlapping IP subnet. This is configured in PME. Care must be taken to survey the entire connected network architecture in order to tabulate the IP addresses and IP subnets already in use, both on the local networks and on any of its routed subnets connected with a gateway. Never assign a conflicting IP Address or configure duplicate IP subnets.

The following examples would be problematic:

5.1.1.1.1 Problem example #1:

Figure 45: CPE330 Overlapping Local IP Subnet Example



The issue demonstrated in Figure 45 is that requests entering one CPE330 interface can be routed out the other interface since both CPE330 Ethernet ports have been configured to be on the same network (255.255.0.0) but are physically connected to separate networks. Avoid this by assigning non-overlapping Subnets.

5.1.1.1.2 Problem example #2:

A user wishes to communicate through a routed network to an RX3i CPU with multiple network interfaces (CPE330, in this example). This remote IP device is configured with the following IP parameters:

IP	192.168.0.5
Subnet Mask	255.255.255.0
Gateway	192.168.0.250

LAN1 and LAN2 on the CPE330 are initially configured with following problematic IP parameters:

	LAN1	LAN2
IP	10.10.0.1	192.168.0.1
Subnet Mask	255.255.255.0	255.255.255.0
Gateway	10.10.0.249	0.0.0.0

The user intends to communicate between the remote device and CPE330 LAN1 (Figure 46). IP Address routing allows the CPE330 to receive the remote IP requests through the respective gateways (192.168.0.250 for the remote node and 10.10.0.249 for CPE330 LAN1). However, since CPE330 LAN2 shares the same IP subnet as the remote network (192.168.0.x), responses may be routed to the local 192.168.0.x network rather than to the remote network (Figure 47).

The duplicate IP subnet in the example must be eliminated. One way to do this is simply change the IP Address assigned to CPE330 LAN2 from 192.168.0.1 to 192.168.1.1 thereby creating a non-overlapping 192.168.1.x network. In short, consider the totality of the network when assigning IP subnets and IP Addresses.

Figure 46: Expected Response Path

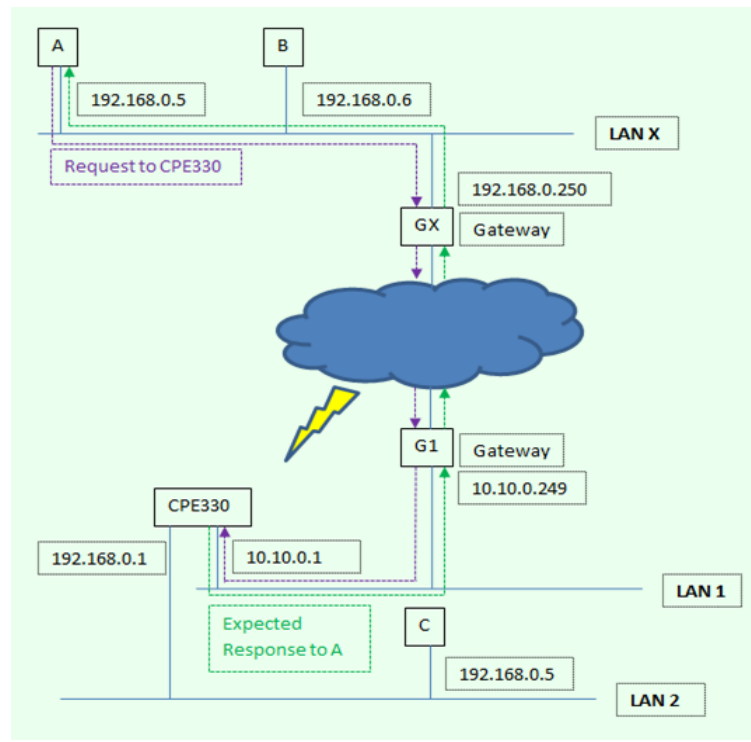
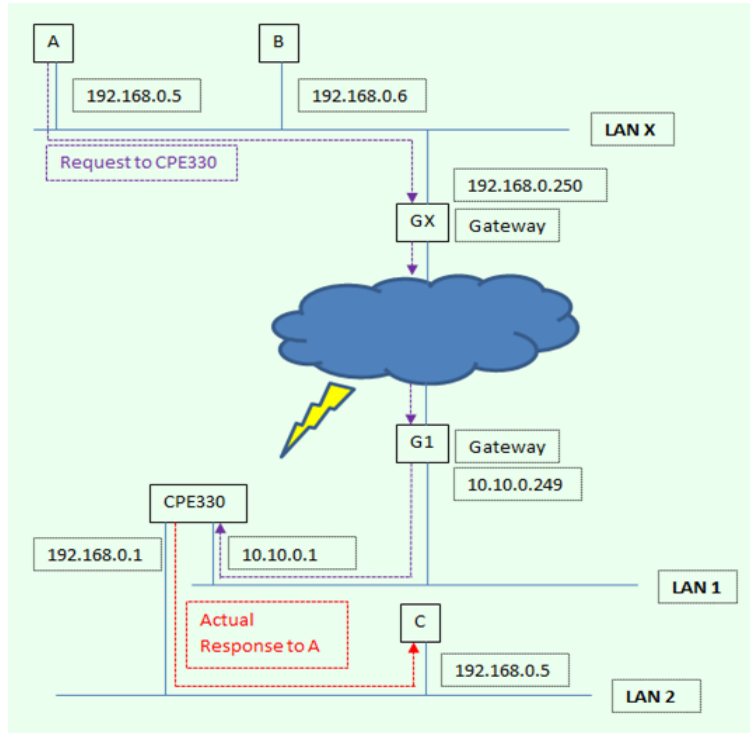


Figure 47: Actual Response Path



CAUTION

The two ports on the Ethernet Interface must *not* be connected, directly or indirectly to the same device. The hub or switch connections in an Ethernet network must form a tree; otherwise duplication of packets may result.

5.1.1.2 RSTi-EP

RSTi-EP_CPE100/CPE115 provides one or more embedded Ethernet interfaces. If used, each interface connects to a Local Area Network (LAN).

The corresponding RJ45 Ethernet port(s) automatically sense the data rate on the attached LAN (100 Mbps or 10 Mbps), as well as the corresponding communication mode (half-duplex or full-duplex), and the corresponding cabling arrangement (straight through or crossover). Automatic detection greatly simplifies installation procedures.

See RSTi-EP CPU Features and Specifications to determine the complete list of Internet protocols supported by each CPU.

Some important protocols supported by all RSTi-EP CPUs are: Some important protocols supported by all RSTi-EP CPUs are:

- TCP/IP, which provides basic Internet capabilities;
- SRTP, which is proprietary and which provides the interface with the PME programming and configuration software and supports communications with certain control systems and supervisory computer layers in the factory;
- Modbus TCP, which supports the Modbus messaging structure over the Internet.

On the CPE100/CPE115, the same shared processor performs both Ethernet port processing and Controller logic processing.

Each interface on a LAN must have a unique IP Address *and* a non-overlapping IP subnet. This is configured in PME. Care must be taken to survey the entire connected network architecture in order to tabulate the IP addresses and IP subnets already in use, both on the local networks and on any of its routed subnets connected with a gateway. Never assign a conflicting IP Address or configure duplicate IP subnets. For examples, please refer to section 5.1.1.1

5.1.1.3 10Base-T/100Base-Tx Port Pin Assignments

Pin assignments are the same for the RX3i and embedded Ethernet ports.

Pin Number	Signal	Description
1	TD+	Transmit Data +
2	TD-	Transmit Data -
3	RD+	Receive Data +
4	NC	No connection
5	NC	No connection
6	RD-	Receive Data -
7	NC	No connection
8	NC	No connection

5.1.1.4 Recovering a Lost IP Address

See Establishing Initial Ethernet Communications, Section 3.4.1.

5.1.2 Ethernet Interface Modules

In addition to Ethernet interfaces embedded in certain CPUs (see *RX3i CPU Features and Specifications*) and RX3i systems support rack-based Ethernet Interface modules. These modules are not interchangeable.

For details about the capabilities, installation, and operation of these modules, refer to PACSystems RX3i TCP/IP Ethernet Communications User Manual GFK-2224 and PACSystems TCP/IP Ethernet Communications Station Manager User Manual, GFK-2225.

Type	Catalog Number	Description
RX3i	IC695ETM001-Jx	Ethernet PCI Module
RX3i	IC695ETM001-Kxxx	Ethernet PCI Module (Version 7.0 or later)

5.2 Serial Communications

RX3i CPUs, except CPE330 and RSTi-EP CPE100/CPE115 support one or more serial ports.

The independent on-board serial ports of the CPU are accessed via external connectors on the module. COM1 and COM2 provide serial interfaces to external devices. COM1 is also used for firmware upgrades.

5.2.1 Serial Port Communications Capabilities

COM1 and COM2 can each be configured for one of the following modes. For details on CPU configuration, refer to *Section 3*:

- RTU Slave – The port can be used for the Modbus RTU slave protocol. This mode also permits connection to the port by an SNP master, such as the WinLoader utility or the programming software. For details, refer to *Section 6*., *Serial I/O, SNP & RTU Protocols*.
- Message Mode – The port is available for access by user logic. This enables C language blocks to perform serial port I/O operations via C Runtime Library functions.
- Available – The port is not to be used by the CPU firmware.
- SNP Slave – The port can only be used for the SNP slave protocol. For details, refer to *Section 6*., *Serial I/O, SNP & RTU Protocols*.
- Serial I/O – The port can be used for general-purpose serial communication through use of COMMREQ functions. For details, refer to *Section 6*., *Serial I/O, SNP & RTU Protocols*.

5.2.1.1 Features Supported

Feature	Serial Port 1 (COM1)	Serial Port 2 (COM2)
RTU Slave protocol	Yes	Yes
SNP Slave	Yes ⁶⁶	Yes
Serial I/O – used with COMMREQs	Yes ⁷⁵	Yes
Firmware Upgrade (WinLoader utility)	PLC in STOP/No IO mode	No
Message Mode –used only with C blocks (C Runtime Library Functions: serial read, serial write, sscanf, sprintf)	Yes	Yes
RS-232	Yes	No
RS-485	No	Yes

⁷⁵ Serial IO is the only protocol supported by CPE400. CPE100/115 doesn't support SNP.
Communications

5.2.2 Configurable STOP Mode Protocols

You can configure the protocol to be used in STOP Mode, based upon the configured serial port (RUN Mode) protocol. The Run/Stop protocol switching is independently configured for each serial port.

The RUN Mode protocol setting determines which choices are available for STOP Mode. If a STOP Mode protocol is not selected, the default STOP Mode protocol is used. For details, refer to *COM1 and COM2 Parameters* in Section 3:.

5.2.3 Serial Port Pin Assignments

5.2.3.1 COM1 (RS-232, 9-pin Subminiature D Connector)

This port has a 9-pin, female, D-sub connector with a standard pin out. This is a DCE (data communications equipment) port that allows a simple straight-through cable to connect with a standard AT-style RS-232 port.

The CPE310 provides the DCD and RI signals to support point-to-point protocol (PPP).

5.2.3.2 COM1 RS-232 Signals

RX3i CPU, RX3i CRU, CPE Models			RX3i CPE310 Model		
Pin No. ⁷⁶	Signal Name	Description	Pin No. ⁷⁶	Signal Name	Description
1	NC	No Connection	1	DCD	Data Carrier Detect
2	TXD	Transmit Data	2	TXD	Transmit Data
3	RXD	Receive Data	3	RXD	Receive Data
4	DSR	Data Set Ready	4	DSR	Data Set Ready
5	0V	Signal Ground	5	COM	Signal Ground
6	DTR	Data Terminal Ready	6	DTR	Data Terminal Ready
7	CTS	Clear to Send	7	CTS	Clear to Send
8	RTS	Request to Send	8	RTS	Request to Send
9	NC	No Connection	9	RI	Ring Indicator

5.2.3.3 COM1(RS-232, Terminal Block Connector)

⁷⁶ Pin 1 is at the bottom right of the connector as viewed from the front of the module.
Communications

The CPE100/CPE115 provides RS-232 communication via a terminal block connector.

RSTi-EP CPE100/CPE115 Models	
Signal Name	Description
TXD	Transmit Data
RXD	Receive Data
0V	Signal Ground
RTS	Request to Send
CTS	Clear to Send

5.2.3.4 COM1 (RS-232, RJ-25 Connector)

The CPE302/CPE305 provides RS-232 communications via an RJ-25 connector and requires shielded cable IC693CBL316.

5.2.3.4.1 CPE302/CPE305 COM1 RS-232 Signals

Pin No.	Signal Name	Description
1	CTS	Clear to Send
2	TXD	Transmit Data
3	0V	Signal Ground
4	0V	Signal Ground
5	RXD	Received Data
6	RTS	Request to Send

5.2.3.5 COM1 (RS232, RJ45 Connector)

The RJ45 Connector is provided for COM1 on CPE400¹⁹ and CPL410 only. It has the following pinout.

Pin No. ⁷⁷	Signal Name	Description
1	NC	No Connection
2	NC	No Connection
3	TX	Transmit Data
4	RX	Receive Data
5	0V	Signal Ground
6	NC	No Connection
7	NC	No Connection
8	NC	No Connection

**Figure 48: COM1 Port
CPE400/CPL410**



⁷⁷ Pin 1 is the leftmost pin as shown in Figure 48.
Communications

5.2.3.6 COM2 (RS-485, 15-pin Female D-sub Connector) – All RX3i CPU/CRU Models & RX3i CPE310

This is a DCE port that allows a simple straight-through cable to connect with a standard AT-style RS-232 port.

5.2.3.6.1 COM2 RS-485 Signals

Pin No.	Signal Name	Description
1	Shield	Cable Shield Located at the bottom right of the connector as viewed from the front of the module.
2	NC	No Connection
3	NC	No Connection
4	NC	No Connection
5	+5Vdc	Logic Power: Provides isolated +5Vdc power (300mA maximum) for powering external options.
6	RTS(A)	Differential Request to Send A
7	0V	Signal Ground
8	CTS(B')	Differential Clear To Send B
9	RT	Resistor Termination
10	RD(A')	Differential Receive Data A
11	RD(B')	Differential Receive Data B
12	SD(A)	Differential Send Data A
13	SD(B)	Differential Send Data B
14	RTS(B')	Differential Request To Send B
15	CTS(A')	Differential Clear To Send A

5.2.3.6.2 Station Manager RS-232 Signals

Pin No. ⁷⁶	Signal Name	Description
1	DCD	Data Carrier Detect
2	TXD	Transmit Data
3	RXD	Receive Data
4	DSR	Data Set Ready
5	0V	Signal Ground
6	DTR	Data Terminal Ready
7	CTS	Clear To Send
8	RTS	Request To Send
9	RI	Ring Indicator

5.2.3.7 COM2 (RS-485, Terminal Block Connector) – RSTi-EP CPE100, CPE115.

The CPE100/CPE115 provides RS-485 communication via a terminal block connector.

RSTi-EP CPE100/CPE115 Models	
RS-485 Pins	Signals
A	RX+
B	RX-
Y	TX+
Z	TX-

5.2.4 Serial Port Electrical Isolation

Some serial communication ports are isolated, while others are not, as indicated in the following table:

Family	Model	COM1	COM2	COM3
RX3i	CPU310	Non-Isolated	Non-Isolated	N/A
	CPU315	Non-Isolated	Non-Isolated	N/A
	CPU320/CRU320	Non-Isolated	Non-Isolated	N/A
	CPE302/CPE305	Non-Isolated	N/A	N/A
	CPE310	Non-Isolated	Non-Isolated	N/A
	CPE330	N/A	N/A	N/A
	CPE400/CPL410	Non-Isolated	N/A	N/A

5.2.5 Serial Cable Lengths and Shielding

The connection from a CPU serial port to the serial port on a computer or other serial device requires a serial cable. Maximum cable lengths (the total distance from the CPU to the last device attached to the serial cable) are:

Port	Maximum Cable Length	Cable Type
COM1 (RS-232)	15 m (50 ft.)	Shielded cable <i>required</i> for RX3i

Note: For details on conformance to radiated emissions standards, refer to Appendix A in the following manuals:

PACSystems RX3i System Manual, GFK-2314

5.2.6 Serial Port Baud Rates

Protocol	COM1 (RS-232)	COM2 (RS-485)	Station Manager - COM3 (RS-232)
RTU Slave	1200, 2400, 4800, 9600, 19.2K, 38.4K, 57.6K, 115.2K	1200, 2400, 4800, 9600, 19.2K, 38.4K, 57.6K, 115.2K	not supported
Firmware Upgrade via WinLoader	1200, 2400, 4800, 9600, 19.2K, 38.4K, 57.6K, 115.2K	Not supported	not supported
Message Mode	1200, 2400, 4800, 9600, 19.2K, 38.4K, 57.6K, 115.2K	1200, 2400, 4800, 9600, 19.2K, 38.4K, 57.6K, 115.2K	not supported
SNP Slave	1200, 2400, 4800, 9600, 19.2K, 38.4K, 57.6K, 115.2K	1200, 2400, 4800, 9600, 19.2K, 38.4K, 57.6K, 115.2K	not supported
Serial I/O	1200, 2400, 4800, 9600, 19.2K, 38.4K, 57.6K, 115.2K	1200, 2400, 4800, 9600, 19.2K, 38.4K, 57.6K, 115.2K	not supported

5.2.7 Communications Coprocessor Module (CMM)

PACSystems **does not** support the following with an IC697CMM711:

- Access to Symbolic variables
- WAIT mode COMMREQs.
- Connecting the programming software to the CPU through the CMM's serial ports.
- Permanent datagrams.

The following restrictions apply when using the IC697CMM711 with PACSystems:

- Access to %W references is partially supported. Only offsets 0–65535 of %W can be accessed via the CMM.
- The Program Name is currently always LDPROG1 for PACSystems.
- Reads and writes beyond currently configured reference table limits will report a minor code error of 90 (REF_OUT_OF_RANGE) instead of F4 (INVALID_PARAMETER) as reported on the Series 90-70.
- In case of ERROR NACK, the Control Program number, privilege level and other piggyback status data will be set to 0.
- PACSystems CPUs return the major/minor type of the 90-70 CPX935 (major type 12, minor type 35) to the CMM scratch pad memory when communicating with a CMM.
- Control Program Number will be returned as 01 in PACSystems instead of FF as reported on the Series 90-70.

Note: For details on operation of the IC697CMM711, refer to the *Series 90 PLC Serial Communications User's Manual*, GFK-0582.

5.2.8 Programmable Coprocessor Module (PCM)

PACSystems **does not** support the following with an IC697PCM711:

- Connecting the programming software to the CPU through the serial ports on the PCM711.

Access to Symbolic variables.

- WAIT mode COMMREQs.
- The following C functions are not supported:
 - chk_genius_bus
 - chk_genius_device
 - get_cpu_type_rev
 - get_memtype_sizes
 - get_one_rackfault
 - get_rack_slot_faults

- The C function `write_dev` will not write to *read only* references (%S references, transition bits, and override bits). If this is attempted, the call will fail at run time and return an error code.
- The following restrictions apply when using the IC697PCM711 with PACSystems:
- Access to %W references is partially supported. Only offsets 0–65535 of %W can be accessed via the PCM.
- The Program Name is currently always LDPROG1 for PACSystems.
- In case of ERROR NACK, the Control Program number, privilege level and other piggyback status data will be set to 0.
- PACSystems CPUs return the major/minor type of the Series 90-70 CPX935 (major type 12, minor type 35) to the PCM scratch pad memory when communicating with a PCM.
- **Note:** For details on operation of the IC697PCM711, refer to Series 90 Programmable Coprocessor Module and Support Software, GFK-0255.

Section 6: Serial I/O, SNP & RTU Protocols

This Section discusses the following topics related to communications on CPU serial ports COM1 and COM2:

- Configuring Serial Ports Using COMMREQ Function 65520
- Serial I/O Protocol
- RTU Slave Protocol
- SNP Slave Protocol

Details of the RTU and SNP protocol are described in the *Series 90 PLC Serial Communications User's Manual*, GFK-0582.

6.1 Configuring Serial Ports Using COMMREQ Function 65520

The Serial Port Setup COMMREQ function 65520 (FFF0 hex) may be used to activate a serial communication protocol for a serial port, overriding the protocol that was specified in the port settings of the CPU configuration. The COMMREQ installed protocol remains active as long as the CPU is in RUN Mode. When the CPU is STOPped, the COMMREQ installed protocol is removed, and the protocol settings from the CPU configuration are reactivated.

The COMMREQ requires that all its command data be placed in the correct order (in a *command block*) in the CPU memory before it is executed. The COMMREQ should be executed by a contact of a one-shot coil to prevent sending the data multiple times. For details on the operands and command block format used by the COMMREQ function, refer to *PACSystems RX3i CPU Programmer's Reference Manual*, GFK-2950 Section 4.

The COMMREQ uses the following TASKS to specify the port for which the operation is intended:

task 19 for COM1
task 20 for COM2

Note: Because address offsets are stored in a 16-bit word field, the full range of %W memory type cannot be used with COMMREQs.

6.1.1 COMMREQ Function Example

In the example, when %M0021 is ON, a Command Block located starting at %R0032 is sent to COM2 (communications task 20) of the CPU (rack 0, slot 0). If an error occurs processing the COMMREQ, %Q0110 is set.

Figure 49: COMMREQ Example



6.1.2 Timing

If a port configuration COMMREQ is sent to a serial port that currently has an SNP master (for example, the programmer) connected to it, the COMMREQ function returns an error code to the COMMREQ status word.

6.1.3 Sending Another COMMREQ to the Same Port

After sending a COMMREQ to configure a serial port, the application program should monitor the COMMREQ status word to determine when it can begin sending protocol specific COMMREQs to that port. It is recommended that the application clear the COMMREQ status word prior to issuing the configuration change. The status word will be set to a nonzero value when the request has been processed.

6.1.4 Invalid Port Configuration Combinations

The PAC Machine Edition programming software safeguards against the download of some hardware configurations that would prevent the programmer from communicating serially with the CPU. In a system that does not have an embedded Ethernet module, if a rack-based Ethernet is not present, a serial connection is required for programmer communications.

For CPE302/CPE305/CPE310 CPUs, which have an embedded Ethernet port that, when configured, is available for programmer communications, the safeguards on serial port configurations are still enforced.

For CPE400 and CPL410, which only support the Serial I/O protocol, the only valid operation is to enter Serial I/O as the Protocol Selector (refer to Section 6.1.5).

6.1.5 COMMREQ Command Block Parameter Values

The following table lists common parameter values that are used within the COMMREQ command blocks for configuring a serial port. All values are in decimal.

Parameter	Values
Protocol Selector	1 = SNP 3 = RTU 5 = Serial I/O 7 = Message Mode
Data Rate	0 = 300 1 = 600 2 = 1200 3 = 2400 4 = 4800 5 = 9600 6 = 19200 7 = 38400 8 = 57600 9 = 115200
Parity	0 = None 1 = Odd 2 = Even
Flow Control	0 = Hardware [RTS / CTS] 1 = None 2 = Software [XON / XOFF] (Serial I/O only)
Bits Per Character	0 = 7 bits 1 = 8 bits
Stop Bits	0 = 1 stop bit 1 = 2 stop bits
Duplex Mode	0 = 2-wire 1 = 4-wire 2 = 4-wire transmitter always on
Turnaround Delay (SNP only)	0 = none 1 = 10ms 2 = 100ms 3 = 500ms
Timeout (SNP only)	0 = Long (8 sec) 1 = Medium (2 sec) 2 = Short (500ms) 3 = None (200ms)

6.1.6 Example COMMREQ Command Blocks for Serial Port Setup function

The following COMMREQ command blocks provide examples for configuring the various protocols. All values are in decimal unless followed by an H indicating hexadecimal.

Note that an example is not provided for Message Mode, but it can be setup with a command block similar to the one for Serial I/O, with a value of 7 for the protocol selector.

6.1.7 Example COMMREQ Command Block for Configuring SNP Protocol

	Values	Meaning
Address	16	Data Block Length
Address + 1	0 = No Wait (WAIT mode not supported)	WAIT/NOWAIT Flag
Address + 2	0008 = %R, register memory	Status Word Pointer Memory Type
Address + 3	Zero-based number that gives the address of the COMMREQ status word (for example, a value of 99 gives an address of 100 for the status word)	Status Word Pointer Offset
Address + 4	not used	Idle Timeout Value
Address + 5	not used	Maximum Communication Time
Address + 6	FFF0H	Command Word (serial port setup)
Address + 7	1 = SNP	Protocol
Address + 8	0 = Slave	Port Mode
Address + 9	See <i>COMMREQ Command Block Parameter Values</i> .	Data Rate
Address + 10	0 = None, 1 = Odd, 2 = Even	Parity
Address + 11	not used (SNP always chooses NONE by default)	Flow Control
Address + 12	0 = None, 1 = 10ms, 2 = 100ms, 3 = 500ms	Turnaround Delay
Address + 13	0 = Long, 1 = Medium, 2 = Short, 3 = None	Timeout
Address + 14	not used (SNP always chooses 8 bits by default)	Bits Per Character
Address + 15	0 = 1 Stop Bit, 1 = 2 Stop bits	Stop Bits
Address + 16	not used	Interface
Address + 17	not used (SNP always chooses 4-wire mode by default)	Duplex Mode
Address + 18	user-provided ⁷⁸	Device identifier bytes 1 and 2
Address + 19	user-provided ⁷⁸	Device identifier bytes 3 and 4
Address + 20	user-provided ⁷⁸	Device identifier bytes 5 and 6
Address + 21	user-provided ⁷⁸	Device identifier bytes 7 and 8

6.1.8 Example COMMREQ Data Block for Configuring RTU Protocol

⁷⁸ The device identifier for SNP Slave ports is packed into words with the least significant character in the least significant byte of the word. For example, if the first two characters are "A" and "B," the Address + 18 will contain the hex value 4241.

	Values	Meaning
Address	13, or 17	Data Block Length
Address + 1	0 = No Wait (WAIT mode not supported)	WAIT/NOWAIT Flag
Address + 2	0008 = %R, register memory	Status Word Pointer Memory Type
Address + 3	Zero-based number that gives the address of the COMMREQ status word (for example, a value of 99 gives an address of 100 for the status word)	Status Word Pointer Offset
Address + 4	not used	Idle Timeout Value
Address + 5	not used	Maximum Communication Time
Address + 6	FFF0H	Command Word (serial port setup)
Address + 7	3 = RTU	Protocol
Address + 8	0 = Slave	Port Mode
Address + 9	See <i>COMMREQ Command Block Parameter Values</i> .	Data Rate
Address + 10	0 = None, 1 = Odd, 2 = Even	Parity
Address + 11	0 = Hardware, 1 = None	Flow Control
Address + 12	not used	Turnaround delay
Address + 13	not used	Timeout
Address + 14	not used (RTU always chooses 8 bits by default)	Bits per Character
Address + 15	not used (RTU always chooses 1 stop bit by default)	Stop Bits
Address + 16	not used	Interface
Address + 17	0 = 2-wire, 1 = 4-wire, 2 = 4-wire transmitter always on	Duplex Mode
Address + 18	Station Address (1-247)	Device Identifier
Address + 19	Count of 100 μs units (0 = 3.5 character times)	End-of-frame timeout ⁷⁹
Address + 20	not used	
Address + 21	not used	
Address + 22	Count of 10 ms units (range 0-255)	Receive-to-transmit delay ⁷⁹

⁷⁹ The End-of-frame timeout and Receive-to-transmit delay values were added in Release 6.70 for the RX3i. They are discussed in the RTU Slave Protocol section. Serial I/O, SNP, & RTU Protocols

6.1.9 Example COMMREQ Data Block for Configuring Serial I/O Protocol

	Values	Meaning
Address	12	Data Block Length
Address + 1	0 = No Wait (WAIT mode not supported)	WAIT/NOWAIT Flag
Address + 2	0008 = %R, register memory	Status Word Pointer Memory Type
Address + 3	Zero-based number that gives the address of the COMMREQ status word (for example, a value of 99 gives an address of 100 for the status word)	Status Word Pointer Offset
Address + 4	not used	Idle Timeout Value
Address + 5	not used	Maximum Communication Time
Address + 6	FFF0H	Command Word (serial port setup)
Address + 7	5 = Serial I/O	Protocol
Address + 8	not used	Port Mode
Address + 9	See <i>COMMREQ Command Block Parameter Values</i> .	Data Rate
Address + 10	0 = None, 1 = Odd, 2 = Even	Parity
Address + 11	0 = Hardware, 1 = None, 2 = Software	Flow Control
Address + 12	not used	Turnaround Delay
Address + 13	not used	Timeout
Address + 14	0=7 bits, 1=8 bits	Bits per Character
Address + 15	0 = 1 stop bit, 1 = 2 stop bits	Stop Bits
Address + 16	not used	Interface
Address + 17	0 = 2-wire, 1 = 4-wire, 2 = 4-wire transmitter always on	Duplex Mode

6.2 Serial I/O Protocol

Serial I/O protocol is a communication protocol that is driven entirely by the application program. Serial I/O protocol is active only when the CPU is in RUN Mode, since it is driven completely by COMMREQ functions in the application program. Those COMMREQ functions are described in detail within this section.

When the CPU is stopped, a port configured for Serial I/O protocol will revert to a STOP Mode protocol as specified in the port settings of the CPU configuration. If a STOP Mode protocol was not specified, RTU slave protocol is used by default.

Serial I/O is the only protocol supported by CPE400 and CPL410. CPE400 requires firmware version 9.40 or later.

6.2.1 Calling Serial I/O COMMREQs from the CPU Sweep

Implementing a serial protocol using Serial I/O COMMREQs may be restricted by the sweep time. For example, if the protocol requires that a reply to a certain message from the remote device be initiated within 5ms of receiving the message, this method may not be successful if the sweep time is 5ms or longer, since timely response is not guaranteed.

6.2.2 Compatibility

The COMMREQ function blocks supported by Serial I/O are not supported by other currently existing protocols (such as SNP slave and RTU slave). Errors are returned if they are attempted for a port configured for one of those protocols.

6.2.3 Status Word for Serial I/O COMMREQs

A value of 1 is returned in the COMMREQ status word upon successful completion of the COMMREQ. Any other value returned is an error code where the low byte is a major error code and the high byte is a minor error code.

Major Error Code	Description	
01 (01h)	Successful Completion (this is the expected completion value in the COMMREQ status word).	
12 (0Ch)	Local error —Error processing a local command. The minor error code identifies the specific error.	
	02 (02h)	COMMREQ command is not supported.
	06 (06h)	Invalid CPU memory type specified.
	07 (07h)	Invalid CPU memory offset specified.
	08 (08h)	Unable to access CPU memory.
	12 (0Ch)	COMMREQ data block length too small.
	14 (0Eh)	COMMREQ data is invalid.
	15 (0Fh)	Could not allocate system resources to complete COMMREQ.

Major Error Code	Description
13 (0Dh)	Remote error — Error processing a remote command. The minor error code identifies the error.
	2 (02h) Number of bytes requested to read is greater than input buffer size OR number bytes requested to write is zero or greater than 250 bytes.
	3 (03h) COMMREQ data block length is too small. String data is missing or incomplete.
	4 (04h) Receive timeout awaiting serial reception of data
	6 (06h) Invalid CPU memory type specified.
	7 (07h) Invalid CPU memory offset specified.
	8 (08h) Unable to access CPU memory.
	12 (0Ch) COMMREQ data block length too small.
	16 (10h) Operating system service error. The operating system service used to perform the request has returned an error.
	17 (11h) Port device error. The port device used to perform the service has detected an error. Either a break was received or a UART Error (parity, framing, overrun) occurred.
	18 (12h) Request cancelled. The request was terminated before it could complete.
48 (30h) Serial output timeout. The serial port was unable to transmit the string. (Could be due to missing CTS signal when the serial port is configured to use hardware flow control.)	
14 (0Eh)	Autodial Error — An error occurred while attempting to send a command string to an attached external modem. The minor error code identifies the specific error.
	2 (02h) The modem command string length exceeds end of reference memory type.
	3 (03h) COMMREQ Data Block Length too small. Output command string data missing or incomplete.
	4 (04h) Serial output timeout. The serial port was unable to transmit the modem autodial output.
	5 (05h) Response was not received from modem. Check modem and cable.
	6 (06h) Modem responded with BUSY. Modem is unable to complete the requested connection. The remote modem is already in use; retry the connection request later.
	7 (07h) Modem responded with NO CARRIER. Modem is unable to complete the requested connection. Check the local and remote modems and the telephone line.
	8 (08h) Modem responded with NO DIALTONE. Modem is unable to complete the requested connection. Check the modem connections and the telephone line.
	9 (09h) Modem responded with ERROR. Modem is unable to complete the requested command. Check the modem command string and modem.

Major Error Code	Description	
	10 (0Ah)	Modem responded with RING, indicating that the modem is being called by another modem. Modem is unable to complete the requested command. Retry the modem command later.
	11 (0Bh)	Unknown response received from the modem. Modem unable to complete the request. Check the modem command string and modem. Response should be CONNECT or OK.

6.2.4 Serial I/O COMMREQ Commands

The following COMMREQs are used to implement Serial I/O:

- Local COMMREQs - do not receive or transmit data through the serial port.
 - ❑ Initialize Port (4300)
 - ❑ Set Up Input Buffer (4301)
 - ❑ Flush Input buffer (4302)
 - ❑ Read port status (4303)
 - ❑ Write port control (4304)
 - ❑ Cancel Operation (4399)
- Remote COMMREQs - receive and/or transmit data through the serial port.
 - ❑ Autodial (4400)
 - ❑ Write bytes (4401)
 - ❑ Read bytes (4402)
 - ❑ Read String (4403)

6.2.5 Overlapping COMMREQs

Some Serial I/O COMMREQs must complete execution before another COMMREQ can be processed. Others can be left pending while others are executed.

6.2.5.1 COMMREQs that Must Complete Execution

- Autodial (4400)
- Initialize Port (4300)
- Set Up Input Buffer (4301)
- Flush Input buffer (4302)

- Read port status (4303)
- Write port control (4304)
- Cancel Operation (4399)
- Serial Port Setup (FFF0)

6.2.5.2 COMMREQs that can be Pending While Others Execute

The table below shows whether Write Bytes, Read Bytes and Read String COMMREQs can be pending when other COMMREQs are executed.

Currently-Pending COMMREQs	NEW COMMREQ										
	Autodial (4400)	Write Bytes (4401)	Initialize Port (4300)	Set Up Input Buffer (4301)	Flush Input Buffer (4302)	Read Port Status (4303)	Write Port Control (4304)	Read Bytes (4402)	Read String (4403)	Cancel Operation (4399)	Serial Port Setup (FFF0)
Write Bytes (4401)	No	No	Yes	Yes	Yes	Yes	Yes	Yes	Yes	Yes	No
Read Bytes (4402)	No	Yes	Yes	No	No	Yes	Yes	No	No	Yes	No
Read String (4403)	No	Yes	Yes	No	No	Yes	Yes	No	No	Yes	No

6.2.6 Initialize Port Function (4300)

This function causes a reset command to be sent to the specified port. It also cancels any COMMREQ currently in progress and flushes the internal input buffer. RTS and DTR are set to inactive.

6.2.6.1 Example Command Block for the Initialize Port Function

	Value (decimal)	Value (hexadecimal)	Meaning
Address	0001	0001	Data block length
Address +1	0000	0000	NOWAIT mode
Address +2	0008	0008	Status word memory type (%R)
Address +3	0000	0000	Status word address minus 1 (%R0001)
Address +4	0000	0000	Not used
Address +5	0000	0000	Not used
Address +6	4300	10CC	Initialize port command

6.2.6.2 Operating Notes

Remote COMMREQs that are cancelled due to this command executing will return a COMMREQ status word indicating request cancellation (minor code 12H).

CAUTION

If this COMMREQ is sent when a Write Bytes (4401) COMMREQ is transmitting a string from a serial port, transmission is halted. The position within the string where the transmission is halted is indeterminate. In addition, the final character received by the device to which the CPU is sending is also indeterminate.

6.2.7 Set Up Input Buffer Function (4301)

This function is provided for compatibility with legacy Serial I/O applications. In PACSystems releases 5.70 and later, the internal input buffer is always set to 2097 bytes. In earlier PACSystems implementations, the internal input buffer is set to 2K bytes.

The Set Up Input Buffer function returns a success status to the COMMREQ status word, regardless of the buffer length specified in the command block.

As data is received from the serial port it is placed in the input buffer. If the buffer becomes full, any additional data received from the serial port is discarded and the Overflow Error bit in the Port Status word (See Read Port Status Function) is set.

6.2.7.1 Retrieving Data from the Buffer

Data can be retrieved from the buffer using the Read String or Read Bytes function. It is not directly accessible from the application program.

If data is not retrieved from the buffer in a timely fashion, some characters may be lost.

6.2.7.2 Example Command Block for the Set Up Input Buffer Function

	VALUE (decimal)	VALUE (hexadecimal)	MEANING
Address	0002	0002	Data block length
Address +1	0000	0000	NOWAIT mode
Address +2	0008	0008	Status word memory type (%R)
Address +3	0000	0000	Status word address minus 1 (%R0001)
Address +4	0000	0000	Not used
Address +5	0000	0000	Not used
Address +6	4301	10CD	Setup input buffer command
Address +7	0064	0040	Buffer length (in words)

6.2.8 Flush Input Buffer Function (4302)

This operation empties the input buffer of any characters received through the serial port but not yet retrieved using a read command. All such characters are lost.

6.2.8.1 Example Command Block for the Flush Input Buffer Function

	VALUE (decimal)	VALUE (hexadecimal)	MEANING
Address	0001	0001	Data block length
Address +1	0000	0000	NOWAIT mode
Address +2	0008	0008	Status word memory type (%R)
Address +3	0000	0000	Status word address minus 1 (%R0001)
Address +4	0000	0000	Not used
Address +5	0000	0000	Not used
Address +6	4302	10CE	Flush input buffer command

6.2.9 Read Port Status Function (4303)

This function returns the current status of the port. The following events can be detected:

1. A read request was initiated previously and the required number of characters has now been received or the specified time-out has elapsed.
2. A write request was initiated previously and transmission of the specified number of characters is complete or a time-out has elapsed.

The status returned by the function indicates the event or events that have completed. More than one condition can occur simultaneously, if both a read and a write were initiated previously.

6.2.9.1 Example Command Block for the Read Port Status Function

	VALUE (decimal)	VALUE (hexadecimal)	MEANING
Address	0003	0003	Data block length
Address +1	0000	0000	NOWAIT mode
Address +2	0008	0008	Status word memory type (%R)
Address +3	0000	0000	Status word address minus 1 (%R0001)
Address +4	0000	0000	Not used
Address +5	0000	0000	Not used
Address +6	4303	10CF	Read port status command
Address +7	0076	004C	Port status memory type (%M)
Address +8	0101	0065	Port status memory offset (%M101)

6.2.9.2 Port Status

The port status consists of a status word and the number of characters in the input buffer that have not been retrieved by the application (characters which have been received and are available).

word 1	Port status word (see below)
word 2	Characters available in the input buffer

6.2.9.2.1 Port Status Word Meanings

Bit	Name	Definition	Status	Meaning
15	RP	Read In progress	Set	Read Bytes or Read String invoked
			Cleared	Previous Read bytes or String has timed out, been canceled, or finished
14	RS	Read Success	Set	Read Bytes or Read String has successfully completed
			Cleared	New Read Bytes or Read String invoked
13	RT	Read Time-out	Set	Receive timeout occurred during Read Bytes or Read String
			Cleared	New Read Bytes or Read String invoked
12	WP	Write In progress	Set	New Write Bytes invoked
			Cleared	Previously-invoked Write Bytes has timed out, been canceled, or finished
11	WS	Write Success	Set	Previously-invoked Write Bytes has successfully completed
			Cleared	New Write Bytes invoked
10	WT	Write Time-out	Set	Transmit timeout occurred during Write Bytes
			Cleared	New Write Bytes invoked
9	CA	Character Available	Set	Unread characters are in the buffer
			Cleared	No unread characters in the buffer
8	OF	Overflow error	Set	Overflow error occurred on the serial port or internal buffer
			Cleared	Read Port Status invoked
7	FE	Framing Error	Set	Framing error occurred on the serial port
			Cleared	Read Port Status invoked
6	PE	Parity Error	Set	Parity error occurred on the serial port
			Cleared	Read Port Status invoked
5	CTS	Clear to Send	Set	Clear to Send signal is active
			Cleared	Clear to Send signal is not active
4	DSR	Data Set Ready	Set	Data Set Ready signal is active
			Cleared	Data Set Ready signal is not active
3	RI	Ring Indicator	Set	Ring Indicator signal is active
			Cleared	Ring Indicator signal is not active
2	DCD	Data Carrier Detect	Set	Data Carrier Detect signal is active
			Cleared	Data Carrier Detect signal is not active
1-0	n/a	Not used	These bits are always set to 0	

6.2.9.3 Operating Notes

For reference, see the tables under *Serial Port Pin Assignments* in Section 5:

Support for the DSR status bit is provided for COM1 only, and on all RX3i models (except CPE302/CPE305), in versions 7.16 and later.

Support for the RP and DCD status bits is provided only for COM1 on the CPE310, in version 7.16 and later.

6.2.10 Write Port Control Function (4304)

This function controls output signals on the specified port:

6.2.10.1 Example Command Block for the Write Port Control Function

	VALUE (decimal)	VALUE (hexadecimal)	MEANING
Address	0002	0002	Data block length
Address +1	0000	0000	NOWAIT mode
Address +2	0008	0008	Status word memory type (%R)
Address +3	0000	0000	Status word address minus 1 (%R0001)
Address +4	0000	0000	Not used
Address +5	0000	0000	Not used
Address +6	4304	10D0	Write port control command
Address +7	xxxx	xxxx	Port control word

6.2.10.2 Port Control Word

15	14	13	12	11	10	9	8	7	6	5	4	3	2	1	0
RTS	DTR	--	--	--	--	--	--	--	--	--	--	--	--	--	--

6.2.10.2.1 Port Control Word Meanings:

15	RTS	Commanded state of Request to Send signal 1 = Activates RTS 0 = Deactivates RTS
14	DTR	Commanded state of Data Terminal Ready signal 1 = Activates DTR 0 = Deactivates DTR
13-0	n/a	Unused (should be zero)

6.2.10.3 Operating Notes

For reference, see the tables under *Serial Port Pin Assignments* in Section 5:.

Support for the DTR output signal is provided for COM1 only, on all RX3i models (except CPE302, CPE305, CPE330, CPE400 and CPL410), in Rel 7.16 and later releases.

For CPU COM2 (RS-485), the RTS signal is also controlled by the transmit driver. Therefore, control of RTS is dependent on the current state of the transmit driver. If the transmit driver is not enabled, asserting RTS with the Write Port Control COMMREQ will not cause RTS to be asserted on the serial line. The state of the transmit driver is controlled by the protocol and is dependent on the current Duplex Mode of the port. For 2-wire and 4-wire Duplex Mode, the transmit driver is only enabled during transmitting. Therefore, RTS on the serial line will only be seen active on COM2 (configured for 2-wire or 4-wire Duplex Mode) when data is being transmitted. For point-to-point Duplex Mode, the transmit driver is always enabled. Therefore, in point-to-point Duplex Mode, RTS on the serial line will always reflect what is chosen with the Write Port Control COMMREQ.

6.2.11 Cancel COMMREQ Function (4399)

This function cancels the current operations in progress. It can be used to cancel both read operations and write operations.

If a read operation is in progress and there are unprocessed characters in the input buffer, those characters are left in the input buffer and available for future reads. The serial port is not reset.

6.2.11.1 Example Command Block for the Cancel Operation Function

	Value (decimal)	Value (hexadecimal)	Meaning
Address	0002	0002	Data block length (2)
Address +1	0000	0000	NOWAIT mode
Address +2	0008	0008	Status word memory type (%R)
Address +3	0000	0000	Status word address minus 1 (%R0001)
Address +4	0000	0000	Not used
Address +5	0000	0000	Not used
Address +6	4399	112F	Cancel operation command
Address +7	0001	0001	Transaction type to cancel 1 - All operations 2 - Read operations 3 - Write operations

6.2.11.2 Operating Notes

Remote COMMREQs that are cancelled due to this command executing will return a COMMREQ status word indicating request cancellation (minor code 12H).

CAUTION

If this COMMREQ is sent in either Cancel All or Cancel Write mode when a Write Bytes (4401) COMMREQ is transmitting a string from a serial port, transmission is halted. The position within the string where the transmission is halted is indeterminate. In addition, the final character received by the device to which the CPU is sending is also indeterminate.

6.2.12 Autodial Function (4400)

This feature allows the CPU to automatically dial a modem and send a specified byte string.

To implement this feature, the port must be configured for Serial I/O. After the autodial function is executed and the modem has established a connection, other serial I/O functions (Write bytes, Set Up Input Buffer, Flush Input buffer, Read port status, Write port control, Read bytes, Read String, and Cancel Operation) can be used.

6.2.12.1 Example

Pager enunciation can be implemented by three commands, requiring three COMMREQ command blocks:

Autodial: 04400 (1130h)	Dials the modem.
Write Bytes: 04401 (1131h)	Specifies an ASCII string, from 1 to 250 bytes in length, to send from the serial port.
Autodial: 04400 (1130h)	It is the responsibility of the application program to hang up the phone connection. This is accomplished by reissuing the autodial command and sending the hang up command string.

6.2.12.2 Autodial Command Block

The Autodial command automatically transmits an Escape sequence that follows the Hayes convention. If you are using a modem that does not support the Hayes convention, you may be able to use the Write Bytes command to dial the modem.

Examples of commonly used command strings for Hayes-compatible modems are listed below:

Command String	Length	Function
ATDP15035559999<CR>	16 (10h)	Pulse dial the number 1-503-555-9999
ATDT15035559999<CR>	16 (10h)	Tone dial the number 1-503-555-9999
ATDT9,15035559999<CR>	18 (12h)	Tone dial using outside line with pause
ATH0<CR>	5 (05h)	Hang up the phone
ATZ <CR>	4 (04h)	Restore modem configuration to internally saved values

6.2.12.3 Sample Autodial Command Block

This COMMREQ command block dials the number 234-5678 using a Hayes-compatible modem.

Word	Definition	Values
1	0009h	CUSTOM data block length (includes command string)
2	0000h	NOWAIT mode
3	0008h	Status word memory type (%R)
4	0000h	Status word address minus 1 (Register 1)
5	0000h	not used
6	0000h	not used
7	04400 (1130h)	Autodial command number
8	00030 (001Eh)	Modem response timeout (30 seconds)
9	0012 (000Ch)	Number of bytes in command string
10	5441h	A (41h), T (54h)
11	5444h	D (44h), T (54h)
12	3332h	Phone number: 2 (32h), 3 (33h)
13	3534h	4 (34h), 5 (35h)
14	3736h	6 (36h), 7 (37h)
15	0D38h	8 (38h) <CR> (0Dh)

6.2.13 Write Bytes Function (4401)

This operation can be used to transmit one or more characters to the remote device through the specified serial port. The character(s) to be transmitted must be in a word reference memory. They should not be changed until the operation is complete.

Up to 250 characters can be transmitted with a single invocation of this operation. The status of the operation is not complete until all the characters have been transmitted or until a timeout occurs (for example, if hardware flow control is being used and the remote device never enables the transmission).

6.2.13.1 Example Command Block for the Write Bytes Function

	Value (decimal)	Value (hexadecimal)	Meaning
Address	0006	0006	Data block length (includes characters to send)
Address +1	0000	0000	NOWAIT mode
Address +2	0008	0008	Status word memory type (%R)
Address +3	0000	0000	Status word address minus 1 (%R0001)
Address +4	0000	0000	Not used
Address +5	0000	0000	Not used
Address +6	4401	1131	Write bytes command
Address +7	0030	001E	Transmit time-out (30 seconds). See note below.
Address +8	0005	0005	Number of bytes to write
Address +9	25960	6568	'h' (68h), 'e' (65h)
Address +10	27756	6C6C	'l' (6Ch), 'l' (6Ch)
Address +11	0111	006F	'o' (6Fh)

Although printable ASCII characters are used in this example, there is no restriction on the values of the characters that can be transmitted.

6.2.13.2 Operating Notes

Specifying zero as the Transmit time-out sets the time-out value to the amount of time actually needed to transmit the data, plus 4 seconds.

CAUTION

If an Initialize Port (4300) COMMEQ is sent or a Cancel Operation (4399) COMMREQ is sent in either Cancel All or Cancel Write mode while this COMMREQ is transmitting a string from a serial port, transmission is halted. The position within the string where the transmission is halted is indeterminate. In addition, the final character received by the device the CPU is sending to is also indeterminate.

6.2.14 Read Bytes Function (4402)

This function causes one or more characters to be read from the specified port. The characters are read from the internal input buffer and placed in the specified input data area. The function returns both the number of characters retrieved and the number of unprocessed characters still in the input buffer. If zero characters of input are requested, only the number of unprocessed characters in the input buffer is returned.

If insufficient characters are available to satisfy the request and a non-zero value is specified for the number of characters to read, the status of the operation is not complete until either sufficient characters have been received or the time-out interval expires. In either of those conditions, the port status indicates the reason for completion of the read operation. The status word is not updated until the read operation is complete (either due to timeout or when all the data has been received).

If the time-out interval is set to zero, the COMMREQ remains pending until it has received the requested amount of data, or until it is cancelled.

If this COMMREQ fails for any reason, no data is returned to the input data area. Any data that has not been read from the internal input buffer remains and it can be retrieved with a subsequent read request.

6.2.14.1 Example Command Block for the Read Bytes Function

	Value (decimal)	Value (hexadecimal)	Meaning
Address	0005	0005	Data block length
Address +1	0000	0000	NOWAIT mode
Address +2	0008	0008	Status word memory type (%R)
Address +3	0000	0000	Status word address minus 1 (%R0001)
Address +4	0000	0000	Not used
Address +5	0000	0000	Not used
Address +6	4402	1132	Read bytes command
Address +7	0030	001E	Read time-out (30 seconds)
Address +8	0005	0005	Number of bytes to read
Address +9	0008	0008	Input data memory type (%R).
Address +10	0100	0064	Input data memory address (%R0100)

6.2.14.2 Return Data Format for the Read Bytes Function

The return data consists of the number of characters actually read, the number of characters still available in the input buffer after the read is complete (if any), and the actual input characters.

Address	Number of characters actually read
Address + 1	Number of characters still available in the input buffer, if any
Address + 2	first two characters (first character is in the low byte)
Address + 3	third and fourth characters (third character is in the low byte)
Address + n	subsequent characters

6.2.14.3 Operating Notes for Read Bytes

If the input data memory type parameter is specified to be a word memory type, and if an odd number of bytes is actually received, then the high byte of the last word to be written with the received data is left unchanged.

As data is received from the serial port it is placed in the internal input buffer. If the buffer becomes full, then any additional data received from the serial port is discarded and the Overflow Error bit in the Port Status word (See Read Port Status Function) is set.

6.2.15 Read String Function (4403)

This function causes characters to be read from the specified port until a specified terminating character is received. The characters are read from the internal input buffer and placed in the specified input data area.

The function returns both the number of characters retrieved and the number of unprocessed characters still in the input buffer. If zero characters of input are requested, only the number of unprocessed characters in the input buffer is returned.

If the terminating character is not in the input buffer, the status of the operation is not complete until either the terminating character has been received or the time-out interval expires. In either of those conditions, the port status indicates the reason for completion of the read operation.

If the time-out interval is set to zero, the COMMREQ remains pending until it has received the requested string, terminated by the specified end character.

If this COMMREQ fails for any reason, no data is returned to the input data area. Any data that has not been read from the internal input buffer remains, and it can be retrieved with a subsequent read request.

6.2.15.1 Example Command Block for the Read String Function

	Value (decimal)	Value (hexadecimal)	Meaning
Address	0005	0005	Data block length

Address +1	0000	0000	NOWAIT mode
Address +2	0008	0008	Status word memory type (%R)
Address +3	0000	0000	Status word address minus 1 (%R0001)
Address +4	0000	0000	Not used
Address +5	0000	0000	Not used
Address +6	4403	1133	Read string command
Address +7	0030	001E	Read time-out (30 seconds)
Address +8	0013	000D	Terminating character (carriage return): must be between 0 and 255 (0xFF), inclusive
Address +9	0008	0008	Input data memory type (%R)
Address +10	0100	0064	Input data memory address (%R0100)

6.2.15.2 Return Data Format for the Read String Function

The return data consists of the number of characters actually read, the number of characters still available in the input buffer after the read is complete (if any), and the actual input characters:

Address	Number of characters actually read
Address + 1	Number of characters still available in the input buffer, if any
Address + 2	first two characters (first character is in the low byte)
Address + 3	third and fourth characters (third character is in the low byte)
Address + n	subsequent characters

6.2.15.3 Operating Notes for Read String

If the input data memory type parameter is specified to be a word memory type, and if an odd number of bytes is actually received, then the high byte of the last word to be written with the received data is left unchanged.

As data is received from the serial port it is placed in the internal input buffer. If the buffer becomes full, then any additional data received from the serial port is discarded and the Overflow Error bit in the Port Status word (See Read Port Status Function) is set.

6.3 RTU Slave Protocol

RTU protocol is a query-response protocol used for communication between the RTU device and a host computer, which is capable of communicating using RTU protocol. The host computer is the master device and it transmits a query to a RTU slave, which responds to the master. The RTU slave device cannot query; it can only respond to the master. A PACSystems CPU can only function as an RTU slave.

The RTU data transferred consists of 8-bit binary characters with an optional parity bit. No control characters are added to the data block; however, an error check (Cyclic Redundancy Check) is included as the final field of each query and response to ensure accurate transmission of data.

Note: You should avoid using station address 1 for any other Modbus slave in a PACSystems control system because the default station address for the PACSystems CPU is 1. The CPU uses the default address in two situations:

1. If you power up without a configuration, the default station address of 1 is used.
2. When the Port Mode parameter is set to Message Mode, and Modbus becomes the protocol in STOP Mode, the station address defaults to 1, unless you specify a STOP Mode for the serial port in the CPU configuration, and then change the station address to be used for STOP Mode.

In either of these situations, if you have a slave configured with a station address of 1, confusion may result when the PACSystems CPU responds to requests intended for that slave.

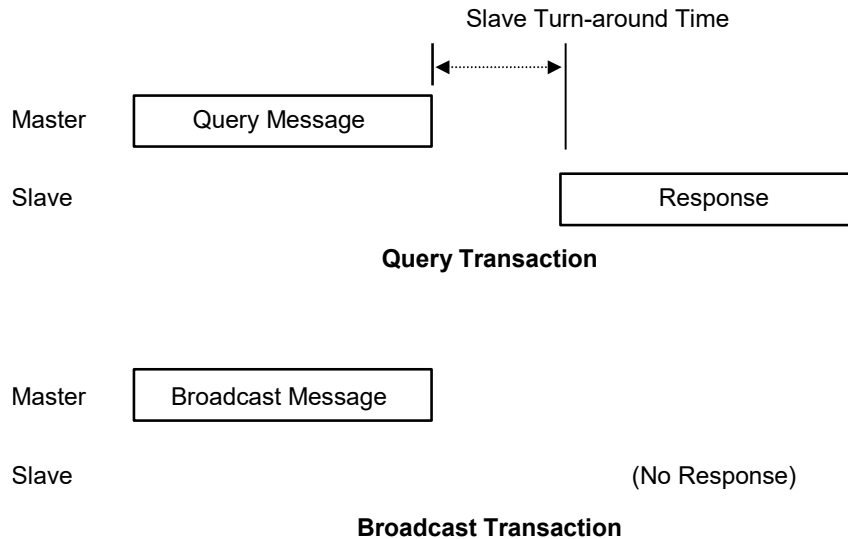
CPE400 and CPL410 do not support this protocol.

6.3.1 Message Format

The general formats for RTU message transfers are shown below:

6.3.1.1 RTU Message Transfers

Figure 50: RTU Message Transactions



The master device begins a data transfer by sending a query or broadcast request message. A slave completes that data transfer by sending a response message if the master sent a query message addressed to it. No response message is sent when the master sends a broadcast request.

6.3.1.2 RTU Slave Turnaround Time

The time between the end of a query and the beginning of the response to that query is called the slave turnaround time. The turnaround time of a PACSystems slave depends on the Controller Communications Window time and the sweep time of the PACSystems. RTU requests are processed only in the Controller Communications Window. In Normal sweep mode, the Controller Communications Window occurs once per sweep. Because the sweep time on PACSystems can be up to 2.5 seconds, the time to process an RTU request could be up to 2.5 seconds. Another factor is the Controller Communications Window time allowed in Hardware Configuration. If you configure a very small Controller Communications Window, the RTU request may not be completed in one sweep, causing RTU processing to require multiple sweeps. For details on CPU window modes, refer to *Window Modes* in Section 4.

6.3.1.3 Receive-to-Transmit Delay

Part of the RTU Slave Turnaround time is the receive-to-transmit delay. The RTU driver inserts this delay after a request from the master has been received, and before the response to the master is sent. Starting with Release 6.70 for the RX3i, the receive-to-transmit delay can be configured with the Serial Port Setup COMMREQ function 65520. The timeout is specified in units of 10 ms, with a range of

0–255 units (maximum delay is 2.55 seconds). If the specified time is less than 3.5 character times, then the delay is set to 3.5 character times.

6.3.1.4 Message Types

The RTU protocol has four message types: query, normal response, error response, and broadcast.

6.3.1.4.1 Query

The master sends a message addressed to a single slave.

6.3.1.4.2 Normal Response

After the slave performs the function requested by the query, it sends back a normal response for that function. This indicates that the request was successful.

6.3.1.4.3 Error Response

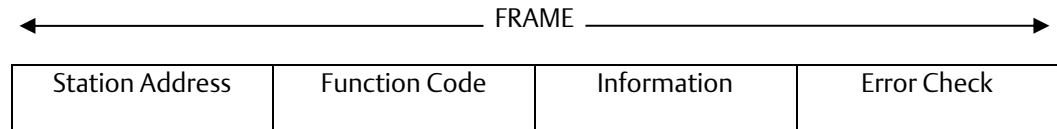
The slave receives the query, but cannot perform the requested function. The slave sends back an error response that indicates the reason the request could not be processed. (No error message will be sent for certain types of errors. For more information, refer to *Communication Errors* below.)

6.3.1.4.4 Broadcast

The master sends a message addressed to all the slaves by using address 0. All slaves that receive the broadcast message perform the requested function. This transaction is ended by a time-out within the master.

6.3.1.5 Message Fields

The message fields for a typical message are shown in the figure below, and are explained in the following sections.



6.3.1.5.1 Station Address

The Station Address is the address of the slave station selected for this data transfer. It is one byte in length and has a value from 0 to 247 inclusive. An address of 0 selects all slave stations, and indicates that this is a broadcast message. An address from 1 to 247 selects a slave station with that station address.

6.3.1.5.2 Function Code

The Function Code identifies the command being issued to the station. It is one byte in length and is defined for the values 0 to 255 as follows:

Function Code	Description
0	Illegal Function
1	Read Output Table
2	Read Input Table
3	Read Registers
4	Read Analog Input
5	Force Single Output
6	Preset Single Register
7	Read Exception Status
8	Loopback Maintenance
9-14	Unsupported Function
15	Force Multiple Outputs
16	Preset Multiple Registers
17	Report Device Type
18–21	Unsupported Function
22	Mask Write 4x Register
23	Read/Write 4x Registers

24-66	Unsupported Function
67	Read Scratch Pad Memory
68-127	Unsupported Function
128-255	Reserved for Exception Responses

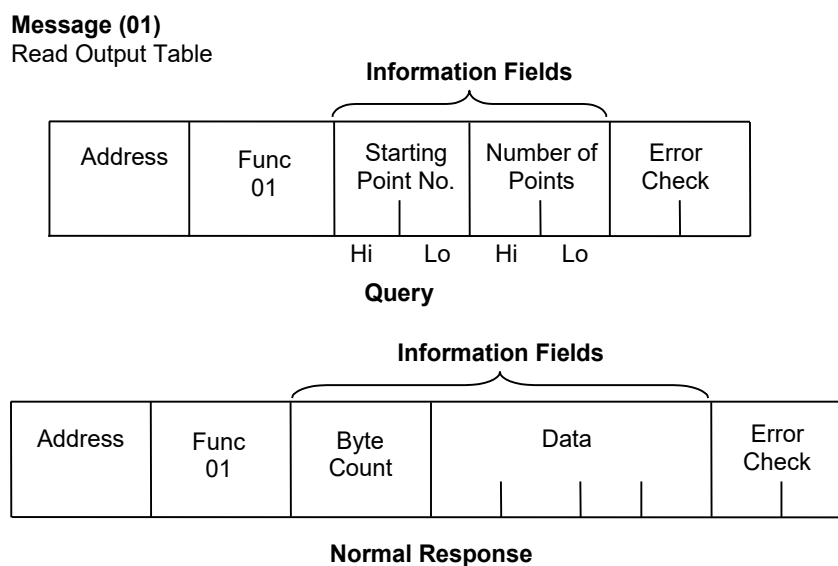
6.3.1.5.3 Information Fields

All message fields, other than the Station Address field, Function Code field, and Error Check field are called, generically, *information fields*. Information fields contain additional information required to specify or respond to a requested function. Different types of messages have different types or numbers of information fields. (Details on information fields for each message type and function code are found in *RTU Message Descriptions*. Some messages (Message 07 Query and Message 17 Query) do not have information fields.

6.3.1.6 Examples

As shown in the following figure, the information fields for message *READ OUTPUT TABLE (01) Query* consist of the Starting Point No. field and Number of Points field. The information fields for message *READ OUTPUT TABLE (01) Response* consist of the Byte Count field and Data field.

Figure 51: RTU Read Output Table Example



Some information fields include entries for the range of data to be accessed in the RTU slave.

Note: Data addresses are 0-based. This means you will need to subtract 1 from the actual address when specifying it in the RTU message. For message (01) *READ OUTPUT TABLE Query*, used in the example above, you would specify a starting data address in the Starting Point No. field. To specify %Q0001 as the starting address, you would place the address %Q0000 in this field. Also, the value placed in the Number of Points field determines how many %Q bits are read, starting with address %Q0001. For example:

- Starting Point No. field = %Q0007, so the starting address is %Q0008.
- Number of Points field = 16 (0010h), so addresses %Q0008 through %Q0023 will be read.

6.3.1.6.1 Error Check Field

The Error Check field is two bytes in length and contains a cyclic redundancy check (CRC-16) code. Its value is a function of the contents of the station Address, Function code, and Information field. The details of generating the CRC-16 code are described in *Cyclic Redundancy Check (CRC)*. Note that the Information field is variable in length. To properly generate the CRC-16 code, the length of frame must be determined. To calculate the length of a frame for each of the defined function codes, see *Calculating the Length of Frame*.

6.3.1.6.2 Message Length

Message length varies with the type of message and amount of data to be sent. Information for determining message length for individual messages is found in *RTU Message Descriptions*.

6.3.1.6.3 Character Format

A message is sent as a series of characters. Each byte in a message is transmitted as a character. The illustration below shows the character format. A character consists of a start bit (0), eight data bits, an optional parity bit, and one stop bit (1). Between characters the line is held in the 1 state.

		MSB	Data Bits						LSB	
10	9	8	7	6	5	4	3	2	1	0
Stop	Parity (optional)									Start

6.3.1.6.4 Message Termination

Each station monitors the time between characters. When a period of three character times elapses without the reception of a character, the end of a message is assumed. The reception of the next character is assumed to be the beginning of a new message. The end of a frame occurs when the first of the following two events occurs:

1. The number of characters received for the frame is equal to the calculated length of the frame.
2. A length of 4 character times elapses without the reception of a character.

6.3.1.6.5 Timeout Usage

Timeouts are used on the serial link for error detection, error recovery, and to prevent the missing of the end of messages and message sequences. Note that although the module allows up to three character transmission times between each character in a message that it receives, there is no more than half a character time between each character in a message that the module transmits. After sending a query message, the master should wait an appropriate amount of time for slave turnaround before assuming that the slave did not respond to the request. Slave turnaround time is affected by the Controller Communications Window time and the CPU sweep time, as described in *RTU Slave Turnaround Time*.

6.3.1.6.6 End-of-Frame Timeout

The End-of-frame timeout is a feature that compensates for message gaps that can occur due to the use of radio modems. The timeout is added to the amount of time allowed for receiving a message from the master. The timeout should be sized according to the maximum gap time that could be

introduced by the master's transmitting equipment. Starting with Release 6.70 for the RX3i, the end-of-frame timeout can be configured with the Serial Port Setup COMMREQ function 65520. The timeout is specified in units of 100 μ s. If the specified time is less than 3.5 character times, then the RTU driver sets the timeout to 3.5 character times.

6.3.2 Cyclic Redundancy Check (CRC)

The CRC is one of the most effective systems for checking errors. The CRC consists of two check characters generated at the transmitter and added at the end of the transmitted data characters. Using the same method, the receiver generates its own CRC for the incoming data and compares it to the CRC sent by the transmitter to ensure proper transmission. A complete mathematic derivation for the CRC is not given in this section. This information can be found in a number of texts on data communications. The essential steps that should be understood in calculating the CRC are as follows:

- The number of bits in the CRC multiplies the data bits that make up the message.
- The resulting product is then divided by the generating polynomial (using modulo 2 with no carries). The CRC is the remainder of this division.
- Disregard the quotient and add the remainder (CRC) to the data bits and transmit the message with CRC.
- The receiver then divides the message plus CRC by the generating polynomial and if the remainder is 0, the transmission was transmitted without error.

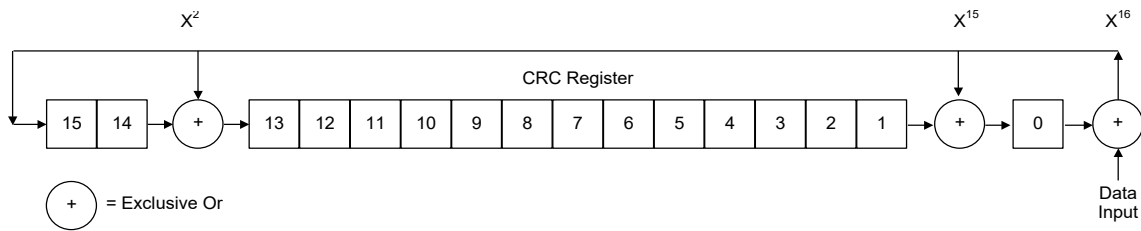
A generating polynomial is expressed algebraically as a string of terms in powers of X such as $X_3 + X_2 + X_0$ (or 1) which, in turn, can be expressed as the binary number 1101.

A generating polynomial could be any length and contain any pattern of 1s and 0s as long as both the transmitter and receiver use the same value. For optimum error detection, however, certain standard generating polynomials have been developed. RTU protocol uses the polynomial $X_{16} + X_{15} + X_2 + 1$ which in binary is 1 1000 0000 0000 0101. The CRC this polynomial generates is known as CRC-16.

The discussion above can be implemented in hardware or software. One hardware implementation involves constructing a multi-section shift register based on the generating polynomial.

6.3.2.1 Cyclic Redundancy Check Register

Figure 52: CRC Register Operation



To generate the CRC, the message data bits are fed to the shift register one at a time. The CRC register contains a preset value. As each data bit is presented to the shift register, the bits are shifted to the right. The LSB is XORed with the data bit and the result is XORed with the old contents of bit 1 (the result placed in bit 0), XORed with the old contents of bit 14 (and the result placed in bit 13), and finally, it is shifted into bit 15. This process is repeated until all data bits in a message have been processed. Software implementation of the CRC-16 is explained in the section below.

6.3.2.2 Calculating the CRC-16

The pseudo code for calculation of the CRC-16 is given below.

Preset byte count for data to be sent.

Initialize the 16-bit remainder (CRC) register to all ones.

XOR the first 8-bit data byte with the high order byte of the 16-bit CRC register. The result is the current CRC.

INIT SHIFT: Initialize the shift counter to 0.

SHIFT: Shift the current CRC register 1 bit to the right.

Increment shift count.

Is the bit shifted out to the right (flag) a 1 or a 0?

If it is a 1, XOR the generating polynomial with the current CRC.

If it is a 0, continue.

Is shift counter equal to 8?

If NO, return to SHIFT.

If YES, increment byte count.

Is byte count greater than the data length?

If NO, XOR the next 8-bit data byte with the current CRC and go to INIT SHIFT.

If YES, add current CRC to end of data message for transmission and exit.

When the message is transmitted, the receiver performs the same CRC operation on all the data bits and the transmitted CRC. If the information is received correctly the resulting remainder (receiver CRC) is 0.

6.3.2.3 Sample CRC-16 Calculation

The RTU device transmits the rightmost byte (of registers or discrete data) first. The first bit of the CRC-16 transmitted is the MSB. Therefore, in the example the MSB of the CRC polynomial is to the extreme right. The X_{16} term is dropped because it affects only the quotient (which is discarded) and not the remainder (the CRC characters). The generating polynomial is therefore 1010 0000 0000 0001. The remainder is initialized to all 1s.

In this example, the CRC-16 is calculated for RTU message, Read Exception Status 07. The message format is as follows:

Address	Function	CRC-16
01	07	

In this example, device number 1 (address 01) is queried. You need to know the amount of data to be transmitted and this information can be found for every message type in *Calculating the Length of Frame*. For this message the data length is 2 bytes.

Transmitter CRC-16 Algorithm						Receiver ⁸⁰ CRC-16 Algorithm					
	MSB ⁸¹		LSB ⁷⁹		Flag		MSB ⁷⁹		LSB ⁷⁹		Flag
Initial Remainder	1111	1111	1111	1111		Rcvr CRC after data	1110	0010	0100	0001	
XOR 1st data byte	0000	0000	0000	0001		XOR 1st byte Trns CRC	0000	0000	0100	0001	
Current CRC	1111	1111	1111	1111		Current CRC	1110	0010	0000	0000	
Shift 1	0111	1111	1111	1111	0	Shift 1	0111	0001	0000	0000	0
Shift 2	0011	1111	1111	1111	1	Shift 2	0011	1000	1000	0000	0
XOR Gen. Polynomial	1010	0000	0000	0001		Shift 3	0001	1100	0100	0000	0
Current CRC	1001	1111	1111	1110		Shift 4	0000	1110	0010	0000	0
Shift 3	0100	1111	1111	1111	0	Shift 5	0000	0111	0001	0000	0
Shift 4	0010	0111	1111	1111	1	Shift 6	0000	0011	1000	1000	0
XOR Gen. Polynomial	1010	0000	0000	0001		Shift 7	0000	0001	1100	0100	0
Current CRC	1000	0111	1111	1110		Shift 8	0000	0000	1110	0010	0
Shift 5	0100	0011	1111	1111	0	XOR 2nd byte Trns CRC	0000	0000	1110	0010	
Shift 6	0010	0001	1111	1111	1	Current CRC	0000	0000	0000	0000	
XOR Gen. Polynomial	1010	0000	0000	0001		Shift 1-8 yields	0000	0000	0000	0000	
Current CRC	1000	0001	1111	1110		All errors for receiver final CRC-16 indicates transmission correct.					
Shift 7	0100	0000	1111	1111	0						
Shift 8	0010	0000	0111	1111	1						
XOR Gen. Polynomial	1010	0000	0000	0001							
Current CRC	1000	0000	0111	1110							
XOR 2nd data byte	0000	0000	0000	0111							
Current CRC	1000	0000	0111	1001							
Shift 1	0100	0000	0011	1100	1						
XOR Gen. Polynomial	1010	0000	0000	0001							
Current CRC	1110	0000	0011	1101							
Shift 2	0111	0000	0001	1110	1						
XOR Gen. Polynomial	1010	0000	0000	0001							
Current CRC	1101	0000	0001	1111							
Shift 3	0110	1000	0000	1111	1						
XOR Gen. Polynomial	1010	0000	0000	0001							
Current CRC	1100	1000	0000	1110							
Shift 4	0110	0100	0000	0111	0						
Shift 5	0011	0010	0000	0011	1						
XOR Gen. Polynomial	1010	0000	0000	0001							
Current CRC	1001	0010	0000	0010							
Shift 6	0100	1001	0000	0001	0						
Shift 7	0010	0100	1000	0000	1						
XOR Gen. Polynomial	1010	0000	0000	0001							
Current CRC	1000	0100	1000	0001							
Shift 8	0100	0010	0100	0000	1						
XOR Gen. Polynomial	1010	0000	0000	0001							
Transmitted CRC	1110	0010	0100	0001							
	E	2	4	1							

6.3.2.4 Calculating the Length of Frame

To generate the CRC-16 for any message, the message length must be known. The length for all types of messages can be determined from the table below.

6.3.2.5 RTU Message Length

Function Code	Name	Query or Broadcast Message Length Less CRC Code	Response Message Length Less CRC Code
0		Not Defined	Not Defined
1	Read Output Table	6	3 + 3rd byte ⁸²
2	Read Input Table	6	3 + 3rd byte ⁸²
3	Read Registers	6	3 + 3rd byte ⁸²
4	Read Analog Input	6	3 + 3rd byte ⁸²
5	Force Single Output	6	6
6	Preset Single Register	6	6
7	Read Exception Status	2	3
8	Loopback/Maintenance	6	6
9-14		Not Defined	Not Defined
15	Force Multiple Outputs	7 + 7th byte ⁸²	6
16	Preset Multiple Registers	7 + 7th byte ⁸²	6
17	Report Device Type	2	8
18-21		Not Defined	Not Defined

⁸⁰ The receiver processes incoming data through the same CRC algorithm as the transmitter. The example for the receiver starts at the point after all the data bits but not the transmitted CRC have been received correctly. Therefore, the receiver CRC should be equal to the transmitted CRC at this point. When this occurs, the output of the CRC algorithm will be zero indicating that the transmission is correct.

The transmitted message with CRC would then be:

Address	Function	CRC-16	
01	07	41	E2

⁸¹ The MSB and LSB references are to the data bytes only, not to the CRC bytes. The CRC MSB and LSB order are the reverse of the data byte order.

⁸² The value of this byte is the number of bytes contained in the data being transmitted.

22	Mask Write 4x Registers	8	8
23	Read/Write 4x Registers	13+byte 11 ⁸²	5+byte 3 ⁸²
24-66		Not Defined	Not Defined
67	Read Scratch Pad	6	3 + 3rd byte ⁸²
68-127		Not Defined	Not Defined
128-255		Not Defined	3

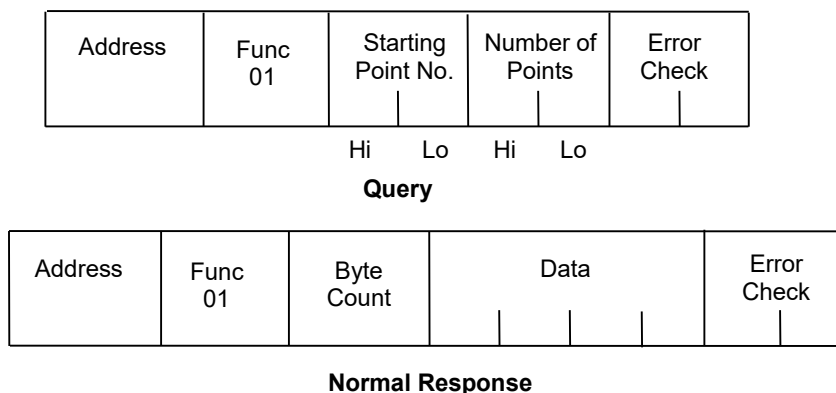
6.3.3 RTU Message Descriptions

This section presents the format and fields for each RTU message.

6.3.3.1 Message (01): Read Output Table

6.3.3.1.1 Format:

Figure 53: RTU Read Output Table Message Format



6.3.3.1.2 Query:

An address of 0 is not allowed because this cannot be a broadcast request.

- The function code is 01.
- The starting point number is two bytes in length and may be any value less than the highest output point number available in the attached CPU. The starting point number is equal to one less than the number of the first output point returned in the normal response to this request.
- The *number of points* value is two bytes in length. It specifies the number of output points returned in the normal response. The sum of the starting point value and the number of points value must be less than or equal to the highest output point number available in the attached

CPU. The high order byte of the Starting Point Number and Number of Points fields is sent as the first byte. The low order byte is the second byte in each of these fields.

6.3.3.1.3 Response:

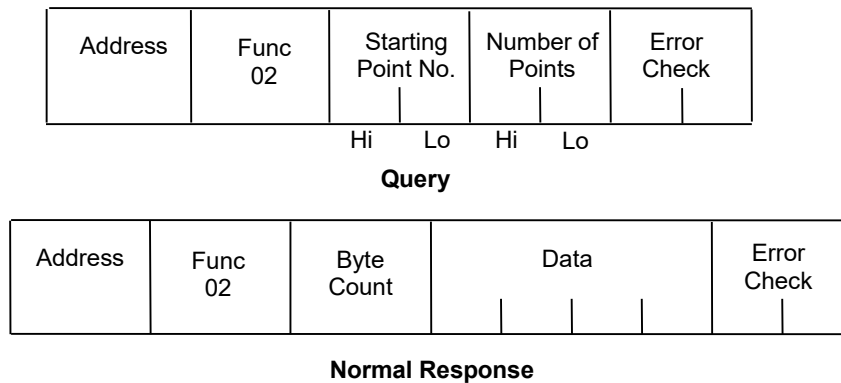
The byte count is a binary number from 1 to 256 (0 = 256). It is the number of bytes in the normal response following the byte count and preceding the error check.

The Data field of the normal response is packed output status data. Each byte contains eight output point values. The least significant bit (LSB) of the first byte contains the value of the output point whose number is equal to the starting point number plus one. The values of the output points are ordered by number starting with the LSB of the first byte of the Data field and ending with the most significant bit (MSB) of the last byte of the Data field. If the number of points is not a multiple of 8, the last data byte contains zeroes in one to seven of its highest order bits.

6.3.3.2 Message (02): Read Input Table

6.3.3.2.1 Format:

Figure 54: RTU Read Input Table Message Format



6.3.3.2.2 Query:

- An address of 0 is not allowed as this cannot be a broadcast request.
- The function code is 02.
- The starting point number is two bytes in length and may be any value less than the highest input point number available in the attached CPU. The starting point number is equal to one less than the number of the first input point returned in the normal response to this request.
- The number of points value is two bytes in length. It specifies the number of input points returned in the normal response. The sum of the starting point value and the number of points value must be less than or equal to the highest input point number available in the attached CPU. The high order byte of the Starting Point Number and Number Of Bytes fields is sent as the first byte. The low order byte is the second byte in each of these fields.

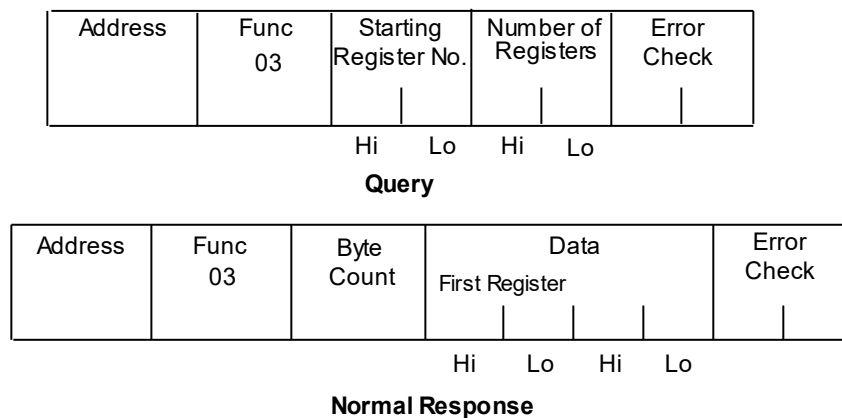
6.3.3.2.3 Response:

- The byte count is a binary number from 1 to 256 (0 = 256). It is the number of bytes in the normal response following the byte count and preceding the error check.
- The Data field of the normal response is packed input status data. Each byte contains eight input point values. The least significant bit (LSB) of the first byte contains the value of the input point whose number is equal to the starting point number plus one. The values of the input points are ordered by number starting with the LSB of the first byte of the Data field and ending with the most significant bit (MSB) of the last byte of the Data field. If the number of points is not a multiple of 8, then the last data byte contains zeroes in one to seven of its highest order bits.

6.3.3.3 Message (03): Read Registers

6.3.3.3.1 Format:

Figure 55: RTU Read Registers Message Format



6.3.3.3.2 Query:

- An address of 0 is not allowed as this request cannot be a broadcast request.
- The function code is equal to 3.
- The starting register number is two bytes in length. The starting register number may be any value less than the highest register number available in the attached CPU. It is equal to one less than the number of the first register returned in the normal response to this request.
- The number of registers value is two bytes in length. It must contain a value from 1 to 125 inclusive. The sum of the starting register value and the number of registers value must be less than or equal to the highest register number available in the attached CPU. The high order byte of the Starting Register Number and Number of Registers fields is sent as the first byte in each of these fields. The low order byte is the second byte in each of these fields.

6.3.3.3.3 Response:

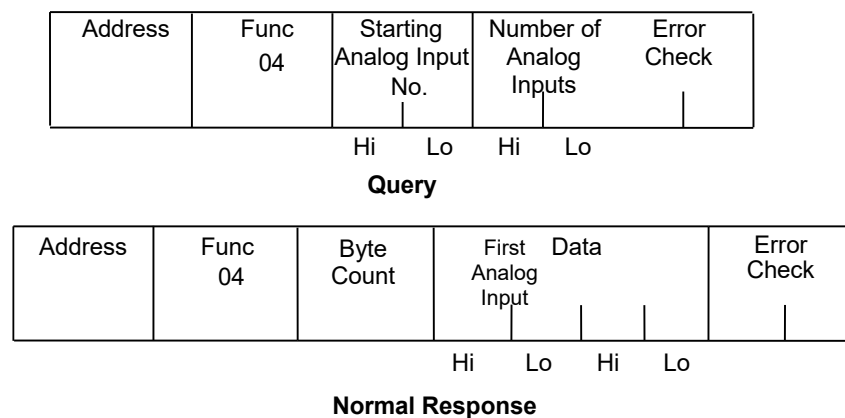
The byte count is a binary number from 2 to 250 inclusive. It is the number of bytes in the normal response following the byte count and preceding the error check. Note that the byte count is equal to two times the number of registers returned in the response. A maximum of 250 bytes (125) registers is set so that the entire response can fit into one 256-byte data block.

The registers are returned in the Data field in order of number with the lowest number register in the first two bytes and the highest number register in the last two bytes of the Data field. The number of the first register in the Data field is equal to the Starting Register Number plus one. The high order byte is sent before the low order byte of each register.

6.3.3.4 Message (04): Read Analog Inputs

6.3.3.4.1 Format:

Figure 56: RTU Read Analog Inputs Message Format



6.3.3.4.2 Query:

- An Address of 0 is not allowed as this request cannot be a broadcast request.
- The function code is equal to 4.
- The Starting Analog Input Number is two bytes in length. The Starting Analog Input Number may be any value less than the highest analog input number available in the attached CPU. It is equal to one less than the number of the first analog input returned in the normal response to this request.
- The Number Of Analog Inputs value is two bytes in length. It must contain a value from 1 to 125 inclusive. The sum of the Starting Analog Input value and the Number Of Analog Inputs value must be less than or equal to the highest analog input number available in the at-attached CPU. The high order byte of the Starting Analog Input Number and Number of Analog Inputs fields is sent as the first byte in each of these fields. The low order byte is the second byte in each of these fields.

6.3.3.4.3 Response:

The Byte Count is a binary number from 2 to 250 inclusive. It is the number of bytes in the normal response following the byte count and preceding the error check. Note that the Byte Count is equal to

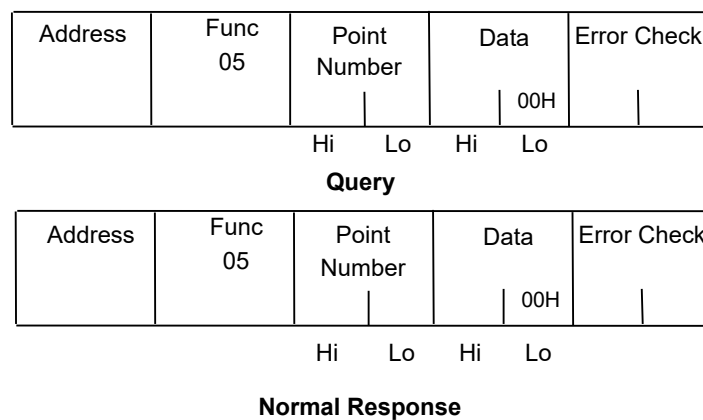
two times the number of analog inputs returned in the response. A maximum of 250 bytes (125 analog inputs) is set so that the entire response can fit into one 256-byte data block.

The analog inputs are returned in the Data field in order of number with the lowest number analog input in the first two bytes and the highest number analog input in the last two bytes of the Data field. The number of the First Analog Input in the Data field is equal to the Starting analog input number plus one. The high order byte is sent before the low order byte of each analog input.

6.3.3.5 Message (05): Force Single Output

6.3.3.5.1 Format:

Figure 57: RTU Force Single Output Message Format



6.3.3.5.2 Query:

- An Address of 0 indicates a broadcast request. All slave stations process a broadcast request and no response is sent.
- The function code is equal to 05.
- The Point Number field is two bytes in length. It may be any value less than the highest output point number available in the attached CPU. It is equal to one less than the number of the output point to be forced on or off.
- The first byte of the Data field is equal to either 0 or 255 (FFH). The output point specified in the Point Number field is to be forced off if the first Data field byte is equal to 0. It is to be forced on if the first Data field byte is equal to 255 (FFH). The second byte of the Data field is always equal to zero.

6.3.3.5.3 Response:

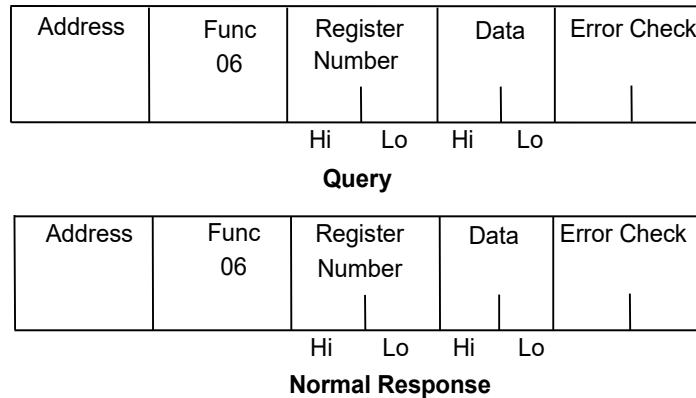
The normal response to a force single output query is identical to the query.

Note: The force single output request is not an output override command. The output specified in this request is ensured to be forced to the value specified only at the beginning of one sweep of the user logic.

6.3.3.6 Message (06): Preset Single Register

6.3.3.6.1 Format:

Figure 58: RTU Preset Single Register Message Format



6.3.3.6.2 Query:

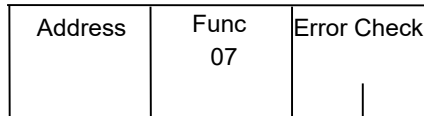
- An Address 0 indicates a broadcast request. All slave stations process a broadcast request and no response is sent.
- The function code is equal to 06.
- The Register Number field is two bytes in length. It may be any value less than the highest register available in the attached CPU. It is equal to one less than the number of the register to be preset.
- The Data field is two bytes in length and contains the value that the register specified by the Register Number Field is to be preset to. The first byte in the Data field contains the high order byte of the preset value. The second byte in the Data field contains the low order byte.

6.3.3.6.3 Response:

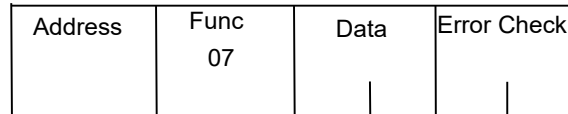
The normal response to a preset single register query is identical to the query. Message (07): Read Exception Status

6.3.3.6.4 Format:

Figure 59: RTU Read Exception Status Message Format



Query



Normal Response

6.3.3.6.5 Query:

This query is a short form of request for the purpose of reading the first eight output points.

- An Address of zero is not allowed as this cannot be a broadcast request.
- The function code is equal to 07.

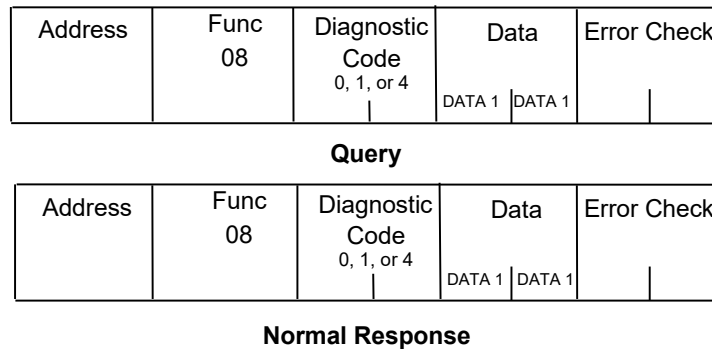
6.3.3.6.6 Response:

The Data field of the normal response is one byte in length and contains the states of output points one through eight. The output states are packed in order of number with output point one's state in the least significant bit and output point eight's state in the most significant bit.

6.3.3.7 Message (08): Loopback/Maintenance (General)

6.3.3.7.1 Format:

Figure 60: RTU Loopback/Maintenance Message Format



6.3.3.7.2 Query:

- The Function code is equal to 8.
- The Diagnostic Code is two bytes in length. The high order byte of the Diagnostic Code is the first byte sent in the Diagnostic Code field. The low order byte is the second byte sent. The loopback/maintenance command is defined only for Diagnostic Codes equal to 0, 1, or 4. All other Diagnostic Codes are reserved.
- The Data field is two bytes in length. The contents of the two Data bytes are defined by the value of the Diagnostic Code. Response:
 - See descriptions for individual Diagnostic Codes.
 - Diagnostic Return Query Data Request (Loopback/Maintenance Code 00):
 - An address of 0 is not allowed for the return query data request.
 - The values of the two Data field bytes in the query are arbitrary.
 - The normal response is identical to the query.
 - The values of the Data bytes in the response are equal to the values sent in the query.

6.3.3.8 Diagnostic Initiate Communication Restart Request (Loopback/Maintenance Code 01):

- An Address of 0 indicates a broadcast request. All slave stations process a broadcast request and no response is sent.
- This request disables the listen-only mode (enables responses to be sent when queries are received so that communications can be restarted).

- The value of the first byte of the Data field (DATA1) must be 0 or FF. Any other value will cause an error response to be sent. The value of the second byte of the Data field (DATA2) is always equal to 0.
- The normal response to an Initiate Communication Restart query is identical to the query.

6.3.3.9 Diagnostic Force Listen-Only Mode Request (Loopback/Maintenance code 04):

- An Address of 0 indicates a broadcast request. All slave stations process a broadcast request.
- After receiving a Force Listen-Only mode request, the RTU device will go into the listen-only mode, will not perform a requested function, and will not send either normal or error responses to any queries. The listen-only mode is disabled when the RTU device receives an Initiate Communication Restart request or when the RTU device is powered up.
- Both bytes in the Data field of a Force Listen-Only Mode request are equal to 0. The RTU device never sends a response to a Force Listen-Only Mode request.

Note: Upon power-up, the RTU device disables the listen-only mode and is enabled to continue sending responses to queries.

6.3.3.10 Message (15): Force Multiple Outputs

6.3.3.10.1 Format:

Figure 61: RTU Force Multiple Outputs Message Format

Address	Func 15	Starting Point No.	Number of Points	Byte Count	Data	Error Check
---------	------------	-----------------------	---------------------	---------------	------	-------------

Query

Address	Func 15	Starting Point No.	Number of Points	Error Check
---------	------------	-----------------------	---------------------	-------------

Normal Response

6.3.3.10.2 Query:

- An Address of 0 indicates a broadcast request. All slave stations process a broadcast request and no response is sent.
- The value of the Function code is 15.
- The Starting Point Number is two bytes in length and may be any value less than the highest output point number available in the attached CPU. The Starting Point Number is equal to one less than the number of the first output point forced by this request.
- The Number of Points value is two bytes in length. The sum of the Starting Point Number and the Number of Points value must be less than or equal to the highest output point number available in the attached CPU. The high order byte of the Starting Point Number and Number of Bytes fields is sent as the first byte in each of these fields. The low order byte is the second byte in each of these fields.
- The Byte Count is a binary number from 1 to 256 ($0 = 256$). It is the number of bytes in the Data field of the force multiple outputs request.
- The Data field is packed data containing the values that the outputs specified by the Starting Point Number and the Number of Points fields are to be forced to. Each byte in the Data field contains the values that eight output points are to be forced to. The least significant bit (LSB) of the first byte contains the value that the output point whose number is equal to the starting point number plus one is to be forced to. The values for the output points are ordered by number starting with the LSB of the first byte of the Data field and ending with the most significant bit (MSB) of the last byte of the Data field. If the number of points is not a multiple of 8, then the last data byte contains zeroes in one to seven of its highest order bits.

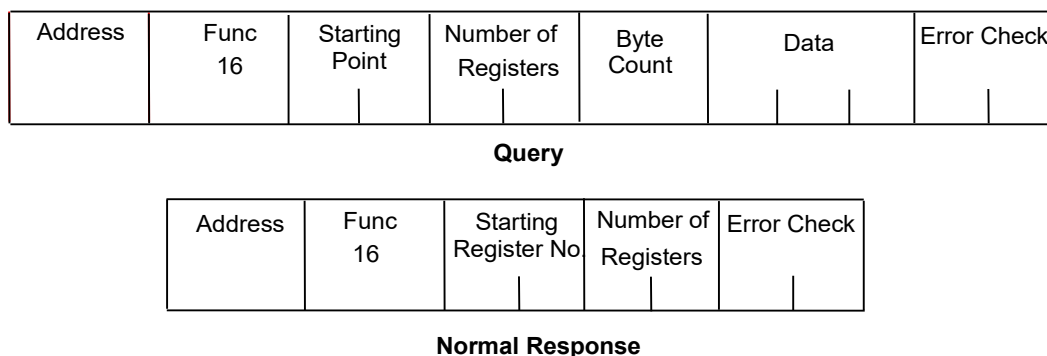
6.3.3.10.3 Response:

- The descriptions of the fields in the response are covered in the query description.

Note: The force multiple outputs request is not an output override command. The outputs specified in this request are ensured to be forced to the values specified only at the beginning of one sweep of the user logic.Message (16): Preset Multiple Registers

6.3.3.10.4 Format:

Figure 62: RTU Preset Multiple Registers Message Format



6.3.3.10.5 Query:

- An Address of 0 indicates a broadcast request. All slave stations process a broadcast request and no response is sent.
- The value of the Function code is 16.
- The Starting Register Number is two bytes in length. The Starting Register Number may be any value less than the highest register number available in the attached CPU. It is equal to one less than the number of the first register preset by this request.
- The Number of Registers value is two bytes in length. It must contain a value from 1 to 125 inclusive. The sum of the Starting Register Number and the Number of Registers value must be less than or equal to the highest register number available in the attached CPU. The high order byte of the Starting Register Number and Number of Registers fields is sent as the first byte in each of these fields. The low order byte is the second byte in each of these fields.
- The Byte Count field is one byte in length. It is a binary number from 2 to 250 inclusive. It is equal to the number of bytes in the data field of the preset multiple registers request. Note that the Byte Count is equal to twice the value of the Number of Registers.
- The registers are returned in the Data field in order of number with the lowest number register in the first two bytes and the highest number register in the last two bytes of the Data field. The number of the first register in the Data field is equal to the starting register number plus one. The high order byte is sent before the low order byte of each register.

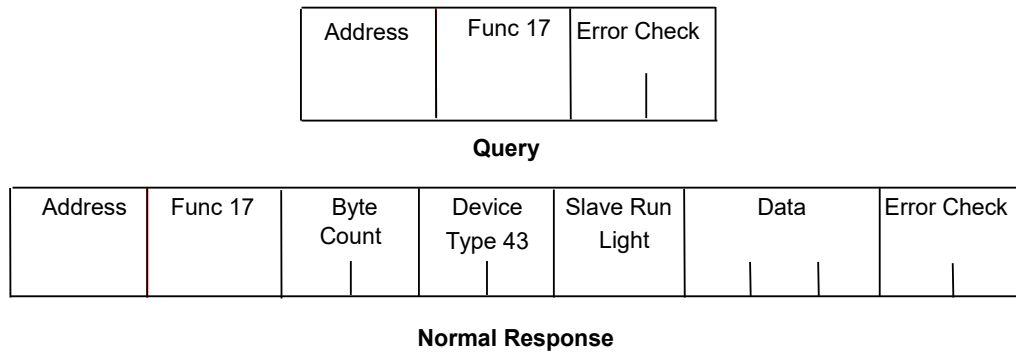
6.3.3.10.6 Response:

The descriptions of the fields in the response are covered in the query description.

6.3.3.11 Message (17): Report Device Type

6.3.3.11.1 Format:

Figure 63: RTU Report Device Type Message Format



6.3.3.11.2 Query:

The Report Device Type query is sent by the master to a slave in order to learn what type of programmable control or other computer it is.

- An Address of zero is not allowed as this cannot be a broadcast request.
- The Function code is 17.

6.3.3.11.3 Response:

- The Byte Count field is one byte in length and is equal to 5.
- The Device Type field is one byte in length and is equal to 43 (hexadecimal) for PACSystems
- The Slave Run Light field is one byte in length. The Slave Run Light byte is equal to OFFH if the CPU is in RUN Mode. It is equal to 0 if the CPU is not in RUN Mode.
- The Data field contains three bytes. For PACSystems CPUs, the first byte is the Minor Type, and the remaining bytes are zeroes. The following table lists minor types.

Response Data (Minor Type)	CPU Model ⁸³
02 hex	IC698CPE010
04 hex	IC698CPE020
05 hex	IC698CRE020
06 hex	IC698CPE030
08 hex	IC698CPE040
0A hex	IC695CPE302 IC695CPE305 IC695CPU310
0C hex	IC695NIU001
10 hex	IC695CPU320
11 hex	IC695CRU320
12 hex	IC695CPE302 IC695CPE305
18 hex	IC695CPU315

6.3.3.12 Message (22): Mask Write 4x Memory

Modifies the contents of a specified 4x register using a combination of an AND mask, an OR mask, and the register's current contents. The function can be used to set or clear individual bits in the register. Broadcast is not supported.

6.3.3.12.1 Query:

The query specifies the 4x reference to be written, the data to be used as the AND mask, and the data to be used as the OR mask.

The function's algorithm is:

Result = (Current Contents AND And_Mask) OR (Or_Mask AND And_Mask)

For example:

	Hex	Binary	
Current Contents	12	0001	0010
And_Mask	F2	1111	0010
Or_Mask	25	0010	0101
And_Mask	0D	0000	1101
Result	17	0001	0111

⁸³ Does not apply to CPE330, which has no serial ports.
Serial I/O, SNP, & RTU Protocols

Note: If the Or_Mask value is zero, the result is simply the logical ANDing of the current contents and And_Mask. If the And_Mask value is zero, the result is equal to the Or_Mask value.

Note: The contents of the register can be read with the Read Holding Registers function (function code 03). They could, however, be changed subsequently as the controller scans its user logic program.

Example of a Mask Write to register 5 in slave device 17, using the above mask values:

Field Name	Example (Hex)
Slave Address	11
Function	16
Reference Address Hi	00
Reference Address Lo	04
And_Mask Hi	00
And_Mask Lo	F2
Or_Mask Hi	00
Or_Mask Lo	25
Error Check (LRC or CRC)	--

6.3.3.12.2 Response:

The normal response is an echo of the query. The response is returned after the register has been written.

6.3.3.13 Message (23): Read Write 4x Memory

Performs a combination of one read and one write operation in a single Modbus transaction. The function can write new contents to a group of 4x registers, and then return the contents of another group of 4x registers. Broadcast is not supported.

6.3.3.13.1 Query:

The query specifies the starting address and quantity of registers of the group to be read. It also specifies the starting address, quantity of registers, and data for the group to be written. The Byte Count field specifies the quantity of bytes to follow in the Write Data field.

Here is an example of a query to read six registers starting at register 5, and to write three registers starting at register 16, in slave device 17:

Field Name	Example (Hex)
Slave address	11
Function	17
Read Reference Address Hi	00
Read Reference Address Lo	04
Quantity to Read Hi	00
Quantity to Read Lo	06
Write Reference Address Hi	00
Write Reference Address Lo	0F
Quantity to Write Hi	00
Quantity to Write Lo	03
Byte Count	06
Write Data 1 Hi	00
Write Data 1 Lo	FF
Write Data 2 Hi	00
Write Data 2 Lo	FF
Write Data 3 Hi	00
Write Data 3 Lo	FF
Error Check (LRC or CRC)	--

6.3.3.13.2 Response:

The normal response contains the data from the group of registers that were read. The Byte Count field specifies the quantity of bytes to follow in the Read Data field.

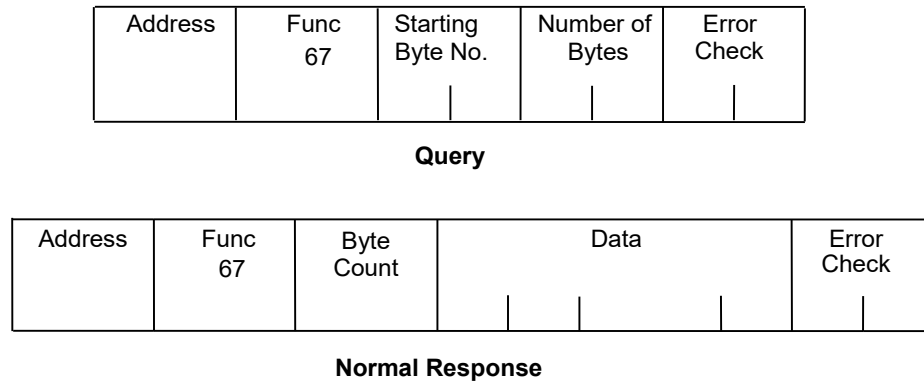
Here is an example of a response to the query:

Field Name	Example (Hex)
Slave Address	11
Function	17
Byte Count	0C
Read Data 1 Hi	00
Read Data 1 Lo	FE
Read Data 2 Hi	0A
Read Data 2 Lo	CD
Read Data 3 Hi	00
Read Data 3 Lo	01
Read Data 4 Hi	00
Read Data 4 Lo	03
Read Data 5 Hi	00
Read Data 5 Lo	0D
Read Data 6 Hi	00
Read Data 6 Lo	FF
Error Check (LRC or CRC)	--

6.3.3.14 Message (67): Read Scratch Pad Memory

6.3.3.14.1 Format:

Figure 64: RTU Read Scratch Pad Memory Message Format



6.3.3.14.2 Query:

- An Address of 0 is not allowed as this cannot be a broadcast request.
- The Function Code is equal to 67.
- The Starting Byte Number is two bytes in length and may be any value less than or equal to the highest scratch pad memory address available in the attached CPU as indicated in the table below. The Starting Byte Number is equal to the address of the first scratch pad memory byte returned in the normal response to this request.
- The Number of Bytes value is two bytes in length. It specifies the number of scratch pad memory locations (bytes) returned in the normal response. The sum of the Starting Byte Number and the Number of Bytes values must be less than two plus the highest scratch pad memory address available in the attached CPU. The high order byte of the Starting Byte Number and Number of Bytes fields is sent as the first byte in each of these fields. The low order byte is the second byte in each of the fields.

6.3.3.14.3 Response:

- The Byte Count is a binary number from 1 to 256 (0 = 256). It is the number of bytes in the Data field of the normal response.
- The Data field contains the contents of the scratch pad memory requested by the query. The scratch pad memory bytes are sent in order of address. The contents of the scratch pad memory byte whose address is equal to the Starting Byte Number is sent in the first byte of the Data field. The contents of the scratch pad memory byte whose address is equal to one less than the sum of the starting byte number and number of bytes values is sent in the last byte of the Data field.

6.3.4 RTU Scratch Pad

The entire scratch pad is updated every time an external READ request is received by the PACSystems RTU slave. All scratch pad locations are *read only*. The scratch pad is a byte-oriented memory type.

6.3.4.1 RTU Scratch Pad Memory Allocation

SP Address	Field Identifier	Bits							
		7	6	5	4	3	2	1	0
00	CPU Run Status	0	0	0	0	See note. ⁸⁴			
01	CPU Command Status	Bit pattern same as SP(00)							
02 03	CPU Type	Major ⁸⁵ (in hexadecimal) Minor ⁸⁶ (in hexadecimal)							
04 – 0B	CPU SNP ID	7 ASCII characters + termination character (00h)							
0C 0D	CPU Firmware Revision No.	Major (in BCD) Minor (in BCD)							
0E 0F	Communications Management Module (CMM) Firmware Revision No.	Major Minor							
10–11	Reserved	00h							
12	Node Type Identifier	PACSystems 43 (hexadecimal)							
13–15	Reserved	00h							
16	RTU Station Address	1–247 (decimal)							
17	Reserved	00h							
18–33 ⁸⁷	Sizes of Memory Types								
18–1B	Register Memory	%R size (words)							
1C–1F	Analog Input Table	%AI size (words)							
20–23	Analog Output Table	%AO size (words)							
24–27	Input Table	%I size (bits)							
28–2B	Output Table	%O size (bits)							
2C–2F	Internal Discrete Memory	%M size (bits)							
30–33	User Program Code	The amount of program memory occupied by the logic program.							
34–FF	Reserved	00h							

6.3.5 Communication Errors

⁸⁴ 0000 = Run_Enabled 0100 = Halted 0001 = Run_Disabled 0101 = Suspended
0010 = Stopped 0110 = Stopped_IO_Enabled

⁸⁵ CPU Major Type Codes: PACSystems 0x43

⁸⁶ PACSystems Minor Types for CPU: refer to Message (17): Report Device Type

⁸⁷ Four bytes hold the hexadecimal length of each memory type with the most significant word reserved for future expansion. For example, the default register memory size of 1024 words (0400h) would be returned in the following format:

Word	Least	Significant	Most	Significant
SP Byte	18	19	1A	1B
Contains	00	04	00	00

Serial link communication errors are divided into three groups:

- Invalid Query Message
- Serial Link Time Outs
- Invalid Transaction

6.3.5.1 Invalid Query Message

When the communications module receives a query addressed to itself, but cannot process the query, it sends one of the following error responses:

	<i>Subcode</i>
Invalid Function Code	1
Invalid Address Field	2
Invalid Data Field	3
Query Processing Failure	4

The format for an error response to a query is as follows:

Figure 65: RTU Error Response Format

Address	Exception Func	Error Subcode	Error Check

The address reflects the address provided on the original request. The exception function code is equal to the sum of the function code of the query plus 128. The error subcode is equal to 1, 2, 3, or 4. The value of the subcode indicates the reason the query could not be processed.

6.3.5.1.1 Invalid Function Code Error Response (1)

An error response with a subcode of 1 is called an invalid function code error response. This response is sent by a slave if it receives a query whose function code is not equal to 1- 8, 15, 16, 17, or 67.

Note: Starting with Release 6.70 for the RX3i, the invalid function code error response is not used. Instead, undefined and unsupported function codes are ignored, and no response is generated.

6.3.5.1.2 Invalid Address Error Response (2)

An error response with a subcode of 2 is called an invalid address error response. This error response is sent in the following cases:

1. The Starting Point Number and Number of Points fields specify output points or input points that are not available in the attached CPU (returned for function codes 1, 2, 15).
2. The Starting Register Number and Number of Registers fields specify registers that are not available in the attached CPU (returned for function codes 4, 16).
3. The Starting Analog Input Number and Analog Input Number fields specify analog inputs that are not available in the attached CPU (returned for function code 3).
4. The Point Number field specifies an output point not available in the attached CPU (returned for function code 5).
5. The Register Number field specifies a register not available in the attached CPU (returned for function code 6).
6. The Analog Input Number field specifies an analog input number not available in the attached CPU (returned for function code 3).
7. The Diagnostic Code is not equal to 0, 1, or 4 (returned for function code 8).
8. The starting Byte Number and Number of Bytes fields specify a scratch pad memory address that is not available in the attached CPU (returned for function code 67).

6.3.5.1.3 Invalid Data Value Error Response (3)

An error response with a subcode of 3 is called an invalid data value error response. This response is sent in the following cases:

The first byte of the Data field is not equal to 0 or 255 (FFh) or the second byte of the Data field is not equal to 0 for the Force Single Output Request (Function Code 5) or the initiate communication restart request (function code 8, diagnostic code 1). The two bytes of the Data field are not both equal to 0 for the Force Listen-Only request (Function Code 8, Diagnostic Code 4). This response is also sent when the data length specified by the Memory Address field is longer than the data received.

6.3.5.1.4 Query Processing Failure Error Response (4)

An error response with a subcode of 4 is called a query processing failure response. This error response is sent by a RTU device if it properly receives a query but communication between the associated CPU and the CMM fails.

6.3.5.2 Serial Link Timeout

The only cause for a RTU device to timeout is if an interruption to a data stream of 4 character times occurs while a message is being received. If this occurs the message is considered to have terminated and no response will be sent to the master. There are certain timing considerations due to the characteristics of the slave that should be taken into account by the master. After sending a query message, the master should wait an appropriate amount of time for slave turnaround before assuming that the slave did not respond to the request. Slave turnaround time is affected by the Controller Communications Window time and the CPU sweep time, as described in *RTU Slave Turnaround Time*.

6.3.5.3 Invalid Transactions

If an error occurs during transmission that does not fall into the category of an invalid query message or a serial link time-out, it is known as an invalid transaction. Types of errors causing an invalid transaction include:

- Bad CRC
- The data length specified by the Memory Address field is longer than the data received
- Framing or overrun errors
- Parity errors

If an error in this category occurs when a message is received by the slave serial port, the slave does not return an error message; rather the slave ignores the incoming message, treating the message as though it was not intended for it.

6.3.6 RTU Slave/SNP Slave Operation with Programmer Attached

A port that has been configured for RTU Slave protocol can switch to SNP protocol if an SNP master such as a programmer begins communicating to the port. The programmer must use the same serial communications parameters (baud rate, parity, stop bits, etc.) as the currently active RTU Slave protocol for it to be recognized. When the CPU recognizes the SNP master, the CPU removes the RTU Slave protocol from the port and installs SNP Slave as the active protocol.

The SNP protocol that is installed in this case has the following fixed characteristics:

- The SNP ID is set to blank. Therefore, the SNP master must use a blank ID in the SNP attach message. This also means that this capability is only useful for point-to-point connections.
- The turnaround time is set to 0ms.
- The idle timeout is set to 10 seconds.

After the programmer is removed, there is a slight delay (equal to the idle timeout) before the CPU recognizes its absence. During this time, no messages are processed on the port. The CPU detects removal of the programmer as an SNP Slave protocol timeout. Therefore, it is important to be careful when disabling timeouts used by the SNP Slave protocol.

When the CPU recognizes the programmer disconnect, it reinstalls RTU Slave protocol unless a new protocol has been configured in the meantime. In that case, the CPU installs the new protocol instead.

6.3.6.1 Example

1. COM1 is running RTU Slave protocol at 9600 baud.
2. A programmer is attached to COM1. The programmer is using 9600 baud.
3. The CPU installs SNP Slave on COM1 and the programmer communicates normally.
4. The programmer stores a new configuration to COM1. The new configuration sets the port for SNP Slave at 4800 baud (it will not take effect until the port loses communications with the programmer).
5. When the CPU loses communications with the programmer, the new configuration takes effect.

6.4 SNP Slave Protocol

PACSystems CPUs can communicate with Machine Edition software through either COM1 or COM2 using SNP slave protocol.

CPU COM1 is wired as an RS-232 Data Communications Equipment (DCE) port, and can be connected directly using straight-through cable to one of the serial ports of a PC running Machine Edition or other SNP master software.

CPU COM2 is wired for RS-485. If the SNP master does not have an RS-485 port, an RS-485/RS-232 converter is required. The RX3i can use converter IC690ACC901, which uses +5Vdc from the serial port. The CPU COM2 does not support IC690ACC901 and requires an externally powered converter.

PACSystems provides the *break free* version of SNP, so that the SNP master does not need to issue a break signal as part of the SNP attach sequence. However, the CPU responds appropriately if a break signal is detected, by resetting the protocol to wait for another attach sequence from the master.

PACSystems supports both point-to-point connections (single master/single slave) and multi-drop connections (single master/multiple slaves).

For details on SNP protocol, refer to the *Series 90 PLC Serial Communications User's Manual*, GFK-0582. CPE400 and CPL410 do not support this protocol.

6.4.1 Permanent Datagrams

Permanent datagrams survive after the SNP session that created them has been terminated. This allows an SNP master device to periodically retrieve datagram data from a number of different controllers on a multi-drop link, without the master having to establish and write the datagram each time it reconnects to the controller.

The maximum number of permanent datagrams that can be established is 32. When this limit is reached, additional requests to establish datagrams are denied. One or more of the permanent datagrams will need to be cancelled before others can be established. Since the permanent datagrams are not automatically deleted when the SNP session is terminated, this limit prevents an inordinate amount of these datagrams from being established.

Permanent datagrams do not survive a power-cycle.

6.4.2 Communication Requests (COMMREQs) for SNP

The PACSystems serial ports COM1 and COM2 currently do not provide SNP Master service, nor do they support COMMREQ functions for SNP commands. However, those COMMREQ functions can be used with PCM/CMM modules that are configured to provide SNP service. For more information, refer to the *Series 90 PLC Serial Communications User's Manual*, GFK-0582.

Appendix.A: Performance Data

This appendix contains instruction and overhead timing collected for each PACSystems CPU module. This timing information can be used to predict CPU sweep times. The information in this appendix is organized as follows:

A-1.1 Boolean Execution Measurements (ms per 1000 Boolean executions)⁸⁸

CPU Model	Boolean Category		
	Simple Address	Complex Address	Passed as Parameter
CPU310	0.253	1.371	0.467
CPE010	0.244	1.329	0.469
CPE020	0.095	0.543	0.198
CRE020	0.096	0.556	0.194
CPE030	0.087	0.450	0.183
CRE030	0.090	0.451	0.184
CPE040	0.029	0.150	0.061
CRE040	0.029	0.149	0.061

For more information on Execution Times (including Boolean Operation) for Ladder Diagram instructions, please see A-1.4, *RX3i & RSTi-EP Instruction Times*.

⁸⁸ Measured with CPU firmware version 7.18.
Serial I/O, SNP, & RTU Protocols

A-1.2 Instruction Timing

A-1.3 Overview

The tables in this section list the execution and incremental times in microseconds (μs) for each function supported by the PACSystems CPUs. Two execution times are shown for each instruction.

Execution Time	Description
Enabled	Time in μs required to execute the function or function block when power flows into the function with valid inputs.
Disabled	Time in μs required to execute the function when it is not enabled.

Notes:

- All times represent typical execution time. Times may vary with input and error conditions.
- Enabled time is for single length units of word-oriented memory.
- COMMREQ time was measured between CPU and Ethernet module with NOWAIT option.
- DOIO time was measured using a discrete output module.
- Timers are updated each time they are encountered in the logic by the amount of time consumed by the last sweep.
- Performance times for the BUS_ functions were measured on the RX3i using an RMX128 Redundancy Memory Xchange Module.
- Performance times for all redundancy (CRE and CRU) CPUs were measured with ECC enabled.
- Due to a change in caching, measured times for some instructions changed for release 6.0 as compared to releases 5.0/5.1. It was found that increases in some instructions were offset by decreases in other instructions, so that no effective net change was observed.
- PLC Version Information

The instruction execution and incremental times were obtained by testing the following CPU versions:

	Model	PLC Firmware Version
All instructions except as listed below	RSTi-EP EPSCPE100	9.15
	RSTi-EP EPSCPE115	9.45
	IC695CPL410	9.55
	IC695CPE400	9.00
	IC695CPE305/CPE310/CPE330	7.10
	IC695CPE302	9.40
	IC695CPU310/CPU315	6.0
	IC695CPU320/IC695CRU320 ⁸⁹	7.18
	IC698CPE010/CPE020	6.0
	IC698CRE020	6.0 (with ECC enabled)
	IC698CPE030/CPE040	6.0
	IC698CRE030/CRE040	6.0 (with ECC enabled)
MOVE_UINT	CPE010/020	3.5
	CRE020 ⁸⁹	2.04 (with ECC enabled)
SVC_REQs for Redundancy	IC695CRU320 ⁸⁹	6.0 (with ECC enabled)
TON, TOF, TP Instructions	CPU310/CPU315/CPU320, CRU320	5.7
	CPE010/CPE030/CPE040	3.6
	CRE030/CRE040 ⁸⁹	3.6 (with ECC enabled)
Instructions for PACMotion	CPU315/CPU320	5.6
	CPU310	6.0

A-1.4 RX3i & RSTi-EP Instruction Times

The following tables are intended to provide guidance for expected instruction execution times when using Ladder Diagram (LD) and C Language. For simplicity, the instructions are grouped as follows:

- Boolean Operation: this includes coil and contact operation (LD only).
- Word Operation: applies to MOVE instruction for all basic types.
- Fixed-point math covers all math operations which are not floating point (INT, UINT, DINT types).
- Floating-point math covers all math operations which are not fixed point (REAL and LREAL types).

⁸⁹ Due to Error Checking and Correction (ECC), Redundant CPU times are approximately 5% slower, on average, than the equivalent Non-Redundant CPU.
Appendix A

Execution Times for LD Instructions					
Type of Operation	CPE100/CPE115	CPE310/CPE305/CPE302	CPU320	CPE330	CPE400/CPL410
Boolean Operation	127ns	87ns	46ns	46ns	46ns
Word Operation	1276ns	722ns	363ns	275ns	363ns
Fixed Point Math	1323ns	778ns	413ns	405ns	413ns
Floating Point Math	1328ns	771ns	420ns	410ns	420ns

Execution Times for C Instructions (Raw processor power)					
Type of Operation	CPE100/CPE115	CPE310/CPE305/CPE302	CPU320	CPE330	CPE400/CPL410
Boolean Operation	N/A	N/A	N/A	N/A	N/A
Word Operation	N/A	2ns	3ns	2ns	3ns
Fixed Point Math	N/A	20ns	3ns	3ns	3ns
Floating Point Math	N/A	24ns	9ns	6ns	7ns

A-1.5 Overhead Sweep Impact Times

This section contains overhead timing information for the PACSystems CPUs. This information can be used in conjunction with the estimated logic execution time to predict sweep times for the CPUs. The information in this section is made up of a base sweep time plus sweep impact times for each of the CPU models. The predicted sweep time is computed by adding the sweep impact time(s), the base sweep, and the estimated logic execution time.

See sample calculation for estimating sweep times at

The following components make up the total sweep time:

- Programmer communications sweep impact
- I/O Scan and fault sweep impact
- Ethernet Global Data sweep impact
- Intelligent Option Module (LAN modules) sweep impact
- I/O interrupt performance and sweep impact
- Timed interrupt performance and sweep impact

A-1.6 Base Sweep Times

Base sweep time is the time for an empty _MAIN program block to execute, with no configuration stored and none of the windows active. The following table gives the base sweep times in microseconds (μs) for each CPU model.

Family	Model	Run I/O enabled (μs)	Run outputs disabled (μs)
RX3i	CPU310 ⁹⁰	1086	1076
	CPU315 CPU320 ⁹⁰	180	176
	CRU320 ⁹⁰	198	194
	CPE302 CPE305 CPE310	426	424
	CPE330	196	192
	CPE400 CPL410	193	189
RSTi-EP	CPE100	887	-
	CPE115	862	-

The following diagram shows the differences between the full sweep phases and the base sweep phases.

⁹⁰ Base sweep time calculated with RUN/STOP switch, single ETM.
Appendix A

Window is never opened. The lack of intelligent option modules means that the Backplane Communications Window is never opened.

A-1.8 What the Sweep Impact Tables Contain

In some tables, functions are shown as asynchronously impacting the sweep. This means that there is not a set phase of the sweep in which the function takes place. For instance, the scanning of all I/O modules takes place during either the input or output scan phase of the CPU's sweep. However, I/O interrupts are totally asynchronous to the sweep and will interrupt any function currently in progress.

The communication functions (with the exception of the high priority programmer requests) are all processed within one of the two windows in the sweep (the Controller Communications Window and the Backplane Communications Window). Sweep impact times for the various service requests are all minimum sweep impact times for the defined functions, where the window times have been adjusted so that no time slicing (limiting) of the window occurs in a given sweep. This means that, as much as possible, each function is completed in one occurrence of the window (between consecutive logic scans). The sweep impact of these functions can be spread out over multiple sweeps (limited) by adjusting the window times to a value lower than the documented sweep impact time. For the programmer, the default time is 10 ms; therefore, some of the functions listed in that section will naturally time slice over successive sweeps.

A-1.9 Programmer Sweep Impact Times

The following table shows nominal programmer sweep impact times in microseconds (μs).

<i>Sweep Impact Item</i>	<i>RX3i</i>			
	<i>CPU310</i> (μs)	<i>CPU315</i> <i>CPU320</i> <i>CRU320</i> (μs)	<i>CPE330</i> <i>CPE400</i> <i>CPL410</i> (μs)	<i>CPE010</i> (μs)
Programmer window	2.90	0.20	1.46	1.95
Reference table monitor	4.90	0.29	1.48	1.20
Editor monitor	4.10	0.31	1.41	1.41

Definitions:

<i>I/O Scan</i>	<i>Description</i>
Programmer window	The time required to open the Programmer Window but not process any requests. The programmer is attached through an Ethernet connection; no reference values are being monitored.
Reference table monitor	The sweep impact to refresh the reference table screen. (The %R table was used as the example.) Mixed table display impacts are slightly larger. The sweep impact may not be continuous, depending on the sweep time of the CPU and the speed of the host of the programming software.
Editor monitor	The sweep impact to refresh the editor screen when monitoring ladder logic. The times given in the table are for a logic screen containing one contact, two coils, and eleven registers. As with the reference table sweep impact, the impact may not be continuous.

A-1.10 I/O Scan and I/O Fault Sweep Impact

The I/O scan sweep impact has two parts, Local I/O and Genius I/O. The equation for computing I/O scan sweep impact is:

$$\boxed{\text{I/O Scan Sweep Impact}} = \boxed{\text{Local Scan Impact}} + \boxed{\text{Genius I/O Scan}}$$

Sweep Impact of Local I/O Modules

The I/O scan of I/O modules is impacted as much by location and reference address of a module as it is by the number of modules. The I/O scan has several basic parts.

<i>I/O Scan</i>	<i>Description</i>
Rack Setup Time	Each expansion rack is selected separately because of the addressing of expansion racks on the VME bus. This results in a fixed overhead per expansion rack, regardless of the number of modules in that rack.
Per Module Setup Time	Each Local I/O module has a fixed setup scan time.
Byte Transfer Time	The actual transfer of bytes is much faster for modules located in the main rack than for those in expansion racks. The byte transfer time differences will be accounted for by using different times for I/O modules in the main rack versus expansion racks.

In addition, analog input expander modules (the same as Genius blocks) have the ability to be grouped into a single transfer as long as consecutive reference addresses are used for modules that have consecutive slot addresses. Each sequence of consecutively addressed modules is called a scan segment. There is a time penalty for each additional scan segment.

RX3i I/O Module Types

<i>Type</i>	<i>Part Numbers</i>
Discrete Input, 16-point	IC694MDL240, IC694MDL241, IC694MDL645, IC694MDL646
Discrete Input - Smart Digital Input, 16-point	IC695MDL664
Discrete Input, 32-point	IC694MDL654, IC694MDL655, IC694MDL654
Discrete Output, 8-point	IC694MDL330, IC694MDL732, IC694MDL930, IC694MDL940
Discrete Output, 16-point and 12-point	IC694MDL340, IC694MDL341, IC694MDL740, IC694MDL741
Discrete Output – Smart Digital Output. 16-point	IC695MDL765
Discrete Output, 32-point	IC694MDL350, IC694MDL340, IC694MDL742, IC694MDL752, IC694MDL753, IC694MDL940
Discrete Output, 32-point	IC694MDL758
Discrete In/Out, 8-point	IC693MDR390, IC693MAR590
Analog Input, 4-channel	IC695ALG220, IC694ALG221
Analog Input, 6-channel	IC695ALG106
Analog Input, 12-channel	IC695ALG112
Analog Input, 16-channel	IC694ALG222, IC694ALG223
Analog Output, 2-channel	IC694ALG390, IC694ALG391
Analog Mixed Input/Output	IC694LG442
Analog Input with Diagnostics	IC694ALG232, IC694ALG233
Analog Mixed Input/Output with Diagnostics	IC694ALG542

RX3i I/O Module Sweep Impact Times

The following table provides sweep impact times for modules in the Main rack and in an expansion (Exp) rack. The base case provides the overhead for a single module in the rack. The increment (Inc) refers to the overhead for each similar module that is added to the same rack. To estimate sweep impact for modules in a remote rack, multiply the time in the main rack by 6:

main rack base time × 6 = approximate sweep impact in remote rack

	CPU310 (μs)				CPU315/CPU320 (μs)				CPE302/CPE305/CPE310 (μs)			
	Main Rack		Exp		Main Rack		Exp		Main Rack		Exp	
	Base	Inc	Base	Inc	Base	Inc	Base	Inc	Base	Inc	Base	Inc
Discrete Input 16-point	57.1	41.4	87.6	74.4	37.4	34.6	68.2	66.3	-	-	-	-
Discrete Input 16-point (Smart Digital Input – IC695MDL664)	24.6	21.6	NA	NA	-	-	NA	NA	-	-	-	-
Discrete Input 32-point	78.4	59.7	105.9	96.1	56.2	55.3	86.1	85.7	-	-	-	-
Discrete Output 8-point	61.0	40.3	84.3	74.9	35.6	34.7	64.5	65.5	-	-	-	-
Discrete Output 16-point	61.5	38.9	87.0	74.4	35.4	34.5	65.2	64.9	-	-	-	-
Discrete Output 16-point (Smart Digital Output – IC695MDL765)	24.8	21.4	NA	NA	-	-	NA	NA	-	-	-	-
Discrete Output 32-point	79.7	57.0	101.8	90.6	54.4	50.1	81.8	81.9	-	-	-	-
Discrete Output 32-point (IC694MDL758)	-	-	-	-	128.6	123.7	220.9	216.0	193.1	-	288.5	-
Discrete Mixed 8-point in/ 8-point out	104.5	85.7	167.0	151.7	72.2	68.9	132.3	131.2	-	-	-	-
Analog In/Out 4-channel	114.9	99.0	142.7	132.0	93.7	92.5	124.8	123.3	-	-	-	-
Analog Input 16-channel	427.7	407.1	538.8	538.0	385.3	378.8	499.9	499.3	-	-	-	-
Analog Output 2-channel	98.3	80.8	154.4	143.4	69.7	66.8	129.1	128.3	-	-	-	-
Analog Input 6-channel, IC695ALG106	92.9	73.4	N/A	N/A	51.6	51.0	N/A	N/A	-	-	-	-
Analog Input 12-channel, IC695ALG112	111.7	94.8	N/A	N/A	66.8	58.7	N/A	N/A	-	-	-	-
Universal Analog IC695ALG600	90.3	77.2	N/A	N/A	50.9	45.7	N/A	N/A	-	-	-	-
Analog Input 8-channel IC695ALG608	84.4	68.3	N/A	N/A	43.3	39.8	N/A	N/A	-	-	-	-
Analog Input 16-channel IC695ALG616	99.5	82.6	N/A	N/A	56.3	55.6	N/A	N/A	-	-	-	-
Analog Output 4-channel IC695ALG704	122.0	101.8	N/A	N/A	54.6	48.3	N/A	N/A	-	-	-	-
Analog Output 8-channel IC695ALG708	121.6	103.3	N/A	N/A	54.7	49.6	N/A	N/A	-	-	-	-

Worksheet A: I/O Module Sweep Time

The following form can be used for computing I/O module sweep impact. The calculation contains times for analog input expanders that are either grouped into the same scan segment as the preceding module or are grouped in a separate new scan segment. The sweep impact times of I/O Modules can be found at *RX3i I/O Module Sweep Impact Times*.

Number of expansion racks	_____		
Sweep impact per expansion rack	x _____	=	_____
Number of discrete I/O modules—main rack	_____		
Sweep impact per discrete I/O module—main rack	x _____	=	_____
Number of discrete I/O modules—expansion rack	_____		
Sweep impact per discrete I/O module—expansion rack	x _____	=	_____
Number of analog input base and output modules—main rack	_____		
Sweep impact per analog input base and output module—main rack	x _____	=	_____
Number of analog input expander modules (same segment)—main rack	_____		
Sweep impact per analog input expander module (same segment)—main rack	x _____	=	_____
Number of analog input expander modules (new segment)—main rack	_____		
Sweep impact per analog input expander module (new segment)—main rack	x _____	=	_____
Number of analog input base and output modules—expansion rack	_____		
Sweep impact per analog input base and output module—expansion rack	x _____	=	_____
Number of analog input base and output modules (same segment)—exp. rack	_____		
Sweep impact per analog input base and output module (same seg.)—exp. rack	x _____	=	_____
Number of analog input base and output modules (new segment)—exp. rack	_____		
Sweep impact per analog input base and output module (new seg.)—exp. rack	x _____	=	_____
Predicted I/O Module Sweep Impact			_____

Note: If point faults are enabled, substitute the corresponding times for point faults enabled.

Sweep Impact of Genius I/O and GBCs

For the sweep impact of Genius I/O and Genius Bus Controllers (GBC), there is a sweep impact for each GBC, a sweep impact for each scan segment, and a transfer time (per word) sweep impact for all I/O data.

The GBC sweep impact has three parts:

1. Sweep impact to open the System Communications Window. This is added only once when the first intelligent option module (of which the GBC is one) is placed in the system.
2. Sweep impact to poll each GBC for background messages (datagrams). This part is an impact for every GBC in the system.

Note: Both the first and second parts of the GBC's sweep impact may be eliminated by closing the Backplane Communications Window (setting its time to 0). This should only be done to reduce scan time during critical phases of a process to ensure minimal scan time. Incoming messages will timeout and COMM_REQs will stop working while the window is closed.

Sweep impact to scan the GBC. This results from the CPU notifying the GBC that its new output data has been transferred, commanding the GBC to ready its input data, and informing the GBC that the CPU has finished another sweep and is still in RUN Mode. Scan segment for a Genius I/O block consists of consecutive memory locations starting from a particular reference address. A new scan segment is created for each starting input or output reference address. The time to process a single scan segment is higher for an input scan segment than it is for an output scan segment. The scan segment processing is the same for analog, discrete, and global data scan segments. Discrete data is transferred a byte at a time and takes longer to complete the transfer than analog data, which is transferred a word at a time. Global data should be counted as either discrete or analog, based on the memory references used in the source or destination.

Sweep Impact Time of Genius I/O and GBCs

Note: Functions in **bold type** impact the sweep continuously. All other functions impact the sweep only when invoked. Not all the timing information listed in the following table was available at print time for this manual (the blank spaces).

	CPU310 (μ s)	CPE010 (μ s)	CPE020 (μ s)	CPE030 (μ s)	CPE040 (μ s)
Genius Bus Controller					
open backplane communications window	30.0	24.0	4.0	4.0	1.0
per Genius Bus Controller polling for background messages	403.0	19.0	11.0	9.0	6.0
per Genius Bus Controller I/O Scan					
Genius Bus Controller in the main rack	469.0	1.0	1.0	1.0	1.0
Genius Bus Controller in the expansion rack	683.0	11.0	7.0	6.9	1.0
Genius I/O Blocks					
per I/O block scan segment	3.0	217.0	217.0	193.7	208.0
per I/O block scan segment w/point faults enabled	3.0	217.0	217.0	194.8	213.0
per byte discrete I/O data in the main rack	13.0	3.0	3.0	2.1	3.0
per byte discrete I/O data in expansion racks	16.0	8.0	5.0	4.2	4.0
per word analog I/O data in the main rack	24.0	5.0	4.0	4.0	5.0
per word analog I/O data in expansion racks	34.0	11.0	8.0	8.0	11.0

Worksheet B: Genius I/O Sweep Time

Use the following worksheet for predicting the sweep impact due to Genius I/O. The sweep impact times can be found in *Sweep Impact Time of Genius I/O and GBCs*.

Open backplane communications window	_____	=	_____
GBC poll for background messages	x _____	=	_____
Number of GBCs			
GBC I/O scan for the main rack	_____		
Number of GBCs in the main rack	x _____	=	_____
GBC I/O scan for the expansion rack	_____		
Number of GBCs in the expansion rack	x _____	=	_____
Input block scan segments—number of I/O block scan segments—sweep impact	x _____	=	_____
Output block scan segments—number of I/O block scan segments—sweep impact	x _____	=	_____
Bytes of discrete I/O data on GBCs—main rack	_____		
Sweep impact/bytes of discrete I/O data—main rack	x _____	=	_____
Bytes of discrete I/O data on GBCs—expansion racks	_____		
Sweep impact/bytes of discrete I/O data—expansion racks	x _____	=	_____
Words of analog I/O data on GBCs—main rack	_____		
Sweep impact/word analog I/O data—main rack	x _____	=	_____
Words of analog I/O data on GBCs—expansion racks	_____		
Sweep impact/word analog I/O data—expansion racks	x _____	=	_____
Predicted Genius I/O Scan Impact			_____

A-1.11 Ethernet Global Data Sweep Impact

Note: Refer to Section, 0 for information on standalone models supporting Embedded Ethernet interface.

Depending on the relationship between the CPU sweep time and an Ethernet Global Data (EGD) exchange's period, the exchange's data may be transferred every sweep or periodically after some number of sweeps. Therefore, the sweep impact varies based on the number of exchanges that are scheduled to be transferred during the sweep. All of the exchanges must be taken into account when computing the worst-case sweep impact.

The Ethernet Global Data (EGD) sweep impact has two parts, Consumption Scan and Production Scan:

$$\boxed{\text{EGD Sweep Impact}} = \boxed{\text{Consumption Scan}} + \boxed{\text{Production Scan}}$$

This sweep impact should be taken into account when configuring the CPU constant sweep mode and setting the CPU watchdog timeout.

Where the Consumption and Production Scans consist of two parts, exchange overhead and byte transfer time:

$$\boxed{\text{Scan Time}} = \boxed{\text{Exchange Overhead}} + \boxed{\text{Byte Transfer Time}}$$

Exchange Overhead

Exchange overhead includes the setup time for each exchange that will be transferred during the sweep. When computing the sweep impact, include overhead time for each exchange.

Note: The exchange overhead times in the table below were measured for a test-case scenario of 1400 bytes over 100 variables.

EGD Exchange Overhead Time			
CPU	Activity	Embedded Ethernet Interface (μs)	Rack-based Ethernet Module (μs)
CPU310/NIU001	Consume / READ	NA	233.6
	Produce / WRITE	NA	480.6
CPU315/CPU320	Consume / READ	NA	100.0
	Produce / WRITE	NA	195.1
CPE010	Consume / READ	184.3	238.2
	Produce / WRITE	342.0	452.0
CPE020	Consume / READ	87.7	117.8
	Produce / WRITE	187.9	257.5
CPE030	Consume / READ	85.1	114.1
	Produce / WRITE	191.8	253.5
CPE040	Consume / READ	35.08	47.12
	Produce / WRITE	75.16	103.0

Data Transfer Time

Note: This is the time required to transfer the data between the CPU module and the rack-based Ethernet module. EGD data transfer times do not increase linearly in relation to data size. Please use the data values in the table below to estimate data transfer times.

Note: CPE modules do not need to use this table with respect their embedded Ethernet port, as there is no transfer of data across the backplane related to EGD traffic.

CPU	Data Size (Bytes)	Direction	Embedded Ethernet Interface (μs)	Rack-based Ethernet Module (μs)
CPU310	1	Consume / READ	NA	9.3
NIU001 ⁹⁴	100	Consume / READ	NA	51.8

⁹⁴ EGD performance is different on the IC695NIU001+ (versions-AAAA and later) compared to the IC695NIU001. In general, consumed data exchanges with a size greater than 31 bytes will result in contributing less of a sweep time impact and data exchanges with a size less than that will contribute slightly greater sweep impact. All produced exchanges on the IC695NIU001+ will appear to have a slightly greater sweep impact when compared to the IC695NIU001.

CPU	Data Size (Bytes)	Direction	Embedded Ethernet Interface (μS)	Rack-based Ethernet Module (μS)
	200	Consume / READ	NA	97.9
	256	Consume / READ	NA	123.8
	1	Produce / WRITE	NA	6.5
	100	Produce / WRITE	NA	14.1
	200	Produce / WRITE	NA	17.7
	256	Produce / WRITE	NA	19.3
CPU315 CPU320	1	Consume / READ	NA	6.2
	100	Consume / READ	NA	49.5
	200	Consume / READ	NA	96.4
	256	Consume / READ	NA	122.8
	1	Produce / WRITE	NA	3.4
	100	Produce / WRITE	NA	9.9
	200	Produce / WRITE	NA	14.9
	256	Produce / WRITE	NA	16.5
CPE010	1	Consume / READ	4.1	8.8
	100	Consume / READ	25.7	23.5
	200	Consume / READ	49.0	38.6
	256	Consume / READ	61.4	46.8
	1	Produce / WRITE	1.9	8.8
	100	Produce / WRITE	4.0	16.5
	200	Produce / WRITE	6.0	22.2
	256	Produce / WRITE	7.1	25.1
CPE020	1	Consume / READ	2.7	5.5
	100	Consume / READ	23.6	19.5
	200	Consume / READ	46.3	34.9
	256	Consume / READ	58.9	42.7
	1	Produce / WRITE	0.8	5.5
	100	Produce / WRITE	2.7	13.9
	200	Produce / WRITE	4.7	19.2
	256	Produce / WRITE	5.9	22.1

A-1.12 EGD Sweep Impact for RX3i CPE330 and CPE400/CPL410

The CPE330 and CPE400 process Ethernet communications independently from logic and sweep execution. This architecture precludes the possibility of Ethernet communications causing the watchdog timer to time out. Consequently, the discussion below does not apply to CPE330 or CPE400.

A-1.13 EGD Sweep Impact for RX3i CPE302/CPE305/CPE310 and RSTi-EP CPE100/CPE115 Embedded Ethernet Interface

Each EGD production or consumption will take about 200 μs regardless of size of exchange. For Produced Exchanges on the embedded port you can think of it as a timed interrupt block that takes 200μs duration to execute each time it is triggered. For Consumed Exchanges on the embedded port you can think of it as an I/O interrupt block that takes 200μs duration to execute each time the remote unit sends an exchange and it is received on the embedded port.

It is important to note that this 200μs per exchange is not a simple ‘sweep impact’ time, rather per execution of that exchange time, and depending on sweep time length and production period it may occur more than one time per sweep.

Users configuring systems with EGD on an embedded Ethernet port should take care to make sure that production and consumption time on the embedded Ethernet port is accounted for.

The impact of EGD Exchanges configured on Embedded Ethernet Interface of RX3i CPE302/CPE305/CPE310 and RSTi-EP CPE100/CPE115 on the Controller sweep can be reflected in two parameters:

1. **Total_EgdImpactPerWDT_ms**: This is the total EGD impact per Watchdog Time period configured in milliseconds (ms).
2. **EgdProcessorUtilization %**: This is the percentage EGD processor utilization.

The formula for calculating these two parameters are shown below:

$$Total_EgdImpactPerWDT_ms = \sum_{n=1}^{255} \left(\frac{Wdt_ms}{Period_ms_n} \times ExchangePresent_n \times 0.200 \right)$$

$$EgdProcessorUtilization_ \% = \left(\frac{Total_EgdImpactPerWDT_ms}{Wdt_ms} \right) \times 100$$

Wdt_ms – Watchdog time configured in ms

Period_ms_n – Exchange Period nth Exchange, as configured in ms (Production Period for production exchanges and Consumption timeout for consumption exchanges)

ExchangePresent_n – nth Exchange configured (value=1) or not configured (value=0)

It is recommended that the calculated **EgdProcessorUtilization_ %** for a given EGD exchange configuration and Watchdog period should be less than 50-55% for stable operation within watchdog period without WDT elapse.

Note: The higher percentage of this parameter indicates that the EGD on Embedded Ethernet interface could have a greater impact on CPU applications.

A-1.14 Example Calculation for EGD Utilization on RX3i CPE302/CPE305/CPE310 and RSTi-EP CPE100/CPE115

The watchdog time configured to 200ms for calculations in the table below:

SN	EGD Exchange	Type of Exchange	Period	Total_EgdImpactPerWDT_ms[n]
1	EGD Exchange#1	Producer	25	1.600
2	EGD Exchange#2	Producer	25	1.600
3	EGD Exchange#3	Producer	30	1.333
4	EGD Exchange#4	Producer	30	1.333
5	EGD Exchange#5	Consumer	30	1.333
6	EGD Exchange#6	Consumer	50	0.800
7	EGD Exchange#7	Consumer	50	0.800
8	EGD Exchange#8	Consumer	50	0.800
Total_EgdImpactPerWDT_ms				9.600
EgdProcessorUtilization_%				4.800

A-1.15 Normal Sweep – EGD on RX3i CPE302/CPE305/CPE310 and RSTi-EP CPE100/CPE115 Embedded Ethernet Interface

The following table shows the chart for setting up EGD exchanges on Embedded Ethernet for RX3i CPE302/CPE305/CPE310 with a no sweep load and no network traffic. The table is a compilation of results based on testing with two RX3i CPE310 Systems in which one is acting as the EGD Producer and the other is acting as the EGD Consumer.

SN	Production Period [Consumption Timeout*] (ms)	Data size per Exchange (Bytes)	Maximum Number of EGD Exchanges (Recommended)
A	500	1400	254
B	500	200	255
C	500	10	255
D	300	1400	166
E	300	200	255
F	300	10	255
G	200	1400	109
H	200	200	255
I	200	10	255
J	100	1400	54
K	100	200	255
L	100	10	255
M	50	1400	27
N	50	200	127
O	50	10	230
P	30	1400	16
Q	30	200	75
R	30	10	136
S	20	1400	11
T	20	200	50
U	20	10	91

The following table shows the chart for setting up EGD exchanges on Embedded Ethernet for RSTi-EP CPE100/CPE115 with a no sweep load and no network traffic. The table is a compilation of results based on testing with two RSTi-EP CPE100/CPE115 Systems in which one is acting as the EGD Producer and the other is acting as the EGD Consumer.

SN	Production Period [= 50% Consumption Timeout] (ms)	Data size per Exchange (Bytes)	Maximum Number of EGD Exchanges (Recommended)
A	500	1400	8
B	300	1400	8
C	200	1400	8
D	100	1400	8
E	50	1400	8
F	30	1400	8
G	20	1400	8

Note: The *Consumption Timeout* is set at twice the *Production Period* on the other consuming RX3i CPE310 / RSTi-EP CPE100/CPE115 node. For example, for A, the *Production Period* for all the Producer exchanges is set to 500ms. This indicates that the *Consumption Timeout* for all the consumer exchanges on the consuming node is set to 1000ms (twice the production period).

The following are important points to be considered when configuring EGD exchanges on Embedded Ethernet Interface.

1. The recommended values in the given table should be used in conjunction with the recommended limit value for ***EgdProcessorUtilization_%*** as per the watchdog time and sweep load of the application.
2. EGD Consumption and Production below 20ms are not recommended for Embedded Ethernet Interface on with RX3i CPE302/CPE305/CPE310, RSTi-EP CPE100/CPE115.
3. It is advisable to limit the number of EGD exchanges or EGD load on Embedded Ethernet Interface of the RX3i CPE302/CPE305/CPE310, RSTi-EP CPE100/CPE115 and use higher periods while defining the system and configuration, and take into account the sweep load for minimizing EGD sweep impact.

A-1.16 Constant Sweep - EGD on RX3i CPE302/CPE305/CPE310 and RSTi-EP CPE100/CPE115 Embedded Ethernet Interface

The EGD on Embedded Ethernet Interface can be treated as interrupt blocks. Therefore, EGD exchanges with Constant sweep may cause sweep overruns and should be avoided. It is also recommended that the Production period for Producer exchanges be set to multiples (3 and above) of the Constant sweep time set to avoid stale data being produced by the RX3i CPE302/CPE305/CPE310 and RSTi-EP CPE100/CPE115 system on Embedded Ethernet Interface. Some of the factors affecting the Constant sweep overruns with EGD on Embedded Ethernet Interface are Constant sweep time, No of Exchanges, Production period, and Exchange data size.

The Constant sweep with EGD exchanges configured on Embedded Ethernet Interface and timed or I/O interrupts will also cause constant sweep overruns and are not recommended.

A-1.17 Sweep Impact of Intelligent Option Modules

The tables in this section list the sweep impact times in microseconds (μ s) for intelligent option modules. The fixed sweep impact is the sum of the polling sweep impact and the I/O scan impact. The opening of the Backplane Communications Window and the polling of each module have relatively small impacts compared to the sweep impact of CPU memory read or write requests.

Intelligent option modules include GBCs being used for Genius LAN capabilities. The sweep impact for these intelligent option modules is highly variable.

Fixed Sweep Impact Times of RX3i Intelligent Option Modules

Sweep Impact Item	CPU310 (µs)				CPU315/CPU320 (µs)				NIU001+ (µs)			
	Main		Exp		Main		Exp		Main		Exp	
	Base	Inc	Base	Inc	Base	Inc	Base	Inc	Base	Inc	Base	Inc
IC694APU300B and earlier	1085	—	—	—	1109	—	—	—	—	—	—	—
IC694APU300-CA and later												
Classic	2759 ⁹⁵	—	—	—	2043 ⁹⁶	—	—	—	—	—	—	—
Enhanced	4074 ⁹⁵	—	—	—	3276 ⁹⁶	—	—	—	—	—	—	—
IC694BEM331 ⁹⁷	See footnote				—	—	—	—	—	—	—	—
IC694DSM314 ⁹⁸	See footnote				—	—	—	—	See footnote			
IC695ETM001	199	—	NA	NA	188	51	NA	NA	—	—	NA	NA
IC695HSC304	208.7	173.9	NA	NA	136.4	131.0	NA	NA	—	—	NA	NA
IC695HSC308	282.4	256.5	NA	NA	202.6	200.3	NA	NA	—	—	NA	NA
IC695PBM300		—	NA	NA		—	NA	NA	—	—	NA	NA
No I/O	132				60							
100 bytes Input, 100 bytes Output	196				105							
100 bytes Input, 200 bytes Output	206				140							
200 bytes Input, 100 bytes Output	248				106							
IC695PNC001 ⁹⁹	NA	NA	NA	NA	See footnote	NA	NA	NA	NA	NA	NA	NA

⁹⁵ CPU firmware version 7.13

⁹⁶ CPU firmware version 7.14

⁹⁷ See Sweep Impact Time of Genius I/O and GBCs

⁹⁸ See DSM314 Sweep Impact

⁹⁹ See PROFINET Controller (PNC001) and PROFINET I/O Sweep Impact

PROFINET Controller (PNC001) and PROFINET I/O Sweep Impact

The PLC CPU sweep impact for a PROFINET IO network is a function of the number of PNCs, the number of PROFINET devices, and the number of each PROFINET device's IO modules. The table below shows the measured sweep impact of the RX3i PROFINET Controller, supported VersaMax PROFINET devices, and I/O modules.

Sweep Impact Item	CPU315/CPU320 (µs)	CPE302/CPE305/CPE310 (µs)	CPE330 w/PNC001 (µs)	CPE330 w/Embedded PNC (µs)	CPE400/CPL410 w/Embedded PNC (µs)
RX3i PROFINET Controller (PNC)	50	48	43	16	12
RX3i Devices					
PROFINET Scanner (PNS) IC695PNS001	46	73	42	10	24
ALG442 Mixed Analog	54	76	38	25	20
ALG220 Analog Input	27	45	29	14	10
ALG390 Analog Output	24	33	12	13	10
MDL645 Discrete Input	23	36	18	15	10
MDL740 Discrete Output	22	31	9	14	9
VersaMax Devices					
PROFINET Scanner (PNS), IC200PNS001	40	80	38	15	24
Discrete Input Module (8/16/32 pt.)	23	40	23	10	10
Discrete Output Module (8/16/32 pt.)	18	45	24	13	12
Analog Input Module (15 channel)	59	96	67	10	11
Analog Output Module (12 channel)	21	45	27	12	14
CMM020 (64AI/64AQ)	204	263	188	18	18

To calculate the total expected PLC sweep impact for a PROFINET I/O network, add the individual sweep impact times for each PROFINET Controller, PROFINET Device, and PROFINET Device I/O module, using the times provided above.

For example, for a PROFINET I/O network that consists of one PNC and one VersaMax PROFINET Scanner, which has both an 8-point input and an 8-point output module:

$$\begin{aligned} \text{Expected PLC Sweep Impact} &= 50 \text{ (PNC)} + 40 \text{ (PNS)} + 23 \text{ (8pt. Input)} + 18 \text{ (8pt. Output)} \\ &= 131 \text{ } \mu\text{s.} \end{aligned}$$

DSM314 Sweep Impact

No. of Axes Configured	Rx3i CPU310 Rack (μs)		Rx3i NIU001+ Rack (μs)	
	Main	Exp	Main	Exp
1	1535	2160	1830	2360
2	2018	2906	2304	3160
3	2500	6371	2840	3920
4	2990	4430	3350	4680

A-1.18 I/O Interrupt Performance and Sweep Impact

There are several important performance numbers for I/O interrupt blocks. The sweep impact of an I/O interrupt invoking an empty block measures the overall time of fielding the interrupt, starting up the block, exiting the block, and restarting the interrupted task. The time to execute the logic contained in the interrupt block affects the limit by causing the CPU to spend more time servicing I/O interrupts and thus reduce the maximum I/O interrupt rate.

The minimum, typical, and maximum interrupt response times reflect the time from when a single I/O module sees the input pulse until the first line of ladder logic is executed in the I/O interrupt block. Minimum response time reflects a 300 μs input card filter time + time from interrupt occurrence to first line of ladder logic in I/O interrupt block. The minimum response time can only be achieved when no intelligent option modules are present in the system and the programmer is not attached. Typical response time is the minimum response time plus a maximum interrupt latency of 2.0 ms. This interrupt latency time is valid, except when one of the following operations occurs:

- The programmer is attached.
- A store of logic, *RUN Mode Store*, or word-for-word change occurs.
- A fault condition (logging of a fault) occurs.
- Another I/O interrupt occurs.
- The CPU is transferring a large amount of input (or output) data from an I/O controller (such as a GBC). Heavily loaded I/O controllers should be placed in the main rack whenever possible.
- An event that has higher priority and requires a response occurs. An example of this type of event is clearing the I/O fault table.

Any one of these events extends the interrupt latency (the time from when the interrupt card signals the interrupt to the CPU to when the CPU services the interrupt) beyond the typical value. However, the latency of an interrupt occurring during the processing of a preceding I/O interrupt is unbounded. I/O interrupts are processed sequentially so that the interrupt latency of a single I/O interrupt is affected by the duration of the execution time of all preceding interrupt blocks. (The worst case is that every I/O interrupt in the system occurs at the same time so that one of them has to wait for all others to complete before it starts.)

The maximum response times shown below do not include the two unbounded events.

I/O Interrupt Block Performance and Sweep Impact Times

Sweep Impact Item	CPE302 CPE305 CPE310 (μs)	CPU310 (μs)	CPU315/ CPU320 (μs)	CPE010 (μs)	CPE020 (μs)	CPE030 (μs)	CPE040 (μs)
I/O interrupt sweep impact	¹⁰⁰	127.8	-	309.7	335	125.6	24.0
Minimum response time	—	151.7	326.1	392.4	334	330.6	315.2
Typical response time	—	175.0	327.3	396.1	336	331.5	315.5
Maximum response time	—	302.7	346.2	434.9	359	375.1	325.7

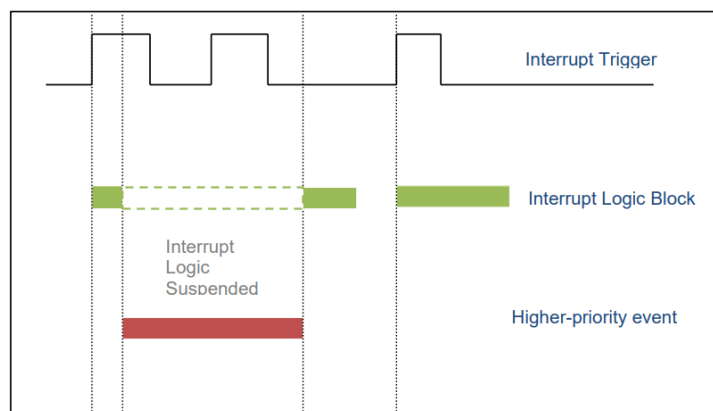
Note that the min, typical, and max response times include a 300 μs Input card filter time.

Dropped Interrupts

When multiple interrupts are triggered during the interrupt latency period, it is possible that interrupt blocks will only be executed one time even though the interrupt trigger has occurred more than once. The likelihood of this occurring will increase if the system interrupt latency has increased due to the specific configuration and use of the system.

This will not cause the CPU to miss a given interrupt; just consolidate the number of times an interrupt block is executed even though the interrupt stimulus had occurred more than one time.

Figure 66: Interrupt Execution Considerations



¹⁰⁰ Performance data not available for this release.

Worksheet D: Programmer, IOM, I/O Interrupt Sweep Time

The following worksheet can be used to calculate the sweep impact times of programmer sweep impact, intelligent option modules, and I/O Interrupts. For time data, refer to the following tables:

Programmer Sweep Impact Times

RX3i I/O Module Sweep Impact Times

Sweep Impact Time of Genius I/O and GBCs

Programmer sweep impact		=	_____
IOM—first module (open comm. window)			_____
IOM—per module (polling)	+		_____
LAN module I/O scan	+		_____
Total IOM Sweep Impact		=	_____
CPU memory access from IOMs		=	_____
I/O interrupt sweep impact			_____
I/O interrupt response time	+		_____
		=	_____
Predicted Sweep Time (Other)			_____

A-1.19 Timed Interrupt Performance

The sweep impact of a timed interrupt invoking an empty program block or timed program measures the overall time of fielding the interrupt, starting up the program or block, exiting the program or block, and restarting the interrupted task. The minimum, average, and maximum interrupt period reflect the time period from when the first line of ladder logic is executed in the timed interrupt block.

Timed Interrupt Performance and Sweep Impact Times for a 0.001s Timed Interrupt Block

Sweep Impact Item	CPU310 (μs)	CPU315 CPU320 (μs)	CPE010 (μs)	CPE020 (μs)	CPE030 (μs)	CPE040 (μs)
Timed interrupt sweep impact	87.3	26.2	88.6	28.0	31.2	23.3
Minimum interrupt period	908.3	969.8	951.4	946.0	922.8	973.0
Average interrupt period	1000.0	1000.0	1005.5	999.7	1000.0	999.9
Maximum interrupt period	1081.2	1030.8	1056.6	1054.0	1077.0	1026.9

A-1.20 User Memory Allocation

User Memory Size is the number of bytes of memory available to the user for PLC applications.

Model	User Memory Size (MB)
IC695CPE302	2MB
IC695CPE305	5MB
IC695CPU310, IC695CPE310, IC698CPE010, IC698CPE020, IC698CRE020	10MB
IC695CPU315	20MB
IC695CPL410, IC695CPE400, IC695CPE330, IC695CPU320, IC695CRU320	64MB
IC698CPE030, IC698CRE030 IC698CPE040, IC698CRE040	64MB
EPSCPE100	1MB
EPSCPE115	1.5MB

For a list of items that count against user memory, see below.

A-1.21 Items that Count Against User Memory

The following items count against the CPU memory and can be used to estimate the minimum amount of memory required for an application. Additional space may be required for items such as Advanced User Parameters, zipped source files, user heap, and published symbols.

Register Memory Size (%R)	Bytes = %R references configured × 2
Word Memory Size (%W)	Bytes = %W references configured × 2

Analog Inputs (%AI)	If point faults enabled: Bytes = %AI references configured × 3 If point faults disabled: Bytes = %AI references configured × 2
Analog Outputs (%AQ)	If point faults enabled: Bytes = %AQ references configured × 3 If point faults disabled: Bytes = %AQ references configured × 2
Discrete Point Faults	If point faults enabled: Bytes = 3072
Managed Memory (Symbolic Variable and I/O Variable Storage)	The total number of bytes required for symbolic and I/O variables. Calculated as follows: [(number of symbolic discrete bits) × 3 / (8 bits/byte)] + [(number of I/O discrete bits) × Md / (8 bits/byte)] + [(number of symbolic words) × (2 bytes/word)] + [(number of I/O words) × (Mw bytes/word)] Md = 3 or 4. The number of bits is multiplied by 3 to keep track of the force, transition, and value of each bit. If point faults are enabled, the number of I/O discrete bits is multiplied by 4. Mw = 2 or 3. There are two 8-bit bytes per 16-bit word. If point faults are enabled, the number of bytes is multiplied by 3 because each I/O word requires an extra byte.
EGD (included in HWC)	Bytes = 0 if no Ethernet Global Data pages are configured
I/O Scan Set File (included in HWC)	Based on number of scan sets used. Note: 32 bytes of user memory are consumed if the application scans all I/O every sweep (the default).
User Programs	Refer to <i>User Program Memory Usage</i> below for details on user programs.

A-1.22 User Program Memory Usage

Space required for user logic includes the following items.

A-1.23 %L and %P Program Memory

%L and %P are charged against your user space and sized depending on their use in your applications. The maximum size of %L or %P is 8192 words per block.

The %L and %P tables are sized to allow extra space for *RUN Mode Stores* per the following rules.

- If %L memory is not used in the block, the %L memory size is 0 bytes. If %L memory is used in the block, a buffer is added beyond the highest %L address actually used in logic or in the variable table. The default buffer size is 256 bytes, but can be changed by editing the Extra Local Words parameter in the block Properties.
- The same rules apply for the size of %P memory, but %P memory can be used in any block in the program.
- The buffer cannot make the %P or %L table exceed the maximum size of 8,192 words. In such a case, a smaller buffer is used.
- You can add, change, or delete %L and/or %P variables in your application and *RUN Mode Store* the application if these variables fit in the size of the last-stored %L/%P tables (where the size includes the previous buffer space), or if going from a zero to non-zero size.
- The size of the %L/%P tables is always recalculated for *STOP Mode Stores*.

A-1.24 Program Logic and Overhead

The data area for C (.gefelf) blocks is considered part of the user program and counts against the user program size. Additional space is required for information internal to the CPU that is used for execution of the C block.

The program block is based on overhead for the block itself plus the logic and register data being used (that is, %L).

Note: The program stack of the LD is not counted against the CPU's memory size.

Note: If your application needs more space for LD logic, consider changing some %P or %L references to %R, %W, %AI, or %AQ. Such changes require a recompilation of the program block and a *STOP Mode Store* to the CPU.

General Contact Information

Home link: <http://www.emerson.com/industrial-automation-controls>

Knowledge Base: <https://www.emerson.com/industrial-automation-controls/support>

Technical Support

Americas

Phone: 1-888-565-4155
1-434-214-8532 (If toll free option is unavailable)

Customer Care (Quotes/Orders>Returns): customercare.mas@emerson.com
Technical Support: support.mas@emerson.com

Europe

Phone: +800-4444-8001
+420-225-379-328 (If toll free option is unavailable)

Customer Care (Quotes/Orders>Returns): customercare.emea.mas@emerson.com
Technical Support: support.mas.emea@emerson.com

Asia

Phone: +86-400-842-8599
+65-6955-9413 (All other Countries)

Customer Care (Quotes/Orders>Returns): customercare.cn.mas@emerson.com
Technical Support: support.mas.apac@emerson.com

Any escalation request should be sent to: mas.sfdcescalation@emerson.com

Note: If the product is purchased through an Authorized Channel Partner, please contact the seller directly for any support.

Emerson reserves the right to modify or improve the designs or specifications of the products mentioned in this manual at any time without notice. Emerson does not assume responsibility for the selection, use or maintenance of any product. Responsibility for proper selection, use and maintenance of any Emerson product remains solely with the purchaser.

© 2020 Emerson. All rights reserved.

Emerson Terms and Conditions of Sale are available upon request. The Emerson logo is a trademark and service mark of Emerson Electric Co. All other marks are the property of their respective owners.

