

FLOW
TRANSMITTERS



ELECTRONICS FOR
INSTRUMENTATION

RT-Ex15 FLOW MONITOR

Users Manual



8809 Industrial Drive, Franksville, WI 53126-9337

Tel: 262-884-9800 Fax: 262-884-9810

E-Mail: aw@awcompany.com Web: <http://www.awcompany.com>

RT-Ex15 FLOW MONITOR

Introduction / Features.....	page 2
Model Number/Sensor Options.....	page 2
Specifications.....	page 2
Dimensional Drawing.....	page 2
Wiring Connections.....	page 3
DC Power Connection.....	page 3
Reset Input.....	page 3
Limits/Pulse Output.....	page 3
Analog Output.....	page 4
Frequency Input (Calibration) Test Point.....	page 4
Display/Programming Buttons and Magnetic Switches...	page 5
Disable External Programming.....	page 5
Programming the RT-Ex15.....	page 6
Startup Message.....	page 6
RT-Ex15 Display Modes.....	page 6
LOGO Mode – Turning On/Off Displays.....	page 7
RATE Display Modes.....	page 8
RATE A ^{GT}	page 8
RATE A ^{PL}	page 8
RATE Mode Programming.....	page 9
KFR A VALUE.....	page 9
GATE A B.....	page 10
SAMPLE A.....	page 10
ENG UNITS A.....	page 10
TOTAL Display Modes.....	page 11
TOTAL A Display.....	page 11
GR TOTAL A Display.....	page 11
TOTAL Reset / Rollover.....	page 11
TOTAL Mode Programming.....	page 12
KFT A VALUE.....	page 12
ENG UNITS A.....	page 13
STATUS ONE Display Mode.....	page 13
ANALOG OUT Display Mode.....	page 13
ANALOG OUT Programming.....	page 13
MA OFFSET.....	page 14
ANALOG POINT.....	Page 14
VALUE AT 20 MA.....	Page 14
LIMITS Display Mode.....	page 15
LIMITS Programming.....	Page 15
RATE/TOTAL limits.....	Page 15
CYCLE OUT (Totalizer Pulse Output)....	Page 15
RATE & TOTAL Display Mode	page 16
BATCH TOTAL Display Mode	page 17
BATCH TOTAL Programming.....	page 17
QUICK-GUIDE to the RT-Ex15 Variables & Displays...	page 18
Limited Warranty Statement.....	page 19

Introduction / Features

The RT-Ex15 is a meter-mounted digital flow monitor housed in a Class I Div. 1 Rated Enclosure. A large, back-lighted LCD graphic display provides easy to read indication of flow rate or total in user programmable engineering units. Programming, display mode selection or reset of the totalizer are accomplished using an attached magnet without opening the enclosure or using the pushbuttons on the faceplate with cover off. An isolated input also allows for remote reset of the totalizer. Programmable opto-isolated NPN open-collector outputs provide flowrate limit indication or a pulsed total output for remote monitoring and recording of totals. A 4-20 mA rate output with user programmable filtering and scaling is also provided for remote indication. A variety of sensor noses are available to provide compatibility with all AW Company flowmeters.

RT-Ex15 Model/Sensor options:

RT-Ex15A	MAG-PB sensor (standard) for JV-CG/KG, HPM & TRG series flowmeters.
RT-Ex15B	IR-PB sensor for JVK series flowmeters.
RT-Ex15C	CP-30 high temp sensor (to 350°F) for JVM-CG/KG, JVS-CG/KG HPM series meters.
RT-Ex15D	MG-300 sensor for TR series turbine flowmeters.

Specifications

Power Requirement:

15-24 VDC/200mA. (customer supplied)

Sensor/Monitor Frequency Range:

0-4000 Hz.

Analog Output 4-20 mA:

16-bit Isolated Loop Powered 2-Wire Output.

12-27 Vdc Loop Supply

Max. Load Impedance 500 Ohm. @ 27V

Max. Load Impedance 250 Ohm. @ 12V

Two Opto-Isolated Open-Collector Outputs:

5-30 VDC Rating, 50 mA Max. (Minimum Load Impedance Required, 600 Ohm @ 30 VDC)

Opto-Isolated Reset Input:

5-30 VDC Input, 3.3Kohm Impedance

Temperature Ratings:

-20 to 60°C (-4 to 140°F) Ambient

85°C (185°F) Max. Fluid Temperature (standard)

175°C (350°F) Max. Fluid Temperature (RT-Ex15C)

Enclosure Certifications:

Class I, Groups B, C, D

Class II, Groups E, F, G

Class III

Atex: EEx d IIC, IP68

NEMA 4X, 7BCD, 9EFG

Connection:

Screw terminal strips

¾" NPT Conduit Entrance

RT-Ex15 Dimensions

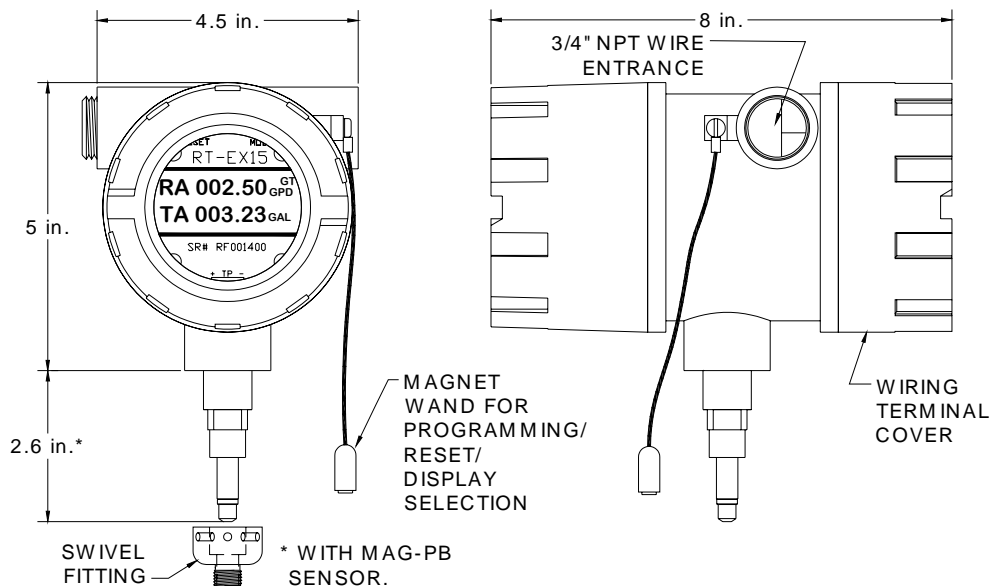

Wiring Connections

Wiring connections are to terminal strips inside the rear cover. A 3/4" NPT wire exit for conduit connection is provided. Connection to conduit is required to maintain the enclosures explosion-proof rating and must be made in accordance with all local and national electrical codes. **TO PREVENT IGNITION OF HAZARDOUS ATMOSPHERES, DISCONNECT CIRCUITS BEFORE REMOVING COVER. KEEP COVER TIGHTLY CLOSED WHILE CIRCUITS ARE ALIVE.**

DC Power Connection

The RT-Ex15 requires a 15-24 VDC/200mA supply for operation. **NOTE: A power supply is still required to operate the RT-Ex15 even if the analog output is used in a loop-powered configuration.** The RT-Ex15 is internally isolated from the DC supply by a DC/DC converter. A power-on LED is provided on the connection board and a 2 Amp mini-fuse protects the circuitry in case of a supply fault. (See drawing below).

WIRING TERMINALS (UNDER REAR COVER)

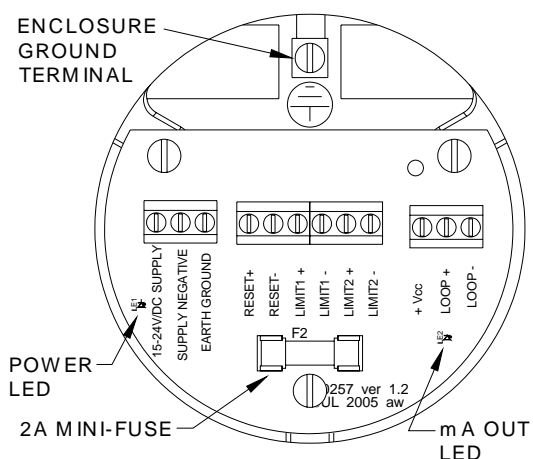

CUSTOMER CONNECTIONS (LEFT TO RIGHT)

15-24/DC SUPPLY + Vdc Supply
 SUPPLY NEGATIVE -Vdc Supply
 EARTH GROUND (Not Used, use Encl. Gnd Term.)

RESET + Optically isolated input (+)
 RESET - Optically isolated input (-)
 LIMIT1 + Optically isolated output (+)
 LIMIT1 - Optically isolated output (-)
 LIMIT2 + Optically isolated output (+)
 LIMIT2 - Optically isolated output (-)

+ Vcc Supply Output (same as DC Supply)
 LOOP + Isolated mA Loop (+)
 LOOP - Isolated mA Loop (-)

Reset Input

Opto-isolated input to reset the TOTAL A (Job Total). See TOTAL A RESET on page 11 for information regarding reset of the job totalizer.

RESET INPUT (Isolated)

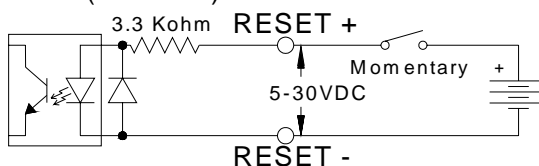

Limits/Pulse Outputs

Two opto-isolated NPN open-collector outputs can sink or source depending on connection. Attention must be paid to polarity of connections, collector (+), emitter (-). See diagram below. Output ratings are listed on page 2. Either output can be assigned to a rate limit, total limit for batching or as a totalizer pulsed output. See LIMITS Display Mode and LIMITS Programming on page 15 for information regarding the display and programming of the limit and pulse output.

LIMIT OUTPUTS (Isolated)

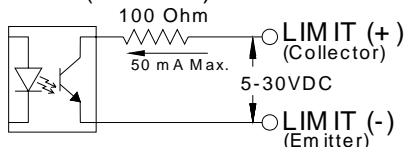

Analog Output

The isolated 16-bit 4-20mA output can be wired in a 2-wire loop-powered arrangement or loop power can be supplied via the DC supply as shown in the wiring examples below. **NOTE: A separate power supply is required to operate the RT-Ex15 even if the analog output is used in a loop-powered configuration.** The mA LED will light with varying intensity in proportion to the mA output for troubleshooting purposes. The assignment, offset, and scaling values for the mA output are programmable. See ANALOG OUT Programming on page 13 for information regarding set-up of the analog output.

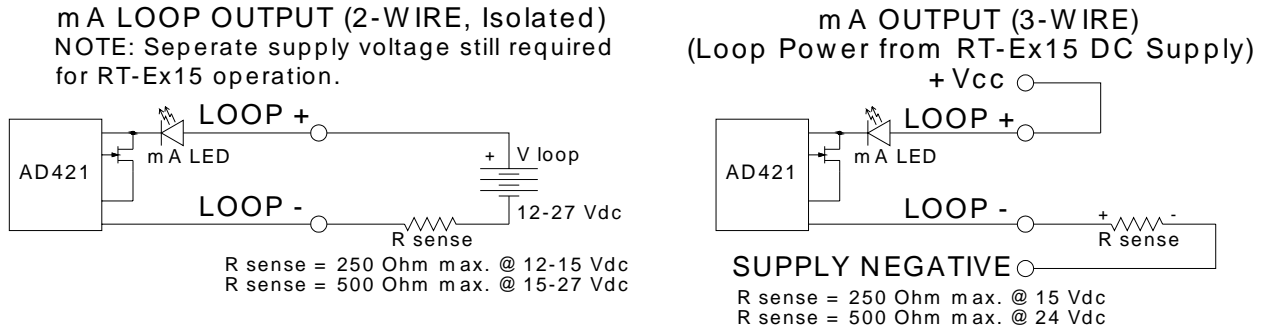

Frequency Input Test Point

The RT-Ex15 has a frequency input test point allowing the user to directly input a frequency signal. This is especially useful for purposes of setting up and testing pulse output or analog output signals during commissioning when flow is not present or where it is not feasible to allow continuous flow for set-up and calibration purposes. The position of a programmable jumper must be changed to allow use of the test point input. The test points and jumper positions are detailed in the diagram below. Be certain to change the jumper back to the correct position before beginning normal operation using the sensor nose.

Test Point input specifications:

- Waveform: DC signal - pulse, square-wave, triangle, or sawtooth.
- Minimum signal amplitude: 2 Volts peak.
- Maximum signal amplitude: 10 Volts peak.
- Frequency: 0-4000Hz

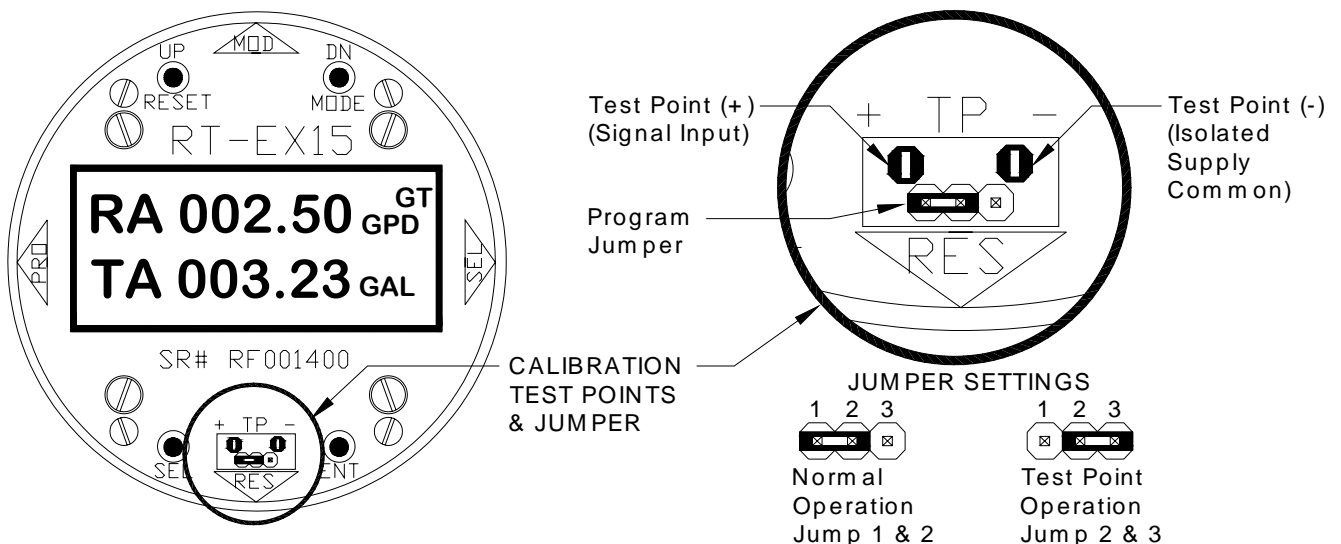

Display/Programming Buttons and Magnetic Switches

Display mode changes, reset of total and programming functions are accomplished using the buttons located on the face plate when the cover is off or external to the cover using the magnetic switches. The magnetic switches are located at the 3, 6, 9 and 12 o'clock positions on the side of the housing. The function of each position is indicated on the faceplate of the RT-Ex15. Touching the side of the magnet wand to the appropriate location will activate the magnetic switches.

DISPLAY/PROGRAMMING BUTTON LOCATIONS

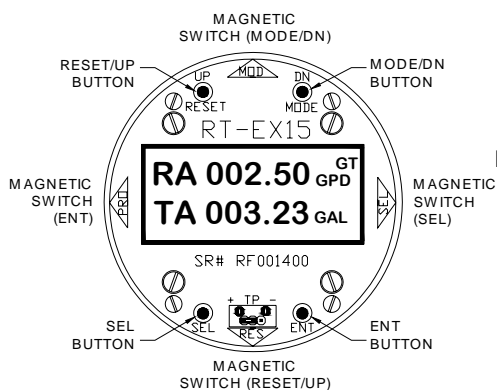

MAGNETIC SWITCH LOCATIONS

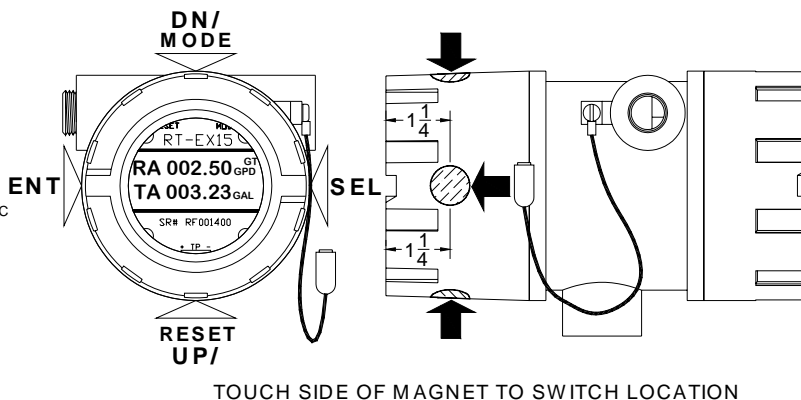

Display mode changes, reset of total and programming functions are accomplished using the buttons located on the face plate when the cover is off or external to the cover using the magnetic switches. The magnetic switches are located at the 3, 6, 9 and 12 o'clock positions on the side of the housing. The function of each position is indicated on the faceplate of the RT-Ex15. Touching the side of the magnet wand to the appropriate location will activate the magnetic switches.

Disable External Programming

All programming is initiated by using the ENT button located on the face plate when the cover is off or external to the cover using the ENT magnetic switch when the cover is installed. The ENT external magnetic switch can be disabled to prevent programming when the cover is on. A jumper is located on the back of the main circuit board on the edge at the 9 o'clock position. If the jumper is set to disable the ENT magnetic switch, the MODE and RESET external magnetic switches are still active to allow mode changes and total reset but program changes can not be made without removing the cover and using the ENT button on the faceplate. The default is switch enabled.

ENABLE/DISABLE EXTERNAL PROGRAMMING

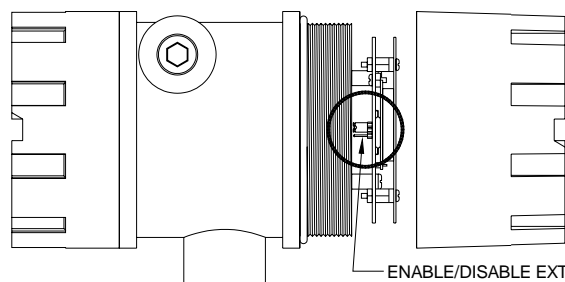

ENABLE/DISABLE EXTERNAL
PROGRAMMING JUMPER ON BACK
OF MAIN CIRCUIT BOARD AT THE
EDGE IN 9 O'CLOCK POSITION
(SEE DETAIL "A")

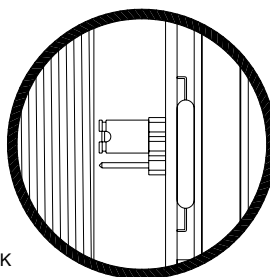

DETAIL "A"



"ENT" MAGNETIC
SWITCH ENABLED
JUMP 1 & 2



"ENT" MAGNETIC
SWITCH DISABLED
JUMP 2 & 3

Programming the RT-Ex15

Power must be applied to perform programming and set-up of the RT-Ex15. The RT-Ex15 can be programmed in the hazardous area with the cover on using the magnetic switches (if function is enabled) or **OUTSIDE THE HAZARDOUS AREA** with the cover removed using the programming buttons. **IF THE COVER IS REMOVED FOR PROGRAMMING THIS MUST BE DONE OUTSIDE THE HAZARDOUS AREA.**

After variable programming is completed and the desired display mode is selected, disconnect the power and tightly install the RT-Ex15 cover before installation in the hazardous area. See Wiring Connections on page 3.

To scale the rate or total display, output, or limits, the RT-Ex15 will require programming of the RATE, TOTAL, ANALOG OUT and LIMIT variables. All RT-Ex15 parameters are programmed from the corresponding display screen. For example, to program the rate scaling-factor, decimal resolution and engineering units for display, select the RATE A GT display. This manual will take the user through the various programming steps in order.

Startup Message

The RT-Ex15 displays an initial window at power up. After a second the following message will be displayed in the window for approximately 2 seconds. After this message, the display will revert to the last active Display Mode selected.

LOAD VARS	RT-EX15
TURN ON 0026.	
MEM LEFT 099.9	
VERSION 222	2006

LOAD VARS – Indicates that the variables are being recalled from EEPROM.

TURN ON – Increments on each power-on cycle of RT-Ex15.

MEM LEFT – Memory life indicator displays % of memory life remaining in .1% increments. The RT-Ex15 stores programmed variables and retained totalizer values in EEPROM (electrically erasable memory). The limit on the number of times memory can be re-written results in a minimum EEPROM life of 5 years with continuous use. This memory IC can be replaced by AW Company if it becomes necessary. Program variables require reprogramming after memory IC change.

VERSION – Indicates the software version installed in the RT-Ex15.

RT-Ex15 Display Modes

The RT-Ex15 has ten display/program modes:

LOGO
RATE A ^{GT}
RATE A ^{PL}
TOTAL A

GR TOTAL A*
STATUS ONE*
ANALOG OUT
LIMITS

RAT A TOT A*
BATCH TOTAL

*Display only, no programming function

During normal operation with the cover secured, the Display Mode is changed by touching the side of the magnet wand to the MODE/DN location (top) on the outside of the housing. The MODE/DN button is used to change the Display Mode when the RT-Ex15 cover is opened during programming. The RT-Ex15 will retain the last display mode selected and display it on power up. Seven of the display modes are also used to program the related variables.

LOGO Mode - Turning On/Off Displays

LOGO – Display Mode “RT-Ex15” is used during unit programming/set-up to turn-on or turn-off Display Modes. Not every user will require all of the display modes and any of the ten Display Modes can be turned off based on a user’s particular needs. To reassign, turn-on, or turn-off a display mode, use the MODE/DN button or magnetic switch to select the LOGO display mode. Press and hold the ENT button or activate and maintain the ENT magnetic switch. The display will first show a P in the lower left-hand corner and then show DISPLAY 00 and indicate which display mode is assigned to DISPLAY 00. DISPLAY 00 is assigned to the LOGO screen allowing access for display activation/deactivation.

NOTE: It is highly recommended that displays to be turned off are done one at a time returning to LOGO display after each screen is turned off. **Always turn off the highest numbered displays first.**

To turn-off a display mode, use the ENT button or magnetic switch to scroll through the DISPLAY #s until the appropriate display mode is encountered. Use the RESET/UP button or magnetic switch to turn the display off. The DISPLAY # assignment will indicate OFF DISPL. Use the ENT button or magnetic switch to store the current assignment and advance the RT-Ex15 to the next available display number (00-09) or exit the LOGO display programming procedure.

To change a DISPLAY # assignment to a different mode use the SEL button or magnetic switch to select from the available display modes. Any DISPLAY # can be assigned as any display mode. Use the ENT button or magnetic switch to store the current assignment and advance the RT-Ex15 to the next available display number (00-09) or exit the LOGO display programming procedure.

To restore a Display Mode that has been turned off, use the ENT button or magnetic switch to select a DISPLAY # with a OFF DSPL assignment. Select a display mode assignment using the SEL button or magnetic switch. Use the ENT button or magnetic switch to store the current assignment and advance the RT-Ex15 to the next available display number (00-09) or exit the LOGO display programming procedure.

NOTE: The LOGO screen can be turned off, but as it will no longer appear there is no way to access screen programming. If the LOGO display is turned off for any reason it can be restored to allow access to screen programming by cycling the power to the RT-Ex15 while pressing and holding the ENT button or maintaining the ENT magnetic switch. This will reactivate the LOGO screen as DISPLAY 00 and restore access to LOGO screen programming.

RATE Display Mode

The RT-Ex15 continuously calculates rate by two methods simultaneously, Gate Time and Pulse Width.

Gate Time - (RATE A ^{GT}) Rate is displayed based on the number of pulses counted during a prescribed time period. RATE A ^{GT} is updated at the programmed interval regardless of the input frequency. Increasing the gate time interval produces a filtering or averaging effect useful for stable display and output of uneven or intermittent flows. The RT-Ex15 analog output is assigned to RATE A ^{GT}.

Pulse Width - (RATE A ^{PL}) Rate is displayed based on the time from pulse edge to pulse edge. The Pulse Width Method is highly responsive, updating more frequently at high input frequencies and less frequently at lower input frequencies. RATE A ^{PL} is useful for observing flow variations or peak intermittent flows. A digital filter SAMPLE A can be used to produce a more stable display response.

RATE A ^{GT} – RATE A Gate Time. Displays the rate by the gate time method based on the programmed GATE AB variable and displayed based on the corresponding KFR factors, decimal locations and engineering units. The zero cutoff frequency for display and analog output is .3 Herz. The pulse length measurement RATE A ^{PL} can be viewed by using the SEL button or magnetic switch while in the RATE A ^{GT} display as illustrated below. The rate display will revert back to RATE A ^{GT} if power is cycled to the RT-Ex15. A typical display would be:



RATE A ^{PL} – RATE A Pulse Length. The rate is calculated by the pulse length method based on the SAMPLE A variable and displayed based on the corresponding KFR factor, decimal location and engineering units. The gate time measurement RATE A ^{GT} can be viewed by using the SEL button or magnetic switch while in the RATE A ^{PL} display as illustrated below. The rate display will revert back to RATE A ^{PL} if power is cycled to the RT-Ex15. A typical display would be:



TOTAL Display Modes

The RT-Ex15 displays the JOB or GRAND total based on the programmed KFT, engineering unit, and decimal location. There are two TOTAL displays, TOTAL A (Job Total) and GRAND TOTAL A. The GRAND total is a second totalizer with a secured reset. Both totals are retained by the RT-Ex15 when the power is removed. The totals retained at power-down are updated once every 25 seconds. Due to this update interval, the totals retained may not include previous flow for up to 25 seconds if flow was present when the power was removed.

TOTAL A DISPLAY

Displays Job Total A. Also used for programming of total scaling factor KFT and reset of TOTAL A and GR TOTAL A. The grand total GR TOTAL A can be viewed by using the SEL button or magnetic switch while in the TOTAL A display as illustrated below. The rate display will revert back to RATE A ^{GT} if power is cycled to the RT-Ex15.

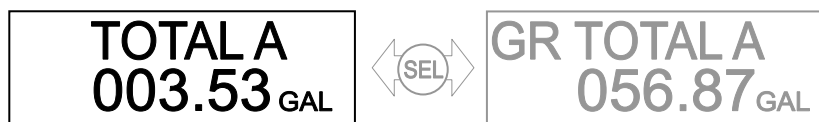

GR TOTAL A DISPLAY

For display of GR TOTAL A only. No programming or reset functions are associated with this display.



TOTAL A RESET – The Job total can be reset using the RESET/UP magnetic switch (or the RESET/UP button while cover is open) when TOTAL A or RAT A TOT A is displayed. Use the MODE/DN magnetic switch or button to select a total display. TOTAL A can also be reset at anytime using the Reset Input. See page 3 for wiring information.

GR TOTAL A RESET – The Grand total can only be reset with the cover off via the front panel buttons using a multiple step sequence. To reset GR TOTAL A, select the TOTAL A display mode using the MODE/DN button. Use the SEL button to change to the GR TOTAL display. Press the RESET/UP and ENT buttons simultaneously and hold until the RT-Ex15 responds. A warning will appear on the screen requesting yes/no verification before resetting the GR TOTAL. The RT-Ex15 prompts the user either to press the ENT button to accept the default answer of NO and exit the reset procedure at this point, or to reset the total. To reset, use the SEL button first to toggle the response to YES and then press the ENT button. GR TOTAL A will be reset to zero by this operation.

TOTAL A Rollover – RT-Ex15 JOB totals will rollover to zero when the total reaches a value of 999999 regardless of the decimal location. When a JOB total rolls over or is reset, the contents of the JOB total are then added in memory to the GRAND total.

GR TOTAL A Rollover – To allow retention of the largest possible GRAND total before data loss, after reaching a value of 999999 regardless of decimal location, a floating decimal feature on GRAND TOTAL rollover automatically reduces decimal resolution by a maximum of two decimal places before rolling over to zero and losing the total. Example: For a KFT with 4 decimal places the GRAND total will reach 9999.99 instead of 99.9999 before resetting to zero.

To program press and hold the ENT button or maintain the ENT magnetic switch. The display will first show a P in the lower left-hand corner and will then display the first program variable for this mode. Three parameters will be accessed in order as follows:

⇒MA OFFSET
 ⇒ANALOG POINT
 ⇒ENTER *VALUE* AT MAX MA_s

MA OFFSET – This variable is used to set to lowest value for the mA output span and as a fine offset adjustment in the field if necessary. The low range of the output span is programmable between 4.00 and 10.00 mA. The RT-Ex15 will not accept a value less than 4 mA. The RT-Ex15 utilizes the output device AD421 manufactured by Analog Devices. The minimum output is trimmed to 4.00mA by the device manufacturer. Consult the manufacturer’s data sheet for AD421 for complete specifications regarding offset tolerance.

When entering or editing the value, the digit being edited will blink starting with left-most digit. Select the digit to edit using the SEL button or magnetic switch. Use the UP or DN button or magnetic switch to increment or decrement the variable value. When the desired value is displayed, use the ENT button or magnetic switch to store the programmed value and advance to the next variable.

ANALOG POINT – This variable is used to “point” to an output assignment for the analog output. The output can be assigned to represent one of 3 possible functions as follows:

RATE A^{GT} (#00) RATE A^{PL} (#01) TOTAL A (#02)

A number corresponding to the output assignment is displayed to indicate the current function of the analog output. The default assignment for the ANALOG POINT is RATE A^{GT} (#00). RATE or TOTAL assignments will produce an output ranging from the MA OFFSET value (4-10 mA) for a zero value, to 20 mA for the maximum programmed flow rate or total.

Use the SEL button or magnetic switch to select the output assignment. Use the ENT button or magnetic switch to store the desired output assignment.

ENTER VALUE AT MAX MA’S – This scaling variable is used to set the maximum mA output (20mA.) to a corresponding rate value producing an output ranging from the MA OFFSET value (4-10 mA) for a zero value, to 20 mA for the maximum programmed flow rate. The entry will correspond with the KFR, decimal location and engineering units for RATE A^{GT}. The initial value is a rate of 10 HZ.

When entering or editing the value, the digit being edited will blink starting with left-most digit. Select the digit to edit using the SEL button or magnetic switch. Use the UP or DN button or magnetic switch to increment or decrement the variable value. When the desired value is displayed, use the ENT button or magnetic switch to store the programmed value and advance to the next variable.

LIMITS Display Mode

The RT-Ex15 has two programmable limit outputs: L1 & L2. The LIMIT display shows the function that each limit is assigned to, the value in engineering units at which each limit will become active or change state, and the current status of the limit outputs. The limit values are displayed using the KFR or KFT, decimal location and engineering units corresponding to the limit assignment. A typical display would be:

L1	RATE A GT	003.00	GPD	ON
L2	CYCLE OUT	000.10	GAL	OFF

LIMITS Programming

The Limits are programmed from the LIMIT display screen. L1 and L2 can be assigned to any of the following functions.

RATE A ^{GT}	TOTAL A
RATE A ^{PL}	CYCLE OUT (Pulse Output)

RATE Limits / Limit MARGIN – To operate a limit based on RATE, select a RATE A function based on pulse length or gate time measurement. The MARGIN variable is programmed in engineering units and determines whether the limit functions as an absolute limit or activates within a margin or “window” around the programmed RATE limit. When the MARGIN is programmed as zero, the limit will activate whenever the selected RATE equals or exceeds the programmed value. When a MARGIN value other than zero is entered, the limit will be active whenever the selected RATE is within the “window” of the programmed RATE limit value plus or minus the MARGIN value.

TOTAL Limits – To operate a limit based on the JOB TOTAL, select TOTAL A for the Limit function. The limit will activate whenever the selected TOTAL equals or exceeds the programmed value. See BATCH TOTAL Display Mode on page 17 for alternate set-up of total limits.

CYCLE OUT (Pulse Output) – The CYCLE OUT limit function provides an incremental output signal for a remote totalizer typically at a lower resolution and frequency. Either or both limits can be assigned to a CYCLE OUT function. Assigning a limit to the CYCLE OUT function will toggle the state of the limit output whenever Job TOTAL A has incremented by the programmed cycle amount. The output will remain on until the cycle amount has accumulated and turn off until the cycle amount has accumulated again as represented in the following diagram. The total accumulated between a rising and falling edge is the cycle value. The total accumulated between any two rising edges is twice the cycle value. The cycle value is entered in engineering units corresponding to the programmed KFT and decimal location. **Do not program a cycle amount that will produce more than ten pulses per second (10 Hz).** Consider the maximum flowrate to determine the resulting output frequency. The frequency produced (in Hz.) is the actual flow rate in Engineering Units per Minute divided by 120, divided by the CYCLE AMOUNT.

NOTE: When considering a large cycle amount, keep in mind that any external totalizer will miss up to at least one cycle amount of accumulation whenever power is cycled to the RT-Ex15.

CYCLE OUT (PULSE OUTPUT) Limit Function

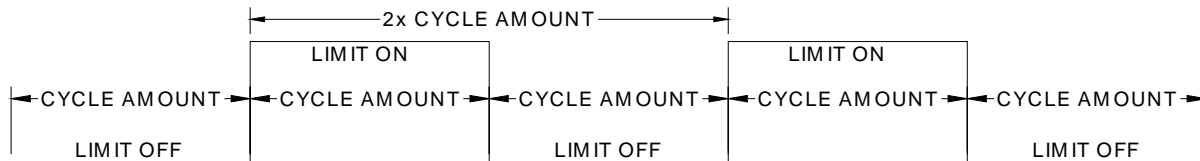

To program limit functions, use the MODE/DN button or magnetic switch to select the LIMIT display. Press and hold the ENT button or maintain the ENT magnetic switch. The display will first show a P in the lower left-hand corner and will then highlight the L1 indication with a blinking cursor. Use the SEL button or magnetic switch to select the function of the limit assignment. Use the ENT button or magnetic switch when the desired mode is displayed for L1. The cursor will now highlight the numeric value to be entered for L1. Entries correspond with the scaling factor, decimal location and engineering units for the function selected. The left-most digit will highlight with a blinking cursor. Move the cursor left to right using the SEL button or magnetic switch. Use the UP or DN button or magnetic switch to increment or decrement each digit's value. When editing is complete and the desired value is displayed, use the ENT button or magnetic switch to store the programmed value for L1. If a RATE assignment has been made, the RT-Ex15 will next prompt the user to enter the RATE LIMIT MARGIN in percent. The left-most digit will be highlighted with the blinking cursor. Move the cursor using the SEL button or magnetic switch. Use the UP or DN button or magnetic switch to increment or decrement each digit's value. When editing is complete and the desired value is displayed, use the ENT button or magnetic switch to store the programmed RATE LIMIT MARGIN. The RT-Ex15 will then highlight the L2 indication with a blinking cursor. Repeat the procedures used for L1. When the L2 programming is complete, use the ENT button or magnetic switch to store the programmed values and exit LIMITS programming.

NOTE: See [Wiring Connections](#) and [Connection Diagram](#) on page 3 for information regarding connection to limit outputs.

RATE A / TOTAL A Display Mode

RATE A^{GT} and TOTAL A (Job Total) are viewed on the same screen using the RATE A_TOT A display. Rates and totals are displayed in the corresponding engineering units based on the programmed KFR and KFT factors and decimal locations. The GR TOTAL can be viewed using the SEL button or magnetic switch to switch between TOTAL A (TA) display and GR TOTAL A (GA) display as illustrated below. After a power cycle, the RT-Ex15 will revert to the Job Total (TA) display). Total A can be reset from this display using the RESET/UP button or magnetic switch. Typical displays would be:



The RATE A_TOT A display is only for viewing the rate and total simultaneously and has no programming function. Rate and Total variables are programmed from the RATE A^{GT} or RATE A^{PL} and TOTAL A screens respectively.

BATCH TOTAL Display Mode

The BATCH TOTAL displays the JOB A total and the S1 & S2 total limit activation levels. When the RT-Ex15 is programmed for BATCH TOTAL operation, both limits are assigned as TOTAL A limits based on the KFT, decimal point, and engineering units. The TOTAL limit activation levels are displayed unless assigned to another function. If so, the S1 or S2 display would read as XXXX to indicate that it is not assigned to JOB A TOTAL function. A typical display would be:

BATCH TOTAL			
0020.5 GAL			
S1	0040.0	S2	0045.0

BATCH TOTAL Programming

The BATCH TOTAL program mode is used to quickly dedicate both limits as total limits and program the values at which the limits (labeled S1 & S2) will activate. The BATCH TOTAL display must be viewed to program the BATCH TOTAL limits. Use the MODE/DN button or magnetic switch to select the BATCH TOTAL display. Press and hold the ENT button or magnetic switch to select the BATCH TOTAL display. Press and hold the ENT button or maintain the ENT magnetic switch. The display will first show a P in the lower left-hand corner and will then highlight the first limit assignment S1 indicated with a blinking cursor. Entering a value will assign the limit as a total limit based on the KFT, decimal location and KFT engineering units. Select the digit to edit using the SEL button or magnetic switch. Use the UP or DN button or magnetic switch to increment or decrement the variable value. When the desired value is displayed, use the ENT button or magnetic switch to store the programmed value and move the cursor to S2. Select the digit to edit using the SEL button or magnetic switch. Use the UP or DN button or magnetic switch to increment or decrement the variable value. When the desired value is displayed, use the ENT button or magnetic switch to store the programmed value and exit the BATCH TOTAL program mode.

If either limit has been previously assigned to a function other than TOTAL A, the RT-Ex15 will respond by asking “Limit mode different, want to change it?” Use the SEL button or magnetic switch to toggle a “N” or “Y” response and use the ENT button or magnetic switch to answer. A “Y” response will reset any previous limit assignment to Total A and zero the limit value. A “N” response will leave the limit assigned to the previous function and the S1 or S2 display will read as XXXX to indicate that it has no function in this mode.

Quick-Guide to the RT-EX15

LOGO DISPLAY PROGRAMMING

With the cover removed and outside of a hazardous area use MODE/UP button* to view LOGO (RT-EX15) display. Press and hold the ENT button*. Display will first show a "P" in the lower left-hand corner and then show the display assigned as DISPLAY 00. LOGO is assigned as DISPLAY 00 to allow programming access. Use SEL button* to select from available display modes including OFF. Press ENT button* to store selection, increment display number, and show the next display assignment.

* or magnetic switch in hazardous area with cover closed

To view displays: Use MODE/DN button or magnetic switch.

RT-EX15

LOGO Screen

Use SEL button or magnetic switch alternate display.

Press & hold ENT button or magnetic switch to program displays.

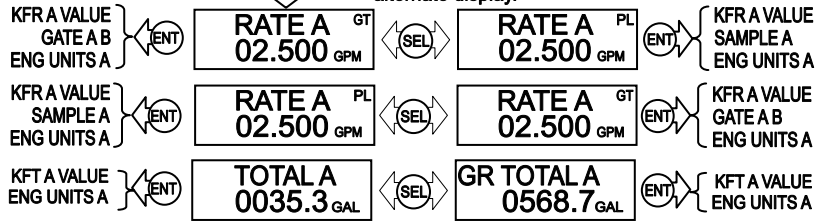

GR TOTAL A
0568.7 GAL

STATUS ONE
RTA 02.500
TOA 0035.3
ANO 004.02

ANALOG OUT 01
04.02 MAS

L1 TOTAL A
0025.0 GAL ON
L2 RATE A PL
02.500 GPM OFF

RA 02.500 GPM PL
TA 0568.7 GAL

BATCH TOTAL
0020.5 GAL
S1 0040.0 S2 0045.0

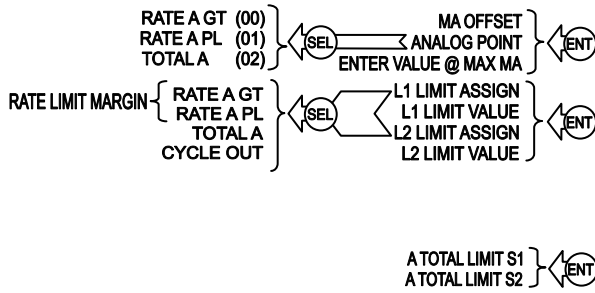
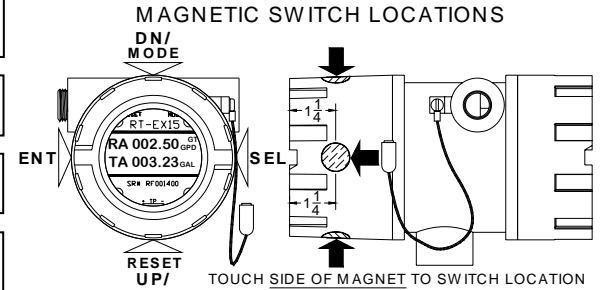

TO PROGRAM RT-EX15 PARAMETERS

With the cover removed and outside of a hazardous area, use the MODE/DN button* to select the display to program. Press and hold the ENT button*. The display will first show a "P" in the lower left-hand corner and will then display the first program variable for that display mode. The RT-Ex15 will prompt for a variable selection or numeric entry.

When entering or editing numeric values or engineering units, the digit or character to enter or edit will blink starting with left-most position. Use the UP or DN button* to increment or decrement the variable value or character. Use the SEL button* to move the blinking cursor to the next digit or character. When the entire value has been entered, use the ENT button* to store the programmed value and advance to the next program variable.

Select LIMIT and ANALOG OUT assignments using the SEL button*. Use the ENT button* to store the assignment and advance to the next program variable. The ENT button* will exit programming after the last variable has been programmed.

* or magnetic switch in hazardous area with cover closed

KFR – Scaling for display of rate in specific engineering units. Determines display decimal resolution.

Initial value = 100.00 (Hz. w/2 decimals)

KFR= T-base SCALING FACTOR/K-FACTOR

Where T-base SCALING FACTOR=:
 100 for eng. units per second
 6000 for eng. units per minute
 360000 for eng. units per hour
 8640000 for eng. units per day

Where **K-FACTOR** is the avg. number of pulses/ eng. unit of the transducer.

Round result to desired decimal accuracy and enter KFR using only that number of decimal places. Use no more than four digits regardless of decimal position! Maximum is 65535 with the decimal in any location.

GATE AB – Gate time, .01 to 600 seconds. Display and analog output update time interval. Initial value is 002.00 seconds

SAMPLE A & B - Digital filter on RATE PL, 0 to 253 (0 min., 253 max.) affecting the update of the display and analog output. Initial value is 010.

ENG UNITS - The desired engineering units for display of rate are programmable using up to four letters. Example: GPM_

KFT – Scaling for display of total in specific engineering units. Determines display decimal resolution.

Initial value=10000. (Pulses w/ no decimals)

KFT = 10000/K-FACTOR

Where **K-FACTOR** is the avg. number of pulses/ eng. unit of the transducer.

Round result to desired decimal accuracy and enter KFT using only that number of decimal places. Use no more than four digits regardless of decimal point position! Maximum = 65535 with the decimal in any location.

ENG UNITS - The desired engineering units for display of total are programmable using up to four letters. Example: GAL_

TOTAL RESET – With the cover removed and outside of a hazardous area use MODE/DN button* to view TOTAL, and RESET/UP button* to reset ... * or magnetic switch in hazardous area with cover closed

GR TOTAL RESET – With cover open only! Use MODE/DN button and SEL button to view GR TOTAL, press RESET/UP button plus ENT button. Use SEL button for "Y", and ENT button to reset and exit.

