



Portable Toxic Gas Monitor SC-8000 Operating Manual (PT0-105)

Request for the Customers

- Read and understand this operating manual before using the gas monitor.
- Use the gas monitor in accordance with the operating manual.
- Regardless of warranty period, we shall not make any indemnification for accidents and damage caused by using this product.
The indemnification shall be made only under the warranty policy of products or parts replacement.
- Because this is a safety unit, a regular maintenance for every six months and daily maintenance must be performed.
- If any abnormality was found in the gas monitor, notify them to RIKEN KEIKI immediately.

RIKEN KEIKI Co., Ltd.

2-7-6 Azusawa, Itabashi-ku, Tokyo, 174-8744, Japan

Phone : +81-3-3966-1113

Fax : +81-3-3558-9110

E-mail : intdept@rikenkeiki.co.jp

Web site : <http://www.rikenkeiki.co.jp/english/>

<Contents>

1	Outline of the Product.....	2
1-1.	Preface	2
1-2.	Purpose of use	2
1-3.	Definition of DANGER, WARNING, CAUTION, and NOTE	2
2	Important Notices on Safety	3
2-1.	Danger cases	3
2-2.	Warning cases	5
2-3.	Precautions	6
2-4.	Safety information	7
3	Product Components.....	8
3-1.	Main unit and standard accessories	8
3-2.	Names and functions for each part.....	10
4	How to Use.....	13
4-1.	Before using the gas monitor.....	13
4-2.	Preparation for start-up.....	13
4-3.	Basic operating procedures.....	18
4-4.	How to start the gas monitor.....	19
4-5.	How to detect	21
4-6.	Modes.....	24
4-7.	Air calibration mode.....	25
4-8.	Display/setting mode	27
4-9.	How to exit.....	32
5	Operations and Functions	33
5-1.	Gas alarm activation.....	33
5-2.	Fault alarm activation	35
5-3.	Other functions	35
6	Maintenance.....	36
6-1.	Maintenance intervals and items	36
6-2.	Gas calibration method.....	37
6-3.	How to clean.....	38
6-4.	Parts replacement	39
7	Storage and Disposal	41
7-1.	Procedures to store the gas monitor or leave it for a long time	41
7-2.	Procedures to use the gas monitor again	42
7-3.	Disposal of products	42
8	Troubleshooting.....	43
9	Product Specifications	45
9-1.	List of specifications	45
9-2.	List of accessories.....	47
10	Definition of Terms.....	48

1

Outline of the Product

1-1. Preface

Thank you for choosing our portable toxic gas monitor SC-8000. Please check that the model number of the product you purchased is included in the specifications on this manual.

This manual explains how to use the gas monitor and its specifications. It contains information required for using the gas monitor properly. Not only the first-time users but also the users who have already used the product must read and understand the operating manual to enhance the knowledge and experience before using the gas monitor.



1-2. Purpose of use

This product is a gas monitor used to detect various toxic gases (CO, HCl, etc.) in the air with a selected sensor.

Detection results are not intended to guarantee life or safety in any way.

In addition to this operating manual, an operating manual for the data logger management program (option) is available for the gas monitor. Contact RIKEN KEIKI if it is needed.

1-3. Definition of DANGER, WARNING, CAUTION, and NOTE

 DANGER	This message indicates that improper handling may cause serious damage on life, health or assets.
 WARNING	This message indicates that improper handling may cause serious damage on health or assets.
 CAUTION	This message indicates that improper handling may cause minor damage on health or assets.
NOTE	This message indicates advice on handling.

2

Important Notices on Safety

2-1. Danger cases



DANGER

About explosion-proof

- Do not modify or change the circuit or structure, etc.
- When using the gas monitor in a hazardous area, take the following countermeasures for preventing dangers resulting from electrostatic charges.
 - (1) Wear anti-static clothes and conductive shoes (anti-static work shoes).
 - (2) For indoor use, use the gas monitor while standing on a conductive work floor (with a leakage resistance of 10 MΩ or less).
- IP Protection grade : IP20
The protection grade on explosion-proof official approval is IP20. IP protection grade at the time of product shipment is 67.

About explosion-proof of the main unit

- The battery units that can be connected are the BUL-8000(S) (certificate number TC20087) or BUD-8000(S) (certificate number TC20088). If battery units other than specification are used, it will deviate from the regulation of explosion-proof official approval.
- The specifications of the gas monitor are as follows:

Pump circuit:	Allowable voltage of 4.95 V, allowable current of 1.12 A, and allowable power of 1138 mW
Toxic gas sensor circuit:	Allowable voltage of 4.95 V, allowable current of 0.834 A, and allowable power of 853 mW
Buzzer circuit:	Allowable voltage of 4.95 V, allowable current of 0.431 A, and allowable power of 441 mW
Main circuit:	Allowable voltage of 4.95 V, allowable current of 0.715A, and allowable power of 732 mW
Backup circuit:	3.0 VDC, 10 μA

About explosion-proof of the battery unit

- Replace the battery unit in a non-hazardous area.
- The main unit that can be connected is SC-8000 (certificate number TC20086) only. The use with unspecified main units deviates from the regulation of explosion-proof certification.
- The specifications of the BUD-8000(S) are as follows:

Pump circuit:	Maximum voltage of 4.95 V, maximum current of 1.12 A, and maximum power of 1138 mW
Toxic gas sensor circuit:	Maximum voltage of 4.95 V, maximum current of 0.834 A, and maximum power of 853 mW
Buzzer circuit:	Maximum voltage of 4.95 V, maximum current of 0.431 A, and maximum power of 441 mW



DANGER

- | | |
|---|--|
| Main circuit: | Maximum voltage of 4.95 V, maximum current of 0.715 A, and maximum power of 732 mW |
| Power supply: | 4.5 VDC, 100 mA (LR6 3 pcs) |
| • The specifications of the BUL-8000(S) are as follows: | |
| Pump circuit: | Maximum voltage of 4.25 V, maximum current of 1.12 A, and maximum power of 901 mW |
| Toxic gas sensor circuit: | Maximum voltage of 4.25 V, maximum current of 0.768 A, and maximum power of 618 mW |
| Buzzer circuit: | Maximum voltage of 4.25 V, maximum current of 0.410 A, and maximum power of 330 mW |
| Main circuit: | Maximum voltage of 4.25 V, maximum current of 0.652 A, and maximum power of 525 mW |
| Charge terminal: | Allowable voltage AC250V |
- Make sure that the product model on the nameplate is correct. Inappropriate combinations of models deviate from the range of explosion-proof certification. The nameplate shows the followings as well as the product model.

Product model:	Main unit: SC-8000
Dry battery unit:	BUD-8000 (S)
Lithium ion battery unit:	BUL-8000(S)
Manufacturer:	RIKEN KEIKI Co., Ltd.
Explosion-proof class:	Ex ia IIC T4
Ambient temperature:	-20 to 50°C (The ambient temperature on explosion-proof certification is -20 to 50°C, and it indicates the temperature range which can maintain the explosion-proof performance and not the product performance.)
 - Please do not perform the desorption of a battery unit, and the desorption of the dry cell of a dry battery unit in a hazardous locations.
 - Please use alkaline AA batteries of designation to the dry battery unit (Type LR6 manufactured by Toshiba).

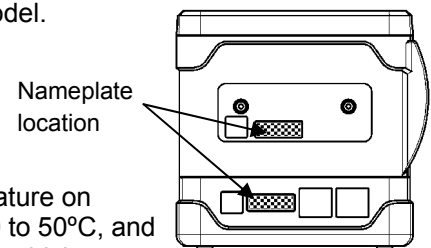

About use

- Toxic or other gases may blow out from the gas exhausting outlet. Never inhale the air or gases.

2-2. Warning cases



WARNING

Sampling point pressure

- The gas monitor is designed to draw gases around it under the atmospheric pressure. If excessive pressure is applied to the gas inlet and outlet (GAS IN, GAS OUT) of the gas monitor, detected gases may be leaked from its inside, thus leading to dangers. Be sure that excessive pressure is not applied to the gas monitor while used.
- Do not connect the gas sampling hose directly to a location with a pressure higher than the atmospheric pressure. The internal piping system may be damaged.

Handling of sensor

Do not disassemble the electrochemical type sensor because it contains electrolyte. Electrolyte may cause severe skin burns if it contacts skin, while it may cause blindness if it contacts eyes. If electrolyte is adhered on your clothes, that part on your clothes is discolored or its material is decomposed. If contact occurs, rinse the area immediately with a large quantity of water.

Fresh air adjustment in atmosphere

When the fresh air adjustment is performed in the atmosphere, check the atmosphere for freshness before beginning the adjustment. If other gases exist, the adjustment cannot be performed properly, thus leading to dangers when the gas leaks.

Response to gas alarm

Issuance of a gas alarm indicates that there are extreme dangers. Take proper actions based on your judgment.

Battery level check

- Before use, check that there remains sufficient battery power. When the gas monitor is used for the first time or is not used for a long period, the batteries may be exhausted. Either fully charge the batteries or replace them with new ones before use.
- If a low battery voltage alarm occurs, gas detection cannot be conducted. If the alarm occurs during use, turn off the power and promptly charge the batteries in a non-hazardous area.

Others

- Do not throw the gas monitor into fire.
- Do not wash the gas monitor in a washing machine or ultrasonic cleaner.
- Do not block the buzzer sound opening. No alarm sound can be heard.
- Do not remove the battery unit while the power is ON.

2-3. Precautions



CAUTION

Do not use the gas monitor where it is exposed to oil, chemicals, etc. Do not submerge the gas monitor under water on purpose.

- Do not use in a place where the gas monitor is exposed to liquids such as oil and chemicals.
- The gas monitor, being compliant to IP67, is not water-pressure-resistant. Do not use the gas monitor where a high water pressure is applied to it (under a faucet, shower, etc.) or submerge it under water for a long time. The gas monitor is water-proof only in fresh water and running water, and not in hot water, salt water, detergent, chemicals, human sweat, etc.
- The gas inlet and outlet are not water-proof. Be careful not to let water such as rainwater get into these parts. Because this may cause trouble and gas cannot be detected.
- Do not place the gas monitor where water or dirt gets accumulated. The gas monitor placed at such a location may malfunction due to water or dirt that gets into the buzzer opening, gas inlet, etc.
- Note that drawing in dirty water, dust, metallic powder, etc. will significantly deteriorate the sensor sensitivities. Be careful when the gas monitor is used in an environment where these elements exist.

Do not use the gas monitor in a place where the temperature drops below -10°C or rises over 40°C.

- The operating temperature of the gas monitor is -10 to 40°C. Do not use the gas monitor at higher temperatures, humidities, and pressures or at lower temperatures than the operating range.
- Avoid long-term use of the gas monitor in a place where it is exposed to direct sunlight.
- Do not store the gas monitor in a sun-heated car.

Observe the operating restrictions to prevent condensation inside the gas monitor or sampling probe.

Condensation formed inside the gas monitor or sampling probe causes clogging or gas adsorption, which may disturb accurate gas detection. Thus, condensation must be avoided. In addition to the operating environment, carefully monitor the temperature/humidity of the sampling point to prevent condensation inside the gas monitor or sampling probe. Please observe the operating restrictions.

Do not use a transceiver near the gas monitor.

- Radio wave from a transceiver near the gas monitor may disturb readings. If a transceiver is used, it must be used in a place where it disturbs nothing.
- Do not use the gas monitor near a device that emits strong electromagnetic waves (high-frequency or high-voltage devices).

Verify that the pump driving indicator is rotating before using the gas monitor.

If the pump driving indicator is not rotating, gas detection cannot be performed properly. Check whether the flow rate is lost.

Do not forget to perform a regular maintenance.

Since this is a safety unit, a regular maintenance must be performed to ensure safety. Continuing to use the gas monitor without performing a maintenance will compromise the sensitivity of the sensor, thus resulting in inaccurate gas detection.

Direct the LCD display upward.

Use the gas monitor with the LCD display facing upward. The gas monitor, when used with the LCD display in a tilted or flat status, may not display correct values. Likewise, store the gas monitor with the LCD display facing upward.

Others

- Pressing buttons unnecessarily may change the settings, preventing alarms from activating correctly. Operate the gas monitor using only the procedures described in this operating manual.
- Do not drop or give shock to the gas monitor. The water-proof and explosion-proof properties and accuracy may be deteriorated.
- Do not use the gas monitor while charging it.

2-4. Safety information

Observe the followings to maintain an explosion-proof system.

<Overseas Specifications>

Safety information

The Portable Toxic Gas Monitor Model SC-8000 is a gas monitor designed to provide continuous exposure monitoring of toxic gas in hazardous environments. The gas sample is sucked in by build-in micro pump.

The battery can be selected either Li-ion battery or alkaline dry battery.

Li-ion battery unit is called BUL-8000 and alkaline dry battery unit is called BUD-8000.

The battery unit can be changed even by the end users.

Specification for safety

- Ex ia IIC T4 Ga



II 1G Ex ia IIC T4 Ga

- Ambient temperature range for use : -20°C to +50°C
- Ambient temperature range during battery charging : 0°C to +40°C

Electrical data

- Power supply of Li-ion battery unit : BUL-8000

Two parallel connected Li-ion cells used in battery pack BP-8000 are from type Maxell INR18650PB1. Um=250V.

- Power supply of alkaline battery unit : BUD-8000

Powered by three series AA size alkaline batteries , model LR6 by TOSHIBA.

- Backup battery type CR1220 manufactured by Maxell.

Certificate numbers

- IECEx Certificate number : IECExDEK 11.0019
- ATEX Certificate number : DEKRA 11ATEX0047

List of standards

- | | |
|-----------------------|-------------------|
| · IEC 60079-0 : 2007 | · EN60079-0:2009 |
| · IEC 60079-11 : 2006 | · EN60079-11:2007 |
| · IEC 60079-26 : 2006 | · EN60079-26:2007 |

WARNING

- Do not charge in hazardous location.
- Do not charge it expect by genuine charger.
- Do not replace battery unit in hazardous location.
- Do not replace dry batteries in hazardous location.
- Do not attempt to disassemble or alter the instrument.
- Use only battery unit type BUD-8000 with three series connected Alkaline AA batteries, type LR6 manufactured by Toshiba, or use chargeable battery unit type BUL-8000.

INST. No. 0 0 0 0 0 0 0 0 0 0
 A B C D E

- A: Manufacturing year (0-9)
- B: Manufacturing month (1-9,XYZ for Oct.-Dec.)
- C: Manufacturing lot
- D: Serial number
- E: Code of factory



RIKEN KEIKI Co., Ltd.

2-7-6 Azusawa, Itabashi-ku, Tokyo, 174-8744, Japan

Phone : +81-3-3966-1113
 Fax : +81-3-3558-9110
 E-mail : intdept@rikenkeiki.co.jp
 Web site : <http://www.rikenkeiki.co.jp>

3

Product Components

3-1. Main unit and standard accessories

After opening the package, check the main unit and accessories.
If anything in the following list is not included, contact RIKEN KEIKI.

<p><Main Unit></p> <p>SC-8000 main unit</p>  <p>Dry battery unit (BUD-8000 (S))</p>	<p><Standard Accessories></p> <ul style="list-style-type: none">• Sampling probe: 1• Shoulder strap• Operating manual• Product warranty  
---	---



DANGER

About explosion-proof

- Do not modify or change the circuit or structure, etc.
- When using the gas monitor in a hazardous area, take the following countermeasures for preventing dangers resulting from electrostatic charges.
 - (1) Wear anti-static clothes and conductive shoes (anti-static work shoes).
 - (2) For indoor use, use the gas monitor while standing on a conductive work floor (with a leakage resistance of 10 MΩ or less).
- IP protection grade : IP20
The protection grade on explosion-proof official approval is IP20. IP protection grade at the time of product shipment is 67.

About explosion-proof of the main unit

- The battery units that can be connected are the BUL-8000(S) (certificate number TC20087) or BUD-8000(S) (certificate number TC20088). If battery units other than specification are used, it will deviate from the regulation of explosion-proof official approval.
- The specifications of the gas monitor are as follows:

Pump circuit:	Allowable voltage of 4.95 V, allowable current of 1.12 A, and allowable power of 1138 mW
Toxic gas sensor circuit:	Allowable voltage of 4.95 V, allowable current of 0.834 A, and allowable power of 853 mW
Buzzer circuit:	Allowable voltage of 4.95 V, allowable current of 0.431 A, and allowable power of 441 mW
Main circuit:	Allowable voltage of 4.95 V, allowable current of 0.715 A, and allowable power of 732 mW
Backup circuit:	3.0 VDC, 10 μA

About explosion-proof of the battery unit

- Replace the battery unit in a non-hazardous area.
- The main unit that can be connected is SC-8000 (certificate number TC20086) only.
The use with unspecified main units deviates from the range of explosion-proof certification.
- The specifications of the BUD-8000(S) are as follows:

Pump circuit:	Maximum voltage of 4.95 V, maximum current of 1.12 A, and maximum power of 1138 mW
Toxic gas sensor circuit:	Maximum voltage of 4.95 V, maximum current of 0.834 A, and maximum power of 853 mW
Buzzer circuit:	Maximum voltage of 4.95 V, maximum current of 0.431 A, and maximum power of 441 mW
Main circuit:	Maximum voltage of 4.95 V, maximum current of 0.715 A, and maximum power of 732 mW
Power supply:	4.5 VDC, 100 mA (LR6 3 pcs)
- The specifications of the BUL-8000(S) are as follows:

Pump circuit:	Maximum voltage of 4.25 V, maximum current of 1.12 A, and maximum power of 901 mW
Toxic gas sensor circuit:	Maximum voltage of 4.25 V, maximum current of 0.768 A, and maximum power of 618 mW
Buzzer circuit:	Maximum voltage of 4.25 V, maximum current of 0.410 A, and maximum power of 330 mW
Main circuit:	Maximum voltage of 4.25 V, maximum current of 0.652 A, and maximum power of 525 mW
Charging terminal :	Allowable voltage AC250V

NOTE

There are the following two combinations of battery units. The following information is printed on the battery unit for the sake of identification to prevent a mistake in combinations.

- Lithium ion battery unit : BUL-8000(S) (certification number TC20087)
- Dry battery unit : BUD-8000(S) (certification number TC20088)

Additionally, a nameplate indicating a compatible model is affixed on the top of the battery unit. Check this information and use a correct combination.

Printing for identification

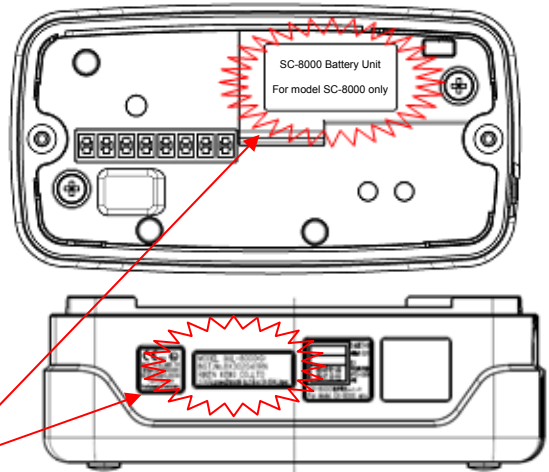

3-2. Names and functions for each part

<Outline Drawing>

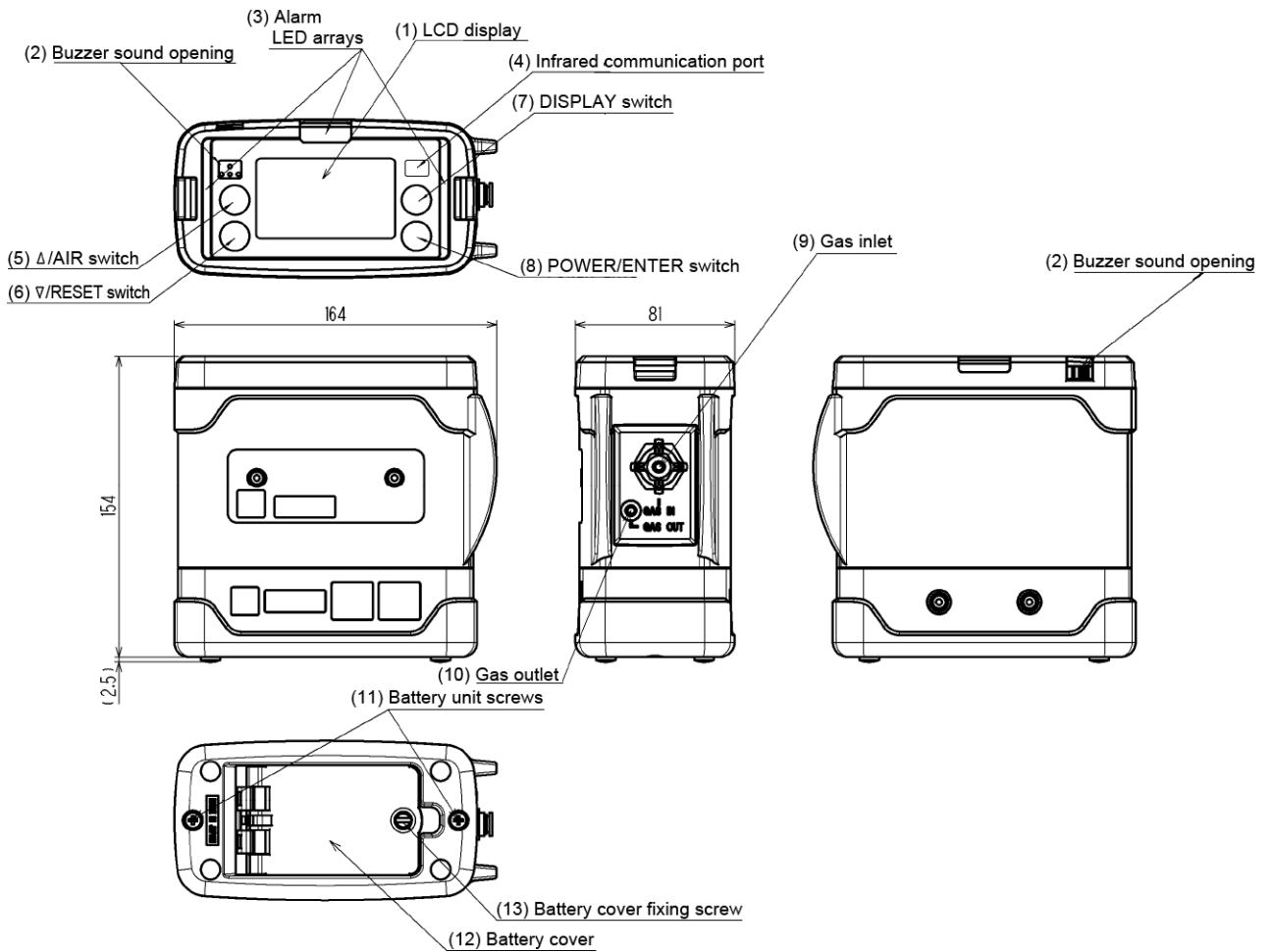

(1)	LCD display	Display gas concentrations, alarms, etc.
(2)	Buzzer sound opening	Emit a buzzer sound at an alarm. (Do not block it.)
(3)	Alarm LED arrays	The lamp blinks in response to an alarm.
(4)	Infrared communication port	Used to carry out data communications with a PC in data logger mode.
(5)	▲/AIR switch	Keep this switch pressed to perform fresh air adjustment.
(6)	▼/RESET switch	When an alarm occurs, press this switch to reset the alarm.
(7)	DISPLAY switch	Press this switch to change between display modes.
(8)	POWER/ENTER switch	Turn on and off the power.
(9)	Gas inlet	Connect a sampling hose to this port.
(10)	Gas outlet	Exhaust the gas drawn into the gas monitor. (Do not block it.)
(11)	Battery unit screws	Turn these screws to detach and replace the battery unit.
(12)	Battery cover	Open or close this cover to replace batteries. Must be closed while the gas monitor is in use.
(13)	Battery cover fixing screw	Fixe the battery cover.



CAUTION

- Do not jab the buzzer opening with a sharp-pointed item. The unit may malfunction or get damaged, allowing water or foreign substance, etc. to get inside.
- Do not remove the panel sheet on the display. The water-proof and dust-proof performances will be deteriorated.
- Do not affix a label on the infrared port. Infrared communications can no longer be conducted.

<LCD Display>

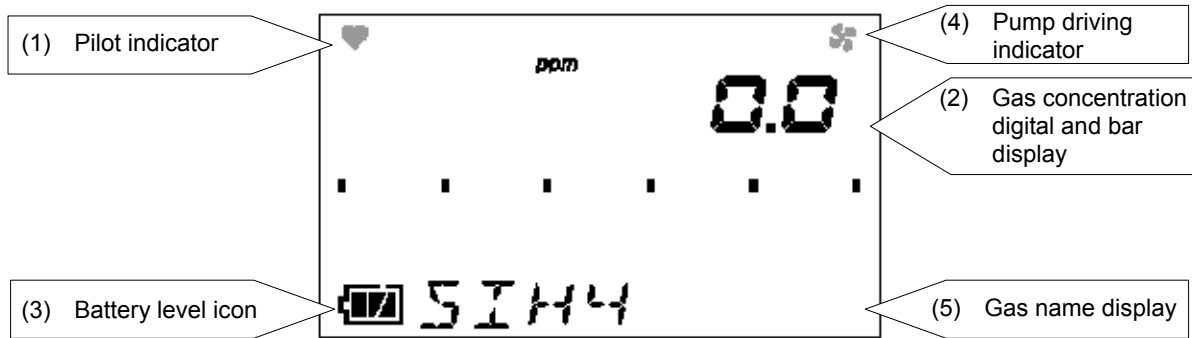

(1)	Pilot indicator	Displays the operating status in the detection mode. Normal: Blinking
(2)	Gas concentration display digital and bar display	Displays the gas concentration as a numeric value and a level in the bar graph.
(3)	Battery level icon	Displays the battery level. See the information below for the meanings of battery level icons.
(4)	Pump driving indicator	Displays the suction status in the detection mode. Normal: Rotating
(5)	Gas name display	Displays the gas name of detection target.

NOTE

The meanings of battery level icons are as follows:

: Sufficient / : Low / : Needs charging

If the battery level is lower than the above, the inside of the battery icon starts to blink ().

4

How to Use

4-1. Before using the gas monitor

Not only the first-time users but also the users who have already used the product must follow the operating precautions.

Ignoring the precautions may damage the gas monitor, resulting in inaccurate gas detection.

4-2. Preparation for start-up

Before starting gas detection, read and understand the following precautions. Ignoring these precautions may prevent correct gas detection.

- Check that the battery level is sufficient.
- Check that there is no bend or hole in the sampling probe.
- Check that the filter in the sampling probe is free of dust or clogging.
- Check that the main unit and sampling probe are connected properly.

<Attaching Batteries> (When the dry battery unit BUD-8000(S) is used)

When the gas monitor is used for the first time, or when the battery level is low, attach new AA alkaline batteries.



CAUTION

<Replacement>

- Turn off the power of the gas monitor before replacing the batteries.
- Replace the batteries in a non-hazardous area.
- Replace all of the three batteries with new ones at one time.
- Pay attention to the polarities of the batteries.
- If the battery cover fixing screw is not completely tightened, the dry batteries may drop off or water may get in through the clearance. Water may also get in if a minute foreign substance is caught beneath the battery unit.
- Please shorten time to make the gas monitor upside-down in case of battery replace.
- Please shorten time to turn off the gas monitor electricity in case of battery replace.

<Batteries>

- Use AA alkaline batteries (Type LR6 manufactured by Toshiba).
Chargeable batteries cannot be used.

- (1) Using a flathead screwdriver or coin, turn the battery cover fixing screw counterclockwise to open the battery cover.

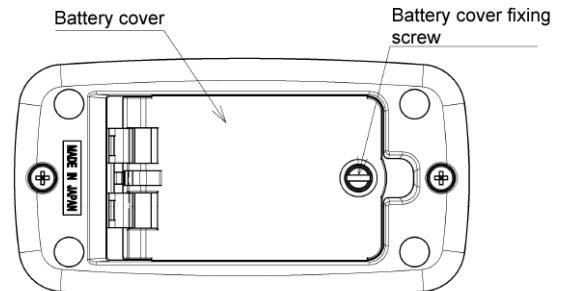

- (2) Paying attention to the polarities of batteries, replace all the three batteries with new ones.

- (3) Close the battery cover and tighten the battery cover fixing screw.

- (4) After replacing the batteries, place the gas monitor with the display facing upward.

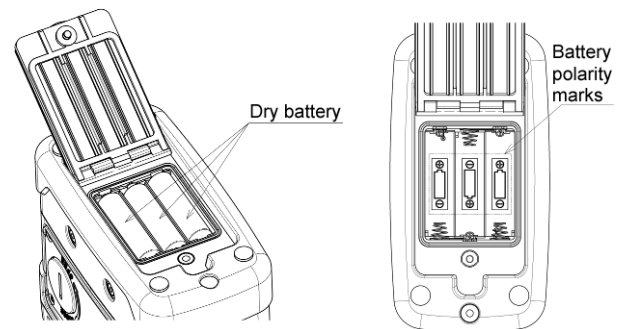

<Charging Battery Unit> (when the lithium ion battery unit BUL-8000(S) <Option> is used)

When the gas monitor is used for the first time, or when the battery level is low, be sure to use the accessory AC powered charger to charge the batteries.



CAUTION

- Use the dedicated AC powered charger.
- Charge the battery unit in a non-hazardous area.
- Charge the battery unit at ambient temperatures between 0 to 40°C.
- Do not use the gas monitor while charging it. Correct measurements cannot be obtained. Furthermore, the batteries get deteriorated more quickly and may have shorter life.
- The AC powered charger is not water-proof or dust-proof. Do not charge the batteries while the gas monitor is wet.
- The AC powered charger is not explosion-proof.

- (1) Open the charging jack cover of the gas monitor.



CAUTION

Do not pull the charging jack cover too hard. It may get damaged.

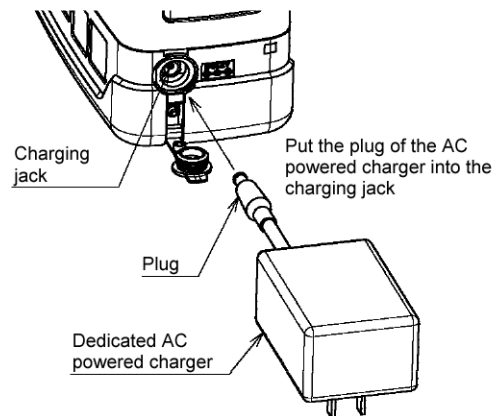

- (2) Put the plug of the AC powered charger into the charging jack of the gas monitor.
- (3) Connect the AC powered charger to the wall electric outlet.
When charging is started, the charging indicator lamp lights up (red).
(Charging time: Three hours at the maximum until the batteries are fully charged)
- (4) When charging is completed, the charging indicator lamp goes off.
- (5) When charging is completed, disconnect the AC powered charger from the wall electric outlet.
- (6) Pull out the AC powered charger plug from the power jack of the gas monitor and reattach the charging jack cover. Put the charging jack cover as far as it will go.



CAUTION

- Do not use the gas monitor with the charging jack cover detached. Dust or water may get into the gas monitor, causing it to malfunction. Replace the charging jack cover if it is damaged.
- If the charging jack cover is not completely closed, water may get in from the power jack. The same thing occurs if a minute foreign substance is caught beneath the cover.
- Disconnect the AC powered charger from the wall electric outlet while it is not in use.

NOTE

- During charging, the battery pack may get hot, but this is not abnormal.
- The temperature of the gas monitor is high immediately after charging is completed. Let it leave for 10 minutes or more before using it. Otherwise, correct measurements may not be obtained.
- When fully charged batteries are charged again, the charging indicator lamp does not go on.

<Detaching Battery Unit>

- (1) Loosen the two battery unit screws.
(They need not be completely detached.)
- (2) Detach the battery unit.
- (3) Attach a new battery unit.

NOTE

Make sure that the battery unit is installed in correct orientation by checking the locations of the connection terminal and projection portions.

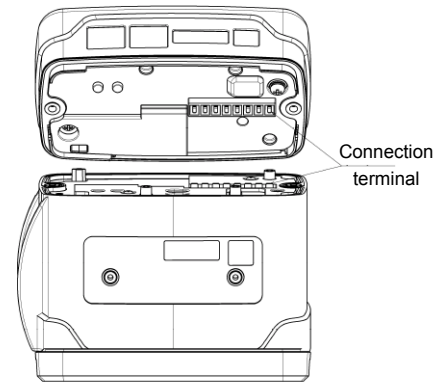

- (4) Securely tighten the two battery unit screws.

**CAUTION**

- Turn off the power of the gas monitor before replacing the battery unit.
- Detach and reattach the battery unit in a non-hazardous area.
- If the battery unit screw is not completely tightened, the battery unit may drop off or water may get in through the clearance. Water may also get in if a minute foreign substance is caught beneath the battery unit.
- Do not damage the rubber seal.
- To maintain the water-proof and dust-proof performances, it is recommended to replace the rubber seal every two years, whether or not it has an abnormality.
- Please shorten time to make the gas monitor upside-down in case of battery replace.
- Please shorten time to turn off the gas monitor electricity in case of battery replace.

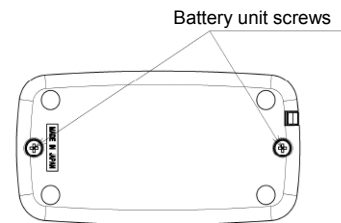
**Bottom of Gas Monitor**

- (5) After attaching the battery unit, place the gas monitor with the display facing upward.

<Connection of Sampling Probe>

- Connect the sampling probe securely to the gas inlet (GAS IN) of the gas monitor.

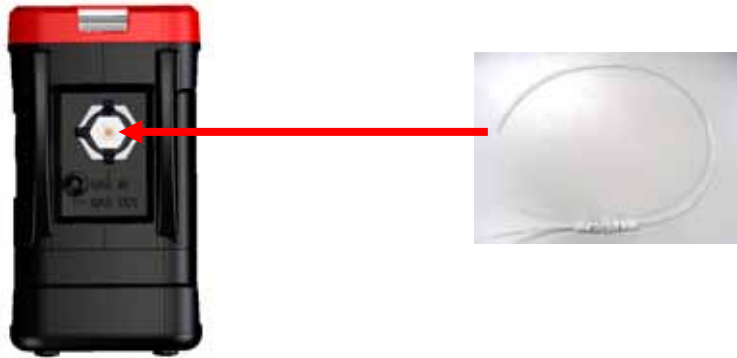

Insert the sampling hose to the gas inlet (GAS IN) until it clicks into place to ensure connection.



CAUTION

- Use only a sampling probe specified by Riken Keiki.
- To avoid drawing foreign substances, always use the gas monitor with the sampling probe connected to it.

NOTE

- To remove the sampling probe from the gas inlet, pull it while pushing the release ring against the main unit.

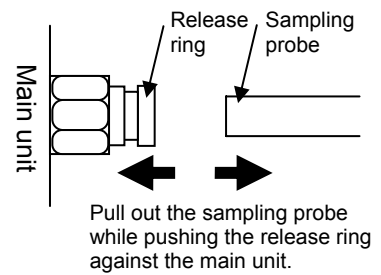

4-3. Basic operating procedures

Normally, the detection mode is used for normal operations. (The detection mode is activated after the power is turned on.)

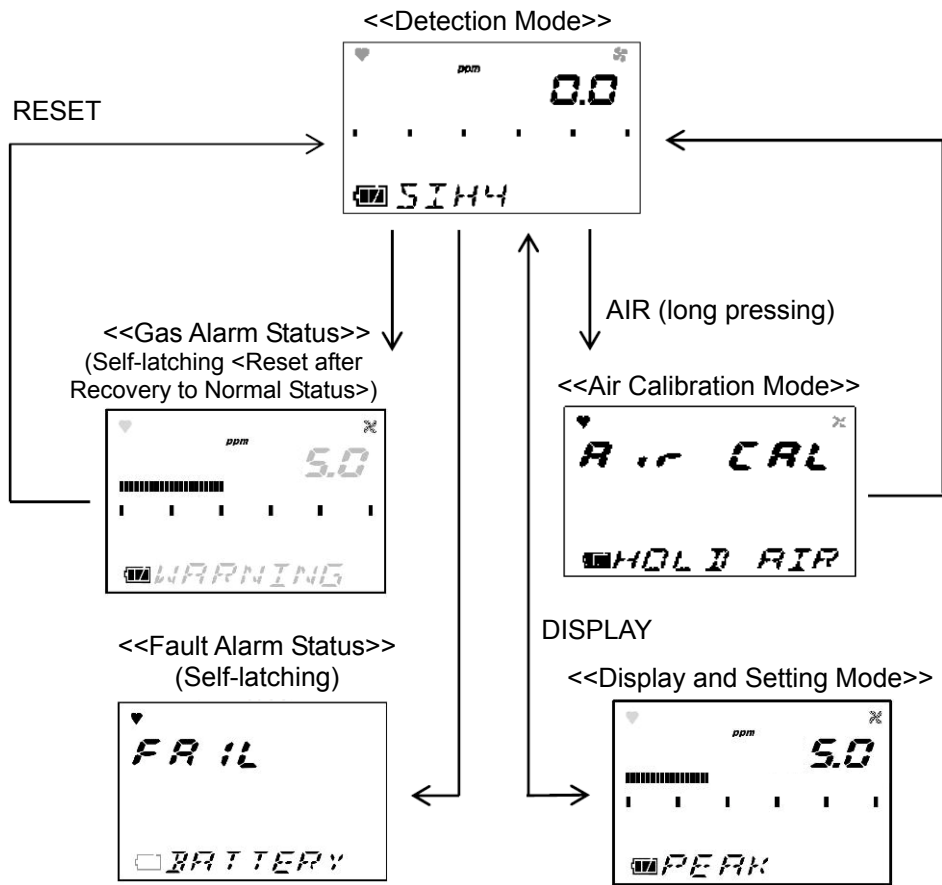

4-4. How to start the gas monitor

<<Start-up Procedure>>

Keep the POWER switch pressed for three seconds or more.



All LCDs Light Up.

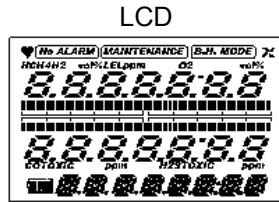

Alarm lamp lights up.
Buzzer sounds once. (Beep)

Date/Time Display

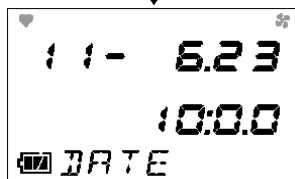

Battery Voltage Display

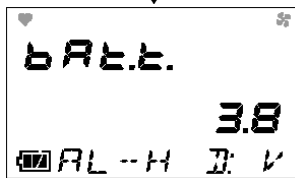

Gas Name and Full Scale Display

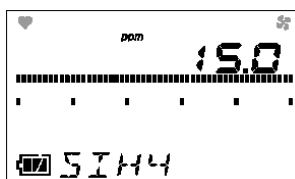

First Alarm Setpoint Display

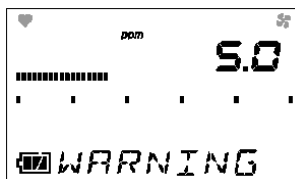

Second Alarm Setpoint Display

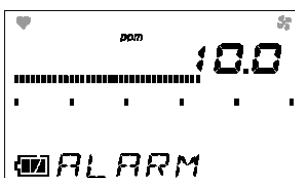

ID Display

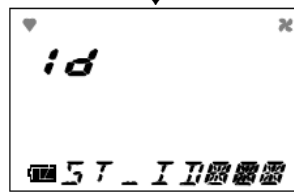

Detection Mode

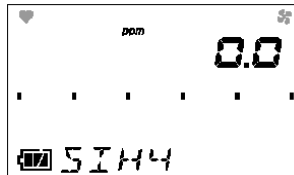

Buzzer sounds twice. (Beep, beep)

**CAUTION**

After start-up, perform air calibration before performing gas detection (air calibration mode).

NOTE

- A sensor abnormality alarm is issued before the detection mode is entered if there is any abnormality in the sensor. Promptly contact RIKEN KEIKI. Gases cannot be detected if there is any abnormality in the sensor.
- If there is an abnormality in the built-in clock, a fault alarm **FAIL CLOCK** may be issued. Press the RESET button. The fault alarm is temporarily reset, and measurement is started with incorrect clock time.
- When the power is turned on in a low-temperature environment, the pump may produce bigger operating sound for warm-up (about 30 seconds). This is not abnormal.

4-5. How to detect

In the detection mode, put the sampling probe close to the detection area and take the reading on the display.

Display example

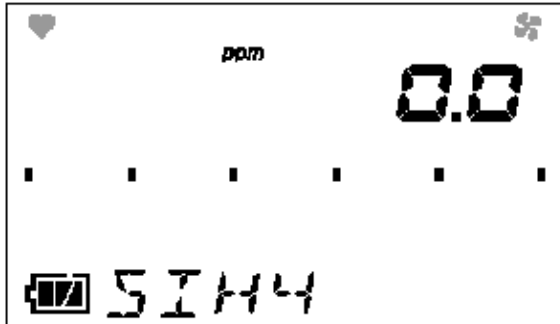

<- Display example

Gas concentration: 0.0 ppm

Battery level: Sufficient



DANGER

- Toxic or other gases may blow out from the gas exhausting outlet. Never inhale the air or gases.



WARNING

- The gas monitor is designed to draw gases around it under the atmospheric pressure. If excessive pressure is applied to the gas inlet and outlet (GAS IN, GAS OUT) of the gas monitor, detected gases may be leaked from its inside, thus leading to dangers. Be sure that excessive pressure is not applied to the gas monitor while used.
- Do not connect the sampling hose directly to a location with a pressure higher than the atmospheric pressure. The internal piping system may be damaged.
- When the fresh air adjustment is performed in the atmosphere, check the atmosphere for freshness before beginning the adjustment. If other gases exist, the adjustment cannot be performed properly, thus leading to dangers when the gas leaks.
- Issuance of a gas alarm indicates that there are extreme dangers. Take proper actions based on your judgment.
- Before use, check that there remains sufficient battery power. When the gas monitor is used for the first time or is not used for a long period, the batteries may be exhausted. Either replace the batteries with new ones or fully charge them before use.
- If a low battery alarm occurs, gas detection cannot be conducted. If the alarm occurs during use, turn off the power and promptly replace the batteries with new ones or charge them in a non-hazardous area.
- Do not block the buzzer sound opening. No alarm sound can be heard.



CAUTION

- Before performing gas detection, attach the sampling probe provided with the gas monitor to prevent disturbances by air dust.
- Use the gas monitor with the LCD display facing upward. The gas monitor, when used with the LCD display in a tilted or flat status, may not display correct values.
- If a high-concentration gas or highly adsorptive gas, such as HCl and NH₃, is drawn, some gas may remain in the hose due to adsorption in the sampling probe or others. After drawing a high-concentration gas or highly adsorptive gas, clean the gas monitor to remove the adsorbed gas (draw fresh air and check that the reading becomes zero).
Performing fresh air adjustment before cleaning it completely will result in inaccurate adjustment, giving adverse influence on measurement.
- In gas detection at the place where the presence of a high-concentration gas is anticipated, ex. Bring a sampling probes to a detection area close gradually. Do not detect high- concentration gas exceeding a full scale. When a high-concentration gas exceeding a full scale is detected, the gas monitor may display OVER (OVER alarm) and FAIL BIAS (failure alarm) by turns. In that case, attract fresh air to the gas monitor. Measured value should descend, and wait until it is stabilized. Then, perform gas calibration. Because, zero point and gas sensitivity may be changed.

NOTE

- In a low-temperature environment, the operating time is shortened due to the battery performance property.
- At a low temperature, the response of the LCD display may get slow down.

<Manual Memory>

Any instantaneous value during measurement can be recorded.

Up to 256 points of data can be recorded. When the number of recorded data points reaches the maximum, recorded data will be overwritten, starting from the oldest data.

- (1) In the detection mode, keep the ▼/RESET switch pressed and press the ▲/AIR switch to prepare for recording (about one second). The following screens are displayed in turn on the gas monitor.

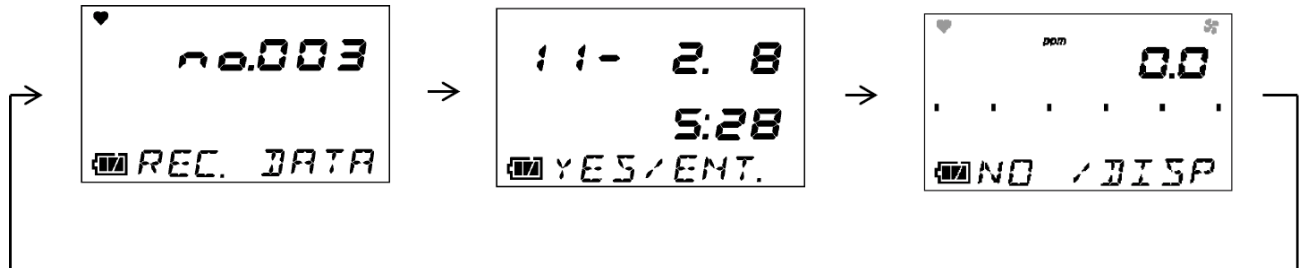

NOTE

The screen displays the memory number, date, and instantaneous value in turn. Go to the next step to execute recording. No value is recorded at this point yet. If you do not want to record a value, press the DISPLAY switch to return to the detection mode.



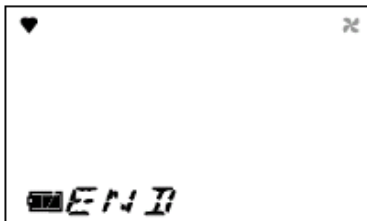





- (2) Press the ENTER switch. The date and the instantaneous value at the time when the ENTER switch is pressed are recorded.
- (3) When END is displayed, the recording is completed.

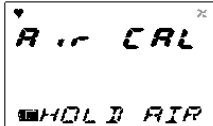

Returns to the detection mode.

4-6. Modes

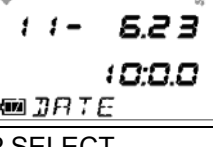
Details on each mode are provided as follows.

Mode	Item	LCD display	Details
Detection Mode	—	Concentration display 	Normal state
Air Calibration Mode	—	AIR CAL 	Perform the zero adjustment.
Display and Setting Mode	Peak Display	PEAK 	Display the maximum concentration detected during measurement from power-on to the present.
	Average Value and Elapsed Time Display	AVERAGE 	Display the average value and elapsed time after power-on. Display example Average value: 3.0 ppm Elapsed time: 56 minutes
	Alarm Setpoint Display Alarm test	ALARM-P 	Display the full scale and alarm setpoint values and check the alarm operations for the settings displayed.
	ID Setting	ID SELECT 	Display an ID if it has been set in advance. Also used to change or set an ID.
	Log Data Display	REC. DATA 	Display data recorded to the manual memory.
	Date/Time Display	DATE 	Display the date and time.
	Buzzer Volume Selection	BEEP SELECT 	Select either large or small for buzzer volume.

4-7. Air calibration mode

Keep pressing the AIR switch until RELEASE is displayed.

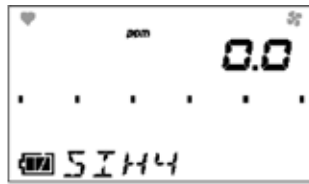

When the AIR switch is pressed, the display changes to Adj - HOLD AIR.

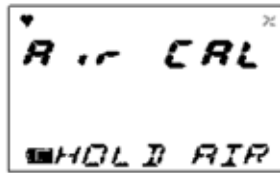

When RELEASE is displayed, release the AIR switch.

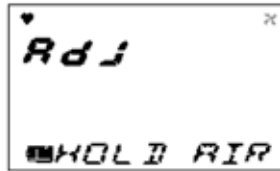

When the zero adjustment is successfully completed, and you return to the detection mode.

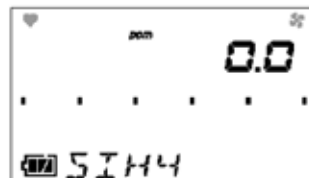

WARNING

When air calibration is performed in the atmosphere, check the atmosphere for freshness before beginning the calibration. If other gases exist, the adjustment cannot be performed properly, thus leading to dangers when the gas leaks.



CAUTION

- Perform air calibration under pressure and temperature/humidity conditions close to those in the operating environment and in fresh air.
- Perform air calibration after the reading is stabilized.
- If there is a sudden temperature change of 15°C or more between the storage and operation locations, turn on the power of the gas monitor, let it leave for about 10 minutes in a similar environment to the operation location, and perform air calibration in fresh air before using it.

NOTE

- Air calibration can be performed even when there is a gas alarm.
- If air calibration fails, "FAIL" - "AIR CAL" is displayed.
Press the RESET button to reset the fault alarm (calibration failure). When the alarm is reset, the value before calibration is displayed.



If sensor is faulty

4-8. Display/setting mode

This mode allows you to change various displays and settings. Every time the DISPLAY switch is pressed, various screens are displayed in turn.

Detection Mode

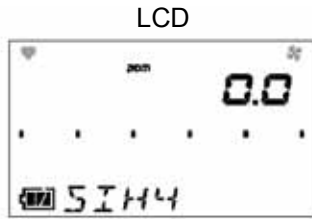

Display and Setting Mode

PEAK

Display the maximum concentration detected during measurement from power-on to the present.



Average Value and Elapsed Time Display

Display the average value and elapsed time after power-on.



Display example
Average value: 3.0 ppm
Elapsed time: 56 minutes



Full Scale Display/Alarm Setpoint Display/Alarm Test

Display the full scale and alarm setpoint values and check the alarm operations for the settings displayed.



→ ENTER

Full Scale Display/Alarm Setpoint Display/Alarm Test
⇒ P30



ID Display/Selection

Display an ID if it has been registered in advance. Also used to select an ID.



→ ID Display/Selection
ENTER ⇒ P31



Log Data Display

Display concentration data recorded to the manual memory.



→ Log Data Display
ENTER ⇒ P32



Date/Time Display

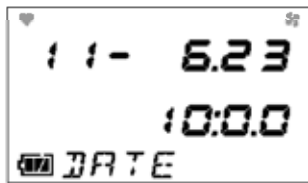

Buzzer Volume Selection



To **Detection Mode**

NOTE

The gas monitor automatically returns to the detection mode in about 20 seconds if the gas monitor is left unoperated.

<Full Scale Display/Alarm Setpoint Display/Alarm Test "ALARM-P">

Display the full scale or alarm setpoint values and check the alarm operations for the settings displayed.

- (1) Press the DISPLAY switch and select the full scale display / alarm setpoint display / alarm test from the display/setting mode menu. The following screens are displayed in turn on the gas monitor.



- (2) Press the ENTER switch to enter the alarm setpoint or other display.

NOTE

If you do not want to enter any display, press the DISPLAY switch to return to the display/setting mode menu.

- (3) Every time the ▲ or ▼ switch is pressed, the full scale and alarm setpoint menus, i.e., full scale display, first alarm setpoint display and second alarm setpoint display, are displayed in turn. Press either the ▲ or ▼ switch to select a setting that you want to check.

Select one of the following screens:

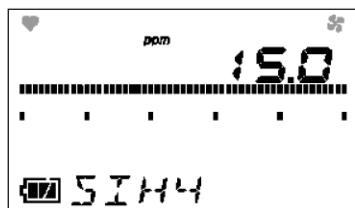

Full Scale Display

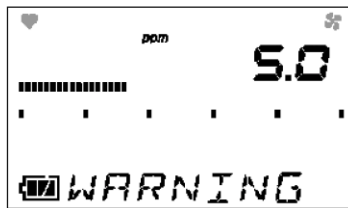

First Alarm Setpoint Display (WARNING)

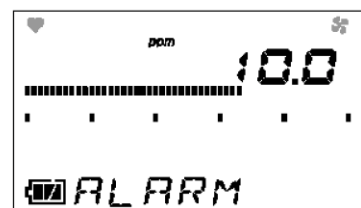

Second Alarm Setpoint Display (ALARM)

- (4) Press the ENTER switch to perform alarm test. The alarm operation on this screen can be checked. Press any switch to stop the alarm operation.
- (5) Press the DISPLAY switch to exit the alarm setpoint display or alarm test. The display/setting mode menu is displayed again.
- (6) After completion, press the DISPLAY switch several times until it returns to the detection mode.

<ID Display/Selection "ID SELECT">

Display an ID if it has been registered in advance. Also used to select an ID.

- (1) Press the DISPLAY switch and select the ID display/selection from the display/setting mode menu. The following screens are displayed in turn on the gas monitor.



- (2) Press the ENTER switch to set or select an ID.

NOTE

- If you do not want to set or select an ID, press the DISPLAY switch to return to the display/setting mode menu.
- On the gas monitor, either of the IDs from ST-ID000 to ST-ID255 has been registered, unless otherwise specified.
- The data logger management program (option) is required to register or change an ID. Please contact RIKEN KEIKI.
- When an ID is not selected (factory default), the following display appears without showing an ID.



- (3) Press either the ▲ or ▼ switch to select an ID. Every time the ▲ or ▼ switch is pressed, the ID number increases or decreases (000-255).

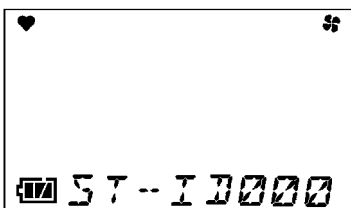

- (4) Press the ENTER switch.
- (5) When END is displayed, the setting is completed.

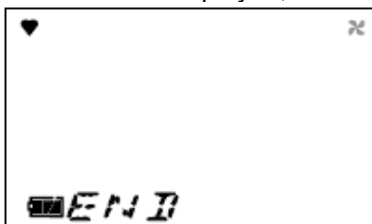

The display/setting mode menu is displayed again.

- (6) After completion, press the DISPLAY switch several times until it returns to the detection mode.

<Log Data Display "REC.DATA">

Display concentration data recorded to the manual memory.

- (1) Press the DISPLAY switch and select the log data display from the display/setting mode menu. The following screens are displayed in turn on the gas monitor.



- (2) Press the ENTER switch to display the log data.

NOTE

If you do not want to display the log data, press the DISPLAY switch to return to the display/setting mode menu.

- (3) Every time the ▲ or ▼ switch is pressed, the log data menus are displayed in turn. Press either the ▲ or ▼ switch to select log data that you want to check. The log data menu displays the year, month, day, time, and memory number.

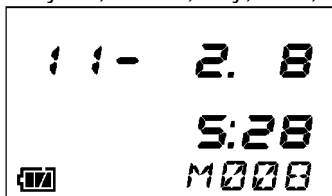

- (4) Press the ENTER switch to display the selected log data.

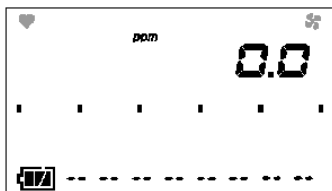

- (5) If you want to display other log data, press the ENTER switch to return to the log data menu. Repeat the steps (3) to (5).
- (6) After completion, press the DISPLAY switch several times until it returns to the detection mode.

<Buzzer Volume Selection>

Select a volume for the alarm sound.

- (1) Press the DISPLAY switch and select the buzzer volume selection display from the display/setting mode menu.
The following screens are displayed in turn on the gas monitor.



- (2) Press the ENTER switch to select a buzzer volume.
- (3) Press either the ▲ or ▼ switch to select a buzzer volume.
- (3) Every time the ▲ or ▼ switch is pressed, SMALL and LARGE are displayed in turn.

Select one of the following screens:



SMALL (buzzer volume: small)



LARGE (buzzer volume: large)

- (4) Press the ENTER switch.
- (5) When END is displayed, the setting is completed.

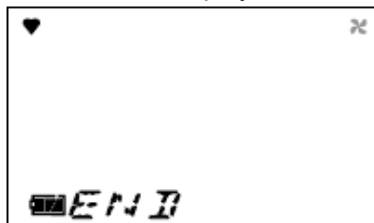

The display/setting mode menu is displayed again.

- (6) After completion, press the DISPLAY switch to return to the detection mode.

4-9. How to exit

Make the gas monitor draw in fresh air. After the display resets to zero, keep the POWER/ENTER switch pressed until the power is turned off.

NOTE

If the display is not zero when the power is turned off, a purge operation may be performed for 30 seconds at the maximum to clean the inside of the gas monitor.



5

Operations and Functions

5-1. Gas alarm activation

Gas alarm: Triggered when the concentration of detected gas reaches or exceeds the alarm setpoint value. <<Self-latching>>

Alarm display: Notified by blinking of a gas concentration value display, sounding of the buzzer, and lighting of the lamp.

Alarm types: First alarm (WARNING), second alarm (ALARM) and OVER alarm

<List of Gas Alarms>

Alarm type	First alarm	Second alarm	OVER alarm
Buzzer	Repeatedly sounds strong and weak beeps at about one second intervals: Beep, beep	Repeatedly sounds strong and weak beeps at about 0.5 second intervals: Blip, blip	Repeatedly sounds strong and weak beeps at about 0.5 second intervals: Blip, blip
Alarm lamp	Repeatedly blinks at about one second intervals.	Repeatedly blinks at about 0.5 second intervals.	Repeatedly blinks at about 0.5 second intervals.
LCD display	Gas concentration and WARNING display blink.	Gas concentration and ALARM display blink.	Gas concentration and OVER display blink.

<Display Operation>

Gas Concentration Display

In a gas alarm, the gas concentration display and the alarm type display blink.

In case of over the detection range (Over Scale), "〇〇〇" is displayed on the LCD.

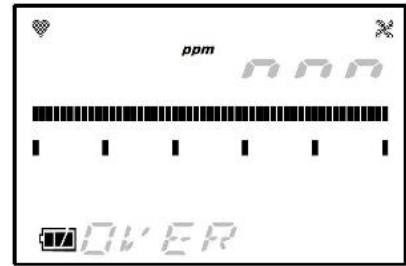

Display example

Alarm Lamp

The alarm consists of two steps. Each of them is triggered when the respective alarm setpoint value is reached to or exceeded.

Buzzer

The alarm consists of two steps. Each of them sounds when the respective alarm setpoint value is reached to or exceeded.

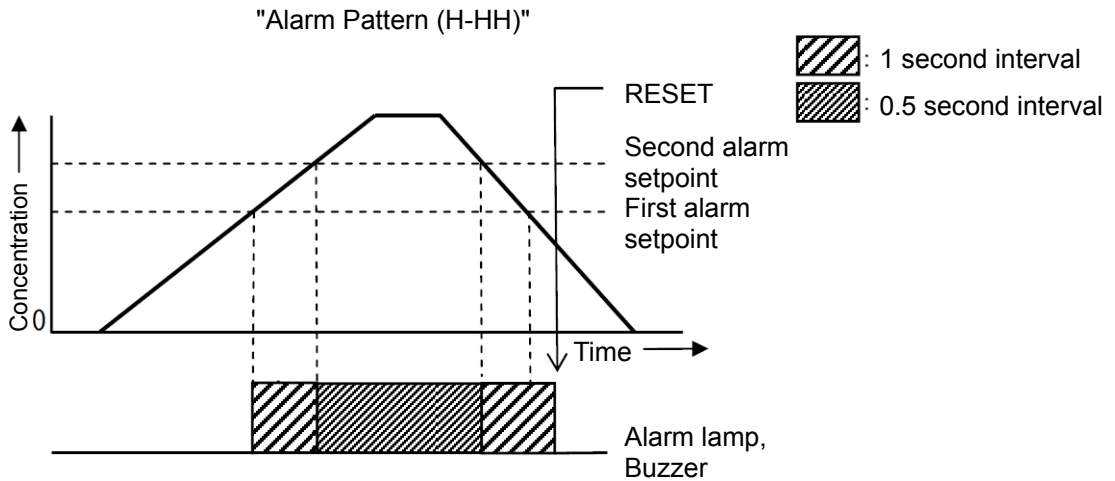

WARNING

Issuance of a gas alarm indicates that there are extreme dangers. Take proper actions based on your judgment.

5-2. Fault alarm activation

Fault alarm: Triggered when an abnormality is detected in the gas monitor. <<Self-latching>>

Alarm display: Notified by display of error messages, sounding of the buzzer, and lighting of the lamp.

Alarm types: Low flow rate, sensor abnormality, battery voltage low, system abnormality, and calibration failure

Determine the causes and take appropriate actions.

If the gas monitor has problems and is repeatedly malfunctioning, contact RIKEN KEIKI immediately.

<Display Operation>

LCD display	Displays an error message.
Alarm lamp	Repeatedly blinks at about one second intervals.
Buzzer	Repeatedly sounds intermittent beeps at about one second intervals: Blip, beep, blip, beep

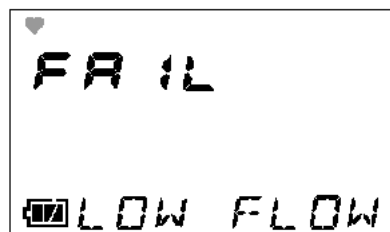

Display example

NOTE

- To reset a low flow rate alarm (FAIL LOW FLOW), remove the cause of the low flow rate, and then press the RESET switch.
- For information on malfunctions (error messages), see "8. Troubleshooting".

5-3. Other functions

<Calibration History/Various Trend/Event History Functions>

The gas monitor has history and trend functions. To use these functions, contact RIKEN KEIKI.

NOTE

The data logger management program (option) is required to use the history and trend functions. Please contact RIKEN KEIKI.

6

Maintenance

The gas monitor is an important instrument for the purpose of safety. To maintain the performance of the gas monitor and improve the reliability of safety, perform a regular maintenance.

6-1. Maintenance intervals and items

- Daily maintenance: Perform maintenance before beginning to work.
- Monthly maintenance: Perform alarm test once a month.
- Regular maintenance: Perform a maintenance once or more for every six months to maintain the performance as a safety unit.

Maintenance item	Maintenance content	Daily maintenance	Monthly maintenance	Regular maintenance
Battery Level Check	Check that the battery level is sufficient.	○	○	○
Concentration Display Check	Make the gas monitor draw in fresh air and check that the concentration display value is zero. When the reading is incorrect, perform the zero adjustment (fresh air adjustment) after ensuring that no other gases exist around it.	○	○	○
Flow Rate Check	See the flow rate indicator to check for abnormalities.	○	○	○
Filter Check	Check the dust filter for dust or clogging.	○	○	○
Alarm Test	Check the alarm lamp and buzzer for normal operation using the alarm test function.		○	○
Span Adjustment	Perform the span adjustment by using the calibration gas.			○
Gas Alarm Check	Check the gas alarm by using the calibration gas.			○

<About Maintenance Services>

- We provide services on regular maintenance including span adjustment, other adjustments and maintenance.
To make the calibration gas, dedicated tools, such as a gas cylinder of the specified concentration and gas sampling bag must be used.
Our qualified service engineers have expertise and knowledge on the dedicated tools used for services, along with other products. To maintain the safety operation of the gas monitor, please use our maintenance service.
- The followings are typical maintenance services. For more information, please contact RIKEN KEIKI.

Main Services

Battery Level Check	: Checks the battery level.
Concentration Display Check	: Verifies that the concentration display value is zero (or 20.9 vol% on the oxygen deficiency meter) by using the zero gas. Performs the zero adjustment (fresh air adjustment) if the reading is incorrect.
Flow Rate Check	: Checks the flow rate indicator to find abnormalities. Checks the flow rate by using an external flow meter to verify the correctness of the flow rate indicator on the gas monitor. If the flow rate is incorrect, performs the flow rate adjustment.
Filter Check	: Checks the dust filter for dust or clogging. Replaces a dirty or clogged dust filter.
Alarm Test	: Checks the alarm lamp and buzzer for normal operation using the alarm test function.
Span Adjustment	: Performs the span adjustment by using the calibration gas.
Gas Alarm Check	: Checks the gas alarm by using the calibration gas. <ul style="list-style-type: none"> • Checks the alarm. (Checks the alarm activation when the alarm setpoint is reached.) • Checks the delay time. (Checks time to delay until the alarm is triggered.) • Checks the buzzer, lamp, and concentration display. (Check each activation of ALM1 and ALM2.)
Cleaning and Repair of Gas Monitor (visual diagnosis)	: Checks dust or damage on surface of the gas monitor, clean and repair such parts of the gas monitor. Replaces parts which are cracked or damaged.
Gas Monitor Operation Check	: Uses the keys to check the operation of functions and parameters.
Replacement of Consumable Parts	: Replaces consumable parts, such as a sensor, filter and pump.

6-2. Gas calibration method

Perform span adjustment of sensors using a calibration gas at least once every six months. The span adjustment requires dedicated equipment and a calibration gas. Request RIKEN KEIKI for it. If you perform the span adjustment for yourself, prepare these tools in advance and perform the adjustment in accordance with the "Maintenance Manual."

6-3. How to clean

Clean the gas monitor if it becomes extremely dirty. The gas monitor must be turned off while cleaning it. Use a waste cloth to remove dust. Do not use water or organic solvent for cleaning because they may cause malfunctions.

Because an extremely large amount of dust inside the sampling probe may disturb the gas detection, it must be cleaned with dry AIR, etc.



CAUTION

When cleaning the gas monitor, do not splash water over it or use organic solvents such as alcohol and benzene on it. The surface of the gas monitor may be discolored or damaged.

NOTE

When the gas monitor gets wet, water may remain in the buzzer sound opening or clearances. Drain water as follows:

- (1) Wipe away moisture on the gas monitor thoroughly using a dry towel, cloth, etc.
- (2) While holding the gas monitor firmly, shake it about ten times with the buzzer sound opening facing downward.
- (3) Wipe away moisture coming out from the inside thoroughly using a towel, cloth, etc.
- (4) Place the gas monitor on a dry towel, cloth, etc. and let it stand at normal temperatures.

6-4. Parts replacement

<Replacement of Consumables>

Sensor Replacement

The built-in sensors of the gas monitor have a validity period and must be replaced regularly (within two years).

The sensor life has expired if, for example, the sensors cannot be calibrated in span adjustment, the readings do not come back after fresh air adjustment, or the readings fluctuate. Contact RIKEN KEIKI. The warranty period is one year for all the sensors.

Dust Filter Replacement Procedure

Because the dust filter may gradually get dirty or clogged over the time, it must be replaced regarding the operating conditions. Check the dust filter, and then replace it as necessary.

The gas monitor has various built-in filters.

Sampling probe

The sampling probe has a built-in Teflon filter. Replace the filter when it has absorbed water, has a low flow rate, or looks significantly contaminated.

- (1) Hold the handling part and turn the middle part (transparent ring) to separate the sampling probe.

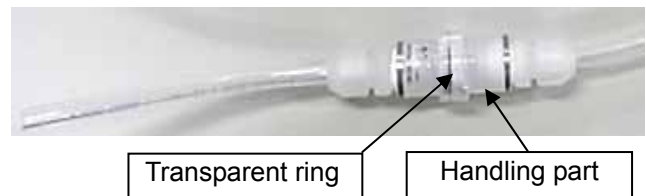

- (2) Take out the following filter and insert a new filter.



- (3) Attach the tip that has been removed.

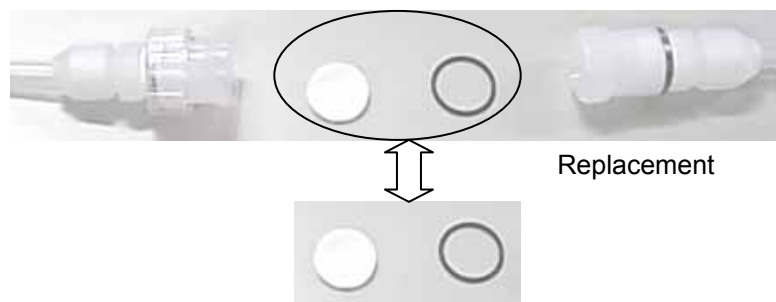

<Replacement of Regular Replacement Parts>

List of recommended regular replacement parts

No.	Item	Maintenance intervals	Replacement intervals	Quantity (pieces per unit)	Remarks
1	Rubber seal	—	2 years	1 set	
2	Tube	6 months	3 - 8 years	1 set	
3	Pump unit (RP-11)	6 months	1 - 2 years	1	
4	Lithium ion battery pack (BP-8000)	—	—	1	<ul style="list-style-type: none"> • About 500 cycles of charging and discharging • For BUL-8000(S)

NOTE

The above replacement intervals are recommendation only. The intervals may change depending on the operating conditions. These intervals do not mean the warranty periods either. The result of the regular maintenance may determine when to replace the parts.

The operation of most of the periodical replacement parts must be checked after replacement by a qualified service engineer.

For the stable operation of the gas monitor and safety, ask a qualified service engineer to take care of replacement of the parts whose operation must be checked. Please contact RIKEN KEIKI.

7

Storage and Disposal

7-1. Procedures to store the gas monitor or leave it for a long time

The gas monitor must be stored under the following environmental conditions.

- In a dark place under the normal temperature and humidity away from direct sunlight
- In a place where gases, solvents or vapors are not present

Store the gas monitor in a shipping carton, if any, in which the product was delivered.

Store the gas monitor away from dust, etc. if the shipping carton is not available.

Make sure to store the gas monitor with the display facing upward.



CAUTION

- If the gas monitor is not used for a long time, turn on the power at least once every six months and check that the pump draws in air (about three minutes). The gas monitor, when not activated for a long time, may cease to work because of hardening of the grease in the pump motor.
- Store the gas monitor with dry batteries attached. While the power of the gas monitor is OFF, the sensor is energized at all times. If dry batteries are removed, the sensor may not function at the next use of the gas monitor. Therefore, it is necessary to store the gas monitor with the batteries in it.

NOTE

- Check that the battery level is sufficient once every six months. If a low battery voltage alarm is triggered while checking, replace the dry batteries with new ones (or charge the Lithium ion battery unit). Because the sensor is energized at all times even when the power is OFF, it is necessary to replace the batteries (or charge the Lithium ion battery unit).
If the gas monitor is used with low-level batteries, battery leaks resulting from over discharging may occur.
- If the gas monitor with a Lithium ion battery unit is not used for a long time, it is recommended to store it after discharging the batteries until the battery level icon shows one battery mark or so. If the gas monitor is stored with the batteries fully charged, the batteries get deteriorated more quickly and may have shorter life.

7-2. Procedures to use the gas monitor again



CAUTION

When you use a stopped/stored gas monitor again, do not forget to perform a gas calibration. For information on readjustment including gas calibration, please contact RIKEN KEIKI.

7-3. Disposal of products

When the gas monitor is disposed of, it must be treated properly as an industrial waste in accordance with the local regulations.



WARNING

- Do not disassemble the electrochemical type sensor because it contains electrolyte. Electrolyte may cause severe skin burns if it contacts skin, while it may cause blindness if it contacts eyes. If electrolyte is adhered on your clothes, that part on your clothes is discolored or its material is decomposed. If contact occurs, rinse the area immediately with a large quantity of water.
- Dispose of the batteries in accordance with procedure specified by the local authority.

8

Troubleshooting

The troubleshooting does not explain the causes of all the malfunctions which occur on the gas monitor. This simply helps to find the causes of malfunctions which frequently occur. If the gas monitor shows a symptom which is not explained in this manual, or still has malfunctions even though remedial actions are taken, please contact RIKEN KEIKI.

<Abnormalities on Unit>

Symptoms	Causes	Actions
<u>The power cannot be turned on.</u>	The battery level is too low.	Lithium ion battery unit: Charge the batteries in a non-hazardous area. Dry battery unit: Replace all the three dry batteries with new ones in a non-hazardous area.
	The power switch was not pressed long enough.	For power-on, keep the POWER switch pressed until a beep is heard (about two seconds).
	Improper installation of the battery unit	Check whether the battery unit is properly attached to the main unit.
<u>Abnormal operations</u>	Disturbances by sudden surge noise, etc.	Turn off and restart the gas monitor.
<u>Key operations are disabled.</u>	Disturbances by sudden surge noise, etc.	In a non-hazardous area, remove the battery unit once, and reinstall the battery unit, and turn on the power to perform operations.
<u>System abnormalities</u> FAIL SYSTEM	A circuit abnormality occurred.	Request RIKEN KEIKI for repair.
<u>System abnormalities</u> FAIL SYSTEM Error No.000	Abnormalities of internal ROM	Request RIKEN KEIKI for repair.
Error No.010	Abnormalities of internal RAM	
Error No.021	Abnormalities of internal FRAM	
Error No.031	Abnormalities of internal FLASH	
<u>Sensor abnormalities</u> FAIL SENSOR	A sensor has failed.	Request RIKEN KEIKI to replace the sensor.
<u>A low battery voltage alarm is displayed.</u> FAIL BATTERY	The battery level is low.	Lithium ion battery unit: Turn off the power and charge it in a non-hazardous area.
		Dry battery unit: Turn off the power and replace the dry batteries with new ones in a non-hazardous area.
<u>A low flow rate alarm is displayed.</u> FAIL LOW FLOW	Water or oil, etc. was drawn in.	Check the gas sampling hose for any damage or mark of drawn water or oil, etc.
	The gas sampling hose is clogged.	Check the gas sampling hose for connections, clogging, twisting, etc.

Symptoms	Causes	Actions
	The pump has deteriorated.	Request RIKEN KEIKI to replace the pump.
<u>Fresh air adjustment cannot be performed.</u> <u>FAIL AIR CAL</u>	Fresh air is not supplied around the gas monitor.	Supply fresh air.
<u>Clock abnormalities</u> <u>FAIL CLOCK</u>	Abnormalities of the internal clock	Make a setting of Date/Time. If such a symptom is observed repeatedly, the built-in clock is seemingly malfunctioning. Thus, it must be replaced. Please contact RIKEN KEIKI.
<u>The batteries cannot be charged.</u> <u>(Li-ion battery unit only)</u>	The charger is not connected properly.	Connect the AC powered charger to the wall electric outlet and jack properly.
	A charging circuit abnormality occurred.	Request RIKEN KEIKI for repair.
	The batteries have been fully charged.	When fully charged batteries are charged again, the charging indicator lamp does not go on.
<u>FAIL BIAS</u>	Abnormalities of bias voltage	Request RIKEN KEIKI for repair.
<u>OVER</u> and <u>FAIL BIAS</u> are displayed by turns.	The concentrated gases far exceeding a full scale was attracted.	Attract fresh air to the gas monitor. Measured value should descend, and wait until it is stabilized. Then, perform gas calibration. Because, zero point and gas sensitivity may be changed.

<Abnormalities of Readings>

Symptoms	Causes	Actions
<u>The reading rises (drops) and it remains so.</u>	Drifting of sensor output	Perform the zero adjustment (fresh air adjustment).
	Presence of interference gas	Disturbances by interference gases cannot be eliminated completely. For information on actions, such as removal filter, please contact RIKEN KEIKI.
	Slow leak	A very small amount of the gas to be detected may be leaking (slow leak). Because ignoring it may cause dangers, take a remedial measure, i.e., taking actions the same as those for the gas alarm.
	Environmental changes	Perform the zero adjustment (fresh air adjustment).
<u>A gas alarm is triggered despite of no gas leak and no other abnormalities at the detection point.</u>	Presence of interference gas	Disturbances by interference gases cannot be eliminated completely. For information on actions, such as removal filter, please contact RIKEN KEIKI.
	Disturbance by noise	Turn off and restart the gas monitor. If such a symptom is observed frequently, take appropriate measures to eliminate the noise.
<u>Slow response</u>	Clogged dust filter	Replace the dust filter.
	Bended or clogged suction tube or exhaust tube	Fix the defective parts.
	Condensation is formed inside the suction tube.	Fix the defective parts.
	Deteriorated sensor sensitivity	Request RIKEN KEIKI to replace the sensor.
<u>Span adjustment impossible</u>	Improper calibration gas concentration	Use the proper calibration gas.
	Deteriorated sensor sensitivity	Request RIKEN KEIKI to replace the sensor.

9

Product Specifications

9-1. List of specifications

<Japanese Specifications>

Detection principle	Electrochemical type
Detectable gas	Toxic gas
Gas concentration display	LCD(digital)
Measuring range	Depend on Detectable gas
Detection method	Pump suction method
Suction flow	Above 0.5L/min
Alarm preset point	Depend on Detectable gas
Various indications	Gas/Battery condition/Pilot indicator/Flow indicator
Alarm sound	Above95dB(A)(30cm)
Alarm accuracy (under an identical condition)	Less than $\pm 30\%$ (against alarm preset point)
Alarm-delay time (under an identical condition)	Less than 60sec(when introducing 1.6 times thicker gas than alarm preset point)
Gas alarm type	Two-level alarm(H-HH)/OVER
Gas alarm indication	Lamp blinking/Intermittent buzzer/Gas concentration display blinking
Gas alarm indication	Latched
Trouble alarm · Self diagnosis	System failure/Sensor failure/Low Battery/Calibration failure/Flow failure
Trouble alarm indication	Lamp blinking/Intermittent buzzer/Content display
Trouble alarm action	Latched
Specification of transmission	IrDA
Various functions	LCD backlight/Data logger/Peak hold/Average/Logged data display/Beep select/Date
Power supply	Dedicated dry battery unit <three AA batteries> [BUD-8000(S)] (Lithium ion battery unit [BUL-8000(S)] is available.)
Continuous operation time	BUD-8000(S): Approx.18hours(25 · Non alarm operation) BUL-8000(S): Approx.25hours(25 · Non alarm operation · After full charge)
Operating temperature	-10 ~ 40 (non-rapidly-vary. It may differ according to mounted sensor.)
Operating humidity	30 ~ 70%RH(non-condensing. It may differ according to mounted sensor.)
Structure	Dust and Water-proof Structure(IP67)
Explosion-proof structure	Intrinsically safe structure
Explosion-proof grade	Exia CT4(TIIS,Japan)
Explosion-proof approval No.	TC20086(TIIS,Japan)
Outer dimension	Approx.154(W)×81(H)×154(D)mm(projection excluding)
Weight	Approx.1.0kg(BUD-8000(S) when in use)/Approx.1.1kg(BUL-8000(S) when in use)

* Specifications subject to changes without notice.

<Overseas Specifications>

Detection principle	Electrochemical type
Detectable gas	Toxic gas
Gas concentration display	LCD(digital)
Measuring range	Depend on Detectable gas
Detection method	Pump suction method
Suction flow	Above 0.5L/min
Alarm preset point	Depend on Detectable gas
Various indications	Gas/Battery condition/Pilot indicator/Flow indicator
Alarm sound	Above95dB(A)(30cm)
Alarm accuracy (under an identical condition)	Less than $\pm 30\%$ (against alarm preset point)
Alarm-delay time (under an identical condition)	Less than 60sec(when introducing 1.6 times thicker gas than alarm preset point)
Gas alarm type	Two-level alarm(H-HH)/OVER
Gas alarm indication	Lamp blinking/Intermittent buzzer/Gas concentration display blinking
Gas alarm action	Latched
Trouble alarm · Self diagnosis	System failure/Sensor failure/Low Battery/Calibration failure/Flow failure
Trouble alarm indication	Lamp blinking/Intermittent buzzer/Content display
Trouble alarm action	Latched
Specification of transmission	IrDA
Various functions	LCD backlight/Data logger/Peak hold/Average/Logged data display/Beep select/Date
Power supply	Dedicated dry battery unit <three AA batteries> [BUD-8000(S)] (Lithium ion battery unit [BUL-8000(S)] is available.)
Continuous operation time	BUD-8000(S): Approx. 18hours(25 · Non alarm operation) BUL-8000(S): Approx. 25hours(25 · Non alarm operation · After full charge)
Operating temperature	-10 ~ 40 (non-rapidly-vary. It may differ according to mounted sensor.)
Operating humidity	30 ~ 70%RH(non-condensing. It may differ according to mounted sensor.)
Structure	Dust and Water-proof Structure(IP67)
Explosion-proof structure	Intrinsically safe structure
Explosion-proof grade	Exia CT4(ATEX/IECEX<DEKRA>)
Explosion-proof approval No.	DEKRA11ATEX0047(DEKRA)/IECEXDEK11.0019(IECEX)
Outer dimension	Approx. 154(W)×81(H)×154(D)mm(projection excluding)
Weight	Approx. 1.0kg(BUD-8000(S) when in use)/Approx. 1.1kg(BUL-8000(S) when in use)

* Specifications subject to changes without notice.

9-2. List of accessories

Standard accessories	<ul style="list-style-type: none">• Dry battery unit (BUD-8000 (S))• Shoulder strap• Sampling probe
Optional accessories	<ul style="list-style-type: none">• Lithium ion battery unit (BUL-8000 (S))• AC powered charger for BUL-8000(S)• Dust filter for sampling probe• Waist strap• Waist strap fixing tool• Sampling probe holder• Activated carbon filter tube (with relay tube)• Filter tube (NOx removal) (with relay tube)• Filter tube fixing belt• Aluminum trunk case• Data logger management program

10

Definition of Terms

ppm	Gas concentration indicated in the unit of one-millionth of the volume
-----	--