

# Gas Detector Head GD-70D Series

## Operating Manual

*Part Number: 71-0446*

*Revision: P1*

*Released: 7/11/19*

### Request for the Customers

- Read and understand this operating manual before using the detector.
- You must operate the detector in accordance with the operating manual.
- Regardless of warranty period, we shall not make any compensation for accidents and damage caused by using this product.

The compensation shall be made only under the warranty policy of products or parts replacement.

- Because this is a safety device, daily and biannual maintenance must be performed.
- If you find abnormalities in the detector, please contact our local representative immediately.

---

## <Contents>

	Request for the Customers .....	1
1	Outline of the Product .....	4
	1-1 Preface .....	4
	1-2 Product Purpose .....	4
	1-3 Definition of DANGER, WARNING, CAUTION and NOTE .....	5
	1-4 Method of confirmation for CE marking type .....	5
2	Important Notices on Safety .....	6
	2-1 Danger Statements .....	6
	2-2 Warning Statements .....	6
	2-3 Caution Statements .....	7
3	Product Components .....	8
	3-1 Main Unit and Standard Accessories .....	8
	3-2 Outline Drawing .....	9
	3-3 Names and Functions for Each Part .....	10
	3-4 Operation Diagrams .....	14
4	Installation .....	16
	4-1 Requirements .....	16
	4-2 Precautions for Installation Sites .....	16
	4-3 Precautions for System Designing .....	18
	4-4 Proper use of alarm contact .....	19
	4-5 Installing the Detector .....	20
	4-6 Wiring the Detector .....	22
	4-7 Making Tubing Connections .....	34
	4-8 Disposal .....	35
5	Operation .....	36
	5-1 Preparation for Start-up .....	36
	5-2 Starting Up the Detector .....	36
	5-3 Turning Off the Detector .....	38
	5-4 Basic Operation .....	38
	5-5 Modes .....	39
6	Detection Mode .....	41
	6-1 Gas Alarm Activation .....	41
	6-2 Fault Alarm Activation .....	47
	6-3 External Output Operation .....	47
	6-4 Other Functions .....	50
	6-5 About LONWORKS (LN specification) .....	53
7	Alarm Test Mode .....	57
	7-1 Alarm Test Mode .....	57
8	User Mode .....	59
	8-1 User Mode .....	59
9	Maintenance Mode .....	65
	9-1 Environmental Setting 1 "2-9" .....	70
	9-2 Alarm Value Setting "2-9" - "SET 1" .....	71
	9-3 Fault Alarm Test "2-9" - "SET 4" .....	73
	9-4 Environmental Setting 2 "2-10" .....	74
	9-5 Date/Time Setting "2-10" - "SET 1" .....	79
	9-6 Energized/De-Energized Contact Setting "2-10" - "SET 6" .....	81
	9-7 ETHERNET Setting "2-10" - "SET 18" .....	83
10	Maintenance .....	86
	10-1 Maintenance Intervals and Items .....	86
	10-2 Calibration Overview .....	86
	10-3 Calibrating with the Target Gas .....	90
	10-4 Calibrating with a Surrogate Gas (Sensors with Factors) .....	93
	10-5 Calibrating with a Gas Bag (Calibrating with HCl) .....	99
	10-6 Calibrating with a Humidifier (MOS Sensors) .....	103
	10-7 Calibrating a Pyrolyzer Unit .....	107
	10-8 Flow Rate Adjustments .....	110
	10-9 Replacing Parts .....	112

---

10-10	Storing the GD-70D .....	115
11	Troubleshooting .....	116
12	Product Specifications .....	119
12-1	Common Specifications .....	119
12-2	Specifications for Each Model .....	119
12-3	Specifications for Each Sensor Type .....	120
12-4	Full Scale and Alarm Points .....	123
13	Calibration Parts List .....	126
14	Replacement Parts List .....	129
	Warranty Policy .....	142

---

# 1

## Outline of the Product

---

### 1-1 Preface

Thank you for choosing our GD-70D Series gas detector head. Please verify that the model number of the product you purchased is included in the specifications on this manual.



This manual explains how to use the detector and its specifications. It contains information required for using the detector properly. All users must read and understand the operating manual before using the detector.

### 1-2 Product Purpose

- This is a fixed type gas detector head which detects gas leaks in semiconductor factories, etc.
- The gas detector is a safety device, not an analyzer or densitometer which performs quantitative/qualitative analysis/measurement for gases. You must understand the features of the detector before using it, so that you can use it properly.
- The detector detects abnormalities in the air caused by the presence of gas (or oxygen deficiency) with the built-in gas sensor unit. The concentrations of detected gases are shown on the LCD.
- The built-in pump in the detector draws gas to perform gas detection.
- The detector has two-step gas alarm contact and fault alarm contact.
- The detector outputs the gas concentration in 4 - 20 mA or digital data.
- The communication method for each specification is as follows.

<b>GD-70D</b>	<b>4 - 20 mA specification</b>	Analog transmission
<b>GD-70D-NT</b>	<b>NT specification</b>	2-wire type DC power-line communication
<b>GD-70D-EA</b>	<b>EA specification</b>	Ethernet and analog transmission (4 - 20 mA)
<b>GD-70D-LN</b>	<b>LN specification</b>	LONWORKS

## 1-3 Definition of DANGER, WARNING, CAUTION and NOTE

 <b>DANGER</b>	This message indicates that improper handling may cause serious damage on life, health or assets.
 <b>WARNING</b>	This message indicates that improper handling may cause serious damage on health or assets.
 <b>CAUTION</b>	This message indicates that improper handling may cause minor damage on health or assets.
<b>NOTE</b>	This message indicates advice on handling.

## 1-4 Method of confirmation for CE marking type

The CE marking is labeled on the detector in case of comply with CE marking. Please confirm the instrument specification before using. Please refer to the Declaration of Conformity that is at the end of this manual if you have CE marking type.

You can confirm instrument specification to see the CE marking as follows.

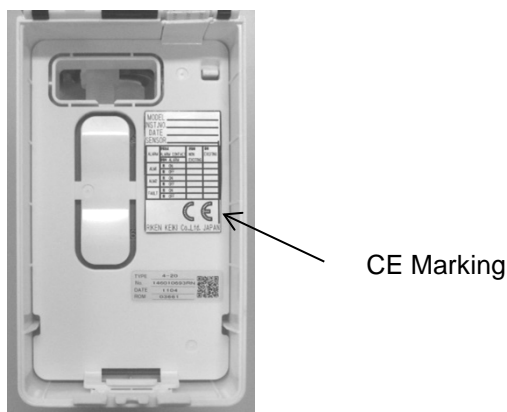

CE marking label (Back of front cover)

---

---

# 2

## Important Notices on Safety

---

### 2-1 Danger Statements



#### DANGER

This is not an explosion-proof device. You must not use it to detect gases exceeding the lower limit of explosion.

### 2-2 Warning Statements



#### WARNING

##### **Power Supply**

Before turning on the detector, always check whether the voltage is properly applied. Do not use an unstable power supply because it may cause malfunctions.

##### **Need of grounding circuit**

Do not cut the grounding circuit or disconnect the wire from the grounding terminal.

##### **Defects in protective functions**

Before starting the detector, check the protective functions for defects. When defects are found in the protective functions, such as protective grounding, do not start the detector.

##### **External connection**

Before connecting the detector to external equipment or an external control circuit, securely connect it to a protective grounding circuit.

##### **Tubing**

The detector is designed to draw gases around it under normal atmospheric pressure. If excessive pressure is applied to the sampling inlet and outlet (GAS IN, GAS OUT) of the detector, detected gases may leak from the flow system and pose dangers. Be sure that excessive pressure is not applied to the detector when it is used. Detected gases must be exhausted from the outlet (GAS OUT) on the bottom of the detector to a safe place using an exhaust tube.

##### **Handling the sensor unit**

Do not disassemble the electrochemical type sensor unit (ESU) or galvanic cell type sensor unit (OSU) because they contain electrolyte. Electrolyte may cause severe skin burns if it contacts skin and may cause blindness if it contacts eyes. It may discolor or damage clothing. If contact occurs, rinse the area immediately with a large quantity of water.

##### **Zero adjustment (AIR Adjustment) in the atmosphere**

When zero adjustment (AIR Adjustment for oxygen deficiency alarm) is performed in the atmosphere, check the atmosphere for freshness before beginning the adjustment. If other gases exist, the adjustment cannot be performed properly and the detector will not properly detect gas.

##### **Operation in a gas**

Do not operate the detector in a place where flammable/explosive gases or vapors are present. Operating the detector in such an environment will lead to extreme dangers.

##### **Response to a gas alarm**

Issuance of a gas alarm indicates that there are extreme dangers. Take proper actions based on your judgment.

## 2-3 Caution Statements



### CAUTION

**Do not use a transceiver (walkie-talkie) near the detector.**

Radio waves from a transceiver near the detector or its cables may disrupt detector operation. When using a transceiver, it must be used in a place where it disturbs nothing.

**Do not turn the detector on less than 5 seconds after it was turned off.**

Restarting the detector less than five seconds after turning it off may cause errors.

**Verify that the reading on the flow rate indicator corresponds to the specified flow rate before using the detector.**

If it does not correspond to the specified flow rate, gas detection cannot be performed properly. Be sure the flow rate is stable.

**Attach the dust filter before using the detector.**

Before using the detector, attach the specified filter to prevent disturbances by possible gas absorption or air dust.

The dust filter used depends on the gas being detected. For more information on dust filters, please contact RKL.

**Observe the operating restrictions to prevent condensation inside the tube.**

Condensation formed inside the tube causes clogging or gas absorption, which disturbs accurate gas detection. Thus, condensation must be avoided. In addition to the installation environment, carefully monitor the temperature/humidity of the sampled area to prevent condensation inside the tube. In particular, when detecting a corrosive, water-soluble gas, such as a strong acid gas, the gas is undetectable and furthermore may corrode internal parts. Please observe the operating restrictions.

**Do not use the external output of the detector to control other devices.**

This is not a control device. You are not allowed to use its external output to control other devices.

**Do not disassemble/modify the detector, or change the settings unless necessary.**

Disassembling/modifying the detector will invalidate the guarantee of the performance. Changing the settings without understanding the specifications may cause alarm malfunctions. Please use the detector properly in accordance with the operating manual.

**Do not forget to perform regular maintenance.**

Since this is a safety device, regular maintenance must be performed to ensure its safety. Continuing to use the detector without performing maintenance will compromise the sensitivity of the sensor, thus resulting in inaccurate gas detection.

---

# 3

## Product Components

---

### 3-1 Main Unit and Standard Accessories

#### <Main Unit>



#### <Standard Accessories>

- Operating manual
- Protective rubber cap (to be removed when using the detector)
- Dedicated handling lever (for wiring)
- Dust filter
- Interference gas removal filter (to be supplied with sensor units for certain gases)



**<Pyrolyzer Unit (PLU-70)(Option)>**

Pyrolyzer Unit



\* This is needed in “pyrolyzer + electrochemical type (ESU)” and “pyrolyzer + pyrolysis-particle type (SSU)”.  
For more information on the pyrolyzer unit (PLU-70), see the separate operating manual.

**3-2 Outline Drawing**

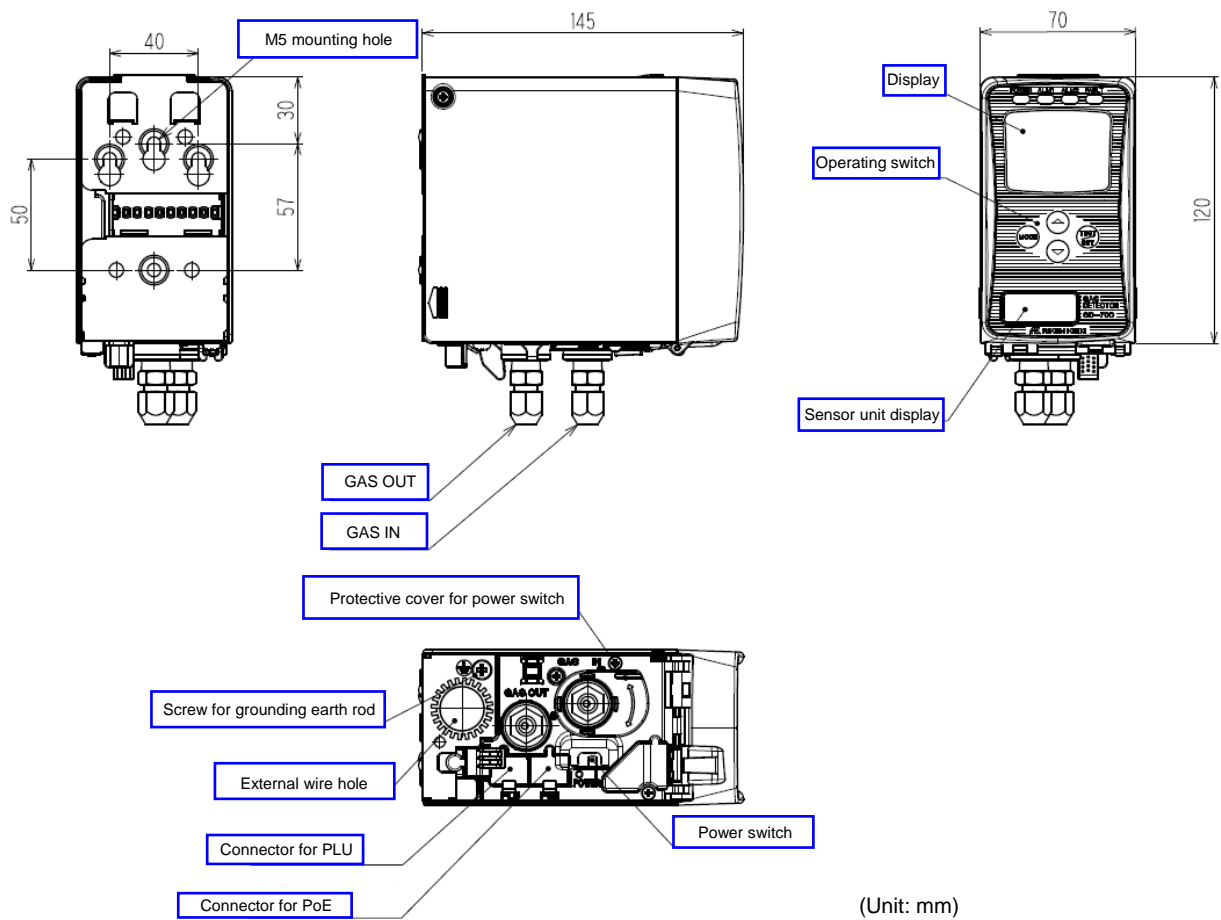

### 3-3 Names and Functions for Each Part

The detector consists of the following units.

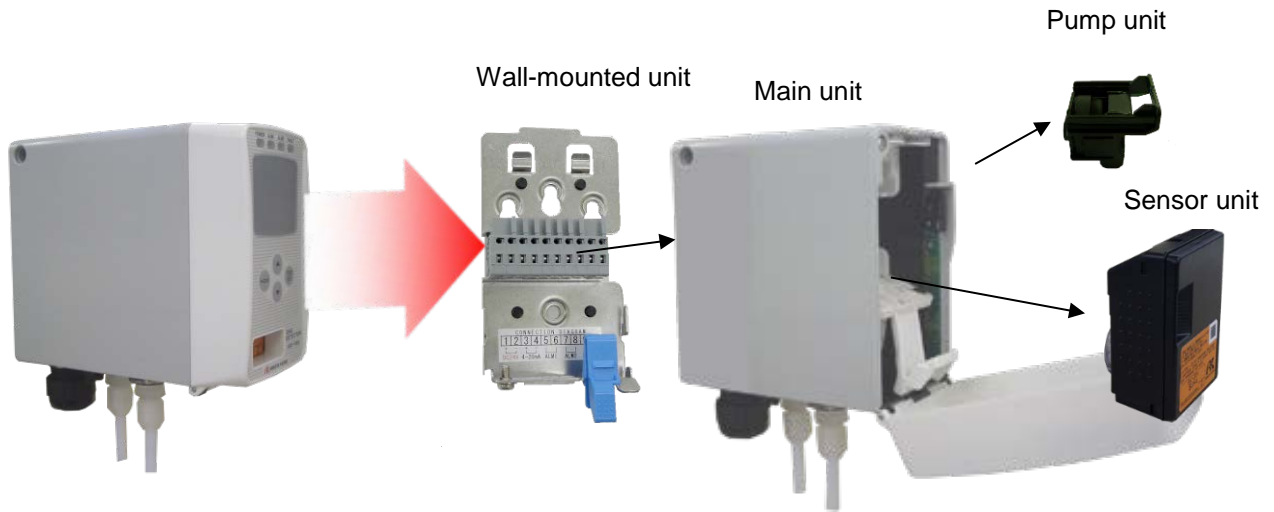

#### CAUTION

Each unit consists of precision parts. When a unit is detached, be careful not to drop it. Dropping the unit compromises its original performance or causes malfunctions.

#### <Front Panel and Character LCD>

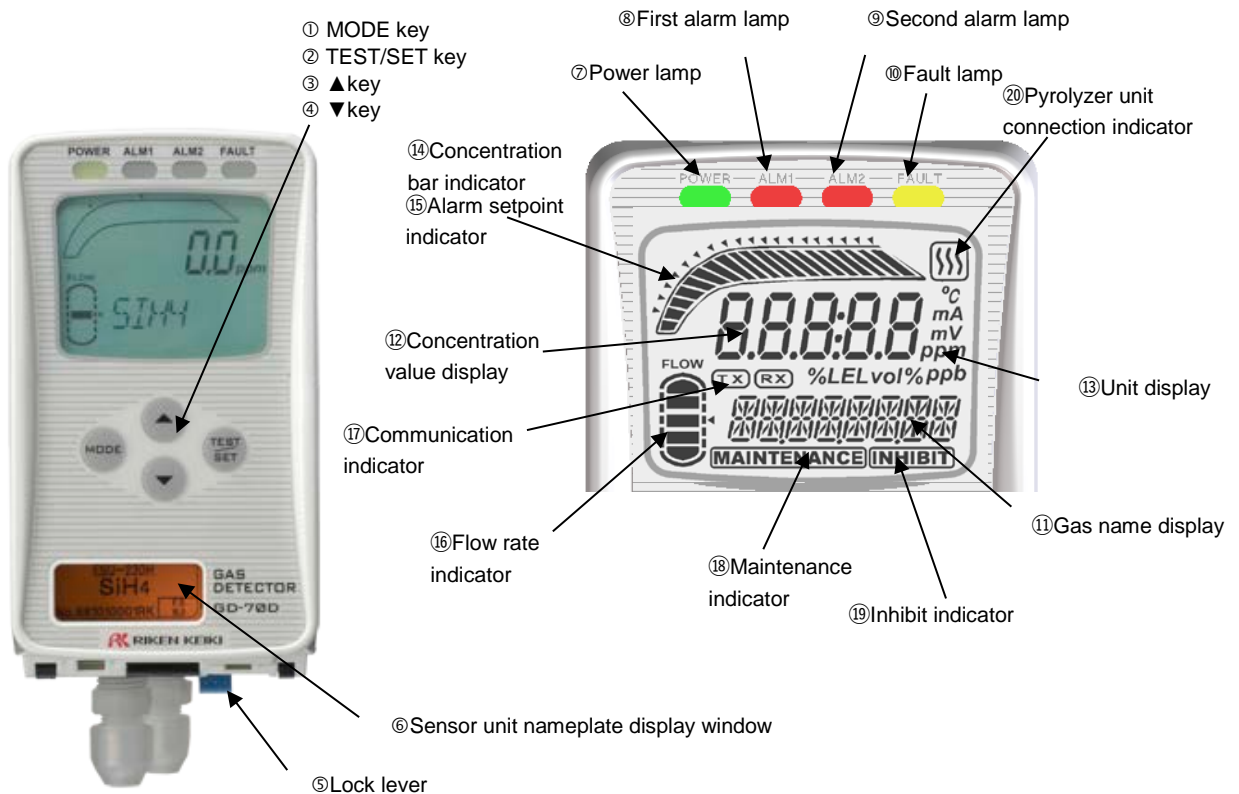

①	<b>MODE key</b>	Used to enter User and Maintenance Mode. It is also used to cancel or skip in a specific mode.
②	<b>TEST/SET key</b>	Used to enter the test mode. It is used for confirmation in a specific mode.
③	<b>▲ key</b>	Used to change screens or change a value (UP).
④	<b>▼ key</b>	Used to change screens or change a value (DOWN).
⑤	<b>Lock lever</b>	Lever to lock the main unit. Push it to attach or detach the main unit.
⑥	<b>Sensor unit nameplate display window</b>	Window to view information on the currently installed sensor.
⑦	<b>Power lamp (POWER)</b>	Power lamp. Turns green when the power is on.
⑧	<b>First alarm lamp (ALM1)</b>	First alarm lamp. Turns red when the first alarm is reached.
⑨	<b>Second alarm lamp (ALM2)</b>	Second alarm lamp. Turns red when the second alarm is reached.
⑩	<b>Fault lamp (FAULT)</b>	Fault lamp. Turns yellow when an abnormality is detected in the detector.
⑪	<b>Gas name display</b>	Displays the gas name in chemical formula (e.g. Silane = $\text{SiH}_4$ ).
⑫	<b>Concentration value display</b>	Displays the gas concentration.
⑬	<b>Unit display</b>	Displays the unit according to the specification (ppm, ppb, vol%, %, %LEL).
⑭	<b>Concentration bar indicator</b>	The detectable range (full scale = FS) is divided into 20 segments. The increase in concentration is displayed in proportion to the full scale.
⑮	<b>Alarm setpoint indicator</b>	The alarm setpoints (AL1 and AL2) are indicated on the concentration bar.
⑯	<b>Flow rate indicator</b>	Displays the flow rate. When the line is in the middle of the indicator, the flow rate is normal (0.5 L/min).
⑰	<b>Communication indicator</b>	For GD-70D-NT, this indicator is displayed while transmitting data with the upper unit (TX, RX).
⑱	<b>Maintenance indicator</b>	Displayed while in Maintenance Mode. When this indicator is displayed, the alarm contact is disconnected and there are no alarms.
⑲	<b>Inhibit indicator</b>	Displayed when the inhibition (point skip) is set.
⑳	<b>Pyrolyzer unit connection indicator</b>	Displayed when the dedicated pyrolyzer unit (PLU-70) is connected.

## <Main Unit>

The main unit of the GD-70D houses the sensor unit, pump unit, and circuitry for the detector. The main unit installs to the mounting plate's terminal plate.

## <Pump Unit>

The pump unit gets installed in the main unit. It draws sample into the detector at 0.5 L/min.

## <Mounting Plate>

The mounting plate gets installed to the installation site. The main unit connects to the mounting plate using the 10-point terminal plate.

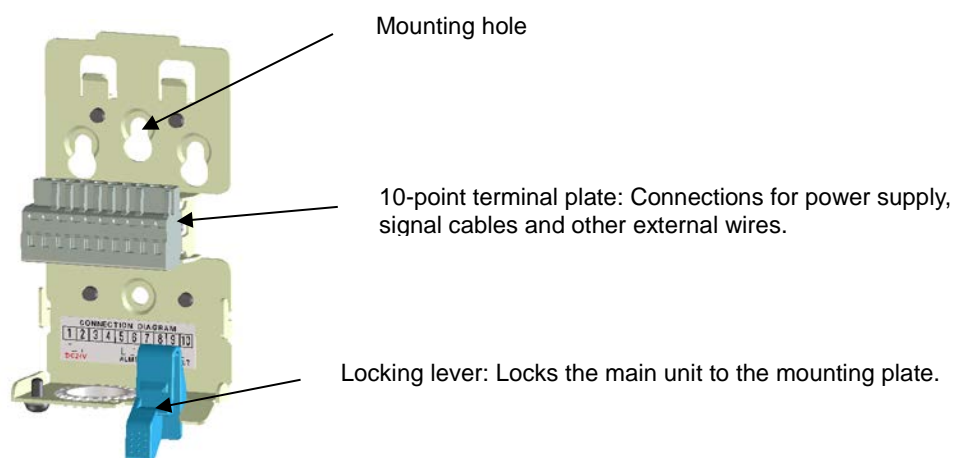

## <Sensor Unit>

A sensor unit installed in the detector is the same regardless of the detection principle which means sensor units are interchangeable. Each sensor unit has a different color that corresponds to the detection principle as shown below. Handling of the sensor unit depends on the detection principle.



### CAUTION

- The sensor unit must be handled carefully to ensure quality. When the sensor unit is stored, a dedicated warehouse and power equipment for the sensor unit are needed. In principal, the sensor unit must not be detached from the detector when it is handled or stored.
- Be sure that the sensor unit is installed properly.  
If a sensor unit is of different specification or principle than the one shipped from the manufacturer, a message will be displayed on the detector LCD (C-02).  
If this message is displayed, make sure you are using the correct sensor unit.
- After the sensor unit is replaced, always perform a gas calibration (zero adjustment and span adjustment).

**Electrochemical type (ESU)**



- Do not disassemble the sensor unit because it contains electrolyte. If contact occurs, rinse the area immediately with a large quantity of water.
- The sensor unit identifies the storage direction. Put the sensor unit in the dedicated case while handling it. Do not place it on its side or upside-down.
- When a new sensor unit is installed, it must be warmed up. Although warm-up time is different depending on the type of the installed sensor, it is recommended that warm-up should be performed for three hours or more. Please contact RKI for more information.
- The sensor unit must be stored in a clean, cool and dark place away from direct sunlight. Some types of the sensor units cannot be stored together with other units. Please contact RKI for more information.

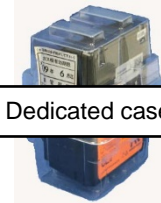

Dedicated case

**Pyrolysis-particle type (SSU)**



- Although the sensor unit contains radioactive materials, it is certified as a specified designing certification device, which is regarded as a device having no influences on health. Observe the "Safety Manual" which stipulates conditions for the certification. To dispose of the sensor unit, you must return it to us. You do not need to take any additional actions.
- The sensor unit contains a small amount of radioactive materials. Do not disassemble it, or dispose of it like other wastes.
- The sensor unit must be put into the dedicated case specified by us, and stored away from direct sunlight in a clean place where the temperature and humidity are maintained at a normal level and where appropriate measures are taken to prevent the sensor from being taken out easily.
- When the sensor unit is transported out of your factory, please use a transportation company which can handle specified designing certification devices (L-type packages).
- For more information, see the "Safety Manual".



Dedicated case

**Semiconductor type (SGU)**



- Before using the sensor unit, it needs to be warmed up for a specified time. The sensor unit is warmed up sufficiently in our factory before it is delivered to you. Therefore, after you receive the sensor unit, please use it as soon as possible so that unpowered time is minimized.
- The warm-up time before using the sensor unit is related to how long the sensor unit was unpowered.

Unpowered time	Suggested warm-up time	
	SGU-8541 (H2)	SGU (Others)
10 minutes or less	10 minutes or more	2 hours or more
1 hour or less	30 minutes or more	2 hours or more
24 hours or less	1 hour or more	4 hours or more
72 hours or less	4 hours or more	24 hours or more
10 days or less	2 days or more	2 days or more
Less than 1 month	7 days or more	7 days or more
Less than 3 months	14 days or more	14 days or more
3 months or more	1 month or more	1 month or more

- To store the sensor unit in an unpowered state, it must be stored under normal temperature/humidity in a clean place away from direct sunlight.

Galvanic cell type (OSU)



- Do not disassemble the sensor unit because it contains electrolyte. If contact occurs, rinse the area immediately with a large quantity of water.
- The sensor unit must be stored under normal temperature/humidity in a clean place away from direct sunlight.

### 3-4 Operation Diagrams

#### <Electric Diagram>

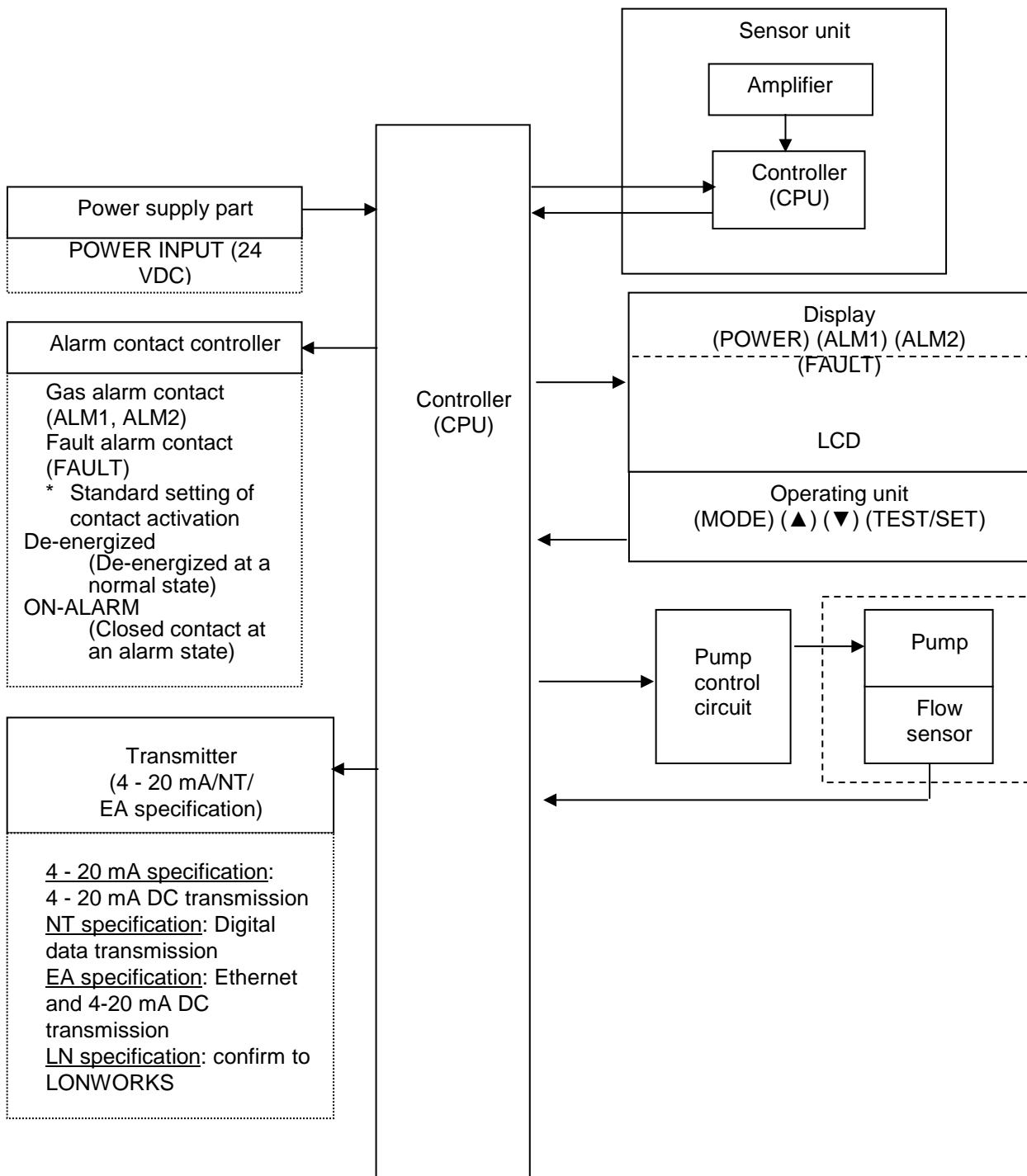

---

<Tubing Diagram>

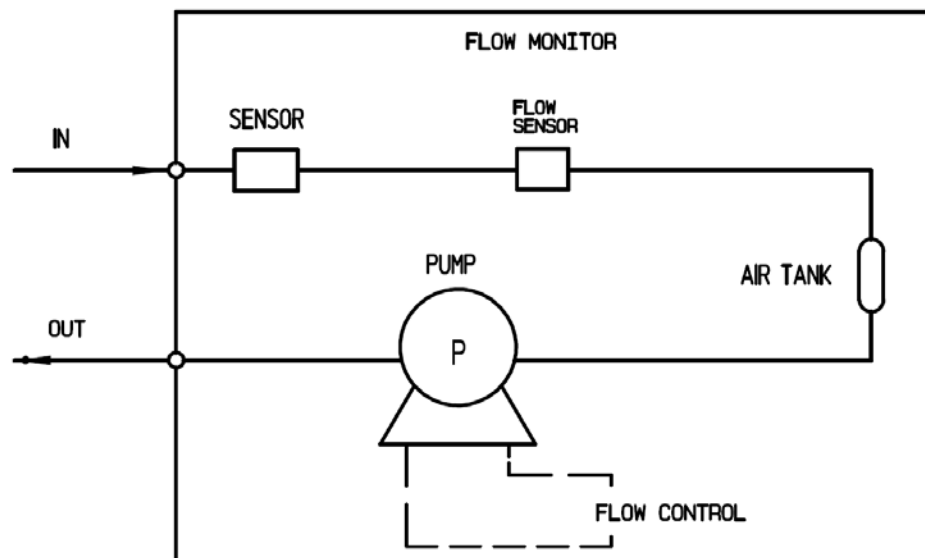

---

# 4 Installation

---

## 4-1 Requirements

All users must follow the operating precautions. Ignoring the precautions may damage the detector, resulting in inaccurate gas detection.



### CAUTION

- After you receive the detector, start using the detector within the specified operation start limit of the sensor unit.

## 4-2 Precautions for installation sites



### CAUTION

- This is a precision instrument. Because the detector may not provide the specified performance in some places (environments), check the environment in the installation site, and then take appropriate actions if necessary.
- Because the detector plays an important role for safety and disaster prevention, you must install as many units of the detector as needed in appropriate points.
- Because gases may leak or collect in different areas depending on the types of gases and the working areas, carefully consider how many units to install and where to install them.

### **Do not install the detector in a place with vibrations or shocks.**

The detector contains sensitive electronic parts. The detector must be installed in a stable place without vibrations or shocks and where it will not fall.

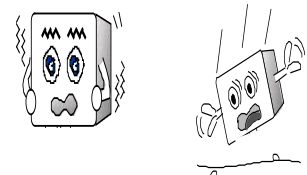

### **Do not install the detector in a place exposed to water, oil or chemicals.**

Avoid installation locations where the detector is exposed to water, oil or chemicals.



### **Do not install the detector in a place where the temperature drops below 0°C or rises over 40°C.**

The operating temperatures of the detector are 0 - 40°C. The detector must be installed in a stable place where the operating temperatures are maintained and do not change suddenly.

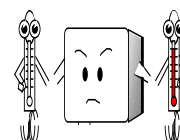



---

**Do not install the detector in a place exposed to direct sunlight or sudden changes in the temperature.**

Avoid installation locations where the detector is exposed to direct sunlight or radiant heat (infrared rays emitted from a high-temperature object), and where the temperature changes suddenly. Condensation may form inside the detector, or the detector cannot adjust to sudden changes in the temperature.

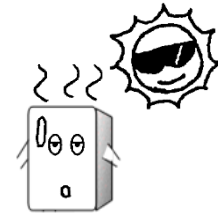

**Keep the detector (and its cables) away from noise source devices.**

Avoid installation locations where high-frequency/high-voltage exist.

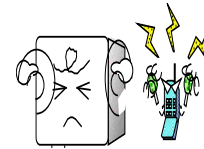

**Do not install the detector in a place where maintenance of the detector cannot be performed or where handling the detector involves dangers.**

Regular maintenance of the detector must be performed.

Do not install the detector in a place where the equipment must be stopped when maintenance is performed, where parts of the equipment must be removed to perform maintenance, or where the detector cannot be removed because tubes or racks prevent access to it. Do not install the detector in a place where maintenance involves dangers, for example, near a high-voltage cable.

**Do not install the detector in equipment which is not properly grounded.**

Before installing the detector in equipment, the equipment must be grounded properly.

**Do not install the detector in a place where other gases exist around it.**

The detector must not be installed in a place where other gases exist around it.

## 4-3 Precautions for System Designing



### CAUTION

- An unstable power supply and noise may cause malfunctions or false alarms.

### Using a stable power supply

The external output and alarm contact of the detector may be activated when the power is turned on, when momentary blackout occurs, or when the system is being stabilized. In such cases, use a safety power supply, or take appropriate actions on the receiving side.

The detector must be provided with the following power supply.

Power supply voltage	24 VDC $\pm$ 10% (the terminal voltage of the detector) or PoE connection (GD-70D-EA)	
Allowed time of momentary blackout	Up to 10 milliseconds (To recover from a momentary blackout longer than 10 milliseconds, restart the detector.)	<b>Example of actions</b> To ensure continuous operation and activation, install a protective power supply outside the detector.
Others	Do not use it with a power supply that has a large power load or high-frequency noise.	<b>Example of actions</b> Use a line filter to avoid the noise source if necessary.

### Heat radiation designing

When it is installed in the closed instrumentation board, attach ventilation fans above and below the board.

### Protecting against lightning

If cables are installed outside the factory/plant, or if internal cables are installed in the same duct as the cables coming from outside the factory/plant, lightning will cause problems. Because lightning acts as a large emission source while cables act as a receiving antenna, devices connected to the cables may be damaged.

Lightning cannot be prevented. Cables installed in a metal conduit or under the ground cannot be completely protected from a power surge caused by lightning. Although complete elimination of disasters caused by lightning is impossible, the following protective measures can be taken.

Protection against lightning	<b>Take appropriate measures in accordance with the importance of the facilities and the environment.</b> <ul style="list-style-type: none"><li>• Connect the transmission signal route by using optical fiber.</li><li>• Provide protection by a lightning arrester (cable safety retainer). (Although inductive lightning surge can be transmitted through the cable, it is prevented by installing a lightning arrester before the field devices and central processing equipment. For information on how to use a lightning arrester, please contact the manufacturer.)</li></ul>
Grounding	In addition to lightning, there are more sources of surge noise. To protect devices from these noise sources, the devices must be grounded.

- \* The lightning arrester has a circuit to remove a surge voltage which damages field devices, so that signals may be attenuated. Before installing a lightning arrester, verify that it works properly.

## 4-4 Proper use of alarm contact

The alarm contact of the detector is used to transmit signals to activate an external buzzer, alarm lamp or rotating lamp. Do not use the detector for controlling purpose (e.g., controlling the shutdown valve).



### CAUTION

- The b contact (break contact) under de-energized state may be opened momentarily by a physical shock, such as external force.
- When the b contact is selected for the alarm contact, take appropriate actions to prepare for a momentary activation by adding signal delay functionality (approximately one second) to the receiving side of the b contact.

The specifications for the alarm contact of the detector are based on the resistive load conditions. If inductive load is used at the alarm contact, the following errors will occur easily because counter electromotive force is generated at the contact.

- Deposition, defective insulation or defective contact at the relay contact
- Damage of any electric parts due to high-voltage generated inside the detector
- Abnormal operations by an out-of-control CPU



### CAUTION

- In principal, do not activate inductive load at the alarm contact of the detector. (In particular, never use the inductive load to activate a fluorescent lamp or motor.)
- If inductive load is activated, relay it with an external relay (contact amplification). However, because the coil of an external relay also involves inductive load, select a relay at a lower voltage (100 VAC or below), and then protect the contact of the detector with an appropriate surge absorbing part, such as a CR circuit.

If load is to be activated, appropriate measures must be taken to stabilize the operation of the detector and protect the alarm contact referring to the following information.

- Relay it with an external relay at 100 VAC or lower (contact amplification). At the same time, the surge absorbing part, SK1, suitable for the specifications must be attached to the external relay.
- In addition, the surge absorbing part, SK2, must be attached to the loaded side of the external relay if necessary.
- It may be recommended that the surge absorbing part be attached to the contact for certain load conditions. It must be attached to an appropriate position by checking how the load is activated.

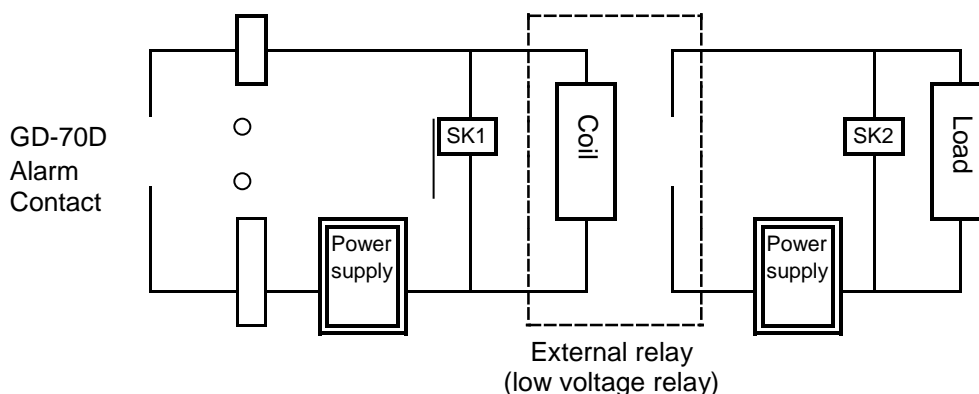

\* SK1, SK2: Surge absorbing parts

## 4-5 Installing the Detector

### NOTE

To use the pyrolyzer unit (PLU-70), also refer to the individual operating manual.



### CAUTION

- Before installing the detector, remove the protective rubber caps from the GAS IN and GAS OUT fittings. If the detector is turned on while the rubber caps are still in place, the pump and sensor may be damaged. Do not forget to remove the caps.

### <Detector Dimensions and Maintenance Space>

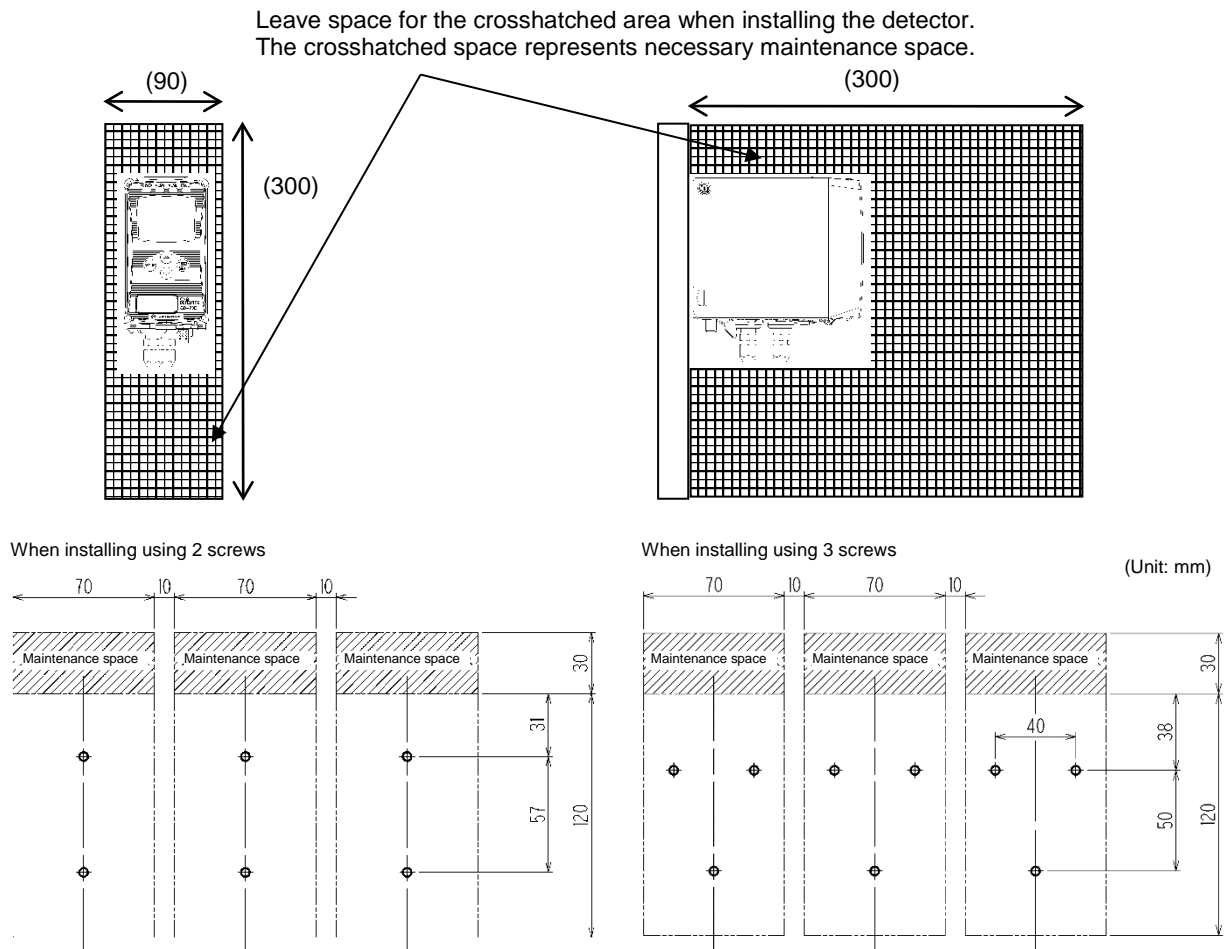

### CAUTION

- Multiple detectors installed in the same location must be installed at least 5 mm apart. It is recommended that they be 10mm apart.
- When you install more than one detector in the same location, install them in a rack or on a wall that is not affected by vibrations.  
When the detectors are installed side-by-side, if the rack or wall in which the detectors are installed does not have enough strength, vibrations from the pumps inside the detectors can cause resonance between them. In this case, take preventive actions like reinforcing the rack or wall.



## CAUTION

- The detector must be installed in the correct orientation to ensure its performance. Install the detector as shown on the following example. (\* The detector must also remain in this orientation during transportation.)

### <Correct Installation Orientation>

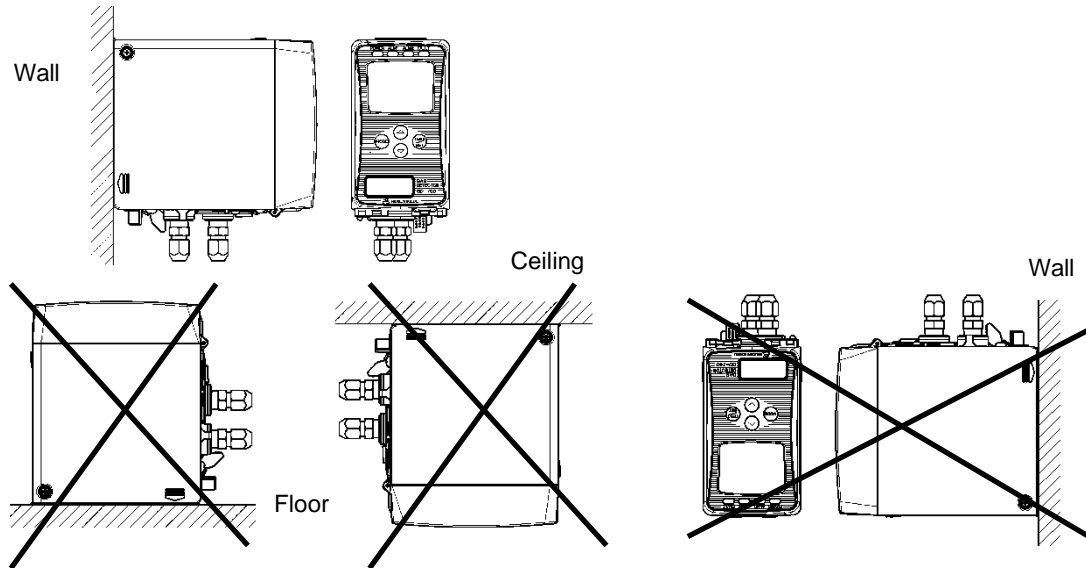

### <Installing the Mounting Plate>

1. Make sure power to the detector is turned off.
2. While pushing the blue lever toward the mounting plate, push the main unit up.
3. If you cannot move the main unit, insert a larger flathead screwdriver into the mounting plate while pushing the lever as shown to the right. Do not rotate or move the plate. Simply insert it into the mounting plate.

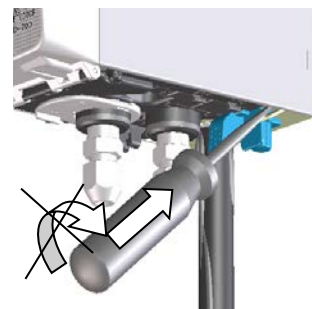

4. Remove the silver mounting plate from the back of the GD-70D.

- Attach the mounting plate to the installation surface using two or three M5 screws.

Recommended mounting screw (M5)  
 Length of 8 mm or more  
 Flat washer of  $\phi 10$  mm or less (small round)

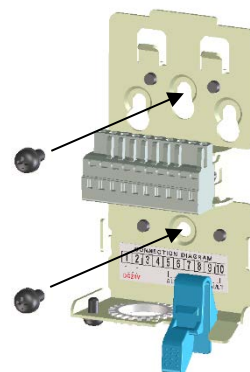

- Leave the main unit detached from the mounting plate and continue to the wiring section.

## 4-6 Wiring the Detector

### NOTE

To use the pyrolyzer unit (PLU-70), also refer to the separate operating manual.



### CAUTION

- Be careful not to damage the internal electronic circuit when wiring. In addition, be careful to provide appropriate strain relief when using cables for wiring.
- The power cables and signal cables must not be installed together with the motor power cables, etc. When these cables must be installed together for unavoidable reasons, put the power cables and signal cables in a metal conduit. The conduit must be connected to a grounding circuit.
- When stranded wires are used, prevent wires from contacting each other.

### <Recommended Cable>

For 3-wire type (common cable for power and signal) (4 - 20 mA/EA specification)	Shielded cable of CVVS, etc. (1.25 mm <sup>2</sup> ) - 3-core
For 2-wire type (power and signal cables separated) (4 - 20 mA/EA specification)	Power: Cable of CVV, etc. (1.25 mm <sup>2</sup> ) - 2-core Signal: Shielded cable of CVVS, etc. (1.25 mm <sup>2</sup> ) - 2-core
For 2-wire type DC power-line communication system (NT specification)	Shielded twisted-pair cable of KPEV-S, etc. (1.25 mm <sup>2</sup> ) - 1P
For Ethernet (EA)	Power: Cable of CVV, etc. (1.25 mm <sup>2</sup> ) - 2-core Signal: Ethernet cable (category 5 or higher)
For PoE (EA)	Ethernet cable (category 5 or higher)
For LONWORKS output cable	Shielded twisted pair cable of KPEV-S, etc. (1.25 mm <sup>2</sup> ) · 1P
For contact	Cable of CVV, etc. (1.25mm <sup>2</sup> ) - max. 6-core

## <Terminal Plate Specifications>

### Specifications of terminal plate

- Rated voltage: 250 VDC
- Rated current: 16 A

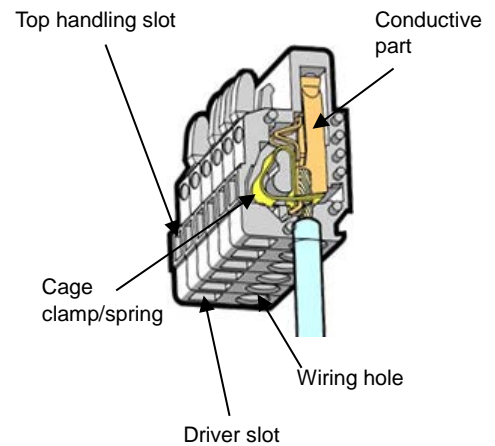

### Connection conditions

- Cable: 0.08 - 2.5mm<sup>2</sup>
- Bare wire length: 8 - 9 mm
- Connecting tool: Dedicated handling lever (accessory)



### CAUTION

- The specified bare wire length must be observed when the wire insulation is peeled off.
- Be careful not to separate the wire strands.



### Compatible bar terminal

For a bar terminal, the following items are available.

- Bar terminal (ferrule): Model 216 Series (manufactured by WAGO)
- Crimping tool: Model VarioCrimp 4 (206-204) (manufactured by WAGO)



### CAUTION

- A bar terminal of the specified model must be used. Using other bar terminals invalidates the guarantee of the performance.

## <Wiring to the Terminal Plate>

### ● 4 - 20 mA/NT/EA Specification

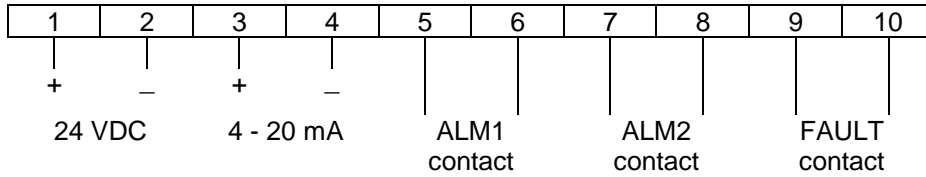

### ● LN Specification

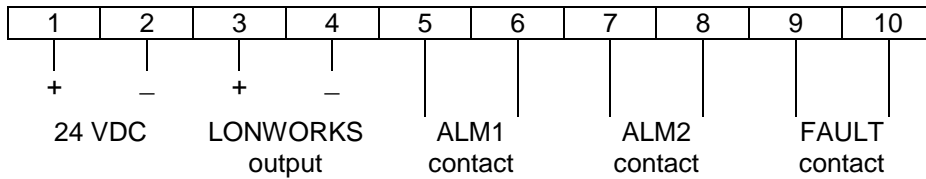

## NOTE

For a 3-wire type 4 - 20 mA, terminal 2 is used as common for the power supply and the 4-20 mA output. Therefore, wiring should be connected to terminals 1, 2, and 3 only. Terminal 4 can be left open.

For the NT specification, terminals 3 and 4 are not used.

For the EA specification with PoE connection, terminals 1 and 2 are disabled.



## CAUTION

- The right tools must be used.
- Only one wire can be connected to each wiring hole.
- Do not connect a wire anywhere other than a wiring hole.

1. Make sure power to the detector is turned off.
2. While pushing the blue lever toward the mounting plate, push the main unit up.
3. If you cannot move the main unit, insert a larger flathead screwdriver into the mounting plate while pushing the lever as shown to the right. Do not rotate or move the flathead screwdriver. Simply insert it into the mounting plate.

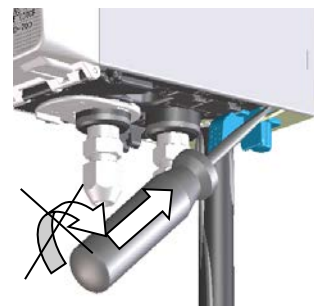



4. Use the handling lever included with the GD-70D or a flathead screwdriver to make wiring connections.
5. Route the wires through the wiring opening in the bottom of the mounting plate.
6. Insert the handling lever into the driver slot associated with the terminal you are wiring.
7. Push the lever toward the terminal plate so the protrusion on the lever goes into the top handling slot and opens the wiring hole. If you are not using the handling lever, push down into the top handling slot with a flathead screwdriver.
8. Hold the lever down while you insert a wire into the wiring hole.
9. Release the lever. Gently pull on the inserted wire to make sure it is connected.
10. Repeat for all other wiring connections.

Push the dedicated handling lever to open the terminals. Insert 1 wire per terminal.

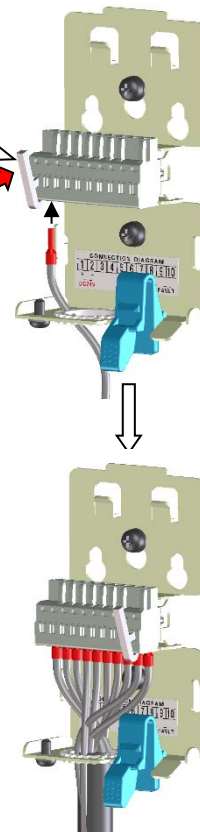

Push the lever with your finger to lower the spring in its inside.



While holding down the lever, insert the wire into the (round) wiring hole until it reaches the deepest point. Once the lever is released, the wire is secured.

## Generic Controller Wiring

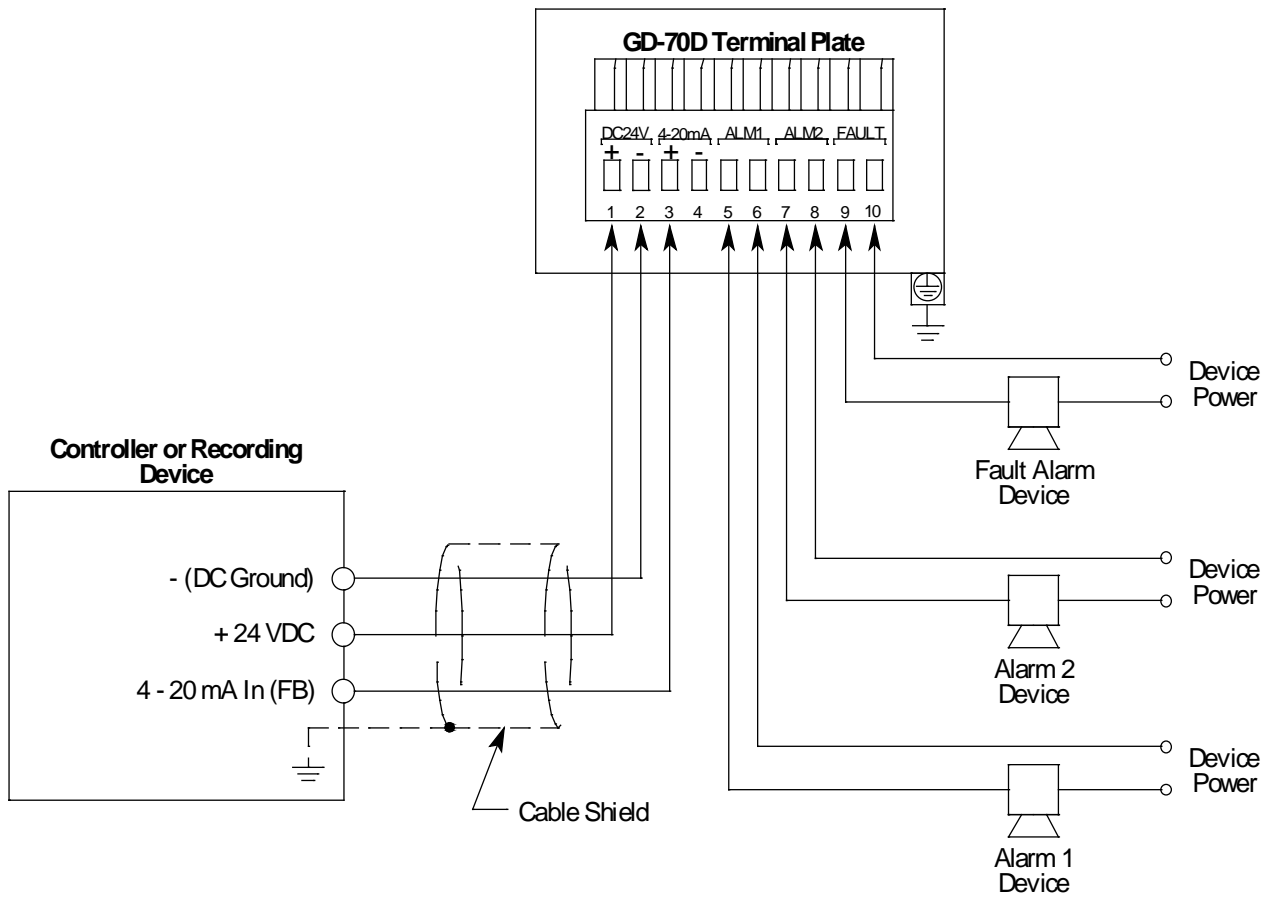

# PLC or DCS Wiring

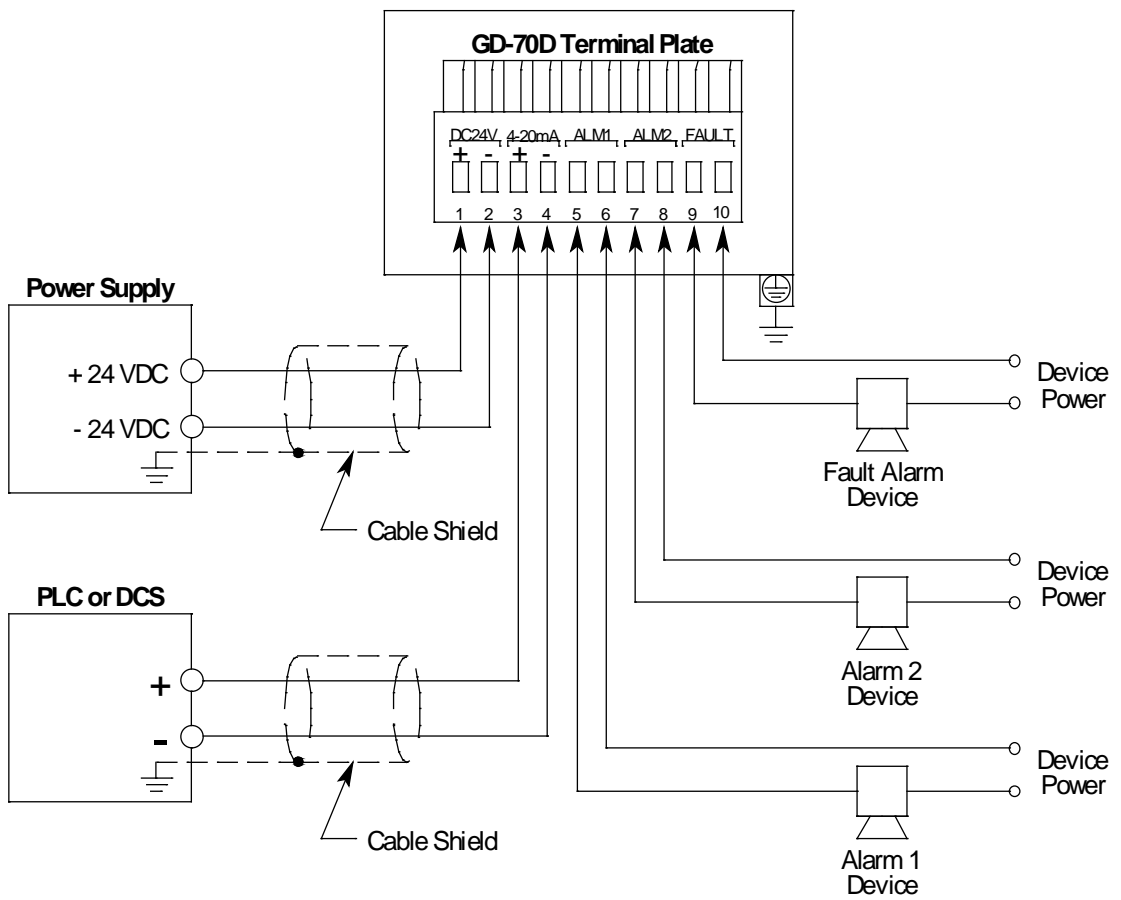

# RM-5003 Wiring

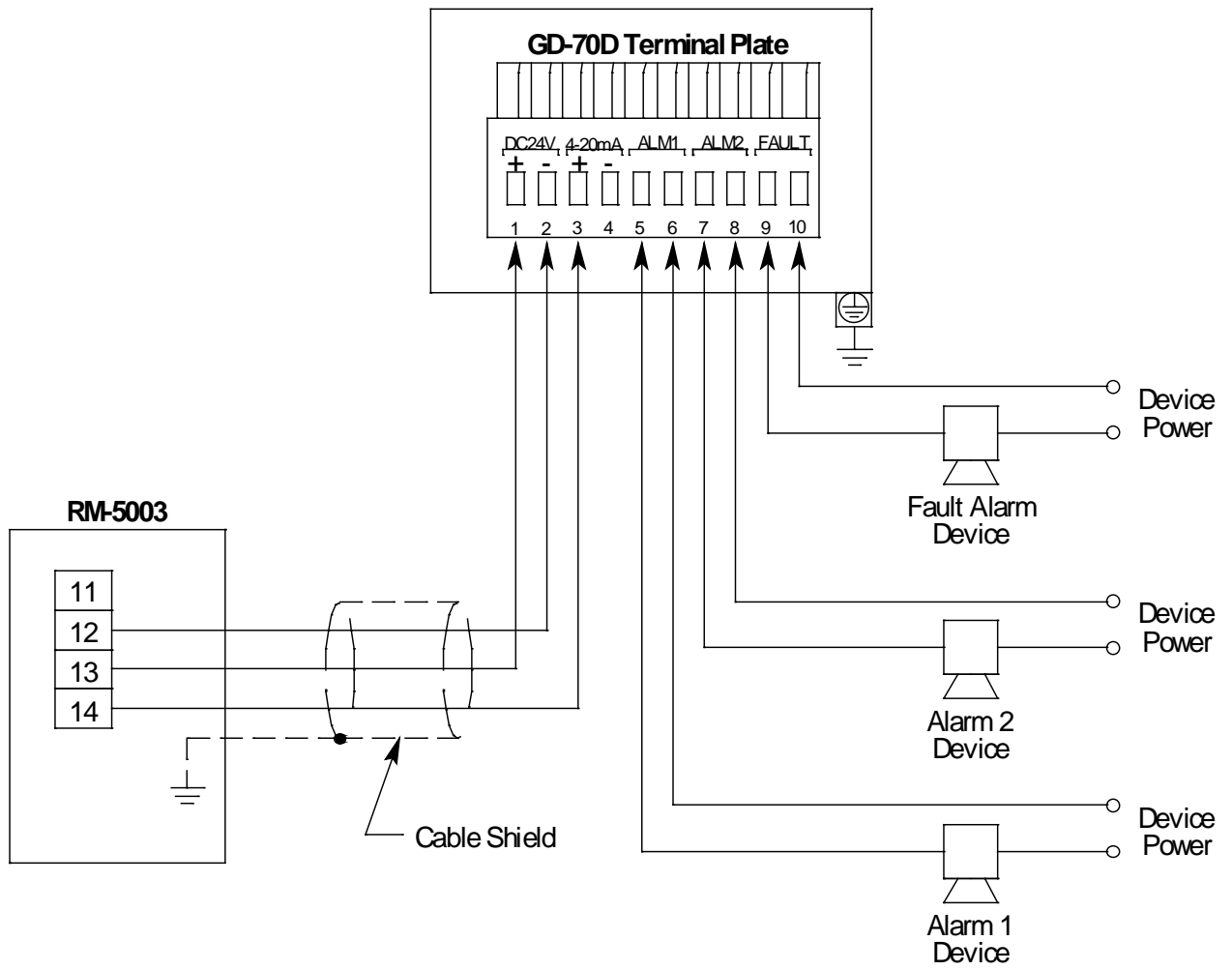

# Ethernet Wiring

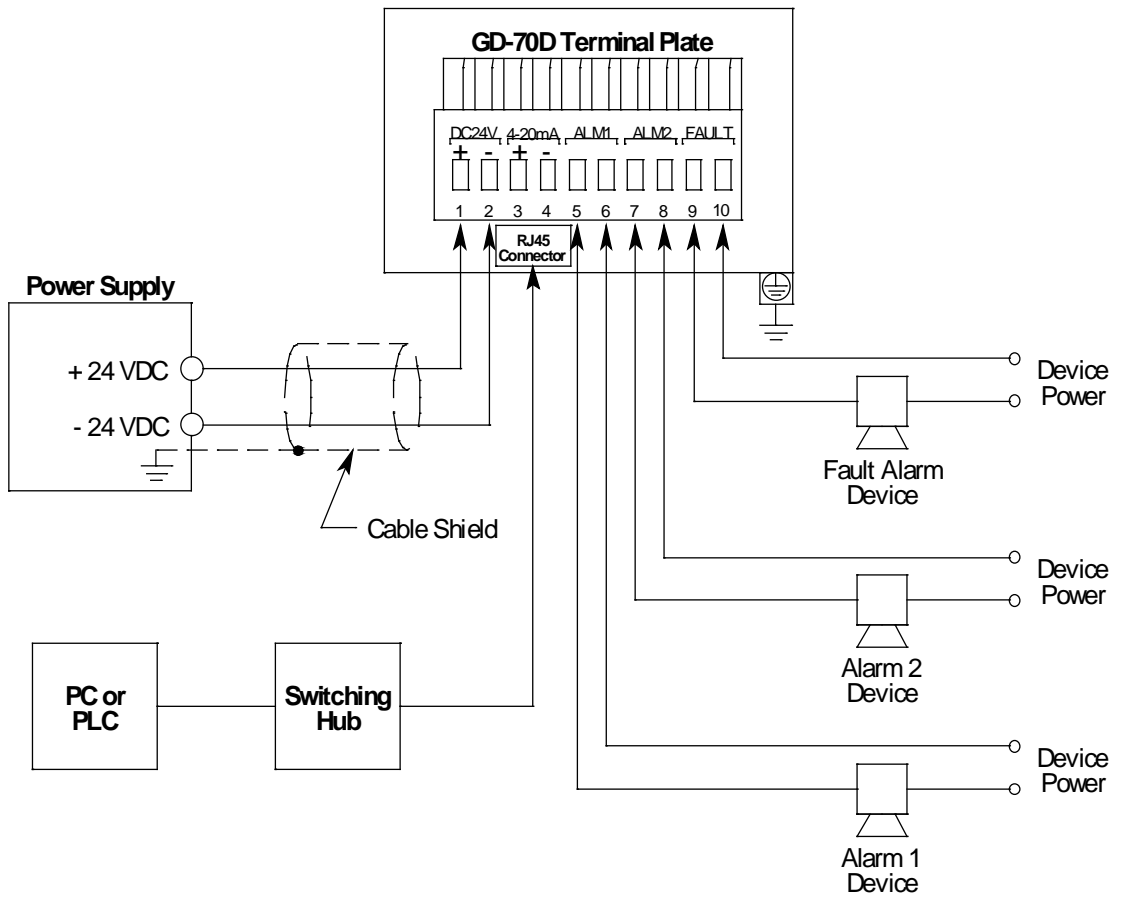

# PoE Wiring

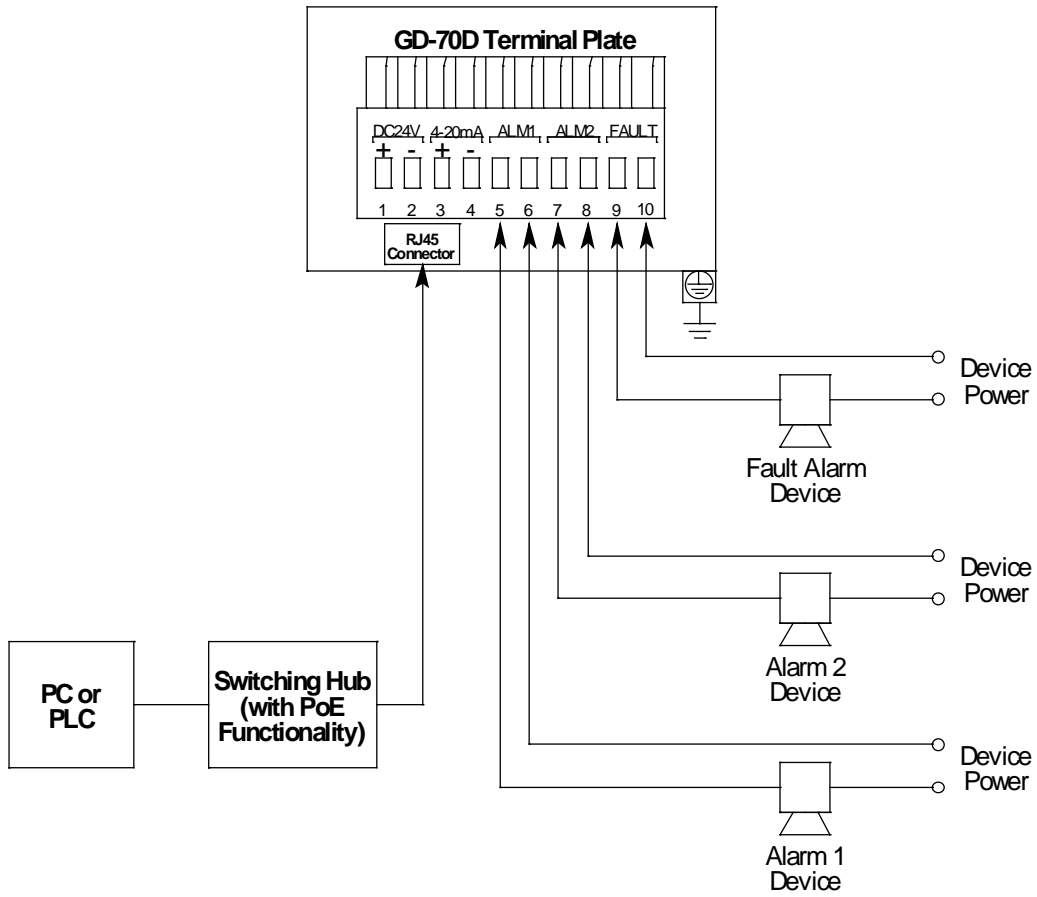

# LON Wiring

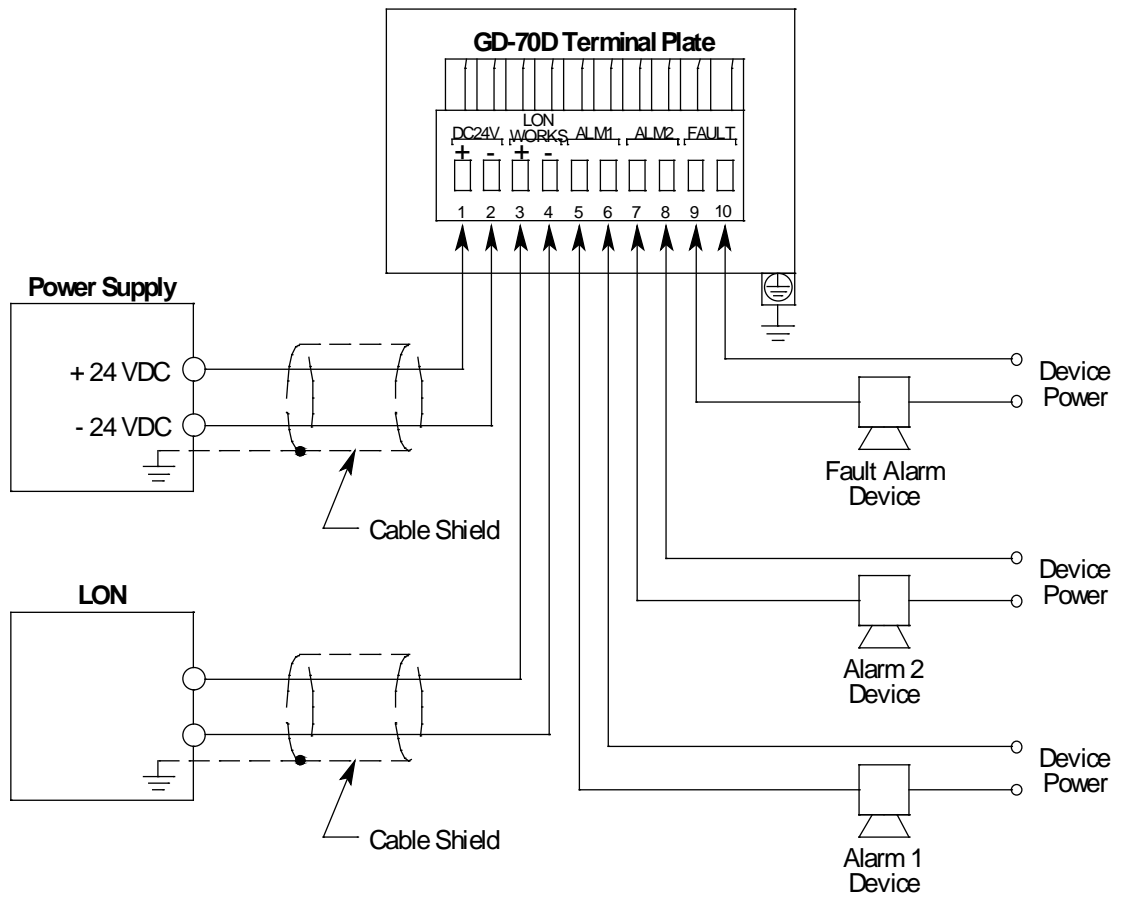

## RM-70NT Wiring (for GD-70D-NT)

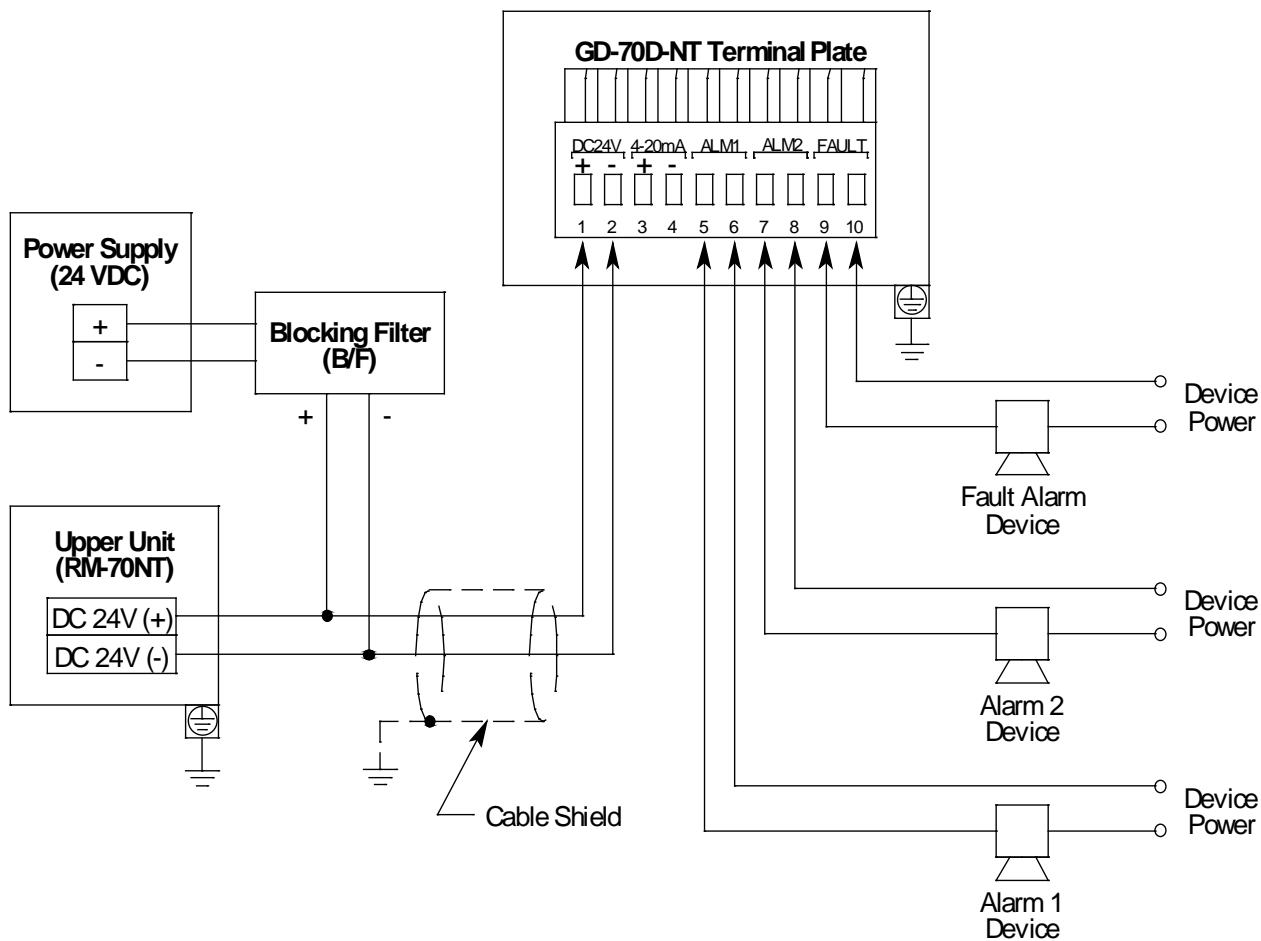

### <How to Clamp Cables>

1. Insert the supplied zip tie into the hole on the mounting plate as shown in the figure to the right.
2. Position the zip tie so that its coarse side faces the wires.
3. Tighten the zip tie to secure the wires.

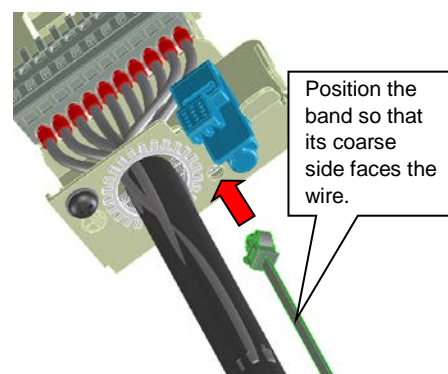

### NOTE

When an optional cable gland is used, it must be attached to the external wiring hole.

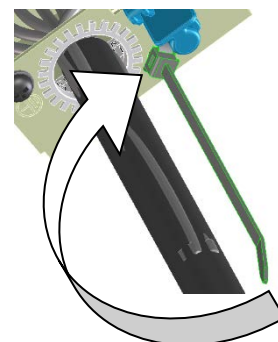



## <Grounding>

Use the grounding terminal to connect the detector to your grounding circuit.



### WARNING

- Before turning on the detector, do not forget to connect it to a grounding circuit.
- For stable operation of the detector and safety, it must be connected to a grounding circuit. Do not connect the grounding wire to a gas pipe. The grounding must be made as D type grounding (below 100  $\Omega$  of grounding resistance).

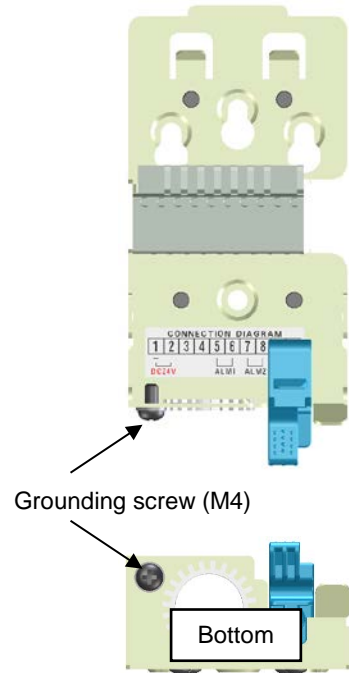

## <Attaching Main Unit to Mounting Plate>

1. Make sure power to the detector is turned off.
2. Position the main unit about 10 mm above the mounting plate.
3. Lower the main unit toward the mounting plate. Be sure both mounting plate hooks fit into the main unit grooves.
4. Press down on the main unit to secure it. The lock at the bottom of the main unit clicks to fix it properly.
5. Make sure that the top center of the mounting plate is above the main unit as viewed from front. If it is not, push the main unit down farther.

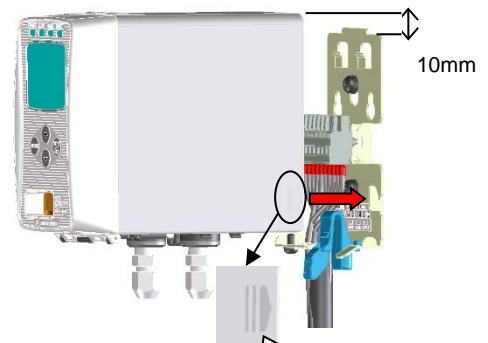

When reinstalling the main unit, align the arrow mark on the side of the housing with the mounting plate hook before pushing down.

When the main unit is fully installed on the mounting plate, the top of the mounting plate will protrude above the main unit.

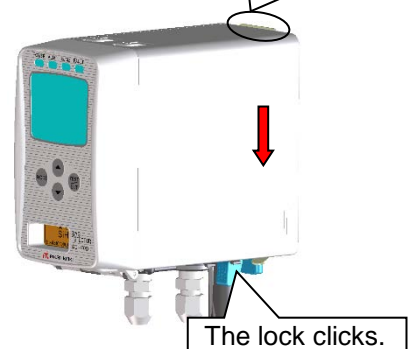

## 4-7 Making Tubing Connections

### NOTE

To use the pyrolyzer unit (PLU-70), also refer to the individual operating manual.

1. The tube nut, ferrule, and tubing insert are shipped uninstalled and the open GAS IN and GAS OUT fittings are plugged with protective rubber caps. Remove the rubber caps from the GAS IN and GAS OUT fittings.
2. Install a short piece of 4 mm x 6 mm Teflon tubing to the GAS IN fitting as shown below. Be sure the tubing insert, ferrule, and nut are installed properly.

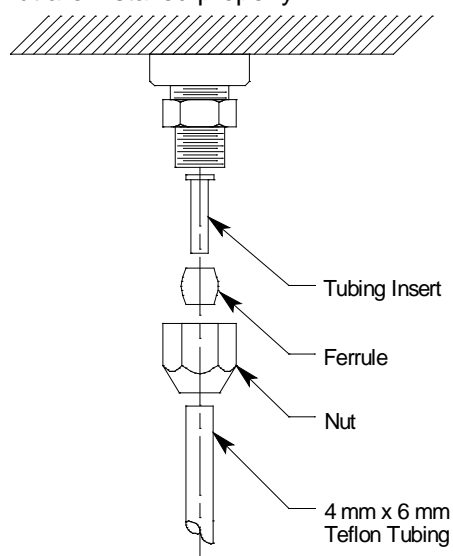

3. Connect the dust filter to the tubing.
4. Install another piece of 4 mm x 6 mm Teflon tubing to the other end of the dust filter and route it to the sample area.

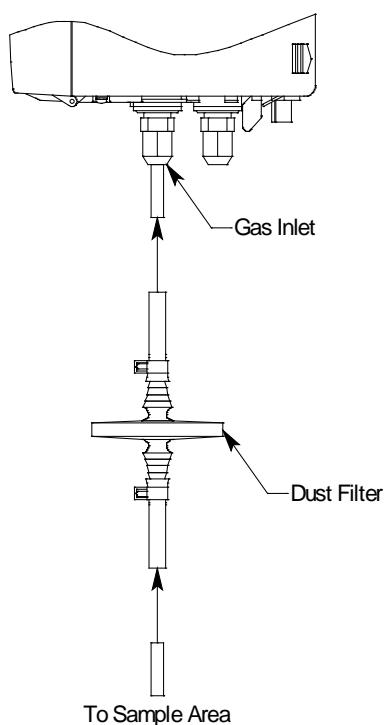

5. Attach 4 mm x 6 mm Teflon tubing to the GAS OUT fitting and route it to a safe area. Be sure to use the tubing insert, ferrule, and nut as shown above.



## WARNING

- The detector is designed to draw gas under normal atmospheric pressure. If excessive pressure is applied to the GAS IN or GAS OUT fitting, detected gases may be leaked from its inside, thus leading to dangers. Be sure that excessive pressure is not applied to the detector during use.



## CAUTION

- Keep the inlet line as short as possible to minimize the absorption of gas by the sample tubing.
- When the humidity in the sampling point is high, condensation may be formed inside of the tube. Make sure to avoid condensation when detecting water-soluble gases such as a strong acid gas, because it may corrode internal parts. Also avoid looping or kinking the tubing.
- Please contact RKI for help determining an inlet tubing length.

## 4-8 Disposal

- A used sensor unit must be returned to RKI.
- If any liquid leaks from the electrochemical type sensor unit (ESU) or galvanic cell type sensor unit (OSU), do not touch the liquid. If any liquid leaks while the sensor unit is installed in the detector, turn off power to the detector and contact RKI immediately.
- Because the pyrolysis-particle type sensor unit (SSU) contains a small amount of radioactive materials, it must be transported appropriately (as a L-type package). When the sensor unit is returned to us, it must be handled by a transportation company which can handle L-type packages.
- When the main unit is disposed of, it must be treated properly as an industrial waste in accordance with the local regulations.



## WARNING

- Do not disassemble the electrochemical type sensor unit (ESU) or the galvanic cell type sensor unit (OSU) because they contain electrolyte. Electrolyte may cause severe skin burns if it contacts skin and may cause blindness if it contacts eyes. Electrolyte may damage or discolor clothing. If contact occurs, rinse the area immediately with a large quantity of water.
- The pyrolysis-particle type sensor unit (SSU) must be returned to us in accordance with its "Safety Manual". We will properly dispose of it. Ignoring the "Safety Manual" will result in legal penalties.

---

# 5 Operation

---

## 5-1 Preparation for Start-up

Before connecting a power supply, read and understand the following precautions. Ignoring these precautions may cause an electric shock or damage the detector.

- Connect the detector to a grounding circuit.
- Ensure the wiring is correctly connected to the external circuit.
- Ensure the main unit is properly installed on the mounting plate.
- Ensure the power supply voltage is appropriate (see Specifications).
- Alarm contacts may be activated during startup. Take steps to ensure this does not have any unwanted effects.
- Verify that the GAS IN and GAS OUT lines are clear.
- Verify that the dust filter is installed correctly.

## 5-2 Starting Up the Detector

1. The power switch is protected by a cover to prevent accidental access. Rotate the switch cover to gain access to the power switch. (Return the switch cover to the original position once you are done.)
2. Turn ON the power switch.
3. After the detector completes the start-up, it enters Detection Mode.



Power switch  
(under cover)

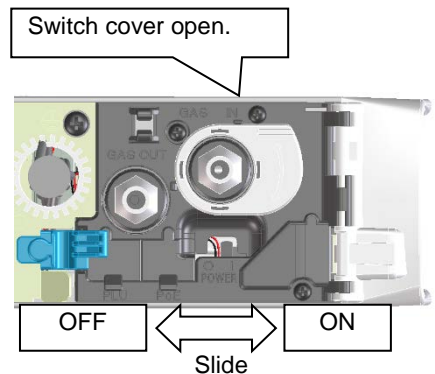
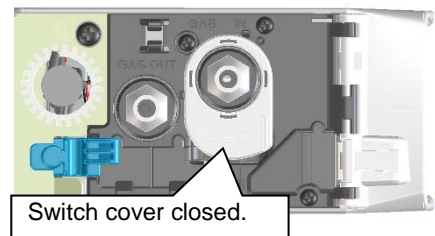

## <Warm-up Sequence>

The warm-up taking approximately 25 seconds to complete.

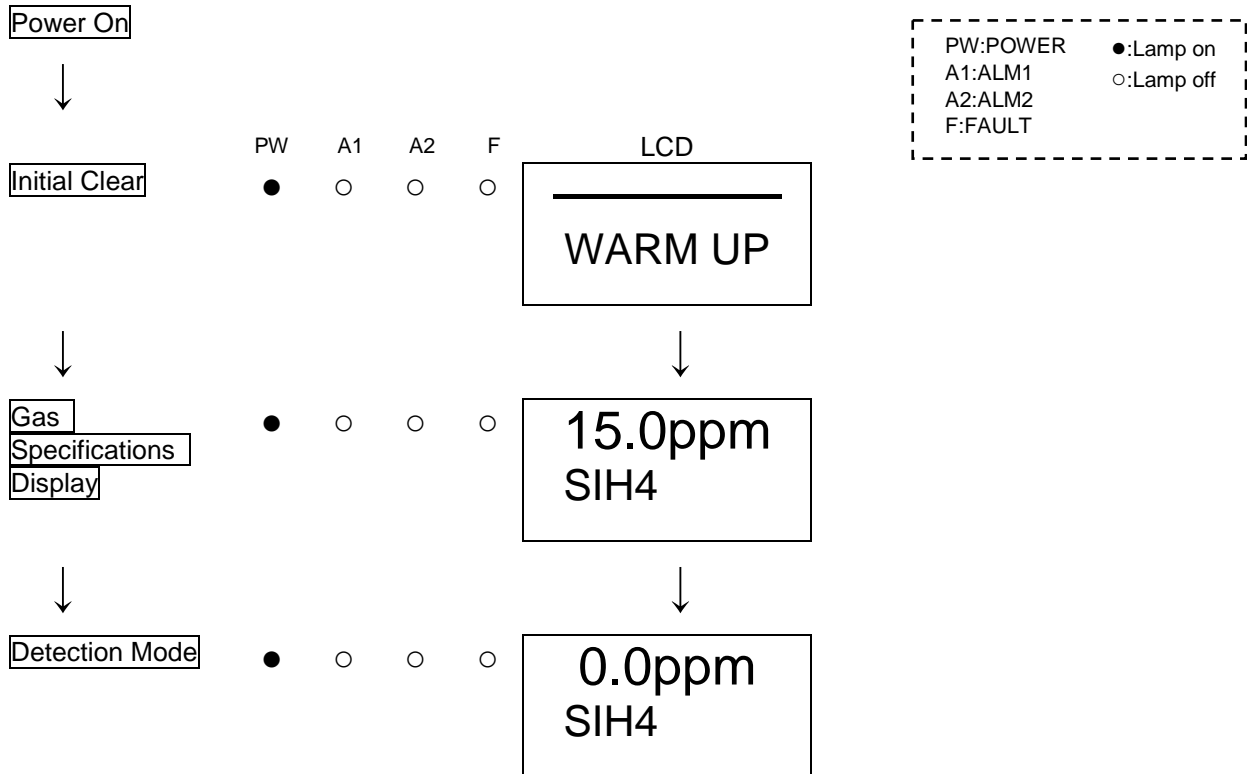

### WARNING

- When Oxygen (OSU) is selected, fresh air (20.9 vol%) is the output after the detector is started in the atmosphere. For a specification where an alarm is triggered by the AIR (normal oxygen concentration) output (e.g., 0 - 5 vol%), be careful of an alarm issue after the detector is started.



### CAUTION

- Do not turn off the detector during the initial clear. The detector is reading the sensor memory during the initial clear.
- If a new sensor unit is installed or the sensor unit is replaced after the detector is started, the sensor unit must be warmed up for a specified period which is determined depending on the type of the sensor unit. Suggested warm-up time for SGU type sensor units is displayed in Maintenance Mode. During the warm-up, the alarm activation and output signals are unstable. Prepare appropriately for false alarms.
- Because the pyrolyzer unit (PLU-70) must be warmed up for one hour, please warm it up with the detector.
- After the warm-up is completed, verify that the reading on the flow rate indicator corresponds to the specified flow rate, and then perform a gas calibration.

## 5-3 Turning Off the Detector

To turn off the detector, open the switch cover on the bottom of the main unit, and turn "OFF" the power switch. Then, turn off the power supply (24 VDC) to the detector.



### WARNING

- When the detector is turned off, an alarm may be activated on the upper (central) system. Before turning off the detector, the inhibit (point skip) on the upper (central) system must be activated. Decide whether the power can be turned off by checking the operation of the devices connected to the external output or external contact output terminal of the detector.
- If the alarm contact is energized (option), they will activate when the detector is turned "OFF".
- If the detected gas is absorptive, the detector must be flushed thoroughly with fresh air before turning "OFF" the detector.

## 5-4 Basic Operation

After the warmup procedure, the detector enters detection mode.

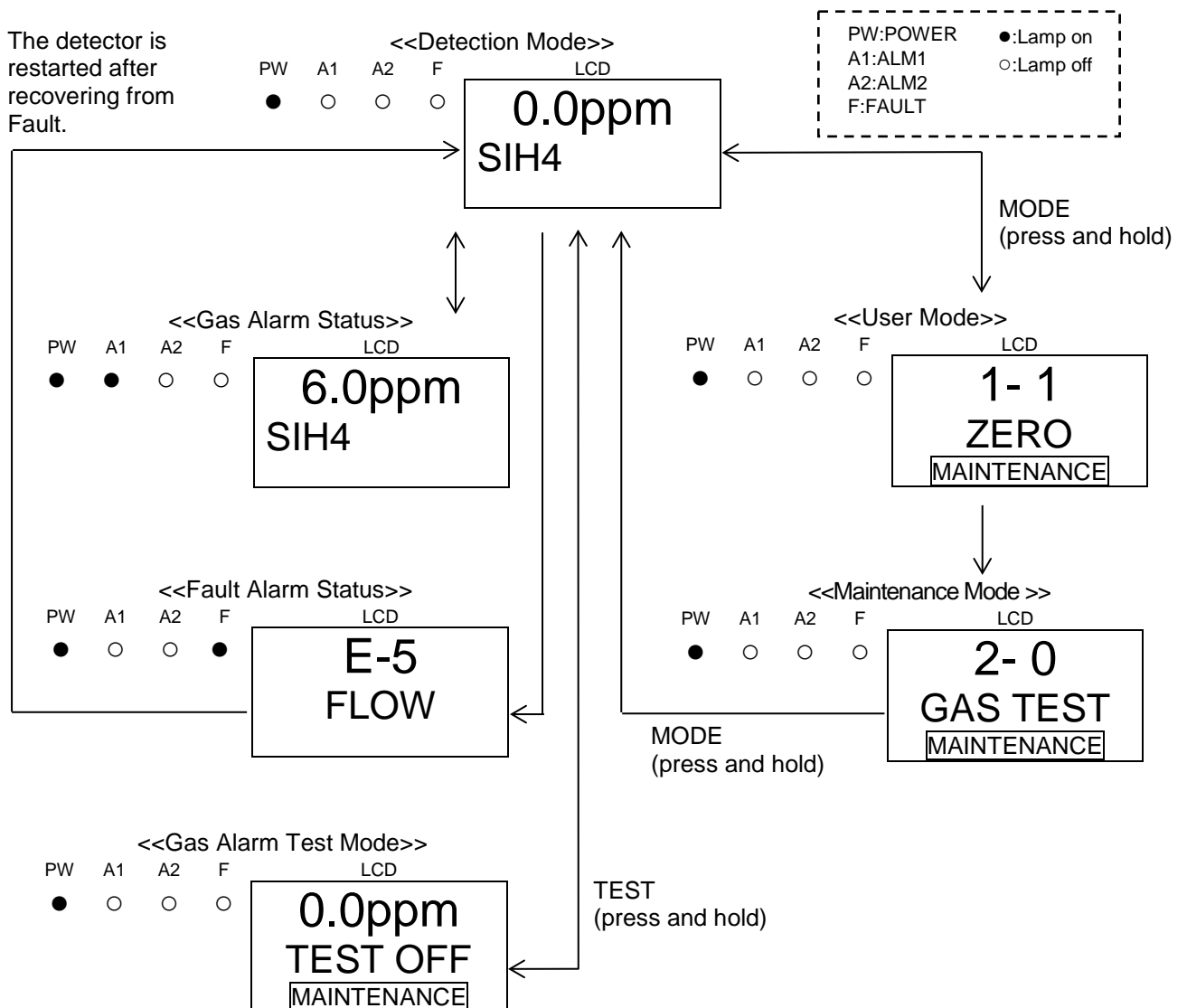



## WARNING

- When the detector enters each mode from Detection Mode while an alarm is activated, the alarm contact is released.

### <Detection Mode>

#### Flow Rate Indicator

Because the suction flow rate of the detector is automatically adjusted by the flow rate control function, the flow rate, in principal, does not need to be controlled. As shown on the figure below, when the flow rate does not correspond to the specified flow rate for some reasons, it is adjusted automatically.

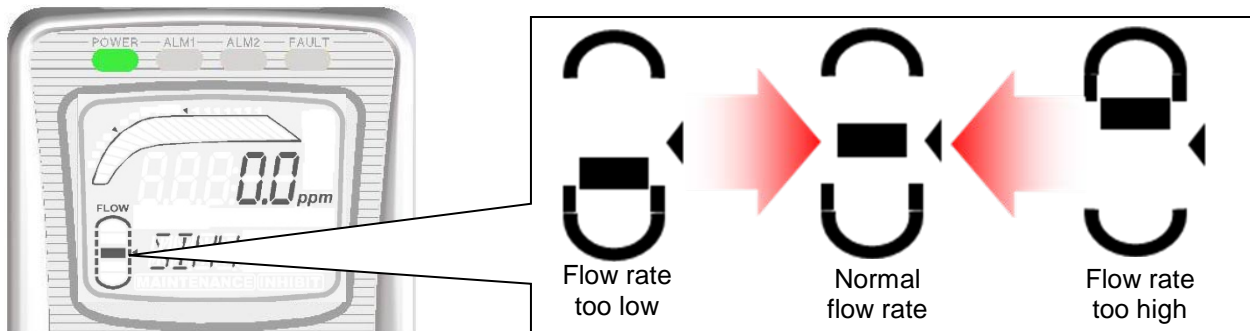

## CAUTION

- If the automatic flow rate adjustment does not work (due to clogged tube or leak), you may get a "FLOW" message (for an unstable flow rate) or an "E-05" message (for flow rate abnormalities). In this case, you must identify the causes and take appropriate actions.

## 5-5 Modes

Details on each mode are provided as follows. (\* Operations are slightly different depending on the detector type or sensor unit.)

Mode	Item	LCD Display	Details
Detection Mode	-	Gas concentration Gas name	Normal state
Gas Alarm Test Mode	-	Gas concentration	Perform the alarm test.
User Mode (see pg. 59)	Zero Adjustment (Span Adjustment for oxygen)	1-1 ZERO (1-1 SPAN for oxygen)	Perform the zero adjustment (span adjustment for oxygen).
	Setting Display	1-2 CONFIRM	Show the setting of typical menus. <ul style="list-style-type: none"> <li>First alarm setpoint (AL1)</li> <li>Second alarm setpoint (AL2)</li> <li>Alarm delay time</li> <li>Zero suppression value</li> <li>Zero follower ON/OFF</li> <li>Sensitivity correction ON/OFF</li> </ul>
	Flow Rate Indicator	1-3 FLOW	Show the current flow rate.
	Address Display	1-4 ADDRESS	Show the address.
	Detector Version Display	1-5 70D VER	Show the program version of the main unit.
	Unit Version Display	1-6 UNIT VER	Show the program version of the sensor unit.
	Net Version Display	1-7 NET VER	Show the program version of the communication function.
	Maintenance Mode Access	1-8 M MODE	Enter maintenance mode.

Mode	Item	LCD Display	Details
Maintenance Mode (see pg. 67)	Gas Introduction Display	2-0 GAS TEST	Perform the gas introduction test.
	Zero Adjustment	2-1 ZERO	Perform the zero adjustment.
	Span Adjustment	2-2 SPAN	Perform the span adjustment.
	Last Calibrated Date	2-3 LAST CAL	Show the last calibrated date.
	Bias Voltage (Element Voltage)	2-4 BIAS (2-4 E VOLT)	Show the bias voltage. (Show the element voltage.)
	Flow Rate Setting (adjusted to 0.5 L/min)	2-5 DEF FLOW	Set the flow sensor with the flow rate at 0.5 L/min.
	Pump Ratio/Flow Rate Indicator	2-6 FLOW	Show the output and flow rate of the current pump.
	Detector Temperature	2-7 TEMP	Show the current temperature of the installation environment.
	Suggested Warm-up Completion Date/Time	2-8 WARMTIME	Show the suggested warm-up completion for semiconductor type (SGU).
	Environmental Setting 1	2-9 SETTING1	Operation settings <ul style="list-style-type: none"> <li>• INHIBIT setting (INHIBIT)</li> <li>• Alarm value setting (ALM P)</li> <li>• Alarm delay time setting (ALM DLY)</li> <li>• Regular replacement operation (pump stop) (MAINTE)</li> <li>• Fault test (F TEST)</li> </ul>
	Environmental Setting 2	2-10 SETTING2	Function settings <ul style="list-style-type: none"> <li>• Address setting (ADDRESS)</li> <li>• Date/Time setting (DAY TIME)</li> <li>• Zero suppression value setting (SUPPRESS)</li> <li>• Zero suppression system setting (SUP TYPE)</li> <li>• Alarm test time contact setting (TEST RLY)</li> <li>• Alarm test time external output setting (TEST4-20)</li> <li>• Energized/De-energized setting (RLY PTRN)</li> <li>• Alarm type setting (ALM TYP)</li> <li>• Alarm activation setting (ALM PTRN)</li> <li>• Alarm value limiter setting (AL LIMIT)</li> <li>• Fault activation setting (FLT PTRN)</li> <li>• Flow rate auto-adjustment setting (AT FLOW)</li> <li>• Zero follower ON/OFF setting (ZERO F)</li> <li>• 24 hours zero follower ON/OFF setting (ZERO 24F)</li> <li>• Sensitivity correction ON/OFF setting (S ASSIST)</li> <li>• External output in maintenance mode setting (MNT OUT)</li> <li>• External output adjustment (MA 4-20)</li> <li>• Backlight setting (BK LIGHT)</li> <li>• ETHERNET setting (ETHERNET)</li> <li>• Pump drive level diagnosis ON/OFF setting (PUMP CK)</li> </ul>
	Pyrolyzer Data Display	2-11 PL DATA	If a pyrolyzer unit is being used, this menu displays data for it (see the PLU-70 operator's manual for more description)
Fault Investigation	2-12 FAULT	Not used	
Factory Mode Switching	2-13 F MODE	Not used	



---

# 6

## Detection Mode

---

### 6-1 Gas Alarm Activation

A gas alarm is activated when the concentration of detected gas reaches or exceeds the alarm setpoint.

This section describes alarms assuming an auto-reset operation.

---

#### NOTE

The alarm setpoint (first alarm and second alarm) is factory set.

The alarm delay time (standard: 2 seconds) is enabled in the detector to prevent a false activation. It can be disabled, if desired.

---

#### <Display Operation During Alarm Condition>

##### **Gas Concentration Display**

The gas concentration is displayed on the LCD. If the concentration is above the detection range (over scale), "□□□□" is displayed on the LCD instead of the gas concentration.

##### **Alarm Indicator Lamp (ALM1: Red), (ALM2: Red)**

When the first alarm setpoint has been reached, the ALM1 LED turns red.

When the second alarm setpoint has been reached, the ALM2 LED turns red.

## <Contact Activation>

The contact is activated when the gas concentration reaches or exceeds the alarm setpoint. The contact activation is reset automatically when the gas concentration drops below the alarm setpoint.

### <Contact Activation (Auto-reset)>

In case of Auto-reset setting, the contact is activated when the gas concentration reaches or exceeds the alarm setpoint value. The contact activation is reset automatically when the gas concentration drops below the alarm setpoint value.

### NOTE

In DETECTION MODE, select and press one of the following key to reset : "MODE", "▲", "▼" or "TEST/SET".

"Alarm Pattern (H-HH)"

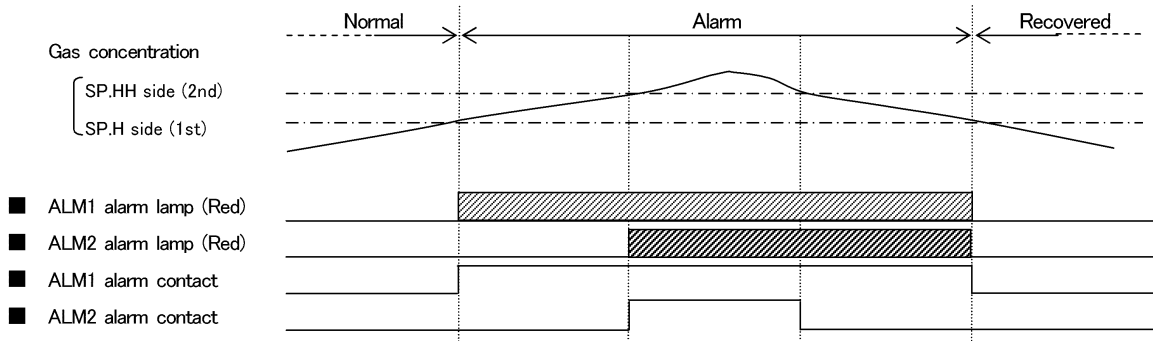

### "Alarm Pattern (L-H)"

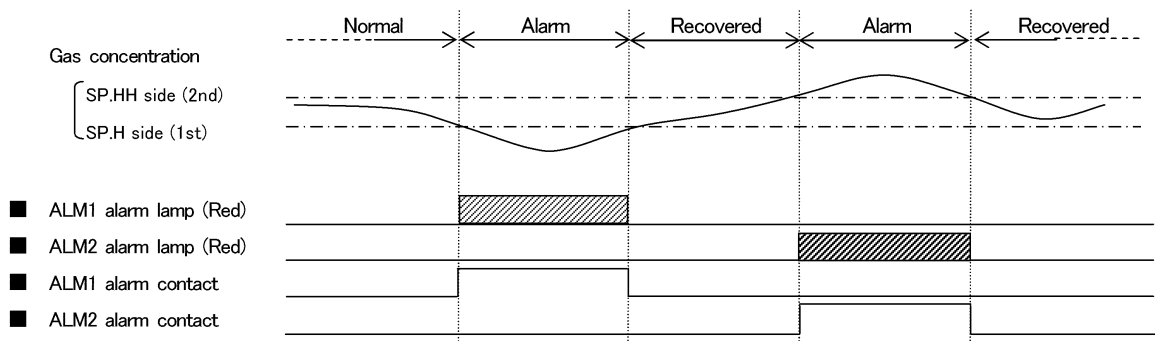

### "Alarm Pattern (L-LL)" (\* oxygen deficiency alarm)

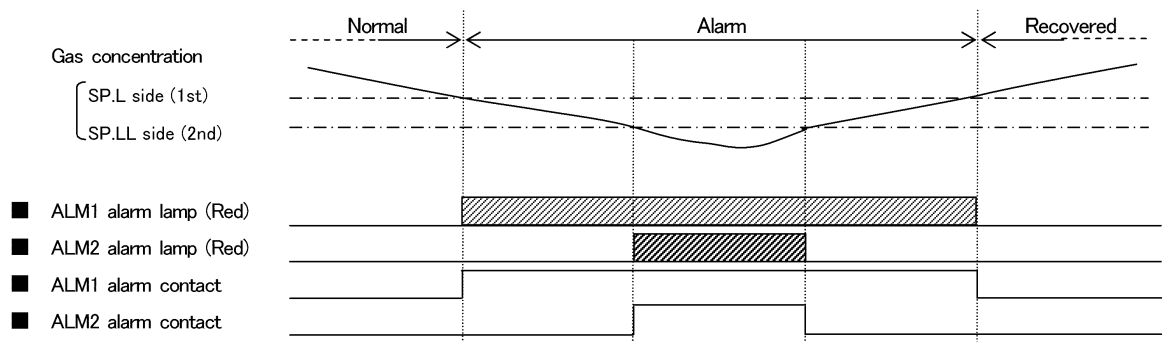

## <Contact Activation (Self-latching)>

In case of Self-latching setting, the contact is activated when the gas concentration reaches or exceeds the alarm setpoint value. The alarm indication lamp blinks during warning. It changes to a light after reset is performed. It turns off when the gas concentration drops below the alarm set point value.

### "Alarm Pattern (H-HH)"

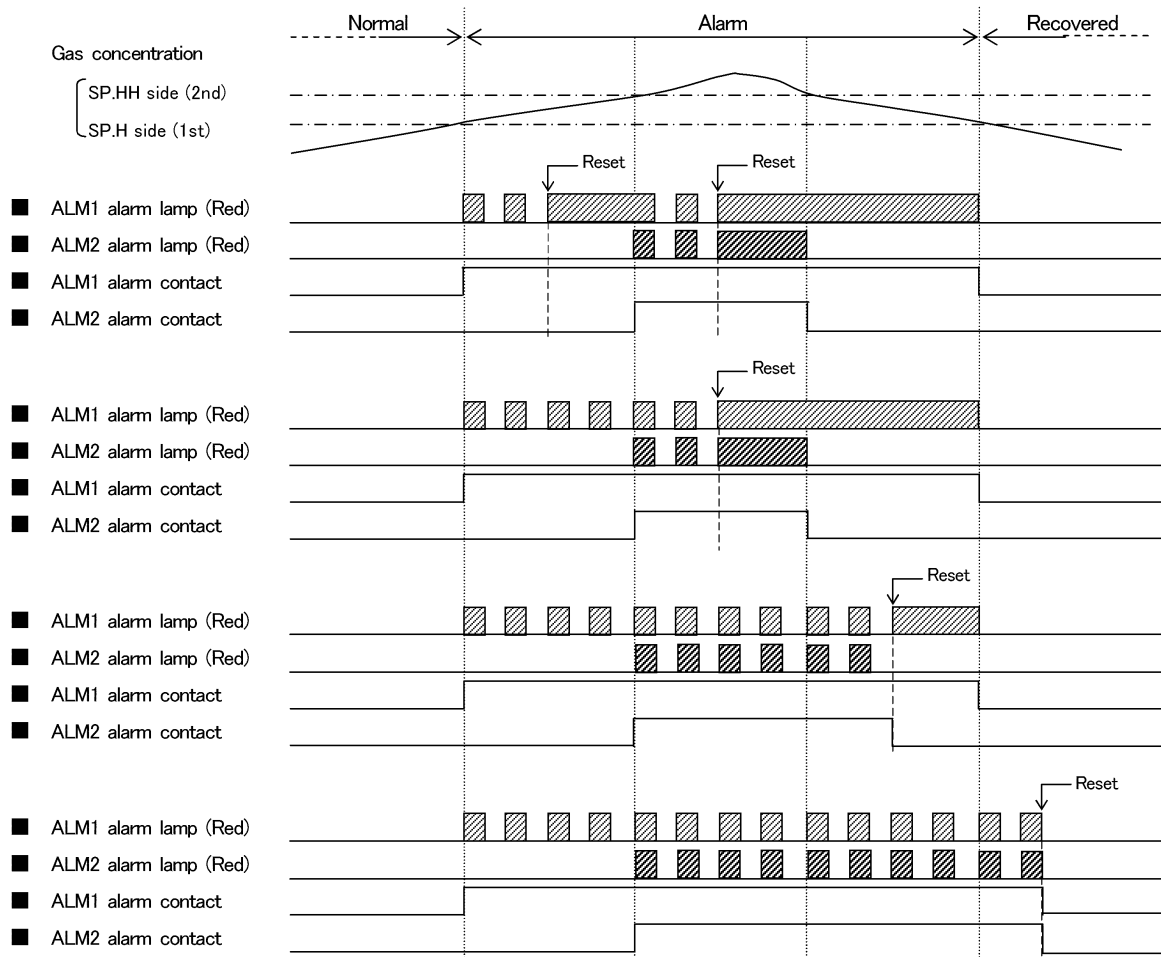

# "Alarm Pattern (L-H)"

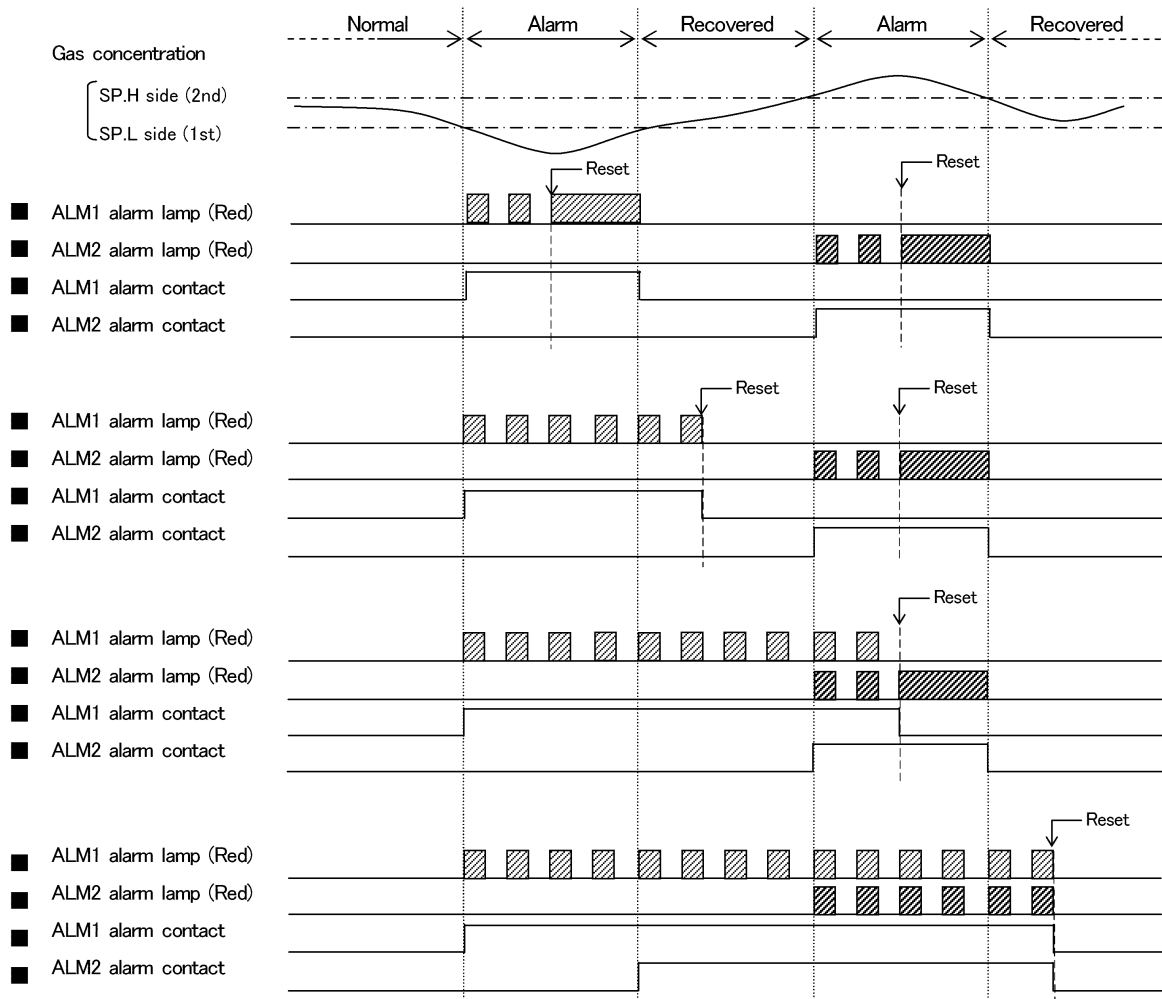

## "Alarm Pattern (L-LL)"

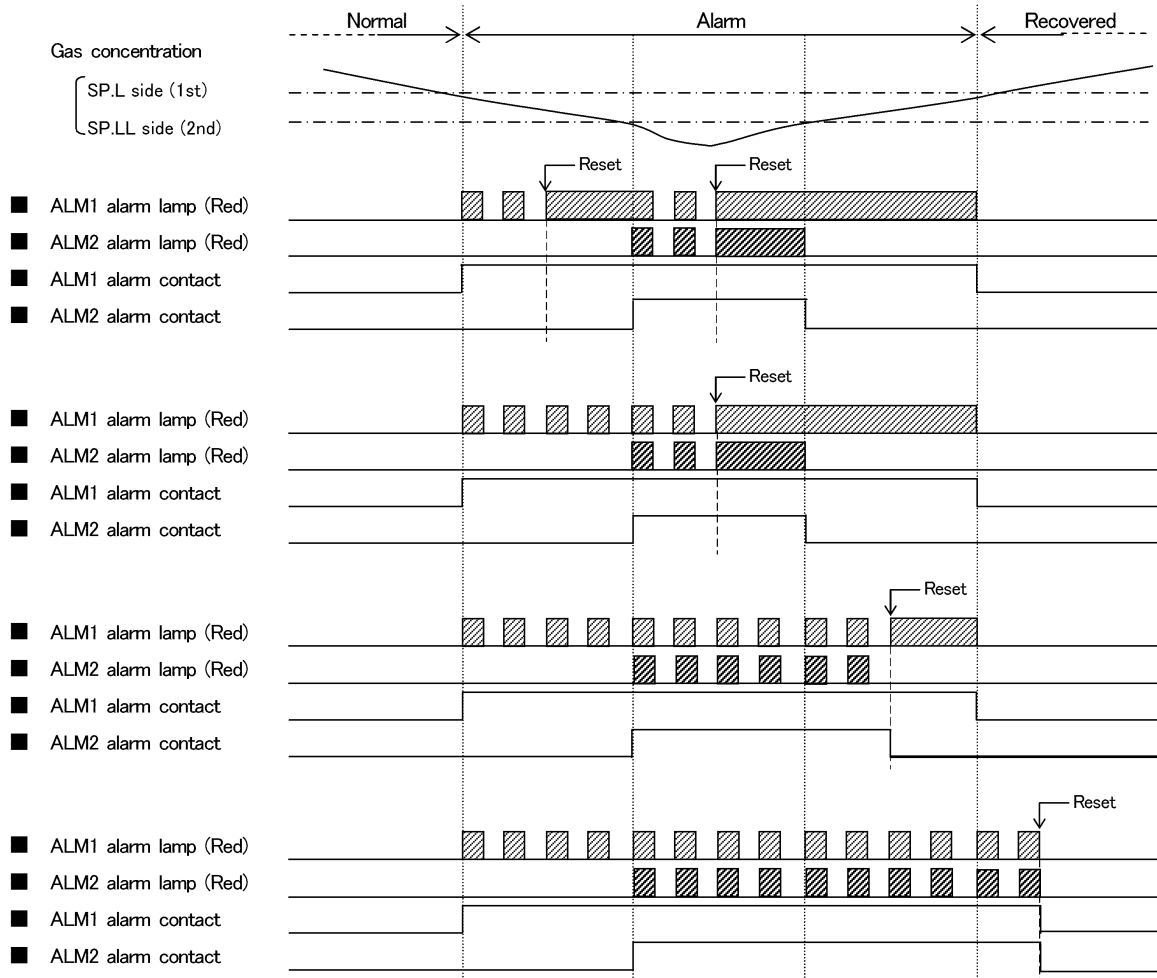

## <Response to Gas Alarm>

When a gas alarm is triggered, take actions in accordance with your company's safety practices for a gas alarm. In general, take the following actions.

1. Check the reading of the detector.

### NOTE

If a gas leak is momentary or if the alarm is triggered by noise, the reading may already have dropped by the time you get to the instrument to check it.

2. Based on your company's safety practices, no one can be allowed to access the monitored zone to ensure safety.
3. If the detector display is still indicating the presence of gas, close the area's main gas valve, and then verify that the detector's gas concentration reading dropped.
4. While wearing protective equipment in case gas is still present, use a portable gas detector to ensure the area is free from gas.
5. If you can determine that the leak point is free from dangers, take actions to fix the gas leak.

## 6-2 Fault Alarm Activation

A fault alarm is triggered when the detector detects abnormalities.

After a fault alarm is triggered, the FAULT lamp (yellow) lights up and an error message is displayed on the LCD.

Determine the causes and take appropriate actions.

After the detector is successfully returned from the fault, it restarts and goes through a normal warmup procedure.

If the detector has problems and is repeatedly malfunctioning, please contact RKI immediately.



\* E-5 FLOW (flow rate abnormalities)

### NOTE

For information on error messages and possible malfunctions, see Troubleshooting on page 116.

## 6-3 External Output Operation

### ● 4 - 20 mA/NT/EA Specification

Specifications/Condition	4 - 20 mA (for GD-70D)	Power-line communication system (for GD-70D-NT)
Signal Transmission System	Electric current transmission (non-isolated)	2-wire type DC power-line communication system
Transmission Path	CVVS	KPEV-S
Transmission Distance	Below 1 km	Below 300 m (depending on the system designing conditions)
Connection Load Resistance	Below 300 Ω	-
① Detection Mode (No Alarm)	4 - 20 mA (concentration output)	Concentration data
② Detection Mode (Gas Alarm)	4 - 20 mA (concentration output)	Concentration data, Alarm bits
③ Initial Clear	Depending on the setting of ④ 2.5 mA setting: 2.5 mA 4 mA, HOLD, 4-20 mA setting: 4 mA*	Initial bit
④ Maintenance Mode	2.5 mA setting: 2.5 mA 4 mA setting: 4mA* HOLD Setting: the previous value retained 4-20 mA setting: 4 - 20 mA (concentration output)	Concentration data, Adjustment bit
⑤ Alarm Test	Output ON setting: 4 - 20 mA (concentration output) Output OFF setting: In accordance with setting of ④	Concentration data, Adjustment bit, Test bit
⑥ Fault Alarm	0.5 mA (Fixed)	Fault bits
⑦ Inhibit	Depending on the setting of ④ 2.5 mA setting: 2.5 mA 4 mA, HOLD, 4 - 20 mA setting: 4 mA*	Concentration data, Adjustment bit, Inhibit bit
⑧ Power Off	0 mA	Signal OFF

\* 17.4 mA for oxygen units

● LN Specification

Specifications	LONWORKS (LN)
Signal transmission method	LONWORKS
Transmission path	KPEV-S
Transmission rate	78kbps
Transmission distance	Max 2700m * When bus topology (Double ended termination ) is used.
Connection load resistance	—

Example of Gas Concentration and External Output  
4 - 20 mA Specification  
(Maintenance output: 2.5 mA setting)

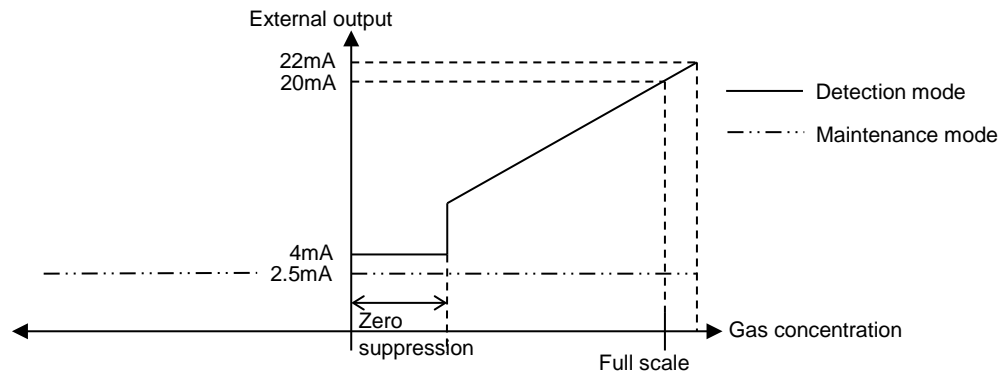

**CAUTION**

<<4 - 20 mA Specification>>

- The 4 - 20 mA output is already adjusted. In case of over scale, an output will not exceed 22 mA.
- Output during inhibit or warmup is based on 4 - 20 mA output setting in Maintenance Mode. The output may drop as low as 2.5 mA during warmup for oxygen units. Understand how the detector functions, and take actions to prepare for false alarms.

<Special Cases>

Maintenance output setting	Sensor unit	Details
2.5 mA	Use OSU (L-LL, L-H).	Output 2.5 mA during maintenance or inhibit. Possibility of false alarm in the upper unit (L alarm)
4 mA, HOLD, 4 - 20 mA	Specification change (To OSU - 0 - 25 vol%)	When changing from a H-HH alarm pattern to an L-LL or L-H alarm pattern, 4 mA (equivalent of concentration zero) is used until the "C-02" change message is confirmed.
	Specification change (From OSU - 0 - 25 vol%)	When changing from an L-LL or L-H alarm pattern to a H-HH alarm pattern, 17.4 mA (equivalent of approx. 84%FS) is used until the "C-02" change message is confirmed.



**<Communication Specifications>**

GD-70D-NT	Power-line communication system	The detector is used in a local network formed with a multi-display unit (RM-70NT) as the base unit. For more information, see the operating manual of the multi-display unit.
GD-70D-EA	Ethernet	<p>The detector offers functions that work in liaison with external software using a standard network protocol. For details, see the separate manual for communication function.</p> <p><b>Web function (HTTP), mail send function (SMTP), and time synchronization function (SNTP)</b></p> <p>Use a Web browser of an upper-unit PC to view and change setting values and perform calibration and test on a graphical user interface. SMTP, when receiving a gas alarm or fault alarm from an external mail server, can send a notification mail to a registered address. SNTP, receiving time information from a time server, can correct the clock at regular intervals.</p> <p><b>Modbus slave function (Modbus/TCP)</b></p> <p>Works as a Modbus slave and feeds back a setting value in response to a read request or changes a setting value in response to a write request.</p> <p><b>PLC linkage function (FINS·MC)</b></p> <p>Sends a setting value to PLC to provide information to be processed by PLC in a ladder program. Reading from PLC is also available to change a setting value or perform calibration and test.</p>
GD-70D-LN	LONWORKS	<p>An internationally standardized network specification for device control. It is a network specification that controls and manages not only gas detectors but also air conditioning, lighting etc. equipment by the same communication protocol called Lon-talk.</p> <p>By constructing an open system, it becomes possible to connect the system without being bound by one manufacturer, it is possible to facilitate procurement of parts at the time of equipment failure, and to increase design flexibility.</p>

---

## 6-4 Other Functions

### <Suppression Function>

Some sensors are influenced by environmental changes (temperature, humidity, and other characteristics) or interference gases which may cause the reading to vary in fresh air.

The suppression function is used to hide (suppress) the variation of the reading under the set suppression value, so that the display indicates zero (or 20.9% for oxygen) until the reading exceeds the set suppression value.

The factory setting for the suppression function is OFF for every gas type except for oxygen.

<<Example: SiH4 0 - 15 ppm range>>

0.5ppm  
SiH4

Suppression Disabled

A variation around zero is displayed as the reading.



0.0ppm  
SiH4

Suppression Enabled

A variation under the set suppression value (ie. 6% of full scale or 0.9 ppm for SiH4) is shown as zero.



### CAUTION

- If the zero reading is BELOW zero, the reading will not change until the reading reaches -10% of full scale.
- A reading that is -10% of full scale is displayed as "-0.0".

## <Zero Follower Function>

Some sensors (ESU and SSU types) have sensitivity variations after being used for a long period of time.

The zero follower function uses program manipulation to correct for sensitivity variations in the zero reading.

Zero Follower Off

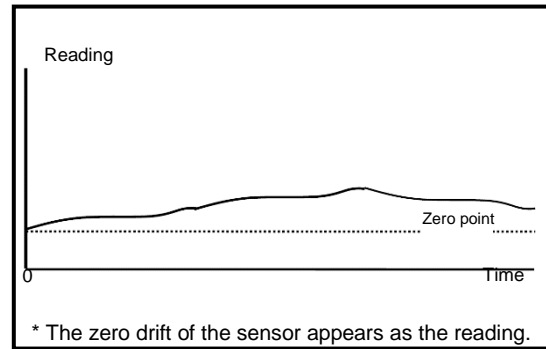

Zero Follower On

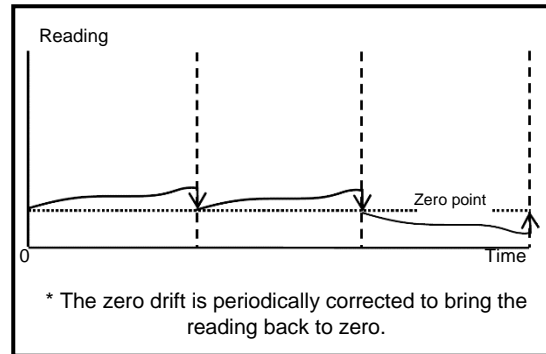

## <Sensitivity Correction Function>

ESU type sensors have sensitivity variations after being used for a long period of time.

The sensitivity correction function compensates for decreasing gas sensitivity as the sensor gets older. It periodically adjusts the span based on the degradation pattern of the sensor.

Sensitivity Correction Off

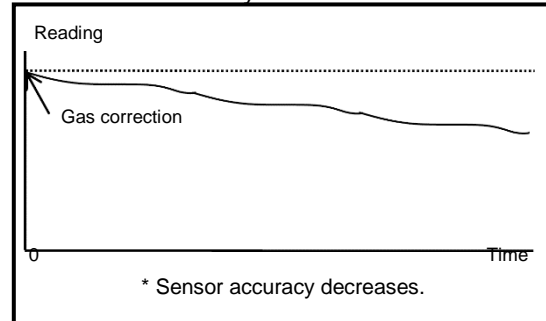

Sensitivity Correction On

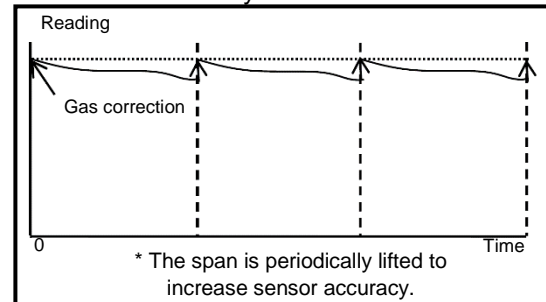

### CAUTION

The sensitivity correction is just an auxiliary function. It uniformly lifts the span up based on the sensor's degradation pattern only. Sensitivity correction cannot consider the sensitivity variation of an individual sensor. To correct the sensitivity variation, you must regularly calibrate the sensor.

## <Calibration History/Alarm Trend History/Event History Functions>

The detector and the sensor unit have their own history functions. To use these functions, contact RKI.

## <Sensor Unit Automatic Recognition Function>

The detector can automatically recognize when a new sensor has been installed. If a replacement sensor of the same type is installed, the detector will display a "C-01 CHG UNIT" message. If a different type sensor is installed, the detector will display a "C-02 CHG SPEC" message.



### Unit Replacement

Displayed when a unit with the same specification (principle, type, range, and so on) is attached (e.g. in a regular replacement).

1. Press the MODE key to confirm the new sensor unit and start the monitor.

The following is displayed alternately if the unit that you installed has the same or earlier date of manufacture than the one that has been replaced.

### "CHG UNIT" <=> "USED SEN"

\*\*\* Check for correct installation if this message is displayed because an old sensor might have been installed by mistake.

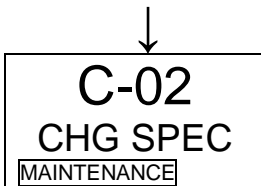

### Specification Change

Displayed when a unit with a different specification (principle, type, range, and so on) from the previous one is attached.

1. Press the MODE key to confirm the new specification and start the monitor.

If you did not install a sensor unit with a different specification, this message might mean there is an installation error. Check the sensor installation.



## CAUTION

If you get a "C-02" message and confirm the specification change by pressing the MODE key, the specification of the gas detector head is changed. The following parameters are changed to their standard settings. If you want to use nonstandard settings, set them in Maintenance Mode.

- Alarm setpoints (ALM P)
- Alarm delay time setting (ALM DLY)
- Suppression value (SUPPRESS)
- Alarm type (ALM TYP) ..... The OSU specification includes "L-LL", "L-H", and "H-HH".

<Standard Setting Values by Principle>

	ESU	SSU	NCU	SGU	OSU (0-25 vol%)	OSU (0 - 5 vol%)	OSU (0 - 50 vol%)
Alarm delay	2-second	2-second	2-second	2-second	2-second	2-second	2-second
Suppression value	6%FS	2 ppm (TEOS)	6%FS (0-100%LEL)	10%FS	0.5 vol% (AIR supp)	0 vol%	0 vol%
Alarm type	H-HH IRU (0-500ppm)	H-HH SHU (0-2000ppm)	H-HH	H-HH	L-LL	H-HH	H-HH
Alarm delay	2-second	2-second					
Suppression value	30 ppm	200 ppm					
Alarm type	H-HH	H-HH					

## 6-5 About LONWORKS (LN specification)

### <Binding method>



#### WARNING

- When adjustment is completed, press the MODE key and be sure to return to detection mode.  
(When left in user mode, it automatically returns to detection mode after 10 hours.)

#### «User mode»

**Detection mode**

Press the MODE key  
for 3 seconds.

PW    A1    A2    F



LCD

0.0ppm  
SIH4



**User mode**

**1-1.ZERO**

Perform the zero  
adjustment.



1-1  
ZERO

MAINTENANCE

→ Zero Adjustment  
SET    ⇒ P51

To reissue the neuron ID, please press the MODE key in user mode for 3 seconds, return to the detection mode, and enter the user mode again.

# GD-70D-LN LonWorks Diagram

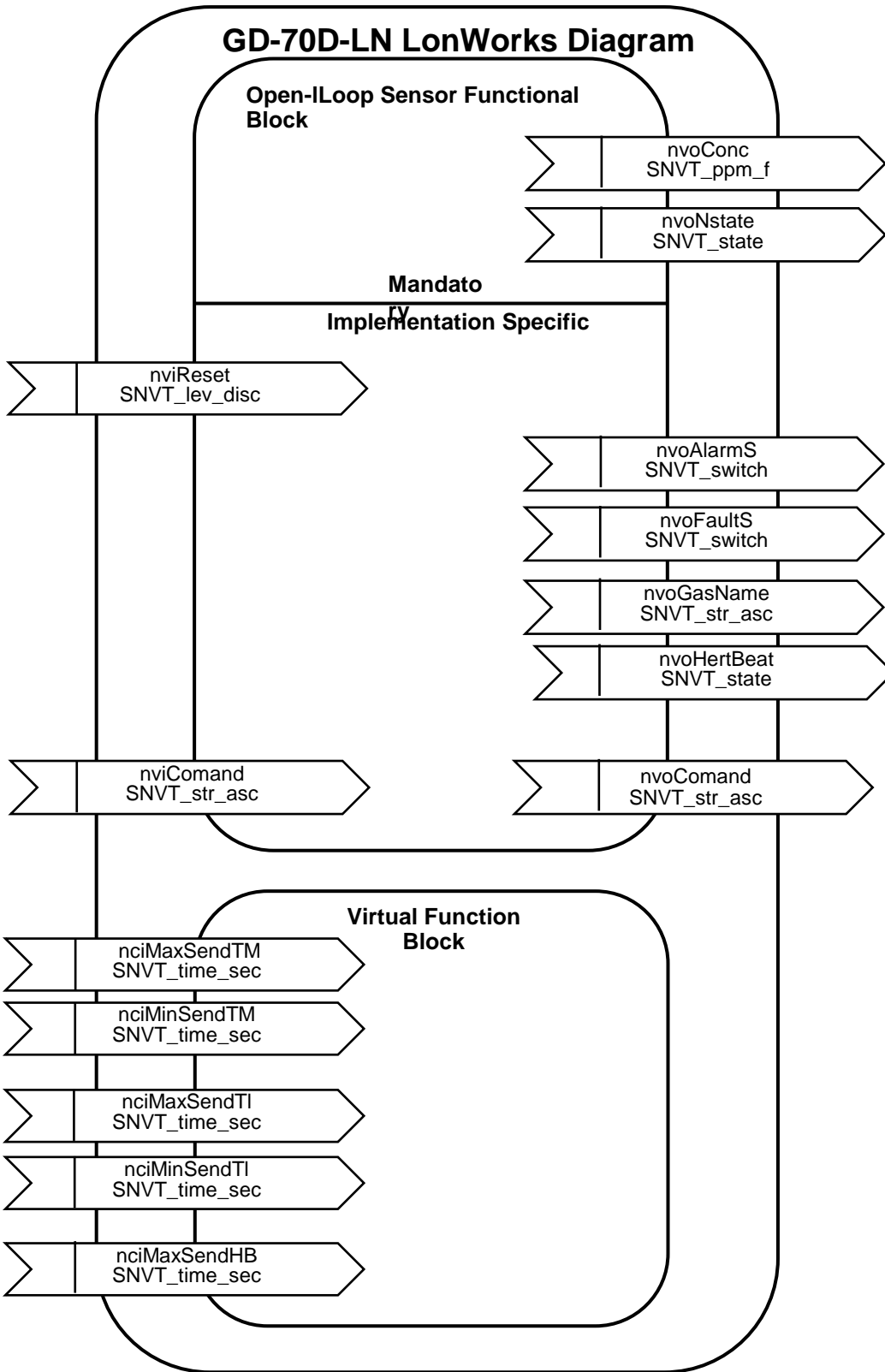

NO.	Variable name	Variable type	Contents
1	nvoConc	SNVT_ppm_f	It is the same as the current density output. Floating point of 16 BIT synchronizes with the display of the detection part.
2	nvoNstate	SNVT_state	It is the same as the current density output. Status of 16 BIT expresses measurement unit, alarm, breakdown etc.
3	nvoAlarmS	SNVT_switch	Expression of alarm state by switch OFF:{0.0,0} 1st :{1.0,1} 2nd :{1.5,1} 1st & 2nd: {2.0,1}
4	nvoFaultS	SNVT_switch	Expression of fault condition by switch Normal : {0.0,0} Fault:{X.X,1} -- X.X : 1.0 = Sensor fault : 5.0 = Flaw rate fault : 7.0 = Pyrolyzer fault : 9.0 = System fault
5	nvoGasName	SNVT_str_asc	Send measured gas name and measurement unit in ASCII character string. From the beginning, we send unit after space (20H) with gas name and the rest is ASCII(00H = NULL)
6	nvoHertBeat	SNVT_state	Count up 8 BIT of 0 to 7 of 16 BIT Count every second and count it. If it is OVER, start with 0. 8 to 15 BIT is reserved.
7	nviReset	SNVT_lev_disc	RESET signal in case of self-latching 0:non not 0:RESET
8	nciMaxSendTM	SNVT_time_sec	1 and 2 update maximum time
9	nciMinSendTM	SNVT_time_sec	1 and 2 update minimum time
10	nciMaxSendTI	SNVT_time_sec	3 ~ 5 update maximum time
11	nciMinSendTI	SNVT_time_sec	3 ~ 5 update minimum time
5	nciMaxSendHB	SNVT_time_sec	6 update maximum time
13	nviComand	SNVT_str_asc	Command input of ASCII 30 byte
14	nvoComand	SNVT_str_asc	Command output of ASCII 30 byte

You can select the transmission status with the combination of the setting point of nciMaxSendTM (8) and nciMinSendTM (9).

- nciMaxSendTM (8) = Asec nciMinSendTM (9) = Bsec --> (1) and (2) transmit every Asec when there is no VAL update. If Bsec has not elapsed since last transmission, wait until Bsec has elapsed before sending it even if VAL is updated.
- nciMaxSendTM (8) = Asec nciMinSendTM (9) = 0sec --> (1) and (2) transmit every Asec when there is no VAL update. If there is an update of VAL, it will be sent immediately.
- nciMaxSendTM (8) = 0sec nciMinSendTM (9) = Bsec --> (1), (2) don't transmit every Asec when there is no VAL update. If Bsec has not elapsed since last transmission, wait until Bsec has elapsed before sending it even if VAL is updated.

You can select the transmission status with the combination of the setting point of nciMaxSendTI (10) and nciMinSendTI (11).

- nciMaxSendTI (10) = Asec nciMinSendTI (11) = Bsec --> (3) ~ (5) transmit every Asec when there is no VAL update. If Bsec has not elapsed since last transmission, wait until Bsec has elapsed before sending it even if VAL is updated.
- nciMaxSendTI (10) = Asec nciMinSendTI (11) = 0sec --> (3) ~ (5) transmit every Asec when there is no VAL update. If there is an update of VAL, it will be sent immediately.
- nciMaxSendTI (10) = 0sec nciMinSendTI (11) = Bsec --> (3) ~ (5) don't transmit every Asec when there is no VAL update. If Bsec has not elapsed since last transmission, wait until Bsec has elapsed before sending it even if VAL is updated.

---

You can select the transmission status with the setting point of nciMaxSendHBb(12)

- nciMaxSendHB (12) = Asec -- > (6) transmit every Asec.
- nciMaxSendHB (12) = 0sec -- > (6) don't transmit every Asec.

It outputs to nvoComand (14) for input data of nviComand (13).

- nviComand (13) = "A1, R," -- > nvoComand (14) = "A1, R, xxxx"  
xxxx express 1st alarm point read value in hexadecimal.
- nviComand (13) = "A2, R," -- > nvoComand (14) = "A2, R, xxxx"  
xxxx express 2nd alarm point read value in hexadecimal.
- nviComand (13) = "AD, R," -- > nvoComand (14) = "AD, R,xxxx"  
xxxx express Alarm delay time (mesc 10 units) read value in hexadecimal.



# 7

## Alarm Test Mode

Alarm Test Mode generates dummy signals that imitate gas concentration signals in order to check the alarm LED activation and the transmission to external circuits.



### WARNING

- Before starting the alarm test (transmission test), prepare for false alarms by disabling alarms or alerting appropriate personnel.
- After the test is completed, do not forget to press the TEST key to return to Detection Mode. (If the detector remains in the alarm test mode, it automatically returns to Detection Mode in ten hours.)

Be sure that the **TEST RLY** and **TEST4-20** items in Maintenance Mode are set appropriately.

### 7-1 Alarm Test Mode

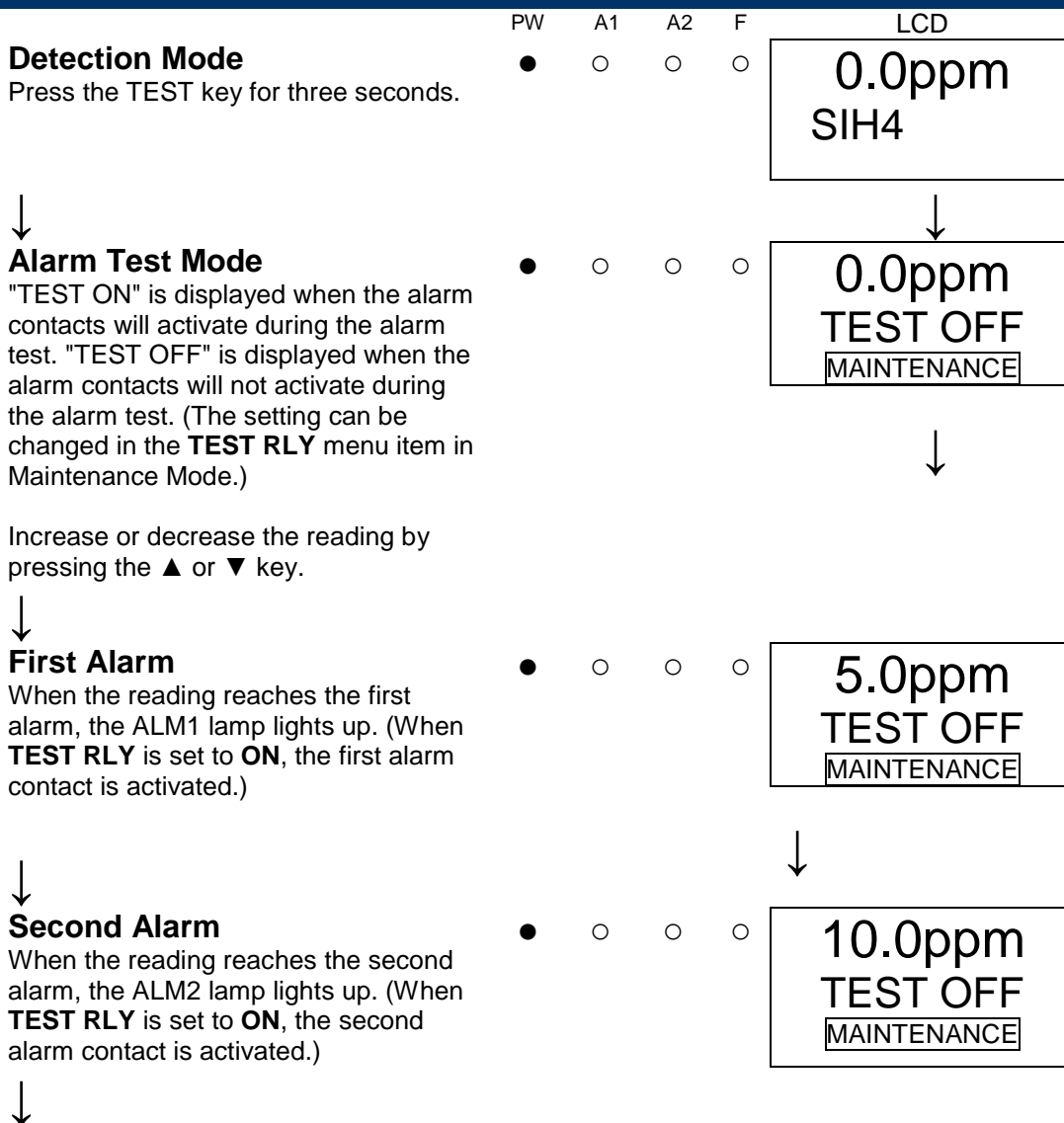

---

**Return to Detection Mode**

Press the TEST key for 3 seconds.

# 8

## User Mode



### WARNING

After the adjustment is completed, do not forget to press the MODE key to return to Detection Mode.

### 8-1 User Mode

#### Detection Mode

Press the MODE key for three seconds.

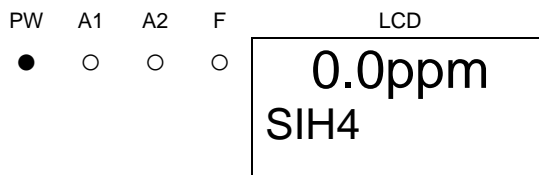

#### User Mode

**1-1.ZERO**  
Perform the zero adjustment.

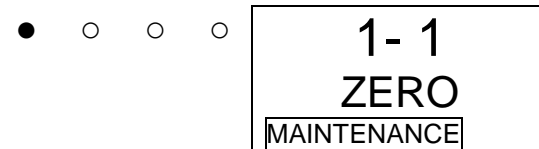

→ SET Zero Adjustment  
⇒P62

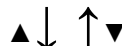

**1-2.CONFIRM**  
Show the typical setpoint.



→ SET Setpoint Display  
⇒P63

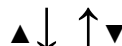

**1-3.FLOW**  
Show the current flow rate.

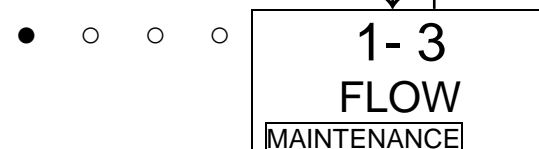

→ SET 0.50  
L/M  
MAINTENANCE

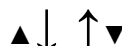

**1-4.ADDRESS**  
Show the address.  
(for GD-70D-NT)



→ SET 01  
ADDRESS  
MAINTENANCE



**1-5.70D VER**

Show the program version of the main unit.

- ○ ○ ○

1- 5  
70D VER  
MAINTENANCE

→ SET

01234  
56AB  
MAINTENANCE



**1-6.UNIT VER**

Show the program version of the installed sensor unit.

- ○ ○ ○

1- 6  
UNIT VER  
MAINTENANCE

→ SET

01234  
56AB  
MAINTENANCE

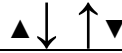

**1-7.NET VER**

Show the program version of the communication function.  
(for GD-70D-NT)

- ○ ○ ○

1- 7  
NET VER  
MAINTENANCE

→ SET

01234  
-----  
MAINTENANCE



**1-8.M MODE**

Enter Maintenance Mode.

- ○ ○ ○

1- 8  
M MODE  
MAINTENANCE

→ SET

See Maintenance Mode on page 65.



To 1-1.ZERO

**【In case of GD-70D-EA】**

**1-7.NET VER**

Show the program version of the communication function.  
(NT specification)

- ○ ○ ○

1- 7  
NET VER  
MAINTENANCE

→ SET

01234  
-----  
MAINTENANCE



**1-8.COM SET**

Set communication output.  
Press the ▲ or ▼ key to select the communication output, and then press the SET key to confirm the value.

- ○ ○ ○

1- 8  
COM SET  
MAINTENANCE

⇔ SET

A  
COM SET  
MAINTENANCE



A: Analog transmission  
E: Ethernet  
EA: Ethernet and analog transmission

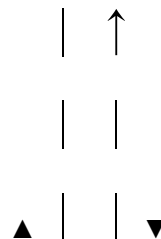

E  
COM SET  
MAINTENANCE



EA  
COM SET  
MAINTENANCE

---

**1-9. M MODE**  
Switch to the regular  
maintenance mode.



**1-9**  
**M MODE**  
**MAINTENANCE**

→  
SET

See Maintenance  
Mode on page 65.



To **1-1. ZERO**

---

## NOTE

- Communication output setting 1-8 (COM SET) is displayed only for EA specification.
  - In EA specification, if only analog transmission is used (Ethernet is not used), if the communication output setting is set to A, Communication Abnormalities E-6 does not occur even if an Ethernet cable is not connected.
-

## <Zero Adjustment "1-1">

This is used to perform the zero adjustment. Before starting the zero adjustment, let the detector draw fresh air or zero air until the reading is stable.

For oxygen units, "1-1" is called the span adjustment instead of the zero adjustment. In this case, fresh air or zero air must be applied to the detector to ensure the reading is 20.9 vol%. For information on the span adjustment, see Maintenance on page 86.

### Zero Adjustment

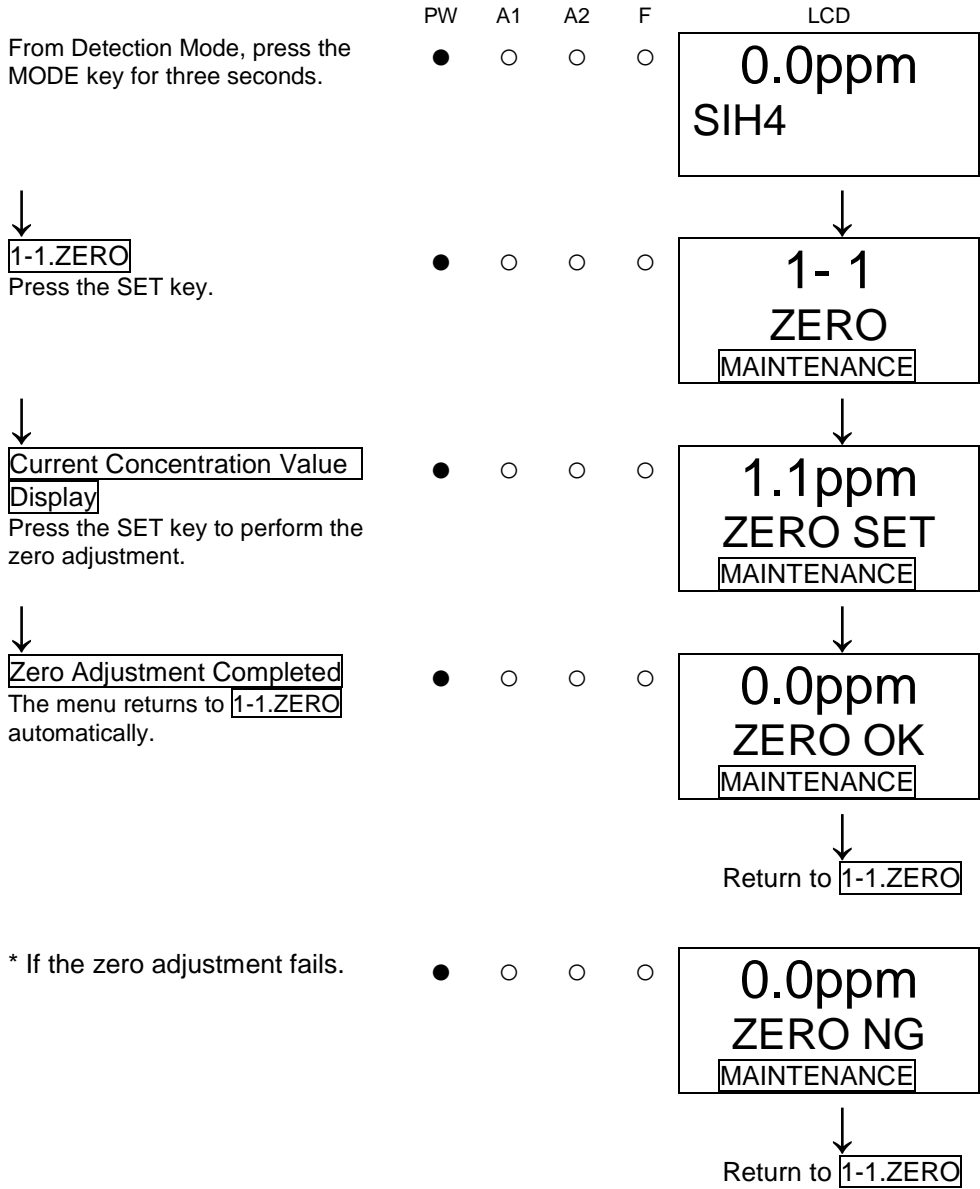

## <Setpoint Indicator "1-2">

Use this menu item to check important setpoints. Setpoints cannot be changed in User Mode.

### Setpoint Display

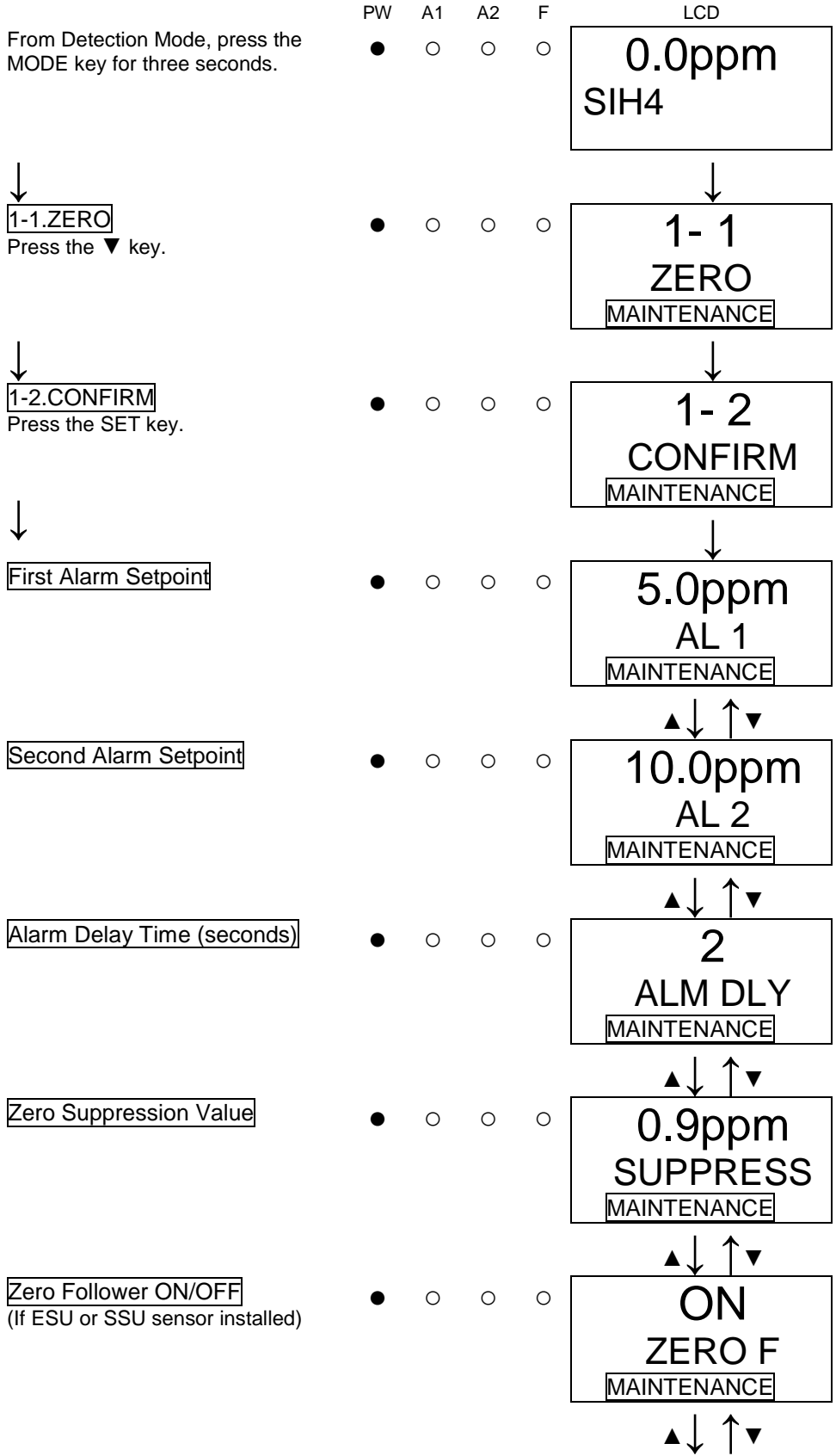

---

Sensitivity Correction ON/OFF  
(If ESU sensor installed)



OFF  
S ASSIST  
MAINTENANCE

▲ ↓ ↑ ▼  
To First Alarm  
Setpoint Indicator



# 9

## Maintenance Mode



### WARNING

After the adjustment is completed, do not forget to press the MODE key to return to Detection Mode.  
(If the detector remains in Maintenance Mode, it automatically returns to Detection Mode in ten hours.)

Maintenance Mode Item	LCD Display	Details
Gas Introduction Display	2-0 GAS TEST	Perform the gas introduction test in the regular maintenance mode.
Zero Adjustment ⇒P86 <b>Error! Bookmark not defined.</b>	2-1 ZERO	Perform the zero adjustment.
Span Adjustment ⇒P86	2-2 SPAN	Perform the span adjustment.
Last Calibrated Date	2-3 LAST CAL	Show the last calibrated date.
Bias Voltage (Element Voltage)	2-4 BIAS (2-4 E VOLT)	Show the bias voltage. (Show the element voltage.)
Flow Rate Setting (adjusted to 0.5 L/min) ⇒P110	2-5 DEF FLOW	Set the flow sensor with the flow rate at 0.5 L/min.
Pump Ratio/Flow Rate Indicator ⇒P110	2-6 FLOW	Show the output and flow rate of the current pump.
Detector Temperature	2-7 TEMP	Show the current temperature of the installation environment.
Suggested Warm-up Completion Date/Time	2-8 WARMTIME	Show the suggested warm-up completion for SGU type sensors.
Environmental Setting 1 ⇒P70	2-9 SETTING1	Operation settings <ul style="list-style-type: none"> <li>• INHIBIT setting (INHIBIT)</li> <li>• Alarm value setting (ALM P) ⇒P71</li> <li>• Alarm delay time setting (ALM DLY)</li> <li>• Pump stop (MAINTE)</li> <li>• Fault alarm test (F TEST) ⇒P73</li> </ul>

Maintenance Mode Item	LCD Display	Details
Environmental Setting 2 ⇒P74	2-10 SETTING2	Function settings <ul style="list-style-type: none"> <li>• Address setting (ADDRESS)</li> <li>• Date/Time setting (DAY TIME) ⇒P79</li> <li>• Zero suppression value setting (SUPPRESS)</li> <li>• Zero suppression type setting (SUP TYPE)</li> <li>• Alarm test mode contact setting (TEST RLY)</li> <li>• Alarm test mode external output setting (TEST4-20)</li> <li>• Energized/De-energized setting (RLY PTRN) ⇒P81</li> <li>• Alarm type setting (ALM TYP)</li> <li>• Alarm activation setting (ALM PTRN)</li> <li>• Alarm value limiter setting (AL LIMIT)</li> <li>• Fault activation setting (FLT PTRN)</li> <li>• Flow rate auto-adjustment setting (AT FLOW)</li> <li>• Zero follower ON/OFF setting (ZERO F)</li> <li>• 24 hours zero follower ON/OFF setting (ZERO 24F)</li> <li>• Sensitivity correction ON/OFF setting (S ASSIST)</li> <li>• External output in maintenance mode setting (MNT OUT)</li> <li>• External output adjustment (MA 4-20)</li> <li>• Backlight setting (BK LIGHT)</li> <li>• ETHERNET setting (ETHERNET)</li> <li>• Pump drive level diagnosis ON/OFF setting (PUMP CK)</li> </ul>
Pyrolyzer Data Display	2-11 PL DATA	When the pyrolyzer unit (PLU-70) is used, a variety of pyrolyzer data is displayed. (See the operating manual for PLU-70)
Fault Investigation	2-12 FAULT	Not used
Factory Mode Switching	2-13 F MODE	Not used

# Maintenance Mode

PW: POWER    ●: Lamp on  
 A1: ALM1     ○: Lamp off  
 A2: ALM2  
 F: FAULT

From Detection Mode, press and hold the MODE key for three seconds.

PW    A1    A2    F

LCD  
 0.0ppm  
 SIH4



1-8.M MODE

Press the ▲ key until the Maintenance Mode screen displays. (For GD-70D-EA units, the Maintenance Mode screen is item 1-9.)

●    ○    ○    ○

1- 8  
 M MODE  
 MAINTENANCE



User Mode

In "1-8.M MODE", press the SET key.

●    ○    ○    ○

1- 8  
 M MODE  
 MAINTENANCE



Then press and hold the SET key again for three seconds.

●    ○    ○    ○

- - - -  
 M MODE  
 MAINTENANCE



Maintenance Mode

2-0.GAS TEST

Perform a test with the gas. The reading changes and the alarm lamp lights up, but the alarm contacts are not activated and the 4-20 mA output does not track the changes.

●    ○    ○    ○

2- 0  
 GAS TEST  
 MAINTENANCE

→ SET

0.2ppm  
 GAS TEST  
 MAINTENANCE

↓ (Alternate Display) ↑



0.2ppm  
 SIH4  
 MAINTENANCE

2-1.ZERO

Perform a zero adjustment.

●    ○    ○    ○

2- 1  
 ZERO  
 MAINTENANCE

→ SET

Zero Adjustment  
 ⇒P86

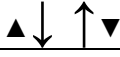

2-2.SPAN

Perform a span adjustment.

●    ○    ○    ○

2- 2  
 SPAN  
 MAINTENANCE

→ SET

Span Adjustment  
 ⇒P86



**2-3.LAST CAL**

Show the most recent calibration date.

- ○ ○ ○ ○

2- 3  
LAST CAL  
MAINTENANCE

→ SET

12:00  
2009.01.01  
MAINTENANCE

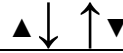

**2-4.BIAS**

Show the bias voltage "BIAS" of electrochemical type (ESU) or the element voltage "EVOLT" of semiconductor type (SGU) and hot-wire semiconductor type (SHU).

- ○ ○ ○ ○

2- 4  
BIAS  
MAINTENANCE

→ SET

0 mV  
BIAS  
MAINTENANCE



**2-5.DEF FLOW**

Set the flow rate to the default value when the flow sensor is replaced, etc. Normally, this is not used because the detector has already been adjusted. On the other hand, if the flow meter is set at other than the specified flow rate, gases cannot be detected properly due to an incorrect flow rate. (Press the MODE key to cancel this menu.)

- ○ ○ ○ ○

2- 5  
DEF FLOW  
MAINTENANCE

↔ SET

1000  
DEF FLOW  
MAINTENANCE



**2-6.FLOW**

Show the output and flow rate of the current pump.

- ○ ○ ○ ○

2- 6  
FLOW  
MAINTENANCE

↔ SET

50 %  
0.50 L/M  
MAINTENANCE



**2-7.TEMP**

Show the temperature of the detector.

- ○ ○ ○ ○

2- 7  
TEMP  
MAINTENANCE

→ SET

25.0 °C  
TEMP  
MAINTENANCE



**2-8. WARMTIME**

Show the suggested warm-up completion date/time for semiconductor type (SGU), and hot-wire semiconductor type (SHU) which requires a long warm-up time.

- ○ ○ ○ ○

2- 8  
WARMTIM  
E  
MAINTENANCE

→ SET

12:00  
2009.01.01  
MAINTENANCE



**2-9. SETTING1**

Enter the environmental setting 1 menu.

- ○ ○ ○ ○

2- 9  
SETTING1  
MAINTENANCE

→ SET

Environmental  
Setting 1 [⇒P71]



**2-10.SETTING2**

Enter the environmental setting 2 menu.

- ○ ○ ○

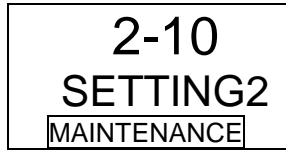

→ SET

Environmental Setting 2 ⇒ P74

**2-11.PL DATA**

Show the pyrolyzer data when the pyrolyzer unit (PLU-70) is used.

- ○ ○ ○



→ SET

For information on Pyrolyzer Data Display, see "PLU-70 Operating Manual".

**2-12.FAULT**

This is used (by the manufacturer) to investigate and analyze the causes of faults. This is not used by the user.

- ○ ○ ○



**2-13.F MODE**

Changes to the factory mode. This is not used by the user.

- ○ ○ ○

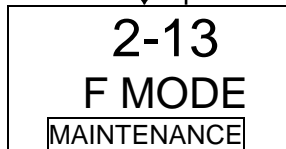

To 2-0.GAS TEST

# 9-1 Environmental Setting 1 "2-9"

The Environmental Setting 1 menu allows you to view and/or change operation settings.

## Environmental Setting 1

From Detection Mode, press and hold the MODE key for three seconds.

PW    A1    A2    F  
           

LCD  
 0.0ppm  
 SIH4



1-8.M MODE

Press the ▲ key until the Maintenance Mode screen displays. (For GD-70D-EA units, the Maintenance Mode screen is item 1-9.)

1- 8  
 M MODE  
 MAINTENANCE



User Mode

In "1-8.M MODE", press the SET key.

1- 8  
 M MODE  
 MAINTENANCE



Then press and hold the SET key again for three seconds.

- - - -  
 M MODE  
 MAINTENANCE



2-0.GAS TEST

The first item in Maintenance Mode will display.

2- 0  
 GAS TEST  
 MAINTENANCE



2-9.SETTING1

Press the ▼ key until the SETTING1 screen displays.

2- 9  
 SETTING1  
 MAINTENANCE

Press the SET key.



SET 0.INHIBIT

Select either **ON** or **OFF**, and then press the SET key to confirm the selection. When ON is selected, the message **INHIBIT** is displayed on the LCD. Any alarms triggered in Detection Mode are not communicated to the relays or to the 4-20 mA output.

SET 0  
 INHIBIT  
 MAINTENANCE

⇔ SET

OFF  
 INHIBIT  
 MAINTENANCE

▲ ↓ ↑ ▼

ON  
 INHIBIT  
 MAINTENANCE  
 INHIBIT

▲ ↓ ↑ ▼

**SET 1. ALM P**

Change the alarm setpoints.

- 
- 
- 
- 



⇔ SET

Alarm Value Setting  
⇒P71

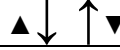

**SET 2. ALM DLY**

Set the alarm delay time. Use the ▲ or ▼ key to change the value (in seconds), and then press the SET key to confirm the value.

- 
- 
- 
- 



⇔ SET



**SET 3. MAINTE**

This is used to stop the pump (useful for pump replacement). Press the SET key to stop the pump. Press the SET key again to restart the pump. (You can also press the MODE key to exit this menu and restart the pump.)

- 
- 
- 
- 



⇔ SET



Pump Stop  
(Drive Sound Stop)



**SET 4. F TEST**

Perform a fault alarm test.

- 
- 
- 
- 



⇔ SET

Fault Alarm Test  
⇒P73



To  
SET 0. INHIBIT Setting

## 9-2 Alarm Value Setting "2-9" - "SET 1"

### Alarm Value Setting

From Detection Mode, press and hold the MODE key for three seconds.

PW A1 A2 F

- 
- 
- 
- 

LCD

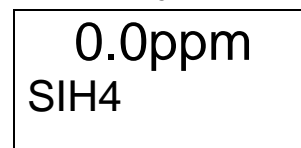

**1-8.M MODE**

Press the ▲ key until the Maintenance Mode screen displays. (For GD-70D-EA units, the Maintenance Mode screen is item 1-9.)

- 
- 
- 
- 

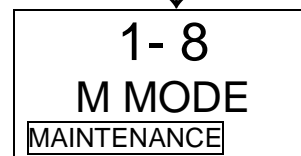

**User Mode**

In "1-8.M MODE", press the SET key.

- 
- 
- 
- 

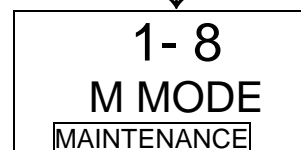

Then press and hold the SET key again for three seconds.



↓

**2-0.GAS TEST**  
The first item in Maintenance Mode will display.



↓

**2-9. SETTING1**  
Press the ▲ key until the **SETTING1** screen displays.



Press the SET key.

↓

**SET 1.AL M P**  
Press the ▼ key until the **AL M P** screen displays.



↓

**SET 1.AL M P**  
Press the SET key.



↓

**First Alarm Value Setting**  
Use the ▲ or ▼ key to change the setpoint. Press the SET key to confirm the value. (Press the MODE key to skip this menu.)

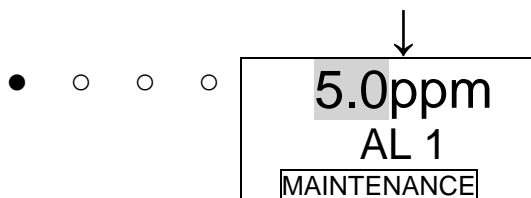

↓

**Second Alarm Value Setting**  
Use the ▲ or ▼ key to change the setpoint. Press the SET key to confirm the value. (Press the MODE key to skip this menu.)

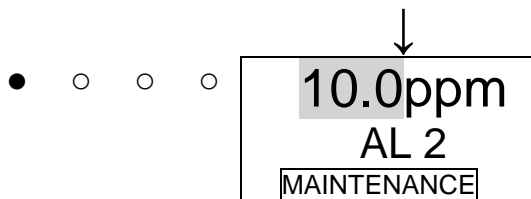

↓

Return to  
**SET 1.AL M P**



## 9-3 Fault Alarm Test "2-9" - "SET 4"

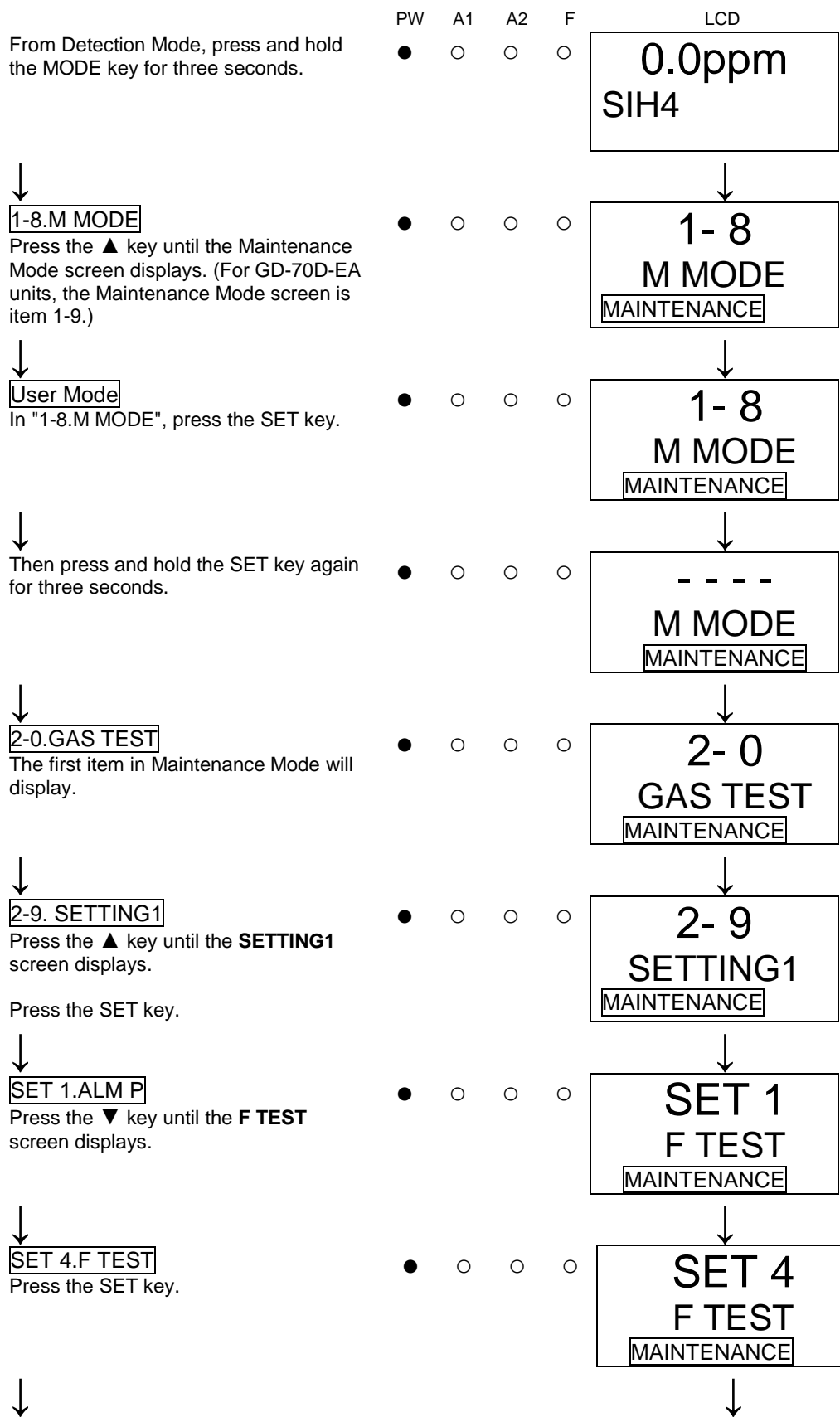

**Fault Test ON/OFF**

With **ON** displayed, press the SET key to activate the fault alarm.  
With **OFF** displayed, press the SET key to deactivate the fault alarm.  
(You can also press the MODE key to cancel this menu and go back to the original state.)

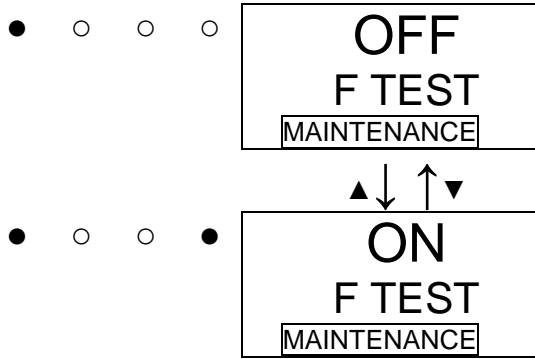

**WARNING**

Because the contact (fault) can be activated only by a fault alarm test in Maintenance Mode, be careful to perform the test. The fault alarm test cannot be performed during inhibit.

## 9-4 Environmental Setting 2 "2-10"

The Environmental Setting 2 menu allows you to view and/or change function settings. (\* It is recommended that any setting changes made be recorded in a log.)

Settings found in the Environmental Setting 2 menu are factory set and do not normally need to be changed. Be careful not to change these settings by mistake.

### Environmental Setting 2

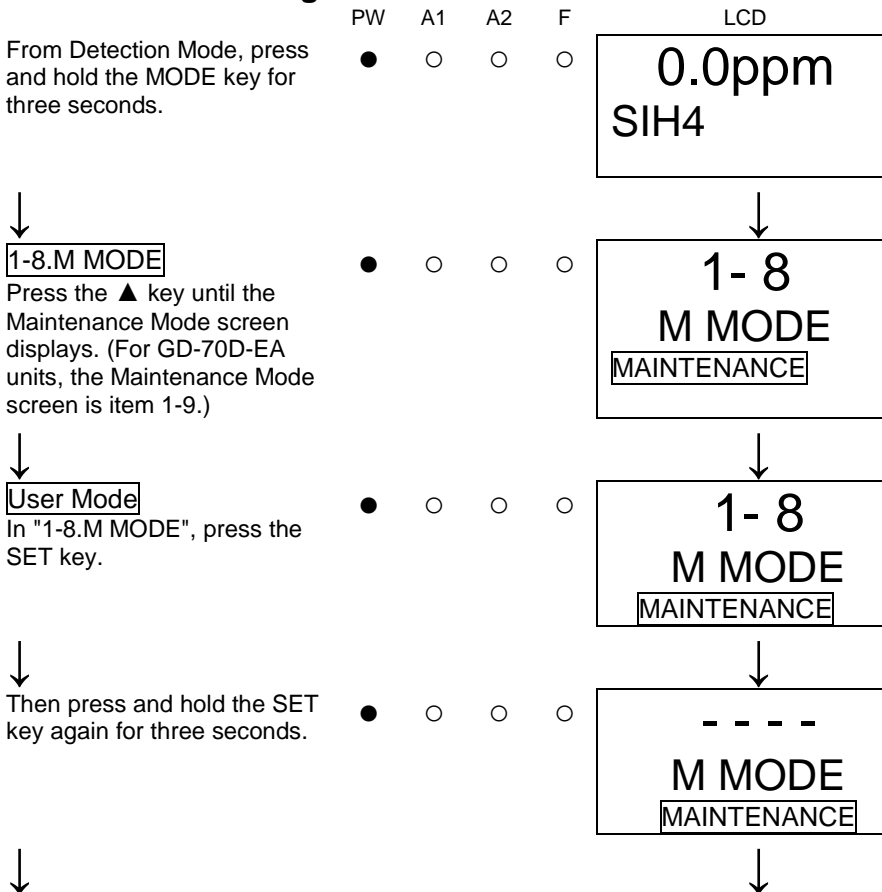

**2-0.GAS TEST**

The first item in Maintenance Mode will display.

- ○ ○ ○



**2-10. SETTING2**

Press the ▲ key until the **SETTING2** screen displays.

- ○ ○ ○

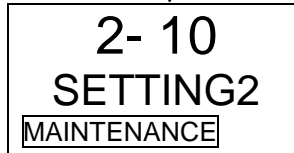

Press the SET key.



**SET 0. ADDRESS**

Set the address for GD-70D-NT units.

Select the number by pressing the ▲ or ▼ key, and then press the SET key to confirm the address.

- ○ ○ ○



↔ SET



**SET 1.DAY TIME**

Set the date/time of the main unit.

- ○ ○ ○



↔ SET

Date/Time Setting  
⇒P79

**SET 2.SUPPRESS**

Set the suppression value.

Select the number by pressing the ▲ or ▼ key, and then press the SET key to confirm the value.

- ○ ○ ○

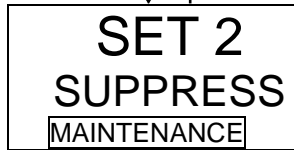

↔ SET



**SET 3. SUP TYPE**

Set the suppression system. Select either **CUT** or **SLOPE**, and then press the SET key to confirm the selection.

When **CUT** is selected, the display will jump up to the gas reading as soon as it exceeds the suppression value. When **SLOPE** is selected, the display will ramp up to the gas reading once it exceeds the suppression value.

- ○ ○ ○

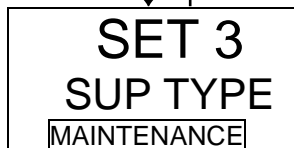

↔ SET

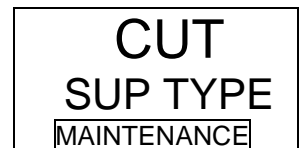

**SET 4. TEST RLY**

Set the contact activation for an alarm test.

Select either **ON** or **OFF**, and then press the SET key to confirm the selection.

When **ON** is selected, the contact can be activated even during an alarm test.

- ○ ○ ○



↔ SET

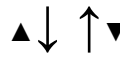

**SET 5.TEST4-20**

Set the external output for an alarm test.

Select either **ON** or **OFF**, and then press the SET key to confirm the selection.

When **ON** is selected, the output follows the reading even during an alarm test. When **OFF** is selected, the output is what it was right before entering alarm test mode.

\* When **4 - 20 mA** is selected in **SET 15**, the 4-20 mA output is generated during an alarm test regardless of this **TEST4-20** setting.

- ○ ○ ○

SET 5  
TEST4-20  
MAINTENANCE

⇔  
SET

ON  
TEST4-20  
MAINTENANCE

▲ ↓ ↑ ▼

OFF  
TEST4-20  
MAINTENANCE

▲ ↓ ↑ ▼

**SET 6.RLY PTRN**

Select either energized/de-energized for the contact. (De-energized by default)

- ○ ○ ○

SET 6  
RLY PTRN  
MAINTENANCE

⇔  
SET

Energized/De-  
Energized Contact  
Setting

⇒P81

▲ ↓ ↑ ▼

**SET 7.ALM TYPE**

Set the alarm type.

When the galvanic cell type (OSU) is installed, you can select either **L-LL** (both alarms decreasing), **L-H** (alarm 1 decreasing, alarm 2 increasing), or **H-HH** (both alarms increasing).

- ○ ○ ○

SET 7  
ALM TYPE  
MAINTENANCE

⇔  
SET

L-LL  
ALM TYPE  
MAINTENANCE

▲ ↓ ↑ ▼

L-H  
ALM TYPE  
MAINTENANCE

▲ ↓ ↑ ▼

H-HH  
ALM TYPE  
MAINTENANCE

▲ ↓ ↑ ▼

**SET 8.ALM PTRN**

This is a setting screen of the gas alarm activation. Do not change the setting when the detector is used in a normal way, because it determines how the detector functions. (Auto-reset setting: "nL" by default)

- ○ ○ ○

SET 8  
ALM PTRN  
MAINTENANCE

▲ ↓ ↑ ▼

**SET 9.AL LIMIT**

This is a setting screen of the alarm value limiter. Do not change the setting when the detector is used in a normal way. (**ON** by default)

- ○ ○ ○

SET 9  
AL LIMIT  
MAINTENANCE

▲ ↓ ↑ ▼

**SET 10. FLT PTRN**

This is a setting screen of the fault alarm activation. Do not change the setting when the detector is used in a normal way, because it determines how the detector functions. (Auto-reset setting: "nL" by default)

- ○ ○ ○



**SET 11. AT FLOW**

Set the flow rate auto-adjustment. Select either **ON** or **OFF**, and then press the SET key to confirm the selection. When **ON** is selected, the flow rate auto-adjustment is activated.

- ○ ○ ○

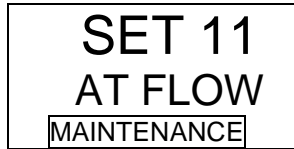

⇔ SET

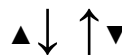

**SET 12. ZERO F**

Set the zero follower when the electrochemical type (ESU), pyrolysis-particle type (SSU), new ceramic type (NCU), or NDIR type (IRU) sensor is installed. Select either **ON** or **OFF**, and then press the SET key to confirm the selection. When **ON** is selected, the zero follower function is activated. \* When SSU is installed, you must select **ON**.

- ○ ○ ○



⇔ SET

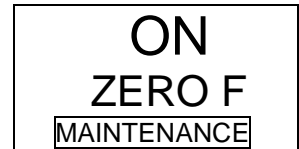

**SET 13. ZERO 24F**

This is a supplemental setting screen for the above zero follower function. (A setting to determine whether the first-24-hour zero follower will be performed after the power is turned on.) Do not change the setting when the detector is used in a normal way. (**ON** by default)

- ○ ○ ○



**SET 14. S ASSIST**

Set the sensitivity correction when the electrochemical type (ESU) is installed. Select either **ON** or **OFF**, and then press the SET key to confirm the selection. When **ON** is selected, the sensitivity correction function is activated.

- ○ ○ ○



⇔ SET

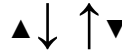
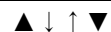

**SET 15. MNT OUT**

Set the external output for Maintenance Mode. Select either **2.5 mA**, **4.0 mA**, **HOLD** (previous value), or **4 - 20 mA** (tracks display value), and then press the SET key to confirm the selection.

- ○ ○ ○

**SET 15**  
**MNT OUT**  
MAINTENANCE

⇔  
SET

**2.5mA**  
**MNT OUT**  
MAINTENANCE

▲ ↓ ↑ ▼

**4.0mA**  
**MNT OUT**  
MAINTENANCE

▲ ↓ ↑ ▼

**HOLD**  
**MNT OUT**  
MAINTENANCE

▲ ↓ ↑ ▼

**4-20mA**  
**MNT OUT**  
MAINTENANCE

▲ ↓ ↑ ▼

**SET 16.MA 4-20**

Adjust the external output (4 - 20 mA). Adjust the output (%) by pressing the ▲ or ▼ key, and then press the SET key to confirm the value. (It must be adjusted to the upper unit or the ammeter.) After adjustment of 4 mA is completed, perform the adjustment of 20 mA. (Press the MODE key to exit menu after entering.)

- ○ ○ ○

**SET 16**  
**MA 4-20**  
MAINTENANCE

⇔  
SET

**100%**  
**4MA ADJ**  
MAINTENANCE

↓

**100%**  
**20MA ADJ**  
MAINTENANCE

▲ ↓ ↑ ▼

**SET 17.BK LIGHT**

Set the backlight. Select either **ON** or **SAVE**, and then press the SET key to confirm the selection. When **ON** is selected, the backlight is on continuously. When **SAVE** is selected, the backlight is normally off, but turns on during an operation or event.

- ○ ○ ○

**SET 17**  
**BK LIGHT**  
MAINTENANCE

⇔  
SET

**ON**  
**BK LIGHT**  
MAINTENANCE

▲ ↓ ↑ ▼

**SAVE**  
**BK LIGHT**  
MAINTENANCE

▲ ↓ ↑ ▼

**SET 18. ETHERNET**

This is a setting screen of the ETHERNET setting. This is not used for the detector.

- ○ ○ ○

**SET 18**  
**ETHERNET**  
MAINTENANCE

▲ ↓ ↑ ▼

**SET 19.PUMP CK**

Set the pump drive level diagnosis. Select either **ON** or **OFF**, and then press the SET key to confirm the selection. When **ON** is selected, the message "FLOW" is displayed if the flow rate is sufficient even though the pump drive level is low. (A function to check the conditions for applying pressure, etc.)

● ○ ○ ○

SET 19  
PUMP CK  
MAINTENANCE

↔ SET

ON  
PUMP CK  
MAINTENANCE

▲ ↓ ↑ ▼

OFF  
PUMP CK  
MAINTENANCE

▲ ↓ ↑ ▼

To

SET 0. ADDRESS

## 9-5 Date/Time Setting "2-10" - "SET 1"

### Date/Time Setting

From Detection Mode, press and hold the MODE key for three seconds.

PW A1 A2 F LCD

● ○ ○ ○

0.0ppm  
SIH4

↓

**1-8.M MODE**

Press the ▲ key until the Maintenance Mode screen displays. (For GD-70D-EA units, the Maintenance Mode screen is item 1-9.)

● ○ ○ ○

1- 8  
M MODE  
MAINTENANCE

↓

**User Mode**

In "1-8.M MODE", press the SET key.

● ○ ○ ○

1- 8  
M MODE  
MAINTENANCE

↓

Then press and hold the SET key again for three seconds.

● ○ ○ ○

- - - -  
M MODE  
MAINTENANCE

↓

**2-0.GAS TEST**

The first item in Maintenance Mode will display.

● ○ ○ ○

2- 0  
GAS TEST  
MAINTENANCE

↓

**2-10. SETTING2**

Press the ▲ key until the **SETTING2** screen displays.

● ○ ○ ○

2- 10  
SETTING2  
MAINTENANCE

Press the SET key.



**SET 1.DAY TIME**  
Press the SET key.

● ○ ○ ○

↓  
**SET 1  
DAY TIME**  
**MAINTENANCE**



**Date/Time Setting Display**  
Press the SET key.

● ○ ○ ○

↓  
**12:00**  
**2009.01.01**  
**MAINTENANCE**

**Year Setting**

Select the number by pressing the ▲ or ▼ key, and then press the SET key to confirm the value.

● ○ ○ ○

↓  
**12:00**  
**2009.01.01**  
**MAINTENANCE**

**Month Setting**

Select the number by pressing the ▲ or ▼ key, and then press the SET key to confirm the value.

● ○ ○ ○

↓  
**12:00**  
**2009.01.01**  
**MAINTENANCE**

**Date Setting**

Select the number by pressing the ▲ or ▼ key, and then press the SET key to confirm the value.

● ○ ○ ○

↓  
**12:00**  
**2009.01.01**  
**MAINTENANCE**

**Hour Setting**

Select the number by pressing the ▲ or ▼ key, and then press the SET key to confirm the value.

● ○ ○ ○

↓  
**12:00**  
**2009.01.01**  
**MAINTENANCE**

**Minute Setting**

Select the number by pressing the ▲ or ▼ key, and then press the SET key to confirm the value.

● ○ ○ ○

↓  
**12:00**  
**2009.01.01**  
**MAINTENANCE**

↓  
Return to

**SET 1.DAY TIME**

\* In the Date/Time Setting mode, press the MODE key to cancel the changes and go back to the previous setting.



# 9-6 Energized/De-Energized Contact Setting "2-10" - "SET 6"

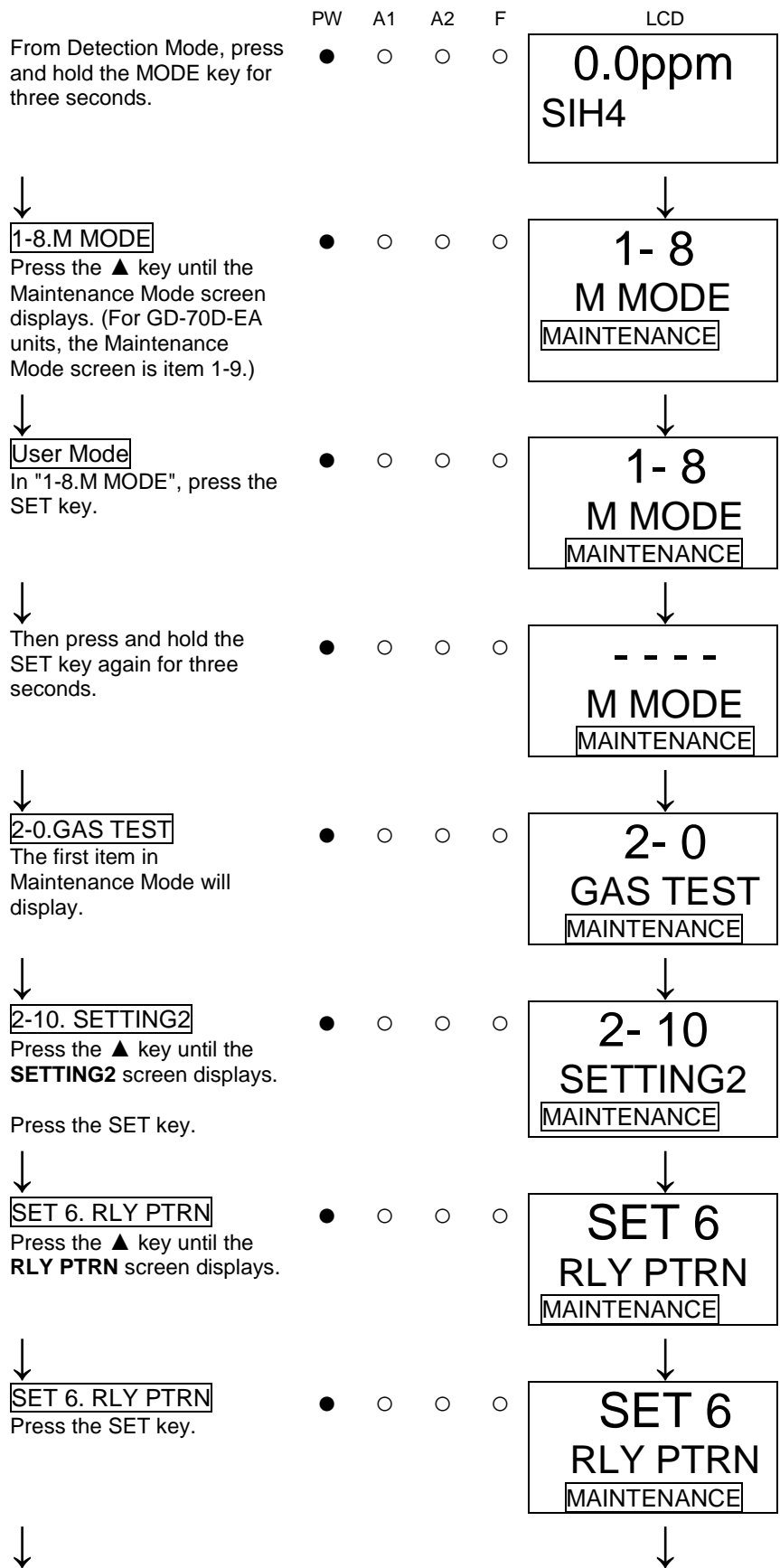

---

First Alarm Contact

Setting

Select either **nd**(De-Energized)/**nE**(Energized), and then press the SET key to confirm the selection. (Press the MODE key to skip this menu.)  
Factory setting is **nd**.



nd  
AL1 RLY  
MAINTENANCE



nE  
AL1 RLY  
MAINTENANCE



Second Alarm Contact

Setting

Select either **nd** (De-Energized)/**nE** (Energized), and then press the SET key to confirm the selection. (Press the MODE key to skip this menu.)  
Factory setting is **nd**.



nd  
AL2 RLY  
MAINTENANCE



nE  
AL2 RLY  
MAINTENANCE



Fault Alarm Contact

Setting

Select either **nd** (De-Energized)/**nE** (Energized), and then press the SET key to confirm the selection. (Press the MODE key to skip this menu.)  
Factory setting is **nd**.



nd  
FLT RLY  
MAINTENANCE



nE  
FLT RLY  
MAINTENANCE



Return to  
SET 6. RLY  
PTRN

---

## NOTE

When De-energized (**nd**) is selected, the relay is energized and activated during an alarm condition (de-energized during normal operation).

- When the alarm contacts are configured as normally open, the contacts are open during normal operation and closed during an alarm condition.
- When the alarm contacts are configured as normally closed, the contacts are closed during normal operation and open during an alarm condition.

When Energized (**nE**) is selected, the relay is energized during normal operation (de-energized during an alarm condition).

- When the alarm contacts are configured as normally open, the contacts are closed during normal operation and open during an alarm condition. They close if the power is turned OFF.
  - When the alarm contacts are configured as normally closed, the contacts are open during normal operation and closed during an alarm condition.
-

# 9-7 ETHERNET Setting "2-10" - "SET 18"

<ETHERNET Setting>

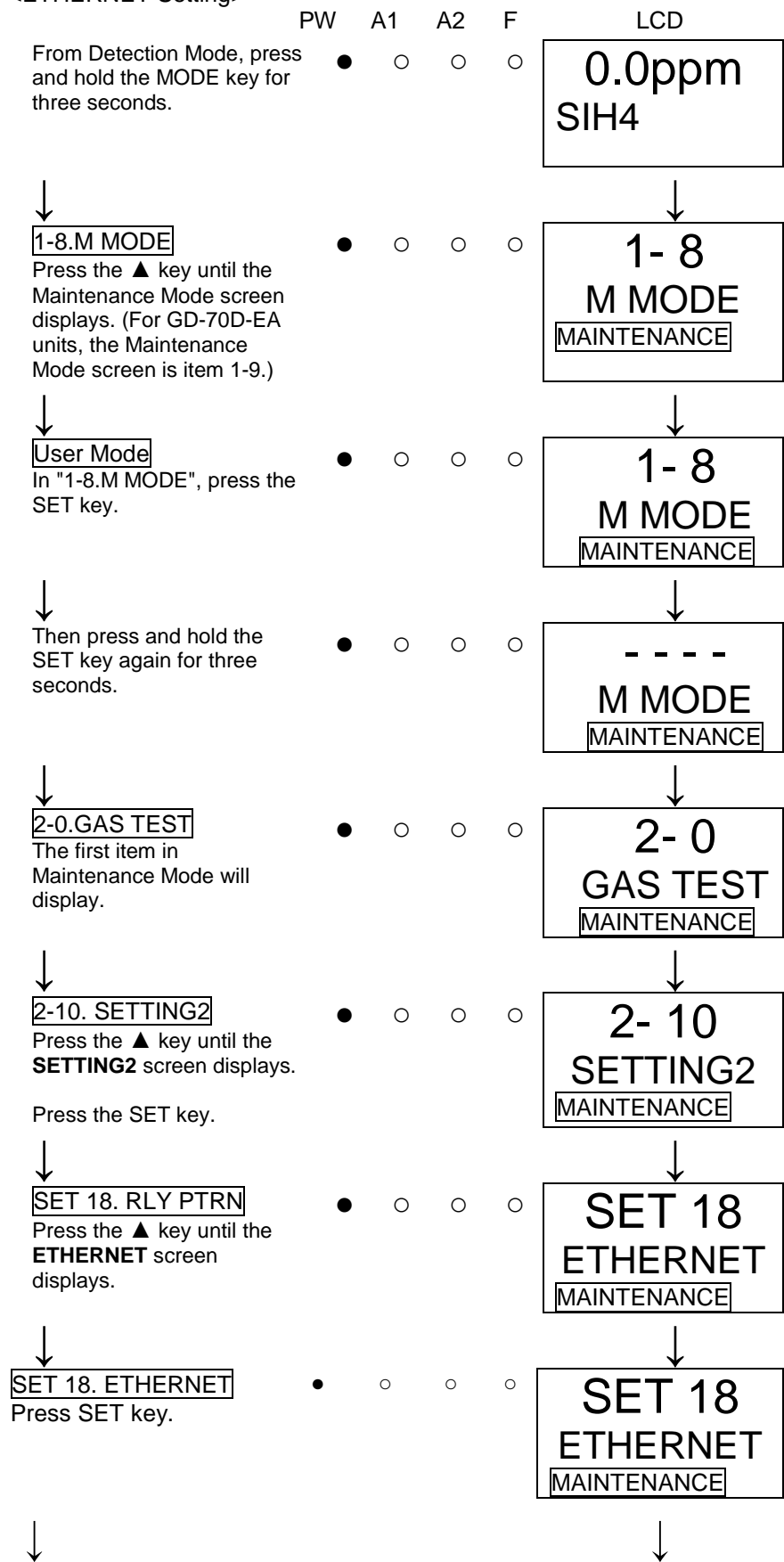

**MAC Address Check**

There are MAC addresses from MAC1 to MAC6. Select one using ▲ and ▼ keys and display them one by one in the same way.  
\* MAC addresses are fixed values unique to the unit.

- ○ ○ ○ ○

00  
MAC 1  
MAINTENANCE



(MAC2 -  
MAC6)

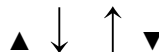

**IP Address Setting**

Change the value by pressing the ▲ or ▼ key, and then press the SET key to confirm the value.

- ○ ○ ○ ○

0  
IP 1  
MAINTENANCE

⇔  
SET

255  
IP 1  
MAINTENANCE



(IP2 - IP4)

There are IP addresses from IP1 to IP4. Select one using ▲ and ▼ keys and set them one by one in the same way.



**Subnet Mask Setting**

Change the value by pressing the ▲ or ▼ key, and then press the SET key to confirm the value.

- ○ ○ ○ ○

0  
SUB 1  
MAINTENANCE

⇔  
SET

255  
SUB 1  
MAINTENANCE



(SUB2 -  
SUB4)

There are subnet masks from SUB1 to SUB4. Select one using ▲ and ▼ keys and set them one by one in the same way.



**Default Gateway Setting**

Change the value by pressing the ▲ or ▼ key, and then press the SET key to confirm the value.

- ○ ○ ○ ○

0  
DEF 1  
MAINTENANCE

⇔  
SET

255  
DEF 1  
MAINTENANCE



(DEF2 - DEF4)

There are default gateways from DEF1 to DEF4. Select one using ▲ and ▼ keys and set them one by one in the same way.

### DHCP Setting

Select either ON/OFF, and then press the SET key to confirm the selection.

When ON is selected, an IP address is automatically obtained from the DHCP server. In this case, the IP1 to IP4, SUB1 to SUB4, and DEF1 to DEF4 settings are disabled.

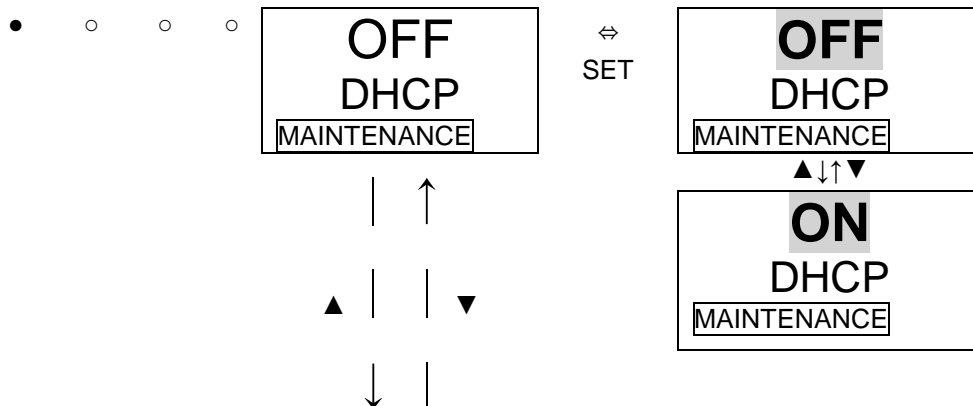

### PLC Mode Setting

Change the value by pressing the ▲ or ▼ key, and then press the SET key to confirm the value.

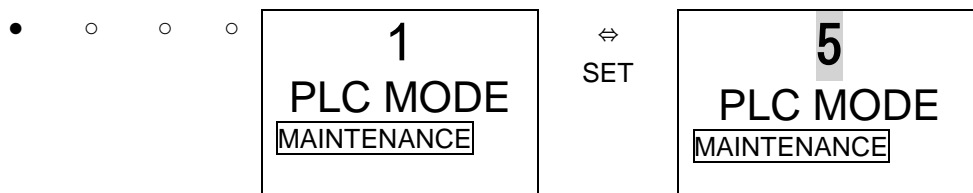

### PLC Area Setting

Change the value by pressing the ▲ or ▼ key, and then press the SET key to confirm the value.



### Setting Result Record

To record the results of the settings made in the above, press the SET key.

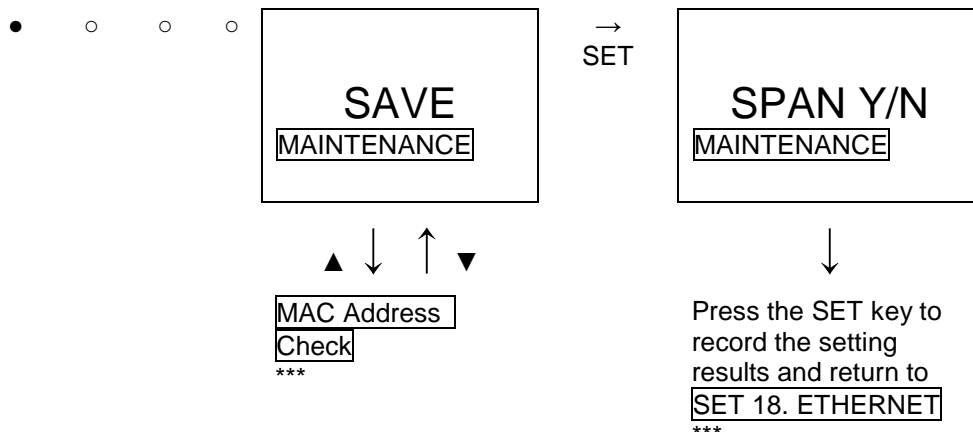

\* In ETHERNET mode, it is necessary to record setting results after all the settings have been selected. Press the MODE key before completion to undo all the changes that have been made.

## NOTE

It takes 10 seconds or more for the address settings to be recorded and for the settings to take effect on the system. (Particularly for DHCP, the time it takes depends on the environment.) While the settings are putting into effect, "0" is displayed for all of MAC1 - 6, IP1 - 4, SUB1 - 4 and DEF1 - 4, and none of the Ethernet functions is available.

---



---

# 10

## Maintenance

---

This is a critical instrument for incident prevention and safety.  
 To maintain the performance of the detector and improve its reliability, perform regular maintenance.

### NOTE

To use the pyrolyzer unit (PLU-70), also refer to the individual operating manual.

---

### 10-1 Maintenance intervals and items

- Daily maintenance: perform maintenance before beginning to work.
- Monthly maintenance: perform maintenance on the alarm circuit (alarm test) once a month.
- Regular maintenance: perform maintenance once every six months.

Task	Description	Daily	Monthly	Biannually
Power supply check	Verify that the power lamp lights up.	○	○	○
Concentration display check	Verify that the gas reading is zero (or 20.9 vol% for oxygen). If the reading is not zero (or 20.9 vol%), perform a zero adjustment.	○	○	○
Flow rate check	See the flow rate indicator to check for abnormalities.	○	○	○
Filter check	Check the dust filter for dust or clogging.	○	○	○
Alarm test	Inspect the alarm circuit by using the alarm test function.		○	○
Span adjustment	Perform a span adjustment using calibration gas.			○
Gas alarm check	Check alarm operation using calibration gas.			○

### 10-2 Calibration Overview

Calibration instructions depend on the GD-70D you are calibrating. The table below will tell you what calibration instructions to use based on your GD-70D's detection gas and range.

Detection Gas	Range	Calibration Instructions
AsH3 (Arsine)	0 - 0.20 ppm	Calibrating with a Surrogate Gas (Sensors with Factors) on page 93
B2H6 (Diborane)	0 - 0.30 ppm	Calibrating with a Surrogate Gas (Sensors with Factors) on page 93
BCl3 (Boron trichloride)	0 - 15.0 ppm	Calibrating with a Gas Bag (Calibrating with HCl) on page 99

Detection Gas	Range	Calibration Instructions
Br <sub>2</sub> (Bromine)	0 - 1.00 ppm	Calibrating with a Surrogate Gas (Sensors with Factors) on page 93
BTBAS (Bis[tertiary-butyl-amino]silane)	0 - 15.0 ppm	Calibrating with a Surrogate Gas (Sensors with Factors) on page 93
C <sub>2</sub> H <sub>2</sub> (Acetylene)	0 - 2,000 ppm	Calibrating with a Humidifier (MOS Sensors) on page 103
C <sub>2</sub> H <sub>2</sub> Cl <sub>2</sub> (Dichloroethene)	0 - 600 ppm	Calibrating with a Humidifier (MOS Sensors) on page 103
C <sub>2</sub> H <sub>4</sub> (Ethylene)	0 - 2,000 ppm	Calibrating with a Humidifier (MOS Sensors) on page 103
C <sub>2</sub> H <sub>5</sub> OH (Ethanol)	0 - 2,000 ppm	Calibrating with a Humidifier (MOS Sensors) on page 103
C <sub>3</sub> H <sub>6</sub> (Propylene)	0 - 5,000 ppm	Calibrating with a Humidifier (MOS Sensors) on page 103
C <sub>3</sub> H <sub>8</sub> (Propane)	0 - 2,000 ppm	Calibrating with a Humidifier (MOS Sensors) on page 103
	0 - 5,000 ppm	
	0 - 100% LEL	Calibrating with on page 90
C <sub>4</sub> F <sub>6</sub> (Hexafluorabutadiene)	0 - 200 ppm	Calibrating with a Humidifier (MOS Sensors) on page 103
C <sub>4</sub> H <sub>10</sub> (Isobutane)	0 - 100 %LEL	Calibrating with a Demand Flow Regulator on page 90
C <sub>6</sub> H <sub>14</sub> (Hexane)	0 - 2,000 ppm	Calibrating with on page 90
CH <sub>2</sub> Cl <sub>2</sub> (Dichloromethane)	0 - 2,000 ppm	Calibrating with a Humidifier (MOS Sensors) on page 103
CH <sub>3</sub> CN (Acetonitrile)	0 - 2,000 ppm	Calibrating with a Humidifier (MOS Sensors) on page 103
CH <sub>3</sub> COOH (Acetic acid)	0 - 30.0 ppm	Calibrating with a Surrogate Gas (Sensors with Factors) on page 93
CH <sub>3</sub> NH <sub>2</sub> (Methylamine)	0 - 15.0 ppm	Calibrating with a Surrogate Gas (Sensors with Factors) on page 93
CH <sub>3</sub> OH (Methanol)	0 - 1,000 ppm	Calibrating with a Humidifier (MOS Sensors) on page 103
	0 - 2,000 ppm	
CH <sub>4</sub> (Methane)	0 - 100 %LEL	Calibrating with a Demand Flow Regulator on page 90
	0 - 2% vol	Calibrating with a Humidifier (MOS Sensors) on page 103
	0 - 2000 ppm	
	0 - 5000 ppm	
CH <sub>6</sub> Si (Methyl silane)	0 - 20.0 ppm	Calibrating with a Surrogate Gas (Sensors with Factors) on page 93
Cl <sub>2</sub> (Chlorine)	0 - 3.00 ppm	Calibrating with a Demand Flow Regulator on page 90
ClF <sub>3</sub> (Chlorine trifluoride)	0 - 0.60 ppm	Calibrating with a Surrogate Gas (Sensors with Factors) on page 93
CO (Carbon monoxide)	0 - 75.0 ppm	Calibrating with a Demand Flow Regulator on page 90
	0 - 150 ppm	
	0 - 300 ppm	
COS (Carbonyl sulfide)	0 - 2,000 ppm	Calibrating with a Humidifier (MOS Sensors) on page 103
	0 - 90.0 ppm	Calibrating a Pyrolyzer Unit on page 107

Detection Gas	Range	Calibration Instructions
COF2 (Cobalt difluorine)	0 - 6.00 ppm	Calibrating with a Surrogate Gas (Sensors with Factors) on page 93
DEA (Diethylamine)	0 - 15.0 ppm	Calibrating with a Surrogate Gas (Sensors with Factors) on page 93
DMA (Dimethylamine)	0 - 15.0 ppm	Calibrating with a Surrogate Gas (Sensors with Factors) on page 93
F2 (Fluorine)	0 - 1.00 ppm	Calibrating with a Surrogate Gas (Sensors with Factors) on page 93
	0 - 3.00 ppm	
GeH4 (Germane)	0 - 0.80 ppm	Calibrating with a Surrogate Gas (Sensors with Factors) on page 93
H2 (Hydrogen)	0 - 100 %LEL	Calibrating with a Demand Flow Regulator on page 90
	0 - 2.00 %volume	Calibrating with a Humidifier (MOS Sensors) on page 103
	0 - 500 ppm	
	0 - 1,000 ppm	
	0 - 2,000 ppm	
	0 - 4,000 ppm	
H2Cl2Si (Dichlorosilane)	0 - 15.0 ppm	Calibrating with a Gas Bag (Calibrating with HCl) on page 99
H2O2 (Hydrogen peroxide)	0 - 3.00 ppm	Calibrating with a Surrogate Gas (Sensors with Factors) on page 93
H2S (Hydrogen sulfide)	0 - 1.00 ppm	Calibrating with a Demand Flow Regulator on page 90
	0 - 30.0 ppm	
H2Se (Hydrogen selenide)	0 - 0.20 ppm	Calibrating with a Surrogate Gas (Sensors with Factors) on page 93
H9NSi3 (Trisilylamine)	0 - 15.0 ppm	Calibrating with a Surrogate Gas (Sensors with Factors) on page 93
HBR (Hydrogen bromide)	0 - 6.00 ppm	Calibrating with a Gas Bag (Calibrating with HCl) on page 99
	0 - 9.00 ppm	
HCl (Hydrogen chloride)	0 - 6.00 ppm	Calibrating with a Gas Bag (Calibrating with HCl) on page 99
	0 - 15.0 ppm	
HCN (Hydrogen cyanide)	0.9 - 15.0 ppm	Calibrating with a Demand Flow Regulator on page 90
HCOOH (Formic acid)	0 - 15.0 ppm	Calibrating with a Surrogate Gas (Sensors with Factors) on page 93
HF (Hydrogen fluoride)	0.4 - 3.00 ppm	Calibrating with a Surrogate Gas (Sensors with Factors) on page 93
	0.4 - 9.00 ppm	
HNO3 (Nitric acid)	0 - 20.0 ppm	Calibrating with a Surrogate Gas (Sensors with Factors) on page 93



Detection Gas	Range	Calibration Instructions
IPA (Isopropyl alcohol)	0 - 2,000 ppm	Calibrating with a Humidifier (MOS Sensors) on page 103
	0 - 100 %LEL	Calibrating with a Surrogate Gas (Sensors with Factors) on page 93
N2O (Nitrous oxide)	0 - 500 ppm	Calibrating with a Demand Flow Regulator on page 90
N2H4 (Hydrazine)	0 - 5.00 ppm	Calibrating with a Surrogate Gas (Sensors with Factors) on page 93
NF3 (Nitrogen trifluoride)	0 - 30.0 ppm	Calibrating a Pyrolyzer Unit on page 107
NH3 (Ammonia)	0 - 75.0 ppm	Calibrating with a Demand Flow Regulator on page 90
NO (Nitric oxide)	0 - 100 ppm	Calibrating with a Demand Flow Regulator on page 90
NO2 (Nitrogen dioxide)	0 - 9.00 ppm	Calibrating with a Demand Flow Regulator on page 90
	0 - 15.0 ppm	
O2 (Oxygen)	0 - 5.00%	Calibrating with a Demand Flow Regulator on page 90
	0 - 25.0%	Calibrating with a Demand Flow Regulator on page 90
O3 (Ozone)	0 - 0.60 ppm	Calibrating with a Surrogate Gas (Sensors with Factors) on page 93
	0 - 1.00 ppm	
PH3 (Phosphine)	0 - 1.00 ppm	Calibrating with a Demand Flow Regulator on page 90
R32 (Difluoromethane)	0 - 2,000 ppm	Calibrating with a Humidifier (MOS Sensors) on page 103
	0 - 5,000 ppm	
	0 - 9,000 ppm	
R41 (Fluoromethane)	0 - 2,000 ppm	Calibrating with a Humidifier (MOS Sensors) on page 103
TEOS (Tetraethyl orthosilicate)	0 - 15.0 ppm	Calibrating a Pyrolyzer Unit on page 107
TMA (Trimethylamine)	0 - 15.0 ppm	Calibrating with a Surrogate Gas (Sensors with Factors) on page 93
TMB (Trimethoxy borane)	0 - 1000 ppm	Calibrating a Pyrolyzer Unit on page 107
TMS (Tetramethyl silane)	0 - 15.0 ppm	Calibrating a Pyrolyzer Unit on page 107
TRIMS (Trimethyl silane)	0 - 15.0 ppm	Calibrating a Pyrolyzer Unit on page 107
Si2H6 (Disilane)	0 - 15.0 ppm	Calibrating with a Surrogate Gas (Sensors with Factors) on page 93
SiCl4 (Silicon tetrachloride)	0 - 15.0 ppm	Calibrating with a Gas Bag (Calibrating with HCl) on page 99
SiH4 (Silane)	0 - 15.0 ppm	Calibrating with a Demand Flow Regulator on page 90
SO2 (Sulphur dioxide)	0 - 6.00 ppm	Calibrating with a Demand Flow Regulator on page 90

## 10-3 Calibrating with the Target Gas

The calibration instructions in this section apply ONLY to the sensors listed in the table below. If your sensor is not listed in the table below, you will need to follow the instructions outlined in one of the other calibration sections. The warm up times listed are the minimum times between powering up a GD-70D and calibrating that GD-70D.

Detection Gas	Range	Calibration Gas/Concentration	Warm Up Time After Power-Up
C3H8 (Propane)	0 - 100 %LEL	Propane: 50% LEL	2 hours
C4H10 (Isobutane)	0 - 100 %LEL	Isobutane: 50% LEL	2 hours
C6H14 (Hexane)	0 - 100 %LEL	Hexane: 50% LEL	2 hours
CH4 (Methane)	0 - 100 %LEL	Methane: 50% LEL	2 hours
Cl2 (Chlorine)	0 - 3.00 ppm	Chlorine: 2 ppm	3 hours
CO (Carbon monoxide)	0 - 75.0 ppm	Carbon monoxide: 50 ppm	3 hours
	0 - 150 ppm	Carbon monoxide: 100 ppm	3 hours
	0 - 300 ppm	Carbon monoxide: 200 ppm	3 hours
H2 (Hydrogen)	0 - 100 %LEL	Hydrogen (H2): 50% LEL	2 hours
H2S (Hydrogen sulfide)	0 - 1.00 ppm	Hydrogen sulfide (H2S): 1 ppm	3 hours
	0 - 30.0 ppm	Hydrogen sulfide (H2S): 15 ppm	3 hours
HCN (Hydrogen cyanide)	0.9 - 15.0 ppm	Hydrogen cyanide (HCN): 10 ppm	3 hours
N2O (Nitrous oxide)	0 - 500 ppm	Nitrous oxide (NO): 250 ppm	1 hour
NH3 (Ammonia)	0 - 75.0 ppm	Ammonia (NH3): 50 ppm	3 hours
NO (Nitric oxide)	0 - 100 ppm	Nitric oxide (NO): 25 ppm	3 hours
NO2 (Nitrogen dioxide)	0 - 9.00 ppm	Nitrogen dioxide (NO2): 5 ppm	6 hours
	0 - 15.0 ppm	Nitrogen dioxide (NO2): 10 ppm	6 hours
O2 (Oxygen)	0 - 5.00%	Oxygen (O2): 2% for span Nitrogen (N2): 100% for zero	10 minutes
	0 - 25.0%	Fresh air for span Nitrogen (N2): 100% for zero	3 hours
PH3 (Phosphine)	0 - 1.00 ppm	Phosphine (PH3): 0.5 ppm	6 hours
SiH4 (Silane)	0 - 15.0 ppm	Silane (SiH4): 5 ppm	6 hours
SO2 (Sulphur dioxide)	0 - 6.00 ppm	Sulphur dioxide (SO2): 5 ppm	3 hours

### Calibration Equipment

- Demand flow regulator (RKI Instruments, Inc. recommends that you dedicate one regulator each for Cl2 and H2S and that you not use that regulator for any other gas)
- Calibration tubing
- Calibration cylinder of appropriate concentration

### Preparing for Calibration

#### **GAS IN Fitting**

Remove the dust filter and the sample line from the GAS IN fitting's tubing stub.

#### **Regulator**

Screw the demand flow regulator onto the calibration cylinder.

**Accessing Maintenance Mode**

From Detection Mode, press and hold the MODE key for three seconds.

↓  
**1-8.M MODE**

Press the ▲ key until the Maintenance Mode screen displays. (For GD-70D-EA units, the Maintenance Mode screen is item 1-9.)

↓  
**User Mode**

In "1-8.M MODE", press the SET key.

↓  
Then press and hold the SET key again for three seconds.

↓  
**2-0.GAS TEST**

The first item in Maintenance Mode will display.

0.0ppm  
SIH4

↓  
1- 8  
M MODE  
MAINTENANCE

↓  
1- 8  
M MODE  
MAINTENANCE

↓  
- - - -  
M MODE  
MAINTENANCE

↓  
2- 0  
GAS TEST  
MAINTENANCE

**Performing a Zero Adjustment**

**2-1. ZERO**

Press the ▲ key until the **ZERO** screen displays.

Press the SET key.

**Current Concentration Value Display**

Press the SET key to perform the zero adjustment.

**Zero Adjustment Completed**

The instrument will indicate whether the zero adjustment passed (OK) or failed (NG) and will return to **2-1.ZERO** automatically.

2- 1  
ZERO  
MAINTENANCE

↓  
1.1ppm  
ZERO SET  
MAINTENANCE

↓  
0.0ppm  
ZERO OK  
MAINTENANCE

OR

↓  
0.0ppm  
ZERO NG  
MAINTENANCE

Return to **2-1.ZERO**

Return to **2-1.ZERO**

## Performing a Span Adjustment

### 2-2. SPAN

Press the ▲ key until the **SPAN** screen displays.

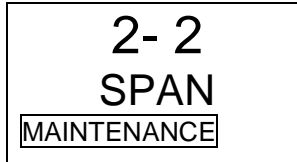

Press the SET key.

### Connect Gas

Use the calibration tubing to connect the demand flow regulator to the tubing stub on the GAS IN fitting. Gas will begin to flow.

Allow gas to flow for 2 minutes.



### Accept Reading

Press the SET key when the reading has stabilized.

\* The reading must be above 10% of the full scale value in order to continue.

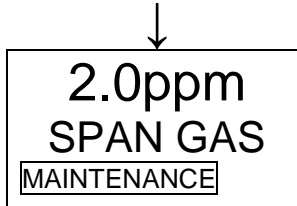



CAUTION

Do not press the SET key before the reading is stabilized.

### Disconnect Gas

Disconnect the calibration tubing from the tubing stub on the GAS IN fitting.



### Span Adjustment

Using the ▲ or ▼ keys, adjust the reading to match the concentration listed on your calibration cylinder.

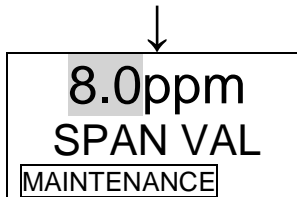

Press the SET key.



### Span Adjustment Completed

The instrument will indicate whether the span adjustment passed (OK) or failed (NG).

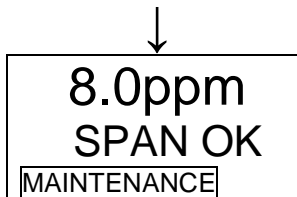

OR



Return to **2-2.SPAN**

### Save Adjustment

To save the adjustment result, press the SET key.  
(Press the MODE key to cancel this menu.)



### Adjustment Completed

After the span has been recorded, the instrument will return to **2-2.SPAN** automatically.

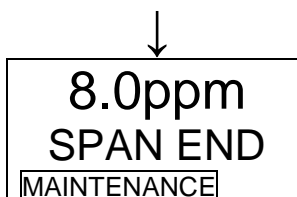



## CAUTION

Exhaust gas must be collected in the exhaust bag or discharged through the exhaust line.

Return to [2-2.SPAN](#)

### Returning to Detection Mode

Store the components of the calibration kit in a safe place.

Reconnect the dust filter and inlet line to the GAS IN fitting.

Press and hold the MODE key to return to Detection Mode.

## 10-4 Calibrating with a Surrogate Gas (Sensors with Factors)

The calibration instructions in this section apply ONLY to the sensors listed in the table below. If your sensor is not listed in the table below, you will need to follow the instructions outlined in one of the other calibration sections. The warm up times listed are the minimum times between powering up a GD-70D and calibrating that GD-70D.

Detection Gas	Range	Calibration Gas/Concentration	Warm Up Time After Power-Up
AsH <sub>3</sub> (Arsine)	0 - 0.20 ppm	Phosphine (PH <sub>3</sub> ): 0.5 ppm**	24 hours
B <sub>2</sub> H <sub>6</sub> (Diborane)	0 - 0.30 ppm	Phosphine (PH <sub>3</sub> ): 0.5 ppm**	24 hours
Br <sub>2</sub> (Bromine)	0 - 1.00 ppm	Chlorine (Cl <sub>2</sub> ): 2 ppm**	3 hours
BTBAS (Bis[tertiary-butyl-amino]silane)	0 - 15.0 ppm	Ammonia (NH <sub>3</sub> ): 5 ppm*	6 hours
CH <sub>3</sub> COOH (Acetic acid)	0 - 30.0 ppm	Chlorine (Cl <sub>2</sub> ): 2 ppm**	3 hours
CH <sub>3</sub> NH <sub>2</sub> (Methylamine)	0 - 15.0 ppm	Ammonia (NH <sub>3</sub> ): 5 ppm**	6 hours
CH <sub>6</sub> Si (Methylsilane)	0 - 20.0 ppm	Silane (SiH <sub>4</sub> ): 5 ppm*	3 hours
ClF <sub>3</sub> (Chlorine trifluoride)	0 - 0.60 ppm	Chlorine (Cl <sub>2</sub> ): 2 ppm*	3 hours
COF <sub>2</sub> (Cobalt difluorine)	0 - 6.00 ppm	Chlorine (Cl <sub>2</sub> ): 2 ppm**	3 hours
DEA (Diethylamine)	0 - 15.0 ppm	Ammonia (NH <sub>3</sub> ): 5 ppm**	24 hours
DMA (Dimethylamine)	0 - 15.0 ppm	Ammonia (NH <sub>3</sub> ): 5 ppm**	6 hours
F <sub>2</sub> (Fluorine)	0 - 3.00 ppm	Chlorine (Cl <sub>2</sub> ): 2 ppm or 5 ppm***	3 hours
	0 - 1.00 ppm	Chlorine (Cl <sub>2</sub> ): 2 ppm**	3 hours
GeH <sub>4</sub> (Germane)	0 - 0.80 ppm	Silane (SiH <sub>4</sub> ): 5 ppm**	3 hours
H <sub>2</sub> O <sub>2</sub> (Hydrogen peroxide)	0 - 3.00 ppm	Phosphine (PH <sub>3</sub> ): 0.5 ppm *	3 hours
H <sub>2</sub> Se (Hydrogen selenide)	0 - 0.20 ppm	Phosphine (PH <sub>3</sub> ): 0.5 ppm**	24 hours
H <sub>9</sub> NSi <sub>3</sub> (Trisilylamine)	0 - 15.0 ppm	Silane (SiH <sub>4</sub> ): 30 ppm*	3 hours
HCOOH (Formic acid)	0 - 15.0 ppm	Chlorine (Cl <sub>2</sub> ): 2 ppm*	3 hours
HF (Hydrogen fluoride)	0.4 - 9.00 ppm	Chlorine (Cl <sub>2</sub> ): 2 ppm or 5 ppm***	3 hours
HNO <sub>3</sub> (Nitric acid)	0 - 20.0 ppm	Chlorine (Cl <sub>2</sub> ): 2 ppm or 5 ppm***	3 hours

Detection Gas	Range	Calibration Gas/Concentration	Warm Up Time After Power-Up
IPA (Isopropyl alcohol)	0 - 100 %LEL	Isobutane (C4H10): 50% LEL* (SET GD-70D TO 60% LEL)	2 hours
N2H4 (Hydrazine)	0 - 5.00 ppm	Nitrous oxide (NO): 10 ppm*	6 hours
O3 (Ozone)	0 - 0.60 ppm	Chlorine (Cl2): 2 ppm**	3 hours
	0 - 1.00 ppm	Chlorine (Cl2): 2 ppm**	3 hours
Si2H6 (Disilane)	0 - 15.0 ppm	Silane (SiH4): 5 ppm or 30 ppm***	3 hours
TMA (Trimethylamine)	0 - 15.0 ppm	Ammonia (NH3): 5 ppm**	6 hours
<p>* No dilution needed.</p> <p>** Gas may or may not need dilution depending on the sensor's factor. The calibration gas multiplied by the factor should be as close to 50% of full scale as possible.</p> <p>*** Use one of the two gases listed, depending on sensor's factor. The calibration gas multiplied by the factor should be as close to 50% of full scale as possible.</p>			

### Discussion for \*\*

Gases with a \*\* next to them in the table above may or may not need to be diluted before being used to calibrate the GD-70D. In order to figure out if you need to dilute the gas, multiply the gas concentration listed on your calibration cylinder by the factor listed on the sensor unit at the GD-70D. The result should be something between 10% and 100% of full scale for the sensor. A value closest to 50% of full scale is ideal but if you can get somewhere between 10% and 100% of full scale without diluting, that is also fine.

### Discussion for \*\*\*

For gases with a \*\*\* next to them in the table above, different concentrations of calibration gas need to be used depending on the factor listed on the sensor unit. The goal is to have the calibration gas multiplied by the factor be as close to 50% of full scale as possible. It is not necessary to dilute these gases to achieve that goal. The concentration listed on the calibration cylinder multiplied by the factor listed on the sensor should be as close to 50% of full scale as possible but any value between 10% and 100% of full scale can be used to calibrate.

### Calibration Equipment for Gases Needing Dilution

- 0.5 LPM fixed flow regulator (RKI Instruments, Inc. recommends that you dedicate one regulator each for Cl2 and that you not use that regulator for any other gas)
- Tedlar gas collection bag with hose and hose clamp
- Calibration cylinder
- 100% nitrogen (N2) cylinder
- Stopwatch or other timing device

### Calibration Equipment for Gases Not Needing Dilution

- Demand flow regulator
- Calibration tubing
- Calibration cylinder of appropriate concentration

### Preparing for Calibration – Gases Needing Dilution

#### Determining Needed Calibration Gas Concentration

Before performing a calibration, you must mix your calibration gas in a gas bag. You need to first determine what final concentration of calibration gas you need.

$$\frac{\text{Concentration of gas cylinder}}{\text{Total parts in gas bag (1 part gas plus X parts N2)}} \times \text{Sensor factor} < \text{Sensor full scale}$$

The final concentration multiplied by the sensor's factor must be between 10% and 100% of full scale. Ideally, the final concentration multiplied by the sensor's factor should be as close to 50% of full scale as possible, but something different is acceptable as long as it's higher than 10% of full scale and less than 100% of full scale. For example, a gas bag full of 0.1 ppm PH3 multiplied by a factor of 1.7 is 0.17 ppm which is below the full scale value of 0.20 ppm for AsH3 or H2Se.

Phosphine does not come in cylinders of 0.1 ppm concentration so you need to determine how much to dilute the cylinder that you have. For example, a cylinder of 0.5 ppm PH<sub>3</sub> diluted 1 part gas to 4 parts nitrogen (5 parts total) would give you 0.1 ppm PH<sub>3</sub>:

$$\frac{0.5 \text{ ppm PH}_3}{5} \times 1.7 = 0.17 \text{ which is } < 0.20 \text{ ppm}$$

But if you had a higher concentration of PH<sub>3</sub> in your calibration cylinder or if your sensor's factor is higher than 1.7, you would need to increase the dilution.

$$\frac{1.0 \text{ ppm PH}_3}{5} \times 1.7 = 0.34 \text{ which is not } < 0.20 \text{ ppm}$$

Changing the dilution to 1 part gas to 8 parts nitrogen (9 parts total):

$$\frac{1.0 \text{ ppm PH}_3}{9} \times 1.7 = 0.19 \text{ which is } < 0.20 \text{ ppm}$$

#### Determining How to Fill Gas Bag

After determining the required dilution, you will need to determine how to fill your gas bag (ie. how long to let each cylinder flow). The GD-70D will need approximately 1 liter of gas for a 2 minute calibration. The fixed flow regulator used to fill the gas bag flows at 0.5 LPM.

The table below provides suggestions for gas flow times based on level of dilution needed. The times listed assume you have a 2 liter gas bag and will provide between 1 and 1.5 liters of gas which is enough to calibrate one detector head. If you want to mix a gas once and calibrate multiple detector heads with it, you will need a bag larger than 2 liters and you will need to increase the times listed below.

Table 1: Gas Flow Times for Gas Bag Dilution

Total Parts in Gas Bag (from discussion in previous section)	Gas Flow Time	Nitrogen Flow Time
2 (1 part gas, 1 part N <sub>2</sub> )	1 minute	1 minute
3 (1 part gas, 2 parts N <sub>2</sub> )	1 minute	2 minutes
4 (1 part gas, 3 parts N <sub>2</sub> )	45 seconds	2 minutes 15 seconds
5 (1 part gas, 4 parts N <sub>2</sub> )	30 seconds	2 minutes
6 (1 part gas, 5 parts N <sub>2</sub> )	20 seconds	1 minute 40 seconds
7 (1 part gas, 6 parts N <sub>2</sub> )	20 seconds	2 minutes
8 (1 part gas, 7 parts N <sub>2</sub> )	15 seconds	1 minute 45 seconds
9 (1 part gas, 8 parts N <sub>2</sub> )	15 seconds	2 minutes
10 (1 part gas, 9 parts N <sub>2</sub> )	12 seconds	1 minute 48 seconds

#### Filling the Gas Bag

1. If not already installed, install the hose and hose clamp on the gas bag.
2. Open the hose clamp on the gas bag.
3. Be sure the gas bag is completely empty.
4. Connect the tubing on the gas bag to the fixed flow regulator's hose barb fitting. Be sure the regulator's knob is in the closed position.
5. Screw the fixed flow regulator onto the calibration cylinder.
6. Turn the regulator's knob counterclockwise. Allow the gas to flow for the appropriate amount of time based on your dilution needs. See Table 1 above.
7. Turn the regulator's knob clockwise to close it.
8. Clamp down on the hose clamp to prevent the release of gas from the gas bag.
9. Remove the gas bag from the regulator.
10. Unscrew the regulator from the calibration cylinder and screw it onto a 100% N<sub>2</sub> cylinder.
11. Connect the gas bag tubing to the regulator's hose barb fitting.
12. Open the hose clamp on the gas bag.
13. Turn the regulator's knob counterclockwise. Allow the gas to flow for the appropriate amount of time based on your dilution needs. See Table 1 above.
14. Turn the regulator's knob clockwise to close it.

15. Clamp down on the hose clamp to prevent the release of gas from the gas bag.
16. Remove the gas bag from the regulator.
17. Unscrew the regulator from the 100% N2 cylinder.
18. Continue to Entering Calibration Mode below.

## Preparing for Calibration – Gases Not Needing Dilution

### Regulator

Screw the demand flow regulator onto the calibration cylinder.

## Entering Calibration Mode

### GAS IN Fitting

Remove the dust filter and the sample line from the GAS IN fitting's tubing stub.

### Accessing Maintenance Mode

From Detection Mode, press and hold the MODE key for three seconds.



1-8.M MODE

Press the ▲ key until the Maintenance Mode screen displays. (For GD-70D-EA units, the Maintenance Mode screen is item 1-9.)



User Mode

In "1-8.M MODE", press the SET key.



Then press and hold the SET key again for three seconds.



2-0.GAS TEST

The first item in Maintenance Mode will display.

0.0ppm  
SIH4



1- 8  
M MODE  
MAINTENANCE



1- 8  
M MODE  
MAINTENANCE



- - - -  
M MODE  
MAINTENANCE



2- 0  
GAS TEST  
MAINTENANCE

## Performing a Zero Adjustment

### 2-1. ZERO

Press the ▲ key until the **ZERO** screen displays.

Press the SET key.

### Current Concentration Value Display

Press the SET key to perform the zero adjustment.

2- 1  
ZERO  
MAINTENANCE



1.1ppm  
ZERO SET  
MAINTENANCE





**Zero Adjustment Completed**

The instrument will indicate whether the zero adjustment passed (OK) or failed (NG) and will return to **2-1.ZERO** automatically.

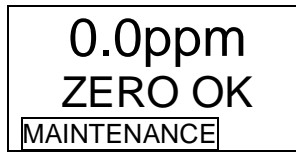

OR



↓  
Return to **2-1.ZERO**

↓  
Return to **2-1.ZERO**

**Performing a Span Adjustment**

**2-2. SPAN**

Press the ▲ key until the **SPAN** screen displays.

Press the SET key.

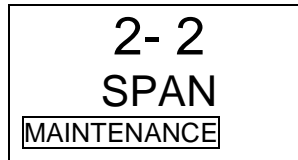

**Connect Gas**

Open the hose clamp on the gas bag and *immediately* connect the tubing to the tubing stub on the GAS IN fitting

OR

Use the calibration tubing to connect the demand flow regulator to the tubing stub on the GAS IN fitting.

Allow gas to flow for 2 minutes.



**Accept Reading**

Press the SET key when the reading has stabilized.

\* The reading must be above 10% of the full scale value in order to continue.

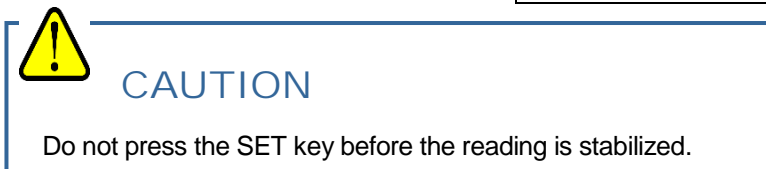
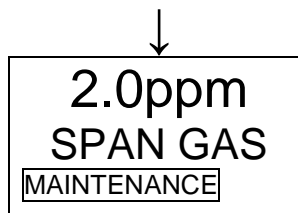

**Disconnect Gas**

Close the gas bag's hose clamp and *immediately* remove the gas bag from the tubing stub on the GD-70D's GAS IN fitting.

OR

Disconnect the calibration tubing from the tubing stub on the GAS IN fitting.



### Span Adjustment

Using the ▲ or ▼ keys, adjust the reading to match the concentration in the gas bag multiplied by the conversion factor on the sensor OR to the value listed in the table at the beginning of this section.

8.0ppm  
SPAN VAL  
MAINTENANCE

For example, a gas bag of 0.1 ppm PH3 multiplied by a conversion factor of 1.7 is 0.17 ppm AsH3 or H2Se.

Press the SET key.



### Span Adjustment Completed

The instrument will indicate whether the span adjustment passed (OK) or failed (NG).

8.0ppm  
SPAN OK  
MAINTENANCE

OR

8.0ppm  
SPAN NG  
MAINTENANCE



Return to 2-2.SPAN

### Save Adjustment

To save the adjustment result, press the SET key.  
(Press the MODE key to cancel this menu.)

8.0ppm  
SPAN Y/N  
MAINTENANCE



### Adjustment Completed

After the span has been recorded, the instrument will return to 2-2.SPAN automatically.

8.0ppm  
SPAN END  
MAINTENANCE

Return to 2-2.SPAN



### CAUTION

Exhaust gas must be collected in the exhaust bag or discharged through the exhaust line.

### Returning to Detection Mode

Store the components of the calibration kit in a safe place.

Reconnect the dust filter and inlet line to the GAS IN fitting.

Press and hold the MODE key to return to Detection Mode.

## 10-5 Calibrating with a Gas Bag (Calibrating with HCl)

The calibration instructions in this section apply ONLY to the sensors listed in the table below. If your sensor is not listed in the table below, you will need to follow the instructions outlined in one of the other calibration sections. The warm up times listed are the minimum times between powering up a GD-70D and calibrating that GD-70D.

Detection Gas	Range	Calibration Gas/Concentration	Warm Up Time After Power-Up
BCl <sub>3</sub> (Boron trichloride)	0 - 15.0 ppm	Hydrogen chloride (HCl): 5 ppm	6 hours
H <sub>2</sub> Cl <sub>2</sub> Si (Dichlorosilane)	0 - 15.0 ppm	Hydrogen chloride (HCl): 5 ppm	6 hours
HBr (Hydrogen bromide)	0 - 6.00 ppm	Hydrogen chloride (HCl): 5 ppm*	24 hours
	0 - 9.00 ppm	Hydrogen chloride (HCl): 5 ppm*	24 hours
HCl (Hydrogen chloride)	0 - 6.00 ppm	Hydrogen chloride (HCl): 5 ppm	6 hours
	0 - 15.0 ppm	Hydrogen chloride (HCl): 5 ppm	6 hours
SiCl <sub>4</sub> (Silicon tetrachloride)	0 - 15.0 ppm	Hydrogen chloride (HCl): 5 ppm	6 hours

*\* May or may not need dilution. In order to figure out if you need to dilute the gas, multiply the gas concentration listed on your calibration cylinder by the factor listed on the sensor unit at the GD-70D. The result should be something between 10% and 100% of full scale for the sensor. A value closest to 50% of full scale is ideal but if you can get somewhere between 10% and 100% of full scale without diluting, that is also fine.*

### Calibration Equipment – No Dilution Needed

- 6 LPM fixed flow regulator (RKI Instruments, Inc. recommends that you dedicate one regulator for use with HCl and that you not use that regulator for any other gas)
- Gas bag with tubing and a hose clamp
- Calibration cylinder of appropriate concentration

### Calibration Equipment – 1:1 Dilution Needed

- 6 LPM fixed flow regulator (RKI Instruments, Inc. recommends that you dedicate one regulator for use with HCl and that you not use that regulator for any other gas)
- Gas bag with tubing and a hose clamp
- Calibration cylinder of appropriate concentration
- 100% N<sub>2</sub> cylinder

### Preparing for Calibration – No Dilution Needed

#### Filling the Gas Bag

RKI Instruments, Inc. recommends screwing a nitrogen calibration cylinder onto the fixed flow regulator and purging the regulator for 30 seconds before starting the calibration process.

1. If not already installed, install the hose and hose clamp on the gas bag.
2. Open the hose clamp on the gas bag.
3. Be sure the gas bag is completely empty.
4. Connect the tubing on the gas bag to the fixed flow regulator's hose barb fitting. Be sure the regulator's knob is in the closed position.
5. Screw the fixed flow regulator onto the calibration cylinder.
6. Turn the regulator's knob counterclockwise.
7. Allow the gas to flow until the gas bag is about half full.
8. Turn the regulator's knob clockwise to close it.
9. Close the hose clamp.
10. Disconnect the gas bag from the regulator.
11. Unscrew the regulator from the calibration cylinder.
12. Continue to Entering Calibration Mode below.

---

## Preparing for Calibration – 1:1 Dilution Needed

### Filling the Gas Bag

RKI Instruments, Inc. recommends screwing a nitrogen calibration cylinder onto the fixed flow regulator and purging the regulator for 30 seconds before starting the calibration process.

1. If not already installed, install the hose and hose clamp on the gas bag.
2. Open the hose clamp on the gas bag.
3. Be sure the gas bag is completely empty.
4. Connect the tubing on the gas bag to the 6LPM fixed flow regulator's hose barb fitting. Be sure the regulator's knob is in the closed position.
5. Screw the fixed flow regulator onto the calibration cylinder.
6. Turn the regulator's knob counterclockwise. Allow the gas to flow for 7 seconds.
7. Turn the regulator's knob clockwise to close it.
8. Clamp down on the hose clamp to prevent the release of gas from the gas bag.
9. Remove the gas bag from the regulator.
10. Unscrew the regulator from the calibration cylinder and screw it onto a 100% N2 cylinder.
11. Connect the gas bag tubing to the regulator's hose barb fitting.
12. Open the hose clamp on the gas bag.
13. Turn the regulator's knob counterclockwise. Allow the gas to flow for 7 seconds.
14. Turn the regulator's knob clockwise to close it.
15. Clamp down on the hose clamp to prevent the release of gas from the gas bag.
16. Remove the gas bag from the regulator.
17. Unscrew the regulator from the 100% N2 cylinder.
18. The gas concentration in the gas bag is half of what is listed on the HCl calibration cylinder.
19. Continue to Entering Calibration Mode below.

## Entering Calibration Mode

### GAS IN Fitting

Remove the dust filter and the sample line from the GAS IN fitting's tubing stub.

### Accessing Maintenance Mode

From Detection Mode, press and hold the MODE key for three seconds. (For GD-70D-EA units, the Maintenance Mode screen is item 1-9.)

↓  
**1-8.M MODE**  
Press the ▲ key until the Maintenance Mode screen displays.

↓  
**User Mode**  
In "1-8.M MODE", press the SET key.

↓  
Then press and hold the SET key again for three seconds.

↓

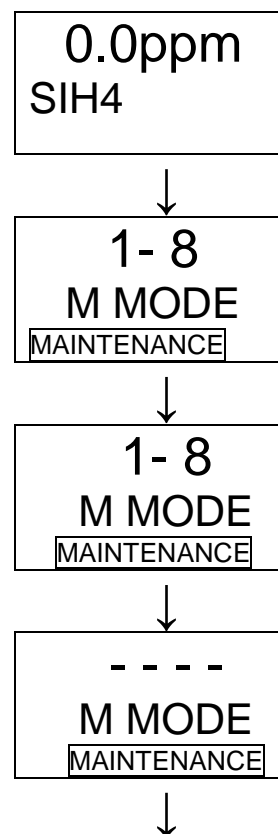

**2-0.GAS TEST**

The first item in Maintenance Mode will display.



**Performing a Zero Adjustment**

**2-1. ZERO**

Press the ▲ key until the **ZERO** screen displays.

Press the SET key.

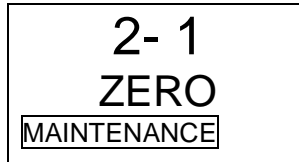

**Current Concentration Value Display**

Press the SET key to perform the zero adjustment.

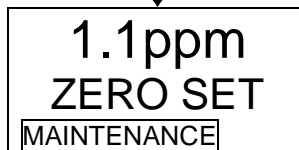

**Zero Adjustment Completed**

The instrument will indicate whether the zero adjustment passed (OK) or failed (NG) and will return to **2-1.ZERO** automatically.

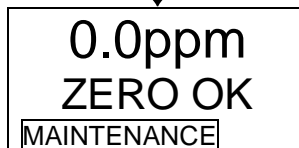

OR

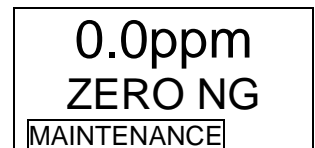

Return to **2-1.ZERO**

Return to **2-1.ZERO**

**Performing a Span Adjustment**

**2-2. SPAN**

Press the ▲ key until the **SPAN** screen displays.

Press the SET key.

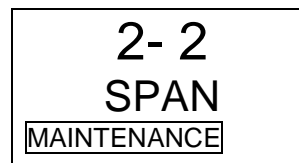

**Connect Gas**

Open the hose clamp on the gas bag and *immediately* connect the tubing to the tubing stub on the GAS IN fitting

OR

Use the calibration tubing to connect the demand flow regulator to the tubing stub on the GAS IN fitting.

Allow gas to flow for 2 minutes.

**Accept Reading**

Press the SET key when the reading has stabilized.

\* The reading must be above 10% of the full scale value in order to continue.

**CAUTION**

Do not press the SET key before the reading is stabilized.

**Disconnect Gas**

Close the gas bag's hose clamp and *immediately* remove the gas bag from the tubing stub on the GD-70D's GAS IN fitting.

OR

Disconnect the calibration tubing from the tubing stub on the GAS IN fitting.



**Span Adjustment**

Using the ▲ or ▼ keys, adjust the reading to match the concentration in your gas bag. If you diluted your gas, the concentration is half of what is listed on the calibration cylinder.

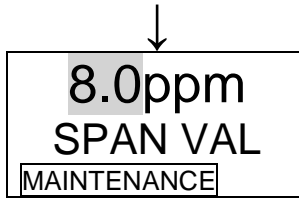

Press the SET key.



**Span Adjustment Completed**

The instrument will indicate whether the span adjustment passed (OK) or failed (NG).

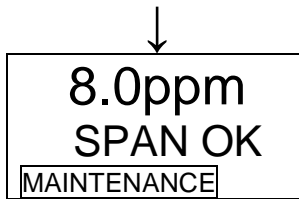

OR



**Save Adjustment**

To save the adjustment result, press the SET key.  
(Press the MODE key to cancel this menu.)

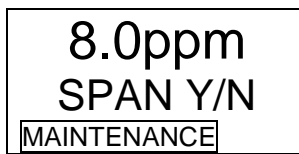

**Adjustment Completed**

After the span has been recorded, the instrument will return to 2-2.SPAN automatically.





CAUTION

Exhaust gas must be collected in the exhaust bag or discharged through the exhaust line.

**Returning to Detection Mode**

Store the components of the calibration kit in a safe place.  
Reconnect the dust filter and inlet line to the GAS IN fitting.

Press and hold the MODE key to return to Detection Mode.

## 10-6 Calibrating with a Humidifier (MOS Sensors)

The calibration instructions in this section apply ONLY to the sensors listed in the table below. If your sensor is not listed in the table below, you will need to follow the instructions outlined in one of the other calibration sections.

The dry gas from a gas cylinder must be humidified for the MOS sensor to respond properly. Failure to humidify gas from a cylinder will result in an artificially low response and an inaccurate calibration.

Detection Gas	Range	Calibration Gas/ Concentration	GD-70D Setting
C <sub>2</sub> H <sub>2</sub> (Acetylene)	0 - 2,000 ppm	Hydrogen (H <sub>2</sub> ): 500 ppm	1000 ppm
C <sub>2</sub> H <sub>2</sub> Cl <sub>2</sub> (Dichloroethene)	0 - 600 ppm	Hydrogen (H <sub>2</sub> ): 4000 ppm	350 ppm
C <sub>2</sub> H <sub>4</sub> (Ethylene)	0 - 2,000 ppm	Hydrogen (H <sub>2</sub> ): 1000 ppm	1000 ppm
C <sub>2</sub> H <sub>5</sub> OH (Ethanol)	0 - 2,000 ppm	Hydrogen (H <sub>2</sub> ): 1000 ppm	500 ppm
C <sub>3</sub> H <sub>6</sub> (Propylene)	0 - 5,000 ppm	Hydrogen (H <sub>2</sub> ): 4000 ppm	1000 ppm
C <sub>3</sub> H <sub>8</sub> (Propane)	0 - 2,000 ppm	Propane (C <sub>3</sub> H <sub>8</sub> ): 1000 ppm	1000 ppm
	0 - 5,000 ppm	Propane (C <sub>3</sub> H <sub>8</sub> ): 2100 ppm	2100 ppm
C <sub>4</sub> F <sub>6</sub> (Hexafluorabutadiene)	0 - 200 ppm	Hydrogen (H <sub>2</sub> ): 100 ppm	130 ppm
CH <sub>2</sub> Cl <sub>2</sub> (Dichloromethane)	0 - 2,000 ppm	Isobutane (C <sub>4</sub> H <sub>10</sub> ): 3600 ppm	1000 ppm
CH <sub>3</sub> CN (Acetonitrile)	0 - 2,000 ppm	Isobutane (C <sub>4</sub> H <sub>10</sub> ): 1800 ppm	1000 ppm
CH <sub>3</sub> OH (Methanol)	0 - 1,000 ppm	Hydrogen (H <sub>2</sub> ): 1000 ppm	800 ppm
	0 - 2,000 ppm	Hydrogen (H <sub>2</sub> ): 1000 ppm	800 ppm
CH <sub>4</sub> (Methane)	0 - 2% vol	Methane (CH <sub>4</sub> ): 5000 ppm (0.5% vol)	0.5% vol
	0 - 2,000 ppm	Methane (CH <sub>4</sub> ): 1000 ppm	1000 ppm
	0 - 5,000 ppm	Methane (CH <sub>4</sub> ): 5% LEL (2500 ppm)	2500 ppm
COS (Carbonyl sulfide)	0 - 2,000 ppm	Hydrogen (H <sub>2</sub> ): 5000 ppm	450 ppm
H <sub>2</sub> (Hydrogen)	0 - 2.00% vol	Hydrogen (H <sub>2</sub> ): 1.20% vol	1.20% vol
	0 - 500 ppm	Hydrogen (H <sub>2</sub> ): 200 ppm	200 ppm
	0 - 1,000 ppm	Hydrogen (H <sub>2</sub> ): 500 ppm	500 ppm
	0 - 2,000 ppm	Hydrogen (H <sub>2</sub> ): 1000 ppm	1000 ppm
	0 - 4,000 ppm	Hydrogen (H <sub>2</sub> ): 2000 ppm	2000 ppm
IPA (Isopropyl alcohol)	0 - 2,000 ppm	Isopropyl alcohol (IPA): 1000 ppm IPA	1000 ppm
R32 (Difluoromethane)	0 - 2,000 ppm	Hydrogen (H <sub>2</sub> ): 250 ppm	1000 ppm
	0 - 5,000 ppm	Hydrogen (H <sub>2</sub> ): 1000 ppm	4000 ppm
R41 (Fluoromethane)	0 - 2,000 ppm	Hydrogen (H <sub>2</sub> ): 500 ppm	900 ppm

The warm up time for the MOS sensors depends on how long the sensor was off of power. Sensors are shipped off of power. The warm up times listed are the minimum times between powering up a GD-70D and calibrating that GD-70D.

Sensor's Total Unpowered Time Before Startup	Warm Up Time After Power-Up	
	Hydrogen Sensors	All Other Sensors
1 - 10 min	10 min	2 hours
10 minutes - 1 hour	30 min	2 hours
1 - 24 hours	1 hour	4 hours
1 - 3 days	4 hours	24 hours
3 - 10 days	2 days or more	
10 - 30 days	7 days or more	
1 - 3 months	14 days or more	
More than 3 months	1 month or more	

### Calibration Equipment

- Demand flow regulator (RKI Instruments, Inc. recommends that you do not use a demand flow regulator that has previously been used for Cl<sub>2</sub> or H<sub>2</sub>S to calibrate a MOS sensor)
- 6" humidifier tube
- Calibration cylinder of appropriate concentration

### Preparing for Calibration

#### GAS IN Fitting

Remove the dust filter and the sample line from the GAS IN fitting's tubing stub.

#### Regulator

Screw the demand flow regulator onto the calibration cylinder.

#### Accessing Maintenance Mode

From Detection Mode, press and hold the MODE key for three seconds. (For GD-70D-EA units, the Maintenance Mode screen is item 1-9.)

↓  
1-8.M MODE  
 Press the ▲ key until the Maintenance Mode screen displays.

↓  
User Mode  
 In "1-8.M MODE", press the SET key.

↓  
 Then press and hold the SET key again for three seconds.

0.0ppm  
SIH4

↓  
 1- 8  
M MODE  
MAINTENANCE

↓  
 1- 8  
M MODE  
MAINTENANCE

↓  
 - - - -  
M MODE  
MAINTENANCE



↓  
**2-0.GAS TEST**  
The first item in Maintenance Mode will display.

↓  
**2- 0  
GAS TEST**  
**MAINTENANCE**

### Performing a Zero Adjustment

**2-1. ZERO**  
Press the ▲ key until the **ZERO** screen displays.

**2- 1  
ZERO**  
**MAINTENANCE**

Press the SET key.

**Current Concentration Value Display**  
Press the SET key to perform the zero adjustment.

↓  
**1.1ppm  
ZERO SET**  
**MAINTENANCE**

**Zero Adjustment Completed**  
The instrument will indicate whether the zero adjustment passed (OK) or failed (NG) and will return to **2-1.ZERO** automatically.

↓  
**0.0ppm  
ZERO OK**  
**MAINTENANCE**

OR

**0.0ppm  
ZERO NG**  
**MAINTENANCE**

↓  
Return to **2-1.ZERO**

↓  
Return to **2-1.ZERO**

### Performing a Span Adjustment

**2-2. SPAN**  
Press the ▲ key until the **SPAN** screen displays.

**2- 2  
SPAN**  
**MAINTENANCE**

Press the SET key.

**Connect Gas**  
Use the humidifier to connect the calibration cylinder to the GAS IN fitting. *Hold the humidifier assembly by the clear tubes at the ends when installing or removing the humidifier to avoid damaging the humidifier. Do not hold the humidifier tube itself.*

Allow gas to flow for 2 minutes.

↓  
**Accept Reading**  
Press the SET key when the reading has stabilized.  
\* The reading must be above 10% of the full scale value in order to continue.

↓  
**2.0ppm  
SPAN GAS**  
**MAINTENANCE**

 **CAUTION**  
Do not press the SET key before the reading is stabilized.

---

### Disconnect Gas

Disconnect the humidifier from the tubing stub on the GAS IN fitting. *Hold the humidifier assembly by the clear tubes at the ends when installing or removing the humidifier to avoid damaging the humidifier. Do not hold the humidifier tube itself.*



### Span Adjustment

Using the ▲ or ▼ keys, adjust the reading to match the concentration shown in the “GD-70D” column in the table at the beginning of this section.

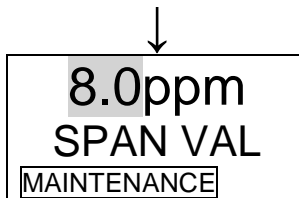

Press the SET key.



### Span Adjustment Completed

The instrument will indicate whether the span adjustment passed (OK) or failed (NG).

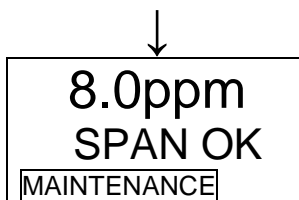

OR

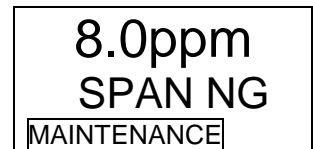

↓  
Return to 2-2.SPAN



### Save Adjustment

To save the adjustment result, press the SET key.  
(Press the MODE key to cancel this menu.)

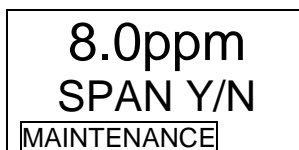

### Adjustment Completed

After the span has been recorded, the instrument will return to 2-2.SPAN automatically.



↓  
Return to 2-2.SPAN

**CAUTION**

Exhaust gas must be collected in the exhaust bag or discharged through the exhaust line.

## Returning to Detection Mode

Store the components of the calibration kit in a safe place.

Reconnect the dust filter and inlet line to the GAS IN fitting.

Press and hold the MODE key to return to Detection Mode.

## 10-7 Calibrating a Pyrolyzer Unit

The calibration instructions in this section apply **ONLY** to the sensors listed in the table below. If your sensor is not listed in the table below, you will need to follow the instructions outlined in one of the other calibration sections. The warm up times listed are the minimum times between powering up a GD-70D and calibrating that GD-70D.

Detection Gas	Range	Calibration Gas/ Concentration	GD-70D Setting	Warm Up Time After Power-Up
COS (Carbonyl sulfide)	0 - 90.0 ppm	Carbonyl sulfide (COS): 40 ppm	40 ppm	24 hours
NF3 (Nitrogen trifluoride)	0 - 30.0 ppm	Nitrogen trifluoride (NF3): 15 ppm	15 ppm	6 hours
TEOS (Tetraethyl orthosilicate)	0 - 15.0 ppm	Silane (SiH <sub>4</sub> ): 15 ppm	10 ppm	2 hours
TMB (Trimethoxy borane)	0 - 1000 ppm	Silane (SiH <sub>4</sub> ): 15 ppm	1000 ppm	2 hours
TMS (Tetramethyl silane)	0 - 15.0 ppm	Silane (SiH <sub>4</sub> ): 15 ppm	15 ppm	2 hours
TRIMS (Trimethyl silane)	0 - 15.0 ppm	Silane (SiH <sub>4</sub> ): 15 ppm	15 ppm	2 hours

### Calibration Equipment

- Demand flow regulator (RKI Instruments, Inc. recommends that you do not use a demand flow regulator that has previously been used for Cl<sub>2</sub> or H<sub>2</sub>S to calibrate a pyrolyzer unit)
- Calibration tubing
- Calibration cylinder of appropriate concentration

### Preparing for Calibration

#### GAS IN Fitting

Remove the dust filter and the sample line from the pyrolyzer's GAS IN fitting's tubing stub.

#### Regulator

Screw the demand flow regulator onto the calibration cylinder.

#### Accessing Maintenance Mode

From Detection Mode, press and hold the MODE key for three seconds.



#### 1-8.M MODE

Press the ▲ key until the Maintenance Mode screen displays. (For GD-70D-EA units, the Maintenance Mode screen is item 1-9.)



#### User Mode

In "1-8.M MODE", press the SET key.



0.0ppm  
SIH4



1- 8  
M MODE  
MAINTENANCE



1- 8  
M MODE  
MAINTENANCE



Then press and hold the SET key again for three seconds.

↓  
**2-0.GAS TEST**

The first item in Maintenance Mode will display.

---  
**M MODE**  
MAINTENANCE

↓  
**2- 0**  
**GAS TEST**  
MAINTENANCE

### Performing a Zero Adjustment

**2-1. ZERO**

Press the ▲ key until the **ZERO** screen displays.

Press the SET key.

**Current Concentration Value Display**

Press the SET key to perform the zero adjustment.

**Zero Adjustment Completed**

The instrument will indicate whether the zero adjustment passed (OK) or failed (NG) and will return to **2-1.ZERO** automatically.

**2- 1**  
**ZERO**  
MAINTENANCE

↓  
**1.1ppm**  
**ZERO SET**  
MAINTENANCE

↓  
**0.0ppm**  
**ZERO OK**  
MAINTENANCE

OR

**0.0ppm**  
**ZERO NG**  
MAINTENANCE

↓  
Return to **2-1.ZERO**

↓  
Return to **2-1.ZERO**

### Performing a Span Adjustment

**2-2. SPAN**

Press the ▲ key until the **SPAN** screen displays.

Press the SET key.

**Connect Gas**

Use the calibration tubing to connect the demand flow regulator to the tubing stub on the GAS IN fitting of the pyrolyzer. Gas will begin to flow. *Do not connect the calibration tubing to the inlet of the GD-70D. Calibration gas must flow through the pyrolyzer in order to get an accurate calibrator.*

Allow gas to flow for 2 minutes.

↓

**2- 2**  
**SPAN**  
MAINTENANCE

↓

**Accept Reading**

Press the SET key when the reading has stabilized.

\* The reading must be above 10% of the full scale value in order to continue.

2.0ppm  
SPAN GAS  
MAINTENANCE

 **CAUTION**

Do not press the SET key before the reading is stabilized.

**Disconnect Gas**

Disconnect the calibration tubing from the tubing stub on the pyrolyzer's GAS IN fitting.



**Span Adjustment**

Using the ▲ or ▼ keys, adjust the reading to match the concentration shown in the "GD-70D" column in the table at the beginning of this section.

8.0ppm  
SPAN VAL  
MAINTENANCE

Press the SET key.



**Span Adjustment Completed**

The instrument will indicate whether the span adjustment passed (OK) or failed (NG).

8.0ppm  
SPAN OK  
MAINTENANCE

OR

8.0ppm  
SPAN NG  
MAINTENANCE



Return to 2-2.SPAN

**Save Adjustment**

To save the adjustment result, press the SET key.  
(Press the MODE key to cancel this menu.)

8.0ppm  
SPAN Y/N  
MAINTENANCE



**Adjustment Completed**

After the span has been recorded, the instrument will return to 2-2.SPAN automatically.

8.0ppm  
SPAN END  
MAINTENANCE

Return to 2-2.SPAN

 **CAUTION**

Exhaust gas must be collected in the exhaust bag or discharged through the exhaust line.

**Returning to Detection Mode**

Store the components of the calibration kit in a safe place.

Reconnect the dust filter and inlet line to the GAS IN fitting on the pyrolyzer.

Press and hold the MODE key to return to Detection Mode.

## 10-8 Flow Rate Adjustments

### <Flow Rate Manual Adjustment "2-6">

The 2-6 FLOW menu item allows the user to manually increase or decrease the flow. The flow rate of the detector is normally automatically adjusted to 0.5 L/min. In order to perform a manual adjustment, you must first turn off the auto-adjustment function (found in Maintenance Mode item 2-10 SET-11).

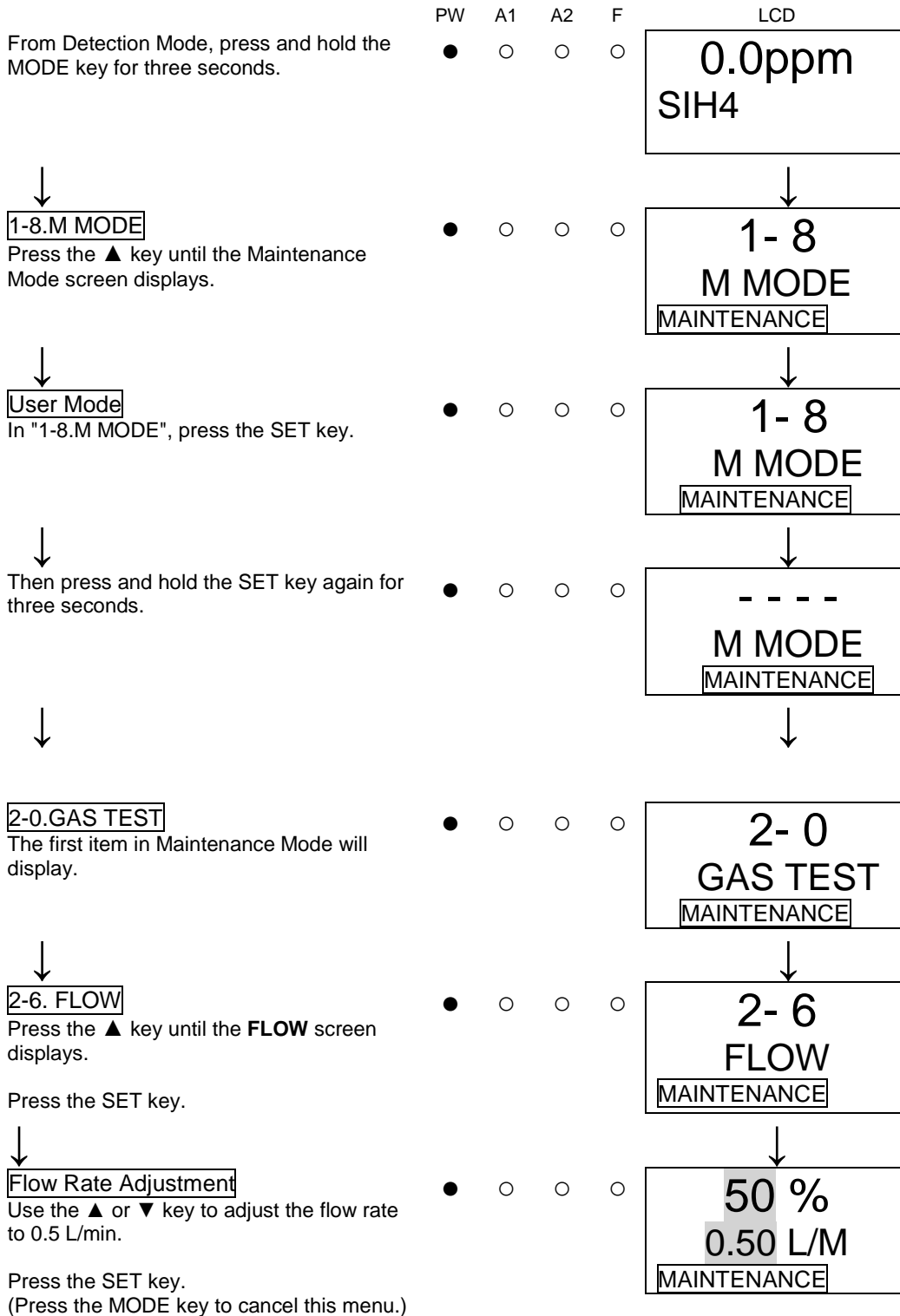

## <Flow Rate Default Set "2-5">

Regardless of whether the flow rate is manually or automatically set, when the reading on the flow rate indicator is incorrect (due to aging degradation, improper flow rate default set, or other reasons), it must be set to provide the right flow rate.

To set the Flow Rate Indicator, prepare and connect a flow meter (which indicates 0.5 L/min precisely), and perform the default set with the flow meter while it is indicating 0.5 L/min.

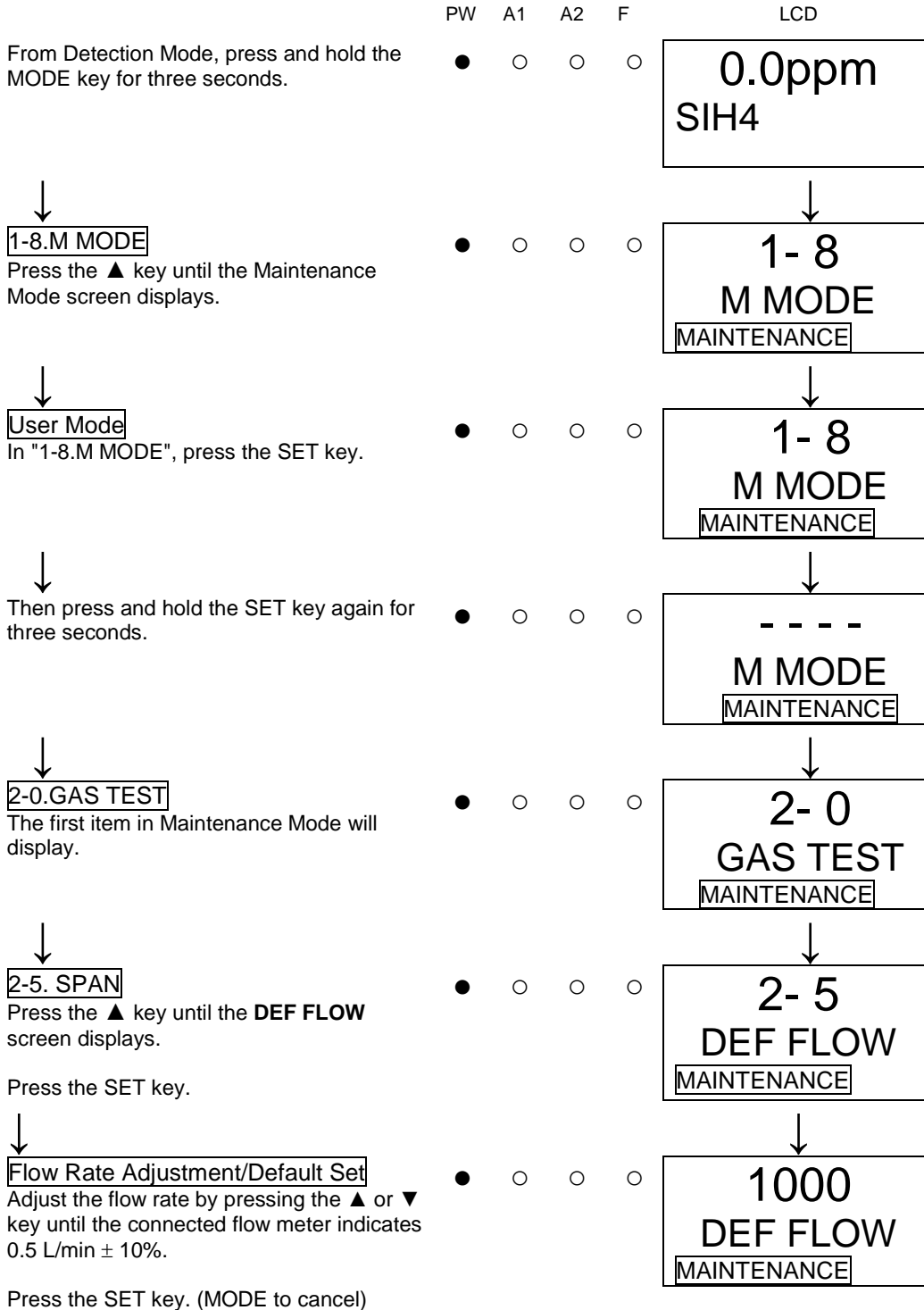

### CAUTION

Perform the flow rate default set after verifying that the flow rate is 0.5 L/min by using a flow meter.



## WARNING

After the adjustment is completed, do not forget to press the MODE key to return to Detection Mode.

## 10-9 Replacing Parts

### <Replacing the Sensor Unit>

1. Push the two buttons at the top of the main unit down to open the front cover.  
\* The front cover opens 90 degrees at first. You can push it down to 180 degrees.



## CAUTION

- Turn the power off before detaching or attaching the sensor unit.

2. Grab the sides of the old sensor unit and pull it out.  
If the sensor unit is hard to detach, insert a finger into the gap at the top right of the sensor unit and pull it out.
3. Insert the new sensor unit into the main unit and make sure that the sensor unit is secured.
4. After replacing the sensor unit, close the front cover. Be sure the front cover clicks into place.
5. Turn the power to the detector back on and allow the sensor unit to warm up, if necessary.
6. Perform a calibration.

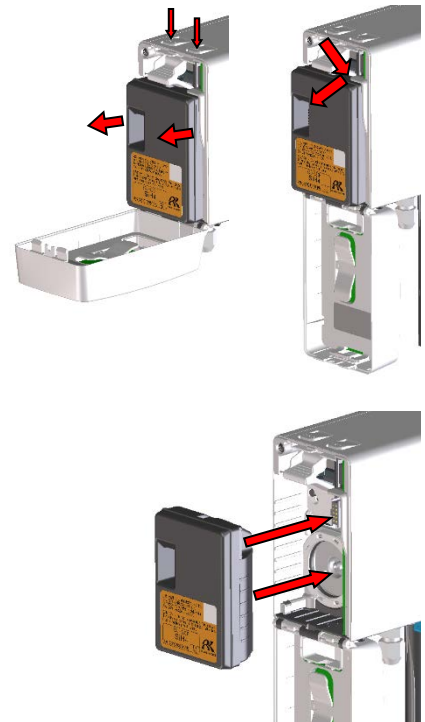

### <Replacing the Sensor Battery (ESU Type Sensors ONLY)>

If you get an E-1 error message for an ESU type sensor, try replacing the battery before replacing the entire sensor.

1. Turn off the GD-70D.
2. Push the two buttons at the top of the main unit down to open the front cover.  
\*The front cover opens 90 degrees at first. You can push it down to 180 degrees.
3. Grab the sides of the sensor unit and pull it out.  
If the sensor unit is hard to detach, insert a finger into the gap at the top right of the sensor unit and pull it out.

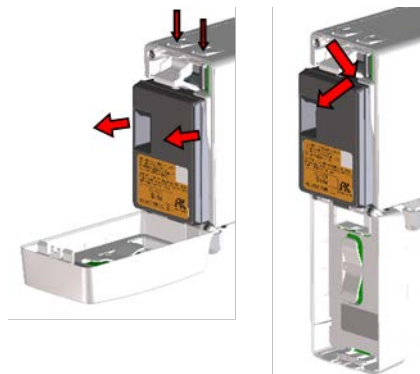



- 
4. Pry the sensor unit lid off of the sensor unit body.



5. Remove the circuit board. *Be very careful not to damage the white connector.*



6. Remove the old battery.
7. Install a new battery.

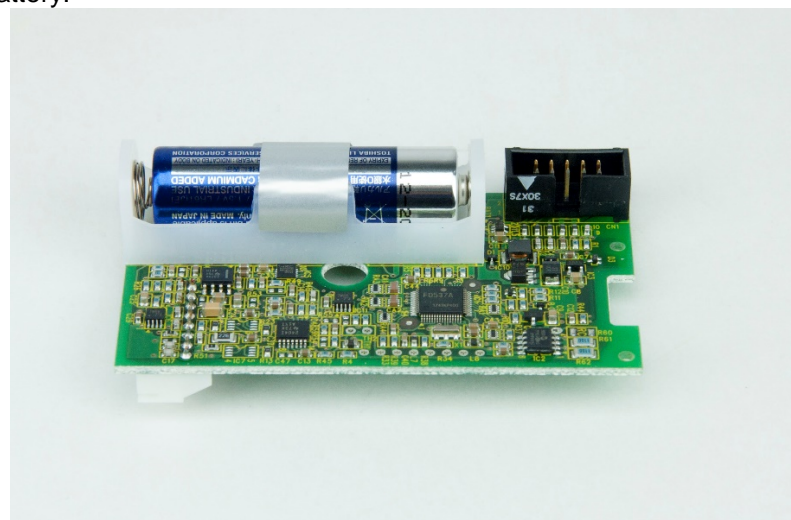

8. Reinstall the circuit board being careful not to damage the white connector.
9. Reinstall the sensor unit lid to the sensor unit body.
10. Insert the sensor unit into the main unit and make sure that the sensor unit is secured.
11. Close the front cover. Be sure the front cover clicks into place.
12. Turn the power to the GD-70D back on.

## <Replacing the External Dust Filter>

Because the external dust filter may gradually get dirty or clogged over the time, it must be replaced. Check the external dust filter, and then replace it as necessary. Frequency of replacement will depend on the operating conditions.

1. Turn off the GD-70D.
2. Remove the sample line from the dust filter.
3. Remove the dust filter from the tubing stub on the GAS IN fitting.
4. Install a new dust filter on the tubing stub on the GAS IN fitting.
5. Reconnect the sample line to the new dust filter.
6. Turn on the GD-70D.



## <Replacing the Pump Unit>

The pump unit should be replaced every 1-2 years.

1. Detach the sensor unit as described in step 1 and 2 of "Replacing the Sensor Unit" above.
2. Push down on the white lever at the top of the detector.
3. Grasp the area of the pump labelled "PULL" and pull the old pump unit out.

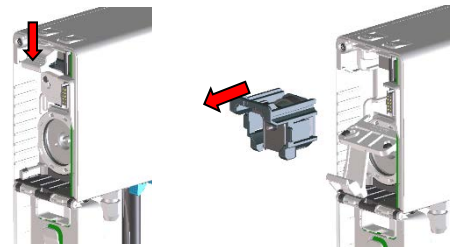

4. Grasp the new pump by the area labelled "PULL".
5. Align the grooves on the new pump unit with the detector rails.
6. Push the new pump unit into the detector. Do not push the pump's center diaphragm. Push the area labeled "PULL".

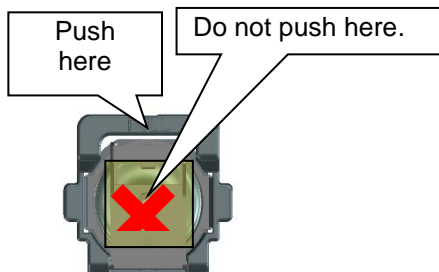
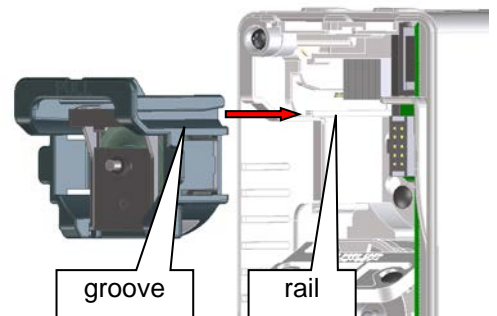

7. Secure the white lever over the pump unit.
8. Insert the sensor unit into the main unit and make sure that the sensor unit is secured.
9. Close the front cover. Be sure the front cover clicks into place.

---

## <Replacing the Flow Sensor>

The flow sensor should be replaced every 5 years.

The flow sensor is not user-serviceable and must be replaced by RKI.

## 10-10 Storing the GD-70D

The detector must be stored under the following environmental conditions.

1. In a dark place under the normal temperature and humidity away from direct sunlight
2. In a place where gases, solvents or vapors are not present



### CAUTION

When you begin to use a detector that was moved or out of operation for a period of time, do not forget to perform a gas calibration. For information on readjustment including gas calibration, please contact RKI.

# 11

## Troubleshooting

This guide discusses frequently-seen malfunctions but does not discuss all malfunctions. If the detector shows a symptom which is not explained in this manual, or if it still has malfunctions even though remedial actions are taken, please contact RKI.

### NOTE

To use the pyrolyzer unit (PLU-70), also refer to the individual operating manual.

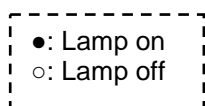

### <Device Abnormalities>

Symptom/Display	FAULT	Causes	Actions
<u>Detector does not turn ON</u>	-	The power switch is turned off.	Turn ON the power switch.
		Abnormalities/momentary blackout of power supply system.	Provide the rated voltage. Check the UPS, power supply line filter and insulation transformer, and then take additional measures.
		Improper installation of the main unit.	Ensure the main unit is properly attached to the mounting plate.
		Cable abnormalities (open circuit/not connected/short circuit).	Check the detector's wiring and the wiring of connected devices.
<u>Abnormal Operations</u>	○	Disturbances by sudden surge noise, etc.	Turn off and restart the detector. If such a symptom is observed frequently, take appropriate measures to eliminate the noise.
<u>Incorrect Flow Rate Indicator</u> (Specified Value Display does not correspond to 0.5 L/min.)	○	Improper flow rate default set.	Use a flow meter to perform the flow rate default set again as described on page 111. <u>If such a symptom is observed frequently, the flow sensor is malfunctioning and must be replaced. Please contact RKI.</u>
<u>Sensor Unit Abnormalities</u> <u>E-1 SENSOR</u>	●	The sensor unit is not connected or improperly connected.	Check whether the sensor unit is connected and the connectors of the unit are securely fastened.
		Errors in communication with the sensor unit.	Replace the sensor unit as described on page 112.
		Zero drift caused by environmental changes or aging degradation cannot be corrected using the zero follower.	Perform a zero adjustment.  If the symptom continues, replace the sensor unit as described on page 112.
		For ESU type sensors, the battery inside the sensor is dead.	Replace the battery inside the sensor unit as described on page 112.
		Faults inside of the sensor unit.	Replace the sensor unit as described on page 112.

Symptom/Display	FAULT	Causes	Actions
<u>Flow Rate Warning</u> <u>FLOW</u>	○	Unstable flow caused by a deteriorated pump.	Replace the pump unit as described on page 114.
		Unstable flow caused by clogged dust filter.	Replace the dust filter as described on page 114.
		Unstable flow caused by bent or clogged inlet or exhaust line.	Fix the defective parts.
		Pressure difference is present in the sampling condition. (The flow rate is ensured even though the pump drive level is low.)	In some sampling conditions (presence of pressure difference between IN and OUT), the flow rate is ensured even though the pump drive level is low. Although the detector can be used in such a situation, the diagnosis function of its pump drive level issues this message. You can disable this function to eliminate the message. (See "7-2. Maintenance Mode".) Check the operating conditions before taking actions.  * If the flow rate indicator is incorrect, the message may be displayed even though pressure difference is not present.
		Flow sensor is malfunctioning.	The flow rate may not be in the range of 0.5 L/min±10% even though the flow rate indicator indicates the specified value. The flow sensor must be replaced. Contact RKI.
<u>Flow Rate Abnormalities</u> <u>E-5 FLOW</u>	●	Protective rubber caps have not been removed.	Remove the protective rubber cap from the GAS IN and GAS OUT fittings.
		Broken pump unit.	Replace the pump unit as described on page 114.
		Flow loss caused by clogged dust filter.	Replace the dust filter as described on page 114.
		Flow loss caused by bent or clogged inlet or exhaust tube.	Fix the defective parts.
		Open circuit or defective connection of flow sensor.	Please contact RKI.
<u>Communication Abnormalities</u> <u>E-6</u> (NT specification)	○	Communication cable abnormalities.	Check the detector wiring and the wiring of connected devices.
		Address abnormalities.	Set the address again.
		Disturbance by external noise.	Turn off and restart the detector. If such a symptom is observed frequently, take appropriate measures to eliminate the noise.
<u>Clock Abnormalities</u> <u>E-9</u>	○	Abnormalities of the clock inside the detector.	Set the Date/Time in Maintenance Mode. Note that when the sensitivity correction function of ESU is used, correction may not be made properly. If such a symptom is observed repeatedly, the built-in clock must be replaced. Contact RKI.
<u>System Abnormalities</u> <u>E-9 SYSTEM</u>	●	The rated voltage is not supplied to the detector.	Check the power supply, and supply the rated voltage.
		Abnormalities of ROM, RAM, or EEPROM inside of the detector.	Please contact RKI.

## <Reading Abnormalities>

Symptoms	Causes	Actions
<u>The reading rises (drops for oxygen) and stays there.</u>	Drifting sensor.	Perform a zero adjustment (AIR adjustment).
	Presence of interference gas.	Disturbances by interference gases, such as solvents, cannot be eliminated completely. For information on actions, such as installing a removal filter, please contact RKI.
	Slow leak.	A very small amount of the gas to be detected may be leaking (slow leak). Because ignoring it may cause dangers, take a remedial measure, i.e., taking actions the same as those for the gas alarm.
	Environmental changes.	Perform a zero adjustment (AIR adjustment). In particular, the galvanic cell type is affected by the air pressure.
<u>A gas alarm is triggered even though gas is not present.</u>	Presence of interference gas.	Disturbances by interference gases, such as solvents, cannot be eliminated completely. For information on actions, such as installing a removal filter, please contact RKI.
	EMI/RFI noise.	Turn off and restart the detector. If such a symptom is observed frequently, take appropriate measures to eliminate the noise.
	Sudden change in the environment.	When the environment (temperature, etc.) changes suddenly, the detector cannot adjust to it. In some cases, the detector triggers an indication alarm. Because the detector cannot be used under sudden and frequent environmental changes, you must take any preventive actions to eliminate them.
<u>Slow Response</u>	Clogged dust filter.	Replace the dust filter as described on page 114.
	Bent or clogged inlet or exhaust line.	Fix the defective parts.
	Condensation in the inlet line.	Fix the defective parts.
	Deteriorated sensor sensitivity.	Replace the sensor unit as described on page 112.
<u>Cannot Calibrate</u>	Improper calibration gas concentration.	Use the proper calibration gas.
	Deteriorated sensor sensitivity.	Replace the sensor unit as described on page 112.

# 12

## Product Specifications

### 12-1 Common Specifications

<b>Display</b>	LCD (Digital and Bar Meter Display)
<b>Flow Rate</b>	0.5L/min $\pm$ 10%
<b>Displays</b>	Gas name display/Flow rate indicator/Mode display/Communication status display/Pyrolyzer connection display
<b>Alarm Display</b>	First: ALM1 lamp on (Red) Second: ALM2 lamp on (Red) Fault: FAULT lamp on (Yellow), fault code displayed on LCD
<b>Alarm Activation</b>	Auto-reset or self-latching (fault alarm is auto-reset only)
<b>Alarm Contact Specifications</b>	<ul style="list-style-type: none"> <li>- No-voltage contact, 2 step independent, normally open (factory setting) or normally closed</li> <li>- Normally de-energized (energized during alarm, factory setting) or normally energized (de-energized during alarm)</li> <li>- Capacity: 125 VAC 0.25A or 24 VDC 0.5A (resistive load)</li> </ul>
<b>Recommended Contact Cable</b>	Cable of CVV, etc. (1.25sq) - max. 6-core
<b>Functions</b>	White backlight/Alarm delay/Suppression/Zero follower/Sensitivity correction/Flow control/Calibration history/Alarm trend history/Event history
<b>Recommended Tubing</b>	4 mm x 6 mm Teflon
<b>Max Tubing Lengths</b>	30 meters
<b>External Dimensions</b>	Approx. 70(W) x 120(H) x 145(D) mm
<b>Weight</b>	Approx. 0.9 kg
<b>Outer Color</b>	Gas detector: grey Front door: white

### 12-2 Specifications for Each Model

	<b>GD-70D</b>	<b>GD-70D-NT</b>
<b>Transmission System</b>	3-wire type analog transmission (Common Power Supply <Power, Signal, Common>) or 2-wire type analog transmission	2-wire type DC power-line communication
<b>Transmission Specification</b>	4 - 20 mA DC (no-insulation/load resistance under 300 $\Omega$ )	
<b>Recommended Transmission Cable</b>	Shielded cable of CVVS, etc. (1.25sq) 3-core or 2-core	Shielded twisted-pair cable (1.25sq) of KPEV-S, etc. - 1P
<b>Recommended Power Cable</b>	Cable of CVV, etc.(1.25sq) - 2-core (Those for 3-wire type are common with the transmission cable.)	(Common with the transmission cable)
<b>Input Power</b>	24VDC $\pm$ 10%	24VDC $\pm$ 10% (Dedicated line by blocking filter)

	<b>GD-70D-EA</b>	<b>GD-70D-LN</b>
<b>Transmission System</b>	<u>Digital transmission</u> : Ethernet (10BASE-T/100BASE-TX) <u>Analog transmission</u> : 3-wire type analog transmission (Common cable for power and signal <Power, Signal, Common>) or 2-wire type analog transmission	LONWORKS (LN)
<b>Transmission Specification</b>	<u>Digital transmission</u> : Ethernet <u>Analog transmission</u> : 4 - 20 mA DC (no-insulation/load resistance under 300 Ω)	LONWORKS
<b>Recommended Transmission Cable</b>	<u>Digital transmission</u> : Ethernet cable (category 5 or higher) <u>Analog transmission</u> : Shielded cable of CVVS, etc. (1.25 mm <sup>2</sup> ) - 3-core or 2-core	Shielded twisted pair cable of KPEV-S, etc. (1.25 mm <sup>2</sup> ) · 1P
<b>Recommended Power Cable</b>	Cable of CVV, etc. (1.25mm <sup>2</sup> ) - 2-core (common with the digital transmission cable when PoE connection is used/common with the analog transmission cable when 3-wire analog connection is used)	Cable of CVV, etc. (1.25 mm <sup>2</sup> ) - 2-core
<b>Input Power</b>	24 VDC ±10% or PoE connection	24 VDC ±10%

## 12-3 Specifications for Each Sensor Type

	<b>ESU</b>	<b>ESU + PLU *1</b>	<b>SSU + PLU *1</b>
<b>Detection principle</b>	Electrochemical type		Pyrolysis-particle type
<b>Gas to be detected</b>	Toxic gas *2	NF3/COS	Toxic gas *2
<b>Detection range</b>	See Full Scale and Alarm Points on page 123	See Full Scale and Alarm Points on page 123	See Full Scale and Alarm Points on page 123
<b>Detection method</b>	Pump suction type	Pump suction type/pyrolysis type	
<b>Alarm setpoint value</b>	See Full Scale and Alarm Points on page 123	See Full Scale and Alarm Points on page 123	See Full Scale and Alarm Points on page 123
<b>Alarm accuracy</b>	Within ±30% *3		
<b>Alarm delay time</b>	60 seconds or less *4		
<b>Alarm type</b>	Two-step alarm (H-HH)		
<b>Power consumption</b>	Approx. 1.5 W (Max. 4 W)		
<b>Power consumption (EA)</b>	24 V: Approx. 3W (Max. approx. 5W) PoE: Approx. 4.5W (Max. approx. 7W)		
<b>Power consumption(DV)</b>	Approx. 2 W (Max. 4.5 W)		
<b>Operating temperature (at a constant condition)</b>	0 - 40°C		
<b>Operating humidities (Non-condensing)</b>	30 - 70%RH		30 - 80%RH



	<b>NCU</b>	<b>SGU</b>	<b>OSU *5</b>
<b>Detection principle</b>	New ceramic	Semiconductor	Galvanic cell type
<b>Gas to be detected</b>	Combustible gas	Combustible gas Toxic gas	Oxygen
<b>Detection range</b>	See Full Scale and Alarm Points on page 123	See Full Scale and Alarm Points on page 123	See Full Scale and Alarm Points on page 123
<b>Detection method</b>	Pump suction type		
<b>Alarm setpoint value</b>	See Full Scale and Alarm Points on page 123	See Full Scale and Alarm Points on page 123	See Full Scale and Alarm Points on page 123
<b>Alarm accuracy</b>	±25% *3	<u>Combustible</u> : ±25% *3 <u>Toxic</u> : ±30% *3	±1 vol% (Accuracy of the reading: ±0.7 vol%)
<b>Alarm delay time</b>	30 seconds or less *4	<u>Combustible</u> : 30 seconds or less *4 <u>Toxic</u> : 60 seconds or less *4	5 seconds or less *6 (90% response: within 30 seconds)
<b>Alarm type</b>	Two-step alarm (H-HH)		Two-step alarm (L-LL, L-H)
<b>Power consumption</b>	Approx. 3W (Max. 5.5W)	Approx. 2.5W (Max. 5W)	Approx. 1.5 W (Max. 4 W)
<b>Power consumption (EA)</b>	<u>24 V</u> : Approx. 4.5W (Max. approx. 6.5W) <u>PoE</u> : Approx. 5.5W (Max. approx. 8.5W)	<u>24 V</u> : Approx. 4W (Max. approx. 6W) <u>PoE</u> : Approx. 5.5W (Max. approx. 7W)	<u>24 V</u> : Approx. 3W (Max. approx. 5W) <u>PoE</u> : Approx. 4.5W (Max. approx. 7W)
<b>Power consumption(DV)</b>	Approx. 3.5W (Max. 6W)	Approx. 3W (Max. 5.5W)	Approx. 2 W (Max. 4.5 W)
<b>Operating temperature (at a constant condition)</b>	0 - 40°C		
<b>Operating humidities (Non-condensing)</b>	95%RH or less		

\*1 Pyrolyzer unit combination specification. For information on the specifications of the pyrolyzer unit (PLU-70), see the separate operating manual.

\*2 The operating temperature/humidity may be different depending on the gas to be detected.

\*3 To the alarm setpoint value

\*4 By providing the gas 1.6 times the alarm setpoint (excluding delay in the tube and in the communication)

\*5 Oxygen deficiency specification

\*6 By letting the detector detect the gas of 10 - 11 vol% (excluding delay in the tube and in the communication).

## NOTE

For information on other specifications such as oxygen leak specifications (OSU), please contact RKI.

	<b>IRU</b>	<b>SHU</b>
<b>Detection principle</b>	NDIR (Non-Dispersive Infrared Absorption)	Hot-wire Semiconductor
<b>Gas to be detected</b>	N <sub>2</sub> O	H <sub>2</sub>
<b>Detection range</b>	See Full Scale and Alarm Points on page 123	See Full Scale and Alarm Points on page 123
<b>Detection method</b>	Pump suction type	
<b>Alarm setpoint value</b>	See Full Scale and Alarm Points on page 123	See Full Scale and Alarm Points on page 123
<b>Alarm accuracy *1</b>	Within ±30%	Within ±25%
<b>Alarm delay time *2</b>	30 seconds or less	30 seconds or less
<b>Alarm type</b>	Two-step alarm (H-HH)	Two-step alarm (H-HH)
<b>Power consumption</b>	Approx. 3 W (Max. 5 W)	Approx. 3 W (Max. 5 W)
<b>Power consumption (EA)</b>	24 V: Approx. 4.5W (Max. approx. 6.5W) PoE: Approx. 5.5W (Max. approx. 8W)	24 V: Approx. 4.5W (Max. approx. 6.5W) PoE: Approx. 5.5W (Max. approx. 8.5W)
<b>Power consumption(DV)</b>	Approx. 3.5 W (Max. 5.5 W)	Approx. 3.5 W (Max. 5.5 W)
<b>Operating temperature (at a constant condition)</b>	0 - 40°C	
<b>Operating humidities (Non-condensing)</b>	95%RH or less	

\*1 To the alarm setpoint value

\*2 By providing the gas 1.6 times the alarm setpoint (excluding delay in the tube and in the communication)

## 12-4 Full Scale and Alarm Points

Detection Gas	Full Scale	Alarm 1	Alarm 2
AsH <sub>3</sub> (Arsine)	0 - 0.20 ppm	0.05 ppm	0.10 ppm
B <sub>2</sub> H <sub>6</sub> (Diborane)	0 - 0.30 ppm	0.10 ppm	0.20 ppm
BCl <sub>3</sub> (Boron trichloride)	0 - 15.0 ppm	5.00 ppm	10.0 ppm
Br <sub>2</sub> (Bromine)	0 - 1.00 ppm	0.30 ppm	0.60 ppm
BTBAS (Bis[tertiary-butyl-amino]silane)	0 - 15.0 ppm	5.00 ppm	10.0 ppm
C <sub>2</sub> H <sub>2</sub> (Acetylene)	0 - 2,000 ppm	500 ppm	1,000 ppm
C <sub>2</sub> H <sub>2</sub> Cl <sub>2</sub> (Dichloroethene)	0 - 600 ppm	200 ppm	400 ppm
C <sub>2</sub> H <sub>4</sub> (Ethylene)	0 - 2,000 ppm	500 ppm	1,000 ppm
C <sub>2</sub> H <sub>5</sub> OH (Ethanol)	0 - 2,000 ppm	500 ppm	1,000 ppm
C <sub>3</sub> H <sub>6</sub> (Propylene)	0 - 5,000 ppm	2,000 ppm	4,000 ppm
C <sub>3</sub> H <sub>8</sub> (Propane)	0 - 2,000 ppm	500 ppm	1,000 ppm
	0 - 5,000 ppm	2,000 ppm	4,000 ppm
	0 - 100% LEL	25% LEL	25% LEL
C <sub>4</sub> F <sub>6</sub> (Hexafluorabutadiene)	0 - 200 ppm	100 ppm	100 ppm
C <sub>4</sub> H <sub>10</sub> (Isobutane)	0 - 100 %LEL	25% LEL	25% LEL
C <sub>6</sub> H <sub>14</sub> (Hexane)	0 - 2,000 ppm	500 ppm	1,000 ppm
CH <sub>2</sub> Cl <sub>2</sub> (Dichloromethane)	0 - 2,000 ppm	500 ppm	1,000 ppm
CH <sub>3</sub> CN (Acetonitrile)	0 - 2,000 ppm	500 ppm	1,000 ppm
CH <sub>3</sub> COOH (Acetic acid)	0 - 30.0 ppm	10.0 ppm	20.0 ppm
CH <sub>3</sub> NH <sub>2</sub> (Methylamine)	0 - 15.0 ppm	5.00 ppm	10.0 ppm
CH <sub>3</sub> OH (Methanol)	0 - 1,000 ppm	250 ppm	500 ppm
	0 - 2,000 ppm	500 ppm	1,000 ppm
CH <sub>4</sub> (Methane)	0 - 100 %LEL	25% LEL	25% LEL
	0 - 2 %volume (NCU Type)	1.00%	1.00%
	0 - 2 %volume (SGU Type)	0.50%	1.00%
	0 - 2,000 ppm	500 ppm	1,000 ppm
	0 - 5,000 ppm	2,000 ppm	4,000 ppm
CH <sub>6</sub> Si (Methylsilane)	0 - 20.0 ppm	5.00 ppm	10.0 ppm
Cl <sub>2</sub> (Chlorine)	0 - 3.00 ppm	1.00 ppm	2.00 ppm
ClF <sub>3</sub> (Chlorine trifluoride)	0 - 0.60 ppm	0.20 ppm	0.40 ppm
CO (Carbon monoxide)	0 - 75.0 ppm	25.0 ppm	50.0 ppm
	0 - 150 ppm	50.0 ppm	100 ppm
	0 - 300 ppm	100 ppm	200 ppm

Detection Gas	Full Scale	Alarm 1	Alarm 2
COS (Carbonyl sulfide)	0 - 2,000 ppm	500 ppm	1,000 ppm
	0 - 90.0 ppm	30.0 ppm	60.0 ppm
COF2 (Cobalt difluorine)	0 - 6.00 ppm	2.00 ppm	4.00 ppm
DEA (Diethylamine)	0 - 15.0 ppm	5.0 ppm	10.0 ppm
DMA (Dimethylamine)	0 - 15.0 ppm	5.0 ppm	10.0 ppm
F2 (Fluorine)	0 - 1.00 ppm	0.30 ppm	0.60 ppm
	0 - 3.00 ppm	1.00 ppm	2.00 ppm
GeH4 (Germane)	0 - 0.80 ppm	0.20 ppm	0.40 ppm
H2 (Hydrogen)	0 - 100 %LEL	10% LEL	50% LEL
	0 - 2.00 %volume (NCU Type)	1.00%	1.00%
	0 - 2.00 %volume (SGU Type)	0.50%	1.00%
	0 - 500 ppm	200 ppm	400 ppm
	0 - 1,000 ppm	250 ppm	500 ppm
	0 - 2,000 ppm	500 ppm	1,000 ppm
	0 - 4,000 ppm	1,000 ppm	2,000 ppm
H2Cl2Si (Dichlorosilane)	0 - 15.0 ppm	5.00 ppm	10.0 ppm
H2O2 (Hydrogen peroxide)	0 - 3.00 ppm	1.00 ppm	2.00 ppm
H2S (Hydrogen sulfide)	0 - 1.00 ppm	0.30 ppm	0.60 ppm
	0 - 30.0 ppm	10.0 ppm	20.0 ppm
H2Se (Hydrogen selenide)	0 - 0.20 ppm	0.05 ppm	0.10 ppm
H9NSi3 (Trisilylamine)	0 - 15.0 ppm	5.0 ppm	10.0 ppm
HBR (Hydrogen bromide)	0 - 6.00 ppm	2.00 ppm	4.00 ppm
	0 - 9.00 ppm	3.00 ppm	6.00 ppm
HCl (Hydrogen chloride)	0 - 6.00 ppm	2.00 ppm	4.00 ppm
	0 - 15.0 ppm	5.0 ppm	10.0 ppm
HCN (Hydrogen cyanide)	0.9 - 15.0 ppm	4.0 ppm	10.0 ppm
HCOOH (Formic acid)	0 - 15.0 ppm	5.0 ppm	10.0 ppm
HF (Hydrogen fluoride)	0.4 - 3.00 ppm	1.00 ppm	2.00 ppm
	0.4 - 9.00 ppm	3.00 ppm	6.00 ppm
HNO3 (Nitric acid)	0 - 20.0 ppm	5.0 ppm	10.0 ppm
IPA (Isopropyl alcohol)	0 - 2,000 ppm	500 ppm	1,000 ppm
	0 - 100 %LEL	25% LEL	25% LEL
N2O (Nitrous oxide)	0 - 500 ppm	50 ppm	100 ppm
N2H4 (Hydrazine)	0 - 5.00 ppm	1.50 ppm	3.00 ppm
NF3 (Nitrogen trifluoride)	0 - 30.0 ppm	10.0 ppm	20.0 ppm
NH3 (Ammonia)	0 - 75.0 ppm	25.0 ppm	50.0 ppm

Detection Gas	Full Scale	Alarm 1	Alarm 2
NO (Nitric oxide)	0 - 100 ppm	5 ppm	10 ppm
NO2 (Nitrogen dioxide)	0 - 9.00 ppm	3.00 ppm	6.00 ppm
	0 - 15.0 ppm	5.0 ppm	10.0 ppm
O2 (Oxygen)	0 - 5.00%	4.00%	4.00%
	0 - 25.0%	18.0%	18.0%
O3 (Ozone)	0 - 0.60 ppm	0.20 ppm	0.40 ppm
	0 - 1.00 ppm	0.30 ppm	0.60 ppm
PH3 (Phosphine)	0 - 1.00 ppm	0.30 ppm	0.60 ppm
R32 (Difluoromethane)	0 - 2,000 ppm	500 ppm	1,000 ppm
	0 - 5,000 ppm	2,000 ppm	4,000 ppm
	0 - 9,000 ppm	5,000 ppm	9,000 ppm
R41 (Fluoromethane)	0 - 2,000 ppm	500 ppm	1,000 ppm
TEOS (Tetraethyl orthosilicate)	0 - 15.0 ppm	10.0 ppm	10.0 ppm
TMA (Trimethylamine)	0 - 15.0 ppm	5.0 ppm	10.0 ppm
TMB (Trimethoxy borane)	0 - 1000 ppm	800 ppm	800 ppm
TMS (Tetramethyl silane)	0 - 15.0 ppm	10.0 ppm	10.0 ppm
TRIMS (Trimethyl silane)	0 - 15.0 ppm	10.0 ppm	10.0 ppm
Si2H6 (Disilane)	0 - 15.0 ppm	5.0 ppm	10.0 ppm
SiCl4 (Silicon tetrachloride)	0 - 15.0 ppm	5.0 ppm	10.0 ppm
SiH4 (Silane)	0 - 15.0 ppm	5.0 ppm	10.0 ppm
SO2 (Sulphur dioxide)	0 - 6.00 ppm	2.00 ppm	4.00 ppm

# 13

## Calibration Parts List

General Parts Description	Part Number
Humidifier, 6", with tubing (for MOS sensor calibration)	33-2001RK-01
Dispensing valve for filling gas bag, for 17 liter and 34 liter steel calibration cylinders (cylinders with external threads)	81-1001RK
Regulator with gauge and knob for filling gas bag, 6 LPM, for 34 liter aluminum, 58 liter, and 103 liter calibration cylinders (cylinders with internal threads)	81-1051RK-60
Regulator, demand flow type, for 34 liter aluminum, 58 liter, and 103 liter calibration cylinders (cylinders with internal threads)	81-1054RK
Regulator, demand flow type, for 17 liter and 34 liter steel calibration cylinders (cylinders with external threads)	81-1055RK
Gas bag with clamp and hose, 9" x 9", 2 liter	81-1126RK

Cylinder Description	Part Number
C3H8 (propane): 1000 ppm in air, 34 liter steel calibration cylinder	81-0005RK-01
C3H8 (propane): 2100 ppm (10% LEL) in air, 17 liter calibration cylinder	81-0003RK-11
C3H8 (propane): 2100 ppm (10% LEL) in air, 34 liter steel calibration cylinder	81-0003RK-13
C3H8 (propane): 50% LEL in air, 34 liter steel calibration cylinder	81-0004RK-01
C3H8 (propane): 50% LEL in air, 103 liter calibration cylinder	81-0004RK-03
C4H10 (isobutane): 1800 ppm in air, 34 liter steel calibration cylinder	81-0038RK-01
C4H10 (isobutane): 1800 ppm in air, 103 liter calibration cylinder	81-0038RK-03
C4H10 (isobutane): 3600 ppm (20% LEL) in air, 34 liter steel calibration cylinder	81-0021RK-01
C4H10 (isobutane): 50% LEL in air, 34 liter steel calibration cylinder	81-0018RK-01
C4H10 (isobutane): 50% LEL in air, 103 liter calibration cylinder	81-0018RK-03
C6H10 (hexane): 1100 ppm (10% LEL) in air, 103 liter calibration cylinder	81-0007RK-03
CH4 (methane): 1000 ppm in air, 34 liter steel calibration cylinder	81-0085RK-01
CH4 (methane): 1000 ppm in air, 103 liter calibration cylinder	81-0085RK-03
CH4 (methane): 2500 ppm (5% LEL) in air, 103 liter calibration cylinder	81-0015RK-03
CH4 (methane): 5000 ppm (0.5% volume) in air, 34 liter steel calibration cylinder	81-0086RK-01
CH4 (methane): 5000 ppm (0.5% volume) in air, 103 liter calibration cylinder	81-0086RK-03
Cl2 (chlorine): 2 ppm in nitrogen, 58 liter calibration cylinder	81-0192RK-02
Cl2 (chlorine): 2 ppm in nitrogen, 34 liter aluminum calibration cylinder	81-0192RK-04
Cl2 (chlorine): 5 ppm in nitrogen, 58 liter calibration cylinder	81-0190RK-02
Cl2 (chlorine): 5 ppm in nitrogen, 34 liter aluminum calibration cylinder	81-0190RK-04
CO (carbon monoxide): 50 ppm in nitrogen, 34 liter steel calibration cylinder	81-0062RK-01
CO (carbon monoxide): 50 ppm in nitrogen, 103 liter calibration cylinder	81-0062RK-03
CO (carbon monoxide): 100 ppm in air, 34 liter steel calibration cylinder	81-0065RK-01
CO (carbon monoxide): 100 ppm in air, 103 liter calibration cylinder	81-0065RK-03
CO (carbon monoxide): 200 ppm in air, 34 liter steel calibration cylinder	81-0066RK-01
CO (carbon monoxide): 200 ppm in air, 103 liter calibration cylinder	81-0066RK-03

<b>Cylinder Description</b>	<b>Part Number</b>
COS (carbonyl sulfide): 40 ppm in air, 58 liter calibration cylinder	81-0188RK-02
H2 (hydrogen): 100 ppm in air, 34 liter steel calibration cylinder	81-0033RK-01
H2 (hydrogen): 100 ppm in air, 103 liter calibration cylinder	81-0033RK-03
H2 (hydrogen): 200 ppm in air, 34 liter steel calibration cylinder	81-0000RK-51
H2 (hydrogen): 250 ppm in air, 34 liter steel calibration cylinder	81-0032RK-01
H2 (hydrogen): 250 ppm in air, 103 liter calibration cylinder	81-0032RK-03
H2 (hydrogen): 500 ppm in air, 34 liter steel calibration cylinder	81-0000RK-71
H2 (hydrogen): 500 ppm in air, 103 liter calibration cylinder	81-0000RK-73
H2 (hydrogen): 1000 ppm in air, 34 liter steel calibration cylinder	81-0000RK-01
H2 (hydrogen): 1000 ppm in air, 103 liter calibration cylinder	81-0000RK-03
H2 (hydrogen): 2000 ppm in air, 34 liter steel calibration cylinder	81-0000RK-21
H2 (hydrogen): 2000 ppm in air, 103 liter calibration cylinder	81-0000RK-23
H2 (hydrogen): 4000 ppm in air, 34 liter steel calibration cylinder	81-0000RK-31
H2 (hydrogen): 4000 ppm in air, 103 liter calibration cylinder	81-0000RK-33
H2 (hydrogen): 1.2% volume in air, 34 liter steel calibration cylinder	81-0001RK-21
H2 (hydrogen): 1.2% volume in air, 103 liter calibration cylinder	81-0001RK-23
H2 (hydrogen): 50% LEL in air, 34 liter steel calibration cylinder	81-0002RK-01
H2 (hydrogen): 50% LEL in air, 103 liter calibration cylinder	81-0002RK-03
H2S (hydrogen sulfide): 1 ppm in nitrogen, 58 liter calibration cylinder	81-0147RK-02
H2S (hydrogen sulfide): 15 ppm in nitrogen, 58 liter calibration cylinder	81-0148RK-02
HCl (hydrogen chloride): 5 ppm in nitrogen, 58 liter calibration cylinder	81-0195RK-02
HCl (hydrogen chloride): 5 ppm in nitrogen, 34 liter aluminum calibration cylinder	81-0195RK-04
HCN (hydrogen cyanide): 10 ppm in nitrogen, 58 liter calibration cylinder	81-0196RK-02
HCN (hydrogen cyanide): 10 ppm in nitrogen, 103 liter calibration cylinder	81-0196RK-04
IPA (isopropyl alcohol): 1000 ppm in air, 34 liter steel calibration cylinder	81-0035RK-01
IPA (isopropyl alcohol): 1000 ppm in air, 103 liter calibration cylinder	81-0035RK-03
N2 (nitrogen): 100% volume, 34 liter steel calibration cylinder	81-0078RK-01
N2 (nitrogen): 100% volume, 103 liter calibration cylinder	81-0078RK-03
N2O (nitrous oxide): 250 ppm in air, 34 liter steel calibration cylinder	81-0183RK-01
N2O (nitrous oxide): 250 ppm in air, 58 liter calibration cylinder	81-0183RK-03
NF3 (nitrogen trifluoride): 15 ppm in N2, 58 liter calibration cylinder	81-0178RK-02
NH3 (ammonia): 5 ppm in nitrogen, 58 liter calibration cylinder	81-0173RK-02
NH3 (ammonia): 50 ppm in nitrogen, 58 liter calibration cylinder	81-0174RK-02
NO (nitric oxide): 10 ppm in nitrogen, 58 liter calibration cylinder	81-0184RK-02
NO (nitric oxide): 25 ppm in nitrogen, 58 liter calibration cylinder	81-0181RK-02
NO (nitric oxide): 25 ppm in nitrogen, 34 liter aluminum calibration cylinder	81-0181RK-04
NO2 (nitrogen dioxide): 5 ppm in air, 58 liter calibration cylinder	81-0182RK-02
NO2 (nitrogen dioxide): 5 ppm in air, 34 liter aluminum calibration cylinder	81-0182RK-04
NO2 (nitrogen dioxide): 10 ppm in air, 58 liter calibration cylinder	81-0180RK-02
NO2 (nitrogen dioxide): 10 ppm in air, 34 liter aluminum calibration cylinder	81-0180RK-04
O2 (oxygen): 2% volume in nitrogen, 103 liter calibration cylinder	81-0074RK-03
PH3 (phosphine): 0.5 ppm in nitrogen, 58 liter calibration cylinder	81-0185RK-02
PH3 (phosphine): 0.5 ppm in nitrogen, 34 liter aluminum calibration cylinder	81-0185RK-04
SiH4 (silane): 5 ppm in nitrogen, 58 liter calibration cylinder	81-0165RK-02
SiH4 (silane): 15 ppm in nitrogen, 58 liter calibration cylinder	81-0169RK-02
SiH4 (silane): 30 ppm in nitrogen, 34 liter aluminum calibration cylinder	81-0166RK-04
SO2 (sulfur dioxide): 5 ppm in nitrogen, 58 liter calibration cylinder	81-0170RK-02

---

<b>Cylinder Description</b>	<b>Part Number</b>
SO2 (sulfur dioxide): 5 ppm in nitrogen, 34 liter aluminum calibration cylinder	81-0170RK-04
Zero air, 34 liter steel calibration cylinder	81-0076RK-01
Zero air, 103 liter calibration cylinder	81-0076RK-03



# 14

## Replacement Parts List

General Parts Description	Part Number
Downloading cable	47-5060RK
Dust filter	33-0165RK-01
Flow sensor	31-1011-01
Pump	30-1020RK
Tubing nut, ferrule and post, 4 x 6 mm	17-2500RK-01
Tubing nut, ferrule and post, 1/4 x 5/32"	17-2503RK-01
Wiring tool lever	46-5100RK

ESU Type Sensor Description	Part Number
AsH3 (Arsine) 0 - 0.20 ppm sensor	ESU-23AHS-ASH3
B2H6 (Diborane) 0 - 0.30 ppm sensor	ESU-23AY-B2H6
BCl3 (Boron trichloride) 0 - 15.0 ppm sensor	ESU-23E-HCL-15
Br2 (Bromine) 0 - 1.00 ppm sensor	ESU-K233-BR2
BTBAS (Bis[tertiary-butyl-amino]silane) 0 - 15.0 ppm	ESU-23RV-BTBAS
CH3COOH (Acetic acid) 0 - 30.0 ppm sensor	ESU-K233-ACET
CH3NH2 (Methylamine) 0 - 15.0 ppm sensor	ESU-23RV-CH3NH2
CH6Si (Methylsilane) 0 - 20.0 ppm sensor	ESU-23DH-MS
Cl2 (Chlorine) 0 - 3.00 ppm sensor	ESU-K233-CL2
ClF3 (Chlorine trifluoride) 0 - 0.60 ppm sensor A type	ESU-K233CS-CLFA
ClF3 (Chlorine trifluoride) 0 - 0.60 ppm sensor C type	ESU-K233CS-CLFC
CO (Carbon monoxide) 0 - 75 ppm sensor	ESU-23-CO-75
CO (Carbon monoxide) 0 - 75 ppm sensor	ESU-231-CO-75
CO (Carbon monoxide) 0 - 150 ppm sensor	ESU-23-CO-150
CO (Carbon monoxide) 0 - 150 ppm sensor	ESU-231-CO-150
CO (Carbon monoxide) 0 - 300 ppm sensor	ESU-23-CO-300
CO (Carbon monoxide) 0 - 300 ppm sensor	ESU-231-CO-300
COF2 (Cobalt difluorine) 0 - 6.00 ppm sensor	ESU-K253-COF2
COS (Carbonyl sulfide) 0 - 90.0 ppm sensor	ESU-238-COS
DEA (Diethylamine) 0 - 15.0 ppm sensor	ESU-23RV-DEA
DMA (Dimethylamine) 0 - 15.0 ppm sensor	ESU-23RV-DMA
F2 (Fluorine) 0 - 1.00 ppm sensor	ESU-K235-F2
F2 (Fluorine) 0 - 3.00 ppm sensor	ESU-K233-F2
GeH4 (Germane) 0 - 0.80 ppm sensor	ESU-23DH-GEH4
H2Cl2Si (Dichlorosilane) 0 - 15.0 ppm sensor	ESU-23E-HCL-15
H2O2 (Hydrogen peroxide) 0 - 3.00 ppm sensor	ESU-23DH-H2O2
H2S (Hydrogen sulfide) 0 - 1.00 ppm sensor	ESU-237IF-H2S
H2S (Hydrogen sulfide) 0 - 30.0 ppm sensor	ESU-237-H2S
H2Se (Hydrogen selenide) 0 - 0.20 ppm sensor	ESU-23SD-H2SE
H9NSi3 (Trisilylamine) 0 - 15.0 ppm sensor	ESU-23DH-TSA

<b>ESU Type Sensor Description</b>	<b>Part Number</b>
HBr (Hydrogen bromide) 0 - 6.00 ppm sensor	ESU-23E-HBR-06
HBr (Hydrogen bromide) 0 - 9.00 ppm sensor	ESU-23E-HBR-09
HCl (Hydrogen chloride) 0 - 6.00 ppm sensor	ESU-23E-HCL-06
HCl (Hydrogen chloride) 0 - 15.0 ppm sensor	ESU-23E-HCL-15
HCN (Hydrogen cyanide) 0.9 - 15.0 ppm sensor	ESU-23DH-HCN
HCOOH (Formic acid) 0 - 15.0 ppm sensor	ESU-K233M-HCOOH
HF (Hydrogen fluoride) 0.40 - 9.00 ppm sensor	ESU-K233-HF-09
HNO3 (Nitric acid) 0 - 20.0 ppm sensor	ESU-K233-HNO3
N2H4 (Hydrazine) 0 - 5.00 ppm sensor	ESU-23E-N2H4
NF3 (Nitrogen trifluoride) 0 - 30.0 ppm sensor	ESU-23AH-D-NF3
NH3 (Ammonia) 0 - 75.0 pm sensor	ESU-23R-NH3
NO (Nitric oxide) 0 - 100 ppm sensor	ESU-23A-NO
NO2 (Nitrogen dioxide) 0 - 9.00 ppm sensor	ESU-23AH-NO2-09
NO2 (Nitrogen dioxide) 0 - 15.0 ppm sensor	ESU-23AH-NO2-15
O2 (Oxygen) 0 - 25.0% volume sensor	ESU-X23-OXY
O3 (Ozone) 0 - 1.00 ppm sensor	ESU-K239C-O3
O3 (Ozone) 0 - 0.60 ppm sensor	ESU-K239C-S-O3
PH3 (Phosphine) 0 - 1.00 ppm sensor AH type	ESU-23AH-PH3
PH3 (Phosphine) 0 - 1.00 ppm sensor DH type	ESU-23DH-PH3
Si2H6 (Disilane) 0 - 15.0 ppm sensor	ESU-23DH-SI2H6
SiH4 (Silane) 0 - 15.0 ppm sensor AH type	ESU-23AH-SIH4
SiH4 (Silane) 0 - 15.0 ppm sensor DH type	ESU-23DH-SIH4
SiCl4 (Silicon tetrachloride) 0 - 15.0 ppm sensor	ESU-23E-HCL-15
SO2 (Sulfur dioxide) 0 - 6.00 ppm sensor	ESU-238-SO2
TMA (Trimethylamine) 0 - 15.0 ppm sensor	ESU-23RV-TMA

<b>IRU Type Sensor Description</b>	<b>Part Number</b>
N2O (Nitrous oxide) 0 – 500 ppm sensor	IRU-2428

<b>NCU Type Sensor Description</b>	<b>Part Number</b>
C3H8 (Propane) 0 - 100% LEL sensor	NCU-6211
C4H10 (Isobutane) 0 - 100% LEL sensor	
C6H10 (Hexane) 0 - 2000 ppm sensor	
H2 (Hydrogen) 0 - 2% volume sensor	
H2 (Hydrogen) 0 - 100% LEL sensor	
IPA (Isopropyl alcohol) 0 - 100% LEL sensor	NCU-6213
CH4 (Methane) 0 - 2% volume sensor	
CH4 (Methane) 0 - 100% LEL sensor	

<b>OSU Type Sensor Description</b>	<b>Part Number</b>
O2 (Oxygen) 0 - 5.00% volume sensor	OSU-8078-05

<b>SGU Type Sensor Description</b>	<b>Part Number</b>
C2H2 (Acetylene) 0 - 2000 ppm sensor	SGU-8521-C2H2-2K
C2H2Cl2 (Dichloroethene) 0 - 600 ppm sensor	SGU-8513-DCE-6

<b>SGU Type Sensor Description</b>	<b>Part Number</b>
C2H4 (Ethylene) 0 - 2000 ppm sensor	SGU-8521-C2H4-2
C2H5OH (Ethanol) 0 - 2000 ppm sensor	SGU-8521-C2H5OH
C3H6 (Propylene) 0 - 5000 ppm sensor	SGU-8511-C3H6-5
C3H8 (Propane) 0 - 2000 ppm sensor	SGU-8511-C3H8-2
C3H8 (Propane) 0 - 5000 ppm sensor	SGU-8511-C3H8-5
C4F6 (Hexafluorabutadiene) 0 - 200 ppm sensor	SGU-8521-C4F6A
CH2Cl2 (Dichloromethane) 0 - 2000 ppm sensor	SGU-8523-DCM-2K
CH2F2 (Difluoromethane) 0 - 9000 ppm sensor	SGU-8521-R32-9K
CH3CN (Acetonitrile) 0 - 2000 ppm sensor	SGU-8521-CH3CN
CH3OH (Methanol) 0 - 1000 ppm sensor	SGU-8521-MET-1K
CH3OH (Methanol) 0 - 2000 ppm sensor	SGU-8521-MET-2K
CH4 (Methane) 0 - 2000 ppm sensor	SGU-8581-CH4-2K
CH4 (Methane) 0 - 5000 ppm sensor	SGU-8511-CH4-5K
CH4 (Methane) 0 - 2% volume sensor	SGU-8511-CH4-20
COS (Carbonyl sulfide) 0 - 2000 ppm sensor	SGU-8562-COS-2K
H2 (Hydrogen) 0 - 500 ppm sensor	SGU-8521-H2-500
H2 (Hydrogen) 0 - 500 ppm sensor (hydrogen specific)	SGU-8541-H2-500
H2 (Hydrogen) 0 - 1000 ppm sensor	SGU-8521-H2-1K
H2 (Hydrogen) 0 - 1000 ppm sensor (hydrogen specific)	SGU-8541-H2-1K
H2 (Hydrogen) 0 - 2000 ppm sensor (hydrogen specific)	SGU-8541-H2-2K
H2 (Hydrogen) 0 - 4000 ppm sensor (hydrogen specific)	SGU-8541-H2-4K
H2 (Hydrogen) 0 - 2% volume sensor	SGU-8511-H2-20K
IPA (Isopropyl alcohol) 0 - 2000 ppm sensor	SGU-8521-IPA-2K
R32 (Difluoromethane) 0 - 2000 ppm sensor	SGU-8521-R32-2K
R32 (Difluoromethane) 0 - 5000 ppm sensor	SGU-8521-R32-5K
R41 (Fluoromethane) 0 - 2000 ppm sensor	SGU-8521-R41-2K

<b>SSU Type Sensor Description</b>	<b>Part Number</b>
TEOS (Tetraethyl orthosilicate) 0 - 15.0 ppm sensor	SSU-1925
TMB (Trimethoxy borane) 0 - 1000 ppm sensor	
TMS (Tetramethyl silane) 0 - 15.0 ppm sensor	
TRIMS (Trimethyl silane) 0 - 15.0 ppm	

## Definition of Terms

<b>External Dust Filter</b>	When the detector is used in a dusty environment, it is recommended that a dust filter be installed in the inlet line.
<b>vol%</b>	Gas concentration indicated in the unit of one-hundredth of the volume.
<b>ppm</b>	Gas concentration indicated in the unit of one-millionth of the volume.
<b>ppb</b>	Gas concentration indicated in the unit of one-billionth of the volume.
<b>Calibration</b>	Determine the relationship between the gas reading and the actual value by using calibration gas.
<b>Maintenance Mode</b>	When maintenance is performed on the detector, the alarm contact is disconnected, and a signal to indicate Maintenance Mode status is sent out to the external output signal.
<b>Initial Clear</b>	The reading is unstable for a few seconds after the power is turned on. To prevent malfunctions for that period, the alarm contact is deactivated. In addition, a signal to indicate the initial clear status is sent out to the external output.
<b>Zero Suppression</b>	A function to obscure the influences of environmental changes, interference gases, etc.
<b>Alarm Delay Time</b>	A function which delays alarm activation to prevent a false alarm caused by noise.
<b>Inhibit</b>	The gas detection function is temporarily suspended during maintenance. This is also called "point skip", which has the same function.
<b>Pyrolyzer Unit</b>	A unit to decompose gases under high temperatures. It pyrolyzes special gases under high temperature to make them detectable.

# Detection principle

## <Electrochemical Type>

The electric potential between the working electrode and reference electrode is kept at a certain level by a potentiostat circuit. The gas to be detected is electrolyzed directly at the working electrode. Because the current generated is proportional to the gas concentration, the gas concentration can be determined by measuring the current between the working electrode and the opposite electrode.

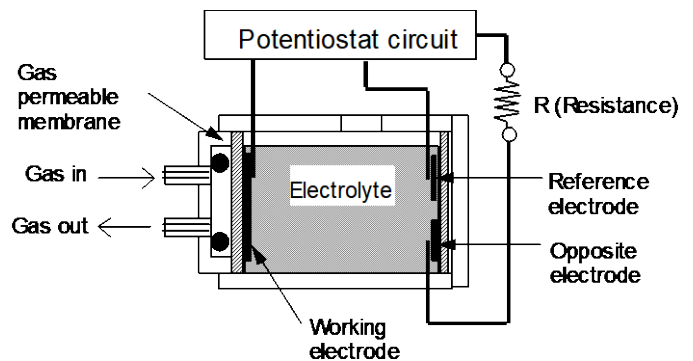

Structure diagram

### Special precautions for this principle

1. The detector is interfered by gases other than the gas to be detected, solvents, vapors, etc.  
Please note that an alarm can be triggered by interference. In addition, the reading may be affected by environmental (temperature, humidity, etc.) changes in the installation site.
2. The alarm must be set within a range where the performance of the detector can be ensured.  
In facilities compliant with the High Pressure Gas Safety Act, an alarm setting below our standard alarm setpoint (threshold limit value) may trigger a false alarm.
3. This is a safety device, not a control device.  
The alarm contact output of the detector must be used for an external alarm lamp/buzzer, while the alarm signal output must be used for an indicator or external recorder. If these outputs are used to control other devices, we shall not be responsible for any malfunctions.
4. Because the contact point of the gas detector sensor is made of porous polymeric membrane, the water repellency of the membrane is deteriorated by solvents, thus causing an electrolyte leak.  
Do not use solvents near the detector. If you must use a solvent for unavoidable reasons, attach the recommended filter to the inlet of the gas detector while using the solvent and for one hour after that.
5. It is recommended that a regular maintenance and gas calibration are performed for every six months in accordance with the regulations.

## <Pyrolysis-Particle Type>

When the gas to be detected is heated to several hundred degrees, particulate solid oxides are formed. This is a sensor to detect particles formed in such a way by using the  $\alpha$  ray absorbing method.

### Structure

This unit consists of a pyrolyzer, which heats gas to several hundred degrees, and a particle detector, which detects oxides. The pyrolyzer has a quartz pipe at its center covered with a heating element and a heat insulator around it. The particle detector consists of the measurement box in which  $\alpha$  ray always generates ion current and the compensation box which has the identical structure (gas is not introduced).

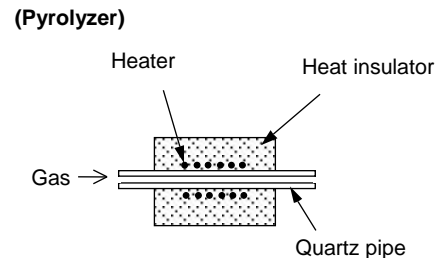

### Principle

When most organic metal (MO) gases, such as TEOS, are heated, particulate oxides are formed. Sample gas which is decomposed to oxides in the Pyrolyzer is introduced into the particle detector.

Inside of the measurement box of the particle detector, the  $\alpha$  ray radiation source (\*1) ionizes the air and generates ion current.

Ion current is also generated in the compensation box, and its ratio is maintained at a certain level in both the measurement box and the compensation box when no gas is present. When particles are introduced into the measurement box, the particles absorb ions, thus reducing the ion current. Its ratio to the compensation box changes, which can be obtained from the detector.

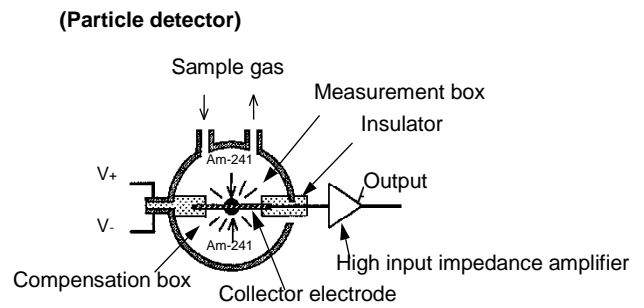

\* 1: SSU-1025: Am-241 37 kBq  
SSU-1027: Am-241 7.4 kBq

### Special precautions for this principle

1. The detector is interfered by gases other than the gas to be detected, and vapors. Please note that an alarm can be triggered by interference. In addition, the reading may be affected by environmental (temperature, humidity, etc.) changes in the installation site.
2. The alarm must be set within a range where the performance of the detector can be ensured. In facilities compliant with the High Pressure Gas Safety Act, an alarm setting below our standard alarm setpoint may trigger a false alarm.
3. This is a safety device, not a control device. The alarm contact output of the detector must be used for an external alarm lamp/buzzer, while the alarm signal output must be used for an indicator or external recorder. If these outputs are used to control other devices, we shall not be responsible for any malfunctions.
4. The gas detection sensor unit attached to the detector contains a small amount of radioactive materials. Do not disassemble it, or dispose of it like other wastes. (For information on how to handle the sensor, see the "Safety Manual".)
5. It is recommended that a regular maintenance and gas calibration are performed for every six months in accordance with the regulations.

The detector has the pyrolysis-particle type sensor, which is a radioisotope-equipped device. It is examined in accordance with the regulations on "Article 12 - 3 of Act on Prevention of Radiation Disease Due to Radioisotopes, etc." (Nuclear Safety Technology Center, a certification and registration body), and certified as a specified designing certification device, which is regarded as a device causing little radiation damage.

(Certificate Number: 0091 )

No registrations have to be made to use a gas detector with the pyrolysis-particle type sensor installed (as far as it is used in accordance with this operating manual).

When the pyrolysis-particle type sensor is used as a single device, observe the certification conditions specified in the "Safety Manual".

<Safety Manual>

No.4019 4059 2

The pyrolysis-particle type sensor (SS-1923/1924 and SS-1925 Note1)) is a radioisotope-equipped device which uses radioisotope 37 kBq 241-Am.

This pyrolysis-particle type sensor is certified as a specified designing certification device by Nuclear Safety Technology Center, a certification and registration body causing little radiation damage. (SS-1923/1924 : Certificate Number 0027, SS-1925 : Certificate Number 0091)

When the sensor is used within Japan, no registrations have to be made Note2).

However, because the regulations are applied to the sensor, it must be used in accordance with the following certification conditions Note3).

- Do not disassemble the sensor Note4).
- The sensor must be installed in our product when it is used. Do not remove it from the product if not necessary.
- When the sensor is detached from the product and is stored, you must introduce measures to prevent it from being taken out freely, i.e., putting it into the dedicated box we specify, and keeping it in a locked room.
- When the sensor is no longer needed, do not dispose of it, but return it to us.
- The sensor must be handled as a L-type package. It must be put into the dedicated box we specify or integrated into our product which is labeled as a "Radioactive L-type package" when it is transported.
- When the sensor is transported, it must be handled by a transportation company which can handle L-type packages Note5).

Note 1) SS-1925 indicates the sensor installed in the pyrolysis-particle type sensor unit SSU-1925.

Note 2) When the sensor is used outside of Japan, observe the regulations of the respective country.

Note 3) When the sensor is used in a way not in accordance with the certification conditions, a usage registration must be made to the Minister of Education, Culture, Sports, Science and Technology.

If you find the sensor which is not controlled properly, please let us know.

Note 4) Do not disassemble the pyrolysis-particle type sensor unit SSU-1925 in which SS-1925 is installed.

Note 5) L-type packages can be handled by us and service companies we specify.

Web site on the designing certification: <http://www.mext.go.jp/>



2-7-6 Azusawa Itabashi-ku Tokyo, 174-8744 Japan  
TEL 03-3966-1112  
RIKEN KEIKI CO., LTD.

## Safety of the radioisotope $^{241}\text{Am}$ (37 KBq) used in the pyrolysis-particle type sensor

The pyrolysis-particle type sensor installed in the gas detector uses the radioisotope  $^{241}\text{Am}$  radiation source ( $18.5 \text{ KBq} \times 2 = 37 \text{ KBq}$ ).

A specified designing certification device must satisfy the specified threshold for "1 cm dose equivalent rate at a point 10 cm away from the surface of the device" as a certificate condition, which is the following value (tolerable amount).

	Tolerable amount
1 cm dose equivalent rate at a point 10 cm away from the surface of the device	$1 \mu\text{Sv}\cdot\text{h}^{-1}$

This detector which uses radioisotope  $^{241}\text{Am}$  radiation source ( $18.5 \text{ KBq} \times 2 = 37 \text{ KBq}$ ) has the following 1 cm dose equivalent rate at a point 10 cm away from its surface, meaning that it completely satisfies the certification condition.

### 1 cm dose equivalent rate at a point 10 cm away from the surface of the sensor (calculated value)

$$D = \frac{Q}{r^2} \cdot \Gamma_{1\text{cm}} = \frac{2 \times 18.5 \times 10^{-3}}{(0.1)^2} \cdot 0.00524 = 0.019 \text{ } [\mu\text{Sv}\cdot\text{h}^{-1}]$$

$Q$  : Amount of radioisotope  $2 \times 18.5 \times 10^{-3} \text{ [MBq]} = (37 \text{ KBq})$

$\Gamma_{1\text{cm}}$  : 1 cm dose equivalent rate constant of  $^{241}\text{Am}$   $0.00524 \text{ } [\mu\text{Sv}\cdot\text{m}^2\cdot\text{MBq}^{-1}\cdot\text{h}^{-1}]$

$r$  : Distance from radiation source  $0.1 \text{ [m]}$

It is certified as a safety device, provided that it is used in accordance with the certification conditions specified in the "Safety Manual".



## <New Ceramic Type>

When a combustible gas burns on the surface of a highly active new ceramic oxidation catalyst in catalytic combustion, the new ceramic-type sensor measures resultant temperature changes by measuring the resistance changes in the heat-resistant alloy wire coil.

The sensor consists of two elements: A detecting element having a heat-resistant alloy wire coil with an ultrafine particle (new ceramic) oxidation catalyst sintered on it together with a carrier and a temperature-compensating element with a mixture of gas-inert alumina and glass sintered on it.

When a combustible gas comes into contact with the surface of the detecting element with new ceramic oxidation catalyst sintered on it, the gas burns, causing the temperature to rise. In accordance with this temperature change, there occurs a change in the resistance of a heat-resistant alloy wire coil that constitutes the element. These resistance values are approximately proportional to gas concentrations. From the changes in the resistance values, potential differences are obtained using a bridge circuit and displayed as gas concentrations on the meter.

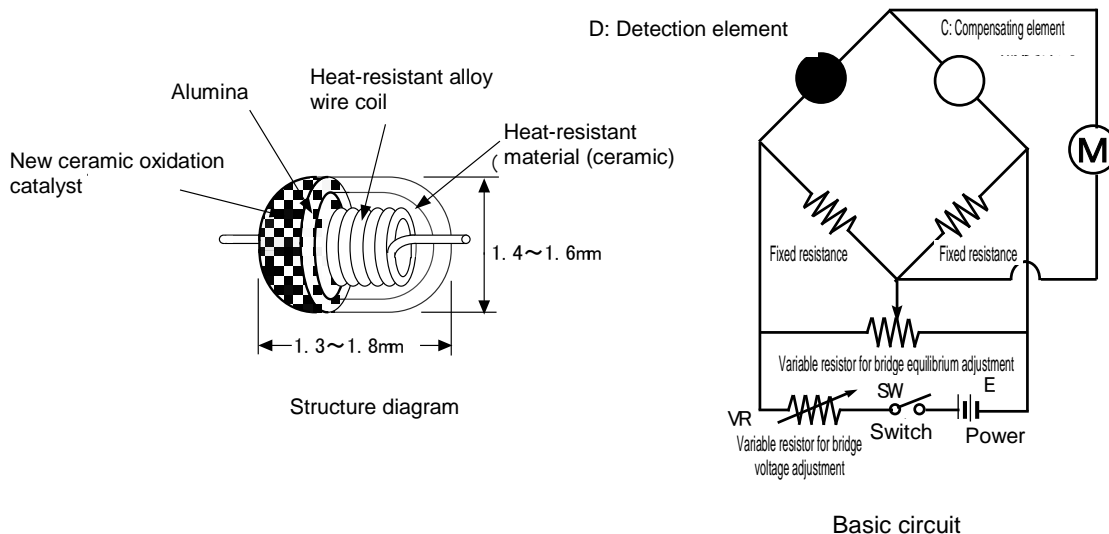

### Special precautions for this principle

1. The detector is interfered by gases other than the gas to be detected, and vapors.  
Please note that the alarm can be triggered by interference. In addition, the reading may be affected by environmental (temperature, humidity, etc.) changes in the installation site.
2. The alarm must be set within a range where the performance of the detector can be ensured.  
In facilities compliant with the High Pressure Gas Safety Act, an alarm setting below our standard alarm setpoint may trigger a false alarm.
3. This is a safety device, not a control device.  
The alarm contact output of the detector must be used for an external alarm lamp/buzzer, while the alarm signal output must be used for an indicator or external recorder. If these outputs are used to control other devices, we shall not be responsible for any malfunctions.
4. The gas sensing part of this detector is made of porous sintered bodies. If silicon or sulfide compounds are accumulated on the surface of the porous sintered body, the area of the gas sensing part becomes smaller, which may result in serious sensitivity deterioration.  
For safety reasons, do not use the detector in the presence of silicon or sulfide compounds.
5. It is recommended that a regular maintenance and gas calibration are performed for every six months in accordance with the regulations.

## <Semiconductor Type>

Metal dioxide can measure gas concentration based on changes in the electric conductivity of semiconductor caused by gas accumulated on its surface.

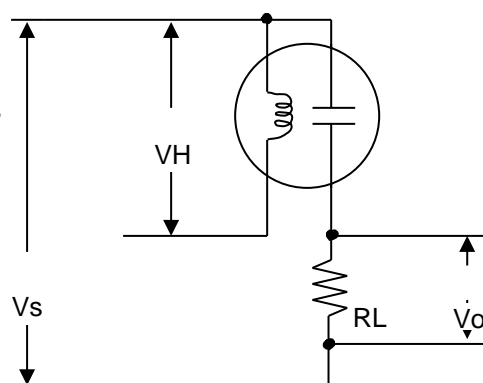

RL: Load resistance Vo: Output voltage  
VH: Heater voltage Vs: Sensor voltage

### Special precautions for this principle

1. The detector is interfered by gases other than the gas to be detected, and vapors.  
Please note that the alarm can be triggered by interference. In addition, the reading may be affected by environmental (temperature, humidity, etc.) changes in the installation site.
2. The alarm must be set within a range where the performance of the detector can be ensured.  
In facilities compliant with the High Pressure Gas Safety Act, an alarm setting below our standard alarm setpoint may trigger a false alarm.
3. This is a safety device, not a control device.  
The alarm contact output of the detector must be used for an external alarm lamp/buzzer, while the alarm signal output must be used for an indicator or external recorder. If these outputs are used to control other devices, we shall not be responsible for any malfunctions.
4. The gas sensing part of this detector is made of porous sintered bodies. If silicon or sulfide compounds are accumulated on the surface of the porous sintered body, the area of the gas sensing part becomes smaller, which may result in serious sensitivity deterioration.  
For safety reasons, do not use the detector in the presence of silicon or sulfide compounds.
5. It is recommended that a regular maintenance and gas calibration are performed for every six months in accordance with the regulations.

---

## <Galvanic Cell Type>

By immersing precious metal and lead in electrolyte and connecting them with a lead wire, a battery can be made (galvanic cell). When oxygen passes through the barrier, a deoxidizing reaction occurs at the precious metal electrode while an oxidizing reaction occurs at the lead electrode.

The electric current generated by this reaction goes through load resistance (thermister), where it is converted into voltage so that it can be read. When the oxygen concentration is decreased, deoxidizing reaction at the precious metal electrode is also decreased, thus lowering the voltage at both ends of the thermister.

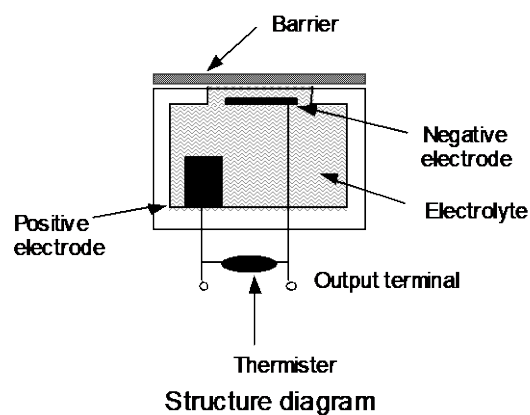

### Special precautions for this principle

1. The readings of the detector fluctuate slightly in response to changes in the air pressure. In particular, be careful of alarm activation when a low air pressure is brought in by typhoon. Environmental (temperature, humidity, etc.) changes in the installation site may also affect the readings.
2. The alarm must be set within a range where the performance of the detector can be ensured. The standard alarm setpoint is 18 vol%.
3. This is a safety device, not a control device.  
The alarm contact output of the detector must be used for an external alarm lamp/buzzer, while the alarm signal output must be used for an indicator or external recorder. If these outputs are used to control other devices, we shall not be responsible for any malfunctions.
4. It is recommended that a regular maintenance and sensitivity calibration are performed for every six months.

---

## <NDIR (Non-Dispersive Infrared Absorption Type)>

IR light enters the cell and gas absorbs the beam, so the absorption rate and the gas concentration will correlate. The IR detector detects the IR light and will put it out as gas concentration.

The band pass filter only lets specific wavelength that is absorbed by the target gas. The detector will not detect any light that has different wavelength. Also, the detector will not detect gas that does not absorb IR rays.

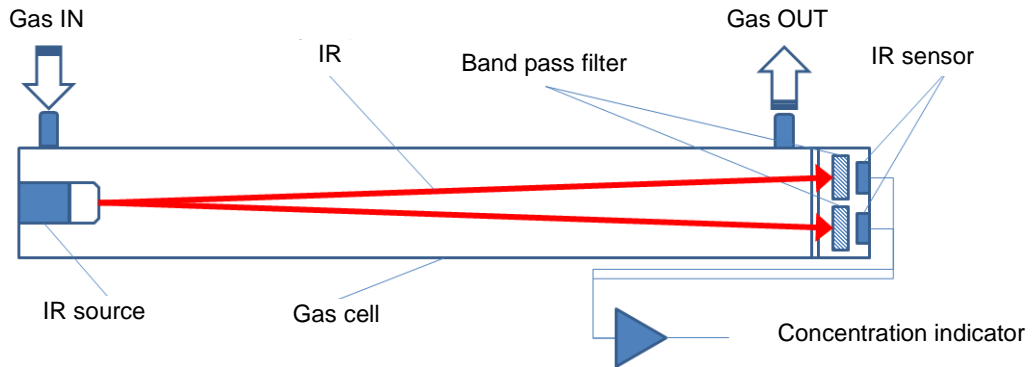

### Special precautions for this principle

1. The alarm must be set within a range where the performance of the detector can be ensured. The standard alarm setpoint value are 50ppm(1st), 100ppm(2nd).
2. This is a safety unit, not a control unit.  
The alarm contact output of the detector must be used for an external alarm lamp/buzzer, while the analog signal output must be used for an indicator or external recorder. If these outputs are used to control other units, we shall not be responsible for any malfunctions.
3. It is recommended that a regular maintenance and sensitivity calibration are performed for every six months.

## <Hot-Wire Semiconductor Type>

The hot-wire semiconductor type sensor detects a change in resistance of the platinum wire coil integrated in a metal oxide semiconductor whose resistance value changes by contact with a gas as gas concentration. This is a highly sensitive gas detection sensor suitable for low concentrations.

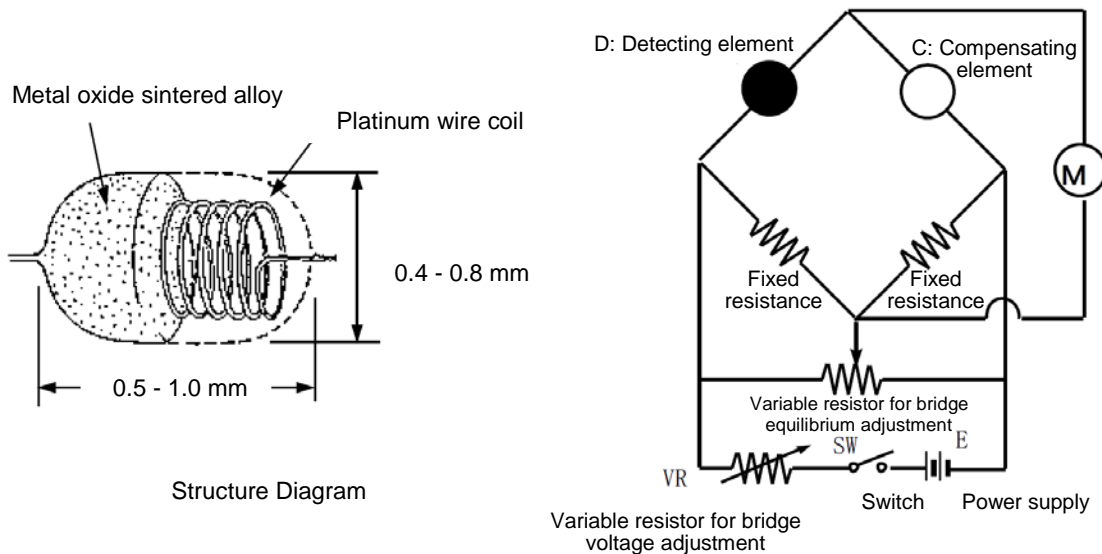

Structure Diagram

Basic Circuit

### Special precautions for this principle

1. This detector may be interfered by gases other than the gas to be detected and vapors. Please note that the alarm may be triggered by interference. In addition, it may be fluctuated by environmental (temperature, humidity, etc.) changes in the installation site.
2. The alarm must be set within a range where the performance of the detector can be ensured. In facilities compliant with the High Pressure Gas Safety Act, an alarm setting below our standard alarm setpoint may trigger a false alarm.
3. This is a safety unit, not a control unit. The alarm contact output of the detector must be used for an external alarm lamp/buzzer, while the analog signal output must be used for an indicator or external recorder. If these outputs are used to control other units, we shall not be responsible for any malfunctions.
4. The gas sensing part of the gas detection sensor installed in the detector is made of porous sintered alloy. If silicon or sulfide compounds are accumulated on the surface of porous sintered alloy, the area of the gas sensing part becomes smaller, which may result in serious deterioration of its sensitivity. For safety reasons, do not use the detector under the presence of silicon or sulfide compounds even though their amount is very small.
5. It is recommended that a regular maintenance and sensitivity calibration are performed for every six months.

---

## Warranty Policy

RKI Instruments, Inc. warrants gas alarm equipment sold by us to be free from defects in materials, workmanship, and performance for a period of one year from date of shipment from RKI Instruments, Inc. Any parts found defective within that period will be repaired or replaced, at our option, free of charge. This warranty does not apply to those items which by their nature are subject to deterioration or consumption in normal service, and which must be cleaned, repaired, or replaced on a routine basis. Examples of such items are:

- a) Absorbent cartridges
- b) Pump diaphragms and valves
- c) Fuses
- d) Batteries
- e) Filter elements

Warranty is voided by abuse including mechanical damage, alteration, rough handling, or repair procedures not in accordance with the operator's manual. This warranty indicates the full extent of our liability, and we are not responsible for removal or replacement costs, local repair costs, transportation costs, or contingent expenses incurred without our prior approval.

*This warranty is expressly in lieu of any and all other warranties and representations, expressed or implied, and all other obligations or liabilities on the part of RKI Instruments, Inc. including but not limited to, the warranty of merchantability or fitness for a particular purpose. In no event shall RKI Instruments, Inc. be liable for indirect, incidental, or consequential loss or damage of any kind connected with the use of its products or failure of its products to function or operate properly.*

This warranty covers instruments and parts sold to users by authorized distributors, dealers, and representatives as appointed by RKI Instruments, Inc.

We do not assume indemnification for any accident or damage caused by the operation of this gas monitor, and our warranty is limited to the replacement of parts or our complete goods.